

Instructions

Tektronix

P5100

2500 V 250 MHz Oscilloscope Probe

070-8151-04

Warning

The servicing instructions are for use by qualified personnel only. To avoid personal injury, do not perform any servicing unless you are qualified to do so. Refer to all safety summaries prior to performing service.

www.tektronix.com

Copyright © Tektronix, Inc. All rights reserved.

Tektronix products are covered by U.S. and foreign patents, issued and pending. Information in this publication supercedes that in all previously published material. Specifications and price change privileges reserved.

Tektronix, Inc., 14200 SW Karl Braun Drive, Beaverton, OR 97077

TEKTRONIX and TEK are registered trademarks of Tektronix, Inc.

WARRANTY

Tektronix warrants that the products that it manufactures and sells will be free from defects in materials and workmanship for a period of one (1) year from the date of shipment. If a product proves defective during this warranty period, Tektronix, at its option, either will repair the defective product without charge for parts and labor, or will provide a replacement in exchange for the defective product.

In order to obtain service under this warranty, Customer must notify Tektronix of the defect before the expiration of the warranty period and make suitable arrangements for the performance of service. Customer shall be responsible for packaging and shipping the defective product to the service center designated by Tektronix, with shipping charges prepaid. Tektronix shall pay for the return of the product to Customer if the shipment is to a location within the country in which the Tektronix service center is located. Customer shall be responsible for paying all shipping charges, duties, taxes, and any other charges for products returned to any other locations.

This warranty shall not apply to any defect, failure or damage caused by improper use or improper or inadequate maintenance and care. Tektronix shall not be obligated to furnish service under this warranty a) to repair damage resulting from attempts by personnel other than Tektronix representatives to install, repair or service the product; b) to repair damage resulting from improper use or connection to incompatible equipment; c) to repair any damage or malfunction caused by the use of non-Tektronix supplies; or d) to service a product that has been modified or integrated with other products when the effect of such modification or integration increases the time or difficulty of servicing the product.

THIS WARRANTY IS GIVEN BY TEKTRONIX IN LIEU OF ANY OTHER WARRANTIES, EXPRESS OR IMPLIED. TEKTRONIX AND ITS VENDORS DISCLAIM ANY IMPLIED WARRANTIES OF MERCHANTABILITY OR FITNESS FOR A PARTICULAR PURPOSE. TEKTRONIX' RESPONSIBILITY TO REPAIR OR REPLACE DEFECTIVE PRODUCTS IS THE SOLE AND EXCLUSIVE REMEDY PROVIDED TO THE CUSTOMER FOR BREACH OF THIS WARRANTY. TEKTRONIX AND ITS VENDORS WILL NOT BE LIABLE FOR ANY INDIRECT, SPECIAL, INCIDENTAL, OR CONSEQUENTIAL DAMAGES IRRESPECTIVE OF WHETHER TEKTRONIX OR THE VENDOR HAS ADVANCE NOTICE OF THE POSSIBILITY OF SUCH DAMAGES.



Table of Contents

Contacting Tektronix	ii
General Safety Summary	iii
Features and Accessories	1
Operating Basics	5
Maximum Non-destructive Input Voltage	5
Grounding the Probe	5
Ground Lead Length	5
Adjustment Procedures	9
Low Frequency (LF) Probe Compensation	9
DC Gain and High Frequency (HF) Compensation	10
Gain Adjustment (DC Accuracy)	11
High-Frequency (HF) Adjustment	12
Performance Verification	15
DC Accuracy Check	16
Bandwidth Check	17
Maintenance	19
Cleaning	19
Preparation for Shipment	19
Replacing Probe Parts	20
Specifications	23
Replaceable Parts	29



Contacting Tektronix

Phone	1-800-833-9200*
Address	Tektronix, Inc. Department or name (if known) 14200 SW Karl Braun Drive P.O. Box 500 Beaverton, OR 97077 USA
Web site	www.tektronix.com
Sales support	1-800-833-9200, select option 1*
Service support	1-800-833-9200, select option 2*
Technical support	Email: techsupport@tektronix.com 1-800-833-9200, select option 3* 1-503-627-2400 6:00 a.m. - 5:00 p.m. Pacific time

* **This phone number is toll free in North America. After office hours, please leave a voice mail message. Outside North America, contact a Tektronix sales office or distributor; see the Tektronix web site for a list of offices.**



General Safety Summary

Review the following safety precautions to avoid injury and prevent damage to this product or any products connected to it. To avoid potential hazards, use this product only as specified.

Only qualified personnel should perform service procedures.

To Avoid Fire or Personal Injury

Connect and Disconnect Properly. Connect the probe output to the measurement instrument before connecting the probe to the circuit under test. Disconnect the probe input and the probe ground from the circuit under test before disconnecting the probe from the measurement instrument.

Observe All Terminal Ratings. To avoid fire or shock hazard, observe all ratings and markings on the product. Consult the product manual for further ratings information before making connections to the product.

Do not apply a potential to any terminal that exceeds the maximum rating of that terminal.

Connect the ground lead of the probe to earth ground only.

Avoid Exposed Circuitry. Do not touch exposed connections and components when power is present.

Do Not Operate With Suspected Failures. If you suspect there is damage to this product, have it inspected by qualified service personnel.

Do Not Operate in Wet/Damp Conditions.

Do Not Operate in an Explosive Atmosphere.

Keep Product Surfaces Clean and Dry.

Safety Terms and Symbols

Terms in This Manual. These terms may appear in this manual:



WARNING. *Warning statements identify conditions or practices that could result in injury or loss of life.*



CAUTION. *Caution statements identify conditions or practices that could result in damage to this product or other property.*

Terms on the Product. These terms may appear on the product:

DANGER indicates an injury hazard immediately accessible as you read the marking.

WARNING indicates an injury hazard not immediately accessible as you read the marking.

CAUTION indicates a hazard to property including the product.

Symbols on the Product. These symbols may appear on the product:



WARNING
Risk of Electric
Shock



Protective Ground
(Earth) Terminal



CAUTION
Refer to Manual



Double
Insulated

Features and Accessories

The P5100 is a 100X, 2500 V (DC + peak AC), 1000 V CAT III oscilloscope probe that provides 250 MHz performance and is certified to international safety standards. The P5100 probe is compatible with all general purpose oscilloscopes and with Tektronix oscilloscopes that automatically detect 100X probe attenuation and display the correct scale readout. The P5100 probe is designed for ground-referenced measurements only.



WARNING. Do not substitute accessories from other products for those provided with the P5100. The accessories for the P5100 have been safety tested, and the use of non-tested accessories may cause injury or death.

To reduce risk of electric shock, keep your fingers behind the finger guard on the probe body. Place your fingers in front of the finger guard only when retracting the hook-tip accessory.

P5100 Features and Standard Accessories

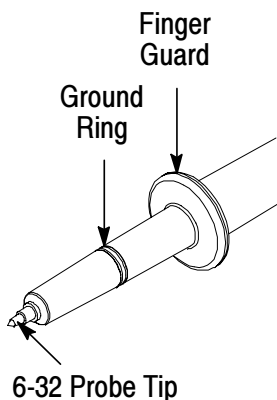

Probe Body - The P5100 probe body is designed for personal safety, ergonomic comfort, and signal fidelity.

The probe body ground ring connection allows a short ground connection for optimal signal fidelity.

The probe tip is a 6-32 threaded post that accepts both standard and optional accessories.

Keep the probe body and accessories clean and dry to reduce the risk of shock due to surface conduction. Refer to page 19 for cleaning instructions.

P5100 Features and Standard Accessories (Cont.)

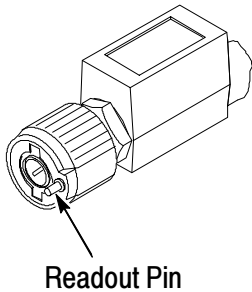

Compensation Box - The P5100 compensation box contains low- and high-frequency compensation adjustments as well as a gain adjustment.

The P5100 is compatible with Tektronix oscilloscopes that automatically detect and display the 100X attenuation factor of the probe.

(If you have an older instrument with a lit vernier indicator, the 10X position will light. Multiply the reading by a factor of 10 to get the true value.)

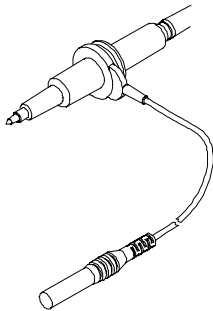

Ground Leads - The P5100 probe comes with a long and a short ground lead. Both ground leads connect to a removable crocodile clip.

Attach the ground lead to the probe body by inserting the probe head into the ground lead as shown.

The length of the ground lead directly impacts the fidelity of high-frequency signals. The longer the ground lead, the more the signal will be distorted. For more information about the ground lead and signal quality, go to page 5.

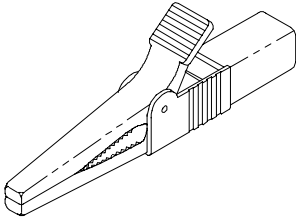

Crocodile Clip - The large crocodile clip attaches to the insulated banana connector on the long ground lead.

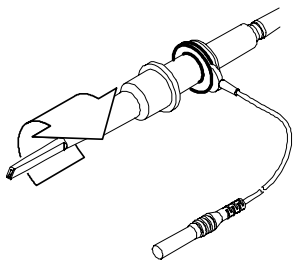

Small Hook Tip - Use the small hook tip for making connections to small conductors such as component leads.

Install the small hook tip by sliding it over the body of the probe and screwing it onto the threaded probe tip.

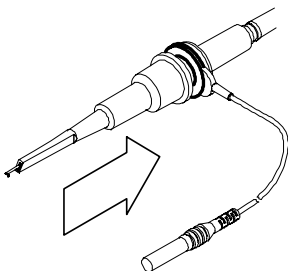

To use the tip, hold the probe body and pull the tip shield back. Hook the tip onto the circuit and release the shield. The hook tip will firmly hold the conductor under test.

P5100 Features and Standard Accessories (Cont.)

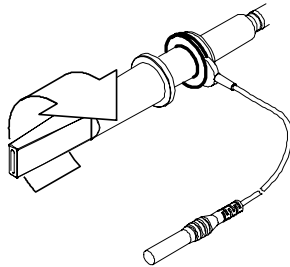

Large Hook Tip - Use the large hook tip when working with larger components such as bolt terminals and buss bars typically found in power distribution equipment.

Install the large hook tip by sliding it over the body of the probe and screwing it onto the threaded probe tip.

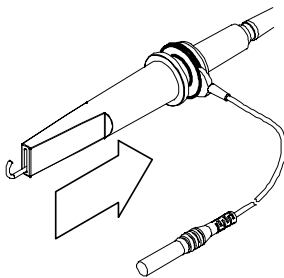

To use the tip, hold the probe body and pull the tip shield back. Hook the tip onto the circuit and release the shield. The hook tip will firmly hold the conductor under test.

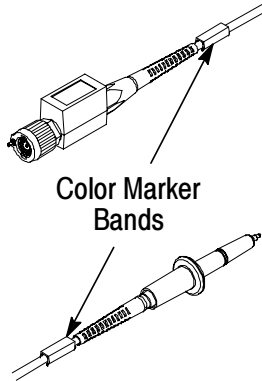

Color Marker Bands - The color marker bands help you identify multiple probes in the circuit under test.

Clip the matching bands onto the cable at the probe head and compensation box to help identify probe channels at a glance.

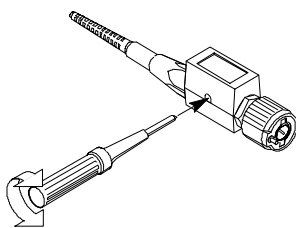

Adjustment Tool - Use the adjustment tool for probe compensation adjustments. Do not use metallic or conductive tools while making adjustments.

P5100 Optional Accessories

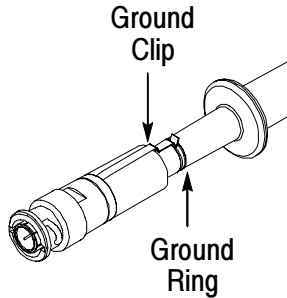

Probe Tip to BNC Adapter - Use the probe tip to BNC adapter to connect the probe directly to BNC connectors. The adapter is recommended for use when verifying or adjusting the probe.

WARNING. *The BNC adapter is rated to 500 V (DC + peak AC). Do not attempt to use the adapter for high voltage testing.*

Attach the adapter by pressing it onto the 6-32 probe tip and making sure that the ground clip makes contact with the ground ring.

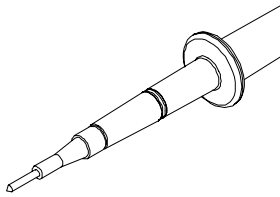

Rubber Spring Tip - Use the rubber spring tip to connect the P5100 to larger test sockets located in equipment or on printed circuit boards.

Connect the rubber spring tip by screwing it onto the threaded probe tip.



Operating Basics

Users need to know this information to get guaranteed performance from the P5100. For best results, please read and apply this information.

Maximum Non-destructive Input Voltage

The P5100 is designed to be used in a high voltage environment; however, the voltage input rating of the probe decreases as the frequency of the applied signal increases. Please refer to the *Specifications* section of this manual for the maximum input voltage and frequency derating information.

Grounding the Probe

Connect the probe to the instrument and connect the ground lead to ground before making any measurements. Be careful that no part of the ground lead contacts voltage in the circuit under test. Except for the probe tip and BNC center conductor, all accessible metal (including the ground clip) is connected to the BNC shell.

Ground Lead Length

Always use as short a ground lead as possible between the probe head and circuit ground.

The series inductance added by the probe tip and ground lead can result in a resonant circuit; this circuit may cause parasitic “ringing” visible within the bandwidth of your oscilloscope. Refer to Figure 1.

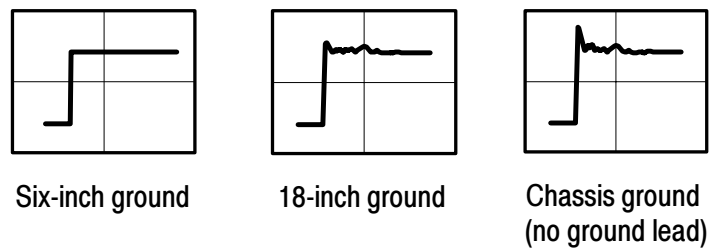

Figure 1: Waveform Distortion from Ground Lead Length

“Ringing” is not a concern when the probe is used with low frequency or long rise time signals.

When you touch your probe tip to a circuit element, you are introducing a new resistance, capacitance, and inductance into the circuit. Refer to Figure 2.

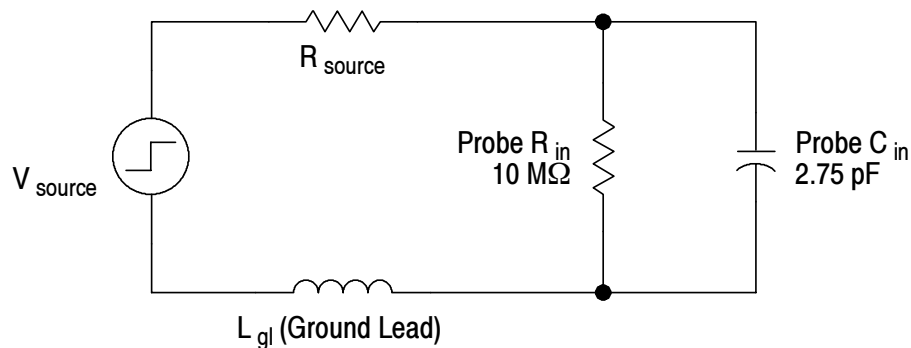

Figure 2: Probe Loading Equivalent Circuit

Ringing and rise time degradation can be masked if the frequency content of the signal degradation is beyond the bandwidth of the oscilloscope.

$$f_0 = \frac{1}{2\pi\sqrt{LC}}$$

The preceding equation shows that reducing the ground lead inductance will raise the resonant frequency. If your measurements are affected by ringing, you can lower the inductance of your ground path (typically by shortening the ground lead) until the resonant frequency is well above the frequency of your measurements.

Adjustment Procedures

The low-frequency compensation of the P5100 must be checked every time that the probe is connected to a different oscilloscope input.

The DC gain and high-frequency compensation may require readjustment if it is used on more than one oscilloscope; however, before making these adjustments, perform a functional check to determine if the adjustments are required.

Low Frequency (LF) Probe Compensation

A probe must be adjusted to match the input impedance of an oscilloscope in the same way that an antenna must be matched to a radio transmitter. If there is a mismatch between the two halves of the system, excessive distortion will result.

Because of the attenuation of a 100X probe, a signal source of at least 5 V peak-to-peak at 10 kHz is ideal (The PG506A Calibration Generator HIGH AMPL output meets this requirement.): however, the front panel calibrator on your oscilloscope may be adequate.

Connect the probe to the signal source to display the test signal on your oscilloscope. To get a clear signal display, select the averaging or high resolution mode on your oscilloscope. Compensate the probe by adjusting **LF** on the probe compensation box so that the corners of the square wave are square. See Figure 3.

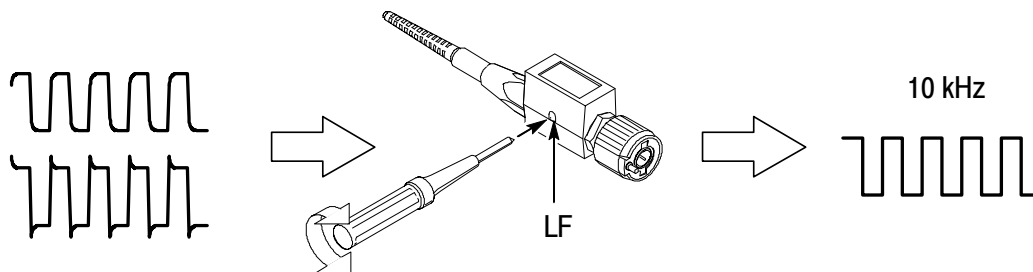

Figure 3: Coarse (LF) Compensation Adjustment

DC Gain and High Frequency (HF) Compensation

Precision, or high-frequency, compensation is not a common user adjustment; however, precision compensation should be checked if the probe was repaired or if any of the following conditions are true:

- the probe has excessive high-frequency aberrations
- the probe fails to meet rated bandwidth specifications
- you have installed the probe on an oscilloscope having an input capacitance near the limits of the probe compensation range (See Table 3 on page 24.)

To perform the high-frequency compensation adjustment you will need a signal source that has all of the following characteristics:

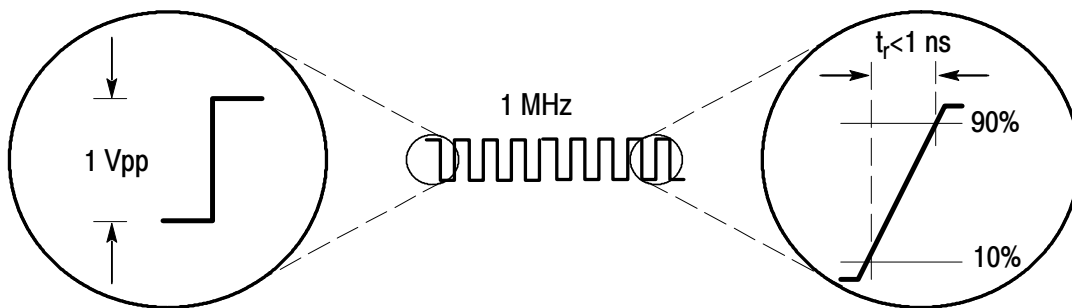

- square-wave output at 1 MHz
- fast rise output with rise time less than 1 ns
- output properly terminated

The Tektronix PG506A Calibration Generator FAST RISE output meets these requirements when properly terminated.

Gain Adjustment (DC Accuracy)

NOTE. *If you adjust the DC gain, you must readjust the low frequency compensation; the DC gain and low frequency compensation adjustments interact with each other.*

1. Remove the top and bottom covers of the compensation box. To remove the covers, insert a thin flat-blade screwdriver between the shell covers and gently rotate the screwdriver to loosen the covers.
2. Connect the probe to the unterminated **STD** output of the calibration generator using the optional probe tip to BNC adapter. See Figure 4.

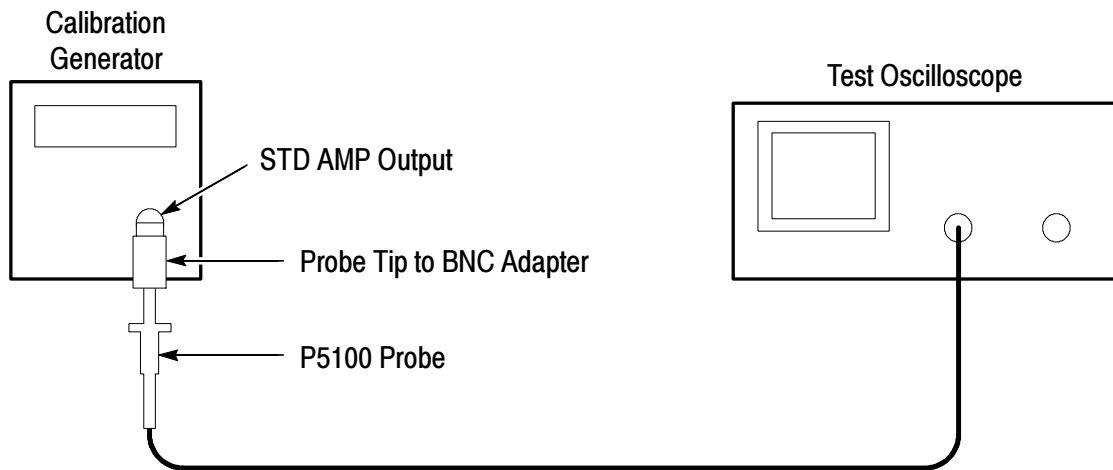

Figure 4: Gain Adjustment Setup

3. Set the calibration generator **AMPLITUDE** to 100 V.
4. Set the oscilloscope to 20 V/division (200 mV/division without scale factor).
5. Adjust the oscilloscope to display two to five cycles of the test signal.

6. Locate the **HF1**, **HF2**, and **DC Gain** adjustments. See Figure 5.

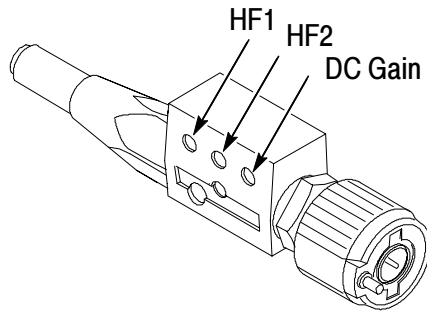

Figure 5: P5100 Adjustment Locations

7. Adjust **DC Gain** for exactly five divisions of signal amplitude at the falling edges of the waveform. (The **HIGH** measurement function of the oscilloscope may also be used to check DC gain).
8. Recheck the LF compensation.

High-Frequency (HF) Adjustment

1. Connect a 50 Ω feedthrough termination to the positive going **FAST RISE** output of the calibration generator. See Figure 6.

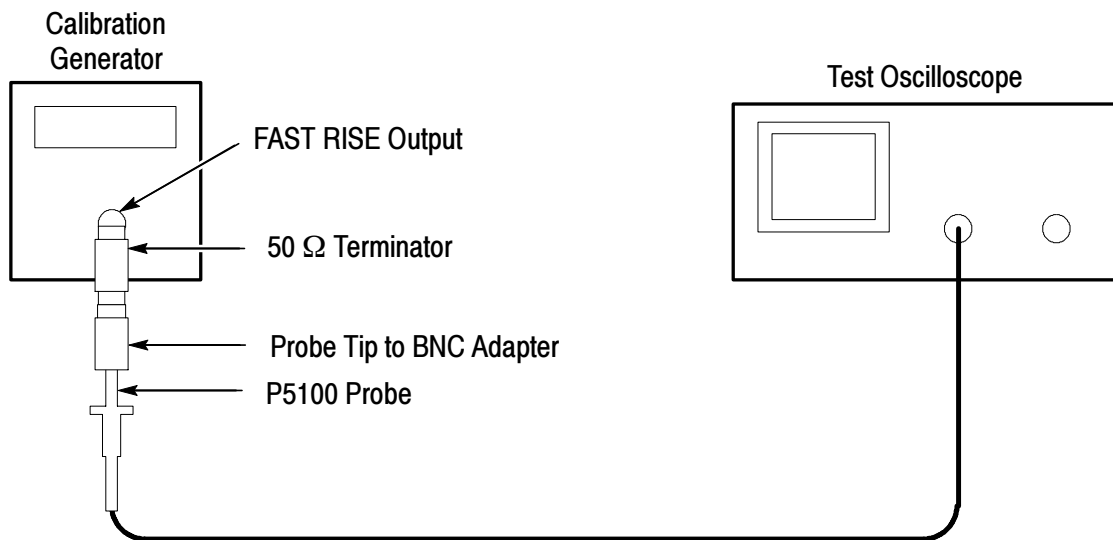

Figure 6: HF Adjustment Setup

2. Using the optional probe tip to BNC adapter, connect the probe to the termination.
3. Set the Calibration Generator to 1 MHz.
4. Set the **PULSE AMPLITUDE** to maximum.
5. Set the oscilloscope to 200 mV/division (2 mV/division without scale factor).
6. Set the oscilloscope averaging to 8.
7. Set the oscilloscope to 20 ns/div. (Adjust the oscilloscope as necessary to view the leading edge of the waveform.)
8. Adjust **HF2** for long term flatness.
9. Adjust **HF1** for a square leading edge. See Figure 7.

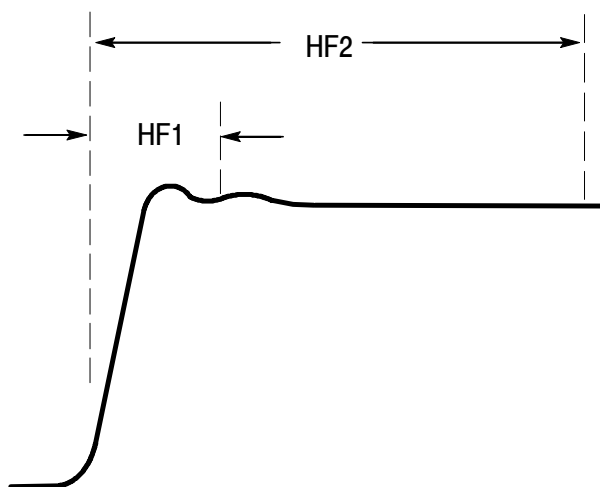

Figure 7: HF Compensation Adjustments

Performance Verification

Use these performance verification procedures to verify that the P5100 meets the warranted specifications. These procedures should be performed in the order given using a TDS460 oscilloscope with the equipment recommended in Table 1.

NOTE. *The probe must be low-frequency compensated before performance can be verified.*

If your P5100 fails to qualify under these conditions, perform the adjustments starting on page 9 and retest.

Table 1: Recommended Test Equipment

Equipment	Minimum Requirements	Recommended Equipment
Oscilloscope	350 MHz	Tektronix TDS460
Calibration Generator	≤1 ns rise time square wave 100 V square wave	Tektronix PG506A
Leveled Signal Generator	50 kHz to 250 MHz	Tektronix SG503
Termination, 50 Ω feedthrough	50 Ω male-to-female BNC	Tektronix 011-0049-01
Adapter, BNC	Female-to-female barrel	Tektronix 103-0028-00
Adapter, probe tip to BNC	Probe tip-to-male BNC	Tektronix 013-0291-00
BNC cable, precision	No substitute ¹	Tektronix 012-0482-00

¹ **Required for use with Tektronix SG503.**

DC Accuracy Check

1. Connect the DC accuracy test setup as shown in Figure 8.

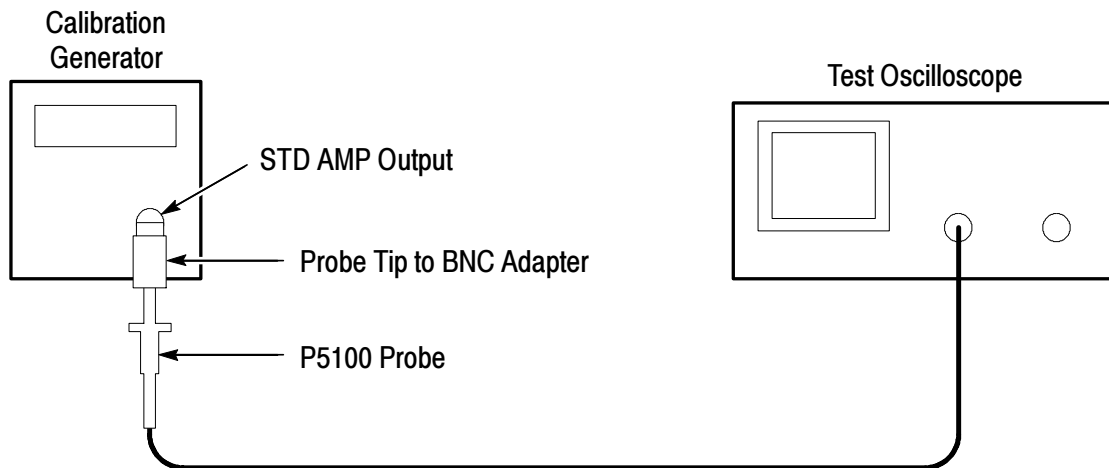

Figure 8: DC Accuracy Test Setup

2. Set the oscilloscope to 20 V/division (200 mV/division without scale factor).
3. Set the Calibration Generator **AMPLITUDE** to 100 V.
4. Adjust the **VARIABLE (OUT)** control on the Calibration Generator for a signal exactly five divisions in amplitude.

NOTE. *The Amplitude measurement selection on the oscilloscope may be used to confirm the signal amplitude.*

5. Note the percent error displayed and compare it to the value given for DC attenuation in Table 2 on page 23.

If the probe does not meet the DC accuracy requirement, perform the adjustments beginning on page 9 and retest.

Bandwidth Check

1. Connect the test setup as shown in Figure 9.

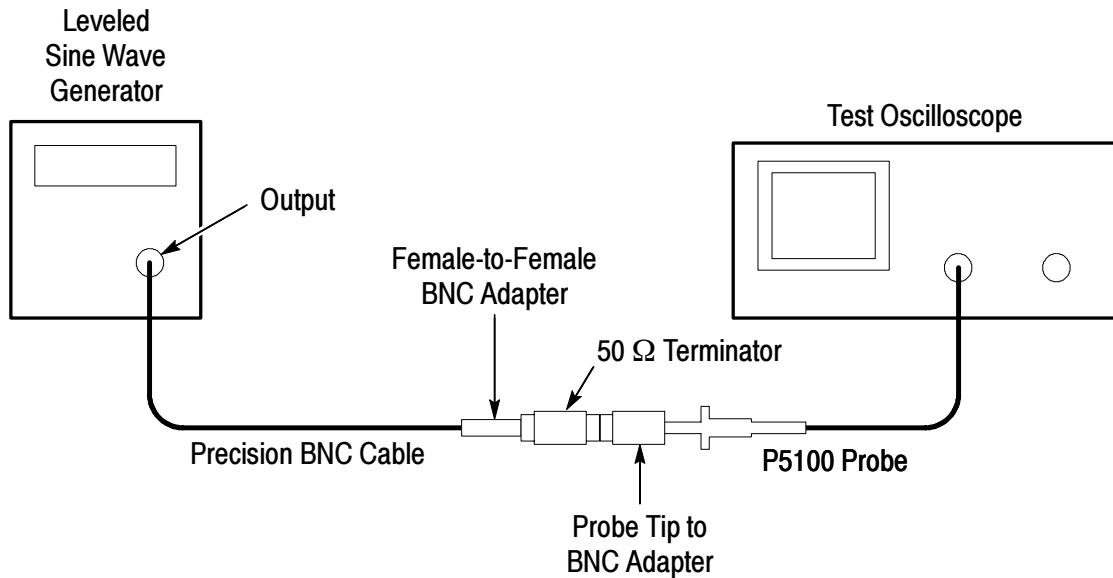

Figure 9: Bandwidth Test Setup

2. Set the Leveled Signal Generator output frequency to **REF** \approx **.05**.
3. Set the oscilloscope to 500 mV/division (5 mV/division without scale factor).
4. Adjust the Leveled Signal Generator for a display exactly 6 divisions peak-to-peak.
5. Increase the Leveled Signal Generator frequency until the display is 4.2 divisions peak-to-peak. (This represents the .707 or half-power amplitude.)
6. Note that the frequency is greater than 250 MHz.

If the probe does not meet the bandwidth requirement, perform the adjustments beginning on page 9 and retest.

Maintenance

This section contains information necessary for the maintenance and repair of the P5100.

Cleaning

The P5100 is designed for high voltage use and should be kept as clean as possible. Surface conduction across the probe body caused by dirt and grease may present an electrical safety hazard.

Dirt and grease may be removed using a cloth dampened with isopropyl alcohol or a mild detergent and water solution.

To prevent damage to probe materials, avoid using chemicals that contain benzene, toluene, xylene, acetone, or similar volatile solvents.

Do not immerse the probe or use abrasive cleaners.

Preparation for Shipment

If you need to ship your probe, pack it carefully to prevent its being damaged while in transit. If the original packaging is unfit for use or not available, use the following packaging guidelines:

1. Use a corrugated cardboard shipping carton having inside dimensions at least one inch greater than the probe dimensions. The box should have a carton test strength of at least 200 pounds.
2. Put the probe into a plastic bag or wrap to protect it from dampness in transit.
3. Place the probe into the box and stabilize it with light packing material.
4. Seal the carton with shipping tape.

Replacing Probe Parts

The P5100 has two major components: the probe head and cable assembly and compensation box. Accessory parts may be ordered as indicated in the replaceable parts list.

NOTE. *If you replace either the probe cable or the compensation box, you must perform a low- and high-frequency compensation of the probe before returning it to service. (See page 9 for details.)*

Use the following procedure to replace the compensation box or cable and probe head assemblies. See Figure 10.

1. Using an adjustable or 1/2 inch (13 mm) wrench, loosen the compensation box cable retaining nut and slide it back.
2. Lightly grasp the cable strain relief and pull the cable out of the compensation box.
3. Slide the cable retaining nut off of the old cable and onto the new one.
4. Push the new cable connector into the compensation box and press it into place.

5. Using the wrench, gently tighten the cable retaining nut into place until it is snug.

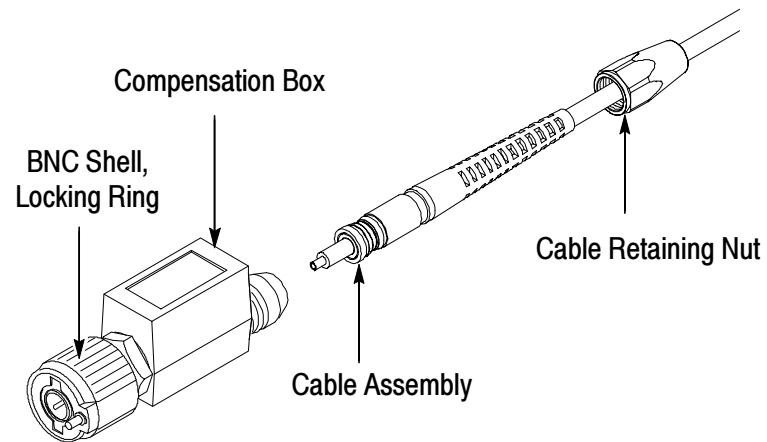

Figure 10: Probe Disassembly

Specifications

Specifications that are not warranted are typical and are provided as general information for the customer's convenience.

Tables 2 through 6 apply to a P5100 probe installed on a Tektronix TDS460 oscilloscope. When used with another instrument, the oscilloscope must have an input impedance of 1 MΩ, an input capacitance within the compensation range in Table 3, and a bandwidth not less than 350 MHz.

The instrument must have a warm-up period of 20 minutes and be in an environment that does not exceed the limits described in Table 5.

Table 2: Warranted Electrical Specifications

Attenuation (System)	X100, ±1.75%
-3 dB Bandwidth (System)	DC to 250 MHz
Maximum Rated Input Voltage ¹ See Figure 11 for frequency derating.	2500 V rms 2500 V (DC + peak AC) 1000 V rms, CAT III

¹ **RMS voltage limited to <2500 V for arbitrary waveshapes including DC. For pulse widths less than 50 us, 4500 V peak, < 30% DF. RMS=Root Mean Square=rms=The square root of the average of the sum of the squares of the instantaneous voltage in one cycle = $\sqrt{\sum (fx_i)^2/n}$**

@25% Duty Factor
≥Vrms=(1/2 Peak V) RMS

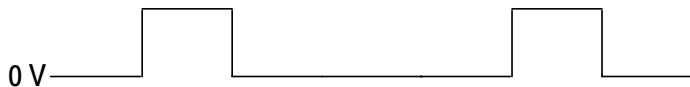

@25% Duty Factor
≥2000 V RMS
= 4000 V peak, rectangular



2500 V DC = 2500 V RMS

3535 V Sinewave Peak = 2500 V RMS

Table 3: Typical Electrical Characteristics

Rise Time (System) Checked using optional BNC adapter.	< 1.75 ns
Input Impedance (System) See Figure 12.	10 MΩ
Compensation Range	7 pF to 30 pF
Input Capacitance (System) Probe connected to instrument and properly compensated. Checked at 1 MHz.	< 2.75 pF

Table 4: Typical Mechanical Characteristics

Net Weight (including accessories)	227 g (0.5 lb)
Cable Length	3.1 m (10 feet)

Table 5: Warranted Environmental Specifications

Temperature MILSTD T28800E, Class 5	Nonoperating: -40° C to +71° C -40° F to +160° F Operating: 0° C to +50° C +32° F to +122° F
Humidity MIL Std T28800E, Class 5	Nonoperating and operating: Five cycles (120 hr. total) at 90% to 95% relative humidity.
Transportation	Qualified under the National Safe Transit Association's Preshipment Test Procedures, Project 1A-B.

Table 6: Certifications and Compliances

EC Declaration of Conformity	
Compliance was demonstrated to the following specifications as listed in the Official Journal of the European Communities:	
Low Voltage Directive 73/23/EEC, Amended by 93/68/EEC.	
EN 61010-1/A2	Safety requirements for electrical equipment for measurement, control, and laboratory use
EN 61010-2-031	Particular requirements for hand-held probe assemblies for electrical measurement and test
Safety	UL 3111-1 CSA 1010.1-92 IEC 61010-1/A1 IEC 61010-2-031
IEC Installation Category	1000 V CAT III
IEC Pollution Degree	Degree 2
IEC Safety Class	Class 1 (Ground referenced)
Installation (Overvoltage) Category Descriptions	<p>Terminals on this product may have different installation (overvoltage) category designations. The installation categories are:</p> <p>CAT III Distribution-level mains (usually permanently connected). Equipment at this level is typically in a fixed industrial location.</p> <p>CAT II Local-level mains (wall sockets). Equipment at this level includes appliances, portable tools, and similar products. Equipment is usually cord-connected.</p> <p>CAT I Secondary (signal level) or battery operated circuits of electronic equipment.</p>

Table 6: Certifications and Compliances (Cont.)

<p>Pollution Degree Descriptions</p>	<p>A measure of the contaminates that could occur in the environment around and within a product. Typically the internal environment inside a product is considered to be the same as the external. Products should be used only in the environment for which they are rated.</p> <p>Pollution Degree 1 No pollution or only dry, nonconductive pollution occurs. Products in this category are generally encapsulated, hermetically sealed, or located in clean rooms.</p> <p>Pollution Degree 2 Normally only dry, nonconductive pollution occurs. Occasionally a temporary conductivity that is caused by condensation must be expected. This location is a typical office/home environment. Temporary condensation occurs only when the product is out of service.</p> <p>Pollution Degree 3 Conductive pollution, or dry, nonconductive pollution that becomes conductive due to condensation. These are sheltered locations where neither temperature nor humidity is controlled. The area is protected from direct sunshine, rain, or direct wind.</p> <p>Pollution Degree 4 Pollution that generates persistent conductivity through conductive dust, rain, or snow. Typical outdoor locations.</p>
--------------------------------------	---

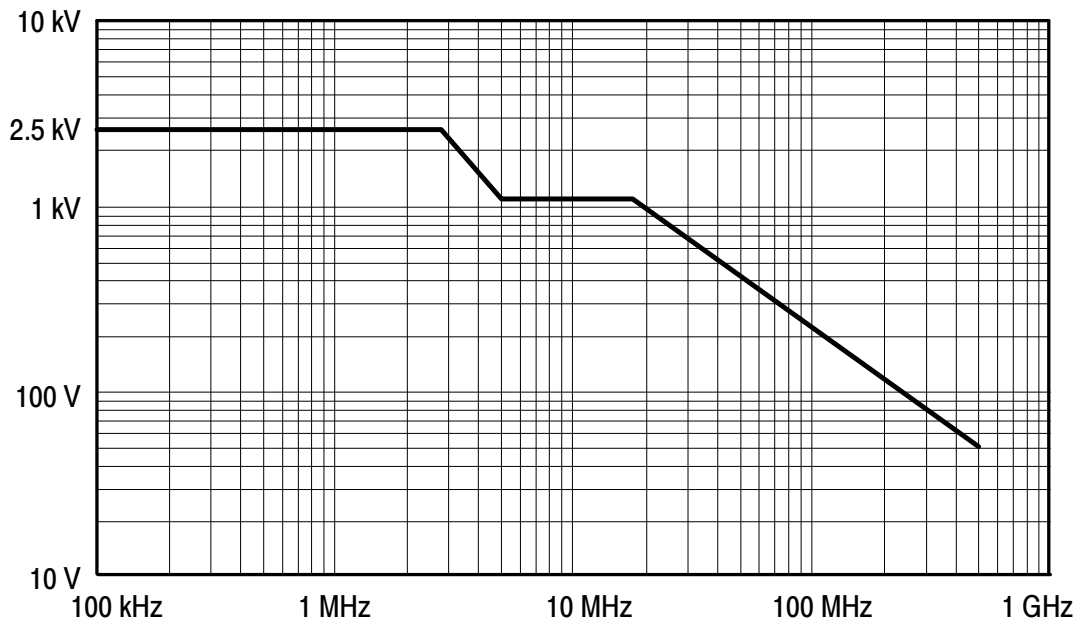

Figure 11: Maximum Input Voltage to Frequency Derating Curve (DC + peak AC)

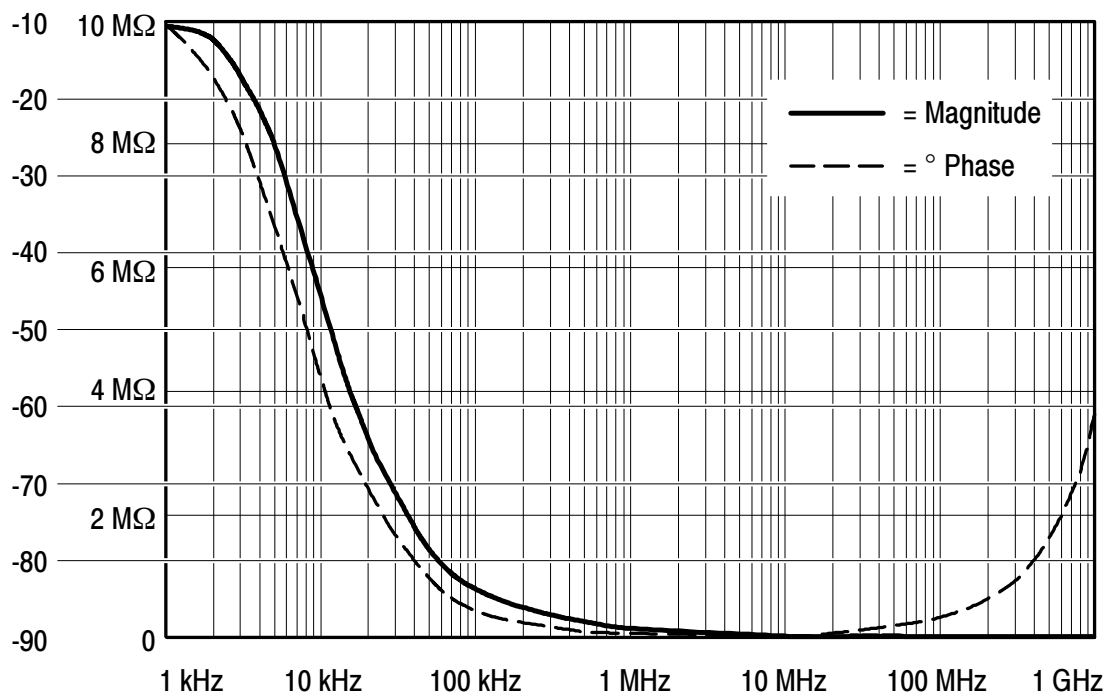

Figure 12: Typical Input Phase and Impedance

Replaceable Parts

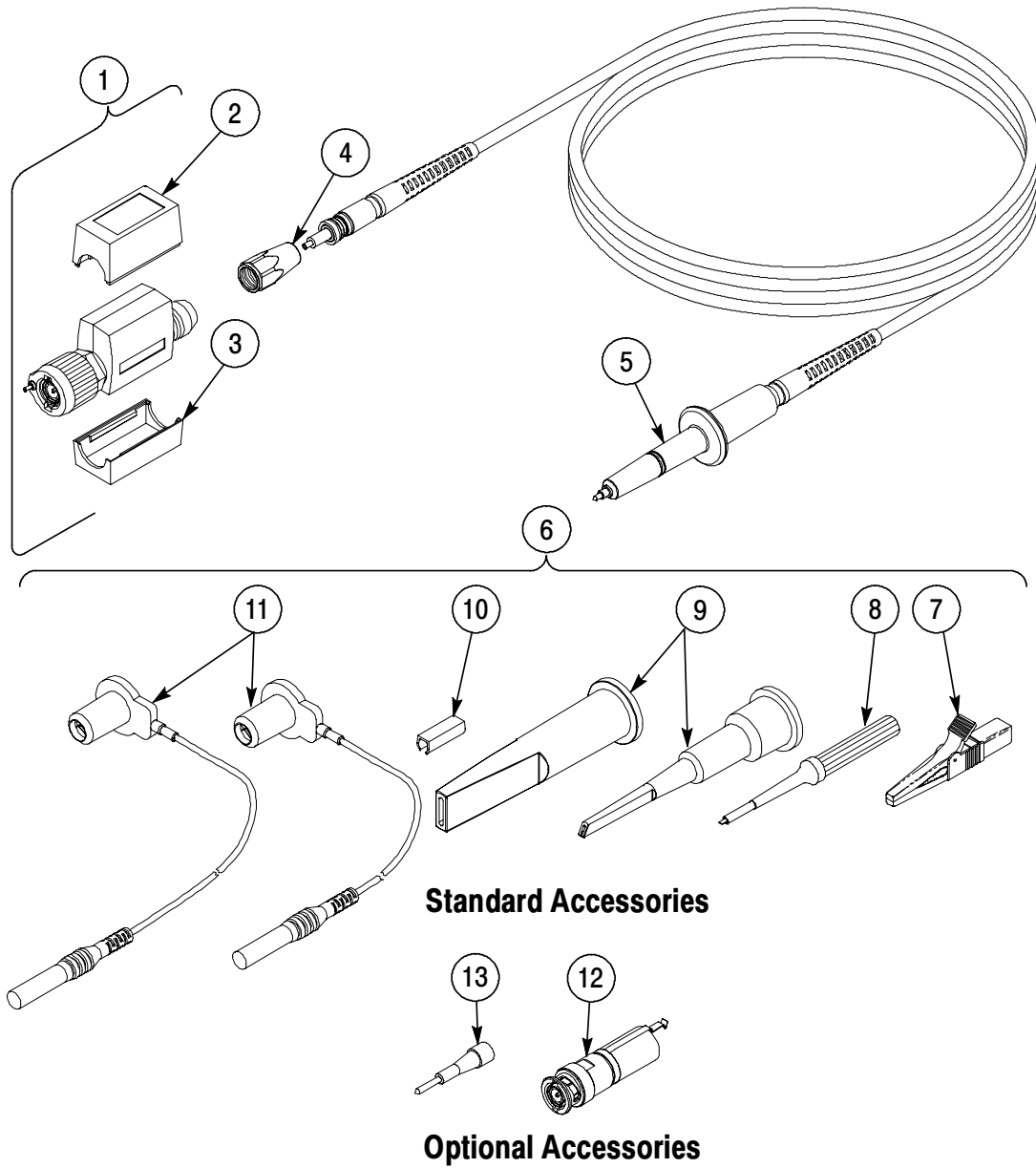

Figure 13: P5100 Replaceable Parts

Replaceable Parts List

Fig. & Index Number	Tektronix Part Number	Serial No. Effective	Serial No. Discont'd	Qty	Name & Description	Mfr. Code	Mfr. Part Number
13-				1	P5100, PROBE, HI VOLTAGE:100X,250 MHZ		
-1	206-0466-00			1	COMP BOX ASSY:P5100	80009	206-0466-00
-2	200-3016-00			1	COVER,COMP BOX:TOP,ABS DOVE GRAY	TK2565	200-3016-00
-3	200-3017-00			1	COVER,COMP BOX:BOTTOM,ABS SLATE GRAY	TK2565	200-3017-00
-4	200-3018-00			1	COVER,CABLE NIP:COMP BOX	0J260	ORDER BY DESCRIP
-5	206-0465-10			1	PROBE HEAD ASSY:P5100,100X W/CABLE ASSY	80009	206-0465-10
STANDARD ACCESSORIES							
-6	020-2137-00			1	ACCESS KIT:LEADS,ADAPTERS AND MARKER	80009	020-2137-00
-7	344-0461-00			1	CLIP,ELEC:CROCODILE,82MM L,4MM	76545	65 RED
-8	003-1433-00			1	SCREWDRIVER:ADJUSTMENT TOOL,METAL TIP	TK2565	003-1433-00
-9	013-0290-02			1	HOOKTIP,SET:HOOKTIP ASSY,LARGE AND SMALL	80009	013-0290-02
-10	334-1275-02			2	CLIP,CABLE MKR:RED,PLASTIC	0JR05	ORDER BY DESCRIP
	334-1275-04			2	CLIP,CABLE MKR:YELLOW,PLASTIC	0JR05	ORDER BY DESCRIP
	334-1275-05			2	CLIP,CABLE MKR:GREEN,PLASTIC	0JR05	ORDER BY DESCRIP
-11	196-3424-00			1	LEAD SET ASSY:PROBE,GROUND ,1 EA,18.0 L,6.0 L	80009	196-3424-00
	070-8151-04			1	MANUAL,TECH:INSTRUCTIONS,P5100,DP	80009	070-8151-04

Replaceable Parts List (Cont.)

Fig. & Index Number	Tektronix Part Number	Serial No. Effective	Serial No. Discont'd	Qty	Name & Description	Mfr. Code	Mfr. Part Number
-12	013-0291-00			1	ADAPTER, PROBE: PROBE TO BNC, P5100	80009	013-0291-00
-13	206-0060-00			1	TIP, PROBE: P6000	80009	206-0060-00
OPTIONAL ACCESSORIES							

Manufacturers Cross Index

Mfr. Code	Manufacturer	Address	City, State, Zip Code
0J260	COMTEK MANUFACTURING OF OREGON	P O BOX 4200 M/S 16-207	BEAVERTON, OR 970764200
0JR05	TRIJEST PRECISION PLASTICS	3000 LEWIS & CLARK HWY PO BOX 66008	VANCOUVER, WA 98666-6008
76545	MUELLER ELECTRIC CO	1583 EAST 31ST ST	CLEVELAND, OH 44114
80009	TEKTRONIX INC	14150 SW KARL BRAUN DR PO BOX 500	BEAVERTON, OR 97077-0001
TK2565	VISION PLASTICS INC	26000 SW PARKWAY CENTER DRIVE	WILSONVILLE, OR 97070