

User Manual

Tektronix

MTG200
MPEG Test Generator
070-9950-00

CE

Copyright © Tektronix, Inc. All rights reserved.

Tektronix products are covered by U.S. and foreign patents, issued and pending. Information in this publication supercedes that in all previously published material. Specifications and price change privileges reserved.

Printed in the U.S.A.

Tektronix, Inc., P.O. Box 1000, Wilsonville, OR 97070-1000

TEKTRONIX and TEK are registered trademarks of Tektronix, Inc.

WARRANTY

Tektronix warrants that the products that it manufactures and sells will be free from defects in materials and workmanship for a period of one (1) year from the date of shipment. If a product proves defective during this warranty period, Tektronix, at its option, either will repair the defective product without charge for parts and labor, or will provide a replacement in exchange for the defective product.

In order to obtain service under this warranty, Customer must notify Tektronix of the defect before the expiration of the warranty period and make suitable arrangements for the performance of service. Customer shall be responsible for packaging and shipping the defective product to the service center designated by Tektronix, with shipping charges prepaid. Tektronix shall pay for the return of the product to Customer if the shipment is to a location within the country in which the Tektronix service center is located. Customer shall be responsible for paying all shipping charges, duties, taxes, and any other charges for products returned to any other locations.

This warranty shall not apply to any defect, failure or damage caused by improper use or improper or inadequate maintenance and care. Tektronix shall not be obligated to furnish service under this warranty a) to repair damage resulting from attempts by personnel other than Tektronix representatives to install, repair or service the product; b) to repair damage resulting from improper use or connection to incompatible equipment; c) to repair any damage or malfunction caused by the use of non-Tektronix supplies; or d) to service a product that has been modified or integrated with other products when the effect of such modification or integration increases the time or difficulty of servicing the product.

THIS WARRANTY IS GIVEN BY TEKTRONIX IN LIEU OF ANY OTHER WARRANTIES, EXPRESS OR IMPLIED. TEKTRONIX AND ITS VENDORS DISCLAIM ANY IMPLIED WARRANTIES OF MERCHANTABILITY OR FITNESS FOR A PARTICULAR PURPOSE. TEKTRONIX' RESPONSIBILITY TO REPAIR OR REPLACE DEFECTIVE PRODUCTS IS THE SOLE AND EXCLUSIVE REMEDY PROVIDED TO THE CUSTOMER FOR BREACH OF THIS WARRANTY. TEKTRONIX AND ITS VENDORS WILL NOT BE LIABLE FOR ANY INDIRECT, SPECIAL, INCIDENTAL, OR CONSEQUENTIAL DAMAGES IRRESPECTIVE OF WHETHER TEKTRONIX OR THE VENDOR HAS ADVANCE NOTICE OF THE POSSIBILITY OF SUCH DAMAGES.

Table of Contents

General Safety Summary	xi
Preface	xiii
Introduction to Digital TV Transmission Technique	
Introduction to Digital TV Transmission Technique	1-1
Definitions and Standards	1-1
Transmission Scenario for DVB	1-4
MPEG-2 Systems	1-5
Device Functions and Transport Streams	
Device Functions and Transport Streams	2-1
Processes	2-2
Transport Streams in the MPEG Test Generator	2-5
Transport Streams for 625 Lines Systems	2-7
Transport Streams for 525 Lines Systems	2-45
Preparation for Use	
Legend for Front and Rear View	3-1
Front Panel	3-2
Rear Panel	3-3
Installation	3-4
Unpacking the Unit	3-4
Functional Check (Switch-On Test)	3-9
Unit Configuration	3-9
Manual Operation	
Manual Operation	4-1
Controls	4-2
Menu Overview	4-3
Explanation of Menus	4-5
Exiting DOS	4-14
Remote Control	
Remote Control	5-1
RS-232 Interface	5-1
Command Set	5-3
Programming Example	5-5
Maintenance and Checking	
Maintenance	6-1
Checking	6-6

Appendices

Appendix A: Device Interfaces	A-1
Asynchronous Serial Transport Stream Interface (TS ASI)	A-1
Synchronous Parallel Transport Stream Interface (TS PARALLEL)	A-1
Transmission Formats	A-2
Keyboard Interface	A-3
Keyboard Layout	A-4
VGA Interface	A-5
RS-232 Interfaces COM1 and COM2	A-6
Parallel Interface LPT1	A-8
TS Parallel EIA RS-422 Interface	A-9
Appendix B: Specifications	B-1

Index

List of Figures

Figure 1–1: Scenario for a DVB distribution network	1–4
Figure 1–2: Functions of a transport stream demultiplexer	1–5
Figure 1–3: PAT and PMT describe the contents of a transport stream	1–7
Figure 1–4: Transport packet	1–11
Figure 1–5: Adaptation field	1–11
Figure 1–6: PES header	1–12
Figure 1–7: Program association section	1–12
Figure 1–8: Program map section	1–13
Figure 1–9: Conditional access section	1–13
Figure 1–10: Private section	1–13
Figure 2–1: Principal diagram of the transport stream	2–1
Figure 2–2: Continuous PCR, PTS and DTS time stamps in repeated sequences	2–2
Figure 2–3: Transport stream information: (monitor hardcopy)	2–3
Figure 2–4: Screen display of TS information on BLUE.GTS	2–12
Figure 2–5: Screen display of TS information on BOUNCE.GTS	2–13
Figure 2–6: Screen display of TS information on BOUNCE_S.GTS	2–14
Figure 2–7: Screen display of TS information on CBARS100.GTS	2–15
Figure 2–8: Screen display of TS information on CBARS75.GTS	2–16
Figure 2–9: Screen display of TS information on CCIR17.GTS	2–17
Figure 2–10: Screen display of TS information on CCIR18.GTS	2–18
Figure 2–11: Screen display of TS information on CCIR3311.GTS	2–19
Figure 2–12: Screen display of TS information on CCIR3312.GTS	2–19
Figure 2–13: Screen display of TS information on CCITT033.GTS	2–20
Figure 2–14: Screen display of TS information on CODEC169.GTS	2–21

Figure 2–15: Screen display of TS information on CODEC43.GTS	2–22
Figure 2–16: R&S MPEG-2 CODEC transport stream	2–22
Figure 2–17: Screen display of TS information on DVTS_2M.GTS	2–25
Figure 2–18: Screen display of TS information on DVTS_4M.GTS	2–25
Figure 2–19: Screen display of TS information on DVTS_6M.GTS	2–25
Figure 2–20: Screen display of TS information on DVTS_9M.GTS	2–26
Figure 2–21: Screen display of TS information on DVTS_15M.GTS	2–26
Figure 2–22: Screen display of TS information on HSWEET1.GTS	2–27
Figure 2–23: Screen display of TS information on NONLIN.GTS	2–28
Figure 2–24: Screen display of TS information on RAMPYC.GTS	2–29
Figure 2–25: Screen display of TS information on RGBSWEEP.GTS	2–30
Figure 2–26: Screen display of TS information on SINXX.GTS	2–31
Figure 2–27: Screen display of TS information on WINDOW.GTS	2–32
Figure 2–28: Screen display of TS information on ZONEPL.GTS	2–33
Figure 2–29: Screen Display of TS information on 6_PROG.GTS	2–34
Figure 2–30: Screen Display of TS information with Program 1 Bounce selected	2–34
Figure 2–31: Screen display of TS information on CODECDBL.GTS	2–35
Figure 2–32: Screen display of TS information on DVTS_DBL.GTS	2–36
Figure 2–33: Screen display of TS information on FLOWERGA.GTS	2–37
Figure 2–34: Screen display of TS information on T_TENNIS.GTS	2–38
Figure 2–35: Screen display of TS information on FACT_3M.GTS	2–39

Figure 2–36: Screen display of TS information on FACT_4M.GTS	2–39
Figure 2–37: Screen display of TS information on FACT_6M.GTS	2–39
Figure 2–38: Screen display of TS information on FACT_9M.GTS	2–40
Figure 2–39: Screen display of TS information on FACT_15M.GTS	2–40
Figure 2–40: Screen display of TS information on NSCHWAN.GTS	2–41
Figure 2–41: Screen display of TS information on DVMD_CHK.GTS	2–42
Figure 2–42: Screen display of TS information on TELETEXT.GTS	2–44
Figure 2–43: Screen display of TS information on FACT_3M.GTS	2–50
Figure 2–44: Screen display of TS information on FACT_4M.GTS	2–50
Figure 2–45: Screen display of TS information on FACT_6M.GTS	2–50
Figure 2–46: Screen display of TS information on FACT_9M.GTS	2–51
Figure 2–47: Screen display of TS information on FACT_15M.GTS	2–51
Figure 2–48: Screen display of TS information on NSCHWAN.GTS	2–52
Figure 2–49: Screen display of TS information on BLUE.GTS	2–53
Figure 2–50: Screen display of TS information on BOUNCE.GTS	2–54
Figure 2–51: Screen display of TS information on BOUNCE_S.GTS	2–55
Figure 2–52: Screen display of TS information on CBARS100.GTS	2–56
Figure 2–53: Screen display of TS information on CBARS75.GTS	2–57
Figure 2–54: Screen display of TS information on CCITTO33.GTS	2–58
Figure 2–55: Screen display of TS information on CODEC43.GTS	2–59
Figure 2–56: R&S MPEG2-CODEC transport stream	2–59

Figure 2–57: Screen display of TS information on CODEC169.GTS	2–62
Figure 2–58: Screen display of TS information on ITS1.GTS	2–63
Figure 2–59: Screen display of TS information on ITS2.GTS	2–64
Figure 2–60: Screen display of TS information on ITS3.GTS	2–65
Figure 2–61: Screen display of TS information on ITS4.GTS	2–66
Figure 2–62: Screen display of TS information on MULTIBUR.GTS	2–67
Figure 2–63: Screen display of TS information on HSWEET1.GTS	2–68
Figure 2–64: Screen display of TS information on NONLIN.GTS	2–69
Figure 2–65: Screen display of TS information on RAMPYC.GTS	2–70
Figure 2–66: Screen display of TS information on RGBSWEEP.GTS	2–71
Figure 2–67: Screen display of TS information on SINXX.GTS	2–72
Figure 2–68: Screen display of TS information on WINDOW.GTS	2–73
Figure 2–69: Screen display of TS information on ZONEPL.GTS	2–74
Figure 2–70: Screen Display of TS information on 6_PROG.GTS	2–75
Figure 2–71: Screen Display of TS information with Program 1 Bounce selected	2–75
Figure 2–72: Screen display of TS information on CODECDBL.GTS	2–76
Figure 2–73: Screen display of TS information on FLOWERGA.GTS	2–77
Figure 2–74: Screen display of TS information on T_TENNIS.GTS	2–78
Figure 2–75: Screen display of TS information on DVMD_CHK.GTS	2–79
Figure 2–76: Screen display of TS information on TELETEXT.GTS	2–81
Figure 3–1: MPEG Test Decoder connected to the MPEG Test Generator	3–6

Figure 3–2: PC connected to the test generator	3–7
Figure 3–3: Setup as DOS PC for operation with transport stream generation program	3–8
Figure 4–1: Transport stream directory displayed on VGA monitor	4–6
Figure 4–2: Transport stream information displayed on VGA monitor	4–8
Figure 4–3: Transport stream directories displayed on VGA monitor	4–12
Figure 5–1: Connecting the controller	5–1
Figure 6–1: Removing panels	6–2
Figure 6–2: Front-panel screws	6–3
Figure 6–3: Position of flat printer cable	6–3
Figure 6–4: Locations of the retaining screws on the RF cover	6–4
Figure 6–5: Position and poles of battery	6–5
Figure A–1: Transmission formats for 188 and 204 byte packets	A–2
Figure A–2: Keyboard layouts	A–4
Figure A–3: Timing diagram for the TS Parallel EIA RS-422	A–11

List of Tables

Table 1–1: PID and Table_ID for PSI / SI	1–10
Table 2–1: Overview of transport streams for short audio frequency response measurements	2–5
Table 2–2: Still-picture and test-pattern sequences in directory: GTS_MEAS	2–7
Table 2–3: Transport streams with two or more programs in directory: GTS_MEAS	2–9
Table 2–4: Moving picture scenes in directory: GTS_LIVE	2–10
Table 2–5: Still picture and test pattern sequences in directory: GTS_ERRO*	2–10
Table 2–6: Transport streams and data contents in directory GTS_DATA	2–11
Table 2–7: Moving picture scenes in directory: GTS_LIVE	2–45
Table 2–8: Still-picture and test-pattern sequences in directory: GTS_MEAS	2–45
Table 2–9: Transport streams with two or more programs in directory: GTS_MEAS	2–48
Table 2–10: Still picture and test pattern sequences in directory: GTS_ERRO*	2–48
Table 2–11: Transport streams and data contents in directory GTS_DATA	2–49
Table 3–1: Legend for front view	3–2
Table 3–2: Legend for rear view	3–3
Table 3–3: PC configuration for German keyboard	3–10
Table 3–4: PC configuration for International keyboard	3–10
Table 3–5: PC configuration for U.S. keyboard	3–11
Table 3–6: Country settings	3–11
Table 3–7: Examples of mouse driver installation	3–12
Table 3–8: Drive assignment under INTERLINK	3–13
Table 4–1: Configuration of remote control interface	4–10
Table 4–2: Error messages	4–13
Table 5–1: Factory setting of COM1	5–2
Table 5–2: Wiring of remote-control cable	5–3
Table 5–3: Common command	5–3
Table 5–4: Device-specific commands	5–4
Table A–1: Pin assignment of TS PARALLEL (corresponds to DVB Document A010)	A–1

Table A–2: AT keyboard (DIN connector, female)	A–3
Table A–3: VGA interface	A–5
Table A–4: Pin assignment of COM1 and COM2	A–6
Table A–5: Baud rates of COM1 and COM2	A–6
Table A–6: Parity settings of COM1 and COM2	A–7
Table A–7: Data-bit settings of COM1 and COM2	A–7
Table A–8: Stop-bit settings of COM1 and COM2	A–7
Table A–9: Retry settings of COM1 and COM2	A–7
Table A–10: Pin assignment of LPT1	A–8
Table A–11: Pin assignment for the TS Parallel EIA RS-422 interface	A–9
Table B–1: Output signals	B–1
Table B–2: Signal outputs	B–1
Table B–3: Environmental characteristics	B–2
Table B–4: Certifications and compliances	B–3
Table B–5: Power characteristics	B–4
Table B–6: Physical characteristics	B–4

General Safety Summary

Review the following safety precautions to avoid injury and prevent damage to this product or any products connected to it. To avoid potential hazards, use this product only as specified.

Only qualified personnel should perform service procedures.

To Avoid Fire or Personal Injury

Use Proper Power Cord. Use only the power cord specified for this product and certified for the country of use.

Use Proper Voltage Setting. Before applying power, ensure that the line selector is in the proper position for the power source being used.

Connect and Disconnect Properly. Do not connect or disconnect probes or test leads while they are connected to a voltage source.

Ground the Product. This product is grounded through the grounding conductor of the power cord. To avoid electric shock, the grounding conductor must be connected to earth ground. Before making connections to the input or output terminals of the product, ensure that the product is properly grounded.

Observe All Terminal Ratings. To avoid fire or shock hazard, observe all ratings and markings on the product. Consult the product manual for further ratings information before making connections to the product.

Do not apply a potential to any terminal, including the common terminal, that exceeds the maximum rating of that terminal.

Replace Batteries Properly. Replace batteries only with the proper type and rating specified.

Do Not Operate Without Covers. Do not operate this product with covers or panels removed.

Use Proper Fuse. Use only the fuse type and rating specified for this product.

Avoid Exposed Circuitry. Do not touch exposed connections and components when power is present.

Wear Eye Protection. Wear eye protection if exposure to high-intensity rays or laser radiation exists.

Do Not Operate With Suspected Failures. If you suspect there is damage to this product, have it inspected by qualified service personnel.

Do Not Operate in Wet/Damp Conditions.

Do Not Operate in an Explosive Atmosphere.

Keep Product Surfaces Clean and Dry.

Provide Proper Ventilation. Refer to the manual's installation instructions for details on installing the product so it has proper ventilation.

Symbols and Terms

Terms in this Manual. These terms may appear in this manual:



WARNING. Warning statements identify conditions or practices that could result in injury or loss of life.



CAUTION. Caution statements identify conditions or practices that could result in damage to this product or other property.

Terms on the Product. These terms may appear on the product:

DANGER indicates an injury hazard immediately accessible as you read the marking.

WARNING indicates an injury hazard not immediately accessible as you read the marking.

CAUTION indicates a hazard to property including the product.

Symbols on the Product. The following symbols may appear on the product:



WARNING
High Voltage



Protective Ground
(Earth) Terminal



CAUTION
Refer to Manual



Double
Insulated

Preface

This manual is divided into eight sections. The sections contain the following information:

- Section 1 contains introductory information about the digital TV transmission technique. It discusses definitions and standards pertinent to using the MTG200 MPEG Test Generator.
- Section 2 describes the transport streams available with the MPEG test generator and their applications. This section also provides screen displays of the various transport streams.
- Section 3 discusses preparing the MPEG test generator for use. This section contains information about the front- and rear-panel controls and connectors. It also contains information, such as setting up the unit, connecting a PC, configuring the unit, and a functional check.
- Section 4 describes the basic functions of MPEG test generator. The section provides explanations of the controls in the cursor block, the menus, and how to switch between DOS mode and the MPEG test generator.
- Section 5 provides the information you need to remotely control the MPEG test generator for instruments with firmware through version 2.0. This section discusses topics such as the RS-232 interface and the command set and provides some sample programs.
- Section 6 lists the basic maintenance that an operator can perform and describes how to replace the battery.
- Section 7 contains the following appendices:
 - Appendix A, which provides additional information about device interfaces.
 - Appendix B, which lists specifications, certifications, and compliances that apply to the MTG200 MPEG Test Generator.
- Section 8 contains the index to this manual.

Contacting Tektronix

Product Support	<p>For application-oriented questions about a Tektronix measurement product, call toll free in North America: 1-800-TEK-WIDE (1-800-835-9433 ext. 2400) 6:00 a.m. – 5:00 p.m. Pacific time</p> <p>Or contact us by e-mail: tm_app_supp@tek.com</p> <p>For product support outside of North America, contact your local Tektronix distributor or sales office.</p>
Service Support	<p>Contact your local Tektronix distributor or sales office. Or visit our web site for a listing of worldwide service locations.</p> <p>http://www.tek.com</p>
For other information	<p>In North America: 1-800-TEK-WIDE (1-800-835-9433) An operator will direct your call.</p>
To write us	<p>Tektronix, Inc. P.O. Box 1000 Wilsonville, OR 97070-1000</p>

Introduction to Digital TV Transmission Technique

The MTG200 MPEG Test Generator and the MTD200 MPEG Test Decoder are based on a completely new technique that is currently being phased in and has become known as the digital TV transmission technique. Not many users of the above units will have sufficient knowledge about this new technique. Therefore, this introductory chapter preceding the other sections of the manual is provided to give an outline of the subject matter and to inform in detail about the aspects relevant to the MPEG test generator and the MPEG test decoder.

The first section gives an overview of the relevant definitions and standards. The keywords MPEG and DVB are focused upon.

The second section presents a possible transmission scenario. The fields of application of the MPEG test generator and the MPEG test decoder are considered in particular.

The third section provides information about a special aspect of MPEG2 (Part 1 / Systems), which is of special interest with regard to the operation of MPEG test generator and the MPEG test decoder.

Definitions and Standards

Digital TV transmission is understood to mean the transmission of moving pictures, sound and data from source to the destination by means of digital methods. The goal is essentially to multiply the transmission capacity by minimizing the redundancy as well as to obtain flexibility in quality (transmission standards) and contents (any combination of vision, sound, and data).

Implementation is made in two steps: source coding and channel coding.

Source coding and multiplexing: First, data reduction for vision and sound is performed. Next, compressed data streams together with additional data (for example, teletext) have to be coded to a multiplex stream. Such multiplex streams are generated by the MPEG test generator and evaluated by the MPEG test decoder. The required methods are defined by MPEG-2. As for additional data, MPEG only defines the basic syntax. The European DVB project stipulates the additional data to be integrated into the multiplex stream and their form.

Channel coding and transmission: The transmission of compressed, almost redundancy-free data streams, requires a high transmission quality or a bit error rate approaching zero to ensure decoding. That is why a channel coding is performed before the digital modulation methods QPSK (Quadrature Phase Shift Keying for satellite transmission) and QAM (Quadrature Amplitude Modulation for transmission via cable). A certain number of bit errors can then be corrected at the end of the transmission link. The methods for channel coding and transmission are defined by the European DVB project.

MPEG-2 MPEG stands for Moving Pictures Experts Group. This standard committee works on the coding of moving pictures and the associated sound. MPEG-2 (ISO/IEC 13818) defines a corresponding standard documentation describing the compression of vision and sound data. Moreover, there is MPEG-1, which describes the recording of video on CD, or MPEG-4 for the transmission of pictures by means of very narrowband transmission channels. MPEG-3, which was to define the distribution of high-resolution TV pictures, has finally become a part of MPEG-2.

MPEG-2, which is subdivided into many sections, is exclusively relevant for this manual. The following MPEG2 sections are applicable to the MPEG test generator and MPEG test decoder:

Part 1 / Systems ISO/IEC 13818-1	Multiplexing of several compressed vision and sound data streams as well as of additional data streams to a transport multiplex
Part 2 / Video ISO/IEC 13818-2	Compression of vision data
Part 3 / Audio ISO/IEC 13818-3	Compression of sound data
Part 4 / Conformance ISO/IEC 13818-4	Test procedure for compressed streams (encoder) and decoder
Part 9 / Real-Time Interface Specification for Low Jitter Applications	Elucidation regarding system-clock jitter during the distribution of transport streams

The interface for the MPEG test generator and the MPEG test decoder is the Transport Stream (TS). The composition and structure of this multiplex stream is described in *MPEG-2 Systems* on page 1–5.

DVB In addition to transmission methods based on the MPEG results, the European DVB project (Digital Video Broadcast) established a number of additional definitions that were stipulated as a standard by ETSI / CENELEC for standardization. The following standards are relevant for the MPEG test generator and the MPEG test decoder:

ETS 300 468:	Specification for Service Information (SI) in Digital Video Broadcast (DVB) Systems
ETS 300 472:	Specification for conveying ITU-R System B Teletext in Digital Video Broadcasting (DVB) Bit Streams
ETR 162:	Allocation of Service Information (SI) codes for Digital Video Broadcasting (DVB) Systems
ETR 211:	Guidelines on implementation and usage of service information
ETR 290:	Measurement Guidelines for DVB-Systems
DVB Technical Module:	
Document A010:	Interfaces for CATV / SMATV Headends and similar Professional Equipment
TM 1341	Common Interface Specification for Conditional Access and other Digital Video Broadcasting Decoder Applications

Transmission Scenario for DVB

Figure 1–1 illustrates a possible transmission scenario for DVB. ‘TS’ indicates the interfaces for the transport stream. The transport stream is the output and input interface of the MPEG test generator and the MPEG test decoder. At any of these interfaces, signals from the MPEG test generator can be fed in or applied to the MPEG test decoder for analysis and decoding. A TS analysis is of vital importance after every TS multiplexer. A program can run through several multiplexers if, for example, programs from different transmission paths are combined and sent on a new path.

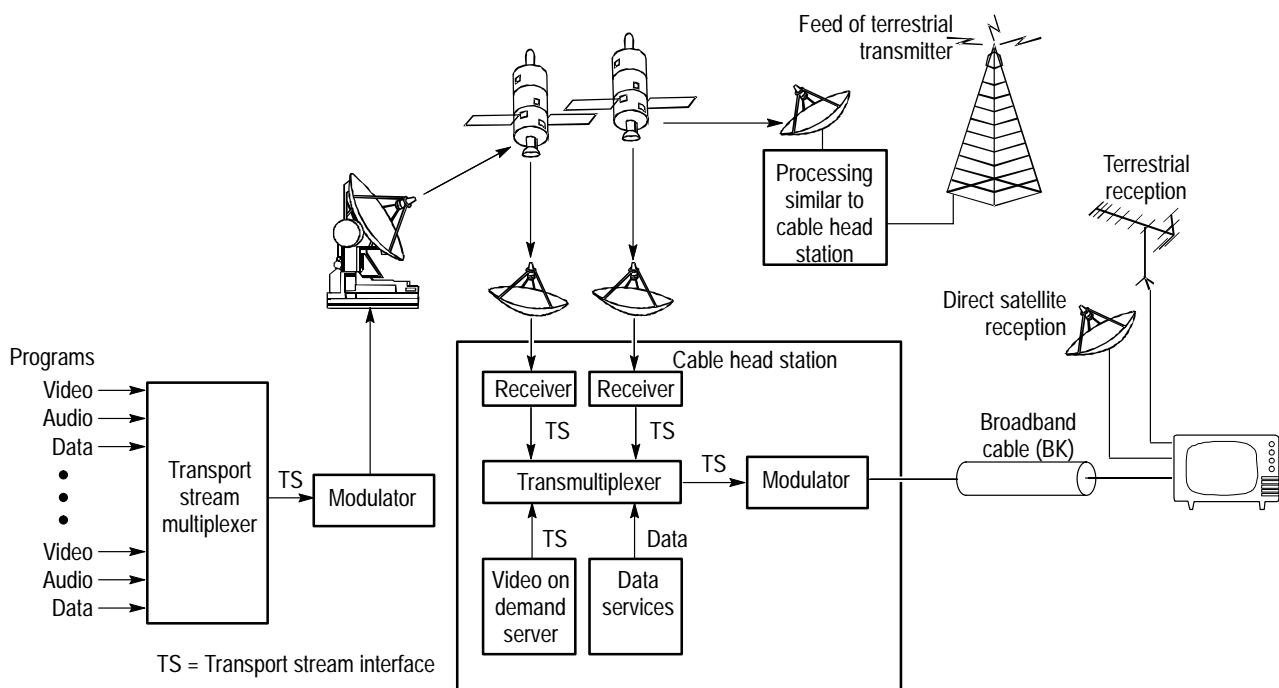

Figure 1–1: Scenario for a DVB distribution network

MPEG-2 Systems

This section describes the structure of a transport stream starting with decoding. The individual steps required for decoding a program are illustrated and the relevant elements of the data stream required are explained. Figure 1–2 presents an overview of the steps involved. The following subsections describe the decoding steps. The most important syntax elements are given in Figure 1–4 through Figure 1–10 starting on page 1–11.

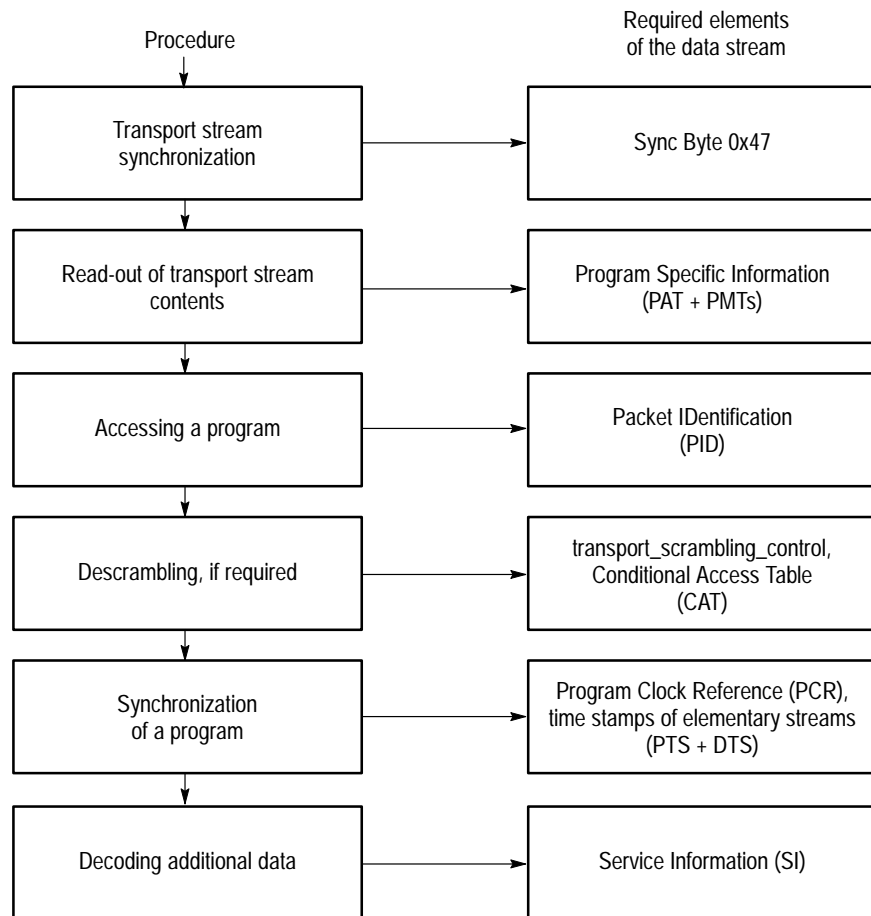

Figure 1–2: Functions of a transport stream demultiplexer

Transport Stream Synchronization and Packet Identification

The transport stream as a multiplex stream has to receive data from different elementary streams. The beginning of a new packet is marked by a sync byte 0x47. The packets of a transport stream have a fixed length of 188 bytes. The value 0x47 is not exclusively reserved for the beginning of a packet. Thus, this value does not always indicate a packet start.

To ensure stable synchronization, however, the repetitive occurrence of a sync byte at 188-byte intervals has to be checked. The hysteresis parameters define how often the value 0x47 must occur at 188-byte intervals for the packet synchronization to be considered locked or how often the sync byte must be missing or the wrong value for the packet synchronization to be declared lost.

The sync byte interval can also be 204 bytes (188 + 16 bytes). In this case, the last 16 bytes originate from the channel coding (Reed-Solomon error protection). Channel decoding has already taken place at the transport stream level so that the 16 bytes at the end of each packet do not carry any useful information. Only the clock conversion from 204 to 188 bytes per packet duration has not been performed.

A header with a length of four bytes precedes each transport stream packet. The first byte of the header is the sync byte, as described above. If not all the bit errors caused by transmission can be eliminated during channel decoding, the Transport Error Indicator is set in the header of the packet concerned.

Critical information for identifying a packet is the PID (Packet IDentification). The PID is a field of 13 bits. It can thus have 8196 different values. A PID is assigned to each substream such as a video or audio stream (not to a program). Some PID values are fixed, such as value 0x000 for the PAT (see *Contents of the Transport Stream* on page 1–6), value 0x0001 for the CAT (see *Descrambling* on page 1–8), and value 0x1FFF for the so-called zero packets that do not contain useful data but only dummy bytes.

Contents of the Transport Stream

The transport stream normally contains several programs consisting of several elementary streams. The contents of the transport stream is described in the Program Specific Information (PSI). Each transport stream contains a Program Association Table (PAT) as well as one or several Program Map Tables (PMTs).

The PAT is contained in the transport stream packets with the PID 0x0000. It refers to all the programs contained in the transport stream. The PAT indicates the program number and the corresponding PID for the Program Map Table (PMT).

The elementary streams (vision sound, data) that belong to the individual programs are described in a PMT. A PMT consists of one or several sections, each describing a program.

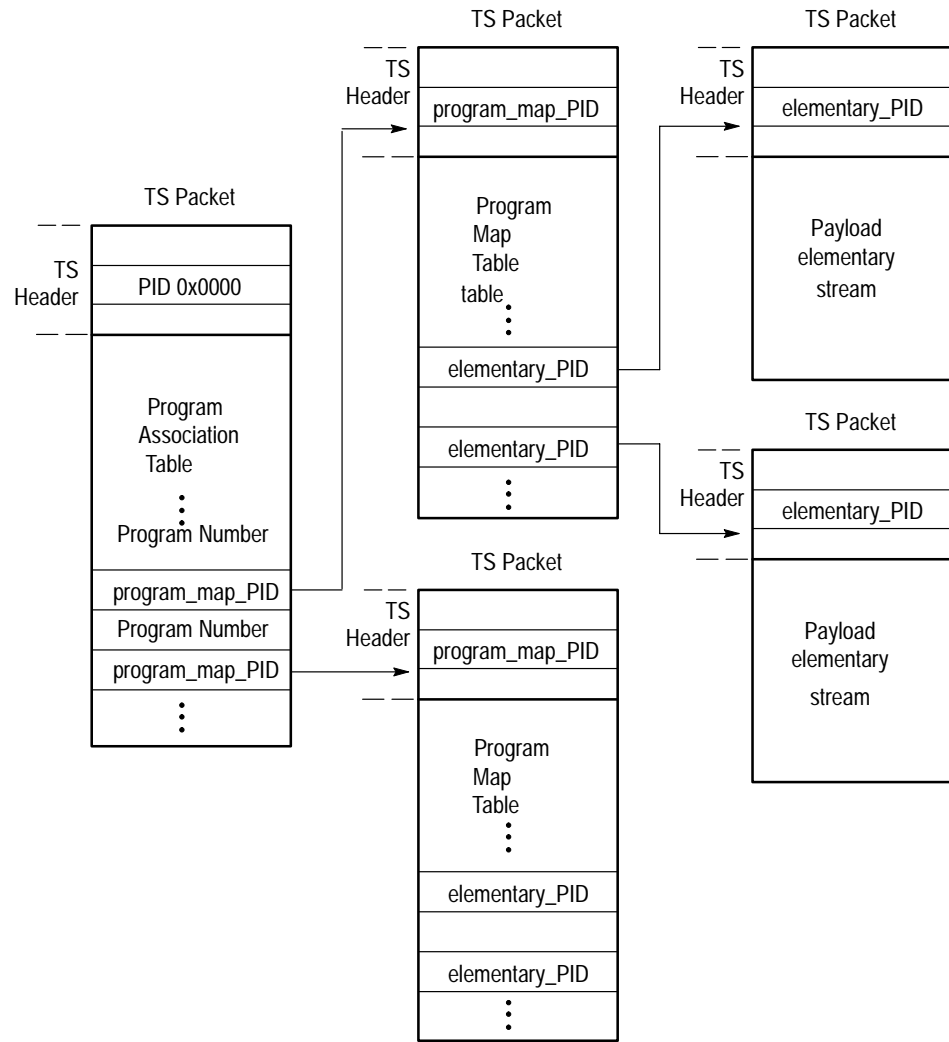

Figure 1–3: PAT and PMT describe the contents of a transport stream

Access to a Program

If the programs contain contending elementary streams (for example, several audio streams), a selection must be made. The packets of the selected elementary streams identified by PID now have to be conveyed from the demultiplexer to the associated decoders.

Analyzing the Continuity Counter in the packet header permits checking whether individual packets belonging to an elementary stream arrive completely and in the correct order. The Continuity Counter is represented by the four least significant bits of the last header bytes (for example, bit 29 to bit 32 of each packet). The value (0–15) is incremented with each new packet. Value 15 is followed by a zero.

Two exceptions are permissible:

- The Discontinuity Indicator is set in the Adaptation Field (during a program step). See Figure 1–5 on page 1–11. The Continuity Counter can then have any value.
- A packet may be transferred twice. The Continuity Counter must not be incremented.

Descrambling

The received data can be scrambled. Scrambling is performed at the level of the transport stream (TS) or of the packetized elementary stream (PES).

The corresponding header information (PES header or TS header) remains unscrambled. If scrambling is required at the transport stream level, this also includes the PES header, whereas the TS headers remain unscrambled in all cases.

If a packet (TS packet or PES packet) is scrambled, this is indicated by the first bit of the scrambling control field of the associated header (TS header or PES header). The second bit in the scrambling control field is required, since the scrambling code changes from time to time. This bit is set if a new scrambling code is valid for the packet in question.

To be able to perform descrambling, the decoder requires specific control data that are transmitted with the entitlement control messages (ECM) and the entitlement management messages (EMM). The ECM contain the scrambling codes and the EMM distribute the access authorizations for the receivers. ECM and EMM are included and referred to in the program specific information (CAT or PMT).

Descrambling is performed in a supplier-specific hardware, which can be connected to the decoder via a DVB-defined interface.

Program Synchronization

In general, a program comprises several elementary streams. A common clock reference is required to synchronize the decoding and display (or output) of the individual elementary streams. This clock reference for each program comes as Program Clock Reference (PCR) and is carried along in an elementary stream of the program. To this effect, every 40 ms at maximum, the 4-byte header of a transport packet is extended by an Adaptation Field (see Figure 1–5 on page 1–11) which contains not only a variety of other signaling information that cannot be dealt with here, but also the PCR. The Adaptation Field is always unscrambled.

The PCR value (42 bits long) corresponds to the state of a counter with a 27 MHz clock at the time of arrival of the first TS-packet byte containing the PCR value. It is used in the decoder for controlling the 27 MHz system clock PLL. Thus, the synchronization of the multiplexer at the transmitter end and of the demultiplexer at the receiver end is ensured.

The individual elementary streams contain time stamps, such as the Decoding Time Stamps (DTS) and the Presentation Time Stamps (PTS), for synchronizing the decoding and display of the individual elementary streams. The Packetized Elementary streams (PES) are transmitted in packets with up to a length of 64 kBytes (more for video streams), which define a certain display length (e.g., a picture in case of video streams). A header precedes each packet of an elementary stream (PES). The header also contains the DTS and PTS. If a transport packet contains the beginning of a PES packet, the 10th bit (Payload Unit Start Indicator) is set in the header of the transport packet.

The PTS / DTS value (33 bit) corresponds to the state of a 90 kHz counter and refers to the 33 most significant bits of the PCR. The ratio of 27 MHz (PCR) to 90 kHz (PTS / DTS) is 300 and is attained by the fact that the 9 least significant bits of PCR only count to 300 (instead of 512).

Two different time stamps (DTS and PTS) are provided, since the order of arrival of the PES packets and their decoding does not always correspond to the order of display (for instance, during the transmission of difference pictures in video streams). In many cases, only one PTS is available.

Service Information

The tables defined by the DVB project (see ETS 300 468) are to be seen as service information. The information contained in these tables is not required for decoding, but provides convenient access for the end user: it might be program information for the viewer or control information for the decoder and units connected to it.

In many cases, PSI (Program Specific Information) is also mentioned in connection with SI (Service Information). PSI is already defined in MPEG-2 and contains the above-mentioned tables PAT (Program Association Table), PMT (Program Map Table), CAT (Conditional Access Table), and NIT (Network Information Table). The latter contains data provided by the network operator for tuning the receivers (for example, orbit positions or transponder numbers). The CAT and NIT contents are specified by the DVB project (and not by MPEG).

Tables additionally defined by the DVB project are as follows:

- BAT (Bouquet Association Table) contains information about the different programs of a broadcaster irrespective of their propagation paths.
- SDT (Service Description Table) describes the programs offered.
- EIT (Event Information table) supplies the data base for an electronic TV guide with information about the type of program and age classification for the viewer.
- RST (Running Status Table) contains status information about the individual programs and especially serves for controlling video recorders.

- TDT (Time and Date Table) provides information about date and current time (UTC).
- TOT (Time Offset Table) provides information about the local time offset in addition to date and time.
- ST (Stuffing Table) has no relevant contents. It is generated when invalid tables are overwritten during transmission (for example, at cable headends).

The PIDs for the tables are predefined. The PMTs whose PIDs are defined in the PAT are an exception. Each table has a Table_ID at the beginning of each table. This Table_ID is required to transmit different tables with a single PID. The interrelation of table type, PID and Table_ID is shown in Table 1–1.

Table 1–1: PID and Table_ID for PSI / SI

Table	PID	Table_ID
PAT	0x0000	0x00
PMT	0x0020 to 0x1FFE	0x02
CAT	0x0001	0x01
NIT	0x0010	0x40 to 0x41
BAT	0x0011	0x4A
SDT	0x0011	0x42, 0x46
EIT	0x0012	0x4E to 0x6F
RST	0x0013	0x71
TDT	0x0014	0x70
TOT	0x0014	0x73
ST	0x0010 to 0x0014	0x72

Syntax Diagrams

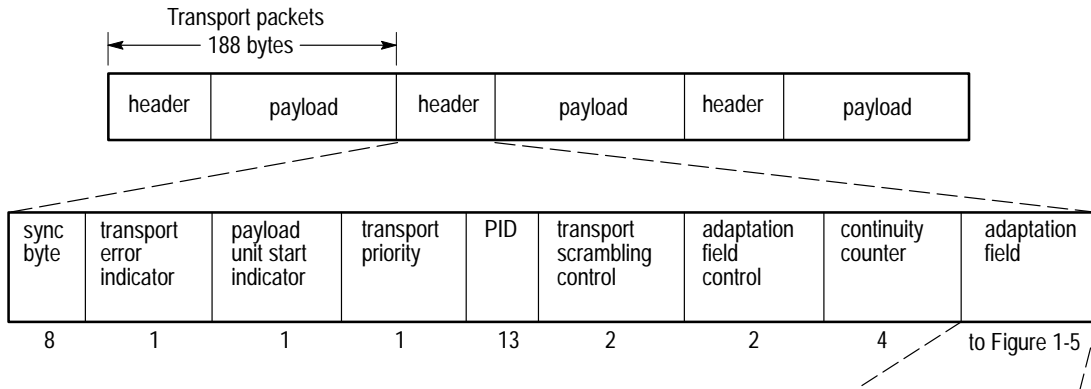

Figure 1-4: Transport packet

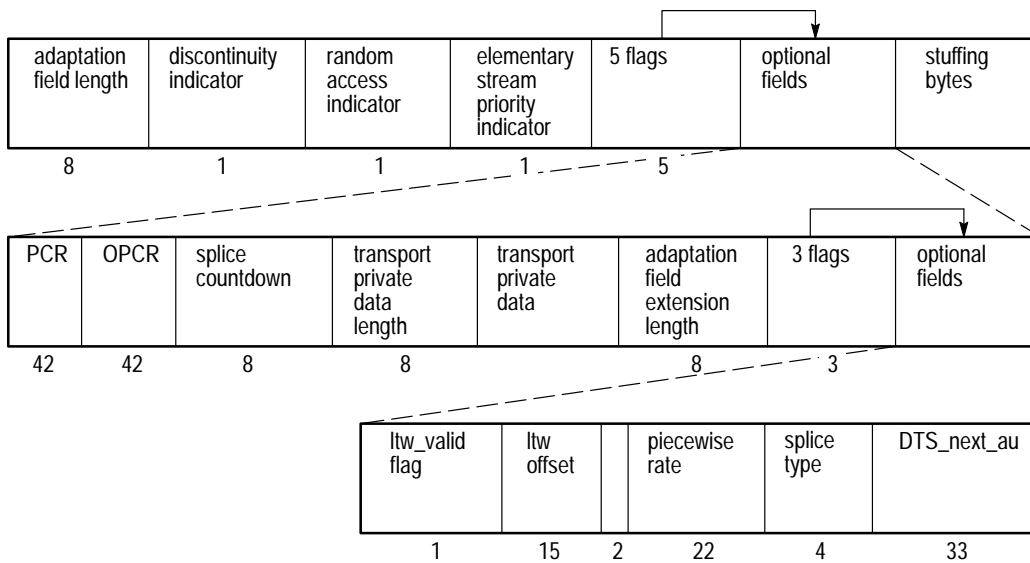

Figure 1-5: Adaptation field

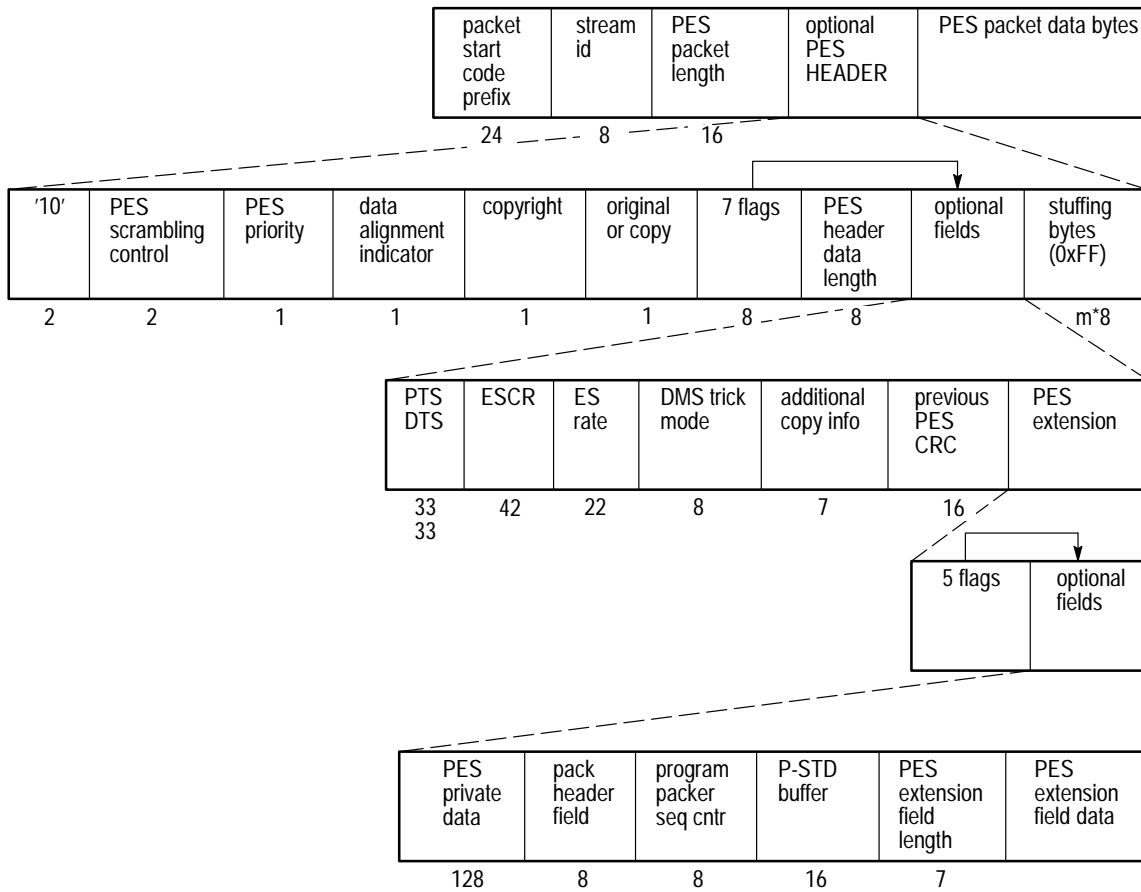

Figure 1-6: PES header

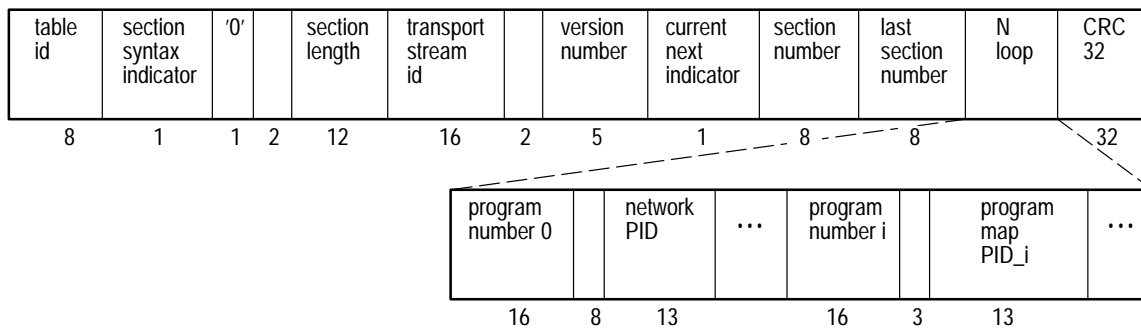

Figure 1-7: Program association section

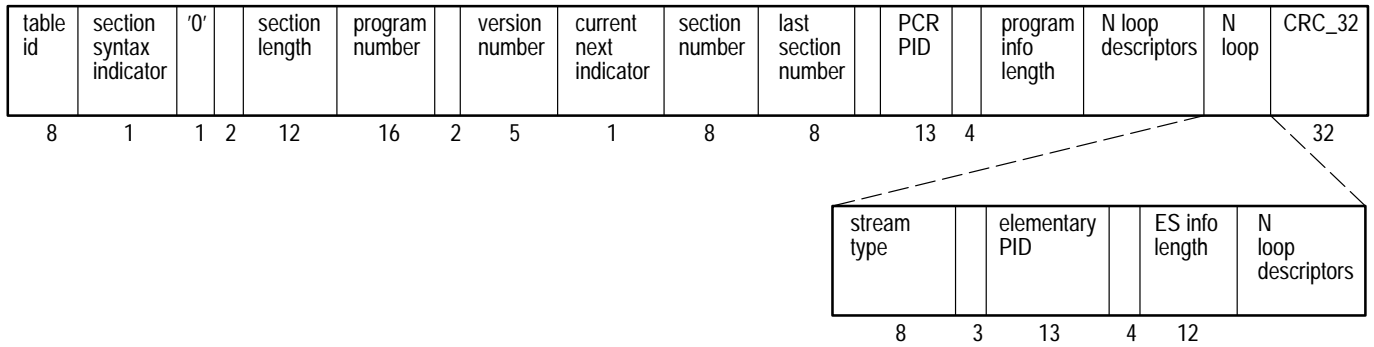

Figure 1-8: Program map section

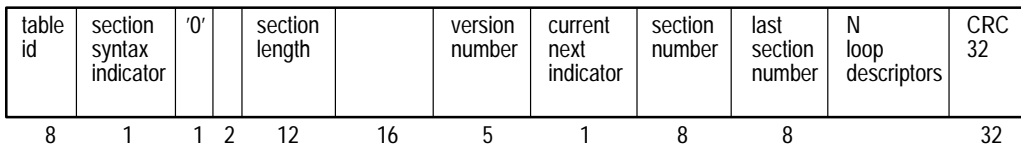

Figure 1-9: Conditional access section

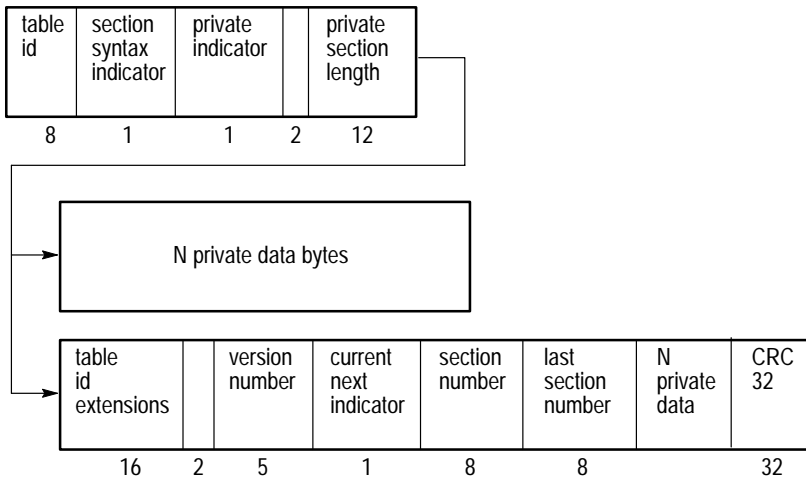

Figure 1-10: Private section

Device Functions and Transport Streams

The MTG200 MPEG Test Generator is a signal source for standardized MPEG-2 transport streams.

As already described in detail in chapter 1, the MPEG-2 standard provides for different types of video and audio digitization, coding, and processing. These types are defined by the MPEG2 Profiles-and-Level Organization. The Main Profile at the Main Level (ML@MP) are intended to replace general analog TV broadcasting. Vision and sound are digitized, coded, and processed to elementary streams according to specific methods. This task is fulfilled by technically elaborate encoders. For the transport, the elementary data are combined in a transport stream.

A main feature of this transport stream is the fact that it contains several programs which consist of several elementary streams.

Associated elementary streams (vision, sound, and data signals) are combined to program elementary streams via a packetizer and multiplexer. Several programs can again form a common transport stream via a multiplexer (see Figure 2–1).

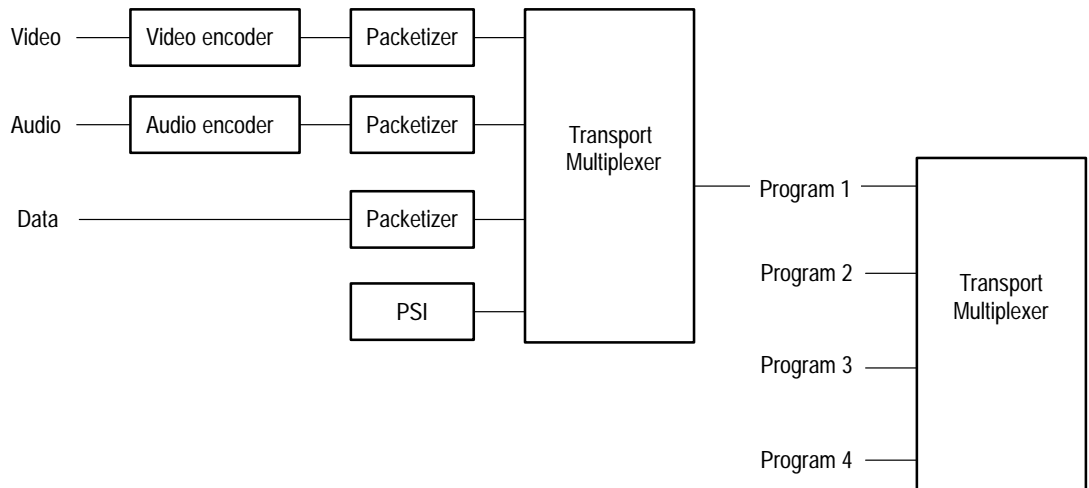

Figure 2–1: Principal diagram of the transport stream

An MPEG-2 transport stream consists of individual data packets of 188 or 204 bytes. The different information or video and sound data are packed in these data packets and are transmitted alternately.

Processes

The MPEG-2 elementary and transport streams are stored on the internal MPEG test generator's hard disk. When a stream is selected, the transport stream data is loaded into RAM and is then continually output with the correct time stamps.

Since the RAM is of fixed size, the video and audio streams are limited in their sequence length. Thus the test generator updates the time stamps (PCR, PTS, and DTS) of the streams in real time so that a continuous data stream is received at the decoder; that is, a continuous data stream is created for the decoder in spite of the repetitive video and sound sequences.

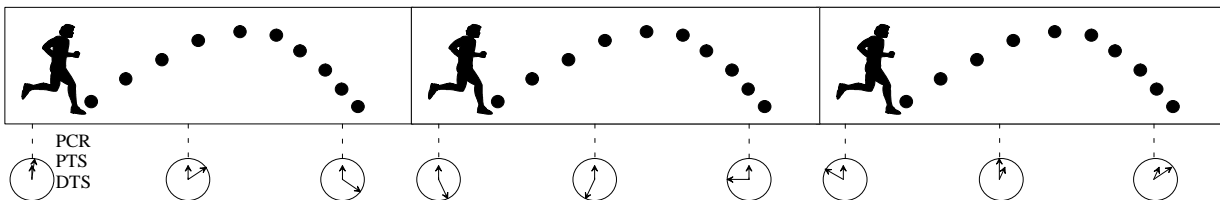

Figure 2–2: Continuous PCR, PTS and DTS time stamps in repeated sequences

The maximum sequence length depends on the RAM size, on the degree of data compression of the coding, and also on the number of sources and the MPEG-coded elementary streams.

The output data rate of the MPEG test generator can be freely selected between the pure useful data rate and the maximum output data rate. To this effect, whenever required, dummy packets are added to the transport stream in addition to the useful data packets. These dummy packets are provided by the hardware and do not have to be stored in the RAM or on the hard disk.

The packet size for each transport stream can be changed from 188 to 204. The bytes for the Reed Solomon error protection are filled up with zeros.

The transport streams on the hard disk are stored in a special MPEG test generator data format (files with extension .gts). The files contain all the important information of the transport stream, which can be displayed as a whole or in individual steps on the VGA monitor (see Figure 2–3). Thus information can be obtained about the type and contents of the transmitted elementary streams or packets.

TS INFORMATION : CODECDBL.GTS		VERSION : V1.10 25.09.96
DATARATE : 20.000000 MBit/s		SEQUENCE LENGTH : 1.92 s
MIN_DATARATE : 8.600000 MBit/S		PACKET LENGTH : 188 Byte
		PCR JITTER : 00000.0 µs
PROGRAM 1 DVG 1	PMT PID : 128 (0080 h)	PCR PID: 100 (0064 h)
ES TYPE : Video 625	ES TYPE : Audio	
ES 1 : Codec 4:3	ES 2 : L+R 1 kHz 1s	
ES PID : 100 (0064 h)	ES PID : 101 (0065 h)	
DATARATE : 3.588 MBit/s	DATARATE : 384 kBit/s	
PROGRAM 2 DVG 2	PMT PID : 129 (0081 h)	PCR PID: 200 (00C8 h)
ES TYPE : Video 625	ES TYPE : Audio	
ES 1 : Codec 16:9	ES 2 : Burst 9.5kHz	
ES PID : 200 (00C8 h)	ES PID : 201 (00C9 h)	
DATARATE : 4.010 MBit/s	DATARATE : 384 kBit/s	

Figure 2–3: Transport stream information: (monitor hardcopy)

NOTE. *The higher the useful packet quantity and data size, the higher the loading time of the MPEG test generator.*

The transport stream is only output after loading (for example, 8 Mbytes correspond to approximately 1 minute loading time).

Transport Streams in the MPEG Test Generator

The following text presents an overview of the most important transport types and their possible uses:

- **Transport streams with moving picture scenes.** A basic function test of decoder, multiplexer, and terminals is possible by means of moving picture scenes (for example, the test of set-top boxes in final production). A transmission interruption or error during the data stream or a decoder processing error can be detected immediately. Due to digital processing, the decoder always outputs the frame last received. This is also the case for transmission errors. That is why pure still pictures are less suitable for a function test.
- **Transport streams with several programs.** It is possible to test demultiplexers and decoders that detect and separately process several programs. Errors can be detected during evaluation of the program information.
- **Synchronization between video and audio.** These sequences allow you to detect a delay between vision and sound during transmission and decoding.
- **Audio test sequences.** The MPEG test generator also offers one or more audio sequences with all the video streams. In addition to pure test tones and test tone sequences for automatic tone tests (EBU line measurement according to CCITT 0.33/CCITT0.33.GTS), there are also short music sequences that are repeated at the rate of the sequence length for the picture.

Table 2-1: Overview of transport streams for short audio frequency response measurements

Transport stream	Frequency
HSWEEP1.GTS	40 Hz
CODEC43.GTS	1 kHz
RAMPYC.GTS	9.5 kHz
NONLIN.GTS	12 kHz
RGBSWEEP.GTS	14 kHz
SINXX.GTS	18 kHz

- **Teletext.** In addition to the transmission of video and audio data, the MPEG standard also provides for general data transmissions within the MPEG-2 multiplex. For a test signal, the MPEG test generator sets the teletext test pages as data packets into the transport stream multiplex.

- **Test patterns/scenes for monitor alignment.** Not only the transmission of transport streams has to be checked but also the analog processing in terminals. D/A conversion in decoders and picture geometry adjustment of TV sets are mainly tested by means of still pictures; also, the analog signal path of the sound has to be tested and adjusted. Therefore, the MPEG test generator contains the important test patterns and sound signals in analog technique (insertion test signal: ITS) for traditional TV measurements.

The main applications of these signals are listed in the *Use* column of the tables beginning on page 2–7.

NOTE. *If signals are encoded according to the MPEG2 method, data reduction is performed by which the signals are changed so that there are differences in frequency response and level.*

Transport Streams for 625 Lines Systems

The supplied transport streams differ in their contents and structure and are suitable for different fields of application.

Table 2-2: Still-picture and test-pattern sequences in directory: GTS_MEAS

File name	Video contents	Audio contents	Special feature	Use
BLUE.GTS	All blue picture	3 audio L + R: 1 kHz, 0 dB _r Sampling rate: A1 = 32 kHz A2 = 44.1 kHz A3 = 48 kHz	Special audio sampling rate	Measurement of chroma noise
BOUNCE.GTS	Alternating all-black and all-white picture	L+R 1 kHz sine only during all-white picture	Alternating still picture	Test of clamping circuits, delay measurements, delay between vision and sound
BOUNCE_S.GTS	All white: 1.44 s All black: 5.280 s	L + R: 1.44 s, 1 kHz, +6 dB _r Silence for 5.280 s	Audio and video synchronized	Test of clamping circuits, delay measurements, delay between video and audio
CBARS100.GTS	CCIR 601 color bars 100/0/100/0	L: sine burst 1 s 15 kHz 4 dB _r R: silence	Still picture	Test and alignment of phase and level ratios for MPEG2 decoders and PAL coders
CBARS75.GTS	CCIR 601 color bars 100/0/75/0	L: silence R: sine burst 1 s 15 kHz, 4 dB _r	Still picture	Test and alignment of phase and level ratios for MPEG2 decoders and PAL coders
CCIR17.GTS	CCIR 17 test signal in frame	L+R: sine burst 1 s 1 kHz, 0 dB _r	Still picture	Test and alignment of level, tilt, overshoot, rounding, pulse distortion, reflection, color subcarrier amplitude and delay, luminance nonlinearity
CCIR18.GTS	CCIR 18 test signal (multiburst) in frame	Sequence L + R, -12 dB _r , 1 s each 40 Hz 80 Hz 200 Hz 500 Hz 820 Hz 2 kHz 3 kHz 5 kHz 6.3 kHz 9.5 kHz 11.5 kHz 13.5 kHz 15 kHz		Video and audio amplitude-frequency response

Table 2-2: Still-picture and test-pattern sequences in directory: GTS_MEAS (cont.)

File name	Video contents	Audio contents	Special feature	Use
CCIR3311.GTS	CCIR 331-1 test signal in frame	L + R: 1 kHz, 0 dB _r	Special audio sampling rate	Measurement of color subcarrier in PAL coders (SET-TOP BOX), nonlinearity of amplitude and phase, luminance-chrominance intermodulation
CCIR3312.GTS	CCIR 331-2 test signal in frame	L + R: 1 kHz, 0 dB _r	Special audio sampling rate	Measurement of color subcarrier in PAL coders (SET-TOP BOX), measurement of amplitude and phase
CCITTO33.GTS	Rohde & Schwarz CODEC test pattern 4:3	CCITT O.33.00 monophonic test sequence	EBU line measurement to CCITT O.33	Test and alignment of insertion gain, frequency response, interchannel gain and phase, THD, compandors, and SNR in audio circuits
CODEC169.GTS	Rohde & Schwarz CODEC test pattern 16:9	L+R: sine burst 20 ms 9.5 kHz, 6 dB _r	Monitor test pattern with moving picture elements	Test and alignment of D/A converters and analog components in the video paths of decoders; monitor geometry alignment
CODEC43.GTS	Rohde & Schwarz CODEC test pattern 4:3	L+R: sine burst 1 s 1 kHz, 0 dB _r	Monitor test pattern with moving picture elements	Test and alignment of D/A converters and analog components in the video paths of decoders; monitor geometry alignment
DVTS_2M.GTS	Sequence of test patterns for encoder test	Classical music	Video with 2 Mbit/s coded	General function test of vision and sound; demonstration of MPEG encoding
DVTS_4M.GTS	Sequence of test patterns for encoder test	Classical music	Video with 4 Mbit/s coded	General function test of vision and sound; demonstration of MPEG encoding
DVTS_6M.GTS	Sequence of test patterns for encoder test	Classical music	Video with 6 Mbit/s coded	General function test of vision and sound; demonstration of MPEG encoding
DVTS_9M.GTS	Sequence of test patterns for encoder test	Classical music	Video with 9 Mbit/s coded	General function test of vision and sound; demonstration of MPEG encoding
DVTS_15.GTS	Sequence of test patterns for encoder test	Classical music	Video with 15 Mbit/s coded	General function test of vision and sound; demonstration of MPEG encoding
HSWEEP1.GTS	H-SWEEP test signal in frame	L+R: sine burst 1 s 40 Hz, -20 dB _r	Still picture	Amplitude frequency response
NONLIN.GTS	Ramps in RGB signal	L+R: sine burst 1 s	Still picture	Test of RGB matrix
RAMPYC.GTS	Ramps in all components in frame	L+R: sine burst 1 s 9.5 kHz, -20 dB _r	Still picture	Missing codes and linearity of D/A converters
RGBSWEEP.GTS	Sweep in RGB signal	L+R: sine burst 1 s 14 kHz, -20 dB _r	Still picture	Test and alignment of RGB output stages

Table 2-2: Still-picture and test-pattern sequences in directory: GTS_MEAS (cont.)

File name	Video contents	Audio contents	Special feature	Use
SINXX.GTS	Sine x/x test signal in frame	L+R: sine burst 1 s 18 kHz, -20 dB _r	Still picture	Amplitude frequency response, nonlinear distortion
WINDOW.GTS	All-white window	L+R: diff. tone 1 s 7 + 11 kHz, -6 dB _r	Still picture	Test of sweep voltage generation and black-level adjustment of monitors
ZONEPL.GTS	Zone plate	L+R noise white/incoherent 10 dB _r	Moving picture scene	Frequency response, both horizontal and vertical direction

Table 2-3: Transport streams with two or more programs in directory: GTS_MEAS

File name	Video contents	Audio contents	Special feature	Use
6_PROG.GTS	Six different still-picture and test-pattern sequences from Table 2-2*	Audio for each program corresponds to that listed in Table 2-2	Six programs in one transport stream	General function test of DVB decoders
CODECDBL.GTS	Program 1: CODEC test pattern 4:3 Program 2: CODEC test pattern 16:9	Program 1: L+R: sine burst 1 s 1 kHz, 0 dB _r Program 2: L+R: sine burst 20 ms 9.5 kHz, 6 dB _r	Monitor test pattern with moving picture elements	Test and alignment of D/A converters and analog components in the video paths of decoders; monitor geometry alignment
DVTS_DBL.GTS	Sequence of test patterns for encoder test Program 1: Video 2 Mbit/s coded Program 2: Video 6 Mbit/s coded	Program 1: classical music Program 2: classical music	Length 7.68 s Video with 2 Mbit/s coded	General function test of vision and sound; demonstration of MPEG encoding

* BOUNCE, H-SWEEP1, RAMPYC, NONLIN, RGBSWEEP, CCIR17

Table 2-3: Transport streams with two or more programs in directory: GTS_MEAS (Cont.)

File name	Video contents	Audio contents	Special feature	Use
FLOWERGA.GTS	Flowers and windmill in background Program 1: 2 Mbit/s coded Program 2: 4 Mbit/s coded Program 3: 6 Mbit/s coded	Classical music Classical music Classical music	Duration: 192 video frames	Test of vision and sound, demonstration of picture quality as a function of data rate
T_TENNIS.GTS	Table tennis match Program 1: 2 Mbit/s coded Program 2: 4 Mbit/s coded Program 3: 6 Mbit/s coded	Applause/Cheers Applause/Cheers Applause/Cheers	Duration: 192 video frames	General function test of vision and sound, demonstration of picture quality as a function of data rate

Table 2-4: Moving picture scenes in directory: GTS_LIVE

File name	Video contents	Audio contents	Special feature	Use
FACT_3M.GTS	Automatic insertion machine in operation	Classical music	Video with 3 Mbit/s coded	General function test of vision and sound
FACT_4M.GTS	Automatic insertion machine in operation	Classical music	Video with 4 Mbit/s coded	General function test of vision and sound
FACT_6M.GTS	Automatic insertion machine in operation	Classical music	Video with 6 Mbit/s coded	General function test of vision and sound
FACT_9M.GTS	Automatic insertion machine in operation	Classical music	Video with 9 Mbit/s coded	General function test of vision and sound
FACT_15M.GTS	Automatic insertion machine in operation	Classical music	Video with 15 Mbit/s coded	General function test of vision and sound
NSCHWAN.GTS	Aerial view of Castle of Neuschwanstein	Classical music	Video with 2 Mbit/s coded	General function test of vision and sound

Table 2-5: Still picture and test pattern sequences in directory: GTS_ERRO

File name	Video contents	Audio contents	Special features	Use
DVMD_CHK.GTS	CODEC test pattern 4:3	L+R: sine burst 1 s 1 kHz, 0 dB _r	Contains errors in most ETR-290 parameters	Stressing DVB decoders, verifying operation of DVB monitors

Table 2-6: Transport streams and data contents in directory GTS_DATA

File name	Video contents	Audio contents	Data contents	Special features	Use
TELETEXT.GTS ¹	CODEC test pattern 4:3	L/R sine burst, 20 ms, 0 dB _r	Teletext test pages	Four teletext lines per frame	Test of teletext transcoders

¹ See page 2-82 for more information about the PES packets.

NOTE. Audio: 0 dB_r = +6 dB_u = 1.55 V (DIN 45406)

For each transport stream, a mask with the most important information is shown. If a PC monitor is not connected to the MPEG test generator, the required information can be looked up in the mask. For each program, the individual elementary stream information such as name, type, PIDs used, data rates, and the minimum data rate and sequence length are indicated.

**Transport Stream
BLUE.GTS**

TS INFORMATION : BLUE.GTS	VERSION : 2.00 19.08.97
TS RATE : 40.000000 MBit/s	SEQUENCELENGTH : 1.92 s
MIN TS RATE : 1.074186 MBit/S	PACKET LENGTH : 188 Byte
	PCR JITTER : 00000.0 µs
PROGRAM 1 Blue screen	VAAA 0.926 MBit/s

Figure 2-4: Screen display of TS information on BLUE.GTS

Video	All blue picture for 48 video frames (1.92 seconds)
Audio (left and right channel)	Three audio L+R sine burst of 1 kHz, 0 dB _r Sampling rate A1: 32 kHz A2: 44.1 kHz A3: 48 kHz
Example of use	Measure chroma noise, audio decoders

NOTE. *some items in the screen display above and in all subsequent displays, are user-definable. These elements include:*

<i>TS RATE:</i>	<i>Adjustable from MIN TS RATE to 160 Mbit/s</i>
<i>PACKET LENGTH:</i>	<i>188 or 204 Bytes</i>
<i>PCR JITTER:</i>	<i>Adjustable through the SETUP menu</i>
<i>PMT; ES PID:</i> <i>(not shown above)</i>	<i>Adjustable through the SETUP menu</i>

**Transport Stream
BOUNCE.GTS**

TS INFORMATION : BOUNCE.GTS		VERSION : V1.2 06.02.97
DATARATE : 20.000000 MBit/s		SEQUENCELENGTH : 1.92 s
MIN_DATARATE : 0.800000 MBit/S		PACKET LENGTH : 188 Byte
		PCR JITTER : 00000.0 µs
PROGRAM 1 DVG 1	PMT PID : 128 (0080 h)	PCR PID: 100 (0064 h)
ES TYPE : Video 625	ES TYPE : Audio	
ES 1 : Bounce	ES 2 : L+R 1 kHz 0.5s	
ES PID : 100 (0064 h)	ES PID : 101 (0065 h)	
DATARATE : 0.271 MBit/s	DATARATE : 0.384 MBit/s	

Figure 2–5: Screen display of TS information on BOUNCE.GTS

Video	Bounce / change from all-white to all-black picture. Change from 12 all-white picture frames to 12 all-black picture frames.
Signal source	CCIR 601 Test Signal Generator: APL Signal. Settings: Time 960 ms / Level 1 0% / Level 2 100%.
Example of use	Test of clamping circuits and delay measurements; as the audio signal is switched on together with the all-white picture, delay measurements between vision and sound are possible.
Audio (left and right channel)	Sine burst of 1 kHz with 0 dB _r with a duration of 12 frames (480 ms) synchronous to white bar and no burst during all-black picture.

**Transport Stream
BOUNCE_S.GTS**

TS INFORMATION : BOUNCE_S.GTS	VERSION : 2.00 19.08.97
TS RATE : 40.000000 MBit/s	SEQUENCELENGTH : 6.72 s
MIN_TS RATE : 0.736371 MBit/S	PACKET LENGTH : 188 Byte
	PCR JITTER : 00000.0 µs
PROGRAM 1 Slow Bounce	PMT PID : 128 (0080 h) PCR PID: 100 (0064 h)
ES TYPE : Video 625	ES TYPE : Audio
ES 1 : Bounce 1s/5s	ES 2 : L+R 1 kHz 1s
ES PID : 100 (0064 h)	ES PID : 101 (0065 h)
DATARATE : 0.238 MBit/s	DATARATE : 0.384 MBit/s

Figure 2-6: Screen display of TS information on BOUNCE_S.GTS

Video	All white picture (for 1.44 seconds) then an all black picture (for 5.280 seconds).
Audio (left and right channel)	L+R sine burst of 1 kHz at 6 dB _r for 1.44 seconds, then silence for 5.280 seconds. Audio synchronized with video.
Example of use	Test clamping circuits and delay measurements between vision and sound.

**Transport Stream
CBARS100.GTS**

TS INFORMATION : CBARS100.GTS		VERSION : V1.2 06.02.97
DATARATE : 20.000000 MBit/s	MIN_DATARATE : 1.300000 MBit/S	SEQUENCELENGTH : 1.92 s
		PACKET LENGTH : 188 Byte
		PCR JITTER : 00000.0 µs
PROGRAM 1 DVG 1	PMT PID : 128 (0080 h)	PCR PID: 100 (0064 h)
ES TYPE : Video 625	ES TYPE : Audio	
ES 1 : Colourbars100	ES 2 : L 15kHz 1s	
ES PID : 100 (0064 h)	ES PID : 101 (0065 h)	
DATARATE : 0.667 MBit/s	DATARATE : 0.384 MBit/s	

Figure 2-7: Screen display of TS information on CBARS100.GTS

Video	Still picture CCIR601 color bar signal 100/0/100/0. Color bar signal with a luminance amplitude of 100% and a color saturation of 100%.
Signal source	CCIR 601 Test Signal Generator.
Example of use	Test and adjustment of phase and level ratios for MPEG-2 decoders and PAL coders. The color coding can very easily be checked by means of a vectorscope.
Audio	
left channel	Sine burst of 15 kHz with 4 dB _r with a duration of 1 s and for the remaining 0.92 s no burst (silence).
right channel	No burst / silence.
Example of use	Measurement of crosstalk.

**Transport Stream
CBARS75.GTS**

TS INFORMATION : CBARS75.GTS		VERSION : V1.2 06.02.97
DATARATE : 20.000000 MBit/s		SEQUENCELENGTH : 1.92 s
MIN_DATARATE : 1.200000 MBit/S		PACKET_LENGTH : 188 Byte
		PCR_JITTER : 00000.0 µs
PROGRAM 1 DVG 1	PMT PID : 128 (0080 h)	PCR PID: 100 (0064 h)
ES TYPE : Video 625	ES TYPE : Audio	
ES 1 : Colourbars75	ES 2 : R 15kHz 1s	
ES PID : 100 (0064 h)	ES PID : 101 (0065 h)	
DATARATE : 0.559 MBit/s	DATARATE : 0.384 MBit/s	

Figure 2-8: Screen display of TS information on CBARS75.GTS

Video	Still picture CCIR601 color bar signal 100/0/75/0. Color bar signal with a luminance amplitude of 100% and a Color saturation of 75%.
Signal source	CCIR 601 Test Signal Generator.
Example of use	Test and adjustment of phase and level ratios for MPEG-2 decoders and PAL coders. The color coding can very easily be checked by means of a vectorscope.
Audio	
left channel	No burst / silence.
right channel	Sine burst of 15 kHz with 4 dB _r with a duration of 1 s and for the remaining 0.92 s no burst (silence).
Example of use	Measurement of crosstalk.

**Transport Stream
CCIR17.GTS**

TS INFORMATION : CCIR17.GTS		VERSION : V1.2 06.02.97
DATARATE : 20.000000 MBit/s	MIN_DATARATE : 1.400000 MBit/S	SEQUENCELENGTH : 1.92 s
		PACKET LENGTH : 188 Byte
		PCR JITTER : 00000.0 µs
PROGRAM 1 DVG 1	PMT PID : 128 (0080 h)	PCR PID: 100 (0064 h)
ES TYPE : Video 625	ES TYPE : Audio	
ES 1 : ITS CCIR17	ES 2 : L+R 1kHz 1s	
ES PID : 100 (0064 h)	ES PID : 101 (0065 h)	
DATARATE : 0.745 MBit/s	DATARATE : 0.384 MBit/s	

Figure 2–9: Screen display of TS information on CCIR17.GTS

Video	Still picture with test line CCIR17. The structure of the test line ITS 1 CCIR 17 corresponds to CCIR recommendation 473-4. A white bar is provided at the beginning of the line followed by a 2T pulse, a modulated 20T pulse, and a five-level luminance staircase.								
Signal source	CCIR 601 Test Signal Generator.								
Example of use	Test and adjustment of levels, tilts, overshoots, roundings, pulse distortions, reflections, color subcarrier amplitudes and delays, and luminance nonlinearity. Standard line for automatic measurement and monitoring of the signal. The following distortions can be measured at the single elements of the signal: <table> <tr> <td>White bar:</td> <td>level error, line-repetitive tilt, overshoot, and roundings.</td> </tr> <tr> <td>2Tpulse:</td> <td>amplitude error, pulse distortions, and reflections.</td> </tr> <tr> <td>20Tpulse:</td> <td>amplitude and delay differences between luminance and chrominance of the CCVS¹ signal.</td> </tr> <tr> <td>Staircase:</td> <td>luminance nonlinearity.</td> </tr> </table>	White bar:	level error, line-repetitive tilt, overshoot, and roundings.	2Tpulse:	amplitude error, pulse distortions, and reflections.	20Tpulse:	amplitude and delay differences between luminance and chrominance of the CCVS ¹ signal.	Staircase:	luminance nonlinearity.
White bar:	level error, line-repetitive tilt, overshoot, and roundings.								
2Tpulse:	amplitude error, pulse distortions, and reflections.								
20Tpulse:	amplitude and delay differences between luminance and chrominance of the CCVS ¹ signal.								
Staircase:	luminance nonlinearity.								
Audio (left and right channel)	Sine burst of 1 kHz with 0 dB _r with a duration of 1 s and for the remaining 0.92 s no burst (silence).								

¹ Composite Color Video Signal

**Transport Stream
CCIR18.GTS**

TS INFORMATION : CCIR18.GTS	VERSION : V2.00 19.08.97
TS RATE : 40.000000 MBit/s	SEQUENCELENGTH : 15.36 s
MIN TS RATE : 2.310444 MBit/S	PACKET LENGTH : 188 Byte
	PCR JITTER : 00000.0 µs
PROGRAM 1 ITS CCIR18	PMT PID : 128 (0080 h) PCR PID: 100 (0064 h)
ES TYPE : Video 625	ES TYPE : Audio
ES 1 : ITS CCIR18	ES 2 : Multitone
ES PID : 100 (0064 h)	ES PID : 101 (0065 h)
DATARATE : 1.670 MBit/s	DATARATE : 0.384 MBit/s

Figure 2-10: Screen display of TS information on CCIR18.GTS

Video	Multiburst in frame.
Audio (left and right channel)	L+R sine burst at -12 dB _r for 1 s each at the following frequencies in sequence: 40 Hz 80 Hz 200 Hz 500 Hz 820 Hz 2 kHz 3 kHz 5 kHz 6.5 kHz 9.5 kHz 11.5 kHz 13.5 kHz 15 kHz then silence.
Example of use	Check video and audio amplitude-frequency response.

**Transport Stream
CCIR3311.GTS**

TS INFORMATION : CCIR3311.GTS	VERSION : V2.00 19.08.97
TS RATE : 40.000000 MBit/s	SEQUENCELENGTH : 1.92 s
MIN TS RATE : 0.790386 MBit/S	PACKET LENGTH : 188 Byte
	PCR JITTER : 00000.0 µs
PROGRAM 1 ITS CCIR331-1 PMT PID : 128 (0080 h) PCR PID: 0100 (0064 h)	
ES TYPE : Video 625 ES TYPE : Audio	
ES 1 : ITS CCIR331-1 ES 2 : L+R 1kHz 1s	
ES PID : 100 (0064 h) ES PID : 101 (0065 h)	
DATARATE : 0.476 MBit/s DATARATE : 0.192 MBit/s	

Figure 2–11: Screen display of TS information on CCIR3311.GTS

- Video** CCIR331-1 test signal in frame.
- Audio (left and right channel)** Sine burst of 1 kHz with 0 dB_r with a duration of 1 s and for the remaining 0.92 s no burst (silence).
- Example of use** Measurement of subcarrier in PAL coders (SET-UP BOX), nonlinearity of amplitude and phase, liminance-chrominance intermodulation.

**Transport Stream
CCIR3312.GTS**

TS INFORMATION : CCIR3312.GTS	VERSION : V2.00 19.08.97
TS RATE : 40.000000 MBit/s	SEQUENCELENGTH : 1.92 s
MIN TS RATE : 0.748146 MBit/S	PACKET LENGTH : 188 Byte
	PCR JITTER : 00000.0 µs
PROGRAM 1 ITS CCIR331-2 PMT PID : 128 (0080 h) PCR PID: 0100 (0064 h)	
ES TYPE : Video 625 ES TYPE : Audio	
ES 1 : ITS CCIR331-2 ES 2 : L+R 1kHz 1s	
ES PID : 100 (0064 h) ES PID : 101 (0065 h)	
DATARATE : 0.438 MBit/s DATARATE : 0.192 MBit/s	

Figure 2–12: Screen display of TS information on CCIR3312.GTS

- Video** CCIR331-2 test signal in frame.
- Audio (left and right channel)** Sine burst of 1 kHz with 0 dB_r with a duration of 1 s and for the remaining 0.92 s no burst (silence).
- Example of use** Measurement of subcarrier in PAL coders (SET-UP BOX), nonlinearity of amplitude and phase.

**Transport Stream
CCITT033.GTS**

TS INFORMATION : CCITT033.GTS		VERSION	: 1.20 06.02.97
DATARATE	: 35.000000 MBit/s	SEQUENCELENGTH	: 30.72 s
MIN_DATARATE	: 3.500000 MBit/S	PACKET LENGTH	: 188 Byte
		PCR JITTER	: 00000.0 µs
PROGRAM 1	CCITT 0.33	PMT PID	: 128 (0080 h) PCR PID: 0100 (0064 h)
ES TYPE	: Video 625	ES TYPE	: Audio
ES 1	: Codec 4:3	ES 2	: CCITT 0.33 MO
ES PID	: 0100 (0064 h)	ES PID	: 0101 (0065 h)
DATARATE	: 2.922 MBit/s	DATARATE	: 0.384 MBit/s

Figure 2-13: Screen display of TS information on CCITT033.GTS

Video

R&S CODEC 4:3 test pattern.

Audio (left and right channel)

Test tone sequence for automatic tone tests in mono (EBU line measurement according to CCITT O.33:00).

**Transport Stream
CODEC169.GTS**

The structure and the elements of this test sequence correspond to those of the CODEC43 sequence with the exception that the picture format corresponds to the 16:9 aspect ratio.

It is thus possible to check format switchover in the terminal and to also test the screen geometry of 16:9 TV CRTs.

TS INFORMATION : CODEC169.GTS	VERSION : V1.2 06.02.97
DATARATE : 20.000000 MBit/s	SEQUENCELENGTH : 1.92 s
MIN_DATARATE : 4.700000 MBit/S	PACKET LENGTH : 188 Byte
	PCR JITTER : 00000.0 µs
PROGRAM 1 DVG 1	PMT PID : 128 (0080 h) PCR PID: 100 (0064 h)
ES TYPE : Video 625	ES TYPE : Audio
ES 1 : Codec 16:9	ES 2 : Burst 9.5kHz
ES PID : 100 (0064 h)	ES PID : 101 (0065 h)
DATARATE : 4.010 MBit/s	DATARATE : 0.384 MBit/s

Figure 2–14: Screen display of TS information on CODEC169.GTS

Video

R&S CODEC 16:9 Test Pattern.
R&S CODEC 4:3 test pattern.

Audio (left and right channel)

Sine burst of 9.5 kHz with 0 dB_r, each of the 12 frames with a duration of 20 ms. In the remaining time, there is no burst.

**Transport Stream
CODEC43.GTS**

TS INFORMATION : CODEC43.GTS		VERSION : V1.10 26.09.96
DATARATE : 20.000000 MBit/s	MIN_DATARATE : 4.500000 MBit/S	SEQUENCELENGTH : 1.92 s
		PACKET LENGTH : 188 Byte
		PCR JITTER : 00000.0 µs
PROGRAM 1 DVG 1	PMT PID : 128 (0080 h)	PCR PID: 100 (0064 h)
ES TYPE : Video 625	ES TYPE : Audio	
ES 1 : Codec 4:3	ES 2 : L+R 1kHz 1s	
ES PID : 100 (0064 h)	ES PID : 101 (0065 h)	
DATARATE : 3.588 MBit/s	DATARATE : 0.384 MBit/s	

Figure 2-15: Screen display of TS information on CODEC43.GTS

Video

R&S CODEC 4:3 Test Pattern

This universal test pattern, MPEG2-CODEC Transport Stream (see Figure 2-16), consists of static picture elements for all analog measurements and, at the same time, of moving picture elements which enable the user to determine whether the MPEG transmission is still valid or whether the decoded image is frozen.

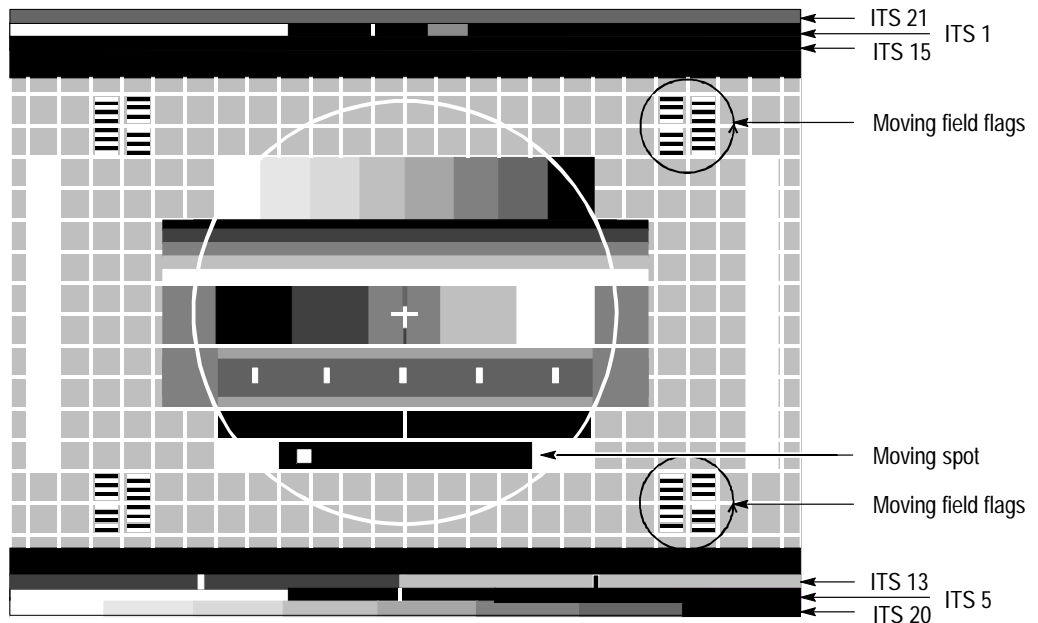

Figure 2-16: R&S MPEG-2 CODEC transport stream

Moving picture elements:

- Field flags** Four successive white areas appearing in every field indicate a continuous decoding of the transport stream. A fast rotating movement is generated.
- Moving spot** White spot that moves back and forth in the black field. A complete movement is performed in 24 frames. Thus, the errors in the time domain can be detected during decoding, and delay measurements between the different transmission paths are possible.

Monitor test pattern:

- Grid and circle** Adjustment of the geometry of the picture tubes and monitors.
- Color bar** Color purity, interchange of components, etc.
- Y ramp** D/A converter test.
- Convergence cross (luminance)+ blue and red pulse** Adjustment of monitor center and interchannel delays between Y, C_b and C_r.
- Multiburst** Frequency response and horizontal resolution.

Insertion Test Signal (ITS):

- ITS 21 red area** Used for PAL or NTSC conversion in terminals (CCVS signal). In the red areas, spurious amplitude and phase noise of the color subcarrier as common for television recording equipment can especially well be detected and measured.
- ITS 1 CCIR 17** Standard line for automatic measurement and monitoring of the signal. The following distortions can be measured at the single elements of the signal:
- White bar: level error, line-repetitive tilt, overshoot, and roundings.
 - 2Tpulse: amplitude error, pulse distortions, and reflections.
 - 20Tpulse: amplitude and delay differences between luminance and chrominance of the CCVS signal.
 - Staircase: luminance nonlinearity.
- ITS 15 ramp** Measurement of luminance nonlinearity and interfering voltage over the whole dynamic range as well as the quantization noise of the D/A converters.

ITS 13 SIN X/X	Frequency response and group-delay measurement.
ITS 5 CCIR 330/5	Similar to ITS 1 /CCIR 17 without 20T pulse and with a 5-level staircase superimposed by a color subcarrier. Therefore, nonlinearities in the range of the color subcarrier can be measured.
ITS 20 color bars	Check of color coding and the phase and level ratios, especially in the CCVS signal.
Audio (left and right channel)	Sine burst of 1 kHz with 0 dB _r with a duration of 1 s and for the remaining 0.92 s no burst (silence).

Transport Stream
DVTS_2M.GTS ...
DVTS_15M.GTS

TS INFORMATION : DVTS_2M.GTS	VERSION : V1.2 06.02.97
DATARATE : 20.000000 MBit/s	SEQUENCELENGTH : 7.68 s
MIN_DATARATE : 3.000000 MBit/S	PACKET LENGTH : 188 Byte
	PCR JITTER : 00000.0 µs
PROGRAM 1 DVG 1	PMT PID : 128 (0080 h) PCR PID: 100 (0064 h)
ES TYPE : Video 625	ES TYPE : Audio
ES 1 : Encodertest	ES 2 : Classic
ES PID : 100 (0064 h)	ES PID : 101 (0065 h)
DATARATE : 2 MBit/s	DATARATE : 0.384 MBit/s

Figure 2-17: Screen display of TS information on DVTS_2M.GTS

TS INFORMATION : DVTS_4M.GTS	VERSION : V1.2 06.02.97
DATARATE : 20.000000 MBit/s	SEQUENCELENGTH : 7.68 s
MIN_DATARATE : 5.000000 MBit/S	PACKET LENGTH : 188 Byte
	PCR JITTER : 00000.0 µs
PROGRAM 1 DVG 1	PMT PID : 128 (0080 h) PCR PID: 100 (0064 h)
ES TYPE : Video 625	ES TYPE : Audio
ES 1 : Encodertest	ES 2 : Classic
ES PID : 100 (0064 h)	ES PID : 101 (0065 h)
DATARATE : 4 MBit/s	DATARATE : 0.384 MBit/s

Figure 2-18: Screen display of TS information on DVTS_4M.GTS

TS INFORMATION : DVTS_6M.GTS	VERSION : V1.2 06.02.97
DATARATE : 20.000000 MBit/s	SEQUENCELENGTH : 7.68 s
MIN_DATARATE : 7.000000 MBit/S	PACKET LENGTH : 188 Byte
	PCR JITTER : 00000.0 µs
PROGRAM 1 DVG 1	PMT PID : 128 (0080 h) PCR PID: 100 (0064 h)
ES TYPE : Video 625	ES TYPE : Audio
ES 1 : Encodertest	ES 2 : Classic
ES PID : 100 (0064 h)	ES PID : 101 (0065 h)
DATARATE : 6 MBit/s	DATARATE : 0.384 MBit/s

Figure 2-19: Screen display of TS information on DVTS_6M.GTS

TS INFORMATION : DVTS_9M.GTS		VERSION	: V1.2 06.02.97
DATARATE	: 20.000000 MBit/s	SEQUENCELENGTH	: 7.68 s
MIN_DATARATE	: 10.000000 MBit/S	PACKET LENGTH	: 188 Byte
		PCR JITTER	: 00000.0 µs
PROGRAM	1 DVG 1	PMT PID	: 128 (0080 h) PCR PID: 100 (0064 h)
ES TYPE	: Video 625	ES TYPE	: Audio
ES 1	: Encodertest	ES 2	: Classic
ES PID	: 100 (0064 h)	ES PID	: 101 (0065 h)
DATARATE	: 9 MBit/s	DATARATE	: 0.384 MBit/s

Figure 2–20: Screen display of TS information on DVTS_9M.GTS

TS INFORMATION : DVTS_15M.GTS		VERSION	: V1.2 06.02.97
DATARATE	: 20.000000 MBit/s	SEQUENCELENGTH	: 3.84 s
MIN_DATARATE	: 16.000000 MBit/S	PACKET LENGTH	: 188 Byte
		PCR JITTER	: 00000.0 µs
PROGRAM	1 DVG 1	PMT PID	: 128 (0080 h) PCR PID: 100 (0064 h)
ES TYPE	: Video 625	ES TYPE	: Audio
ES 1	: Encodertest	ES 2	: Classic
ES PID	: 100 (0064 h)	ES PID	: 101 (0065 h)
DATARATE	: 15 MBit/s	DATARATE	: 0.384 MBit/s

Figure 2–21: Screen display of TS information on DVTS_15M.GTS

- Video** Moving picture scene; test picture scene for encoder test coded with different data rates from 2 Mbit/s to 15 Mbit/s.
- Use: Demonstration of picture quality and coding effects at different data rates.
- Audio** Extract from a piece of classical music recorded on CD; signals of harmony.

**Transport Stream
HSWEEP1.GTS**

TS INFORMATION : HSWEEP1.GTS		VERSION : V1.2 06.02.97
DATARATE : 20.000000 MBit/s		SEQUENCELENGTH : 1.92 s
MIN_DATARATE : 3.100000 MBit/S		PACKET LENGTH : 188 Byte
		PCR JITTER : 00000.0 µs
PROGRAM 1 DVG 1	PMT PID : 128 (0080 h)	PCR PID: 100 (0064 h)
ES TYPE : Video 625	ES TYPE : Audio	
ES 1 : H-Sweep 1	ES 2 : L+R 40Hz 1s	
ES PID : 100 (0064 h)	ES PID : 101 (0065 h)	
DATARATE : 2.294 MBit/s	DATARATE : 0.384 MBit/s	

Figure 2–22: Screen display of TS information on HSWEEP1.GTS

Video	Still picture with test line H-SWEEP 1. For the H sweep, the whole video frequency range is swept over a line starting with 5.5 MHz at the beginning of the line down to 0 Hz in the middle of the line and increasing again to 5.5 MHz at the end of the line. The signal is generated with an amplitude of 100% and has a constant frequency response over the whole frequency range at a high energy density and is superimposed to a grey level of 50%. HSWEEP1 is generated with a phase of 180°.
Signal source	Video Generator R&S SAF: Signal group: ITS / Signal No. 8 HSWEEP1.
Example of use	Amplitude-frequency response and frequency-dependent phase distortions are visible through the evaluation in the time domain. In case of a distortion, purely from the amplitude-frequency response, the sweep envelope is distorted symmetrically about the middle of the line. For exclusively group-delay distortion an asymmetrical ripple of the sweep envelope with reference to the middle of the line is obtained. If the two distortions are both present, the asymmetrical ripple and the symmetrical envelope about the middle of the line are superimposed.
Audio (left and right channel)	Sine burst of 40 Hz with –20 dB _r with a duration of 1 s and for the remaining 0.92 s no burst (silence).
Example of use	Short frequency response test for 40 Hz. See also Table 2–3 on page 2–9.

**Transport Stream
NONLIN.GTS**

TS INFORMATION : NONLIN.GTS		VERSION : V1.2 06.02.97
DATARATE : 20.000000 MBit/s	MIN_DATARATE : 2.000000 MBit/S	SEQUENCELENGTH : 1.92 s
		PACKET LENGTH : 188 Byte
		PCR JITTER : 00000.0 μs
PROGRAM 1 DVG 1	PMT PID : 128 (0080 h)	PCR PID: 100 (0064 h)
ES TYPE : Video 625	ES TYPE : Audio	
ES 1 : Nonlinearity	ES 2 : L+R 12kHz 1s	
ES PID : 100 (0064 h)	ES PID : 101 (0065 h)	
DATARATE : 1.434 MBit/s	DATARATE : 0.384 MBit/s	

Figure 2–23: Screen display of TS information on NONLIN.GTS

Video	Still picture to test nonlinearities. A line signal with the ramp signals in Y, C _B and C _R yielding full-range ramps (from 0 to 700 mV) with different slopes in analog RGB display.
Signal source	CCIR 601 Test Signal Generator.
Example of use	Test of nonlinearities in Y, C _b and C _r and test of RGB matrix.
Audio (left and right channel)	Sine burst of 12 kHz with –20 dB _r with a duration of 1 s and for the remaining 0.92 s no burst (silence).
Example of use	Short frequency response test for 12 kHz. See also Table 2–3 on page 2–9.

**Transport Stream
RAMPYC.GTS**

TS INFORMATION : RAMPYC.GTS		VERSION : V1.2 06.02.97
DATARATE : 20.000000 MBit/s		SEQUENCELENGTH : 1.92 s
MIN_DATARATE : 2.000000 MBit/S		PACKET LENGTH : 188 Byte
		PCR JITTER : 00000.0 μs
PROGRAM 1 DVG 1	PMT PID : 128 (0080 h)	PCR PID: 100 (0064 h)
ES TYPE : Video 625	ES TYPE : Audio	
ES 1 : Ramp Y C	ES 2 : L+R 9.5kHz 1s	
ES PID : 100 (0064 h)	ES PID : 101 (0065 h)	
DATARATE : 1.396 MBit/s	DATARATE : 0.384 MBit/s	

Figure 2–24: Screen display of TS information on RAMPYC.GTS

Video	Still Picture with ramps in all components.
Signal source	CCIR 601 Test Signal Generator.
Example of use	Missing codes and linearity of D/A converters.
Audio (left and right channel)	Sine burst of 9.5 kHz with -20 dB _r with a duration of 1 s and for the remaining 0.92 s no burst (silence).
Example of use	Short frequency response test for 9.5 kHz. See also Table 2–3 on page 2–9.

**Transport Stream
RGSWEEP.GTS**

TS INFORMATION : RGSWEEP.GTS		VERSION : V1.2 06.02.97
DATARATE : 20.000000 MBit/s		SEQUENCELENGTH : 1.92 s
MIN_DATARATE : 3.200000 MBit/S		PACKET_LENGTH : 188 Byte
		PCR_JITTER : 00000.0 µs
PROGRAM 1 DVG 1	PMT PID : 128 (0080 h)	PCR PID: 100 (0064 h)
ES TYPE : Video 625	ES TYPE : Audio	
ES 1 : RGB Sweep	ES 2 : L+R 14kHz 1s	
ES PID : 100 (0064 h)	ES PID : 101 (0065 h)	
DATARATE : 2.536 MBit/s	DATARATE : 0.384 MBit/s	

Figure 2–25: Screen display of TS information on RGSWEEP.GTS

Video

Still Picture with sweep in RGB components.

For the RGB sweep, the video frequency range for each of the RGB components is swept over a line starting with 5.8 MHz at the beginning of the line down to 0 Hz in the middle of the line and increasing again to 5.8 MHz at the end of the line. The corresponding component is generated with an amplitude of 100%, i.e., full range with analog signal from 0 to 700 mV.

The R sweep is transmitted in the first third of the frame, followed by G sweep and B sweep in the second and third.

Signal source

CCIR601 Test Signal Generator.

Example of use

Test and adjustment of RGB final stages. Measurements of amplitude-frequency response and group delay in RGB channels.

Audio (left and right channel)

Sine burst of 14 kHz with -20 dB_r with a duration of 1 s and for the remaining 0.92 s no burst (silence).

Example of use

Short frequency response test for 14 kHz. See also Table 2–3 on page 2–9.

**Transport Stream
SINXX.GTS**

TS INFORMATION : SINXX.GTS		VERSION : V1.2 06.02.97
DATARATE : 20.000000 MBit/s	MIN_DATARATE : 1.400000 MBit/S	SEQUENCELENGTH : 1.92 s
		PACKET LENGTH : 188 Byte
		PCR JITTER : 00000.0 µs
PROGRAM 1 DVG 1	PMT PID : 128 (0080 h)	PCR PID: 100 (0064 h)
ES TYPE : Video 625	ES TYPE : Audio	
ES 1 : Sinus x/x	ES 2 : L+R 18kHz 1s	
ES PID : 100 (0064 h)	ES PID : 101 (0065 h)	
DATARATE : 0.857 MBit/s	DATARATE : 0.384 MBit/s	

Figure 2–26: Screen display of TS information on SINXX.GTS

Video	Still picture with test line sine x/x. The sinx/x pulse is characterized by a uniform distribution of energy in the frequency spectrum. The pulse is calculated for a video bandwidth of 5 MHz.
Signal source	CCIR601 Test Signal Generator:
Example of use	For amplitude-frequency response measurements, the sinx/x signal can directly be evaluated with a spectrum analyzer. The presence of nonlinear distortions is shown by two different envelopes being displayed on the spectrum analyzer. The signal is also a very sensitive indicator for the group-delay response. The group-delay response is detected through the different amplitudes of the preshoot and postshoot in the measurement of the analog signal (after D/A conversion and analog processing) as measured on the oscilloscope.
Audio (left and right channel)	Sine burst of 18 kHz with -20 dB_r with a duration of 1 s and for the remaining 0.92 s no burst (silence).
Example of use	Short frequency response test for 18 kHz. See also Table 2–3 on page 2–9.

**Transport Stream
WINDOW.GTS**

TS INFORMATION : WINDOW.GTS		VERSION : V1.2 06.02.97
DATARATE : 20.000000 MBit/s		SEQUENCELENGTH : 1.92 s
MIN_DATARATE : 1.100000 MBit/S		PACKET LENGTH : 188 Byte
		PCR JITTER : 00000.0 µs
PROGRAM 1 DVG 1	PMT PID : 128 (0080 h)	PCR PID: 100 (0064 h)
ES TYPE : Video 625	ES TYPE : Audio	
ES 1 : Window Pluge	ES 2 : L+R 7/11kHz	
ES PID : 100 (0064 h)	ES PID : 101 (0065 h)	
DATARATE : 0.484 MBit/s	DATARATE : 0.384 MBit/s	

Figure 2–27: Screen display of TS information on WINDOW.GTS

Video	Still picture with white window and 2T pulse. The signal consists of a white window (100% amplitude), a PLUGE signal ($\pm 2\%$ amplitude), as well as a 2T pulse and a modulated 20T pulse with 100% amplitude each.
Signal source	CCIR601 Test Signal Generator: APL Signal.
Example of use	Test of sweep voltage generation and black adjustment of monitors with the PLUGE signal. With the inserted window, field-frequency (50 Hz), and line-frequency (15 kHz), tilts are made visible on the picture monitor or waveform monitor.
Audio (left and right channel)	Sine burst of 7 kHz mixed with a sine burst of 11 kHz with -6 dB_r with a duration of 1 s and for the remaining 0.92 s no burst (silence).
Example of use	Difference-frequency distortion.

**Transport Stream
ZONEPL.GTS**

TS INFORMATION : ZONEPL.GTS		VERSION : V1.2 06.02.97
DATARATE : 20.000000 MBit/s		SEQUENCELENGTH : 1.92 s
MIN_DATARATE : 15.800000 MBit/S		PACKET LENGTH : 188 Byte
		PCR JITTER : 00000.0 μs
PROGRAM 1 DVG 1	PMT PID : 128 (0080 h)	PCR PID: 100 (0064 h)
ES TYPE : Video 625	ES TYPE : Audio	
ES 1 : Zoneplate	ES 2 : L+R Noise 1s	
ES PID : 100 (0064 h)	ES PID : 101 (0065 h)	
DATARATE : 15 MBit/s	DATARATE : 0.384 MBit/s	

Figure 2–28: Screen display of TS information on ZONEPL.GTS

Video	Circular zone-plate test signal.
Signal source	CCIR601 Test Signal Generator.
Audio (left and right channel)	White noise (incoherent) with -10 dB_r with a duration of 1 s and for the remaining 0.92 s no burst (silence).
Example of use	Acoustic measurements.

**Transport Stream
6_PROG.GTS**

TS INFORMATION : 6_PROG.GTS		VERSION : 1.20 06.02.97
DATARATE : 35.000000 MBit/s		SEQUENCE LENGTH : 1.92 s
MIN_DATARATE : 14.000000 MBit/S		PACKET LENGTH : 188 Byte
		PCR JITTER : 00000.0 µs
PROGRAM 1	Bounce	VA 0.655 MBit/s
PROGRAM 2	H-Sweep 1	VAA 3.062 MBit/s
PROGRAM 3	Ramp Y C	VA 1.780 MBit/s
PROGRAM 4	Nonlinearity	VA 1.818 MBit/s
PROGRAM 5	RGB Sweep	VA 2.920 MBit/s
PROGRAM 6	CCIR17	VA 1.129 MBit/s

Figure 2–29: Screen Display of TS information on 6_PROG.GTS

TS INFORMATION : 6_PROG.GTS		VERSION : 1.20 06.02.97
DATARATE : 35.000000 MBit/s		SEQUENCE LENGTH : 1.92 s
MIN_DATARATE : 14.000000 MBit/S		PACKET LENGTH : 188 Byte
		PCR JITTER : 00000.0 µs
PROGRAM 1	Bounce	
PMT PID: 0120 (0000 h)		
PCR PID: 0100 (0064 h)		
ES 1	Video 625	0100 (0064 h) DATARATE: 0.271 MBit/s
ES 2	Audio	0101m(0065 h) DATARATE: 0.384 Mbits/s

Figure 2–30: Screen Display of TS information with Program 1 Bounce selected

- Video** Multiple test patterns.
- Audio (left and right channel)** See Table 2–2 on page 2–7 for audio contents for each program.
- Example of use** Testing a decoder’s ability to decode different programs from one transport stream.

Transport Stream CODECDBL.GTS Transport stream with two programs consisting of the elementary streams of transport streams CODEC43.GTS and CODEC169.GTS.

TS INFORMATION : CODECDBL.GTS		VERSION : V1.2 06.02.97
Datarate : 20.000000 MBit/s		SEQUENCE LENGTH : 1.92 s
MIN_Datarate : 8.600000 MBit/s		PACKET LENGTH : 188 Byte
		PCR JITTER : 00000.0 µs
PROGRAM 1 DVG 1	PMT PID : 128 (0080 h)	PCR PID: 100 (0064 h)
ES TYPE : Video 625	ES TYPE : Audio	
ES 1 : Codec 4:3	ES 2 : L+R 1 kHz 1s	
ES PID : 100 (0064 h)	ES PID : 101 (0065 h)	
Datarate : 3.588 MBit/s	Datarate : 0.384 MBit/s	
PROGRAM 2 DVG 2	PMT PID : 129 (0081 h)	PCR PID: 200 (00C8 h)
ES TYPE : Video 625	ES TYPE : Audio	
ES 1 : Codec 16:9	ES 2 : Burst 9.5kHz	
ES PID : 200 (00C8 h)	ES PID : 201 (00C9 h)	
Datarate : 4.010 MBit/s	Datarate : 0.384 MBit/s	

Figure 2–31: Screen display of TS information on CODECDBL.GTS

Video CODEC 4:3 and 16:9 Test Pattern.
 Program 1; R&S CODEC 4:3 Test Pattern.
 Program 2; R&S CODEC 16:9 Test Pattern.

Audio Program 1; see Transport Stream CODEC43.GTS.
 Program 2; see Transport Stream CODEC169.GTS.

**Transport Stream
DVTS_DBL.GTS**

TS INFORMATION : DVTS_DBL.GTS		VERSION : V1.2 06.02.97
DATARATE : 20.000000 MBit/s	MIN_DATARATE : 10.000000 MBit/S	SEQUENCE LENGTH : 7.68 s
		PACKET LENGTH : 188 Byte
		PCR JITTER : 00000.0 µs
PROGRAM 1 DVG 1	PMT PID : 30 (001E h)	PCR PID: 100 (0024 h)
ES TYPE : Video 625	ES TYPE : Audio	
ES 1 : Encodertest	ES 2 : Classic	
ES PID : 36 (0024 h)	ES PID : 201 (00C9 h)	
DATARATE : 2.0 MBit/s	DATARATE : 0.384 MBit/s	
PROGRAM 2 DVG 2	PMT PID : 31 (001F h)	PCR PID: 200 (0025 h)
ES TYPE : Video 625	ES TYPE : Audio	
ES 1 : Encodertest	ES 2 : Queen/Magic	
ES PID : 37 (0025 h)	ES PID : 301 (012D h)	
DATARATE : 6.0 MBit/s	DATARATE : 0.384 MBit/s	

Figure 2-32: Screen display of TS information on DVTS_DBL.GTS

Video

Moving picture scene; test picture scene for encoder test coded with different data rates.

Use: Demonstration of picture quality and coding effects at different data rates.

Audio

Extract from a piece of classical music recorded on CD; signals of harmony.

**Transport Stream
FLOWERGA.GTS**

TS INFORMATION : FLOWERGA.GTS		VERSION : 2.00 18.08.97
TS RATE : 40.000000 MBit/s		SEQUENCE LENGTH : 7.68 s
MIN TS RATE : 14.144107 MBit/S		PACKET LENGTH : 188 Byte
		PCR JITTER : 00000.0 µs
PROGRAM 1 Flower Garden	PMT PID 0110 (006E h)	PCR PID: 0111 (006F h)
ES TYPE : Video 625	ES TYPE : Audio	
ES 1 : Flower Garden	ES 2 : Classic	
ES PID : 0111 (006F h)	ES PID : 0112 (0070 h)	
DATARATE : 2.000 MBit/s	DATARATE : 0.192 MBit/s	
PROGRAM 2 Flower Garden	PMT PID 0120 (0078 h)	PCR PID: 0121 (0079 h)
ES TYPE : Video 625	ES TYPE : Audio	
ES 1 : Flower Garden	ES 2 : Classic	
ES PID : 0121 (0079 h)	ES PID : 0122 (007A h)	
DATARATE : 4.000 MBit/s	DATARATE : 0.192 MBit/s	
PROGRAM 3 Flower Garden	PMT PID :0130 (0082 h)	PCR PID: 0131 (0083 h)
ES TYPE : Video 625	ES TYPE : Audio	
ES 1 : Flower Garden	ES 2 : Classic	
ES PID : 0131 (0083 h)	ES PID : 0132 (0084 h)	
DATARATE : 6.000 MBit/s	DATARATE : 0.384 MBit/s	

Figure 2–33: Screen display of TS information on FLOWERGA.GTS

Video	Flowers and windmill in background for 192 frames (7.68s).
Signal source	EBU test scene
Audio	Classical music
Examples of use	Test visual and audio, demonstrate picture quality as a function of data rate.

**Transport Stream
T_TENNIS.GTS**

TS INFORMATION : T_TENNIS.GTS		VERSION : 2.00 18.08.97
TS RATE : 40.000000 MBit/s		SEQUENCE LENGTH : 7.68 s
MIN TS RATE : 14.355387 MBit/S		PACKET LENGTH : 188 Byte
		PCR JITTER : 00000.0 µs
PROGRAM 1 Table Tennis PMT PID 0110 (006E h) PCR PID: 0111 (006F h)		
ES TYPE : Video 625	ES TYPE : Audio	
ES 1 : Table Tennis	ES 2 : Applause	
ES PID : 0111 (006F h)	ES PID : 0112 (0070 h)	
DATARATE : 2.000 MBit/s	DATARATE : 0.192 MBit/s	
PROGRAM 2 Flower Garden PMT PID 0120 (0078 h) PCR PID: 0121 (0079 h)		
ES TYPE : Video 625	ES TYPE : Audio	
ES 1 : Table Tennis	ES 2 : Applause	
ES PID : 0121 (0079 h)	ES PID : 0122 (007A h)	
DATARATE : 4.000 MBit/s	DATARATE : 0.192 MBit/s	
PROGRAM 3 Flower Garden PMT PID :0130 (0082 h) PCR PID: 0131 (0083 h)		
ES TYPE : Video 625	ES TYPE : Audio	
ES 1 : Table Tennis	ES 2 : Applause	
ES PID : 0131 (0083 h)	ES PID : 0132 (0084 h)	
DATARATE : 6.000 MBit/s	DATARATE : 0.384 MBit/s	

Figure 2-34: Screen display of TS information on T_TENNIS.GTS

- Video** Pan shot of a table tennis match for 192 frames (7.68s).
- Signal source** EBU test scene
- Audio** Applause
- Examples of use** General function test of vision and sound, demonstration of picuter quality as a function of data rate.

Transport Stream
FACT_3M.GTS ...
FACT_15M.GTS

TS INFORMATION : FACT_3M.GTS	VERSION : V1.2 06.02.97
DATARATE : 20.000000 MBit/s	SEQUENCE LENGTH : 7.68 s
MIN_DATARATE : 5.000000 MBit/S	PACKET LENGTH : 188 Byte
	PCR JITTER : 00000.0 µs
PROGRAM 1 DVG 1	PMT PID : 128 (0080 h) PCR PID: 100 (0064 h)
ES TYPE : Video 625	ES TYPE : Audio
ES 1 : R&S Factory	ES 2 : Classic
ES PID : 100 (0064 h)	ES PID : 101 (0065 h)
DATARATE : 3 MBit/s	DATARATE : 0.384 MBit/s

Figure 2–35: Screen display of TS information on FACT_3M.GTS

TS INFORMATION : FACT_4M.GTS	VERSION : V1.2 06.02.97
DATARATE : 20.000000 MBit/s	SEQUENCE LENGTH : 7.68 s
MIN_DATARATE : 5.000000 MBit/S	PACKET LENGTH : 188 Byte
	PCR JITTER : 00000.0 µs
PROGRAM 1 DVG 1	PMT PID : 128 (0080 h) PCR PID: 100 (0064 h)
ES TYPE : Video 625	ES TYPE : Audio
ES 1 : R&S Factory	ES 2 : Classic
ES PID : 100 (0064 h)	ES PID : 101 (0065 h)
DATARATE : 4 MBit/s	DATARATE : 0.384 MBit/s

Figure 2–36: Screen display of TS information on FACT_4M.GTS

TS INFORMATION : FACT_6M.GTS	VERSION : V1.2 06.02.97
DATARATE : 20.000000 MBit/s	SEQUENCE LENGTH : 7.68 s
MIN_DATARATE : 7.000000 MBit/S	PACKET LENGTH : 188 Byte
	PCR JITTER : 00000.0 µs
PROGRAM 1 DVG 1	PMT PID : 128 (0080 h) PCR PID: 100 (0064 h)
ES TYPE : Video 625	ES TYPE : Audio
ES 1 : R&S Factory	ES 2 : Classic
ES PID : 100 (0064 h)	ES PID : 101 (0065 h)
DATARATE : 6 MBit/s	DATARATE : 0.384 MBit/s

Figure 2–37: Screen display of TS information on FACT_6M.GTS

TS INFORMATION : FACT_9M.GTS		VERSION : V1.2 06.02.97
DATARATE : 20.000000 MBit/s		SEQUENCE LENGTH : 7.68 s
MIN_DATARATE : 11.000000 MBit/S		PACKET LENGTH : 188 Byte
		PCR JITTER : 00000.0 µs
PROGRAM 1 DVG 1	PMT PID : 128 (0080 h)	PCR PID: 100 (0064 h)
ES TYPE : Video 625	ES TYPE : Audio	
ES 1 : R&S Factory	ES 2 : Classic	
ES PID : 100 (0064 h)	ES PID : 101 (0065 h)	
DATARATE : 9 MBit/s	DATARATE : 0.384 MBit/s	

Figure 2-38: Screen display of TS information on FACT_9M.GTS

TS INFORMATION : FACT_15M.GTS		VERSION : V1.2 06.02.97
DATARATE : 20.000000 MBit/s		SEQUENCE LENGTH : 3.84 s
MIN_DATARATE : 16.000000 MBit/S		PACKET LENGTH : 188 Byte
		PCR JITTER : 00000.0 µs
PROGRAM 1 DVG 1	PMT PID : 128 (0080 h)	PCR PID: 100 (0064 h)
ES TYPE : Video 625	ES TYPE : Audio	
ES 1 : R&S Factory	ES 2 : Classic	
ES PID : 100 (0064 h)	ES PID : 101 (0065 h)	
DATARATE : 15 MBit/s	DATARATE : 0.384 MBit/s	

Figure 2-39: Screen display of TS information on FACT_15M.GTS

- Video** Moving picture scene with automatic insertion machine.
Length 7.68 seconds.
Coded with different data rates (from 3 Mbit/s to 15 Mbit/s).
- Audio** Extract from a piece of classical music recorded on CD;
signals of harmony.

**Transport Stream
NSCHWAN.GTS**

TS INFORMATION : NSCHWAN.GTS		VERSION : V1.2 06.02.97
DATARATE : 20.000000 MBit/s		SEQUENCELENGTH : 7.68 s
MIN_DATARATE : 3.000000 MBit/S		PACKET LENGTH : 188 Byte
		PCR JITTER : 00000.0 µs
PROGRAM 1 DVG 1	PMT PID : 128 (0080 h)	PCR PID: 100 (0064 h)
ES TYPE : Video 625	ES TYPE : Audio	
ES 1 : Castle	ES 2 : Classic	
ES PID : 100 (0064 h)	ES PID : 101 (0065 h)	
DATARATE : 2 MBit/s	DATARATE : 0.384 MBit/s	

Figure 2–40: Screen display of TS information on NSCHWAN.GTS

- Video** Moving picture scene: Aerial view of Castle of Neuschwanstein and the Bavarian Alps.
- Audio** Extract from a piece of classical music recorded on CD; signals of harmony.

**Transport Stream
DVMD_CHK.GTS**

TS INFORMATION : DVMD_CHK.GTS		VERSION : 1.20 18.03.97
DATARATE : 35.000000 MBit/s		SEQUENCELENGTH : 9.60 s
MIN_DATARATE : 3.500000 MBit/S		PACKET LENGTH : 188 Byte
		PCR JITTER : 00000.0 μs
PROGRAM 1 : DVMD CHECK	PMT PID : 0128 (0080 h)	PCR PID: 0511 (01FF h)
ES TYPE : Video 625	ES TYPE : Audio	
ES 1 : Codec 4:3	ES 2 : L+R 1kHz 1s	
ES PID : 0511 (01FF h)	ES PID : 0512 (0200 h)	
DATARATE : 2.922 MBit/s	DATARATE : 0.384 MBit/s	

Figure 2–41: Screen display of TS information on DVMD_CHK.GTS

- Video** R&S CODEC 4:3 Test Pattern. This universal test pattern, MPEG2-CODEC Transport Stream (see Figure 2–16 on page 2–22), consists of static picture elements for all analog measurements and, at the same time, of moving picture elements which enable the user to determine whether the MPEG transmission is still valid or whether the decoded image is frozen.
- Audio (left and right channel)** Sine burst of 1 kHz at 0 dB_r for 1 s followed by 0.92 s of silence.
- Example of Use** This transport sequence contains multiple errors that will result in unstable operation of decoders. It tests a decoder’s ability to handle errors with minimal disruption to the video/audio program.
- Errors** The following list indicates the first, second, and third priority errors, as described in DVB document EBR 290, present in this transport stream.
- First priority errors:**
- PAT:TABLE_ID
 - PMT:SCRAMBLED
 - SYNC_BYTE:BURST
 - CONT_COUNT:PACK ORDER a M.T. TWICE
 - PID:MISSING

Second priority errors:

- TRANSPORT
- PTS
- CRC²

Third priority errors:

- TDT:UPPER DISTANCE
- SI:REPEAT

² Error in event information table

All errors are repeated every 8.008 s and occur approximately every second in the following order:

- SYNC
- PAT
- CONT
- PMT
- PID
- TRANS
- CRC
- OTHER

**Transport Stream
TELETEXT.GTS**

TS INFORMATION : TELETEXT.GTS	VERSION : V2.00 19.08.97
TS RATE : 40.000000 MBit/s	SEQUENCELENGTH : 1.92 s
MIN TS RATE : 4.467851 MBit/S	PACKET LENGTH : 188 Byte
	PCR JITTER : 00000.0 µs
PROGRAM 1 TELETEXT PMT PID : 128 (0080 h)	PCR PID: 0511 (01FF h)
ES TYPE : Video 625	ES TYPE : Audio
ES 1 : CODEC 4:3	ES 2 : L+R 1kHz 1s
ES PID : 0511 (01FF h)	ES PID : 0512 (0200 h)
DATARATE : 3.588 MBit/s	DATARATE : 0.384 MBit/s

Figure 2-42: Screen display of TS information on TELETEXT.GTS

- Video** CODEC test pattern 4:3
- Audio** Sine burst L+R for 20ms at 0dB
- Data contents¹** Teletext test pages, four teletext lines per frame
- Examples of use** Test of teletext transcoders

¹ See page 2-82 for more information about the data contents.

Transport Streams for 525 Lines Systems

The supplied transport streams differ in their contents and structure and are suitable for different fields of application.

Table 2-7: Moving picture scenes in directory: GTS_LIVE

File name	Video contents	Audio contents	Special feature	Use
FACT_3M.GTS	Automatic insertion machine in operation	Classical music	Video with 3 Mbit/s coded	General function test of vision and sound
FACT_4M.GTS	Automatic insertion machine in operation	Classical music	Video with 4 Mbit/s coded	General function test of vision and sound
FACT_6M.GTS	Automatic insertion machine in operation	Classical music	Video with 6 Mbit/s coded	General function test of vision and sound
FACT_9M.GTS	Automatic insertion machine in operation	Classical music	Video with 9 Mbit/s coded	General function test of vision and sound
FACT_15M.GTS	Automatic insertion machine in operation	Classical music	Video with 15 Mbit/s coded	General function test of vision and sound
NSCHWAN.GTS	Aerial view of Castle of Neuschwanstein	Classical music	Video with 4 Mbit/s coded	General function test of vision and sound

Table 2-8: Still-picture and test-pattern sequences in directory: GTS_MEAS

File name	Video contents	Audio contents	Special feature	Use
BLUE.GTS	All blue picture	3 audio L + R: 1 kHz, 0 dBr Sampling rate: A1 = 32 kHz A2 = 44.1 kHz A3 = 48 kHz	Special audio sampling rate	Measurement of chroma noise
BOUNCE.GTS	Alternating all-black and all-white picture	L+R 1 kHz sine only during all-white picture	Alternating still picture	Test of clamping circuits, delay measurements, delay between vision and sound
BOUNCE_S.GTS	All white: 1.201 s All black: 5.205 s	L + R: 1.20 s, 1 kHz, +6 dBr Silence for 5.21 s	Audio and video synchronized	Test of clamping circuits, delay measurements, delay between video and audio
CBARS100.GTS	CCIR 601 color bars 100/0/100/0	L: sine burst 1 s 15 kHz 4 dB _r R: silence	Still picture	Test and alignment of phase and level ratios for MPEG2 decoders and PAL coders
CBARS75.GTS	CCIR 601 color bars 100/0/75/0	L: silence R: sine burst 1 s 15 kHz, 4 dB _r	Still picture	Test and alignment of phase and level ratios for MPEG2 decoders and PAL coders

Table 2–8: Still-picture and test-pattern sequences in directory: GTS_MEAS (cont.)

File name	Video contents	Audio contents	Special feature	Use
CCITTO33.GTS	Rohde & Schwarz CODEC test pattern 4:3	CCITT O.33.00 mono- phonic test sequence	EBU line measure- ment to CCITT O.33	Test and alignment of insertion gain, frequency response, interchannel gain and phase, THD, compandors, and SNR in audio circuits
CODEC169.GTS	Rohde & Schwarz CODEC test pattern 16:9	L+R: sine burst 20 ms 9.5 kHz 6 dB _r	Monitor test pattern with moving picture elements	Test and alignment of D/A converters and analog components in the video paths of decoders; monitor geometry alignment
CODEC43.GTS	Rohde & Schwarz CODEC test pattern 4:3	L+R: sine burst 1 s 1 kHz, 0 dB _r	Monitor test pattern with moving picture elements	Test and alignment of D/A converters and analog components in the video paths of decoders; monitor geometry alignment
HSWEEP1.GTS	H-SWEEP test signal in frame	L+R: sine burst 1 s 40 Hz, –20 dB _r	Still picture	Amplitude frequency response
ITS1.GTS	NTC7 Composite signal ITS 1 test signal in frame	L+R: sine burst 1 s 1 kHz, 0 dB _r	Still picture	Test and alignment of level, tilt, overshoot, rounding, pulse distortion, reflection, color subcarrier amplitude and delay, luminance nonlinearity
ITS2.GTS	NTC7 Combined signal ITS 2 test signal in frame	L+R: sine burst 1 s 40 Hz, –20 dB _r	Still picture	Test and alignment of level, color subcarrier amplitude and phase, chrominance/luminance intermodula- tion
ITS3.GTS	FCC Composite signal ITS 3 test signal in frame	L+R: sine burst 1 s 9.5 kHz, –20 dB _r	Still picture	Test and alignment of level, tilt, overshoot, rounding, pulse distortion, reflection, color subcarrier amplitude and delay, luminance nonlinearity
ITS4.GTS	VIRS (Vertical Interval Reference Signal) ITS 4 test signal in frame	L+R: sine burst 1 s 12 kHz, –20 dB _r	Still picture	The signal is used as reference for the chrominance to correct phase and amplitude errors on the trans- mission link

Table 2-8: Still-picture and test-pattern sequences in directory: GTS_MEAS (cont.)

File name	Video contents	Audio contents	Special feature	Use
MULTIBUR.GTS	Multiburst in frame	Sequence L + R, -12 dB _r , 1 s each 40 Hz 80 Hz 200 Hz 500 Hz 820 Hz 2 kHz 3 kHz 5 kHz 6.3 kHz 9.5 kHz 11.5 kHz 13.5 kHz 15 kHz		Video and audio amplitude-frequency response
NONLIN.GTS	Ramps in RGB	L+R: sine burst 1 s 12 kHz, -20 dB _r	Still picture	Test of RGB matrix
RAMPYC.GTS	Ramps in all components in frame	L+R: sine burst 1 s 9.5 kHz, -20 dB _r	Still picture	Missing codes and linearity of D/A converters
RGBSWEEP.GTS	Sweep in RGB signal	L+R: sine burst 1 s 14 kHz, -20 dB _r	Still picture	Test and alignment of RGB output stages
SINXX.GTS	Sine x/x test signal in frame	L+R: sine burst 1 s 18 kHz, -20 dB _r	Still picture	Amplitude frequency response, nonlinear distortion
WINDOW.GTS	All-white window	L+R: diff. tone 1 s 7 + 11 kHz, -6 dB _r	Still picture	Test of sweep voltage generation and black-level adjustment of monitors
ZONEPL.GTS	Zone plate	L+R noise white/incoherent 10 dB _r	Moving picture	Frequency response, both horizontal and vertical

Table 2-9: Transport streams with two or more programs in directory: GTS_MEAS

File name	Video contents	Audio contents	Special feature	Use
6_PROG.GTS	Six different still-picture and test-pattern sequences from Table 2-7*	Audio for each program corresponds to that listed in Table 2-7	Six programs in one transport stream	General function test of DVB decoders
CODECDBL.GTS	Program 1: CODEC test pattern 4:3 Program 2: CODEC test pattern 16:9	Program 1: L+R: sine burst 1 s 1 kHz, 0 dB _r Program 2: L+R: sine burst 20 ms 9.5 kHz, 6 dB _{rr}	Monitor test pattern with moving picture elements	Test and alignment of D/A converters and analog components in the video paths of decoders; monitor geometry alignment
FLOWERGA.GTS	Flowers and windmill in background Program 1: 2 Mbit/s coded Program 2: 4 Mbit/s coded Program 3: 6 Mbit/s coded	Classical music Classical music Classical music	Duration: 192 video frames	Test of vision and sound, demonstration of picture quality as a function of data rate
T_TENNIS.GTS	Table tennis match Program 1: 2 Mbit/s coded Program 2: 4 Mbit/s coded Program 3: 6 Mbit/s coded	Applause Applause Applause	Duration: 192 video frames	General function test of vision and sound, demonstration of picture quality as a function of data rate

* BOUNCE, H-SWEEP1, RAMPYC, NONLIN, RGBSWEEP, CCIR17

Table 2-10: Still picture and test pattern sequences in directory: GTS_ERRO*

File name	Video contents	Audio contents	Special features	Use
DVMD_CHK.GTS	CODEC test pattern 4:3	L+R: sine burst 1 s 1 kHz, 0 dB _r	Contains errors in most ETR-290 parameters	Testing MPEG2 and DVB protocol analyzers

Table 2–11: Transport streams and data contents in directory GTS_DATA

File name	Video contents	Audio contents	Data contents	Special features	Use
TELETEXT.GTS ¹	CODEC test pattern 4:3	L/R sine burst, 20 ms, 0 dB _r	Teletext test pages	Four teletext lines per frame	Test of teletext transcoders

¹ See page 2–82 for more information about the PES packets.

NOTE. Audio: $0 \text{ dB}_r = +6 \text{ dB}_u = 1.55 \text{ V (DIN 45406)}$

For each transport stream, a mask with the most important information is shown. If a PC monitor is not connected to the MPEG test generator, the required information can be looked up in the mask. For each program, the individual elementary stream information, such as name, type, PIDs used, data rates, and the minimum data rate and sequence length, are indicated.

Transport Stream
FACT_3M.GTS ...
FACT_15M.GTS

TS INFORMATION : FACT_3M.GTS	VERSION : V1.2 06.02.97
DATARATE : 20.000000 MBit/s	SEQUENCE LENGTH : 6.41 s
MIN_DATARATE : 5.000000 MBit/S	PACKET LENGTH : 188 Byte
	PCR JITTER : 00000.0 µs
PROGRAM 1 DVG 1	PMT PID : 128 (0080 h) PCR PID: 100 (0064 h)
ES TYPE : Video 525	ES TYPE : Audio
ES 1 : R&S Factory	ES 2 : Classic
ES PID : 100 (0064 h)	ES PID : 101 (0065 h)
DATARATE : 3 MBit/s	DATARATE : 0.384 MBit/s

Figure 2-43: Screen display of TS information on FACT_3M.GTS

TS INFORMATION : FACT_4M.GTS	VERSION : V1.2 06.02.97
DATARATE : 20.000000 MBit/s	SEQUENCE LENGTH : 6.41 s
MIN_DATARATE : 5.000000 MBit/S	PACKET LENGTH : 188 Byte
	PCR JITTER : 00000.0 µs
PROGRAM 1 DVG 1	PMT PID : 128 (0080 h) PCR PID: 100 (0064 h)
ES TYPE : Video 525	ES TYPE : Audio
ES 1 : R&S Factory	ES 2 : Classic
ES PID : 100 (0064 h)	ES PID : 101 (0065 h)
DATARATE : 4 MBit/s	DATARATE : 0.384 MBit/s

Figure 2-44: Screen display of TS information on FACT_4M.GTS

TS INFORMATION : FACT_6M.GTS	VERSION : V1.2 06.02.97
DATARATE : 20.000000 MBit/s	SEQUENCE LENGTH : 6.41 s
MIN_DATARATE : 7.000000 MBit/S	PACKET LENGTH : 188 Byte
	PCR JITTER : 00000.0 µs
PROGRAM 1 DVG 1	PMT PID : 128 (0080 h) PCR PID: 100 (0064 h)
ES TYPE : Video 525	ES TYPE : Audio
ES 1 : R&S Factory	ES 2 : Classic
ES PID : 100 (0064 h)	ES PID : 101 (0065 h)
DATARATE : 6 MBit/s	DATARATE : 0.384 MBit/s

Figure 2-45: Screen display of TS information on FACT_6M.GTS

TS INFORMATION : FACT_9M.GTS	VERSION : V1.2 06.02.97
DATARATE : 20.000000 MBit/s	SEQUENCE LENGTH : 6.41 s
MIN_DATARATE : 11.000000 MBit/S	PACKET LENGTH : 188 Byte
	PCR JITTER : 00000.0 µs
PROGRAM 1 DVG 1	PMT PID : 128 (0080 h) PCR PID: 100 (0064 h)
ES TYPE : Video 525	ES TYPE : Audio
ES 1 : R&S Factory	ES 2 : Classic
ES PID : 100 (0064 h)	ES PID : 101 (0065 h)
DATARATE : 9 MBit/s	DATARATE : 0.384 MBit/s

Figure 2-46: Screen display of TS information on FACT_9M.GTS

TS INFORMATION : FACT_15M.GTS	VERSION : V1.2 06.02.97
DATARATE : 20.000000 MBit/s	SEQUENCE LENGTH : 3.20 s
MIN_DATARATE : 16.000000 MBit/S	PACKET LENGTH : 188 Byte
	PCR JITTER : 00000.0 µs
PROGRAM 1 DVG 1	PMT PID : 128 (0080 h) PCR PID: 100 (0064 h)
ES TYPE : Video 525	ES TYPE : Audio
ES 1 : R&S Factory	ES 2 : Classic
ES PID : 100 (0064 h)	ES PID : 101 (0065 h)
DATARATE : 15 MBit/s	DATARATE : 0.384 MBit/s

Figure 2-47: Screen display of TS information on FACT_15M.GTS

- Video** Moving picture scene with automatic insertion machine.
Length 6.41 seconds.
Coded with different data rates (from 3 Mbit/s to 15 Mbit/s).
- Audio** Extract from a piece of classical music recorded on CD;
signals of harmony.

NOTE. some items in the screen display above and in all subsequent displays, are user-definable. These elements include:

- TS RATE:* Adjustable from MIN TS RATE to 160 Mbit/s
- PACKET LENGTH:* 188 or 204 Bytes
- PCR JITTER:* Adjustable through the SETUP menu
- PMT; ES PID:* Adjustable through the SETUP menu

**Transport Stream
NSCHWAN.GTS**

TS INFORMATION : NSCHWAN.GTS		VERSION : V1.2 06.02.97
DATARATE : 20.000000 MBit/s		SEQUENCELENGTH : 6.41 s
MIN_DATARATE : 5.000000 MBit/S		PACKET_LENGTH : 188 Byte
		PCR_JITTER : 00000.0 µs
PROGRAM 1 DVG 1	PMT PID : 128 (0080 h)	PCR PID: 100 (0064 h)
ES TYPE : Video 525	ES TYPE : Audio	
ES 1 : Castle	ES 2 : Classic	
ES PID : 100 (0064 h)	ES PID : 101 (0065 h)	
DATARATE : 4 MBit/s	DATARATE : 0.384 MBit/s	

Figure 2-48: Screen display of TS information on NSCHWAN.GTS

- Video** Moving picture scene of aerial view of Castle of Neuschwanstein and the Bavarian Alps.
- Audio** Extract from a piece of classical music recorded on CD; signals of harmony.

**Transport Stream
BLUE.GTS**

TS INFORMATION : BLUE.GTS	VERSION :	2.00 19.08.97
TS RATE : 40.000000 MBit/s	SEQUENCELENGTH :	1.60 s
MIN_TS RATE : 1.0032720 MBit/S	PACKET LENGTH :	188 Byte
	PCR JITTER :	00000.0 µs
PROGRAM 1 Blue screen	VAAA	0.687 MBit/s

Figure 2–49: Screen display of TS information on BLUE.GTS

Video	All blue picture for 48 video frames (1.60 seconds)
Audio (left and right channel)	Three audio L+R sine burst of 1 kHz, 0 dB _r Sampling rate A1: 32 kHz A2: 44.1 kHz A3: 48 kHz
Example of use	Measure chroma noise, audio decoders

**Transport Stream
BOUNCE.GTS**

TS INFORMATION : BOUNCE.GTS		VERSION : V1.2 06.02.97
DATARATE : 20.000000 MBit/s		SEQUENCELENGTH : 1.60 s
MIN_DATARATE : 0.800000 MBit/S		PACKET_LENGTH : 188 Byte
		PCR_JITTER : 00000.0 µs
PROGRAM 1 DVG 1	PMT PID : 128 (0080 h)	PCR PID: 100 (0064 h)
ES TYPE : Video 525	ES TYPE : Audio	
ES 1 : Bounce	ES 2 : L+R 1kHz 0.5s	
ES PID : 100 (0064 h)	ES PID : 101 (0065 h)	
DATARATE : 0.288 MBit/s	DATARATE : 0.384 MBit/s	

Figure 2-50: Screen display of TS information on BOUNCE.GTS

Video	Bounce \ change from all-white to all-black picture Change from 12 all-white picture frames to 12 all-black picture frames.
Signal source	CCIR 601 APL Signal Settings: Time 960 ms / Level 1 0% / Level 2 100%.
Example of use	Test of clamping circuits and delay measurements; as the audio signal is switched on together with the all-white picture, delay measurements between vision and sound are possible.
Audio (left and right channel)	Sine burst of 1 kHz with 0 dB _r with a duration of 12 frames (480 ms) synchronous to white bar and no burst during all-black picture.

**Transport Stream
BOUNCE_S.GTS**

TS INFORMATION : BOUNCE_S.GTS	VERSION : 2.00 19.08.97
TS RATE : 40.000000 MBit/s	SEQUENCELENGTH : 6.42 s
MIN_TS RATE : 0.792853 MBit/S	PACKET LENGTH : 188 Byte
	PCR JITTER : 00000.0 µs
PROGRAM 1 Slow Bounce	PMT PID : 128 (0080 h) PCR PID: 100 (0064 h)
ES TYPE : Video 525	ES TYPE : Audio
ES 1 : Bounce 1s/5s	ES 2 : L+R 1 kHz 1s
ES PID : 100 (0064 h)	ES PID : 101 (0065 h)
DATARATE : 0.288 MBit/s	DATARATE : 0.384 MBit/s

Figure 2–51: Screen display of TS information on BOUNCE_S.GTS

- Video** All white picture (for 1.44 seconds) then an all black picture (for 5.280 seconds).
- Audio (left and right channel)** L+R sine burst of 1 kHz at 6 dB_r for 1.44 seconds, then silence for 5.280 seconds. Audio synchronized with video.
- Example of use** Test clamping circuits and delay measurements between vision and sound.

**Transport Stream
CBARS100.GTS**

TS INFORMATION : CBARS100.GTS		VERSION : V1.2 06.02.97
DATARATE : 20.000000 MBit/s		SEQUENCELENGTH : 1.60 s
MIN_DATARATE : 1.300000 MBit/S		PACKET LENGTH : 188 Byte
		PCR JITTER : 00000.0 µs
PROGRAM 1 DVG 1	PMT PID : 128 (0080 h)	PCR PID: 100 (0064 h)
ES TYPE : Video 525	ES TYPE : Audio	
ES 1 : Colourbars100	ES 2 : L 15kHz 1s	
ES PID : 100 (0064 h)	ES PID : 101 (0065 h)	
DATARATE : 0.579 MBit/s	DATARATE : 0.384 MBit/s	

Figure 2-52: Screen display of TS information on CBARS100.GTS

Video	Still picture CCIR 601 Color bar signal 100/0/100/0. Color bar signal with a luminance amplitude of 100% and a color saturation of 100%.
Signal source	CCIR 601 Test Signal Generator.
Example of use	Test and adjustment of phase and level ratios for MPEG-2 decoders and PAL coders. The color coding can very easily be checked by means of a vectorscope.
Audio	
left channel	Sine burst of 15 kHz with 4 dB _r with a duration of 1 s and for the remaining 0.92 s no burst (silence).
right channel	No burst / silence.
Example of use	Measurement of crosstalk.

**Transport Stream
CBARS75.GTS**

TS INFORMATION : CBARS75.GTS		VERSION : V1.2 06.02.97
DATARATE : 20.000000 MBit/s		SEQUENCELENGTH : 1.60 s
MIN_DATARATE : 1.200000 MBit/S		PACKET LENGTH : 188 Byte
		PCR JITTER : 00000.0 µs
PROGRAM 1 DVG 1	PMT PID : 128 (0080 h)	PCR PID: 100 (0064 h)
ES TYPE : Video 525	ES TYPE : Audio	
ES 1 : Colourbars75	ES 2 : R 15kHz 1s	
ES PID : 100 (0064 h)	ES PID : 101 (0065 h)	
DATARATE : 0.559 MBit/s	DATARATE : 0.384 MBit/s	

Figure 2–53: Screen display of TS information on CBARS75.GTS

Video	Still picture CCIR 601 color bar signal 100/0/75/0. Color bar signal with a luminance amplitude of 100% and a color saturation of 75%.
Signal source	CCIR 601 Test Signal Generator.
Example of use	Test and adjustment of phase and level ratios for MPEG-2 decoders and PAL coders. The color coding can very easily be checked by means of a vectorscope.
Audio	
left channel	No burst / silence.
right channel	Sine burst of 15 kHz with 4 dB _r with a duration of 1 s and for the remaining 0.92 s no burst (silence).
Example of use	Measurement of crosstalk.

**Transport Stream
CCITTO33.GTS**

TS INFORMATION : CCITTO33.GTS		VERSION : V1.2 06.02.97
DATARATE : 20.000000 MBit/s		SEQUENCELENGTH : 30.43 s
MIN_DATARATE : 4.000000 MBit/S		PACKET LENGTH : 188 Byte
		PCR JITTER : 00000.0 µs
PROGRAM 1 DVG 1	PMT PID : 128 (0080 h)	PCR PID: 100 (0064 h)
ES TYPE : Video 525	ES TYPE : Audio	
ES 1 : Codec 4:3	ES 2 : CCITT 0.33 MO	
ES PID : 100 (0064 h)	ES PID : 101 (0065 h)	
DATARATE : 2.999 MBit/s	DATARATE : 0.384 MBit/s	

Figure 2-54: Screen display of TS information on CCITTO33.GTS

Video

R&S CODEC 4:3 Test Pattern.

Audio (left and right channel)

Test tone sequence for automatic tone tests in mono (EBU line measurement according to CCITTO.33).

**Transport Stream
CODEC43.GTS**

TS INFORMATION : CODEC43.GTS		VERSION : V1.2 06.02.97
DATARATE : 20.000000 MBit/s		SEQUENCELENGTH : 1.60 s
MIN_DATARATE : 5.500000 MBit/S		PACKET LENGTH : 188 Byte
		PCR JITTER : 00000.0 µs
PROGRAM 1 DVG 1	PMT PID : 128 (0080 h)	PCR PID: 100 (0064 h)
ES TYPE : Video 525	ES TYPE : Audio	
ES 1 : Codec 4:3	ES 2 : L+R 1kHz 1s	
ES PID : 100 (0064 h)	ES PID : 101 (0065 h)	
DATARATE : 4.771 MBit/s	DATARATE : 0.384 MBit/s	

Figure 2–55: Screen display of TS information on CODEC43.GTS

Video

R&S CODEC 4:3 Test Pattern.

This universal test pattern, MPEG2-CODEC Transport Stream (see Figure 2–56), consists of static picture elements for all analog measurements and, at the same time, of moving picture elements which enable the user to determine whether the MPEG transmission is still valid or whether the decoded image is frozen.

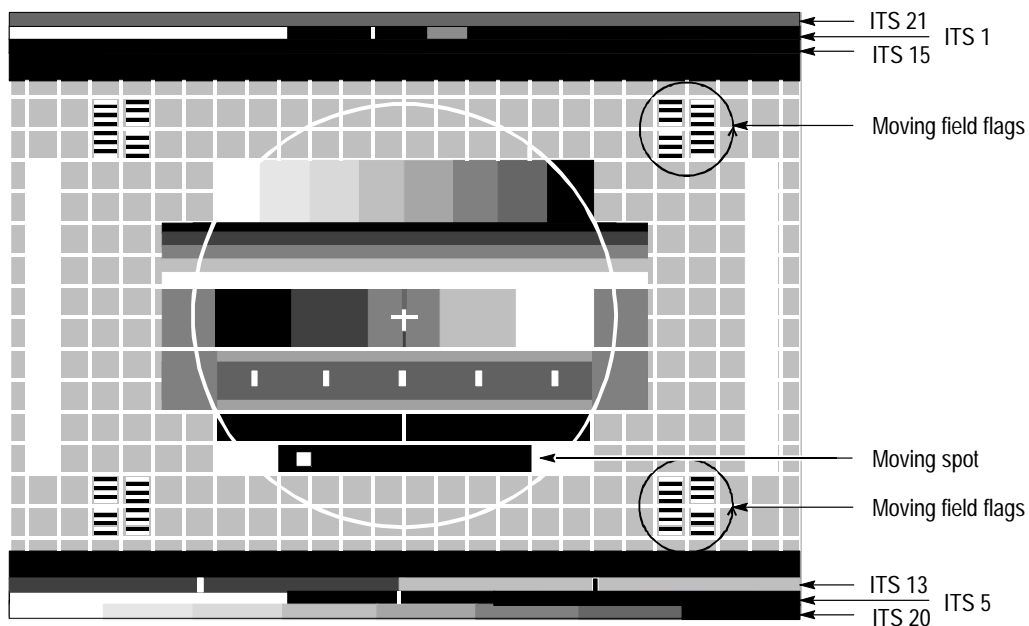

Figure 2–56: R&S MPEG2-CODEC transport stream

Moving picture elements:

- Field flags** Four successive white areas appearing in every field indicate a continuous decoding of the transport stream. A fast rotating movement is generated.
- Moving spot** White spot that moves back and forth in the black field. A complete movement is performed in 24 frames. Thus, the errors in the time domain can be detected during decoding; also, delay measurements between the different transmission paths are possible.

Monitor test pattern:

- Grid and circle** Adjustment of the geometry of the picture tubes and monitors.
- Color bar** Color purity / interchange of components etc.
- Y ramp** D/A converter test.
- Convergence cross (luminance)+ blue and red pulse** Adjustment of monitor center and interchannel delays between Y, C_b and C_r.
- Multiburst** Frequency response and horizontal resolution.

Insertion Test Signal (ITS):

- ITS 21 red area** Used for PAL or NTSC conversion in terminals (CCVS signal). In the red areas, spurious amplitude and phase noise of the color subcarrier as common for television recording equipment can be detected especially well and measured.
- ITS 1 CCIR 17** Standard line for automatic measurement and monitoring of the signal. The following distortions can be measured at the single elements of the signal:
- White bar: level error, line-repetitive tilt, overshoot, and roundings.
 - 2Tpulse: amplitude error, pulse distortions, and reflections
 - 20Tpulse: amplitude and delay differences between luminance and chrominance of the CCVS signal.
 - Staircase: luminance nonlinearity

ITS 15 ramp	Measurement of luminance nonlinearity, interfering voltage over the whole dynamic range, as well as the quantization noise of the D/A converters.
ITS 13 SIN X/X	Frequency response and group-delay measurement.
ITS 5 CCIR 330/5	Similar to ITS 1 /CCIR 17 without 20T pulse and with a 5-level staircase superimposed by a color subcarrier. Therefore, nonlinearities in the range of the color subcarrier can be measured.
ITS 20 color bars	Check of color coding and the phase and level ratios, especially in the CCVS signal.
Audio (left and right channel)	Sine burst of 1 kHz with 0 dB _r with a duration of 1 s and for the remaining 0.92 s no burst (silence).

**Transport Stream
CODEC169.GTS**

The structure and the elements of this test sequence correspond to those of the CODEC43 sequence with the exception that the picture format corresponds to the 16:9 aspect ratio.

It is thus possible to check format switchover in the terminal and to also test the screen geometry of 16:9 TV CRTs.

TS INFORMATION : CODEC169.GTS		VERSION	: V1.2 06.02.97
		SEQUENCELENGTH	: 1.60 s
DATARATE	: 20.000000 MBit/s	PACKET LENGTH	: 188 Byte
MIN_DATARATE	: 6.200000 MBit/S	PCR JITTER	: 00000.0 µs
PROGRAM	1 DVG 1	PMT PID	: 128 (0080 h) PCR PID: 100 (0064 h)
ES TYPE	: Video 525	ES TYPE	: Audio
ES 1	: Codec 16:9	ES 2	: Burst 9.5kHz
ES PID	: 100 (0064 h)	ES PID	: 101 (0065 h)
DATARATE	: 5.552 MBit/s	DATARATE	: 0.384 MBit/s

Figure 2-57: Screen display of TS information on CODEC169.GTS

Video

R&S CODEC 16:9 Test Pattern.

Audio (left and right channel)

Sine burst of 9.5 kHz with 0 dB_r, repeated for 12 frames with a duration of 20 ms. In the remaining time, there is no burst.

**Transport Stream
ITS1.GTS**

TS INFORMATION : ITS1.GTS		VERSION : V1.2 06.02.97
DATARATE : 20.000000 MBit/s		SEQUENCELENGTH : 1.60 s
MIN_DATARATE : 1.400000 MBit/S		PACKET LENGTH : 188 Byte
		PCR JITTER : 00000.0 μs
PROGRAM 1 DVG 1	PMT PID : 128 (0080 h)	PCR PID: 100 (0064 h)
ES TYPE : Video 525	ES TYPE : Audio	
ES 1 : ITS 1	ES 2 : L+R 1kHz 1s	
ES PID : 100 (0064 h)	ES PID : 101 (0065 h)	
DATARATE : 0.745 MBit/s	DATARATE : 0.384 MBit/s	

Figure 2–58: Screen display of TS information on ITS1.GTS

Video	Still picture with test line ITS1. Structure of the test line ITS 1; a white bar is provided at the beginning of the line followed by a 2T pulse, modulated 12.5T pulse, and a five-level luminance modulated staircase.
Signal source	CCIR 601 Test Signal Generator.
Example of use	Test and adjustment of levels, tilts, overshoots, roundings, pulse distortions, reflections, color subcarrier amplitudes and delays, and luminance nonlinearity. Standard line for automatic measurement and monitoring of the signal. The following distortions can be measured at the single elements of the signal: White bar: level error, line-repetitive tilt, overshoot , and roundings. 2Tpulse: amplitude error, pulse distortions, and reflections. 20Tpulse: amplitude and delay differences between luminance and chrominance of the CCVS signal. Modulated Staircase: differential gain and phase, and line time. nonlinearity.
Audio (left and right channel)	Sine burst of 1 kHz with 0 dB _r with a duration of 1 s and for the remaining 0.60 s no burst (silence).

**Transport Stream
ITS2.GTS**

TS INFORMATION : ITS2.GTS		VERSION : V1.2 06.02.97
DATARATE : 20.000000 MBit/s	SEQUENCELENGTH : 1.60 s	PACKET LENGTH : 188 Byte
MIN_DATARATE : 2.000000 MBit/S	PCR JITTER : 00000.0 µs	
PROGRAM 1 DVG 1	PMT PID : 128 (0080 h)	PCR PID: 100 (0064 h)
ES TYPE : Video 525	ES TYPE : Audio	
ES 1 : ITS 2	ES 2 : L+R 40Hz 1s	
ES PID : 100 (0064 h)	ES PID : 101 (0065 h)	
DATARATE : 1.212 MBit/s	DATARATE : 0.384 MBit/s	

Figure 2-59: Screen display of TS information on ITS2.GTS

Video	Still picture with test line ITS2. This signal consists of a 100 IRE luminance bar, a multiburst with $V_{p-p} = 50$ IRE and a modulated pedestal superimposed on a 50 IRE grey level. Six individual sine wave bursts compose the multiburst. The frequencies are 0.5, 1, 2, 3, 3.579, and 4.2 MHz.
Signal source	CCIR 601 Test Signal Generator.
Example of use	Irregularities of the amplitude versus frequency response in the time domain can be determined with the aid of the multiburst. The modulated pedestal permits chrominance/luminance intermodulation and subcarrier phase and amplitude to be determined as a function of the subcarrier level.
Audio (left and right channel)	Sine burst of 40 Hz with -40 dB _r with a duration of 1 s and for the remaining 0.60 s no burst (silence).

**Transport Stream
ITS3.GTS**

TS INFORMATION : ITS3.GTS		VERSION : V1.2 06.02.97
DATARATE : 20.000000 MBit/s	MIN_DATARATE : 1.400000 MBit/S	SEQUENCELENGTH : 1.60 s
		PACKET LENGTH : 188 Byte
		PCR JITTER : 00000.0 μs
PROGRAM 1 DVG 1	PMT PID : 128 (0080 h)	PCR PID: 100 (0064 h)
ES TYPE : Video 525	ES TYPE : Audio	
ES 1 : ITS 3	ES 2 : L+R 9.5kHz 1s	
ES PID : 100 (0064 h)	ES PID : 101 (0065 h)	
DATARATE : 0.698 MBit/s	DATARATE : 0.384 MBit/s	

Figure 2–60: Screen display of TS information on ITS3.GTS

Video	<p>Still picture with test line ITS3.</p> <p>This signal consists of the following:</p> <ul style="list-style-type: none"> ■ A 5 step staircase modulated with the subcarrier, the maximum luminance amplitude being 80 IRE ■ A 2T pulse ■ A modulated 12.5 T pulse ■ A 100 IRE luminance bar
Signal source	CCIR 601 Test Signal Generator.
Example of use	<p>Test and adjustment of levels, tilts, overshoots, roundings, pulse distortions, reflections, color subcarrier amplitudes and delays, and luminance nonlinearity. Standard line for automatic measurement and monitoring of the signal. The following distortions can be measured at the single elements of the signal:</p> <p>Staircase: determination of the differential gain, and phase of the subcarrier.</p> <p>2Tpulse: amplitude error, pulse distortions, and reflections.</p> <p>20Tpulse: amplitude and delay differences between luminance and chrominance of the CCVS signal.</p> <p>White bar: level error, line-repetitive tilt, overshoot, and roundings.</p>
Audio (left and right channel)	Sine burst of 9.5 kHz with -20 dB_r with a duration of 1 s and for the remaining 0.60 s no burst (silence).

**Transport Stream
ITS4.GTS**

TS INFORMATION : ITS4.GTS		VERSION : V1.2 06.02.97
DATARATE : 20.000000 MBit/s		SEQUENCELENGTH : 1.60 s
MIN_DATARATE : 1.000000 MBit/S		PACKET LENGTH : 188 Byte
		PCR JITTER : 00000.0 μs
PROGRAM 1 DVG 1	PMT PID : 128 (0080 h)	PCR PID: 100 (0064 h)
ES TYPE : Video 525	ES TYPE : Audio	
ES 1 : ITS 4	ES 2 : L+R 12kHz 1s	
ES PID : 100 (0064 h)	ES PID : 101 (0065 h)	
DATARATE : 0.402 MBit/s	DATARATE : 0.384 MBit/s	

Figure 2-61: Screen display of TS information on ITS4.GTS

Video	Still picture with test line ITS2. This consists of the following sequence of signals: <ul style="list-style-type: none"> ■ A 70 IRE luminance bar modulated with 40 IRE modulation ■ A 50 IRE grey pedestal ■ A 7.5 IRE setup
Signal source	CCIR 601 Test Signal Generator.
Example of use	The signal is used as the reference of the chrominance to correct phase and amplitude errors on the transmission link.
Audio (left and right channel)	Sine burst of 12 kHz with -20 dB_r with a duration of 1 s and for the remaining 0.60 s no burst (silence).

**Transport Stream
MULTIBUR.GTS**

TS INFORMATION : MULTIBUR.GTS	VERSION : V2.00 19.08.97
TS RATE : 40.000000 MBit/s	SEQUENCELENGTH : 13.21 s
MIN TS RATE : 2.098141 MBit/S	PACKET LENGTH : 188 Byte
	PCR JITTER : 00000.0 µs
PROGRAM 1 Multiburst	PMT PID : 128 (0080 h) PCR PID: 100 (0064 h)
ES TYPE : Video 525	ES TYPE : Audio
ES 1 : Multiburst	ES 2 : Multitone
ES PID : 100 (0064 h)	ES PID : 101 (0065 h)
DATARATE : 1.668 MBit/s	DATARATE : 0.384 MBit/s

Figure 2–62: Screen display of TS information on MULTIBUR.GTS

Video	Multiburst in frame.
Audio (left and right channel)	L+R sine burst at -12 dB _r for 1 s each at the following frequencies in sequence: 40 Hz 80 Hz 200 Hz 500 Hz 820 Hz 2 kHz 3 kHz 5 kHz 6.5 kHz 9.5 kHz 11.5 kHz 13.5 kHz 15 kHz then silence.
Example of use	Check video and audio amplitude-frequency response.

**Transport Stream
HSWEEP1.GTS**

TS INFORMATION : HSWEEP1.GTS		VERSION : V1.2 06.02.97
DATARATE : 20.000000 MBit/s		SEQUENCELENGTH : 1.60 s
MIN_DATARATE : 3.100000 MBit/S		PACKET LENGTH : 188 Byte
		PCR JITTER : 00000.0 µs
PROGRAM 1 DVG 1	PMT PID : 128 (0080 h)	PCR PID: 100 (0064 h)
ES TYPE : Video 525	ES TYPE : Audio	
ES 1 : H-Sweep 1	ES 2 : L+R 40Hz 1s	
ES PID : 100 (0064 h)	ES PID : 101 (0065 h)	
DATARATE : 2.236 MBit/s	DATARATE : 0.384 MBit/s	

Figure 2–63: Screen display of TS information on HSWEEP1.GTS

Video

Still picture with test line H-SWEEP 1.

For the H sweep, the whole video frequency range is swept over a line starting with 5.5 MHz at the beginning of the line down to 0 Hz in the middle of the line and increasing again to 5.5 MHz at the end of the line. The signal is generated with an amplitude of 100% and has a constant frequency response over the whole frequency range at a high energy density and is superimposed to a grey level of 50%. HSWEEP1 is generated with a phase of 180°.

Signal source

CCIR 601 Test Signal Generator.

Example of use

Amplitude-frequency response and frequency-dependent phase distortions are visible through the evaluation in the time domain. In case of a distortion purely from the amplitude-frequency response, the sweep envelope is distorted symmetrically about the middle of the line. For exclusively group-delay distortion, an asymmetrical ripple of the sweep envelope with reference to the middle of the line is obtained. If the two distortions are both present, the asymmetrical ripple and the symmetrical envelope about the middle of the line are superimposed.

Audio (left and right channel)

Sine burst of 40 Hz with –20 dB_r with a duration of 1 s and for the remaining 0.92 s no burst (silence).

Example of use

Short frequency response test for 40 Hz. See also Table 2–8 on page 2–45.

**Transport Stream
NONLIN.GTS**

TS INFORMATION : NONLIN.GTS		VERSION : V1.2 06.02.97
DATARATE : 20.000000 MBit/s		SEQUENCELENGTH : 1.60 s
MIN_DATARATE : 2.000000 MBit/S		PACKET LENGTH : 188 Byte
		PCR JITTER : 00000.0 μs
PROGRAM : 1 DVG 1	PMT PID : 128 (0080 h)	PCR PID: 100 (0064 h)
ES TYPE : Video 525	ES TYPE : Audio	
ES 1 : Nonlinearity	ES 2 : L+R 12kHz 1s	
ES PID : 100 (0064 h)	ES PID : 101 (0065 h)	
DATARATE : 1.392 MBit/s	DATARATE : 0.384 MBit/s	

Figure 2–64: Screen display of TS information on NONLIN.GTS

Video	Still picture to test nonlinearities. A line signal with the ramp signals in Y, C _b and C _r yielding full-range ramps (from 0 to 700 mV) with different slopes in analog RGB display.
Signal source	CCIR 601 Test Signal Generator.
Example of use	Test of nonlinearities in Y, C _b and C _r and test of RGB matrix.
Audio (left and right channel)	Sine burst of 12 kHz with –20 dB _r with a duration of 1 s and for the remaining 0.92 s no burst (silence).
Example of use	Short frequency response test for 12 kHz. See also Table 2–8 on page 2–45.

**Transport Stream
RAMPYC.GTS**

TS INFORMATION : RAMPYC.GTS		VERSION : V1.2 06.02.97
DATARATE : 20.000000 MBit/s		SEQUENCELENGTH : 1.60 s
MIN_DATARATE : 2.000000 MBit/S		PACKET LENGTH : 188 Byte
		PCR JITTER : 00000.0 µs
PROGRAM 1 DVG 1	PMT PID : 128 (0080 h)	PCR PID: 100 (0064 h)
ES TYPE : Video 525	ES TYPE : Audio	
ES 1 : Ramp Y C	ES 2 : L+R 9.5kHz 1s	
ES PID : 100 (0064 h)	ES PID : 101 (0065 h)	
DATARATE : 1.396 MBit/s	DATARATE : 0.384 MBit/s	

Figure 2–65: Screen display of TS information on RAMPYC.GTS

Video	Still picture with ramps in all components.
Signal source	CCIR 601 Test Signal Generator.
Example of use	Missing codes and linearity of D/A converters.
Audio (left and right channel)	Sine burst of 9.5 kHz with -20 dB _r with a duration of 1 s and for the remaining 0.92 s no burst (silence).
Example of use	Short frequency response test for 9.5 kHz. See also Table 2–8 on page 2–45.

**Transport Stream
RGSWEEP.GTS**

TS INFORMATION : RGSWEEP.GTS		VERSION : V1.2 06.02.97
DATARATE : 20.000000 MBit/s		SEQUENCELENGTH : 1.60 s
MIN_DATARATE : 3.300000 MBit/S		PACKET LENGTH : 188 Byte
		PCR JITTER : 00000.0 µs
PROGRAM 1 DVG 1	PMT PID : 128 (0080 h)	PCR PID: 100 (0064 h)
ES TYPE : Video 525	ES TYPE : Audio	
ES 1 : RGB Sweep	ES 2 : L+R 14kHz 1s	
ES PID : 100 (0064 h)	ES PID : 101 (0065 h)	
DATARATE : 2.759 MBit/s	DATARATE : 0.384 MBit/s	

Figure 2–66: Screen display of TS information on RGSWEEP.GTS

Video	Still picture with sweep in RGB components. For the RGB sweep, the video frequency range for each of the RGB components is swept over a line starting with 5.8 MHz at the beginning of the line down to 0 Hz in the middle of the line and increasing again to 5.8 MHz at the end of the line. The corresponding component is generated with an amplitude of 100% (that is, full range with analog signal from 0 to 700 mV). The R sweep is transmitted in the first third of the frame, followed by G sweep and B sweep in the second and third.
Signal source	CCIR 601 Test Signal Generator.
Example of use	Test and adjustment of RGB final stages. Measurements of amplitude-frequency response and group delay in RGB channels.
Audio (left and right channel)	Sine burst of 14 kHz with -20 dB_r with a duration of 1 s and for the remaining 0.92 s no burst (silence).
Example of use	Short frequency response test for 9.5 kHz. See also Table 2–8 on page 2–45.

**Transport Stream
SINXX.GTS**

TS INFORMATION : SINXX.GTS		VERSION : V1.2 06.02.97
DATARATE : 20.000000 MBit/s		SEQUENCELENGTH : 1.60 s
MIN_DATARATE : 1.400000 MBit/S		PACKET LENGTH : 188 Byte
		PCR JITTER : 00000.0 μs
PROGRAM 1 DVG 1	PMT PID : 128 (0080 h)	PCR PID: 100 (0064 h)
ES TYPE : Video 525	ES TYPE : Audio	
ES 1 : Sinus x/x	ES 2 : L+R 18kHz 1s	
ES PID : 100 (0064 h)	ES PID : 101 (0065 h)	
DATARATE : 0.825 MBit/s	DATARATE : 0.384 MBit/s	

Figure 2–67: Screen display of TS information on SINXX.GTS

Video	Still picture with test line sine x/x. The sinx/x pulse is characterized by a uniform distribution of energy in the frequency spectrum. The pulse is calculated for a video bandwidth of 5 MHz.
Signal source	CCIR 601 Test Signal Generator.
Example of use	For amplitude-frequency response measurements, the sinex/x signal can directly be evaluated with a spectrum analyzer. The presence of nonlinear distortions is shown by two different envelopes being displayed on the spectrum analyzer. The signal is also a very sensitive indicator for the group-delay response. The group-delay response is detected through the different amplitudes of the preshoot and postshoot in the measurement of the analog signal (after D/A conversion and analog processing) as measured on the oscilloscope.
Audio (left and right channel)	Sine burst of 18 kHz with -20 dB_r with a duration of 1 s and for the remaining 0.92 s no burst (silence).
Example of use	Short frequency response test for 18 kHz. See also Table 2–8 on page 2–45.

**Transport Stream
WINDOW.GTS**

TS INFORMATION : WINDOW.GTS		VERSION : V1.2 06.02.97
DATARATE : 20.000000 MBit/s	MIN_DATARATE : 1.100000 MBit/S	SEQUENCELENGTH : 1.60 s
		PACKET LENGTH : 188 Byte
		PCR JITTER : 00000.0 µs
PROGRAM 1 DVG 1	PMT PID : 128 (0080 h)	PCR PID: 100 (0064 h)
ES TYPE : Video 525	ES TYPE : Audio	
ES 1 : Window Pluge	ES 2 : L+R 7/11kHz	
ES PID : 100 (0064 h)	ES PID : 101 (0065 h)	
DATARATE : 0.476 MBit/s	DATARATE : 0.384 MBit/s	

Figure 2–68: Screen display of TS information on WINDOW.GTS

Video	Still picture with white window and 2T pulse. The signal consists of a white window (100% amplitude), a PLUGE signal ($\pm 2\%$ amplitude), a 2T pulse, and a modulated 20T pulse with 100% amplitude each.
Signal source	CCIR 601 Test Signal Generator.
Example of use	Test of sweep voltage generation and black adjustment of monitors with the PLUGE signal. With the inserted window, field-frequency (50 Hz) and line-frequency (15 kHz), tilts are made visible on the monitor or oscilloscope.
Audio (left and right channel)	Sine burst of 7 kHz mixed with a sine burst of 11 kHz with -6 dB_r with a duration of 1 s and for the remaining 0.92 s no burst (silence).
Example of use	Difference-frequency distortion.

**Transport Stream
ZONEPL.GTS**

TS INFORMATION : ZONEPL.GTS		VERSION : V1.2 06.02.97
DATARATE : 20.000000 MBit/s		SEQUENCELENGTH : 1.60 s
MIN_DATARATE : 16.000000 MBit/S		PACKET LENGTH : 188 Byte
		PCR JITTER : 00000.0 μs
PROGRAM 1 DVG 1	PMT PID : 128 (0080 h)	PCR PID: 100 (0064 h)
ES TYPE : Video 525	ES TYPE : Audio	
ES 1 : Zoneplate	ES 2 : L+R Noise 1s	
ES PID : 100 (0064 h)	ES PID : 101 (0065 h)	
DATARATE : 15 MBit/s	DATARATE : 0.384 MBit/s	

Figure 2-69: Screen display of TS information on ZONEPL.GTS

Video	Circular zone-plate test signal.
Signal source	CCIR 601 Test Signal Generator.
Audio (left and right channel)	White noise (incoherent) with -10 dB_r with a duration of 1 s and for the remaining 0.92 s no burst (silence).
Example of use	Acoustic measurements.

**Transport Stream
6_PROG.GTS**

TS INFORMATION : 6_PROG.GTS		VERSION : 1.20 06.02.97
DATARATE : 35.000000 MBit/s		SEQUENCE LENGTH : 1.60 s
MIN_DATARATE : 14.000000 MBit/S		PACKET LENGTH : 188 Byte
		PCR JITTER : 00000.0 µs
PROGRAM 1	Bounce	VA 0.672 MBit/s
PROGRAM 2	H-Sweep 1	VAA 3.004 MBit/s
PROGRAM 3	Ramp Y C	VA 1.780 MBit/s
PROGRAM 4	Nonlinearity	VA 1.776 MBit/s
PROGRAM 5	RGB Sweep	VA 3.143 MBit/s
PROGRAM 6	CCIR17	VA 1.129 MBit/s

Figure 2–70: Screen Display of TS information on 6_PROG.GTS

TS INFORMATION : 6_PROG.GTS		VERSION : 1.20 06.02.97
DATARATE : 35.000000 MBit/s		SEQUENCE LENGTH : 1.60 s
MIN_DATARATE : 14.000000 MBit/S		PACKET LENGTH : 188 Byte
		PCR JITTER : 00000.0 µs
PROGRAM 1	Bounce	
PMT PID: 0120 (0000 h)		
PCR PID: 0100 (0064 h)		
ES 1	Video 525	0100 (0064 h) DATARATE: 0.288 MBit/s
ES 2	Audio	0101m(0065 h) DATARATE: 0.384 Mbits/s

Figure 2–71: Screen Display of TS information with Program 1 Bounce selected

Video	Multiple test patterns.
Audio (left and right channel)	See Table 2–7 on page 2–45 for audio contents for each program.
Example of use	Testing a decoder’s ability to decode different programs from one transport stream.

Transport Stream CODECDBL.GTS Transport stream with two programs consisting of the elementary streams of transport streams CODEC43.GTS and CODEC169.GTS.

TS INFORMATION : CODECDBL.GTS		VERSION	: V1.2 06.02.97
DATARATE : 20.000000 MBit/s		SEQUENCE LENGTH	: 1.60 s
MIN_DATARATE	: 12.000000 MBit/S	PACKET LENGTH	: 188 Byte
		PCR JITTER	: 00000.0 µs
PROGRAM	1 CODEC 4:3	PMT PID	: 128 (0080 h) PCR PID: 100 (0064 h)
ES TYPE	: Video 525	ES TYPE	: Audio
ES 1	: Codec 4:3	ES 2	: L+R 1 kHz 1s
ES PID	: 100 (0064 h)	ES PID	: 101 (0065 h)
DATARATE	: 3.588 MBit/s	DATARATE	: 0.384 MBit/s
PROGRAM	2 CODEC 16:9	PMT PID	: 129 (0081 h) PCR PID: 200 (00C8 h)
ES TYPE	: Video 525	ES TYPE	: Audio
ES 1	: Codec 16:9	ES 2	: Burst 9.5kHz
ES PID	: 200 (00C8 h)	ES PID	: 201 (00C9 h)
DATARATE	: 5.552 MBit/s	DATARATE	: 0.384 MBit/s

Figure 2-72: Screen display of TS information on CODECDBL.GTS

Video CODEC 4:3 and 16:9 Test Pattern.
 Program 1; R&S CODEC 4:3 Test Pattern.
 Program 2; R&S CODEC 16:9 Test Pattern.

Audio Program 1; see Transport Streams CODEC43.GTS.
 Program 2; see Transport Stream CODEC169.GTS.

**Transport Stream
FLOWERGA.GTS**

TS INFORMATION : FLOWERGA.GTS		VERSION : 2.00 18.08.97
TS RATE : 40.000000 MBit/s		SEQUENCE LENGTH : 6.41 s
MIN TS RATE : 14.144481 MBit/S		PACKET LENGTH : 188 Byte
		PCR JITTER : 00000.0 µs
PROGRAM 1 Flower Garden	PMT PID 0110 (006E h)	PCR PID: 0111 (006F h)
ES TYPE : Video 525	ES TYPE : Audio	
ES 1 : Flower Garden	ES 2 : Classic	
ES PID : 0111 (006F h)	ES PID : 0112 (0070 h)	
DATARATE : 2.000 MBit/s	DATARATE : 0.192 MBit/s	
PROGRAM 2 Flower Garden	PMT PID 0120 (0078 h)	PCR PID: 0121 (0079 h)
ES TYPE : Video 525	ES TYPE : Audio	
ES 1 : Flower Garden	ES 2 : Classic	
ES PID : 0121 (0079 h)	ES PID : 0122 (007A h)	
DATARATE : 4.000 MBit/s	DATARATE : 0.192 MBit/s	
PROGRAM 3 Flower Garden	PMT PID :0130 (0082 h)	PCR PID: 0131 (0083 h)
ES TYPE : Video 525	ES TYPE : Audio	
ES 1 : Flower Garden	ES 2 : Classic	
ES PID : 0131 (0083 h)	ES PID : 0132 (0084 h)	
DATARATE : 6.000 MBit/s	DATARATE : 0.384 MBit/s	

Figure 2-73: Screen display of TS information on FLOWERGA.GTS

Video	Flowers and windmill in background for 192 frames (6.41 s).
Signal source	EBU test scene
Audio	Classical music
Examples of use	Test visual and audio, demonstrate picture quality as a function of data rate.

**Transport Stream
T_TENNIS.GTS**

TS INFORMATION : T_TENNIS.GTS		VERSION : 2.00 18.08.97
TS RATE : 40.000000 MBit/s		SEQUENCE LENGTH : 6.41 s
MIN TS RATE : 14.933281 MBit/S		PACKET LENGTH : 188 Byte
		PCR JITTER : 00000.0 µs
PROGRAM 1 Table Tennis PMT PID 0110 (006E h) PCR PID: 0111 (006F h)		
ES TYPE : Video 525	ES TYPE : Audio	
ES 1 : Table Tennis	ES 2 : Applause	
ES PID : 0111 (006F h)	ES PID : 0112 (0070 h)	
DATARATE : 2.000 MBit/s	DATARATE : 0.192 MBit/s	
PROGRAM 2 Flower Garden PMT PID 0120 (0078 h) PCR PID: 0121 (0079 h)		
ES TYPE : Video 525	ES TYPE : Audio	
ES 1 : Table Tennis	ES 2 : Applause	
ES PID : 0121 (0079 h)	ES PID : 0122 (007A h)	
DATARATE : 4.000 MBit/s	DATARATE : 0.192 MBit/s	
PROGRAM 3 Flower Garden PMT PID :0130 (0082 h) PCR PID: 0131 (0083 h)		
ES TYPE : Video 525	ES TYPE : Audio	
ES 1 : Table Tennis	ES 2 : Applause	
ES PID : 0131 (0083 h)	ES PID : 0132 (0084 h)	
DATARATE : 6.000 MBit/s	DATARATE : 0.384 MBit/s	

Figure 2-74: Screen display of TS information on T_TENNIS.GTS

- Video** Pan shot of a table tennis match for 192 frames (7.68s).
- Signal source** EBU test scene
- Audio** Applause
- Examples of use** General function test of vision and sound, demonstration of picuter quality as a function of data rate.

**Transport Stream
DVMD_CHK.GTS**

TS INFORMATION : DVMD_CHK.GTS		VERSION : 1.20 18.03.97
DATARATE : 35.000000 MBit/s		SEQUENCELENGTH : 9.60 s
MIN_DATARATE : 3.500000 MBit/S		PACKET LENGTH : 188 Byte
		PCR JITTER : 00000.0 µs
PROGRAM 1	DVMD CHECK	PMT PID : 0128 (0080 h) PCR PID: 0511 (01FF h)
ES TYPE :	Video 625	ES TYPE : Audio
ES 1 :	Codec 4:3	ES 2 : L+R 1kHz 1s
ES PID :	0511 (01FF h)	ES PID : 0512 (0200 h)
DATARATE :	2.922 MBit/s	DATARATE : 0.384 MBit/s

Figure 2–75: Screen display of TS information on DVMD_CHK.GTS

- Video** R&S CODEC 4:3 Test Pattern. This universal test pattern, MPEG2-CODEC Transport Stream (see Figure 2–56 on page 2–59), consists of static picture elements for all analog measurements and, at the same time, of moving picture elements which enable the user to determine whether the MPEG transmission is still valid or whether the decoded image is frozen.
- Audio (left and right channel)** Sine burst of 1 kHz at 0 dB_r for 1 s followed by 0.92 s of silence.
- Example of Use** This transport sequence contains multiple errors that will result in unstable operation of decoders. It tests a decoder’s ability to handle errors with minimal disruption to the video/audio program.
- Errors** The following list indicates the first, second, and third priority errors, as described in DVB document EBR 290, present in this transport stream.
- First priority errors:**
- PAT:TABLE_ID
 - PMT:SCRAMBLED
 - SYNC_BYTE:SINGLE
 - CONT_COUNT:PACK ORDER a M.T. TWICE
 - PID:MISSING

Second priority errors:

- TRANSPORT
- PTS
- CRC

Third priority errors:

- TDT:UPPER DISTANCE

***NOTE.** This transport stream was created specifically to test MPEG2 analyzers. Decoding errors might therefore occur.*

All errors are repeated every 9.600 s and occur approximately every second in the following order:

- SYNC
- PAT
- CONT
- PMT
- PID
- TRANS
- CRC
- OTHER

**Transport Stream
TELETEXT.GTS**

TS INFORMATION : TELETEXT.GTS	VERSION : V2.00 19.08.97
TS RATE : 40.000000 MBit/s	SEQUENCELENGTH : 1.60 s
MIN TS RATE : 5.777685 MBit/S	PACKET LENGTH : 188 Byte
	PCR JITTER : 00000.0 µs
PROGRAM 1 TELETEXT PMT PID : 128 (0080 h)	PCR PID: 0511 (01FF h)
ES TYPE : Video 525	ES TYPE : Audio
ES 1 : CODEC 4:3	ES 2 : L+R 1kHz 1s
ES PID : 0511 (01FF h)	ES 3 : Teletext
DATARATE : 4.771 MBit/s	ES PID : 0512 (0200 h)
	ES PID : 0513 (0201 h)
	DATARATE : 0.384 MBit/s
	DATARATE: 0.047 MBit/s

Figure 2-76: Screen display of TS information on TELETEXT.GTS

- Video** CODEC test pattern 4:3
- Audio** Sine burst L+R for 20ms at 0dB
- Data contents¹** Teletext test pages, four teletext lines per frame
- Examples of use** Test of teletext transcoders

¹ See page 2-82 for more information about the data contents.

Example of PES header. The following is an example of a PES header from the TELETEXT.GTS transport stream.

```

packet_start_code_prefix      : 0x000001
    stream_id                  : 189 (private stream 1 e.g.
                                videotext)
    PES_packet_length          : 362
    10                         : 0x02
    PES_scrambling_control     : 0
    PES_priority               : 0
    data_alignment_indicator   : 1
    copyright                  : 0
    original_or_copy           : 1
    PTS_DTS_flags              : 0x02
    ESCR_flag                  : 0
    ES_rate_flag               : 1
    DSM_trick_mode_flag        : 0
    additional_copy_info_flag  : 0
    PES_CRC_flag               : 0
    PES_extension_flag         : 0
    PES_header_data_length     : 36 (0x24)
    '0010'                     : 0x02
    PTS[32..30]                : 0x00
    marker_bit                  : 1
    PTS[29..15]                : 0x0000
    marker_bit                  : 1
    PTS[10..0]                 : 0x10AE
                                Time_stamp : 00:00:00.047
                                actual_STC : 00:00:00.001
    marker_bit                  : 1
    ES_rate                     : 97 (* 50 Bytes/s = 38800 Bit/s)
    marker_bit                  : 1
    
```

Example of PES packet. The following is an example of a PES packet from the TELETEXT.GTS transport stream.

data_identifier : 0x10 (EBU data)

INFO: Data_unit contains:

data_unit_id : 0x02 (EBU Teletext non-subtitle data)

data_unit_length : 44

field_parity : 1 = first video field

line_offset : 20 = videoline 20

(= 1st line in transport stream)

framing_code : 0xE4

magazine_and_packet_header : 0x40A8 (magazine: 1 row: 0)

data_block : 0xA8 0xA8 0x7A 0x40 0xA8 0x40 0xA8 0xE3

data_block : 0x23 0x6B 0x43 0xB5 0x2A 0xA7 0x37 0xA7

data_block : 0x2F 0xA7 0x1F 0x2F 0x04 0x04 0x04 0x04

data_block : 0x04 0x04 0x04 0x04 0x04 0x04 0x04 0x04

data_block : 0x04 0x04 0x04 0x04 0x04 0x04 0x04 0x04

Page_header!

Page_header (row 0 contains):

page : 100

time : 10 : 13

erase : 0

newsflash : 0

subtitle : 0

suppress header : 0

update : 0

interrupted sequence : 0

inhibit display : 0

magazine serial : 1

unallocated : 0

unallocated : 0

unallocated : 0

data block in reverse : DVB teletext



Preparation for Use

This chapter discusses general instructions on the preparation for use and operation of the MTG200 MPEG Test Generator. It contains brief explanations of the controls and connectors on the front and rear panels. The chapter also provides step-by-step guidance to put the unit into operation.

Legend for Front and Rear View

The control elements of the unit are grouped together and color-coded according to their respective functions. The individual groups of control elements are described in Table 3-1 (front panel) on page 3-2 and Table 3-2 (rear panel) on page 3-3.

Front Panel

Front view of MTG200

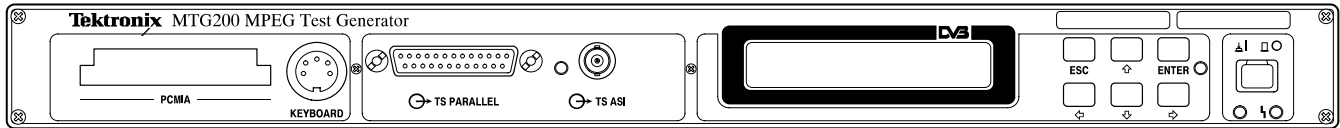

Table 3-1: Legend for front view

Control/Connector	Description
	<p>POWER</p> <p>This is the power switch. When the unit is connected to the AC supply and switched on, the green LED lights.</p> <p>The red LED signals a defect. The unit has to be switched off and disconnected from the AC supply to undergo repair. However, a quick flashing of the red LED when switching the unit on or off does not indicate a defect.</p>
	<p>KEYPAD</p> <p>The keypad comprises four CURSOR keys, an ENTER key, and an ESCAPE key. The CURSOR keys are used to select the desired menu item. Use the ENTER key to call the associated submenu. Press the ESCAPE key to quit the submenu.</p>
	<p>LC DISPLAY</p> <p>The backlit liquid crystal display provides readout information. It has 2 lines, each of which can have 20 characters.</p>
	<p>TS ASI</p> <p>This BNC connector is a generator output for the set transport stream as defined as ASYNCHRONOUS SERIAL INTERFACE in the DVB DOCUMENT A010.</p> <p>The green LED indicates that a transport stream is present at the generator output and that the generator is not in the initializing or PC mode</p>
	<p>TS PARALLEL</p> <p>The 25-contact connector is another generator output for the set transport stream as defined as SYNCHRONOUS PARALLEL INTERFACE or LVDS (Low Voltage Differential Signaling) in the DVB DOCUMENT A010.</p>
	<p>KEYBOARD</p> <p>This is a 5-contact connector for a PC keyboard.</p>
	<p>PCMCIA</p> <p>This slot is a fully featured PCMCIA interface which serves to connect PCMCIA-compatible hard disks, CD-ROM disk drives, modem or network cards.</p>

Rear Panel

Rear view of MTG200

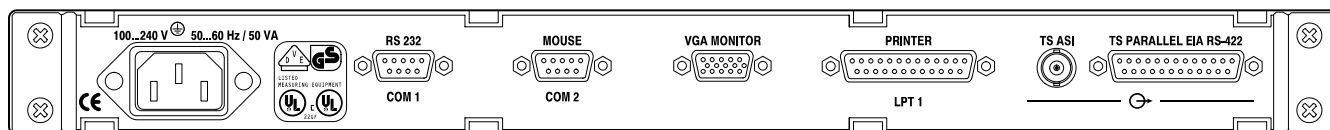

Table 3-2: Legend for rear view

Connector	Description
	<p>POWER</p> <p>This is the connector for the power source.</p> <p>The attached flap can be used to prevent the power cable from becoming disconnected.</p>
	<p>COM1</p> <p>This is a serial RS-232 interface, which is addressed as COM1 under DOS. This interface is meant to be used as a remote control interface.</p>
	<p>COM2</p> <p>This is a serial RS-232 interface, which is addressed as COM2 under DOS. This interface is provided for connecting a mouse.</p>
	<p>VGA</p> <p>This is a 15-contact connector for connecting a PC monitor.</p>
	<p>LPT1</p> <p>This is a 25-contact connector with a parallel CENTRONICS interface for connecting a PC printer.</p>
	<p>TS ASI</p> <p>This BNC connector is a second serial generator output; it outputs the set transport stream as defined as ASYNCHRONOUS SERIAL INTERFACE in the DVB DOCUMENT A010.</p> <p>TS Parallel EIA RS-422</p> <p>This 25 pin, RS-422 connector is used to output parallel transport stream data (0 V – +4.0 V) and input an external clock with which to drive the MTG200. The pin-out table for this connector is on page A-9.</p>

Unpacking the Unit

After unpacking the unit check that the equipment supplied is complete as listed in *Standard Accessories*.

Check the unit carefully for any mechanical damage. If damage is found, immediately inform the carrier in charge of the delivery. Keep the cardboard box and the packing material in case you need to return the instrument.

Accessories

The MTG200 MPEG Test Generator is shipped with several standard accessories listed below.

Standard Accessories

The following accessories are included with this product.

- MTG200 MPEG Test Generator
- Power cable
- Modem bypass cable (RS-232)
- Locking device (used to prevent the power cable from being disconnected)
- This manual

Installation



CAUTION. *To prevent damage to the MPEG test generator, make sure that the following conditions are met before operating the unit:*

- *The earthing contact of the power cable is connected to protective earth.*
 - *The ventilation inlets are unobstructed.*
 - *The signal voltage levels at the inputs are within the permissible limits.*
 - *The outputs of the unit are not overloaded or improperly connected.*
-

Setting up the Unit

Desktop. The generator is for indoor use. The requirements on the location of the unit are as follows:

- The ambient temperature should be between +5 and +45° C.
- The ventilation inlets and the air outlet on top of the unit must not be obstructed.
- The unit should be set up on a level surface.

For use in the laboratory or on a desk, it is recommended that you fold down the feet at the bottom of the unit.

Mounting the Unit in a 19 inch Rack.

CAUTION. When mounting the unit in a rack, make sure that the air inlet and outlet perforations are unobstructed.

To install a standard MPEG test generator in a 19-inch rack, you can use the Rack Adapter, (Option 1R or part number ZZA91). Mounting instructions are supplied with the adapter.

EMC Measures

In order to avoid electromagnetic interference, the unit is to be closed when in use. Only suitably shielded signal and control cables may be used.



CAUTION. Only well grounded and shielded cables and external devices (for instance, a disk drive, mouse, or keyboard) may be used with this instrument. Failure to provide proper grounding may cause the MTG200 MPEG Test Generator to emit unacceptable levels of electromagnetic interference.

You may order an acceptable keyboard from Tektronix using the following part number and description:

- Keyboard, English (Tektronix part number PSAZI)

Compliance with the various EMC requirements to which the MTG200 is certified is contingent upon the use of appropriate cables and peripheral devices.

AC Supply Voltage

The test generator can be connected to supply voltages between 100 and 240 VAC with frequencies from 47 to 63 Hz. The power supply connector is located at the rear of unit (see Table 3–2 on page 3–3).

Connecting a Receiver

The test generator generates an MPEG2 transport stream, which is output via its synchronous parallel output and its two asynchronous serial outputs. An MPEG2 decoder can be connected to these outputs to make the content of the transport streams visible or audible (that is, suitable for evaluation). Figure 3–1 shows a typical configuration.

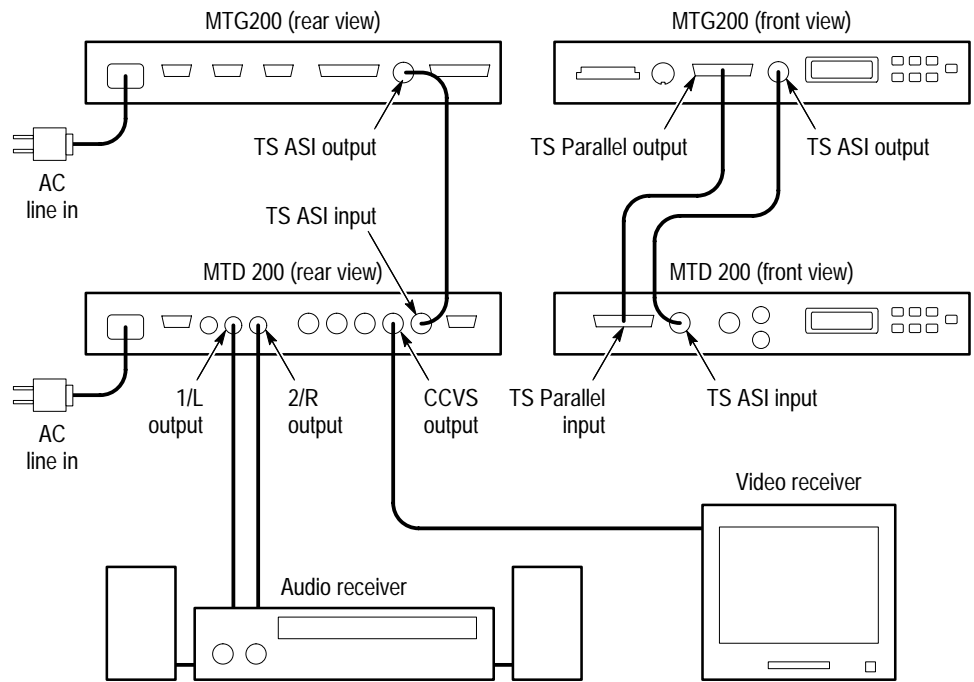

Figure 3–1: MPEG Test Decoder connected to the MPEG Test Generator

Connecting a PC for Remote Control

The test generator can also be integrated into an automatic test system. For this purpose, the test generator is connected via the RS-232 interface to a remote-control PC with a null-modem cable. See Figure 3–2.

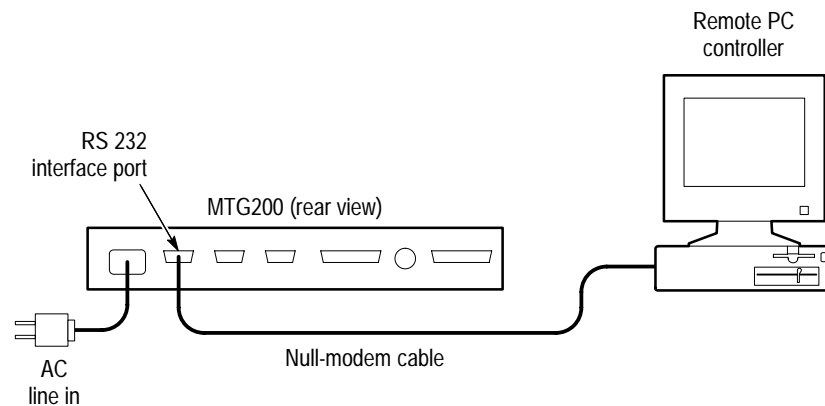

Figure 3-2: PC connected to the test generator

Connecting Accessories

The MPEG test generator not only serves as an MPEG generator, but can also fulfill the functions of a DOS PC when connected to a monitor and a keyboard. With such a setup, the following additional facilities are available:

- Compiling transport streams
- Copying transport streams from the PCMCIA interface to the internal hard disk
- Using other DOS programs

The following accessories can be connected to the MPEG test generator:

- VGA monitor
- PC keyboard
- Mouse
- Printer
- 2nd PC via RS-232 interface
- CD-ROM disk via PCMCIA interface

Alternatively, a PCMCIA hard disk or a PCMCIA network card can be connected via the PCMCIA interface.

Figure 3–3 shows a typical configuration. All DOS functions are available with this setup.



CAUTION. Only well grounded and shielded cables and external devices (for instance, a disk drive, mouse, or keyboard) may be used with this instrument. Failure to provide proper grounding may cause the MTG200 MPEG Test Generator to emit unacceptable levels of electromagnetic interference.

You may order an acceptable keyboard from Tektronix using the following part number and description:

- Keyboard, English (Tektronix part number PSAZ1)

Compliance with the various EMC requirements to which the MTG200 is certified is contingent upon the use of appropriate cables and peripheral devices.

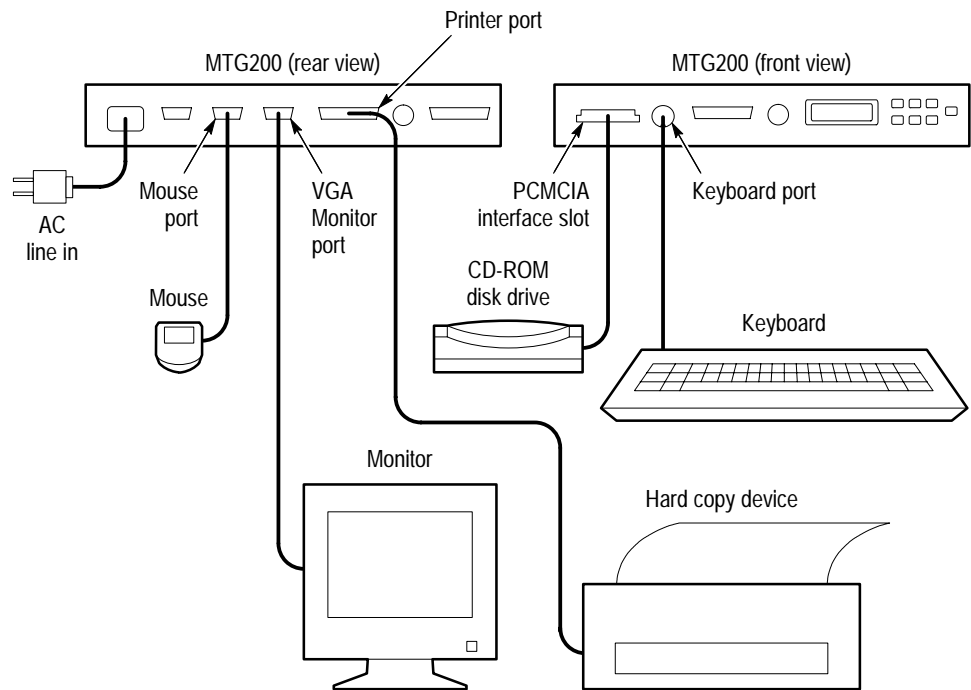

Figure 3–3: Setup as DOS PC for operation with transport stream generation program

Functional Check (Switch-On Test)

The unit is switched on by pressing the POWER switch, which is followed by a built-in test. With this test completed after a few seconds, the display is switched on and the most recently used transport stream is generated and output. The green LED at the generator outputs on the front panel signals that generation has been completed. The name and the major parameters of the transport stream are indicated on the display.

If the MPEG test generator is to be used as a DOS PC for transport stream configuration and data exchange, proceed as follows:

1. Connect keyboard and VGA monitor.
2. Switch unit off and on.
3. Following booting, press <CTRL><C> on the keyboard.

The DOS prompt C:\> appears on the VGA monitor, and now all DOS functions are available.

4. To return to the generator mode, enter C:\> DVG.

Unit Configuration

RS-232 Interface

As discussed earlier, the MPEG test generator can be used in two operating modes: as a generator and as a DOS PC. The configurations of the RS-232 interface may be different for the two operating modes. In the generator mode, configuration of the MPEG test generator is as set on the LC display using the SETUP menu, where any configuration changes of this operating mode have to be carried out (refer to *Menu SETUP* on page 4–8). In the DOS PC mode, the configuration of the two interfaces can be changed by means of the DOS command `MODE COMx BAUD= PARITY= DATA= STOP= RETRY=`, x being the number of the serial interface. The command can also be written in the following simplified version:

```
C:\> MODE COM1 96,n,8,1
```

(interface COM1 9600 Baud, no parity check, 8 data bits and 1 stop bit)

For further information see the MS-DOS 6.2 user manual and *Appendix A: Device Interfaces* of this manual.

Interfaces for Accessories

The MPEG test generator is provided with the following peripherals drivers:

- DOS 6.20
- PCMCIA hard-disk driver

Configuration of Keyboard Driver (Keyboard Layout)

The MPEG test generator is shipped with the following factory-set configurations.

For delivery within Germany:

- German keyboard layout
- Character set 437

Table 3–3: PC configuration for German keyboard

in CONFIG.SYS:	in AUTOEXEC.BAT:
DEVICEHIGH=C:\DOS\ANSI.SYS /K	LOADHIGH KEYB GR,437,C:\DOS\KEYBOARD.SYS
COUNTRY=...049, 850,..., C:\DOS\COUNTRY.SYS	

Default state for delivery in all other countries:

- Convention used for display of date, time, character sorting sequence and characters valid for file names: international (061 and 850)
- International keyboard layout (character \ at bottom left next to SHIFT key)
- Character set 850

Table 3–4: PC configuration for International keyboard

in CONFIG.SYS:	in AUTOEXEC.BAT:
DEVICEHIGH=C:\DOS\ANSI.SYS /K	LOADHIGH KEYB UK,850,C:\DOS\KEYBOARD.SYS
COUNTRY=061,850,C:\DOS\COUNTRY.SYS	

If other country-specific key assignments or settings are to be used, you can use the DOS editor to configure the files CONFIG.SYS and AUTOEXEC.BAT. To configure the files, complete the following procedure:

1. Enter the following:

```
EDIT C:\CONFIG.SYS
```
2. Change the country code in the line COUNTRY= to the code for the country you want (refer to Table 3–5 for U.S. key assignments or to Table 3–6 for other countries).
3. Quit the editor, saving the file.
4. Enter the following:

```
EDIT C:\AUTOEXEC.BAT
```

5. Change the line KEYB to the keyboard code for the country you want (refer to Table 3–5 for U.S. or Table 3–6 for other countries).
6. Quit the editor, saving the file.
7. Press <CTRL><ALT> to reboot the unit.

Table 3–5: PC configuration for U.S. keyboard

in CONFIG.SYS:	in AUTOEXEC.BAT:
DEVICEHIGH=C:\DOS\ANSI.SYS /K	LOADHIGH KEYB US,850,C:\DOS\KEYBOARD.SYS
COUNTRY=061,850,C:\DOS\COUNTRY.SYS	

Table 3–6: Country settings

Country, region or language	Country code	Keyboard code	Standard code page	Alternative code page
Belgium	032	be	850	437
Brazil	055	br	850	437
Canada (French)	002	cf	863	850
Czech Republic	042	cz	852	850
Denmark	045	dk	850	865
English (International)	061	+	437	850
Finland	358	su	850	437
France	033	fr	850	437
Germany	049	gr	850	437
Hungary	036	hu	852	850
Italy	039	it	850	437
Latin America	003	la	850	437
Netherlands	031	nl	850	437
Norway	047	no	850	865
Poland	048	pl	852	850
Portugal	351	po	850	860
Slovak Republic	042	sl	852	850
Spain	034	sp	850	437
Sweden	046	sv	850	437

Table 3-6: Country settings (cont.)

Country, region or language	Country code	Keyboard code	Standard code page	Alternative code page
Switzerland (French)	041	sf	850	437
Switzerland (German)	041	sg	850	437
UK	044	uk	437	850
USA	001	us	437	850
Yugoslavia	038	yu	852	850

Configuring the Mouse Driver

For licensing reasons, no mouse driver is provided. If a mouse is to be used, it can be connected to the serial interface COM2. After copying the mouse driver to the directory `C:\DRV\MOUSE`, the file `AUTOEXEC.BAT` must be modified accordingly with the aid of the DOS editor. To do this, complete the following steps:

1. Enter the following:

```
EDIT C:\AUTOEXEC.BAT
```
2. Change the lines `PATH` and `MOUSE` according to the installation instructions by the manufacturer of the mouse (refer to the example in Table 3-7 below).
3. Quit the editor, saving the file.
4. Press `<CTRL><ALT>` to reboot the unit.

Table 3-7: Examples of mouse driver installation

Mouse	Entry in AUTOEXEC.BAT
MS-MOUSE	LOADHIGH C:\DRV\MOUSE\MOUSE.COM /2 or LH C:\DRV\MOUSE\MOUSE.COM /2
MOUSE SYSTEMS	LOADHIGH C:\DRV\MOUSE\MSCMOUSE /2
LOGITECH	PATH = C:\DRV\MOUSE;%PATH% LOADHIGH MOUSE SER 2 LOADHIGH CLICK LOADHIGH LOGIMENU



CAUTION. *COM2 is used for connecting a mouse; interface COM1 is reserved for remote control. Mouse drivers are to be copied to the directory `C:\DRV\MOUSE`.*

For further information see the MS-DOS 6.2 user manual.

Installing Additional Drivers and Programs

The MPEG test generator is supplied only with drivers for recommended peripherals and programs. In some cases, however, the installation of additional drivers or programs may be desirable. The DOS driver INTERLINK installed in the MPEG test generator may be used for this purpose. Proceed as follows:

- Use the modem bypass cable to connect the MPEG test generator to the RS-232 interface as shown in Figure 3–2 on page 3–7.
- Call DOS-6.2 program INTERSRV.EXE on the remote control PC.

The PC now functions as server, and its disk drives are available to the MPEG test generator as additional drives. The disk drives are renamed as shown in Table 3–8.

Table 3–8: Drive assignment under INTERLINK

MPEG test generator	SERVER PC
A: (not available)	
B: (not available)	
C: internal hard disk	
D: PCMCIA interface	
E: equivalent to	Disk drive A:
F: equivalent to	Disk drive B:
G: equivalent to	Hard disk C:
LPT1: printer interface	
LPT2 equivalent to	LPT1
LPT3 equivalent to	LPT2

The desired drivers and programs can now be copied to drive C: of the MPEG test generator by entering the DOS commands COPY and XCOPY. If the installation of the programs and drivers requires entries in the CONFIG.SYS and AUTOEXEC.BAT files, proceed as described in *Configuration of Keyboard Driver (Keyboard Layout)* on page 3–10.

Automatic installation programs of drivers only available on disk can be started from the PC disk drives (E: F: G:).

If the files AUTOEXEC.BAT and CONFIG.SYS function without error, they should be saved so they can be restored after the configuration has been changed. This requires copying of these files to the directory C:\CONFIG under any desired name, but with a predefined extension, which is AXC for the AUTOEXEC.BAT file and CFS for the CONFIG.SYS file. The names of a properly functioning configuration may be, for instance, GEHT.AXC and GEHT.CFS.

This PC configuration can then be recalled by entering the command CONFIG GEHT. Configurations FACTORY and FABRIK have already been saved as factory settings.

For further information on the PC configuration, refer to the MS-DOS 6.2 user manual.

Manual Operation

This section explains the basic functions of the MTG200 MPEG Test Generator system. If further detailed information is given in other sections, it will be referenced. The following topics are discussed:

- Controls
- Menu Overview
- Explanation of Menus
- Exiting DOS

NOTE. *When a new MPEG test generator is switched on for the first time, the unit is in the factory-set default state. Any change of the device settings is stored (even if the unit is switched off) and will be available when the unit is switched on again.*

Controls

Cursor Block

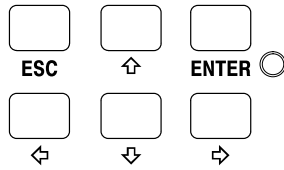

Cursor left. The cursor is moved from the current menu item to the menu item to the left. The cursor jumps from the first to the last menu item.

Cursor right. The cursor is moved from the current menu item to the menu item to the right. The cursor jumps from the last to the first menu item.

Cursor up. The cursor is moved from the current menu item to the next higher menu item. The corresponding information is displayed in a submenu. The cursor jumps from the first menu line to the last.

Cursor down. The cursor is moved from the current menu item to the next lower menu item. The corresponding information is displayed in a submenu. The cursor jumps from the last menu line to the first.

ENTER. This key opens up the submenu selected by the cursor. If settings are possible in this submenu, the ENTER LED lights. The setting is taken over by pressing ENTER.

ESC. This key opens up the next higher menu. The cursor is positioned on the menu item from which the submenu was called.

Menu Overview

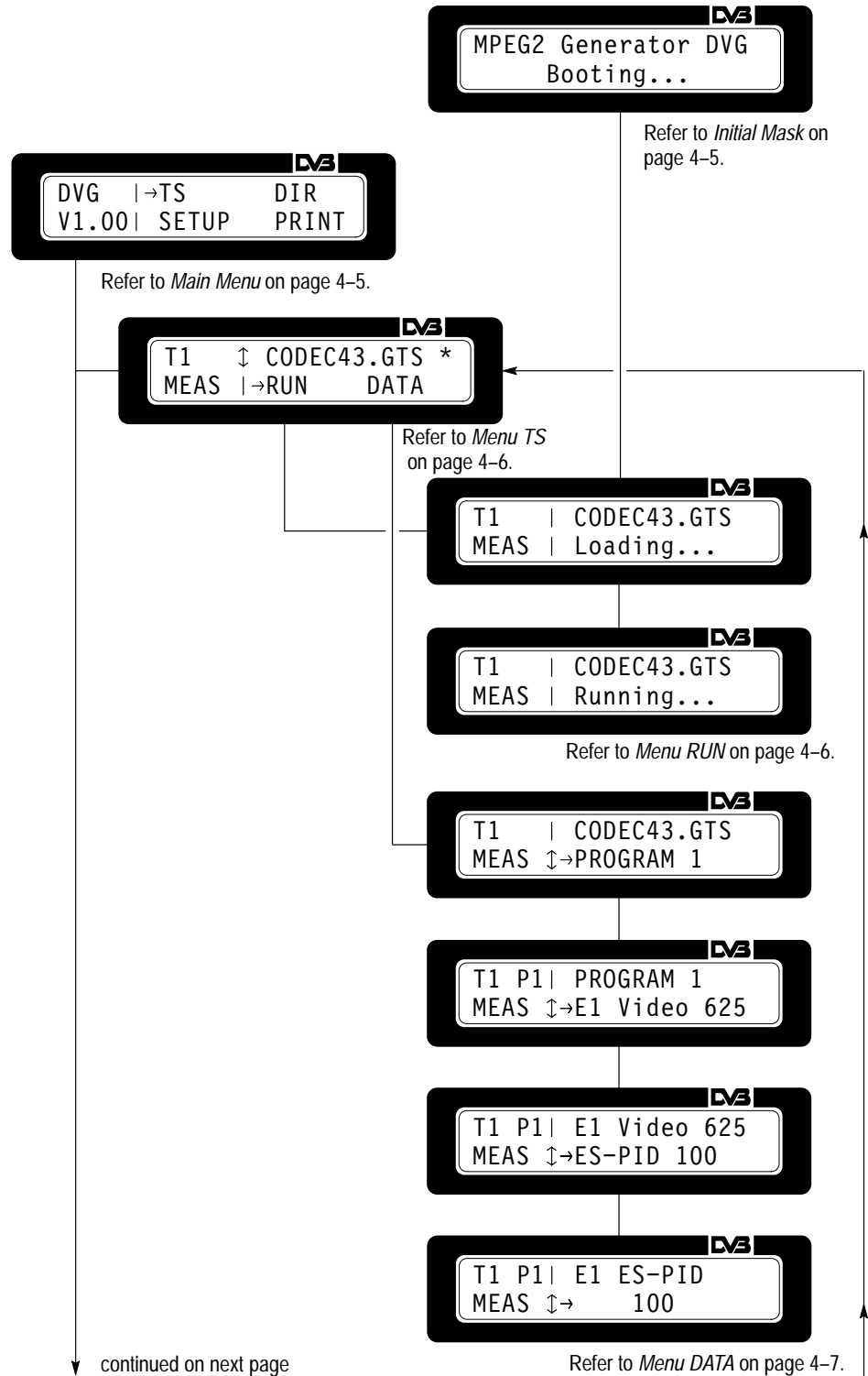

continued on next page

continued from previous page

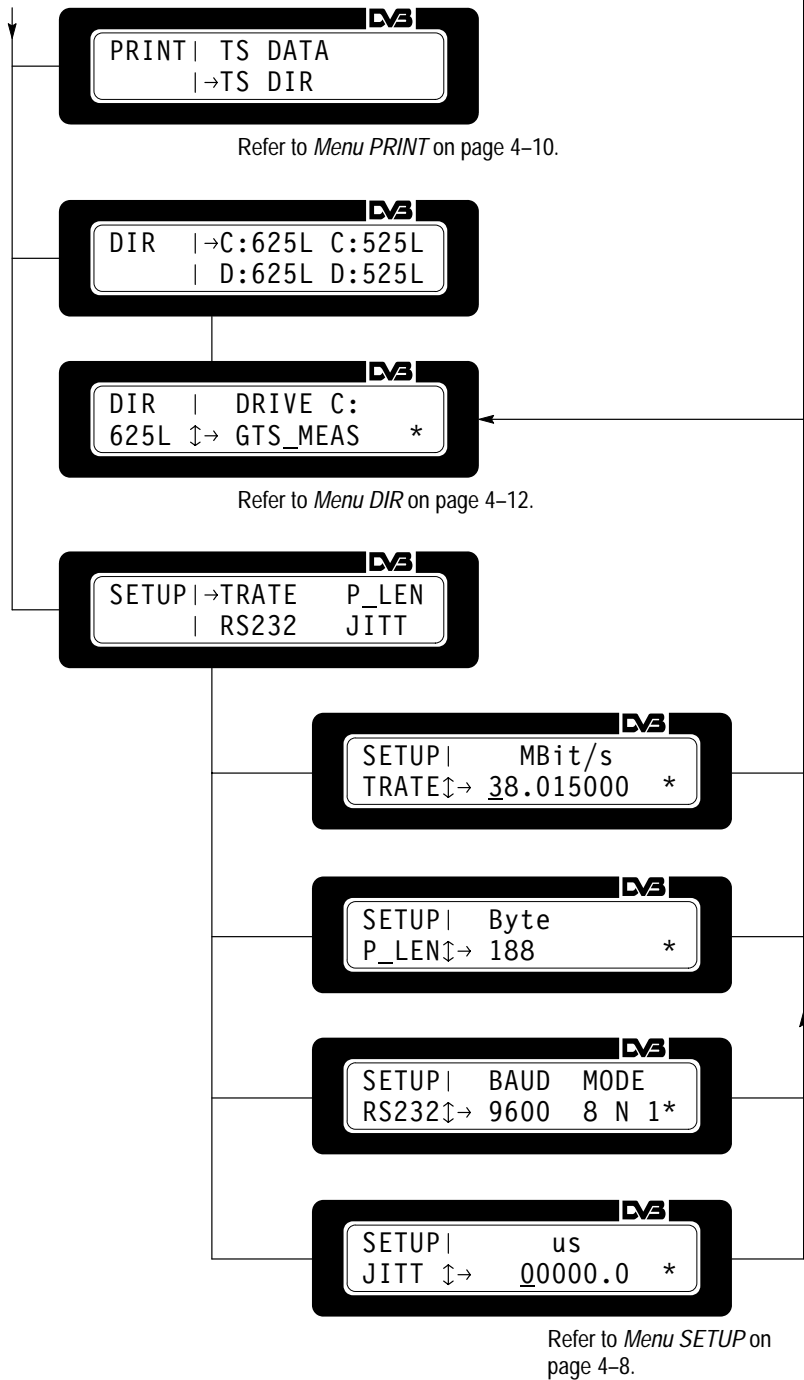

Explanation of Menus

Initial Mask When the MPEG test generator is powered on, a system start is performed and information about the power on is displayed.

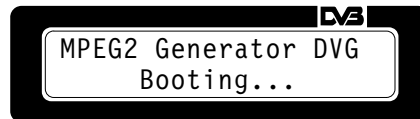

The transport stream last selected is loaded.

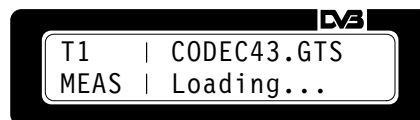

Then the transport stream is output.



Main Menu Pressing the ESC key twice opens up the main menu with the selectable menu items and the firmware version number.



The menu items can be selected with the cursor keys \leftarrow , \rightarrow , \uparrow , \downarrow ; the corresponding submenu is called up with the ENTER key. The submenus are as follows:

- TS Transport stream menu
- DIR GTS directory menu
- SETUP Setup menu
- PRINT Print menu

Menu TS In the transport stream menu, the user can scroll through the list of transport streams available in the MPEG test generator using the cursor keys **▲** and **▼** (marked by the symbol **↕**).

T1 Transport stream No. 1
 CODEC43.GTS Transport stream name
 MEAS Transport stream directory GTS_MEAS

The transport stream loaded last is marked by *****. The cursor can be set to the menus **RUN** and **DATA** using the cursor keys **◀** and **▶**.



The list of transport streams is shown on the LC display and simultaneously output on the VGA monitor (see Figure 4–1).

DIRECTORY OF C:\DVG\GTS_625L\GTS_MEAS			
1	BOUNCE.GTS	11	DVTS_15M.GTS
2	CBARS100.GTS	12	HSWEEP1.GTS
3	CBARS75.GTS	13	NONLIN.GTS
4	CCIR17.GTS	14	RAMPYC.GTS
5	CODEC169.GTS	15	RGBSWEEP.GTS
6	CODEC43.GTS *	16	SINXX.GTS
7	DVTS_2M.GTS	17	WINDOW.GTS
8	DVTS_4M.GTS	18	ZONEPL.GTS
9	DVTS_6M.GTS	19	CODECDBL.GTS
10	DVTS_9M.GTS	20	DVTS_DBL.GTS

Figure 4–1: Transport stream directory displayed on VGA monitor

Menu RUN. After pressing the ENTER key, the displayed transport stream is loaded and then output.



Menu DATA. The following information about the structure of the selected transport stream can be displayed in this submenu:

- Structure of transport stream

Info text	CODEC43.GTS
Length of sequence	1.92 s
Program info 1	PROGRAM 1



- Structure of program

Program info 1	PROGRAM 1
PMT PID	128
PCR PID	100
Elementary stream – type 1	video 625
Elementary stream – type 2	audio



- Structure of elementary video and audio streams

Elementary stream –info 1	Codec 4:3
ES PID	100
ES data rate	3.588 Mbit/s

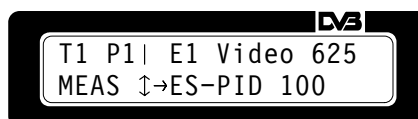

The different information levels are called up by pressing the ENTER key. Scrolling through the list is via cursor keys \blacktriangle and \blacktriangledown (marked by the symbol \updownarrow). The information levels and the submenu DATA are quit by pressing the ESC key.

The elementary stream PID can be modified in the submenu containing information about the elementary streams.

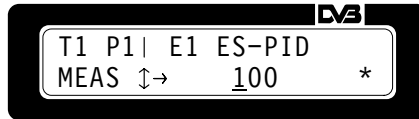

Using the cursor keys \blacktriangleleft and \blacktriangleright , a flashing cursor is moved to the numeral to be modified; the cursor keys are used to edit the numeral (marked by the symbol \updownarrow). Pressing the ENTER key updates the ES PID and marks it by *. To quit the menu, press the ESC key.



CAUTION. This setting disappears when another transport stream is loaded. After loading a transport stream, the PID of the stored transport stream file are valid.

The transport stream data are shown on the LC display and simultaneously output on the VGA monitor (See Figure 4-2).

TS INFORMATION: CODEC43.GTS		VERSION	: 01.02 09.09.96
DATARATE	: 38.015000 MBit/s	SEQUENCE LENGTH	: 1.92 s
MIN_DATARATE	: 4.500000 MBit/s	PACKET LENGTH	: 188 Byte
		PCR JITTER	: 00000.0 us
PROGRAM 1	DUG 1	PMT PID: 128	<0080 h>
ES TYPE	: Video 625	PCR PID: 100	<0064 h>
ES 1	: Codec 4:3	ES TYPE	: Audio
ES PID	: 100 <0064 h>	ES 2	: L+R 1kHz 1s
DATARATE	: 3.588 MBit/s	ES PID	: 101 <0065 h>
		DATARATE	: 384 kBit/s

Figure 4-2: Transport stream information displayed on VGA monitor

Menu SETUP

The SETUP menu enables the user to modify the transport stream data rate, the transport stream packet length, and the PCR jitter as well as to configure the RS232 interface COM1 (remote control). The menu items are selected using the cursor keys \blacktriangle , \blacktriangledown , \blacktriangleleft and \blacktriangleright .



Menu TRATE. Submenu for setting the transport stream data rate.

NOTE. The frequency of the external clock must match the transport stream data rate (TRATE). Use the following equation for making this adjustment:

$$f_{\text{ext.clk}} = \text{TRATE} / 8 \text{ (Bits per Byte)}$$

or

$$\text{TRATE} = f_{\text{ext.clk}} * 8 \text{ (Bits per Byte)}$$

The frequency of the external clock is measured before running TS and can be accepted by pressing *ENTER*.

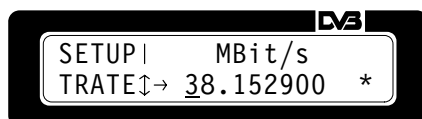

Using the cursor keys \leftarrow and \rightarrow , a flashing cursor is moved to the numeral to be modified; cursor keys \uparrow and \downarrow are used to edit the numeral (marked by the symbol \updownarrow). Pressing the ENTER key updates and stores the data rate and marks it by *. Press the ENTER key once more to call up the transport stream menu (menu TS). To return to the SETUP menu, press the ESC key.

Menu P_LEN. Submenu for setting the transport stream packet length.

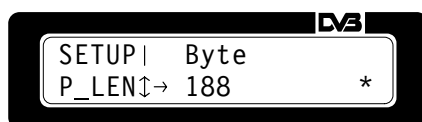

A packet length of 188 bytes or 204 bytes is selected using the cursor keys \uparrow and \downarrow (marked by the symbol \updownarrow). Press the ENTER key to accept and store the setting and mark it by *. Press the ENTER key once more to call up the transport stream menu (menu TS). To return to the SETUP menu, press the ESC key.

Menu RS232. Configuration of the RS232 interface COM1 (remote control).

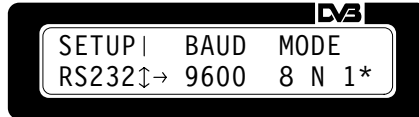

The menu items are selected using the cursor keys ◀ and ▶. The baud rate and mode settings can be changed by means of the cursor keys ▲ and ▼ (marked by the symbol ↕). The current configuration is marked by *. The new values for the baud rate and the mode are accepted by pressing the ENTER key. Press the ENTER key once more to call up the transport stream menu (menu TS). To return to the SETUP menu, press the ESC key.

Refer to Table 4–1 for the possible settings.

Table 4–1: Configuration of remote control interface

Baud rate	Mode		
	Data bits	Parity bit	Stop bits
300, 600, 1200, 2400, 4800. 9600, 19200	7 or 8	N (none), E (even), O (odd)	1 or 2

Menu JITT. Submenu for setting the PCR jitter. The deviation of the PCR values from the nominal value can be changed in the range from 0 to 1000 μs. The PCR jitter is the +/- value of the jitter. The setting is valid for all transport streams.

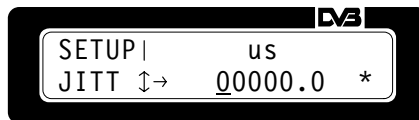

Using the cursor keys ◀ and ▶, a flashing cursor is moved to the numeral to be modified; cursor keys ▲ and ▼ are used to edit the numeral (marked by the symbol ↕). Pressing the ENTER key updates and stores the PCR jitter and marks it by *. Press the ENTER key once more to call up the transport stream menu (menu TS). To return to the SETUP menu, press the ESC key.

Menu PRINT

Output of a list of available transport streams or of information about the currently output transport stream. The menu items can be selected with cursor keys ▲ and ▼. After pressing the ENTER key, the information is output via the parallel printer interface LPT1. The submenu PRINT is quit by pressing the ESC key.



Example: Transport stream CODEC43.GTS

TS INFO TEXT:

DATE: V1.0 25.07.96
 TS_DATA RATE: 10.000000 Mbit/s
 PACKET_LENGTH: 188 bytes
 NUMBER_OF_TS_PACKETS: 63829
 NUMBER_OF_GTS_PACKETS: 26130
 SEQUENCE_LENGTH: 1920000 μ s
 DIFFERENCE: 1184000000
 LOOP_MODE: 1

PROGRAM_NUMBER: 1
 PROGRAMM_INFOTEXT: CODEC43
 PMT_PID: 128
 PCR_PID: 100
 NUMBER_OF_PCR_PACKETS: 303

ES_NUMBER: 1
 ES_PID: 100
 NUMBER_OF_PTS_PACKETS: 4
 NUMBER_OF_DTS_PACKETS: 4
 ES_TYPE: video 625
 ES_DATARATE: 3.588 Mbit/s
 ES_FILENAME: codec43.mpg
 ES_INFOTEXT: CODEC 4:3
 V_PROFILE/LEVEL: main/main
 VBV_BUFFER_SIZE: 112

ES_NUMBER: 2
 ES_PID: 101
 NUMBER_OF_PTS_PACKETS: 4
 NUMBER_OF_PTS_PACKETS: 0
 ES_TYPE: audio
 ES_DATARATE: 0.384 Mbit/s
 ES_FILENAME: t12_192.MP2
 ES_INFOTEXT: L+R 1kHz 1 s
 ES_MPEG_NUMBER: 1
 A_ES_LAYER: 2
 A_ES_MODE: stereo

Menu DIR This submenu is for selecting a transport stream directory in the MPEG test generator (C:625L or C:525L) or on a harddisk connected to the PCMCIA interface (D:625L or D:525L). Using the cursor keys \blacktriangleleft , \blacktriangleright , \blacktriangleup , and \blacktriangledown , the GTS directory for transport streams with 625 lines / 50 Hz (C:625L) or 525 lines / 60 Hz video signals (C:525L) can be selected. The ENTER key is used to select the desired directory.

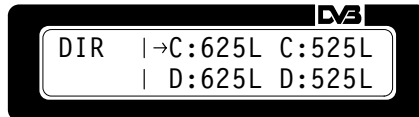

The cursor keys \blacktriangleup and \blacktriangledown are used to scroll through the list of subdirectories (marked by the symbol \updownarrow). Pressing the ENTER key selects the subdirectory, marks it by *, and stores it. The abbreviated designation of the subdirectory is displayed in the transport stream menu (GTS_MEAS → MEAS). Press the ENTER key once again to call up the transport stream menu (menu TS). Pressing the ESC key once activates the DIR menu; pressing it twice calls up the main menu.



The list of transport stream directories is shown on the LC display and simultaneously output on the VGA monitor (see Figure 4–3).

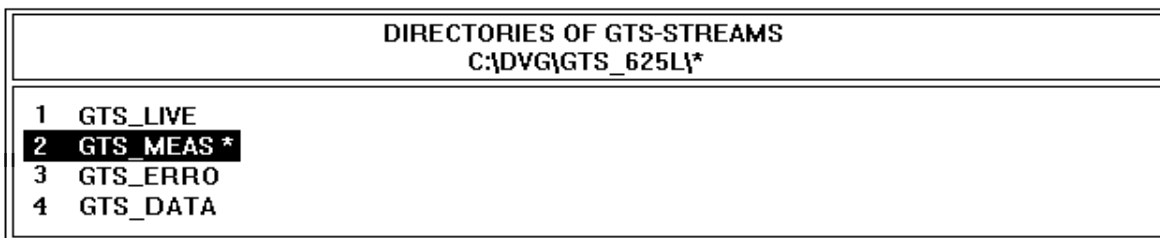

Figure 4-3: Transport stream directories displayed on VGA monitor

NOTE. To read the directories and the included transport streams on an external harddisk, the directories must have the structure shown below:

```

\DVG\GTS_625L\GTS_LIVE\*.GTS
    |
    | \GTS_MEAS\*.GTS
    |
GTS_525L\GTS_LIVE\*.GTS
    |
    | \GTS_MEAS\*.GTS
  
```

The stored transport streams must have the extension .GTS (for example, CCIR17.GTS).

Error Messages

An error message is output on the LC display in the event of function failures during the loading of transport streams or in the case of operating errors.



Table 4-2: Error messages

Error message	Description
ERROR ERROR	Function failure
OPEN FILE	The GTS data file cannot be opened.
ERROR ERROR	Function failure
READ FILE	The GTS data file cannot be read.
ERROR ERROR	Function failure
PCR PACKET	Number of PCR packets wrong.
ERROR ERROR	Function failure
PTS PACKET	Number of PTS packets wrong.
ERROR ERROR	Function failure
DTS PACKET	Number of DTS packets wrong.
ERROR ERROR	Function failure
PACKET START	Sync byte not available.
ERROR ERROR	Function failure
LOAD LCA	LCA cannot be loaded

Table 4-2: Error messages (Cont.)

Error message	Description
NOT ENOUGH MEMORY	The memory capacity is insufficient to load the transport stream.
ERROR ERROR TS-RATE TO LOW MIN. TS-RATE IS xx.xxxxxx Mbit/s	Selected data rate <625 kbit/s or Data rate smaller than required data rate. The data rate must be >xx.xxxxxx Mbit/s.
ERROR ERROR TS-RATE TO HIGH	Selected data rate >160 Mbit/s.
ERROR ERROR ES-PID TO LOW	Selected ES PID <16.
ERROR ERROR ES-PID TO HIGH	Selected ES PID >8190.
NEW ES-PID ALREADY EXISTS	The selected ES PID is already contained in an elementary stream.
PRINTER NOT AVAILABLE	No printer connected or printer off.
NO GTS-FILE AVAILABLE	No GTS file contained in the selected directory.
NO GTS-DIR AVAILABLE	No GTS subdirectory contained in the selected directory

Exiting DOS

When the unit is switched on with a keyboard and a VGA monitor connected, pressing <CTRL><C> on the keyboard aborts the MPEG test generator mode and returns the MPEG test generator to the DOS mode.

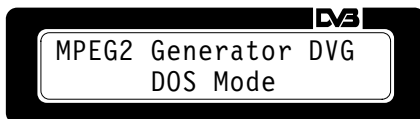

The DOS prompt C:\> is displayed on the VGA monitor. All the functions of a DOS controller are available. To return to the generator mode, type DVG and press ENTER.

Remote Control

The MTG200 MPEG Test Generator can be remote-controlled as standard via the RS-232 interface COM1. The 9-pin connector is located on the rear panel (COM1). The interface can be configured in the SETUP submenu (baud rate and mode).

NOTE. Every remote control action, such as sending a character to the MPEG test generator, interrupts the output (running...) of the selected transport stream. It is therefore advisable to query all necessary information before starting the transport stream (command `RUN:GTS [TSNAME]`).

RS-232 Interface

Connecting the Controller

Connect the controller to the COM1 interface of the MPEG test generator using a null-modem cable (see Figure 5–1).

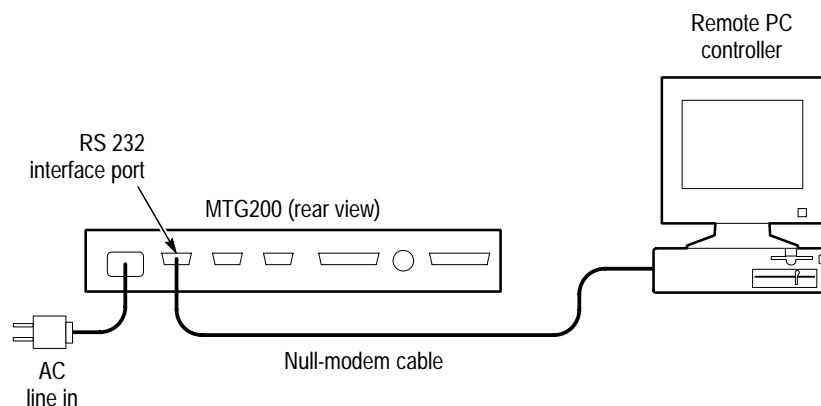

Figure 5–1: Connecting the controller

For wiring of null-modem cable, see Table 5–2 on page 5–3.

Setting the Transmission Parameters

The MPEG test generator and the controller must have the same transmission parameter settings to ensure trouble-free and correct data transmission. The transmission parameters can manually be modified in the SETUP submenu.

- Baud rate. The MPEG test generator enables 7 different transmission speeds: 300, 600, 1200, 2400, 4800, 9600, 19200.
- Data bits. Data transmission is in 7- or 8-bit ASCII code. The LSB (least significant bit) is the first bit to be transmitted.
- Parity bit. A parity bit can be transmitted for error control. The following parity settings are possible: none, even or odd.
- Stop bits. The transmission of a data byte can be terminated by 1 or 2 stop bits.

The transmission parameters of the interface are factory-set as follows:

Table 5-1: Factory setting of COM1

Baud rate	9600
Data bits	8
Parity	none
Stop bits	1

Switchover to Remote Control

On power-up, the unit is always in the manual control mode (LOCAL) and can be operated from the front panel. Switchover to remote control (REMOTE) is effected as soon as the MPEG test generator receives a command from the controller. All the remote-control settings are indicated on the MPEG test generator display.

Return to manual control is again via the front panel. The device settings are not changed by the switchover from manual to remote control or vice versa.

Handshake

The MPEG test generator signals its ready-to-receive state via the RTS line. A logic 0 (active) means “ready;” a logic 1 means “not ready.” The MPEG test generator is informed about the ready-to-receive state of the remote station via the CTS line. A logic 0 activates the data output, a logic 1 informs the MPEG test generator to stop sending further data. The DTR line remains active (logic 0) as long as the serial interface operates as the remote-control interface.

Connection of the MPEG test generator and controller (9-pin and 25-pin configuration) for handshake.

Table 5-2: Wiring of remote-control cable (= modem bypass cable)

MPEG test generator 9 pins		Controller 9 pins	MPEG test generator 9 pins		Controller 25 pins
1		1	1		8
2	---RXD/TXD---	3	2	---RXD/TXD---	2
3	---TXD/RXD---	2	3	---TXD/RXD---	3
4	---DTR/DSR---	6	4	---DTR/DSR---	6
5	---GND/GND---	5	5	---GND/GND---	7
6	---DSR/DTR---	4	6	---DSR/DTR---	20
7	---RTS/CTS---	8	7	---RTS/CTS---	5
8	---CTS/RTS---	7	8	---CTS/RTS---	4
9		9	9		22

Command Set

The command set consists of the standard IEC-625/IEEE-488 command set, the standard SCPI command set and of device-specific commands complying with SCPI to the greatest possible extent. If these commands are already part of the SCPI specification, they will be used. None of the MPEG test generator commands have been submitted to the SCPI Consortium as proposals.

The commands are classified in two groups:

- Common commands
- Device-specific commands

Common Command

The common command is taken from standard IEEE 488.2 (IEC 625.2). A particular command always has the same effect in different devices. The headers of common commands consists of a * followed by three letters.

Table 5-3: Common command

Command	Data	Meaning
*IDN?	alphanumeric characters	Identification Query Query of device identification. The answer is for example: "Rohde&Schwarz.DVG,02,1.00" 02 = model 1.00 = firmware version

Device-Specific Commands

These commands consist of a header and usually one or more parameters. Header and parameters are separated by a white space (ASCII code 0 to 9, 11, to 32 decimal; for example, space). The headers can be made up of several keywords. Queries are generated by appending a question mark to the header.

A header must be entered completely and can be written in upper- or lower-case letters.

Table 5–4: Device-specific commands

Command (HEADER)	Data	Meaning
MESSAGE:ENABLE	-----	The start byte is output before the transport stream is started.
MESSAGE:DISABLE	-----	No start byte is output before the transport stream is started.
PRINT:DIR_GTS	-----	Outputs a list of the available transport streams at the printer interface.
PRINT:DATA_GTS	-----	Outputs info files regarding the selected transport stream at the printer interface.
READ:CLOCK?	-----	Outputs clock source. 1=external clock, 0=internal clock.
READ:DIR?	-----	Queries the currently used GTS directory.
READ:DIR_LIST?	-----	Lists the available GTS directories.
READ:DRIVE?	-----	Queries the currently used drive and standard.
READ:DRIVE_LIST?	-----	Lists the available drives.
READ:GTS?	-----	Queries the currently output transport stream.
READ:DIR_GTS?	-----	Queries the available transport streams.
READ:DATA_GTS?	-----	Info query regarding the selected transport stream.
READ:PCR_JITTER?	-----	Queries the PCR jitter.
READ:P_LENGTH?	-----	Queries the current packet length.
READ:MESSAGE?	-----	Queries whether a start byte is output: 0 = no start byte 1 = start byte
READ:TS_RATE?	-----	Queries the current transport stream data rate.
RUN:GTS	1 to xxx #xxxxxxx.gts	Loads and starts a transport stream with GTS number or file name. If the command MESSAGE:ENABLE was sent prior to the load command, the start byte is output before the transport stream is started.
SET:CLOCK	0	Sets the clock source to internal
SET:CLOCK	1	Sets the clock source to external
SET:TS_RATE	38000000	Sets the transport stream data rate.
SET:P_LENGTH	188 / 204	Sets the packet length.
SET:PCR_JITTER	0 to 10000 μ s	Sets the time deviation of the PCR values.

Table 5-4: Device-specific commands (Cont.)

Command (HEADER)	Data	Meaning
SET:DRIVE	#drive name	Selects a drive and the standard: C:GTS_625L, C:GTS_525L D:GTS_625L, D:GTS_525L
SET:DIR	#directory name	Selects a GTS directory: GTS_LIVE, GTS_MEAS

Programming Example

This example illustrates the remote control of the MPEG test generator using a controller. Borland C was used as the programming language. The “V.24 Tools plus” software package of Messrs. Langner GmbH was used to support the serial interface.

Any command line sent to the MPEG test generator and to be processed immediately has to be terminated by a carriage return (CR). In this case, the MPEG test generator signals on the RTS handshake line to stop the controller for a certain time. After command processing, the RTS line is enabled again and the controller can send further commands.

Explanation of Library Calls Used for V24 Support

The serial interface is initialized by the functions v24open, v24setparams, v24handshake, v24settimeout, v24setbuffer and v24flush.

Function v24puts outputs a string on the serial interface. This string is not automatically terminated by CR/LF.

Function v24getc reads in a character from the serial interface.

Function v24close closes the serial interface.

Example

The following example shows how to select and initialize the serial interface and to enter the control commands.

```

/*****
**
**          MTG200 TERMINAL          VERSION 1.00
**
*****/

#include <stdio.h>
#include <conio.h>
#include <string.h>
    
```

```
#include <dos.h>
#include <v24tools.h>

#define FALSE 0
#define TRUE 1
#define INPUT_BUFFER_CAPACITY 10000
#define MAX_WAITING_TIME (18 * 1) /* = 1 second */

int port;
int ser;
int conf;
char command_string[20];
long baud = 9600L;
int data = 8;
int parity = 0x4E;
int stop = 1;
int message = 0;
char buffer[INPUT_BUFFER_CAPACITY];
char inbuffer[INPUT_BUFFER_CAPACITY];

long b_field[7] = {19200L,9600L,4800L,2400L,1200L,600L,300L};
int d_field[2] = { 8, 7};
int p_field[3] = { 0x4E, 0x45, 0x4F};
int s_field[2] = { 1, 2};

/* FUNCTION*****
**
** Initializing the RS-232 interface
**
***** */

int init_rem(void)
{
    int err = 0;
    if (ser == 2)
        port = v24open("com2");
    else
        port = v24open("com1");
    if (port >= 0)
    {
        err = v24setparams(port, baud, data, parity, stop);
        err = v24sethandshake(port, V24RTSCTS);
        err = v24setTimeout(port, MAX_WAITING_TIME); /* = 1 second */
        err = v24setbuffer(port, RCV, INPUT_BUFFER_CAPACITY);
        err = v24flush(port, RCV);
    }
    return(err);
}
```

```

}

/*****
/* FUNCTION *****/
**
** Sending a control command to DVG
**
*****/

int remote_out(char *string)
{
    int err = 0;
    char outbuffer[80];    /* Determine output buffer capacity */
    char *cr = "\n";      /* Addition to the old function */
    char *cr = "\r";      /* Terminator = Carriage Return */
    outbuffer[0] = '\0';
    strcat(outbuffer, string);
    strcat(outbuffer, cr); /* Addition to the old function */
    strcat(outbuffer, lf);
    err = v24puts(port, outbuffer);
    return(err);
}

/*****
/* FUNCTION *****/
**
** Reading data from input buffer
**
*****/

int remote_in(char *string)
{
    char character;
    int error = FALSE;
    gotoxy(1, 20);
    clrhol();
    do
    {
        error= v24getc(port,&character,MAX_WAITING_TIME);
        if (error == 1) /* Receive characters */
        {
            if (character == ';')
                printf("\n");
            else
                printf("%c",character);
        }
    }
}

```

```
    } while(error == 1);
    return(error);
}

/* FUNCTION
*****
/* Output of heading */
void header(void)
{
    clrscr();
    printf("\n");

printf("-----")
;
    printf("MTG200 TERMINAL    Version 1.00 ");

printf("-----")
;
    printf("\n");
    printf("\n");
}

/*****
/* FUNCTION *****/
/* Selecting and configuring serial interface */
void config(void)
{
    int set = 1;
    char inp;
    printf("Select serial interface  COM1 <1> or COM2 <2> :");
    scanf("%d", &ser);
    while (set)
    {
        header();
        gotoxy(1,9);
        printf("\n");
        printf("Baud rate    %5d        <0>\n",baud);
        printf("Data bits      %d        <1>\n",data);
        printf("Parity         %c        <2>\n",parity);
        printf("Stop bits      %d        <3>\n",stop);
        printf("\n");
        printf("Accept setting <9>\n");
        printf("\n");
        gotoxy(1, 17);
        printf("Configure interface :");
        clreol();
    }
}
```

```

scanf("%d", &conf);
printf("\n");
switch (conf)
{
  case 0:
    printf("Baud rate 19200 <0> 9600 <1> 4800 <2> 2400 <3>
1200 <4> 600 <5> 300 <6> :");
    scanf("%d", &inp);
    baud = b_field[inp];
    gotoxy(1, 19);
    delline();
    break;
  case 1:
    printf("Data bits 8 <0> 7 <1> :");
    scanf("%d", &inp);
    data = d_field[inp];
    gotoxy(1, 19);
    delline();
    break;
  case 2:
    printf("Parity NONE <0> EVEN <1> ODD <2> :");
    scanf("%d", &inp);
    parity = p_field[inp];
    gotoxy(1, 19);
    delline();
    break;
  case 3:
    printf("Stop bits 1 <0> 2 <1> :");
    scanf("%d", &inp);
    stop = s_field[inp];
    gotoxy(1, 19);
    delline();
    break;
  case 9:
    set = 0;
    break;
  default:
    break;
}
}
}

/*****
/* FUNCTION*****/
/* Display of command set on monitor */
void commands(void)

```

```

{
  printf("Command set :\n");
  printf("\n");
  printf("RUN:GTS 1....          READ:GTS?
*IDN?\n");
  printf("PRINT:DIR_GTS          READ:DIR_GTS?\n");
  printf("PRINT:DATA_GTS          READ:DATA_GTS?\n");
  printf("SET:TS_RATE 38152900    READ:TS_RATE?\n");
  printf("SET:P_LENGTH 188/204     READ:P_LENGTH?\n");
  printf("SET:PCR_JITTER 100.0     READ:PCR_JITTER?\n");
  printf("SET:DRIVE #C/D:GTS_625L  READ:DRIVE?\n");
  printf("SET:DIR #NAME            READ:DIR?\n");
  printf("MESSAGE:ENABLE/DISABLE  READ:MESSAGE?");
  printf("\n");
  gotoxy(1, 18);
  clrscr();
  printf("Command <x = End> : ");
}

```

```

/*****
/* FUNCTION *****/
void command(void)
{
  int set;
  int p;
  int q;
  char *query;
  set = 1;
  while(set)
  {
    gotoxy(21,18);
    gets(command_string);
    gotoxy(1,1);
    header();
    commands();
    if (command_string[0] == '\0')
    {
      remote_in(buffer);
    }
    else
    {
      if (command_string[0] != 'x')
      {
        remote_out(command_string);
        q = strcmp(command_string, "message:enable");
        if (q == 0)

```

```
        message = 1;
    q = strcmp(command_string, "message:disable");
    if (q == 0)
        message = 0;
    query = strchr(command_string, '?');
    if (query)
        remote_in(buffer);
    else
    {
        p = strncmp(command_string, "RUN", 3);
        if (p == 0)
        {
            if (message)
            {
                while(v24qempty(port, RCV));
                remote_in(buffer);
            }
            else
                remote_in(buffer);
        }
    }
}
else
{
    set = 0;
}
}
}
```



```
/* *****  
/* FUNCTION *****  
void main(void)  
{  
    int error = 0;  
    header();  
    config();  
    error = init_rem();    /* Initializing RS-232 interface */  
    if(!error)  
    {  
        header();  
        commands();  
        command();  
        v24close(port);  
    }  
    else  
    {  
        printf("Interface not initialized !!!!");  
    }  
}
```

Maintenance and Checking

Maintenance

The MTG200 MPEG Test Generator requires no regular maintenance. Generally, maintenance is confined to cleaning the instrument and possibly changing the battery. Make sure that air inlets and outlets are not contaminated and clean them at regular intervals.

Cleaning

Clean the outside of the instrument with a soft, lint-free cloth or a brush. In the case of heavier contamination, use spirit or mild soap suds for cleaning.



CAUTION. To avoid damaging the front-panel labels or plastic parts, do not use solvents, such as nitro thinners or acetone.

Any dust collected inside the instrument should be removed at regular intervals to ensure unimpaired cooling (approximately every 1 to 2 years depending on the daily on-time of the equipment and the amount of dust in the rooms).

Storage

Storage temperature of the instrument:

–40° to +70° C.

When stored for an extended period of time the instrument should be protected against dust.

Replacing the Battery



WARNING. To prevent injury, avoid short circuiting or charging the battery, since this can cause the battery to explode. Do not open discharged batteries; dispose of them as hazardous waste.

The instrument has a lithium battery for storing the selected status and for operation of the real-time clock. The battery has a lifetime of approximately five years and should be replaced as required (for example, after a long storage period at high temperature). Replace the discharged battery with one of the same type.



CAUTION. *The instrument contains electrostatic-sensitive components. To prevent damage to these components, any repair work should be done on a grounded work position.*

The instrument must be opened to replace the battery.

Tools required:	Phillips screwdrivers, size 0, 1, and 2 Soldering iron
Material required:	Lithium battery, 3 V. Order part number 0565.1687.00. Cable tie (width 2 mm)



WARNING. *To prevent electric shock, disconnect power plug before opening the instrument.*

1. Opening the instrument:
 - a. Switch off instrument and disconnect power plug.
 - b. Unscrew and remove the two rear-panel feet (2 Phillips screws each).
 - c. Take off top and bottom covers towards the rear (see Figure 6–1).

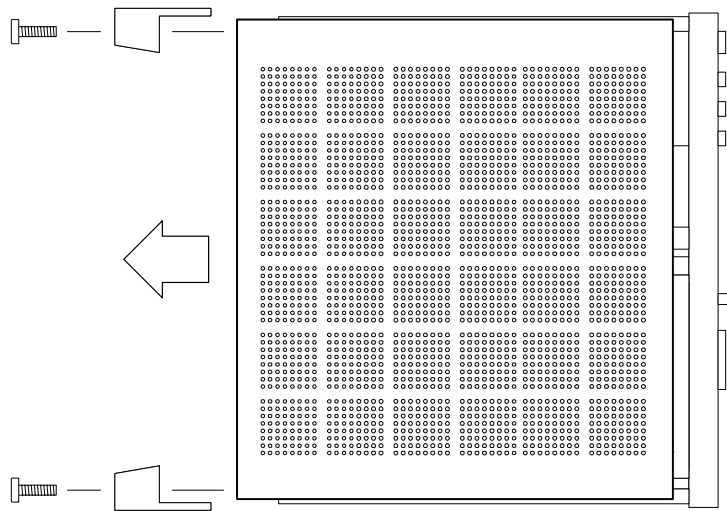

Figure 6–1: Removing panels

2. Removing the front panel (see Figure 6–2):
 - a. Remove the 2 trim screws on the front panel.

- b. Remove the 4 attaching screws.
- c. Remove the front panel.

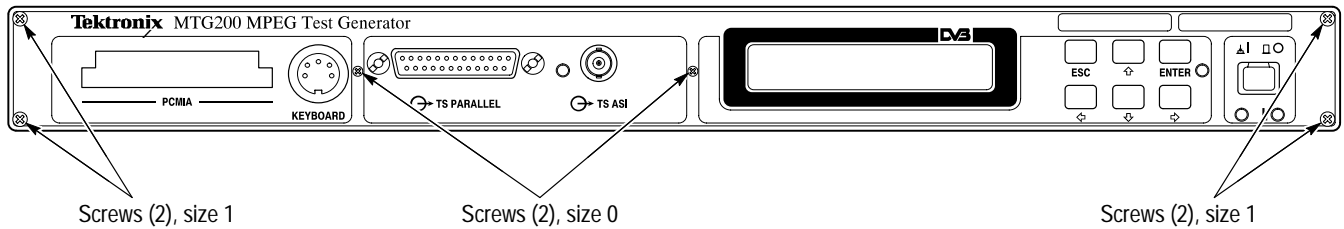

Figure 6-2: Front-panel screws

3. Removing the module:
 - a. Disconnect flat cable to printer (LPT1) at the rear of the instrument (see Figure 6-3).

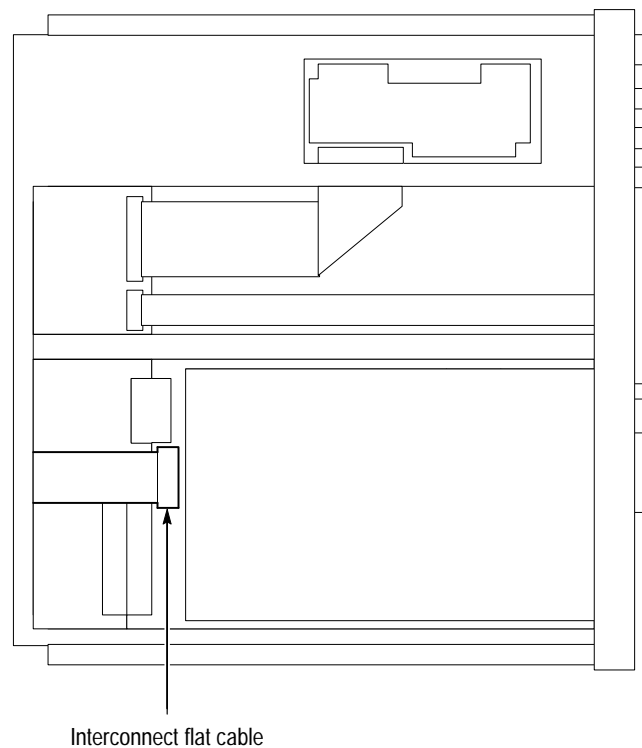

Figure 6-3: Position of flat printer cable

- b. Remove the 2 attaching screws on the right front panel near the BNC-Connector TS ASI.
 - c. Withdraw module to the front.
4. Opening the module:
- a. Unscrew top RF cover of the generator board.
 - b. Turn instrument upside down.
 - c. Unscrew lower RF cover of generator board (see Figure 6–4).
 - d. Turn instrument around again.

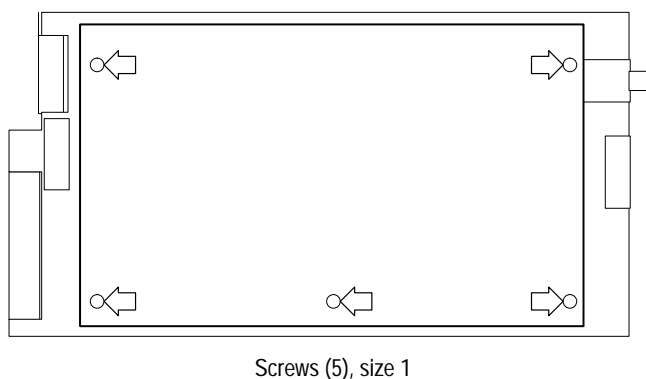

Figure 6–4: Locations of the retaining screws on the RF cover

5. Replacing the battery:
- Replace the battery properly (use solder lugs and fasten with cable tie). Make sure that the poles are correctly connected. They are marked on the battery with “+” and “-”. For position and polarity of the battery on the generator board, see Figure 6–5.
- a. Cut the cable tie holding the battery using side cutters.
 - b. Unsolder battery terminals (negative pole first).
 - c. Cut terminals of the new battery as required, and solder them (positive pole first).
 - d. Insert new cable tie through openings and tighten.

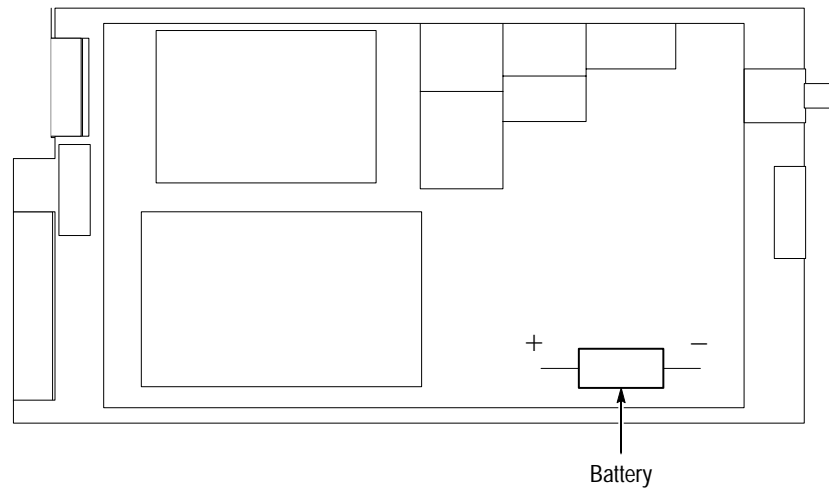

Figure 6-5: Position and poles of battery

6. Closing the instrument

- a.** Put upper RF cover onto generator board and screw it on.
- b.** Slide on top cover from the rear.
- c.** Put instrument upside down.
- d.** Put lower RF cover onto generator board and screw it on.
- e.** Slide on bottom cover from the rear.
- f.** Put back feet on rear panel and screw them on.

After this, date and time must be reset. This can only be done with the keyboard and VGA monitor connected:

- g.** Switch on the instrument.
- h.** After power-up, wait until “Booting:” on the LCD disappears.
- i.** Abort generator function by pressing the key combination (Ctrl. C>). The DOS prompt “C:\DVG\GTS>” is displayed.
- j.** Enter “Date” and current date.
- k.** Enter “Time” and current time.
- l.** Return to generator mode with command “DVG.”

Checking

After power-up, the instrument starts booting with a memory check and driver installation the same as a PC. If a fault occurs, a message is displayed on the VGA monitor.

After booting, the generator program (in firmware) is started automatically and the version number is displayed.

Malfunctions may also be caused by additionally installed drivers and PC software which are not part of the equipment supplied. For a check, proceed as follows:

- Store the autoexec.bat and config.sys files in the CONFIG directory under the file names myinstal.axc and myinstal.cfs.
- Enter command “config factory.”

This command overwrites the autoexec.bat and config.sys files and restarts the MPEG Test Generator with a defined software and driver configuration.

To restore your configuration, type “config.myinstal.”

In the case of a total failure send the instrument to your local service center.

Appendix A: Device Interfaces

Asynchronous Serial Transport Stream Interface (TS ASI)

The asynchronous serial transport stream interface uses a constant bit rate of 270 Mbit/s. Data streams (8-bit) of 27 Mbyte/s maximum are transmitted via this interface. According to a standard table, two additional bits are added to each byte for marking nonrelevant (dummy) data bytes, which are required for filling up the 27-Mbyte/s rate, and also for preventing redundancy in the serial signal.

The interface is a BNC connector with an output impedance of 75 Ω. The level is 800 mV (±10%).

Synchronous Parallel Transport Stream Interface (TS PARALLEL LVDS)

Pin Assignment

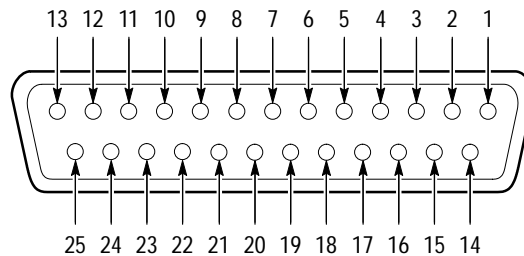

Table A-1: Pin assignment of TS PARALLEL (corresponds to DVB Document A010)

Pin	Signal	Description	Pin	Signal	Description
1	CLOCK A	Clock for data word	14	Clock B	Clock for data word, inverted
2	GND	Ground	15	GND	Ground
3	DATA BIT 7 A (MSB)	Data bit 7 (most significant bit)	16	DATA BIT 7 B (MSB)	Data bit 7, inverted (most significant bit)
4	DATA BIT 6 A	Data bit 6	17	DATA BIT 6 B	Data bit 6, inverted
5	DATA BIT 5 A	Data bit 5	18	DATA BIT 5 B	Data bit 5, inverted
6	DATA BIT 4 A	Data bit 4	19	DATA BIT 4 B	Data bit 4, inverted
7	DATA BIT 3 A	Data bit 3	20	DATA BIT 3 B	Data bit 3, inverted
8	DATA BIT 2 A	Data bit 2	21	DATA BIT 2 B	Data bit 2, inverted
9	DATA BIT 1 A	Data bit 1	22	DATA BIT 1 B	Data bit 1, inverted

Table A-1: Pin assignment of TS PARALLEL (corresponds to DVB Document A010) (Cont.)

Pin	Signal	Description	Pin	Signal	Description
10	DATA BIT 0 A (LSB)	Data bit 0 (least significant bit)	23	DATA BIT 0 B (LSB)	Data bit 0, inverted (least significant bit)
11	DVALID A	Data word valid	24	DVALID B	Data word valid, inverted
12	PSYNC A	Packet sync	25	PSYNC B	Packet sync inverted
13	GND	Ground	---	-----	-----

Transmission Formats

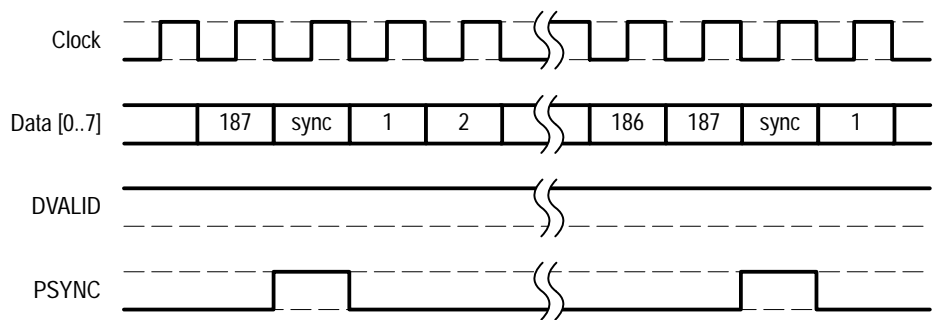

Transmission format with packets of 188 bytes

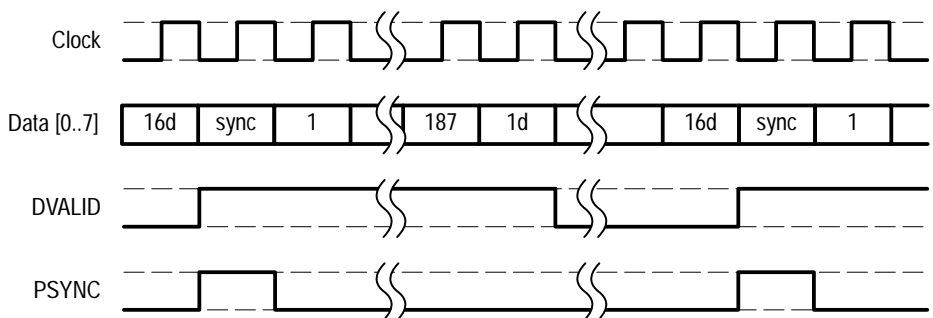

Transmission format with packets of 188 bytes and 16 dummy bytes (= 204 bytes)

Figure A-1: Transmission formats for 188 and 204 byte packets

Keyboard Interface

Pin Assignment

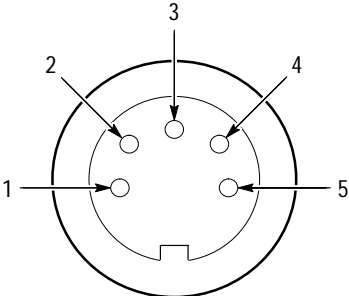

Table A-2: AT keyboard (DIN connector, female)

Pin	Signal	Description
1	CLK	Clock
2	GND	Ground
3	DATA	Data
4	+5V	Power supply
5	nc	Not connected

Keyboard Layout

International



German

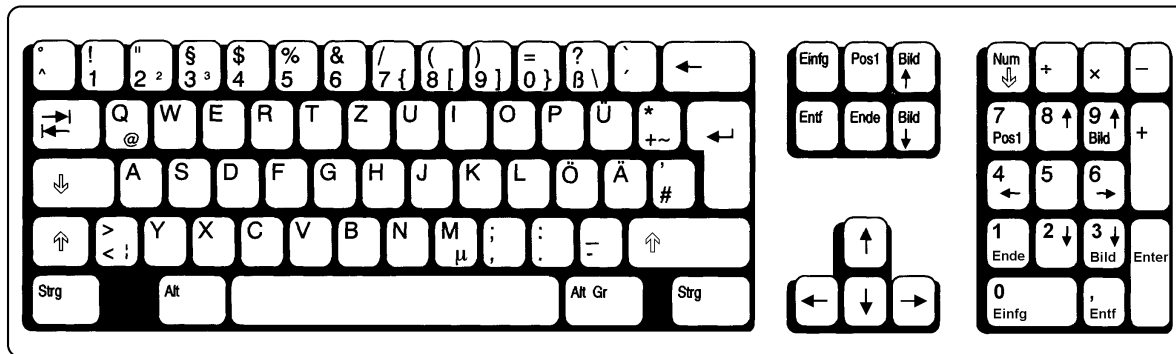

Figure A-2: Keyboard layouts

VGA Interface

Pin Assignment

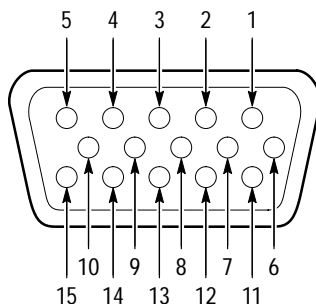

Table A-3: VGA interface

Pin	Signal	Description
1	RED	Red channel
2	GREEN	Green channel
3	BLUE	Blue channel
4	NC	Not connected
5	GND	Ground
6	GND	Ground
7	GND	Ground
8	GND	Ground
9	NC	Not connected
10	GND	Ground
11	NC	Not connected
12	NC	Not connected
13	HSYNC	Horizontal sync
14	VSYNC	Vertical sync
15	NC	Not connected

RS-232 Interfaces COM1 and COM2

Pin Assignment

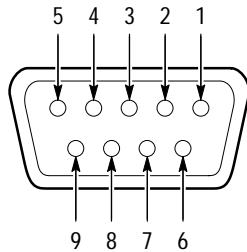

Table A-4: Pin assignment of COM1 and COM2

Pin	Signal	Description
1	CD	Carrier Detect
2	RXD	Receive Data
3	TXD	Transmit Data
4	DTR	Data Terminal Ready
5	GND	Ground
6	DSR	Data Set Ready
7	RTS	Request To Send
8	CTS	Clear To Send
9	RI	Ring Indicator

Table A-5: Baud rates of COM1 and COM2

Value for BAUD	Transmission rate
11	110 baud
15	150 baud
30	300 baud
60	600 baud
12	1200 baud
24	2400 baud
48	4800 baud
96	9600 baud
19	19200 baud

Table A-6: Parity settings of COM1 and COM2

Value of PARITY	Meaning
n	No parity check
e	Even parity
o	Odd parity
m	Parity bit, logic 1
s	Parity bit, logic 0

Table A-7: Data-bit settings of COM1 and COM2

Value for DATA	Meaning
7	7 data bits
8	8 data bits

Table A-8: Stop-bit settings of COM1 and COM2

Value for STOP	Meaning
1	1-bit end character
1.5	1.5-bit end character
2	2-bit end character

Table A-9: Retry settings of COM1 and COM2

Value for RETRY	Meaning
e	Error output after status check of an assigned contact.
b	Display of "Occupied" after status check of an assigned contact.
p	Retry until contact accepts output.
r	Display of "Ready" after status check of an assigned contact.
n (standard setting)	Attempt not repeated if contact is occupied.

Parallel Interface LPT1

Pin Assignment

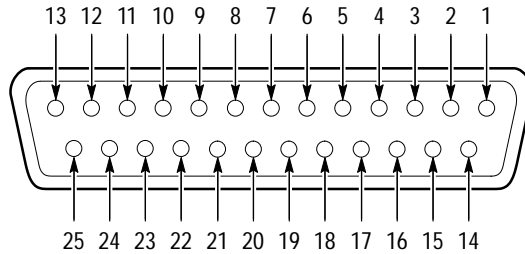

Table A-10: Pin assignment of LPT1

Pin	Signal	Description
1	STROBE	Clock for data word
2	DATA BIT 0	Data bit 0 (least significant bit)
3	DATA BIT 1	Data bit 1
4	DATA BIT 2	Data bit 2
5	DATA BIT 3	Data bit 3
6	DATA BIT 4	Data bit 4
7	DATA BIT 5	Data bit 5
8	DATA BIT 6	Data bit 6
9	DATA BIT 7	Data bit 7 (most significant bit)
10	ACKNOWLEDGE	Acknowledgement
11	BUSY	Not ready
12	PAPER END	Error message: Paper end
13	SELECT	
14	AUTO LINE FEED	
15	ERROR	Error message
16	INITIALIZE PRINTER	
17	SELECT IN	

Table A-10: Pin assignment of LPT1 (Cont.)

Pin	Signal	Description
18	GND	Ground
19	GND	Ground
20	GND	Ground
21	GND	Ground
22	GND	Ground
23	GND	Ground
24	GND	Ground
25	GND	Ground

TS Parallel EIA RS-422 Interface

Pin Assignment

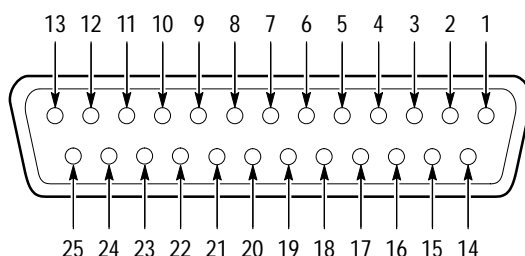

Table A-11: Pin assignment for the TS Parallel EIA RS-422 interface

Pin	Signal	Description
1	SENSE	Ground through 100 Ω
2	D0+	Output data of the parallel transport stream
3	D1+	Output data of the parallel transport stream
4	D2+	Output data of the parallel transport stream
5	D3+	Output data of the parallel transport stream
6	D4+	Output data of the parallel transport stream
7	D5+	Output data of the parallel transport stream
8	D6+	Output data of the parallel transport stream
9	D7+	Output data of the parallel transport stream
10	SYNC+	Output synchronizing pulse of the parallel transport stream
11	BYTECLK+	Output clock of the parallel transport stream

Table A-11: Pin assignment for the TS Parallel EIA RS-422 interface (Cont.)

Pin	Signal	Description
12	CLKIN+	Ground
13	GND	Inverted output data of the parallel transport stream
14	D0-	Inverted output data of the parallel transport stream
15	D1-	Inverted output data of the parallel transport stream
16	D2-	Inverted output data of the parallel transport stream
17	D3-	Inverted output data of the parallel transport stream
18	D4-	Inverted output data of the parallel transport stream
19	D5-	Inverted output data of the parallel transport stream
20	D6-	Inverted output data of the parallel transport stream
21	D7-	Inverted output data of the parallel transport stream
22	SYNC-	Inverted output synchronizing pulse of the parallel transport stream
23	BYTECLK-	Inverted output clock of the parallel transport stream
24	CLKIN-	Inverted external input clock
25	GND	Ground

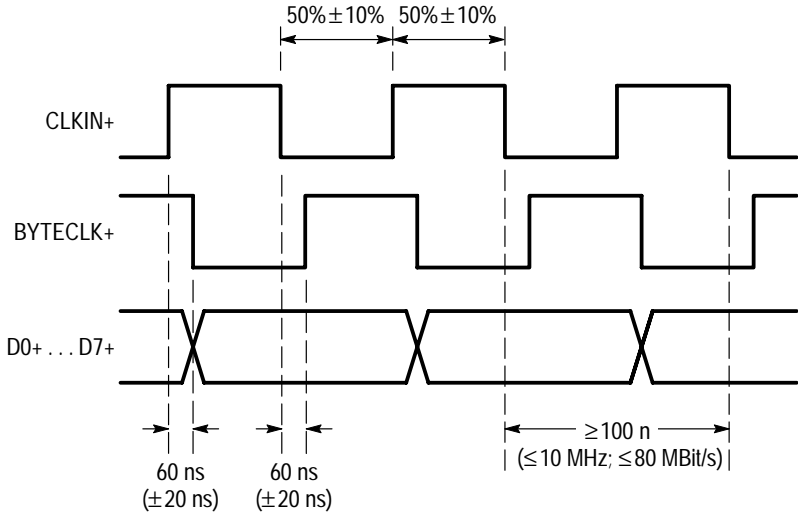

Figure A-3: Timing diagram for the TS Parallel EIA RS-422

Appendix B: Specifications

Table B-1: Output signals

Characteristic	Performance requirement	Supplemental information
Standard		Transport signals to ISO/IEC 1-13818
Data Rate (including null packets)	0.6 to 160 Mbit/s	Selectable in 1 Hz steps
Data Rate for Video/Audio Contents	Up to 15 Mbit/s	
Data Quantity for Video/Audio Contents	Up to 100 Mbit	
MPEG2 Sequence Length	Endless loop	
Video/Audio Sequence Length	192 video frames (typ)	Depending on data rate for video/audio channels.
Length of Transport Stream Packets	188/204 bytes	Selectable
Stored Signals		Various transport streams, moving picture sequences, test patterns, and test tones.
Error of Data Rate	± 3 ppm with one year calibration interval	Additional ± 0.5 ppm error per year without calibration
Data Jitter	$< 0.05 U_{I_{p-p}}$ (10 Hz to 100 kHz) (typ) Asynchronous Serial Interface (ASI) Outputs (typ): $< 0.1 U_{I_{p-p}}$ (10Hz to 100MHz) Synchronous Parallel Output (typ): $< 0.2 U_{I_{p-p}}$ (10 Hz to 200 kHz)	

Table B-2: Signal outputs

Characteristic	Performance requirement	Supplemental information
Synchronous Parallel MPEG2 Data Stream, LVDS	Level: 410 mV _{p-p} , centered at 1.25 V DC Impedance: 100 Ω	Standard: To DVB A010 Connector: Front-panel 25 pin connector
Asynchronous Serial MPEG2 Transport Stream	Data Rate: 270 Mbit/s Level: 800 mV _{p-p} Impedance: 75 Ω	Standard: To DVB A010 Connector: Front- and rear-panel BNC

Table B-2: Signal outputs (Cont.)

Characteristic	Performance requirement	Supplemental information
Parallel MPEG2 Transport Stream	Data Rate: Up to 80 Mbit/s Level: 0 V to 4 V Impedance: 100 Ω	Standard: To EIA RS-422 Connector: Rear-panel 25 pin connector
Interface for Integrated Controller		PC keyboard VGA monitor Two RS-232 serial interfaces Parallel printer interface PCMCIA (PC card)

Table B-3: Environmental characteristics

Characteristic	Performance requirement	Supplemental information
Temperature Range	Operating: +5 to +50° C Storage: -40 to +70° C Climactic Stressing: +25/ +40° C	rated from 0 to $\pm 50^{\circ}$ C cyclically at 95% RH
Humidity		To IEC 68-2-30
Vibration	Sine wave: 5 to 150 Hz, maximum 2 g at 55 Hz, 0.5 g from 55 to 150 Hz Random: 10 to 300 Hz, 1.2 g _{rms}	Complies with IEC 68-2-6, IEC 1010-1, Mil-T-28800 D class 5
Shock	40 g shock spectrum	Complies with MIL-STD-810 C and MIL-T-28800 D class 3 and 5



CAUTION. Only well grounded and shielded cables and external devices (for instance, a disk drive, mouse, or keyboard) may be used with this instrument. Failure to provide proper grounding may cause the MTG200 MPEG Test Generator to emit unacceptable levels of electromagnetic interference.

Compliance with the various EMC requirements to which the MTG200 is certified is contingent upon the use of appropriate cables and peripheral devices.

Table B-4: Certifications and compliances

Certification	Compliance
EC Declaration of Conformity – EMC	Meets intent of Directive 89/336/EEC for Electromagnetic Compatibility. Compliance was demonstrated to the following specifications as listed in the Official Journal of the European Communities: EN 50081-1 Emissions: EN 55022 Class A Radiated and Conducted Emissions EN 60555-2 AC Power Line Harmonic Emissions EN 50082-1 Immunity: IEC 801-2 Electrostatic Discharge Immunity IEC 801-3 RF Electromagnetic Field Immunity IEC 801-4 Electrical Fast Transient/Burst Immunity IEC 801-5 Power Line Surge Immunity
FCC Compliance	Emissions comply with FCC Code of Federal Regulations 47, Part 15, Subpart B, Class A Limits
EC Declaration of Conformity – Low Voltage	Compliance was demonstrated to the following specification as listed in the Official Journal of the European Communities: Low Voltage Directive 73/23/EEC EN 60950/A1: 1993 Safety of Information Technology Equipment, Including Electrical Business Equipment (Second Edition)
Approvals	
U.S. Nationally Recognized Testing Laboratory Listing	UL1950 Safety of Information Technology Equipment, Including Electrical Business Equipment
Canadian Certification	CAN/CSA C22.2 No. 950 M89 Safety of Information Technology Equipment, Including Electrical Business Equipment
European Union Compliance	Low Voltage Directive 73/23/EEC, Amended by 93/68/EEC EN60950 Safety of Information Technology Equipment, Including Electrical Business Equipment
Conditions for Safety Certification	Operating temperature: +5° C to +40° C Max. operating altitude: 2000 m Safety class: Class I, grounded product Pollution degree: Pollution Degree 2, rated for indoor use only

Table B-4: Certifications and compliances (cont.)

Certification	Compliance
Installation Category Descriptions	<p>Terminals on this product may have different installation category designations. The installation categories are:</p> <p>CAT III Distribution-level mains (usually permanently connected). Equipment at this level is typically in a fixed industrial location</p> <p>CAT II Local-level mains (wall sockets). Equipment at this level includes appliances, portable tools, and similar products. Equipment is usually cord-connected</p> <p>CAT I Secondary (signal level) or battery operated circuits of electronic equipment</p>

Table B-5: Power characteristics

Characteristic	Description
Line Voltage	88 to 264 V AC
Line Frequency	47 to 63 Hz
Power Consumption	50 W

Table B-6: Physical characteristics

Dimensions	mm	in
Height	43	1.75
Width	434	17.1
Depth	460	18.1
Weight	kg	lb
Net	5	11

Index

Numbers

188 bytes, 2-1
204 bytes, 2-1

A

asynchronous serial interface, A-1
Audio, 4-7
AUTOEXEC.BAT, 3-9, 3-12, 6-6

B

Battery, 6-1
baud rate, 5-2, A-6
Bit error, 2-5
BNC connector, A-1

C

CAT, 1-6
CCITT O.33, 2-5
CCITT O.33:00, 2-20
CCVS, 2-23
Cleaning, 6-1
CODEC test pattern, 2-6
COM1, 4-10
commands
 common, 5-3
 device-specific, 5-3
CONFIG, 6-6
CONFIG.SYS, 3-9, 6-6

D

D/A conversion, 2-6
DATA, 4-7
Data reduction, 2-6
DATA_GTS, 5-4
Date, 6-5
Decoder, 2-2, 2-5, 2-6
descrambling, 1-8
device-specific commands, 5-3
DIR, 4-5
DIR_GTS, 5-4

directory menu, 4-12
DOS prompt, 4-14, 6-5
DTS, 2-2
dummy bytes, A-1
Dummy packets, 2-2
DVB DOCUMENT A010, A-1
DVB standards, 1-3

E

EBU line measurement, 2-5
ECM, 1-8
Electrostatic sensitive components, 6-2
Elementary stream, 2-1
elementary stream, 4-7
EMM, 1-8
Encoder, 2-1
Entitlement Control Messages, 1-8
Entitlement Management Messages, 1-8
ESC, 4-2

F

Firmware, 6-6
Firmware version number, 6-6
Frequency response, 2-6
Front panel, 6-2
Function test, 2-5

G

Generator mode, 6-5
GTS, 5-4

H

Hard disk, 2-2

I

INFO_GTS, 5-4
Insertion test signal, 2-6
ITS, 2-6
ITS test patterns, 2-6

K

- KEYBOARD, 3-2
- Keyboard, 6-5
- keyboard interface, A-3
- keypad, 3-2

L

- LC display, 2-2, 3-2
- Level, 2-6
- Loading time, 2-3

M

- Main Level, 2-1
- Main Profile, 2-1
- Maintenance, 6-1
- Menu DIR, 4-12
- ML@MP, 2-1
- MOUSE, 3-10
- mouse, 3-7
- Moving picture scenes, 2-5
- MPEG-2
 - standards, 1-2
 - Systems, 1-5
 - transport stream, 2-1
- Multiplexer, 2-1, 2-5
- Music, 2-5

N

- NTSC, 2-23

O

- Output data rate, 2-2

P

- P_LENGTH, 5-4
- Packetized Elementary Stream, 1-8
- Packetizer, 2-1
- PAL, 2-23
- parity, A-7
- PATH, 3-10
- PCMCIA, 3-2, 3-7

- PCR, 2-2
- PCR jitter, 4-10
- PCR_JITTER, 5-4
- PES, 1-8
- Picture geometry, 2-6
- PID, 1-10
- POWER, 3-2, 3-3
- PRINT, 4-5, 5-4
- printer, 3-7
- Processing error, 2-5
- Program elementary stream, 2-1
- Program information, 2-5
- Program Specific Information, 1-8
- program structure, 4-7
- Programs, 2-5
- PTS, 2-2

R

- RAM, 2-2
- Real-time clock, 6-1
- Rear panel, 6-2
- RS-232
 - configuration, 4-10
 - menu, 4-10
- RUN, 4-6, 5-4

S

- Scrambling Control Field, 1-8
- SECAM, 2-23
- Sequence length, 2-2
- SET, 5-4
- set-top box, 2-5
- SETUP, 4-5, 4-8
- Signal source, 2-1
- Still pictures, 2-6
- Synchronisation, 1-8
- Synchronism, 2-5

T

Table_ID, 1–10
Temperature, 6–1
Terminals, 2–5
Test sequences, 2–5
Test tones, 2–5
Time, 6–5
Transmission error, 2–5
TS, 4–5
TS ASI, 3–2, 3–3, 6–4
TS PARALLEL, 3–2, A–1
TS_RATE, 5–4

U

Useful data rate, 2–2

V

VGA, 3–3
VGA monitor, 2–2, 6–5, 6–6
Video, 4–7
video stills, 2–5

