

Service Manual



AFG3000 Series Arbitrary/Function Generators

071-1640-02

This document supports firmware version 1.2.0 and above.

www.tektronix.com

Copyright © Tektronix. All rights reserved. Licensed software products are owned by Tektronix or its subsidiaries or suppliers, and are protected by national copyright laws and international treaty provisions.

Tektronix products are covered by U.S. and foreign patents, issued and pending. Information in this publication supercedes that in all previously published material. Specifications and price change privileges reserved.

TEKTRONIX and TEK are registered trademarks of Tektronix, Inc.

Contacting Tektronix

Tektronix, Inc.
14200 SW Karl Braun Drive
P.O. Box 500
Beaverton, OR 97077
USA

For product information, sales, service, and technical support:

- In North America, call 1-800-833-9200.
- Worldwide, visit www.tektronix.com to find contacts in your area.

WARRANTY 16

Tektronix warrants that the product will be free from defects in materials and workmanship for a period of three (3) years from the date of original purchase from an authorized Tektronix distributor. If the product proves defective during this warranty period, Tektronix, at its option, either will repair the defective product without charge for parts and labor, or will provide a replacement in exchange for the defective product. Batteries are excluded from this warranty. Parts, modules and replacement products used by Tektronix for warranty work may be new or reconditioned to like new performance. All replaced parts, modules and products become the property of Tektronix.

In order to obtain service under this warranty, Customer must notify Tektronix of the defect before the expiration of the warranty period and make suitable arrangements for the performance of service. Customer shall be responsible for packaging and shipping the defective product to the service center designated by Tektronix, shipping charges prepaid, and with a copy of customer proof of purchase. Tektronix shall pay for the return of the product to Customer if the shipment is to a location within the country in which the Tektronix service center is located. Customer shall be responsible for paying all shipping charges, duties, taxes, and any other charges for products returned to any other locations.

This warranty shall not apply to any defect, failure or damage caused by improper use or improper or inadequate maintenance and care. Tektronix shall not be obligated to furnish service under this warranty a) to repair damage resulting from attempts by personnel other than Tektronix representatives to install, repair or service the product; b) to repair damage resulting from improper use or connection to incompatible equipment; c) to repair any damage or malfunction caused by the use of non-Tektronix supplies; or d) to service a product that has been modified or integrated with other products when the effect of such modification or integration increases the time or difficulty of servicing the product.

THIS WARRANTY IS GIVEN BY TEKTRONIX WITH RESPECT TO THE PRODUCT IN LIEU OF ANY OTHER WARRANTIES, EXPRESS OR IMPLIED. TEKTRONIX AND ITS VENDORS DISCLAIM ANY IMPLIED WARRANTIES OF MERCHANTABILITY OR FITNESS FOR A PARTICULAR PURPOSE. TEKTRONIX' RESPONSIBILITY TO REPAIR OR REPLACE DEFECTIVE PRODUCTS IS THE SOLE AND EXCLUSIVE REMEDY PROVIDED TO THE CUSTOMER FOR BREACH OF THIS WARRANTY. TEKTRONIX AND ITS VENDORS WILL NOT BE LIABLE FOR ANY INDIRECT, SPECIAL, INCIDENTAL, OR CONSEQUENTIAL DAMAGES IRRESPECTIVE OF WHETHER TEKTRONIX OR THE VENDOR HAS ADVANCE NOTICE OF THE POSSIBILITY OF SUCH DAMAGES.

Table of Contents

General Safety Summary	vii
Service Safety Summary	ix
Preface	xi
Finding Other Information	xii
Manual Conventions	xii
Introduction	xiii
Performance Verification Procedures	xiii
Strategy for Servicing	xiii
Tektronix Service Offerings	xiv

Specifications

Specifications	1-1
Performance Conditions	1-1
Electrical	1-1
Inputs/Outputs	1-8
General	1-9

Operating Information

Operating Basics	2-1
General Features	2-1
Installation	2-2
Protect Your Instrument from Misuse	2-3
Floating Ground	2-4
Protect Your DUT	2-5
Powering the Instrument On and Off	2-6
Self Test and Self Calibration	2-7
Getting Acquainted with Your Instrument	2-8
Screen Interface	2-10

Theory of Operation

Theory of Operation	3-1
Overview	3-1
Platform	3-3
Generator section	3-4

Performance Verification

Performance Verification	4-1
Self Tests	4-1
Performance Tests	4-3
Test Record	4-5
Frequency/Period Test	4-19
Amplitude Test	4-20
DC Offset Test	4-22

AC Flatness Test	4-24
Harmonics Distortion Test	4-26
Total Harmonic Distortion Test.	4-28
Spurious Test.	4-30
Rise-Fall time Test	4-33

Adjustment Procedures

Adjustment Procedures	5-1
Purpose	5-1
Equipment Required	5-2
Performance Conditions	5-3
Enable the service mode	5-3
Save menu	5-3
Clear CAL Data menu.	5-3
Reference Clock	5-4
LF Adjustment.	5-5
Flatness adjustment	5-6
Spurious adjustment	5-8
Trigger delay adjustment.	5-10
Setting the Serial number	5-12
Setting the MAC Address (AFG310x and AFG325x only)	5-12

Maintenance

Maintenance	6-1
Preparation	6-1
Preventing ESD.	6-1
Inspection and Cleaning	6-2
Removal and Installation Procedures	6-7
Adjustment after repair	6-7
List of Modules	6-7
Summary of Procedures	6-8
Tools Required	6-9
Flip feet	6-9
Front-Panel knob	6-10
Rear case	6-10
Top cover.	6-12
Front case	6-12
A75 Front-panel board	6-13
Display module	6-14
Output board (AFG310x, AFG325x)	6-14
Separation of the rear module and main chassis	6-15
Inverter	6-17
Fan.	6-18
Power supply	6-19
A70, A72 CPU board	6-20
A82 BNC Insulator board.	6-21
Generator board.	6-22
A81 BNC Insulator board, BNC bracket	6-23
Troubleshooting	6-25

Required tools and equipment	6-25
Troubleshooting tree	6-25
Diagnostics	6-28
Calibration	6-29
Error Codes	6-30

Electrical Parts List

Electrical Parts List	7-1
--	------------

Diagrams

Diagrams	8-1
---------------------------	------------

Replaceable Parts

Replaceable Parts	9-1
Parts Ordering Information	9-1
Using the Replaceable Parts List	9-2

List of Tables

Table 1-1: Operation mode	1-1
Table 1-2: Waveforms	1-2
Table 1-3: Frequency/Period	1-2
Table 1-4: Phase (except DC, Noise, and Pulse)	1-3
Table 1-5: Lead Delay (Pulse)	1-3
Table 1-6: Amplitude	1-3
Table 1-7: DC Offset	1-4
Table 1-8: Internal Noise Add	1-4
Table 1-9: Output Characteristics	1-4
Table 1-10: Modulation	1-6
Table 1-11: Front Panel	1-8
Table 1-12: Rear Panel	1-8
Table 1-13: System Characteristics	1-9
Table 1-14: Power	1-9
Table 1-15: Environmental, EMC, Safety	1-10
Table 2-1: General features	2-1
Table 3-1: Combination of circuit boards used in each model	3-1
Table 4-1: Performance test items	4-3
Table 4-2: Test equipment	4-4
Table 5-1: Adjustments performed after repair	5-1
Table 5-2: Test equipment	5-2
Table 6-1: External inspection check list	6-3
Table 6-2: Internal inspection check list	6-4
Table 6-3: Required equipment	6-25
Table 6-4: Error codes	6-30

List of Figures

Figure 1-1: AFG3000 Series dimensions	1-11
Figure 1-2: RM3100 Rackmount dimensions	1-11
Figure 2-1: Front size	2-2
Figure 2-2: Output and Input connectors	2-3
Figure 2-3: Fuse adapter	2-3
Figure 2-4: Grounding equivalent circuit	2-4
Figure 2-5: Front panel controls	2-8
Figure 2-6: Rear panel	2-9
Figure 2-7: Screen interface	2-10
Figure 3-1: AFG3000 Series block diagram	3-2
Figure 4-1: Frequency/Period tests	4-19
Figure 4-2: 50 ohm terminator accuracy	4-20
Figure 4-3: Amplitude tests	4-20
Figure 4-4: 50 ohm terminator accuracy	4-22
Figure 4-5: DC offset tests	4-22
Figure 4-6: AC flatness tests	4-24
Figure 4-7: Harmonic distortion tests	4-26
Figure 4-8: Total Harmonic distortion tests	4-28
Figure 4-9: Spurious tests	4-30
Figure 4-10: Rise-Fall time tests	4-33
Figure 5-1: Reference Clock adjustment	5-4
Figure 5-2: LF adjustment	5-5
Figure 5-3: Flatness adjustment	5-6
Figure 5-4: Spurious adjustment	5-8
Figure 5-5: Trigger delay adjustment	5-10
Figure 6-1: Disassembly order	6-8
Figure 6-2: Removing and installing the flip feet	6-9
Figure 6-3: Rear case removal	6-10
Figure 6-4: Pasting the urethane-form-gaskets	6-11
Figure 6-5: Top cover removal	6-12
Figure 6-6: Front case removal	6-13
Figure 6-7: A75 front-panel board removal	6-13
Figure 6-8: Display module removal	6-14
Figure 6-9: Output board removal	6-15
Figure 6-10: Separation of the rear module and main chassis	6-16
Figure 6-11: Pull out the rear module	6-16
Figure 6-12: Inverter removal	6-17
Figure 6-13: Inverter installation	6-17
Figure 6-14: Fan removal	6-18
Figure 6-15: Power supply removal	6-19
Figure 6-16: Remove the BNC connectors	6-20

Figure 6-17: CPU board removal	6-21
Figure 6-18: Generator board removal	6-22
Figure 6-19: A81 BNC Insulator board and BNC bracket removal	6-23
Figure 6-20: Platform troubleshooting procedure	6-26
Figure 6-21: Generator troubleshooting procedure	6-27
Figure 8-1: Interconnection for AFG302x	8-2
Figure 8-2: Interconnection for AFG310x and AFG325x	8-3
Figure 9-1: Exploded diagram	9-6
Figure 9-2: Exploded diagram, rear modules	9-9

General Safety Summary

Review the following safety precautions to avoid injury and prevent damage to this product or any products connected to it. To avoid potential hazards, use this product only as specified.

Only qualified personnel should perform service procedures.

To Avoid Fire or Personal Injury

Use Proper Power Cord. Use only the power cord specified for this product and certified for the country of use.

Ground the Product. This product is grounded through the grounding conductor of the power cord. To avoid electric shock, the grounding conductor must be connected to earth ground. Before making connections to the input or output terminals of the product, ensure that the product is properly grounded.

Observe All Terminal Ratings. To avoid fire or shock hazard, observe all ratings and markings on the product. Consult the product manual for further ratings information before making connections to the product.

The common terminal is at ground potential. Do not connect the common terminal to elevated voltages.

Do not apply a potential to any terminal, including the common terminal, that exceeds the maximum rating of that terminal.

Do Not Operate Without Covers. Do not operate this product with covers or panels removed.

Avoid Exposed Circuitry. Do not touch exposed connections and components when power is present.

Do Not Operate With Suspected Failures. If you suspect there is damage to this product, have it inspected by qualified service personnel.

Do Not Operate in Wet/Damp Conditions.

Do Not Operate in an Explosive Atmosphere.

Keep Product Surfaces Clean and Dry.

Provide Proper Ventilation. Refer to the manual's installation instructions for details on installing the product so it has proper ventilation.

Symbols and Terms **Terms in this Manual.** These terms may appear in this manual:



WARNING. *Warning statements identify conditions or practices that could result in injury or loss of life.*



CAUTION. *Caution statements identify conditions or practices that could result in damage to this product or other property.*

Terms on the Product. These terms may appear on the product:

DANGER indicates an injury hazard immediately accessible as you read the marking.

WARNING indicates an injury hazard not immediately accessible as you read the marking.

CAUTION indicates a hazard to property including the product.

Symbols on the Product. The following symbols may appear on the product:



WARNING
High Voltage



Protective Ground
(Earth) Terminal



CAUTION
Refer to Manual



Double
Insulated

Service Safety Summary

Only qualified personnel should perform service procedures. Read this *Service Safety Summary* and the *General Safety Summary* before performing any service procedures.

Do Not Service Alone. Do not perform internal service or adjustments of this product unless another person capable of rendering first aid and resuscitation is present.

Disconnect Power. To avoid electric shock, disconnect the mains power by means of the power cord or, if provided, the power switch.

Use Care When Servicing With Power On. Dangerous voltages or currents may exist in this product. Disconnect power, remove battery (if applicable), and disconnect test leads before removing protective panels, soldering, or replacing components.

To avoid electric shock, do not touch exposed connections.

Preface

This manual provides instructions to verify the performance of, calibrate, troubleshoot, and repair the arbitrary/function generators to the module level.

Unless noted otherwise, the term “AFG3000 Series” refers to the models in the AFG3021, AFG3022, AFG3101, AFG3102, AFG3251, and AFG3252 arbitrary/function generators.

The manual consists of the following sections:

- *Specifications* contains a description of the arbitrary/function generator and the characteristics that apply to it.
- *Operating Information* includes general information and operating instructions.
- *Theory of Operation* contains circuit descriptions that support service to the module level.
- *Performance Verification* contains procedures for confirming that the arbitrary/function generator functions properly and meets warranted limits.
- *Adjustment Procedures* contains information that you need to manually adjust the arbitrary/function generator so that it meets specifications.
- *Maintenance* contains information and procedures for performing preventive and corrective maintenance of the arbitrary/function generator. These instructions include cleaning, module removal and installation, and fault isolation to the module.
- *Replaceable Electrical Parts* contains a statement referring you to *Replaceable Mechanical Parts*, where both electrical and mechanical modules are listed.
- *Diagrams* contains interconnection diagrams.
- *Replaceable Mechanical Parts* includes a table of all replaceable modules, their descriptions, and their Tektronix part numbers.

Finding Other Information

This manual mainly focuses on the performance verification, troubleshooting and maintenance of the arbitrary/function generator. See the following list for other documents supporting the arbitrary/function generator. All documents except Built-in Help are on the AFG3000 Series Product Documents CD-ROM that shipped with instrument.

Document name	Description
<i>AFG3000 Series Quick Start User Manual</i>	A quick reference to major features of the instrument and how they operate. It also provides several tutorials to familiarize the user with basic instrument features.
<i>AFG3000 Series Reference Manual</i>	An encyclopedia of topics that describe the arbitrary/function generator interface and features, and gives background information on how to use them. It provides Menu Structures, User Interface, and Programming Information.
<i>AFG3000 Series Built-in Help</i>	A built-in help system, integrated with the User Interface application that ships with this product. The help is preinstalled in the instrument.

Manual Conventions

This manual uses certain conventions that you should become familiar with.

Some sections of the manual contain procedures for you to perform. To keep those instructions clear and consistent, this manual uses the following conventions:

- Front-panel controls and menu names appear in the same case (initial capitals, all uppercase, and so on) in the manual as is used on the arbitrary/function generator front-panel and menus. Front-panel labels are all upper case letters (for example, MENU, SELECT, PULSE GEN, and so on).
- Instruction steps are numbered unless there is only one step.

Modules

Throughout this manual, any replaceable component, assembly, or part of the arbitrary/function generator is referred to generically as a module. In general, a module is an assembly (like a circuit board), rather than a component (like a resistor or an integrated circuit). Sometimes a single component is a module; for example, the chassis of the arbitrary/function generator is a module.

Safety

Symbols and terms related to safety appear in the *Safety Summary* near the beginning of this manual.

Introduction

This manual contains information that is needed to properly service the AFG3000 Series Arbitrary/Function Generators as well as general information that is critical to safe and effective servicing.

To prevent personal injury or damage to the arbitrary/function generator, consider the following before attempting service:

- The procedures in this manual should be performed only by a qualified service person.
- Read the *General Safety Summary* on page vii and the *Service Safety Summary*, beginning on page ix.
- Read *Installation* in *Operating Information* on page 2-2.

When using this manual for servicing, be sure to follow all warnings, cautions, and notes.

Performance Verification Procedures

The performance check described in the *Performance Verification* section should be done every 12 months. In addition, a performance check is recommended after module replacement.

If the AFG3000 Series does not meet performance criteria, repair is necessary.

Strategy for Servicing

Throughout this manual, the term, *module*, refers to any field-replaceable component, assembly, or part of the arbitrary/function generator.

This manual contains the information needed for periodic maintenance of the arbitrary/function generator. Further, it contains information for corrective maintenance down to the module level. To isolate a failure to a module, use the troubleshooting procedures found in the *Maintenance* section. To remove and replace any failed module, follow the instructions in the *Removal and Installation Procedures* subsection. After isolating a faulty module, replace it with a fully-tested module obtained from the factory. The *Replaceable Mechanical Parts* section contains part number and ordering information for all replaceable modules.

Tektronix Service Offerings

Tektronix provides service to cover repair under warranty as well as other services that may provide a cost-effective answer to your service needs.

Whether providing warranty repair service or any of the other services listed below, Tektronix service technicians are well trained to service the arbitrary/function generator. They have access to the latest information on improvements to the AFG3000 Series as well as new options.

Warranty Repair Service

Tektronix warrants this product for three years from date of purchase. The warranty appears at the front of this manual. Tektronix technicians provide warranty service at most Tektronix service locations.

Self Service

Tektronix supports repair to the replaceable part and module level.

For More Information. Contact your local Tektronix service center or sales engineer for more information on any of the repair or adjustment services just described.



Specifications

Specifications

These specifications apply to all AFG3000 Series Arbitrary/Function Generators. All specifications are guaranteed unless labeled “typical”. Typical specifications are provided for your convenience but are not guaranteed.

Specifications that are check marked with the ✓ symbol are checked directly (or indirectly) in the *Performance Verification* section.

All specifications apply to the arbitrary/function generator unless noted otherwise. These specifications are valid under the following conditions:

Performance Conditions

The performance limits in this specification are valid with these conditions:

- The instrument must have been calibrated/adjusted at an ambient temperature between +20 °C and +30 °C.
- The instrument must be operating at an ambient temperature between +10 °C and +40 °C.
- The instrument must have had a warm-up period of at least 20 minutes.
- The instrument must be in an environment with temperature, altitude, and humidity within the operating limits described in these specifications.

Electrical

Table 1-1: Operation mode

Characteristics	Description
Run Mode	Continuous, Modulation, Sweep, and Burst
Burst Count	1 to 1,000,000 cycles or Infinite
Internal Trigger Rate	1.000 ms to 500.0 s

Table 1-2: Waveforms

Characteristics	Description		
Standard	Sine, Square, Pulse, Ramp, More (Sin(x)/x, Noise, DC, Gaussian, Lorentz, Exponential Rise, Exponential Decay, and Haversine)		
Arbitrary Waveform	AFG3021/AFG3022	AFG3101/AFG3102	AFG3251/AFG3252
Waveform Length	2 to 65,536	2 to 131,072	2 to 131,072
Sampling Rate	250 MS/s	Waveform Length ≤16384: 1 GS/s 16384 < Waveform Length: 250 MS/s	Waveform Length ≤16384: 2 GS/s 16384 < Waveform Length: 250 MS/s
Resolution	14 bits		
Number of Non-volatile Waveform Memory	4		

Table 1-3: Frequency/Period

Characteristics	Description			PV reference page
Frequency Range	AFG3021/AFG3022	AFG3101/AFG3102	AFG3251/AFG3252	
Sine ¹	1 μHz to 25 MHz	1 μHz to 100 MHz	1 μHz to 240 MHz	
Square	1 μHz to 12.5 MHz	1 μHz to 50 MHz	1 μHz to 120 MHz	
Pulse	1 mHz to 12.5 MHz	1 mHz to 50 MHz	1 mHz to 120 MHz	
Ramp, Sin(x)/X, Gaussian, Lorentz, Exponential Rise, Exponential Decay, Haversine	1 μHz to 250 kHz	1 μHz to 1 MHz	1 μHz to 2.4 MHz	
Arbitrary	1 mHz to 12.5 MHz	1 mHz to 50 MHz	1 mHz to 120 MHz	
Noise Bandwidth (-3 dB), typical	25 MHz	100 MHz	240 MHz	
Resolution	1 μHz or 12 digits			
✓Accuracy (Stability)	±1 ppm, 0 °C to 50 °C (except Arb) ±1 ppm ±1 μHz, 0 °C to 50 °C (Arb)			page 4-19
Accuracy (Aging)	±1 ppm/year			

1. **Triggered/Gated Burst Mode:**
AFG3021/AFG3022, 1 μHz to 12.5 MHz
AFG3101/AFG3102, 1 μHz to 50 MHz
AFG3251/AFG3252, 1 μHz to 120 MHz

Table 1-4: Phase (except DC, Noise, and Pulse)

Characteristics	Description
Range ¹	-180.00° to +180.00°

¹ Resolution: 0.01° (sine), 0.1° (other standard waveforms)

Table 1-5: Lead Delay (Pulse)

Characteristics	Description
Range	0 ps to Period – [Pulse Width + 0.8 * (Leading Edge Time + Trailing Edge Time)]
Resolution	10 ps or 8 digits

Table 1-6: Amplitude

Characteristics	Description			PV reference page
	AFG3021/AFG3022	AFG3101/AFG3102	AFG3251/AFG3252	
Range ¹ (into open circuit load)	10 mV _{p-p} to 10 V _{p-p} 20 mV _{p-p} to 20 V _{p-p}	20 mV _{p-p} to 10 V _{p-p} 40 mV _{p-p} to 20 V _{p-p}	50 mV _{p-p} to 5 V _{p-p} 100 mV _{p-p} to 10 V _{p-p}	
✓Accuracy	±(1% of setting +1 mV) (at 1 kHz sine waveform, amplitude >10 mV _{p-p} , 0 V offset)			page 4-20
Resolution	0.1 mV _{p-p} , 0.1 mV _{rms} , 1 mV, 0.1 dBm or 4 digits			
Units ²	V _{p-p} , V _{rms} , dBm, and Volt (High Level and Low Level)			
Output Impedance	50 Ω			
Isolation	42 V _{pk} maximum to earth			

¹ AFG3251/AFG3252 (frequency range: >200 MHz to 240 MHz): 50 mV_{p-p} to 4 V_{p-p} into 50 Ω, 100 mV_{p-p} to 8 V_{p-p} into open circuit load

² dBm is used only for sine waveform.

Table 1-7: DC Offset

Characteristics	Description			PV reference page
Range ¹	AFG3021/AFG3022	AFG3101/AFG3102	AFG3251/AFG3252	
	$\pm 5 V_{pk}$ ac + dc into 50 Ω	$\pm 5 V_{pk}$ ac + dc into 50 Ω	$\pm 2.5 V_{pk}$ ac + dc into 50 Ω	
✓Accuracy ²	$\pm(1\% \text{ of } \text{setting} + 5 \text{ mV} + 0.5\% \text{ of amplitude } (V_{p-p}))$			page 4-22
Resolution	1 mV			
Output Impedance	50 Ω			

1. AFG3021/AFG3022 and AFG3101/AFG3102: $\pm 10 V_{pk}$ ac + dc; into open circuit load
AFG3251/AFG3252: $\pm 5 V_{pk}$ ac + dc; into open circuit load
2. AFG3021/AFG3022 and AFG3101/AFG3102: Add 0.5 mV per °C for operation outside the range of 20 °C to 30 °C.
AFG3251/AFG3252: Add 2.0 mV per °C for operation outside the range of 20 °C to 30 °C.

Table 1-8: Internal Noise Add

Characteristics	Description
Range	0% to 50% of amplitude setting (V_{p-p}) of signal waveform
Resolution	1%

Table 1-9: Output Characteristics

Characteristics	Description			PV reference page
Sine Wave	AFG3021/AFG3022	AFG3101/AFG3102	AFG3251/AFG3252	
✓Flatness (at 1.0 V_{p-p} amplitude (+4 dBm), relative to 100 kHz)	1 MHz \leq frq < 5 MHz: ± 0.15 dB 5 MHz \leq frq < 20 MHz: ± 0.3 dB 20 MHz \leq frq \leq 25 MHz: ± 0.5 dB	1 MHz \leq frq < 5 MHz: ± 0.15 dB 5 MHz \leq frq < 25 MHz: ± 0.3 dB 25 MHz \leq frq \leq 100 MHz: ± 0.5 dB	1 MHz \leq frq < 5 MHz: ± 0.15 dB 5 MHz \leq frq < 25 MHz: ± 0.3 dB 25 MHz \leq frq < 100 MHz: ± 0.5 dB 100 MHz \leq frq < 200 MHz: ± 1.0 dB 200 MHz \leq frq \leq 240 MHz: ± 2.0 dB	page 4-24

Table 1-9: Output Characteristics (cont.)

Characteristics	Description			PV reference page
✓Harmonic Distortion (at 1.0 V _{p-p} amplitude)	10 Hz ≤ frq < 20 kHz: <-70 dBc 20 kHz ≤ frq < 1 MHz: <-60 dBc 1 MHz ≤ frq < 10 MHz: <-50 dBc 10 MHz ≤ frq ≤ 25 MHz: <-40 dBc	10 Hz ≤ frq < 1 MHz: <-60 dBc 1 MHz ≤ frq < 5 MHz: <-50 dBc 5 MHz ≤ frq ≤ 100 MHz: <-37 dBc	10 Hz ≤ frq < 1 MHz: <-60 dBc 1 MHz ≤ frq < 5 MHz: <-50 dBc 5 MHz ≤ frq < 25 MHz: <-37 dBc 25 MHz ≤ frq ≤ 240 MHz: <-30 dBc	page 4-26
✓Total Harmonic Distortion (at 1 V _{p-p} amplitude)	10 Hz to 20 kHz: <0.2%			page 4-28
✓Spurious ¹ (non harmonic) (at 1 V _{p-p} amplitude)	10 Hz ≤ frq < 1 MHz: <-60 dBc 1 MHz ≤ frq ≤ 25 MHz: <-50 dBc	10 Hz ≤ frq < 1 MHz: <-60 dBc 1 MHz ≤ frq < 25 MHz: <-50 dBc 25 MHz ≤ frq ≤ 100 MHz: -50 dBc + 6 dBc/oct	10 Hz ≤ frq < 1 MHz: <-50 dBc 1 MHz ≤ frq < 25 MHz: <-47 dBc 25 MHz ≤ frq ≤ 240 MHz: -47 dBc + 6 dBc/oct	page 4-30
Phase Noise, typical (at 1 V _{p-p} amplitude)	20 MHz: <-110 dBc/Hz at 10 kHz offset			
Residual Clock Noise, typical	-63 dBm	-57 dBm	-57 dBm	
Square Wave	AFG3021/AFG3022	AFG3101/AFG3102	AFG3251/AFG3252	
✓Rise Time/Fall Time	≤ 18 ns	≤ 5 ns	≤ 2.5 ns	page 4-33
Jitter (rms), typical	500 ps	200 ps	100 ps	
Pulse	AFG3021/AFG3022	AFG3101/AFG3102	AFG3251/AFG3252	
Pulse Width	30 ns to 999.99 s	8 ns to 999.99 s	4 ns to 999.99 s	
Resolution	10 ps or 5 digits			
Pulse Duty	0.001% to 99.999%			
Leading Edge/Trailing Edge transition time	18 ns to 0.625 * Pulse Period	5 ns to 0.625 * Pulse Period	2.5 ns to 0.625 * Pulse Period	
Resolution	10 ps or 4 digits			
Overshoot, typical	<5%			
Jitter (rms), typical	500 ps	200 ps	100 ps	
Ramp				
Linearity (at Frequency: 1 kHz, Amplitude: 1 V _{p-p} , Symmetry: 100%)	≤ 0.1% of peak output at 10% to 90% of ampli- tude range	≤ 0.15% of peak output at 10% to 90% of ampli- tude range	≤ 0.2% of peak output at 10% to 90% of ampli- tude range	
Symmetry	0% to 100%			

Table 1-9: Output Characteristics (cont.)

Characteristics	Description			PV reference page
	AFG3021/AFG3022	AFG3101/AFG3102	AFG3251/AFG3252	
Arbitrary	AFG3021/AFG3022	AFG3101/AFG3102	AFG3251/AFG3252	
Rise Time/Fall Time, typical	≤ 20 ns	≤ 8 ns	≤ 3 ns	
Jitter (rms), typical	4 ns	1 ns at 1 GS/s 4 ns at 250 MS/s	500 ps at 2 GS/s 4 ns at 250 MS/s	

1. Exclude harmonics and channel crosstalk.

Table 1-10: Modulation

Characteristics	Description		
AM (Amplitude Modulation)			
Carrier Waveforms	Standard waveforms (except Pulse, DC, and Noise) and Arb		
Modulation Source	Internal or External		
Internal Modulating Waveforms	Sine, Square, Ramp, Noise, and Arb ¹		
Internal Modulating Frequency	2 mHz to 50.00 kHz		
Depth	0.0% to 120.0%		
FM (Frequency Modulation)	AFG3021/AFG3022	AFG3101/AFG3102	AFG3251/AFG3252
Carrier Waveforms	Standard waveforms (except Pulse, DC, and Noise) and Arb		
Modulation Source	Internal or External		
Internal Modulating Waveforms	Sine, Square, Ramp, Noise, and Arb ²		
Internal Modulating Frequency	2 mHz to 50.00 kHz		
Peak Deviation	DC to 12.5 MHz	DC to 50 MHz	DC to 120 MHz
PM (Phase Modulation)			
Carrier Waveforms	Standard waveforms (except Pulse, DC, and Noise) and Arb		
Modulation Source	Internal or External		
Internal Modulating Waveforms	Sine, Square, Ramp, Noise, and Arb ²		
Internal Modulating Frequency	2 mHz to 50.00 kHz		
Phase Deviation Range	0.0 to 180.0 degrees		

Table 1-10: Modulation

Characteristics	Description		
FSK (Frequency Shift Keying)			
Carrier Waveforms	Standard waveforms (except Pulse, DC, and Noise) and Arb		
Modulation Source	Internal or External		
Internal Key Rate	2 mHz to 1.000 MHz		
Numbers of Key	2		
PWM (Pulse Width Modulation)			
Carrier Waveforms	Pulse		
Modulation Source	Internal or External		
Internal Modulating Waveforms	Sine, Square, Ramp, Noise, and Arb ²		
Internal Modulating Frequency	2 mHz to 50.00 kHz		
Deviation Range	0.0% to 50.0% of pulse period		
Sweep	AFG3021/AFG3022	AFG3101/AFG3102	AFG3251/AFG3252
Type	Linear or Logarithmic		
Start/Stop Frequency ³ (except Arb)	1 μ Hz to 25 MHz	1 μ Hz to 100 MHz	1 μ Hz to 240 MHz
Start/Stop Frequency (Arb)	1 mHz to 25 MHz	1 mHz to 100 MHz	1 mHz to 240 MHz
Sweep/Hold/Return Time ⁴	Range: 1 ms to 300 s (Sweep time) 0 ms to 300 s (Hold/Return time) Resolution: 1 ms or 4 digits		
Total Sweep Time Accuracy, typical	$\leq 0.4\%$		

1. The maximum waveform length for Arb is 4,096. Waveform data points over 4,096 are ignored.
2. The maximum waveform length for Arb is 2,048. Waveform data points over 2,048 are ignored.
3. Pulse, DC, and Noise waveforms are not available.
4. Total sweep time = Sweep time + Hold time + Return time ≤ 300 s

Inputs/Outputs

Table 1-11: Front Panel

Characteristics	Description		
Trigger Output	AFG3021/AFG3022	AFG3101/AFG3102	AFG3251/AFG3252
Level	Positive TTL level pulse into 1 k Ω		
Impedance	50 Ω		
Jitter (rms), typical	500 ps	200 ps	100 ps
Trigger Input			
Level	TTL compatible		
Pulse Width	100 ns minimum		
Impedance	10 k Ω		
Slope	Positive/Negative, selectable		
Trigger Delay	0.0 ns to 85.000 s Resolution: 100 ps or 5 digits		
Jitter (rms), typical	Burst: <500 ps (Trigger input to signal output)		

Table 1-12: Rear Panel

Characteristics	Description
External Modulation Input	
Input Range	± 1.0 V full scale (except FSK) 3.3 V logic level (FSK)
Impedance	10 k Ω
Frequency Range	AM, FM, PM, FSK, PWM: DC to 25 kHz (Sampling rate: 122 kS/s)
External Reference Output (AFG3101/AFG3102 and AFG3251/AFG3252)	
Impedance	50 Ω , AC coupled
Amplitude	1.2 V _{p-p} into 50 Ω
External Reference Input	
Impedance	1 k Ω , AC coupled
Required Input Voltage Swing	100 mV _{p-p} to 5 V _{p-p}
Lock Range	10 MHz ± 35 kHz
CH1 Additional Input (AFG3101/AFG3102 and AFG3251/AFG3252)	
Impedance	50 Ω
Input Range	-1 V to +1 V (DC + peak AC)
Bandwidth	DC to 10 MHz (-3 dB) at 1 V _{p-p}

General

Table 1-13: System Characteristics

Characteristics	Description		
Warm-up Time, typical	20 minutes minimum		
Power On Self Calibration, typical	<16 s		
Configuration Times, typical	USB	LAN	GPIB
Function Change	95 ms	103 ms	84 ms
Frequency Change	2 ms	19 ms	2 ms
Amplitude Change	60 ms	67 ms	52 ms
Select User Arb	88 ms	120 ms	100 ms
Data Download, typical	4000 points waveform data GPIB: 42 ms USB: 20 ms LAN: 84 ms		
Acoustic Noise, typical	<50 dBA		
Weight (approximate)	4.5 kg		
Dimensions	See Figure 1-1 and Figure 1-2 on page 1-11		

Table 1-14: Power

Characteristics	Description
Source Voltage and Frequency	100 V to 240 V, 47 Hz to 63 Hz 115 V, 360 Hz to 440 Hz
Power Consumption	Less than 120 W

Table 1-15: Environmental, EMC, Safety

Characteristics	Description
Temperature Range	
Operating	0 °C to +50 °C
Non operating	-30 °C to +70 °C
Humidity	
Operating	At or below +40 °C: ≤ 80% >+40 °C to +50 °C: ≤ 60%
Altitude	
Operating	Up to 3,000 meters (10,000 feet)
EMC Compliance	
European Union	EN 61326 Class A ^{1, 2} EN 61000-3-2, 3-3 IEC 61000-4-2, 4-3, 4-4, 4-5, 4-6, 4-11
Australia	AS/NZS 2064
Safety	UL 61010-1:2004 CAN/CSA C22.2, No. 61010-1:2004 IEC 61010-1:2001

1. Emissions that exceed the levels required by this standard may occur when this equipment is connected to a test object.
2. To ensure compliance to the standards listed above, attach only high quality shielded cables to this instrument. High quality shielded cables typically are braid and foil types that have low impedance connection to shielded connectors at both ends.

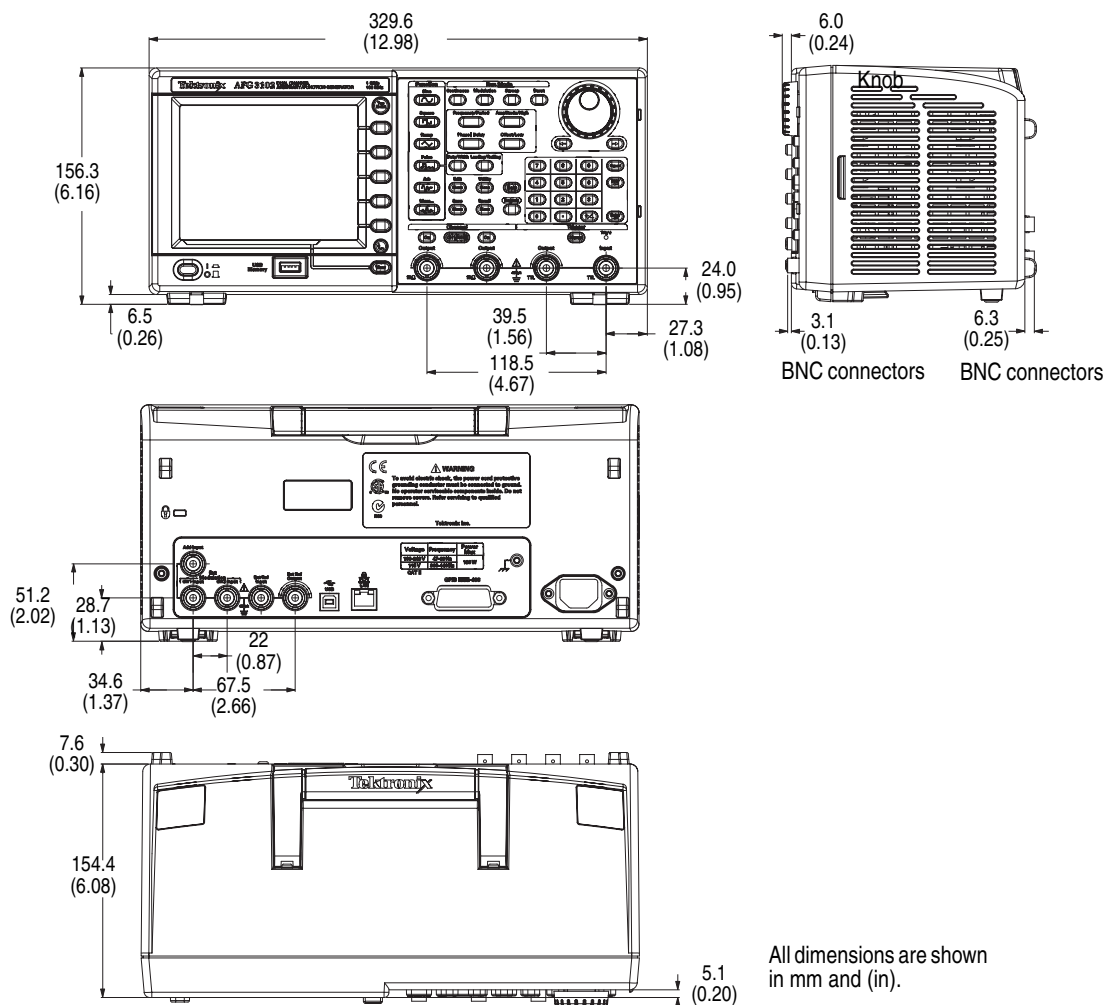

Figure 1-1: AFG3000 Series dimensions

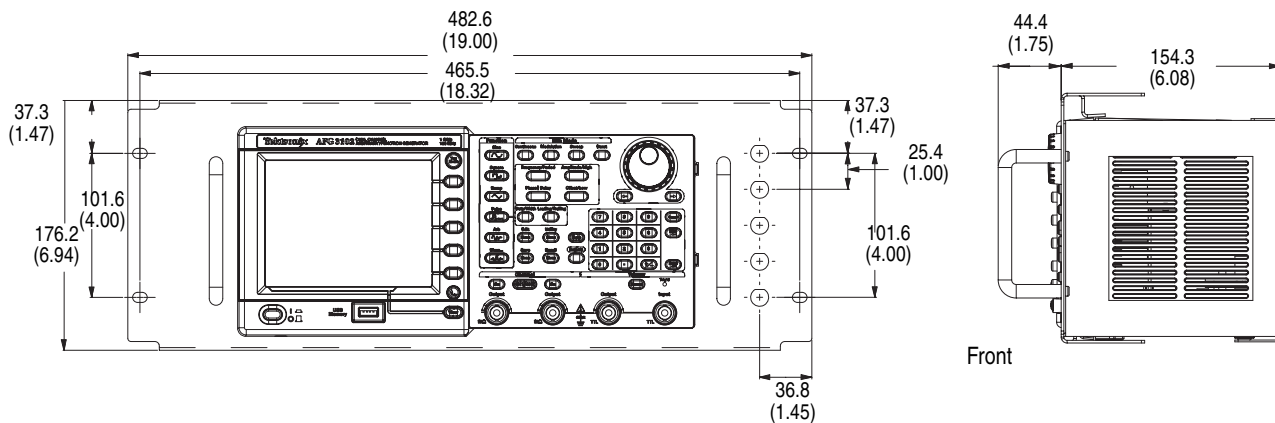

Figure 1-2: RM3100 Rackmount dimensions



Operating Information

Operating Basics

This section provides installation and operating information that is necessary for service.

General Features

The following table and bulleted list describe the general features of AFG3000 Series Arbitrary/Function Generators.

Table 2-1: General features

Feature	AFG3021	AFG3022	AFG3101	AFG3102	AFG3251	AFG3252
Channel	1	2	1	2	1	2
Sine	25 MHz		100 MHz		240 MHz	
Pulse / Square	12.5 MHz		50 MHz		120 MHz	
Ramp / Gaussian	250 kHz		1 MHz		2.4 MHz	
Arbitrary						
Waveform Length	2 to 65,536		2 to 131,072		2 to 131,072	
Sample Rate						
Waveform Length \leq 16384	250 MS/s		1 GS/s		2 GS/s	
16384 < Waveform Length	250 MS/s		250 MS/s		250 MS/s	
Resolution	14 bits		14 bits		14 bits	
Amplitude	10 V _{p-p}		10 V _{p-p}		5 V _{p-p}	
Display	Monochrome	Color	Color		Color	
Interface	USB		USB, LAN, GPIB		USB, LAN, GPIB	

- Three functions integrated into one generator
 - 25 MHz to 240 MHz Function Generator
 - 12.5 MHz to 120 MHz Pulse Generator
 - 14 bits Arbitrary Waveform Generator
- Ground isolation
- Synchronous operation
- USB memory interface
- ArbExpress Software
- Context-sensitive Help system

Installation

Use the following information to safely install your instrument.

Operating Requirements

Environmental

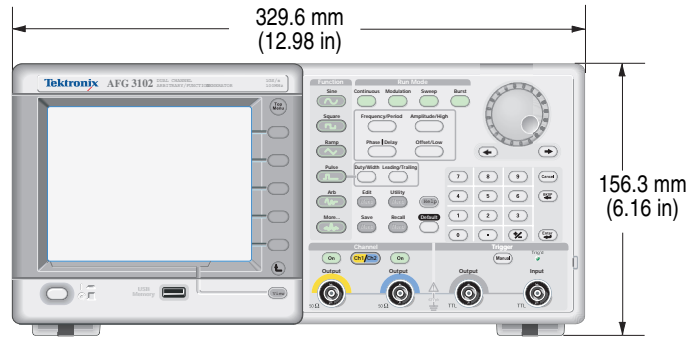

Figure 2-1: Front size

1. Place the instrument on a cart or bench, observing clearance requirements:
 - Sides: 50 mm (2 in)
 - Rear: 50 mm (2 in)
2. Before operating, ensure that the ambient temperature is between 0 °C and +50 °C (+32 °F and +122 °F).



CAUTION. To ensure proper cooling, keep both sides of the instrument clear of obstructions.

Power Supply Requirements

Source Voltage and Frequency	100 V to 240 V, 47 Hz to 63 Hz or 115 V, 360 Hz to 440 Hz
Power Consumption	Less than 120 W

Protect Your Instrument from Misuse

Check Input and Output Connectors

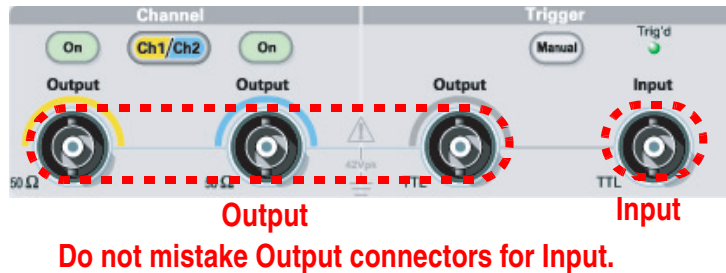

Figure 2-2: Output and Input connectors

1. The instrument has both input and output connectors on the front panel. When connecting a cable, be sure to distinguish the input connector from the output connectors.

The arbitrary/function generator input and output connectors are floating inputs/outputs.



WARNING. To prevent electrical shocks, do not apply voltages in excess of 42 Vpk to any BNC connector ground or to the chassis ground.



CAUTION. Do not short output pins or apply external voltages to Output connectors. The instrument may be damaged.

Do not apply excessive inputs over +5 V to Trigger Input connector. The instrument may be damaged.

Avoid Instrument Damage

The instrument will be damaged if a large DC or AC voltage is applied to the output or input connectors. To protect the output circuits, a fuse adapter is provided as an optional accessory. When the instrument is used by students or other inexperienced users, always attach the fuse adapter to the output connectors to avoid damage.

Tektronix part numbers for the fuse adapter are as follows:

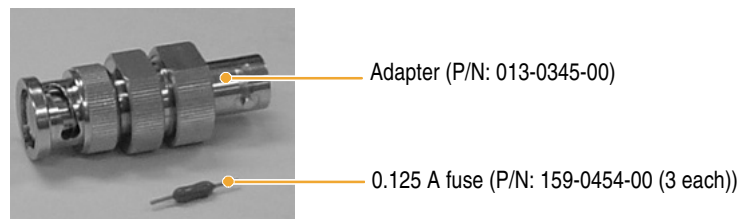

Figure 2-3: Fuse adapter

Floating Ground

Since the common (input and output channel common) of the arbitrary/function generator is electrically isolated from the chassis ground (the instrument chassis and ground line of the AC connector), you can make a floating connection between the instrument and other equipment.

All the signal output connectors are connected to the common ground, and the remote interface connector is connected to the chassis ground.



CAUTION. When you make a floating connection, review the following precautions:

The maximum rated voltage between the chassis ground and common ground is $42 V_{p-p}$ (DC + peak AC). When the potential voltage between the chassis ground and common ground goes over $42 V_{p-p}$, the internal protective circuit will be activated to protect the circuits. However, higher voltage may cause the internal circuits in the instrument to be damaged.

When a potential voltage exists between the chassis ground and common ground, a short circuit from output to ground causes the instrument internal fuse to open and the output is stopped. If the fuse opens, you need to contact your local Tektronix Service Support.

When a potential voltage exists between the common ground and chassis ground, short-circuiting between them may lead to excessive current flow and the internal or external circuits may be damaged.

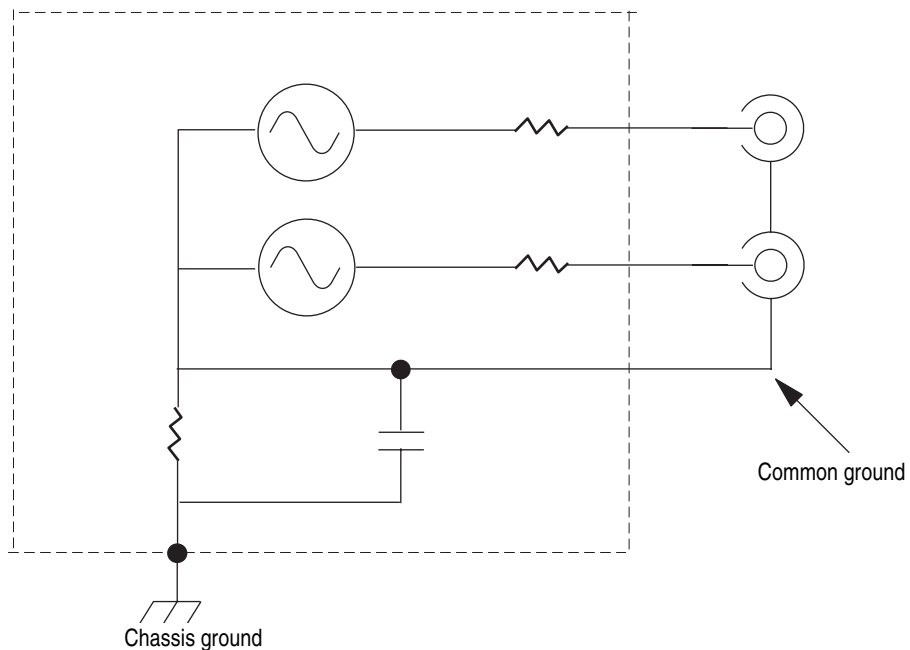
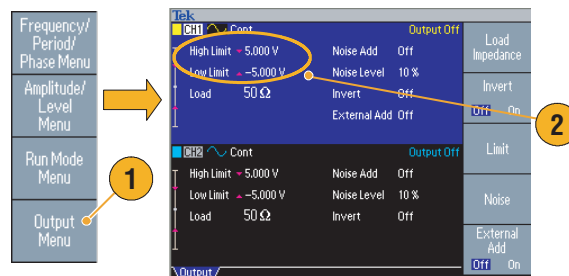

Figure 2-4: Grounding equivalent circuit

Protect Your DUT

Use care when you connect the instrument Channel Output to your DUT (device under test). To avoid damage to your DUT, the following preventive measures are provided. Follow these steps to set the limit values for high level and low level.



1. Push the front-panel Top Menu  button. The **Output Menu** is displayed at the bottom of the bezel menu. Select **Output Menu**.
2. In this example, High Limit is set to 5.000 V, and Low Limit is set to -5.000 V.

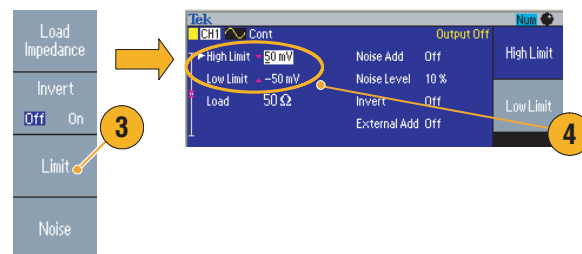

3. Push the **Limit** bezel button.
4. Select **High Limit**. Use numeric keys or the general purpose knob to enter a value. Enter 50 mV for High Limit, and -50 mV for Low Limit.

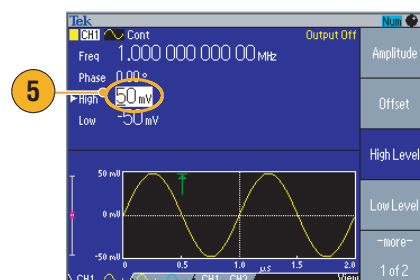

5. Push the front-panel **Sine** button to display the waveform parameter. Confirm that High and Low voltage levels were changed. You cannot enter any values greater than 50 mV for High level.

NOTE. When you set limit values using Output Menu, a level indicator is displayed at left end of graph area. Refer to Screen Interface on page 2-10 for the level indicator.

Powering the Instrument On and Off

Power On

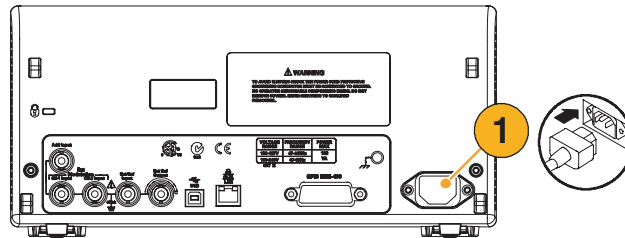

1. Insert the AC power cord into the power receptacle on the rear panel.



2. Use the front-panel power button to power on the instrument.

Wait until the front panel display shows that all power-on self tests passed. In this example, High Limit is set to 5.000 V, and Low Limit is set to -5.000 V.

NOTE. You can select the instrument settings, Default settings or Last powered-off settings, which are restored when you power on the instrument. Use the **Utility** menu to change the settings.

Power Off

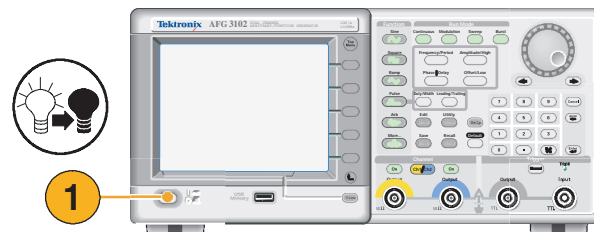

1. Use the front-panel power button to power off the instrument.

Self Test and Self Calibration

The arbitrary/function generator performs a limited set of hardware tests at power-on. You can also perform the manual diagnostics and/or self calibration using the Utility menu.

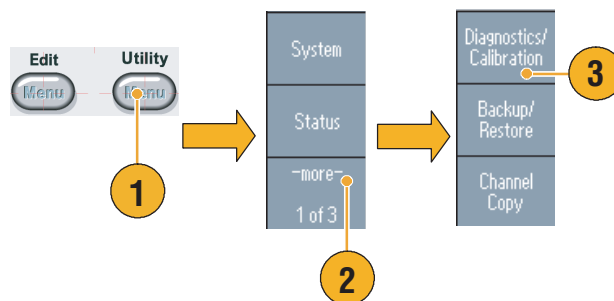

1. Push the front-panel Utility button.
2. Push the **-more-** bezel button.
3. Push the **Diagnostics/Calibration** bezel button.

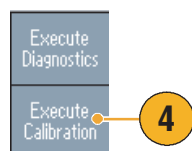

4. The Diagnostics/Calibration execution menu is displayed.
To execute self calibration, push the Execute Calibration bezel button.
To execute the instrument diagnostics, push the Execute Diagnostics bezel button.



CAUTION. Do not power off the instrument while executing self calibration. The calibration data may be damaged/ lost.

NOTE. Before executing self calibration, ensure that the ambient temperature is between +20 °C and +30 °C (+68 °F to +86 °F).

Allow a 20 minute warm-up period prior to executing self calibration.

Getting Acquainted with Your Instrument

Front Panel Overview The front panel is divided into easy-to-use functional areas. This section provides you with a quick overview of the front panel controls and the screen interface. The following figure shows the front panel of the dual-channel model.

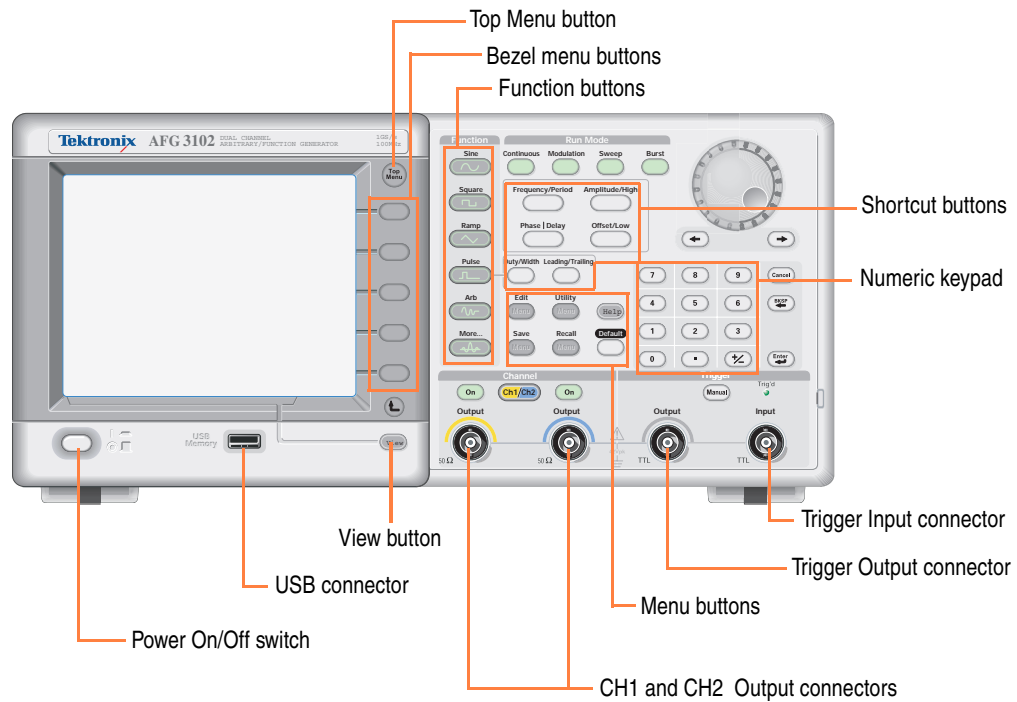

Figure 2-5: Front panel controls

Rear Panel The following illustration shows the rear panel connectors for the instrument.

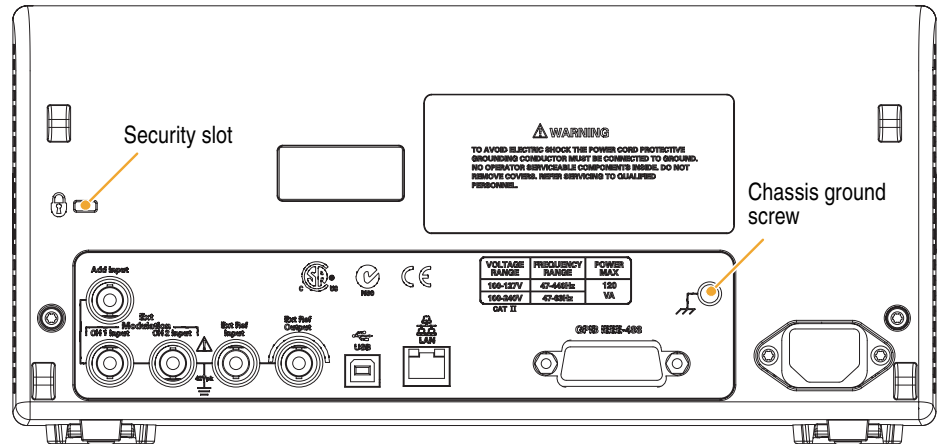

Figure 2-6: Rear panel

EXT REF INPUT. This input is used when synchronizing multiple arbitrary/function generators or an arbitrary/function generator and another device.

EXT REF OUTPUT. When you want to synchronize multiple AFG3000 series arbitrary/function generators, or synchronize your arbitrary/function generator and another instrument, use the external reference output connector. (Except AFG3021 and AFG3022)

ADD INPUT. The ADD INPUT connector is provided with AFG3101/AFG3102 and AFG3251/AFG3252. This connector lets you add an external signal to the CH1 output signal.

EXT MODULATION INPUT (CH1 and CH2). The CH1 INPUT and CH2 INPUT are independent. The signal input level of these connectors controls modulation depth.

USB. Used to connect a USB controller. (Type B)

LAN. Used to connect the instrument to a network. Connect a 10BASE-T or 100BASE-T cable here. (Except AFG3021/ AFG3022)

GPIB. Used to control the instrument through GPIB commands. (Except AFG3021/AFG3022)

Security Slot. Use a standard laptop computer security cable to secure your instrument to your location.

Chassis Ground Screw. The chassis ground screw is used to ground the instrument. Use a unified coarse screw (#6-32, 6.35 mm length or less).

Screen Interface

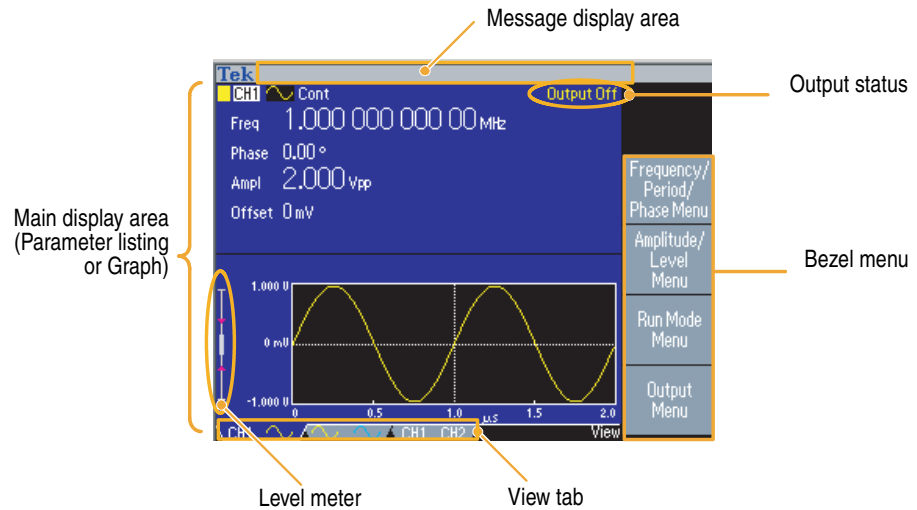

Figure 2-7: Screen interface

Bezel Menu. When you push a front panel button, the instrument displays the corresponding menu on the right side of the screen. The menu shows the options that are available when you push the unlabeled bezel buttons directly to the right of the screen. (Some documentation may also refer to the bezel buttons as option buttons, side-menu buttons, or soft keys.)

Main Display Area and View Tab. Pushing the front-panel View button toggles through the view format of the main display area. The view tabs correspond with the current view format. The arbitrary/function generator can display three different screen formats.

Output Status. If the output is set to disable, Output Off message is displayed in this area. When you push the front panel channel output button to enable the output, the message will disappear.

Message Display Area. A message that monitors hardware status such as clock or trigger is displayed in this area.

Level Meter. Amplitude level is displayed. Refer to page 2-5 for setting the high limit and low limit. The following figure describes the level meter.

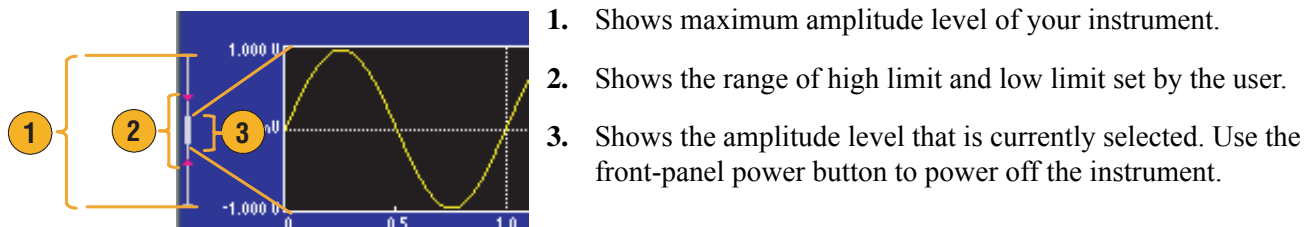

1. Shows maximum amplitude level of your instrument.
2. Shows the range of high limit and low limit set by the user.
3. Shows the amplitude level that is currently selected. Use the front-panel power button to power off the instrument.



Theory of Operation

Theory of Operation

This section describes the electrical operation of the AFG3000 Series Arbitrary/Function Generators to the module level. It describes the basic operation of each functional circuit block shown in Figure 3-1. The descriptions for the one and two channel units, and the color and monochrome units are slightly different.

Overview

AFG3000 Series Arbitrary/Function Generators provide six models with different frequency and number of channels. Each model consists of two major sections: the platform section and the generator section. The platform section is common to each model.

The combination of circuit boards in each model is shown in Table 3-1.

Table 3-1: Combination of circuit boards used in each model

Circuit board	AFG3021	AFG3022	AFG3101	AFG3102	AFG3251	AFG3252
A11 Generator with Amp 1ch	1					
A12 Generator with Amp 2ch		1				
A31 Generator 1ch			1			
A32 Generator 2ch				1		
A41 Generator High 1ch					1	
A42 Generator High 2ch						1
A51 Output Amp			1	2		
A61 Output Amp					1	2
A70 CPU without LAN, GPIB	1	1				
A72 CPU			1	1	1	1
A75 Front Panel	1	1	1	1	1	1
A80			1	2	1	2
A81 Front BNC Insulator	1	1	1	1	1	1
A82 Rear BNC Insulator	1	1	1	1	1	1

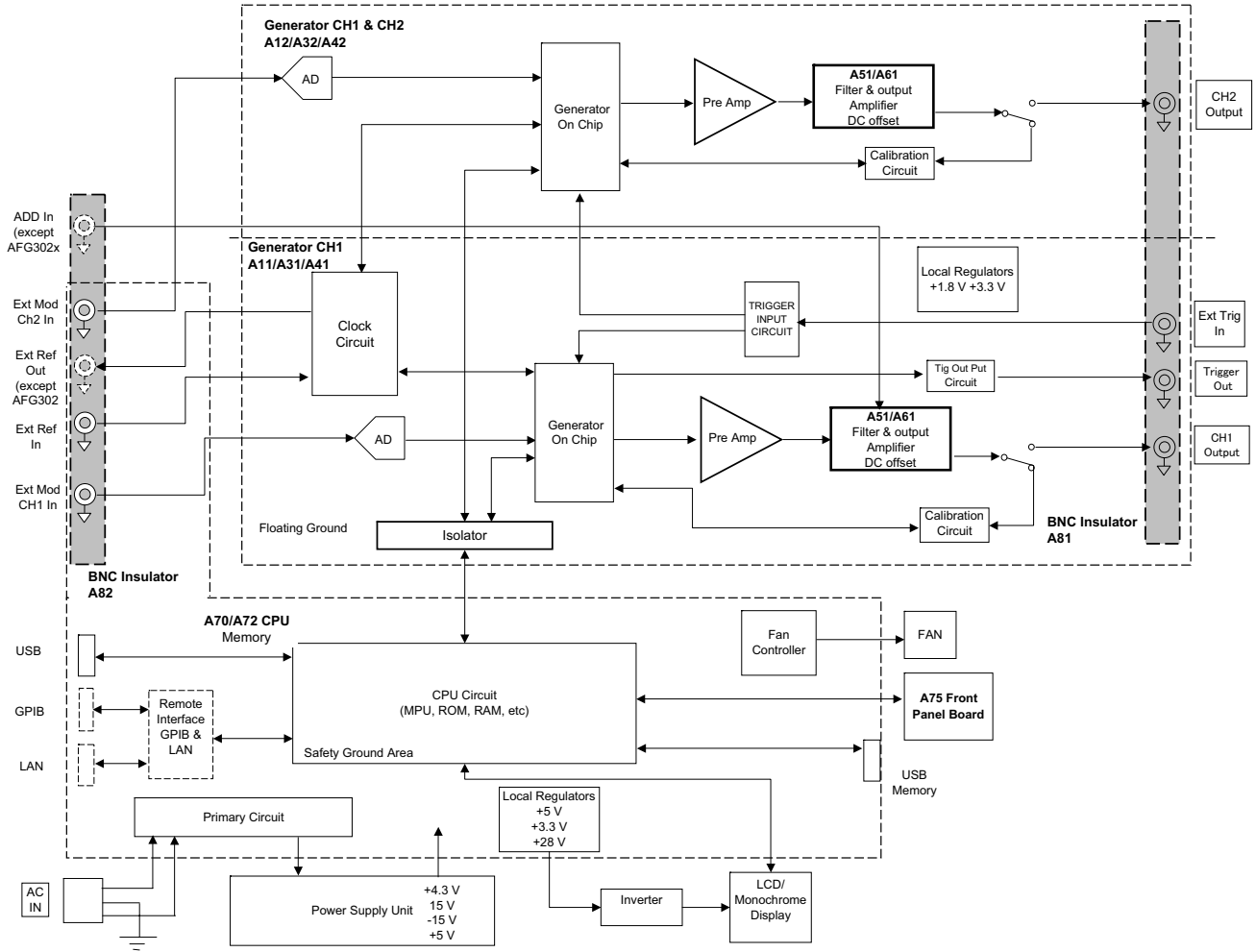

Figure 3-1: AFG3000 Series block diagram

Platform

CPU Board (A70/A72)	<p>CPU Circuit: The CPU Circuit contains an MPU, Flash RAM, and DRAM to control the instrument. The liquid crystal controller and the USB circuit are included in the MPU.</p> <p>Local Regulators: This regulator stabilizes and supplies +3.3 V and +5.0 V for the logic circuit.</p> <p>Remote Interface: The A72 board contains a GPIB and LAN driver circuit. The A70 board installed in the AFG3021 and AFG3022 does not contain the GPIB and LAN driver circuit.</p> <p>Fan Controller: This circuit controls the speed of the fan.</p> <p>Primary Circuit: Contains the power switch and the filter circuit.</p> <p>Signal I/O Circuit: The Reference Clock Input/Output and the Modulation Input signals are transmitted to the Generator section through this board.</p>
Front Panel	The Front Panel controls a rubber button matrix, LED, a buzzer, and a rotary encoder.
Power Supply	The power supply module provides +4.3 V, ± 15 V, and +5 V to the circuit. This power supply module accepts the input voltage within the range of 250 VAC from 90 VAC.
LCD	The display is a color/monochrome Quarter VGA (320 x 240) STN LCD display. The high voltage power for LCD is supplied through the inverter. A monochrome display is used in the AFG3021.
Fan	A 90 mm by 90 mm size, DC 12 V type fan. It is driven by fan controller on the CPU board.
BNC Insulator Board (A81/ A82)	These boards insulate the I/O signal from the chassis. The A81 board is used for the rear panel connectors and the A82 board is used for the front panel connectors.

Generator section

Generator with Amp Board (A11/A12)

Isolator: Transmit the serial control signal from the CPU board to the following circuits with electrical insulation.

Clock Circuit: Generates a 1 GHz high-speed clock necessary for the signal generation from a 10 MHz reference clock by PLL. This circuit has a function of selecting the reference signal source as well.

GoC ASIC: GoC (Generator on Chip) ASIC is a CMOS waveform synthesis IC which includes 2 GS/s DA, Direct Digital Synthesis, waveform SRAM 128 K, x8 MUX, Modulation, Burst and Sweep. So GoC manages most of the generator section.

Trigger Circuit: Receives an External Trigger input signal, executes the level conversion, then supplies the level converted trigger signal to the GoC ASIC.

Pre-Amplifier Circuit: Converts the differential output signal of the GoC to single ended output, then supplies the single ended output to the Output Amplifier through the Attenuator.

Output Amplifier: The output of the pre-amplifier is amplified and output. LPF is used when a sine wave is output.

Trig Out Circuit: Sync Out signal from GoC ASIC is level converted to Trigger Out.

ADC: Modulation by an external source is performed by digitally sampling the external input from the Ext Modulation Input connector.

Local Regulator: Supplies the necessary +1.8 V, +3.3 V, +15 V, and -15 V power.

On/Off Relay: On/Off of the output signal.

Calibration Circuit: DC Calibration of the output signal is done by a 16 bit AD Converter.

Generator with Amp Board (A31/A32/A41/A42)

The A31/A32/A41/A42 boards are the same as the A11/A12 boards except they have a different Output Amplifier board.

**Output Amp Board
(A51/A61)**

Output Amplifier: Amplifying the output of the pre-amplifier with the DC offset.

Output Filter: LPF is used when a sine wave is output.



Performance Verification

Performance Verification

Two types of Performance Verification procedures can be performed on this product: *Self Tests* and *Performance Tests*. You may not need to perform all of these procedures, depending on what you want to accomplish.

- To quickly confirm that the AFG3000 Series Arbitrary/Function Generators are operating properly, complete the *Self Tests* which begin on page 4-1.

Advantage: These procedures require minimal time to perform, and test the internal hardware of the AFG3000 Series Arbitrary/Function Generators.

- To further check functionality and proper calibration, first complete the *Self Tests*; then complete the *Performance Tests* beginning on page 4-3.

Advantages: These procedures add direct checking of warranted specifications. These procedures require suitable test equipment and more time to execute. (Refer to Table 4-2 Test equipment on page 4-4)

Self Tests

There are two types of tests in this section that provide a quick way to confirm basic functionality and proper adjustment:

- Diagnostics
- Calibration (you must perform this calibration before the performance tests.)

These procedures use internal diagnostics to verify that the instrument passes the internal circuit tests, and calibration routines to check and adjust the instrument internal calibration constants.

Diagnostics

This procedure uses internal routines to verify that the instrument is operating correctly.

Equipment required	None
Prerequisites	<ul style="list-style-type: none">■ Power on the instrument and allow a 20 minute warm-up before doing this procedure.■ The instrument must be operating at an ambient temperature between +0 °C and +50 °C.

Do the following steps to run the internal routines that confirm basic functionality and proper adjustment:

1. Select Diagnostics in the Utility menu:

Utility (front-panel) > **-more-** (bezel) > **Diagnostics/Calibration** > **Execute Diagnostics**

2. Wait until the test is completed.
3. Verify passing of the diagnostics.

If the diagnostics completes without finding any problems, the message “PASSED” is displayed.

When an error is detected during diagnostic execution, the instrument displays an error code. Error codes are described in *Error codes* on page 6-30.

4. Press any front panel button to exit the diagnostics.

Calibration

This procedure uses internal routines to verify that the instrument is operating correctly.

Equipment required	None
Prerequisites	<ul style="list-style-type: none"> ■ Power on the instrument and allow a 20 minute warm-up before doing this procedure. ■ An ambient temperature is between +20 °C and +30 °C.

Do the following steps to run the internal routines that confirm basic functionality and proper adjustment:

1. Select Diagnostics in the Utility menu;

Utility (front-panel) > **-more-** (bezel) > **Diagnostics/Calibration** > **Execute Calibration**

2. Wait until the test is completed.
3. Verify passing of the calibration.

If the calibration completes without any problems, the message “PASSED” is displayed.

When an error is detected during calibration execution, the instrument displays an error code. Error codes are described in *Error Codes* on page 6-30.

4. Press any front panel button to exit the diagnostics.

NOTE. Do not turn off the power while executing calibration. If the power is turned off during calibration, data stored in internal nonvolatile memory may be lost.

Performance Tests

The *Performance Tests* include functional tests, such as the interface functional test, in this manual.

- The *Functional Tests* verify the functions; they verify that the AFG3000 Series Arbitrary/Function Generators features operate. They do not verify that they operate within limits.
- The *Performance Tests* verify that the AFG3000 Series Arbitrary/Function Generators performs as warranted. The *Performance Tests* check all the characteristics that are designated as checked in *Specifications*. (The characteristics that are checked appear with a ✓ in *Specifications*.)

Table 4-1: Performance test items

Titles	Test items	Reference page
Frequency/Period Test	Internal clock output frequency accuracy	page 4-19
Amplitude Test	Amplitude accuracy	page 4-20
DC Offset Test	Amplitude accuracy	page 4-22
AC Flatness Test	AC Flatness	page 4-24
Harmonic Distortion Test	Harmonic Distortion	page 4-26
THD (Total Harmonic Distortion) Test	Total Harmonic Distortion	page 4-28
Spurious Test	Spurious	page 4-30
Rise-Fall Time Test	Rise-Fall Time	page 4-33

Performance Conditions

The tests in this section comprise an extensive, valid confirmation of performance and functionality when the following requirements are met:

- The cabinet covers must be on the AFG3000 Series.
- The instrument must have been performed and passed the procedures under calibration and diagnostics.
- The instrument must have been calibrated/adjusted at an ambient temperature between +20 °C and +30 °C.
- The instrument must be operating at an ambient temperature between +0 °C and +50 °C.
- The instrument must have had a warm-up period of at least 20 minutes.

Equipment Required Table 4-2 lists the required equipment used to complete the performance tests.

Table 4-2: Test equipment

Description	Minimum requirements	Recommended equipment	Purpose
1. Digital Multi Meter (DMM)	AC volts, true rms, AC coupled Accuracy: $\pm 0.1\%$ to 1 kHz DC volts Accuracy: 50 ppm, resolution 100 μ V Resistance Accuracy: $\pm 0.05 \Omega$	Agilent 3458A	Measures voltage. Used in multiple procedures.
2. Power Meter	100 kHz to 250 MHz 1 μ W to 100 mW (-30 dBm to +20 dBm) Accuracy: 0.02 dB Resolution: 0.01 dB	R&S NRVS	Measures voltage. Used in multiple procedures.
3. Power Head	100 kHz to 250 MHz 1 μ W to 100 mW (-30 dBm to +20 dBm)	R&S NRV-Z5	Measures voltage. Used in multiple procedures.
4. Frequency Counter	Accuracy: 0.01ppm Phase measurement	Agilent 53132A	Checks clock frequency.
5. Oscilloscope	1 GHz Bandwidth 50 Ω input termination	Tektronix TDS5104B	Checks output signals. Used in multiple procedures.
6. Spectrum Analyzer	20 kHz to 1.25 GHz	Tektronix RSA3303A	Checks output signals. Harmonics Spurious.
7. BNC Coaxial Cable (3 required)	50 Ω , male to male BNC connector, 91 cm	Tektronix part number 012-0482-00	Signal interconnection
8. BNC terminator	50 Ω , $\pm 1\Omega$, 2W, DC to 1GHz, BNC	Tektronix part number 011-0049-02	Signal termination
9. Attenuator (2 required)	50 Ω , x10, BNC	Tektronix part number 011-0059-03	Signal attenuation
10. Adapter Dual-Banana Plug	BNC (female) to dual banana	Tektronix part number 103-0090-00	Signal interconnection to a DMM
11. Adapter BNC(fe)-N(ma)	BNC (female) to N (male)	Tektronix part number 103-0045-00	Signal interconnection to a Spectrum Analyzer

Test Record

Photocopy this test record and use to record the performance test results for your AFG3000 Series Arbitrary/Function Generators. Excel spreadsheet Test record with embedded calculation formulas is also available in standard accessory document CD P/N 063-3828-xx.

AFG3000 Series Performance Test Record

Instrument Serial Number: _____ Certificate Number: _____
 Temperature: _____ RH %: _____
 Date of Calibration: _____ Technician: _____

AFG3000 Series Performance Test Record

	Minimum	Test result	Maximum
Frequency			
Sine at 1.000000 MHz	0.999999 MHz		1.000001 MHz
Pulse at 1.000000 MHz	0.999999 MHz		1.000001 MHz
Amplitude			
AFG302X, AFG310X		$CF = 2 / (1 + 50 \Omega / \text{Measurement } \Omega) =$	
CH1 Amplitude			
30.0 mVrms at 1.00 kHz	$(30.0 \times CF - 0.654) \text{ mVrms}$		$(30.0 \times CF + 0.654) \text{ mVrms}$
300.0 mVrms at 1.00 kHz	$(300.0 \times CF - 3.35) \text{ mVrms}$		$(300.0 \times CF + 3.35) \text{ mVrms}$
800.0 mVrms at 1.00 kHz	$(800.0 \times CF - 8.35) \text{ mVrms}$		$(800.0 \times CF + 8.35) \text{ mVrms}$
1.500 Vrms at 1.00 kHz	$(1.500 \times CF - 0.0154) \text{ Vrms}$		$(1.500 \times CF + 0.0154) \text{ Vrms}$
2.000 Vrms at 1.00 kHz	$(2.000 \times CF - 0.0204) \text{ Vrms}$		$(2.000 \times CF + 0.0204) \text{ Vrms}$
2.500 Vrms at 1.00 kHz	$(2.500 \times CF - 0.0254) \text{ Vrms}$		$(2.500 \times CF + 0.0254) \text{ Vrms}$
3.500 Vrms at 1.00 kHz	$(3.500 \times CF - 0.0354) \text{ Vrms}$		$(3.500 \times CF + 0.0354) \text{ Vrms}$
CH2 Amplitude			
30.0 mVrms at 1.00 kHz	$(30.0 \times CF - 0.654) \text{ mVrms}$		$(30.0 \times CF + 0.654) \text{ mVrms}$
300.0 mVrms at 1.00 kHz	$(300.0 \times CF - 3.35) \text{ mVrms}$		$(300.0 \times CF + 3.35) \text{ mVrms}$
800.0 mVrms at 1.00 kHz	$(800.0 \times CF - 8.35) \text{ mVrms}$		$(800.0 \times CF + 8.35) \text{ mVrms}$
1.500 Vrms at 1.00 kHz	$(1.500 \times CF - 0.0154) \text{ Vrms}$		$(1.500 \times CF + 0.0154) \text{ Vrms}$
2.000 Vrms at 1.00 kHz	$(2.000 \times CF - 0.0204) \text{ Vrms}$		$(2.000 \times CF + 0.0204) \text{ Vrms}$
2.500 Vrms at 1.00 kHz	$(2.500 \times CF - 0.0254) \text{ Vrms}$		$(2.500 \times CF + 0.0254) \text{ Vrms}$
3.500 Vrms at 1.00 kHz	$(3.500 \times CF - 0.0354) \text{ Vrms}$		$(3.500 \times CF + 0.0354) \text{ Vrms}$

AFG3000 Series Performance Test Record (cont.)

	Minimum	Test result	Maximum
Amplitude			
AFG325X $CF = 2 / (1 + 50 \Omega / \text{Measurement } \Omega) =$			
CH1 Amplitude			
0.030 Vrms at 1.00 kHz	$(30.0 \times CF - 0.654) \text{ mVrms}$		$(30.0 \times CF + 0.654) \text{ mVrms}$
0.300 Vrms at 1.00 kHz	$(300.0 \times CF - 3.35) \text{ mVrms}$		$(300.0 \times CF + 3.35) \text{ mVrms}$
0.800 Vrms at 1.00 kHz	$(800.0 \times CF - 8.35) \text{ mVrms}$		$(800.0 \times CF + 8.35) \text{ mVrms}$
1.500 Vrms at 1.00 kHz	$(1.500 \times CF - 0.0154) \text{ Vrms}$		$(1.500 \times CF + 0.0154) \text{ Vrms}$
CH2 Amplitude			
30.0 mVrms at 1.00 kHz	$(30.0 \times CF - 0.654) \text{ mVrms}$		$(30.0 \times CF + 0.654) \text{ mVrms}$
300.0 mVrms at 1.00 kHz	$(300.0 \times CF - 3.35) \text{ mVrms}$		$(300.0 \times CF + 3.35) \text{ mVrms}$
800.0 mVrms at 1.00 kHz	$(800.0 \times CF - 8.35) \text{ mVrms}$		$(800.0 \times CF + 8.35) \text{ mVrms}$
1.500 Vrms at 1.00 kHz	$(1.500 \times CF - 0.0154) \text{ Vrms}$		$(1.500 \times CF + 0.0154) \text{ Vrms}$
DC Offset			
AFG302X, AFG310X $CF = 2 / (1 + 50 \Omega / \text{Measurement } \Omega) =$			
CH1 DC Offset			
+5.000 Vdc	$(+5.000 \times CF - 0.055) \text{ Vdc}$		$(+5.000 \times CF + 0.055) \text{ Vdc}$
0.000 Vdc	-0.005 Vdc		+0.005 Vdc
-5.000 Vdc	$(-5.000 \times CF - 0.055) \text{ Vdc}$		$(-5.000 \times CF + 0.055) \text{ Vdc}$
CH2 DC Offset			
+5.000 Vdc	$(+5.000 \times CF - 0.055) \text{ Vdc}$		$(+5.000 \times CF + 0.055) \text{ Vdc}$
0.000 Vdc	-0.005 Vdc		+0.005 Vdc
-5.000 Vdc	$(-5.000 \times CF - 0.055) \text{ Vdc}$		$(-5.000 \times CF + 0.055) \text{ Vdc}$
AFG325X $CF = 2 / (1 + 50 \Omega / \text{Measurement } \Omega) =$			
CH1 DC Offset			
+2.500 Vdc	$(+2.500 \times CF - 0.030) \text{ Vdc}$		$(+2.500 \times CF + 0.030) \text{ Vdc}$
0.000 Vdc	-0.005 Vdc		+0.005 Vdc
-2.500 Vdc	$(-2.500 \times CF - 0.030) \text{ Vdc}$		$(-2.500 \times CF + 0.030) \text{ Vdc}$
CH2 DC Offset			
+2.500 Vdc	$(+2.500 \times CF - 0.030) \text{ Vdc}$		$(+2.500 \times CF + 0.030) \text{ Vdc}$
0.000 Vdc	-0.005 Vdc		+0.005 Vdc
-2.500 Vdc	$(-2.500 \times CF - 0.030) \text{ Vdc}$		$(-2.500 \times CF + 0.030) \text{ Vdc}$

AFG3000 Series Performance Test Record (cont.)

	Minimum	Test result	Maximum
AC Flatness			
AFG302X			
CH1 AC Flatness			
Frequency 100.00 kHz (Ampl: +4.0 dBm)	-----	dB (= Reference)	-----
Frequency 500.00 kHz	Reference - 0.15 dB	dB	Reference + 0.15 dB
Frequency 1.00 MHz	Reference - 0.15 dB	dB	Reference + 0.15 dB
Frequency 5.00 MHz	Reference - 0.30 dB	dB	Reference + 0.30 dB
Frequency 15.00 MHz	Reference - 0.30 dB	dB	Reference + 0.30 dB
Frequency 25.00 MHz	Reference - 0.50 dB	dB	Reference + 0.50 dB
CH2 AC Flatness			
Frequency 100.00 kHz (Ampl: +4.0 dBm)	-----	dB (= Reference)	-----
Frequency 500.00 kHz	Reference - 0.15 dB	dB	Reference + 0.15 dB
Frequency 1.00 MHz	Reference - 0.15 dB	dB	Reference + 0.15 dB
Frequency 5.00 MHz	Reference - 0.30 dB	dB	Reference + 0.30 dB
Frequency 15.00 MHz	Reference - 0.30 dB	dB	Reference + 0.30 dB
Frequency 25.00 MHz	Reference - 0.50 dB	dB	Reference + 0.50 dB

AFG3000 Series Performance Test Record (cont.)

	Minimum	Test result	Maximum
AC Flatness			
AFG310X			
CH1 AC Flatness			
Frequency 100.00 kHz (Ampl: +4.0 dBm)	-----	dB(= Reference)	-----
Frequency 1.00 MHz	Reference - 0.15 dB	dB	Reference + 0.15 dB
Frequency 5.00 MHz	Reference - 0.30 dB	dB	Reference + 0.30 dB
Frequency 25.00 MHz	Reference - 0.50 dB	dB	Reference + 0.50 dB
Frequency 50.00 MHz	Reference - 0.50 dB	dB	Reference + 0.50 dB
Frequency 100.0 MHz	Reference - 0.50 dB	dB	Reference + 0.50 dB
CH2 AC Flatness			
Frequency 100.00 kHz (Ampl: +4.0 dBm)	-----	dB(= Reference)	-----
Frequency 1.00 MHz	Reference - 0.15 dB	dB	Reference + 0.15 dB
Frequency 5.00 MHz	Reference - 0.30 dB	dB	Reference + 0.30 dB
Frequency 25.00 MHz	Reference - 0.50 dB	dB	Reference + 0.50 dB
Frequency 50.00 MHz	Reference - 0.50 dB	dB	Reference + 0.50 dB
Frequency 100.0 MHz	Reference - 0.50 dB	dB	Reference + 0.50 dB

AFG3000 Series Performance Test Record (cont.)

	Minimum	Test result	Maximum
AC Flatness			
AFG325X			
CH1 AC Flatness			
Frequency 100.00 kHz (Ampl: +4.0 dBm)	-----	dB(= Reference)	-----
Frequency 1.00 MHz	Reference - 0.15 dB	dB	Reference + 0.15 dB
Frequency 5.00 MHz	Reference - 0.30 dB	dB	Reference + 0.30 dB
Frequency 25.00 MHz	Reference - 0.50 dB	dB	Reference + 0.50 dB
Frequency 50.00 MHz	Reference - 0.50 dB	dB	Reference + 0.50 dB
Frequency 100.0 MHz	Reference - 1.00 dB	dB	Reference + 1.00 dB
Frequency 150.00 MHz	Reference - 1.00 dB	dB	Reference + 1.00 dB
Frequency 240.0 MHz	Reference - 2.00 dB	dB	Reference + 2.00 dB
CH2 AC Flatness			
Frequency 100.00 kHz (Ampl: +4.0 dBm)	-----	dB(= Reference)	-----
Frequency 1.00 MHz	Reference - 0.15 dB	dB	Reference + 0.15 dB
Frequency 5.00 MHz	Reference - 0.30 dB	dB	Reference + 0.30 dB
Frequency 25.00 MHz	Reference - 0.50 dB	dB	Reference + 0.50 dB
Frequency 50.00 MHz	Reference - 0.50 dB	dB	Reference + 0.50 dB
Frequency 100.0 MHz	Reference - 1.00 dB	dB	Reference + 1.00 dB
Frequency 150.00 MHz	Reference - 1.00 dB	dB	Reference + 1.00 dB
Frequency 250.0 MHz	Reference - 2.00 dB	dB	Reference + 2.00 dB

AFG3000 Series Performance Test Record

Harmonic Distortion	Fundamental = reference	2nd	3rd	4th	5th	Limit
AFG302X	Spectrum Analyzer reading					
Sine 20 kHz	20 kHz	40 kHz	60 kHz	80 kHz	100 kHz	
CH1 Harmonic Distortion	dBc	dBc	dBc	dBc	dBc	
reading - reference	0 dBc	dBc	dBc	dBc	dBc	Nth - reference < -60 dBc
CH2 Harmonic Distortion	dBc	dBc	dBc	dBc	dBc	
reading - reference	0 dBc	dBc	dBc	dBc	dBc	Nth - reference < -60 dBc
Sine 100 kHz	100 kHz	200 kHz	300 kHz	400 kHz	500 kHz	
CH1 Harmonic Distortion	dBc	dBc	dBc	dBc	dBc	
reading - reference	0 dBc	dBc	dBc	dBc	dBc	Nth - reference < -60 dBc
CH2 Harmonic Distortion	dBc	dBc	dBc	dBc	dBc	
reading - reference	0 dBc	dBc	dBc	dBc	dBc	Nth - reference < -60 dBc
Sine 1 MHz	1 MHz	2 MHz	3 MHz	4 MHz	5 MHz	
CH1 Harmonic Distortion	dBc	dBc	dBc	dBc	dBc	
reading - reference	0 dBc	dBc	dBc	dBc	dBc	Nth - reference < -50 dBc
CH2 Harmonic Distortion	dBc	dBc	dBc	dBc	dBc	
reading - reference	0 dBc	dBc	dBc	dBc	dBc	Nth - reference < -50 dBc
Sine 25MHz	25 MHz	50 MHz	75 MHz	100 MHz	125 MHz	
CH1 Harmonic Distortion	dBc	dBc	dBc	dBc	dBc	
reading - reference	0 dBc	dBc	dBc	dBc	dBc	Nth - reference < -40 dBc
CH2 Harmonic Distortion	dBc	dBc	dBc	dBc	dBc	
reading - reference	0 dBc	dBc	dBc	dBc	dBc	Nth - reference < -40 dBc

AFG3000 Series Performance Test Record (cont.)

Harmonic Distortion	Fundamental = reference	2nd	3rd	4th	5th	Limit
AFG310X	Spectrum Analyzer reading					
Sine 1 MHz	1 MHz	2 MHz	3 MHz	4 MHz	5 MHz	
CH1 Harmonic Distortion	dBc	dBc	dBc	dBc	dBc	
reading - reference	0 dBc	dBc	dBc	dBc	dBc	Nth - reference < -50 dBc
CH2 Harmonic Distortion	dBc	dBc	dBc	dBc	dBc	
reading - reference	0 dBc	dBc	dBc	dBc	dBc	Nth - reference < -50 dBc
Sine 5 MHz	5 MHz	10 MHz	15 MHz	20 MHz	25 MHz	
CH1 Harmonic Distortion	dBc	dBc	dBc	dBc	dBc	
reading - reference	0 dBc	dBc	dBc	dBc	dBc	Nth - reference < -37 dBc
CH2 Harmonic Distortion	dBc	dBc	dBc	dBc	dBc	
reading - reference	0 dBc	dBc	dBc	dBc	dBc	Nth - reference < -37 dBc
Sine 25MHz	25 MHz	50 MHz	75 MHz	100 MHz	125 MHz	
CH1 Harmonic Distortion	dBc	dBc	dBc	dBc	dBc	
reading - reference	0 dBc	dBc	dBc	dBc	dBc	Nth - reference < -37 dBc
CH2 Harmonic Distortion	dBc	dBc	dBc	dBc	dBc	
reading - reference	0 dBc	dBc	dBc	dBc	dBc	Nth - reference < -37 dBc
Sine 100 MHz	100 MHz	200 MHz	300 MHz	400 MHz	500 MHz	
CH1 Harmonic Distortion	dBc	dBc	dBc	dBc	dBc	
reading - reference	0 dBc	dBc	dBc	dBc	dBc	Nth - reference < -37 dBc
CH2 Harmonic Distortion	dBc	dBc	dBc	dBc	dBc	
reading - reference	0 dBc	dBc	dBc	dBc	dBc	Nth - reference < -37 dBc

AFG3000 Series Performance Test Record (cont.)

Harmonic Distortion	Fundamental = reference	2nd	3rd	4th	5th	Limit
AFG325X	Spectrum Analyzer reading					
Sine 1 MHz	1 MHz	2 MHz	3 MHz	4 MHz	5 MHz	
CH1 Harmonic Distortion	dBc	dBc	dBc	dBc	dBc	
reading - reference	0 dBc	dBc	dBc	dBc	dBc	Nth - reference < -50 dBc
CH2 Harmonic Distortion	dBc	dBc	dBc	dBc	dBc	
reading - reference	0 dBc	dBc	dBc	dBc	dBc	Nth - reference < -50 dBc
Sine 5 MHz	5 MHz	10 MHz	15 MHz	20 MHz	25 MHz	
CH1 Harmonic Distortion	dBc	dBc	dBc	dBc	dBc	
reading - reference	0 dBc	dBc	dBc	dBc	dBc	Nth - reference < -37 dBc
CH2 Harmonic Distortion	dBc	dBc	dBc	dBc	dBc	
reading - reference	0 dBc	dBc	dBc	dBc	dBc	Nth - reference < -37 dBc
Sine 100 MHz	100 MHz	200 MHz	300 MHz	400 MHz	500 MHz	
CH1 Harmonic Distortion	dBc	dBc	dBc	dBc	dBc	
reading - reference	0 dBc	dBc	dBc	dBc	dBc	Nth - reference < -30 dBc
CH2 Harmonic Distortion	dBc	dBc	dBc	dBc	dBc	
reading - reference	0 dBc	dBc	dBc	dBc	dBc	Nth - reference < -30 dBc
Sine 240 MHz	240 MHz	480 MHz	720 MHz	960 MHz	1.20 GHz	
CH1 Harmonic Distortion	dBc	dBc	dBc	dBc	dBc	
reading - reference	0 dBc	dBc	dBc	dBc	dBc	Nth - reference < -30 dBc
CH2 Harmonic Distortion	dBc	dBc	dBc	dBc	dBc	
reading - reference	0 dBc	dBc	dBc	dBc	dBc	Nth - reference < -30 dBc

AFG3000 Series Performance Test Record

Total Harmonic Distortion (THD)

AFG3xxxx	Spectrum Analyzer reading						
	Fundamental = reference	2nd	3rd	4th	5th	6th	7th
Sine 20.0 kHz	20 kHz	40 kHz	60 kHz	80 kHz	100 kHz	120 kHz	140 kHz
CH1 reading (dBm)	A ₁ =	A ₂ =	A ₃ =	A ₄ =	A ₅ =	A ₆ =	A ₇ =
reading - reference (A _n - A ₁) (dBc)	B ₁ = 0	B ₂ =	B ₃ =	B ₄ =	B ₅ =	B ₆ =	B ₇ =
C _n = 10 ^{Bn/20}	C ₁ = 1	C ₂ =	C ₃ =	C ₄ =	C ₅ =	C ₆ =	C ₇ =
$\text{THD} = \frac{\sqrt{\sum_{n=2} C_n^2}}{C_1}$							Limit < 0.2%
CH2 reading (dBm)	A ₁ =	A ₂ =	A ₃ =	A ₄ =	A ₅ =	A ₆ =	A ₇ =
reading - reference (A _n - A ₁) (dBc)	B ₁ = 0	B ₂ =	B ₃ =	B ₄ =	B ₅ =	B ₆ =	B ₇ =
C _n = 10 ^{Bn/20}	C ₁ = 1	C ₂ =	C ₃ =	C ₄ =	C ₅ =	C ₆ =	C ₇ =
$\text{THD} = \frac{\sqrt{\sum_{n=2} C_n^2}}{C_1}$							Limit < 0.2%

AFG3000 Series Performance Test Record

Spurious

AFG302X	Spectrum Analyzer			Measurement		
Frequency	Center Frequency	Span	RBW	Spurious Frequency	Spurious (Max)	Limit
CH1 Spurious						
Sine 100 kHz	10 MHz / 300 MHz	20 MHz / 600 MHz	20 kHz / 20 kHz	MHz MHz	dBc dBc	< -60 dBc
Sine 1.00 MHz	10 MHz / 300 MHz	20 MHz / 600 MHz	20 kHz / 20 kHz	MHz MHz	dBc dBc	< -50 dBc
Sine 10.00 MHz	10 MHz / 300 MHz	20 MHz / 600 MHz	20 kHz / 20 kHz	MHz MHz	dBc dBc	< -50 dBc
Sine 25.00 MHz	10 MHz / 300 MHz	20 MHz / 600 MHz	20 kHz / 20 kHz	MHz MHz	dBc dBc	< -50 dBc
CH2 Spurious						
Sine 100 kHz	10 MHz / 300 MHz	20 MHz / 600 MHz	20 kHz / 20 kHz	MHz MHz	dBc dBc	< -60 dBc
Sine 1.00 MHz	10 MHz / 300 MHz	20 MHz / 600 MHz	20 kHz / 20 kHz	MHz MHz	dBc dBc	< -50 dBc
Sine 10.00 MHz	10 MHz / 300 MHz	20 MHz / 600 MHz	20 kHz / 20 kHz	MHz MHz	dBc dBc	< -50 dBc
Sine 25.00 MHz	10 MHz / 300 MHz	20 MHz / 600 MHz	20 kHz / 20 kHz	MHz MHz	dBc dBc	< -50 dBc

AFG3000 Series Performance Test Record

Spurious

AFG310X	Spectrum Analyzer			Measurement		
Frequency	Center Frequency	Span	RBW	Spurious Frequency	Spurious (Max)	Limit
CH1 Spurious						
Sine 100 kHz	10 MHz 300 MHz	20 MHz 600 MHz	20 kHz 20 kHz	MHz MHz	dBc dBc	< -60 dBc
Sine 1.00 MHz	10 MHz 300 MHz	20 MHz 600 MHz	20 kHz 20 kHz	MHz MHz	dBc dBc	< -50 dBc
Sine 10.00 MHz	10 MHz 300 MHz	20 MHz 600 MHz	20 kHz 20 kHz	MHz MHz	dBc dBc	< -50 dBc
Sine 25.00 MHz	10 MHz 300 MHz	20 MHz 600 MHz	20 kHz 20 kHz	MHz MHz	dBc dBc	< -50 dBc
Sine 50.00 MHz	10 MHz 300 MHz	20 MHz 600 MHz	20 kHz 20 kHz	MHz MHz	dBc dBc	< -44 dBc
Sine 100.00 MHz	10 MHz 300 MHz	20 MHz 600 MHz	20 kHz 20 kHz	MHz MHz	dBc dBc	< -38 dBc
CH2 Spurious						
Sine 100 kHz	10 MHz 300 MHz	20 MHz 600 MHz	20 kHz 20 kHz	MHz MHz	dBc dBc	< -60 dBc
Sine 1.00 MHz	10 MHz 300 MHz	20 MHz 600 MHz	20 kHz 20 kHz	MHz MHz	dBc dBc	< -50 dBc
Sine 10.00 MHz	10 MHz 300 MHz	20 MHz 600 MHz	20 kHz 20 kHz	MHz MHz	dBc dBc	< -50 dBc
Sine 25.00 MHz	10 MHz 300 MHz	20 MHz 600 MHz	20 kHz 20 kHz	MHz MHz	dBc dBc	< -50 dBc
Sine 50.00 MHz	10 MHz 300 MHz	20 MHz 600 MHz	20 kHz 20 kHz	MHz MHz	dBc dBc	< -44 dBc
Sine 100.00 MHz	10 MHz 300 MHz	20 MHz 600 MHz	20 kHz 20 kHz	MHz MHz	dBc dBc	< -38 dBc

AFG3000 Series Performance Test Record

Spurious

AFG325X	Spectrum Analyzer			Measurement		
Frequency	Center Frequency	Span	RBW	Spurious Frequency	Spurious (Max)	Limit
CH1 Spurious						
Sine 100 kHz	10 MHz 300 MHz	20 MHz 600 MHz	20 kHz 20 kHz	MHz MHz	dBc dBc	< -50 dBc
Sine 1.00 MHz	10 MHz 300 MHz	20 MHz 600 MHz	20 kHz 20 kHz	MHz MHz	dBc dBc	< -47 dBc
Sine 10.00 MHz	10 MHz 300 MHz	20 MHz 600 MHz	20 kHz 20 kHz	MHz MHz	dBc dBc	< -47 dBc
Sine 25.00 MHz	10 MHz 300 MHz	20 MHz 600 MHz	20 kHz 20 kHz	MHz MHz	dBc dBc	< -47 dBc
Sine 50.00 MHz	10 MHz 300 MHz	20 MHz 600 MHz	20 kHz 20 kHz	MHz MHz	dBc dBc	< -41 dBc
Sine 100.00 MHz	10 MHz 300 MHz	20 MHz 600 MHz	20 kHz 20 kHz	MHz MHz	dBc dBc	< -35 dBc
Sine 200.00 MHz	10 MHz 300 MHz	20 MHz 600 MHz	20 kHz 20 kHz	MHz MHz	dBc dBc	< -29 dBc
Sine 240.00 MHz	10 MHz 300 MHz	20 MHz 600 MHz	20 kHz 20 kHz	MHz MHz	dBc dBc	< -28 dBc
CH2 Spurious						
Sine 100 kHz	10 MHz 300 MHz	20 MHz 600 MHz	20 kHz 20 kHz	MHz MHz	dBc dBc	< -50 dBc
Sine 1.00 MHz	10 MHz 300 MHz	20 MHz 600 MHz	20 kHz 20 kHz	MHz MHz	dBc dBc	< -47 dBc
Sine 10.00 MHz	10 MHz 300 MHz	20 MHz 600 MHz	20 kHz 20 kHz	MHz MHz	dBc dBc	< -47 dBc
Sine 25.00 MHz	10 MHz 300 MHz	20 MHz 600 MHz	20 kHz 20 kHz	MHz MHz	dBc dBc	< -47 dBc
Sine 50.00 MHz	10 MHz 300 MHz	20 MHz 600 MHz	20 kHz 20 kHz	MHz MHz	dBc dBc	< -41 dBc
Sine 100.00 MHz	10 MHz 300 MHz	20 MHz 600 MHz	20 kHz 20 kHz	MHz MHz	dBc dBc	< -35 dBc
Sine 200.00 MHz	10 MHz 300 MHz	20 MHz 600 MHz	20 kHz 20 kHz	MHz MHz	dBc dBc	< -29 dBc
Sine 240.00 MHz	10 MHz 300 MHz	20 MHz 600 MHz	20 kHz 20 kHz	MHz MHz	dBc dBc	< -28 dBc

AFG3000 Series Performance Test Record

			Minimum	Test result	Maximum
Rise-Fall Time					
AFG302X					
CH1	Rise Time	Amplitude: 1.0 V _{pp}	-----		18 ns
	Fall Time	Amplitude: 1.0 V _{pp}	-----		18 ns
	Rise Time	Amplitude: 10.0 V _{pp}	-----		18 ns
	Fall Time	Amplitude: 10.0 V _{pp}	-----		18 ns
CH2	Rise Time	Amplitude: 1.0 V _{pp}	-----		18 ns
	Fall Time	Amplitude: 1.0 V _{pp}	-----		18 ns
	Rise Time	Amplitude: 10.0 V _{pp}	-----		18 ns
	Fall Time	Amplitude: 10.0 V _{pp}	-----		18 ns
AFG310X					
CH1	Rise Time	Amplitude: 1.0 V _{pp}	-----		5 ns
	Fall Time	Amplitude: 1.0 V _{pp}	-----		5 ns
	Rise Time	Amplitude: 10.0 V _{pp}	-----		5 ns
	Fall Time	Amplitude: 10.0 V _{pp}	-----		5 ns
CH2	Rise Time	Amplitude: 1.0 V _{pp}	-----		5 ns
	Fall Time	Amplitude: 1.0 V _{pp}	-----		5 ns
	Rise Time	Amplitude: 10.0 V _{pp}	-----		5 ns
	Fall Time	Amplitude: 10.0 V _{pp}	-----		5 ns

AFG3000 Series Performance Test Record (cont.)

			Minimum	Test result	Maximum
AFG325X					
CH1	Rise Time	Amplitude: 1.0 V _{pp}	-----		2.5 ns
	Fall Time	Amplitude: 1.0 V _{pp}	-----		2.5 ns
	Rise Time	Amplitude: 5.0 V _{pp}	-----		2.5 ns
	Fall Time	Amplitude: 5.0 V _{pp}	-----		2.5 ns
CH2	Rise Time	Amplitude: 1.0 V _{pp}	-----		2.5 ns
	Fall Time	Amplitude: 1.0 V _{pp}	-----		2.5 ns
	Rise Time	Amplitude: 5.0 V _{pp}	-----		2.5 ns
	Fall Time	Amplitude: 5.0 V _{pp}	-----		2.5 ns

Frequency/Period Test

This test verifies the frequency accuracy of the arbitrary/function generator. All output frequencies are derived from a single generated frequency. Only one frequency point of channel 1 is required to be checked.

1. Connect the arbitrary/function generator to the frequency counter as shown in Figure 4-1.

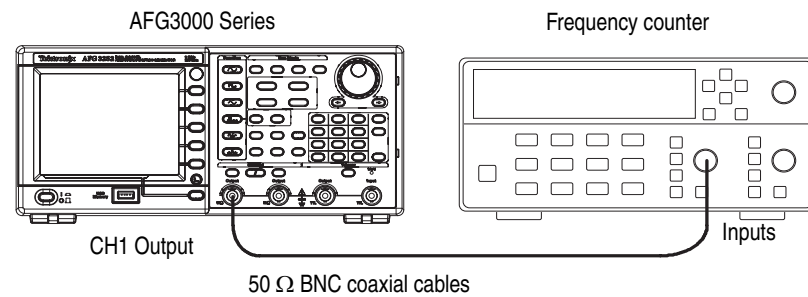

Figure 4-1: Frequency/Period tests

2. Push the **Default** front-panel button and **OK** menu button to recall the arbitrary/function generator default setup.
3. Set up the arbitrary/function generator using the following steps:

Select menu	Setting	Operation
Function	Sine	Sine (front)
Frequency	1.000000 MHz	Frequency/Period (front)
Amplitude	1.00 Vpp	Amplitude/High (front)
Channel 1 Output	On	On (front)

4. Check that reading of the Frequency Counter is between 0.999999 MHz and 1.000001 MHz.
5. Set up the arbitrary/function generator using the following steps:

Select menu	Setting	Operation
Function	Pulse	Pulse (front)

6. Check that reading of the frequency counter is between 0.999999 MHz and 1.000001 MHz.

Amplitude Test

This test verifies the amplitude accuracy of the arbitrary/function generator. All output amplitudes are derived from a combination of attenuators and 3 dB variable gain. Some amplitude points are checked. This test uses a 50 Ω terminator. It is necessary to know the accuracy of a 50 Ω terminator in advance of this amplitude test. This accuracy is used as a calibration factor.

1. Connect the 50 Ω terminator to the DMM as shown in Figure 4-2 and measure the register value.

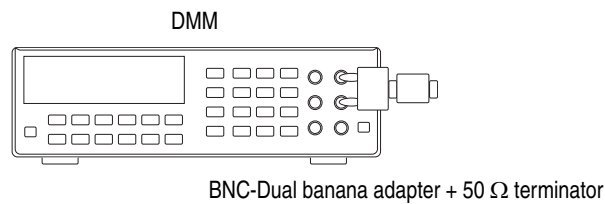

Figure 4-2: 50 ohm terminator accuracy

2. Calculate the 50 Ω calibration factor (CF) from the reading value and record as follows:

CF (Calibration Factor) = $2 / (1 + 50 \Omega / \text{Measurement } \Omega)$	
Measurement (reading of the DMM)	CF
Ω	
Example	
50.50 Ω	1.0050 (= $2 / (1 + 50 / 50.50)$)
49.62 Ω	0.9962 (= $2 / (1 + 50 / 49.62)$)

3. Connect the arbitrary/function generator to the DMM as shown in Figure 4-3. Be sure to connect the 50 Ω terminator to the arbitrary/function generator Output connector side.

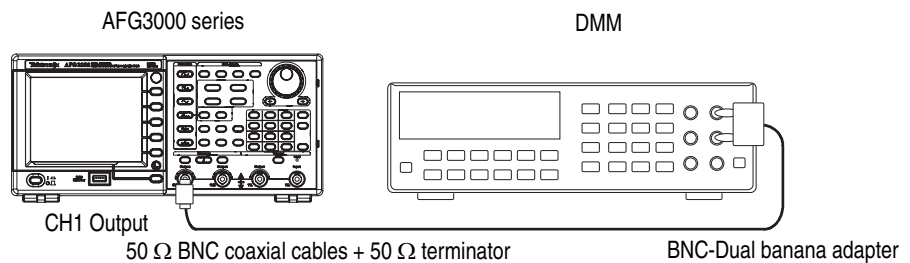

Figure 4-3: Amplitude tests

4. Set up the arbitrary/function generator using the following steps:

Select menu	Setting	Operation
Function	Sine	Sine (front)
Frequency	1.000000 kHz	Frequency/Period (front)
Amplitude Units	V rms The voltage unit should be matched to that of DMM.	Top Menu > Amplitude/Level Menu > -more-> Units > V rms
Amplitude	0.030 Vrms	Amplitude/High (front)
Channel 1 Output	On	On (front)

5. Verify that each amplitude measurement is within the range specified in the following tables.

AFG302x and AFG310x			Measurement	Range
Function	Frequency	Amplitude		
Sine	1.000 kHz	30.0 mVrms	mVrms	$(30.0 \times CF \pm 0.654)$ mVrms
Sine	1.000 kHz	300.0 mVrms	mVrms	$(300.0 \times CF \pm 3.35)$ mVrms
Sine	1.000 kHz	800.0 mVrms	mVrms	$(800.0 \times CF \pm 8.35)$ mVrms
Sine	1.000 kHz	1.500 Vrms	Vrms	$(1.500 \times CF \pm 0.0154)$ Vrms
Sine	1.000 kHz	2.000 Vrms	Vrms	$(2.000 \times CF \pm 0.0204)$ Vrms
Sine	1.000 kHz	2.500 Vrms	Vrms	$(2.500 \times CF \pm 0.0254)$ Vrms
Sine	1.000 kHz	3.500 Vrms	Vrms	$(3.500 \times CF \pm 0.0354)$ Vrms

AFG325x			Measurement	Range
Function	Frequency	Amplitude		
Sine	1.000 kHz	30.0 mVrms	mVrms	$(30.0 \times CF \pm 0.654)$ mVrms
Sine	1.000 kHz	300.0 mVrms	mVrms	$(300.0 \times CF \pm 3.35)$ mVrms
Sine	1.000 kHz	800.0 mVrms	mVrms	$(800.0 \times CF \pm 8.35)$ mVrms
Sine	1.000 kHz	1.500 Vrms	Vrms	$(1.500 \times CF \pm 0.0154)$ Vrms

6. (AFG3xx2 only) Repeat steps 3 through 5 for the channel 2 output.

DC Offset Test

This test verifies the DC offset accuracy of the arbitrary/function generator. This test uses a 50 Ω terminator. It is necessary to know the accuracy of a 50 Ω terminator in advance of this test. This accuracy is used for as a calibration factor.

1. Connect the 50 Ω terminator to the DMM as shown in Figure 4-4 and measure the register value.

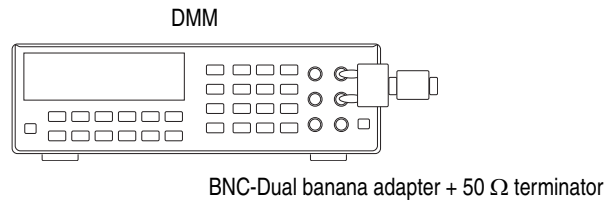

Figure 4-4: 50 ohm terminator accuracy

2. Calculate the 50 Ω calibration factor (CF) from the reading value and record as follows:

CF (Calibration Factor) = $2 / (1 + 50 \Omega / \text{Measurement } \Omega)$	
Measurement (reading of the DMM)	CF
Ω	
Example	
50.50 Ω	1.0050 (= $2 / (1 + 50 / 50.50)$)
49.62 Ω	0.9962 (= $2 / (1 + 50 / 49.62)$)

3. Connect the arbitrary/function generator to the DMM as shown in Figure 4-5. Be sure to connect the 50 Ω terminator to the arbitrary/function generator Output connector side.

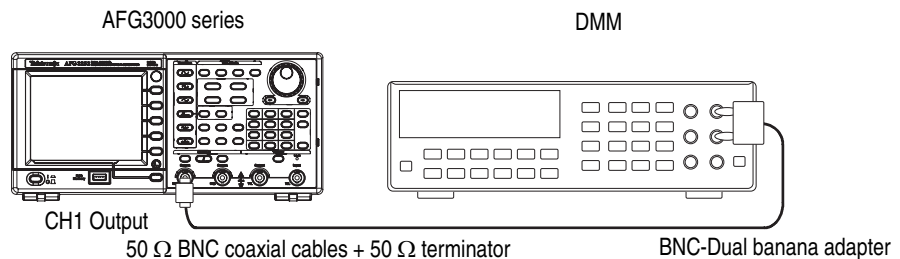

Figure 4-5: DC offset tests

4. Set up the arbitrary/function generator using the following steps:

Select menu	Setting	Operation
Function	DC	More... (front) > More Waveform Menu > DC
Frequency	1.000000 kHz	Frequency/Period (front)
Offset	+ 5.000 V + 2.500 V (AFG325x)	Offset/Low (front)
Channel 1 Output	On	On (front)

5. Verify that each offset measurement is within the range specified in the following tables.

AFG302x and AFG310x		Measurement	Range
Function	Offset		
DC	+ 5.000 Vdc	Vdc	$(5.000 \times CF \pm 0.055) \text{ Vdc}$
DC	0.000 Vdc	Vdc	$\pm 0.005 \text{ Vdc}$
DC	- 5.000 Vdc	Vdc	$(- 5.000 \times CF \pm 0.055) \text{ Vdc}$

AFG3251 and AFG3252		Measurement	Range
Function	Offset		
DC	+ 2.500 Vdc	Vdc	$(2.500 \times CF \pm 0.030) \text{ Vdc}$
DC	0.000 Vdc	Vdc	$\pm 0.005 \text{ Vdc}$
DC	- 2.500 Vdc	Vdc	$(- 2.500 \times CF \pm 0.030) \text{ Vdc}$

6. (AFG3xx2 only) Repeat steps 3 through 5 for the channel 2 output.

AC Flatness Test

This test verifies the flatness of a sine wave to 100 kHz sine wave.

1. Connect the arbitrary/function generator to the power meter with a power head as shown in Figure 4-6.

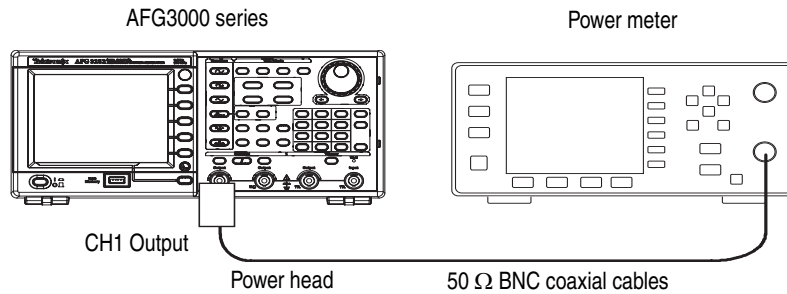

Figure 4-6: AC flatness tests

2. Set up the arbitrary/function generator using the following steps:

Select menu	Setting	Operation
Function	Sine	Sine (front)
Frequency	100.0000 kHz	Frequency/Period (front)
Amplitude Units	dBm	TopMenu > Amplitude/Level Menu > -more- > Units > dBm
Amplitude	+ 4.0 dBm	Amplitude/High (front)
Channel 1 Output	On	On (front)

3. Set the frequency of the Power Meter to 100 kHz.
4. Write the Power Meter reading of the 100 kHz sine wave as a reference power value.
5. Verify that the power measurement at each frequency is within the error specified in the following tables.

AFG302x			Measurement	Range
Function	Amplitude	Frequency	(dB)	(dB)
Sine	+ 4.0 dBm	100.00 kHz	= Reference	-----
Sine	+ 4.0 dBm	500.00 kHz		Reference \pm 0.15
Sine	+ 4.0 dBm	1.00 MHz		Reference \pm 0.15
Sine	+ 4.0 dBm	5.00 MHz		Reference \pm 0.30
Sine	+ 4.0 dBm	15.00 MHz		Reference \pm 0.30
Sine	+ 4.0 dBm	25.00 MHz		Reference \pm 0.50

AFG310x			Measurement	Range
Function	Amplitude	Frequency	(dB)	(dB)
Sine	+ 4.0 dBm	100.00 kHz	= Reference	-----
Sine	+ 4.0 dBm	1.00 MHz		Reference \pm 0.15
Sine	+ 4.0 dBm	5.00 MHz		Reference \pm 0.30
Sine	+ 4.0 dBm	25.00 MHz		Reference \pm 0.50
Sine	+ 4.0 dBm	50.00 MHz		Reference \pm 0.50
Sine	+ 4.0 dBm	100.00 MHz		Reference \pm 0.50

AFG325x			Measurement	Range
Function	Amplitude	Frequency	(dB)	(dB)
Sine	+ 4.0 dBm	100.00 kHz	= Reference	-----
Sine	+ 4.0 dBm	1.00 MHz		Reference \pm 0.15
Sine	+ 4.0 dBm	5.00 MHz		Reference \pm 0.30
Sine	+ 4.0 dBm	25.00 MHz		Reference \pm 0.50
Sine	+ 4.0 dBm	50.00 MHz		Reference \pm 0.50
Sine	+ 4.0 dBm	100.00 MHz		Reference \pm 1.00
Sine	+ 4.0 dBm	150.00 MHz		Reference \pm 1.00
Sine	+ 4.0 dBm	240.00 MHz		Reference \pm 2.00

6. (AFG3xx2 only) Repeat steps 3 through 5 for the channel 2 output.

Harmonics Distortion Test

This test verifies the harmonic distortion using a spectrum analyzer.

1. Connect the arbitrary/function generator to the spectrum analyzer as shown in Figure 4-7.

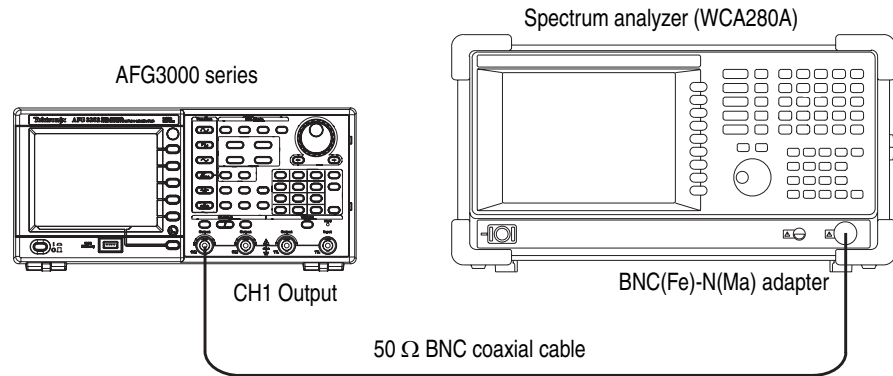

Figure 4-7: Harmonic distortion tests

2. Push the **Default** front-panel button and **OK** menu button to recall the arbitrary/function generator default setup.
3. Set up the arbitrary/function generator using the following steps:

Select menu	Setting	Operation
Function	Sine	Sine (front)
Frequency	20.00 kHz: AFG302x 1.000 MHz: AFG310x 1.000 MHz: AFG325x	Frequency/Period (front)
Amplitude Units	Vpp	TopMenu > Amplitude/Level Menu > -more- > Units > Vpp
Amplitude	1.00 Vpp	Amplitude/High (front)
Channel 1 Output	On	On (front)

4. Set up the spectrum analyzer according the frequency setup of the arbitrary/function generator.
5. Read the signal level in the Fundamental frequency for each signal. Use this level as a Reference value in step 6.
6. Verify that the differences between the reference level and the signal level in the frequency of higher-order at each frequency are below the limit specified in the following tables.

AFG302x	Spectrum Analyzer			Measurement					Limit
	Frequency	Center Frequency	Span	RBW	Fundamental (= Reference)	2nd	3rd	4th	
20.00 kHz	100 kHz	200 kHz	500 Hz	20 kHz	40 kHz	60 kHz	80 kHz	100 kHz	< -60 dBc
100.00 kHz	500 kHz	1 MHz	2 kHz	100 kHz	200 kHz	300 kHz	400 kHz	500 kHz	< -60 dBc
1.00 MHz	5.00 MHz	10 MHz	20 kHz	1 MHz	2 MHz	3 MHz	4 MHz	5 MHz	< -50 dBc
25.00 MHz	125 MHz	250 MHz	20 kHz	25 MHz	50 MHz	75 MHz	100 MHz	125 MHz	< -40 dBc

AFG310x	Spectrum Analyzer			Measurement					Limit
	Frequency	Center Frequency	Span	RBW	Fundamental (= Reference)	2nd	3rd	4th	
1 MHz	5.00 MHz	10 MHz	20 kHz	1 MHz	2 MHz	3 MHz	4 MHz	5 MHz	< -50 dBc
5 MHz	10 MHz / 25 MHz	20 MHz / 50 MHz	20 kHz / 20 kHz	5 MHz	10 MHz	15 MHz	20 MHz	25 MHz	< -37 dBc
25 MHz	125 MHz	250 MHz	20 kHz	25 MHz	50 MHz	75 MHz	100 MHz	125 MHz	< -37 dBc
100 MHz	500 MHz	1 GHz	100 kHz	100 MHz	200 MHz	300 MHz	400 MHz	500 MHz	< -37 dBc

AFG325x	Spectrum Analyzer			Measurement					Limit
	Frequency	Center Frequency	Span	RBW	Fundamental (= Reference)	2nd	3rd	4th	
1 MHz	5.00 MHz	10 MHz	20 kHz	1 MHz	2 MHz	3 MHz	4 MHz	5 MHz	< -50 dBc
5 MHz	10 MHz / 25 MHz	20 MHz / 50 MHz	20 kHz / 20 kHz	5 MHz	10 MHz	15 MHz	20 MHz	25 MHz	< -37 dBc
100 MHz	500 MHz	1 GHz	100 kHz	100 MHz	200 MHz	300 MHz	400 MHz	500 MHz	< -30 dBc
240 MHz	625 MHz	1.25 GHz	100 kHz	240 MHz	480 MHz	720 MHz	960 MHz	1.20 GHz	< -30 dBc

7. (AFG3xx2 only) Repeat steps 2 through 6 for the channel 2 output.

Total Harmonic Distortion Test

This test verifies the total harmonic distortion (THD) using a spectrum analyzer.

1. Connect the arbitrary/function generator to the spectrum analyzer as shown in Figure 4-8.

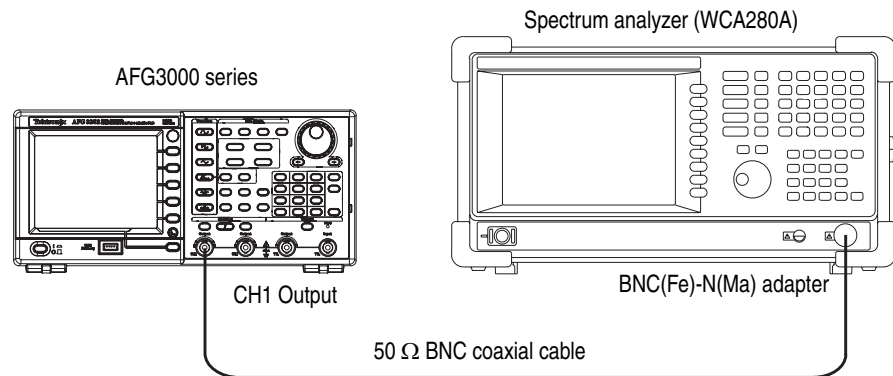

Figure 4-8: Total Harmonic distortion tests

2. Set up the arbitrary/function generator using the following steps:

Select menu	Setting	Operation
Function	Sine	Sine (front)
Frequency	20.00 kHz	Frequency/Period (front)
Amplitude Units	Vpp	TopMenu > Amplitude/Level Menu > -more- > Units > Vpp
Amplitude	1.00 Vpp	Amplitude/High (front)
Channel 1 Output	On	On (front)

3. Set up the spectrum analyzer according to the following table:

Center Frequency	Span	RBW
100 kHz	200 kHz	500 Hz

4. When the THD cannot be measured directly, it is obtained by using the following calculation:

$$THD = \frac{\sqrt{\sum_{n=2} C_n^2}}{C_1}$$

5. Measure and record each level (A_1 to A_7) to the seventh harmonics of the 20 kHz sine wave.

6. Calculate the each B₁ to B₇, C₁ to C₇ value and the THD.

AFG3xxx		Measurement						
Function	Frequency	Fundamental = reference	2nd	3rd	4th	5th	6th	7th
sine	20.00 kHz	20 kHz	40 kHz	60 kHz	80 kHz	100 kHz	120 kHz	140 kHz
reading (dBm)		A ₁ =	A ₂ =	A ₃ =	A ₄ =	A ₅ =	A ₆ =	A ₇ =
reading - reference B _n = A _n - A ₁ (dBc)		B ₁ = 0	B ₂ =	B ₃ =	B ₄ =	B ₅ =	B ₆ =	B ₇ =
C _n = 10 ^{Bn/20}		C ₁ = 1	C ₂ =	C ₃ =	C ₄ =	C ₅ =	C ₆ =	C ₇ =
$\text{THD} = \frac{\sqrt{\sum_{n=2} C_n^2}}{C_1}$		THD = Limit < 0.2%						
Sample: reading		1.5 dBm	-58.5 dBm	-58.5 dBm	-63.5 dBm	-58.5 dBm	-63.5 dBm	-63.5 dBm
reading - reference		0	-60 dBm	-60 dBm	-65 dBm	-60 dBm	-65 dBm	-65 dBm
C _n =		1.000	0.001	0.001	0.000562	0.001	0.000562	0.000562
$\text{THD} = \frac{\sqrt{\sum_{n=2} C_n^2}}{C_1}$		0.1987% Limit < 0.2%						

NOTE. When all the harmonic components are -62dBm or less, the calculation of THD can be skipped because it is THD<0.2%.

7. Verify that the THD is less than 0.2%.
8. (AFG3xx2 only) Repeat steps 2 through 7 for the channel 2 output.

Spurious Test

This test verifies the spurious using a spectrum analyzer.

1. Connect the arbitrary/function generator to the spectrum analyzer as shown in Figure 4-9.

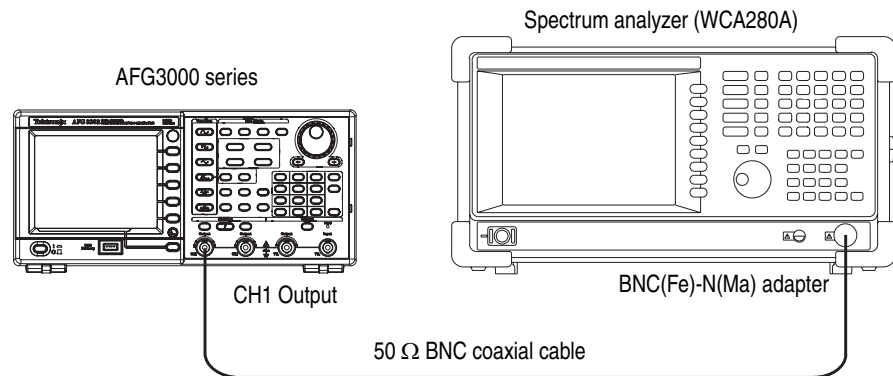

Figure 4-9: Spurious tests

2. Set up the arbitrary/function generator using the following steps:

Select menu	Setting	Operation
Function	Sine	Sine (front)
Frequency	100.00 kHz	Frequency/Period (front)
Amplitude Units	Vpp	TopMenu > Amplitude/Level Menu > -more- > Units > Vpp
Amplitude	1.00 Vpp	Amplitude/High (front)
Channel 1 Output	On	On (front)

3. Set the center frequency of the spectrum analyzer to 10 MHz. Other settings are shown in the following tables.
4. Measure the maximum spurious level other than harmonic distortion of 1 V_{pp} sine wave in each frequency.
5. Set the center frequency of the spectrum analyzer to 300 MHz. Other settings are shown in the following tables.
6. Measure the maximum spurious level other than harmonic distortion of 1 V_{pp} sine wave in each frequency.
7. Verify that the spurious signal at each frequency is equal to or less than the limit specified in the following tables.

8. (AFG3xx2 only) Repeat steps 2 through 7 for the channel 2 output.

AFG302x	Spectrum Analyzer			Measurement		
	Frequency	Center Frequency	Span	RBW	Spurious Frequency	Spurious (Max)
100.00 kHz	10 MHz 300 MHz	20 MHz 600 MHz	20 kHz 20 kHz	MHz MHz	dBc dBc	< -60 dBc
1.00 MHz	10 MHz 300 MHz	20 MHz 600 MHz	20 kHz 20 kHz	MHz MHz	dBc dBc	< -50 dBc
10.00 MHz	10 MHz 300 MHz	20 MHz 600 MHz	20 kHz 20 kHz	MHz MHz	dBc dBc	< -50 dBc
25.00 MHz	10 MHz 300 MHz	20 MHz 600 MHz	20 kHz 20 kHz	MHz MHz	dBc dBc	< -50 dBc

AFG310x	Spectrum Analyzer			Measurement		
	Frequency	Center Frequency	Span	RBW	Spurious Frequency	Spurious (Max)
100.00 kHz	10 MHz 300 MHz	20 MHz 600 MHz	20 kHz 20 kHz	MHz MHz	dBc dBc	< -60 dBc
1.00 MHz	10 MHz 300 MHz	20 MHz 600 MHz	20 kHz 20 kHz	MHz MHz	dBc dBc	< -50 dBc
10.00 MHz	10 MHz 300 MHz	20 MHz 600 MHz	20 kHz 20 kHz	MHz MHz	dBc dBc	< -50 dBc
25.00 MHz	10 MHz 300 MHz	20 MHz 600 MHz	20 kHz 20 kHz	MHz MHz	dBc dBc	< -50 dBc
50.00 MHz	10 MHz 300 MHz	20 MHz 600 MHz	20 kHz 20 kHz	MHz MHz	dBc dBc	< -44 dBc
100.00 MHz	10 MHz 300 MHz	20 MHz 600 MHz	20 kHz 20 kHz	MHz MHz	dBc dBc	< -38 dBc

AFG325x	Spectrum Analyzer			Measurement		
Frequency	Center Frequency	Span	RBW	Spurious Frequency	Spurious (Max)	Limit
100.00 kHz	10 MHz 300 MHz	20 MHz 600 MHz	20 kHz 20 kHz	MHz MHz	dBc dBc	< -50 dBc
1.00 MHz	10 MHz 300 MHz	20 MHz 600 MHz	20 kHz 20 kHz	MHz MHz	dBc dBc	< -47 dBc
10.00 MHz	10 MHz 300 MHz	20 MHz 600 MHz	20 kHz 20 kHz	MHz MHz	dBc dBc	< -47 dBc
25.00 MHz	10 MHz 300 MHz	20 MHz 600 MHz	20 kHz 20 kHz	MHz MHz	dBc dBc	< -47 dBc
50.00 MHz	10 MHz 300 MHz	20 MHz 600 MHz	20 kHz 20 kHz	MHz MHz	dBc dBc	< -41 dBc
100.00 MHz	10 MHz 300 MHz	20 MHz 600 MHz	20 kHz 20 kHz	MHz MHz	dBc dBc	< -35 dBc
200.00 MHz	10 MHz 300 MHz	20 MHz 600 MHz	20 kHz 20 kHz	MHz MHz	dBc dBc	< -29 dBc
240.00 MHz	10 MHz 300 MHz	20 MHz 600 MHz	20 kHz 20 kHz	MHz MHz	dBc dBc	< -28 dBc

Rise-Fall time Test

This test verifies the pulse rise time of the arbitrary/function generator.

1. Connect the arbitrary/function generator to the oscilloscope as shown in Figure 4-10.

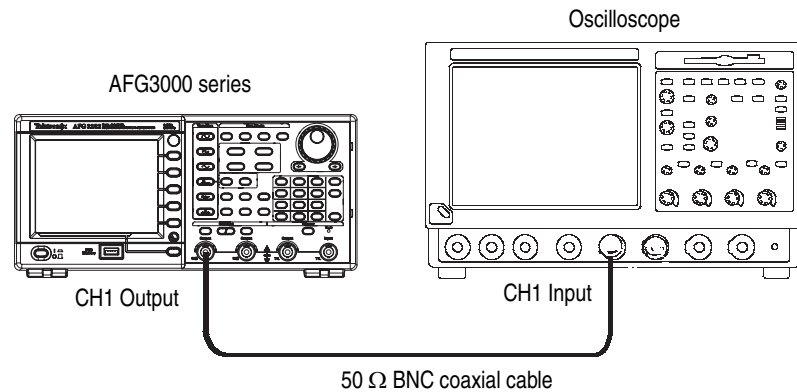

Figure 4-10: Rise-Fall time tests

2. Set up the arbitrary/function generator using the following steps:

Select menu	Setting	Operation
Function	Square	Square (front)
Frequency	10.00 MHz	Frequency/Period (front)
Amplitude Units	Vpp	TopMenu > Amplitude/Level Menu > -more- > Units > Vpp
Amplitude	1.0 Vpp	Amplitude/High (front)
Offset	0.0 V	TopMenu > Offset/Low (front)
Channel 1 Output	On	On (front)

3. Set up the Oscilloscope so the square waveform of 5 division amplitude is displayed.
4. Verify that the rise/fall time of the square waveform on the oscilloscope at each amplitude is equal to or less than the limit specified in the following tables. Use 10-90% reference level for rise/fall time measurement.

AFG302x				Oscilloscope		Measurement
Function	Frequency	Offset	Amplitude	Vertical	Horizontal	Limit
Square	10.00 MHz	0.0 V	1.0 V _{pp}	200 mV/div	5 ns/div	≤ 18 ns
Square	10.00 MHz	0.0 V	10.0 V _{pp}	200 mV/div with x10 attenuator	5 ns/div	≤ 18 ns

AFG310x				Oscilloscope		Measurement
Function	Frequency	Offset	Amplitude	Vertical	Horizontal	Limit
Square	10.00 MHz	0.0 V	1.0 V _{pp}	200 mV/div	2 ns/div	≤ 5 ns
Square	10.00 MHz	0.0 V	10.0 V _{pp}	200 mV/div with x10 attenuator	2 ns/div	≤ 5 ns

AFG325x				Oscilloscope		Measurement
Function	Frequency	Offset	Amplitude	Vertical	Horizontal	Limit
Square	10.00 MHz	0.0 V	1.0 V _{pp}	200 mV/div	1 ns/div	≤ 2.5 ns
Square	10.00 MHz	0.0 V	5.0 V _{pp}	1.0 V/div	1 ns/div	≤ 2.5 ns

5. (AFG3xx2 only) Repeat steps 2 through 4 for the channel 2 output.



Adjustment Procedures

Adjustment Procedures

This section describes the procedures necessary to manually adjust the AFG3000 Series Arbitrary/Function Generators. Execute each adjustment when you exchange a circuit board.

Purpose

This procedure returns the arbitrary/function generator to compliance with its Warranted Characteristics as listed in *Specification* section. It can also be used to optimize the performance of the arbitrary/function generator.

Adjustment Interval Generally, these adjustments should be done every 12 months.

Adjustment After Repair After the removal and replacement of a module due to electrical failure, perform the adjustment procedure in this section. The table below lists the adjustment items that should be performed after repair.

Table 5-1: Adjustments performed after repair

Adjustment	AFG3021, AFG3022		AFG3101, AFG3102, AFG3251, AFG3252		
	A70 CPU	A11, A12 Generator	A72 CPU	A31, A32, A41, A42 Generator	A51, A61 Output
Reference Clock	X	X	X	X	
LF			X	X	X
Flatness	X	X	X	X	X
Spurious	X	X	X	X	X
Trigger Delay	X	X	X	X	

Equipment Required

Table 5-2 lists the equipment that is required to complete the adjustment procedures.

Table 5-2: Test equipment

Description	Minimum requirements	Recommended equipment	Purpose
1. Digital Multi Meter (DMM)	AC volts, true rms, AC coupled Accuracy: $\pm 0.02\%$ to 1 MHz DC volts Accuracy: 50 ppm, resolution 100 μ V Resistance Accuracy: $\pm 0.05 \Omega$	Agilent 3458A	Measures voltage. Used in multiple procedures.
2. Power Meter	100 kHz to 250 MHz 1 μ W to 100 mW (-30 dBm to +20 dBm) Accuracy: 0.02 dB Resolution: 0.01 dB	R&S NRVS	Measures voltage. Used in multiple procedures.
3. Power Head	100 kHz to 250 MHz 1 μ W to 100 mW (-30 dBm to +20 dBm)	R&S NRV-Z5	Measures voltage. Used in multiple procedures.
4. Frequency Counter	50 kHz to 5 GHz, Accuracy: 0.01ppm Phase measurement	Agilent 53132A	Checks clock frequency.
5. Oscilloscope	1 GHz Bandwidth 50 Ω input termination	Tektronix TDS5104B	Checks output signals. Used in multiple procedures.
6. Spectrum Analyzer	20 kHz to 1.25 GHz	Tektronix RSA3303A	Checks output signals. Harmonics Spurious.
7. BNC Coaxial Cable (3 required)	50 Ω , male to male BNC connector, 91 cm	Tektronix part number 012-0482-00	Signal interconnection
8. BNC terminator	50 Ω , $\pm 1 \Omega$, 2 W, DC to 1 GHz, BNC	Tektronix part number 011-0049-02	Signal termination
9. Attenuator (2 required)	50 Ω , x10, BNC	Tektronix part number 011-0059-03	Signal attenuation
10. Adapter Dual-Banana Plug	BNC (female) to dual banana	Tektronix part number 103-0090-00	Signal interconnection to a DMM
11. Adapter BNC(fe)-N(ma)	BNC (female) to N (male)	Tektronix part number 103-0045-00	Signal interconnection to a Spectrum Analyzer

Performance Conditions

The adjustments in this section are an extensive, valid confirmation of performance and functionality when the following requirements are met:

- The cabinet covers must be on the AFG3000 Series.
- The instrument must have been calibrated/adjusted at an ambient temperature between +20 °C and +30 °C.
- The instrument must have had a warm-up period of at least 20 minutes.

Enable the service mode

You must enable the service mode to perform the adjustment procedure. Do the following steps to enter the service mode:

1. Push the power button to power on the arbitrary/function generator.
2. After the beep, push the front-panel **Recall** button, and then push the front-panel **7** numeric button.
3. Keep pushing these buttons until the power-on screen is displayed.
4. Release the buttons when the top screen is displayed.
5. Check whether the service mode is available by pushing the **Utility** > **-more-** > **-more-** buttons. Service Menu is displayed in the third page of Utility menu.

Save menu

You can adjust the Reference Clock, LF, Flatness, Spurious, and Trigger Delay parameters on the Manual Calibration that is described in this section. Each of changed parameters is stored in non-volatile memory of the arbitrary/function generator after you push the Save menu in the first page of Manual Calibration. Previous adjustment parameters will be recalled after a power cycle unless you push the Save menu button.

Clear CAL Data menu

The Clear CAL Data menu in the second page of Manual Calibration clears all the current adjustment parameters and sets them to 0. But unless you push the Save menu button, the previous adjustment parameters will be recalled after a power cycle.

Reference Clock

This procedure adjusts the frequency accuracy of the arbitrary/function generator. For any model, only one frequency point of channel 1 is adjusted.

1. Connect the arbitrary/function generator to the frequency counter as shown in Figure 5-1.

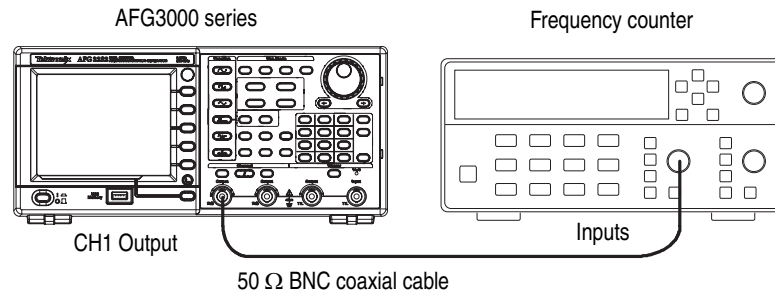

Figure 5-1: Reference Clock adjustment

2. Push the **Default** front-panel button and **OK** menu button to recall the arbitrary/function generator default setup.
3. Set up the arbitrary/function generator using the following steps:

Select menu	Setting	Operation
Function	Sine	Sine (front)
Frequency	1.000000 MHz	Frequency/Period (front)
Amplitude	1.00 Vpp	Amplitude/High (front)
Channel 1 Output	On	On (front)

4. Push the **Utility** > **-more-** > **-more-** > **Service Menu** > **Manual Calibration** > **-more-** > **Reference Clock** buttons. Ref Clock value is selected.
5. Adjust the Ref Clock value with the rotary knob so that the frequency counter reading is between 0.999999 MHz and 1.000001 MHz.
6. Push the **Save** menu button to save the adjusted value.

LF Adjustment

This procedure adjusts the LF amplitude accuracy of the arbitrary/function generator. This adjustment is not necessary in the AFG3021 and AFG3022.

1. Connect the arbitrary/function generator to the DMM as shown in Figure 5-2.

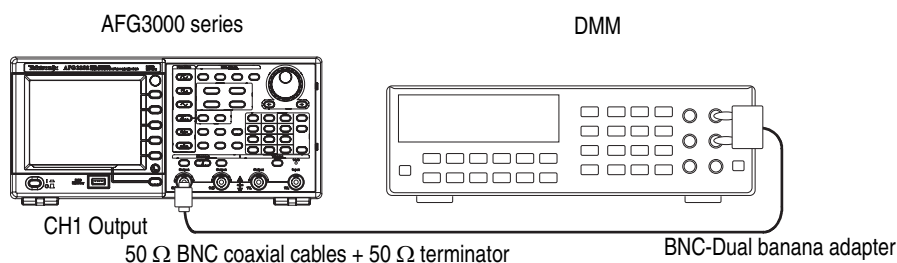

Figure 5-2: LF adjustment

2. Set up the arbitrary/function generator using the following steps:

Select menu	Setting	Operation
Function	Sine	Sine (front)
Frequency	10.00000 kHz: AFG310x 100.00000 kHz: AFG325x	Frequency/Period (front)
Load Impedance	50 Ω	TopMenu > Output Menu > Load Impedance > 50 Ω
Amplitude	1.00 Vpp	Amplitude/High (front)
Channel 1 Output	On	On (front)

3. Set the DMM voltage unit to VAC (effective voltage).

4. Record the DMM voltage reading:

AFG	Function	Frequency	DMM reading
AFG310x	Sine	10.00000 kHz	CH1: (CH2:)
AFG325x	Sine	100.00000 kHz	CH1: (CH2:)

5. Set the AFG3000 Series frequency to **100.000 Hz**.
6. Push the **Utility > -more- > -more- > Service Menu > Manual Calibration > LF Adjustment > (CH1)** buttons. LF Adj value is selected.
7. Adjust the LF Adj value with the rotary knob so that the DMM voltage reading is the same as shown in the Table at step 4.

8. (AFG3102, AFG3252 only) Connect the AFG3000 Series CH2 Output to the DMM. Repeat steps 2 through 7 for the channel 2 output.
9. Push the  and the **Save** button to save the adjusted value.

Flatness adjustment

To obtain the flatness of sine waveform relative to the 100 kHz sine waveform, compensate the output level of sine waveform at 5 MHz interval with the power meter.

1. Connect the arbitrary/function generator to the power meter with a power head as shown in Figure 5-3.

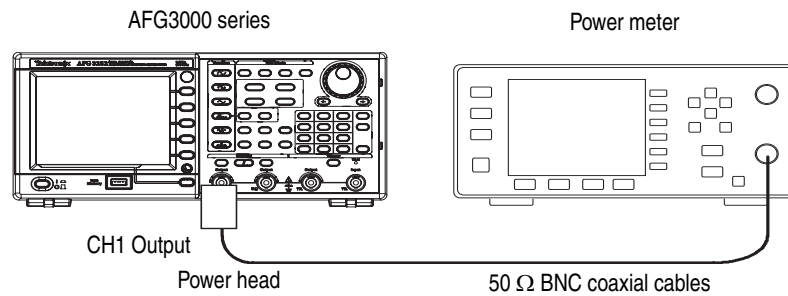



Figure 5-3: Flatness adjustment

2. Set up the arbitrary/function generator using the following steps:

Select menu	Setting	Operation
Amplitude Units	Vpp	TopMenu > Amplitude/Level Menu > -more- > Units > Vpp
Amplitude	1.0 Vpp	Amplitude/High (front)
Offset	0 V	Offset/Low (front)
Channel 1 Output	On	On (front)

3. Push the **Utility > -more- > -more- > Service Menu > Manual Calibration > Flatness > CH1-Flatness Next Frequency** buttons. The setting of the first frequency of the arbitrary/function generator is 100 kHz.
4. Set the frequency parameter of the power meter to 100 kHz, and compensate the power meter so that the reading value at 100 kHz may become 0 dB with the frequency dependent offset function. Then set up the power meter to the relative measurement mode.
5. Push the **CH1-Flatness Next Frequency** button. The setting of next frequency of the arbitrary/function generator becomes 5 MHz.

6. Change the frequency of the power meter setting to 5 MHz (same as the arbitrary/function generator frequency).
7. The power meter shows the value difference from the reference value. Set this value to the Flatness field of the arbitrary/function generator.
8. Repeat steps 5 through 7 until the setting of the arbitrary/function generator is: 25 MHz; AFG302x, 100 MHz; AFG310x, or 240 MHz; AFG325x.
The frequency of the output signal of the arbitrary/function generator increases in 5 MHz step every time you push the CH1-Flatness Next Frequency button. Set the frequency of the power meter to the same frequency of the arbitrary/function generator in step 6.
Pushing the CH1-Flatness Previous Frequency button decreases the output frequency of the arbitrary/function generator.
9. Push the **CH1-Flatness Apply Parameters** button to enable the input data for flatness correction.
10. (AFG3xx2 only) Repeat steps 2 through 9 for the channel 2 output.
11. Push the  button and **Save** menu button to save the adjusted value.

Spurious adjustment

This adjustment minimizes spurious of the output signal by adjusting spurious in the frequency of several points. This adjustment is not necessary in the AFG3021 and AFG3022.

1. Connect the arbitrary/function generator to the spectrum analyzer as shown in Figure 5-4.

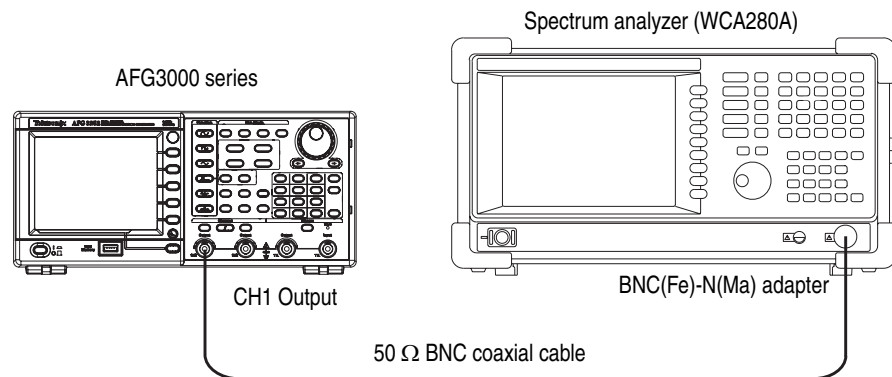

Figure 5-4: Spurious adjustment

2. Set up the arbitrary/function generator using the following steps:

Select menu	Setting	Operation
Function	Sine	Sine (front)
Amplitude Units	Vpp	TopMenu > Amplitude/Level Menu > -more- > Units > Vpp
Amplitude	1.0 Vpp	Amplitude/High (front)
Channel 1 Output	On	On (front)

3. AFG310X:

Push the **Utility > -more- > -more- > Service Menu > Manual Calibration > Spurious Adjustment > CH1 Pulse 2.7 MHz** buttons.



AFG325X:

Push the **Utility > -more- > -more- > Service Menu > Manual Calibration > Spurious Adjustment > CH1 Sine 0.1 MHz** buttons.

4. Set up the spectrum analyzer according to the Spurious adjust setup of the AFG3000 Series.

AFG310x	Spectrum Analyzer		
Spurious Adjust	Center Frequency	Span	Spurious Frequency
Pulse 2.7 MHz	247.3 MHz	100 kHz	247.3 MHz

AFG325x	Spectrum Analyzer		
Spurious Adjust	Center Frequency	Span	Spurious Frequency
Sine 0.1 MHz	249.9 MHz	100 kHz	249.9 MHz
Sine 50 MHz	200 MHz	100 kHz	200 MHz
Sine 200 MHz	50 MHz	100 kHz	50 MHz
Pulse 2.7 MHz	247.3 MHz	100 kHz	247.3 MHz

5. Push the **CH1-Sine (Pulse) x.x MHz Gain** menu button.
6. Adjust the **Spurious Gain** value with the rotary knob to minimize the spurious on the spectrum analyzer screen.
7. Push the **CH1-Sine x.x MHz Phase** menu button.
8. Adjust the **Spurious Phase** value with the rotary knob to minimize the spurious on the spectrum analyzer screen.
9. Push the  button. Repeat steps 4 through 8 to minimize the spurious display on the spectrum analyzer screen for each frequency of the Sine (Pulse) x.x MHz.
10. (AFG3xx2 only) Repeat steps 2 through 9 for the channel 2 output.
11. Push the  button and the **Save** menu button to save the adjusted value.

Trigger delay adjustment

This procedure adjusts trigger timing of two channels. This adjustment is not necessary in AFG3021, AFG3101, and AFG3251.

1. Connect the arbitrary/function generator to the oscilloscope as shown in Figure 5-5.

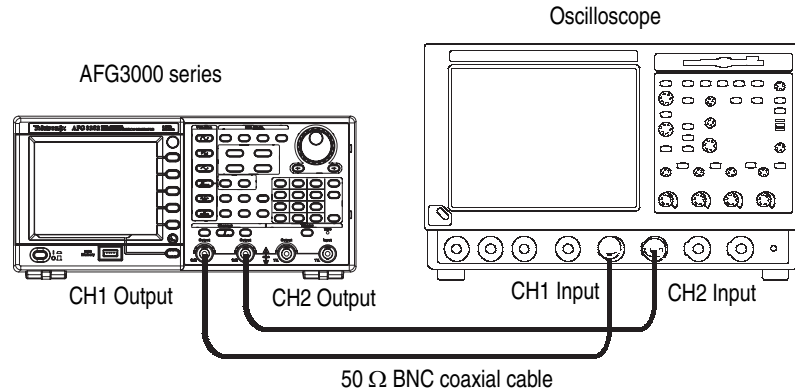

Figure 5-5: Trigger delay adjustment

2. Push the **Default** front-panel button and **OK** menu button to recall the arbitrary/function generator default setup.
3. Set up the arbitrary/function generator using the following steps:

Select menu	Setting	Operation
Function (CH1)	Pulse	Pulse (front)
Leading (CH1)	AFG3022: 18 ns AFG3102: 5 ns AFG3252: 2.5 ns	Pulse Parameter Menu (menu) > Leading Edge
Delay (CH1)	0.00 ns	Delay (front)
Function (CH2)	Pulse	CH1/CH2 > Pulse (front)
Leading (CH2)	AFG3022: 18 ns AFG3102: 5 ns AFG3252: 2.5 ns	Pulse Parameter Menu (menu) > Leading Edge
Delay (CH2)	0.00 ns	Delay (front)
Run Mode (CH2)	Burst	Burst (front)
Trigger Delay	0.0 ns	more (menu) > Delay
Run Mode (CH2)	Continuous	Continuous (front)
Channel 1 Output	On	On (front)
Channel 2 Output	On	On (front)

4. Set up the oscilloscope using the following steps:

Select menu	Setting	Operation
Horizontal	200 ns/div	Sec/div knob
Vertical (CH1 and CH2)	200 mV/div	Volts/div knob
Vertical position	Align the baseline of each channel	CH1 and CH2 Vertical position knob

5. Push the **Utility > -more- > -more- > Service Menu > Manual Calibration > -more- > Trigger Delay** buttons.
6. Change the value of the **Trigger Delay** in Service menu to the value other than 0.0 ns, then return it to 0.0 ns.
7. Push the **CH1/CH2** button to activate the CH1 screen.
8. Push the **Burst > -more- > Delay** buttons to change the CH1 Run mode to Burst mode.
9. Change the value of the **Trigger Delay** in Burst menu to the value other than 0.0 ns, then return it to 0.0 ns.
10. Push the **Continuous** button to change the CH1 Run mode to Continuous mode.
11. Push the **Phase | Delay > Recover Lead Delay** buttons.
12. Change the Horizontal setting of the oscilloscope to 1 ns/div.
13. Write the skew time of two signals from the oscilloscope screen.
14. Push the **Utility > -more- > -more- > Service Menu > Manual Calibration > -more- > Trigger Delay** buttons.
15. Set the Trigger Delay to the value written down in step 13.
16. Push the **-more- > Save > OK** buttons.
17. Push the **Burst > -more- > Delay** buttons to change the CH1 Run mode to Burst mode.
18. Change the value of the **Trigger Delay** in Burst menu to a value other than 0.0 ns, then return it to 0.0 ns.
19. Push the **Continuous** button to change the CH1 Run mode to Continuous mode.
20. Push the **Phase | Delay > Recover Lead Delay** buttons.
21. Check that the skew time of the two signals on the oscilloscope screen is less than 1 ns.

Setting the Serial number

When you replace the A70, A72 CPU board, you must set the serial number. Perform the following procedure to set the serial number:

1. Enable the service mode. Refer to page 5-3.
2. Push the **Utility** > **-more-** > **-more-** buttons.
3. Push the **Service Menu** > **Factory Initialize** > **Serial Number** buttons.
4. Enter the serial number with numeric keys and Function buttons.

NOTE. Use the Function buttons to enter alphabetical characters. The *Sine to More...* button corresponds to A through F.

Setting the MAC Address (AFG310x and AFG325x only)

MAC Address has already been set, and need not usually be set. When a new MAC address setup is required, perform the following procedure:

1. Enable the service mode. Refer to page 5-3.
2. Push the **Utility** > **-more-** > **-more-** buttons.
3. Push the **Service Menu** > **Factory Initialize** > **MAC Address** buttons.
4. Enter the MAC address with numeric keys and Function buttons.

NOTE. Use the Function buttons to enter alphabetical characters. The *Sine to More...* button corresponds to A through F.

Use the +/- key to enter the hyphen.

5. Push the **OK** button.



Maintenance

Maintenance

This section contains the information needed to do periodic and corrective maintenance on the arbitrary/function generator. The following subsections are included:

- *Preparation* — Tells you how to get ready to do arbitrary/function generator maintenance.
- *Preventing ESD* — Provides general information on preventing damage to internal modules when doing maintenance.
- *Inspection and Cleaning* — Information and procedures for inspecting the arbitrary/function generator and cleaning its external and internal modules.
- *Removal and Installation Procedures* — Procedures for the removal of defective modules and replacement of new or repaired modules.
- *Troubleshooting* — Information for isolating failed modules. Information for isolating failed modules. Included are instructions for operating the internal diagnostic routines of the arbitrary/function generator and troubleshooting trees. Most of the trees make use of these internal diagnostic routines to speed fault isolation to a module.

Preparation

Only qualified person should perform service procedures. Before performing any service procedures, read the *Safety Summary* and *General Safety Summary* section of this manual and the ESD information below. Also refer to the Operating Information section and your arbitrary/function generator user manual for information about using the arbitrary/function generator.

Preventing ESD

When performing any service that requires internal access to the arbitrary/function generator, adhere to the following precautions. These precautions will help you avoid damaging internal modules and their components due to electrostatic discharge (ESD).



CAUTION. *Static discharge can damage any semiconductor component in this arbitrary/function generator.*

- Minimize handling of static-sensitive modules.

- Transport and store static-sensitive modules in their static protected containers or on a metal rail. Label any package that contains static-sensitive modules.
- Discharge the static voltage from your body by wearing a grounded antistatic wrist strap while handling these modules. Service static-sensitive modules only at a static-free work station.
- Do not allow anything capable of generating or holding a static charge on the work station surface.
- Handle circuit boards by the edges when possible.
- Do not slide the modules over any surface.
- Avoid handling modules in areas that have a floor or work-surface covering that is capable of generating a static charge.

Inspection and Cleaning

This section describes how to inspect for dirt and damage, and how to clean the exterior and interior of the arbitrary/function generator. Inspection and cleaning are done as preventive maintenance. Preventive maintenance, when done regularly, may prevent malfunctions and enhance reliability.

Preventive maintenance consists of visually inspecting and cleaning the arbitrary/function generator, and using general care when operating it. Perform preventive maintenance more often if you operate the arbitrary/function generator in a severe environment. A good time to perform preventive maintenance is just before adjustment of the arbitrary/function generator.

General Care

For optimum performance, follow these recommendations:

- Protect the arbitrary/function generator from adverse weather conditions. The arbitrary/function generator is not waterproof.
- Do not store or leave the arbitrary/function generator whether the liquid crystal display (LCD) will be exposed to direct sunlight or high humidity for long periods of time.
- The front and rear cases help keep dust out of the arbitrary/function generator and must be in place during normal operation.
- To avoid damage to the arbitrary/function generator, do not expose them to any sprays, liquids, or solvents.

Inspection and Cleaning procedures

The collection of dirt on internal components can cause them to overheat and fail. Dirt also provides an electrical conduction path that could cause an arbitrary/function generator failure, especially under high-humidity conditions. Inspect the arbitrary/function generator as often as operating conditions require.



CAUTION. Avoid the use of chemical cleaning agents which might damage the plastics used in this AFG3000 Series arbitrary/function generator. Use only deionized water when cleaning the front-panel buttons. Use an ethyl alcohol solution as a cleaner and rinse with deionized water.

Inspection — Exterior. Inspect the outside of the arbitrary/function generator for damage, wear, and missing parts, using Table 6-1 as a guide. Arbitrary/function generator that appears to have been dropped or otherwise abused should be checked thoroughly to verify correct operation and performance. Immediately repair defects that could cause personal injury or cause further arbitrary/function generator.

Table 6-1: External inspection check list

Item	Inspect for	Repair action
Cabinet, front-panel, and cover	Cracks, scratches, deformations, damaged hardware or gaskets.	Repair or replace defective module.
Front-panel knobs	Missing, damaged, or loose knobs.	Repair or replace missing or defective knobs.
Connectors	Broken shells, cracked insulation, and deformed contacts. Dirt in connectors.	Repair or replace defective modules. Clear or wash out dirt.
Carrying handle, bail, cabinet feet.	Correct operation.	Repair or replace defective module.

Cleaning Procedure — Exterior. Do the following steps to clean the arbitrary/function generator exterior:

1. Remove loose dust on the outside of the arbitrary/function generator with a lint-free cloth. Use care to avoid scratching the clear glass display shield.
2. Remove remaining dirt with a lint free cloth dampened in a general purpose detergent-and-water solution. Do not use abrasive cleaners.



CAUTION. To prevent getting moisture inside the arbitrary/function generator during external cleaning, use only enough liquid to dampen the cloth or applicator. To avoid damage to the surface of the arbitrary/function generator, do not use any abrasive or chemical cleaning agents.

Flat Panel Display Cleaning. The display is a soft plastic display and must be treated with care during cleaning.



CAUTION. *Imported cleaning agents or methods can damage the flat panel display.*

Avoid using abrasive cleaners or commercial cleaners to clean the display surface.

Avoid spraying liquids on the display surface.

Avoid scrubbing the display with excessive force.

1. Clean the flat panel display surface by gently rubbing the display with a clean-room wipe (such as Wypall Medium Duty Wipes, #05701, available from Kimberly-Clark Corporation).
2. If the display is very dirty, moisten the wipe with distilled water or a 75% isopropyl alcohol solution and gently rub the display surface. Avoid using excess force or you may damage the plastic display surface.



CAUTION. *To prevent getting moisture inside the arbitrary/function generator during external cleaning, use only enough liquid to dampen the cloth or applicator.*

Inspection — Interior. Inspect and clean the interior if it appears that the arbitrary/function generator may have been damaged or exposed to an unusually dirty environment.

To access the inside of the arbitrary/function generator for inspection and cleaning, refer to the *Removal and Installation Procedures* in this section.

Inspect the internal portions of the AFG3000 Series arbitrary/function generator for damage and wear, using Table 6-2 as a guide. Defects should be repaired immediately.



CAUTION. *To prevent damage from electrical arcing, ensure that circuit boards and components are dry before applying power to the arbitrary/function generator.*

Table 6-2: Internal inspection check list

Item	Inspect for	Repair action
Front and Rear Case	Cracks or deformations. Scratched lettering or display filter. Loose connectors or labels.	Repair or replace defective hardware.
Circuit boards	Loose, broken, or corroded solder connections. Burned circuit boards. Burned, broken, or cracked circuit-run plating.	Remove failed module and replace with a new module.
Solder connections	Cold solder or rosin joints.	Resolder joint and clean with ethyl alcohol.

Table 6-2: Internal inspection check list (cont.)

Item	Inspect for	Repair action
Wiring and cables	Loose plugs or connectors. Burned, broken, or frayed wiring.	Firmly seat connectors. Repair or replace modules with defective wires or cables.
Chassis	Dents, deformations, and damaged hardware.	Straighten, repair, or replace defective hardware.

Cleaning Procedure — Interior. Do the following steps to clean the arbitrary/function generator interior:

1. Blow off dust with dry, low-pressure, deionized air (approximately 9 psi).
2. Remove any remaining dust with a lint-free cloth dampened in isopropyl alcohol (75% solution) and rinse with warm deionized water. (A cotton-tipped applicator is useful for cleaning in narrow spaces and on circuit boards.)

NOTE. *If steps 1 and 2 do not remove all the dust or dirt, please contact Tektronix. (See Contacting Tektronix at the front of this manual.)*

Lubrication. There is no periodic lubrication required for the AFG3000 Series arbitrary/function generator.

Removal and Installation Procedures

This section describes how to remove and install the major mechanical and electrical modules. It provides the following information:

Preparation Read this section to prepare for module removal and installation.



WARNING. Only qualified personnel should perform service procedures. Before doing this or any other procedure in this manual, read the *General Safety Summary* and *Service Safety Summary* found at beginning of this manual.

Always disconnect the power cord before disassembling any portion of the arbitrary/function generator.

To prevent damage to electrical components, read *Preventing ESD* on page 6-1.

- *List of Modules* on page 6-7 describes where to locate a list of replaceable modules.
- See Figure 9-1 on page 9-6 for an overview of how the entire arbitrary/function generator is assembled.
- Read the *Summary of Procedures* on page 6-8 to understand which procedure to use to access a given module. Then read *Tools Required* on page 6-9 for a list of tools needed to remove and install modules in the arbitrary/function generator.
- *Flip feet*, on page 6-9 begins a series of procedures that describe the removal and installation of modules.
- If you are disassembling the arbitrary/function generator for cleaning, refer to *Inspection and Cleaning* on page 6-2 for cleaning instructions.

Adjustment after repair

After the removal and replacement of a module due to electrical failure, perform the adjustment procedures. Refer to the *Adjustment Procedures* section.

List of Modules

The *Replaceable Parts* section provides a list of all replaceable modules. Any electrical or mechanical module, assembly, or part listed in the parts list is referred to as a module.

Summary of Procedures

Disassembly for replacement is best achieved by removing and replacing the modules in a specific order. Complete disassembly is best achieved by following the procedures in the order given in Figure 6-1.

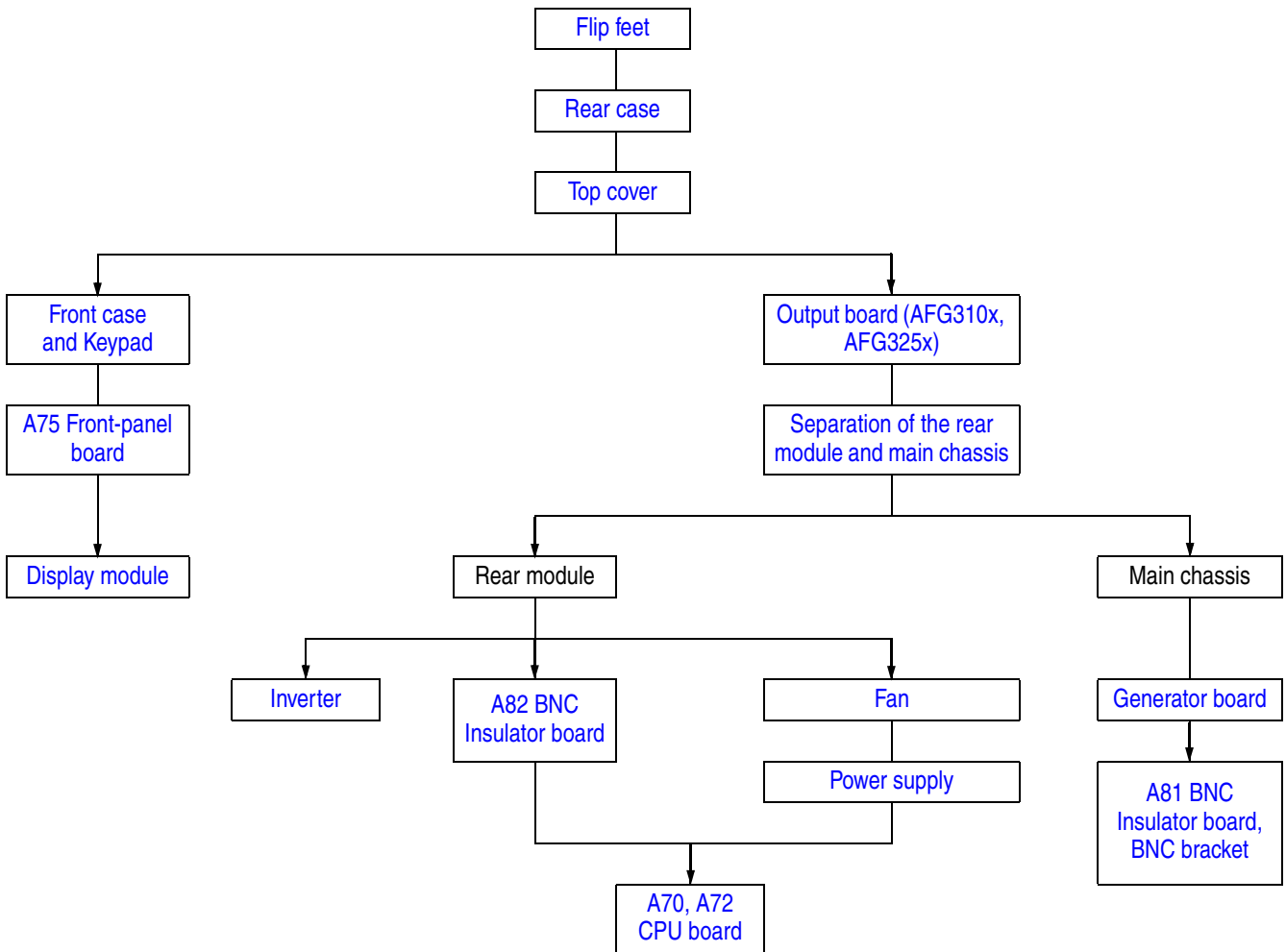

Figure 6-1: Disassembly order

Tools Required

Use the following tools to remove and replace all modules in the arbitrary/function generator:

- Torque-limiting screwdriver, long shank, 8 lb-in (0.85 N m) range with Torx T-15 tip
- 16 mm (5/8 inch) deep socket with wide center hole
- 7 mm (9/32 inch) socket
- Torque wrench to 30 in-lb (3.3 N m)
- Screwdriver with 1/4 inch flat blade
- Pliers (all-purpose and needle-nose)
- Tweezers

Flip feet

You will need needle-nose pliers to remove the flip feet.

Removal. To remove the flip feet, refer to Figure 6-2 and follow these steps:

1. Place the arbitrary/function generator top down on a soft surface such as an anti-static mat.
2. Grip the flip foot with the pliers as close to the notches as possible and squeeze gently on the foot.
3. Twist slightly to swing one hinge free of the slot.

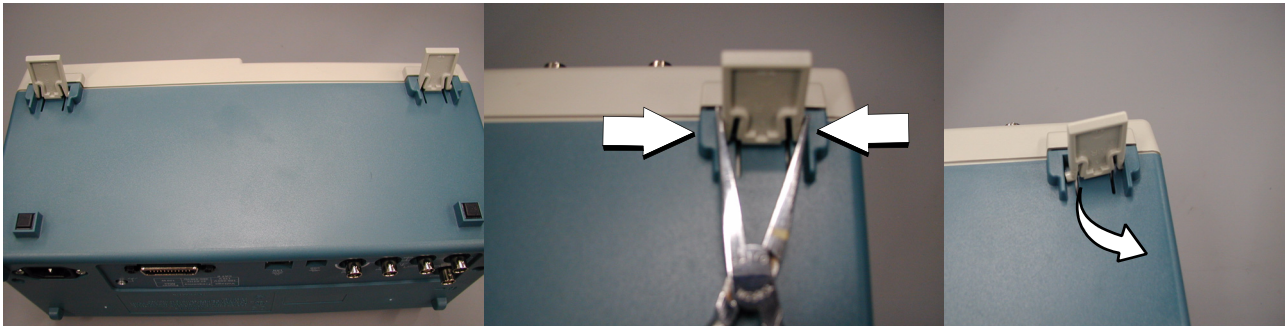

Figure 6-2: Removing and installing the flip feet

Installation. To install the flip feet, refer to Figure 6-2 and follow these steps:

1. Place the arbitrary/function generator top down on a soft surface such as an anti-static mat.
2. Hold the flip foot with the smooth side facing down.
3. Gently squeeze the foot so that the hinge on one side fits into the slot, and twist slightly to snap into the slot on the other side.

Front-Panel knob

Remove: Firmly grasp the knob and pull it away from the shaft.

Install: Align the keyed knob with the shaft and press the knob onto the shaft.

Rear case

You will need a torque-limiting Torx T-15 screwdriver for this procedure.

Removal. To remove the rear case, refer to Figure 6-3 and follow these steps:

1. Place the arbitrary/function generator face down on a soft surface such as an anti-static mat.
2. Remove the four screws located on the rear case. Tilt the handle to gain better access to the top two screws. When the chassis grand screw is attached, remove it.
3. Lift the rear case off of the arbitrary/function generator.



Figure 6-3: Rear case removal

Installation. To install, reverse this procedure.

NOTE. When you remove the rear case, the front rubber feet (attached to the front case) come off. Before you reinstall the rear case, reattach the front feet to the front case. Confirm that they are in place before reassembling the case.

Remember to attach the chassis grand screw if you removed it.

exchange. If your AFG is the AFG310x or AFG325x, the urethane-form-gasket must be attached inside of the rear case.

1. Remove the protective backing from the adhesive urethane-form-gaskets (348-1848-00 x 2, 348-1849-00 x 2 and 348-1850 x 1) then paste them around the edges of the rear case and on the bottom of it. Refer to the following figures for the pasting position.

Make sure the gaskets are stick out 2.0 mm to 2.5 mm from the edge of the rear case to obtain the contact of excellent ground.

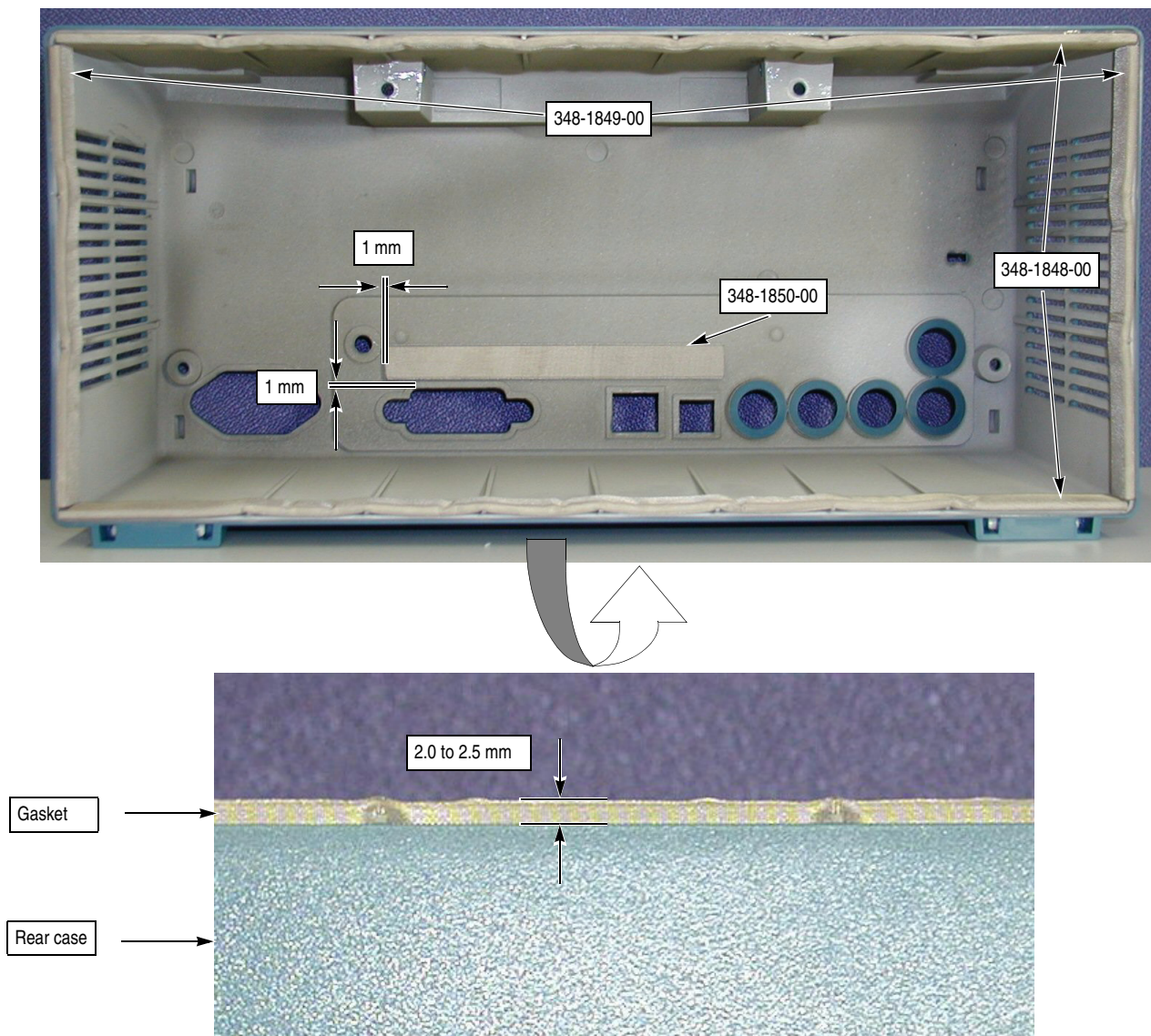

Figure 6-4: Pasting the urethane-form-gaskets

Top cover

You will need a torque-limiting Torx T-15 screwdriver and a flat-blade screwdriver for this procedure.

Removal. To remove the top cover, refer to Figure 6-5 and follow these steps:

1. Remove the nine screws attaching the top cover to the main chassis and the rear sub-panel. Four screws are on the upper part of the top cover. Five screws are on the rear panel side.
2. Using a flat-blade screwdriver, pull the top cover backwards.

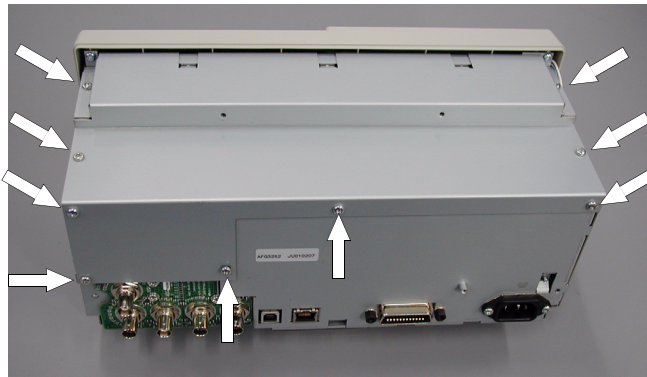

Figure 6-5: Top cover removal

Installation. To install, reverse this procedure.

Front case

You will need a torque-limiting Torx T-15 screwdriver.

Removal. To remove the front case, refer to Figure 6-6 and follow these steps:

1. Remove the front-panel knob by firmly grasping the knob and pulling it away from the front panel.
2. Remove the four tapping screws attaching the front case to the main chassis.
3. The front case and the rubber switch can be removed together.



Figure 6-6: Front case removal

Installation. To install, reverse this procedure. Remember to attach the rubber front feet to the front case.

A75 Front-panel board

You will need a torque-limiting Torx T-15 screwdriver.

Removal. To remove the A75 front-panel board, refer to Figure 6-7 and follow these steps:

1. Remove the front case using the procedures on page 6-12.
2. Remove the seven screws attaching the A75 front-panel board to the main chassis.
3. Disconnect the front-panel board cable.

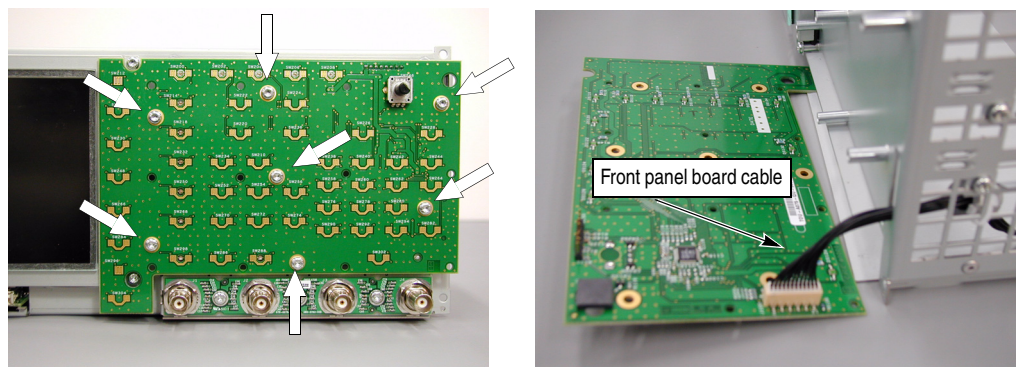

Figure 6-7: A75 front-panel board removal

Installation. To install, reverse this procedure.

Display module

You will need a torque-limiting Torx T-15 screwdriver and tweezers.

Removal. To remove the display module, refer to Figure 6-8 and follow these steps:

1. Use tweezers or needle-nose pliers to disconnect the backlight cable at the Inverter unit located near the fan unit.
2. Remove the four screws attaching the display module to the main chassis.
3. Disconnect the display cable at on the back side of the display module.

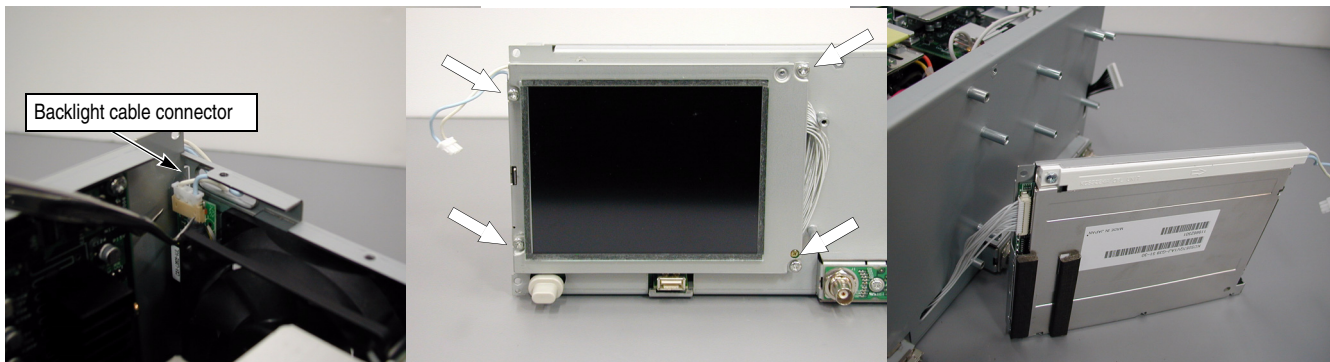

Figure 6-8: Display module removal

Installation. To install, reverse this procedure.

Output board (AFG310x, AFG325x)

You will need a torque-limiting Torx T-15 screwdriver.

Removal. To remove the output board, refer to Figure 6-9 and follow these steps:

1. Disconnect the two peltola cables at J100 (CH1; from J380, CH2; from J780) and J170 (CH1; from J390, CH2; from J790) on the output board.
2. Remove the two screws attaching the output module to the rear sub-panel.
3. Gently pull out the output board toward the rear according to the guide.



Figure 6-9: Output board removal

Installation. To install, reverse this procedure.

Separation of the rear module and main chassis

To remove and replace the internal modules, Generator board, CPU board, Power supply, fan, or backlight inverter board, you must first separate the rear module and the main chassis. You will need a torque-limiting Torx T-15 screwdriver and a flat-blade screwdriver for this procedure.

Removal. To separate the rear module and main chassis, refer to Figure 6-10 and Figure 6-11 and follow these steps:

1. Disconnect the following cables:
 - The front-panel cable at J300
 - The display inverter cable from the LCD Display
 - The display data cable at J400 from the LCD Display
 - The add-in cable at J370 from the ADD Input connector
2. Remove the three screws attaching the CPU board to the main chassis.
3. Remove the two screws near the air outlet attaching the rear module and main chassis.

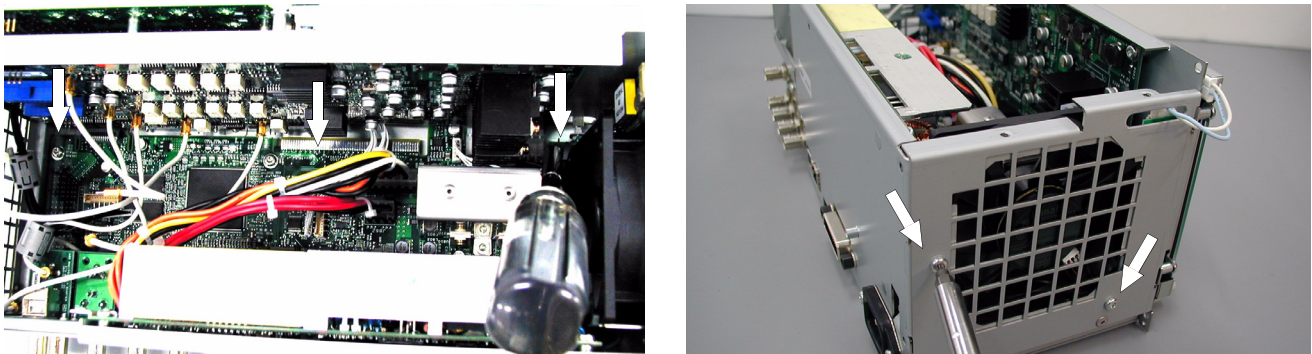

Figure 6-10: Separation of the rear module and main chassis

4. Use the flat-blade screwdriver to loosen the rear module and main chassis.
5. Pull out the rear module toward the rear.

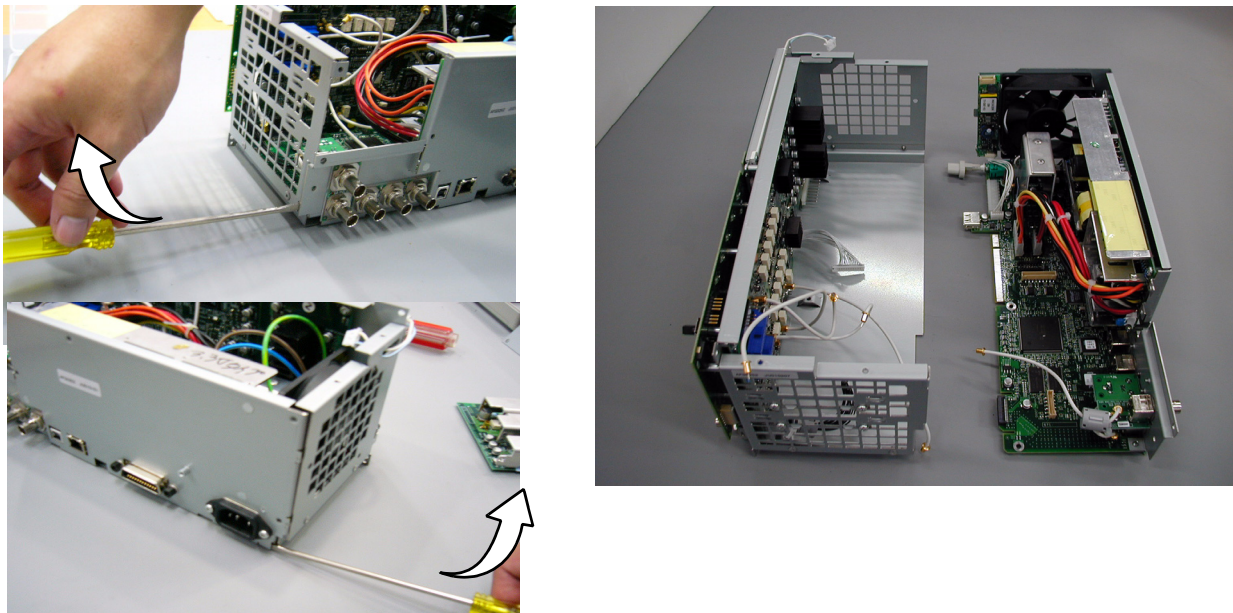

Figure 6-11: Pull out the rear module

Installation. To install, reverse this procedure.

Inverter

You will need needle-nose pliers and tweezers.

Removal. To remove the Inverter, refer to Figure 6-12 and follow these steps:

1. Use needle-nose pliers to bend the two Inverter-bracket tabs out of the way.
2. Remove the Inverter board.
3. Disconnect the Inverter cable from the CPU board.

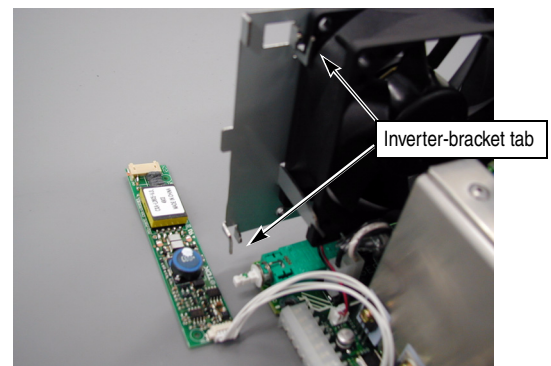
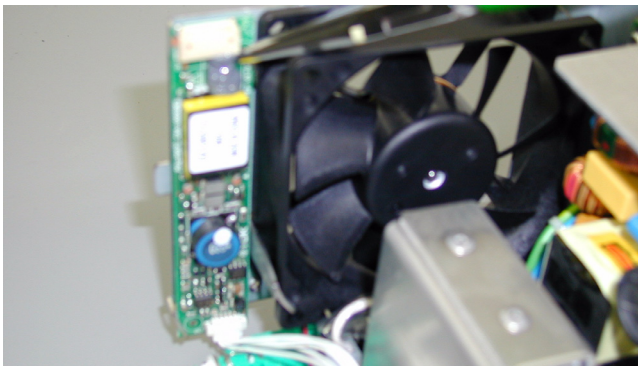

Figure 6-12: Inverter removal

Installation. To install, refer to Figure 6-13 and follow these steps:

1. Connect the Inverter cable from the CPU board at J404.
2. Align the Inverter board with the Inverter-bracket. Make sure that the two hooks on the Inverter-bracket with the two holes on the Inverter board.
3. Use the pliers to bend the two Inverter-bracket tabs into place and secure the Inverter board.

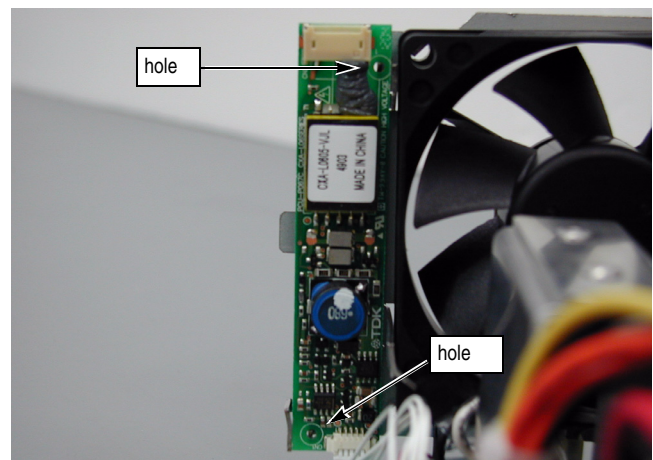
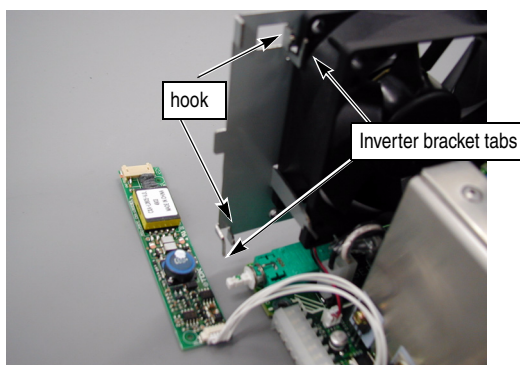

Figure 6-13: Inverter installation

Fan

You will need needle-nose pliers and tweezers.

Removal. To remove the fan, refer to Figure 6-14 and follow these steps:

1. Use needle-nose pliers to bend the two fan-bracket tabs out of the way.
2. Remove the fan.
3. Disconnect the fan cable from the CPU board.

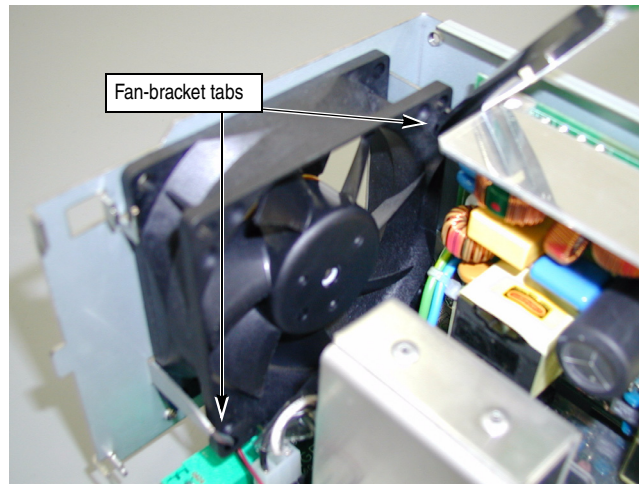

Figure 6-14: Fan removal

Installation. To install the fan, follow these steps:

1. Connect the fan cable to the CPU board at J920.
2. Align the fan with the fan-bracket. Align the fan so that air blows out the side of the chassis, not into the chassis.
3. Use the pliers to bend the two fan-bracket tabs into place and secure the fan.

Power supply

You will need a torque-limiting Torx T-15 screwdriver.

Removal. To remove the power supply module, refer to Figure 6-15 and follow these steps:

1. Remove the fan using the procedures on page 6-18.
2. Disconnect the three cable connectors at J866, J862, and J900.
3. Remove the four screws attaching the power supply module and the insulator to the rear sub-panel.

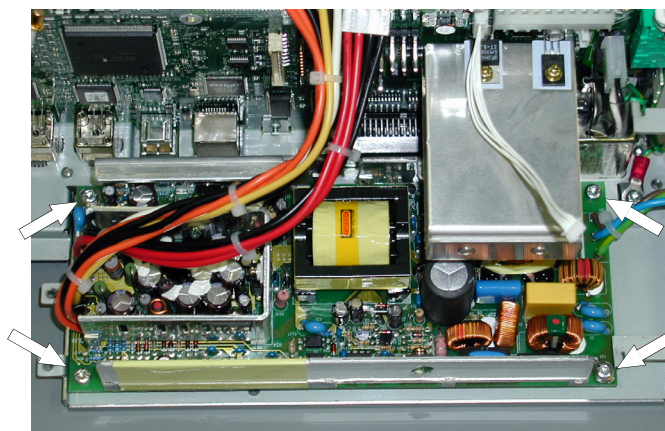

Figure 6-15: Power supply removal

installation. To install, reverse this procedure.

A70, A72 CPU board

You will need a torque-limiting Torx T-15 screwdriver, a torque wrench, a 16 mm (5/8 inch) deep socket, 7 mm socket and needle-nose pliers.

Removal. To remove the CPU board, refer to Figure 6-16 and follow these steps:

1. (AFG3101, AFG3102, AFG3251, AFG3252 only)
Use the 7 mm socket torque wrench to remove the two hex screws and the two washers attaching the GPIB connector to the rear sub-panel.
2. (AFG3101, AFG3102, AFG3251, AFG3252 only)
Remove the CH1 Add Input BNC connector:
 - a. Disconnect the peltola cable at J370 on the Generator board.
 - b. Use the 16 mm (5/8 inch) deep socket to remove the nut and the wave washer from the BNC connector.
 - c. Push the CH1 Add Input BNC connector and the insulator bushing to remove them from the rear sub-panel.
3. (AFG3022, AFG3102, AFG3252 only)
Remove the EXT Modulation CH2 Input BNC connector:
 - a. Disconnect the Peltola cable at J852 on the CPU board.
 - b. Use the 16 mm (5/8 inch) deep socket to remove the nut and the spring washer from the BNC connector.
 - c. Push the EXT Modulation CH2 Input BNC connector and the insulator bushing to remove them from the rear sub-panel.
4. Remove the nuts and wave washers of the EXT Modulation CH1 Input, the Ext Ref Input, and the Ext Ref Output connectors. These connectors are mounted on the CPU board:
 - a. Use the 16 mm (5/8 inch) deep socket to remove the nuts and the spring washers from these BNC connectors.

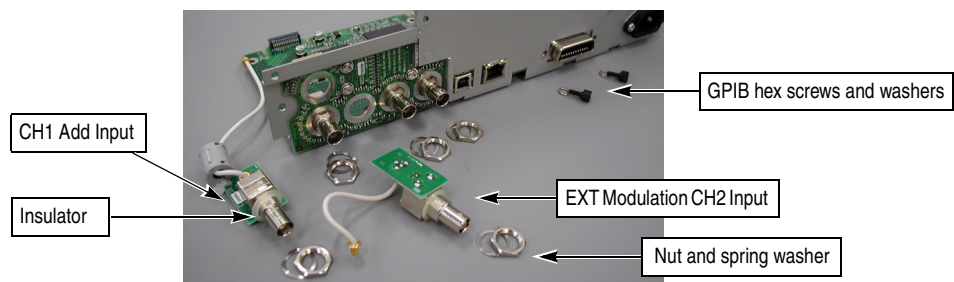

Figure 6-16: Remove the BNC connectors

5. Disconnect the AC input cable at J860 on the CPU board.
6. Disconnect the A75 Key Board cable at J300 on the CPU board.

7. Remove the three screws from the bottom side that attach the CPU board to the rear sub-panel.
8. Remove the CPU board from the rear sub-panel.

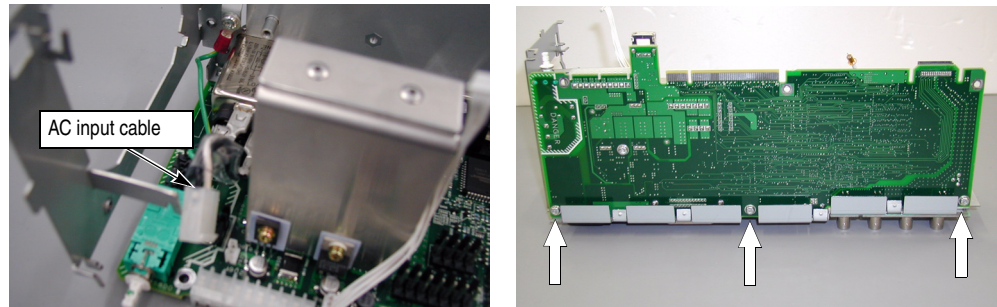

Figure 6-17: CPU board removal

Installation. To install, reverse this procedure. Remember to attach the wave washers and the insulator bushings.

NOTE. After you replace the CPU board, you must set the serial number. Refer to *Setting the Serial Number* on page 5-12.

A82 BNC Insulator board

You will need a torque-limiting Torx T-15 screwdriver, a torque wrench, and a 16 mm (5/8 inch) deep socket.

Removal. To remove the A82 BNC Insulator board, follow these steps:

1. Remove the CH1 Add Input BNC connector and the EXT Modulation CH2 Input BNC connector using the procedures on page 6-20.
2. Remove the nuts and wave washers of the EXT Modulation CH1 Input, the Ext Ref Input, and the Ext Ref Output connectors using the procedures on page 6-20.
3. Remove the three screws that attach the A82 BNC Insulator board to the rear sub-panel.
4. Remove the A82 BNC Insulator board from the rear sub-panel.

Installation. To install, reverse this procedure.

Generator board

You will need a torque-limiting Torx T-15 screwdriver.

Removal. To remove the generator board, refer to Figure 6-18 and follow these steps:

1. Remove the six screws attaching the Generator board to main chassis.
2. Remove the two screws attaching the Generator board to main chassis from the bottom side.
3. Remove the Generator board from the main chassis.

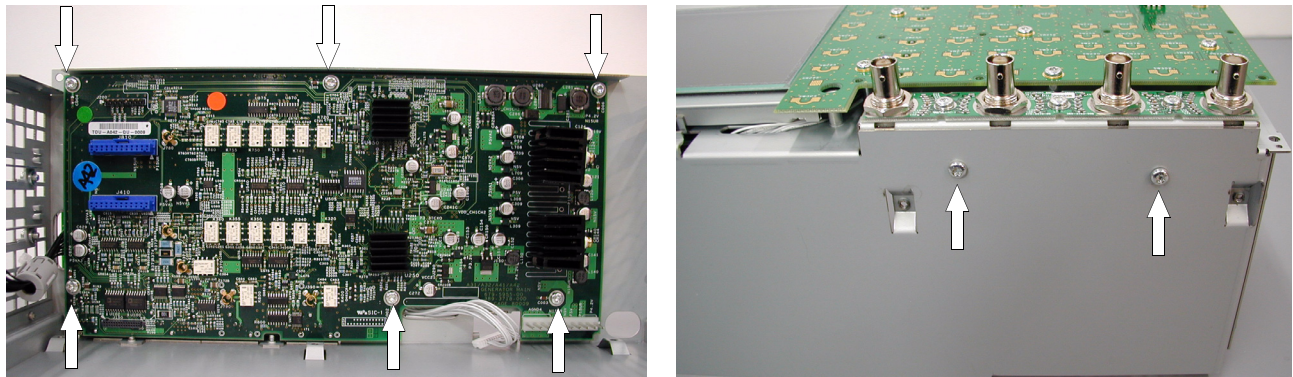

Figure 6-18: Generator board removal

Installation. To install, reverse this procedure.

A81 BNC Insulator board, BNC bracket

You will need a torque-limiting Torx T-15 screwdriver, a torque wrench, a 16 mm (5/8 inch) deep socket.

Removal. To remove the A81 BNC Insulator and BNC bracket, refer to Figure 6-19 and follow these steps:

1. Remove the Generator board using the procedures on page 6-22.
2. Use the 16 mm (5/8 inch) deep socket to remove the nuts and the wave washers from the BNC connectors (CHx Output, Trigger Input, and Trigger Output).
3. Remove the three screws that attach the A81 BNC Insulator board to the Generator board.
4. Remove the A81 BNC Insulator board and BNC bracket.

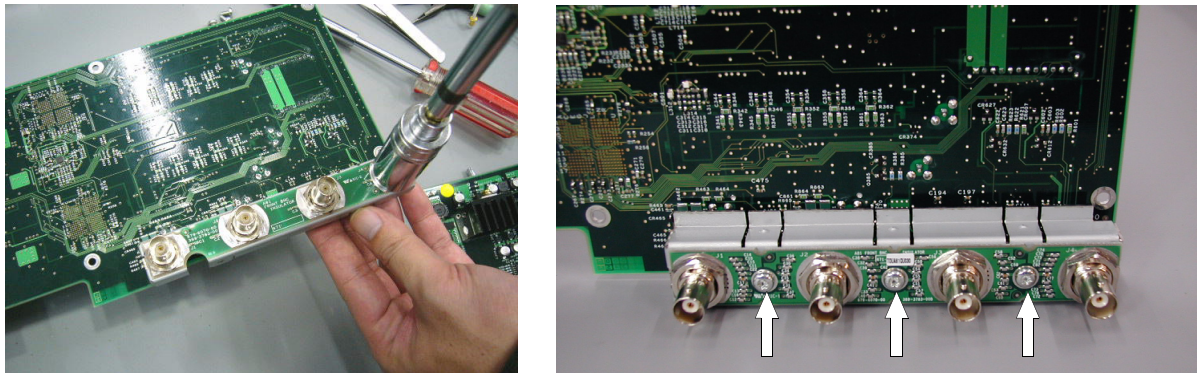

Figure 6-19: A81 BNC Insulator board and BNC bracket removal

installation. To install, reverse this procedure.

Troubleshooting

This section contains information to help you isolate faulty modules in the AFG3000 Series Arbitrary/Function Generators.

- Troubleshooting trees
- Diagnostics

Troubleshooting trees show how to find and isolate faulty modules. The Diagnostics section describes the diagnostics supplied with the arbitrary/function generator, its operation and status messages.

After troubleshooting and identifying the faulty part, follow the *Removal and Installation Procedures* section to exchange the modules.

Required tools and equipment

You may need the following tools and equipment to troubleshoot the arbitrary/function generator.

Table 6-3: Required equipment

Tools and equipment	Example
Digital Multimeter (DMM)	3.5 or greater digit DMM
Oscilloscope with probe	Tektronix TDS1000 or TDS2000 series oscilloscope

Troubleshooting tree

To isolate a problem to a specific troubleshooting procedure, use the troubleshooting trees in Figure 6-20 and Figure 6-21. Detailed procedures follow the trees.



WARNING. To prevent electrical shock, do not touch the heat sink of the power supply assembly. There are potentially dangerous voltages present on the heat sink of the power supply assembly.

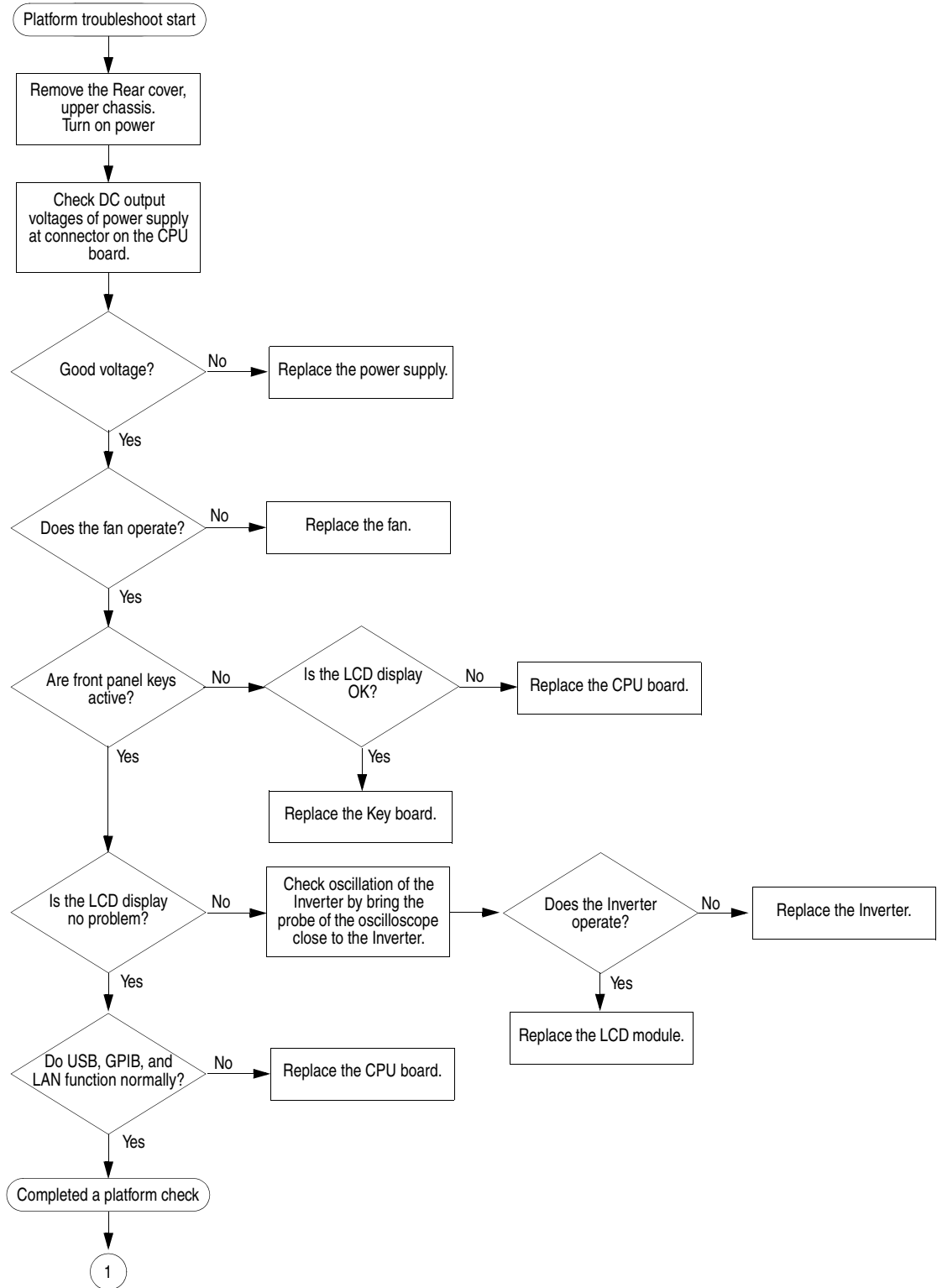

Figure 6-20: Platform troubleshooting procedure

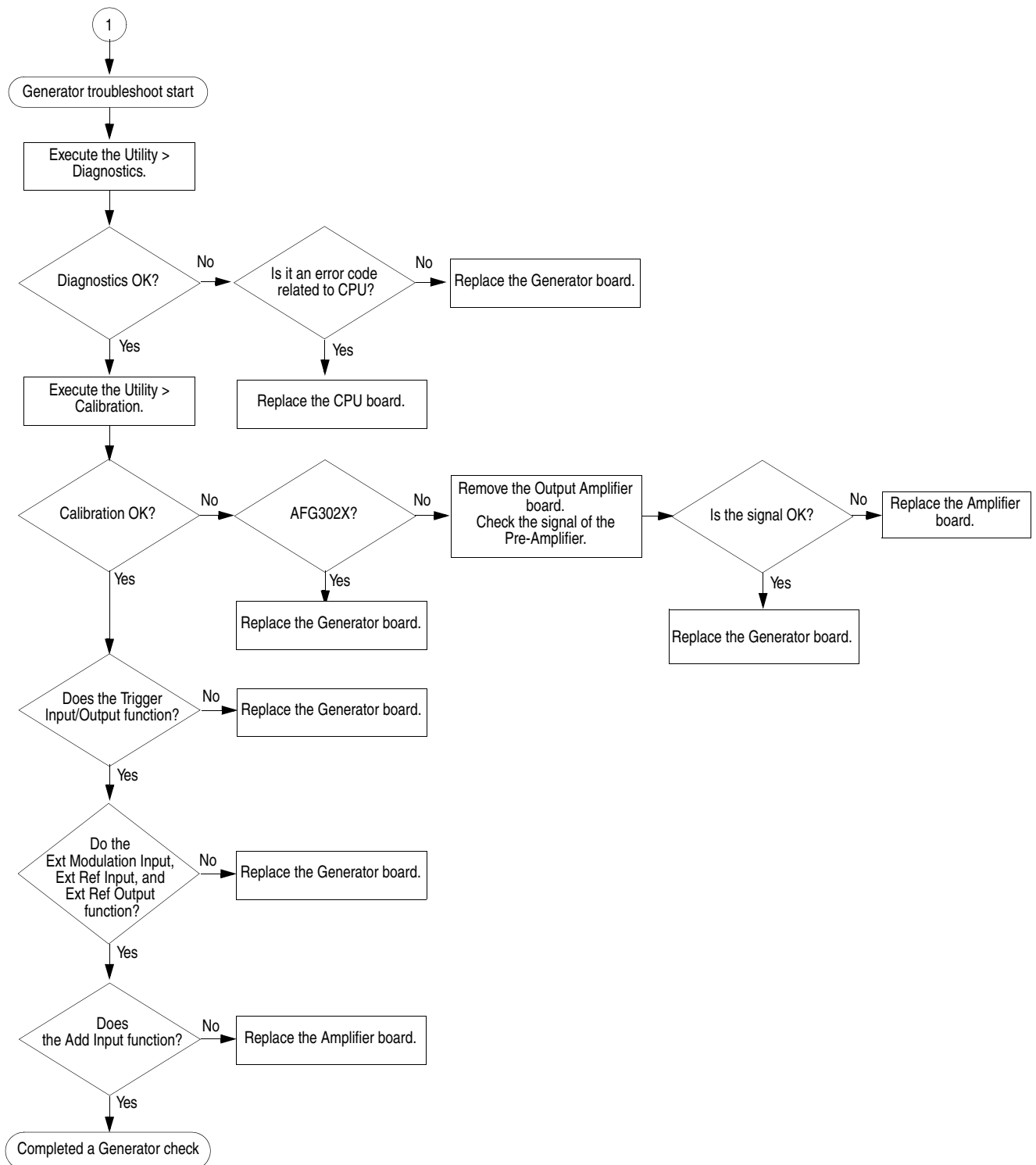

Figure 6-21: Generator troubleshooting procedure

Diagnostics

Power on diagnostic test When you power on the AFG3000 Series, it automatically executes a diagnostic test for all the diagnostics items before the Startup screen appears. When detecting an error, this test displays an error message. If you see such a message, press the **OK** button to proceed with the next step. The AFG3000 Series software starts. When the AFG3000 Series contains an unsolved error, the test cannot be conducted normally.

Diagnostic test from menu This procedure uses internal routines to verify that the instrument is operating correctly.

Equipment required	None
Prerequisites	<ul style="list-style-type: none"> ■ Power on the instrument and allow a 20 minute warm-up before doing this procedure. ■ The instrument must be operating at an ambient temperature between +0 °C and +50 °C

1. Select the Diagnostics item in the Utility menu.

Utility (front-panel) > -more- (bezel) > Diagnostics/Calibration > Execute Diagnostics

2. Wait until the test is completed.
3. Verify passing of the diagnostics.

If the diagnostics completes without finding any problems, the message “PASSED” is displayed.

When an error is detected during diagnostic execution, the instrument shows an error code. Error codes are described in *Error Codes* section on page 6-30.

4. Press any front panel button to exit from the diagnostics.

Calibration

This procedure uses internal routines to verify that the instrument is operating correctly.

Equipment required	None
Prerequisites	<ul style="list-style-type: none"> ■ Power on the instrument and allow a 20 minute warm-up before doing this procedure. ■ An ambient temperature is between +20 °C and +30 °C.

Do the following steps to run the internal routines that confirm basic functionality and proper adjustment:

1. Select the Diagnostics item in the Utility menu.

Utility (front-panel) > **-more-** (bezel) > **Diagnostics/Calibration** > **Execute Calibration**

2. Wait until the test is completed.
3. Verify passing of the calibration.

If the calibration completes without any problems, the message “PASSED” is displayed.

When an error is detected during calibration execution, the instrument displays an error code. Error codes are described in *Error Codes* on page 6-30.

4. Press any front panel button to exit from the diagnostics.

NOTE. Do not turn off the power while executing calibration. If the power is turned off while calibration, data stored in internal nonvolatile memory may be lost.

Error Codes

If Diagnostics detects a malfunction, it displays the character string “Fail” and the error code. Table 6-4 describes the Error code and related modules Category of the Diagnostics Error Code.

Table 6-4 shows the error code and related modules reporting a failure.

Table 6-4: Error codes

Error code	Description	Related module
--- Calibration ---		
1101	CH1 Internal offset calibration failure	A1x/A3x/A4x/A51/A61
1102	CH2 Internal offset calibration failure	A12/A32/A42/A51/A61
1103	CH1 Output offset calibration failure	A1x/A3x/A4x/A51/A61
1104	CH2 Output offset calibration failure	A12/A32/A42/A51/A61
1105	CH1 Output gain Calibration failure	A1x/A3x/A4x/A51/A61
1106	CH2 Output gain Calibration failure	A12/A32/A42/A51/A61
1201	CH1 x3dB attenuator calibration failure	A1x/A3x/A4x/A51/A61
1202	CH2 x3dB attenuator calibration failure	A12/A32/A42/A51/A61
1203	CH1 x6dB attenuator calibration failure	A1x/A3x/A4x/A51/A61
1204	CH2 x6dB attenuator calibration failure	A12/A32/A42/A51/A61
1205	CH1 x10dB attenuator calibration failure	A1x/A3x/A4x/A51/A61
1206	CH2 x10dB attenuator calibration failure	A12/A32/A42/A51/A61
1207	CH1 x20dB 1 attenuator calibration failure	A1x/A3x/A4x/A51/A61
1208	CH2 x20dB 1 attenuator calibration failure	A12/A32/A42/A51/A61
1209	CH1 x20dB 2 attenuator calibration failure	A1x/A3x/A4x/A51/A61
1210	CH2 x20dB 2 attenuator calibration failure	A12/A32/A42/A51/A61
1211	CH1 Filter calibration failure	A1x/A3x/A4x/A51/A61
1212	CH2 Filter calibration failure	A12/A32/A42/A51/A61
1301	CH1 Sine Flatness calibration failure	A1x/A3x/A4x/A51/A61
1302	CH2 Sine Flatness calibration failure	A12/A32/A42/A51/A61
1401	CH1 ASIC TINT calibration failure	A1x/A3x/A4x/A51/A61
1402	CH2 ASIC TINT calibration failure	A12/A32/A42/A51/A61
1403	CH1 ASIC SGEN calibration failure	A1x/A3x/A4x/A51/A61
1404	CH2 ASIC SGEN calibration failure	A12/A32/A42/A51/A61
1405	CH1 ASIC clock duty calibration failure	A1x/A3x/A4x/A51/A61
1406	CH2 ASIC clock duty calibration failure	A12/A32/A42/A51/A61

Table 6-4: Error codes (cont.)

Error code	Description	Related module
--- Diagnostics ---		
2100	Calibration data not found	A70/A72
2101	Calibration data checksum	A70/A72
2102	Calibration data invalid	A70/A72
2201	ASIC1 memory failure	A1x/A3x/A4x
2202	ASIC2 memory failure	A12/A32/A42
2203	ASIC1 Overheat	A1x/A3x/A4x
2204	ASIC2 Overheat	A12/A32/A42
--- Output Diagnostics ---		
2301	CH1 Internal offset failure	A1x/A3x/A4x
2302	CH2 Internal offset failure	A12/A32/A42
2303	CH1 Output offset failure	A1x/A3x/A4x/A51/A61
2304	CH2 Output offset failure	A12/A32/A42/A51/A61
2305	CH1 Output gain failure	A1x/A3x/A4x/A51/A61
2306	CH2 Output gain failure	A12/A32/A42/A51/A61
2401	CH1 x3dB attenuator failure	A1x/A3x/A4x
2402	CH2 x3dB attenuator failure	A12/A32/A42
2403	CH1 x6dB attenuator failure	A1x/A3x/A4x
2404	CH2 x6dB attenuator failure	A12/A32/A42
2405	CH1 x10dB attenuator failure	A1x/A3x/A4x
2406	CH2 x10dB attenuator failure	A12/A32/A42
2407	CH1 x20dB 1 attenuator failure	A1x/A3x/A4x
2408	CH2 x20dB 1 attenuator failure	A12/A32/A42
2409	CH1 x20dB 2 attenuator failure	A1x/A3x/A4x
2410	CH2 x20dB 2 attenuator failure	A12/A32/A42
2411	CH1 Filter failure	A51/A61
2412	CH2 Filter failure	A51/A61
2501	CH1 Sine Flatness failure	A1x/A3x/A4x/A51/A61
2502	CH2 Sine Flatness failure	A12/A32/A42/A51/A61



Electrical Parts List



Electrical Parts List

Refer to the *Replaceable Parts List* section for a complete listing and description of replaceable parts for the AFG3000 Series Arbitrary/Function Generators.



Diagrams

Diagrams

This section describes the electrical operation of the AFG3000 Series using the major circuit blocks or modules. Figure 8-1 and Figure 8-2 show the AFG3000 Series module interconnections. These diagrams show how the modules in the arbitrary/function generator connect together.

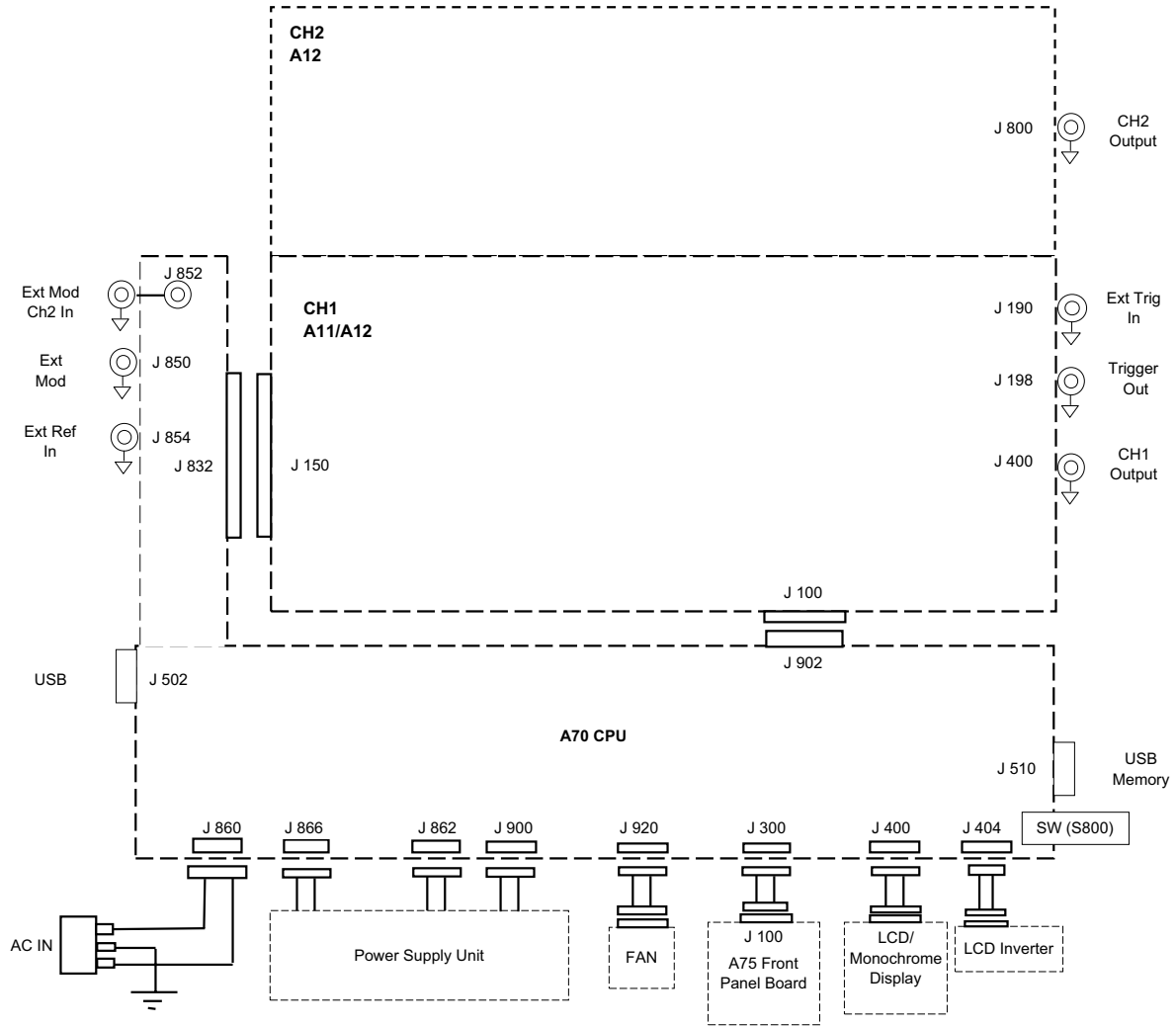

Figure 8-1: Interconnection for AFG302x

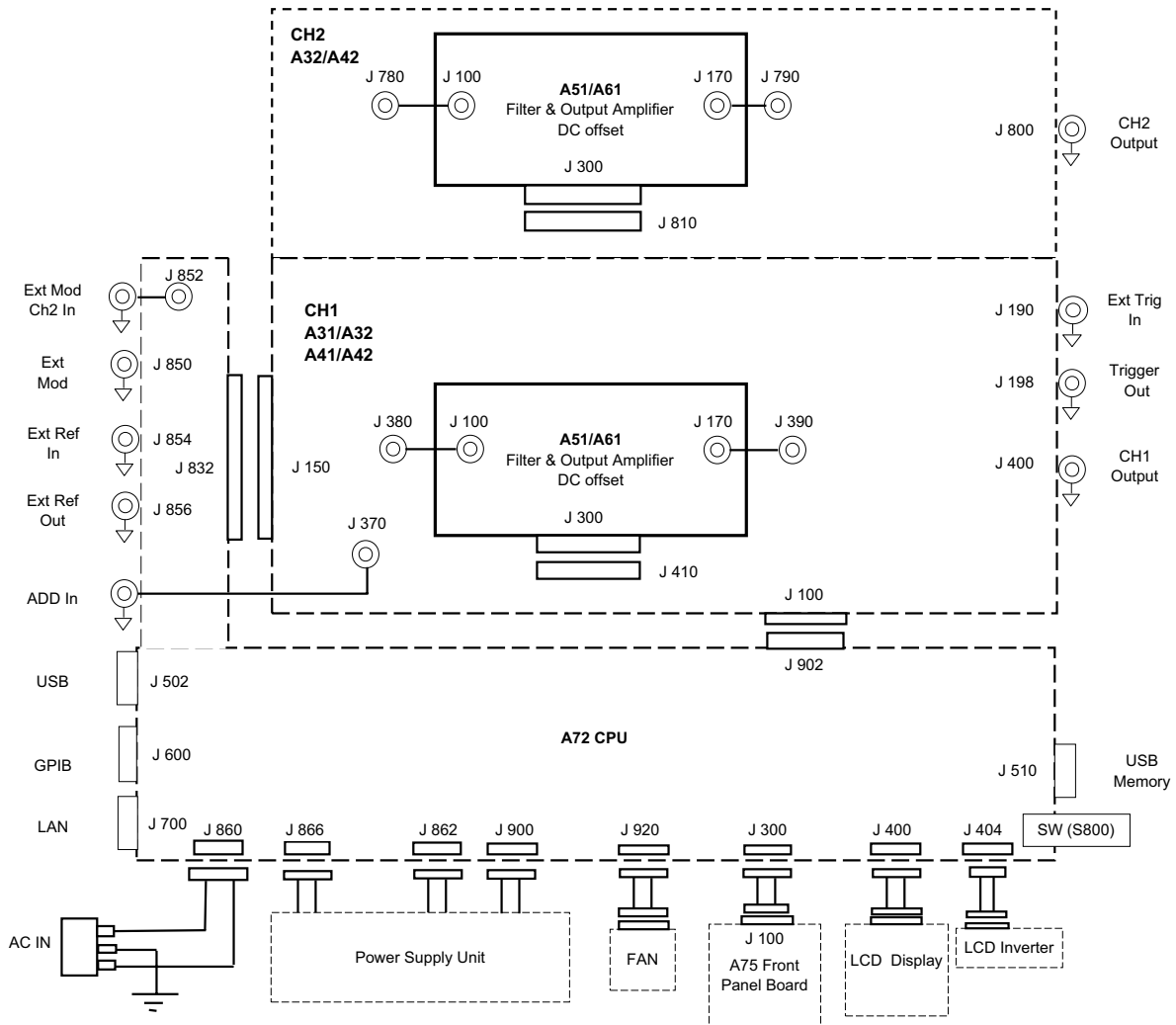

Figure 8-2: Interconnection for AFG310x and AFG325x



Replaceable Parts

Replaceable Parts

This section contains a list of the replaceable modules for the AFG3000 Series Arbitrary/Function Generators. Use this list to identify and order replacement parts.

Parts Ordering Information

Replacement parts are available through your local Tektronix field office or representative.

Changes to Tektronix instruments are sometimes made to accommodate improved components as they become available and to give you the benefit of the latest circuit improvements. Therefore, when ordering parts, it is important to include the following information in your order.

- Part number
- Instrument type or model number
- Instrument serial number
- Instrument modification number, if applicable

If you order a part that has been replaced with a different or improved part, your local Tektronix field office or representative will contact you concerning any change in part number.

Using the Replaceable Parts List

This section contains a list of the mechanical and/or electrical components that are replaceable for the arbitrary/function generator. Use this list to identify and order replacement parts. The following table describes each column in the parts list.

Parts List Column Descriptions

Column	Column name	Description
1	Figure & Index Number	Items in this section are referenced by component number.
2	Tektronix Part Number	Use this part number when ordering replacement parts from Tektronix.
3	Model number	This indicates the model that uses this item.
4 and 5	Serial Number	Column three indicates the serial number at which the part was first effective. Column four indicates the serial number at which the part was discontinued. No entries indicates the part is good for all serial numbers.
6	Qty	This indicates the quantity of parts used.
7	Name & Description	An item name is separated from the description by a colon (:). Because of space limitations, an item name may sometimes appear as incomplete. Use the U.S. Federal Catalog handbook H6-1 for further item name identification.

Abbreviations Abbreviations conform to American National Standard ANSI Y1.1-1972.

Replaceable Parts List (Refer to Figure 9-1 on page 9-6)

Fig. & index number	Tektronix part number	Model	Serial #. effective	Serial # no. dis-cont'd	Qty.	Name & description
9-1						
-01	650-4605-00	AFG3021			1	FRAME ASSEMBLY; DISPLAY,MONO
	650-4349-01	AFG3022, 3101, 3102, 3251, 3252			1	FRAME ASSEMBLY; DISPLAY,COLOR
-02	348-1845-00	AFG3021, 3022, 3101, 3102, 3251, 3252			2	GASKET,SHLD,ELEK; PU FORM,60MM L W/3M 467MP BACKSIDE; TOURBILLON,LCD CABLE
-03	131-6363-00	AFG3021, 3022, 3101, 3102, 3251, 3252			1	EMI GASKET; GROUNDING,0.320 L X 0.365 W (2 CONTACTS) X 0.110 DEEP,ELECTROLESS NICKEL PLATE
-04	441-2370-00	AFG3021, 3022, 3101, 3102, 3251, 3252			1	CHASSIS ASSY; MAIN,0.039 EG STEEL
-05	211-1198-00	AFG3021, 3022			40	SCREW,MACHINE; 6-32 X 0.250,PNH,STL,ZNPL,T-15 TORX DR
	211-1198-00	AFG3101, 3251			42	SCREW,MACHINE; 6-32 X 0.250,PNH,STL,ZNPL,T-15 TORX DR
	211-1198-00	AFG3102, 3252			44	SCREW,MACHINE; 6-32 X 0.250,PNH,STL,ZNPL,T-15 TORX DR
-06	220-0265-00	AFG3021, 3101, 3251			3	NUT,PLAIN,HEX; 0.5-28 X 0.625 HEX,BRS CD PL
	220-0265-00	AFG3022, 3102, 3252			4	NUT,PLAIN,HEX; 0.5-28 X 0.625 HEX,BRS CD PL
-07	210-1544-00	AFG3021, 3101, 3251			3	WASHER, SPRING; 0.610 OD X 0.490 ID X 0.007 THK, WAVE SHAPE, STAINLESS STEEL
	210-1544-00	AFG3022, 3102, 3252			4	WASHER, SPRING; 0.610 OD X 0.490 ID X 0.007 THK, WAVE SHAPE, STAINLESS STEEL
-08	671-6070-XX	AFG3021, 3022, 3101, 3102, 3251, 3252			1	CIRCUIT BD ASSY;A81 FRONT BNC INSULATOR,389378300 WIRED
-09	407-5043-00	AFG3021, 3022, 3101, 3102, 3251, 3252			1	BRACKET,CONN:GENERATOR BD,BNC SUPPORT,0.039 EG STEEL
-10	342-1135-00	AFG3021, 3101, 3251			3	INSULATOR,BSHG:NYLON,0.509 X 0.470 D HOLE X 0.687 OD X 0.035 T
	342-1135-00	AFG3022, 3102, 3252			4	INSULATOR,BSHG:NYLON,0.509 X 0.470 D HOLE X 0.687 OD X 0.035 T
-11	671-5973-XX	AFG3021			1	CIRCUIT BD ASSY; A11 GENERATOR MAIN,389361200 WIRED
	671-5842-XX	AFG3022			1	CIRCUIT BD ASSY; A12 GENERATOR MAIN,389361200 WIRED
	671-6052-XX	AFG3101			1	CIRCUIT BD ASSY; A31 GENERATOR MAIN 389371800 WIRED
	671-5955-XX	AFG3102			1	CIRCUIT BD ASSY; A32,GENERATOR MAIN 389371800 WIRED
	671-6083-XX	AFG3251			1	CIRCUIT BD ASSY; A41 GENERATOR MAIN 389371800 WIRED
	671-6084-XX	AFG3252			1	CIRCUIT BD ASSY; A42 GENERATOR MAIN 389371800 WIRED
-12	441-2371-00	AFG3021, 3022, 3101, 3102, 3251, 3252			1	CHASSIS,REAR; 0.039 EG STEEL
-13	202-0411-00	AFG3021, 3022			1	CASE, REAR; PC/ABS, PLASTIC BLEND, TEK BLUE, SAFETY CONTROLLED
	202-0435-00	AFG3101, 3102, 3251, 3252			1	CASE, REAR; 202041100 W/METALIZED, SAFETY CONTROLLED
-14	367-0538-00	AFG3021, 3022, 3101, 3102, 3251, 3252			1	HANDLE, CARRYING; OVERMOLDED
-15	650-4827-00	AFG3021, 3022			1	REAR CASE ASSY; 202041100 W/FEET & HANDLE
	650-4828-00	AFG3101, 3102, 3251, 3252			1	REAR CASE ASSY; 202043500 W/FEET & HANDLE
-16	335-1394-00	AFG3021, 3022, 3101, 3102, 3251, 3252			1	LABEL, MANUFACTURED; PRODUCT ID, 2- 5 IN X 1.5 IN, SAFETY CONTROLLED

Replaceable Parts List (Refer to Figure 9-1 on page 9-6)

Fig. & index number	Tektronix part number	Model	Serial #. effective	Serial # no. dis-cont'd	Qty.	Name & description
9-1-17	335-1173-00	AFG3021			1	MARKER, IDENT; LABEL, REAR PANEL, 2.05 X 9.51, 0.010 PC FILM, LEXAN, W/ADHESIVE BACK, SAFETY CONTROLLED, AFG3021
	335-1174-00	AFG3022			1	MARKER, IDENT; LABEL, REAR PANEL, 2.05 X 9.51, 0.010 PC FILM, LEXAN, W/ADHESIVE BACK, SAFETY CONTROLLED, AFG3022
	335-1283-00	AFG3101, 3251			1	MARKER, IDENT; LABEL, REAR PANEL, 2.05 X 9.51, 0.010 PC FILM, LEXAN, W/ADHESIVE BACK, SAFETY CONTROLLED, AFG3101, AFG3251
	335-1175-00	AFG3102, 3252			1	MARKER, IDENT; LABEL, REAR PANEL, 2.05 X 9.51, 0.010 PC FILM, LEXAN, W/ADHESIVE BACK, SAFETY CONTROLLED, AFG3102, AFG3252
-18	348-1791-00	AFG3021, 3022, 3101, 3102, 3251, 3252			2	FOOT; REAR,BLACK, 0.4 X 0.4 X 0.1(HEIGHT)
-19	348-1703-00	AFG3021, 3022, 3101, 3102, 3251, 3252			2	FOOT; FRONT,FLIPMPC/ABS,SILVER GRAY
-20	348-1850-00	AFG3101, 3102, 3251, 3252			1	GASKET, ELEC; CONDUCTIVE URETHANE FORM, 12.7 MM W X 3.2MM T X 125 MM L, W/ADHESIVE TAPE
-21	348-1849-00	AFG3101, 3102, 3251, 3252			2	GASKET, ELEC; CONDUCTIVE URETHANE FORM, 12.7 MM W X 3.2MM T X 138 MM L, W/ADHESIVE TAPE
-22	348-1848-00	AFG3101, 3102, 3251, 3252			2	GASKET, ELEC; CONDUCTIVE URETHANE FORM, 12.7 MM W X 3.2MM T X 325 MM L, W/ADHESIVE TAPE
-23	174-5154-00	AFG3101, 3251			1	CA ASSY,SP; PELTOLA,4.35 L,SAFETY CONTROLLED
	174-5154-00	AFG3102, 3252			2	CA ASSY,SP; PELTOLA,4.35 L,SAFETY CONTROLLED
-24	174-5153-00	AFG3101, 3251			1	CA ASSY,SP; PELTOLA,6.7 L,SAFETY CONTROLLED
	174-5153-00	AFG3102, 3252			2	CA ASSY,SP; PELTOLA,6.7 L,SAFETY CONTROLLED
-25	650-4806-01	AFG3101			1	SHIELD SUBASSEMBLY; A51
	650-4806-01	AFG3102			2	SHIELD SUBASSEMBLY; A51
	650-4807-01	AFG3251			1	SHIELD SUBASSEMBLY; A61
	650-4807-01	AFG3252			2	SHIELD SUBASSEMBLY; A61
-26	366-0840-00	AFG3021, 3022, 3101, 3102, 3251, 3252			1	PUSH BUTTON; POWER, PC/ABS, SILVER GRAY
-27	348-1839-00	AFG3101, 3102, 3251, 252			1	GASKET, EMI; 1.8 L, CLIP ON, BE CU, NICKEL PLATED
-28	211-1143-00	AFG3021, 3022, 3101, 3102, 3251, 3252			4	SCREW,PT; K35-1.57,PAN HEAD,T-15
-29	260-2791-00	AFG3021, 3022, 3101, 3102, 3251, 3252			1	ENCODER, DIGITAL; 24 CPR, 24 DETENTS, INCREMENTAL, QUADRATURE OUTPUT
-30	346-0299-00	AFG3251, 3252			1	BAND; BAND,PA
-31	276-0324-00	AFG3101, 3102			1	CORE; EM FERRITE,EMI; AFG310
-32	174-4658-00	AFG3021, 3022, 3101, 3102			1	CA ASSY,SP; DISCRETE,26 AWG,5.5 L,FEMALE,1 X 12,0.059 (1.5 MM) CTR,DUAL ENDED,FRONT PANEL,2 CHANNEL
	174-5231-00	AFG3251, 3252			1	174-4658 -00 W/COPPER TAPE
-33	671-5817-XX	AFG3021, 3022, 3101, 3102, 3251, 3252			1	CIRCUIT BD ASSY; A75 KEY BOARD,389-3586-00 WIRED
-34	260-2797-00	AFG3021, 3022, 3101, 3102, 3251, 3252			1	SWITCH,KEYPAD; ELASTOMERIC,FRONT PANEL,PUSHBUTTON
-35	348-1525-00	AFG3021, 3022, 3101, 3102, 3251, 3252			2	FOOT; FRONT,SANTOPRENE,BLACK,64 DEROMETER,TEXTURED
-36	202-0410-01	AFG3021, 3022, 3101, 3102			1	CASE, FRONT; PC/ABS, PLASTIC BLEND, SILVER GRAY, SAFETY CONTROLLED
	202-0434-01	AFG3251, 3252			1	CASE, FRONT; 202041000 WITH METALIZED, SAFETY CONTROLLED

Replaceable Parts List (Refer to Figure 9-1 on page 9-6)

Fig. & index number	Tektronix part number	Model	Serial #. effective	Serial # no. dis-cont'd	Qty.	Name & description	
9-1-37	335-1171-00	AFG3021, 3101, 3251			1	MARKER, IDENT; LABEL, FRONT PANEL, 1 CH, 5.33 X 6.24, 0.010 PC FILM, LEXAN, W/ADHESIVE BACK, SAFETY CONTROLLED, AFG3021	
	335-1172-00	AFG3022, 3102, 3252			1	MARKER, IDENT; LABEL, FRONT PANEL, 2 CH, 5.33 X 6.24, 0.010 PC FILM, LEXAN, W/ADHESIVE BACK, SAFETY CONTROLLED, AFG3022, AFG3102, AFG3252	
-38	366-0841-00	AFG3021, 3022, 3101, 3102, 3251, 3252			1	KNOB, CAP; 1.380 DIA, PC/ABS, SILVER GRAY	
-39	335-1289-01				1	MARKER, IDENT; LABEL, FRONT PANEL, 6.100 X 3.800, 0.015 POLYCARBONATE, FRENCH	
	335-1290-01				1	MARKER, IDENT; LABEL, FRONT PANEL, 6.100 X 3.800, 0.015 POLYCARBONATE, GERMAN	
	335-1291-01				1	MARKER, IDENT; LABEL, FRONT PANEL, 6.100 X 3.800, 0.015 POLYCARBONATE, JAPANESE	
	335-1292-01				1	MARKER, IDENT; LABEL, FRONT PANEL, 6.100 X 3.800, 0.015 POLYCARBONATE, SIMPLE CHINESE	
	335-1293-01				1	MARKER, IDENT; LABEL, FRONT PANEL, 6.100 X 3.800, 0.015 POLYCARBONATE, TRADITIONAL CHINESE	
	335-1294-01				1	MARKER, IDENT; LABEL, FRONT PANEL, 6.100 X 3.800, 0.015 POLYCARBONATE, KOREAN	
	335-1539-00				1	MARKER, IDENT; LABEL, FRONT PANEL, 6.100 X 3.800, 0.015 POLYCARBONATE, RUSSIAN	
	-40	335-1170-00	AFG3021			1	MARKER, IDENT; LABEL, MKD AFG3021, 0.010 PC FILM, LEXAN, W/ADHESIVE BACK, SAFETY CONTROLLED
		335-1169-00	AFG3022			1	MARKER, IDENT; LABEL, MKD AFG3022, 0.010 PC FILM, LEXAN, W/ADHESIVE BACK, SAFETY CONTROLLED
335-1280-00		AFG3101			1	MARKER, IDENT; LABEL, MKD AFG3101, 0.010 PC FILM, LEXAN, W/ADHESIVE BACK, SAFETY CONTROLLED	
335-1168-00		AFG3102			1	MARKER, IDENT; LABEL, MKD AFG3102, 0.010 PC FILM, LEXAN, W/ADHESIVE BACK, SAFETY CONTROLLED	
335-1281-00		AFG3251			1	MARKER, IDENT; LABEL, MKD AFG3251, 0.010 PC FILM, LEXAN, W/ADHESIVE BACK, SAFETY CONTROLLED	
335-1167-00		AFG3252			1	MARKER, IDENT; LABEL, MKD AFG3252, 0.010 PC FILM, LEXAN, W/ADHESIVE BACK, SAFETY CONTROLLED	
-41	174-5150-00	AFG3021			1	CA ASSY, SP; DATA, MONO, 7.0 L	
	174-4673-00	AFG3022, 3101, 3102, 3251, 3252			1	CA ASSY, SP; DATA, COLOR, 7.0 L	

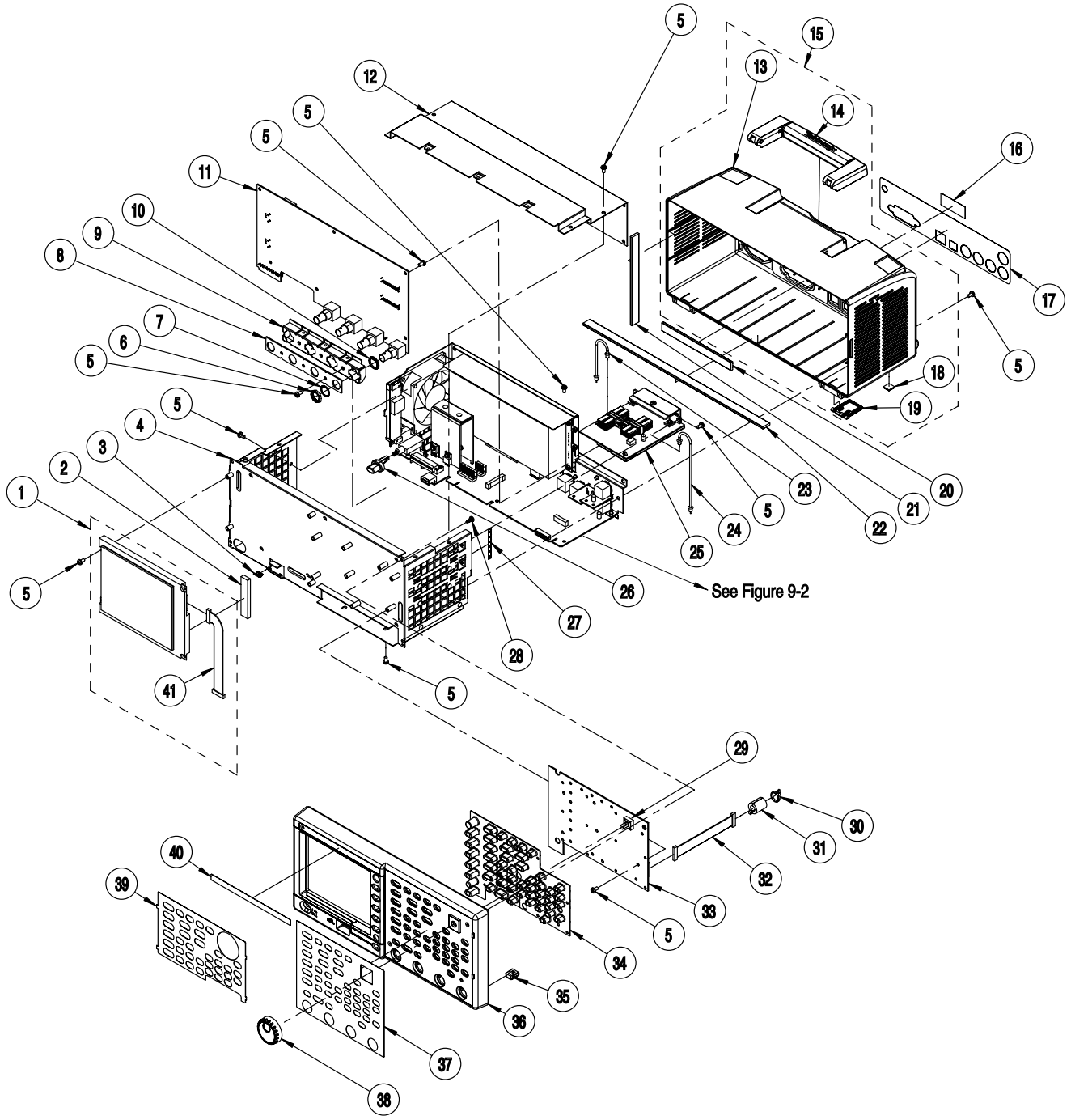

Figure 9-1: Exploded diagram

Replaceable Parts List (Refer to Figure 9-2 on page 9-9)

Fig. & index number	Tektronix part number	Model	Serial #. effective	Serial # no. dis-cont'd	Qty.	Name & description
9-2						Rear modules
-01	211-1198-00	AFG3021, 3022, 3101, 3102, 3251, 3252			13	SCREW,MACHINE; 6-32 X 0.250,PNH,STL,ZNPL,T-15 TORX DR
-02	196-3496-00	AFG3021, 3022, 3101, 3102, 3251, 3252			1	LEAD,ELECTRICAL; 18 AWG,4.0 L,5-4 SAFETY CONTROLLED
-03	210-0008-00	AFG3021, 3022, 3101, 3102, 3251, 3252			1	WASHER,LOCK; #8 INTL,0.02 THK,STL CD PL
-04	386-7416-00	AFG3021, 3022, 3101, 3102, 3251, 3252			1	SUBPANEL, REAR; 0.039 EG STEEL
-05	174-5152-00	AFG3021, 3022, 3101, 3102, 3251, 3252			1	CA ASSY,SP,ELEC;2,28 AWG,10 CM L,W/HOLDER,173977-3 & 173977-2
-06	174-B836-00	AFG3021, 3022, 3101, 3102, 3251, 3252			1	CA ASSY,SP,ELEC; 5,28AWG,W/CONN,10CM L,W87,IRREGULAR CROSS WIRING.
-07	119-6930-00	AFG3021, 3022, 3101, 3102, 3251, 3252			1	INVERTER BOARD
-08	119-7116-00	AFG3021, 3022, 3101, 3102, 3251, 3252			1	FAN,DC:TUBEAXIAL,12V,2.08W,2950RPM,39.6CFM,32.0DBA,80MM X 80MM X 25.5MM,W/O LEAD, SAFETY CONTROLLED
-09	119-7153-00	AFG3021, 3022, 3101, 3102, 3251, 3252			1	POWER SUPPLY; AC-DC; 150 W MAX IN; 87-264 VAC 47-63 HZ, 100-127 VAC 360-440 HZ IN; +4.3V @ 2.3A, +5V @ 3.2A, +15V @ 2A, -15V @ 2A OUT; SAFETY CONTROLLED
-10	342-1146-00	AFG3021, 3022, 3101, 3102, 3251, 3252			1	INSULATOR; PROTECTION COVER, POWER SUPPLY, 0.5 MM THK CLEAR POLYCARBONATE, UL94-V1, SAFETY CONTROLLED
-11	119-6009-00	AFG3021, 3022, 3101, 3102, 3251, 3252			1	FILTER,RFI; 3A,250VAC,0.5,MA,0.15OHM; SAFETY CONTROLLED
-12	174-5151-00	AFG3021, 3022, 3101, 3102, 3251, 3252			1	CA ASSY,SP,ELEC;2,18 AWG,7 CM L,W/HOLDER,09050-3031 & FASTON
-13	213-1061-00	AFG3101, 3102, 3251, 3252			2	JACKSCREW; 6-32 X 0.320 EXT THD,M3.5 X 0.6-6 INT THD X 0.215L,GPIB,BLACK OXIDE,BULK PACK
-14	210-0056-00	AFG3101, 3102, 3251, 3252			2	WASHER,LOCK; #10 SPLIT,0.047 THK,SI BRZ NP
-15	131-6363-00	AFG3021, 3022, 3101, 3102, 3251, 3252			1	EMI GASKET; GROUNDING,0.320 L X 0.365 W (2 CONTACTS) X 0.110 DEEP,ELECTROLESS NICKEL PLATE
-16	220-0265-00	AFG3021			2	NUT,PLAIN,HEX; 0.5-28 X 0.625 HEX,BRS CD PL
	220-0265-00	AFG3022			3	NUT,PLAIN,HEX; 0.5-28 X 0.625 HEX,BRS CD PL
	220-0265-00	AFG3101, 3251			4	NUT,PLAIN,HEX; 0.5-28 X 0.625 HEX,BRS CD PL
	220-0265-00	AFG3102, 3252			5	NUT,PLAIN,HEX; 0.5-28 X 0.625 HEX,BRS CD PL
-17	210-1544-00	AFG3021			2	WASHER, SPRING; 0.610 OD X 0.490 ID X 0.007 THK, WAVE SHAPE, STAINLESS STEEL
	210-1544-00	AFG3022			3	WASHER, SPRING; 0.610 OD X 0.490 ID X 0.007 THK, WAVE SHAPE, STAINLESS STEEL
	210-1544-00	AFG3101, 3251			4	WASHER, SPRING; 0.610 OD X 0.490 ID X 0.007 THK, WAVE SHAPE, STAINLESS STEEL
	210-1544-00	AFG3102, 3252			5	WASHER, SPRING; 0.610 OD X 0.490 ID X 0.007 THK, WAVE SHAPE, STAINLESS STEEL
-18	671-6071-XX	AFG3021,3022, 3101, 3102, 3251, 3252			1	CIRCUIT BD ASSY;A82 REAR BNC INSULATOR,389378400 WIRED

Replaceable Parts List (Refer to Figure 9-2 on page 9-9)

Fig. & index number	Tektronix part number	Model	Serial #. effective	Serial # no. dis-cont'd	Qty.	Name & description
9-2-19	348-1840-00	AFG3251, 3252			1	GASKET, ELEC; CONDUCTIVE URETHANE FORM STRIP, 5MM W X 0.5 MM T X 95 MM L, W/ADHESIVE TAPE
-20	348-1841-00	AFG3251, 3252			1	GASKET, ELEC; CONDUCTIVE URETHANE FORM STRIP, 5MM W X 0.5 MM T X 10 MM L, W/ADHESIVE TAPE
-21	348-1842-00	AFG3251, 3252			1	GASKET, ELEC; CONDUCTIVE URETHANE FORM STRIP, 5MM W X 0.5 MM T X 20 MM L, W/ADHESIVE TAPE
-22	342-1135-00	AFG3021			2	INSULATOR,BSHG:NYLON,0.509 X 0.470 D HOLE X 0.687 OD X 0.035 T
	342-1135-00	AFG3022			3	INSULATOR,BSHG:NYLON,0.509 X 0.470 D HOLE X 0.687 OD X 0.035 T
	342-1135-00	AFG3101, 3251			4	INSULATOR,BSHG:NYLON,0.509 X 0.470 D HOLE X 0.687 OD X 0.035 T
	342-1135-00	AFG3102, 3252			5	INSULATOR,BSHG:NYLON,0.509 X 0.470 D HOLE X 0.687 OD X 0.035 T
-23	671-6069-XX	AFG3022, 3101, 3251			1	CIRCUIT BD ASSY;A80 BNC/PELTOLA ADAPTER,389378200 WIRED
	671-6069-XX	AFG3102, 3252			2	CIRCUIT BD ASSY;A80 BNC/PELTOLA ADAPTER,389378200 WIRED
-24	174-5155-00	AFG3101, 3102, 3251, 3252			1	CA ASSY,SP; PELTOLA,5.5 L,SAFETY CONTROLLED
-25	276-0324-00	AFG3101, 3102, 3251, 3252			1	CORE; EM FERRITE,EMI;AFG310
-26	174-5156-00	AFG3022, 3102, 3252			1	CA ASSY,SP; PELTOLA,3.55 L,SAFETY CONTROLLED
-27	671-5968-XX	AFG3021, 3022			1	CIRCUIT BD ASSY; A70 CPU MAIN, 389358400 WIRED; ADDING HEATSINK ASSY
	671-5815-XX	AFG3101, 3102, 3251, 3252			1	CIRCUIT BD ASSY; A72 CPU MAIN, 389358400 WIRED; ADDING HEATSINK ASSY

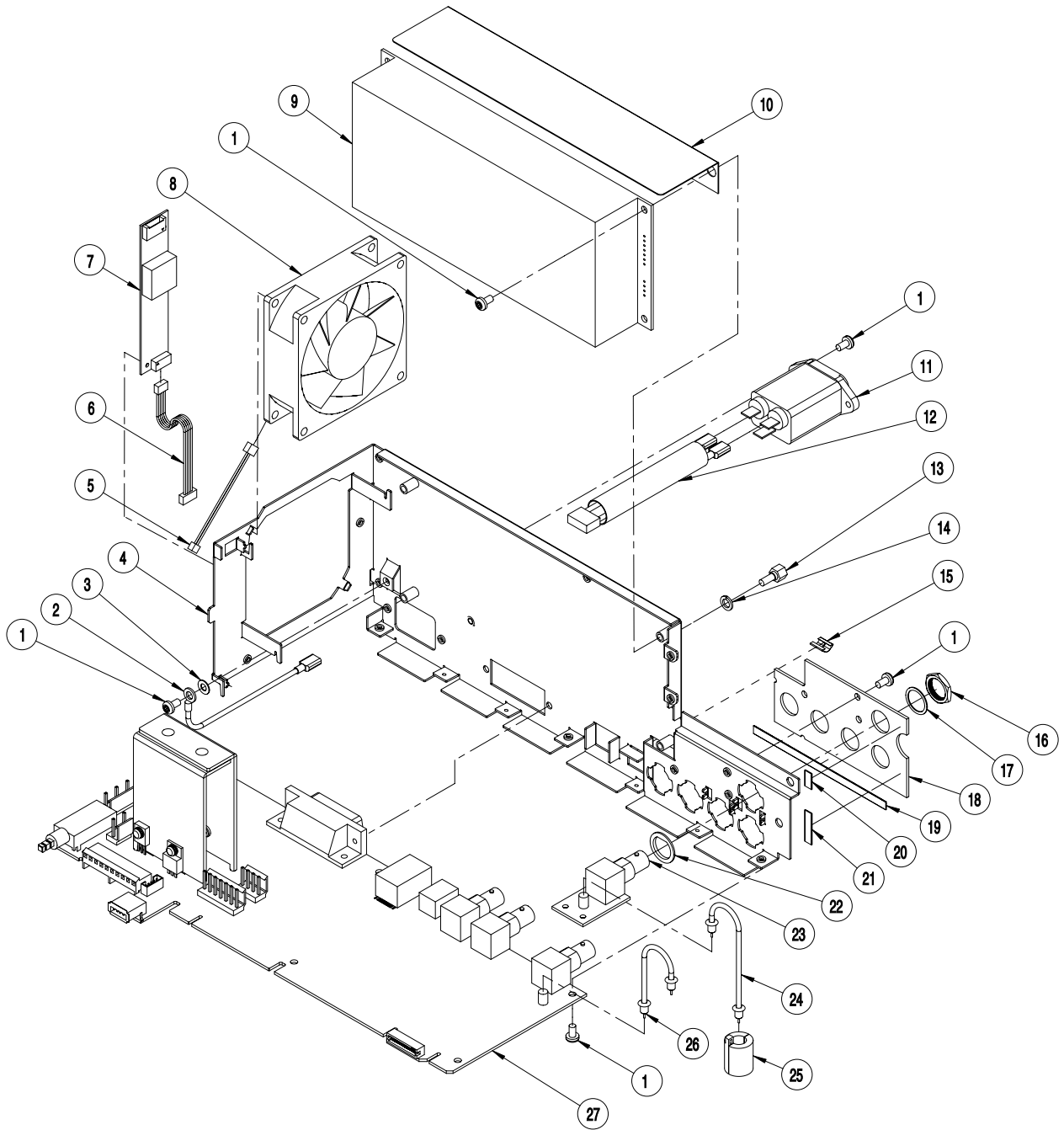

Figure 9-2: Exploded diagram, rear modules

