

User Manual

VM Series Video Measurement System

071-2103-07



User Manual



VM Series Video Measurement System

071-2103-07

This document applies to Option SD/HD software version 3.X and above.

This document applies to Option VGA software version 3.X and above.

www.tektronix.com

Copyright © Tektronix. All rights reserved. Licensed software products are owned by Tektronix or its suppliers and are protected by United States copyright laws and international treaty provisions.

Tektronix products are covered by U.S. and foreign patents, issued and pending. Information in this publication supercedes that in all previously published material. Specifications and price change privileges reserved.

TEKTRONIX and TEK are registered trademarks of Tektronix, Inc.

Contacting Tektronix

Tektronix, Inc.
14200 SW Karl Braun Drive
P.O. Box 500
Beaverton, OR 97077
USA

For product information, sales, service, and technical support:

- In North America, call 1-800-833-9200.
- Worldwide, visit www.tektronix.com to find contacts in your area.

Warranty 2

Tektronix warrants that this product will be free from defects in materials and workmanship for a period of one (1) year from the date of shipment. If any such product proves defective during this warranty period, Tektronix, at its option, either will repair the defective product without charge for parts and labor, or will provide a replacement in exchange for the defective product. Parts, modules and replacement products used by Tektronix for warranty work may be new or reconditioned to like new performance. All replaced parts, modules and products become the property of Tektronix.

In order to obtain service under this warranty, Customer must notify Tektronix of the defect before the expiration of the warranty period and make suitable arrangements for the performance of service. Customer shall be responsible for packaging and shipping the defective product to the service center designated by Tektronix, with shipping charges prepaid. Tektronix shall pay for the return of the product to Customer if the shipment is to a location within the country in which the Tektronix service center is located. Customer shall be responsible for paying all shipping charges, duties, taxes, and any other charges for products returned to any other locations.

This warranty shall not apply to any defect, failure or damage caused by improper use or improper or inadequate maintenance and care. Tektronix shall not be obligated to furnish service under this warranty a) to repair damage resulting from attempts by personnel other than Tektronix representatives to install, repair or service the product; b) to repair damage resulting from improper use or connection to incompatible equipment; c) to repair any damage or malfunction caused by the use of non-Tektronix supplies; or d) to service a product that has been modified or integrated with other products when the effect of such modification or integration increases the time or difficulty of servicing the product.

THIS WARRANTY IS GIVEN BY TEKTRONIX WITH RESPECT TO THE PRODUCT IN LIEU OF ANY OTHER WARRANTIES, EXPRESS OR IMPLIED. TEKTRONIX AND ITS VENDORS DISCLAIM ANY IMPLIED WARRANTIES OF MERCHANTABILITY OR FITNESS FOR A PARTICULAR PURPOSE. TEKTRONIX' RESPONSIBILITY TO REPAIR OR REPLACE DEFECTIVE PRODUCTS IS THE SOLE AND EXCLUSIVE REMEDY PROVIDED TO THE CUSTOMER FOR BREACH OF THIS WARRANTY. TEKTRONIX AND ITS VENDORS WILL NOT BE LIABLE FOR ANY INDIRECT, SPECIAL, INCIDENTAL, OR CONSEQUENTIAL DAMAGES IRRESPECTIVE OF WHETHER TEKTRONIX OR THE VENDOR HAS ADVANCE NOTICE OF THE POSSIBILITY OF SUCH DAMAGES.

Table of Contents

Preface	xiii
About This Manual	xiii
Related Manuals and Online Documents	xiv
General Safety Summary	xv
Environmental Considerations	xvii

Getting Started

Product Description	1-1
Key Features	1-1
Compatibility of the VM Series Option HD with the VM5000HD	1-3
Firmware Upgrade	1-3
Recommended Oscilloscope Probes	1-3
Installation	1-5
Unpacking	1-5
Checking the Environment Requirements	1-6
Powering On the Instrument	1-7
Shutting Down the Instrument	1-7
Connecting to a Network	1-8
Adjusting Display Contrast	1-9
Getting Acquainted with your Instrument	1-10
Backing Up User Files	1-12
Installing Software	1-13
Incoming Inspection	1-15
Self Tests	1-15
Functional Test	1-16
Options and Accessories	1-23
Options	1-23
Accessories	1-24

Operating Basics

Operating Basics	2-1
Input Signal Connection Requirements	2-1
Connecting Input Signals	2-3
Signal Path Compensation	2-17
Sync Pickoff Compensation - VM6000 and DPO7000 Series, Option SD/HD only	2-18
The Matrix Test Signal	2-21
Starting the Application	2-25
The VM Series Application User Interface	2-27
Measurement Steps Overview	2-28
Setting the Input Signal Format	2-29
Selecting the Measurements	2-33
Setting the Measurement Run Operations	2-34
Setting the Measurement Warnings	2-39
Setting Reference and Limits Options	2-41

Displaying the Input Signal as a Picture	2-43
Changing Picture Display Settings	2-44
Displaying the Input Signal in a Vectorscope Window for Option SD/HD	2-46
Taking and Viewing the Measurement Results	2-48
Taking Measurements Across Multiple Lines	2-51
Changing Line Number or Averaging on the Results Screen	2-52
Saving Measurement Setups	2-54
Recalling Measurement Settings	2-56
Saving Measurement Results (Reports)	2-58

Reference

Reference Overview	3-1
Menu Descriptions	3-3
File Menu	3-3
Configuration Menu	3-5
Results Menu	3-19
Utilities Menu	3-32
Help Menu	3-33
Option SD/HD Detailed Measurement Information	3-35
Matrix Signals and Line Numbers	3-35
Averaging	3-35
Channel Delay	3-36
Color Bars	3-37
Frequency Response	3-38
H Sync	3-41
H Sync Jitter	3-42
Levels	3-43
Multiburst	3-44
Noise	3-45
Non Linearity	3-46
Short Time Distortion	3-46
Spatial Distortion	3-48
V Sync	3-54
Option VGA Detailed Measurement Information	3-57
Matrix Signals and Line Numbers	3-57
Averaging	3-57
Ch-Ch Mismatch Measurement	3-58
Ch-Ch Skew Measurement	3-59
Color Bars Measurement	3-60
H Sync Measurement	3-61
H Sync Jitter Measurement	3-64
H Timing Measurement	3-65
Linearity Measurement	3-66
Luma Levels Measurement	3-68
Noise Inj Ratio Measurement	3-69
V Sync Measurement	3-71
V Timing Measurement	3-74
Video Transient Measurement	3-75

Setting Up Measurements	3-77
Taking Measurements	3-77
Taking Measurements Relative to a Reference	3-78
Creating a Custom Reference File	3-80
Taking Measurements with Limit Testing	3-82
Customizing a Limits File	3-84
Setting Up the Channel Delay Measurement	3-85
Setting Up the Color Bars Measurement	3-86
Setting Up the Frequency Response Measurement	3-88
Setting Up the H Sync Measurement	3-91
Setting Up the H Sync Jitter Measurement	3-93
Setting Up the Levels Measurement	3-96
Setting Up the Multiburst Measurement	3-98
Setting Up the Noise Measurement	3-99
Setting Up the Noise Spectrum Measurement	3-102
Setting Up the Non Linearity Measurement	3-104
Setting Up the Short Time Distortion Measurement	3-105
Setting Up the Spatial Distortion Measurement	3-106
Setting Up the V Sync Measurement	3-108
Configuring the Device Under Test for Option VGA	3-108
Setting Up the Ch-Ch Mismatch Measurement	3-111
Setting Up the Ch-Ch Skew Measurement	3-112
Setting Up the Color Bars Measurement	3-114
Setting Up the H Sync Measurement	3-115
Setting Up the H Sync Jitter Measurement	3-116
Setting Up the H Timing Measurement	3-117
Setting Up the Linearity Measurement	3-118
Setting Up the Luma Levels Measurement	3-119
Setting Up the Noise Inj Ratio Measurement	3-120
Setting Up the V Sync Measurement	3-121
Setting Up the V Timing Measurement	3-122
Setting Up the Video Transient Measurement	3-123
Viewing Measurement Results	3-125
Displaying the Results Summary	3-125
Displaying Channel Delay Measurement Results	3-127
Displaying Color Bars Measurement Results	3-128
Displaying Frequency Response Measurement Results	3-130
Displaying H Sync Measurement Results	3-131
Displaying H Sync Jitter Measurement Results	3-133
Displaying Levels Measurement Results	3-134
Displaying Multiburst Measurement Results	3-135
Displaying Noise Measurement Results	3-136
Displaying Non Linearity Measurement Results	3-138
Displaying Short Time Distortion Measurement Results	3-140
Displaying Spatial Distortion Measurement Results	3-141
Displaying V Sync Measurement Results	3-142
Displaying Ch-Ch Mismatch Measurement Results	3-146
Displaying Ch-Ch Skew Measurement Results	3-147
Displaying Color Bars Measurement Results	3-148
Displaying H Sync Measurement Results	3-150
Displaying H Sync Jitter Measurement Results	3-151
Displaying H Timing Measurement Results	3-153

Displaying Linearity Measurement Results	3-154
Displaying Luma Levels Measurement Results	3-155
Displaying Noise Inj Ratio Measurement Results	3-157
Displaying V Sync Measurement Results	3-158
Displaying V Timing Measurement Results	3-159
Displaying Video Transient Measurement Results	3-161
Displaying Pass/Fail Results	3-163

Appendices

Appendix A: Specifications	A-1
Option SD/HD	A-2
Option VGA	A-11
EMC Compliance Information	A-17
Appendix B: Performance Verification	B-1
Option SD/HD Performance Verification	B-1
Prerequisites	B-1
Required Equipment	B-2
Option SD/HD Procedure	B-2
RGBHV Measurement Interface Unit (012-1685-XX)	
Performance Verification	B-5
Prerequisites	B-5
Required Equipment	B-6
Test A: Initial Connection and Setup	B-8
Test B: RGB LF Mode DC Termination Accuracy	B-9
Test C: RGB LF Mode and HV LF Mode DC Gain	B-10
Test D: HV Input LF Mode DC Termination Accuracy and WB Mode DC Input Impedance	B-14
Test E: HV Input LF Mode Current Sources	B-15
Test F: RGB WB Mode Bandwidth	B-16
Test G: H/V Inputs WB Mode Bandwidth	B-20
Appendix C: Cleaning	C-1
Exterior Cleaning	C-1
Flat Panel Display Cleaning	C-1
Appendix D: Rebuilding the Hard Drive	D-1
Appendix E: Signal Sources Package Contents	E-1
Signal Source Discs for Option SD/HD	E-1
Baseband Test Signals CD	E-2
ATSC Transport Stream CD	E-4
Advanced TV Elementary Streams CD	
Standard Definition TV Elementary Streams CD	E-5
480 and 576 Line DVDs	E-7
H.264 SD & HD Streams CDs	E-8
Signal Source Disc for Option VGA	E-10

Index

List of Figures

Figure 1-1: Instrument space requirements	1-6
Figure 1-2: On/Standby switch location	1-7
Figure 1-3: Powering off the instrument	1-8
Figure 1-4: Connecting to a network	1-8
Figure 1-5: Front panel of the instrument	1-10
Figure 1-6: Side and rear panels of the instrument	1-11
Figure 1-7: Displaying measurement values in color bars measurement	1-18
Figure 1-8: Format panel	1-20
Figure 1-9: Results Summary display	1-20
Figure 1-10: Color Bars measurement results display	1-21
Figure 1-11: H Sync measurement results display	1-21
Figure 1-12: V Sync measurement results display	1-21
Figure 1-13: Video Transient measurement results display	1-22
Figure 2-1: Connecting the T-connector to the VM Series System	2-1
Figure 2-2: RGBHV Measurement Interface Unit	2-2
Figure 2-3: VGA connector to 5X cable	2-2
Figure 2-4: Connecting to a VM6000 / DPO7000 Series instrument	2-4
Figure 2-5: Connecting to a VM5000 / TDS5000 Series instrument	2-4
Figure 2-6: Connecting to a VM6000 / DPO7000 Series instrument	2-5
Figure 2-7: Connecting to a VM5000 / TDS5000 Series instrument	2-6
Figure 2-8: Connecting the 012-1680-00 Sync Pickoff to CH1 input	2-6
Figure 2-9: Connecting to a VM6000 / DPO7000 Series instrument	2-7
Figure 2-10: Connecting to a VM5000 / TDS5000 Series instrument	2-7
Figure 2-11: Connecting to a VM6000 / DPO7000 Series instrument	2-8
Figure 2-12: Connecting to a VM5000 / TDS5000 Series instrument	2-8

Figure 2-13: Connecting to a VM6000 / DPO7000 Series instrument	2-9
Figure 2-14: Connecting to a VM5000 / TDS5000 Series instrument	2-10
Figure 2-15: Connecting the DUT to the RGBHV Measurement Interface Unit	2-11
Figure 2-16: Connecting the RGBHV MIU to a VM6000 / DPO7000 Series instrument	2-11
Figure 2-17: Connecting the RGBHV MIU to a VM5000 / TDS5000 Series instrument	2-12
Figure 2-18: Connecting the RS-232C cable between the MIU and the VM Series System	2-12
Figure 2-19: Selecting the Use MIU option on the Configuration > Operations tab	2-13
Figure 2-20: Connecting the VGA to 5X cable to the input channel	2-14
Figure 2-21: Building the 2.21 kilohms and 301 ohms terminations	2-15
Figure 2-22: Connecting the PC video output signals to the VM6000 / DPO7000 Series instrument	2-16
Figure 2-23: Connecting the PC video output signals to the VM5000 / TDS5000 Series instrument	2-16
Figure 2-24: Appearance of the pop-up warning when making H Sync measurement	2-17
Figure 2-25: Connecting the Sync Pickoff cable to CH1 and CH4	2-18
Figure 2-26: Attaching the Sync Pickoff to a BNC-to-minigrabbers adapter and connecting to PROBE COMP	2-18
Figure 2-27: Selecting AUTOSET	2-19
Figure 2-28: Properly compensated	2-19
Figure 2-29: Under compensated	2-19
Figure 2-30: Over compensated	2-20
Figure 2-31: Adjusting the compensation	2-20
Figure 2-32: Option SD/HD Matrix signal	2-21
Figure 2-33: Option VGA Matrix test signal	2-23
Figure 3-1: Signal processing overview	3-43
Figure 3-2: Block diagram for measuring video spatial distortion both in horizontal and vertical dimensions	3-49

Figure 3-3: Block diagram for one dimensional refined alignment measurement	3-50
Figure 3-4: Signal definitions (H Sync)	3-61
Figure 3-5: Jitter in H Sync period	3-64
Figure 3-6: Frequency response with 500 MHz filter for Noise In Ratio measurement	3-69
Figure 3-7: Voltage ripple and noise	3-70
Figure 3-8: Signal definitions (V Sync)	3-71
Figure 3-9: Signal definitions (Video transient)	3-75
Figure 3-10: Results of the Color Bars measurement	3-78
Figure 3-11: Enabling relative to reference results	3-79
Figure 3-12: Relative to reference results displayed (Option SD/HD)	3-80
Figure 3-13: Relative to reference results displayed (Option VGA)	3-80
Figure 3-14: Editing a reference file	3-81
Figure 3-15: Enabling limit testing	3-83
Figure 3-16: Results when limit testing is available	3-83
Figure 3-17: Customizing a limits file	3-84
Figure 3-18: Changing the filter type	3-100
Figure 3-19: Changing the noise filter bandwidth frequency	3-101
Figure 3-20: Changing the cursor frequency	3-103
Figure 3-21: Changing the channel	3-103
Figure 3-22: Illustration of the BMP test signal in full screen mode	3-110
Figure 3-23: Illustration of the BMP image set as wallpaper	3-110
Figure 3-24: Displaying the results summary (Option SD/HD)	3-125
Figure 3-25: Displaying the results summary (Option VGA)	3-125
Figure 3-26: Displaying the Channel Delay measurement	3-127
Figure 3-27: Displaying limit values for the Channel Delay measurement	3-128
Figure 3-28: Displaying the Color Bars measurement	3-128
Figure 3-29: Displaying limit values for the Color Bars measurement	3-129
Figure 3-30: Displaying the Frequency Response measurement ...	3-130
Figure 3-31: Displaying limit values for the Frequency Response measurement	3-131
Figure 3-32: Displaying additional units for the Frequency Response measurement	3-131

Figure 3-33: Displaying the H Sync measurement	3-132
Figure 3-34: Displaying limit values for the H Sync measurement	3-132
Figure 3-35: Displaying the H Sync Jitter measurement	3-133
Figure 3-36: Displaying limit values for the H Sync Jitter measurement	3-134
Figure 3-37: Displaying the Levels measurement	3-134
Figure 3-38: Displaying limit values for the Levels measurement	3-135
Figure 3-39: Displaying the Multiburst measurement	3-135
Figure 3-40: Displaying limit values for the Multiburst measurement	3-136
Figure 3-41: Displaying the Noise measurement	3-137
Figure 3-42: Displaying limit values for the Noise measurement	3-137
Figure 3-43: Displaying the Noise Spectrum measurement	3-138
Figure 3-44: Displaying the Noise Spectrum on the VM Series video monitor	3-138
Figure 3-45: Displaying the Non Linearity measurement	3-139
Figure 3-46: Displaying limit values for the Non Linearity measurement	3-139
Figure 3-47: Displaying the Short Time Distortion measurement	3-140
Figure 3-48: Displaying limit values for the Short Time Distortion measurement	3-141
Figure 3-49: Displaying the Spatial Distortion measurement	3-141
Figure 3-50: Displaying limit values for the Spatial Distortion measurement	3-142
Figure 3-51: Displaying the V Sync measurement for SD Interlaced format	3-142
Figure 3-52: Displaying the V Sync measurement for SD Progressive format	3-143
Figure 3-53: Displaying the V Sync measurement for SD Interlaced format	3-143
Figure 3-54: Displaying the V Sync measurement for HD Progressive format	3-143
Figure 3-55: Displaying limit values for the V Sync measurement for SD Interlaced format	3-144
Figure 3-56: Displaying limit values for the V Sync measurement for SD Progressive format	3-144

Figure 3-57: Displaying limit values for the V Sync measurement for HD Interlaced format	3-145
Figure 3-58: Displaying limit values for the V Sync measurement for HD Progressive format	3-145
Figure 3-59: Ch-Ch Mismatch measurement results	3-146
Figure 3-60: Limit values for the Ch-Ch Mismatch measurement	3-147
Figure 3-61: Ch-Ch Skew measurement results	3-147
Figure 3-62: Limit values for the Ch-Ch Skew measurement	3-148
Figure 3-63: Color Bars measurement results	3-148
Figure 3-64: Limit values for the Color Bars measurement	3-149
Figure 3-65: H Sync measurement results	3-150
Figure 3-66: Limit values for the H Sync measurement	3-151
Figure 3-67: H Sync Jitter measurement results	3-151
Figure 3-68: Limit values for the H Sync Jitter measurement	3-152
Figure 3-69: H Timing measurement results	3-153
Figure 3-70: Limit values for the H Timing measurement	3-154
Figure 3-71: Linearity measurement results	3-154
Figure 3-72: Limit values for the Linearity measurement	3-155
Figure 3-73: Luma Levels measurement results	3-155
Figure 3-74: Limit values for the Luma Levels measurement	3-156
Figure 3-75: Noise Inj Ratio measurement results with MIU	3-157
Figure 3-76: Limit values for the Noise Inj Ratio measurement ...	3-158
Figure 3-77: V Sync measurement results	3-158
Figure 3-78: Limit values for the V Sync measurement	3-159
Figure 3-79: V Timing measurement results	3-159
Figure 3-80: Limit values for the V Timing measurement	3-160
Figure 3-81: Video Transient measurement results	3-161
Figure 3-82: Limit values for the Video Transient measurement	3-162
Figure 3-83: Displaying Pass/Fail results in results summary for Option SD/HD	3-163
Figure 3-84: Displaying Pass/Fail results in results summary for Option VGA	3-163
Figure 3-85: Displaying Pass/Fail results (Option SD/HD)	3-164
Figure 3-86: Displaying Pass/Fail results (Option VGA)	3-164

Figure A-1: Graph of VM6000 Opt VGA Noise Floor	A-18
Figure B-1: Noise floor accuracy test hookup	B-3
Figure E-1: Using TG700 baseband test signals	E-4
Figure E-2: Using ATSC transport stream signals	E-5
Figure E-3: Using elementary stream signals	E-6
Figure E-4: Using DVD signals	E-7

List of Tables

Table 1-1: Recommended Probes	1-3
Table 1-2: Instrument options	1-23
Table 1-3: Standard Accessories	1-24
Table 1-4: Recommended Accessories	1-26
Table 1-5: Optional Accessories	1-27
Table 2-1: Required connections of the VGA signal, VM Series System, and the terminator	2-17
Table 2-2: Option SD/HD Matrix signal elements	2-22
Table 2-3: Elements of Option VGA Matrix Signal	2-23
Table 2-4: Resolutions and line number ranges supported at 60 Hz (DMT standard) for Option VGA	2-24
Table 3-1: Overview of menu descriptions	3-1
Table 3-2: Scanning systems for SD in accordance with the EIA-770.2-A standard	3-54
Table 3-3: Scanning systems for HD in accordance with the EIA-770.3-A standard High Definition TV analog Component Video Interface	3-55
Table 3-4: Elements of the reference file	3-81
Table 3-5: Matching measurements to the appropriate Full Field test pattern	3-109
Table 3-6: Status Box Indicators in Results Summary pane	3-126
Table 3-7: Warning Box Indicators in Results Summary pane	3-126

Table A-1: Video measurement specifications	A-2
Table A-2: Sync Pick-Off Accessory (012-1680-01) Specifications	A-9
Table A-3: Option VGA Video Measurement Specifications	A-11
Table A-4: RGBHV Measurement Interface Unit (MIU) Specifications	A-16
Table B-1: Required test equipment for Option SD/HD performance verification	B-2
Table B-2: The Noise (dB) Measured values when filter bandwidth is 30 MHz	B-4
Table B-3: The Noise (dB) Measured values when filter bandwidth is 60 MHz	B-5
Table B-4: Equipment required for performance verification	B-6
Table B-5: RGB WB mode bandwidth worksheet	B-17
Table B-8: Sample Table 4 worksheet	B-20
Table E-1: Signal Sources discs appropriate for Option SD/HD	E-1
Table E-2: Test Signal Files - File and Signal Formats	E-2
Table E-3: TG700 DNL analog signal format files	E-2
Table E-4: TG700 DNL digital signal format files	E-3
Table E-5: Available MXT100 .trp signal setup files	E-4
Table E-6: Advanced TV Elementary Streams	E-5
Table E-7: Advanced TV Bitmaps	E-5
Table E-8: Standard Definition TV Elementary Streams	E-6
Table E-9: Standard Definition TV Bitmaps	E-6
Table E-10: Available formats of DVD files	E-7
Table E-11: H.264 Elementary Streams	E-8
Table E-12: H.264 Transport Streams	E-9

Preface

This is the user manual for the VM Series Video Measurement System. This manual focuses on the automatic video measurement functionality; it does not cover the oscilloscope functionality. Refer to *Related Manuals and Online Documents* to locate information about using the oscilloscope functionality.

About This Manual

This manual is composed of the following chapters:

- *Getting Started* shows you how to configure and install your instrument and provides a functional check procedure.
- *Operating Basics*, using a highly-graphical approach, walks you through the basics of using the instrument user interface.
- *Reference* goes into more detail on the menu functions, understanding the measurements, and interpreting your results.
- *Appendices* provides additional information including instrument specifications, performance verification, cleaning information, and signal source descriptions.

Related Manuals and Online Documents

This manual is part of a document set of manuals and online documentation. See the following list for other documents supporting operation and service:

Manual name	Description
<i>VM Series Quick Start User Manual</i> (printed, and also available on the software CD as a PDF file)	The VM Series Quick Start User Manual provides information about installation and basic operating concepts to enable you to start using VM Series as quickly as possible.
<i>VM Series Video Measurement System Online Help</i>	An integrated online help system, which can be accessed from the VM Series help menu (located in the middle of the screen when the VM Series application is open).
<i>VM Series Programmer Manual</i> (only in PDF format)	Documentation for GPIB commands, with syntax and description, and commands that are specific to the VM Series.
<i>DPO7000 Series Quick Start User Manual</i>	The Quick Start User Manual provides information about installation and basic operating concepts to enable you to easily use the basic oscilloscope functionality.
<i>DPO7000 Series Digital Phosphor Oscilloscopes Service Manual</i>	A description of how to service the instrument to the module level. This optional manual must be ordered separately.

General Safety Summary

Review the following safety precautions to avoid injury and prevent damage to this product or any products connected to it. To avoid potential hazards, use this product only as specified.

Only qualified personnel should perform service procedures.

While using this product, you may need to access other parts of the system. Read the *General Safety Summary* in other system manuals for warnings and cautions related to operating the system.

To Avoid Fire or Personal Injury

Use Proper Power Cord. Use only the power cord specified for this product and certified for the country of use.

Connect and Disconnect Properly. Do not connect or disconnect probes or test leads while they are connected to a voltage source.

Ground the Product. This product is grounded through the grounding conductor of the power cord. To avoid electric shock, the grounding conductor must be connected to earth ground. Before making connections to the input or output terminals of the product, ensure that the product is properly grounded.

Observe All Terminal Ratings. To avoid fire or shock hazard, observe all ratings and markings on the product. Consult the product manual for further ratings information before making connections to the product.

Do Not Operate Without Covers. Do not operate this product with *metal* covers or panels removed.

Avoid Exposed Circuitry. Do not touch exposed connections and components when power is present.

Do Not Operate With Suspected Failures. If you suspect there is damage to this product, have it inspected by qualified service personnel.

Do Not Operate in Wet/Damp Conditions.

Do Not Operate in an Explosive Atmosphere.

Keep Product Surfaces Clean and Dry.

Provide Proper Ventilation. Refer to the manual's installation instructions for details on installing the product so it has proper ventilation.

Symbols and Terms

Terms in this Manual. These terms may appear in this manual:



WARNING. *Warning statements identify conditions or practices that could result in injury or loss of life.*



CAUTION. *Caution statements identify conditions or practices that could result in damage to this product or other property.*

Terms on the Product. These terms may appear on the product:

DANGER indicates an injury hazard immediately accessible as you read the marking.

WARNING indicates an injury hazard not immediately accessible as you read the marking.

CAUTION indicates a hazard to property including the product.

Symbols on the Product. The following symbols may appear on the product:



Environmental Considerations

This section provides information about the environmental impact of the product.

Product End-of-Life Handling

Observe the following guidelines when recycling an instrument or component:

Equipment Recycling. Production of this equipment required the extraction and use of natural resources. The equipment may contain substances that could be harmful to the environment or human health if improperly handled at the product's end of life. In order to avoid release of such substances into the environment and to reduce the use of natural resources, we encourage you to recycle this product in an appropriate system that will ensure that most of the materials are reused or recycled appropriately.



This symbol indicates that this product complies with the applicable European Union requirements according to Directives 2002/96/EC and 2006/66/EC on waste electrical and electronic equipment (WEEE) and batteries. For information about recycling options, check the Support/Service section of the Tektronix Web site (www.tektronix.com).

Mercury Notification. This product uses an LCD backlight lamp that contains mercury. Disposal may be regulated due to environmental considerations. Please contact your local authorities or, within the United States, refer to the E-cycling Central Web page (www.eiae.org) for disposal or recycling information.

Perchlorate Materials. This product contains one or more type CR lithium batteries. According to the state of California, CR lithium batteries are classified as perchlorate materials and require special handling. See www.dtsc.ca.gov/hazardouswaste/perchlorate for additional information.

Restriction of Hazardous Substances

This product has been classified as Monitoring and Control equipment, and is outside the scope of the 2002/95/EC RoHS Directive.



Getting Started

Product Description

This manual supports the VM Series Video Measurement System.

This chapter summarizes and highlights some of the key features of the instrument. Following this description are three sections:

- *Installation* shows you how to configure and install the instrument, as well as how to reinstall the system software included with the product.
- *Incoming Inspection* procedure verifies basic operation and functionality.
- *Accessories* lists the standard and optional accessories for this product.

Key Features

The VM Series Video Measurement System is a high-performance, oscilloscope-based video measurement system. Key features include:

- Fast, accurate, and repeatable video measurements
- Comprehensive component analog signal analysis
- Support for SD, HDTV, and RGBHV component analog video formats using options
- Automated testing of PC and DTV consumer video devices
- Automated VESA compliance testing for PC graphics devices
- Picture, Vector, and Waveform Displays
- Integrated Pass-Fail limit testing
- Companion Test Signal Package
- GPIB Remote Control and LAN Connectivity
- Complete 1 GHz bandwidth, 4 Channel DPO Functionality
- Time Saving Test Utilities and Automatic Report Generator
- Technology-specific Software Options for Jitter and Timing Measurements, Power Measurements, Serial Data, Ethernet, and USB2.0 Compliance Testing
- Video Measurement Accessories and Pinpoint Triggering

- Large 12.1 inch XGA Touch Screen Display and CD-R/W drive (DVD Read only)

Targeted to meet the needs of video professionals developing, testing, and manufacturing the next generation of Digital Television reception and play-out devices, PC and play-out devices, the instrument incorporates the power, features, and functionality needed in R&D, QA, and Production Test applications. It enables manufacturers to ensure that DTV video signal (Option SD/HD), and PC video signal (Option VGA) quality is up to the challenge of high performance displays, and to clearly differentiate between input signal and display device impairments.

You can use the VM Series Video Measurement System for the following purposes:

- R&D
- Compliance and certification testing
- Quality/Audit testing
- Installation and Troubleshooting
- Automated production test
- Off-air video systems testing

The VM Series System automates a variety of component analog video measurements which verify the integrity and quality of DTV video signals (Option SD/HD) and PC video signals (Option VGA).

The VM Series System automatically assesses conformance of selected video signal parameters to applicable EIA-770-3 (for HD), SMPTE -274M, and 296M standards (Option SD/HD), or the VESA version 1 revision 2 standard (Option VGA).

The VM Series System also automates measurement of other industry-standard video parameters that quantify the performance of PCs or other consumer video reception and play-out devices with component analog interfaces.

By integrating automated measurement algorithms and a high-speed, wide bandwidth signal acquisition platform into one instrument, Tektronix offers a reliable means to make fast, objective, and accurate video measurements. Product verification activities that previously took hours or days to complete can now be completed in seconds or minutes. Offering near plug-and-play video measurement capability, even unskilled operators can reliably assess PC video output signal quality.

As a fully integrated video analyzer, the VM Series System offers configuration menu settings that can readily be recalled or copied, eliminating complicated oscilloscope setups, tedious manual measurements, and time-consuming results

correlation exercises. Product quality is enhanced because test results can be reliably generated, easily replicated with other VM Series System instruments, and readily communicated across a global engineering, supply, or sales organization.

The DTV formats from 480i through 1080i and either RGB or YPbPr color space are supported in Options SD and HD. Option VGA supports common analog RGBHV signal resolutions from 640x480p through 2048x1536p, and refresh rates from 50 Hz through 100 Hz. The highest refresh rate for option VGA is 120 Hz and the highest resolution is 2048X2048.

The VM Series System runs the Windows operating system, which provides for easy operation with minimal training time. A 12.1 in (307 mm) color display provides a bright, clear, and crisp display of waveforms and measurement results.

Compatibility of the VM Series Option HD with the VM5000HD

If you are upgrading an existing VM5000HD, some default settings have changed. The changes are as follows:

- The default trigger channel has changed from CH1 to CH4.
- The Operation menu 'Run Mode' default setting has changed from 'Continuously' to 'Once.'

Firmware Upgrade

Tektronix may offer firmware upgrade kits for the VM Series System instrument. Contact your Tektronix service representative for more information (refer to *Contacting Tektronix* at the beginning of the manual).

Recommended Oscilloscope Probes

Table 1-1 lists the recommended oscilloscope probes to use when using the instrument as an oscilloscope.

Table 1-1: Recommended Probes

Probe type	Tektronix probe
Passive, 10X, 500 MHz	P5050
Passive, 100X, 250 MHz, high voltage	P5100
Passive, 1000K, 100 MHz, high voltage	P6015A
Passive, 15 MHz, 1X	P6101B

Table 1-1: Recommended Probes (Cont.)

Probe type	Tektronix probe
Active, DC to 1.0 GHz, FET high speed digital, for CMOS/TTL technology	P6243
Active, DC to 1.5 GHz, FET high speed digital, for all technologies	P6245
Active, DC to 400 MHz, FET, high bandwidth differential	P6246
Active, DC to 1.0 GHz, FET, high bandwidth differential	P6247
Active, DC to 1.7 GHz, FET, high bandwidth differential	P6248
Active, 100 MHz, high voltage differential	P5205
Active, 50 MHz, high voltage differential	P5210
AC Current	P6021
AC Current	P6022
DC/AC Current	AM5030S
High Speed Current	CT-1/CT-2
Current, 250 KHz to 2 GHz, 50 Ω input, AC Only, for temporary in-circuit installation	CT-6
Current, DC to 50 MHz, 15 A DC	TCP202
Low Capacitance, 20X, 3 GHz	P6158
Current Measurement	TCPA3000
Current Measurement	TCPA4000
Differential Preamp	ADA400A
High Voltage Differential	P5200
Optical/Electrical Converter	P6701B
Optical/Electrical Converter	P6703B

Installation

This section addresses instrument installation:

- *Unpacking* on page 1-5
- *Checking the Environment Requirements* on page 1-6
- *Connecting the Mouse* on page 1-10
- *Powering On the Instrument* on page 1-7
- *Shutting Down the Instrument* on page 1-7
- *Backing Up User Files* on page 1-12
- *Installing Software* on page 1-13
- *Connecting to a Network* on page 1-8
- *Adjusting Display Contrast* on page 1-9

Unpacking

Refer to the tables beginning on page 1-23 for a list of the options and accessories shipped with this instrument. Remember to fill out and send in the customer registration card.

Checking the Environment Requirements

Read this section before starting any installation procedures. This section describes site considerations, power requirements, and ground connections for your instrument.

Site Considerations

The instrument is designed to operate on a bench or on a cart in the normal position (on the bottom feet). For proper cooling, make sure that there is at least three inches (76.20 mm) of clearance on the left side of the instrument. See Figure 1-1. If you need to access the instrument CD-RW drive, you will also need at least 5.1 inches (129.54 mm) of clearance on the right side of the instrument.

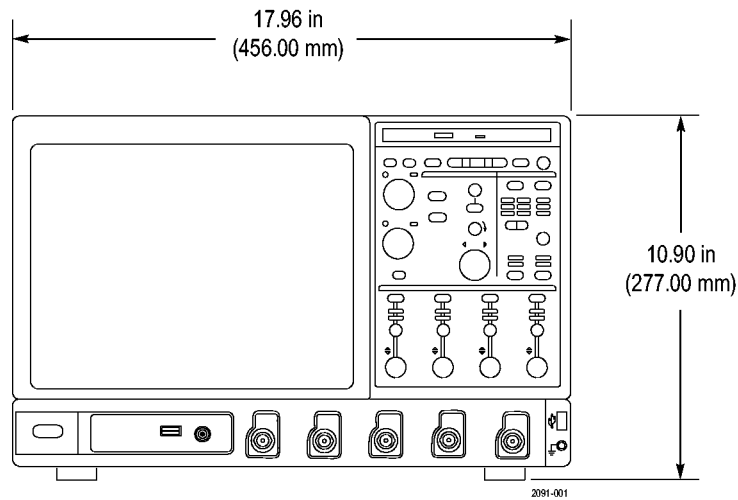

Figure 1-1: Instrument space requirements



CAUTION. To ensure proper cooling, keep the bottom and left side of the instrument clear of obstructions.

Operating Requirements

The specifications in *Appendix A* list the power source, temperature, humidity, and altitude operating requirements for the instrument.

Powering On the Instrument

Follow these steps to power on the instrument for the first time:



CAUTION. To ensure proper operation, connect the keyboard, mouse, and other accessories before applying power to the product the first time.

1. Connect one end of the instrument power cord to the instrument and the other end to a power source.
2. Push the On/Standby switch to power on the instrument (see Figure 1-2 for the switch location).

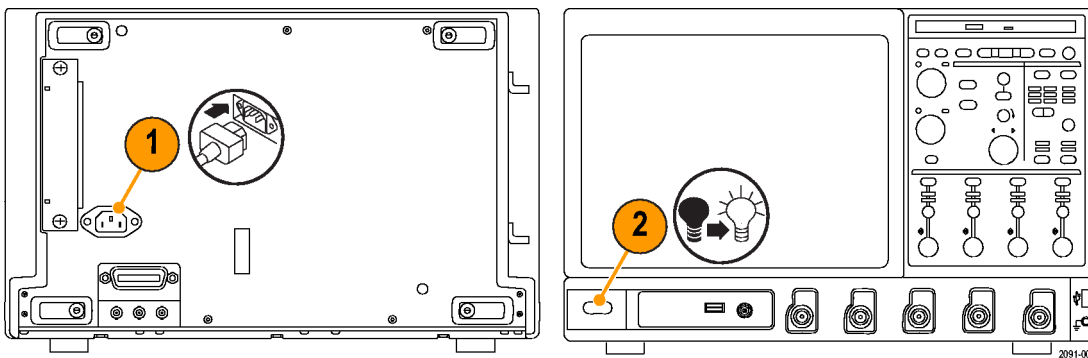

Figure 1-2: On/Standby switch location

Shutting Down the Instrument

To shut down the instrument, push the front-panel On/Standby switch. The instrument preserves settings and then starts a shutdown process (including a Windows shutdown) to put the instrument into standby mode. Avoid disconnecting the power cord or power source to shut down the instrument.

NOTE. If you remove power instead of using the On/Standby switch to shut down the instrument, the instrument will be in the factory Default Setup when powered on the next time.

If the shutdown process does not start immediately after pushing the ON/Standby switch, push and hold the On/Standby switch for up to 20 seconds to start the shutdown process.

To completely remove power to the instrument, push the On/Standby switch and then disconnect the power cord from the power source.

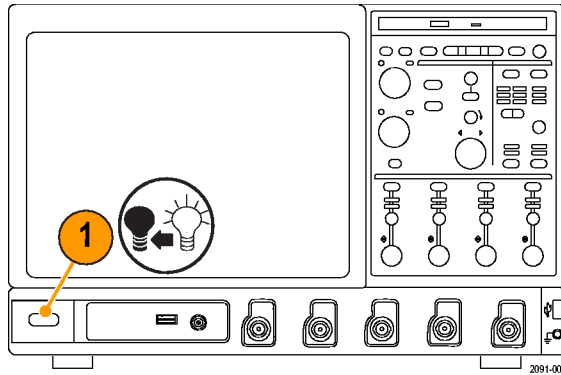

Figure 1-3: Powering off the instrument

Connecting to a Network

You can connect your instrument to a network for printing, file sharing, Internet access, and other functions. Consult with your network administrator and use the standard Windows utilities to configure the instrument for your network.

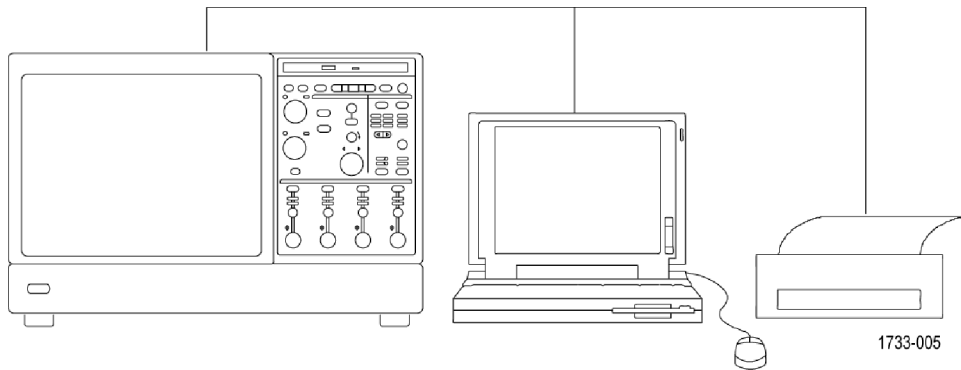

Figure 1-4: Connecting to a network

NOTE. If you want to disable network access for the instrument, perform the following procedure, except substitute *Disabled* for the command listed in step 8. The instrument will boot faster with network access disabled.

1. Begin with the instrument power off.
2. Attach a keyboard and mouse to the instrument.
3. Power on the instrument.

4. As the instrument begins to boot, press the keyboard **F2** key repeatedly until the “Loading SETUP” message appears.
5. In the BIOS Setup Utility, use the keyboard right-arrow key to highlight the **Advanced** menu at the top of the screen.
6. Use the arrow down key to highlight **Peripheral Configuration** in the Advanced screen, and then press **Enter**.
7. Use the arrow down key to highlight **LAN Device** in the Peripheral Configuration screen, and then press **Enter**.
8. Use the arrow up or down key to highlight **Enabled**, and then press **Enter**.
9. Press the **F10** key to save and quit. Confirm Save of the configuration changes when you are prompted on screen.
10. Use the Windows network setup utility to define the instrument as a network client, and configure it for your network. You can find the network setup utility in the Windows **Start** menu if you select **Settings > Control Panel** and then double click **Network**. You should consult your network administrator for specific instructions to make these settings.

Adjusting Display Contrast

If you find that the instrument screen is too bright or too dark, use these steps to adjust the LCD display contrast to your preference. You must have a mouse attached to perform this procedure.

1. Right click the Windows desktop.
2. Select **Properties**.
3. Select the **Settings** tab.
4. Click **Advanced**.
5. Select the **Color** tab.
6. Adjust the slider control for the desired gamma setting. The screen brightness will change as you move the slider control.
7. Click **Apply**.
8. Click **OK**.

Getting Acquainted with your Instrument

Front Panel The front panel points of the instrument are shown in the following figure :

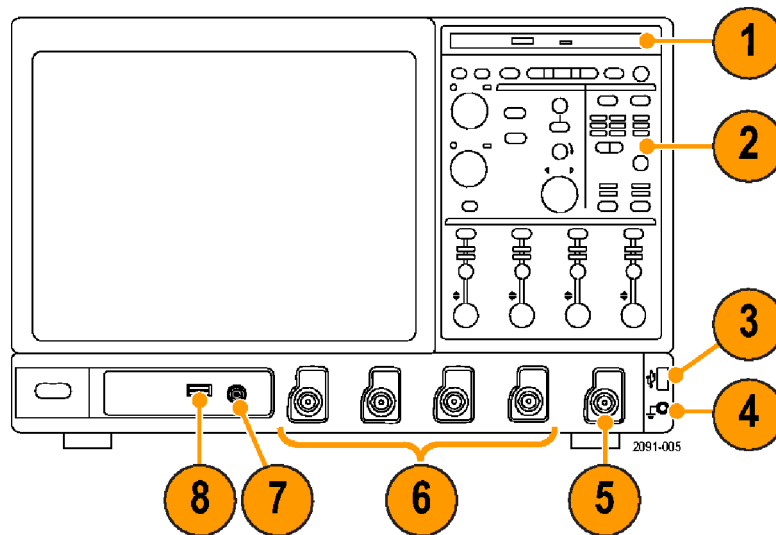

Figure 1-5: Front panel of the instrument

1. DVD/CD-RW drive
2. Front panel controls
3. USB port
4. Ground terminal
5. Auxillary Trigger Input
6. Channel 1-4 inputs
7. Probe calibration output
8. Probe compensation output
9. Recovered clock output
10. Recovered data output

Side and Rear Panels

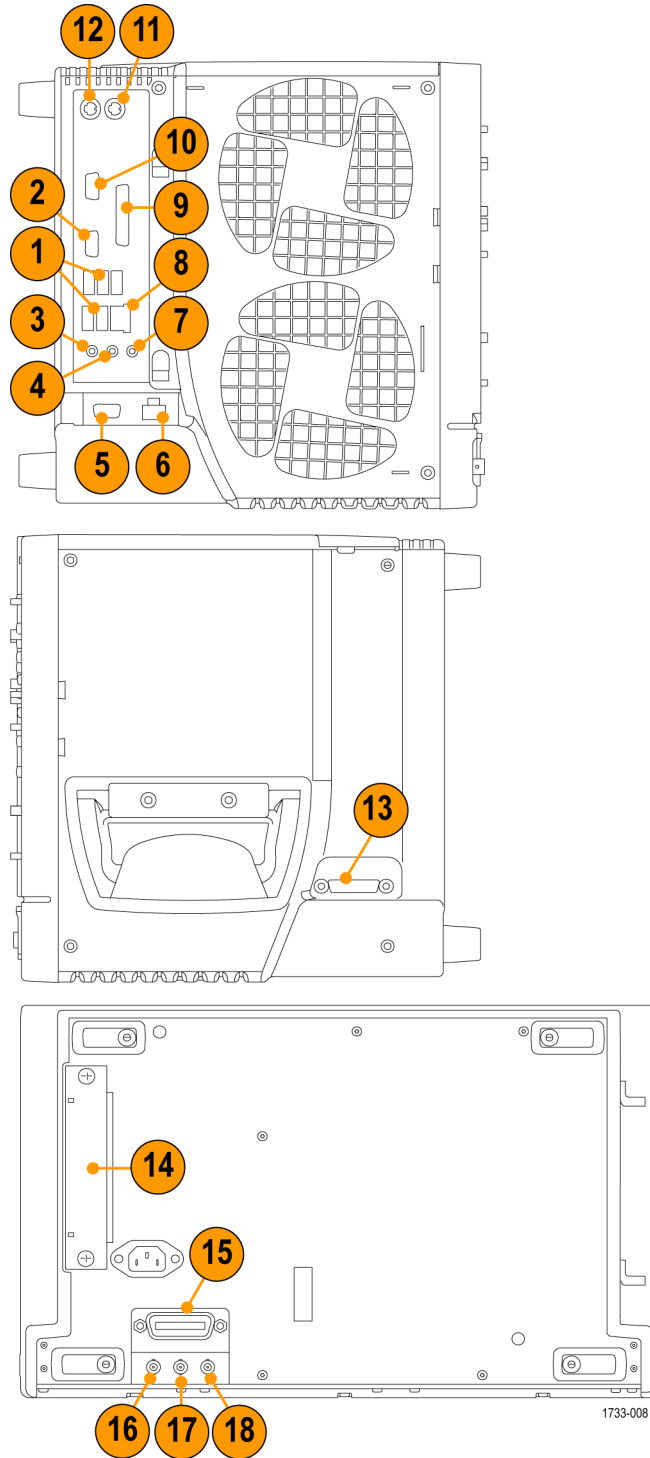

Figure 1-6: Side and rear panels of the instrument

1. USB ports
2. Video port to connect a monitor for side-by-side display
3. Mic connector for microphone
4. Line Out connector for speaker
5. Scope Only XGA Out video port to connect a monitor
6. Printer connection
7. Line In connector
8. RJ-45 LAN connector to connect to a network
9. Centronics Parallel Port
10. COM1 serial port
11. PS-2 connector for mouse
12. PS-2 connector for keyboard
13. Tek Link connector for future use
14. Removable hard disk drive
15. GPIB port to connect to controller
16. Auxiliary output
17. Channel 3 output
18. External reference input

Backing Up User Files

Always back up your user files on a regular basis. Use the Windows Backup tool to back up files stored on the hard disk. The Backup tool is located in the System Tools folder in the Accessories folder.

Use these steps to back up your files:

1. Quit the instrument application by selecting the File menu **Exit** command.
2. Click the Windows **Start** button.
3. Select **Programs > Accessories > System Tools > Backup**.
4. Use the Backup Wizard to select the items you want to back up and the destination. The destination can be the floppy drive or a third-party storage device over one of the side-panel ports.

Installing Software

The instrument system and application software is preinstalled at the factory. If you have to reinstall the software for any reason, refer to the instructions that accompany the CD-ROMs that are shipped with the instrument.

Software Release Notes

Read the software release notes (README.TXT) on the product software CD-ROM before performing installation procedures. This file contains additional information that supercedes other product documentation.

To view README.TXT, start the Windows Notepad accessory and open the file from the *VM Series Video Measurement System Product Software* CD-ROM.

VM Series Remote Command Information

The GPIB programmer information is available in the *VM Series Video Measurement System Programmer Manual PDF* located on the VM Series product software CD-ROM.

Desktop Applications

You can install desktop application software on the instrument. The instrument has been tested with the following software products installed:

- Microsoft Office 98 (Word, Excel, PowerPoint)
- MathCad (Option SD/HD only)
- MATLAB (Option SD/HD only)

Other software products may be compatible but have not been tested by Tektronix. If the instrument malfunctions after you install software, uninstall the software and then reinstall the instrument software (if necessary) to restore proper operation.

Quitting the instrument Application. Before installing other desktop applications, quit the instrument application. To do this, select the **File > Exit** command.

Incoming Inspection

This section contains instructions for performing a self test and functional verification of the instrument. These procedures verify that the instrument is operating correctly after shipment, but they do not check product specifications.

If the instrument fails any test within this section, it may need service. To contact Tektronix for service, see *Contacting Tektronix* on the copyright page.

Make sure you have installed the instrument as described in *Installation* starting on page 1-5.

Self Tests

This procedure uses internal routines to verify that the instrument functions and was adjusted properly. No test equipment or hookups are required.

Equipment required	None
Prerequisites	Power on the instrument and allow a 20 minute warm-up.

Perform these substeps to verify internal diagnostics:

1. *Display the system diagnostics menu as follows:*
 - a. If the instrument is in the toolbar mode, click **Menu** (far right toolbar button) to switch to menu bar mode.
 - b. From the Utilities menu, select **Instrument Diagnostics** to open the Instrument Diagnostics control window.
 - c. In the **Subsystem**, **Area**, and **Test** lists, ensure that you select **ALL**.
2. *Run the system diagnostics as follows:*
 - a. Disconnect all input signals from all four channels.
 - b. Click **Run** in the Instrument Diagnostics control window.

The internal diagnostics do an exhaustive verification of proper instrument function, taking five to fifteen minutes. When complete, the resulting status appears in the diagnostics control window.

3. *Verify that no failures are found and reported:* The instrument should pass all tests. If any failures occur, record the failure information and contact your local Tektronix service personnel for more information.

4. *Run the signal path compensation routine as follows:*
 - a. From the Utilities menu, select **Instrument Calibration** to open the Instrument Calibration control window.
 - b. Click **Calibrate** to start the routine.
 - c. *Confirm signal path compensation returns passed status:* Signal path compensation may take up to ten minutes to run. Verify that the word **Pass** appears in the Status text box.
5. Click **Close** to quit the Instrument Calibration control window.

Functional Test

Option SD/HD

This procedure uses the output from a video signal generator, TG700 or equivalent, to verify the VM Series System HD and SD video application functionality. Two functional tests are described, one for option HD and another for option SD. If you have both options, either test alone will verify functionality adequately.

Equipment required	VM6000 75Ω precision BNC terminations (3) BNC “T” connectors (3) A TG700 video generator with either a AWVG7 (for HD) or AVG7 (for SD) (or equivalent generator)
---------------------------	---

NOTE. *These procedures verify that the application features operate. They do not verify that they operate within limits. Therefore, when the instructions in these functional tests call for you to verify that a signal appears on screen “that is about five divisions in amplitude” or “has a period of about six horizontal divisions,” and so on, do not interpret the quantities given as limits.*

Do not change the front-panel settings unless directed to by the procedure. If you change front-panel settings, you may obtain invalid results. In this case, redo the procedure from step 1.

When you are instructed to press a front-panel button or screen button, the button may already be selected (its label is lighted). If this is the case, it is not necessary to press the button.

1. Set the video generator to output 1080i/60 100% (for option HD) color bars, or 480i/60 100% color bars (for option SD).
2. Connect the signal generator to the VM Series System instrument as shown in the following diagram:

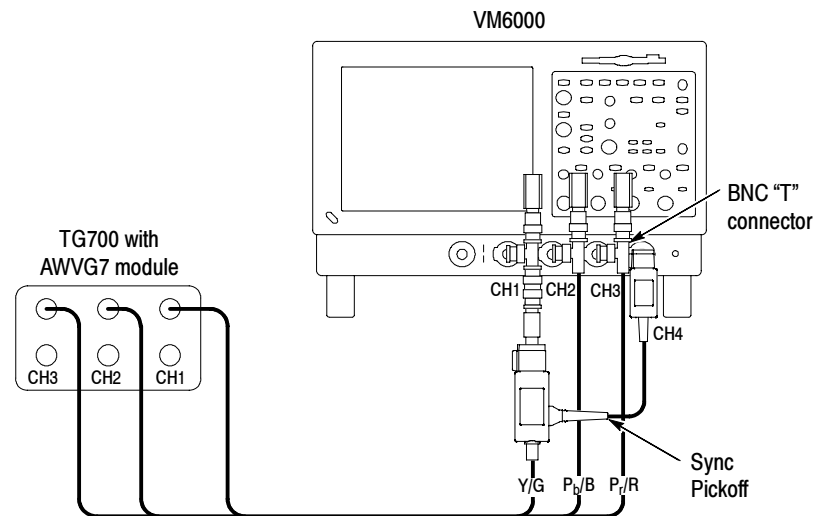

3. Power on the VM Series System instrument and wait for it to complete the power-on process.
4. Select **File > Run Application > VM HD and SD Video** to display the VM Series System application window.
5. In the application window, select **File > Recall Default** to load the application default settings.
6. In the application window, select **Configuration > Format** to display the Format view.
7. Select the **1080i/60 (HD) or 480i/60 (SD)** button.
8. In the application window, select **Configuration > Operation** to display the Operation view.

- In the application window, select the **Run** button to start the application measurement process.



The instrument begins taking measurements and displays a Color bars measurement view listing measurement values similar to those as shown (To update).

Results: Color Bars

Format: 1024x768_60Hz

Line Number: 184

Average: 1

Measured	Relative	Reference	Limits
Unit: mV			
	G	B	R
White	693.654	686.602	691.383
Yellow	693.299	0.822	691.874
Cyan	694.417	685.858	0.936
Green	692.762	1.151	0.212
Magenta	1.552	685.906	691.004
Red	0.417	1.133	691.271
Blue	0.193	684.864	0.999
Black	-0.093	1.099	0.04

Figure 1-7: Displaying measurement values in color bars measurement

- Select the Picture button to display the VM Series Video Monitor Window. Verify that a color bars signal appears.

This completes the functional test. If your VM Series did not complete the functional test satisfactorily, please contact your local Tektronix Service representative.

Option VGA

This procedure uses the output of a PC Display Card to verify the functionality of the VM Series System Option VGA measurement set (comprising the VM Series VGA, RGBHV Measurement Interface Unit (MIU) and associated cables).

Equipment required	VM6000 Option VGA RGBHV Measurement Interface Unit VGA to 5 BNC cable, part number 174-5126-XX PC with VGA Display Card
---------------------------	--

NOTE. *These procedures verify that the application features operate. They do not verify that they operate within limits. Therefore, when the instructions in these functional tests call for you to verify that a signal appears on screen “that is about five divisions in amplitude” or “has a period of about six horizontal divisions”, and so on, do not interpret the quantities given as limits.*

Do not change the front-panel settings unless directed to by the procedure. If you change front-panel settings, you may obtain invalid results. In this case, redo the procedure from step 1.

When you are instructed to press a front-panel button or screen button, the button may already be selected (its label is lighted). If this is the case, it is not necessary to press the button.

1. Connect the RGBHV MIU to the VM Series System as described in *Option VGA Setup 1: RGBHV Measurement Interface Unit* on page 2-9.
2. Set the VGA display card under test to any built-in format (such as 800x600@60) supported by Option VGA. This can be done in the PC by using the **Display Properties** menu. Select the corresponding Matrix BMP file (Resolution 800x600-Matrix Signal.bmp) from the PC Bitmap Graphics CD (part number 020-2634-XX) and display the BMP file in full screen mode.
3. Remove the PC monitor connection from the VGA display card and connect the VGA display card output to the input channels on the MIU using the VGA to 5 x BNC adapter cable.
4. Ensure that all four channels of the VM Series System are enabled. All four channel buttons must be glowing.
5. Press the Autoset button on the VM Series System. You should see the signals from all four channels on the display with some visible activity.
6. Launch the VM Series System application from the TekScope menu bar by selecting **File > Run Application > VM VGA Video**.
7. In the Format Panel (**Configuration > Format**), select the 800 x 600 resolution and 60 Hz refresh rate. Leave the Timing standard as the default (that is, DMT). If the VGA display card generates signals using a different Timing Standard, change the Timing selection accordingly. Refer to Figure 1-8.

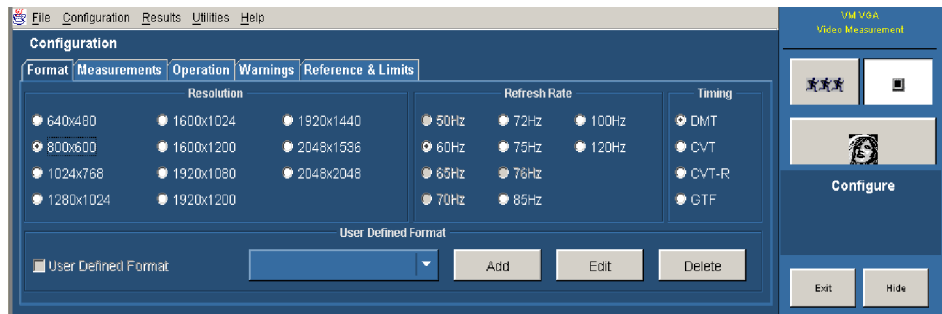

Figure 1-8: Format panel

8. In the Measurements panel (Configuration > Measurements), select the following measurements:

- Color Bars
- H Sync
- V Sync
- Video Transient

Leave the settings in other configuration panels at their default values.

9. Press the Run button.

10. If the VM Series System is functioning normally, the four selected measurements will be executed without any warning message(s). The results should be displayed on the corresponding result panels (for example, **Results > H Sync**). Because multiple measurements are selected, the Results Summary panel will appear. Some representative screen shots are shown in the Figures 1-9 through 1-13.

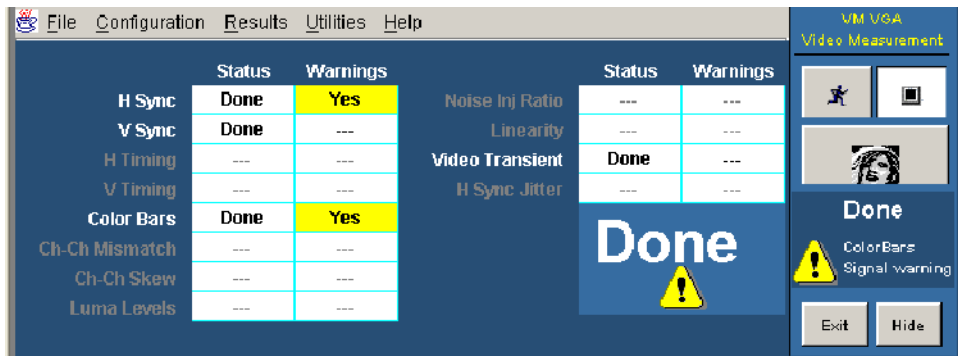

Figure 1-9: Results Summary display

11. To view results for individual measurements, go to their respective screens. For example, to see the results of the color bars measurement, select **Results > Color Bars**.

The results shown in Figure 1-10 through Figure 1-13 are typical results. Your results may vary.

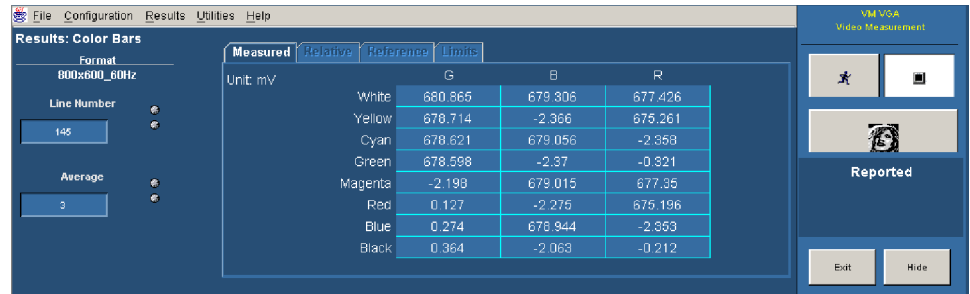

Figure 1-10: Color Bars measurement results display

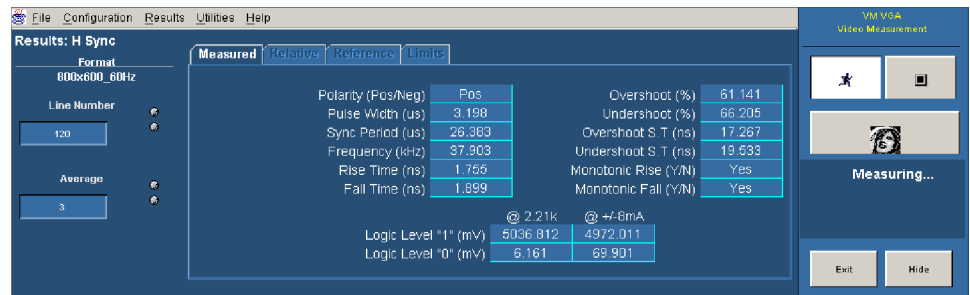

Figure 1-11: H Sync measurement results display

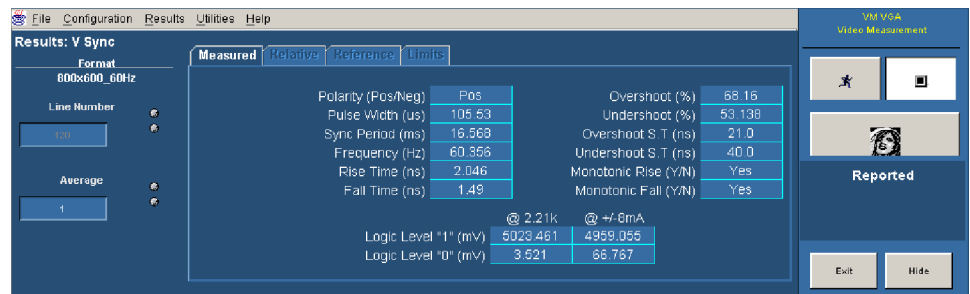

Figure 1-12: V Sync measurement results display

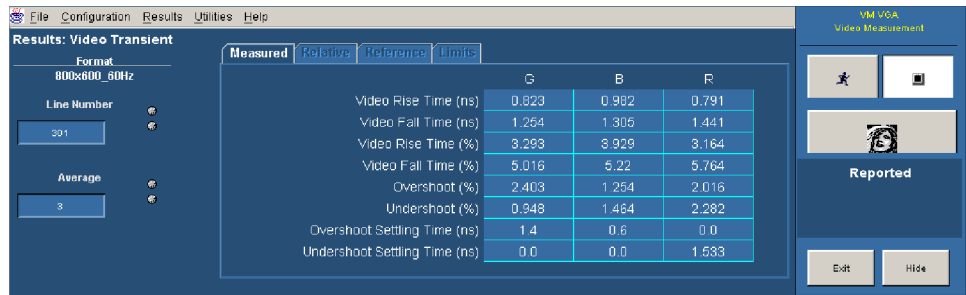

Figure 1-13: Video Transient measurement results display

Possible Errors and Troubleshooting Tips. If there is any problem associated with the MIU or its connections, the following error message appears:

Error occurred in configuring the MIU

Perform the following steps to isolate the problem:

1. To further localize the problem, check the results display. For example, if there is no signal on the G channel, the corresponding results will not be displayed. So, check the G channel cables and their connection at the input side of the MIU. Between the MIU and VM Series System check the Ch 1 cable and its connections.
2. If expected results still do not appear, there might be some internal problem in the MIU.
3. Other warning messages can be due to an incorrect signal or no signal. If the warning is due to no signal, carry out the checks specified in step 1 above. If the warning is due to an incorrect signal, ensure that the VGA card is set to the same resolution, refresh rate, and timing standard as selected in the Format panel of the application and that the appropriate BMP file is used.

This completes the VM Series functional test for Option VGA. If your VM Series System did not complete the functional test satisfactorily, contact your local Tektronix Service representative.

Options and Accessories

This section lists the product options, standard accessories, and optional accessories that are available for the instrument.

Options

You can order the options shown in Table 1-2 with the instrument. For the current list of accessories, upgrades, and options, including service options, available for your VM6000, visit the Tektronix Web site, www.tektronix.com.

Table 1-2: Instrument options

Hardware	18 ¹	Touch-screen interface
	1R	Rackmount kit
	FHD	Front panel removable hard drive
	1K	Scope Cart
	655-4920-00	Thermal Printer - 1P
Mounting	016-1946-XX	TDS5000B Series Rackmount Kit - 1R
Software	SM	Series Communications mask testing
	CP2 ²	TDSCPM2 - ANSI/ITU telecom pulse compliance testing software (This requires option SM)
	HD ³	HD component analog video measurements & format support, includes test signal package
	SD ³	SD component analog video measurements & format support, excludes test signal package
	VGA ³	RGBHV Video Measurements and VESA Compliance Tests
	DVD	TDSDVD - Optical storage analysis software
	ET3	TDSET3 - Ethernet compliance test software
	J2	TDSDDM2 - Hard disk drive measurements software
	J3E	TDSJIT3E - Jitter and timing analysis software essentials
	JA3	TDSJIT3 V2.0 Advanced- Jitter and timing analysis software
	JT3	TDSJIT3 V2.0 Essentials- Jitter and timing analysis software
PW3	TDSPWR3 - Power measurements software	

Table 1-2: Instrument options (Cont.)

	USB	TDSUSBS; USB 2.0 Compliance test software only
Service	C3	Calibration Service 3 years
	C5	Calibration Service 5 years
	D1	Calibration Data Report
	D3	Calibration Data Report 3 years (with Option C3)
	D5	Calibration Data Report 5 years (with Option C5)
	R3	Repair service 3 years (including warranty)
	R5	Repair service 5 years (including warranty)

- ¹ No upgrade path for this option, must be ordered at the time of initial purchase.
- ² Requires option SM.
- ³ At least one of the Option HD, SD, or VGA is mandatory for each VM6000 Instrument.

Upgrades equivalent to original options can be ordered to extend instrument performance after initial purchase. Users can install upgrades without opening the instrument case or requiring on-site service. To upgrade a VM5000, order a VM5UP with one or more of the options listed above. Factory installation is available by specifying Option IF. For older VM5000HD instrument upgrades, order VM5HDUP with one or more of the following options: 1R, DVD, ET3, J2, J3E, JT 3, PW3, USB.

Accessories

This section lists the standard and optional accessories. The accessories listed in Table 1-3 are shipped standard with the instrument. Please specify the power plug and the manual language option when ordering.

Table 1-3: Standard Accessories

Accessory	Part number
<i>VM Series Video Measurement System Quick Start User Manual in English (and a French, German, Spanish, Traditional Chinese, Simplified Chinese, or Japanese translation if a language option was ordered)</i>	071-2091-XX
<i>VM Series Video Measurement System User Manual</i>	071-2103-XX
<i>VM Series Video Measurement System Programmer Manual</i> in PDF format on VM Series Video Measurement System Product Software CD	071-2104-XX
DPO7000, DSA70000, and DPO70000 Digital Phosphor Oscilloscopes Quick Start User Manual	071-1733-XX

Table 1-3: Standard Accessories (cont.)

Accessory	Part number
<i>VM Series Video Measurement System Product Software</i> CD-ROM (includes VM Series Video Measurement System product software with online help, VM Series Video Measurement System User Manual PDF, VM Series Video Measurement System Quick Start User Manual PDF, and release notes)	020-2767-XX
DPO7000, DSA70000, and DPO70000 Product Software CD-ROM	063-2693-XX
DPO7000, DSA70000, and DPO70000 Operating System Restore CD	063-2659-XX
<i>Optional Applications Software</i> CD-ROM and Documentation Kit	020-2700-XX
Tek Restore Software License for Recovery Media/OS Restore	---
Getting Started with <i>OpenChoice</i> [™] Solutions Kit	020-2513-XX
DPO7000, DSA70000, and DPO70000 Online help (part of the Product Software)	---
DPO7000, DSA70000, and DPO70000 Performance Verification (a PDF file on the Product Software CD)	---
DPO7000, DSA70000, and DPO70000 Programmer Online Guide (files on the Product Software CD)	---
NIST, Z540-1, and ISO9001 Calibration Certificate	---
Sync pick-off cable (Option SD/HD only)	012-1680-00
Option VGA	
VGA to 5X BNC cable (3 foot long)	174-5126-XX
VGA to 5X BNC cable (6 inch long)	174-5147-XX
RGBHV Measurement Interface Unit	012-1685-XX
RS-232 RGBHV MIU Control Cable	012-1692-00
BNC-to-Binding Post Adapters (2)	011-0183-XX
Power Cord	
North America (Option A0)	161-0104-00
Universal Euro (Option A1)	161-0104-06
United Kingdom (Option A2)	161-0104-07
Australia (Option A3)	161-0104-05
240V North America (Option A4)	161-0104-08
Switzerland (Option A5)	161-0167-00
Japan (Option A6)	161-0005-00
China (Option A10)	161-0306-00
India (Option A11)	161-0324-00
No power cord or AC Adapter (Option A99)	---
Mouse, optical	119-7054-XX

Table 1-3: Standard Accessories (cont.)

Accessory	Part number
Mini-Keyboard, USB with 2-port hub	118-7083-XX
Front cover	200-4963-XX
Accessory pouch	016-1966-XX
Probe Calibration and Deskew Fixture, with instructions	067-0405-XX
Nero OEM Software CD	063-3781-XX
TPA-BNC Service Replacement Adapter Option SD & HD - 1 Option VGA - 4	013-0355-02
P5050 10X, 500 MHz, Passive Voltage Probe	P5050
Blank CDR / CDRW	020-2434-XX
Click 'N Burn Patch floppy disk	063-XXXX-XX
Precision 75 Ω terminations (4)	011-0102-XX
2.21 K Ω and 301 Ω terminator kit	020-2633-XX
BNC female-to-female connector	103-0028-XX
BNC male-to-male connector	103-0029-XX
BNC "T" connectors (4)	103-0030-XX
2.21 k Ω resistor	322-3226-00
301 Ω resistor	322-3143-00
VGA Sync Combiner cable	012-1664-XX

Table 1-4: Recommended Accessories

Accessories	Part Number
VM Series Signal Sources, 480 line DVD and 580 line DVD	020-2770-XX
VM Series Signal Sources, standard definition elementary streams	020-2771-XX
VM Series Signal Sources, advanced TV elementary streams	020-2772-XX
VM Series Signal Sources, ATSC transport streams	020-2773-XX
VM Series Signal Sources, baseband test signals	020-2774-XX
VM Series Signal Sources, PC bitmap graphics test signal files	020-2775-XX
VM Series Signal Sources, H.264 SD & HD streams	020-2776-XX
<i>DPO70000 Series Digital Phosphor Oscilloscopes Service Manual</i>	071-1174-XX
Transit case	016-1937-XX
Probe calibration, compensation, and deskew adapter	067-0405-XX

Table 1-4: (Cont.) Recommended Accessories

Accessories	Part Number
Power deskew fixture	067-1478-00
Video display clamp	013-0278-XX
P5050 500 MHz 10x passive probe	P5050
GPIB cable (3.3 ft. or 1m)	012-0991-01
GPIB cable (6.6 ft. or 2m)	012-0991-00
Centronics (printer) cable	012-1214-00

The accessories in Table 1-5 were orderable for use with the instrument at the time this manual was published. Consult a current Tektronix catalog or the Tektronix Web site for additions, changes, and details.

Table 1-5: Optional Accessories

Accessories	Part Number
Transit case	016-1937-00
Video display clamp	013-0278-XX
Thermal printer paper	016-1897-00
Probe calibration, compensation and deskew adapter requires a separate pulse generator	067-0405-XX
Power deskew fixture	067-1478-00
Extra front removable hard drive	065-0692-XX
P6101B 15 MHz 1X Passive Probe	P6101B
Extra P5050 500 MHz 10X Passive Probe	P5050
TCPA300, TCPA400 Series Current Measurement Systems (requires TCPA300 / TCPA400 style probe)	TCPA300 / TCPA400
AMT75 1 GHz 75 Ω adapter	AMT75
AFTDS Differential signal adapter	AFTDS
K420 Scope Cart with mouse accessory tray	436-0317-XX
TDS5000 Series, VM5000 Option HD rackmount kit	016-1887-XX
GPIB cable (3.3 ft / 1 m)	012-0991-01
GPIB cable (6.6 ft / 2m)	012-0991-00
Centronics cable	012-1250-00



Operating Basics

Operating Basics

This section provides basic information on how to use the VM Series System. More detailed measurement information can be found in the *Reference* section.

Input Signal Connection Requirements

Option SD/HD Use only 75 Ω coaxial cables to connect the video device under test to the instrument.

Install the included 75 Ω terminations between the end of the coaxial cables and the instrument input channels, using the included BNC “T” connectors. See Figure 2-1. For accurate frequency response measurements, it is important to attach the “T” connector directly to the input channel BNCs.

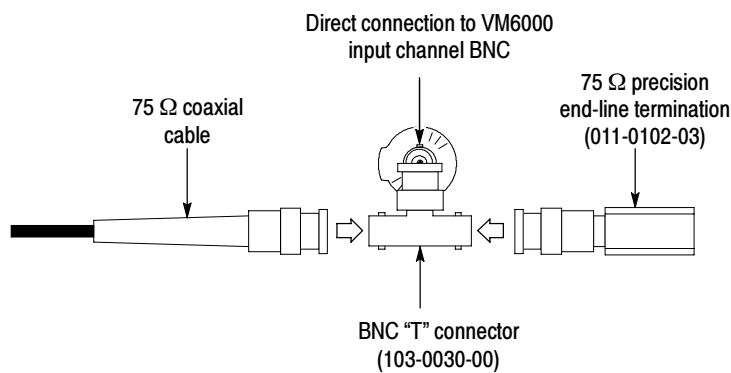

Figure 2-1: Connecting the T-connector to the VM Series System

Option VGA The preferred method of connecting the video device under test to the instrument is to use the RGBHV Measurement Interface Unit. The Measurement Interface Unit contains an impedance-matching circuit to ensure the most accurate measurement results. For some measurements, a low-frequency path is used and for other measurements a wideband path is used.

The VM Series System selects which path is used through an RS-232 connection to the Measurement Interface Unit. See Figure 2-2.

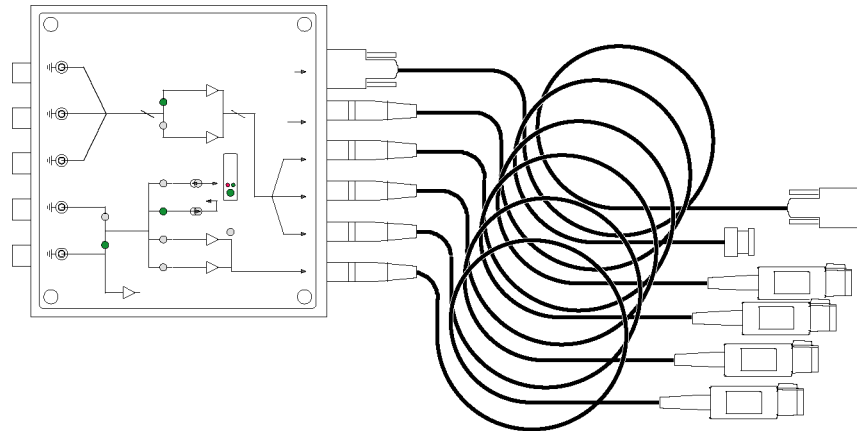

Figure 2-2: RGBHV Measurement Interface Unit

You can also connect the video device under test to the VM Series System by using the supplied VGA Connector to 5X cable. See Figure 2-3. If you use this method, you will need to connect the cable to the VM Series System using the supplied precision terminations. Depending on which measurements you take, you may need to manually change terminations while taking measurements.

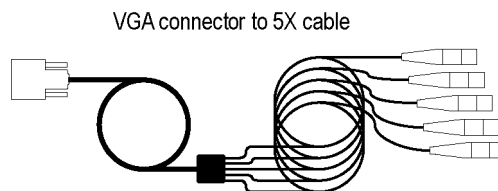

Figure 2-3: VGA connector to 5X cable

Connecting Input Signals

Use the following diagrams to determine the optimum input signal setup for your measurement needs.

Setup 1 - Three-Wire Analog Video with Composite Sync (Option SD/HD)

Setups 1A and 1B are the preferred setups for testing 3-wire component analog video signals (Y/G, Pb/B, Pr/R) with the composite sync signal on Y/G. These setups use the sync pickoff accessory to derive the trigger signal from the Y/G signal on CH1. The triggering source is set to Channel 4. This configuration provides more accurate low-level noise measurements (below -60 dB at 30 MHz bandwidth) than setup 2.

This type of connection allows you to make more accurate noise measurements on CH1 while triggering on CH4, without adding additional cabling between CH1 and CH4. The additional cabling could adversely impact frequency response and multiburst measurements.

To achieve the best frequency response and multiburst measurements, the 75 Ω termination should be connected as close to the input connector as possible, as shown in the setup illustration.

Setup 1A - Three-Wire Video with Composite Sync for Sync Pickoff 012-1680-01 (Option SD/HD)

There are two ways to connect the Sync Pickoff to the VM Series System. One way connects the Sync Pickoff directly to the input and the other way connects through a T-connector attached to a 75 Ω termination. If you are using a 012-1680-01 Sync Pickoff (contains internal 75 Ω termination), connect the Sync Pickoff directly to the VM Series System CH1 input (using a TPA-BNC adapter) as shown in the following Figure 2-4. If you are using a 012-1680-00 Sync Pickoff (requires external 75 Ω termination), use the Figure 2-6 shown in Setup 1B.

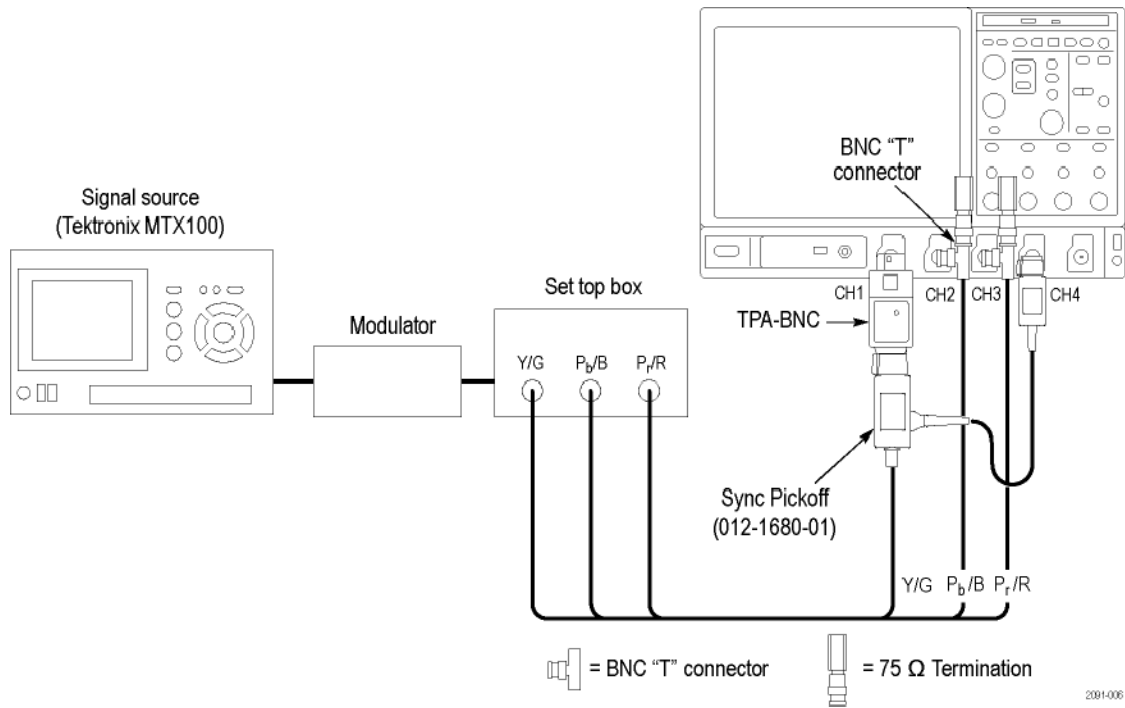

Figure 2-4: Connecting to a VM6000 / DPO7000 Series instrument

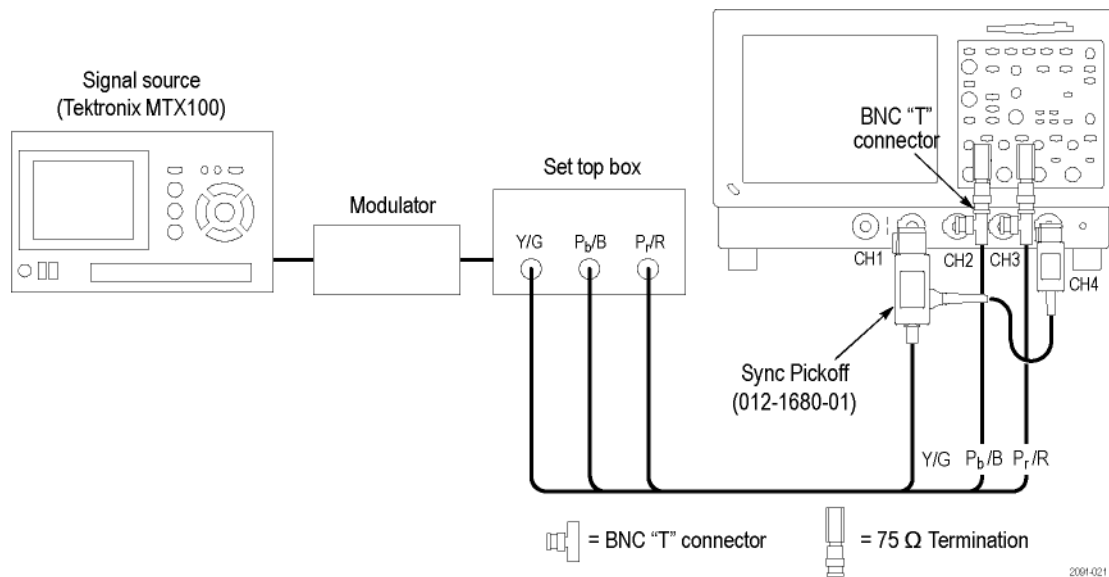

Figure 2-5: Connecting to a VM5000 / TDS5000 Series instrument

**Setup 1B - Three-Wire
Analog Video with
Composite Sync for Sync
Pickoff 012- 1680-00
(Option SD/HD)**

There are two ways to connect the Sync Pickoff to the VM Series System. One way connects the Sync Pickoff directly to the input and the other way connects through a T-connector attached to a 75 Ω termination. If you are using a 012-1680-00 Sync Pickoff (the part number is located on the label of the larger module), connect the Sync Pickoff to the VM Series System CH1 input as shown in the following Figure 2-6. If you are using a 012-1680-01 Sync Pickoff, use the Figure 2-4 shown in Setup 1A.

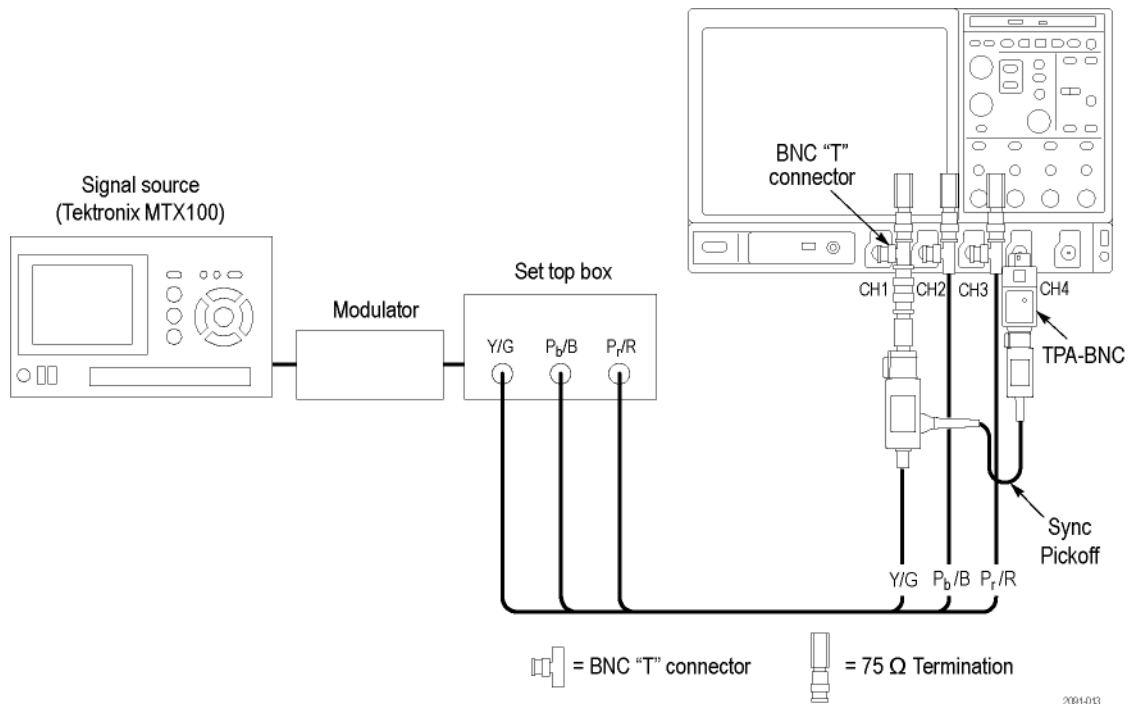

Figure 2-6: Connecting to a VM6000 / DPO7000 Series instrument

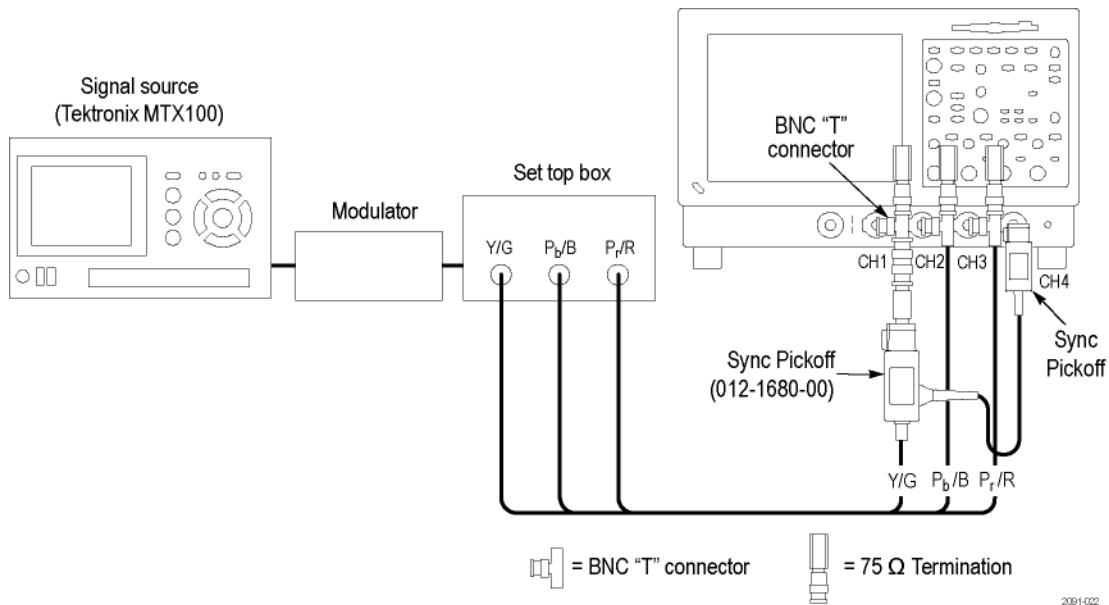

Figure 2-7: Connecting to a VM5000 / TDS5000 Series instrument

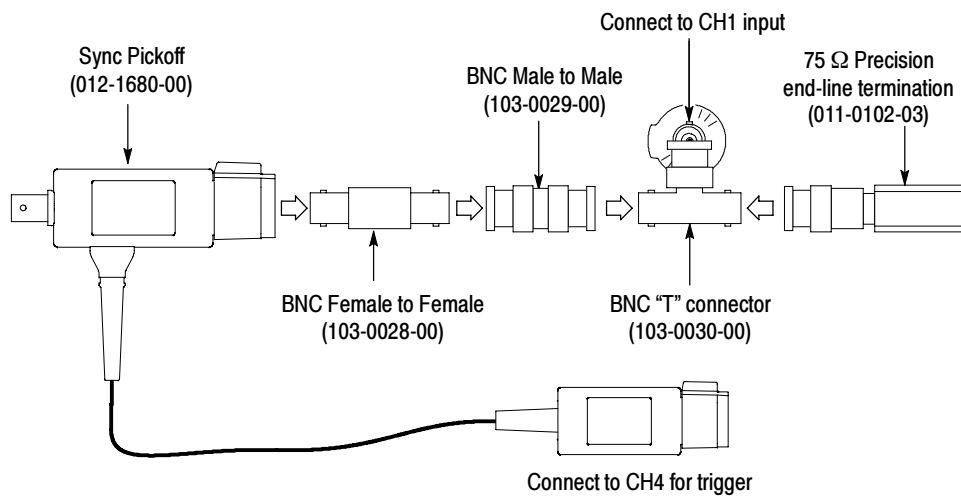

Figure 2-8: Connecting the 012-1680-00 Sync Pickoff to CH1 input

NOTE. Verify that the trigger channel is set to Channel 4 (the default setting). If the trigger setting (Configuration > Operation) is not set to Channel 4, you will see signal warning messages and will be unable to take measurements.

Setup 2 - Three-Wire Analog Video with Composite Sync (Option SD/HD)

Use this setup for testing 3-wire component analog video signals (Y/G, Pb/B, Pr/R) with the composite sync signal on Y/G. Set the triggering on the instrument to Channel 1 (the default trigger setting is CH4). This setup is simpler than the others mentioned in this section, but limits noise measurement on Y/G to -65 dB (30 MHz noise bandwidth).

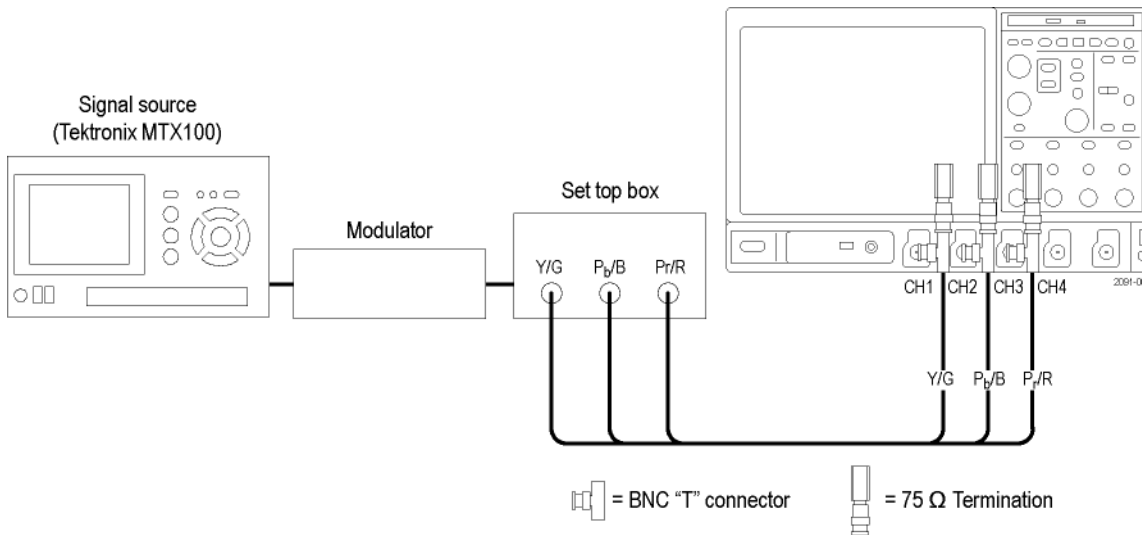

Figure 2-9: Connecting to a VM6000 / DPO7000 Series instrument

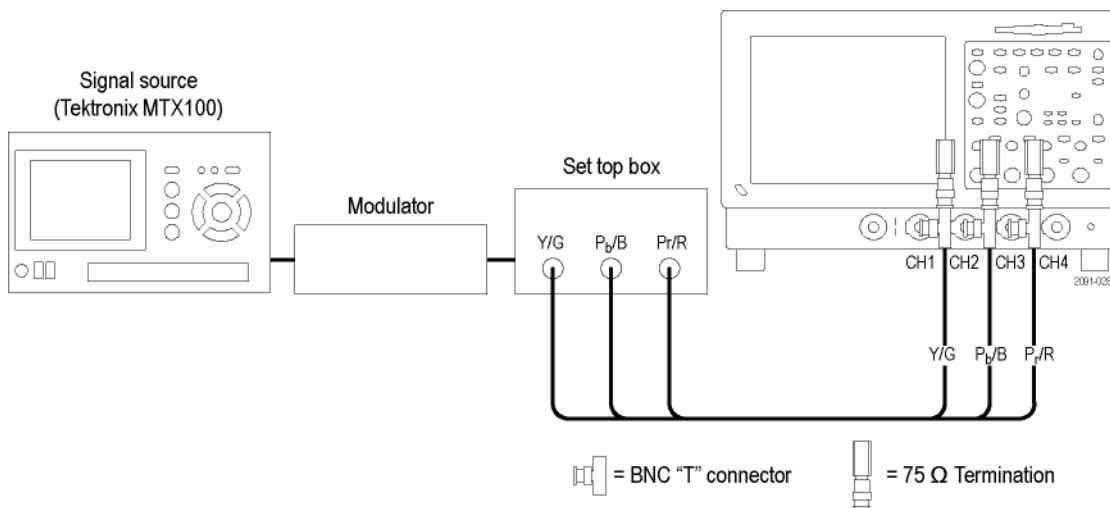

Figure 2-10: Connecting to a VM5000 / TDS5000 Series instrument

Setup 3 - Four-Wire Video with Separate Composite Sync (Option SD/HD)

Use this setup for testing 4-wire component analog video signals (Y/G, Pb/B, Pr/R) with the composite sync signal on a separate output line. For CH4, termination is optional. For only CH4, you can connect the signal without using a termination or you can use a 75 Ω termination of lower accuracy than the 75 Ω terminations that are provided with the instrument. See Figure 2-11.

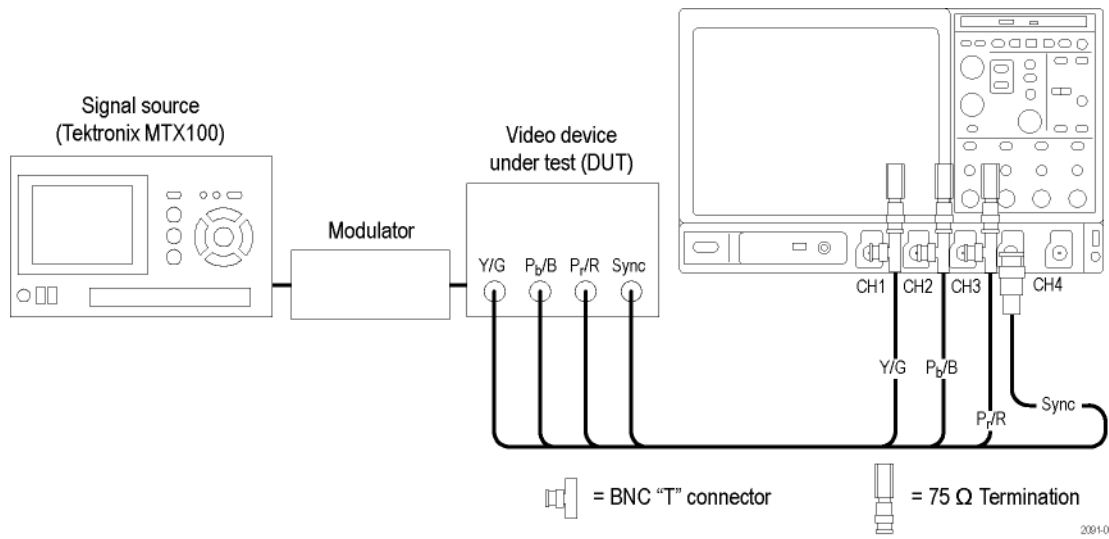

Figure 2- 11: Connecting to a VM6000 / DPO7000 Series instrument

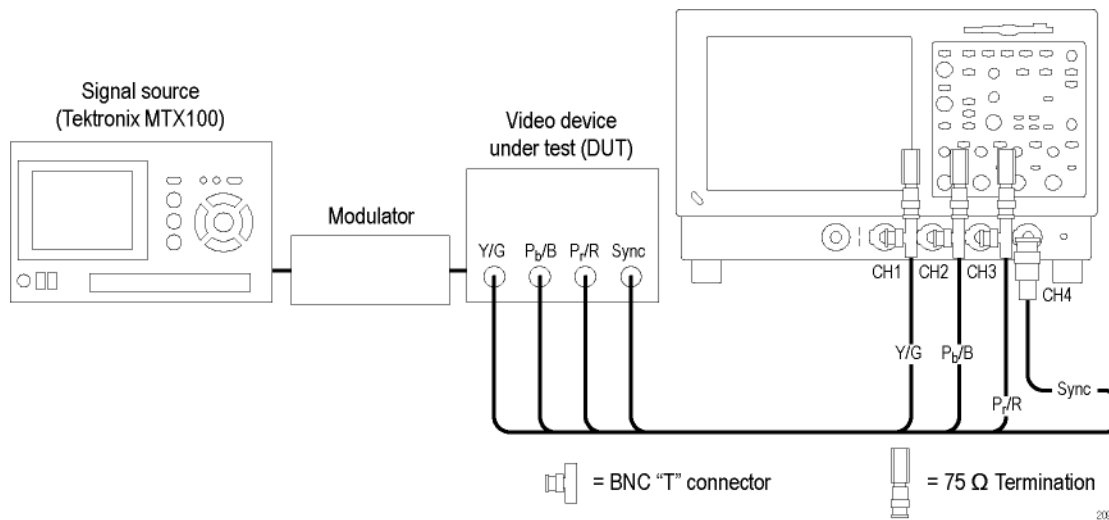

Figure 2- 12: Connecting to a VM5000 / TDS5000 Series instrument

NOTE. Verify that the trigger channel is set to Channel 4 (the default setting). If the trigger setting (Configuration > Operation) is not set to Channel 4, you will see signal warning messages and will be unable to take measurements.

Use the following diagrams to determine the optimum input signal setup for your measurement needs.

**Option VGA Setup 1:
RGBHV Measurement
Interface Unit**

This is the preferred setup for testing PC and play-out device video. Use the RGBHV Measurement Interface Unit to connect the PC video card to the VM Series System. Using the RGBHV MIU provides the most accurate measurement results.

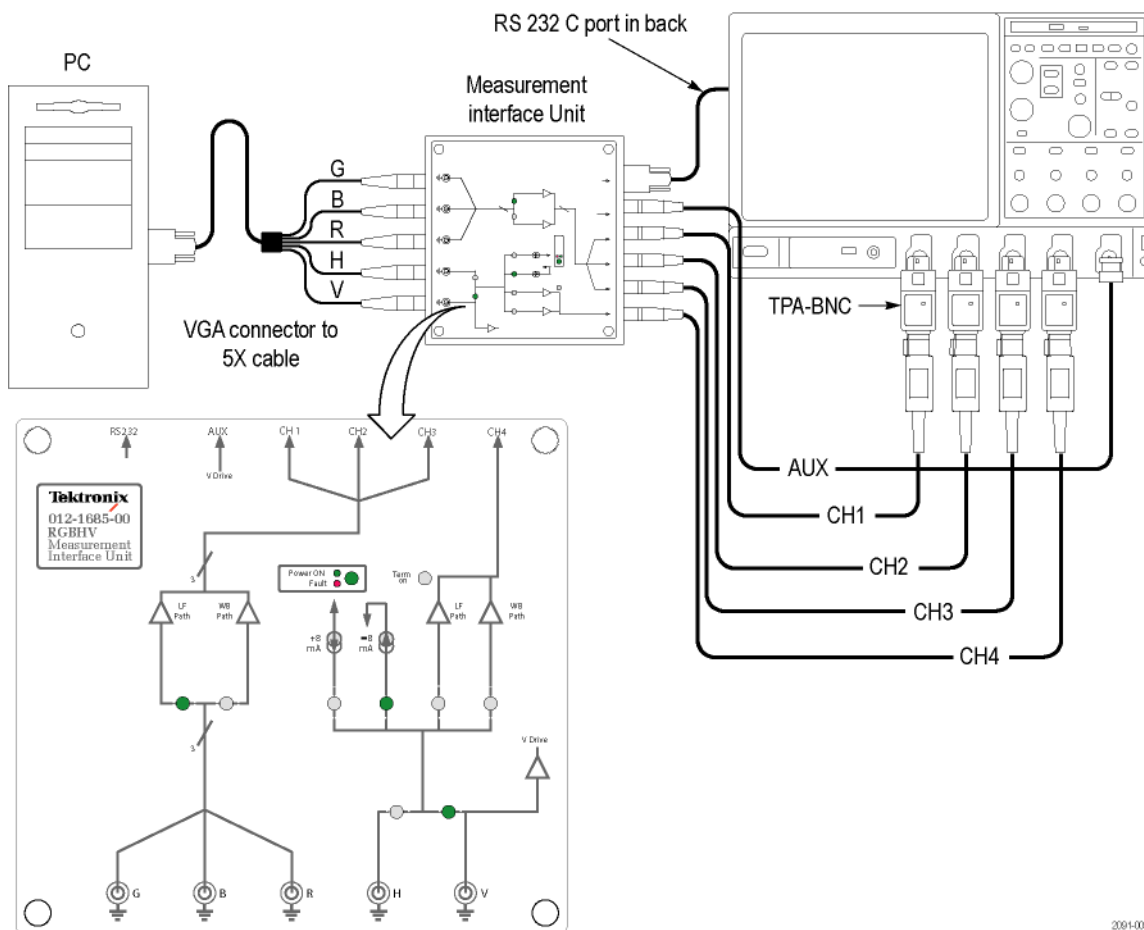

Figure 2-13: Connecting to a VM6000 / DPO7000 Series instrument

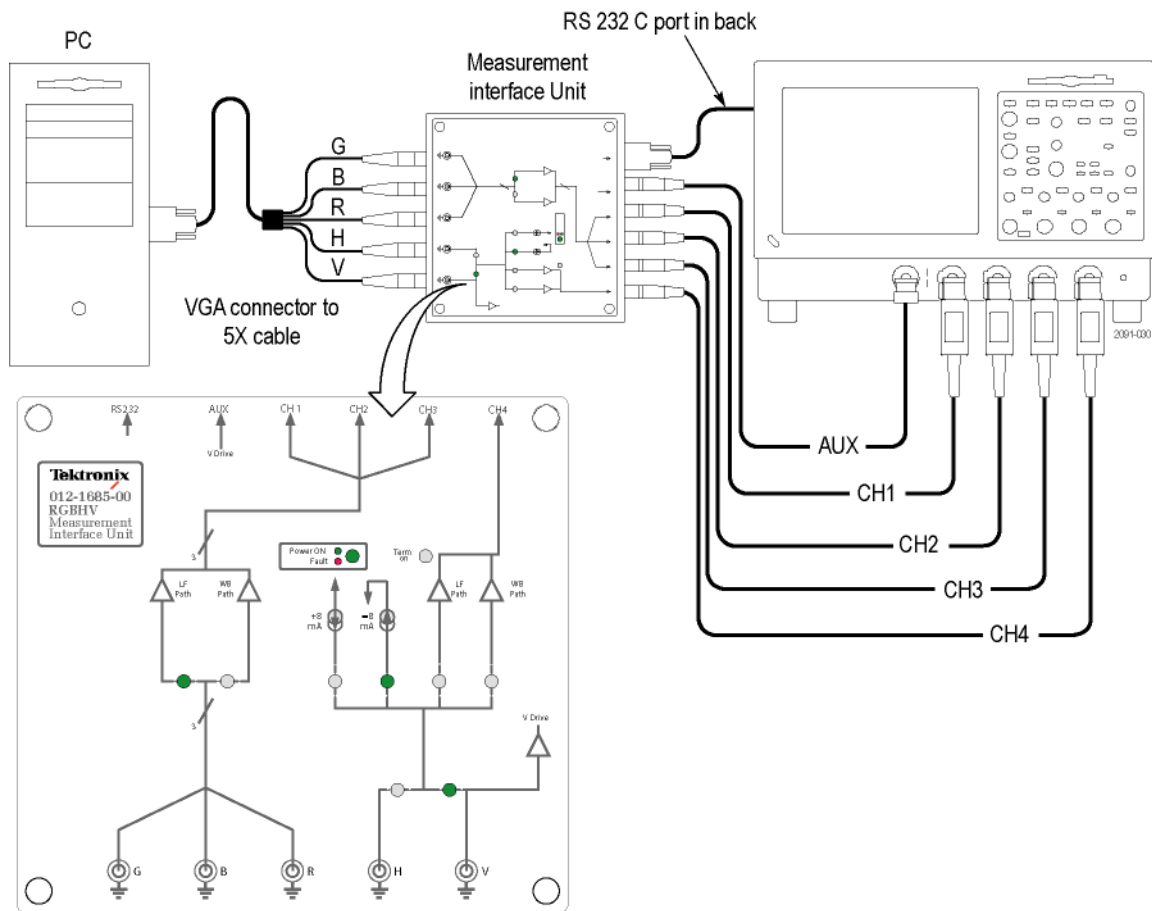

Figure 2- 14: Connecting to a VM5000 / TDS5000 Series instrument

To connect the RGBHV Measurement Interface Unit:

1. Connect the device-under-test (DUT) to the input side of the RGBHV Measurement Interface Unit using one of the VGA-to-BNC adapter cables supplied with your VM Series System.

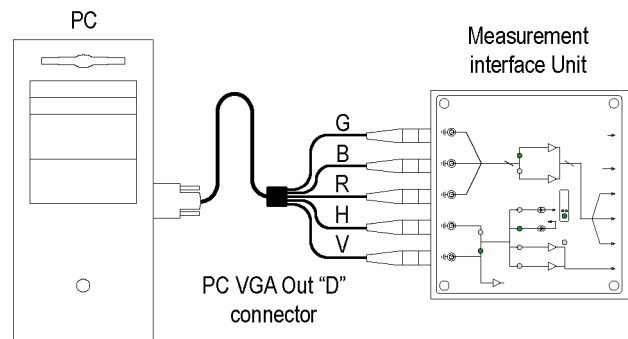

Figure 2- 15: Connecting the DUT to the RGBHV Measurement Interface Unit

2. Connect the outputs (Aux, CH1-CH4) of the RGBHV Measurement Interface Unit to same inputs on the VM Series System (that is, connect the CH1 output to the CH1 input).

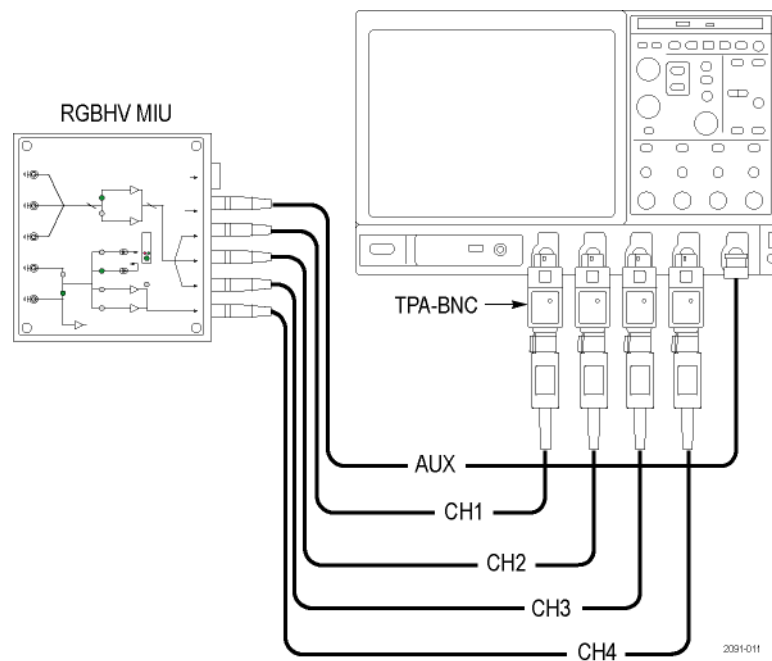

Figure 2- 16: Connecting the RGBHV MIU to a VM6000 / DPO7000 Series instrument

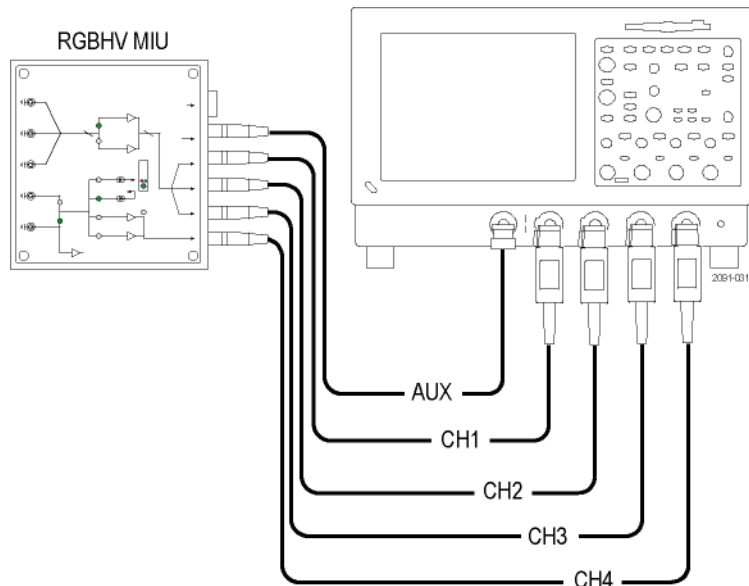

Figure 2-17: Connecting the RGBHV MIU to a VM5000 / TDS5000 Series instrument

3. Connect the RS-232C cable between the RGBHV Measurement Interface Unit and the COM1 port on the VM Series System. See Figure 2-18.

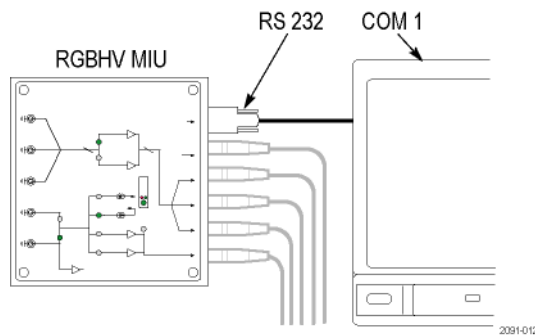

Figure 2-18: Connecting the RS-232C cable between the MIU and the VM Series System

4. Verify that the **Use MIU** check box on the Configuration > Operations tab is selected. See Figure 2-19.

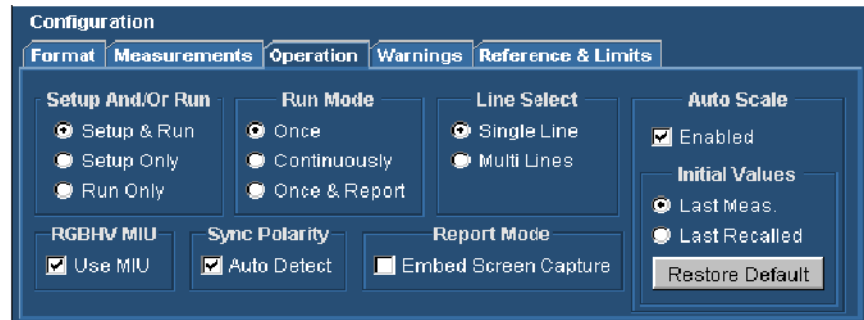

Figure 2-19: Selecting the Use MIU option on the Configuration > Operations tab

Option VGA Setup 2: VGA Connector to 5X Cable

Use this setup for testing PC and play-out device video when it is not convenient to use the RGBHV Measurement Interface Unit. To ensure accurate measurements, connect the signals to the VM Series System using the T-connectors and precision terminations on CH1-CH4. You must use 75 Ω terminations on CH1-CH3 (used for GBR) and 2.21 k Ω and 301 Ω terminations on CH4 (used for H Sync and V Sync measurements). This method requires you to change the signal and termination connections on CH4 for certain horizontal and vertical measurements. The VM Series displays a dialog box prompting you to make these changes when necessary (the RGBHV Measurement Interface Unit performs these connection and termination changes internally).

To connect the DUT to the VM Series System using a 5X cable:

1. Install the included $75\ \Omega$ terminations between the end of the BNC cables and the instrument input Channels 1 through 3, using the included BNC T-connectors. See Figure 2-20. To achieve accurate measurements, it is important to attach the T-connectors directly to the input channel BNCs.

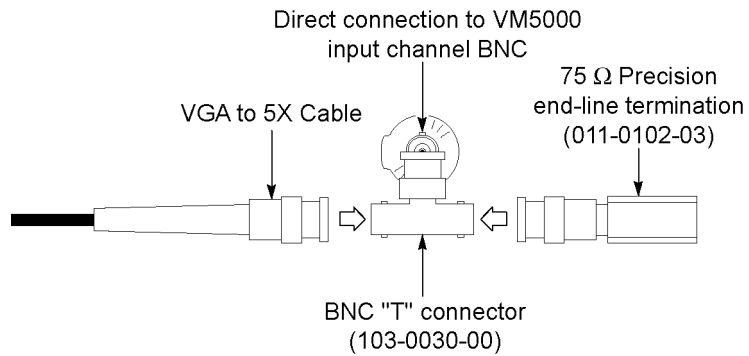

Figure 2-20: Connecting the VGA to 5X cable to the input channel

2. If you will be making H Sync, V Sync, or V Timing measurements, you will need to make $2.21\ \text{k}\Omega$ and $301\ \Omega$ terminations using the BNC-to-Binding Post adapters and resistors supplied as standard accessories.

Attach each resistor to an adapter. See Figure 2-21.

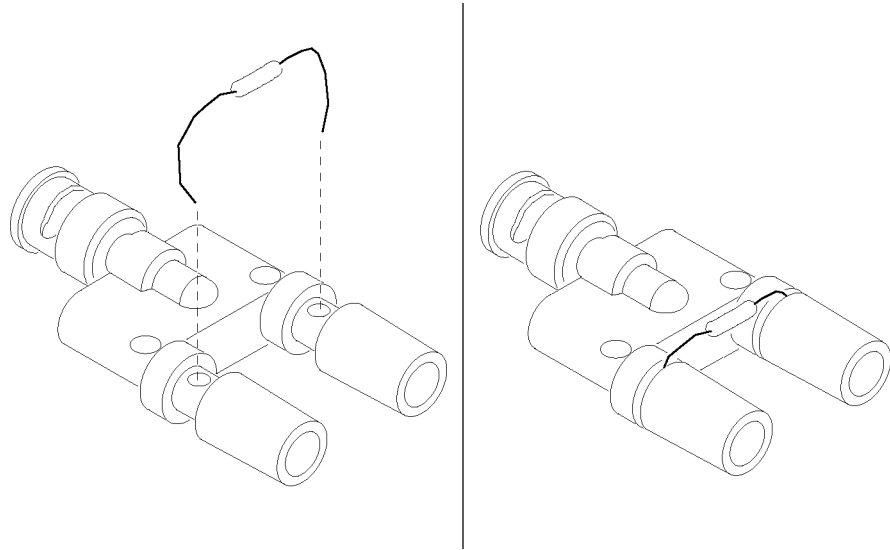

Figure 2-21: Building the 2.21 kilohms and 301 ohms terminations

3. Connect the PC video output signals to the VM Series System. See Figure 2-23. Connect the H Sync signal using the 2.21 k Ω adapter to begin with. The VM Series System will prompt you to change it to the 301 Ω adapter if necessary.

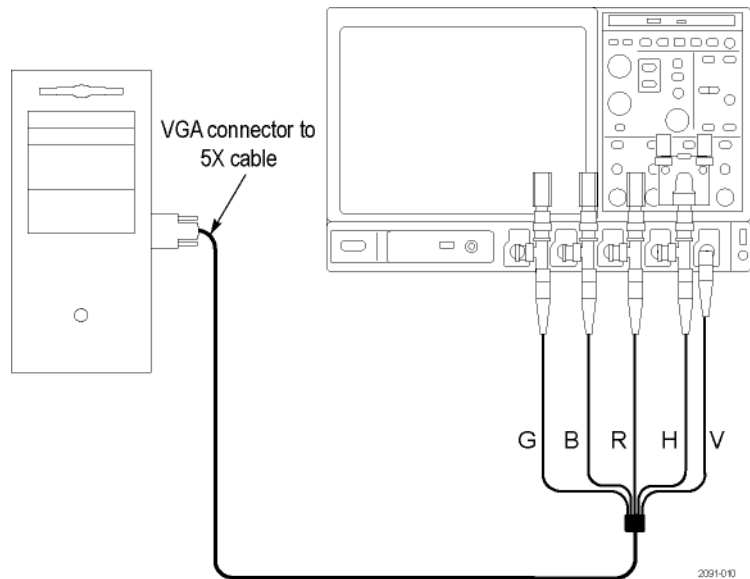

Figure 2-22: Connecting the PC video output signals to the VM6000 / DPO7000 Series instrument

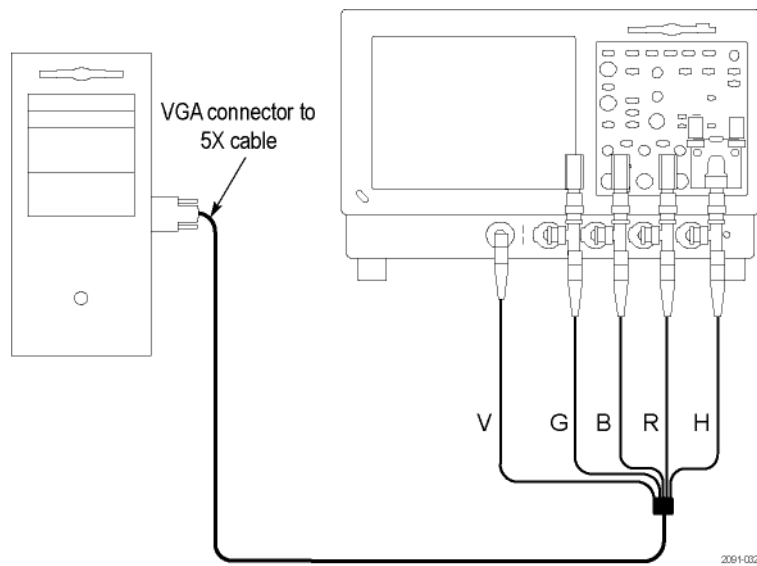

Figure 2-23: Connecting the PC video output signals to the VM5000 / TDS5000 Series instrument

A pop-up warning appears to prompt you to change signal termination on CH4 when making a H Sync measurement. See Figure 2-24.

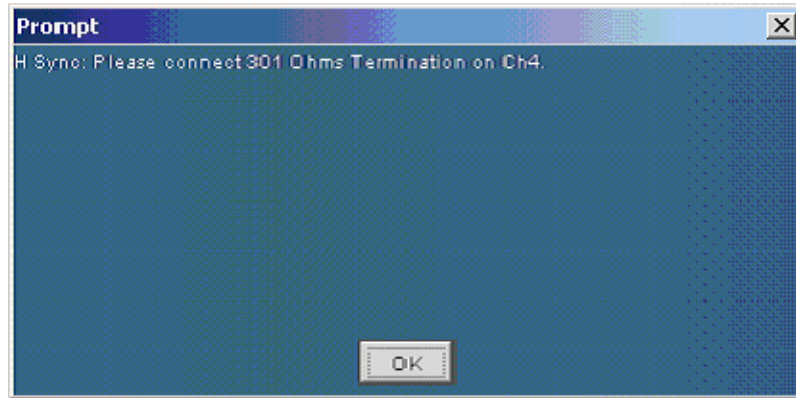

Figure 2-24: Appearance of the pop-up warning when making H Sync measurement

Table 2-1 identifies which signal from the Device-Under-Test (DUT) should be connected to which input connector on the VM Series System and the terminator that should be used for each signal.

Table 2-1: Required connections of the VGA signal, VM Series System, and the terminator

VGA signal (Device Under Test)	VM Series System Input Connector	Terminator
Green	CH1	75 Ω
Blue	CH2	75 Ω
Red	CH3	75 Ω
H Sync	CH4 ¹	2.21 k Ω and 301 Ω
V Sync	AUX	None

¹ V Sync signal is connected to this channel only when making a V Timing or V Sync measurement. The VM Series System will prompt you for this connection change if necessary.

Signal Path Compensation

To optimize measurement accuracy, see the oscilloscope online help to perform the instrument signal path compensation procedure. Use the procedure if the temperature has changed more than 5 °C since the last signal path compensation. Perform the signal path compensation once a week. Failure to do so may result in the instrument not meeting warranted performance levels at those volts/div settings.

Sync Pickoff Compensation - VM6000 and DPO7000 Series, Option SD/HD only

To properly compensate the sync pickoff:

1. Connect the sync pickoff cable to CH1 and CH4. the small housing, labeled “Connect to Trigger Channel”, should be connected to CH4.

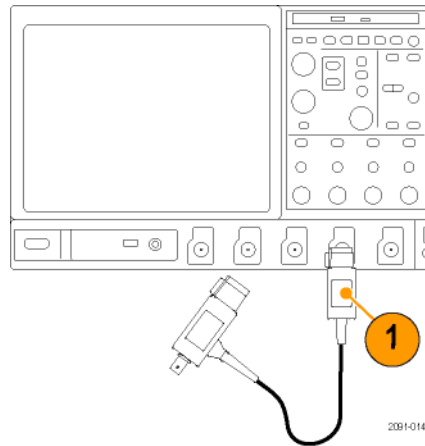

Figure 2- 25: Connecting the Sync Pickoff cable to CH1 and CH4

2. Attach the sync pickoff BNC connector to a BNC-to-minigrabbers connector (Pomana Electronics model number 3789).
3. Connect the minigrabbers to the PROBE COMP connector.

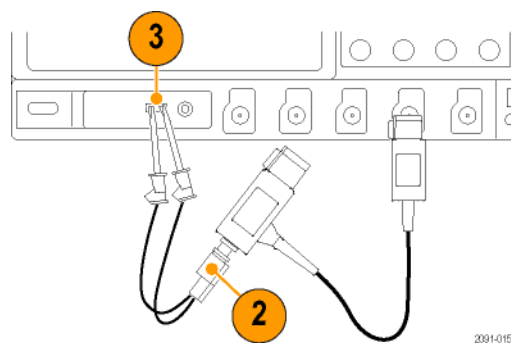

Figure 2- 26: Attaching the Sync Pickoff to a BNC-to-minigrabbers adapter and connecting to PROBE COMP

4. Select CH1 and CH4. Push **FastAcq**. Push **AUTOSET**.

Both the Channel 1 and Channel 4 waveforms should be displayed. It is normal for the waveform to show tilt, caused by the 75 Ω Sync Pickoff termination loading the PROBE COMP output signal.

5. Compare the Channel 1 and Channel 4 waveforms. If they do not have the same shape, adjust the Sync Pickoff compensation (the adjustment is accessed through the side of the small housing).

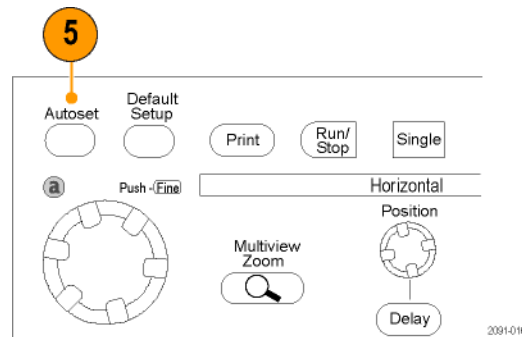

Figure 2-27: Selecting AUTOSSET

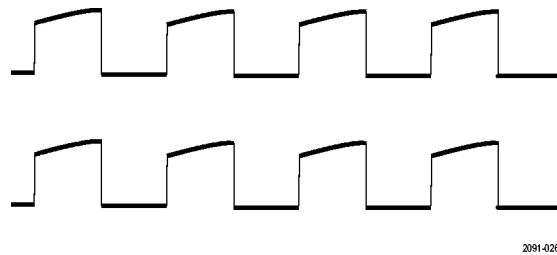

Figure 2-28: Properly compensated

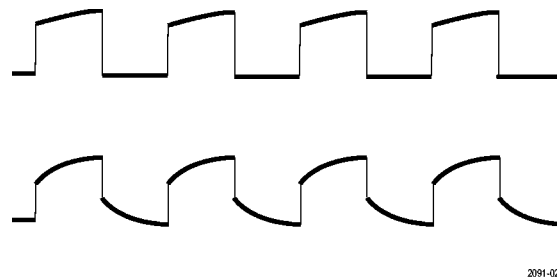
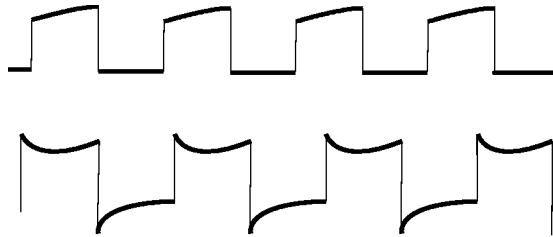

Figure 2-29: Under compensated



2091-025

Figure 2-30: Over compensated

6. If necessary, adjust the sync pickoff. Repeat as needed

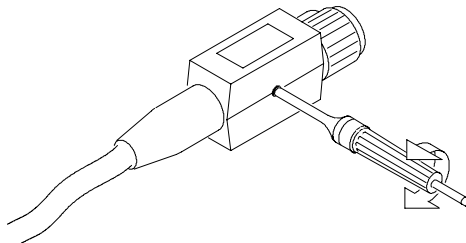

Figure 2-31: Adjusting the compensation

The Matrix Test Signal

The Matrix test signal is available as optional accessories with this product. There is Matrix signal signal for Options SD/HD and a Matrix signal for Option VGA. The Matrix test signal incorporates all the analog video signal requirements within one file (different files are used for Option SD/HD and Option VGA). Using this single test file eliminates the need to change test signals when running different measurements. You can select the setup file (.vmset) that matches the format of the Matrix test signal. The default line number setting is provided for each measurement type. You can change the line number as needed. See Appendix E, *Signal Source Package Contents* for a full description of the files in the Signal Source Disks.

Figure 2-32 shows the Option SD/HD Matrix test signal. Table 2-2 shows the signal elements.

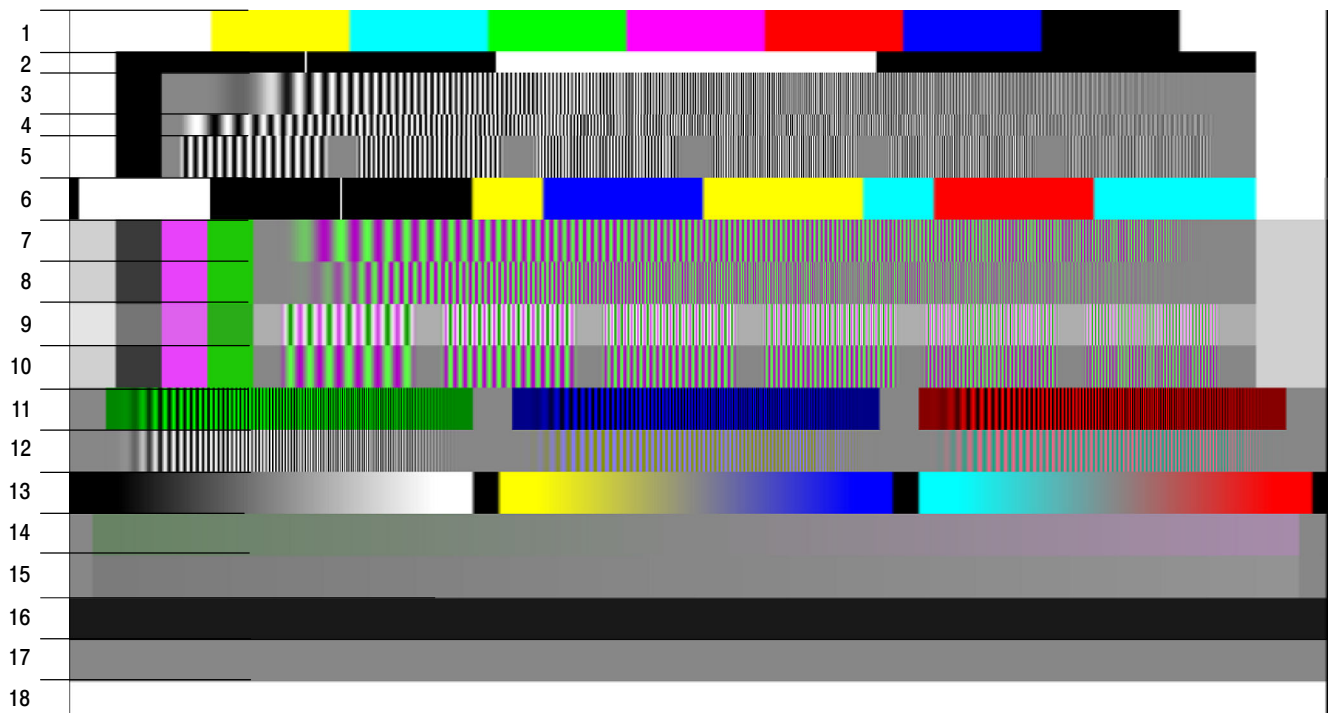

Figure 2-32: Option SD/HD Matrix signal

Table 2-2: Option SD/HD Matrix signal elements

Signal Name	Format	Signal Name	Format	Signal Name	Format
1. Color bars	All	7. YPbPr Sweep Time	YPbPr	13. Valid Ramp	All
2. RGB Pulse Bars	RGB	8. YPbPr Multiburst	YPbPr	14. YPbPr Shallow Ramp	YPbPr
3. RGB Frequency Sweep	RGB	9. YPbPr Multiburst	YPbPr	15. RGB Shallow Ramp	RGB
4. RGB Time Sweep	RGB	10. YPbPr Multiburst	YPbPr	16. Flat Field 7.5%	All
5. RGB Multiburst	RGB	11. RGB Crosstalk	RGB	17. Flat Field 50%	All
6. RGB Pulse Bars	RGB	12. YPbPr Crosstalk	YPbPr	18. Flat Field 100%	All

Figure 2-33 shows the Option VGA Matrix test signal. Table 2-3 shows the signal elements.



Figure 2-33: Option VGA Matrix test signal

Table 2-3: Elements of Option VGA Matrix Signal

Signal Name	Signal Name
1. Half White and Half Black	5. Black White Black
2. Nine Colorbars	6. Full White
3. 32 Steps	7. Ramp
4. Alternate White and Black	8. Half White and Half Black

The addressable line number pattern of the matrix signal is based on the following equations:

Half White and Half Black Bars (1-9.5%)
 Nine Color Bars (10.5-29.5%)

- 32 Steps (30.5-39.5%)
- Alternate White and Black Bars(40.5-49.5%)
- Black-White-Black Bars (50.5-59.5%)
- Full White (60.5-69.5%)
- Staircase (70.5-89.5%)
- Half White and Half Black Bars(90.5-100%)

The actual line number which user enters in the application is calculated based on the following equation:

$$\text{Active Line Number} = \text{Vertical Sync Time} + \text{Back Porch} + \text{Addressable Line Number according percentage}$$

For 1280x1024 resolution, 85 Hz refresh rate, and DMT timing standard the Vertical Sync Line is 3, Vertical Back Porch is 44.

For Half White and Half Black pattern,
 The Start Active Line Number = 3 + 44 + 1 = 48
 The End Active Line Number = 3 + 44 + 97 = 144
 The line range for Half White and Half Black for 1280x1024 at 85 Hz would be 48 - 144.

Table 2-4 shows an example of the resolutions and the corresponding line number ranges the DMT timing standard supports at 60 Hz refresh rate for Option VGA matrix signal.

Table 2-4: Resolutions and line number ranges supported at 60 Hz (DMT standard) for Option VGA

Pattern	640x480	800x600	1024x768	1280x1024	1600x1200	1920x1200	1920x1440
1. Half White and Half Black	28-73	28-84	36-108	42-138	50-163	43-156	60-196
2. Nine Colorbar	77-169	90-204	116-262	149-343	175-403	168-396	210-484
3. 32 Steps	173-217	210-264	269-338	353-445	415-523	408-516	498-628
4. Alternate White and Black	221-265	270-324	346-415	456-548	535-643	528-636	642-772
5. BlackWhite-Black	269-313	330-384	423-492	558-650	655-763	648-756	786-916
6. Full White	317-361	390-444	500-569	661-753	775-883	768-876	930-1060
7. Ramp	365-457	450-564	576-722	763-957	895-1123	888-1116	1074-1348
8. Half White and Half Black	461-507	570-627	730-803	968-1065	1135-1249	1128-1242	1362-1499

For other refresh rates, the actual starting line number can be noticeably different from the 60 Hz refresh rate. To view the active video line number location for a specific pattern at another refresh rate, locate the Microsoft Excel file, Matrix-Signals-LineNumbers.xls located on the VM Series software CD. This file lists the Actual Video line numbers for all supported refresh rates.

Starting the Application

Ensure that you have set up the input signal sources before running the measurements (See page 2-28).

1. Power on the instrument. The instrument displays the default main screen.

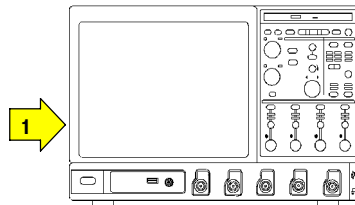

2. On the menu bar, click **File > Run Application > VM HD and SD Video V3.2.** or **Analyze > VM HD and SD Video V3.2** or

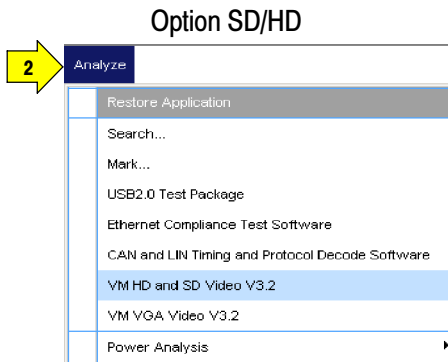

- or
- File > Run Application > VM VGA Video V3.2** or **Analyze > VM VGA Video V3.2.**

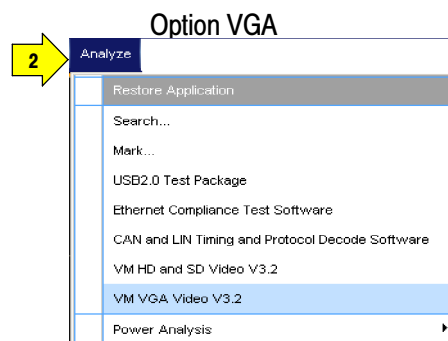

- The instrument reduces the waveform area to the upper part of the screen, and opens the VM Series application in the lower part of the screen.

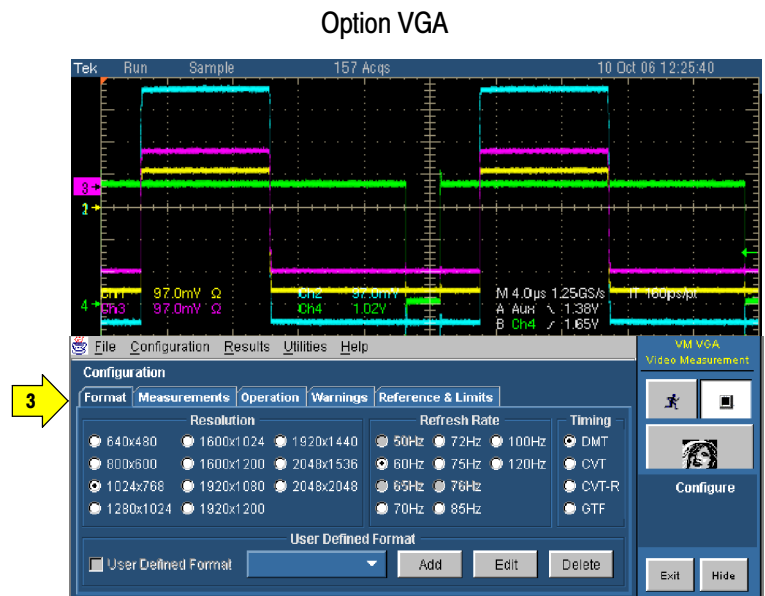
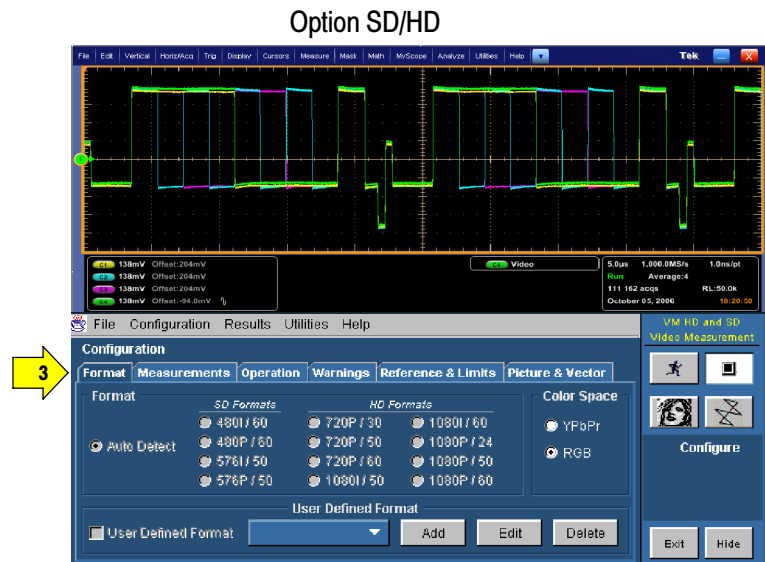

The VM Series Application User Interface

1. Menu bar: The menu bar allows you to configure the different parameters of the application. Use the menu bar to display the results information in the Results window.
2. Application view: The main application window displays the configuration controls and the measurement results.

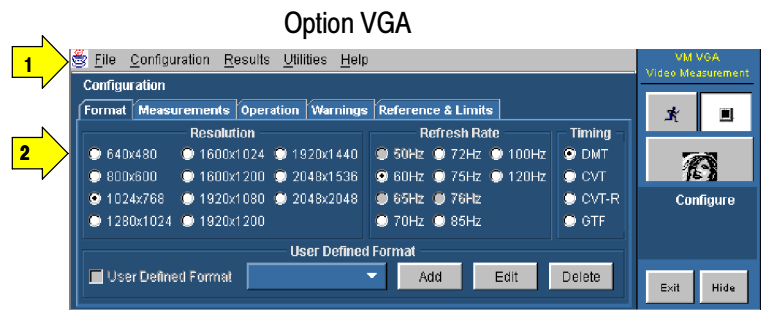
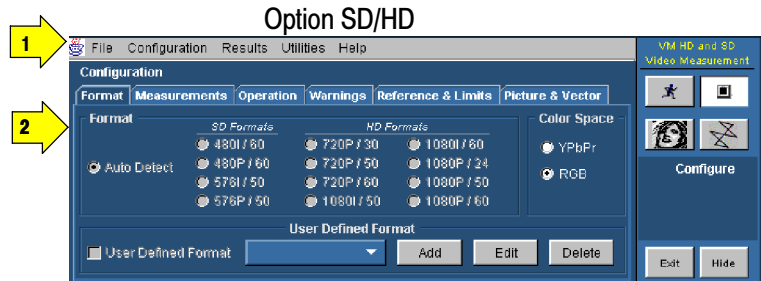

3. Run button: Click **Run** to run the selected measurements and to display the results.
4. Stop button: Click **Stop** to stop running the selected measurements.

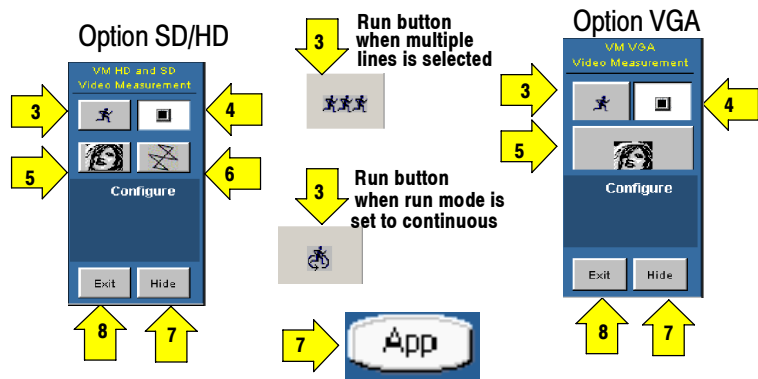

5. Picture button: Click the **Picture** button to display the picture of the signal.
6. Vectorscope button (Option SD/HD): Displays the signal in vectorscope format.
7. To access the Windows desktop, for example, to view reports, click **Hide**. In the main screen, click **File > Minimize**, and then click **Hide** again.

8. Exit button: Click **Exit** to quit the application. From the Exit dialog box you can choose whether to retain the settings. The default setting for **Restore Scope Setting?** is **No**. Click the button to change the option to **Yes**.

To quit the application, click **OK**. If you don't want to quit the application, click **Cancel**.

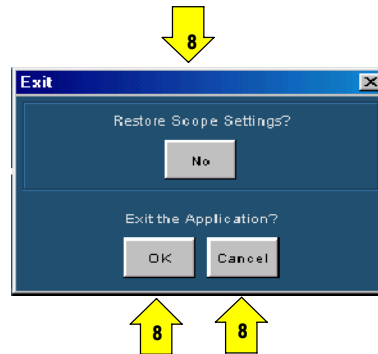

9. To restore the application window after hiding it, select the **Analyze > Restore Application**.

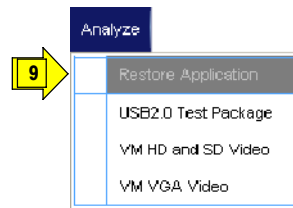

Measurement Steps Overview

1. Use the **Configuration > Format** menu to set the input signal format standard (such as 1080i/60) and refresh rate (page 2-29).
2. Use the **Configuration > Measurements** menu to select one or more measurements to run (page 2-33).
3. Use the **Configuration > Operations** menu to set the measurement run operations, such as run mode and trigger channel (page 2-34).
4. Click **Run** to run the selected measurements and view the measurement results (page 2-48).
5. Use the **Utilities > Generate Report** menu to save the measurement results to a file (page 2-58).

Setting the Input Signal Format

1. On the menu bar, click **Configuration > Format**.

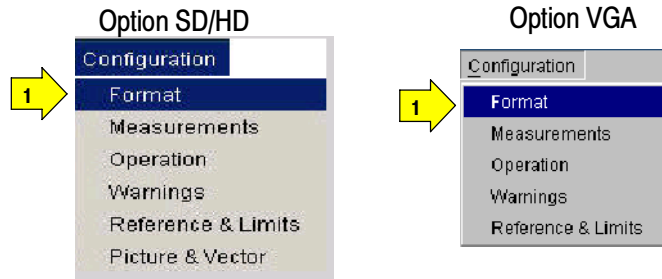

2. The Format panel appears.

When Auto Detect is selected or a valid format is not available, then the format dependent measurement input parameters are disabled.

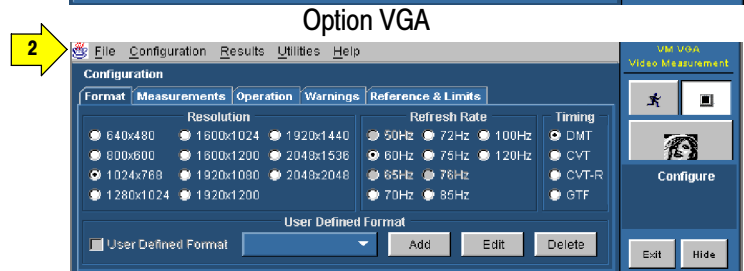
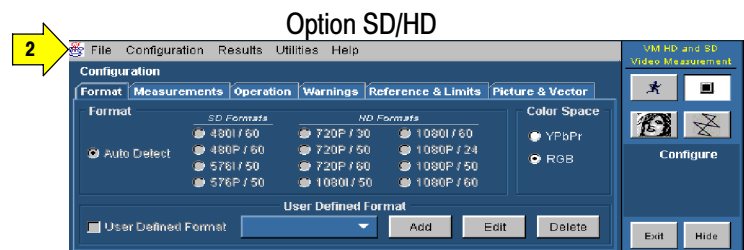

3. Select one of the standard video formats or define your own format using the User Defined Format option.

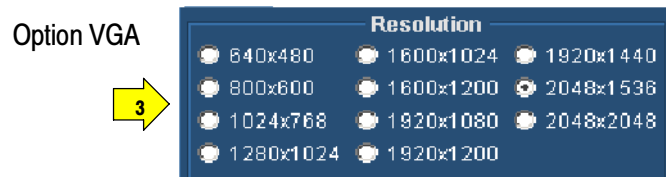
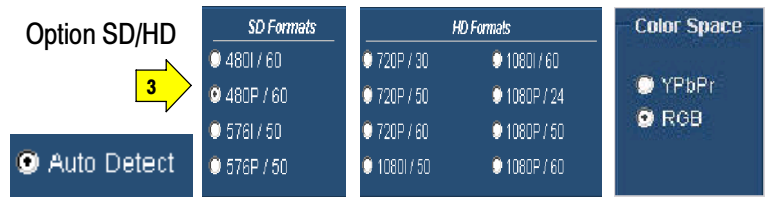

When Auto Detect is selected, the application automatically detects the input format once the run button is pressed without you having to specify a valid format, selects the associated measurement line number setup, and performs the selected measurements.

If relative and limit testing have been enabled, then the application will also load the appropriate reference and limit values from the files associated with the detected format.

The detected format name is displayed under the measurement name in the Results panel for each selected measurement. “---” will be displayed when a valid format has not been detected.

- The application supports creating customized formats and provides the values for the list of parameters that are required to correctly define and identify a format. You can choose a user-defined custom format by selecting the “User Defined Format” in the Format Configuration pane.

To add a new user-defined format, select **User Defined Format** and click **Add**.

To edit a user-defined format select **User Defined Format** and click **Edit**. The User Defined Format window appears. Enter appropriate values for the horizontal and vertical parameters. To save your new format, enter a name in the Format Name field and click **Save**.

To delete a user defined format, select the User Defined format and click **Delete**.

Option SD/HD

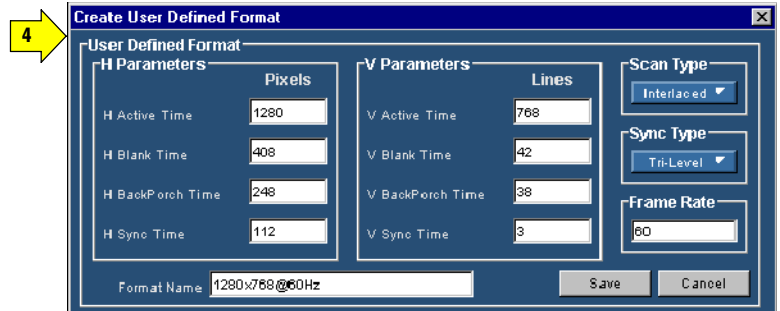

Option VGA

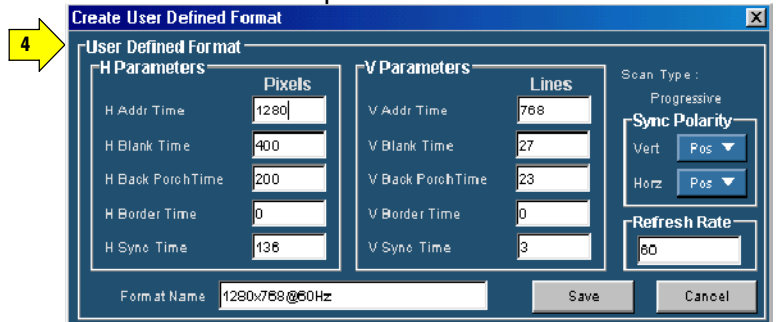

Option SD/HD

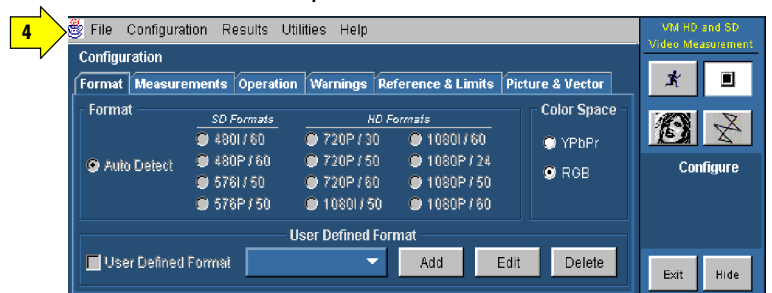

Option VGA

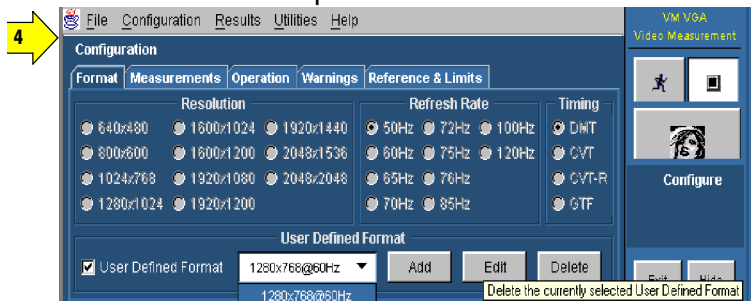

5. Select the appropriate Color Space (Option SD/HD) or Refresh Rate (Option VGA).

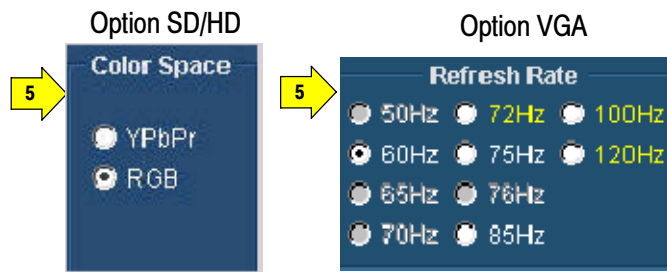

6. Select the appropriate timing standard for the signal (Option VGA).

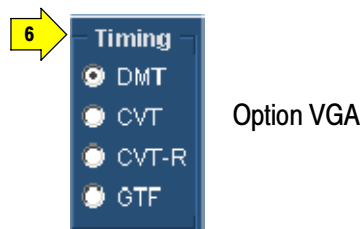

- **DMT:** The Display Monitor Timing standards and guidelines are used for lower resolutions or refresh rates that are in common industry use in lower performance systems.
- **CVT:** The Coordinated Video Timing standard is a method for generating a consistent and coordinated set of standard formats, display refresh rates, and timing specifications for computer display products, both those employing CRTs and those using other display technologies. CVT addresses problems found in GTF.
- **CVT-R:** The Coordinated Video Timing Reduced Blanking standard is for use with non-CRT displays that can accept reduced horizontal blanking times.
- **GTF:** The Generalized Timing Formula standard is a method for generating general purpose display timings and new formats. This allows much greater flexibility in the choice of refresh rates and pixel formats than currently available with discrete monitor timings. GTF enables new formats and refresh rates to be developed, but is based on some set parameters to improve the likelihood of interchange.

If a timing standard or refresh rate is not available for the selected resolution, then the timing standard or refresh rate is disabled. Select the resolution, refresh rate, and the timing standard for the signal you are measuring. If a resolution is selected and the currently selected refresh rate is not available in the selected resolution, the refresh rate will automatically change to the default value of 60 Hz. A message informs you of the change. If a resolution is selected and the currently selected timing standard is not available for the selected resolution, the timing standard will automatically change to a supported timing standard in the order of CVT, DMT, and GTF. A message informs you of the change.

Selecting the Measurements

1. On the menu bar, click **Configuration > Measurements**.

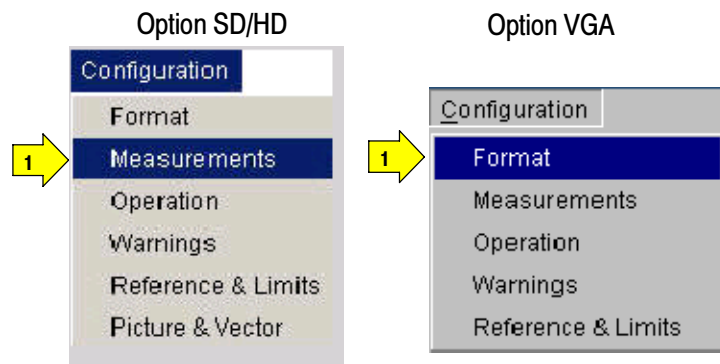

2. Select from one to twelve measurements in any combination.

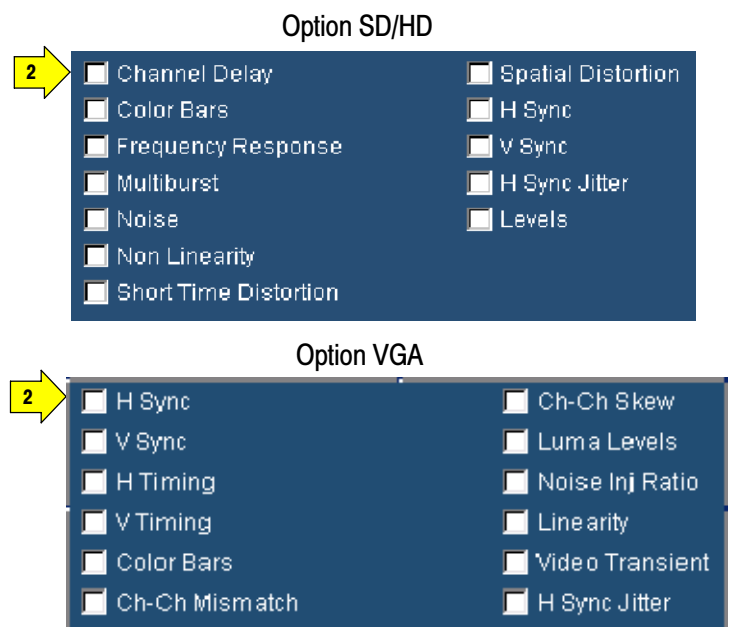

Setting the Measurement Run Operations

1. Select **Configuration > Operation.**

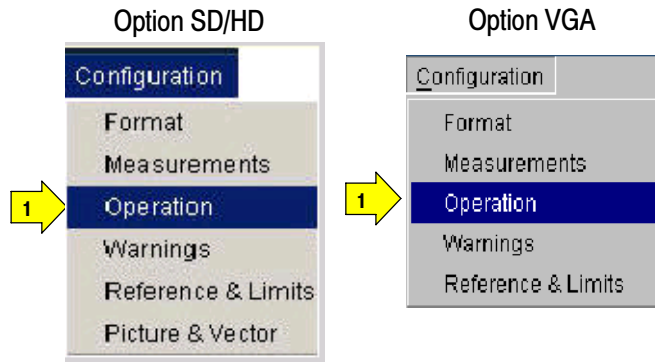

2. The instrument displays the Operations window. These settings control how the instrument sets up and acquires measurements when you click **Run.**

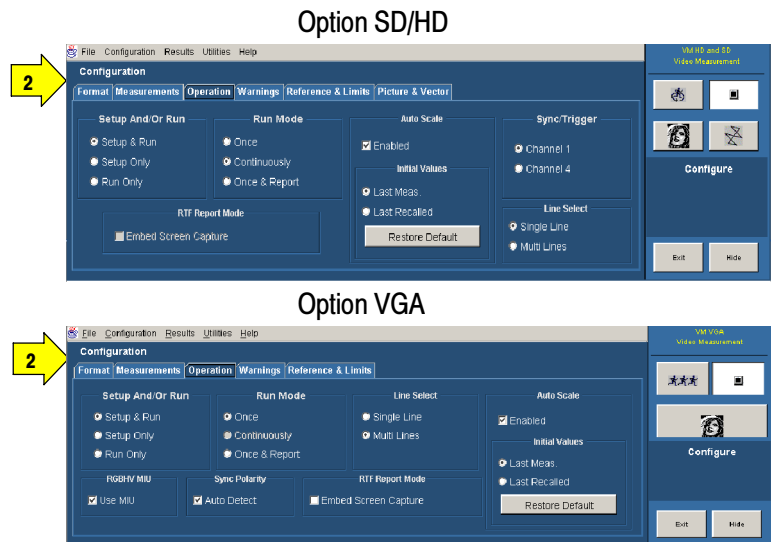

3. Select how the instrument sets up and runs the measurements.



Setup & Run: Configures the instrument setting and takes a measurement, for each selected measurement, and for each measurement acquisition. Use this when taking multiple measurements that require different instrument setups.

Setup Only: Configures the instrument for a measurement but does not take the measurement. Use this to set up customized settings. Try out your settings by pressing the Run button, making adjustments as needed (for example, change the horizontal scale), and then pressing the Run button again. Once you are satisfied with your customization, use the Run Only setting to collect results. Setup Only is not selectable for certain measurements like H Sync, V Sync, Noise Inj Ratio, V Timing, and Video Transient as they need multiple settings for the oscilloscope and MIU.

Run Only: Takes a measurement using the existing instrument configuration. Designed for taking measurements with custom settings (see the *Setup Only* description above).

4. Select how the application acquires measurements (Run Mode).



Once takes each selected measurement the number of times determined by the averaging setting, then stops taking measurements.

Continuously continually takes measurements. You must select the Stop button to stop measurements.

Once & Report takes each selected measurement the number of times determined by the averaging setting, presents the report, and stops taking measurements.

5. Auto Scale fits the signal within the available vertical scale. Auto Scaling adjusts the vertical scale units so that the input signals fill the graticule as much as possible. Auto Scaling occurs once for each selected measurement. Select the Enabled check box to enable waveform Auto Scale. Clear the **Enabled** check box to disable waveform autoscaling.

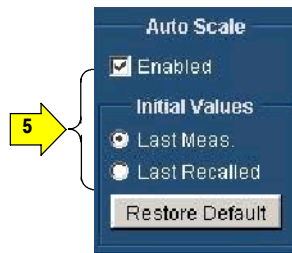

In the initial values pane, there are three settings:
Last Meas, **Last Recalled**,
and **Restore Default**.

Last Meas.: is the default. When selected, the values from the last measurement will be used at the start of the next Auto Scale step.

Last Recalled: when selected, the values recalled with the last recalled setup will be used at the start of the next Auto Scale step. If a setup (File > Recall Setup) has not been recalled since the program was started, the application will load the Auto Scale settings from the last power up.

Restore Default: when selected, the Factory Default Auto Scale starting points will be used at the start of the next Auto Scale step. See page 3-8 for details.

NOTE. *If you take measurements on the wrong line or with the wrong scale setup, press the Restore Default button before taking measurements again.*

6. (Option SD/HD) Select the instrument channel that has the sync signal for triggering.

If you use the wrong trigger channel (and Signal Warnings is on), you will get a signal warning. See the setup diagrams and trigger requirements on page 2-3.

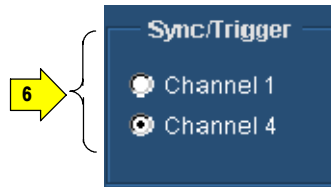

7. Choose the Line Select setting as appropriate. In Single Line mode, each measurement is made on a single line (for example, line 153). In Multi Lines mode, measurements are made across a range of lines (for example, lines 153-185).

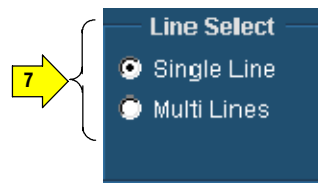

Single Line takes each selected measurement on the line specified in the Line Number field of the Results window.

Multi Lines takes each selected measurement across a range of lines. You acquire measurements across multiple lines by specifying the starting and the ending line numbers. When Multi Lines is selected, the Generate Report button in the Utilities > Generate Report panel is not selectable. When Multi Lines is selected, the Run Mode operation settings Once and Once & Report are selectable and the report is generated based on the configuration set in the Utilities > Generate Report. The Results Summary panel is not accessible when Multi Lines is selected. For more information, see *Taking Measurements Across Multi Lines*, on page 2-51.

8. (Option VGA) Select Use MIU to automatically route H and V signals to the CH4 output depending on the selected measurements.



9. (Option VGA) The specified polarities for the H Sync and V Sync signals vary between the timing standards.



In the absence of the MIU and with Auto Detect selected, the VM Series will prompt you to connect the H Sync and V Sync signals to determine the polarities. If you use the MIU, the VM Series will automatically determine the H Sync and V Sync polarities.

Once the sync signal polarities are determined, the measurement cycle begins. This “polarity test” is performed at the beginning of every measurement cycle. To prevent this test from running at the beginning of every measurement cycle, take any measurement once with Auto Detect selected. Once a measurement cycle has been completed with Auto Detect selected, you can clear Auto Detect.

The VM Series remembers the polarity of the sync signals. Any time you change the format setup for the device-under-test, you should complete a measurement with Auto Detect selected.

10. In the RTF Report Mode pane, select Embed Screen Capture to include a snapshot of the waveform display in the results report only in RTF format.

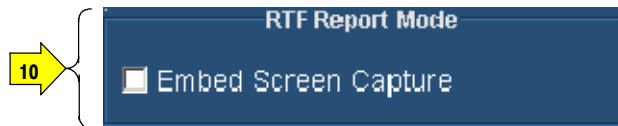

Setting the Measurement Warnings

1. On the menu bar, click **Configuration > Warnings**.

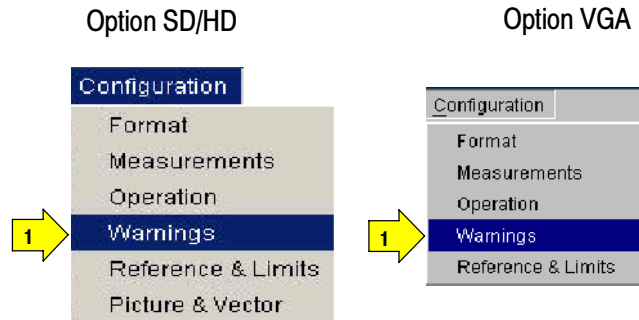

2. The instrument displays the Warnings view. These settings control how the instrument sets up the Warning Types Reported and the Control Options when you select the Run button.

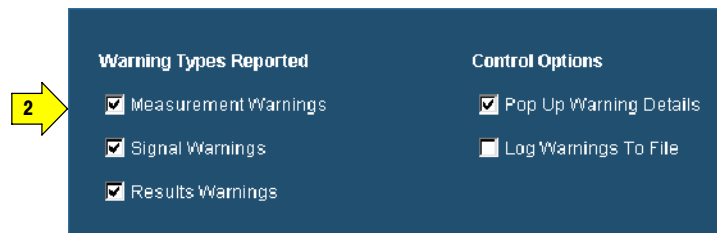

3. Select the warning messages to report when a warning occurs.

See page 3-10 for more information.

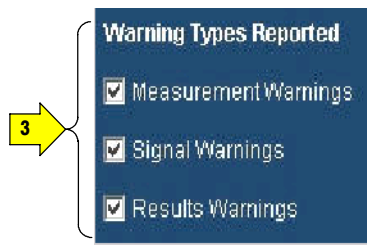

4. Select how to report warning messages by selecting the check boxes in the control options pane. Messages can be displayed in a window or logged to a file.

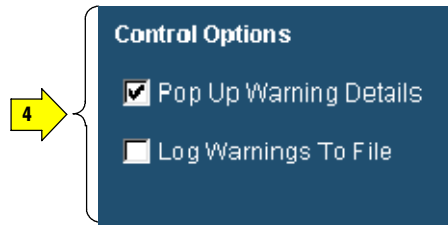

NOTE. If *Log Warnings To File* is selected, the warnings are written to the *Log.txt* file (Option *SD/HD* at *C:\VMApps\OptHDSD* or Option *VGA* at *C:\VMApps\OptVGA*). Warnings are appended to the *Log.txt* file until it reaches 1 MB in size. At that point, it is renamed *LogOld.txt* and a new *Log.txt* file is created. If the new file reaches 1 MB in size, it will be renamed *LogOld.txt* and will be written over the existing *LogOld.txt* file. If you want to save the data in the *LogOld.txt* file, you must save the file under a different name before it is overwritten.

Setting Reference and Limits Options

When you run a measurement relative to a reference, the VM Series runs the measurements and displays the difference between the measured value and the reference value. The reference values are stored in a reference file. Limit Testing provides a Pass/Fail indication by comparing the measured value to limit values. The limit values are the maximum and minimum values that are stored in limit files.

NOTE. *The default reference file (or default limits file) is provided as is without warranty of any kind, and is intended to be used as a template only. WARRANTIES OF MERCHANTABILITY AND FITNESS FOR A PARTICULAR PURPOSE ARE EXPLICITLY DISCLAIMED.*

1. Select **Configuration > Reference & Limits**.

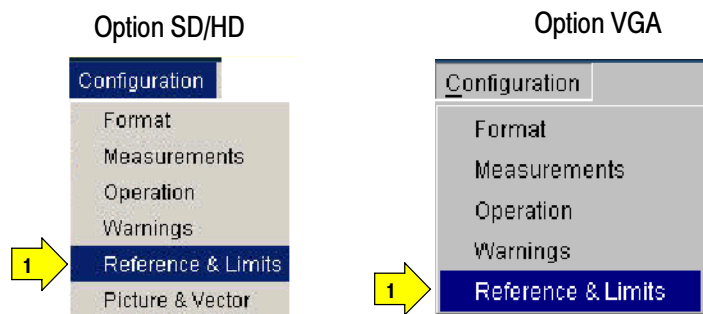

2. The instrument displays: the **Relative Result Display** and the **Limit Testing** in the Configuration display view.

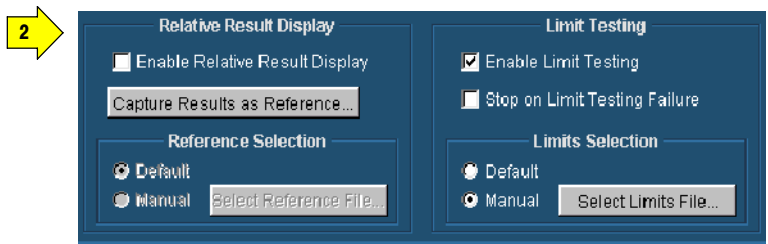

3. When you select **Enable Relative Result Display**, the VM Series enables the options in **Reference Selection** to select a reference file. For more details, see page 3-78.

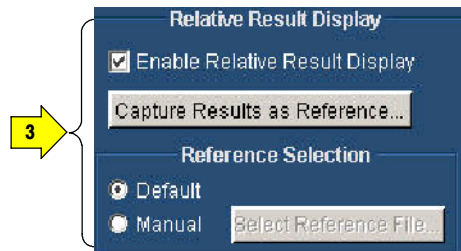

Capture Result as Reference saves measurements to a reference file using the actual measured values as the reference values. For more details, see page 3-82.

4. Select **Enable Limit Testing** to enable pass/fail testing. When limit testing is enabled, the choices under Limits Selection are used to specify the limits file used. By default, the VM Series application automatically selects a limits file from a set of supplied templates that matches the selected signal format. For more details, see page 3-82.



When you select the **Stop on Limit Testing Failure** option, the measurement execution stops when limit testing fails.

Displaying the Input Signal as a Picture

The VM Series will display a picture of the input signal for Options SD, HD, and VGA.

1. Click the picture button.



2. This launches the video monitor window. The instrument displays the picture. Click the maximize button to expand the picture to full screen.

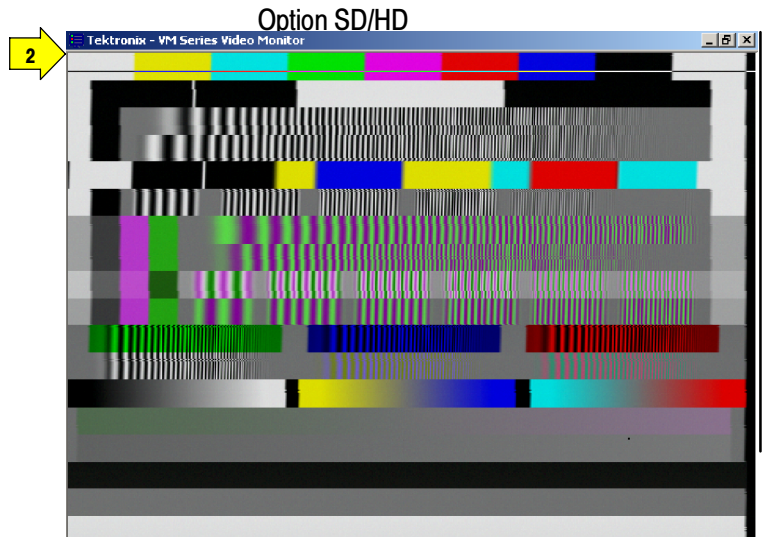

Option VGA

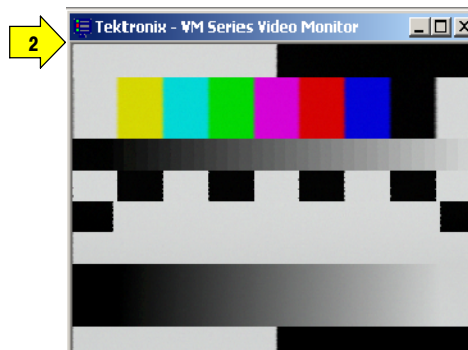

Changing Picture Display Settings

Option SD/HD You can change the settings for the Picture and Vector displays as follows:

1. Select **Configuration > Picture & Vector.**

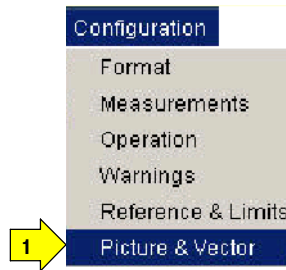

2. The instrument displays the Picture & Vector panel. These settings control the display parameters of the picture and vectorscope displays.

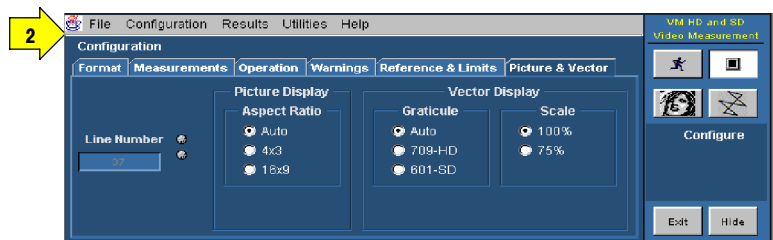

3. Line Number sets the video line number that is displayed in the vectorscope display or that is highlighted in the picture display.

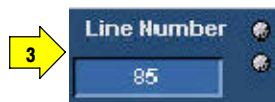

Use the line number to identify features in the picture. To remove the line, set the line number to a line outside the active video. Note that the line number on the Picture & Vector tab is not used to specify where measurements are taken.

4. Sets the width to height ratio of the picture display based on the format.

Auto is the default. Auto determines the aspect ratio of the video signal and sets the picture display accordingly

The **4x3** setting is for SD format and **16x9** is for HD format.

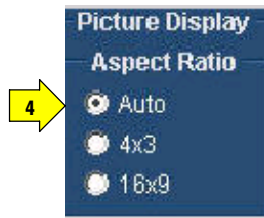

5. Sets the Graticule and the Scale of the Vector Display.

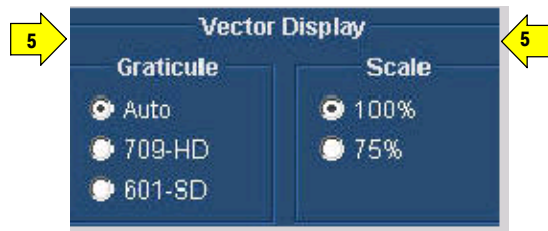

Displaying the Input Signal in a Vectorscope Window for Option SD/HD

The VM Series can display the input signal in a vectorscope window so that you can quickly see the color range of the signal.

The vectorscope display is created by displaying the chrominance portion of the video signal in its two components, B-Y and R-Y. These two signals are then plotted against each other in an X-Y fashion, with B-Y on the horizontal axis and R-Y on the vertical axis.

Three color bars signals are used with vectorscopes: 75% and 100% full field color bars and the SMPTE color bars. The 100% and 75% labels refer to the amplitude of the signal.

1. Select **Configuration > Picture & Vector.**

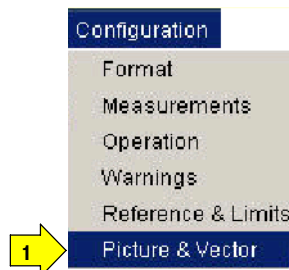

2. The instrument displays the Picture & Vector tab which provides access to the picture and vectorscope settings.

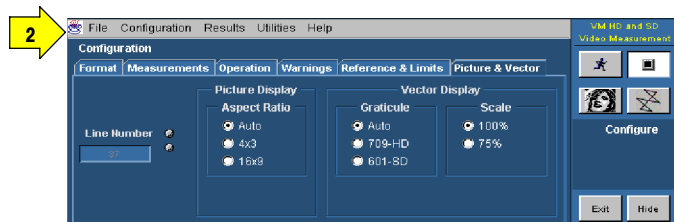

3. Sets the video line number that is displayed in the vectorscope display.

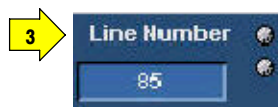

NOTE. The line number on the Picture & Vector tab is not used to specify where measurements are taken.

4. Sets the Graticule and the Scale according the video signal format.

Auto is the default setting in Graticule. This setting can be either HD or SD depending on the format selected.

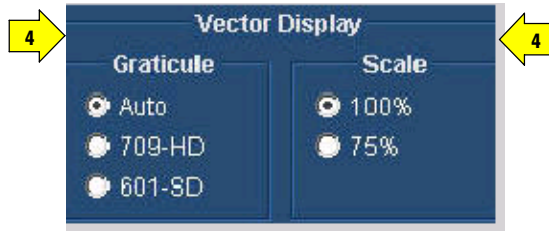

5. Click the vector button.



6. This launches the video monitor display window. Click the maximize button to expand the vectorscope display to full screen.

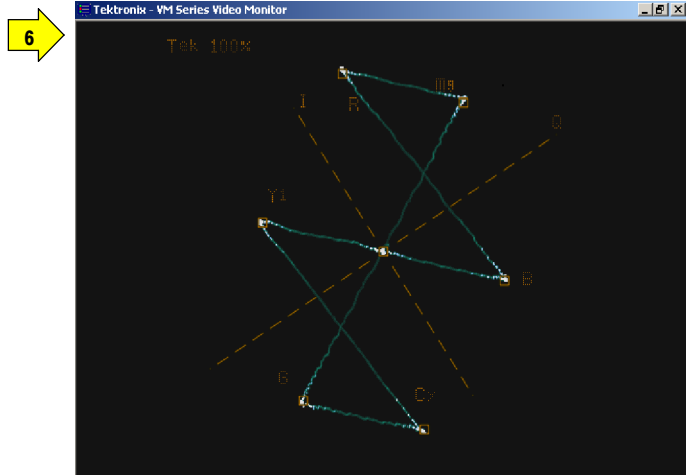

Taking and Viewing the Measurement Results

Ensure that you select a signal format, select one or more measurements, and configure the run options before you run a measurement.

1. Select the Run button.

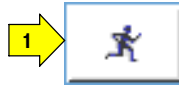

The instrument begins taking measurements and displays the measurement results for the recently taken measurement.

Option SD/HD

Line Number	Measured	Relative	Reference	Limits
229	Front Porch	1304.8	T(ns)	Line Time
	Neg. Sync Fall	137.71		33.57
	Neg. Sync Width	4886.0		Start of AV
	Sync Rise	150.5		End of AV
	Pos. Sync Width	---		Front Porch Level
	Pos. Sync Fall	---		Neg. Sync Level
	Back Porch	4300.8		Pos. Sync Level

Option VGA

Line Number	Measured	Relative	Reference	Limits
637	mV	11.553	G	11.553
		36.198	B	36.198
		1.533	R	1.533
	Inj Ratio (%)	1.533		1.533

NOTE. The internal measurement results have a higher precision than the results displayed, which are rounded to three decimal places.

- The instrument displays the Results Summary window when two or more measurements are selected. The results are displayed as Pass or Fail if Limit Testing is enabled.

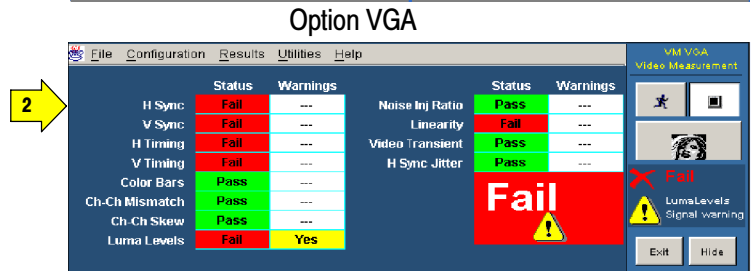
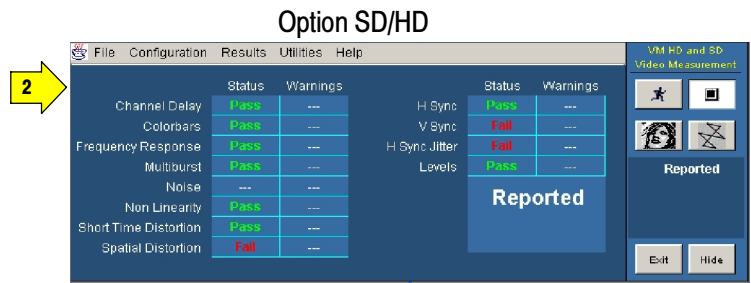

- To view the detailed results for the measurements, select the Results menu and any one of the selected measurements.

Option SD/HD



Option VGA

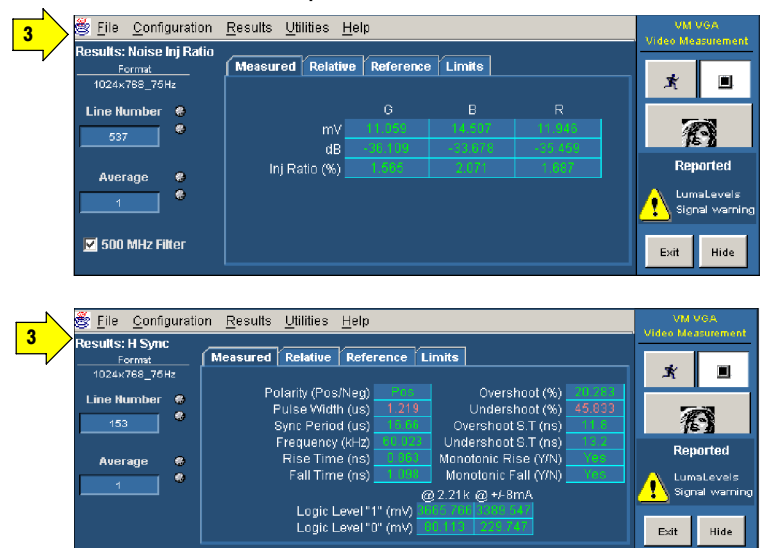

- If you set the run operation to **Continuously**, press the **Stop** button to stop taking measurements.



Taking Measurements Across Multiple Lines

To take measurements across multiple lines, you must set the Line Select mode to Multiple Lines. When the Multiple Lines mode is enabled, you can specify which measurements are taken and the range of lines across which they are taken.

When Line Select is set to Multiple Lines, measurement results are automatically saved to a file. The Multiple Lines result for the specified range of lines are averaged and displayed in the Results panel. The Results panel also displays the range of line numbers in the Line Number field.

To view the results of multiple line measurements, open the report file using the appropriate application.

The Results Summary panel is not accessible when Multi Lines is selected.

1. After setting Line Select to Multiple Lines in the Operation panel, select **Configuration > Measurements**.

Select the measurements you want to take. Enter the Start Line and End Line values for each measurement. Click Utilities > Generate Report to specify the parameters of the file into which the measurement results will be saved.

The Results panel displays the range of line numbers in the Line Number field.

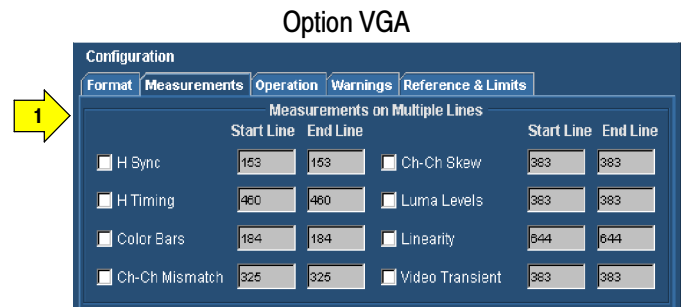
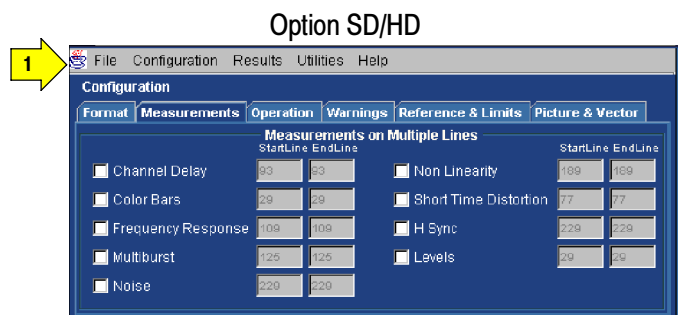

Changing Line Number or Averaging on the Results Screen

You can change the video signal line number and the number of measurements to average before displaying the results. The instrument stops measuring, changes the results to dashes, and uses the new settings at the start of its next measurement cycle. See page 3-17 for information on line numbers and averaging.

1. Select a measurement from the Results menu. For example, click **Results > Color Bars**

Option SD/HD

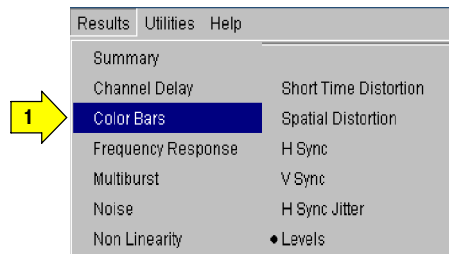

The instrument displays the Color Bars measurement results.

Measured	Relative	Reference	Limits
Unit: mV	Y / G	Pb / B	Pr / R
White	765.75	707.21	706.21
Yellow	707.48	1.57	707.96
Cyan	767.98	707.6	2.67
Green	708.11	1.59	0.85
Magenta	2.79	707.78	709.0
Red	1.48	1.74	707.35
Blue	0.92	707.72	1.69
Black	0.49	1.6	1.07

Option VGA



Measured	Relative	Reference	Limits
Unit: mV	G	B	R
White	881.856	884.713	888.868
Yellow	881.528	0.475	881.177
Cyan	881.436	884.881	0.481
Green	881.868	0.756	0.147
Magenta	1.132	883.798	888.437
Red	0.743	0.882	888.711
Blue	0.557	883.88	0.882
Black	0.488	0.888	0.743

2. To change a value, select the field and enter a value using the keyboard. You can also change values using one of the methods outlined in step 3 and step 4.

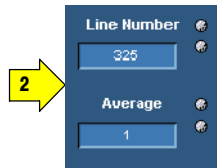

3. Select the keypad icon to the left of the field to display a virtual keyboard to enter values using the touch screen.

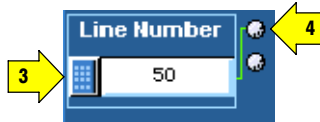

4. Use the indicated general purpose knob to change the values.

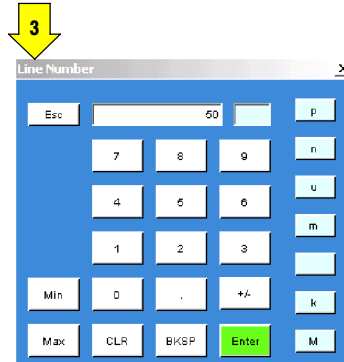

Saving Measurement Setups

1. Select **File > Save Setup**.

The application displays the Save dialog box.

The default save location for Option SD/HD is C:\VMApps\OptHDS.

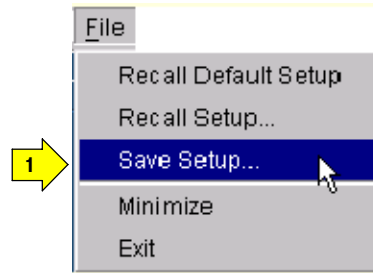

Option SD/HD

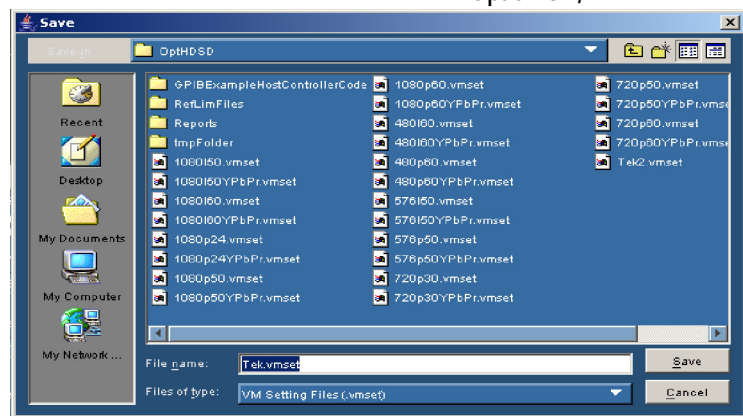

Option VGA

The default save location for Option VGA is C:\VMApps\OptVGA.

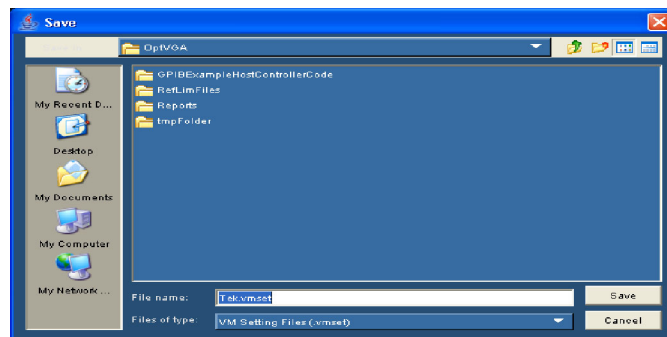

2. Select the **Look in** list to navigate to a different directory other than the default save location.

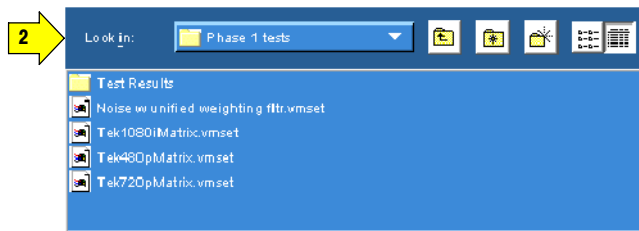

3. Enter a file name in the File Name box. The instrument offers an available file name (or you can choose your own). It automatically appends .vmset to the file name of measurement setup files.
4. Select **Save** to save the measurement settings.



Recalling Measurement Settings

1. Select **File > Recall**.

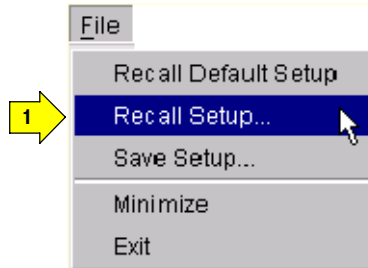

2. The application displays the Recall dialog box and lists all the instrument setting files present in the default directory

Option SD/HD default directory:
C:\VMApps\OptHDS

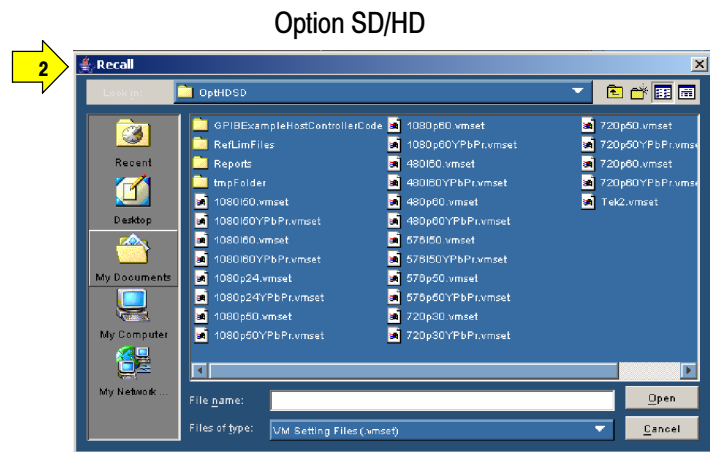

Option VGA default directory:
C:\VMApps\OptVGA.

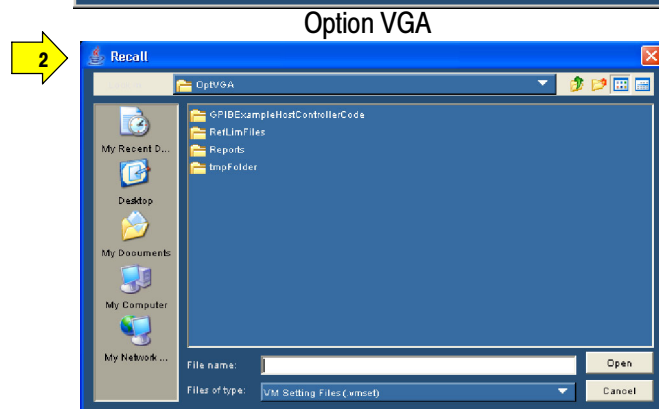

3. Select the **Look in:** drop-down list to navigate to a different directory other than the default location.

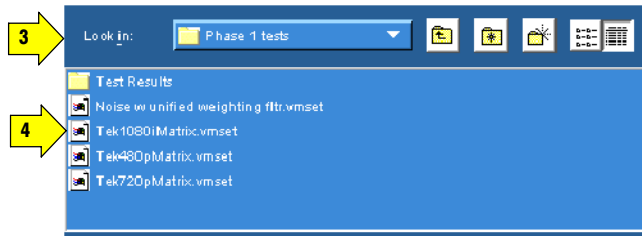

4. Select a file from those listed.

5. Enter a file name in the **File name** box or select a file from the list.



6. Select **Open** to load the settings file and configure the instrument.

Saving Measurement Results (Reports)

You can use the Generate Report feature to save your measurement results.

1. Select **Utilities > Generate Report.**



2. The instrument displays the **Utilities: Generate Report** view.

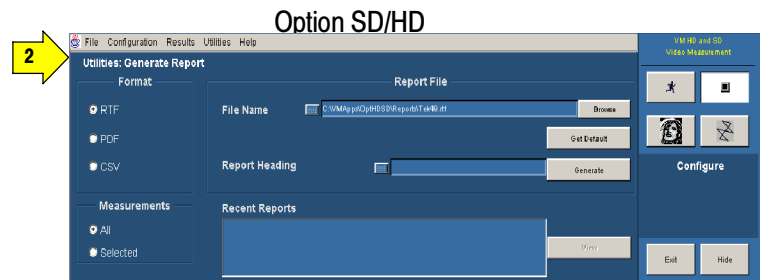

3. Select a report format. Which format you to select depends on what you want to do with the measurement results.

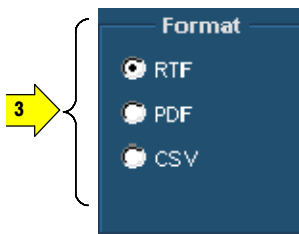

- RTF:** Use RTF (Rich Text Format) to create results data that you can incorporate into documents.
- PDF:** Use PDF (Portable Document Format) to create files of the measurement data for distribution and viewing.
- CSV:** Use CSV (Comma-Separated Values) to save results in a format that contains information on all the new measurements and options. For example, Relative to Reference and Limit Testing results are included in the report.

4. Use the File Name box to specify where you want to save the report. Use the Browse button to navigate to a specific location. Use the Get Default button to reset the file name to the default location and name for the selected format.

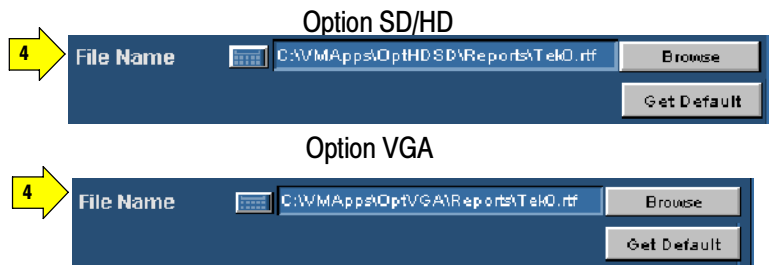

5. Use the Report Heading field to add notes into the report file. You can enter up to 46 characters. For example: “Serial Number 123456789012 tested by Joe P.”



Select Generate to save the measurement results in the specified format and location. All selected measurements are saved together in a single file; each measurement has its own area in the report.

When Multi Lines is selected, the Generate button in the Utilities > Generate Report is not selectable.

6. Use the Measurements option to select which measurements to save to a report.



All: Creates a report with all the measurements you have run since starting the application which have valid results in the results panels.

Selected: Creates a report with only the measurements that are currently selected in the Configuration > Measurements screen and that have valid results in the results panels.

7. Click Generate in the application to save the measurement results in a report file in the specified format. You can either specify a file name or use the report file name generated by the application. All selected measurements are saved together in a single file; each measurement has its own area in the report.

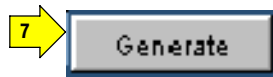

8. Click View to display the recent report files in the Recent Reports pane that is created for the measurements in any of the supported formats: RTF, PDF, or CSV.



The application creates the report files automatically if you select Once & Report in the Configuration pane or manually if you click Generate in the Utilities > Generate Report.

A maximum of twenty report files can be listed. When the list gets full the old entries at the bottom of the list are deleted and the new entries are added at the top of the list.

When the application is started for the first time after installation, the View button is not selectable and the Recent Reports pane will not have any report files listed.



Reference

Reference Overview

This chapter provides a detailed description of the VM5000 instrument menus and measurements.

- Menu descriptions. Table 3-1 below lists the top level menus of the instrument and the corresponding sections in this chapter that document those menus. The menu descriptions include high-level descriptions of the measurements.
- Measurement details. In-depth descriptions of each measurement begin page 3-35 and page 3-57.

Table 3-1: Overview of menu descriptions

Menu	Submenu	Function	Page
File	Recall Default Setup	Restores default settings of the application.	3-3
	Recall Setup...	Recalls (load) application settings that have been previously saved on the hard disk.	
	Save Setup...	Saves (write) current application setting to hard disk.	
	Minimize	Minimizes the application to the Windows task bar.	
	Exit	Opens the application Exit dialog box.	
Configuration	Format	Sets the input signal format.	3-6
	Measurements	Selects the measurements.	
	Operation	Sets the measurement runtime options.	
	Warnings	Sets the type of warning reported.	
	Reference & Limits	Sets the Reference and the Limit Testing related options.	
	Picture and Vectorscope (Option SD/HD)	Sets the settings related to the Picture and vectorscope display of the video signal.	

Table 3- 1: Overview of menu descriptions (Cont.)

Overview of menu descriptions			
Menu	Submenu	Function	Page
Results	Summary	Displays the result summary for all the measurements.	3-19
	Channel Delay, Color Bars, Frequency Response, H Sync, H Sync Jitter, Levels, Multiburst, Noise, Non Linearity, Short Time Distortion, Spatial Distortion, and V Sync (Option SD/HD) Ch-Ch Mismatch, Ch-Ch Skew, Color Bars, H Sync, H Sync Jitter, H Timing, Linearity, Luma Levels, Noise Inj Ratio, V Sync, V Timing, and Video Transient (Option VGA)	Adjusts the individual measurement settings and display the results. Adjusts the measurement specific settings and display the results.	
Utilities	Generate Report	Configures the report generation related setting and manually generate reports to a specified file format.	3-32
Help	Help Topics	Opens the VM Series online help system.	3-33
	About VM HD and SD... (Option SD/HD)	Displays the application version number.	
	About VM VGA... (Option VGA)	Displays the application version number.	

Menu Descriptions

The following tables list each menu item and its functions. Items in **bold face** are the default application settings when you first start the application or after you do a Recall Default or Recall Setup... operation.

File Menu

Recalling a setup file changes the configuration; current measurements will stop execution and the results appear as dashes.



CAUTION. To avoid losing unsaved measurement results, generate a report before you recall the default setup or another .vmset setup file.

Menu Item	Function	Setting or field	Description
Recall Default Setup	VM Series recalls (loads) and applies the default settings of the application.		
Recall Setup...			Recalls (loads) and applies application settings that have been previously saved on the hard disk.
	Look in	Drop-down menu	Specifies the directory listed in the File list area. Option SD/HD: default location is C:\VMApps\OptHDSD Option VGA: default location is C:\VMApps\OptVGA
	File list area	Filename list field	Lists directories (folders) and setup files that are in the current directory (as set by Look in).
	File name	Text entry field	Field in which to enter an application setup file to load and apply. You can also double-click on a file name in the File list area to enter the name in the File Name field.
	Files of type	Drop-down list box	Lists the valid setup file types. The only valid entry is .vmset. To get valid test results, be sure to choose the appropriate setup file for the signal source you are using. Option SD/HD: For example, for the Matrix signal source file Tek1080iMatrix.trp, be sure to use the Tek1080iMatrix.vmset setup file. The correct .vmset setup file will have the correct line numbers for each measurement as the default Option VGA: For example, for the Matrix signal source file Matrix.bmp, be sure to use the Matrix.vmset setup file. The correct .vmset setup file will have the correct line numbers for each measurement as the default.

Menu Descriptions

Menu Item	Function	Setting or field	Description
	Open		Loads and applies the specified instrument setting file.
	Cancel		Closes (exits) the Recall dialog and does not load or apply any settings.
Save Setup...	Saves (writes) the current application measurement settings to the specified file name and directory. All of the Save dialog functions are the same as those for the Recall dialog except for the Save button.		
	Save		Saves the application measurement settings to the specified file directory (as set by Look in) and file name (as entered in the File name field) as file type .vmset.
Minimize	Minimizes the application to the Windows task bar.		
Exit	Opens the application Exit dialog box.		

Configuration Menu

Option SD/HD

In the configuration menu you can set the format of the input signal, select one or more measurements, set the setup mode, run mode, set the warning options, enable reference and limit testing, and set Picture and Vector display parameters.

All the selected measurement results will appear as dashes any time you change any of the following configurations:

- Format
- Color Space
- Trigger

If you change a configuration while running a measurement or a setup, the measurement or setup will stop.

Recalling a setup file changes the configuration; current measurements will stop and results appear as dashes.



CAUTION. *To avoid losing unsaved measurement results, generate a report before changing any configuration parameters other than selecting measurements or turning warnings on or off.*

Bold values in the *Setting or field* column in the following tables indicate the default value.

Menu Item	Function	Setting or field	Description	
Format	Set the video input signal format. The Format setting also affects other measurement settings, such as the video signal line number to use when taking measurements.			
	Format	Auto Detect	Configures to automatically detect the format.	
		SD Formats 480I / 60 480P / 60 576I / 50 576P / 50	Sets the input signal format.	
		HD Formats 720P / 30 720P / 50 720P / 60 1080P / 24 1080P / 50 1080P / 60 1080I / 60 1080I / 50		
	Color Space	YPbPr RGB	Sets the input signal color space type.	
	User Defined Format	User Defined Format		Sets the user defined formats available for the input signal that you intend to measure. When the user defined format is selected, all the formats along with the auto detect are disabled.
		List box		Lists the User Defined Formats available.
Add			Creates a new User Defined Format.	
Edit			Modifies the selected User Defined Format.	
Delete			Deletes the selected User Defined Format.	

Menu Item	Function	Setting or field	Description
Measurements	Select the video signal measurements to take. You can select from one to twelve measurements, in any combination.		
	Measurements	Channel Delay Color Bars Frequency Response H Sync H Sync Jitter Levels Multiburst Noise Non Linearity Short Time Distortion, Spatial Distortion V Sync	Select from one to twelve measurements, in any combination. When you click Run, the selected measurements will be taken. The result of the selected measurements will be included in any report that you generate. Click Utilities > Generate Report and set Measurements to Selected. For more information see <i>Detailed Measurement Information</i> on page 3-35. For a high-level overview of measurements, see <i>Results Menu</i> on page 3-19.
Operation	Set the measurement runtime options, including test run mode, input trigger channel, and warning message display.		
	Setup And/Or Run	Setup & Run	For each selected measurement, and for each measurement acquisition, this setting automatically configures the instrument settings and takes a measurement. Use this when taking multiple measurements that require different instrument setups.
		Setup Only	The application configures the instrument for a measurement but does not take the measurement. Use this to set up customized settings. Customized settings might include changes to the instrument Horizontal or Vertical front panel controls to display and measure a non-supported video signal standard. Click Run to try out the settings, make adjustments as needed (for example, change the horizontal scale), and then click Run again. Once you are satisfied with the customizations, use the Run Only setting to collect results.
		Run Only	This setting uses the current instrument and application settings to take a measurement. Use this for taking measurements after you setup the instrument by using Setup Only to create custom settings.
	Run Mode	Once	The application takes each selected measurement the number of times required for the average you have selected, and then stops taking measurements.
	Run Mode	Continuously	This setting continually takes measurements, in the order the measurements are listed in the Configuration > Measurements view. Select Stop to stop measurements.
Once & Report		The application takes each selected measurement the number of times determined by the averaging setting, then stops taking measurements and generates a report.	

Menu Item	Function	Setting or field	Description
	Auto Scale	<p>Enabled</p> <p>Initial Values—Last Meas, Last Recalled, Restore Default</p>	<p>Select the Enabled check box to enable waveform autoscaling. Deselect the Enabled check box to disable waveform autoscaling. In the selection Initial Values, there are three settings: Last Meas., Last Recalled, and Restore Default. Last Meas. is the default. When selected the values from the last measurement will be used at the start of the next Auto Scale step. Last Recalled when selected, the values recalled with the last recalled setup will be used at the start of the next Auto Scale step. If a setup (File > Recall Setup) has not been recalled since the program was started, it will load the Auto Scale settings from the last power up. Restore Default when selected, the Factory Default Auto Scaling adjusts the vertical scale units so that the input signals fill the entire graticule as much as possible without going out of range. Auto Scaling occurs once for each selected measurement.</p> <p>If you are using custom instrument settings (for example, changes to Vertical or Horizontal settings made from the instrument front panel or from remote GPIB commands), you should turn Auto Scaling Off.</p> <p>If you are sure your signal is set up correctly and you want to make further measurements in a high speed production line, set Auto Scale to Off.</p>
	Sync/Trigger	<p>Channel 1</p> <p>Channel 4</p>	<p>This setting sets the input channel on which to trigger the instrument. Refer to the setup illustrations starting on page 2-2 for appropriate trigger channel settings.</p>
	Line Select	Single Line	Sets measurements to be taken on a single line.
		Multi Lines	Sets measurements to be taken across a range of lines.
	RTF Report Mode	Embed Screen Capture	Embeds a screen capture of the waveform display into generated RTF reports.

NOTE. *The Auto Detect disables Start and End lines.*

When the Line Select in the Operation tab is set to Multi Lines, the Measurements tab displays the Measurements on Multiple Lines window as follows:

Menu Item	Function	Setting or field	Description
Measurements	Channel Delay	Start Line	Sets the start line number for the Channel Delay measurement. Note the start line number should be less than or equal to the end line number.
		End Line	Sets the end line number for the Channel Delay measurement. Note the end line number should be greater than or equal to the start line number.

Menu Item	Function	Setting or field	Description
	Color Bars	Start Line	Sets the start line number for the Color Bars measurement. Note the start line number should be less than or equal to the end line number.
		End Line	Sets the end line number for the Color Bars measurement. Note the end line number should be greater than or equal to the start line number.
	Frequency Response	Start Line	Sets the start line number for the Frequency Response measurement. Note the start line number should be less than or equal to the end line number.
		End Line	Sets the end line number for the Frequency Response measurement. Note the end line number should be greater than or equal to the start line number.
	H Sync	Start Line	Sets the start line number for the H Sync measurement. Note the start line number should be less than or equal to the end line number.
		End Line	Sets the end line number for the H Sync measurement. Note the end line number should be greater than or equal to the start line number.
	Levels	Start Line	Sets the start line number for the Levels measurement. Note the start line number should be less than or equal to the end line number.
		End Line	Sets the end line number for the Levels measurement. Note the end line number should be greater than or equal to the start line number.
	Multiburst	Start Line	Sets the start line number for the Multiburst measurement. Note the start line number should be less than or equal to the end line number.
		End Line	Sets the end line number for the Multiburst measurement. Note the end line number should be greater than or equal to the start line number.
	Noise	Start Line	Sets the start line number for the Noise measurement. Note the start line number should be less than or equal to the end line number.
		End Line	Sets the end line number for the Noise measurement. Note the end line number should be greater than or equal to the start line number.
	Non Linearity	Start Line	Sets the start line number for the Non Linearity measurement. Note the start line number should be less than or equal to the end line number.
		End Line	Sets the end line number for the Non Linearity measurement. Note the end line number should be greater than or equal to the start line number.

Menu Descriptions

Menu Item	Function	Setting or field	Description
	Short Time Distortion	Start Line	Sets the start line number for the Short Time Distortion measurement. Note the start line number should be less than or equal to the end line number.
		End Line	Sets the end line number for the Short Time Distortion measurement. Note the end line number should be greater than or equal to the start line number.

Menu Item	Function	Setting or field	Description
Warnings	Specifies whether or not warning messages are displayed or logged to a file.		
	Warning Types Reported	Measurement Warnings Signal Warnings Results Warnings	<p>Set the warning messages to pop up dialog boxes on the instrument screen while taking measurements. All warning messages are selected by default. Clear them to disable warning messages.</p> <p>Measurement warnings include the most general information about potential problems in taking the measurement. Signal warnings appear if signals either change or are absent. If there are some valid results, Results Warnings lets you know that some of the displayed results may not be valid. Results Warnings also shows you the types of test results that are included in the report you have just generated.</p> <p>If warnings are selected, message boxes may appear on screen, requiring you to click OK. To avoid interruptions to your testing, clear all the Warning reporting.</p>
	Control Options	Pop Up Warning Details Log Warnings to File	<p>Control Options determines whether warnings are displayed or logged to a file. When any one of the Warning Types Reported is selected, Control Options is enabled.</p> <p>If Log Warnings to File is checked, the warnings are written to a file named Log.txt. Warnings are appended to the Log.txt file until it reaches 1 MB in size. At that point, it is renamed LogOld.txt and a new Log.txt file is created. If the new file reaches 1 MB in size, it will be renamed LogOld.txt and be written over the existing LogOld.txt file. If you wish to save the data in the LogOld.txt file, you must save the file under a different name before it is overwritten.</p> <p>If Pop Up Warning Details is selected, then a message box appears on the screen. To avoid interruptions to your testing, clear all the Warning reporting.</p>

Menu Item	Function	Setting or field	Description
Reference & Limits	Sets the measurement or measurements options to Relative Result Display, and Limit Testing.		
	Relative Result Display	Enable Relative Result Display	Selecting Enable Relative Result Display enables the Relative to Reference testing.
		Capture Results as Reference	This is a fast and easy way to create a reference file.
	Reference Selection	Default	Select Default to automatically load the Tektronix reference file. The only valid entry is .csv. The actual file can be a text file if it is formatted as a comma-separated-value file. To get valid test results, be sure to choose the appropriate reference file. The correct .csv reference file will have the appropriate values for each of the measurements.
		Manual	Select Manual to enable the user defined Select Reference File.
		Select Reference File...	Click Select Reference File to open the file chooser to browse and select the file. Without selecting the reference file, the measurement will run without producing valid relative results. A reference file can still be loaded after a measurement completes to produce relative results for the latest measured values.
Reference & Limits	Limit Testing	Enable Limits Testing	Selecting Enable Limit Testing enables Pass/Fail testing.
		Stop on Limit Testing Error	Check the Stop on Limit Testing Error option to cause the software to stop testing when a measured value falls outside the defined limits.
	Limit Selection	Default	Select Default to automatically load the Tektronix limit file.
		Manual	Select Manual to enable user-defined select limit File.
		Select Limits File...	Click Select Limit File to open the file chooser to browse and select file. Without selecting the limit file, the measurement will run producing valid relative results during continuous mode. A limit file can still be loaded after a measurement completes to produce valid results for the latest measured values.

NOTE. *The Default Reference file (or Default Limit file) is provided AS IS without warranty of any kind, and is intended to be used as a template only. WARRANTIES OF MERCHANTABILITY AND FITNESS FOR A PARTICULAR PURPOSE ARE EXPLICITLY DISCLAIMED.*

Menu Item	Function	Setting or field	Description
Picture & Vector	Select the display type to either Picture, Vector, or Noise spectrum. The Picture and Vector displays will stop measurements when they are displayed. The measurement continue to run only when Spectrum is displayed.		
	Aspect ratio	Auto	Set the width to height ratio of the picture frame to auto mode. Auto is the default. This setting can be either HD or SD depending on the input format selected.
		4X3	Set the width to height ratio of the picture frame to 4:3.
		16X9	Set the width to height ratio of the picture frame to 16:9.
	Graticule	Auto	Set the graticule of the vector display to auto mode. Auto is the default setting in Graticule. This setting can be either HD or SD depending on the input format selected.
		709-HD	Set the graticule of the vector display to SD colorimetry.
		601-SD	Set the graticule of the vector display to HD colorimetry.
	Scale	100%	Set the scale of the vector display to 100% bars.
		75%	Set the scale of the vector display to 75% bars.
	Line Number		Set the Line Number for the line select in the Picture display or the one line displayed in the Vectorscope display.

Option VGA

All the selected measurement results will appear as dashes any time you change any of the following configurations:

- Resolution
- Refresh Rate
- Timing Standard

If you change a configuration while running a measurement or a setup, the measurement or setup will stop.

Recalling a default setup or recalling setup using setup file changes the configuration; current measurements will stop execution and results appear as dashes in the Results window.



CAUTION. *To avoid losing unsaved measurement results, generate a report before you change any configuration parameters other than selecting measurements or turning warnings on or off.*

Bold values in the *Setting or field* column in the following tables indicate the default value.

Command	Function	Setting or field	Description
Format	Set the video input signal format. The Format setting also affects other measurement specific settings, such as the video signal line number to use when taking measurements.		
	Resolution	640x480 800x600 1024x768 1280x1024 1600x1024 1600x1200 1920x1080 1920x1200 1920x1440 2048x1536 2048x2048	Sets the video signal resolution for the input signal you intend to measure.
	Refresh Rate	50 Hz 60 Hz 65 Hz 70 Hz 72 Hz 75 Hz 76 Hz 85 Hz 100 Hz 120 Hz	Sets the refresh rate for the signal that you intend to measure. Note that all refresh rates are not available at all times; the selectable refresh rate depends on the currently selected resolution.
	Timing	DMT CVT CVT-R GTF	Sets the timing standard available for the input signal that you intend to measure.
	User Defined Format	User Defined Format	Sets the user defined formats available for the input signal that you intend to measure.
	List box		Lists the User Defined Formats available.
	Add		Creates a new User Defined Format.
	Edit		Modifies the selected User Defined Format.
	Delete		Deletes the selected User Defined Format.

Menu Descriptions

Command	Function	Setting or field	Description
Measurements	Select the video signal measurements to take. You can select from one to twelve measurements, in any combination.		
	Measurements	Ch–Ch Mismatch Ch–Ch Skew Color Bars H Sync H Sync Jitter H Timing Linearity Luma Levels Noise Inj Ratio V Sync V Timing Video Transient	Select from one to twelve measurements, in any combination. When you click Run, the selected measurements will be taken. For more information see <i>Option VGA Detailed Measurement Information</i> on page 3-57. For a high-level overview of measurements, refer to <i>Results Menu</i> on page 3-19.
Operation	Set the measurement runtime options, including test run mode, waveform autoscaling, line select setting, using RGBHV Measurement Interface Unit accessory, sync polarity, and embed screen captures in report mode.		
	Setup And/Or Run	Setup & Run	For each selected measurement, and for each measurement acquisition, this setting automatically configures the instrument settings and takes a measurement. Use this when taking multiple measurements that require different instrument setups.
		Setup Only	The application configures the instrument for a measurement but does not take the measurement. Use this to set up customized settings. Customized settings might include changes to the instrument Horizontal or Vertical front panel controls to display and measure a non-supported video signal standard. Click Run to try out the settings, make adjustments as needed (for example, change the horizontal scale), and then click Run again. Once you are satisfied with the customizations, use the Run Only setting to collect results.
		Run Only	This setting uses the current instrument and application settings to take a measurement. Use this for taking measurements after you setup the instrument by using Setup Only to create custom settings.
	Run Mode	Once	The application takes each selected measurement the number of times required for the average you have selected, and then stops taking measurements.
		Continuously	This setting continually takes measurements, in the order the measurements are listed in the Configuration > Measurements view. Select Stop to stop measurements.
Once & Report		The application takes each selected measurement the number of times determined by the averaging setting, then stops taking measurements and generates a report.	

Command	Function	Setting or field	Description
	Auto Scale	Enabled	Select the Enabled check box to enable waveform autoscaling. Deselect the Enabled check box to disable waveform autoscaling.
		Initial Values — Last Meas, Last Recalled, Restore Default	NOTE: If you take measurements on the wrong line or with the wrong scale setup, press the Restore Default button before taking measurements again.
	Initial Values	Last Meas	Last Meas. is the default. When selected the values from the last measurement will be used at the start of the next Auto Scale step.
		Last Recalled	Last Recalled when selected, the values recalled with the last recalled setup will be used at the start of the next Auto Scale step. If a setup (File > Recall Setup) has not been recalled since the program was started, it will load the Auto Scale settings from the last power up.
		Restore Default	Restore Default when selected, the Factory Default Auto Scaling adjusts the vertical scale units so that the input signals fill the entire graticule as much as possible without going out of range. Auto Scaling occurs once for each selected measurement. Auto Scaling occurs once for each selected measurement.
	Line Select	Single Line	Sets measurements to be taken on a single line.
Multi Lines		Sets measurements to be taken across a range of lines.	

When the Line Select in the Operation tab is set to Multi Lines, the Measurements tab displays the Measurements on Multiple Lines pane as follows:

Command	Function	Setting or field	Description
	Ch-Ch Mismatch	Start Line	Sets the start line number for the Ch-Ch Mismatch measurement. Note the start line number should be less than or equal to the end line number.
		End Line	Sets the end line number for the Ch-Ch Mismatch measurement. Note the end line number should be greater than or equal to the start line number.
	Ch-Ch Skew	Start Line	Sets the start line number for the Ch-Ch Skew measurement. Note the start line number should be less than or equal to the end line number.
		End Line	Sets the end line number for the Ch-Ch Skew measurement. Note the end line number should be greater than or equal to the start line number.

Menu Descriptions

Command	Function	Setting or field	Description
	Color Bars	Start Line	Sets the start line number for the Color Bars measurement. Note the start line number should be less than or equal to the end line number.
		End Line	Sets the end line number for the Color Bars measurement. Note the end line number should be greater than or equal to the start line number.
	H. Sync	Start Line	Sets the start line number for the H Sync measurement. Note the start line number should be less than or equal to the end line number.
		End Line	Sets the end line number for the H Sync measurement. Note the end line number should be greater than or equal to the start line number.
	H. Timing	Start Line	Sets the start line number for the H Timing measurement. Note the start line number should be less than or equal to the end line number.
		End Line	Sets the end line number for the H Timing measurement. Note the end line number should be greater than or equal to the start line number.
	Linearity	Start Line	Sets the start line number for the Linearity measurement. Note the start line number should be less than or equal to the end line number.
		End Line	Sets the end line number for the Linearity measurement. Note the end line number should be greater than or equal to the start line number.
	Luma Levels	Start Line	Sets the start line number for the Luma Levels measurement. Note the start line number should be less than or equal to the end line number.
		End Line	Sets the end line number for the Luma Levels measurement. Note the end line number should be greater than or equal to the start line number.
	Video Transient	Start Line	Sets the start line number for the Video Transient measurement. Note the start line number should be less than or equal to the end line number.
		End Line	Sets the end line number for the Video Transient measurement. Note the end line number should be greater than or equal to the start line number.

Command	Function	Setting or field	Description
Operation	RGBHV MIU	Use MIU	Uses the RGBHV Measurement Interface Unit accessory.
	Sync Polarity	Auto Detect	Automatically detects the V Sync polarity.

Command	Function	Setting or field	Description
	RTF Report Mode	Embed Screen Capture	Embeds a screen capture of the waveform display into generated RTF reports.
Warnings	Specifies whether or not warning messages are displayed or logged to a file.		
	Warning Types Reported	Measurement Warnings Signal Warnings Results Warnings	Specifies the type of warnings to be reported. All warnings are selected by default. Clear them to disable warnings. Measurement warnings include general information about potential problems in taking the measurement. Signal warnings appear if signals either change or are absent. If there are some invalid results, Results Warnings lets you know that some of the displayed results may not be valid. Results Warnings also shows you the types of test results that are included in the report you have just generated. If warnings are selected, message boxes may appear on screen, requiring you to click OK. To avoid interruptions to your testing, clear all the Warning reporting.
	Control Options	Pop Up Warning Details Log Warnings to File	Control Options determines whether warnings are displayed or logged to a file. When any one of the Warning Types Reported is selected, Control Options is enabled. If Log Warnings to File is checked, the warnings are written to a file named Log.txt. Warnings are appended to the Log.txt file until it reaches 1 MB in size. At that point, it is renamed LogOld.txt and a new Log.txt file is created. If the new file reaches 1 MB in size, it will be renamed LogOld.txt and be written over the existing LogOld.txt file. If you wish to save the data in the LogOld.txt file, you must save the file under a different name before it is overwritten. If Pop Up Warning Details is selected, then a message box appears on the screen. To avoid interruptions to your testing, clear all the Warning reporting.

Command	Function	Setting or field	Description	
Reference & Limits	Sets the measurement or measurements options to Relative Result Display, and Limit Testing.			
	Relative Result Display	Enable Relative Result Display	Selecting Enable Relative Result Display enables the Relative to Reference testing.	
		Capture Results as Reference	This is a fast and easy way to create a reference file. Uses current results as the basis for a new reference file.	
	Reference Selection	Default	Select Default to automatically load the Tektronix reference file. The only valid entry is .csv. The actual file can be a text file if it is formatted as a comma-separated-value file. To get valid test results, be sure to choose the appropriate reference file. The correct .csv reference file will have the appropriate values for each of the measurements.	
		Manual	Select Manual to enable the user defined Select Reference File.	
		Select Reference File	Click Select Reference File to open the file chooser to browse and select the file. Without selecting the reference file, the measurement will run without producing valid relative results. A reference file can still be loaded after a measurement completes to produce relative results for the latest measured values.	
	Limit Testing	Enable Limits Testing	Selecting Enable Limit Testing enables Pass/Fail testing.	
		Stop on Limit Testing Failure	Check the Stop on Limit Testing Failure option to cause the software to stop testing when a measured value falls outside the defined limits.	
	Limits Selection	Default	Select Default to automatically load the Tektronix limits file.	
		Manual	Select Manual to enable user-defined select limits File.	
		Select Limits File	Click Select Limits File to open the file chooser to browse and select file. Without selecting the limit file, the measurement will run producing valid relative results during continuous mode. A limit file can still be loaded after a measurement completes to produce valid results for the latest measured values.	
		Select Reference File	Click Select Reference File to open the file chooser to browse and select the file. Without selecting the reference file, the measurement will run without producing valid relative results. A reference file can still be loaded after a measurement completes to produce relative results for the latest measured values.	
				NOTE: The Default Reference file (or Default Limit file) is provided AS IS without warranty of any kind, and is intended to be used as a template only. WARRANTIES OF MERCHANTABILITY AND FITNESS FOR A PARTICULAR PURPOSE ARE EXPLICITLY DISCLAIMED.

Results Menu

Option SD/HD The Results menu enables you to display a summary of measurement results or display detailed results for a specific measurement.

If you change the Line Number or Average values for any measurement, or if you change the Filter configuration in the Noise measurement, then the changed measurement will stop running and its results will change to dashes.

All the selected measurement results will be invalidated any time you change any of the following configurations:

- Format
- Color Space
- Trigger

If you change a configuration while running a measurement or a setup, the measurement or setup will stop. The Average setting interacts with your choices for the Run Mode. For example, if you select Once for the Run Mode and you set the averages to 2, then when you select the Run button, each selected measurement will run twice and then stop. On the other hand, if you select Continuously for the Run Mode and 2 averages, then when you select the Run button, each selected measurement will run twice, display results, and then continue running and updating the results for every two measurements.

For a detailed discussion of measurements, refer to page 3-35.

The following table lists the measurements that appear in the Results menu and details the values that appear on the Results page for each measurement. Bold values in the *Setting or Field* column in the following tables indicate default values.

Menu item	Function	Setting or Field	Description
Summary	Shows the status during and after the selected measurements are measured in the summary panel. This is useful when multiple measurements are selected to run.		
Channel Delay	Measures the time variation between the three video channels. The instrument measures the crossings of all three channels.		
	Channel Delay Measurement Setup	Line Number	Sets the video signal line number to measure. The default value depends on the input signal format as set by Configuration > Format, and assumes that the appropriate Matrix image file is being used to generate the test signal. When the format Auto Detect is selected or a valid format is not available, the Line Number is disabled.
		Average: 1	Sets the number of acquisitions over which to calculate an average measurement value.

Menu Descriptions

Menu item	Function	Setting or Field	Description
	Results (ns)		Displays the time variation, in nanoseconds, from channel 1 to channel 2, from channel 2 to channel 3, and from channel 3 to channel 1. Results are reported on the Measured tab, and if enabled, on the Relative, Reference, and Limits tabs.
Color Bars	Measures all eight color levels of the three video channels. The instrument locates and measures the back porch signal of each channel, and then measures each channel's color values relative to that channel's back porch level.		
	Color Bar Measurement Setup	Line Number	Sets the video signal line number to measure. The default value depends on the input signal format as set by Configuration > Format, and assumes that the appropriate Matrix image file is being used to generate the test signal. When the format Auto Detect is selected or a valid format is not available, the Line Number is disabled.
		Average: 1	Sets the number of measurements acquisitions over which to calculate an average measurement value.
	Results (mV)		Displays eight color values, in mV, for each channel (24 measurements total). Results are reported on the Measured tab, and if enabled, on the Relative, Reference, and Limits tabs.
Frequency Response	Measures the amplitude at selected time or frequency location of the input signal.		
	Frequency Response Setup	Line Number	Sets the input signal line number to measure. The default value depends on the input signal format as set by Configuration > Format, and assumes that the appropriate Matrix image file is being used to generate the test signal. When the format Auto Detect is selected or a valid format is not available, the Line Number is disabled.
		Average: 1	Sets the number of measurements acquisitions over which to calculate an average measurement value.
		Dist BW(MHz)	Sets the distortion bandwidth frequency. When the format Auto Detect is selected or a valid format is not available, the Dist BW is disabled.
	Meas Location	Freq 4:4:4	When Meas Location is set to Freq 4:4:4, the measurement uses the same frequency for the measurement location on all three signals (CH1 (Y/G), CH2(Pb/B), and CH3(Pr/R)). This setting is the best option for RGB (GBR) signals. When the format Auto Detect is selected or a valid format is not available, the Meas Location is disabled.
Freq 4:2:2		When Meas Location is set to Freq 4:2:2, the measurement uses the full frequency for CH1 and half that frequency for CH2 and CH3. This setting is the best option for YPbPr signals. When the format Auto Detect is selected or a valid format is not available, the Meas Location is disabled.	

Menu item	Function	Setting or Field	Description
		Time	When the Meas location is set to Time, the measurement reports the waveform frequency at that specified time. When the format Auto Detect is selected or a valid format is not available, the Time is disabled.
		Freq (MHz)	Sets the measurement location frequency. When the format Auto Detect is selected, the Freq (MHz) is disabled.
		Time (μ s)	Sets the measurement location time. When the format Auto Detect is selected, the Time (μ s) is disabled.
	Frequency Response Results		Displays the Flag Amplitude (mV), Frequency (MHz), Amplitude (dB) with reference to the Flag, Time Position (μ s), and RMS Distortion (%) of the video signal. Results are reported on the Measured tab, and if enabled, on the Relative, Reference, and Limits tabs.
H Sync	Measures the sync signal timing and voltage values. The instrument measures the sync signal rise and fall times (at the 10% and 90% signal amplitude levels) and the sync pulse width (at the 50% signal amplitude level) to determine the signal timing values.		
	Sync Measurement Setup	Line Number	Sets the video signal line number to measure. The default value depends on the input signal format as set by Configuration > Format, and assumes that the appropriate Matrix image file is being used to generate the test signal. When the format Auto Detect is selected or a valid format is not available, the Line Number is disabled.
		Average: 1	Sets the number of measurements acquisitions over which to calculate the average measurement value.
		Measured on CH1	Results in better measurement accuracy when triggering on CH4.
	Tri-Level Sync Results		Displays the sync signal timing values in ns, and the signal levels in mV. Results that are meaningless for bi-level sync appear as dashes. Results are reported on the Measured tab, and if enabled, on the Relative, Reference, and Limits tabs.
H Sync Jitter	Measures the variations in the Horizontal Sync frequency.		
	H Sync Jitter Measurement Setup	No. of Lines	Sets the number of lines to measure. When the format Auto Detect is selected or a valid format is not available, the No. of Lines is disabled.
		Average: 1	Sets the number of measurements acquisitions over which to calculate the average measurement value.
	Input	Jitter	Sets the Input type to Jitter.
		Peak (ns)	Allows the user to set the jitter peak when the input type selected is Jitter.
		Probability	Sets the Input type to Probability.
		Probability	Allows the user to set the probability when the input type selected is probability.
	Demarc Freq	Jitter (Hz)	Allows you to set the jitter demarcation frequency

Menu Descriptions

Menu item	Function	Setting or Field	Description
		Wander (Hz)	Allows you to set the wander demarcation frequency
	H Sync Jitter Results		Displays the RMS Jitter (ns), Accumulated Time (ms), Pos Peak Jitter (ns), Neg Peak Jitter (ns), Pos Peak Probability, Neg Peak Probability, Min Freq Offset (ppm), Max Freq Offset (ppm), Min Freq Drift Rate (ppm/s), and Max Freq Drift Rate (ppm/s) of the video signal. Results are reported on the Measured tab, and if enabled, on the Relative, Reference, and Limits tabs.
Levels	Measures the average signal level in the segments of the signal defined by the cursor location upto eight levels on each of the three channels.		
	Levels Measurement Setup	Line Number	Sets the video signal line number to measure. The default value depends on the input signal format as set by Configuration > Format, and assumes that any of the available patterns in the Matrix image file is being used as the test signal. When the format Auto Detect is selected or a valid format is not available, the Line Number is disabled.
		Average: 1	Sets the number of measurements acquisitions over which to calculate the average measurement value.
	Configure Levels (When the format Auto Detect is selected or a valid format is not available, the Configure Levels is disabled.)	Level Name	Allows you to enter the level name.
		Cursor 1 (μ s)	Allows you to enter the cursor 1 position
		Cursor 2 (μ s)	Allows you to enter the cursor 2 position
		Apply	Saves the selected settings of the level name, cursor 1, and cursor 2 and uses them for performing the Levels measurement.
		Cancel	Cancel the settings of the level name, cursor 1, and cursor 2.
	Levels Results		Displays the results for all the eight levels on each of the three channels. Results are reported on the Measured tab, and if enabled, on the Relative, Reference, and Limits tabs.
Multiburst	Measures the video channel frequency response and amplitude. The instrument measures the flag pulse on each channel to determine and measure the six burst frequencies with the largest amplitude.		
	Multiburst Measurement Setup	Line Number	Sets the video signal line number to measure. The default value depends on the input signal format as set by Configuration > Format, and assumes that the appropriate Matrix image file is being used to generate the test signal. When the format Auto Detect is selected or a valid format is not available, the Line Number is disabled.

Menu item	Function	Setting or Field	Description
		Average: 1	Sets the number of measurements acquisitions over which to calculate an average measurement value.
	Multiburst Measurement Results		Displays the flag signal value (in mV) for each channel in the first display row. The following six rows list the frequency (in MHz) and amplitude (in dB) of each channel, for each of the six burst signals. Results are reported on the Measured tab, and if enabled, on the Relative, Reference, and Limits tabs.
Noise	Measures video signal noise using one of three filter settings.		
	Noise Measurement Setup	Line Number	Sets the video signal line number. The default value depends on the input signal format as set by Configuration > Format, and assumes that the appropriate Matrix image file is being used to generate the test signal. When the format Auto Detect is selected or a valid format is not available, the Line Number is disabled.
		Average: 1	Sets the number of measurements acquisitions over which to calculate an average measurement value.
	Filter	Off	Disables (turns off) all noise signal filtering. Use this setting to measure broadband noise without any filtering. When the format Auto Detect is selected, this option is disabled.
		Unified Weighting	Enables (turns on) unified weighting noise signal filtering. Use this setting to measure noise with the psychovisual weighting established by CCIR Recommendation (Rec) 576-2, adjusted for the selected video format. When the format Auto Detect is selected or a valid format is not available, the Unified Weighting is disabled.
		Unweighted BW	Enables (turns on) unweighted noise signal filtering and activates the filter bandwidth field. Use this setting to remove high frequency noise from your signal. When the format Auto Detect is selected or a valid format is not available, the Unweighted BW is disabled.
	Noise at Cursor Position	Bandwidth Hz	Sets the bandwidth filter cutoff frequency. Selecting Unweighted activates this field. The default value depends on the input signal format as set by Configuration > Format. When the format Auto Detect is selected or a valid format is not available, the Bandwidth is disabled.
		Cursor (Hz)	Sets the Cursor frequency. When the format Auto Detect is selected or a valid format is not available, the Cursor is disabled.
		mV	Displays the noise in mV on each of the three channels
		dB	Displays the noise in dB on each of the three channels

Menu item	Function	Setting or Field	Description
	Set Time Window (When the format Auto Detect is selected or a valid format is not available, the Set Time Window is disabled.)	Default	Selects the application to perform the Noise measurement over the full active video time duration.
		Custom	Selects the application to perform the Noise measurement over the time frame window specified by the values in the Start Position and the End Position fields. The Start Position and the End Position values can be adjusted by using the knobs on the front panel and the vertical cursors will be automatically enabled when this option is selected.
		Start Position (μ s)	Sets the start position of time when custom is selected to perform the Noise measurement.
		End Position (μ s)	Sets the end position of time when custom is selected to perform the Noise measurement.
		Apply	Saves the selected settings of the start position and the end position and uses them for performing the Noise measurement.
		Cancel	Cancel the settings of the start position and the end position.
		Y/G	Sets the channel for the Noise Spectrum measurement. When the format Auto Detect is selected or a valid format is not available, the Set Time Window is disabled.
		Frequency Resolution (Hz)	Sets the frequency resolution for the Noise Spectrum measurement. When the format Auto Detect is selected or a valid format is not available, the Frequency Resolution is disabled.
		Spectrum	Displays the noise spectrum. This option is enabled only when the Run mode in the Operation tab is set to Continuously. When the format Auto Detect is selected or a valid format is not available, the Spectrum is disabled.
	Noise Results		Displays the noise measurement results on each of the three channels in dB (relative to peak white) and mV. Results are reported on the Measured tab, and if enabled, on the Relative, Reference, and Limits tabs.

Menu item	Function	Setting or Field	Description
Non Linearity	Measures channel signal linearity based on a ramp or five-step linearity test signal. If using a ramp signal, the instrument divides the ramp signal into five values to determine the equivalent step values. The instrument then measures the bottom, individual step, and top values of the test signal, and compares these values to a nominal value to determine the percent of deviation of the test signal from the nominal signal.		
	Non Linearity Measurement Setup	Line Number	Sets the video signal line number to measure. The default value depends on the input signal format as set by Configuration > Format, and assumes that the appropriate Matrix image file is being used to generate the test signal. When the format Auto Detect is selected or a valid format is not available, the Line Number is disabled.
		Average: 16	Sets the number of measurements acquisitions over which to calculate an average measurement value.
	Results (%)	Displays the percent of deviation of the test signal from a nominal signal value, as a percentage, for each step on each channel. Results are reported on the Measured tab, and if enabled, on the Relative, Reference, and Limits tabs.	
Short Time Distortion	Measures the short time distortion of the input signal.		
	Short Time Distortion Setup	Line Number	Sets the input signal line number to measure. The default value depends on the input signal format as set by Configuration > Format, and assumes that the appropriate Matrix image file is being used to generate the test signal. When the format Auto Detect is selected or a valid format is not available, the Line Number is disabled.
		Average: 1	Sets the number of measurements acquisitions over which to calculate the average measurement value.
	Short Time Distortion Results	Displays the Rise Time (ns), Fall Time (ns), Overshoot (%), Undershoot (%), Settling Rise (ns), and Settling Fall (ns) of the video signal. Results are reported on the Measured tab, and if enabled, on the Relative, Reference, and Limits tabs.	

Menu Descriptions

Menu item	Function	Setting or Field	Description
Spatial Distortion	Measures the horizontal and vertical scale, offset or shift, the missing picture portions near the edges or borders, first line, last line, horizontal start, and the horizontal end of the video output.		
	Spatial Distortion Setup	Line Number	Sets the input signal line number to measure. The default value depends on the input signal format as set by Configuration > Format, and assumes that the appropriate Matrix image file is being used to generate the test signal.
		Average: 1	Sets the number of measurements acquisitions over which to calculate the average measurement value.
	Select BMP Ref File	Default	Selects the default Tektronix reference file to perform the Spatial Distortion measurement.
		Manual	Uses your own 24 bit BMP reference file which is selected by clicking the Browse to perform the Spatial Distortion measurement.
Browse		Selects the user defined bitmap reference file.	
Spatial Distortion Results		Displays the Top crop (lines), Bottom crop (lines), Left crop (pixels), Right crop (pixels), First active line, Last active line, H start (pixels), H end (pixels), V Scaling (%), H Scaling (%), V Offset (lines), and H Offset (pixels) of video signal. Results are reported on the Measured tab, and if enabled, on the Relative, Reference, and Limits tabs.	
V Sync	Measures the vertical synchronization signal timing and amplitude. The instrument measures the sync signal rise and fall times (at the 10% and 90% signal amplitude levels) and the sync pulse width (at the 50% signal amplitude level) to determine the signal timing values.		
	V Sync Measurement Setup	Average: 1	Sets the number of measurements acquisitions over which to calculate the average measurement value.
	V Sync Results		<p>For SD formats with Interlaced scanning, displays the Field Period (ms), V Blank Before Pre Eq (μs), Vertical Blanking (lines), Pre Eq Duration (μs), V Sync Duration (lines), and Serr Pulse Width (μs).</p> <p>For SD formats with Progressive scanning, displays the Frame Period (ms), Eq Pulse Width (μs), and V Sync Duration (lines).</p> <p>For HD formats with Interlaced scanning, displays the Field Period (ms), V Sync Duration (lines), Broad Pulse Start (μs), Broad Pulse End (μs).</p> <p>For HD formats with Progressive scanning, displays the Frame Period (ms), V Sync Duration (lines), Broad Pulse Start (μs), and Broad Pulse End (μs).</p> <p>Results are reported on the Measured tab, and if enabled, on the Relative, Reference, and Limits tabs.</p>

Option VGA

If you change the Line Number or Average values for any measurement, then the changed measurement will stop execution and its results will change to dashes.

All the selected measurement results will be invalidated any time you change the following configurations:

- Resolution
- Refresh Rate
- Timing

If you change a configuration that is recall a setup while running a measurement, the measurement will stop execution.

The Average setting interacts with your choices for the Run Mode. For example, if you select Once for the Run Mode and you set the averages to 2, then when you select the Run button, each selected measurement will run twice and then stop. On the other hand, if you select Continuously for the Run Mode and 2 averages, then when you select the Run button, each selected measurement will run twice, display results, and then continue running and updating the results for every two measurements.

For a detailed discussion of measurements, refer to page 3-57.

Values in bold text in the *Setting or field* column in the following tables indicate default values.

Command	Function	Setting or field	Description
Summary	The Summary window displays the status of the selected measurements when they are run. It also displays the warnings, if any. The Summary window is useful when you run multiple measurements.		
Ch-Ch Mismatch	The Ch-Ch Mismatch is the difference in any steady-state voltage amplitude between R,G, and B video outputs.		
	Ch-Ch Mismatch Measurement Setup	Line Number	Sets the video signal line number to measure. The default value depends on the input signal format as set by Configuration > Format, and assumes that the appropriate Matrix image file is being used to generate the test signal.
		Average	Sets the number of acquisitions over which to calculate an average measurement value.
	Ch-Ch Mismatch Results		Displays the Ch-Ch mismatch between G to B, G to R, and B to R channels of the video signal values in (mV) and in (%)Peak-Peak. Results are reported on the Measured tab, and if enabled, on the Relative, Reference, and Limits tabs.

Menu Descriptions

Command	Function	Setting or field	Description
Ch-Ch Skew	Ch-Ch Skew is the phase relationship (time delay) among R, G, and B video outputs of the graphics subsystem.		
	Ch-Ch Skew Measurement Setup	Line Number	Sets the video signal line number to measure. The default value depends on the input signal format as set by Configuration > Format, and assumes that the appropriate Matrix image file is being used to generate the test signal.
		Average	Sets the number of acquisitions over which to calculate an average measurement value.
Ch-Ch Skew Results		Displays the Ch-Ch Skew for G to B, G to R, and B to R channels values in (ns) and in (%) Pixel Clock. Results are reported on the Measured tab, and if enabled, on the Relative, Reference, and Limits tabs.	
Color Bars	Color Bars measurement measures the GBR color bars of a VGA card in a PC. The Color Bars measurement measures the amplitude level (relative to back porch) of each of the eight colors, that is, white, yellow, cyan, green, magenta, red, blue, and black for each active channel.		
	Color Bars Measurement Setup	Line Number	Sets the video signal line number to measure. The default value depends on the input signal format as set by Configuration > Format, and assumes that the appropriate Matrix image file is being used to generate the test signal.
		Average	Sets the number of acquisitions over which to calculate an average measurement value.
Color Bars Results in mV		Displays the amplitude for the White, Yellow, Cyan, Green, Magenta, Red, Blue, and Black colors on the G, B, and R channels (24 measurements total). Results are reported on the Measured tab, and if enabled, on the Relative, Reference, and Limits tabs.	
H Sync	Sync is the pulse occurring from 2.4 V to 5.5 V at the beginning of each line. This pulse signal causes the monitor to go back to the left side of the display and trace another horizontal line of picture information. This measurement measures rise time, fall time, overshoot, undershoot, settling time, and monotonicity. This measurement measures the steady-state voltage and current amplitudes of logic levels '1' and '0' at 2.21 k Ω and 301 Ω termination.		
	H Sync Measurement Setup	Line Number	Sets the video signal line number to measure. The default value depends on the input signal format as set by Configuration > Format, and assumes that the appropriate Matrix image file is being used to generate the test signal.
		Average	Sets the number of acquisitions over which to calculate an average measurement value.
H Sync Results		Displays the Polarity (Pos/Neg), Pulse Width (μ s), Sync Period (μ s), Frequency (kHz), Rise Time (ns), Fall Time (ns), Overshoot (%), Undershoot (%), Overshoot S.T. (ns), Undershoot S.T. (ns), Monotonic Rise (Y/N), Monotonic Fall (Y/N), Logic Level "1" (mV) @2.21 k Ω and \pm 8 mA, and Logic Level "0" (mV) @2.21 k Ω and \pm 8 mA. Results are reported on the Measured tab, and if enabled, on the Relative, Reference, and Limits tabs.	

Command	Function	Setting or field	Description
H Sync Jitter	H Sync Jitter is the time superimposed image of the second sync pulse over the first, or triggered edge.		
	H Sync Jitter Measurement Setup	No. of Lines	Sets the number of lines to measure.
	H Sync Jitter Results		Displays the H Sync Jitter in (ns) and in (%) Pixel Clock. Results are reported on the Measured tab, and if enabled, on the Relative, Reference, and Limits tabs.
H Timing	H Timing comprises of the horizontal sync pulse, the back porch, the addressable video signal, the front porch, the left border, and the right border.		
	H Timing Measurement Setup	Line Number	Sets the video signal line number to measure. The default value depends on the input signal format as set by Configuration > Format, and assumes that the appropriate Matrix image file is being used to generate the test signal.
		Average	Sets the number of acquisitions over which to calculate an average measurement value.
	H Timing Results		Displays the Back Porch (μ s), Left Border (μ s), Addressable Video (μ s), Right Border (μ s), Front Porch (μ s) on the G, B, and R channels, and Sync Pulse Width (μ s), Pixel Clock (MHz). Results are reported on the Measured tab, and if enabled, on the Relative, Reference, and Limits tabs.
Linearity	Linearity is a measure of how well the device-under-test performs analog to digital and digital to analog conversions. Linearity consists of the Resolution, Integral linearity, Differential linearity, and Monotonic measurements.		
	Linearity Measurement Setup	Line Number	Sets the video signal line number to measure. The default value depends on the input signal format as set by Configuration > Format, and assumes that the appropriate Matrix image file is being used to generate the test signal.
		Average	Sets the number of acquisitions over which to calculate an average measurement value.
	Linearity Results		Displays the Resolution (Bits), Max INL (LSB), @ Step No, Max DNL (LSB), @ Step No, Monotonic (Y/N), and @ Step No on the G, B, and R channels. Results are reported on the Measured tab, and if enabled, on the Relative, Reference, and Limits tabs.

Command	Function	Setting or field	Description
Luma Levels	Luma corresponds to the sensitivity of human vision to each of the RGB primaries standardized for video. The Luma Levels measurement reports the minimum and maximum level from the five white and black bars of the active video for each of the three channels.		
	Luma Levels Measurement Setup	Line Number	Sets the video signal line number to measure. The default value depends on the input signal format as set by Configuration > Format, and assumes that the appropriate Matrix image file is being used to generate the test signal.
		Average	Sets the number of acquisitions over which to calculate an average measurement value.
Luma Levels Results in mV		Displays the Max and the Min luminance of the displayed image on the G, B, and R channels. Results are reported on the Measured tab, and if enabled, on the Relative, Reference, and Limits tabs.	
Noise Inj Ratio	Noise Injection Ratio is the noise injected in the VGA output for the Device Under Test. It is the amount of noise relative to the signal amplitude rather than the absolute amount of noise that tends to cause problems. Noise Inj Ratio measures the signal-to-noise ratio of the three channels simultaneously.		
	Noise Inj Ratio Measurement Setup	Line Number	Sets the video signal line number to measure. The default value depends on the input signal format as set by Configuration > Format, and assumes that the appropriate Matrix image file is being used to generate the test signal.
		Average	Sets the number of acquisitions over which to calculate an average measurement value.
Noise Inj Ratio Results		Displays the Noise mV, dB, and Inj Ratio (%) on the G, B, and R channels of the video signal. Results are reported on the Measured tab, and if enabled, on the Relative, Reference, and Limits tabs.	
V Sync	This measurement measures the steady-state voltage and current amplitudes of logic levels '1' and '0' at 2.21 k Ω and ± 8 mA termination. It also measures rise time, fall time, overshoot, undershoot, settling time, and monotonicity.		
	V Sync Measurement Setup	Average	Sets the number of acquisitions over which to calculate an average measurement value.
	V Sync Results		Displays the Polarity (Pos/Neg), Pulse Width (μ s), Sync Period (ms), Frequency (Hz), Rise Time (ns), Fall Time (ns), Overshoot (%), Undershoot (%), Overshoot S.T. (ns), Undershoot S.T. (ns), Monotonic Rise (Y/N), Monotonic Fall (Y/N), Logic Level "1" (mV) @2.2k and ± 8 mA, and Logic Level "0" (mV) @2.2k and ± 8 mA. Results are reported on the Measured tab, and if enabled, on the Relative, Reference, and Limits tabs.

Command	Function	Setting or field	Description
V Timing	V Timing comprises of the vertical sync pulse, the back porch, the addressable lines, the front porch, top border, and bottom border.		
	V Timing Measurement Setup	Average	Sets the number of acquisitions over which to calculate an average measurement value.
	V Timing Results		Displays the Back Porch (Line), Top Border (Line), Addressable Lines (Line), Bottom Border (Line), and Front Porch (Line) on the G, B, and R channels and the Sync Pulse Width (Line). Results are reported on the Measured tab, and if enabled, on the Relative, Reference, and Limits tabs.
Video Transient	Video Transients are the video signals that endure for a brief time. Use the Video Transient measurement to check synchronization signal timing and amplitude. It also measures video rise time, fall time, overshoot, undershoot, and settling time.		
	Video Transient Measurement Setup	Line Number	Sets the video signal line number to measure. The default value depends on the input signal format as set by Configuration > Format, and assumes that the appropriate Matrix image file is being used to generate the test signal.
		Average	Sets the number of acquisitions over which to calculate an average measurement value.
	Video Transient Results		Displays the Video Rise Time (ns), Video Fall Time (ns), Video Rise Time (%), Video Fall Time (%), Overshoot (%), Undershoot (%), Overshoot Settling Time (ns), and Undershoot Settling Time (ns) on the G, B, and R channels. Results are reported on the Measured tab, and if enabled, on the Relative, Reference, and Limits tabs.

Utilities Menu



CAUTION. To avoid losing unsaved measurement results, generate a report before you recall a setup file or change any configuration parameters other than selecting measurements or turning warnings on or off.

Command	Function	Setting or field	Description
Generate Report	You can save measurement results in three popular data formats.		
	Format	RTF	Use RTF (Rich Text Format) to create results data that you can incorporate into documents.
		PDF	Use PDF (Portable Document Format) to create PDF files of the measurement data for distribution and viewing.
		CSV	CSV - contains measurement results and some more information. The Legacy format includes only the information on measurements that were available in the VM5000HD software. Results for newer measurements only appears in the CSV VM5000 format.
	Report File	File Name Text entry field	Field in which to enter the report file name. (Option SD/HD) C:\VMApps\OptHSDS\Reports\Tek0.rtf (Option VGA) C:\VMApps\OptVGA\Reports\Tek0.rtf
		Browse	Selects the location to which to write (save) the report.
		Get Default	Sets the report write directory to the default location and name (Option SD/HD) C:\VMApps\OptHSDS\Reports\Tek0.rtf (Option VGA) C:\VMApps\OptVGA\Reports\Tek0.rtf
		Report Heading Text entry field	Adds a brief note into the report file. You can enter up to 46 characters.
		Generate	Writes the specified measurement data in the selected report format to the specified location.
		Measurements	All
	Selected		Creates a report with only the measurements that are currently selected in the Configuration > Measurements screen.
	Recent Reports	View	Displays the recent report files in the Recent Reports panel when you click View.

Help Menu

Command	Function
Help Topics	Opens the VM Series online help window that provides you with application information on your instrument screen.
About VM HD and SD Video... (Option SD/HD)	Displays a VM Series dialog that contains the application software version number.
About VM VGA Video... (Option VGA)	

Option SD/HD Detailed Measurement Information

For a high-level procedure on how to take a measurement, refer to page 2-28.

For a high-level overview of all the measurements, refer to the table beginning on page 3-19.

The following information applies to all the measurements.

Matrix Signals and Line Numbers

The matrix signals that are included with the Signal Source Set (refer to page E-1) provide appropriate signals for all the measurements. Refer to the Readme.txt files on the Signal Source Set for extensive information about the files provided.

Averaging

The higher the average, the lower the variance of the measurement in the presence of noise or other transient signal components. Set the average higher if you would like to reduce the fluctuations in the measurement results.

The instrument averages results, not input waveforms. (If, on the other hand, the Noise waveforms were averaged instead of the Noise results, the noise results would appear lower than they should. Because of the instrument average results, this problem is avoided.)

Channel Delay

The channel delay measurement is used to verify relative timing of the three channels of video. Nominal channel delay is zero between all channels. Deviations from zero correspond to decreased video quality. For example, the greater the delay between channels, the more likely the edges in video will be perceived as distorted. Using a narrow band signal, the delay at a particular frequency band can be measured and thus group delay can be obtained.

In addition, channel delay is a function of relative cable lengths for each of the channels. Thus, if a splitter is used at the video source output, delay due to cable length mismatch can be measured.

Signal Source

You can use the matrix signal, or you can use a signal with high cross-correlation between each pair of channels to be tested. The default signal is the multiburst signal used for multiburst measurement, but many other types of signals can be used, including sweeps and even some live program material. If the cross-correlation is high enough for at least one pair of channels, the measurement results will display. Otherwise, running the measurement will result in '---' for each channel. If warnings are enabled, low correlation between channels will result in associated warnings.

Interpreting Results

A positive number indicates that the first signal arrives later than the second signal. For example, Y to Pb delay of 4.03 ns means that the signal in the Y channel is delayed 4.03 ns relative to Pb. However, the signals may contain distortions, which create different delays for different portions of the video line. In such a case, the measurement result is the delay compensation required to maximize the cross-correlation of the second channel with the first, generally giving a weighted average of the various delays. For narrow band signals, the delays at a particular frequency band may be measured. An ensemble of such measurements may be collected to develop a portrait of group delay.

If the signals of the three channels are highly mutually correlated (which is the case if the signals are reconstructed well and free of distortions other than delay), the 'loop' delay will be approximately zero:

$$\text{Delay1} - \text{Delay2} + \text{Delay3} = 0, \text{ where}$$

Delay1 is Y to Pb or G to B

Delay2 is Y to Pr or G to R

Delay3 is Pb to Pr or B to R

The more the loop delay deviates from zero, the less the three signals mutually correlate. High loop delay corresponds to different types of signals among the three channels, because of differences either in distortions or in the inherent source signal (as in some live program material, for example). Loop delay greater than 5ns will generate a warning if warnings are enabled.

How Results are Calculated

The maximum cross-correlation of transitions is found between each pair of channels. The location of the maximum is the delay in time. Generally, one may think of the calculation of the delay as the average match of transitions, weighted by the amplitude of each transition.

The Channel Delay relative to reference value is calculated as follows:

$$\text{Result} = (\text{measured value} - \text{reference value})$$

Color Bars

Measuring GBR color bars from a set-top-box can be used to verify the correct colorimetry conversion. Likewise, conversion from 1080i/720p to 480p colorimetry in YPbPr can be verified. The Color Bars measurement also can be used to check individual channel gain. In addition, it can be used as a crude check of linearity since severe clipping or other non-linear distortions will alter the measurement results from the ideal.

Signal Source

You can use the matrix signal, or you can use a signal with all eight valid color bars on the line. There is no requirement for the order of the bars except for the bias that black will be searched after (to the right of) blue. Each of the bars should be at least 1/24 of the active line time in duration.

Interpreting Results

The Color Bars measurement measures the amplitude level (relative to back porch) of each of the eight colors (white, yellow, cyan, green, magenta, red, blue, black) for each active channel. Therefore, this measurement makes eight measurements on three channels for 24 total measurements. The software assumes Y is on Channel 1, Pb is on Channel 2, and Pr is on Channel 3.

NOTE. *Some signals intentionally reverse or change the order from the traditional color bar test signal order. Because the bars are measured regardless of order, if channel inputs are swapped, especially in the case of RGB, the resulting input will consist of 'valid' color levels for all eight bars, but the order will be incorrect.*

How Results are Calculated

First, the bars are identified using the relative amplitudes of the three channels and the specification for the selected format and colorimetry.

The amplitudes are calculated using waveform averaged values within each identified bar relative to back porch. Thus, it is important to ensure that the sync signal is within the captured data window for valid measurements. For example, if a manual setup is performed, not only are all eight bars required on the waveform display, but the entire horizontal blanking area to the right of the

signal being measured is also required to locate the sync signal and the associated back porch.

The Color Bars relative to reference values are calculated as follows:

$$\text{mV : Result} = (\text{measured value} - \text{reference value})$$

$$\%: \text{Result} = \left(\frac{\text{measured value} - \text{reference value}}{\text{reference value}} \right) \times 100$$

Frequency Response

The Frequency Response measurement technique provides the most accurate representation of display performance. Frequency response is measured on a sweep signal, not a burst. This measurement evaluates a system ability to uniformly transfer signal components of different frequencies without affecting their amplitudes. The amplitude variation can be expressed in dB or percent. The reference amplitude (0dB, 100%) is typically the flag. Frequency response problems can cause a wide variety of aberrations in the picture.

The flag amplitude measurement is a reference signal amplitude. Amplitude is measured with reference to the flag amplitude.

Signal Source

Use a sweep signal with a flag on the front of the signal. You can also use the matrix signal, or any multiburst signal with a reference flag preceding the bursts. The more cycles present in each burst, the more robust and generally more accurate the measurement will be. A burst with less than two cycles is not recommended.

Interpreting Results

Frequency Response measurements are made with a sweep signal by measuring the peak-to-peak amplitude of the sweep signal at a specified point. The sweep input must begin with a reference flag. The point at which the measurement is made is selectable as Freq 4:4:4, Freq 4:2:2, or Time. If Time is selected, the measurement is made on all three channels of the sweep signal at the specified time. If Frequency 4:4:4 is selected, the specified Frequency is found on all three channels. If Frequency 4:2:2 is selected, the specified Frequency is found on Channel 1 and one-half the specified frequency is found on Channels 2 and 3. This is the same for both formats YPbPr and RGB. After the specified point is found on the input sweep signal, five results are measured:

- The frequency is measured at the specified time if time is selected; otherwise the specified frequency is found and displayed in MHz.
- The time is measured at the specified frequency if frequency is selected; otherwise the input time is displayed in μs .

- The amplitude of the input signal is measured relative to the flag on the input signal and the result is displayed in dB.
- The flag amplitude is measured and displayed in mV.
- The RMS Distortion is measured as the vector sum of all additional sinusoidal components normalized by the amplitude of the fundamental sinusoid at the specified time location.

How Results are Calculated

If a time is specified, the instantaneous frequency (within the context of a 3 μ s raised cosine window centered at this time) is measured along with frequencies and amplitudes of nonlinear distortion.

If a frequency is specified, the same algorithm used in the multiburst measurement is used for measuring flag amplitude and relative sinusoidal signal amplitude along with frequencies and amplitudes of nonlinear distortion. If Freq 4:4:4 is specified, the specified frequency is used for all channels. If Freq 4:2:2 is specified, the specified frequency is used for Y and 1/2 the input frequency is used for Pb and Pr.

The Flag Amplitude (mV) is calculated as the peak to peak amplitude of the flag signal.

Freq (MHz) calculated is the frequency specified in the Meas Location (MHz).

Time (μ s) is calculated at the Meas Location (MHz).

The frequency response distortion result is calculated as the percent ratio of the square root of the sum of the squares of the additional spectral components above the noise floor.

Relative to Reference Calculation

The Relative to Reference values for mV | Hz | μ s units are calculated as follows:

Frequency: Result = Frequency measured - Frequency reference

Time: Result = Time measured - time reference

Flag: Result = Flag measured - flag reference

Amplitude: Result = Amplitude measured (in dB) - Amplitude reference (in dB)

RMS Distortion: Result = RMS distortion measured - RMS distortion reference

The Relative to Reference values for the % display are calculated as follows:

$$\text{Frequency} = \left(\frac{\text{measured frequency} - \text{reference frequency}}{\text{reference frequency}} \right) \times 100$$

$$Time = \left(\frac{measured\ time - reference\ time}{reference\ time} \right) \times 100$$

$$Flag = \left(\frac{measured\ flag - reference\ flag}{reference\ flag} \right) \times 100$$

$$Flag = 20 \log \left(\frac{\frac{measured\ amplitude}{reference\ flag} - reference\ amplitude}{reference\ amplitude} \right) \times 100$$

$$RMS\ Distortion = \left(\frac{measured\ distortion - reference\ distortion}{reference\ distortion} \right) \times 100$$

Measured Calculation

The measured values appear in the Results panel when Measured tab is selected. These values are calculated as follows:

Frequency = Frequency measured

Time = Time measured

Flag = Measured flag amplitude in mV

Amplitude = Amplitude of signal at the time or frequency input

$$Result = 20 \log \left(\frac{measured\ amplitude}{measured\ flag\ amplitude} \right)$$

Amplitude (note that attenuated signals give results in -dB)

$$Result = \left(\frac{RMS\ correlated\ distortion\ amplitude}{RMS\ signal\ amplitude} \right) \times 100$$

H Sync

This measurement is used to check synchronization signal timing and amplitude, including the relative position of the start and end of active video (interpreted by looking at front and back porch times).

Signal Source

You can use the matrix signal, or you can use a signal with signal amplitude greater than 7.5% at the beginning and end of active video in order to measure front porch and back porch times.

Interpreting Results

The amplitudes are measured relative to back porch.

Selecting either 1080 or 720 formats will display the tri-level sync results. Selecting either 480 or 576 will display the bi-level sync results.

How Results are Calculated

The amplitudes are measured relative to back porch.

The times are taken as the time between half amplitudes of adjacent transitions. For example, “Neg. Sync Width” is the measured time between the half amplitude of the falling or leading edge of negative sync and the half amplitude of the rising or trailing edge of negative sync.

In the absence of sufficiently large (greater than 7.5%) video signal, the width of front porch and back porch may not be found. In this case, the measurement of the respective porch widths will not be valid.

The Sync relative to reference value is calculated as follows:

$$\text{Result} = (\text{measured value} - \text{reference value})$$

H Sync Jitter

The H Sync Jitter measurement measures the variations in the horizontal sync frequency.

The minimum time window that can be used for a jitter measurement is the time for one frame. For example, a 1080I/60 format signal should be measured for at least 1125 lines. The minimum time window also depends on the chosen jitter demarcation frequency.

Horizontal Sync Jitter is used to quantify the variation observed in the H Sync frequency. Jitter is the variation that is faster than a set frequency called the jitter demarcation frequency. Wander is the variation that is slower than a set frequency called the wander demarcation frequency. Wander frequency is the value you set in the Wander (Hz) field of the Demarc Freq pane.

Jitter frequency is the value you can set in the Jitter (Hz) field of the Demarc Freq pane.

When the input type is set to Jitter, the measurement displays the peak jitter value with the estimated probability for the specified peak jitter.

When the input type is set to Probability, the measurement displays the probability and the estimated jitter for the specified probability.

Accumulated Time displays the duration of the signal observed for the peak jitter/probability estimates.

The quantified minimum and maximum values of the wander are displayed in the Freq Offset (ppm) fields. The wander measured over a period of time is displayed in the Freq Drift Rate (ppm/s) field for both minimum and maximum values.

Signal Source

The test signal used for the H Sync Jitter measurement is the Tektronix Matrix pattern.

Interpreting Results

When the reported Probability is low, it means that the chances of jitter exceeding the set positive peak or negative peak value is less. The ideal value is zero. The drift rate of H Sync frequency should be low, ideally zero.

How Results are Calculated

The acquired data is subjected to a SW sync stripper, TIE and IFO extraction (as per method 3 of IEEE 1521-2003), and filtering (also as per IEEE 1521-2003). After filtering, peak calculations of frequency offset and drift rate are made.

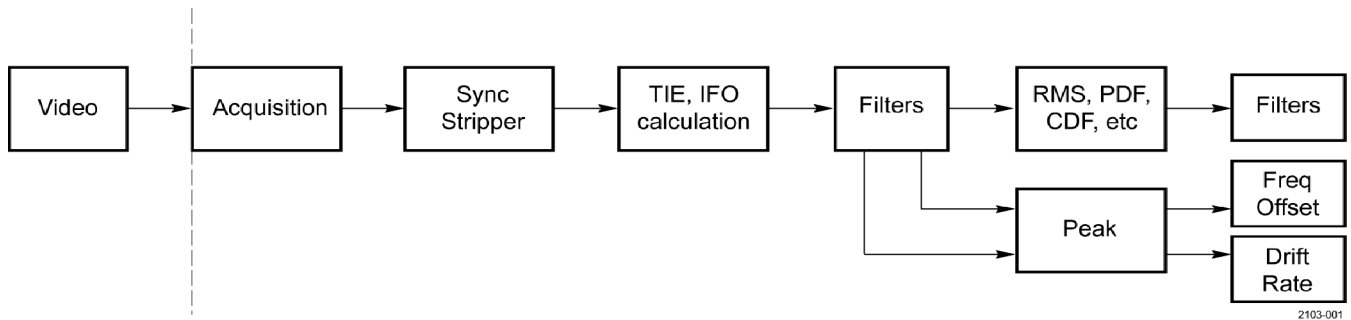

Figure 3-1: Signal processing overview

Levels

The Levels measurement measures the average signal level in the segments of the signal defined by the cursor position or location. This measurement supports a maximum of eight different levels. Each of these levels can be customized to perform the measurement based on user-selectable cursor positions. The levels are named as Level 1, Level 2, Level 3, Level 4, Level 5, Level 6, Level 7, and Level 8. However, it is possible to change the default names. The Configure Levels setting allows you customize the Levels measurement with a high degree of accuracy for the different levels. The cursors, which are displayed when the Levels Config window is selected, are two vertical bars. The left cursor is a solid vertical line and the right cursor is a dashed vertical line. When both cursors are on the same point, they appear as a dotted vertical line. We can measure the amplitude of average signal levels with the amplitude of the reference level by selecting in the Levels Configuration pane.

NOTE. On the VM6000 and DPO oscilloscopes, after the Configure Levels is clicked and when the Levels Configuration dialog appears, disable and re-enable the Cursors button. Then use the knob to adjust the cursor locations for the required levels.

Signal Source You can use any pattern of interest as a signal source.

Interpreting Results The default reference and limit values provided serve as a template. This template needs to be edited for the reference and the limit values to match the input pattern.

How Results are Calculated

The average level of the signal between the two cursor positions is measured relative to the back porch of the signal and is reported on each of the three channels for all the eight levels.

Multiburst

The Multiburst measurement is used to verify frequencies and corresponding amplitudes of sinusoidal bursts. It can be used to verify the proper reconstruction of a band-limited video signal across the frequency spectrum. For example, a frequency roll-off (decrease in amplitude with increasing frequency) is seen with video from an analog-to-digital converter that lacks a reconstruction filter with $\sin(x)/x$ correction. In this example, quality is reduced by things like loss of detail in the video or color shifts in details.

Deviations in frequency from the reference test signal frequency (for example, a 30 MHz burst is rendered as a 20 MHz burst) may indicate things such as a frequency shift due to format change, frequency aliasing due to digital and/or analog re-sampling, and/or frequency aliasing due to the lack of a proper reconstruction filter.

The flag amplitude measurement can be used to verify the channel gain across a wider frequency range than each burst. Burst amplitudes are measured relative to the flag amplitude.

Signal Source

You can use the matrix signal, or you can use any multiburst signal with a reference flag preceding the bursts. The more cycles present in each burst, the more robust and generally more accurate the measurement will be. A burst with less than 2 cycles is not recommended.

The frequencies are always displayed from lowest to highest regardless of the order of burst frequencies in the multiburst signal. To avoid confusion regarding the correspondence between the results burst numbering and the signal burst ordering, a signal with increasing burst frequencies (from left to right) is recommended.

Interpreting Results

For multiburst signals free of non-linear distortion and with increasing burst frequencies, the 'Frq(MHz)' column displays the fundamental frequency of burst specified in each row. The "Amp(dB)" column has the magnitude of the corresponding burst.

However, if non-linear distortion is present, interpreting results may be less straight forward.

In many consumer set-top boxes, lack of a reconstruction filter (with out-of-band rejection plus $\sin(x)/x$ correction) leads to roll-off in the fundamental frequency component of the bursts even though the envelope of the bursts may be flat on

average. In this case, the amplitude results for the highest frequency may be low by a few dB even though the waveform shows the same burst with peak-to-peak amplitude closer to 0 dB. This indicates that the burst is no longer a pure windowed sinusoid, but has other spectral content (at least one alias frequency in this example). If the extra spectral content is removed by filtering, the resulting sinusoid will have the amplitude shown in the results.

Generally, if the signal has undergone processing without a required anti-alias filter (as in re-sampling for format conversion, or signal reconstruction), each burst may contain one or several frequency aliases. In such cases, burst frequencies that increase with each burst of the input signal may contain burst frequencies in nearly any order in the output of the device under test.

For example, in the 480p rendering of an ATSC 1080i multiburst signal, 5 MHz is rescaled to 4.85 MHz, 10 MHz to 9.71, but 15 MHz, 20 MHz, 25 MHz, and 30 MHz become any number of frequencies (including 12.44 MHz, 7.58 MHz, 2.73 MHz, and 2.12 MHz respectively). These frequency aliases and respective amplitudes are measured and displayed in order: 2.12 MHz, 2.73 MHz, 4.85 MHz, 7.58 MHz, 9.71 MHz, 12.44 MHz.

How Results are Calculated

The six largest peaks are found in the spectrum of signal on the pedestal. These frequencies are displayed in order from lowest to highest. For each of these frequencies, the maximum magnitude of the cross-correlation between the signal within the pedestal area and a windowed complex sinusoid is found. This gives the amplitude.

Noise

The unweighted noise within the nominal bandwidth of the video signal is measured to ensure that the video quality is not reduced by random errors such as those that cause 'snow'.

Signal Source

You can use the matrix signal, or you can use any flat line or line pedestal signal.

Interpreting Results

As a rule of thumb, errors generally become visible when the signal-to-noise dB measurement ranges in the low 40s. However, the degree of visibility depends on many factors, including spectral distribution of the noise. In standard definition television, noise weighting filters such as the CCIR Recommendation (Rec) 576-2 unified weighting filter are used to weight the noise spectrum to better match the visibility of noise in typical viewing conditions. The unified weighting filter has been modified to exactly match the 'visibility of noise characteristics' of 576-2 on the screen for each selected video format.

How Results are Calculated

After line tilt and other low frequency distortions are removed from the signal, all AC signal content is spectrally weighted by the selected filter, if any, and the resulting RMS voltage is calculated along with the signal-to-noise ratio in dB using a 700 mV peak signal value.

The Noise relative to reference value is calculated as follows:

$$Result = (measured\ value - reference\ value)$$

Non Linearity

This measurement is used to measure deviations from a straight line ramp test signal. Deviations can be caused by such things as soft-limiting from analog amplifiers and digital processing errors. Problems in linearity can reduce video quality by, for example, reducing contrast at various average luminance levels, or creating color shifts.

Signal Source

You can use the matrix signal, or you can use either a ramp or step signal. However, a ramp signal will give the best accuracy.

Interpreting Results

The measurement shows deviations from linear increase in the test signal as a percentage of the largest increase per time found.

How Results are Calculated

In the case of steps, results are deviations in step amplitudes in the test signal as a percentage of the largest step found.

In the case of ramps, using six equal time intervals across the ramp, results are deviations from linear increase in the test signal as a percentage of the largest increase per time found.

The Non Linearity relative to reference value is calculated as follows:

$$Result = (measured\ value - reference\ value)$$

Short Time Distortion

The Short Time Distortion measurement measures the rise and fall time, overshoot and undershoot, settling time on the rising edge, and the settling time on the falling edge. Short time distortions produce fuzzy vertical edges.

Signal Source

Short time distortion can be measured with any signal that has a T rise time white bar and pulse section of the matrix signal. The pulse is used for the K2T measurement; the bar is used for the other measurements. A T rise time bar has a 10% to 90% rise time of nominally 100 ns. Many common test signals have 2T

rather than T rise times and are not suitable for this measurement. Also note that T rise time signals will suffer significant distortion when passed through a TV transmitter as they contain spectral components that will be removed by the transmitter 5 or 6 MHz low pass filter. Short time distortion measurements made on transmitted signals will therefore evaluate only those components in approximately the 200 ns to 1 μ s range.

Interpreting Results

The affected signal components range in duration from 0.100 μ s to 1 μ s. Short time distortions are most often characterized by measuring K_{2T} .

The rise and fall times are calculated on the bar using the 10% and 90% points. The result is displayed in ns. The overshoot is calculated as the highest excursion of the signal on the positive edge relative to the V_{max} steady state. The undershoot is calculated as the lowest excursion of the signal on the negative edge relative to V_{min} steady state. These two results are displayed in % using the steady state value as a reference. The Settling time on the rising edge is measured from the end of the overshoot to the point where the amplitude of the video ringing is down to $\pm 5\%$ of the final steady state value. The Settling time on the falling edge is measured from the end of the undershoot to the point where the amplitude of the video ringing is down to $\pm 5\%$ of the final steady state value. The K_{2T} measurement is an indicator of the quality of the video signal as perceived by a human viewer.

How Results are Calculated

K_{2T} is an estimate of the degradation of subjective quality due to linear distortions of the video signal. Linear distortions include any linear combination of the original pulse such as repeated pulses (from reflections, for example), ringing, etc. Ideally, the signal beyond 2T before and after the center of the pulse is practically zero. Linear distortions can cause deviations from zero. The greatest perceptual deviation from zero is used as the K_{2T} measurement. Perceptually, a low amplitude pulse far from the original pulse is more noticeable than the same pulse very close to the original. Therefore, signal amplitude deviations are weighted accordingly. A reference signal deviation far from the pulse is used. CCIR specifies 4% of the test pulse amplitude as the reference deviation amplitude ($K = .04$).

Measurements of the undershoot, and overshoot at the edge of a T rise bar are not generally calculated as a percent of the transition amplitude but in terms of an amplitude weighing system that yields results in percent SD. This weighing is necessary because the amount of distortion depends not only on the distortion amplitude but also on the time the distortion occurs with respect to the transition.

The Short Time Distortion relative to reference value is calculated as follows:

$$\text{Result} = (\text{measured value} - \text{reference value})$$

Spatial Distortion

The Spatial Distortion measurement measures the horizontal and vertical scale, offset or shift, and the missing picture portions near the edges or borders of the video output. It also measures the first line, last line, horizontal start, and the horizontal end of the active video output of the signal.

Signal Source

Spatial distortion can be measured using the default image test signal Tektronix provides by selecting the Default option in the Select BMP Ref File pane. You can also use your own image test signal and provide the 24-bit BMP reference file by selecting the Manual option in the Select BMP Ref File pane. Click Browse to select your defined bitmap reference file to run the spatial distortion measurement.

Interpreting Results

Video reformatting requires that images fit into a new aspect ratio (width:height) which either requires truncation of the image on the sides or adding blank border image segments on the sides, top, and bottom. To make an automated picture quality measurement between a test and reference sequence pair, spatial alignment is required. When a digital image is repositioned or resized, different pixels are required from those in the original image. Simply replicating or removing pixels causes unwanted artifacts.

Ideally the top crop, bottom crop, left crop, right crop, vertical scaling, horizontal scaling, vertical scaling, vertical offset, and horizontal offset should be zero. When the vertical scaling value is lower than 100 percent, the image is compressed vertically and when the value is greater than 100 percent, the image is stretched vertically. Similarly when the horizontal scaling value is lower than 100 percent, the image is compressed horizontally and when the value is greater than 100 percent, the image is stretched horizontally.

How Results are Calculated

Determining the location of the edge of each (test & reference) image (video frame) means that number of pixels on the right, left, top, and bottom of the image are blanking or border the image. Hence the two active images (test and reference) are mapped to one another, corner to corner. A variable phase (and corresponding co-efficient) all-pass reconstruction filter is used for interpolation when scaling the larger to smaller image in each dimension. Spatial distortion measurement is performed as shown in Figure 3-2 and Figure 3-3.

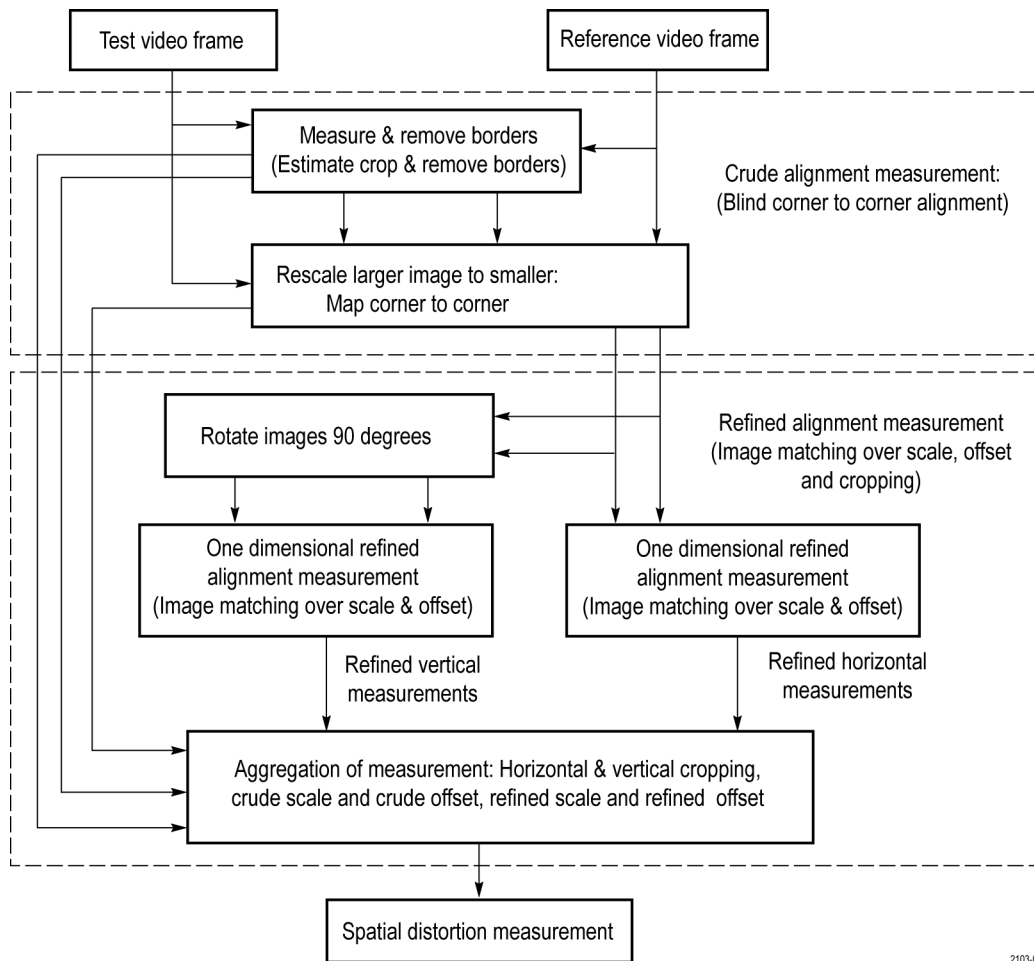

2103-002

Figure 3-2: Block diagram for measuring video spatial distortion both in horizontal and vertical dimensions

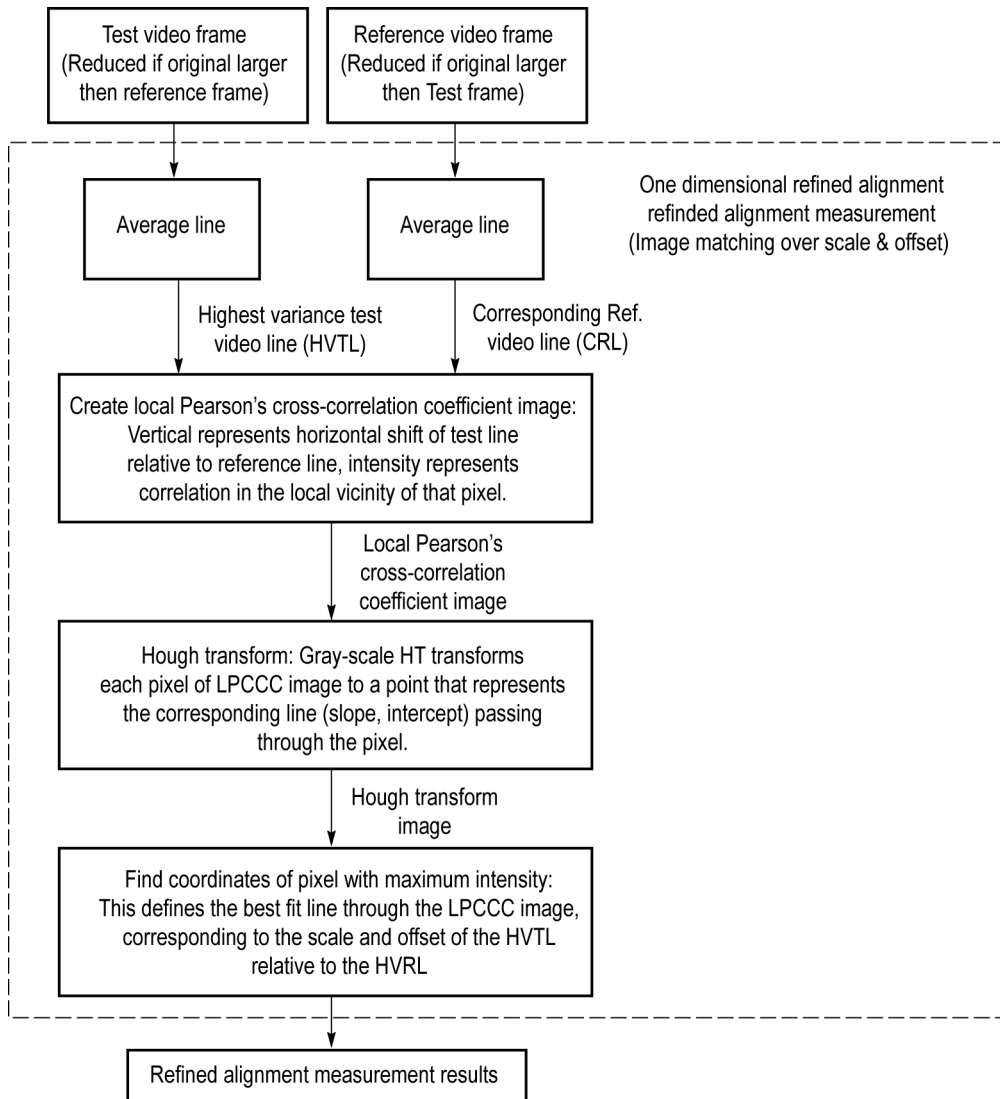

2103-003

Figure 3-3: Block diagram for one dimensional refined alignment measurement

The input signal is processed as follows:

1. **Measure and Remove Borders:** Determine the location of the edge of each test and reference image (video frame). This amounts to determining how many pixels on the right, left, top and bottom of the image are blanking or non-active portions of the image. The corresponding identified active portion of the test and reference images will be used for subsequent measurement processing.
2. **Rescale each larger dimension of the two images (active reference image and active test image) to match the smaller of the two.** The result is two images

with the same resolution. For example, if a 704 X 480 active test image and a 1920 X 1080 active reference image are input, the resulting test and reference images are both 704 X 480 due to the reference being resampled (using methods of prior). In effect, the two active images are mapped to one another, corner to corner.

3. Find the highest variance test line (HVTL) from the active test image and the corresponding reference line (CRL) in the active reference image.
 - a. Select a vertical image segment from the active test image: A test image segment (full width, partial height) is defined by including equal number of lines above and below the HVTL.
 - b. This selected test image segment is registered to the reference image using 2-D correlation and a search window centered at the reference line with maximum variance, provided the window is within the cropping tolerance and search window.

The method of spatial registration of the active test image segment to the active reference image is essentially the same as that used in measuring ANSI T1.801.03-1996, 5.4 (Active video shift). However, other methods could be used, such as the spatial registration method used in ANSI T1.801.03-2003 6.1 (Spatial Registration). Either method searches for the optimal metric corresponding to the best match over spatial shift for a vertical segment to find which reference line corresponds to the test line with greatest variance.

- c. The center line of the corresponding reference vertical segment is selected for subsequent processing.
4. Create local Pearson's cross-correlation coefficient (LPCCC) image from the CRL and the HVTL at different horizontal shifts. Each line of this LPCCC image is generated using the CRL and horizontally shifted version of the HVTL as inputs, locally cross-correlated using a 1-D version of the same general method used in the local 2-D correlation in US Patent #6,975,776 Predicting Human Vision Perception And Perceptual Difference.

This method of calculating cross-correlation locally basis amounts to extrapolating the concepts of discrete ensemble measures (mean, variance, covariance) to that of continuous measures (local means taken as IIR low-pass filter {IIR LPF} output, local variance taken as IIR LPF processed differences of pixel values and local means of pixel values).

The IIR LPF is a recursive filter, applied once forwards on the input line and then again backwards on the intermediate output from the forward direction. In effect, every summation used in discrete statistical calculations can be replaced with an IIR LPF operation. Whereas the Pearson's correlation coefficient is calculated as the covariance divided by the square root of the product of test and reference variances, the LPCCC is calculated for each

pixel of the CRL as the local covariance divided by the square root of the product of test and reference local variances.

For each CRL pixel, local covariance is calculated as the IIR LPF applied to the product the CRL pixel deviation from local CRL pixel mean and the corresponding (at the given horizontal shift) HVTL pixel deviation from local HVTL pixel mean, the pixel means themselves resulting from subjecting the respective lines to the IIR LPF.

So, the LPCCC[*row*][*column*] image is given by:

$$LPCC[shift][n] = LocalCovariance(HVTL[shift], CRL)[n] / (sqrt(LocalVariance(HVTL[shift])[n] * LocalVariance(CRL)[n]))$$

Where

$IIR_LPF(X)[n]$ = *nth output of the IIR LPF applied successively in both directions to input image line X.*

Thus, $IIR_LPF(X)[n]$ is the local mean of X at the *nth* pixel.

$$LocalVariance(X)[n] = (X[n] - IIR_LPF(X)[n])^2$$

$$LocalVariance(X, Y)[n] = IIR_LPF((X[n] - IIR_LPF(X)[n]) * (Y[n] - IIR_LPF(Y)[n]))[n]$$

The filter is initialized with X[0] in the forward pass and equivalently for the reverse pass.

The HVTL shift range corresponds to the ratio of HVTL to CRL image scale range the algorithm can detect. Higher shift (scale measurement) ranges have a correspondingly higher computational cost.

5. Find highest average intensity line across the LPCCC image. The slope of this line corresponds to the ratio of HVLP and CRL image scales, whereas the y intercept corresponds to the shift or spatial offset. To identify this line, a linear gray-scale Hough transform is used:

Each pixel/Point in the LPCCC image maps to a Hough Transform line via a parametric line equation:

Input image = LPCCC[*row* = *y*][*column* = *x*] with

x = original image pixel index

y = horizontal shift for correlation – maximum negative shift

For each LPCCC(*x*,*y*), map to Hough Transform [*Theta*, *R*] for each *Theta* (parameterized using the *Theta* increment index *ThetaAngleBin*):

$$Theta = \Pi * ThetaAngleBin / ThetaIndexMax$$

$$R = x * \cos(Theta) + y * \sin(Theta)$$

$$\text{HoughTransformImage}[\text{ThetaAngleBin}][R] + = \text{LPCCC}$$

Note that nonlinear scaling (as with fish-eye effect) will result in corresponding distortions in the brightest line of the LPCCC. This nonlinearity may also be measured.

6. Find co-ordinates of the Hough Transform image pixel with maximum intensity (max Hough[ThetaAngleBin][R] intensity): This defines the best fit line through the LPCCC image, corresponding to the scale and offset of the HVTL relative to the CRL.

7. Convert Hough transform Theta and R to spatial scale and offset:

$$\text{refinedScale} = 1 + \tan(\text{ThetaMaxHough} + (\frac{\pi}{2}))$$

$$\text{nominalVerticalDatum} = \frac{\text{LPCC} \cdot \text{Height}}{2}$$

$$\text{yIntercept} = \frac{\text{RMaxHough}}{\sin(\text{ThetaMaxHough})}$$

$$\text{refinedOffset} = \text{nominalVerticalDatum} - \text{yIntercept}$$

8. Calculate refined scale and offset for the vertical dimension. This may be done reusing the same method as steps 3 through 7 using 90 degree rotated versions of the active test and reference images.
9. The crude and refined offsets and scale values are combined to give total horizontal and vertical scale and offset values. Likewise the blanking or border measurements can be used in combination with the refined measurements to give cropping measurements.

V Sync

The V Sync measurement is used to check the vertical synchronization signal timing and amplitude.

The EIA STANDARD Definition TV Analog Component Video Interface EIA-770.2-A defines an analog video signal that includes synchronization pulses and control the scanning line-by-line from left to right and field-by-field from top to bottom. The pulses that control the vertical scanning are called the vertical synchronization pulses.

Table 3-2: Scanning systems for SD in accordance with the EIA-770.2-A standard

Characteristic	Scanning Format	
	Interlaced	Progressive
Pixels per active line	720	720
Active lines per frame	480	480
Frame Rate (Hz)	30	60
Scanning Format	858	858
Total lines per frame	525	525

When the format is set to SD Interlaced, the values of the field period, vertical blank before pre-equalization, vertical blanking, pre-equalization duration, equalization pulse width, vertical sync duration, and serration pulse width are displayed in the result screen.

When the format is set to SD Progressive, the values of the frame period, equalization pulse width, and vertical sync duration are displayed in the result screen.

Each field is divided into an active picture area and a vertical blanking interval. The vertical blanking interval for the Y luminance signal contains the vertical synchronizing information surrounded by the blanking periods to properly position the vertical sync and by space allocated for specific vertical interval signals called equalizing pulses.

Vertical blank before pre equalization is the front porch of the last active line. Field period is the reciprocal of the frame rate. This is applicable to both HD and SD formats with interlaced scanning.

Serration pulses are the pulses that occur during the vertical sync interval, at twice the normal horizontal scan rate. These pulses ensure correct 2:1 interlacing and eliminate the buildup of DC offset.

Table 3-3: Scanning systems for HD in accordance with the EIA-770.3-A standard High Definition TV analog Component Video Interface

Characteristic	Scanning Nomenclature	
	1280 X 720	1920 X 1080
Samples per active line	1280	1920
Active lines per frame	720	1080
Frame Rate (Hz)	60	30
Scanning Format	Progressive	2:1 Interlace
Pixel Frequency (MHz)	74.25	74.25
Total sample per line	1650	2200
Total lines per frame	750	1125

When the format is set to HD Interlaced, the values of the field period, vertical sync duration, broad pulse start, and broad pulse end are displayed in the result screen. Refer to the following figure for 1080I interface horizontal timing details:

When the format is set to HD Progressive, the values of the frame period, vertical sync duration, broad pulse start, and broad pulse end are displayed in the result screen.

Broad pulses or the vertical synchronizing pulses are the pulses in the center of the vertical interval. These pulses are long enough to be distinguished from all others and are the part of the signal actually detected by vertical sync separators.

Equalizing pulses are pulses of one-half the width of the horizontal sync pulses which are transmitted at twice the rate of the horizontal sync pulses during the blanking intervals immediately preceding and following the vertical sync pulses. Frame rate is the rate at which frames of video are scanned on the screen. Frame period is the reciprocal of twice the frame rate. This is applicable to both HD and SD formats with progressive scanning.

Signal Source

You can use the full white or matrix signal as the signal source.

Interpreting Results

Synchronization pulses ensure that the video image is locked on a video monitor vertically and horizontally without any jitter or rolling. If vertical sync is lost, the picture may move or tear vertically.

How Results are Calculated

For the video format SD with interlaced scanning, each field is divided into an active picture area and a vertical blanking interval. The vertical blanking for the Y luminance signal contains the vertical synchronizing information surrounded

by blanking periods to properly position the vertical sync and by space allocated for special vertical interval signals.

For the video format SD with progressive scanning, the frame is divided into an active picture area and a vertical blanking interval. The vertical blanking interval for the Y luminance signal contains the vertical synchronizing information surrounded by blanking periods to properly position the vertical sync.

Option VGA Detailed Measurement Information

For a high-level procedure on how to take a measurement, refer to page 2-28.

For a high-level overview of all the measurements, refer to the table beginning on page 3-27.

The following information applies to all the measurements.

Matrix Signals and Line Numbers

The matrix signals that are included with the Signal Source Set (refer to page E-10) provide appropriate signals for all the measurements. Refer to the Readme.txt files on the Signal Source Set for extensive information about the files provided.

When using Tektronix supplied matrix test signals, if a .vmset file is provided for that format of matrix test signal, be sure to use the default line numbers in the associated .vmset file (File > Recall). Otherwise, under most circumstances, use the instrument default line numbers (File > Recall Defaults).

For example, click **File > Recall**, and then navigate to where you have saved the setup file:

Tek.vmset

The line numbers in this setup file may be used for all formats, such as 640X480, 800X600, 1024X768, 1280X1024, 1600X1200 @60, 75, and 85 Hz in RGB.

For the equivalent matrix test signal, the Signal Sources disk supplies .bmp files. The device under test generates the signal that the VM5000 analyzes.

Averaging

The higher the average, the lower the variance of the measurement in the presence of noise or other transient signal components. Set the average higher if you would like to reduce the fluctuations in the measurement results.

The instrument averages results, not input waveforms. (If, on the other hand, the Noise waveforms were averaged instead of the Noise results, the noise results would appear lower than they should. Because of the instrument average results, this problem is avoided). The maximum average value you can set in the Results screen is 64.

Ch-Ch Mismatch Measurement

The Ch-Ch Mismatch measurement measures the difference in any steady-state voltage amplitude between R, G, and B video outputs. The amplitude difference of all the 32 steps is measured between two channels. The maximum amplitude difference is shown as the result.

Signal Source

The test signal used for Ch-Ch Mismatch measurement is a 32 Step Staircase (required to test for compliance with the VESA Test procedure), which is located on the Test Signal Files CD-ROM.

The 32 Step Staircase test signal contains a pattern where each step is equal to 1/32 of the maximum input voltage (700 mV) for R, G, and B channels. The PC color setting must be set to True Color mode.

If you plan to take only Ch-Ch Mismatch measurement, use a 32-Step Staircase Full Field test pattern. Select the bitmap file that matches the format and the refresh rate of the test. For example, look for the 640x480-32Steps.bmp file to test a 640x480 resolution format.

You can also use a Matrix signal as a test signal. For more information on the Matrix signal refer to page 2-21. For example, look for the 640x480-Matrix.bmp. This file has a 32 Step Staircase which is suited to the Ch-Ch Mismatch measurement.

Interpreting Results

The maximum limit for the Ch-Ch Mismatch is 6% of any voltage over the full range in accordance with the VESA specifications.

The ideal value of Ch-Ch mismatch result should be 0 mV. A positive value indicates that the step voltage of the first channel is greater than that of the second channel. A negative value indicates that the step voltage of the first channel is less than that of the second channel.

For example, -8.923 mV mismatch between G to B channel indicates that the step voltage of the G channel is less than the step voltage of the B channel.

How Results are Calculated

For a given step, the voltage amplitude is measured with reference to the back porch. The amplitude is measured for two channels (say G and B). The amplitude difference of two channels is calculated and displayed as the result. The results are reported as a percentage by dividing the calculated result by V_{max} steady state (typically 700 mV).

Ch-Ch Skew Measurement

Ch-Ch Skew is the phase relationship (time delay) among R, G, and B video outputs of the graphics subsystem. In addition, Ch-Ch Skew is a function of the relative cable lengths for each of the channels.

The Ch-Ch Skew measurement is used to verify the relative timing of the three video channels. Nominal Ch-Ch Skew is zero between all the channels. The Ch-Ch Skew measurement also displays the pixel clock (%) in the Results window that is the channel-to-channel delay as a percentage of the pixel clock period.

Ch-Ch Skew incurs a slight color shift at the edge of the white bar. Visually, it appears as a focus error.

Signal Source

The test signal used for the Ch-Ch Skew measurement is the Alternate White and Black Bars (required to test for compliance with the VESA Test procedure), which is located on the Test Signal Files CD-ROM.

There are nine bars in the Alternate White and Black bars test signal.

If you plan to take only Ch-Ch Skew measurement, use an Alternate White and Black bars Full Field test pattern. Select the bitmap file that matches the format and the refresh rate of the device under test. For example, look for an 640x480-AlternateWhite&BlackBars.bmp file to test a 640x480 resolution format.

You can also use a Matrix signal as a test signal. For more information on the Matrix signal refer to page 2-21. For example, look for a 640X480-Matrix.bmp file to test a 640x480 resolution format.

Interpreting Results

The ideal value of Ch-Ch skew is 0 ns. A positive number indicates that the first signal arrives later than the second signal. For example, G to B delay of 4.03 ns means that the signal in the G channel is delayed 4.03 ns relative to B.

If the signals of the three channels are highly correlated, the “loop” delay will be approximately zero:

$$\text{Delay1} - \text{Delay2} + \text{Delay3} = 0,$$

where

Delay1 is between channels G to B

Delay2 is between channels G to R

Delay3 is between channels B to R

How Results are Calculated The leading edge position of the second white bar is determined for all three video channels. For each pair of channels, the difference in the above values is computed and reported. The result is also reported as a percentage of the pixel clock period.

Color Bars Measurement

The Color Bars measurement measures the GBR color bars of a VGA card in a PC. The Color Bars measurement measures the amplitude level (relative to back porch) of each of the eight colors, that is, white, yellow, cyan, green, magenta, red, blue, and black for each active channel. Therefore, this measurement makes eight measurements on three channels for 24 total measurements. The software assumes that G is on Channel 1, B is on Channel 2, and R is on Channel 3.

The Color Bars measurement is also used to check individual channel gain. In addition, it can be used as a crude check of linearity because severe clipping or other non-linear distortions will alter the measurement results from the ideal.

Signal Source The test signal used for the Color Bars measurement is the color bars pattern located on the Test Signal Files CD-ROM.

The color bars test signal used has nine colors. They are white, yellow, cyan, green, magenta, red, blue, black, and white. If you generate your own color bars test signal, it should have the first and the last bar white and the remaining seven color bars in any order. Each of the bars should be at least 1/24 of the active line time in duration.

If you plan to take only Color Bars measurements, use a Full Field test pattern of the type Color Bars. Select the bitmap file that matches the format and the refresh rate of the test. For example, use the 640x480-ColorBars.bmp file to test a 640x480 resolution format.

You can also use a Matrix signal as a test signal. For more information on the Matrix signal refer to page 2-21. For example, look for a 640x480-Matrix.bmp file to test a 640x480 resolution format.

Interpreting Results The reference value of the amplitude level relative to the back porch of each of the colors is either 0 mV or 700 mV for G, B, and R channels.

For example, relative value of 15 mV for yellow (G channel) indicates that the measured value of the signal is greater than the reference value of the signal.

How Results are Calculated First, the bars are identified using the relative amplitudes of the three channels and the specification for the selected format and colorimetry.

The amplitudes are calculated using waveform averaged values within each identified bar relative to the back porch. Thus, it is important to ensure that the

sync signal is within the captured data window for valid measurements. For example, if a manual setup is performed, all eight bars are required on the waveform display.

The Color Bars relative to reference values are calculated as follows:

$$\text{mV} : \text{Result} = (\text{measured value} - \text{reference value})$$

$$\% : \text{Result} = \left(\frac{\text{measured value} - \text{reference value}}{\text{reference value}} \right) \times 100$$

H Sync Measurement

Horizontal Sync is the pulse occurring from 2.4 V to 5.5 V at the beginning of each line. This pulse causes the electronic beam of a CRT to go back to the left side of the display and trace another horizontal line of picture information. This measurement characterizes the rise time, fall time, overshoot, undershoot, and settling time shown in the Figure 3-4.

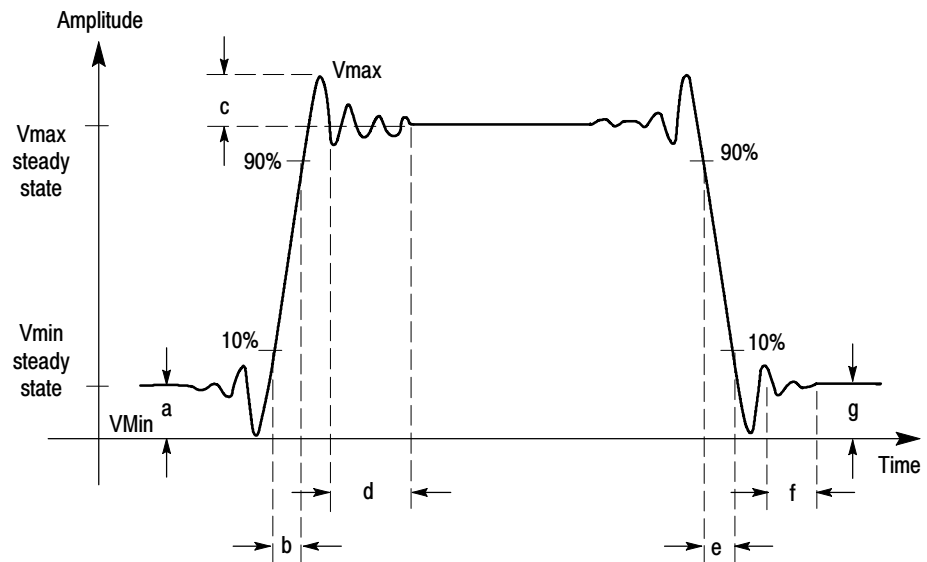

Figure 3-4: Signal definitions (H Sync)

where a - Vmin steady state amplitude before transition
b - Rise Time
c - Overshoot
d - Settling time
e - Fall time
f - Settling time
g - Undershoot

This measurement also characterizes monotonicity and steady-state voltage amplitude at logic levels '1' and '0'. When the MIU is present, a current source inside the MIU automatically presents the required load. So no manual intervention is required. In the absence of the MIU, external 2.21 k Ω and 301 Ω terminations have to be manually presented. The user is prompted to change the termination from 2.21 k Ω to a 301 Ω termination for measuring the level when drawing maximum current.

Variations in the sync pulse voltage may cause instability in the displayed image or for extreme cases may even prevent the monitor from locking on to the correct scan frequency.

Rise time is measured from the 10% to the 90% amplitude points of a positive-going transition.

Fall time is measured from the 90% to the 10% amplitude points of a negative-going transition.

Overshoot refers to rise above the steady state value in a positive-going transition. Undershoot refers to fall below the steady state value in a negative-going transition.

Settling time is measured from the end of the overshoot or undershoot to the point where the amplitude of the video ringing is down to $\pm 5\%$ of the final steady state value.

Monotonicity is the property whether or not the video signal is continuously rising or falling without any inflection points. Monotonicity is decided by determining the progression of the successive gray levels.

When measuring transients (rise time, fall time, overshoot, etc.), the MIU is set to use the Sync Wide bandwidth path. When measuring amplitude levels, the MIU is set to use the Sync low bandwidth path.

Signal Source

The H Sync measurement does not require a specific test pattern. It can be taken with any of the patterns in the Matrix signal (located on the Test Signal Files CD-ROM).

Interpreting Results

Horizontal Sync polarity is detected by looking at the signal level after skipping a nominal pulse width duration. It is considered to be positive if the signal level

is less than one volt. If not, the polarity is negative. H Sync edge and corner characteristics are determined by detecting the edge of the H sync signal. A smaller rise/fall time value indicates a higher quality signal. The overshoot and undershoot amplitude, and settling time should be zero under ideal conditions. When H Sync monotonicity is Yes in the results panel, it indicates that the incoming signal does not change its sign during the rise/fall period.

NOTE. *H Sync and V Sync transient measurements, such as rise time, fall time, overshoot, undershoot, settling time, and monotonicity, are very sensitive to signal connection. Option VGA provides the 012-1685-XX Measurement Interface Unit (MIU). If an RGBHV signal output is VESA-compliant, using the MIU and bundled cables together will generate the most accurate Option VGA test results.*

Some H Sync or V Sync signal outputs on a device will not have the VESA-specified 50 Ω source impedance. Since the MIU uses 50 Ω transmission lines for the H Sync and V Sync signal routing, reflections and signal distortions may result if the device source impedance is not 50 Ω . The magnitude of the distortion will depend on the impedance error. Whether the distortion is detectable depends on the signal rise time.

In general:

Sync signals with rise times slower than 10ns will have little sensitivity to impedance error.

Source impedances within 10 Ω of the specified 50 Ω will generally provide proper rise/fall time and monotonicity measurements, irrespective of the signal rise time.

Please check the reflection by adding a length of 50 Ω RG-58 cable to the signal input between the short cable BNC and the MIU input BNC before the crucial measurement. If reflection-caused steps are visible on the leading edge, they will increase in length (time) when the cable length is added: approximately 3ns per foot of cable. If adding the cable does not alter the shape of leading-edge distortions, then they are not the result of impedance mismatch.

How Results are Calculated

The Scope trace is triggered by the trailing edge of the H Sync pulse. Transient and pulse width measurements are made on the H Sync pulse at the end of the specified line.

Sync levels are measured with reference to oscilloscope ground and reported at two different conditions:

- When the H Sync signal or channel is terminated by a 2.21 k Ω resistor
- When the H Sync signal or channel is connected to a current source of ± 8 mA (+8 mA is connected when H Sync level is high, -8 mA when H Sync level is low)

Horizontal Sync amplitude is determined by averaging the points that lie between 30% and 90% of the pulse width. Sync pulse width is determined by detecting the edges of the sync signal. The position difference between the two edges is shown as the result.

Rise time is the time taken for the signal to rise from 10% to 90% of steady state level.

Overshoot/Undershoot settling time is the time taken for the signal to reach 5% of its steady state value.

H Sync frequency is derived from pulse time value.

H Sync Jitter Measurement

Horizontal Sync Jitter is the time between the superimposed image of the second sync pulse over the first, or triggered edge. Jitter is the variation of a digital signal's significant instants, such as transition points from the ideal positions in time. Use the **H Sync Jitter** measurement to measure the Horizontal Sync Jitter. See Figure 3-5.

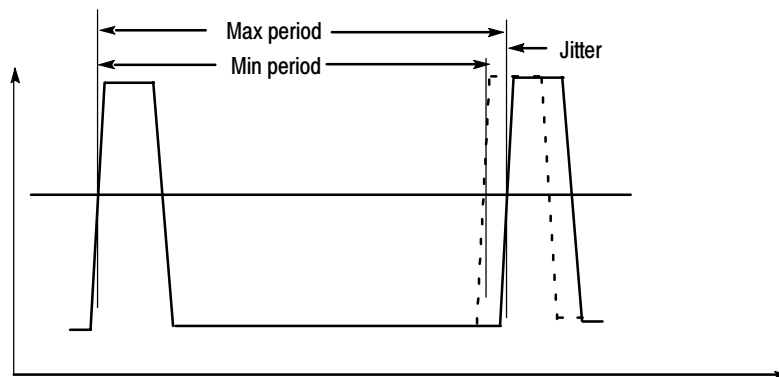

Figure 3-5: Jitter in H Sync period

Signal Source

The test signal used for the H Sync Jitter measurement can be any of the available patterns in the Matrix signal, which is located on the Test Signal Files CD-ROM.

Interpreting Results

A low numeric value of the H Sync jitter indicates a higher quality of incoming signal.

How Results are Calculated

The peak to peak H Sync Jitter is calculated as follows:

$$Jitter (peak - peak) = \left(\frac{Max. SyncPeriod value - Min. SyncPeriod value}{2} \right)$$

$$Jitter(\%) = \frac{Jitter (peak - peak)}{pixel\ clock\ period}$$

The H Sync Jitter is calculated for N consecutive lines of video frames. N is entered by the user.

Half of the difference between the minimum and maximum is reported as the H Sync period jitter. This value is also quantified as a percentage of the pixel clock period.

H Timing Measurement

The Horizontal Timing measurement consists of the following measurements: the horizontal sync pulse, the back porch, the addressable video signal, the front porch, the left border, and the right border.

Back porch is the portion of the video signal that lies between the trailing edge of the horizontal sync pulse and the start of the active picture.

Border is the period during which a background colored border is displayed in order to allow the image to extend beyond the limits of the surrounding bezel on overscan type monitors. The duration of the left border or the right border in the active video constitute one-tenth of the total time.

Addressable video is the period during which active video image information is transmitted.

Front porch is the portion of the video signal between the end of the active picture and the leading edge of the horizontal sync.

Sync pulse width is the period of the active sync pulse.

Signal Source

The test signal used for the H Timing measurement is Black White Black (required to test for compliance with the VESA Test procedure), which is located on the Test Signal Files CD-ROM.

The Black White Black test signal contains a black pattern (10%) followed by a white pattern (80%), and this is again followed by a black pattern (10%). Because some graphics cards insert a border around the picture, this test signal facilitates border detection.

If you plan to take only H Timing measurements, use a Black White Black Full Field test pattern. Select the bitmap file that matches the format and the refresh

rate of the test. For example, use the 640x480-BlackWhiteBlackBars.bmp file to test a 640x480 resolution format.

You can also use a Matrix signal as a test signal. For more information on the Matrix signal refer to page 2-21. For example, use the 640x480-Matrix.bmp file to test a 640x480 resolution format.

Interpreting Results

The H Timing Results must match the values specified by the standards depending on the timing standard selected.

How Results are Calculated

In H Timing, if any borders are detected, their width is measured. A border is considered present if there are pulses around SAV or EAV with heights of at least 15% of the white level. Edges of the white band are detected and addressable video width is estimated by considering the white band is 80% of the addressable portion of the H sync pulse width. Sync period is measured by detecting the edges in the sync signal.

Linearity Measurement

Linearity is a measure of how well the device-under-test performs analog to digital and digital to analog conversions.

Linearity consists of the Resolution, Integral linearity, Differential linearity, and Monotonic measurements.

The integral linearity is the actual nth value compared to the ideal nth value, normalized to the ideal LSB command voltage (LSBc).

Differential linearity is the difference between the DAC output voltage measured in the nth value and that of the previous value (n-1) normalized to the ideal LSB command voltage (LSBc).

Resolution refers to the number of distinct vertical levels in the video signal based on the steps. Resolution is represented as a bit.

For a 256 level DAC, the resolution is reported as eight bits. For levels greater than 128 and less than 256, the resolution reported is eight bits.

Monotonicity is the property whether or not the video signal is continuously rising or falling without any inflection points. Monotonicity is decided by determining the progression of the successive gray levels.

Signal Source

The test signal used for the Linearity measurement is the Staircase, which is located on the Test Signal Files CD-ROM.

The Staircase test signal contains a pattern ranging from black to white. The file is available in BMP format for an 8-bit staircase test signal and in PNG format for a 10-bit staircase test signal.

If you plan to take only Linearity measurements, use a Staircase Full-Field test pattern. Select the bitmap file that matches the format and the refresh rate of the test. For example, look for a 640x480-Staircase.bmp file to test a 640x480 resolution format.

You can also use a Matrix signal as a test signal. For more information on the Matrix signal refer to page 2-21. For example, look for a 640x480-Matrix.bmp file to test a 640x480 resolution format.

Interpreting Results

By using a staircase signal, the bit resolution of the device under test can be determined. The integral and differential linearity values should be close to zero under ideal conditions.

How Results are Calculated

The Linearity of an input signal is calculated by using the RGB wide bandwidth signal path of the MIU.

Normalized Integral Linearity Error is calculated as follows:

$$\text{NormIntegLinErr} = \left(\frac{V_{\text{actual}} - V_{\text{idealval}}}{\text{LSBc}} \right)$$

where

NormIntegLinErr is the Normalized Integral Linearity Error

V actual is the actual voltage amplitude of the step

V idealval is the ideal voltage amplitude of the step

LSBc (for an 8-bit DAC) is given by

$$\left(\frac{\text{Voltage amplitude of 255th step} - \text{Voltage amplitude of 0th step}}{255} \right)$$

Normalized Differential Linearity Error is calculated as follows:

$$\text{NormDiffLinErr} = \left(\frac{V_{\text{actualnstep}} - V_{\text{actualnprestep}}}{\text{LSBc}} \right)$$

where

NormDiffLinErr is the Normalized Differential Linearity Error

$V_{actualNstep}$ is the actual voltage amplitude of the Nth step

$V_{actualNprestep}$ is the actual voltage amplitude of the previous (N-1)th step

The Normalized Integral Linearity Error and the Normalized Differential Linearity Error are calculated for each step. The step at which the maximum Normalized Integral Linearity Error and the Normalized Differential Linearity Error observed is displayed in the Linearity results window.

Luma Levels Measurement

Luma corresponds to the sensitivity of human vision to each of the RGB primaries standardized for video.

The Luma Levels measurement reports the minimum and maximum level from the five white and black bars of the active video for each of the three channels.

Signal Source

The test signal used for the Luma Levels measurement is Alternate White and Black Bars (required to test for compliance with the VESA Test procedure), which is located on the Test Signal Files CD-ROM.

The Alternate White and Black bars test signal contains alternating white and black bars. There are five white and black bars in this pattern.

If you plan to take only Luma Levels measurements, use the Alternate White and Black Bars Full Field test pattern. Select the bitmap file that matches the format and the refresh rate setting of the test device. For example, use the 640x480-AlternateWhite&BlackBars.bmp file to test a 640x480 resolution format.

You can also use a Matrix signal as a test signal. For more information on the Matrix signal refer to page 2-21. For example, use a 640x480-Matrix.bmp file to test a 640x480 resolution format.

Interpreting Results

The Luma Levels measurement results indicate the purity of the signal on the selected channel.

How Results are Calculated

The results are calculated with reference to the oscilloscope ground by taking an average of 100,000 points between the 20% and 80% regions of the addressable video range. The selected line from consecutive frames will be used to get the required number of points. The maximum and minimum amplitude values are shown as the result.

Noise Inj Ratio Measurement

Noise Injection Ratio is the ratio of the peak-peak noise amplitude injected to the maximum signal amplitude in the video signal.

To make use of the instrument's full bandwidth and get the highest sampling rate, each channel is acquired separately at 5 GS/s (gigasamples per second). The minimum bandwidth as specified by the VESA specification for Noise Injection Ratio measurement is 500 MHz. There can be minor variations in the Noise floor of different instruments, which can result in different results for the same DUT, therefore a filter option is provided to limit the bandwidth to a pre-defined value. By using a 500 MHz filter, more accurately measured values are obtained for the signal noise regardless of bandwidth of the measurement devices.

With the 500 MHz Filter option selected, the data is low-pass filtered with a single pole filtered with the response shown. See Figure 3-6.

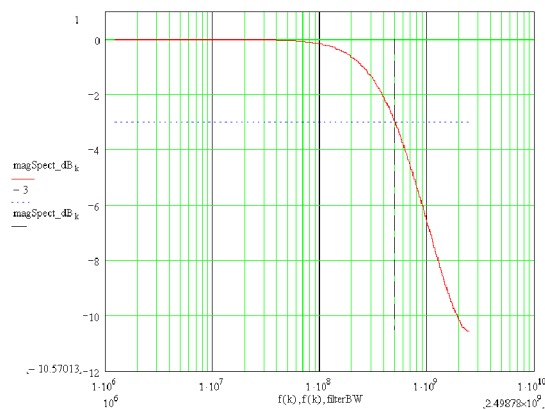

Figure 3-6: Frequency response with 500 MHz filter for Noise In Ratio measurement

Signal Source

The test signal used for the Noise Injection Ratio measurement is Full White, which is located on the Test Signal Files CD-ROM.

If you plan to take only Noise Inj Ratio measurements, use a Full White Full Field test pattern. Select the bitmap file that matches the format and refresh rate of the test. For example, use the 640x480-FullWhite.bmp file to test a 640x480 resolution format.

You can also use a Matrix signal as a test signal. For more information on the Matrix signal refer to page 2-21. For example, use the 640x480-Matrix.bmp file to test a 640x480 resolution format.

Interpreting Results

When the injection ratio is below a certain threshold, noise will not be perceived. With the injection ratio greater than the threshold, perceived image quality is degraded as a function of noise injection ratio. Noise Injection Ratio in dB is less negative when the noise amplitude increases.

How Results are Calculated

Using a Full White signal, the peak-to-peak fluctuation in luminance voltage (of at least 100,000 samples) is measured. The noise amplitude is measured with reference to oscilloscope ground. The Noise Injection Ratio measurement uses the video wide bandwidth signal path of the MIU. The maximum value of the fluctuation is used for computing the Noise Injection Ratio as shown in the Figure 3-7.

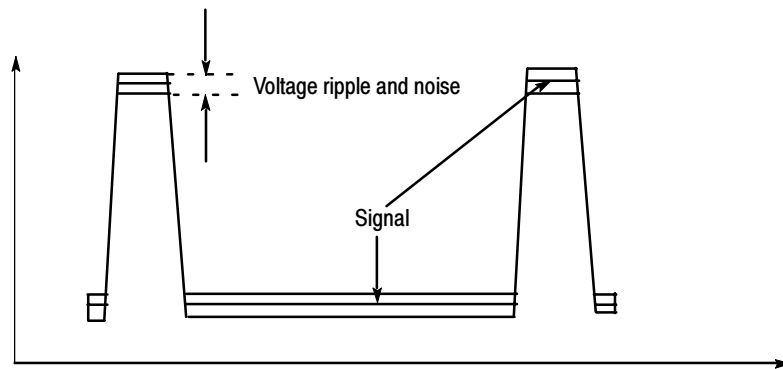

Figure 3-7: Voltage ripple and noise

The noise amplitude is calculated as follows:

$$\text{Noise amplitude (mV)} = \sqrt{(V_{\text{peak-peak}})^2 - (NF)^2}$$

where

$V_{\text{peak-peak}}$ is the peak to peak fluctuation in the input signal

NF is the peak to peak fluctuation observed with oscilloscope channel coupling set to ground

$$\text{Injection ratio (\%)} = \left(\frac{\text{Noise amplitude (mV)}}{V_{\text{signal amplitude}}} \right) \times 100$$

The signal-to-noise ratio in dB is calculated using the average signal amplitude.

V Sync Measurement

The Vertical Sync measurement is used to check synchronization signal timing. This measurement measures the steady-state voltage amplitudes of logic levels '1' and '0'. When the MIU is present, a current source inside the MIU automatically presents the required load, so no manual intervention is required. In the absence of the MIU, external 2.21 k Ω and 301 Ω terminations have to be manually presented. The user is prompted to change the termination from 2.21 k Ω to a 301 Ω termination for measuring the level when drawing maximum current. This measurement characterizes the rise time, fall time, overshoot, undershoot, and settling time shown in the Figure 3-8.

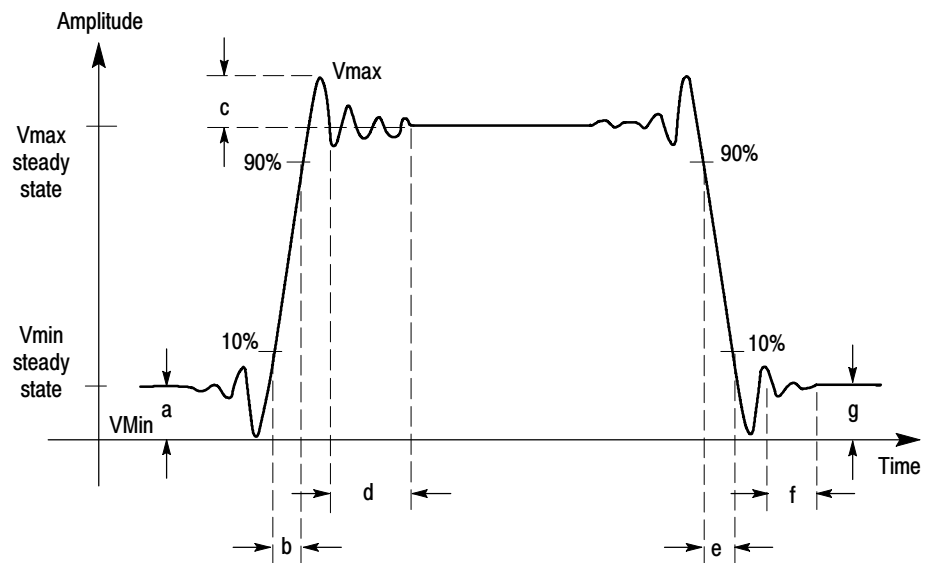

Figure 3-8: Signal definitions (V Sync)

where

- a - Vmin steady state amplitude before transition
- b - Rise Time
- c - Overshoot
- d - Settling time
- e - Fall time
- f - Settling time
- g - Undershoot

The measurement also characterizes the Monotonicity of the H Sync pulse. Variations in the sync pulse voltage may cause instability in the displayed image or for extreme cases may even prevent the monitor from locking on to the correct scan frequency.

Rise time is measured from the 10% to the 90% amplitude points of a positive-going transition.

Fall time is measured from the 90% to the 10% amplitude points of a negative-going transition.

Overshoot refers to the rise above the steady state value in a positive-going transition. Undershoot refers to the fall below the steady state value in a negative-going transition.

Settling time is measured from the end of the overshoot or undershoot to the point where the amplitude of the video ringing is less than or equal to $\pm 5\%$ of the final steady state value.

Monotonicity is the property whether or not the video signal is continuously rising or falling without any inflection points. Monotonicity of the signal is decided by determining the progression of the successive gray levels.

When measuring transients, the MIU is set to use the Sync wide bandwidth path. When measuring amplitude levels, the MIU is set to use the Sync low bandwidth path.

For V Sync Period, the scope horizontal scale is adjusted to be able to see at least two V sync pulses and the duration between the leading edges of the two sync pulses is measured.

Signal Source

The test signal used for the V Sync measurement can be any of the available patterns in the Matrix signal, which is located on the Test Signal Files CD-ROM.

Interpreting Results

Vertical Sync polarity is detected by looking at the signal level after skipping a nominal pulse width duration. It is considered to be positive if the signal level is less than one volt. If not, the polarity is negative.

V Sync edge and corner characteristics are determined by detecting the edge of the V sync signal. A numerically smaller rise/fall time value indicates a higher quality signal. The overshoot and undershoot amplitude, and settling time should be zero under ideal conditions. When V Sync monotonicity is Yes in the results panel, it indicates that the incoming signal does not change its polarity during the rise/fall period.

NOTE. *H Sync and V Sync transient measurements, such as rise time, fall time, overshoot, undershoot, settling time, and monotonicity, are very sensitive to signal connection. Option VGA provides the 012-1685-XX Measurement Interface Unit (MIU). If an RGBHV signal output is VESA-compliant, using the MIU and bundled cables together will generate the most accurate Option VGA test results.*

Some H Sync or V Sync signal outputs on a device will not have the VESA-specified 50 Ω source impedance. Since the MIU uses 50 Ω transmission lines for the H Sync and V Sync signal routing, reflections and signal distortions may result if the device source impedance is not 50 Ω . The magnitude of the distortion will depend on the impedance error. Whether the distortion is detectable depends on the signal rise time.

In general:

Sync signals with rise times slower than 10ns will have little sensitivity to impedance error.

Source impedances within 10 Ω of the specified 50 Ω will generally provide proper rise/fall time and monotonicity measurements, irrespective of the signal rise time.

Please check the reflection by adding a length of 50 Ω RG-58 cable to the signal input between the short cable BNC and the MIU input BNC before the crucial measurement. If reflection-caused steps are visible on the leading edge, they will increase in length (time) when the cable length is added: approximately 3ns per foot of cable. If adding the cable does not alter the shape of leading-edge distortions, then they are not the result of impedance mismatch.

How Results are Calculated

The Scope trace is triggered by the leading edge of the V Sync pulse. Sync levels are measured with reference to oscilloscope ground and reported at two different conditions:

- When V Sync is terminated by a 2.21 k Ω resistor
- When V Sync is connected to a current source of ± 8 mA (+8 mA is connected when the voltage level is high, -8 mA when the voltage level is low).

Vertical Sync amplitude is determined by averaging the points that lie between 30% and 90% of the pulse width. Sync pulse width is determined by detecting the edges of the sync signal. The position difference between the two edges is shown as the result. Rise time is the time taken for the signal to rise from 10% to 90% of the steady state level. Overshoot/Undershoot settling time is the time taken for the signal to reach 5% of its steady state value. V Sync frequency is derived from pulse time value.

V Timing Measurement

V Timing consists of the measurements: the vertical sync pulse, the back porch, the addressable lines, the front porch, top border, and bottom border.

Back porch is the portion of the video signal that lies between the trailing edge of the vertical sync pulse and the start of the active picture.

Border is the period during which a background colored border is displayed in order to allow the image to extend beyond the limits.

Addressable Lines is the period during which active video image information is transmitted.

Front porch is the portion of the video signal between the end of the active picture and the leading edge of the horizontal sync.

Sync pulse width is the period of the active sync pulse.

Signal Source

The test signal used for the V Timing measurement is Half White & Half Black Bars (required to test for compliance with the VESA Test procedure), which is located on the Test Signal Files CD-ROM.

The Half White & Half Black bars test signal contains a white bar and a black bar.

If you plan to take only V Timing measurements, use the Half White & Half Black Full Field test pattern. Select the bitmap file that matches the format and the refresh rate of the test. For example, use the 640x480-HalfWhiteHalf-Black.bmp file to test a 640x480 resolution format.

You can also use a Matrix signal as a test signal. For more information on the Matrix signal, refer to page 2-21. For example, use the 640x480-Matrix.bmp file to test a 640x480 resolution format.

Interpreting Results

The V Timing Results must match the values specified by the timing standard selected.

How Results are Calculated

The V Timing measurement requires a test pattern with lines that are half white and half black. The first and the last addressable lines are required to be in this pattern and they indicate the beginning and end of the addressable video. If any non-black lines are detected before the beginning of the addressable video or after the end of it, they are considered part of the top or bottom border respectively.

Beginning five lines before the first addressable line (as per the standard), 15 lines are scanned to detect the first addressable line. With the start of addressable video, the scan begins again at five lines before the nominal end of the address-

able video and continues on for 15 lines. The MIU is set to use the low bandwidth path for Video and Sync.

Video Transient Measurement

Use the Video Transient measurement to check the transient characteristics of the video. The measurement characterizes the video rise time, fall time, overshoot, undershoot, and settling time as shown in the Figure 3-9.

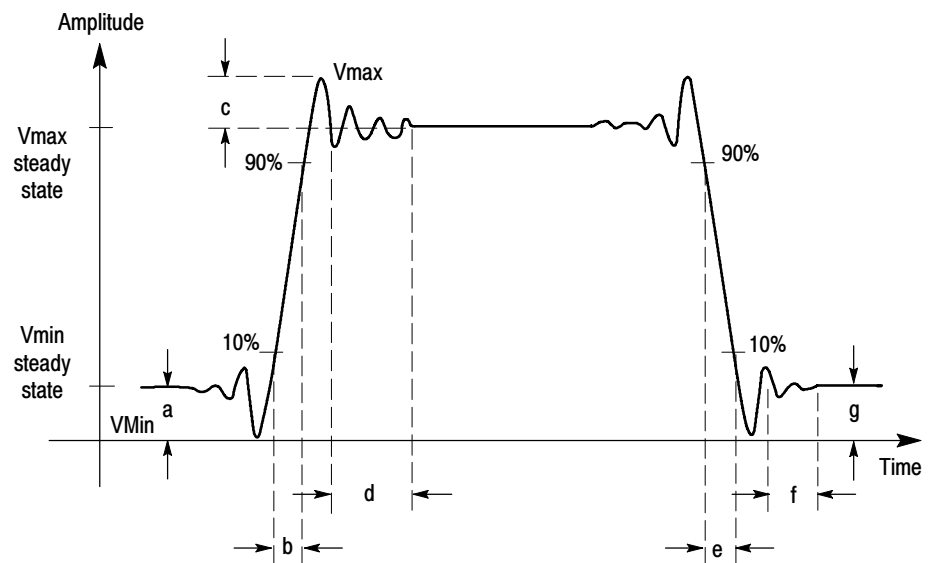

Figure 3-9: Signal definitions (Video transient)

where

- a - Vmin steady state amplitude before transition
- b - Rise Time
- c - Overshoot
- d - Settling time
- e - Fall time
- f - Settling time
- g - Undershoot

Video Transient measurement reports the result of the middle bar (the third white bar).

Rise time is measured from the 10% to the 90% amplitude points of a positive-going transition.

Fall time is measured from the 90% to the 10% amplitude points of a negative-going transition.

Overshoot refers to the rise above the steady state value in a positive-going transition. Undershoot refers to the fall below the steady state value in a negative-going transition.

Settling time measured from the end of the overshoot or undershoot to the point where the amplitude of the video ringing is down to $\pm 5\%$ of the final steady state value.

To make use of the full bandwidth and get highest sampling rate with the instrument, each channel is acquired separately at 5 gigasamples per second.

Signal Source

The test signal used for the Video Transient measurement is Alternate White and Black bars (required to test for compliance with the VESA Test procedure), which is located on the Test Signal Files CD-ROM.

The Alternate White and Black bars test signal contains a series of alternating white and black bars. There are nine bars in this test signal.

If you plan to take only the Video Transient measurement, use the Alternate White and Black bars Full Field test pattern. Select the bitmap file that matches the format and the refresh rate of the test. For example, use the 640x480-AlternateWhite&BlackBars.bmp file to test a 640x480 resolution format.

You can also use a Matrix signal as a test signal. For more information on the Matrix signal refer to page 2-21. For example, use the 640x480-Matrix.bmp file to test a 640x480 resolution format.

Interpreting Results

A numerically smaller rise/fall time value indicates a higher quality signal. The overshoot and undershoot amplitude, and settling time should be zero under ideal conditions.

How Results are Calculated

The MIU is set to the high-bandwidth path for Video. The Alternate White and Black bar pattern is used for measuring video transients. Measurements are made on the middle white bar. . The results are compensated for the MIU transient characteristics. Rise time is the time taken for the signal to rise from 10% to 90% of steady state level. Overshoot/Undershoot settling time is the time taken for the signal to reach 5% of its steady state value.

Setting Up Measurements

There are three ways to set up the VM Series System to take measurements: taking measurements, taking measurements relative to a reference, and taking measurements with limit testing. The differences between the three ways of taking measurements are:

- Taking measurements displays only the results of the measurements.
- Taking measurements relative to a reference displays the results of the measurements taken and the difference between the measured value and a reference value.
- Taking measurements with limit testing displays the results of the measurements taken and a Pass/Fail indication of whether the taken measurement falls within (pass) or outside (fail) specified maximum and minimum values.

You can choose to take measurements relative to a reference and with limit testing concurrently.

Taking Measurements

The procedure for taking measurements is:

1. Option SD/HD: Select the appropriate format and the color space for the input signal.
or
Option VGA: Select the appropriate resolution, the refresh rate and the timing standard for the input signal.
2. Select one or more measurements to take.
3. Select **Configuration > Operations**.
4. Set the Setup And/Or Run, Run Mode, and Auto Scaling setting for controlling the operation.
5. Select the Run button to take and view the measurements.
6. View the measurement results by selecting the corresponding menu item in the results panel of the measurement.

Figure 3-10 shows the results of the Color Bars measurement.

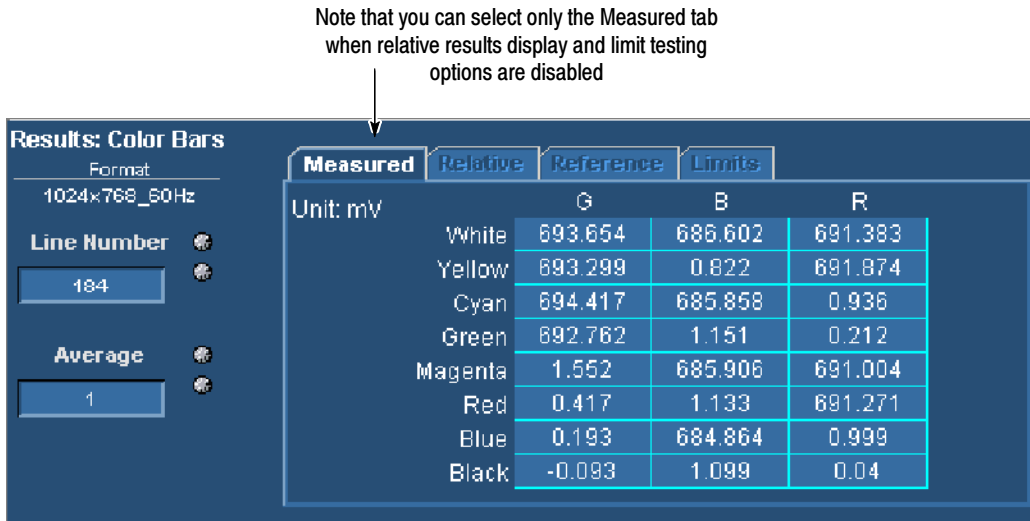

Figure 3-10: Results of the Color Bars measurement

Taking Measurements Relative to a Reference

The procedure to take measurements relative to a reference is:

1. Option SD/HD: Select the appropriate format and the color space for the input signal.
or
Option VGA: Select the appropriate resolution, the refresh rate, and the timing standard for the input signal.
2. Select one or more measurements to take.
3. Set the measurement run operation.
4. Select **Configuration > Reference & Limits**.

5. Select **Enable Relative Result Display**. See Figure 3-11.

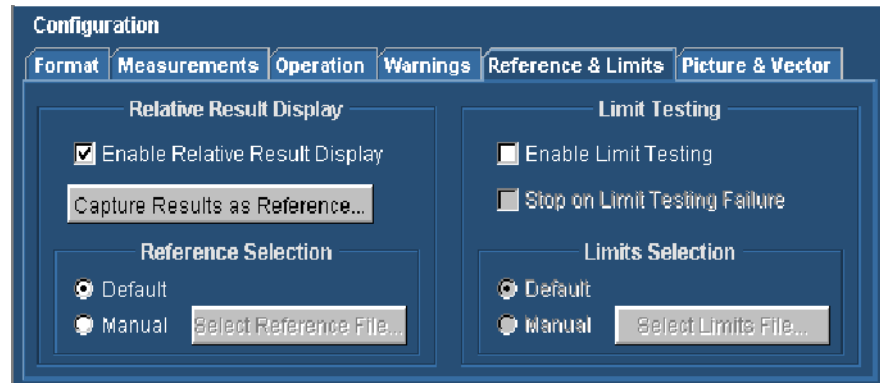

Figure 3-11: Enabling relative to reference results

By default, the software selects a reference file appropriate to the specified signal format. However, you can specify a different reference file by selecting **Manual** in the **Reference Selection** panel.

6. To specify a reference file, click **Manual** under **Reference Selection**. Click **Select Reference File** and navigate to the required reference file and select it.
7. After you have selected the reference file, click the Run button to take and view the measurements.
8. View the measurement results by selecting the corresponding menu item in the results panel of the measurement.

In Figure 3-12 (and Figure 3-13 for Option VGA), note that the **Measured**, **Relative**, and **Reference** tabs are selectable. To display the value of the measurements relative to the reference value, select the **Relative** tab in the Results display.

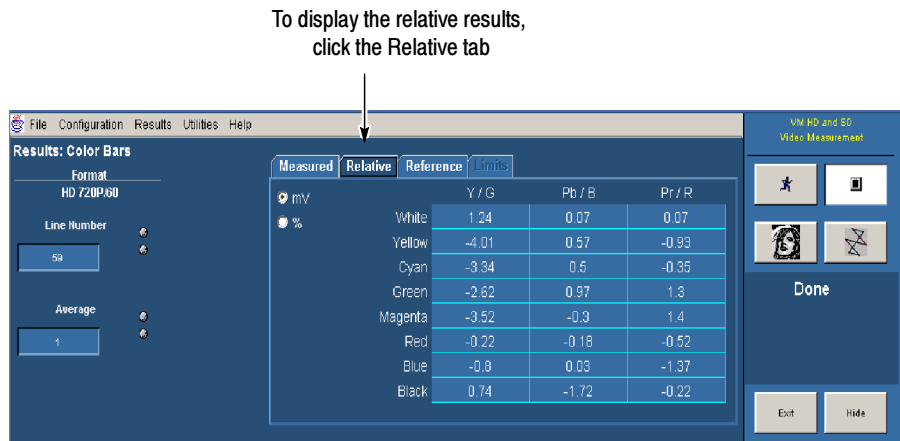

Figure 3- 12: Relative to reference results displayed (Option SD/HD)

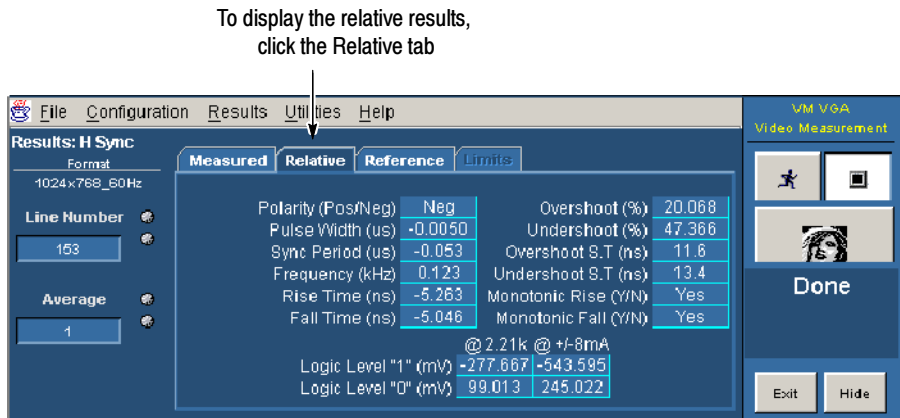

Figure 3- 13: Relative to reference results displayed (Option VGA)

Creating a Custom Reference File

Reference files are used as the source of comparison for calculating the Relative to Reference values for the measurements. The VM Series System includes a set of reference files that you can use as a starting point to create reference files to suit your needs.

Option SD/HD: There is a different file for each signal format and color space
 Option VGA: There is a different file for each signal resolution, refresh rate, and timing standard.

The reference files are saved in CSV format. The VM Series includes a set of default reference files and you can create your own reference file. Reference values for all measurements are in one file. Each format has its own reference file. The reference file contains the details shown in Table 3-4.

Table 3-4: Elements of the reference file

Option SD/HD	Option VGA
Format	Resolution
Color Space type	Refresh Rate type

Name of the measurement, parameters measured with the nominal values

There are two ways to create a custom reference file: edit an existing reference file, and capture a set of measurement results to create a new reference file.

Using an Existing Reference File to Create a New Reference File

One way to create a custom reference file is to edit an existing reference file. The easiest way to edit a reference file is to use a spreadsheet program, such as Microsoft Excel or OpenOffice.org. See Figure 3-14. Because the files are in plain ASCII format, you can also edit the files with a text editor. If you choose to edit files with a text editor, make sure that the CSV format is maintained.

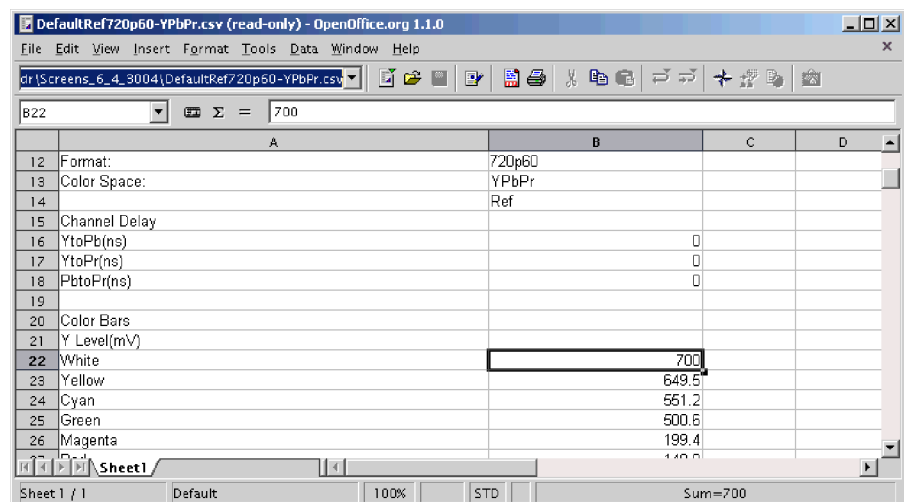

Figure 3-14: Editing a reference file

To customize an existing reference file:

1. Open a reference file for the appropriate input signal format standard by using a spreadsheet program (or a text editor).
2. Change the values in the file to those that suit your needs.
3. Save the file under a new name. Remember to save the file in CSV format.

Capturing Measurement Results to Create a New Reference File

A second way to create a reference file is to use the **Capture Results as Reference** button. The Capture Results as Reference function saves measurements to a reference file using the actual measured values as the reference values.

To create a new reference file:

1. Select **Configuration > Reference & Limits**.
2. Select **Enable Relative Result Display**.
3. Configure and run the measurements to save the result values in the reference file.
4. Select **Configuration > Reference & Limits**.
5. Select **Capture Results as Reference...**
6. Save the file to the desired location by using the Save dialog box.

Taking Measurements with Limit Testing

The procedure to take measurements with limit testing is:

1. Option SD/HD: Select the appropriate format and the color space for the input signal.
or
Option VGA: Select the appropriate resolution, the refresh rate, and the timing standard for the input signal.
2. Select one or more measurements to take.
3. Set the measurement run operation.
4. Select **Configuration > Reference & Limits**.

5. Select **Enable Limit Testing**. See Figure 3-15.

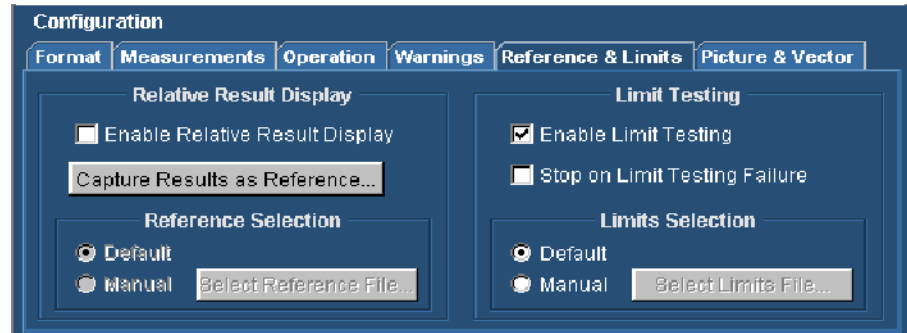

Figure 3-15: Enabling limit testing

By default, the software selects a limit file appropriate to the specified signal. However, you can specify a different reference file by selecting **Manual** in the **Limits Selection** area.

6. To specify a non-default limits file, select **Manual** under **Limits Selection**. Click **Select Limits File** and navigate to the desired limits file and select it.
7. After you have selected the limits file, select the Run button to take and view the measurements.
8. View the measurement results by selecting the corresponding menu item in the results panel of the measurement. See Figure 3-16.

Note that you can select the Limits tab

The screenshot shows the 'Results: Color Bars' panel with the 'Limits' tab selected. The table below shows the measured values for various colors.

Measured	Relative	Reference		
		G	B	R
Unit: mV				
<input checked="" type="radio"/> min	White	665.0	665.0	665.0
<input type="radio"/> max	Yellow	665.0	-35.0	665.0
	Cyan	665.0	665.0	-35.0
	Green	665.0	-35.0	-35.0
	Magenta	-35.0	665.0	665.0
	Red	-35.0	-35.0	665.0
	Blue	-35.0	665.0	-35.0
	Black	-35.0	-35.0	-35.0

Figure 3-16: Results when limit testing is available

Customizing a Limits File

A limits file defines the maximum and minimum acceptable values for measurements. Limits files are used as the source of comparison for Limit Testing measurements. The VM Series includes a set of limits files which you can use as a starting point to create limits files to suit your needs. There is a different file for each signal (Option SD/HD) format and color space or (Option VGA) resolution, refresh rate, and timing standard.

The limits file is in Comma-Separated-Value (CSV) format. The limit values for all measurements are in one file. The reference file contains the following details:

- Format
- (Option SD/HD) Color Space type or (Option VGA) Refresh Rate
- Name of the measurement with maximum and minimum acceptable values

The easiest way to edit a limits file is to use a spreadsheet program, such as Microsoft Excel or OpenOffice.org. See Figure 3-17. Because the files are in plain ASCII format, you can also edit the files with a text editor. If you do edit files with a text editor, be certain to maintain the CSV format.

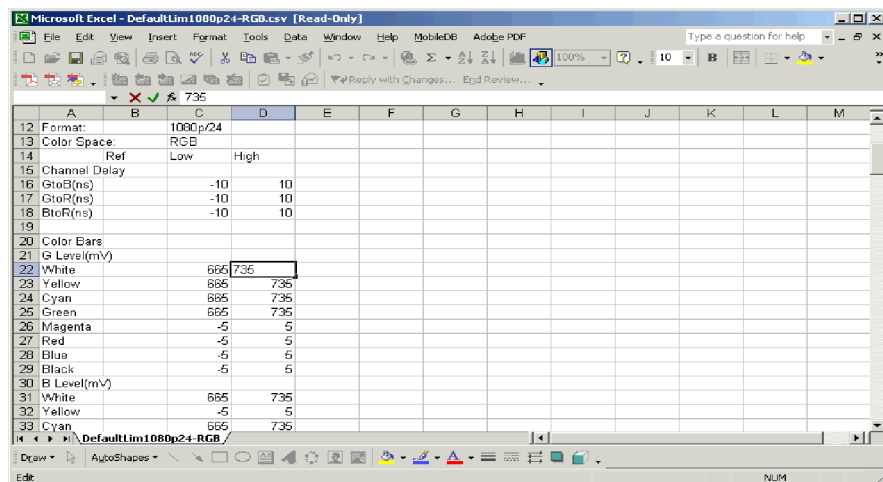

Figure 3-17: Customizing a limits file

To customize a limits file:

1. Open a reference file for the appropriate format and color space using a spreadsheet program (or a text editor).
2. Change the values in the file to those that suit your needs. Use columns C and D for the minimum and maximum values.
3. Save the file under a new name; remember to save the file in CSV format.

Setting Up the Channel Delay Measurement

Option SD/HD

To set up the channel delay measurements, select Results > Channel Delay to display the results panel. The results panel for the measurement shows the settings that can be changed for the measurement. For channel delay, you can choose the line on which the measurement is made and the number of times the measurement is averaged.

To change the settings for the Channel Delay measurements:

1. Select **Results > Channel Delay**.
2. To change the setting for Line Number, click the Line Number box.

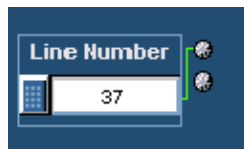

There are three ways to change the number:

- Turn the top knob on the front panel to change the number. When it is set to the correct number, click outside the box to enter the change.
- Click the keypad button to the left of the number entry box. Use the pop-up keypad to enter a setting for the line number.
- Use the keyboard to directly input the desired value.

3. Click the Average box to change the number of times the measurement is averaged.

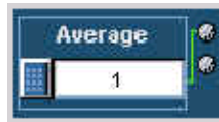

There are three ways to change the average:

- Turn the top knob on the front panel to change the number of averages. When it is set to the correct number, click outside the box to enter the change.
- Click the keypad button to the left of the number entry box. Use the pop-up keypad to enter a setting for the number of averages to perform.
- Use the keyboard to directly input the desired value.

The next time the Channel Delay measurement is run, it will run with the newly entered numbers.

Setting Up the Color Bars Measurement

Option SD/HD

To set up the Color Bars measurements, select Results > Color Bars to display the results panel. The results panel for the measurement shows the settings that can be changed for the measurement. For color bars, you can choose the line on which the measurement is made and the number of times the measurement is averaged.

To change the settings for the Color Bars measurements:

1. Select **Results > Color Bars**.
2. To change the setting for Line Number, click the Line Number box.



There are three ways to change the number:

- Turn the top knob on the front panel to change the number. When it is set to the correct number, click outside the box to enter the change.
- Click the keypad button to the left of the number entry box. Use the pop-up keypad to enter a setting for the line number.
- Using the keyboard to directly input the desired value.

3. Click the Average box to change the number of times the measurement is averaged.



There are three ways to change the average:

- Turn the top knob on the front panel to change the number of averages. When it is set to the correct number, click outside the box to enter the change.
- Click the keypad button to the left of the number entry box. Use the pop-up keypad to enter a setting for the number of averages to perform.
- Use the keyboard to directly input the desired value.

The next time the Color Bars measurement is run, it will run with the newly entered numbers.

Setting Up the Frequency Response Measurement

Option SD/HD

To set up the Frequency Response measurements, select Results > Frequency Response to display the results panel. The results panel for the measurement shows the settings that can be changed for the measurement. For frequency response, you can choose the line on which the measurement is made, and the number of times the measurement is averaged. You can set the measurement location to either Frequency or Time, specify a value, and set the filter bandwidth frequency.

To change the settings for the Frequency Response measurements:

1. Select **Results > Frequency Response**.

2. To change the setting for Line Number, click the Line Number box.

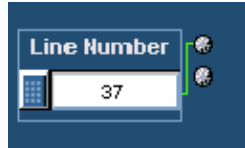

There are three ways to change the number:

- Turn the top knob on the front panel to change the number. When it is set to the correct number, click outside the box to enter the change.
 - Click the keypad button to the left of the number entry box. Use the pop-up keypad to enter a setting for the line number.
 - Use the keyboard to directly input the desired value.
3. Click the Average box to change the number of times the measurement is averaged.



There are three ways to change the average:

- Turn the top knob on the front panel to change the number of averages. When it is set to the correct number, click outside the box to enter the change.
- Click the keypad button to the left of the number entry box. Use the pop-up keypad to enter a setting for the number of averages to perform.
- Using the keyboard to directly input the desired value.

When Meas Location is set to Freq 4:4:4, the measurement uses the same frequency for the measurement location on all three signals (CH1 (Y/G), CH2 (Pb/B), and CH3 (Pr/R)).

This setting is the best option for RGB (GBR) signals.

When Meas Location is set to Freq 4:2:2, the measurement uses the full frequency for CH1 and half that frequency for CH2 and CH3.



Click the Freq (MHz) box to change the measurement location to a particular frequency.

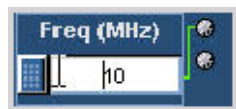

There are three ways to change the frequency:

- Turn the top knob on the front panel to change the frequency location. When it is set to the correct number, click outside the box to enter the change.
- Click the keypad button to the left of the number entry box. Use the pop-up keypad to enter a setting for the frequency location to perform.
- Use the keyboard to directly input the desired value.

When Meas Location is set to Time, the measurement reports the waveform frequency at that specified time.

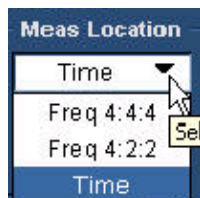

Click the Time (μ s) box to change the measurement location to a particular time.

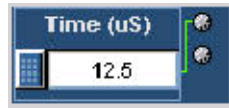

There are three ways to change the time:

- Turn the top knob on the front panel to change the time location. When it is set to the correct number, click outside the box to enter the change.
- Click the keypad button to the left of the number entry box. Use the pop-up keypad to enter a setting for the time location to perform.
- Use the keyboard to directly input the desired value.

Click the Dist BW(MHz) box to change the distortion bandwidth frequency. This setting applies only to the RMS Distortion measurement.

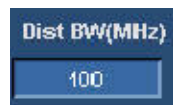

There are three ways to change the frequency:

- Turn the top knob on the front panel to change the frequency location. When it is set to the correct number, click outside the box to enter the change.
- Click the keypad button to the left of the number entry box. Use the pop-up keypad to enter a setting for the frequency location to perform.
- Use the keyboard to directly input the desired value.

The next time the Frequency Response measurement is run, it will run with the newly entered numbers.

Setting Up the H Sync Measurement

Option SD/HD

To set up the H Sync measurements, select Results > H Sync to display the results panel. The results panel for the measurement shows the settings that can be changed for the measurement. For H Sync, you can choose the line on which the measurement is made and the number of times the measurement is averaged.

To change the settings for the H Sync measurements:

1. Select **Results > H Sync**.
2. To change the setting for Line Number, click the Line Number box.



There are three ways to change the number:

- Turn the top knob on the front panel to change the number. When it is set to the correct number, click outside the box to enter the change.
 - Click the keypad button to the left of the number entry box. Use the pop-up keypad to enter a setting for the line number.
 - Use the keyboard to directly input the desired value.
3. Click the Average box to change the number of times the measurement is averaged.



There are three ways to change the average:

- Turn the top knob on the front panel to change the number of averages. When it is set to the correct number, click outside the box to enter the change.
- Click the keypad button to the left of the number entry box. Use the pop-up keypad to enter a setting for the number of averages to perform.
- Use the keyboard to directly input the desired value.

Select the **Measured on CH1** check box to take the measurements on channel CH1 for better measurement accuracy. This option is available only if triggering on CH4, which is the default.



When the triggering is set to channel CH1, the **Measured on CH1** check box is not available.

The next time the H Sync measurement is run, it will run with the newly entered numbers.

Setting Up the H Sync Jitter Measurement

Option SD/HD

To set up the H Sync Jitter measurements, select Results > H Sync Jitter to display the results panel. The results panel for the measurement shows the settings that can be changed for the measurement. For H Sync Jitter, you can choose the No. of Lines, Input, Peak, Demarc Freq, and the number of times the measurement is averaged.

To change the settings for the H Sync Jitter measurements:

1. Select **Results > H Sync Jitter**.
2. To change the number of lines, click the No. of Lines box.



There are three ways to change the number of lines:

- Turn the top knob on the front panel to change the number. When it is set to the correct number, click outside the box to save the change.
 - Click the keypad button to the left of the Line Number box to open the virtual keyboard. Use the pop-up keypad to enter the new value for the line number.
 - Use the keyboard to directly input the desired value.
3. Click the Average box to change the number of times the measurement is averaged.

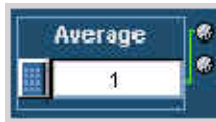

There are three ways to change the average:

- Turn the top knob on the front panel to change the number of averages. When it is set to the correct number, click outside the box to enter the change.
- Click the keypad button to the left of the number entry box. Use the pop-up keypad to enter a setting for the number of averages to perform.
- Use the keyboard to directly input the desired value.

When Input is set to Jitter, you can specify the peak jitter value in the Peak (ns) field to estimate the probability of the jitter.



Click the Peak (ns) box to change the peak jitter. There are three ways to change the Peak:

- Turn the top knob on the front panel to change the peak jitter value. When it is set to the correct number, click outside the box to enter the change.
- Click the keypad button to the left of the number entry box. Use the pop-up keypad to enter a setting for the peak jitter value to perform.
- Use the keyboard to directly input the desired value.

When Input is set to Probability, you can specify the probability in the Probability field to estimate the actual peak jitter value measured.

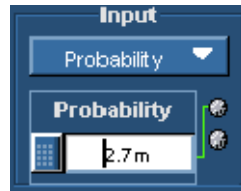

Click the Probability box to change the probability. There are three ways to change the Probability:

- Turn the top knob on the front panel to change the probability value. When it is set to the correct number, click outside the box to enter the change.
- Click the keypad button to the left of the number entry box. Use the pop-up keypad to enter a setting for the probability value to perform.
- Use the keyboard to directly input the desired value.

Click the Jitter (Hz) box to in the Demarc Freq panel to change the jitter demarcation frequency.

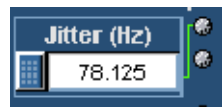

There are three ways to change the frequency:

- Turn the top knob on the front panel to change the frequency location. When it is set to the correct number, click outside the box to enter the change.
- Click the keypad button to the left of the number entry box. Use the pop-up keypad to enter a setting for the frequency location to perform.
- Use the keyboard to directly input the desired value.

Click the Wander (Hz) box in the Demarc Freq panel to change the Wander demarcation frequency.

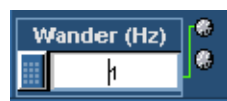

There are three ways to change the frequency:

- Turn the top knob on the front panel to change the frequency location. When it is set to the correct number, click outside the box to enter the change.
- Click the keypad button to the left of the number entry box. Use the pop-up keypad to enter a setting for the frequency location to perform.
- Use the keyboard to directly input the desired value.

The next time the H Sync Jitter measurement is run, it will run with the newly entered numbers.

Setting Up the Levels Measurement

Option SD/HD

To set up the Levels measurements, select Results > Levels to display the results panel. The results panel for the measurement shows the settings that can be changed for the measurement. For Levels, you can choose the line on which the measurement is made and the number of times the measurement is averaged.

To change the settings for the Levels measurements:

1. Select **Results > Levels**.
2. To change the setting for Line Number, click the Line Number box.

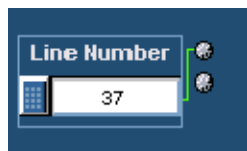

There are three ways to change the number:

- Turn the top knob on the front panel to change the number. When it is set to the correct number, click outside the box to enter the change.
- Click the keypad button to the left of the number entry box. Use the pop-up keypad to enter a setting for the line number.
- Use the keyboard to directly input the desired value.

- Click the Average box to change the number of times the measurement is averaged.



There are three ways to change the average:

- Turn the top knob on the front panel to change the number of averages. When it is set to the correct number, click outside the box to enter the change.
- Click the keypad button to the left of the number entry box. Use the pop-up keypad to enter a setting for the number of averages to perform.
- Use the keyboard to directly input the desired value.

Click the Configure Levels to display the Levels Configuration dialog box, which allows the customization of the different levels.



The Levels Configuration dialog box is shown in the following figure:

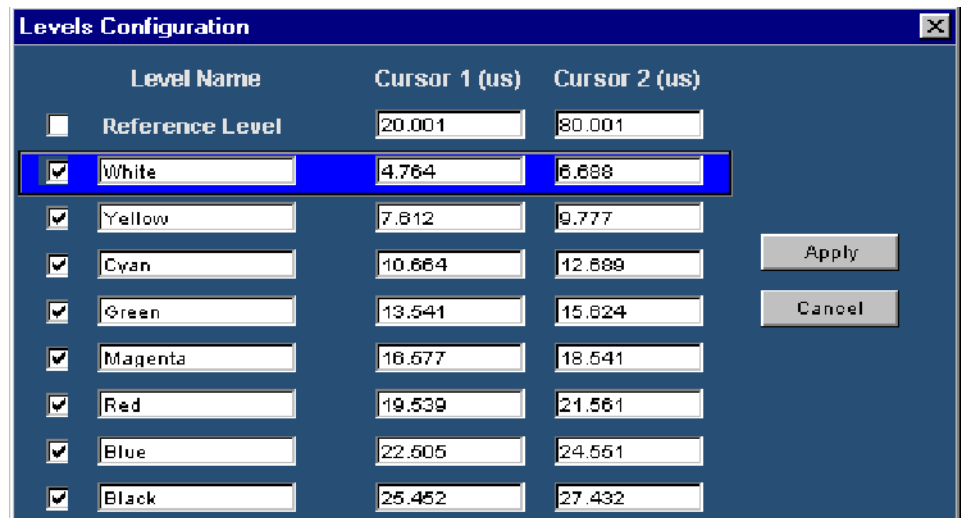

You can change the level name by using the keyboard to directly input the desired value for the selected level (which is highlighted).

You can change the cursor 1 and cursor 2 position for the selected level (which is highlighted) in two ways:

- Use the keyboard to directly input the desired value.
- Adjust the knobs on the oscilloscope front panel when the Levels Configuration is active. The vertical cursors are automatically enabled.

NOTE. On the VM6000 and DPO oscilloscopes, after the *Configure Levels* button is clicked and when the *Levels Configuration* dialog appears, ensure that the *Cursors* button is on. Then use the knob to adjust the cursor locations for the required levels.

The next time the Levels measurement is run, it will run with the newly entered numbers.

Setting Up the Multiburst Measurement

Option SD/HD

To set up the Multiburst measurements, select **Results > Multiburst** to display the results panel. The results panel for the measurement shows the settings that can be changed for the measurement. For Multiburst, you can choose the line on which the measurement is made, and the number of times the measurement is averaged.

To change the settings for the Multiburst measurements:

1. Select **Results > Multiburst**.
2. To change the setting for Line Number, click the Line Number box.



There are three ways to change the number:

- Turn the top knob on the front panel to change the number. When it is set to the correct number, click outside the box to enter the change.
- Click the keypad button to the left of the number entry box. Use the keypad to enter a setting for the line number.
- Use the keyboard to directly input the desired value.

- Click the Average box to change the number of times the measurement is averaged.



There are three ways to change the average:

- Turn the top knob on the front panel to change the number of averages. When it is set to the correct number, click outside the box to enter the change.
- Click the keypad button to the left of the number entry box. Use the pop-up keypad to enter a setting for the number of averages to perform.
- Use the keyboard to directly input the desired value.

The next time the Multiburst measurement is run, it will run with the newly entered numbers.

Setting Up the Noise Measurement

Option SD/HD

To set up the Noise measurements, select Results > Noise to display the results panel. The results panel for the measurement shows the settings that can be changed for the measurement. For noise, you can choose the line on which the measurement is made, and the number of times the measurement is averaged. You can specify the filter type and the cut-off frequency of bandwidth filter, and configure the Set Time Window.

To change settings for the Noise measurements:

- Select **Results > Noise**.
- To change the setting for Line Number, click the Line Number box.

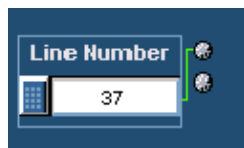

There are three ways to change the number:

- Turn the top knob on the front panel to change the number. When it is set to the correct number, click outside the box to enter the change.
 - Click the keypad button to the left of the number entry box. Use the pop-up keypad to enter a setting for the line number.
 - Use the keyboard to directly input the desired value.
3. Click the Average box to change the number of times the measurement is averaged.



There are three ways to change the average:

- Turn the top knob on the front panel to change the number of averages. When it is set to the correct number, click outside the box to enter the change.
 - Click the keypad button to the left of the number entry box. Use the pop-up keypad to enter a setting for the number of averages to perform.
 - Use the keyboard to directly input the desired value.
4. To change the Filter type and the cut-off frequency of the bandwidth filter. Refer to Figure 3-18.



Figure 3- 18: Changing the filter type

Select a Filter type from the three available options Off, Unified Weighting, and Unweighted Bandwidth.

- Set the Filter option to Off to measure the broadband noise without any filter.
- Set the Filter option to Unified Weighting to measure the noise using the psychovisual weighting established by CCIR Recommendation (Rec.) 576-2, adjusted for the selected video format.
- Set the Filter option to Unweighted Bandwidth to remove high frequency noise from your signal.

To change the cut-off frequency of the filter bandwidth (this option is available only if the filter type selected is Unweighted Bandwidth). Refer to Figure 3-19.



Figure 3-19: Changing the noise filter bandwidth frequency

Click the box below Bandwidth (Hz). There are three ways to change the number:

- Turn the top knob on the front panel to change the number of averages. When it is set to the correct number, click outside the box to enter the change.
 - Click the keypad button to the left of the number entry box. Use the pop-up keypad to enter a setting for the number of averages to perform.
 - Use the keyboard to directly input the desired value.
5. To set the start and end position, click the Set Time Window button.



The Set Time Window button opens the Time Window Configuration dialog box which allows the customization of the time window to be used for the Noise measurement.

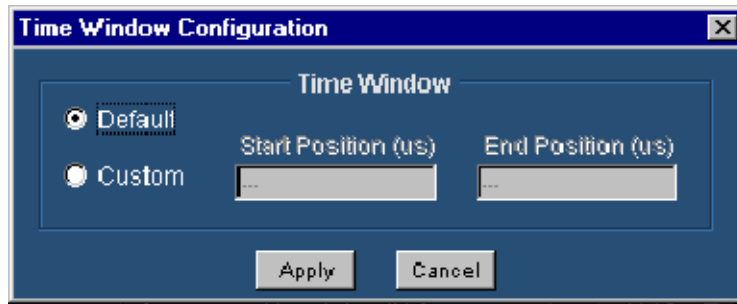

You can set the time in the following two ways:

- When Default is selected, the application performs the Noise measurement over the full active video time duration.
- When Custom is selected, the application performs the Noise measurement over the time frame window specified by the values in the Start Position and the End Position fields. These values can be set in the following two ways:
 - Use the keyboard to directly input the desired value.
 - Adjust the knobs on the oscilloscope front panel when the Custom option is selected. The vertical cursors are automatically enabled.

NOTE. On the VM6000 and DPO oscilloscopes, after the Set Time Window option is clicked and when the Custom is selected in the Time Window Configuration dialog, ensure that the Cursors button is on. Then use the knob to adjust the cursor locations for the required position.

The next time the Noise measurement is run, it will run with the newly entered numbers.

Setting Up the Noise Spectrum Measurement

Option SD/HD

To set up the Noise Spectrum measurement, select Results > Noise to display the results panel. The results panel for the measurement shows the settings that can be changed for the measurement. For noise spectrum, you can choose the Cursor and select a channel (Y/G, Pb/B, or Pr/R).

To change the settings for the Noise Spectrum measurements:

1. Select **Results > Noise**.
2. To change the setting for the Cursor, click the Cursor (Hz) box. Refer to Figure 3-20.



Figure 3-20: Changing the cursor frequency

There are three ways to change the number:

- Turn the top knob on the front panel to change the number. When it is set to the correct number, click outside the box to enter the change.
 - Click the keypad button to the left of the number entry box. Use the pop-up keypad to enter a setting for the line number.
 - Use the keyboard to directly input the desired value.
3. Set the resolution frequency for the noise spectrum using the keyboard to directly input the desired value.



4. Select one of the channels (Y/G, Pb/B, or Pr/R) in the list box to change the channel for the noise spectrum measurement. Refer to Figure 3-21.



Figure 3-21: Changing the channel

5. Click Spectrum to display the noise spectrum. This button is enabled only when the Run mode in the Operation tab is set to Continuously.

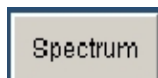

The next time the Noise Spectrum measurement is run, it will run with the newly entered numbers.

Setting Up the Non Linearity Measurement

Option SD/HD

To set up the Non Linearity measurements, select Results > Non Linearity to display the results panel. The results panel for the measurement shows the settings that can be changed for the measurement. For Non Linearity, you can choose the line on which the measurement is made, and the number of times the measurement is averaged.

To change the settings for the Non Linearity measurements:

1. Select **Results > Non Linearity**.
2. To change the setting for Line Number, click the Line Number box.

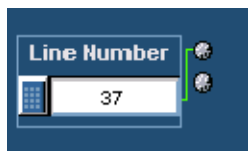

There are three ways to change the number:

- Turn the top knob on the front panel to change the number. When it is set to the correct number, click outside the box to enter the change.
- Click the keypad button to the left of the number entry box. Use the pop-up keypad to enter a setting for the line number.
- Use the keyboard to directly input the desired value.

- Click the Average box to change the number of times the measurement is averaged.



There are three ways to change the average:

- Turn the top knob on the front panel to change the number of averages. When it is set to the correct number, click outside the box to enter the change.
- Click the keypad button to the left of the number entry box. Use the pop-up keypad to enter a setting for the number of averages to perform.
- Use the keyboard to directly input the desired value.

The next time the Non Linearity measurement is run, it will run with the newly entered numbers.

Setting Up the Short Time Distortion Measurement

Option SD/HD

To set up the Short Time Distortion measurements, select Results > Short Time Distortion to display the results panel. The results panel for the measurement shows the settings that can be changed for the measurement. For Short time Distortion, you can choose the line on which the measurement is made, and the number of times the measurement is averaged.

To change the settings for the Short Time Distortion measurements:

- Select **Results > Short Time Distortion**.
- To change the setting for Line Number, click the Line Number box.

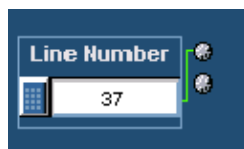

There are three ways to change the number:

- Turn the top knob on the front panel to change the number. When it is set to the correct number, click outside the box to enter the change.
 - Click the keypad button to the left of the number entry box. Use the pop-up keypad to enter a setting for the line number.
 - Use the keyboard to directly input the desired value.
3. Click the Average box to change the number of times the measurement is averaged.



There are three ways to change the average:

- Turn the top knob on the front panel to change the number of averages. When it is set to the correct number, click outside the box to enter the change.
- Click the keypad button to the left of the number entry box. Use the pop-up keypad to enter a setting for the number of averages to perform.
- Use the keyboard to directly input the desired value.

The next time the Short Time Distortion measurement is run, it will run with the newly entered numbers.

Setting Up the Spatial Distortion Measurement

Option SD/HD

To set up the Spatial Distortion measurements, select Results > Spatial Distortion to display the results panel. The results panel for the measurement shows the settings that can be changed for the measurement. For Spatial Distortion, you can choose the number of times the measurement is averaged.

To change the settings for the Spatial Distortion measurements:

1. Select **Results > Spatial Distortion**.
2. Click the Average box to change the number of times the measurement is averaged.



There are three ways to change the average:

- Turn the top knob on the front panel to change the number of averages. When it is set to the correct number, click outside the box to enter the change.
 - Click the keypad button to the left of the number entry box. Use the pop-up keypad to enter a setting for the number of averages to perform.
 - Use the keyboard to directly input the desired value.
3. Spatial Distortion can be measured using the test signal and the the reference BMP file.



There are two ways to select the reference file.

- Selecting the Default option in the Select BMP Ref File panel, you can use the Tektronix reference file to run the Spatial Distortion measurement.
- Selecting the Manual option in the Select BMP Ref File panel, you can use your own image test signal provide the 24-bitmap reference file. Click Browse and select the file to run the Spatial Distortion measurement.

The next time the Spatial Distortion measurement is run, it will run with the newly entered numbers.

Setting Up the V Sync Measurement

Option SD/HD To set up the V Sync measurement, select Results > V Sync to display the results panel. The results panel for the measurement shows the settings that you can change for the measurement. For V Sync, you can choose the number of times the measurement is averaged.

To change the settings for the V Sync measurement:

1. On the menu bar, click **Results > V Sync**.
2. Click the Average box to change the number of times the measurement is averaged.



There are three ways to change the average:

- Turn the top knob on the front panel to change the number of averages. When it is set to the correct number, click outside the box to enter the change.
- Click the keypad button to the left of the number entry box. Use the pop-up keypad to enter a setting for the number of averages to perform.
- Use the keyboard to directly input the desired value.

The next time the V Sync measurement is run, it will run with the newly entered numbers.

Configuring the Device Under Test for Option VGA

To perform measurements on the DUT, you must provide an appropriate video signal to the VM Series System. You can accomplish this by displaying a bitmap file on the PC in which the DUT is operating. The preferred bitmap file, when taking multiple measurements, is the Matrix signal. All the necessary Matrix signal and full-field test pattern bitmaps required to test for compliance to the VESA Test Procedure - Evaluation of Display Graphics Subsystems (Version 1 Rev. 1), are located on the PC Bitmap Graphics Test Signal Files CD-ROM.

1. Set the resolution, refresh rate, and timing standard of the DUT to the required values corresponding to the selected Matrix signal.

2. On the PC containing the DUT, display the contents of the Test Signal Files CD-ROM.
3. Display the contents of either the Matrix or Full Field folder.
 - If you plan to take multiple measurements, open the Matrix folder.
 - If you plan to take only one measurement, open the Full Field folder and select the appropriate test pattern using Table 3-5.

Table 3-5: Matching measurements to the appropriate Full Field test pattern

Measurement	Test Pattern
Ch-Ch Mismatch	32-step Staircase
Ch-Ch Skew	Alternate White and Black
Color Bars	Nine Color Bars
H Sync	Any pattern
H Sync Jitter	Any pattern
H Timing	Black-White-Black
Linearity	Staircase
Luma Levels	Alternate White and Black
Noise Inj Ratio	Full White
V Sync	Any pattern
V Timing	Half White and Half Black
Video Transient	Alternate White and Black

Whether you choose a single test pattern or take multiple measurements, you must select the appropriate file that you will use to generate the video test signal. The file you select depends on the format you want to test and for some patterns, refresh rate must also be considered. Suppose you want to test a 1280x1024 resolution format. Within the appropriate folder, look for a file that matches the format of the test you want to perform. If you want to test Linearity, you would need to choose either full-field Staircase test pattern or use the Matrix test pattern. Within the Staircase folder, you would look for a file named 1280x1024-Matrix.bmp (refresh rate is important for the Matrix pattern).

4. Select the bitmap file that fits your requirements and open the file with a program such as Paint Shop Pro. If you set up the DUT to drive a second display, you can set the background of the second display to the bitmap file rather than opening the file with a bitmap editor. This displays the bmp file in full screen mode without any borders (applied for Single Monitor mode).



Figure 3-22: Illustration of the BMP test signal in full screen mode

5. From the File menu, select File > Set as Wallpaper (centered).



Figure 3-23: Illustration of the BMP image set as wallpaper

6. Disconnect the output of the DUT from the monitor and connect the output of the DUT to the VM Series System.

Setting Up the Ch-Ch Mismatch Measurement

Option VGA To set up the Ch-Ch Mismatch measurement, select Results > Ch-Ch Mismatch to display the results panel. The results panel for the measurement shows the settings that can be changed for the measurement. For Ch-Ch Mismatch, you can choose the line on which the measurement is made and the number of times the measurement is averaged.

To change the settings for the Ch-Ch Mismatch measurements:

1. Click **Results > Ch-Ch Mismatch**.
2. To change the line number, click the Line Number box.

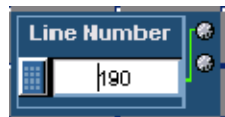

There are three ways to change the line number:

- Turn the top knob on the front panel to change the number. When it is set to the correct number, click outside the box to enter the change.
 - Click the keypad button to the left of the number entry box. Use the pop-up keypad to enter a setting for the line number.
 - Use the keyboard to directly input the desired value.
3. Click the Average box to change the number of times the measurement is averaged.



There are three ways to change the average:

- Turn the top knob on the front panel to change the number of averages. When it is set to the correct number, click outside the box to enter the change.
- Click the keypad button to the left of the number entry box. Use the pop-up keypad to enter a setting for the number of averages to perform.
- Using the keyboard to directly input the desired value.

The next time the Ch-Ch Mismatch measurement is run, it will run with the newly entered numbers.

Setting Up the Ch-Ch Skew Measurement

Option VGA

To set up the Ch-Ch Skew measurement, select Results > Ch-Ch Skew to display the results panel. The results panel for the measurement shows the settings that you can change for the measurement. For Ch-Ch Skew, you can choose the line on which the measurement is made and the number of times the measurement is averaged.

To change the settings for the Ch-Ch Skew measurement:

1. On the menu bar, click **Results > Ch-Ch Skew**.
2. To change the line number, click the Line Number box.

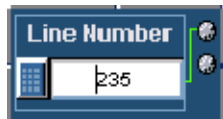

There are three ways to change the line number:

- Turn the top knob on the front panel to change the number. When it is set to the correct number, click outside the box to enter the change.
 - Click the keypad button to the left of the number entry box. Use the pop-up keypad to enter a setting for the line number.
 - Use the keyboard to directly input the desired value.
3. Click the Average box to change the number of times the measurement is averaged.



There are three ways to change the number:

- Turn the top knob on the front panel to change the number of averages. When it is set to the correct number, click outside the box to enter the change.
- Click the keypad button to the left of the number entry box. Use the pop-up keypad to enter a setting for the number of averages to perform.
- Use the keyboard to directly input the desired value.

The next time the Ch-Ch Skew measurement is run, it will run with the newly entered numbers.

Setting Up the Color Bars Measurement

Option VGA To set up the Color Bars measurement, select Results > Color Bars to display the results panel. The results panel for the measurement shows the settings that you can change for the measurement. For Color Bars, you can choose the line on which the measurement is made and the number of times the measurement is averaged.

To change the settings for the Color Bars measurement:

1. On the menu bar, click **Results > Color Bars**.
2. To change the line number, click the Line Number box.



There are three ways to change the line number:

- Turn the top knob on the front panel to change the number. When it is set to the correct number, click outside the box to enter the change.
 - Click the keypad button to the left of the number entry box. Use the pop-up keypad to enter a setting for the line number.
 - Use the keyboard to directly input the desired value.
3. Click the Average box to change the number of times the measurement is averaged.

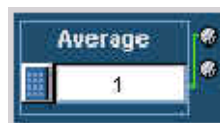

There are three ways to change the average:

- Turn the top knob on the front panel to change the number of averages. When it is set to the correct number, click outside the box to enter the change.
- Click the keypad button to the left of the number entry box. Use the pop-up keypad to enter a setting for the number of averages to perform.
- Use the keyboard to directly input the desired value.

The next time the Color Bars measurement is run, it will run with the newly entered numbers.

Setting Up the H Sync Measurement

Option VGA To set up the H Sync measurement, select Results > H Sync to display the results panel. The results panel for the measurement shows the settings that you can change for the measurement. For H Sync, you can choose the line on which the measurement is made and the number of times the measurement is averaged.

To change the settings for the H Sync measurement:

1. On the menu bar, click **Results > H Sync**.
2. To change the line number, click the Line Number box.

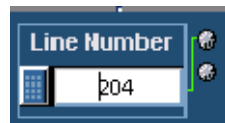

There are three ways to change the line number:

- Turn the top knob on the front panel to change the number. When it is set to the correct number, click outside the box to enter the change.
 - Click the keypad button to the left of the number entry box. Use the pop-up keypad to enter a setting for the line number.
 - Use the keyboard to directly input the desired value.
3. Click the Average box to change the number of times the measurement is averaged.



There are three ways to change the average:

- Turn the top knob on the front panel to change the number of averages. When it is set to the correct number, click outside the box to enter the change.

- Click the keypad button to the left of the number entry box. Use the pop-up keypad to enter a setting for the number of averages to perform.
- Use the keyboard to directly input the desired value.

The next time the H Sync measurement is run, it will run with the newly entered numbers.

Setting Up the H Sync Jitter Measurement

Option VGA To set up the H Sync Jitter measurement, select Results > H Sync Jitter to display the results panel. The results panel for the measurement shows the settings that you can change for the measurement. For H Sync Jitter, you can choose the number of lines on which the measurement is made.

To change the settings for the H Sync Jitter measurement:

1. On the menu bar, click **Results > H Sync Jitter**.
2. To change the number of lines, click the No. of Lines box.



There are three ways to change the number of lines:

- Turn the top knob on the front panel to change the number. When it is set to the correct number, click outside the box to save the change.
- Click the keypad button to the left of the Line Number box to open the virtual keyboard. Use the pop-up keypad to enter the new value for the line number.
- Use the keyboard to directly input the desired value.

The next time the H Sync Jitter measurement is run, it will run with the newly entered numbers.

Setting Up the H Timing Measurement

Option VGA To set up the H Timing measurement, select Results > H Timing to display the results panel. The results panel for the measurement shows the settings that you can change for the measurement. For H Timing, you can choose the line on which the measurement is made and the number of times the measurement is averaged.

To change the settings for the H Timing measurement:

1. On the menu bar, click **Results > H Timing**.
2. To change the line number, click the Line Number box.

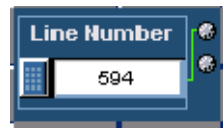

There are three ways to change the line number:

- Turn the top knob on the front panel to change the number. When it is set to the correct number, click outside the box to enter the change.
 - Click the keypad button to the left of the number entry box. Use the pop-up keypad to enter a setting for the line number.
 - Use the keyboard to directly input the desired value.
3. Click the Average box to change the number of times the measurement is averaged.

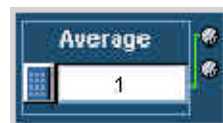

There are three ways to change the average:

- Turn the top knob on the front panel to change the number of averages. When it is set to the correct number, click outside the box to enter the change.
- Click the keypad button to the left of the number entry box. Use the pop-up keypad to enter a setting for the number of averages to perform.
- Use the keyboard to directly input the desired value.

The next time the H Timing measurement is run, it will run with the newly entered numbers.

Setting Up the Linearity Measurement

Option VGA To set up the Linearity measurement, you must display the Results > Linearity panel. The results panel for the measurement shows the settings that you can change for the measurement. For Linearity, you can choose the line on which the measurement is made and the number of times the measurement is averaged.

To change the settings for the Linearity measurement:

1. On the menu bar, click **Results > Linearity**.
2. To change the line number, click the Line Number box.

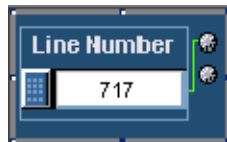

There are three ways to change the line number:

- Turn the top knob on the front panel to change the number. When it is set to the correct number, click outside the box to enter the change.
 - Click the keypad button to the left of the number entry box. Use the pop-up keypad to enter a setting for the line number.
 - Use the keyboard to directly input the desired value.
3. Click the Average box to change the number of times the measurement is averaged.



There are three ways to change the average:

- Turn the top knob on the front panel to change the number of averages. When it is set to the correct number, click outside the box to enter the change.

- Click the keypad button to the left of the number entry box. Use the pop-up keypad to enter a setting for the number of averages to perform.
- Use the keyboard to directly input the desired value.

The next time the Linearity measurement is run, it will run with the newly entered numbers.

Setting Up the Luma Levels Measurement

Option VGA To set up the Luma Levels measurement, select Results > Luma Levels to display the results panel. The results panel for the measurement shows the settings that you can change for the measurement. For Luma Levels, you can choose the line on which the measurement is made and the number of times the measurement is averaged.

To change the settings for the Luma Levels measurement:

1. On the menu bar, click **Results > Luma Levels**.
2. To change the line number, click the Line Number box.

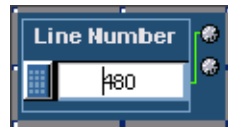

There are three ways to change the line number:

- Turn the top knob on the front panel to change the number. When it is set to the correct number, click outside the box to enter the change.
 - Click the keypad button to the left of the number entry box. Use the pop-up keypad to enter a setting for the line number.
 - Use the keyboard to directly input the desired value.
3. Click the Average box to change the number of times the measurement is averaged.

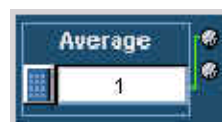

There are three ways to change the average:

- Turn the top knob on the front panel to change the number of averages. When it is set to the correct number, click outside the box to enter the change.
- Click the keypad button to the left of the number entry box. Use the pop-up keypad to enter a setting for the number of averages to perform.
- Use the keyboard to directly input the desired value.

The next time the Luma Levels measurement is run, it will run with the newly entered numbers.

Setting Up the Noise Inj Ratio Measurement

Option VGA

To set up the Noise Inj Ratio measurement, select Results > Noise Inj Ratio to display the results panel. The results panel for the measurement shows the settings that you can change for the measurement. For Noise Inj Ratio, you can choose the line on which the measurement is made and the number of times the measurement is averaged.

To change the settings for the Noise Inj Ratio measurement:

1. On the menu bar, click **Results > Noise Inj Ratio**.
2. To change the line number, click the Line Number box.

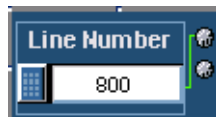

There are three ways to change the line number:

- Turn the top knob on the front panel to change the number. When it is set to the correct number, click outside the box to enter the change.
- Click the keypad button to the left of the number entry box. Use the pop-up keypad to enter a setting for the line number.
- Use the keyboard to directly input the desired value.

3. Click the Average box to change the number of times the measurement is averaged.



There are three ways to change the average:

- Turn the top knob on the front panel to change the number of averages. When it is set to the correct number, click outside the box to enter the change.
 - Click the keypad button to the left of the number entry box. Use the pop-up keypad to enter a setting for the number of averages to perform.
 - Use the keyboard to directly input the desired value.
4. Select the 500 MHz Filter, to ensure accuracy and compliance with VESA specifications. With the filter off, you can run the measurement over a bandwidth greater than 500 MHz.



The next time the Noise Inj ratio measurement is run, it will run with the newly entered numbers.

Setting Up the V Sync Measurement

- Option VGA** To set up the V Sync measurement, select Results > V Sync to display the results panel. The results panel for the measurement shows the settings that you can change for the measurement. For V Sync, you can choose the number of times the measurement is averaged.

To change the settings for the V Sync measurement:

1. On the menu bar, click **Results > V Sync**.
2. Click the Average box to change the number of times the measurement is averaged.



There are three ways to change the average:

- Turn the top knob on the front panel to change the number of averages. When it is set to the correct number, click outside the box to enter the change.
- Click the keypad button to the left of the number entry box. Use the pop-up keypad to enter a setting for the number of averages to perform.
- Use the keyboard to directly input the desired value.

The next time the V Sync measurement is run, it will run with the newly entered numbers.

Setting Up the V Timing Measurement

Option VGA

To set up the V Timing measurement, select Results > V Timing to display the results panel. The results panel for the measurement shows the settings that you can change for the measurement. For V Timing, you can choose the number of times the measurement is averaged.

To change the settings for the V Timing measurement:

1. On the menu bar, click **Results > V Timing**.
2. Click the Average box to change the number of times the measurement is averaged.



There are three ways to change the average:

- Turn the top knob on the front panel to change the number of averages. When it is set to the correct number, click outside the box to enter the change.
- Click the keypad button to the left of the number entry box. Use the pop-up keypad to enter a setting for the number of averages to perform.
- Use the keyboard to directly input the desired value.

The next time the V Timing measurement is run, it will run with the newly entered numbers.

Setting Up the Video Transient Measurement

Option VGA

To set up the Video Transient measurement, select Results > Video Transient to display the results panel. The results panel for the measurement shows the settings that you can change for the measurement. For Video Transient, you can choose the line on which the measurement is made and the number of times the measurement is averaged.

To change the settings for the Video Transient measurement:

1. On the menu bar, click **Results > Video Transient**.
2. To change the line number, click the Line Number box.

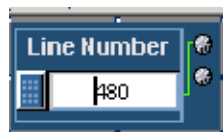

There are three ways to change the line number:

- Turn the top knob on the front panel to change the number. When it is set to the correct number, click outside the box to enter the change.
- Click the keypad button to the left of the number entry box. Use the pop-up keypad to enter a setting for the line number.
- Use the keyboard to directly input the desired value.

3. Click the Average box to change the number of times the measurement is averaged.

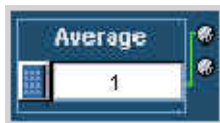

There are three ways to change the average:

- Turn the top knob on the front panel to change the number of averages. When it is set to the correct number, click outside the box to enter the change.
- Click the keypad button to the left of the number entry box. Use the pop-up keypad to enter a setting for the number of averages to perform.
- Use the keyboard to directly input the desired value.

The next time the Video Transient measurement is run, it will run with the newly entered numbers.

Viewing Measurement Results

Use the Results menu to select the measurement results you want to display. You can choose to display a summary of all results or select a single measurement to see complete results for that measurement.

Displaying the Results Summary

The results summary panel is displayed automatically if more than one measurement has been selected for execution. When only a single measurement is selected, the results panel corresponding to the selected measurement gets displayed automatically. However, the results summary can be manually selected any time by selecting Results > Summary. With the Multi Line measurements are enabled, the results summary is not available.

A Results Summary window displays the Status and Warnings for the selected measurements, and the status for unselected measurements is displayed as '---'. Refer to Figure 3-24 for Option SD/HD. Refer to Figure 3-25 for Option VGA.

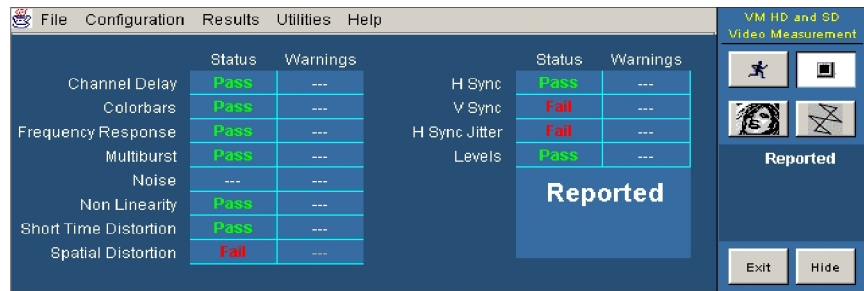

Figure 3-24: Displaying the results summary (Option SD/HD)

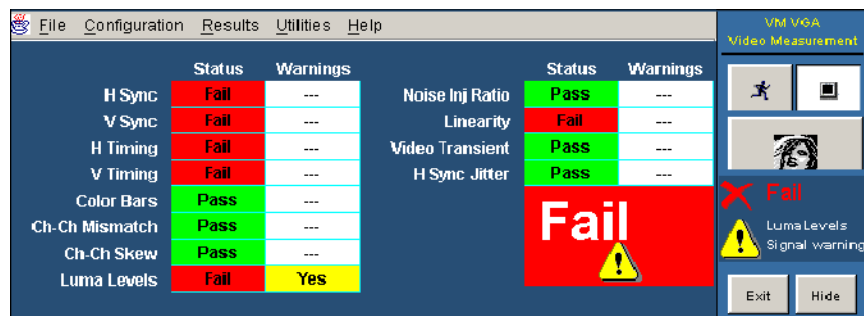

Figure 3-25: Displaying the results summary (Option VGA)

The Results Summary displays the current status of the measurements. If no measurements have been taken, --- is displayed in all the boxes in the summary table. Once measurements have been taken, the contents vary depending on whether limit testing was enabled, and whether warnings were generated.

Tables 3-6 and 3-7 describe the indicators that can appear in the Results Summary.

Table 3-6: Status Box Indicators in Results Summary pane

Status box	Description
---	No measurements taken
Done	Measurement completed
Fail	Measurement completed with Limit testing enabled and Failed
Pass	Measurement completed with Limit testing enabled and Passed

Table 3-7: Warning Box Indicators in Results Summary pane

Warning box	Description
--- (gray)	No warnings; no measurements taken
--- (white)	Measurements completed with no warnings
Yes	Measurements completed with warnings

Displaying Channel Delay Measurement Results

Option SD/HD Configure the Channel Delay measurements as explained in *Setting Up the Channel Delay Measurement* on page 3-85. Take the measurement by clicking the Run button. Click **Results > Channel Delay**. Refer to Figure 3-26.

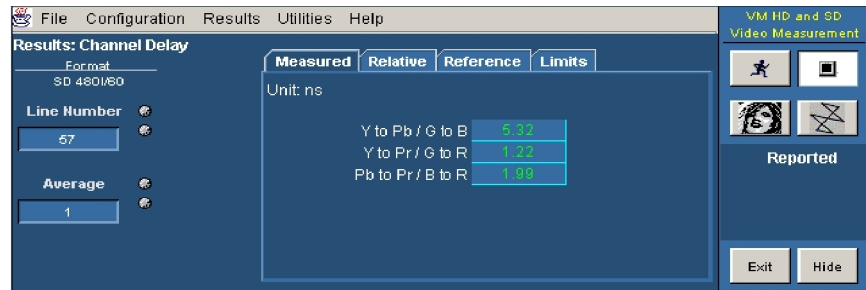

Figure 3-26: Displaying the Channel Delay measurement

- Measured Values** Click the **Measured** tab to display the measured channel delay in ns in the Results Channel Delay panel for the channel delay measurement.
- Relative Values** If Relative to Reference testing is enabled (see *Taking Measurements Relative to a Reference*, on page 3-78), you can display the calculated relative values by clicking the **Relative** tab.
- Reference Values** If Relative to Reference testing is enabled you can display the reference values by clicking the **Reference** tab. (To create a custom reference file, see *Creating a Custom Reference File* on page 3-80).
- Limit Values** If Limit testing is enabled (see *Taking Measurements with Limit Testing* on page 3-82), you can display the Limit values by clicking the **Limits** tab. The minimum and maximum values are set in the limits file for each signal format and color space.

Select the **min** option to display the minimum channel delay values. Select the **max** option to display the maximum channel delay values. Refer to Figure 3-27.

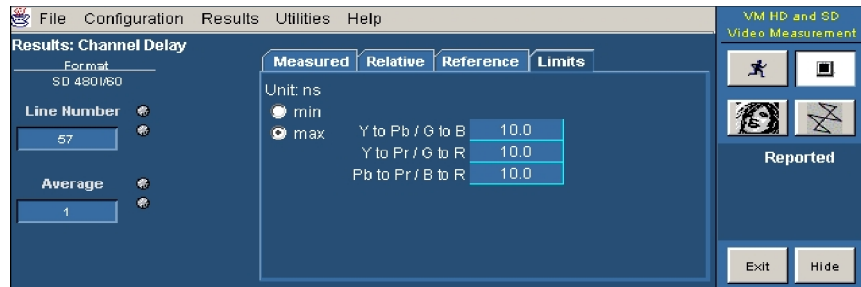

Figure 3-27: Displaying limit values for the Channel Delay measurement

Displaying Color Bars Measurement Results

Option SD/HD

Configure the Color Bars measurements as explained in *Setting Up the Color Bars Measurement* on page 3-86. Take the measurement by clicking the Run button. Click **Results > Color Bars**. Refer to Figure 3-28.



Figure 3-28: Displaying the Color Bars measurement

Measured Values

Click the **Measured** tab to display the measured amplitude levels for each of the eight colors for the color bars measurement.

Relative Values

If Relative to Reference testing is enabled (see *Taking Measurements Relative to a Reference* on page 3-78), you can display the calculated relative values by clicking the **Relative** tab.

Reference Values If Relative to Reference testing is enabled you can display the reference values by clicking the **Reference** tab (To create a custom reference file, see *Creating a Custom Reference File* on page 3-80).

Limit Values If Limit testing is enabled (see *Taking Measurements with Limit Testing* on page 3-82), you can display the Limit values by clicking the **Limits** tab. The minimum and maximum values are set in the limits file for each signal format and color space. Select the **min** option to display the minimum limit values. Select the **max** option to display the maximum limit values. Refer to Figure 3-29.

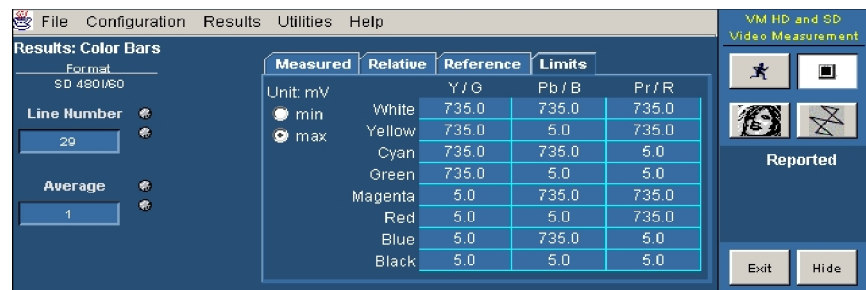

Figure 3-29: Displaying limit values for the Color Bars measurement

Additional Units The only additional unit available in the Results panel for the Color Bars measurement is % under the Relative tab.

Displaying Frequency Response Measurement Results

Option SD/HD Configure the Frequency Response measurements as explained in *Setting Up the Frequency Response Measurement* on page 3-88. Take the measurement by clicking the Run button. Click **Results > Frequency Response**. Refer to Figure 3-30.

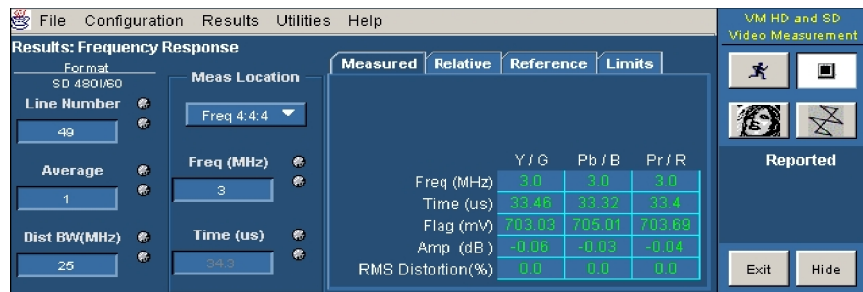

Figure 3-30: Displaying the Frequency Response measurement

Measured Values Click the **Measured** tab to display the Flag amplitude (mV), Frequency (MHz), Amplitude (dB), Time Position (μ s), and RMS Distortion (% of Amp) measured values.

Relative Values If Relative to Reference testing is enabled (see *Taking Measurements Relative to a Reference*, on page 3-78), you can display the calculated relative values by clicking the **Relative** tab.

Reference Values If Relative to Reference testing is enabled you can display the reference values by clicking the **Reference** tab (To create a custom reference file, see *Creating a Custom Reference File*, on page 3-80).

Limit Values If Limit testing is enabled (see *Taking Measurements with Limit Testing*, on page 3-82), you can display the Limit values by clicking the **Limits** tab. The minimum and maximum values are set in the limits file for each signal format and color space.

Select the **min** option to display the minimum values specified for the measurement. Select the **max** option to display the maximum values specified for the measurement. Refer to Figure 3-31.

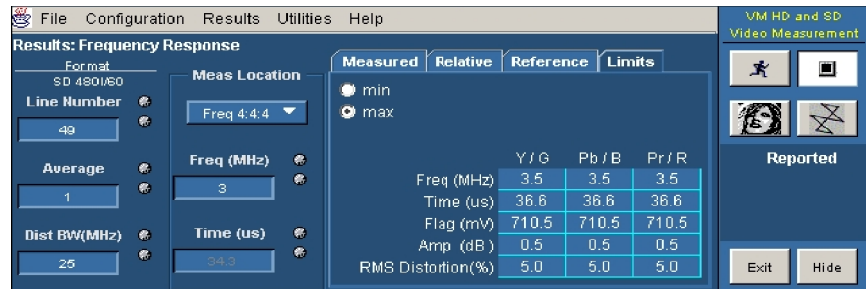

Figure 3-31: Displaying limit values for the Frequency Response measurement

Additional Units

The only additional unit in the Results panel for Frequency Response measurements is % under the Relative tab. In the results display, the readout ‘-Infinity’ indicates that there was an attempt to divide a result by zero, and ‘NaN’ indicates that there was an attempt to divide zero by zero. Refer to Figure 3-32.

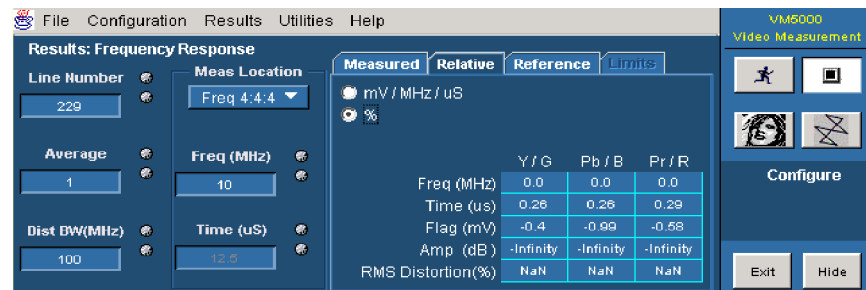

Figure 3-32: Displaying additional units for the Frequency Response measurement

Displaying H Sync Measurement Results

Option SD/HD

Configure the H Sync measurements as explained in *Setting Up the H Sync Measurement* on page 3-91. Take the measurement by clicking the Run button. Refer to Figure 3-33.

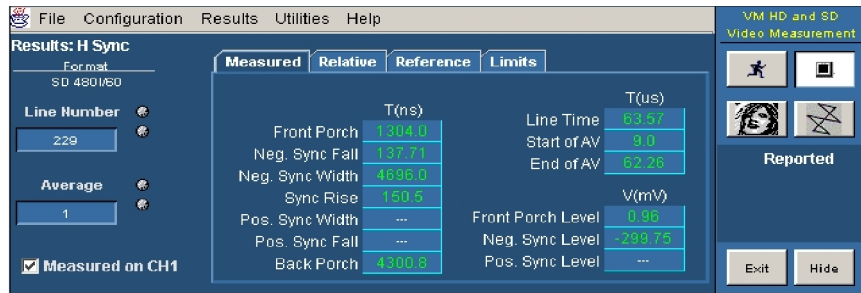

Figure 3-33: Displaying the H Sync measurement

Measured Values

Click the **Measured** tab to display the measured H Sync values.

Relative Values

If Relative to Reference testing is enabled (see *Taking Measurements Relative to a Reference*, on page 3-78), you can display the calculated relative values by clicking the **Relative** tab.

Reference Values

If Relative to Reference testing is enabled you can display the reference values by clicking the **Reference** tab (To create a custom reference file, see *Creating a Custom Reference File*, on page 3-80).

Limit Values

If Limit testing is enabled (see *Taking Measurements with Limit Testing*, on page 3-82), you can display the Limit values by clicking the **Limits** tab. The minimum and maximum values are set in the limits file for each signal format and color space. Select the **min** option to display the minimum values. Select the **max** option to display the maximum values. Refer to Figure 3-34.

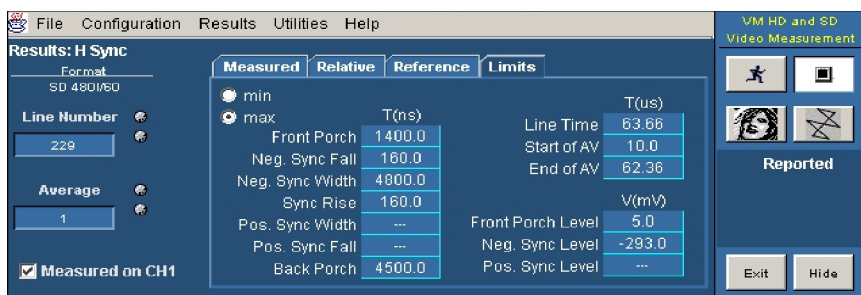

Figure 3-34: Displaying limit values for the H Sync measurement

Displaying H Sync Jitter Measurement Results

Option SD/HD Configure the H Sync Jitter measurements as explained in *Setting Up the H Sync Jitter Measurement* on page 3-91. Take the measurement by clicking the Run button. Refer to Figure 3-35.

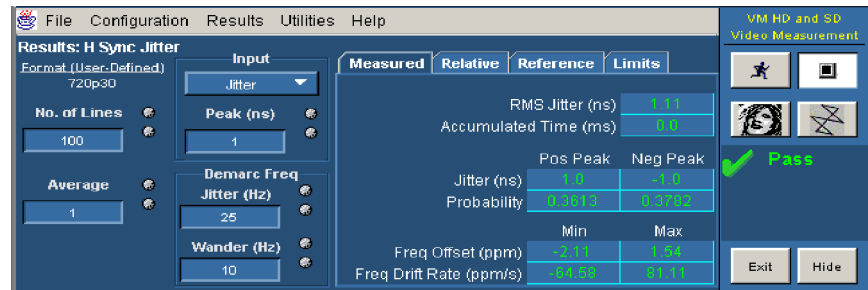

Figure 3-35: Displaying the H Sync Jitter measurement

Measured Values Click the **Measured** tab to display the measured H Sync Jitter values.

Relative Values If Relative to Reference testing is enabled (see *Taking Measurements Relative to a Reference*, on page 3-78), you can display the calculated relative values by clicking the **Relative** tab.

Reference Values If Relative to Reference testing is enabled you can display the reference values by clicking the **Reference** tab (To create a custom reference file, see *Creating a Custom Reference File*, on page 3-80).

Limit Values If Limit testing is enabled (see *Taking Measurements with Limit Testing*, on page 3-82), you can display the Limit values by clicking the **Limits** tab. The minimum and maximum values are set in the limits file for each signal format and color space. Select the **min** option to display the minimum values. Select the **max** option to display the maximum values. Refer to Figure 3-36.

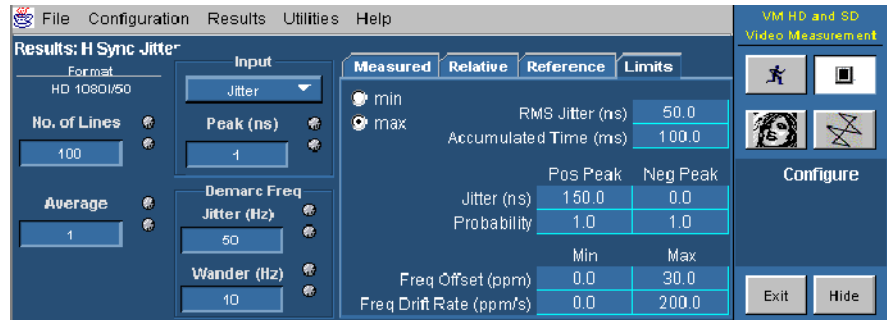

Figure 3-36: Displaying limit values for the H Sync Jitter measurement

Displaying Levels Measurement Results

Option SD/HD Configure the Levels measurements as explained in *Setting Up the Levels Measurement* on page 3-91. Take the measurement by clicking the Run button. Refer to Figure 3-37.



Figure 3-37: Displaying the Levels measurement

Measured Values Click the **Measured** tab to display the measured Levels values.

Relative Values If Relative to Reference testing is enabled (see *Taking Measurements Relative to a Reference*, on page 3-78), you can display the calculated relative values by clicking the **Relative** tab.

Reference Values If Relative to Reference testing is enabled you can display the reference values by clicking the **Reference** tab (To create a custom reference file, see *Creating a Custom Reference File*, on page 3-80).

Limit Values

If Limit testing is enabled (see *Taking Measurements with Limit Testing*, on page 3-82), you can display the Limit values by clicking the **Limits** tab. The minimum and maximum values are set in the limits file for each signal format and color space. Select the **min** option to display the minimum values. Select the **max** option to display the maximum values. Refer to Figure 3-38.

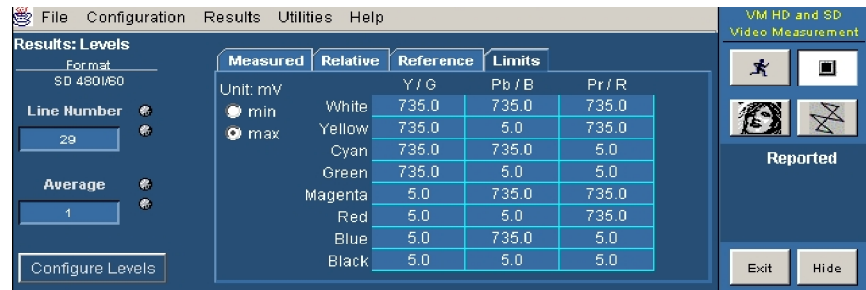

Figure 3-38: Displaying limit values for the Levels measurement

Displaying Multiburst Measurement Results

Option SD/HD

Configure the Multiburst measurements as explained in *Setting Up the Multiburst measurement* on page 3-98. Take the measurement by clicking the Run button. Click **Results > Multiburst**. Refer to Figure 3-39.



Figure 3-39: Displaying the Multiburst measurement

Measured Values

Click the **Measured** tab to display the Flag (mV), Burst1, Burst2, Burst3, Burst4, Burst5, and Burst6 values.

Relative Values

If Relative to Reference testing is enabled (see *Taking Measurements Relative to a Reference*, on page 3-78), you can display the calculated relative values by clicking the **Relative** tab.

Reference Values If Relative to Reference testing is enabled you can display the reference values by clicking the **Reference** tab (To create a custom reference file, see *Creating a Custom Reference File*, on page 3-80).

Limit Values If Limit testing is enabled (see *Taking Measurements with Limit Testing*, on page 3-82), you can display the Limit values by clicking the **Limits** tab. The minimum and maximum values are set in the limits file for each signal format and color space.

Select the **min** option to display the minimum values for the measurement. Select the **max** option to display the maximum values for the measurement. Refer to Figure 3-40.

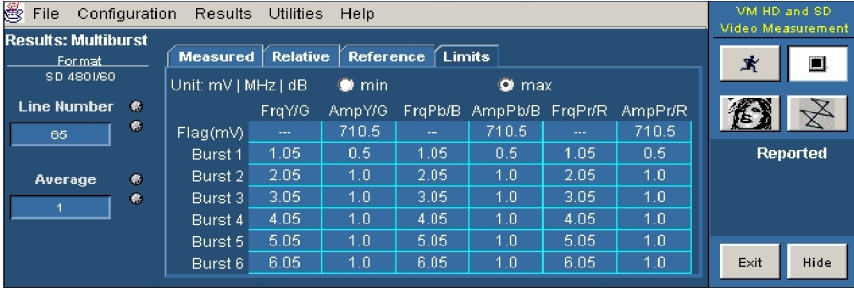

Line Number	Measured					
	Unit: mV MHz dB	min		max		
65	FrgYG	AmpYG	FrgPb/B	AmpPb/B	FrgPr/R	AmpPr/R
Burst 1	1.05	0.5	1.05	0.5	1.05	0.5
Burst 2	2.05	1.0	2.05	1.0	2.05	1.0
Burst 3	3.05	1.0	3.05	1.0	3.05	1.0
Burst 4	4.05	1.0	4.05	1.0	4.05	1.0
Burst 5	5.05	1.0	5.05	1.0	5.05	1.0
Burst 6	6.05	1.0	6.05	1.0	6.05	1.0

Figure 3-40: Displaying limit values for the Multiburst measurement

Additional Units The only additional unit in the Results pane for Multiburst measurement is % under the Measured tab and Relative tab.

Displaying Noise Measurement Results

Option SD/HD Configure the Noise measurements as explained in *Setting Up the Noise Measurement* on page 3-99. Take the measurement by clicking the Run button. Click **Results > Noise**. Refer to Figure 3-41.

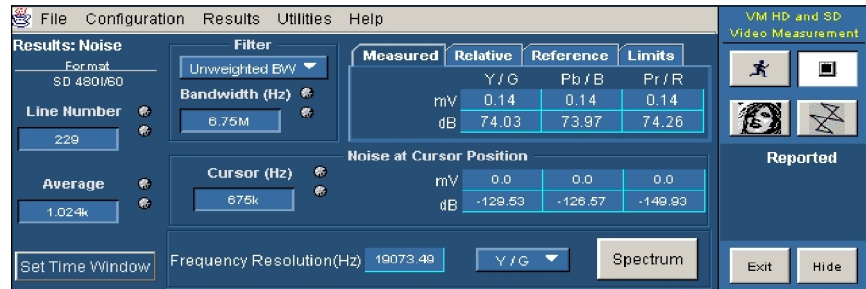

Figure 3-41: Displaying the Noise measurement

Measured Values Click the **Measured** tab to display the measured amplitude level values.

Relative Values If Relative to Reference testing is enabled (see *Taking Measurements Relative to a Reference*, on page 3-78), you can display the calculated relative values by clicking the **Relative** tab.

Reference Values If Relative to Reference testing is enabled you can display the reference values by clicking the **Reference** tab (To create a custom reference file, see *Creating a Custom Reference File*, on page 3-80).

Limit Values If Limit testing is enabled (see *Taking Measurements with Limit Testing*, on page 3-82), you can display the Limit values by clicking the **Limits** tab. The minimum and maximum values are set in the limits file for each signal format and color space. Select the **min** option to display the minimum amplitude level values. Select the **max** option to display the maximum amplitude level values. Refer to Figure 3-42.

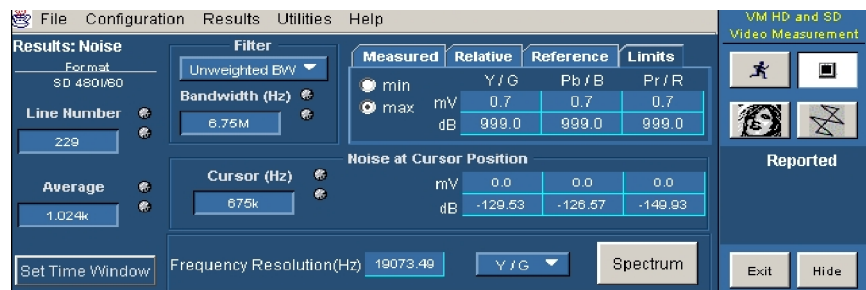

Figure 3-42: Displaying limit values for the Noise measurement

Displaying Noise Spectrum

Configure the Noise Spectrum measurements as explained in *Setting up for Noise Spectrum measurements* on page 3-102. Take the measurement by clicking the Run button. Refer to Figure 3-43.

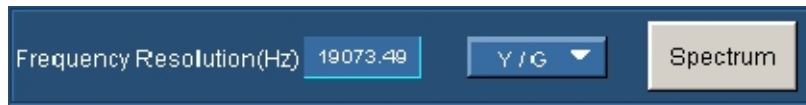

Figure 3-43: Displaying the Noise Spectrum measurement

Click the **Spectrum** box to get the noise spectrum display on the VM Series System Video Monitor. Refer to Figure 3-44.

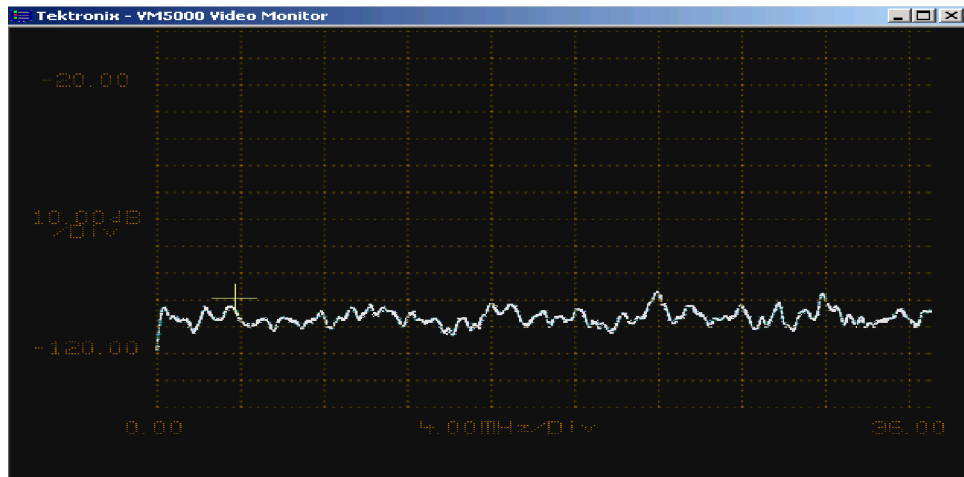

Figure 3-44: Displaying the Noise Spectrum on the VM Series video monitor

Displaying Non Linearity Measurement Results

Option SD/HD

Configure the Non Linearity measurements as explained in *Setting Up the Non Linearity Measurement* on page 3-104. Take the measurement by clicking the Run button. Click **Results > Non Linearity**. Refer to Figure 3-45.

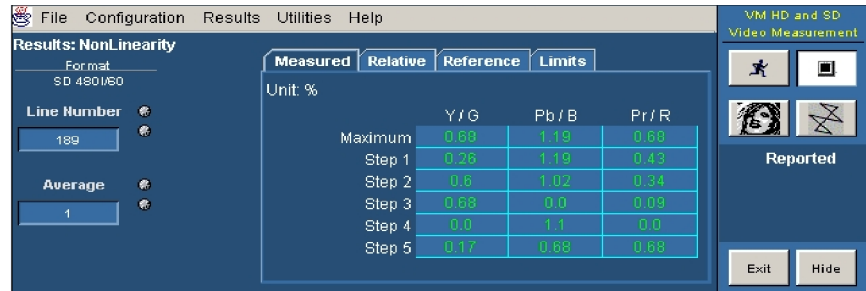

Figure 3-45: Displaying the Non Linearity measurement

Measured Values Click the **Measured** tab to display the measured Non Linearity values.

Relative Values If Relative to Reference testing is enabled you can display the calculated relative values by clicking the **Relative** tab (see *Taking Measurements Relative to a Reference*, on page 3-78).

Reference Values If Relative to Reference testing is enabled you can display the reference values by clicking the **Reference** tab (To create a custom reference file, see *Creating a Custom Reference File*, on page 3-80).

Limit Values If Limit testing is enabled (see *Taking Measurements with Limit Testing*, on page 3-82), you can display the Limit values by clicking the **Limits** tab. The minimum and maximum values are set in the limits file for each signal format and color space. Select the **min** option to display the minimum Non Linearity values. Select the **max** option to display the maximum Non Linearity values. Refer to Figure 3-46.

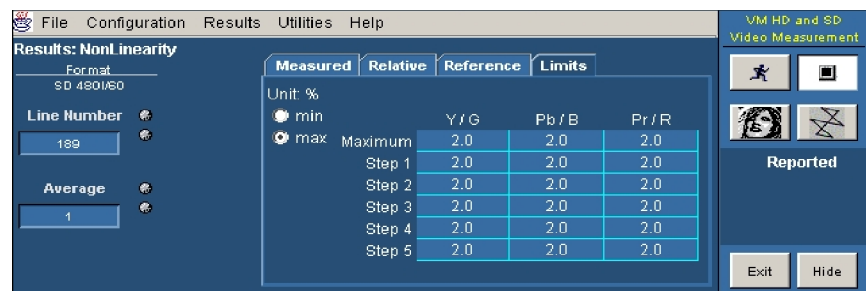

Figure 3-46: Displaying limit values for the Non Linearity measurement

Displaying Short Time Distortion Measurement Results

Option SD/HD Configure the Short Time Distortion measurements as explained in *Setting Up the Short Time Distortion Measurement* on page 3-105. Take the measurement by clicking the Run button. Click **Results > Short Time Distortion**. Refer to Figure 3-47.

	Y / G	Pb / B	Pr / R
Rise(ns)	253.75	254.7	253.52
Fall(ns)	252.56	253.68	252.27
Overshoot(%)	0.31	0.13	0.3
Undershoot(%)	0.73	0.63	0.74
Settling Rise(ns)	0.0	0.0	0.0
Settling Fall(ns)	0.0	0.0	0.0
K2T(%)	0.48		

Figure 3-47: Displaying the Short Time Distortion measurement

Measured Values Click the **Measured** tab to display the Rise Time, Fall time, Overshoot, Undershoot, and Settling Time.

Relative Values If Relative to Reference testing is enabled (see *Taking Measurements Relative to a Reference*, on page 3-78), you can display the calculated relative values by clicking the **Relative** tab.

Reference Values If Relative to Reference testing is enabled you can display the reference values by clicking the **Reference** tab (To create a custom reference file, see *Creating a Custom Reference File*, on page 3-80).

Limit Values If Limit testing is enabled, you can display the Limit values by clicking the **Limits** tab (see *Taking Measurements with Limit Testing*, on page 3-82). The minimum and maximum values are set in the limits file for each signal format and color space.

Select the **min** option to display the minimum values. Select the **max** option to display the maximum values. Refer to Figure 3-48.

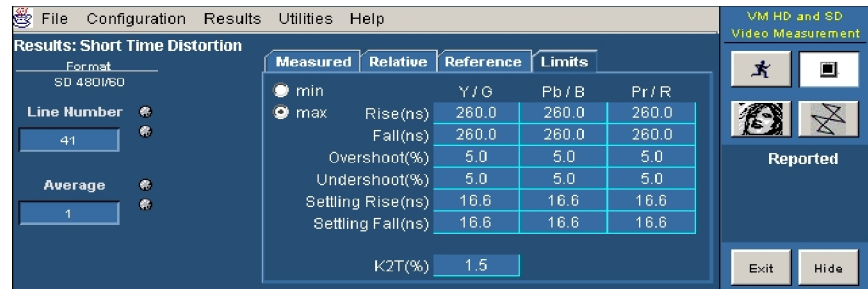

Figure 3-48: Displaying limit values for the Short Time Distortion measurement

Displaying Spatial Distortion Measurement Results

Option SD/HD

Configure the Spatial Distortion measurements as explained in *Setting Up the Spatial Distortion Measurement* on page 3-105. Take the measurement by clicking the Run button. Click **Results > Spatial Distortion**. Refer to Figure 3-49.

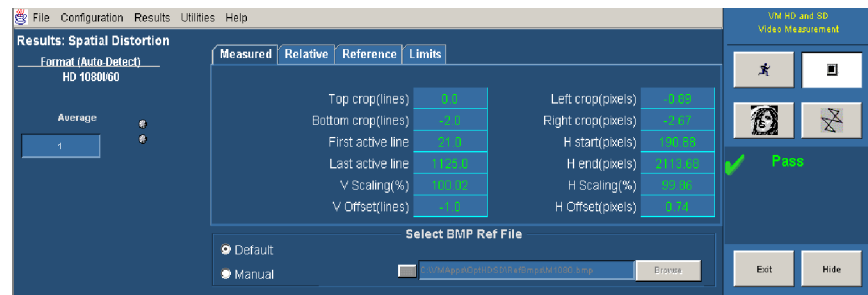

Figure 3-49: Displaying the Spatial Distortion measurement

Measured Values

Click the **Measured** tab to display the Top crop, Bottom crop, First active line, Last active line, V Scaling, V Offset, Left crop, Right crop, H start, H end, H Scaling, and H Offset.

Relative Values

If Relative to Reference testing is enabled (see *Taking Measurements Relative to a Reference*, on page 3-78), you can display the calculated relative values by clicking the **Relative** tab.

Reference Values If Relative to Reference testing is enabled you can display the reference values by clicking the **Reference** tab (To create a custom reference file, see *Creating a Custom Reference File*, on page 3-80).

Limit Values If Limit testing is enabled, you can display the Limit values by clicking the **Limits** tab (see *Taking Measurements with Limit Testing*, on page 3-82). The minimum and maximum values are set in the limits file for each signal format and color space.

Select the **min** option to display the minimum values. Select the **max** option to display the maximum values. Refer to Figure 3-50.

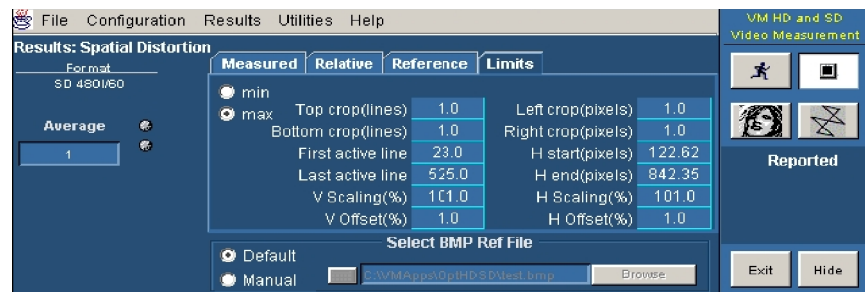

Figure 3-50: Displaying limit values for the Spatial Distortion measurement

Displaying V Sync Measurement Results

Option SD/HD Configure the V Sync measurements as explained in *Setting Up the V Sync Measurement* on page 3-91. Take the measurement by clicking the Run button. Refer to Figure 3-51 through Figure 3-54.



Figure 3-51: Displaying the V Sync measurement for SD Interlaced format

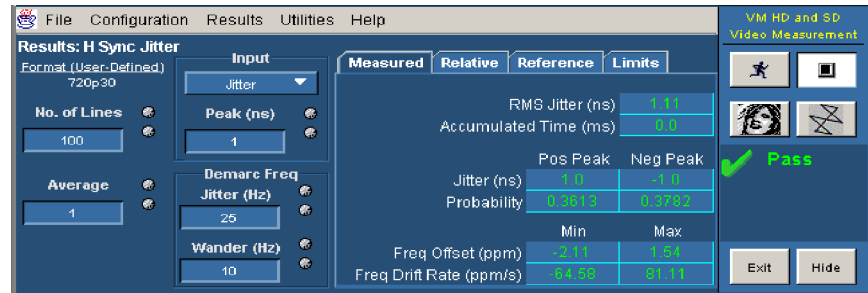

Figure 3-52: Displaying the V Sync measurement for SD Progressive format

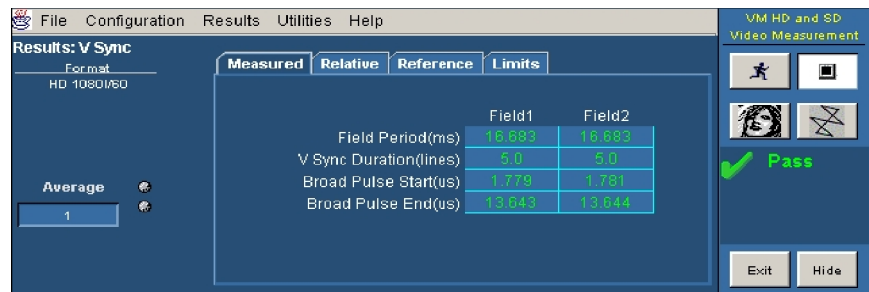

Figure 3-53: Displaying the V Sync measurement for SD Interlaced format

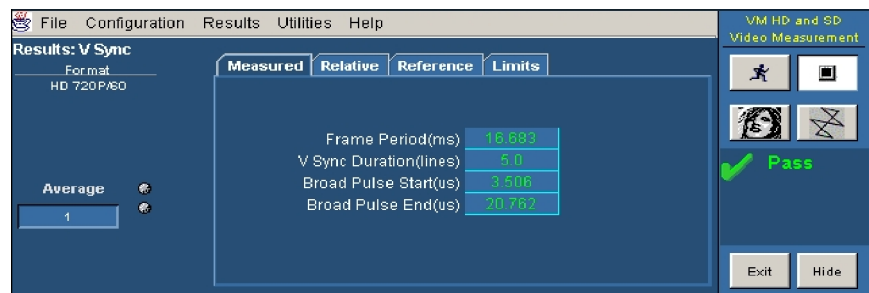

Figure 3-54: Displaying the V Sync measurement for HD Progressive format

Measured Values

Click the **Measured** tab to display the measured V Sync values.

Relative Values

If Relative to Reference testing is enabled (see *Taking Measurements Relative to a Reference*, on page 3-78), you can display the calculated relative values by clicking the **Relative** tab.

Reference Values

If Relative to Reference testing is enabled you can display the reference values by clicking the **Reference** tab (To create a custom reference file, see *Creating a Custom Reference File*, on page 3-80).

Limit Values

If Limit testing is enabled (see *Taking Measurements with Limit Testing*, on page 3-82), you can display the Limit values by clicking the **Limits** tab. The minimum and maximum values are set in the limits file for each signal format and color space. Select the **min** option to display the minimum values. Select the **max** option to display the maximum values. Refer to Figure 3-55 through Figure 3-58.

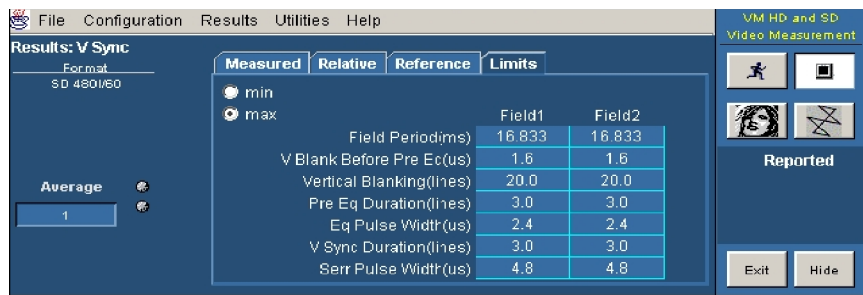

Figure 3-55: Displaying limit values for the V Sync measurement for SD Interlaced format

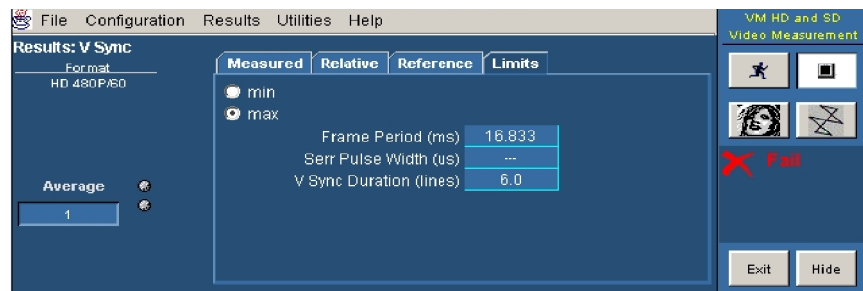

Figure 3-56: Displaying limit values for the V Sync measurement for SD Progressive format

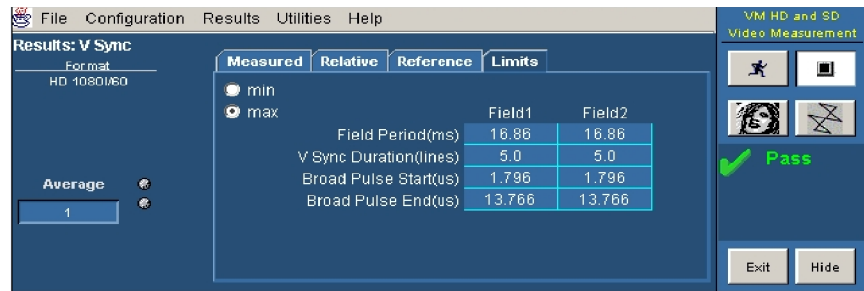

Figure 3-57: Displaying limit values for the V Sync measurement for HD Interlaced format

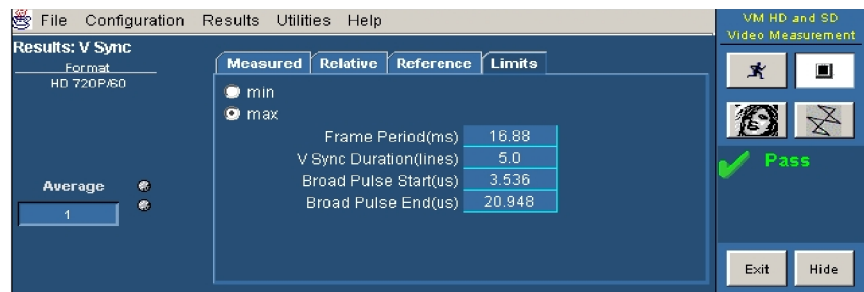

Figure 3-58: Displaying limit values for the V Sync measurement for HD Progressive format

Displaying Ch-Ch Mismatch Measurement Results

Option VGA Configure the Ch-Ch Mismatch measurement as explained in *Setting Up the Ch-Ch Mismatch Measurement* on page 3-111. Take the measurement by clicking the Run button. Click **Results > Ch-Ch Mismatch**. Refer to Figure 3-59.

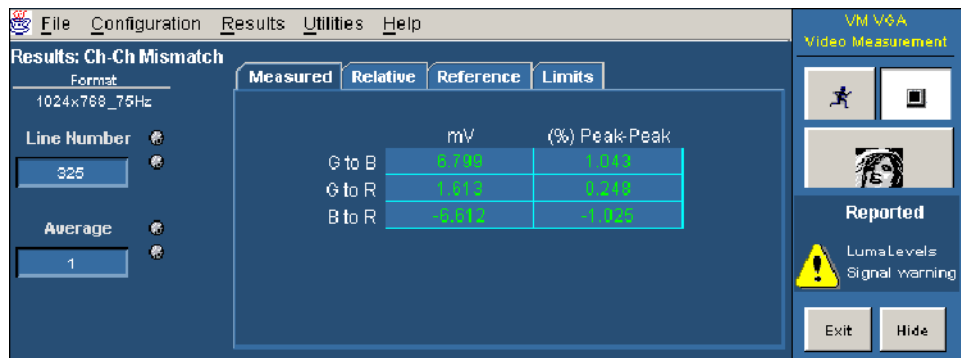

Figure 3-59: Ch-Ch Mismatch measurement results

Measured Values Click the **Measured** tab to display the measured values in mV and %Peak-Peak.

Relative Values If Relative to Reference testing is enabled you can display the calculated relative values by clicking the **Relative** tab (see *Taking Measurements Relative to a Reference*, on page 3-78).

Reference Values If Relative to Reference testing is enabled, you can display the reference values by clicking the **Reference** tab (see *Creating a Custom Reference File*, on-page 3-80).

Limit Values If Limit testing is enabled, you can display the Limit values by clicking the **Limits** tab (see *Taking Measurements with Limit Testing*, on page 3-82). The minimum and maximum values are set in the limits file for the supported combination of resolution, refresh rate, and timing standard. Select the **min** option to display the minimum limit values.

Select the **max** option to display the maximum limit values. Refer to Figure 3-60.

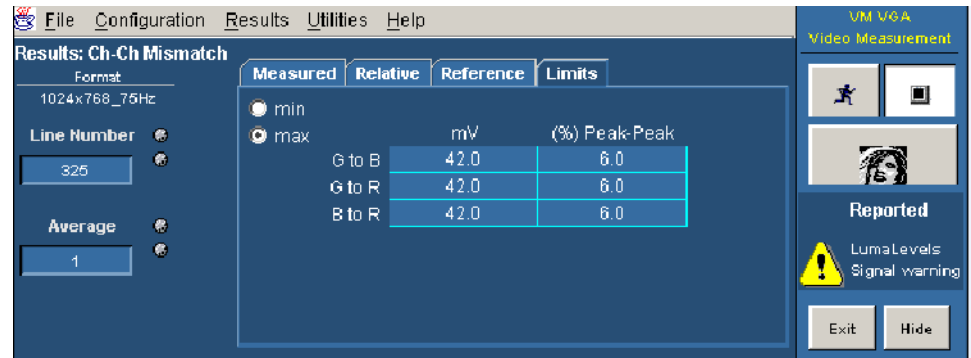

Figure 3-60: Limit values for the Ch-Ch Mismatch measurement

Displaying Ch-Ch Skew Measurement Results

Option VGA Configure the Ch-Ch Skew measurement as explained in *Setting Up the Ch-Ch Skew Measurement* on page 3-112. Take the measurement by clicking the Run button. Click **Results > Ch-Ch Skew**. Refer to Figure 3-61.

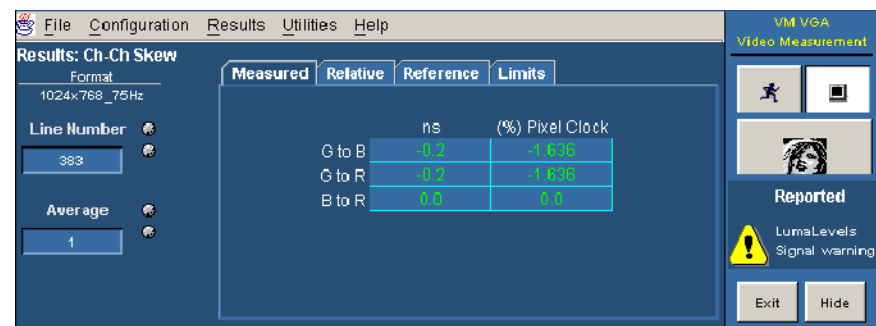

Figure 3-61: Ch-Ch Skew measurement results

Measured Values Click the **Measured** tab to display the measured values in ns and (%)Pixel Clock.

Relative Values If Relative to Reference testing is enabled, you can display the calculated relative values by clicking the **Relative** tab (see *Taking Measurements Relative to a Reference* on page 3-78).

Reference Values If Relative to Reference testing is enabled, you can display the reference values by clicking the **Reference** tab (see *Creating a Custom Reference File* on page 3-80).

Limit Values If Limit testing is enabled, you can display the Limit values by clicking the **Limits** tab (see *Taking Measurements with Limit Testing* on page 3-82). The minimum and maximum values are set in the limits file for the supported combination of resolution, refresh rate, and timing standard.

Select the **min** option to display the minimum limit values. Select the **max** option to display the maximum limit values. Refer to Figure 3-62.

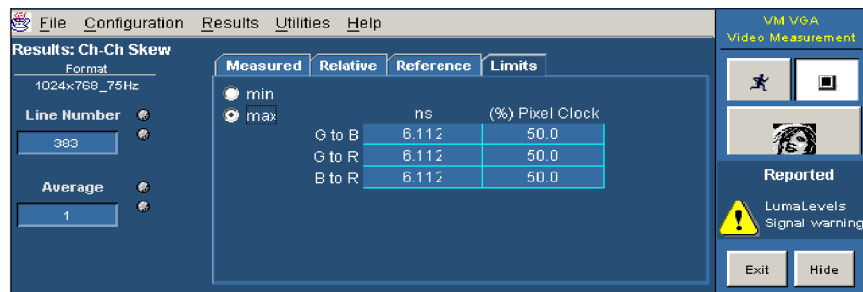

Figure 3-62: Limit values for the Ch-Ch Skew measurement

Displaying Color Bars Measurement Results

Option VGA Configure the Color Bars measurements as explained in *Setting Up the Color Bars Measurements* on page 3-114. Take the measurement by clicking the Run button. Click **Results > Color Bars**. Refer to Figure 3-63.



Figure 3-63: Color Bars measurement results

- Measured Values** Click the **Measured** tab to display the measured amplitude levels for each of the eight colors for the Color Bars measurement.
- Relative Values** If Relative to Reference testing is enabled, you can display the calculated relative values by clicking the **Relative** tab (see *Taking Measurements Relative to a Reference* on page 3-78).
- Reference Values** If Relative to Reference testing is enabled, you can display the reference values by clicking the **Reference** tab (see *Creating a Custom Reference File* on page 3-82).
- Limit Values** If Limit testing is enabled, you can display the Limit values by clicking the **Limits** tab (see *Taking Measurements with Limit Testing* on page 3-82). The minimum and maximum values are set in the limits file for the supported combination of resolution, refresh rate, and timing standard. Select the **min** option to display the minimum limit values. Select the **max** option to display the maximum limit values. Refer to Figure 3-64.

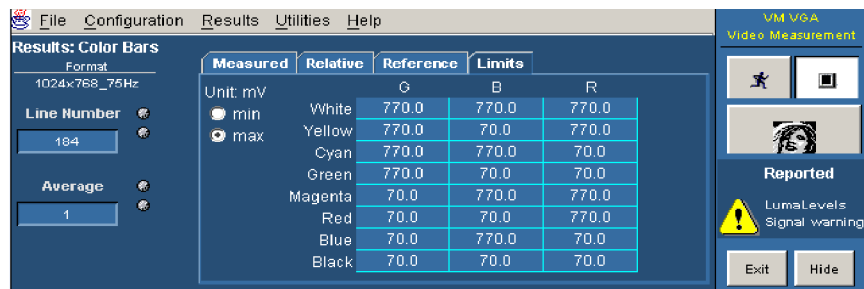

Figure 3-64: Limit values for the Color Bars measurement

- Additional Units** The only additional unit available in the Results window for the Color Bars measurement is % in the **Relative** tab.

Displaying H Sync Measurement Results

Option VGA Configure the H Sync measurements as explained in *Setting Up the H Sync Measurement* on page 3-115. Take the measurement by clicking the Run button. Click **Results > H Sync**. Refer to Figure 3-65.

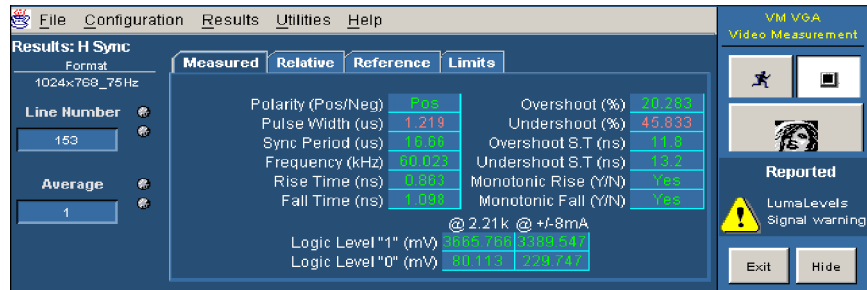

Figure 3- 65: H Sync measurement results

Measured Values Click the **Measured** tab to display the measured values.

Relative Values If Relative to Reference testing is enabled, you can display the calculated relative values by clicking the **Relative** tab (see *Taking Measurements Relative to a Reference* on page 3-78).

Reference Values If Relative to Reference testing is enabled, you can display the reference values by clicking the **Reference** tab (see *Creating a Custom Reference File* on page 3-80).

Limit Values If Limit testing is enabled, (see *Taking Measurements with Limit Testing* on page 3-82) you can display the Limit values by clicking the **Limits** tab. The minimum and maximum values are set in the limits file for the supported combination of resolution, refresh rate, and timing standard.

Select the **min** option to display the minimum limit values specified for the measurement. Select the **max** option to display the maximum limit values specified for the measurement. Refer to Figure 3-66.

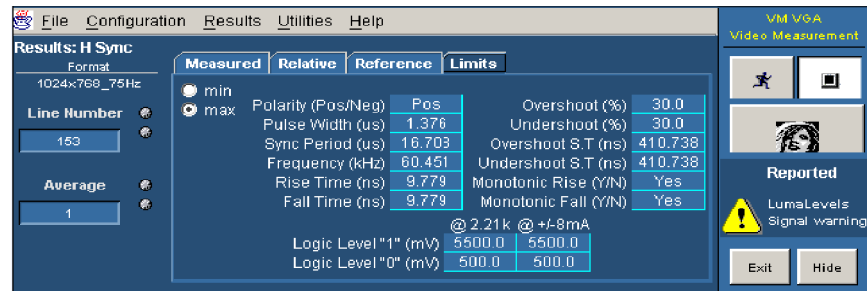

Figure 3-66: Limit values for the H Sync measurement

In the Result panel of the H Sync measurement, the parameters are different in the absence of MIU.

Additional Units

The only additional unit available in the Results window for the H Sync measurement is % in the **Relative** tab.

Displaying H Sync Jitter Measurement Results

Option VGA

Configure the H Sync Jitter measurements as explained in *Setting Up the H Sync Jitter Measurement* on page 3-116. Take the measurement by clicking the Run button. Click **Results > H Sync Jitter**. Refer to Figure 3-67.

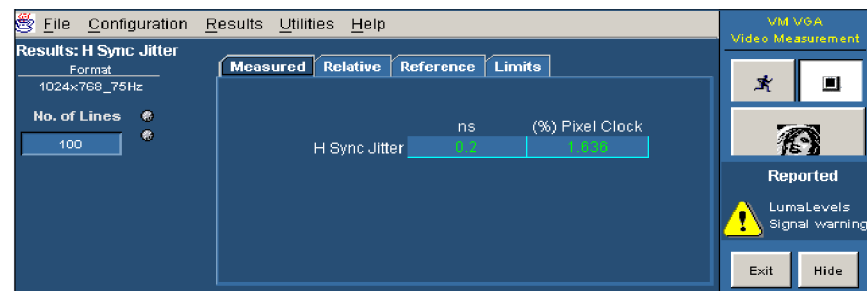

Figure 3-67: H Sync Jitter measurement results

Measured Values

Click the **Measured** tab to display the measured values.

Relative Values If Relative to Reference testing is enabled, you can display the calculated relative values by clicking the **Relative** tab (see *Taking Measurements Relative to a Reference* on page 3-78).

Reference Values If Relative to Reference testing is enabled, you can display the reference values by clicking the **Reference** tab (see *Creating a Custom Reference File* on page 3-80).

Limit Values If Limit testing is enabled (see *Taking Measurements with Limit Testing* on page 3-82), you can display the Limit values by clicking the **Limits** tab. The minimum and maximum values are set in the limits file for the supported combination of resolution, refresh rate, and timing standard. Select the **min** option to display the minimum limit values for the measurement. Select the **max** option to display the maximum limit values for the measurement. Refer to Figure 3-68.

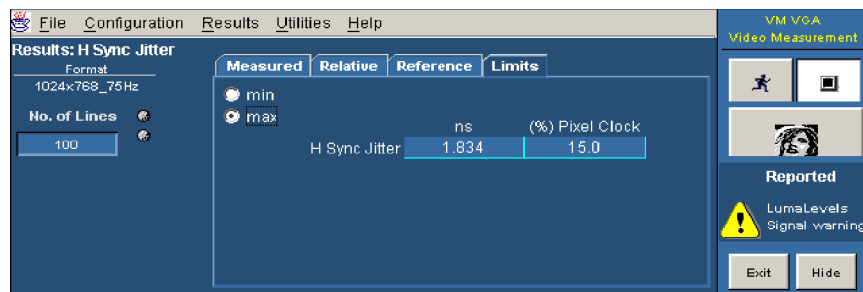

Figure 3-68: Limit values for the H Sync Jitter measurement

Additional Units The only additional unit available in the Results window for the H Sync Jitter measurement is % in the **Measured** tab and the **Relative** tab.

Displaying H Timing Measurement Results

Option VGA Configure the H Timing measurements as explained in *Setting Up the H Timing Measurement* on page 3-117. Take the measurement by clicking the Run button. Click **Results > H Timing**. Refer to Figure 3-69.

	G	B	R
Back Porch (us)	2.221	2.221	2.221
Left Border (us)	0.035	0.035	0.035
Addressable Video (us)	12.965	12.966	12.966
Right Border (us)	0.035	0.035	0.034
Front Porch (us)	0.22	0.22	0.22
Sync Pulse Width (us)	1.219		
Pixel Clock (MHz)	70.979		

Reported
LumaLevels
Signal warning

Figure 3-69: H Timing measurement results

Measured Values Click the **Measured** tab to display the measured values.

Relative Values If Relative to Reference testing is enabled, you can display the calculated relative values by clicking the **Relative** tab (see *Taking Measurements Relative to a Reference* on page 3-78).

Reference Values If Relative to Reference testing is enabled, you can display the reference values by clicking the **Reference** tab (see *Creating a Custom Reference File* on page 3-80).

Limit Values If Limit testing is enabled (see *Taking Measurements with Limit Testing* on page 3-82), you can display the Limit values by clicking the **Limits** tab. The minimum and maximum values are set in the limits file for the supported combination of resolution, refresh rate, and timing standard.

Select the **min** option to display the minimum limit values for the measurement. Select the **max** option to display the maximum limit values for the measurement. Refer to Figure 3-70.

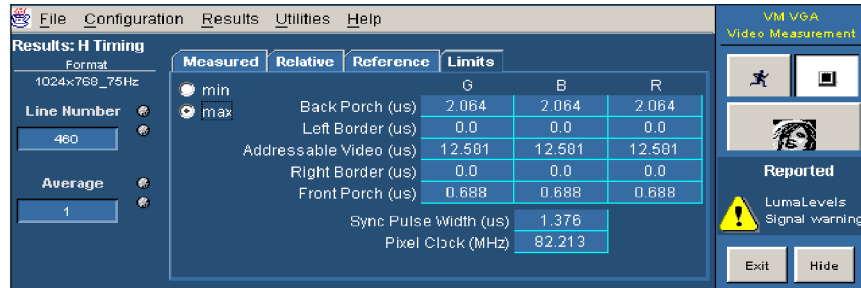

Figure 3-70: Limit values for the H Timing measurement

Displaying Linearity Measurement Results

Option VGA Configure the Linearity measurements as explained in *Setting Up the Linearity Measurement* on page 3-118. Take the measurement by clicking the Run button. Click **Results > Linearity**. Refer to Figure 3-71.



Figure 3-71: Linearity measurement results

Measured Values Click the **Measured** tab to display the measured values.

Relative Values If Relative to Reference testing is enabled, you can display the calculated relative values by clicking the **Relative** tab (see *Taking Measurements Relative to a Reference* on page 3-78).

Reference Values If Relative to Reference testing is enabled, you can display the reference values by clicking the **Reference** tab (see *Creating a Custom Reference File* on page 3-80).

Limit Values If Limit testing is enabled, you can display the Limit values by clicking the **Limits** tab (see *Taking Measurements with Limit Testing* on page 3-82). The minimum and maximum values are set in the limits file for the supported combination of resolution, refresh rate, and timing standard. Select the **min** option to display the minimum limit values for the measurement. Select the **max** option to display the maximum limit values for the measurement. Refer to Figure 3-72.

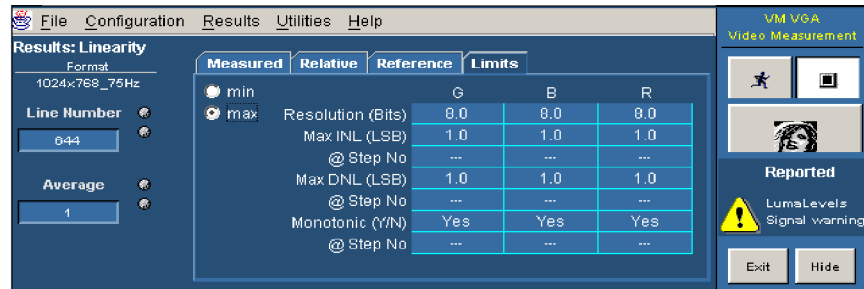

Figure 3-72: Limit values for the Linearity measurement

Displaying Luma Levels Measurement Results

Option VGA Configure the Luma Levels measurements as explained in *Setting Up the Luma Levels Measurement* on page 3-119. Take the measurement by clicking the Run button. Click **Results > Luma Levels**. Refer to Figure 3-73.

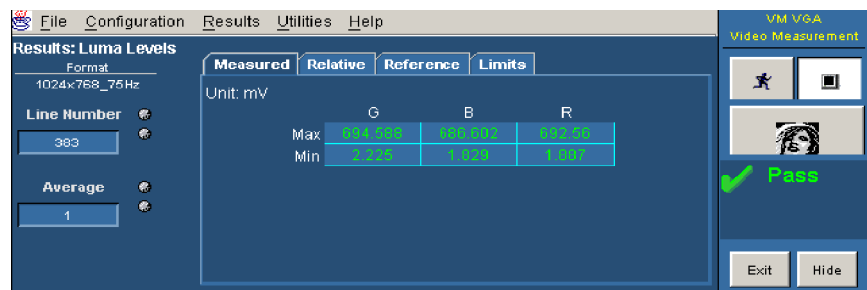

Figure 3-73: Luma Levels measurement results

- Measured Values** Click the **Measured** tab to display the measured values.
- Relative Values** If Relative to Reference testing is enabled, you can display the calculated relative values by clicking the **Relative** tab (see *Taking Measurements Relative to a Reference* on page 3-78).
- Reference Values** If Relative to Reference testing is enabled, you can display the reference values by clicking the **Reference** tab (see *Creating a Custom Reference File* on page 3-80).
- Limit Values** If Limit testing is enabled, you can display the Limit values by clicking the **Limits** tab (see *Taking Measurements with Limit Testing* on page 3-82). The minimum and maximum values are set in the limits file for the supported combination of resolution, refresh rate, and timing standard.
- Select the **min** option to display the minimum limit values for the measurement. Select the **max** option to display the maximum limit values for the measurement. Refer to Figure 3-74.

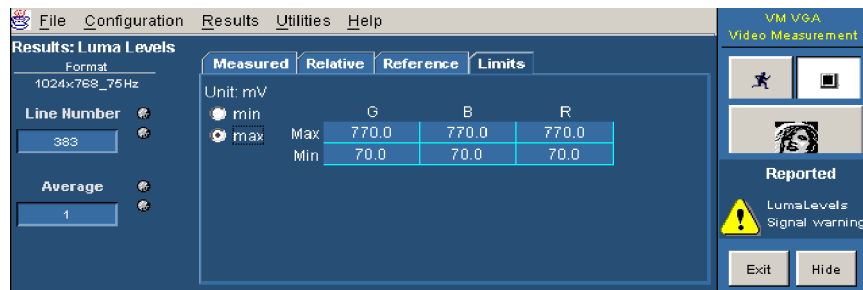

Figure 3-74: Limit values for the Luma Levels measurement

- Additional Units** The only additional unit available in the Results window for the Luma Levels measurement is % in the **Relative** tab.

Displaying Noise Inj Ratio Measurement Results

Option VGA Configure the Noise Inj Ratio measurements as explained in *Setting Up the Noise Inj Ratio Measurement* on page 3-120. Take the measurement by clicking the Run button. Click **Results > Noise Inj Ratio**. Refer to Figure 3-75.

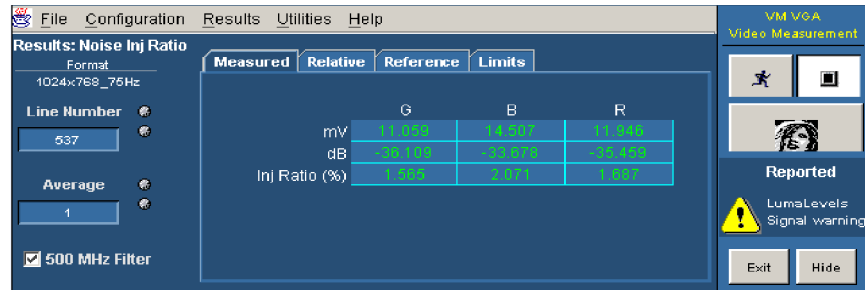

Figure 3-75: Noise Inj Ratio measurement results with MIU

Measured Values Click the **Measured** tab to display the measured values in mV, dB, and Inj Ratio (%). When the MIU is used, the measured values of Noise (in mV) less than 1 mV are displayed as <1. When the MIU is not used, the measured values of Noise (in mV) less than 0.1 mV are displayed as <.1.

Relative Values If Relative to Reference testing is enabled, you can display the calculated relative values by clicking the **Relative** tab (see *Taking Measurements Relative to a Reference* on page 3-78).

Reference Values If Relative to Reference testing is enabled, you can display the reference values by clicking the **Reference** tab (see *Creating a Custom Reference File* on page 3-80).

Limit Values If Limit testing is enabled, you can display the Limit values by clicking the **Limits** tab (see *Taking Measurements with Limit Testing* on page 3-82). The minimum and maximum values are set in the limits file for the supported combination of resolution, refresh rate, and timing standard. Select the **min** option to display the minimum limit values.

Select the **max** option to display the maximum limit values. Refer to Figure 3-76.

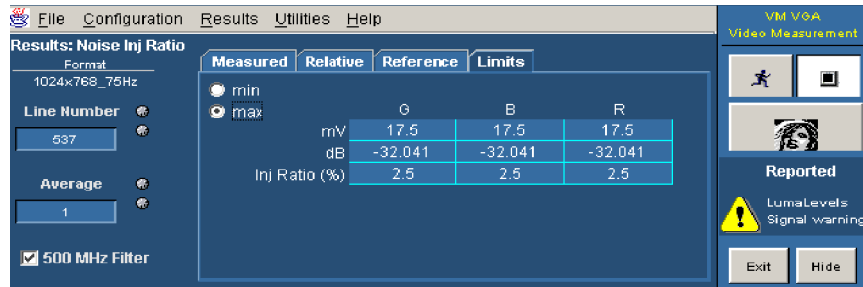

Figure 3-76: Limit values for the Noise Inj Ratio measurement

Displaying V Sync Measurement Results

Option VGA Configure the V Sync measurements as explained in *Setting Up the V Sync Measurement* on page 3-121. Take the measurement by clicking the Run button. Click **Results > V Sync**. Refer to Figure 3-77.

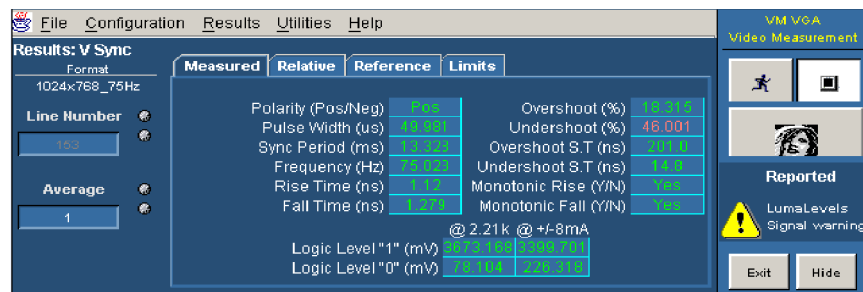

Figure 3-77: V Sync measurement results

Measured Values Click the **Measured** tab to display the measured values.

Relative Values If Relative to Reference testing is enabled, you can display the calculated relative values by clicking the **Relative** tab (see *Taking Measurements Relative to a Reference* on page 3-78).

Reference Values If Relative to Reference testing is enabled, you can display the reference values by clicking the **Reference** tab (see *Creating a Custom Reference File* on page 3-80.)

Limit Values

If Limit testing is enabled, you can display the Limit values by clicking the **Limits** tab (see *Taking Measurements with Limit Testing* on page 3-82). The minimum and maximum values are set in the limits file for the supported combination of resolution, refresh rate, and timing standard.

Select the **min** option to display the minimum limit values. Select the **max** option to display the maximum limit values. Refer to Figure 3-78.

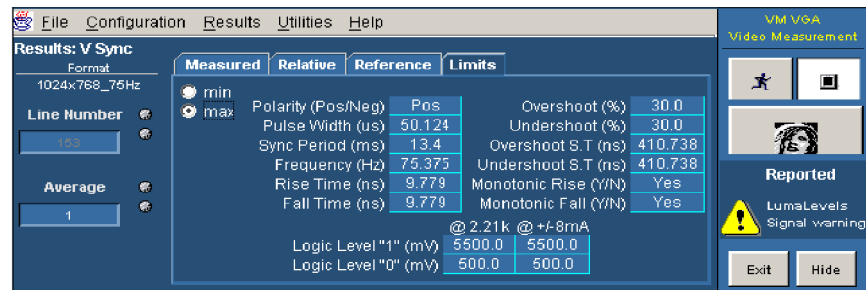

Figure 3-78: Limit values for the V Sync measurement

In the Result panel of the V Sync measurement, the parameters are different in the absence of MIU.

Displaying V Timing Measurement Results

Option VGA

Configure the V Timing measurements as explained in *Setting Up the V Timing Measurement* on page 3-122. Take the measurement by clicking the Run button. Click **Results > V Timing**. Refer to Figure 3-79.

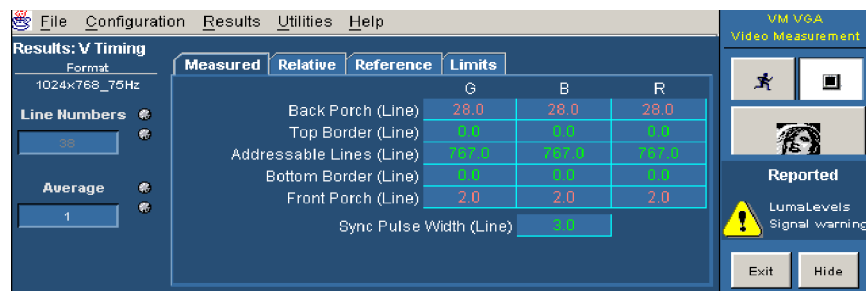

Figure 3-79: V Timing measurement results

- Measured Values** Click the **Measured** tab to display the measured values.
- Relative Values** If Relative to Reference testing is enabled, you can display the calculated relative values by clicking the **Relative** tab (see *Taking Measurements Relative to a Reference* on page 3-78).
- Reference Values** If Relative to Reference testing is enabled, you can display the reference values by clicking the **Reference** tab (see *Creating a Custom Reference File* on page 3-80).
- Limit Values** If Limit testing is enabled, you can display the Limit values by clicking the **Limits** tab (see *Taking Measurements with Limit Testing* on page 3-82). The minimum and maximum values are set in the limits file for the supported combination of resolution, refresh rate, and timing standard. Select the **min** option to display the minimum limit values for the measurement. Select the **max** option to display the maximum limit values for the measurement. Refer to Figure 3-80.

	G	B	R
Back Porch (Line)	30.0	30.0	30.0
Top Border (Line)	0.0	0.0	0.0
Addressable Lines (Line)	772.0	772.0	772.0
Bottom Border (Line)	0.0	0.0	0.0
Front Porch (Line)	1.0	1.0	1.0
Sync Pulse Width (Line)	3.0		

Figure 3-80: Limit values for the V Timing measurement

Displaying Video Transient Measurement Results

Option VGA Configure the Video Transient measurements as explained in *Setting Up the Video Transient Measurement* on page 3-123. Take the measurement by clicking the Run button. Click **Results > Video Transient**. Refer to Figure 3-81.

	G	B	R
Video Rise Time (ns)	3.343	3.327	3.308
Video Fall Time (ns)	3.365	3.379	3.347
Video Rise Time (%)	18.337	18.218	17.184
Video Fall Time (%)	18.346	18.405	18.374
Overshoot (%)	0.779	1.380	0.917
Undershoot (%)	1.443	1.113	1.823
Overshoot Settling Time (ns)	0.0	0.0	0.0
Undershoot Settling Time (ns)	0.0	0.0	0.0

Figure 3-81: Video Transient measurement results

Measured Values Click the **Measured** tab to display the measured values.

Relative Values If Relative to Reference testing is enabled, you can display the calculated relative values by clicking the **Relative** tab (see *Taking Measurements Relative to a Reference* on page 3-78).

Reference Values If Relative to Reference testing is enabled, you can display the reference values by clicking the **Reference** tab (see *Creating a Custom Reference File* on page 3-80.)

Limit Values If Limit testing is enabled, you can display the Limit values by clicking the **Limits** tab (see *Taking Measurements with Limit Testing* on page 3-82). The minimum and maximum values are set in the limits file for the supported combination of resolution, refresh rate, and timing standard.

Select the **min** option to display the minimum limit values. Select the **max** option to display the maximum limit values. Refer to Figure 3-82.

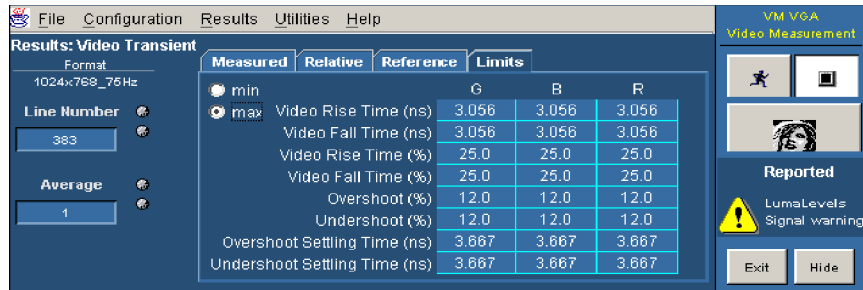

Figure 3-82: Limit values for the Video Transient measurement

Displaying Pass/Fail Results

To display Pass/Fail results, you must enable Limit Testing. Note that results that Pass appear in green and results that Fail appear in red. You can display the Pass/Fail results for more than one measurement in the results summary. Refer to Figure 3-83 for Option SD/HD. Refer to Figure 3-84 for Option VGA.

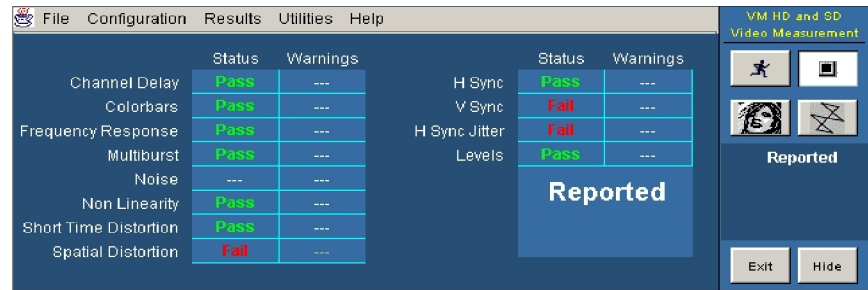

Figure 3-83: Displaying Pass/Fail results in results summary for Option SD/HD

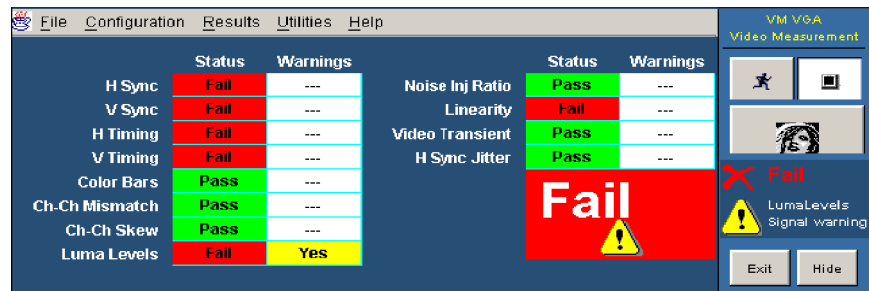

Figure 3-84: Displaying Pass/Fail results in results summary for Option VGA

To display the pass/fail results for a specific measurement, select it from the Results menu. After selecting a measurement, the results display for that measurement appears where you can view the pass/fail status of individual measurements. Refer to Figure 3-85 for Option SD/HD. Refer to Figure 3-86 for Option VGA.

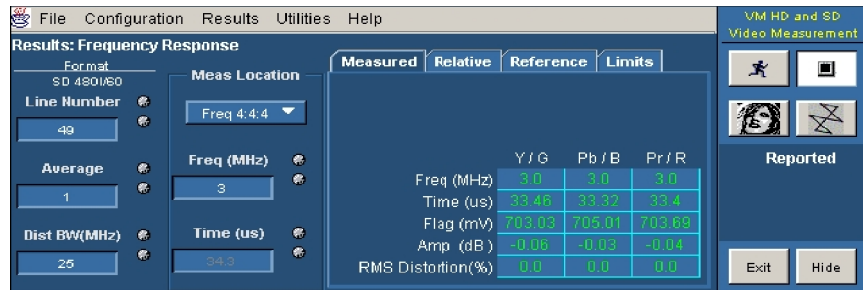

Figure 3-85: Displaying Pass/Fail results (Option SD/HD)

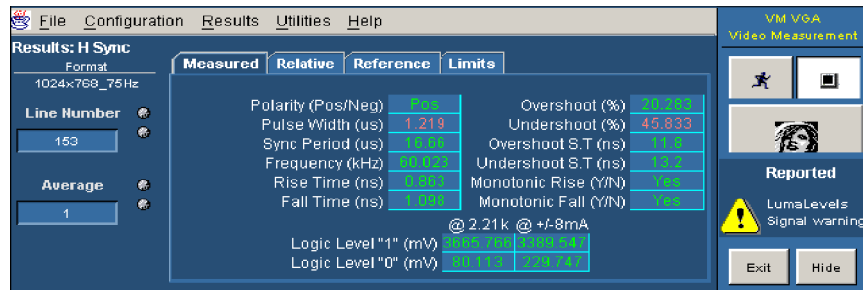

Figure 3-86: Displaying Pass/Fail results (Option VGA)

To display Pass/Fail results for an individual measurement:

1. Enable limit testing as described on page 3-82.
2. Select **Configure > Measurements**. Select the measurements you wish to run.
3. Click the Run button to take the measurements.
4. Select the measurement you wish to view from the Results menu.

Results appear in green text if the measurement falls between the maximum and minimum limits. Results appear in red text if the measurement falls above the maximum limit or below the minimum limit.



Appendices

Appendix A: Specifications

All specifications are guaranteed unless labeled “typical.” Typical specifications are usually achieved by the product but are not guaranteed.

- The instrument must have been calibrated in an ambient temperature between 20 °C and 30 °C (68 °F and 86 °F).
- The instrument must be operating within the environmental limits listed in the DPO7000, DSA/DPO70000 Series Digital Phosphor Oscilloscopes Specifications and Performance Verification Technical Reference, Tektronix part number 071-1735-XX. The Technical Reference is provided as a PDF file on the DPO7000, DPO70000 and DSA7000 Series Product Software CD, Tektronix part number 020-2693-XX.
- The instrument must be powered from a source that meets the specifications listed in the DPO7000, DSA/DPO70000 Series Digital Phosphor Oscilloscopes Specifications and Performance Verification Technical Reference, Tektronix part number 071-1735-XX. The Technical Reference is provided as a PDF file on the DPO7000, DPO70000 and DSA7000 Series Product Software CD, Tektronix part number 020-2693-XX.
- The oscilloscope instrument must have been operating continuously for at least 20 minutes within the specified operating temperature range.
- You must perform the Signal Path Compensation procedure (Option SD/HD only) after the 20-minute warm-up period. If the ambient temperature changes more than 5 °C (10 °F) you must restart the procedure. See *Signal Path Compensation for Option SD/HD* on page 2-18.

The specifications specific to Option SD/HD begin on page A-2. The specifications specific to Option VGA begin on page A-11.

Option SD/HD

Tables A-1 and A-2 provide characteristics specific to Option SD/HD.

Table A-1: Video measurement specifications

Characteristic	Description	
Color bar measurement accuracy	<i>Accuracy</i>	Measurement of all 8 bar levels. YPbPr or RGB formats.
Absolute mode (typical)	$\pm 3.0 \text{ mV} \pm 0.5\%$ of reading (VM6000, DPO7000 series) $\pm 3.0 \text{ mV} \pm 0.8\%$ of reading (VM5000 series, TDS5000 series)	Bar amplitude level is measured with respect to signal Back Porch. Displayed in absolute (mV) values.
Relative mode (typical)	$\pm 4 \text{ mV}$	Bar amplitude level, measured with respect to signal back porch, is compared to a previously stored measurement. Measurement difference is expressed in mV.
Noise measurement	<i>Range and Accuracy</i>	
Unweighted	-20 to -60 dB, $\pm 1 \text{ dB}$ (30 MHz measurement bandwidth)	Noise measurement bandwidth selectable, 200 KHz to 250 MHz. Trigger on CH 4 required for measurements below -60 dB. 32 Averages.
	-60 to -70 dB, $\pm 2 \text{ dB}$ (6 to 30 MHz measurement bandwidth) -60 to -70 dB, $\pm 2.5 \text{ dB}$ (30 to 60 MHz measurement bandwidth)	
Weighted	-20 to -60 dB, $\pm 1 \text{ dB}$ -60 to -70 dB, $\pm 1 \text{ dB}$ (VM6000, DPO7000 series) -60 to -70 dB, $\pm 2 \text{ dB}$ (VM5000 series, TDS5000 series)	Unified Weighting Filter. Trigger on CH 4 required for measurements below -60 dB. 64 Averages.

Table A- 1: Video measurement specifications (Cont.)

Characteristic	Description	
Multiburst measurement	<i>Accuracy</i>	
Flag amplitude (typical)	$\pm 3 \text{ mV} \pm 0.5\%$ of reading (VM6000, DPO7000 series) $\pm 3.0 \text{ mV} \pm 0.8\%$ of reading (VM5000 series, TDS5000)	
Absolute mode(typical)	$\pm 0.4 \text{ dB}$ 1-30 MHz packets (VM6000, DPO7000 series) $\pm 0.5 \text{ dB}$ 1-10 MHz packets (VM5000 series, TDS5000 series) $\pm 0.75 \text{ dB}$ 10-30 MHz packets (VM5000 series, TDS5000 series)	Measurement relative to reference flag amplitude. 32 Averages.
Relative mode	$\pm 0.3 \text{ dB}$ 1-30 MHz packets	Relative specification requires the same offset and amplitude on the test measurement as the reference measurement such that flag pedestals match within 2 mV. 256 Averages used on the captured reference with 32 Averages made on the measured signal. Noise less than 5mV RMS (-43 dB relative to 700 mV).
Frequency readout	$\pm 0.5\%$, 1-30 MHz	Multiburst packet frequency is measured and displayed. 32 Averages.

Table A-1: Video measurement specifications (Cont.)

Characteristic	Description	
Frequency Response Measurement	<i>Accuracy</i>	
Flag Amplitude (typical)	± 3.0 mV $\pm 0.5\%$ of reading (VM6000, DPO7000 series) ± 3.0 mV $\pm 0.8\%$ of reading (VM5000 series, TDS5000 series)	
Absolute mode (typical)	± 0.4 dB 1-30 MHz (VM6000, DPO7000 series) ± 0.5 dB 1-10 MHz (VM5000 series, TDS5000 series) ± 0.75 dB 10-30 MHz (VM5000 series, TDS5000 series)	Peak-peak signal amplitude measured relative to flag amplitude. Displayed in dB. Measurement point is selected by either specifying desired signal frequency, or the time location within the line. 3 μ s nominal measurement window. 32 Averages.
Relative mode	± 0.3 dB 1-30 MHz	Relative specification requires the same offset and amplitude on the test measurement as the reference measurement such that flag pedestals match within 2 mV. 256 Averages used on the captured reference with 32 Averages made on the measured signal. Noise less than 5mV RMS (-43 dB relative to 700 mV).
Frequency readout	$\pm 0.5\%$, 1-30 MHz	Selected frequency is measured and displayed. 32 Averages.
Distortion readout (typical)	$\pm 2\%$ for readings <10%	Readout of RMS total of all frequency terms, other than the fundamental, found in the 3 μ s search window, and expressed as a percentage of the RMS amplitude of the fundamental frequency.

Table A- 1: Video measurement specifications (Cont.)

Characteristic	Description	
Non-linearity measurement	Accuracy	Non-linearity measurement using a ramp or 5-step staircase test signal. Incremental linearity is reported over five equally spaced intervals, as well as an overall linearity figure for each channel.
Absolute mode(typical)	±3%	Results are expressed as a percentage of the largest interval or step.
Relative mode(typical)	±0.3%	Individual step or ramp interval amplitudes are compared to those of a stored reference. Results are expressed as a percentage of the stored reference value. 256 Averages used on the captured reference with 32 Averages made on the measured signal.
Short Time Distortion Measurement	Accuracy	
2T Pulse K-factor (K2T)(typical)	±1.0% Kf	2T Pulse K-factor measurement. Based on ITU-R Rec 569. Nominal 700mV pulse assumed.
2T Bar Rise Time & Fall Time - Absolute mode(typical)	SD image formats: ±5 ns (VM5000 series, TDS5000 series) ±4.4 ns (DPO7054) ±5.3 ns (VM6000, DPO7104) ±6.2 ns (DPO7254) HD image formats: ±2ns	10-90% rise and fall time measurements on 2T bar signal.
2T Bar Rise Time & Fall Time - Relative mode(typical)	SD image formats: ±3.5 ns (VM5000 series, TDS5000 series) ±3.2 ns (DPO7054) ±3.8 ns (VM6000, DPO7104) ±4.5 ns (DPO7254) HD image formats: ±2ns	10-90% rise and fall time measurements on 2T bar, compared to a previously stored measurement.

Table A-1: Video measurement specifications (Cont.)

Characteristic	Description	
2T Bar Overshoot & Under-shoot (typical)	±1.5%	Measurement of overshoot following a bar level transition, expressed as a percent of bar amplitude. Nominal 700 mV bar assumed.
Rise & Fall Settle Times (typical)	±5 ns	
Sync Level measurements	<i>Accuracy</i>	
Absolute mode (typical)	±3.0 mV ±0.5% of reading (VM6000, DPO7000 series) ±3.0 mV ±0.8% of reading (VM5000 series, TDS5000 series)	Measurements of Front Porch voltage, Negative sync tip voltage, and positive sync tip voltage.
Relative mode (typical)	±4 mV	
Sync Timing measurements	<i>Accuracy</i>	
Intervals and Pulse Widths	±{(1/sample rate) + 2.5 ppm of reading} peak (VM6000 and DPO7000 series) ±{(1/sample rate) + 15 ppm of reading} peak (VM5000 series and TDS5000 series)	Measurements of Vertical intervals and Vertical Sync, Horizontal Front and Back Porch intervals, Horizontal Sync pulse width, fall time, and rise time (both negative and positive pulse portions for tri-level syncs), Total Horizontal Line time, and start and end of active video.
Sync Rise and Fall time - Absolute mode (typical)	SD image formats: ±5 ns (VM5000 series, TDS5000 series) ±2.5 ns (DPO7054) ±3 ns (VM6000, DPO7104) ±3.5 ns (DPO7254) HD image formats: ±5 ns (VM5000 series, TDS5000 series) ± 2ns (VM6000, DPO7000 series)	

Table A- 1: Video measurement specifications (Cont.)

Characteristic	Description	
Sync Rise and Fall time - Relative mode (typical)	SD interlaced image formats: ±2 ns (VM5000 series, TDS5000 series) ±2 ns (DPO7054) ±2.2 ns (VM6000, DPO7104) ±2.6 ns (DPO7254) SD progressive image formats: ±1 ns (VM5000 series, TDS5000 series) ±2 ns (DPO7054) ±2.2 ns (VM6000, DPO7104) ±2.6 ns (DPO7254) HD image formats: ±1 ns (VM5000 series, TDS5000 series) ± 2ns (VM6000, DPO7000 series)	Specification assumes that 32 Averages are used for the measured signal and 256 averages for the stored reference.
Channel delay measurement	CH 1 to CH 2, CH 1 to CH 3, CH 2 to CH 3; readouts in ns.	
Measurement Range	±35 ns minimum	
Delay measurement accuracy - Absolute mode	± 2 ns	
Delay measurement accuracy - Relative mode	± 500 ps Option SD ± 300 ps Option HD	Measurement is compared to a previously stored measurement.
Spatial Distortion measurement	Accuracy	Compares the test image against a reference, and reports relative image scaling, offset, and cropping, in both vertical and horizontal dimensions.
Vertical Scaling	± 1%	Vertical image size difference, between test and reference image, expressed in percent of reference image size.
Vertical Offset	±1 line	Vertical image offset, between test and reference image, after scale differences are removed. Expressed in horizontal lines.

Table A-1: Video measurement specifications (Cont.)

Characteristic	Description	
Vertical Cropping	± 1 line	Vertical image loss, at top and bottom of image, compared to the reference image. Expressed in horizontal lines.
Horizontal Scaling	$\pm 1\%$	Horizontal image size difference, between test and reference image, expressed in percent of reference image size.
Horizontal Offset	± 1 pixel (VM6000, DPO7000 series) ± 3 pixels (VM5000, TDS5000B) ± 6 pixels (VM5000HD, TDS5000)	Horizontal image loss, at left and right sides of image, compared to the reference image. Expressed in horizontal pixels.
Horizontal Cropping	± 1 pixel (VM6000, DPO7000 series) ± 3 pixels (VM5000, TDS5000B) ± 6 pixels (VM5000HD, TDS5000)	Horizontal image loss, at left and right sides of image, compared to the reference image. Expressed in horizontal pixels.
H Sync Jitter measurement accuracy	± 5 ns RMS ± 15 ns peak-to-peak for 3 sigma (P=0.997)	Measurement of the time variation in horizontal sync events. For peak-to-peak readout, either Probability of Occurrence or P-P Jitter is input and then the other is measured. Specification assumes that Random Jitter terms are Gaussian distributed.
H Sync Wander measurement		
Minimum Wander Cut-off frequency	≤ 0.05 Hz	Effective -3dB high pass filter frequency for Wander measurements. User adjustable.

Table A- 1: Video measurement specifications (Cont.)

Characteristic	Description	
Frequency Offset measurement accuracy	±15 ppm accuracy (VM6000, DPO7000 series with 200MS RL) ±60 ppm accuracy (VM6000, DPO7000 series with 40MS RL) ±200 ppm accuracy (VM5000, TDS5000B series) ±350 ppm accuracy (VM5000HD, TDS5000 series)Wander cut-off frequency is set to 0.05 Hz.	Measurement of Instantaneous sync frequency variation from average sync frequency. Expressed in ppm of sync frequency. Accuracy specification is tied to Sample Rate: a higher sample rate yields higher accuracy. The Wander cut-off frequency setting affects the Sample Rate. For a given Record Length (RL), the higher the Wander cut-off frequency, the higher the sample rate and hence measurement accuracy. Specifications listed are for a 0.05 Hz Wander HPF setting.
Frequency Drift Rate measurement accuracy	±40 ppm/s accuracy (VM6000, DPO7000 series with 200MS RL) ±200 ppm/s accuracy (VM6000, DPO7000 series with 40MS RL) ±500 ppm/s accuracy (VM5000, TDS5000B series) ±1000 ppm/s accuracy (VM5000HD, TDS5000 series)Wander cut-off frequency is set to 0.05 Hz.	Measurement of the Rate of Change of the Instantaneous sync frequency. Expressed in ppm of sync frequency per second.

Table A- 2: Sync Pick- Off Accessory (012- 1680- 01) Specifications

Characteristic	Description	Reference Information
Main Signal Path	Accuracy	
DC Termination	75 Ω ± 0.2%	DC Resistance measured from BNC center conductor to BNC shell.
Frequency Response(typical)	50 KHz to 30 MHz ±1%	Frequency response through the main signal path. Terminated in 1 MΩ, 18 pF nominal. Driven from 75 Ohm source.

Table A-2: Sync Pick-Off Accessory (012-1680-01) Specifications (Cont.)

Characteristic	Description	Reference Information
Trigger Path	Accuracy / Value	
DC Attenuation(Sync Pick-off only)	10X \pm 0.7% at 25 °C. Termination is 1.00 M Ω \pm 0%.	DC attenuation from Main Path to Trigger Path output. Trigger Path output loaded with a precision 1 M Ω resistor.
DC Attenuation (with oscilloscope)	10X \pm 1.5% at 25 °C. Termination is 1.00 M Ω \pm 1%.	DC attenuation from Main Path to Trigger Path output when connected to oscilloscope. This specification is guaranteed by design if the 10X \pm 0.7% specification above is met.
DC Attenuation Temperature Coefficient(typical)	\pm 0.1% / 10 °C	Change in DC attenuation with ambient temperature.
Load on Main Signal Path(typical)	10 M Ω in parallel with 6 pF	
Minimum compensation range	12 pF to 24 pF	18 pF is nominal
Frequency Response(typical)	50 KHz to 30 MHz \pm 5%	Frequency response through the trigger signal path. Terminated in 1 M Ω , 18 pF with compensation properly adjusted at 25 °C. Main path is driven by 75 Ω source.
Environmental	Range	
Operating Temperature	+5 °C to +45 °C	
Operating Humidity	20% to 80% RH, non-condensing	

Option VGA

Tables A-3 and A-4 describe characteristics specific to Option VGA.

Table A-3: Option VGA Video Measurement Specifications

Characteristic	Accuracy	Description
Amplitude Measurements	Accuracy	Performance specifications assume use of 012-1685-00 Measurement Interface Unit (MIU).
Luma Levels (typical)	$\pm 5.0 \text{ mV} \pm 0.6\%$ of reading (VM6000, DPO7000 series) $\pm 5.0 \text{ mV} \pm 0.9\%$ of reading (VM5000 series, TDS5000 series)	Maximum and Minimum RGB Luma Levels, referenced to signal ground return lines. VESA Test Procedure section 6.1.
Color Bars (typical)	$\pm 3.0 \text{ mV} \pm 0.6\%$ of reading (VM6000, DPO7000 series) $\pm 3.0 \text{ mV} \pm 0.9\%$ of reading (VM5000 series, TDS5000 series)	Bar amplitude level is measured with respect to signal Back Porch.
Channel-to-Channel Mismatch (mV readout)(typical)	$\pm 5 \text{ mV} \pm 0.9\%$ of reading (VM6000 and DPO7000 series) $\pm 5 \text{ mV} \pm 1.3\%$ of reading (VM5000 series and TDS5000 series)	Amplitude level of one channel, measured relative to signal Back Porch, is compared to the amplitude level of a second channel, measured relative to its Back Porch. Differences are expressed both in mV and as a percentage.
Channel-to-Channel Mismatch (% read-out)(typical)	$\pm 0.7\% \pm (0.9\%) \times (\text{Luma Level}) \div (\text{Max Luma Level})$; maximum of $\pm 1.6\%$ (VM6000 and DPO7000 series) $\pm 0.7\% \pm (1.3\%) \times (\text{Luma Level}) \div (\text{Max Luma Level})$; maximum of $\pm 2.0\%$ (VM5000 series and TDS5000 series)	VESA Test Procedure section 6.5.

Table A-3: Option VGA Video Measurement Specifications (Cont.)

Characteristic	Accuracy	Description
Sync Level (typical)	$\pm[8 \text{ mV} \pm (0.01) \times (\text{p-p sync amplitude})]$ $\pm 0.5\%$ of reading (VM6000 and DPO7000 series) $\pm[8 \text{ mV} \pm (0.01) \times (\text{p-p sync amplitude})] \pm 0.8\%$ of reading (VM5000 series and TDS5000 series)	Absolute measurement of sync Logic "0" and Logic "1" voltage levels. Displayed in mV. Measurement is ground referenced. VESA Test Procedure section 7.1.
Transient Response	Value / Accuracy	Performance specifications assume use of 012-1685-00 Measurement Interface Unit (MIU) and 174-5147 VGA to 5-BNC cable (supplied 6 inch adapter cable).
RGB video system rise time (typical)	350 ps (VM6000, DPO7104, VM5000 series, TDS5104 series) 230 ps (DPO7254)	RGB channel rise time of oscilloscope and MIU combination.
Sync rise and fall time measurement (typical)	$\pm 5\%$ of reading for rise times $>5\text{ns}$ $\pm 11\%$ of reading for rise times between 2 ns and 5 ns	10% to 90% rise time measurement made on sync logic "0" to logic "1" transition. Results are corrected for MIU sync channel bandwidth, nominally 350 MHz (1ns rise time).
Overshoot and Undershoot Amplitude measurement (typical)	$\pm 2\%$ of reading for settling times $<1 \text{ ns}$ $\pm 1\%$ of reading for settling times 1-10 ns	Measurement of the amplitude of the initial overshoot transient. Applies to both RGB and Sync channels. VESA Test Procedure section 6.8 and 7.3.

Table A-3: Option VGA Video Measurement Specifications (Cont.)

Characteristic	Accuracy	Description
Settling Time measurement (typical)	± 1 ns for H/V sync ± 350 ps for RGB video (all except DPO7254) ± 230 ps for RGB video (DPO7254)	Measurement of the time for the initial transient to settle within 5% of the steady-state amplitude value. Applies to both RGB and Sync channels. VESA Test Procedure section 6.3 and 7.4.
Linearity	Value / Accuracy	
Video Resolution measurement range (typical)	5 to 10 bits	Quantization detected over black to white range, nominally 700 mV. VESA Test Procedure section 6.4.
Video Integral Linearity measurement (typical)	± 1% (all except DPO7254) ± 1.5% (DPO7254 only)	Integral Linearity measurement over black to white range, nominally 700 mV. VESA Test Procedure section 6.4.
Video Differential Linearity measurement (typical)	± 0.25 LSB at 8 bits (all except DPO7254) ± 0.5 LSB at 8 bits (DPO7254 only) ± 0.5 LSB at 10 bits (all except DPO7254) ± 1 LSB at 10 bits (DPO7254 only)	Differential Linearity measurement over black to white range, nominally 700 mV. VESA Test Procedure section 6.4.
Video Monotonicity detection error (typical)	± 0.25 LSB at 8 bits (all except DPO7254) ± 0.5 LSB at 8 bits (DPO7254 only) ± 0.5 LSB at 10 bits (all except DPO7254) ± 1 LSB at 10 bits (DPO7254 only)	Ability to detect if a signal is transitioning monotonically (slope does not change sign). VESA Test Procedure section 6.4.
HV Sync Monotonicity measurement (typical)	Detects monotonicity errors as small as 1% (all except DPO7254) and 2% (DPO7254 only) of p-p sync amplitude	Ability to detect if a signal is transitioning monotonically (slope does not change sign). VESA Test Procedure section 6.4.

Table A-3: Option VGA Video Measurement Specifications (Cont.)

Characteristic	Accuracy	Description
Noise	Accuracy	
RGB Video Noise measurement (mV readout)(typical)	± 5.75 mV, 8 to 15 mV measurement range- Lesser of ± 7 mV or $\pm 35\%$ of reading, 15 to 25 mV range 500 MHz bandwidth selected, 10 averages	Peak-to-peak noise measurement on active video. Readout in mV. Measurement is corrected for instrument noise floor. VESA Test Procedure section 6.6.
RGB Video Noise Injection Ratio measurement (% readout)(typical)	$\pm 0.75\%$, 1.1% to 2.1% measurement range $\pm 1\%$, 2.1% to 3.6% measurement range 500 MHz bandwidth selected, 10 averages	Noise Injection Ratio measurement, as per VESA Test Procedure. Readout in percent. Measurement is corrected for instrument noise floor. 100% reference point is 700 mV. VESA Test Procedure section 6.6.
Timing Measurements	Accuracy	
Pixel Clock Frequency	$\pm 0.01\%$ of reading	Measurement of Pixel Clock Frequency (PCF), in Hz.
Horizontal Timing	$\pm\{(1/\text{sample rate}) + 2.5 \text{ ppm of reading}\}$ peak (VM6000 and DPO7000 series) $\pm\{(1/\text{sample rate}) + 15 \text{ ppm of reading}\}$ peak (VM5000 series and TDS5000 series)	Measurements of horizontal sync period (total line time), sync pulse width, Front Porch, Back Porch, Left Border, Right Border, and Addressable Video time, in seconds.
Vertical Timing	± 0.5 lines. Readout resolution is 1 line.	Measurements of vertical Front Porch, Back Porch, Top Border, Bottom Border, and Addressable Lines, in lines.
Vertical Sync	$\pm\{(1/\text{sample rate}) + 2.5 \text{ ppm of reading}\}$ peak (VM6000 and DPO7000 series) $\pm\{(1/\text{sample rate}) + 15 \text{ ppm of reading}\}$ peak (VM5000 series and TDS5000 series)	Measurements of vertical sync period (total field time) and vertical sync pulse width, in seconds.

Table A-3: Option VGA Video Measurement Specifications (Cont.)

Characteristic	Accuracy	Description
Channel Skew	± 500 ps	Measurements of video channel timing skew: G to B, G to R, and B to R, in seconds. Minimum measurement range is ± 35 ns. Alternate implementation of VESA 6.7.
H Sync Jitter measurement	Accuracy	
Seconds readout	± 100 ps $\pm (2.5$ ppm x H sync period) (VM6000 and DPO7000 series) ± 100 ps $\pm (15$ ppm x H sync period) (VM5000 series and TDS5000 series)	Measurement of peak-to-peak H Sync jitter, per VESA test procedure section 7.5, both in seconds and percentage of pixel clock period. Specification assumes VESA-compliant amplitude, noise, rise and fall time characteristics. Note that a peak-to-peak jitter measurement of a gaussian-distributed random component will vary up to 14% (3 standard deviations) from the asymptotic mean, for 100,000 samples. This variation occurs irrespective of the measurement system accuracy.
Percent readout PCF < 200 MHz	$\pm 3\%$ of pixel clock (VM6000 and DPO7000 series) $\pm 4\%$ of pixel clock (VM5000 series and TDS5000 series)	
Percent readout 200 MHz < PCF < 400 MHz	$\pm 5\%$ of pixel clock (VM6000 and DPO7000 series) $\pm 7.5\%$ of pixel clock (VM5000 series and TDS5000 series)	

Table A-4: RGBHV Measurement Interface Unit (MIU) Specifications

Characteristic	Description	
DC Gain, RGB Channels	Value / Accuracy	
Wideband mode (typical)	0.1 ± 3%	Oscilloscope automatically compensates for Wideband mode attenuation
Precision LF mode	1.0 ± 0.002%	Oscilloscope termination is 1 MΩ
DC Gain, HV Channels	Value / Accuracy	
Wideband mode (typical)	0.01 ± 5%	Oscilloscope automatically compensates for Wideband mode attenuation
Precision LF mode	1.0 ± 0.002%	Oscilloscope termination is 1 MΩ
DC Termination, RGB Channels	Value / Accuracy	
Wideband mode (typical)	75 Ω nominal	
Precision LF mode	75 Ω ± 0.3%	
DC Termination, HV Channels	Value / Accuracy	
Wideband mode	2.2 kΩ ± 3%	
Precision LF mode	2.2 kΩ ± 1.5%	
Input Capacitance, HV Channels (typical)	3 pF nominal	Wideband mode only
Bandwidth, RGB Channels	Value / Accuracy	
Wideband mode (typical)	3 dB down at 1500 MHz	
Precision LF mode (typical)	DC to 10 MHz	

Table A- 4: RGBHV Measurement Interface Unit (MIU) Specifications (Cont.)

Characteristic		Description	
Bandwidth, HV Channels		Value / Accuracy	
	Wideband mode	< 3 dB down at 320 MHz	
	Precision LF mode(typical)	DC to 10 MHz	
Current Source Loads, HV Channels		+8 mA \pm 2.5% -8 mA \pm 2.5%	Current sources provide loads for H and V Sync Voh and Vol testing. Precision LF mode only.
Environmental		Range	
	Operating Temperature	+5 °C to +45 °C	
	Operating Humidity	20% to 80% RH, non-condensing	
Power Source		Power is provided from host oscilloscope probe power (CH 1, 2, 3, 4). Maximum power consumption is 5 W.	VM6000 and DPO7000 series use TPA-BNC adapters.

EMC Compliance Information

For EMC compliance information, refer to the DPO7000 documentation that ships with this product. The DPO7000 EMC compliance information applies to the VM6000, modified by the following statement.

With the 012-1685-00 MIU accessory attached to the VM6000 and Option VGA active, the noise floor may degrade when exposed to electromagnetic fields. Typical degradation may be up to 15 dB in fields of 3 V/m, generated in accordance with IEC 61000-4-3. For critical VM6000 Noise Injection Ratio measurements in an environment where electromagnetic field levels are unknown, it is recommended that the Noise Floor be determined. This can be done by placing terminators on the MIU RGB inputs and performing a Noise Injection Ratio measurement.

Appendix B: Performance Verification

Use the procedures in this appendix to verify that your VM Series System meets its warranted characteristics. There are two major sections to this appendix. The first section contains the performance verification for Option SD/HD. The second section contains the performance verification for 012-1685 RGBHV Measurement Interface Unit, a hardware accessory used with Option VGA.

These procedures only check parameters not already checked by performing the performance verification for the base oscilloscope platform: TDS5000 series PV for VM5000HD, VM5000, and TDS5000 series platforms; and DPO7000 series PV for VM6000 and DPO7000 series platforms. To verify your VM Series product you must perform these procedures in addition to those contained in this appendix.

Option SD/HD Performance Verification

Most of the warranted Option SD/HD specifications (Table A-1 in *Appendix A, Specifications*) are verified by performing the oscilloscope platform (TDS5000 or DPO7000) performance verification procedure. The Option SD/HD Performance Verification contains the additional unique tests necessary to support some Option SD/HD specifications.

Prerequisites

The prerequisites for the performance verification are:

- The test signal generator and VM Series instrument require a minimum 20 minute warm-up time before doing any performance verification tests.
- Perform the oscilloscope internal system diagnostics in the Utilities menu. The instrument must pass the diagnostics before you can verify performance.
- Perform the oscilloscope platform Signal Path Calibration (SPC) procedure. The instrument must pass the SPC before you can verify performance.

Required Equipment

The Option SD/HD performance verification requires the equipment shown in Table B-1.

Table B-1: Required test equipment for Option SD/HD performance verification

Item number and description	Minimum requirements	Example	Purpose
CAV Television Test Signal generator (one required)	Option HD: Produces SMPTE-274M compliant 1080i 59.94 or 60 Hz analog sync Option SD: Produces EIA-770.2 compliant 480i 59.94 or 60 Hz analog sync.	Tektronix TG700 with AWVG7 module (HD) or AVG7 module (SD)	Noise Floor check Note: A noise floor check can be made with either the SD or HD option. If both SD and HD options are installed, it is preferable to make the checks using an HD format such as 1080i.
75 Ω BNC Cable (one required)	42 inches (106.68 cm) long	Tektronix part number 012-0074-00	Noise Floor check
75 Ω precision BNC terminations (four required)	1% or better accuracy, suitable for use to 30 MHz	Tektronix part number 011-0102-03	Noise Floor check
Connector, BNC 'T' (one required)	Male BNC-to-dual female BNC	Tektronix part number 103-0030-00	Noise Floor check

Option SD/HD Procedure

Check Noise Floor Measurement Accuracy

This test verifies the noise floor of the three VM Series video input channels (CH1, CH2, CH3) and digitizers. Noise floor affects the accuracy of the Noise measurement between -60 and -70 dB. Noise floor also indirectly affects the accuracy of the Channel Delay and Jitter measurements.

Required equipment	HD CAV Television Test Signal generator (Tektronix TG700 with AWVG7 module) 75 Ω BNC cable (1) 75 Ω precision BNC terminations (4) Connector, BNC 'T' (1)
Prerequisites	The test signal generator must warm up for at least 20 minutes before doing this test.

This test can be performed using any of the supported SD or HD formats. If you have both SD and HD options on your VM series product, testing with one of the

HD format is preferable. The following procedure assumes use of 1080i-59.94 YPbPr.

1. Connect the instrument to the test signal source. Refer to Figure B-1 while doing the following steps:
 - a. Connect a 75 Ω BNC cable to the CH1 (Y channel with sync on Y) AWVG7 outputs.
 - b. Connect the other end of the cable to the VM Series System CH 4 input and a 75 Ω termination using a BNC 'T' connector.
 - c. Place 75 Ω terminations on the VM Series CH1, CH2, and CH3 inputs.

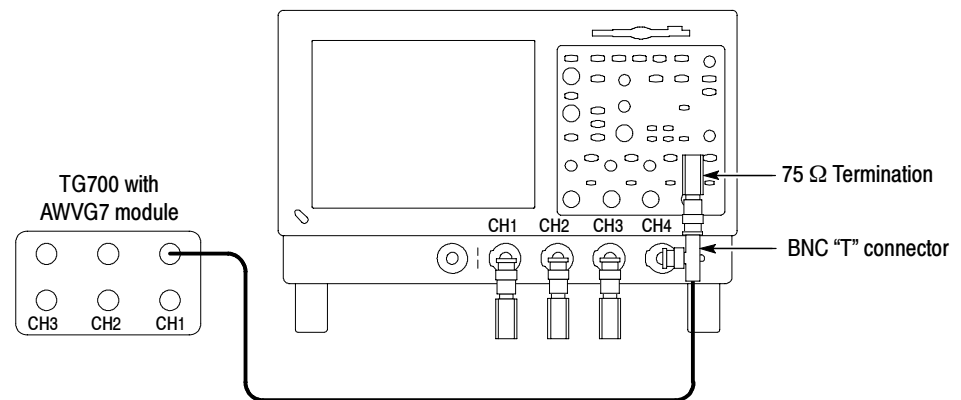

Figure B-1: Noise floor accuracy test hookup

2. Set the test signal generator output format to 1080i, 59.94 or 60 Hz, YPbPr format with sync on Y. Select a 100% Color Bars test signal. Use the following steps for a TG700 with AWVG7:
 - a. Press **MODULE** repeatedly until **AWVG7** is displayed.
 - b. Press **FORMAT** repeatedly until **1080 59i YPbPr** is displayed.
 - c. Press **ENTER**.

NOTE. Press and hold the **FRONT PANEL ENABLE** button to unlock the front panel.

- d. Press **COLOR BAR** repeatedly until "100% Color Bars" is displayed.
3. Start the VM HD and SD Video application: For VM6000 and DPO7000 series platforms (**Analyze > VM HD and SD Video**).

For VM5000 and TDS5000 series platforms (**File > Run Application > VM HD and SD Video**).

4. In the VM application window, select **File > Recall Default Setup**.
5. Select **Configuration > Format** and select **1080I/60, YPbPr Color Space**.
6. Select **Configuration > Measurements**. Select the **Noise** check box and deselect the **Color Bars** check box.
7. Select **Configuration > Operation**, Verify that **Sync/Trigger** is set to **Channel 4**.
8. Select **Results > Noise**.
9. Under **Filter**, select **Unweighted BW**. Adjust the **Bandwidth (Hz)** setting to **30.0 MHz**.
10. Change the **Averages** setting to **32**.
11. Push the VM option **Run** button. The Noise measurement results table should appear with continuously updating measurements. Wait until **Done** appears in the status window.
12. CHECK - that the Noise dB **Measured** values for each channel are numerically greater than the appropriate figure in the following table:

Table B-2: The Noise (dB) Measured values when filter bandwidth is 30 MHz

Oscilloscope	Noise (dB)
VM6000 and DPO7000 series platforms	77.0
VM5000 and TDS5000 series platforms	76.0

For example, for a VM6000, a 78 dB reading passes. A 76 dB reading fails.

NOTE. Be sure to use the dB values under the "Measured" tab. Do not use the "Noise at Cursor Position" dB values.

13. Change the **Filter Bandwidth (Hz)** from **30.0 MHz** to **60.0 MHz**. Again press the VM option **Run** button. The measurement is finished when **Done** appears in the status window.

14. CHECK - that the Noise dB **Measured** values for each channel are numerically greater than the appropriate figure in the following table:

Table B-3: The Noise (dB) Measured values when filter bandwidth is 60 MHz

Oscilloscope	Noise (dB)
VM6000 and DPO7000 series platforms	74.0
VM5000 and TDS5000 series platforms	73.0

This completes the Noise Floor check for Option SD/HD.

RGBHV Measurement Interface Unit (012-1685-XX) Performance Verification

This performance verification can be used to establish that the RGBHV Measurement Interface Unit (MIU) meets its warranted performance specifications (Table A-4 in *Appendix A, Specifications*).

The MIU accessory is used only with Option VGA.

If the MIU is used with a VM6000 or DPO7000 series platform, four Tektronix TPA-BNC TekProbe BNC adapters are used to connect the MIU CH1, CH2, CH3, and CH4 pigtailed to the oscilloscope platform. Otherwise, the procedure is the same for all VM Series Option VGA products.

The MIU performance specifications are independent of the specific oscilloscope platform, and can be checked using any VM Series platform (VM5000, VM5000HD, TDS5000, VM6000, or DPO7000 series).

The Performance Verification procedure uses the VM5000 platform as an example.

Prerequisites

The prerequisites for the performance verification are:

- Before running this procedure, verify that the VM-series platform being used to test the MIU passes its internal system diagnostics (Utilities menu).
- Running Signal Path Calibration (SPC) is not required.
- Both the host VM-series platform and the MIU should have a minimum 20 minutes warm-up time.
- Associated test equipment should also be warmed up according to manufacturer's instructions, prior to making measurements.

- This procedure assumes measurements are conducted at an ambient temperature between 18 °C and 28 °C.

The seven checks below are independent of one another, so if only some specifications are of interest, then only those sections of the procedure need to be performed.

Required Equipment

Table B-4: Equipment required for performance verification

Description	Quantity required	Minimum requirement	Recommended equipment	Where used
VM Series with mouse and keyboard	1	Tektronix VM Series System, TDS5104x, or TDS5054x oscilloscope (provides power and mode control)	Tektronix VM Series System with 119-6298-XX Mouse and 119-6633-XX Keyboard	All tests
Digital Multimeter	1	At least 5 1/2 digits, with a 4-wire Ohms mode and DC current mode. Ohms accuracy better than 0.02% at 75 Ω , 0.1% at 2200 Ω , and 2% at 15 Ω . DC current accuracy better than 0.1% at 8 mA.	Keithley model 2000	Tests B, C, D, E
Spectrum Analyzer with Tracking Generator	1	50 Ω , minimum frequency range 1-1800 MHz, minimum Reference Level range 0 dBm to -65 dBm, 0.3 dB Reference Level accuracy -20 dBm to -60 dBm, 1 dB/div and 10 dB/div display modes, response normalization mode, displayed noise floor less than -120 dBm (100 Hz RBW), minimum RBW range 300 kHz to 3 MHz, marker and center frequency accuracy better than 0.02%. Tracking generator 50 Ω , output level 0 dBm, output flatness +2 dB or better, 1 to 1500 MHz.	Agilent Technologies model E4403B option BTG	Tests F, G
75/50 Min-loss pad	2	BNC Male on 75 Ω end, BNC female on 50 Ω end. Attenuation loss 5.7 dB + 0.5 dB 1-1500 MHz. VSWR 1.2:1 or better 1-1500 MHz.	JFW Industries model 75Z-3G-BNC	Test F
6 dB Attenuator	2	50 Ω , through-style with male BNC on one end and female BNC on the other. VSWR 1.20:1 or better, 1-1500 MHz. Insertion loss 6.0 dB + 0.5 dB, 1-1500 MHz.	Tektronix part number 011-0069-03; JFW Industries 50FPG-006-BNC	Tests F, G
50 Ω BNC Cable	2	RG-58, male BNC connectors, length 43 inches.	Tektronix part number 012-0057-01	All tests

Table B- 4: Equipment required for performance verification (Cont.)

Description	Quantity required	Minimum requirement	Recommended equipment	Where used
Type N to BNC adapter	2	50 Ω , Type N male to BNC female	Tektronix part number 103-0045-00; Amphenol 31-216-RFX	Tests F, G
75 Ω BNC female/female adapter	1	75 Ω female BNCs each end. VSWR 1.10:1 (26 dB RL) or better, 1-1500 MHz.	Tyco/AMP model 222117-1	Test F
50 Ω BNC female/female adapter	1	50 Ω , female BNCs each end. VSWR 1.10:1 (26 dB RL) or better, 1-1500 MHz.	Tektronix part number 103-0028-00; Amphenol 31-219-RFX	Tests C, F, G
BNC T adapter	1	50 Ω , 1 male BNC, 2 female BNCs	Tektronix part number 103-0030-00; Amphenol 31-208-RFX	Tests B, C, D, E
BNC female to dual banana adapter	2	Standard (0.750 inch) banana plug spacing	Tektronix part number 103-0090-00; Pomona Electronics model 1269	Tests B, C, D, E
BNC Shorting cap	1	BNC male connector, center conductor connected to shell with less than 0.1 Ω resistance.	Amphenol models 5275 or 31-17	Test C

Vendor Contact Information

Vendors for equipment listed above can be contacted at their Web sites.

- Agilent Technologies – www.agilent.com
- Amphenol – www.amphenolrf.com
- JFW Industries, Inc. – www.jfwindustries.com
- Keithley Instruments – www.keithley.com
- Pomona Electronics, Inc. – www.pomonaelectronics.com
- Tektronix, Inc. – www.tektronix.com
- Tyco/AMP – www.tycoelectronics.com
- Wide Band Engineering Co. – www.wbecoinc.com

Test A: Initial Connection and Setup

1. With the VM Series System Power off, connect all five MIU coaxial cables to the host VM Series System. Use the labels on the MIU as a guide.

Connect the RS232 cable between the MIU and COM1 port on the VM Series System. Attach a keyboard and mouse to the VM Series System. Turn on the VM Series System. The MIU Power ON led should be lit and the MIU Fault LED should be off. If the Fault indicator is lit, check that all of the coaxial cables have been properly connected.

2. Open Hyperterminal on the VM Series System. If an “MIU – Hyperterminal” session was previously established and saved, open it. If not, establish a session as follows:
 - a. Minimize open programs, such as the oscilloscope application and the VM Series System application, so that the Windows desktop is visible.
 - b. Open the terminal emulation program Hyperterminal. Hyperterminal is typically located under Start > Programs > Accessories > Communications > Hyperterminal.
 - c. When Hyperterminal is first opened, a pop-up window Connection Description will open. Under name, enter MIU, and then click OK.
 - d. A Connect To window will open. Under Connect using, select COM1, and click OK.
 - e. A COM1 Properties window will open. Set the Port Settings as follows:
 - Bits per second = 9600
 - Data bits = 8
 - parity = None
 - Stop bits = 1
 - Flow Control = None

After changing the settings, click OK.

3. The Hyperterminal window should be open, as connection MIU. Select File>Properties. The MIU Properties window will appear. Select the Settings tab, followed by clicking the ASCII Setup button. Select Echo typed characters locally and Send line ends with line feeds. Click OK to close the ASCII Setup window, and then click OK to close the MIU Properties window.
4. From the keyboard, type \$ID? The MIU should identify itself, returning a response similar to id = miu_v1.0. If there is no response, double check all electrical connections and the Hyperterminal settings described above.

NOTE. *If typed keyboard characters appear in duplicate (for example, \$\$IIDD??), the MIU echo is on. Turn the echo off by typing \$ECHO=OFF.*

5. If the terminal appears to operate properly, save the configuration by selecting File > Save in the Hyperterminal window. For convenience, place a shortcut on the Windows desktop, as this terminal connection will be used throughout this Performance Verification procedure.

Test B: RGB LF Mode DC Termination Accuracy

This test verifies the accuracy of the internal 75 Ω terminations connected to the G, B, and R inputs when the RGB LF path is active. The specification for all three terminations is 75 $\Omega \pm 0.3\%$.

The following equipment is required for the test:

- Host VM Series System with mouse and keyboard
 - Digital Multimeter
 - 50 Ω BNC cable (Qty 2)
 - BNC “T” adapter (Qty 1)
 - BNC female-to-dual banana adapter (Qty 2)
1. Connect the MIU to the VM Series System, apply power, and establish communications using Hyperterminal as described in Test A of this procedure.
 2. Check that the green LED in the RGB LF Path is illuminated. If not, using Hyperterminal, send the command \$LOAD = 0000000 to the MIU. Verify that the LED in the RGB LF Path is now illuminated.

NOTE. *The V channel and H/V LF Path LEDs will also be illuminated.*

3. On the VM Series System front panel, under VERTICAL, select 1 M Ω for CH1, CH2, and CH3.
4. Connect the two BNC-to-banana adapters to the Multimeter: one to the Ohms input, the other to the Ohms Sense input. Orient the adapters so the BNC shell is connected to the LO terminal of each input (on typical adapters, the banana plug connected to the BNC shell has a GND label).
5. Connect a BNC cable to each BNC-to-banana adapter. Connect the other end of each cable to the BNC “T” adapter. This connects Ohms input and Ohms Sense input in parallel, at the BNC “T” adapter.

6. On the multimeter, select 4-wire Ohms mode and 100 Ω range.
7. Connect the BNC “T” adapter to the G input BNC on the MIU.
8. CHECK – that the Multimeter reads between 74.840 and 75.160 Ω .
9. Connect the BNC “T” adapter to the B input BNC on the MIU.
10. CHECK – that the Multimeter reads between 74.840 and 75.160 Ω .
11. Connect the BNC “T” adapter to the R input BNC on the MIU.
12. CHECK – that the Multimeter reads between 74.840 and 75.160 Ω .
13. Disconnect the BNC “T” adapter from the R input BNC.

Test C: RGB LF Mode and HV LF Mode DC Gain

This test checks the gain error of the G, B, and R channels when the RGB LF Path is active, and of the H and V channels when the HV LF Path is active. The specification for all five channels is $1.0 \pm 0.002\%$ (20 ppm) when driven from a 0 Ω source and with a 1 M Ω load (provided by the VM Series System).

The following equipment is required for the test:

- Host VM Series System, with mouse and keyboard
 - Digital Multimeter
 - BNC female-to-dual banana adapter (Qty 2)
 - 50 Ω BNC cable (Qty 2)
 - 50 Ω BNC female/female adapter (Qty 1)
 - BNC “T” adapter (Qty 1)
 - BNC shorting cap (Qty 1)
1. Connect the MIU to the VM Series System, apply power, and establish communications using Hyperterminal as described in Test A of this procedure.
 2. Connect the two BNC-to-banana adapters to the Multimeter: one to the Ohms input, the other to the Ohms Sense input. Orient the adapters so the BNC shell is connected to the “LO” terminal of each input (note: on typical adapters, the banana plug connected to the BNC shell has a “GND” label).
 3. Connect a BNC cable to each BNC-to-banana adapter. Connect the other end of each cable to the BNC “T” adapter. This connects Ohms input and Ohms Sense input in parallel, at the BNC “T” adapter.

4. On the Multimeter, select 4-wire Ohms mode and 100 Ω range.
5. Connect the BNC “T” adapter to the G input BNC on the MIU.
6. Connect the BNC shorting cap to one end of the BNC female/female adapter. Disconnect the MIU CH1 coaxial cable from the VM Series System.

Note that the MIU Fault LED is now illuminated. This is normal, indicating that the CH1 coaxial cable has been disconnected from the VM Series System. Connect the MIU CH1 coaxial cable to the open end of the BNC female/female adapter with shorting cap. To do this, the latching ring must be rotated to the full CW position, as viewed from the pin-side of the connector. Carefully insert the BNC adapter, noting the location of the slots for the BNC “ears”. This connection shorts the center conductor to the shield so that the series resistance through the MIU can be measured.

7. Check if the green LED in the RGB LF Path is illuminated. If not, using Hyperterminal, send the command \$LOAD=0000000 to the MIU. Verify that the LED in the RGB LF Path is now illuminated.

NOTE. *The V channel and H/V LF Path LEDs will also be illuminated.*

8. CHECK – that the Multimeter reads less than 15.0 Ω .

NOTE. *The multimeter will typically read between 10 Ω and 11 Ω . If the reading is around 75 Ω , check that the BNC short is fully inserted into the MIU CH1 coaxial cable BNC and that the RGB LF Path LED is illuminated.*

9. Remove the BNC short and reconnect the MIU CH1 coaxial cable to the VM Series System CH1 input.
10. Connect the BNC “T” adapter to the B input BNC on the MIU.
11. Disconnect the MIU CH2 coaxial cable from the VM Series System, and connect the BNC short to the cable end, as described in step 6.
12. Check that the green LED in the RGB LF Path is still illuminated. If not, using Hyperterminal, send the command \$LOAD=0000000 to the MIU. Verify that the LED in the RGB LF Path is now illuminated.

NOTE. *The V channel and H/V LF Path LEDs will also be illuminated.*

13. CHECK – that the Multimeter reads less than 15.0 Ω .

NOTE. *The multimeter will typically read between 10 Ω and 11 Ω . If the reading is around 75 Ω , check that the BNC short is fully inserted into the MIU CH2 coaxial cable BNC and that the RGB LF Path LED is illuminated.*

14. Remove the BNC short and reconnect the MIU CH2 coaxial cable to the VM Series System CH2 input.
15. Connect the BNC “T” adapter to the R input BNC on the MIU.
16. Disconnect the MIU CH3 coaxial cable from the VM Series System and connect the BNC short to the cable end, just as was done for CH1 (and described in step 6 above).
17. Check that the green LED in the RGB LF Path is still illuminated. If not, using Hyperterminal, send the command \$LOAD=0000000 to the MIU. Verify that the LED in the RGB LF Path is now illuminated.

NOTE. *The V channel and H/V LF Path LEDs will also be illuminated.*

18. CHECK – that the Multimeter reads less than 15.0 Ω .

NOTE. *The multimeter will typically read between 10 Ω and 11 Ω . If the reading is around 75 Ω , check that the BNC short is fully inserted into the MIU CH3 coaxial cable BNC and that the RGB LF Path LED is illuminated.*

19. Remove the BNC short and reconnect the MIU CH3 coaxial cable to the VM Series System CH3 input.
20. Connect the BNC “T” adapter to the V input BNC on the MIU.
21. Disconnect the MIU CH4 coaxial cable from the VM Series System and connect the BNC short to the cable end, just as was done for CH1 (and described in step 6 above). All of the LEDs on the MIU will be extinguished, but the MIU is still powered for the H and V channel measurements.
22. Using Hyperterminal, send the command \$LOAD=0000000 to the MIU. No LEDs will be illuminated, but the V channel and HV LF Path are now selected.
23. CHECK – that the Multimeter reads less than 19.0 Ω .

NOTE. The multimeter will typically read between 10 Ω and 11 Ω . If the reading is >100 Ω , check that the BNC short is fully inserted into the MIU CH4 coaxial cable BNC. If the >100 Ω reading persists, check that the MIU is in the proper mode by sending the query (via Hyperterminal) \$LOAD?. You should receive a reply load=0000000.

24. Connect the BNC “T” adapter to the H input BNC on the MIU.
25. Using Hyperterminal, send the command \$LOAD=0010000 to the MIU. No LEDs will be illuminated, but the H channel and HV LF Path are now selected.
26. CHECK – that the Multimeter reads less than 19.0 Ω .

NOTE. The multimeter will typically read between 10 Ω and 11 Ω . If the reading is >100 Ω , check that the BNC short is fully inserted into the MIU CH4 coaxial cable BNC. If the >100 Ω reading persists, check that the MIU is in the proper mode by sending the query (via Hyperterminal) \$LOAD?. You should receive a reply load=0010000.

27. Remove the BNC short and reconnect the MIU CH4 coaxial cable to the VM Series System CH4 input.
28. Disconnect the BNC “T” adapter from the H input BNC.

The above check evaluates gain error by measuring the MIU series resistance that forms a voltage divider with the 1 M Ω input resistance of the VM Series System. The 15.0 Ω (G,B,R inputs) and 19.0 Ω (H,V inputs) test limits ensure that the gain error does not exceed ± 20 ppm. If desired, the exact gain error can be calculated from the measured resistance R_m using the expressions:

G,B,R channels:

$$\text{GainError(ppm)} = \left\{ \frac{-(75.0)(R_m)}{\{(1.0E06)(75.0 - R_m) + (75.0)(R_m)\}} \right\} + (1.0E06), R_m \text{ in } \Omega$$

H,V channels:

$$\text{GainError(ppm)} = \left\{ \frac{-(R_m)}{\{(1.0E06) + (R_m)\}} \right\} + (1.0E06), R_m \text{ in } \Omega$$

Test D: HV Input LF Mode DC Termination Accuracy and WB Mode DC Input Impedance

This test checks the accuracy of the 2.20 k Ω termination that can be switched on in the HV LF Path (Term On LED) and the DC input impedance of the HV WB Path. The specification for the LF Path termination is 2.20 k $\Omega \pm 1.5\%$. The specification for the WB path DC input impedance is 2.20 k $\Omega \pm 3.0\%$.

The following equipment is required for the test:

- Host VM Series System with mouse and keyboard
 - Digital Multimeter
 - 50 Ω BNC cable (Qty 2)
 - BNC “T” adapter (Qty 1)
 - BNC female-to-dual banana adapter (Qty 2)
1. Connect the MIU to the VM Series System, apply power, and establish communications using Hyperterminal as described in Test A of this procedure.
 2. Using Hyperterminal, send the command \$LOAD=0011000 to the MIU. Verify that the H channel, HV LF Path, and Term On LEDs are illuminated. The + 8 mA and –8 mA LEDs must be off.
 3. On the VM Series System front panel, under VERTICAL, select 1 M Ω for CH4.
 4. Connect the two BNC-to-banana adapters to the multimeter: one to the Ohms input, the other to the Ohms Sense input. Orient the adapters so the BNC shell is connected to the “LO” terminal of each input (note: on typical adapters, the banana plug connected to the BNC shell has a “GND” label).
 5. Connect a BNC cable to each BNC-to-banana adapter. Connect the other end of each cable to the BNC “T” adapter. This connects Ohms input and Ohms Sense input in parallel, at the BNC “T” adapter.
 6. On the multimeter, select 4-wire Ohms mode and 10 k Ω range.
 7. Connect the BNC “T” adapter to the H input BNC on the MIU.
 8. CHECK – that the multimeter reads between 2175 Ω and 2225 Ω .
 9. Using Hyperterminal, send the command \$LOAD=0110000 to the MIU. Verify that the H channel and HV WB Path LEDs are illuminated, and that the +8 mA, –8 mA, and Term On LEDs are off.

10. On the VM Series System front panel, under VERTICAL, select 50 Ω for CH4.
11. CHECK – that the Multimeter reads between 2142 Ω and 2258 Ω .
12. Disconnect the BNC “T” adapter from the H input BNC.

Test E: HV Input LF Mode Current Sources

This test checks the accuracy of the + 8 mA and –8 mA current sources. The specification is 8 mA \pm 2.5% and –8 mA \pm 2.5%.

The following equipment is required for the test:

- Host VM Series System with mouse and keyboard
 - Digital Multimeter
 - 50 Ω BNC cable (Qty 1)
 - BNC female-to-dual banana adapter (Qty 1)
1. Connect the MIU to the VM Series System, apply power, and establish communications using Hyperterminal as described in Test A of this procedure.
 2. On the VM Series System front panel, under VERTICAL, select 1 M Ω for CH4.
 3. Using Hyperterminal, send the command \$LOAD=0010101 to the MIU. Verify that the H channel, HV LF Path, and +8 mA LEDs are illuminated. The Term On and -8 mA LEDs must be off.
 4. Connect the BNC-to-banana adapter to the Amps input of the multimeter. Orient the adapter so the BNC shell is connected to the “LO” terminal of the Amps input (on typical adapters, the banana plug connected to the BNC shell has a “GND” label).
 5. Connect one end of the BNC cable to the BNC-to-banana adapter.
 6. On the multimeter, select DC Amps mode and 10 mA range.
 7. Connect the other end of the BNC cable to the H input BNC on the MIU.
 8. CHECK – that the multimeter reads between 7.85 and 8.15 mA.
 9. Using Hyperterminal, send the command \$LOAD=0010011 to the MIU. Verify that the H channel, HV LF Path, and –8 mA LEDs are now illuminated. The Term On and +8 mA LEDs must be off.
 10. CHECK – that the Multimeter reads between –7.85 and –8.15 mA.

11. Using Hyperterminal, send the command \$RESET to the MIU.
12. Disconnect the BNC cable from the H input BNC.

Test F: RGB WB Mode Bandwidth

This test checks the bandwidth of the G, B, and R inputs when the RGB WB Path is active. Typical performance is approximately 3 dB down at 1500 MHz.

The following equipment is required for the test:

- Host VM Series System with mouse and keyboard
 - Spectrum Analyzer with Tracking Generator
 - 75/50 Min-loss Pad (Qty 2)
 - 6 dB Attenuator (Qty 2)
 - 50 Ω BNC cable (Qty 2)
 - Type N to BNC adapter (Qty 2)
 - 75 Ω BNC female/female adapter
 - 50 Ω BNC female/female adapter
1. Connect the MIU to the VM Series System, apply power, and establish communications using Hyperterminal as described in Test A of this procedure.
 2. Check that the MIU RGB WB Path LED is lit. If not, using Hyperterminal, send the command \$LOAD=1000000 to the MIU. Verify that the RGB WB Path LED is illuminated.
 3. On the VM Series System front panel, under VERTICAL, select 50 Ω for CH1, CH2, and CH3.
 4. Set the tracking generator and spectrum analyzer controls as follows:
 - Tracking Generator output level = 0 dBm
 - Spectrum Analyzer Vertical scale = 1 dB/div
 - Spectrum Analyzer Reference Level = -10 dBm
 - Horizontal scale (Span) = Max Span (or 200 MHz/div if available)
 - Center Frequency = 900-1000 MHz (10 div display)
 - Resolution BW (RBW) = 3 MHz

5. Connect a Type N to BNC adapter, followed by a 6 dB attenuator, to the tracking generator output. Connect a 50 Ω BNC cable to the other end of the attenuator. Connect a second Type N to BNC adapter and 6 dB attenuator to the spectrum analyzer input, and connect the other end of this attenuator to a second 50 Ω BNC cable. Connect the two cables together with a 50 Ω BNC female/female adapter.
6. Adjust the analyzer Reference Level control until the displayed signal is entirely on screen over the frequency range 1 MHz to 1800 MHz.
7. Using the analyzer Display memory, store the swept display. Activate the “active display minus stored display” mode (sometimes called “B minus Save A”). A straight line display, with less than 0.2 dB ripple, should appear, typically at mid-screen. This is the frequency response with the flatness errors of the tracking generator, attenuators, spectrum analyzer, and cables normalized out.
8. Connect two 75/50 min-loss pads together, using a 75 Ω BNC female/female adapter. Insert this connection in place of the 50 Ω BNC female/female adapter. Decrease the analyzer Reference Level by 11 dB, so that the frequency response of the series connected min-loss pads can be observed. Measure the response at 1500 MHz, relative to 1 MHz, and record this value in Table B-5, column C1. Divide this value by 2 and enter it in column C2. The value in column C2 is the average 1500 MHz response for the two pads.

NOTE. The display will typically have some amplitude ripple. Estimate the midpoint of the ripple and use this as the measurement point. Typical 1500 MHz loss for a series-connected pair of good-quality matching pads will be less than 1 dB.

Table B-5: RGB WB mode bandwidth worksheet

	C1 – series connected min-loss pad (“A”+”B”) 1500 MHz response (dB)	C2 – Average 1500 MHz response of single min-loss pad (dB)	C3 – MIU 1500 MHz response with min-loss pad “A” (dB)	C4 – MIU 1500 MHz response with min-loss pad “B” (dB)	C5 – Average MIU 1500 MHz response (dB)	C6 – Corrected MIU 1500 MHz response
G CH						
B CH						
R CH						
Equations		$C2=(C1)/2$			$C5=(C3+C4)/2$	$C6=C5-C2$

9. Disconnect the 50 Ω cables from the series-connected min-loss pads. Separate the two min-loss pads. Connect one of the min-loss pads (male end)

to the MIU G input BNC. Connect the other (female) end of the pad to the cable coming from the 6 dB attenuator and tracking generator output. Attach a 50 Ω BNC female/female adapter to the open end of the cable going to the 6 dB attenuator on the analyzer input. Disconnect the MIU CH1 cable from the VM Series System. Attach this cable to open end of the BNC female/female adapter. To do this, the latching ring must be rotated to the full clockwise position, as viewed from the pin-side of the probe housing. Then carefully insert the BNC adapter, noting the location of the slots for the BNC “ears”.

NOTE. Take care not to short the probe housing pins to the BNC adapter shell while inserting it. Momentarily shorted pins will not damage the MIU but can cause it to change operating mode.

10. Decrease the analyzer Reference Level an additional 13dB from the level of step 8. (a total of 24 dB from the Reference Level of step 6). The frequency response of the MIU G channel should be visible.

NOTE. Take care in identifying the correct signal trace. On many analyzers two traces, the H channel frequency response with and without normalization, will be visible. The proper signal trace is the one that is closest to the the position of the normalized display of step 6.

11. Measure the loss difference between low frequency (far left side of trace) and that at 1500 MHz. The measurement method will vary with analyzer model. Many analyzers have amplitude cursor modes to simplify this type of measurement. Usually the most accurate way to make this measurement (and the method to use for an analyzer without amplitude cursor modes) is to vary the analyzer Reference Level:
 - a. Using the fine Reference Level adjust, position the left side of the signal trace to a convenient reference line (such as a graticule line or marker).
 - b. Note the Reference Level reading and then adjust the Reference Level control until the signal trace at 1500 MHz aligns with the same reference line. The difference between the two Reference Level settings is the 1500 MHz response relative to the low frequency response.
 - c. Record this value in Table B-5, column C3.

Example: The left side of trace (low frequency end) is vertically positioned, using the fine Reference Level control, so that it overlays the center graticule line. The Reference Level reads -34.0 dBm. Then the Reference Level control is decreased until the 1500 MHz portion of the trace overlays the same graticule line. The Reference Level now reads

-35.5 dBm. The response at 1500 MHz, relative to low frequency, is $(-35.5) - (-34.0) = -1.5$ dB.

12. Replace the min-loss pad connected to the G input with the other min-loss pad. With this pad in the signal path, measure the uncorrected G channel 1500 MHz response using the procedure of step 11. Record this value in Table B-5, column C4.
13. Add the values of column C3 and C4. Divide this value by 2 and enter it in column C5. This is the average uncorrected G channel 1500 MHz response. Now subtract the average min-loss pad 1500 MHz response (column C2) from the average uncorrected G channel 1500 MHz response (column C5) and enter the result in column C6. This is the G channel response at 1500 MHz.
14. CHECK – that the G channel response at 1500 MHz is approximately 3.0 dB down. Loss exceeding 5 dB may indicate a malfunctioning channel.
15. Disconnect the MIU CH1 coaxial cable from the BNC female/female adapter, and reconnect it the VM Series System CH1 input. Disconnect the MIU CH2 cable from the VM Series System. Attach this cable to open end of the BNC female/female adapter. Move the min-loss pad and cable currently connected to the MIU G input BNC to the B input BNC. The frequency response of the MIU B channel should be visible.
16. Repeat steps 11–13 for the B channel.
17. CHECK – that the B channel response at 1500 MHz is approximately 3.0 dB down. Loss exceeding 5 dB may indicate a malfunctioning channel.
18. Disconnect the MIU CH2 coaxial cable from the BNC female/female adapter, and reconnect it the VM Series System CH2 input. Now disconnect the MIU CH3 cable from the VM Series System. Attach this cable to open end of the BNC female/female adapter. Move the min-loss pad and cable currently connected to the MIU B input BNC to the R input BNC. The frequency response of the MIU R channel should be visible.
19. Repeat steps 11–13 for the R channel.
20. CHECK – that the R channel response at 1500 MHz is approximately 3.0 dB down. Loss exceeding 5 dB may indicate a malfunctioning channel.
21. Disconnect the MIU CH3 coaxial cable from the BNC female/female adapter, and reconnect it the VM Series System CH3 input.

**Example Table B-5
Calculations**

The series connected min-loss pads measure -0.6 dB at 1500 MHz. The MIU G channel measures -1.6 dB at 1500 MHz with one min-loss pad, and -1.4 dB at 1500 MHz with the second min-loss pad. The corrected G channel 1500 MHz response is calculated to be -1.2 dB (column C6). See Table B-6.

Table B-6: Sample Table 4 worksheet

	C1 – series connected min-loss pad (“A”+”B”) 1500 MHz response (dB)	C2 – Average 1500 MHz response of single min-loss pad (dB)	C3 – MIU 1500 MHz response with min-loss pad “A” (dB)	C4 – MIU 1500 MHz response with min-loss pad “B” (dB)	C5 – Average MIU 1500 MHz response (dB)	C6 – Corrected MIU 1500 MHz response
G CH	-0.6dB		-1.6dB	-1.4dB	-1.5dB	-1.2dB
B CH						
R CH						
Equations		$C2=(C1)/2$			$C5=(C3+C4)/2$	$C6=C5-C2$

Test G: H/V Inputs WB Mode Bandwidth

This test checks the bandwidth of the H and V inputs when the HV WB Path is active. The specification is less than 3 dB down at 320 MHz.

The following equipment is required for the test:

- Host VM Series System with mouse and keyboard
 - Spectrum Analyzer with Tracking Generator
 - 50 Ω 6 dB Attenuator (Qty 2)
 - 50 Ω BNC cable (Qty 2)
 - Type N to BNC adapter (Qty 2)
 - 50 Ω BNC female/female adapter
1. Connect the MIU to the VM Series System, apply power, and establish communications using Hyperterminal as described in Test A of this procedure.
 2. Using Hyperterminal, send the command \$LOAD=0110000 to the MIU. Verify that the H input and HV WB Path LEDs are illuminated.
 3. Set the tracking generator and spectrum analyzer controls as follows:
 - Tracking Generator output level = 0 dBm
 - Spectrum Analyzer Vertical scale = 1 dB/div
 - Spectrum Analyzer Reference Level = -6 dBm
 - Horizontal scale (Span) = 50 MHz/div

- Center Frequency = 250 MHz (10 div display)
 - Resolution BW (RBW) = 3 MHz
4. Connect a Type N to BNC adapter, followed by a 6 dB attenuator, to the tracking generator output. Connect a 50 Ω BNC cable to the other end of the attenuator. Connect a second Type N to BNC adapter and 6 dB attenuator to the spectrum analyzer input, and connect the other end of this attenuator to a second 50 Ω BNC cable. Connect the two cables together with a 50 Ω BNC female/female adapter.
 5. Adjust the analyzer Reference Level control until the displayed signal is entirely on screen over the frequency range 1 MHz to 500 MHz.
 6. Using the analyzer Display memory, store the swept display. Activate the “active display minus stored display” mode (sometimes called “B minus Save A”). A straight line display, with less than 0.2 dB ripple, should appear, typically at mid-screen. This is the frequency response with the flatness errors of the tracking generator, attenuators, spectrum analyzer, and cables normalized out.
 7. Disconnect the two 50 Ω cables at the BNC female/female adapter. Keep the female/female adapter connected to the cable going to the analyzer input.
 8. Disconnect the MIU CH4 coaxial cable from the VM Series System. All of the MIU LEDs, including Power, will extinguish, but the MIU is still receiving power to conduct this test. Connect the MIU CH4 coaxial cable to the cable coming from the analyzer input, using the BNC female/female adapter. To do this, the latching ring must be rotated to the full clockwise position, as viewed from the pin-side of the probe housing. Then carefully insert the BNC adapter, noting the location of the slots for the BNC “ears”.

NOTE. Take care not to short the probe housing pins to the BNC adapter shell while inserting it. Momentarily shorted pins will not damage the MIU, but can cause it to change operating mode.

9. Connect the cable coming from the tracking generator and 6 dB attenuator to the MIU H input BNC.
10. Using Hyperterminal, send the query \$LOAD? to the MIU. Verify that you receive the response: load=0110000. This checks that the MIU operating mode did not change as a result of disconnecting the CH4 coaxial cable.

NOTE. If the string is not correct, send the command \$LOAD=0110000 to the MIU.

11. Decrease the analyzer Reference Level by 34 dB from the Reference Level selected in step 5. For example, if the Reference Level is -6 dBm, then decrease it to -40 dBm. The frequency response of the H channel should be visible in approximately the same position as was the normalized display of step 6.

NOTE. Take care in identifying the correct signal trace. On many analyzers two traces, the H channel frequency response with and without normalization, will be visible. The proper signal trace is the one that is closest to the position of the normalized display of step 6.

12. Measure the loss difference between low frequency (far left side of trace) and that at 320 MHz. The measurement method will vary with analyzer model. Many analyzers have amplitude cursor modes to simplify this type of measurement. Usually the most accurate way to make this measurement (and the method to use for an analyzer without amplitude cursor modes) is to vary the analyzer Reference Level:
 - a. Using the fine Reference Level adjust, position the left side of the signal trace to a convenient reference line (such as a graticule line or marker). Note the Reference Level reading.
 - b. Adjust the Reference Level control until the signal trace at 320 MHz aligns with the same reference line. The difference between the two Reference Level settings is the 320 MHz response relative to the low frequency response.

The left side of trace (low frequency end) is vertically positioned, using the fine Reference Level control, so it overlays the center graticule line. The Reference Level reads $(-40.25$ dBm). Then the Reference Level control is decreased until the 320 MHz portion of the trace (1.2 div right from 250 MHz center screen value) overlays the same graticule line. The Reference Level now reads $(-41.75$ dBm). The response at 320 MHz, relative to low frequency, is $(-41.75)-(-40.25)=(-1.5$ dB).

13. CHECK – that the H channel response at 320 MHz is less than 3.0 dB down.
14. Using Hyperterminal, send the command `$LOAD=0100000` to the MIU. This selects the V channel and the HV WB path. No LEDs will be lit on the MIU.
15. Move the cable connected to the H input BNC to the V input BNC. The V channel frequency response should appear on the analyzer. Its position and appearance should be similar to the H channel response observed above. If not, verify that the MIU is in the proper mode by sending the query `$LOAD?`. You should receive the reply `load=0100000`. If the string is not correct, send the command `$LOAD=0100000`.

- 16.** Repeat the procedure of step 12 above to measure the V channel 320 MHz response.
- 17.** CHECK – that the V channel response at 320 MHz is less than 3.0 dB down.
- 18.** Remove the cable from the V input. Disconnect the MIU CH4 coaxial cable from the BNC female/female adapter. Reconnect the MIU CH4 coaxial cable to the VM Series System CH4 input.

This completes the 012-1685-XX RGBHV Measurement Interface Unit (MIU) Performance Verification.

Appendix C: Cleaning

Use these procedures to clean your instrument. If additional cleaning is required, have your instrument serviced by qualified service personnel.

Exterior Cleaning

Clean the exterior surfaces of the chassis with a dry lint-free cloth or a soft-bristle brush. If any dirt remains, use a cloth or swab dipped in a 75% isopropyl alcohol solution. Use a swab to clean narrow spaces around controls and connectors. Do not use abrasive compounds on any part of the chassis.

Clean the On/Standby switch using a dampened cleaning towel. Do not spray or wet the switch directly.



CAUTION. Do not use chemical cleaning agents that might damage the plastics used in this instrument. Use only deionized water when cleaning the front-panel buttons. Use a 75% isopropyl alcohol solution as a cleaner and rinse with deionized water. Before using any other type of cleaner, consult your Tektronix Service Center or representative.

To prevent getting moisture inside the instrument during external cleaning, use only enough liquid to dampen the cloth or applicator.

Flat Panel Display Cleaning

The display is soft plastic and must be treated with care during cleaning.



CAUTION. Improper cleaning agents or methods can damage the flat panel display.

Do not use abrasive cleaners or commercial glass cleaners to clean the display surface.

Do not spray liquids directly on the display surface.

Do not scrub the display with excessive force.

Clean the flat panel display surface by gently rubbing the display with a clean-room wipe (such as Wypall Medium Duty Wipes, #05701, available from Kimberly-Clark Corporation).



CAUTION. *To prevent getting moisture inside the instrument during external cleaning, use only enough liquid to dampen the cloth or applicator.*

If the display is very dirty, moisten the wipe with distilled water or a 75% isopropyl alcohol solution and gently rub the display surface. Avoid using excess force or you may damage the plastic display surface.

Appendix D: Rebuilding the Hard Drive

If you need to rebuild the hard drive, you must install software from three CDs in the following order:

1. Follow the directions in the DPO7000, DSA70000 and DPO70000 Operating System Restore CD jewelcase booklet to install the operating system (Tektronix part number 020-2659-XX).
2. Follow the directions in the DPO7000, DSA70000 and DPO70000 Product Software CD jewelcase booklet to install the instrument software (Tektronix part number 020-2693-XX).
3. Follow the directions in the VM Series Video Measurement System Product Software CD jewelcase booklet to install the VM Series System software (Tektronix part number 020-2767-XX).

When asked, enter your option key information from the label on the back of your instrument.

Appendix E: Signal Sources Package Contents

There are two ways to get the signal sources:

1. Buy the specific signal source disk that you need.
2. Buy the Option SS Signal Sources package, which contains all the available signal source disks.

You must order the disks individually or altogether as Option SS. Signal source disks are not included as standard accessories.

Signal Source Discs for Option SD/HD

The Signal Sources Discs is a collection of DVDs and CDs that contain Matrix test pattern signal source files in a number of video formats. See page 2-21 for information on the Matrix test pattern. The Signal Sources Discs are available as individual disks or one package that contains all available disks. You can purchase a single disc if that is all you need or you can purchase the whole collection (Option SS Signal Sources) at a substantial discount. Table E-1 lists the Signal Source discs that can be used with Options SD/HD.

Table E- 1: Signal Sources discs appropriate for Option SD/HD

Title	Tektronix part number
480 and 576 Line DVDs, Version 3.0	020-2770-XX
Standard Definition TV Elementary Streams, Version 3.0	020-2771-XX
Advanced TV Elementary Streams, Version 3.0	020-2772-XX
ATSC Transport Streams, Version 3.0	020-2773-XX
Baseband Test Signals, Version 3.0	020-2774-XX
H.264 SD & HD Streams	020-2776-XX

Table E-2 provides an overview of the test signal formats that can be generated using files located on the Signal Sources discs. The table also lists which TG700 modules are required to generate test signals with the TG700 using the DNL files supplied with the Signal Sources discs.

Table E-2: Test Signal Files - File and Signal Formats

Test Signal Format	Bitmap File	TG700 DNL				ATSC Transport Stream	Compressed MPEG Elementary Stream	DVD
		AVG7	AWVG7	DVG7	HDVG7			
480i/59.94 704 pixels	X	X		X		X	X	X
480i/59.94 720 pixels	X						X	
576i/50	X	X		X			X	X
480p/59.94	X	X		X		X	X	
576p/50	X	X		X			X	
720p/30	X		X		X			
720p/50	X		X		X		X	
720p/59.94	X		X		X	X	X	
1080i/50	X		X		X		X	
1080i/59.94	X		X		X	X	X	
1080p/24	X		X		X	X	X	
1080p/50	X							
1080p/59.94	X							

Baseband Test Signals CD

The Baseband Test Signals disc (Tektronix part number 063-3794-XX) contains files for generating baseband test signals. There is one directory:

- The TG700 directory contains setup (.dnl) files for generating Matrix test signals using the Tektronix TG700 TV Signal Generator Platform. Table E-3 lists the analog image format standard .dnl setup files. Table E-4 lists the digital image format standard .dnl setup files.

Table E-3: TG700 DNL analog signal format files

Image signal format	Field rate	TG700 module	Color space	Signal file name
480 (525 total lines) 704 pixels	59.94	AVG7	RGB	525I59G.DNL
			YP _b P _r	525I59Y.DNL
			RGB	525P59G.DNL
			YP _b P _r	525P59Y.DNL

Table E- 3: TG700 DNL analog signal format files (Cont.)

Image signal format	Field rate	TG700 module	Color space	Signal file name
576 (625 total lines)	50	AVG7	RGB	625i50G.DNL
			YP _b P _r	625i50Y.DNL
			RGB	625p50G.DNL
			YP _b P _r	625p50Y.DNL
720p	29	AWVG7	RGB	720p29G.DNL
			YPbPr	720p29Y.DNL
720p	50	AWVG7	RGB	720p50G.DNL
			YP _b P _r	720p50Y.DNL
720p	59.94	AWVG7	RGB	720p59G.DNL
			YP _b P _r	720p59Y.DNL
1080i	50	AWVG7	RGB	1080i50G.DNL
			YP _b P _r	1080i50Y.DNL
	59.94	AWVG7	RGB	1080i59G.DNL
			YP _b P _r	1080i59Y.DNL
1080p	24	AWVG7	RGB	1080p24G.DNL
			YP _b P _r	1080p24Y.DNL

Table E- 4: TG700 DNL digital signal format files

Image signal format	Field rate	TG700 module	Color space	Signal file name
720p	50	HDVG7	YP _b P _r	720P50D.DNL
	59.94	HDVG7	YP _b P _r	720P59D.DNL
1080i	50	HDVG7	YP _b P _r	1080I50D.DNL
	59.94	HDVG7	YP _b P _r	1080I59D.DNL
1080p	24	HDVG7	YP _b P _r	1080P24D.DNL

To use the TG700 .dnl setup files, copy the required file or files to a PC. Then use the communication program that came with the TG700 to move the setup files over your network from the PC to the TG700 instrument. Figure E-1 shows a typical test signal setup using the TG700 instrument as the signal source.

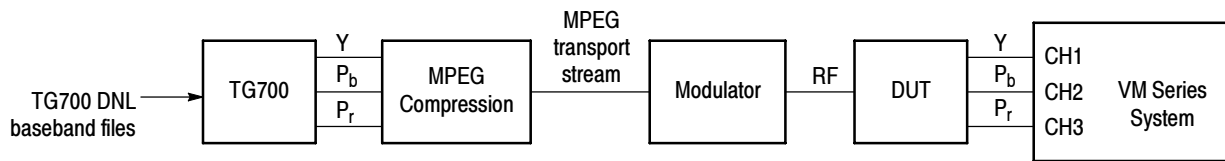

Figure E-1: Using TG700 baseband test signals

ATSC Transport Stream CD

The ATSC Transport Streams disc (Tektronix part number 020-2773-XX) contains files for playout on an MPEG player (such as the Tektronix MTX100 MPEG Recorder and Player) to generate Matrix pattern compressed ATSC transport stream test signals for 480, 720, and 1080 standards. Table E-5 lists the available image format standard .trp setup files.

Table E-5: Available MXT100 .trp signal setup files

Image format	Field rate	MTX100 setup file(s)
480i	59.94	M480i4x3A.trp M480i16x9A.trp
480p	59.94	M480p4x3.trp M480p16x9.trp
720p	59.94	M720p59.trp
1080p	24	M1080p24.trp
1080i	59.94	M1080i59.trp

The disc also has WFMS directory that contains .bmp-format screen captures from the Tektronix WFMNLE Software Waveform Monitor, showing individual lines and channels of the Matrix test signal 1 minute video loop, for a particular format.

To use the MTX100 .trp setup files, insert the disc into the MTX00. Refer to the *MTX100 MPEG Recorder and Player User manual* for information on loading instrument setup files. Figure E-2 shows a typical test signal setup using the MTX100 instrument as the signal source.

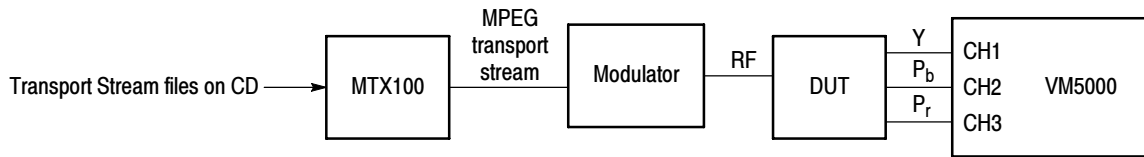

Figure E-2: Using ATSC transport stream signals

Advanced TV Elementary Streams CD Standard Definition TV Elementary Streams CD

The Advanced TV Elementary Streams disc (Tektronix part number 020-2772-XX) and the Standard Definition TV Elementary Streams disc (Tektronix part number 020-2771-XX) contain MPEG2-compressed elementary stream files. You use these files with a transport stream multiplexer to build advanced TV or standard definition TV transport streams. Tables E-6 and E-8 list the elementary stream formats. Each disc also contains bitmap images (in BMP format) that you can display on a PC to see what a good signal should look like when displayed on a TV monitor. Tables E-7 and E-9 list the bitmap files. The RGB .bmp files with the XT suffix have been processed with an anti-alias filter applied to the Pb and Pr portion for 4:2:2 or 4:0:0 representation such as in the .mpg and .trp files. Use the XT files for any compression, for example MPEG2, which requires subsampling of the color difference signals.

Table E-6: Advanced TV Elementary Streams

Image format	Field rate	File	Ratio
720p	50	M720p50.mpg	16:9
	59.94	M720p59.mpg	16:9
1080p	24	M1080p24.mpg	16:9
1080i	50	M1080i50.mpg	16:9
	59.94	M1080i59.mpg	16:9

Table E-7: Advanced TV Bitmaps

Image format	File name
720	M720.BMP
	M720XT.BMP
1080	M1080.BMP
	M1080XT.BMP

Table E- 8: Standard Definition TV Elementary Streams

Image format	Field rate	File	Ratio
480i, 704 pixels	59.94	M480i4x3A.mpg	4:3
		M480i4x3D.mpg	4:3
		M480i16x9A.mpg	16:9
		M480i16x9D.mpg	16:9
480i, 720 pixels	59.94	M480i4x3DW.mpg	4:3
		M480i16x9DW.mpg	16:9
480p, 704 pixels	59.94	M480p4x3.mpg	4:3
		M480p16x9.mpg	16:9
480p, 720 pixels	59.94	M480p4x3W.mpg	4:3
		M480p16x9W.mpg	16:9
576i	59.94	M576i4x3.mpg	4:3
		M576i16x9.mpg	16:9
576p	59.94	M576p4x3.mpg	4:3
		M576p16x9.mpg	16:9

Table E- 9: Standard Definition TV Bitmaps

Image format	File name
480	M480.BMP
	M480XT.BMP
576	M576.BMP
	M576XT.BMP

To use the elementary stream files, copy the appropriate files into your transport stream multiplexor. Figure E-3 shows a typical elementary stream test setup.

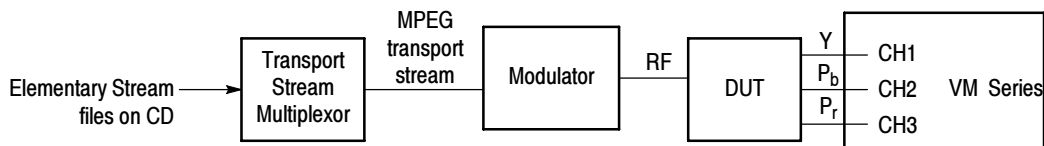

Figure E- 3: Using elementary stream signals

480 and 576 Line DVDs

The 480 and 576 Line DVDs (Tektronix part number 020-2770-XX), both generate 60-second Matrix pattern test signals for use with the VM Series System instrument. The DVD files are available in the formats listed in Table E-10.

Table E-10: Available formats of DVD files

DVD	Image format	Field rate	Program/Track	Ratio
480 Line	480i	59.94	1	16:9
			2	4:3
576 Line	576i	50	1	16:9
			2	4:3

To use the DVD, insert the appropriate DVD into the player, then select the appropriate program/track for the ratio. Figure E-4 shows the typical setup for testing DVD players.

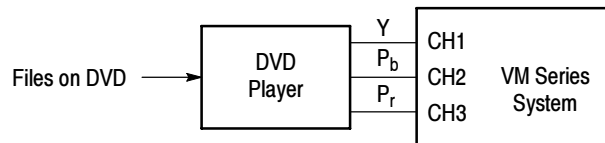

Figure E-4: Using DVD signals

NOTE. The DVD files are in interlace format. The playback device must be set to progressive mode (480p or 576p) before sending signals to the VM Series System instrument.

H.264 SD & HD Streams CDs

The H.264 SD & HD Streams Signal Source package consists of two CDs that contain Elementary Streams and Transport Streams. All Elementary Streams are on disc 1. All Transport Streams are on disc 2. Table E-11 describes the elementary streams and Table E-12 describes the transport streams. For additional information on the disk contents, refer to the ReadMe file on the CDs.

Table E- 11: H.264 Elementary Streams

Image format	Field rate	Length	File name
480i	60	3600 frames, 60.06 s	M480i60.264
480p	60	3600 frames, 60.06 s	M480p60.264
576i	50	3000 frames, 60 s	M576i50.264
576p	50	3000 frames, 60 s	M576p50.264
720p	30	1800 frames, 60.06 s	M720p30.264
	50	3000 frames, 60 s	M720p50.264
	60	3600 frames, 60.06 s	M720p60.264
1080i	50	3000 frames, 60 s	M1080i50.264
	60	3600 frames, 60.06 s	M1080i60.264
1080p	24	1440 frames, 60 s	M1080p24.264
	50	3000 frames, 60 s	M1080p50.264
	60	3600 frames, 60.06 s	M1080p60.264

When using the transport streams, be aware of the following:

- The transport streams are not set to loop. You will have to set your player to loop the streams if you want them to loop.
- PID is 48 and Program Number is 3.
- The H.264 video is PID number 49 and the Stream type = 27.
- The AC-3 Audio is PID number 52, and the stream type = 129.
- No other TS tables are included. If you require additional tables, you can use the Tektronix MTS400 to remultiplex the transport streams including the tables you require.

Table E- 12: H.264 Transport Streams

Image format	Field rate	Length	File name
480i	60	3600 frames, 60.06 s	M480i60.trp
480p	60	3600 frames, 60.06 s	M480p60.trp
576i	50	3000 frames, 60 s	M576i50.trp
576p	50	3000 frames, 60 s	M576p50.trp
720p	30	1800 frames, 60.06 s	M720p30.trp
	50	3000 frames, 60 s	M720p50.trp
	60	3600 frames, 60.06 s	M720p60.trp
1080i	50	3000 frames, 60 s	M1080i50.trp
	60	3600 frames, 60.06 s	M1080i60.trp
1080p	24	1440 frames, 60 s	M1080p24.trp
	50	3000 frames, 60 s	M1080p50.trp
	60	3600 frames, 60.06 s	M1080p60.trp

Signal Source Disc for Option VGA

The Option VGA Signal Source package consists of one CD that contains Full Field/Matrix test pattern signal source files in BMP format for all the measurements except the 10-bit Linearity measurement which are in PNG format. See page 2-21 for more information on the Matrix test pattern.

PC Bitmap Graphics Test Signal Files CD-ROM

The Test Signals disc (Tektronix part number 020-2775-XX) contains files for generating test signals. The disc contains the following:

- The FullFieldSignals folder that contains a set of test pattern sub-directories to take a measurement. Select the pattern depending on the measurement selected. Once the pattern sub-directory is opened, you can see a list of files in BMP format. Select the file depending on the video format set. You can open the file with Microsoft Paint and display the test pattern in full screen mode (for a single monitor setup) or set as Wallpaper Centered (for a dual-monitor setup).
- The MatrixSignals folder that contains a set of test pattern sub-directories that contain images and takes one or more measurements. Select the pattern depending on the measurement selected. Once the pattern sub-directory is opened, you can see a list of files in BMP format. Select the file depending on the video format set. You can open the file with Microsoft Paint and display the test pattern in full screen mode (for a single monitor setup) or set as Wallpaper Centered (for a dual-monitor setup).



Index

Index

Numbers

- 3-wire composite sync setup, 2-3, 2-5
- 4-wire with separate sync setup, 2-7, 2-8
- 75 Ohm termination, CH4, 2-7, 2-8

A

- Access the Windows desktop, 2-27
- Accessories, 1-23
 - optional, 1-27
 - probes, 1-3-1-4
 - recommended, 1-26
 - standard, 1-24
- Adjusting display contrast, 1-9
- Algorithm descriptions. *See* Measurements, detailed information
- All Button, 2-60
- All button, 3-32
- Ambient temperature, A-1
- App button, 2-27
- Application display, default, 2-26
- Application software version number, 3-33
- Application view area, 2-27
- Applications, Microsoft, 1-13
- Auto Scale
 - buttons, 3-8, 3-15
 - options, 2-36
- Average, 3-35, 3-57
- Averages
 - interactions with results, 3-19, 3-27
 - interactions with Run Mode, 3-19, 3-27

B

- Backing up user files, 1-12
- Baseband files, Matrix test pattern, E-2
- Buttons
 - All, 3-32
 - App (restore hidden application), 2-27
 - Auto Scale On/Off, 3-8, 3-15
 - exit, 2-28
 - Generate Report, 2-59, 2-60
 - input signal format, 2-30

- Open (load measurement settings), 2-57
- PDF, 3-32
- picture, 2-27
- refresh rate, 2-32
- RTF, 3-32
- Run, 2-27
- Run Only, 3-7
- Save (measurement settings), 2-55
- Selected, 3-32
- Setup & Run, 3-7, 3-11
- Setup Only, 3-7, 3-11
- Stop, 2-27
- sync signal trigger channel select, 2-37

C

- CD-ROMs, product software, 1-13
- Ch-Ch Mismatch
 - detailed measurement information, 3-58
 - displaying, 3-146
 - setting up, 3-111
- Ch-Ch Skew
 - detailed measurement information, 3-59
 - displaying, 3-147
 - setting up, 3-112
- Changing Measurement Settings, 2-52
- Channel Delay
 - detailed measurement information, 3-36
 - displaying, 3-127
 - setting up, 3-85
- Cleaning
 - exterior, C-1
 - flat panel display, C-1
- Color Bars
 - detailed measurement information, 3-37, 3-43, 3-60
 - displaying, 3-128, 3-148
 - setting up, 3-86, 3-114
- Compatibility of the VM5000 option HD to the VM5000HD, 1-3
- compensating sync pickoff, Option SD/HD, 2-18
- Compressed elementary stream files, E-5
- Compressed transport stream files, E-4
- Configuration menu, 3-5
- Connecting input signals, 2-3

D

- Default application display, 2-26
- Description
 - key features, 1-1
 - product, 1-1
- Desktop, accessing windows, 2-27
- Display Frequency Response
 - measured values, 3-130, 3-150
 - reference values, 3-130, 3-150
 - relative values, 3-130, 3-150
- DNL files, Matrix test pattern, E-2
- Documentation, related, xiv
- DVD files, Matrix test pattern, E-7
- Dynamic range, maximize by autoscaling, 3-8, 3-15

E

- Elementary stream files, Matrix test pattern, E-5
- Environment requirements, 1-6
- Exit button, 2-27
- Exiting the application, 1-13
- Exterior cleaning, C-1

F

- File menu, 3-3
- Files
 - .vmset, 3-3
 - Matrix test pattern signal source, E-1
- Filter settings, 3-19
- Firmware, upgrade, 1-3
- Flat panel display cleaning, C-1
- Format, Input Signal, 2-29
- Frequency Response
 - detailed measurement information, 3-38
 - displaying, 3-130
 - setting up, 3-88
- Function reference, 3-3

H

- H Sync
 - detailed measurement information, 3-61
 - displaying, 3-150
 - setting up, 3-115
- H Sync Jitter
 - detailed measurement information, 3-64
 - displaying, 3-151
 - setting up, 3-116

H Timing

- detailed measurement information, 3-65
 - displaying, 3-153
 - setting up, 3-117
- H.264 signal sources, E-8
 - Help, 3-33
 - Hide button, 2-27
 - How to Run the Measurements, 2-51
 - How to Select the Measurements, 2-33
 - How to Set the Measurement Run Operations, 2-34
 - How to Start the Application, 2-25
 - How to View the Measurement Results, 2-51

I

- Input Matrix test pattern files
 - for a DVD player, E-7
 - for MTX100, E-4
 - for TG700, E-2
 - for transport stream multiplexor, E-5
- Input signal. *See* Matrix test pattern; Measurements, detailed information
- Input signal connection requirements, 2-1
- Input Signal Format, 2-29
- Input Signal Format View, 2-29
- Input signal setups Option SD/HD
 - 3-wire composite sync, 2-3, 2-5
 - 4-wire with separate sync, 2-7, 2-8
- Input signal setups Option VGA
 - RGBHV measurement interface unit, 2-9
 - VGA connector to 5X cable, 2-13
- Installation, 1-5
 - incoming inspection procedure, 1-15
 - software installation, 1-13
- Installing system software, D-1
- Interpreting results. *See* Measurements, detailed information
- Introduction, to this manual, xiii

K

- Key features, 1-1

L

- LCD display contrast, 1-9
- Limits, 2-41
- Line Number, 3-19, 3-27
- Line Number defaults in .vmset file, 3-3

Linearity
 detailed measurement information, 3-66
 displaying, 3-154
 setting up, 3-118
 Loading saved measurement setups, 2-56
 Luma Levels
 detailed measurement information, 3-68
 displaying, 3-155
 setting up, 3-119

M

Manuals
 part numbers, 1-24, 1-27
 related, xiv
 Matrix signal line numbers, 3-35, 3-57
 Matrix test pattern
 formats, E-1
 picture, 2-21
 Matrix test signal, matching setup file, 3-3
 Measurement Result Display, 3-125
 Pass/Fail Results, 3-163
 Measurement Results Display, result summary display,
 3-125
 Measurement Settings, Changing, 2-52
 Measurement Setups
 recall, 2-56
 save, 2-54
 Measurement steps overview, 2-28
 Measurements, 2-43
 detailed information, 3-35, 3-57
 how to set the measurement warnings, 2-39
 how to set the run operations, 2-34
 measurements to report, 2-60, 3-32
 overview, 3-19
 reports, 2-58
 saving results (reports) to a file, 2-58
 select, 2-33
 set, 2-41
 Measurements Setup, 3-77
 capture measurements to create new reference file,
 3-82
 create custom reference file, 3-80
 customizing limit file, 3-84
 take just measurements, 3-77
 take measurements with limit testing, 3-82
 take relative to reference measurements, 3-78
 use existing reference file to create new reference
 file, 3-81
 Menu bar, 2-27
 Menu descriptions, 3-3
 Minimizing the application and main display, 2-27

MTX100 files, Matrix test pattern, E-4
 Multiburst
 detailed measurement information, 3-44
 displaying, 3-135
 setting up, 3-98
 Multiplexor files, Matrix test pattern, E-5

N

Noise
 detailed measurement information, 3-45
 displaying, 3-136
 setting up, 3-99
 Noise Inj Ratio
 detailed measurement information, 3-69
 displaying, 3-157
 setting up, 3-120
 NoiseSpectrum, setting up, 3-102
 Non Linearity
 detailed measurement information, 3-46
 displaying, 3-138
 setting up, 3-104

O

On/Standby switch, 1-7
 Online help, 3-33
 Open (Load Measurement Settings) Button, 2-57
 Opening, .vmset files, 3-3
 Operating requirements, 1-6
 Optimizing for production line testing, auto scale Off,
 3-8
 Option SS, E-1
 Optional accessories, 1-27
 Options, 1-23
 All, 2-60
 Auto Scale enabled, 2-36
 Continuously, 2-35, 3-16
 CSV VM5000, 2-59
 Last Meas., 2-36
 Last Recalled, 2-36
 Line Select, 2-37
 Multi Lines, 2-37
 Once, 2-35, 3-14
 Once & Report, 2-35
 PDF, 2-59
 Restore Default, 2-36
 RTF, 2-59
 Run Mode, 2-35
 Run Only, 2-35, 3-14
 Selected, 2-60

- Setup & Run, 2-35, 3-14
- Setup Only, 2-35, 3-14
- Single Line, 2-37
- Out of range, preventing by autoscaling, 3-8, 3-15

P

- PDF, 2-59, 3-32
- Performance verification
 - functional tests, 1-16
 - self tests, 1-15
- Peripherals, connecting, 1-10
- Picture, 2-43
- Powering off, 1-7
- Powering on, 1-7
- Probes, supported, 1-3
- Product
 - accessories. *See* Accessories
 - description, 1-1
 - models, 1-1
 - unpacking, 1-5
- Product features, 1-1

Q

- Quitting the application, 1-13

R

- Rebuilding the Hard Drive, D-1
- Recall Measurement Setups, 2-56
- Recommended accessories, 1-26
- Reference, 2-41
- Reinstalling the system software, D-1
- Related documentation, xiv
- Release notes, 1-13
- Report Mode, 2-38
- Reports, viewing on the MS Windows desktop, 2-27
- Restore Application, 2-27
- Restore the application when hidden, 2-27
- Results appear as dashes, 3-5, 3-12
- Results menu, 3-19
- RTF, 2-59, 3-32
- Run button, 2-27
- Run Mode
 - interactions with Average setting, 3-19, 3-27

- option, 2-35
- Run Only, 3-14
- Run Only button, 3-7
- Run Only Option, 2-35
- Running Measurements Overview, 2-28

S

- Saving measurement setups, 2-54
- Selected button, generating reports, 3-32
- Selected Option, generating reports, 2-60
- Selecting Measurement, 2-43
- Set Measurements, 2-41
- Setup & Run, 3-14
- Setup & Run button, 3-7, 3-11
- Setup & Run Option, 2-35
- Setup Only, 3-14
- Setup Only button, 3-7, 3-11
- Setup Only Option, 2-35
- Short Time Distortion
 - detailed measurement information, 3-46, 3-48
 - displaying, 3-140, 3-141
 - setting up, 3-105
- Show the application when hidden, 2-27
- Shutdown, 1-7
- Signal path compensation, 1-16, A-1
- Signal sources
 - matrix files, E-1
 - non-matrix. *See* Measurements, detailed information
- Site considerations, 1-6
- Software installation, 1-13, D-1
- Software version number, 3-33
- Space requirements, 1-6
- Specifications, A-1
 - video measurements, A-2
- Standard accessories, 1-24
- Stop button, 2-27
- Switch Accessory, options, 2-38
- Sync
 - detailed measurement information, 3-41, 3-42, 3-54
 - displaying, 3-131, 3-133, 3-134, 3-142
 - setting up, 3-91, 3-93, 3-96, 3-106
 - sync pickoff, compensation, 2-18
 - Sync Polarity Mode, 2-38
 - Sync signal trigger channel buttons, 2-37
 - System diagnostics menu, 1-15

T

Taking a measurement, 2-48
Termination, 75 Ohm, CH4, 2-7, 2-8
Test signal. *See* Matrix test pattern
TG700 DNL files, Matrix test pattern, E-2
Timing Standard
 CVT, 2-32
 CVT-R, 2-32
 DMT, 2-32
Timing Standard, GTF, 2-32
Transport stream files, Matrix test pattern, E-4

U

Unhiding hidden application, 2-27
Upgrade, firmware, 1-3
User files, backing up, 1-12
User interface description, 2-27
Using Custom Instrument Settings, 3-8
Utilities menu
 Generate Report, 3-32
 Instrument Calibration, 1-16
 Instrument Diagnostics, 1-15

V

V Sync
 detailed measurement information, 3-71

 displaying, 3-158
 setting up, 3-108, 3-121

V Timing

 detailed measurement information, 3-74
 displaying, 3-159
 setting up, 3-122

Vectorscope, 2-46

Verification, incoming inspection procedure, 1-15

Version number, 3-33

Vertical scale autoscaling, 3-8, 3-15

Video specifications, A-2

Video Transient

 detailed measurement information, 3-75
 displaying, 3-161
 setting up, 3-123

Viewing measurement results, 2-48

Viewing reports on the desktop, 2-27

VMSET files, recalling, 3-3

W

Warning Message Reporting, 2-39

Warnings, 2-39

Windows desktop, accessing, 2-27

Windows operating system, backup tool, 1-12

