

**WFM6120, WFM7020, WFM7120,
WFM6100 Opt. MB, WFM7000 Opt. MB,
and WFM7100 Opt. MB
Waveform Monitors
Quick Start User Manual**

Copyright © Tektronix. All rights reserved. Licensed software products are owned by Tektronix or its subsidiaries or suppliers, and are protected by national copyright laws and international treaty provisions.

Tektronix products are covered by U.S. and foreign patents, issued and pending. Information in this publication supersedes that in all previously published material. Specifications and price change privileges reserved.

TEKTRONIX and TEK are registered trademarks of Tektronix, Inc.

Manufactured under license from Dolby Laboratories. *Dolby*, *Pro Logic*, and the double-D symbol are trademarks of Dolby Laboratories.

Contacting Tektronix

Tektronix, Inc.
14200 SW Karl Braun Drive
P.O. Box 500
Beaverton, OR 97077
USA

For product information, sales, service, and technical support:

- In North America, call 1-800-833-9200.
- Worldwide, visit www.tektronix.com to find contacts in your area.

Warranty 2

Tektronix warrants that this product will be free from defects in materials and workmanship for a period of one (1) year from the date of shipment. If any such product proves defective during this warranty period, Tektronix, at its option, either will repair the defective product without charge for parts and labor, or will provide a replacement in exchange for the defective product. Parts, modules and replacement products used by Tektronix for warranty work may be new or reconditioned to like new performance. All replaced parts, modules and products become the property of Tektronix.

In order to obtain service under this warranty, Customer must notify Tektronix of the defect before the expiration of the warranty period and make suitable arrangements for the performance of service. Customer shall be responsible for packaging and shipping the defective product to the service center designated by Tektronix, with shipping charges prepaid. Tektronix shall pay for the return of the product to Customer if the shipment is to a location within the country in which the Tektronix service center is located. Customer shall be responsible for paying all shipping charges, duties, taxes, and any other charges for products returned to any other locations.

This warranty shall not apply to any defect, failure or damage caused by improper use or improper or inadequate maintenance and care. Tektronix shall not be obligated to furnish service under this warranty a) to repair damage resulting from attempts by personnel other than Tektronix representatives to install, repair or service the product; b) to repair damage resulting from improper use or connection to incompatible equipment; c) to repair any damage or malfunction caused by the use of non-Tektronix supplies; or d) to service a product that has been modified or integrated with other products when the effect of such modification or integration increases the time or difficulty of servicing the product.

THIS WARRANTY IS GIVEN BY TEKTRONIX WITH RESPECT TO THE PRODUCT IN LIEU OF ANY OTHER WARRANTIES, EXPRESS OR IMPLIED. TEKTRONIX AND ITS VENDORS DISCLAIM ANY IMPLIED WARRANTIES OF MERCHANTABILITY OR FITNESS FOR A PARTICULAR PURPOSE. TEKTRONIX' RESPONSIBILITY TO REPAIR OR REPLACE DEFECTIVE PRODUCTS IS THE SOLE AND EXCLUSIVE REMEDY PROVIDED TO THE CUSTOMER FOR BREACH OF THIS WARRANTY. TEKTRONIX AND ITS VENDORS WILL NOT BE LIABLE FOR ANY INDIRECT, SPECIAL, INCIDENTAL, OR CONSEQUENTIAL DAMAGES IRRESPECTIVE OF WHETHER TEKTRONIX OR THE VENDOR HAS ADVANCE NOTICE OF THE POSSIBILITY OF SUCH DAMAGES.

Table of Contents

General Safety Summary	iii
Environmental Considerations	v
Certifications and Compliances	vi
Preface	ix
Key Features	ix
Instrument Options	xi
Where to Find More Information	xiii
Conventions Used in this Manual	xiii
Installation	1
Before Installation	1
Connecting Power and Powering On/Off	2
Installing in a Video System	3
Getting Acquainted With Your Instrument	5
Instrument Display	5
Front-Panel Controls	9
Rear-Panel Connectors	11
Selecting a Measurement	20
Setting Measurement Parameters	21
Selecting Signal Inputs	22
3 Gb/s Input Monitoring	23
Dual Link Input Monitoring	25
Simultaneous Input Monitoring	26
Measuring Audio/Video Delay	29
Setting Gain, Sweep, and Magnification	30
Using Presets	31
Measuring Waveforms with Cursors	32
Capturing the Display	34
Setting Line Select Mode	37
Configuring Your Instrument	38
Using Online Help	38
To Adjust Headphone Volume and Source	40
To Connect Directly to a PC	41
Checking Chroma/Luma Delay (Lightning Display)	42
Checking Gamut	44
Setup for Gamut Checks	45
Checking RGB Gamut	46
Checking Composite Gamut	48
Checking Luma Gamut	49
Automating Gamut Checks	50
Adjusting Gamut Limits	51
Monitoring the SDI Physical Layer	52
Display Types	52

Configuring Physical Layer Settings (Options EYE and PHY)	52
Configuring Physical Layer Settings (Option 3G or JIT)	58
Taking Eye Measurements	60
Taking Jitter Measurements	65
Taking Cable Loss Measurements	69
Using the ARIB Displays	70
ARIB Status	71
ARIB STD-B.39 Display	72
ARIB STD-B.37 Display and Status Screens	74
ARIB STD-B.35 Display and Status Screens	76
ARIB TR-B.23 (1) Display and Status Screens	77
ARIB TR-B.23 (2) Display and Status Screens	78
ARIB TR-B.22 Display and Status Screens	80
Monitoring Audio	82
Configuring Audio Inputs	82
Selecting Audio Input	83
Checking Audio Level & Phase	84
Checking Surround Sound	86
Monitor Dolby-Based Surround Sound	91
Configuring Dolby Inputs	91
Displaying Dolby Inputs	96
Viewing Dolby Metadata	98
Usage Notes	98
Monitoring Closed Captioning (CC), Teletext, and Safe Area Compliance	103
Monitoring Closed Captioning and Teletext	104
Monitoring for Safe Area Compliance	107
Using Alarms	110
Configuring Alarms	110
Monitoring Alarms	114
Application Example	115
Timing a Studio	115
Upgrading Instrument Software	121
Index	

General Safety Summary

Review the following safety precautions to avoid injury and prevent damage to this product or any products connected to it.

To avoid potential hazards, use this product only as specified.

Only qualified personnel should perform service procedures.

While using this product, you may need to access other parts of a larger system. Read the safety sections of the other component manuals for warnings and cautions related to operating the system.

To Avoid Fire or Personal Injury

Use Proper Power Cord. Use only the power cord specified for this product and certified for the country of use.

Connect and Disconnect Properly. Do not connect or disconnect probes or test leads while they are connected to a voltage source.

Connect and Disconnect Properly. De-energize the circuit under test before connecting or disconnecting the current probe.

Connect and Disconnect Properly. Connect the probe output to the measurement instrument before connecting the probe to the circuit under test. Connect the probe reference lead to the circuit under test before connecting the probe input. Disconnect the probe input and the probe reference lead from the circuit under test before disconnecting the probe from the measurement instrument.

Ground the Product. This product is grounded through the grounding conductor of the power cord. To avoid electric shock, the grounding conductor must be connected to earth ground. Before making connections to the input or output terminals of the product, ensure that the product is properly grounded.

Ground the Product. This product is indirectly grounded through the grounding conductor of the mainframe power cord. To avoid electric shock, the grounding conductor must be connected to earth ground. Before making connections to the input or output terminals of the product, ensure that the product is properly grounded.

Observe All Terminal Ratings. To avoid fire or shock hazard, observe all ratings and markings on the product. Consult the product manual for further ratings information before making connections to the product.

Connect the probe reference lead to earth ground only.

Do not apply a potential to any terminal, including the common terminal, that exceeds the maximum rating of that terminal.

Power Disconnect. The power cord disconnects the product from the power source. Do not block the power cord; it must remain accessible to the user at all times.

Do Not Operate Without Covers. Do not operate this product with covers or panels removed.

Do Not Operate With Suspected Failures. If you suspect that there is damage to this product, have it inspected by qualified service personnel.

Avoid Exposed Circuitry. Do not touch exposed connections and components when power is present.

Do Not Operate in Wet/Damp Conditions.

Do Not Operate in an Explosive Atmosphere.

Keep Product Surfaces Clean and Dry.

Provide Proper Ventilation. Refer to the manual's installation instructions for details on installing the product so it has proper ventilation.

Terms in this Manual

These terms may appear in this manual:



WARNING. Warning statements identify conditions or practices that could result in injury or loss of life.



CAUTION. Caution statements identify conditions or practices that could result in damage to this product or other property.

Symbols and Terms on the Product

These terms may appear on the product:

- DANGER indicates an injury hazard immediately accessible as you read the marking.
- WARNING indicates an injury hazard not immediately accessible as you read the marking.
- CAUTION indicates a hazard to property including the product.

The following symbol(s) may appear on the product:



CAUTION
Refer to Manual



Protective Ground
(Earth) Terminal

Environmental Considerations

This section provides information about the environmental impact of the product.

Product End-of-Life Handling

Observe the following guidelines when recycling an instrument or component:

Equipment Recycling. Production of this equipment required the extraction and use of natural resources. The equipment may contain substances that could be harmful to the environment or human health if improperly handled at the product's end of life. In order to avoid release of such substances into the environment and to reduce the use of natural resources, we encourage you to recycle this product in an appropriate system that will ensure that most of the materials are reused or recycled appropriately.

The symbol shown below indicates that this product complies with the European Union's requirements according to Directive 2002/96/EC on waste electrical and electronic equipment (WEEE). For information about recycling options, check the Support/Service section of the Tektronix Web site (www.tektronix.com).



Mercury Notification. This product uses an LCD backlight lamp that contains mercury. Disposal may be regulated due to environmental considerations. Please contact your local authorities or, within the United States, the Electronics Industries Alliance (www.eiae.org) for disposal or recycling information.

Perchlorate Materials

This product contains one or more type CR lithium coin cell batteries. According to the state of California, CR lithium coin cells are classified as perchlorate materials and require special handling. See www.dtsc.ca.gov/hazardouswaste/perchlorate for additional information.

Restriction of Hazardous Substances

This product has been classified as Monitoring and Control equipment, and is outside the scope of the 2002/95/EC RoHS Directive.

Certifications and Compliances

EC Declaration of Conformity – EMC

Meets intent of Directive 2004/108/EC for Electromagnetic Compatibility. Compliance was demonstrated to the following specifications as listed in the Official Journal of the European Communities:

EN 55103:1996. Product family standard for audio, video, audio-visual and entertainment lighting control apparatus for professional use.^{1 2}

- Environment E2 – commercial and light industrial
- Part 1 Emission
 - EN 55022:2006. Class B radiated and conducted emissions
 - EN 55103-1:1996 Annex A. Radiated magnetic field emissions
- Part 2 Immunity
 - IEC 61000-4-2:1999. Electrostatic discharge immunity
 - IEC 61000-4-3:2002. RF electromagnetic field immunity
 - IEC 61000-4-4:2004. Electrical fast transient / burst immunity
 - IEC 61000-4-5:2005. Power line surge immunity
 - IEC 61000-4-6:2003. Conducted RF Immunity
 - IEC 61000-4-11:2004. Voltage dips and interruptions immunity
 - EN 55103-2:1996 Annex A Radiated magnetic field immunity
 - EN 55103-2:1996 Annex B Balanced ports common mode immunity

EN 61000-3-2:2000. AC power line harmonic emissions

EN 61000-3-3:1995. Voltage changes, fluctuations, and flicker

European Contact.

Tektronix UK, Ltd.
Western Peninsula
Western Road
Bracknell, RG12 1RF
United Kingdom

¹ To ensure compliance with the EMC standards listed here, high quality shielded interface cables should be used.

² Inrush current: 8 A peak.

Australia / New Zealand Declaration of Conformity – EMC

Complies with the EMC provision of the Radiocommunications Act per the following standard, in accordance with ACMA:

- EN 55103-1:1996. Product family standard for audio, video, audio-visual and entertainment lighting control apparatus for professional use, Part 1 — emissions.

EC Declaration of Conformity – Low Voltage

Compliance was demonstrated to the following specification as listed in the Official Journal of the European Communities:
Low Voltage Directive 2006/96/EC.

- EN 61010-1: 2001. Safety requirements for electrical equipment for measurement control and laboratory use.

U.S. Nationally Recognized Testing Laboratory Listing

- UL 61010B-1: 2004, 2nd Edition. Standard for electrical measuring and test equipment.

Canadian Certification

- CAN/CSA C22.2 No. 61010-1:2004. Safety requirements for electrical equipment for measurement, control, and laboratory use. Part 1.

Additional Compliances

- IEC 61010-1: 2001. Safety requirements for electrical equipment for measurement, control, and laboratory use.
- ISA S82.02.01:1999. Safety standard for electrical and electronic test, measuring, controlling, and related equipment.

Equipment Type

Test and measuring equipment.

Safety Class

Class 1 – grounded product.

Pollution Degree Description

A measure of the contaminants that could occur in the environment around and within a product. Typically the internal environment inside a product is considered to be the same as the external. Products should be used only in the environment for which they are rated.

- Pollution Degree 1. No pollution or only dry, nonconductive pollution occurs. Products in this category are generally encapsulated, hermetically sealed, or located in clean rooms.
- Pollution Degree 2. Normally only dry, nonconductive pollution occurs. Occasionally a temporary conductivity that is caused by condensation must be expected. This location is a typical office/home environment. Temporary condensation occurs only when the product is out of service.
- Pollution Degree 3. Conductive pollution, or dry, nonconductive pollution that becomes conductive due to condensation. These are sheltered locations where neither temperature nor humidity is controlled. The area is protected from direct sunshine, rain, or direct wind.
- Pollution Degree 4. Pollution that generates persistent conductivity through conductive dust, rain, or snow. Typical outdoor locations.

Pollution Degree

Pollution Degree 2 (as defined in IEC 61010-1). Note: Rated for indoor use only.

Preface

This manual describes the installation and basic operation of the following instruments:

- WFM6120
- WFM7020
- WFM7120
- WFM6100 with Option MB
- WFM7000 with Option MB
- WFM7100 with Option MB

Key Features

Tektronix waveform monitors can help you monitor and measure SD SDI, HD SDI, and/or composite analog signals. All instrument models come standard with SD SDI input monitoring capabilities. The following table includes key features available on standard equipped instruments. If a feature requires a specific option, the required option is noted.

Feature	Description
FlexVu™ display	The FlexVu™ display is a four-tiled, high-resolution XGA display that provides four concurrent views of a monitored signal. The instrument also provides the flexibility to configure each of the four display tiles independently, enabling you to quickly check the integrity of a signal. For instruments with the simultaneous input monitoring (Option SIM) capability, the FlexVu™ display allows for the monitoring of two signals at the same time, dividing the display into two sides: one for each signal.
CaptureVu™	The CaptureVu™ capability allows capture of a full frame of video data, either user-initiated or triggered by an alarm condition.
Presets	Customizable presets allow you to quickly save and recall commonly used configurations.
Digital and analog support	Support for digital applications. Analog support is available with optional composite-analog monitoring (Option CPS).
Fully digital processing	Fully Digital Processing allows for accurate, repeatable, drift-free operation that surpasses traditional analog designs.
Waveform display	Traditional waveform displays allow signals to be overlaid or paraded.
Vector display	Vector display with Composite and Component Compass Rose Graticules, as well as gain, sweep, and magnification controls. Traditional and Lightning Vector displays are available. The latter visualizes both luma and chroma amplitudes, as well as quantify inter-channel timing.
Gamut monitoring	Arrowhead, Diamond, and Split Diamond displays offer user-selectable gamut thresholds so that you can set monitoring limits appropriate to a specific operation. Gamut monitoring is fully integrated with the alarm logging and reporting capabilities.
Timing and LTC waveform displays	Longitudinal Time Code (LTC) is monitored in a frame rate display to allow observation of amplitude, synchronization and phase with respect to reference vertical interval time code (VITC).

Feature	Description
Audio monitoring	<p>Surround Sound display of audio signals and phase relationships of normal channel pairs.</p> <p>Lissajous display lets you monitor a user-specified pairing of channel inputs.</p> <p>Support and options for viewing and monitoring both levels of normal channel pairs for AES, analog, embedded audio, and Dolby signals (Dolby support available with the WFM6120 and WFM7120, only).</p> <p>Loudness measurement, audio control packet coding, and many popular audio scales, including BBC scales, are also supported.</p>
Ancillary data monitoring	Support for monitoring ancillary data including data conforming to ARIB standards and EIA608 Extended Data Services (XDS).
Closed Captioning support	Support for decode and display of CC standards (EIA 608 (VBI), EIA 608 (ANC), EIA (608/708), EIA 708, TeletextB (VBI), TeletextB OP47 SDP (ANC), and TeletextB OP47 Multi (ANC)) with caption text and V-chip information overlaid on the picture (monitor mode) or on Status, Alarm, or Error screens. There are also settings for missing (incorrectly inserted) closed captioning.
Picture area	Support for standard and custom Safe Graticules for Picture displays for monitoring for incorrect placements of graphics, logos. Two Safe Area graticules and Safe Title graticules are supported.
Status screens	Status screens provide content status at a glance.
Physical measurements	(Option EYE and PHY only) Verification and automatic measurement of the electrical characteristics of the SDI physical layer. An Eye display lets you use the graticule or voltage and time cursors to measure the waveform. A Jitter waveform display shows jitter and jitter thermometers provide two independent measurements of jitter and one of cable loss, and relates those measurements to defined alarm limits.
Error tracking	Configurable alarms and error logging.
Remote control	Full remote control for complete installation flexibility.

Instrument Options









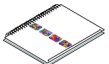

The WFM6120, WFM7020, and WFM7120 ship with support for monitoring standard definition (SD) serial digital signals. The following options are available for purchase with the indicated instrument models. You can verify which options are installed on your instrument after power-up by pressing the **CONFIG** button and looking under the **View HW/SW Options** submenu.

Option	Instrument	Description
3G	WFM7020 WFM7120	Adds support for 1920 x 1080p/50/59.94/60 3Gbps video formats. (Requires Option HD.) Option 3G cannot be installed simultaneously with Options EYE or PHY.
JIT	WFM7120	Adds 3Gbps jitter measurement and jitter waveform capabilities. Includes 3Gbps generator output capabilities. (Requires Option 3G.)
DL	WFM7020 WFM7120	Adds dual link (DL) support. Dual link allows for the reception of two different input signals at the same time. Information from each input is combined and shown on a single display. Supports all 10 bit and 12 bit YCbCr and RGB formats. This option includes option HD.
SIM	WFM7120	Adds simultaneous input monitoring (SIM) support. SIM allows for monitoring of two different input channels at the same time. Input information is displayed as separate waveform displays in two FlexVuTM tiles (either horizontally or vertically). Supports SDI-SDI and SDI-Composite input combinations only. Comparison of HD-HD, SD-SD, HD-SD, SD-Composite, and HD-Composite signals is available.
HD	WFM7020 WFM7120	Adds support for high definition (HD) serial digital monitoring; two HD-SDI inputs. This option included with Option DL.
CPS	WFM6120 WFM7020 WFM7120	Adds support for composite (CPS) analog video monitoring (NTSC and PAL); two passive loop-through inputs; two composite analog inputs.
AD	WFM6120 WFM7020 WFM7120	Adds support for digital audio monitoring, and analog audio and digital audio in embedded and AES/EBU formats; two sets of six channels of analog audio inputs; eight channels analog audio outputs.
DDE	WFM7120	Adds option AD capabilities, plus support for decoding and monitoring Dolby Digital (AC-3) and Dolby E audio.
AVD	WFM7120	Adds support for Audio/Video delay (AVD) measurement.
EYE	WFM7120	Adds support for Eye pattern display, jitter measurements, and cable parameter measurements.
PHY	WFM7120	Adds option EYE capabilities, plus support for jitter waveform and automated eye measurements.
DAT	WFM6120 WFM7120	Adds data analysis capabilities. Allows for logic-level view of video and embedded audio data stream and ANC data extraction.

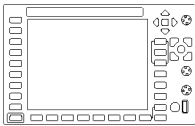
You can add any or all of the following service options to any instrument:





- Option C3. Adds 3 years of Calibration Service.
- Option C5. Adds 5 years of Calibration Service.
- Option D1. Adds a Calibration Data Report.
- Option D3. Adds 3 years of Calibration Data Report (when ordered with option C3).
- Option D5. Adds 5 years of Calibration Data Report (when ordered with option C5).
- Option R3. Adds 3 years of Repair Service (including the period under warranty).
- Option R5. Adds 5 years of Repair Service (including period under warranty).

Where to Find More Information

Item	Purpose	Location
Quick Start User Manual (this manual)	Installation and high-level overview of instrument operation	 +  +  WWW.Tektronix.com
Technical Reference	In-depth descriptions of instrument operation	 +  WWW.Tektronix.com
Online Help	In-depth instrument operation and UI help	
Specifications and Performance Verification Technical Reference	Specifications and procedure for checking instrument performance	 +  WWW.Tektronix.com
WVR, WFM, & AMM Series Management Information Base (MIB) Reference	SNMP command reference for remotely controlling the instrument	 +  WWW.Tektronix.com
Service Manual	Optional manual supporting module-level servicing of the instrument	 www.Tektronix.com

Conventions Used in this Manual

The following icons are used throughout this manual:

Sequence Step	Connect power	Network	XGA	USB
				

Installation

Your instrument is shipped in a wrap-around chassis that covers the instrument bottom and two sides. A cover is installed on the chassis and the rear panel is made up of the module rear panels. You can operate the instrument in the chassis (be sure the top cover is on) or installed in an approved portable cabinet or rack adapter. You can also custom install your instrument.

To install your instrument in a cabinet or rack, follow the instructions that are included with the optional accessory kits that are available for each type of installation.



CAUTION. Do not install this instrument in any cabinet except those that are listed in the Accessories table. Attempting to do so can damage the instrument and the cabinet.

If you install your instrument in a custom application, such as a console, be sure to provide adequate airflow. Do not block the ventilating holes.



CAUTION. Failure to provide adequate airflow to the instrument could cause the instrument to shut down. If the airflow is blocked and the instrument does not shut down, the instrument could be seriously damaged.

Before Installation

Unpack the instrument and check that you have received all of the items listed as standard accessories. You may want to save the shipping carton and packing materials (including the anti-static bag) in case you need to ship the instrument.

Accessories

The table below shows which items are standard accessories and which items are optional accessories. Check the Tektronix Web site (www.tektronix.com) for the most current information on accessories.

Accessory	Standard	Optional	Tektronix part number
WFM6120, WFM7020, and WFM7120 Waveform Monitors Quick Start User Manual	•		071-2223-XX
WFM6120, WFM7020, and WFM7120 Waveform Monitors Release Notes	•		061-4340-XX
WFM6120, WFM7020, and WFM7120 Waveform Monitors Customer Documentation CD	•		063-4055-XX
This CD contains the following documents in PDF format. (All documents are in English unless noted otherwise):			
Quick Start User Manual (English, Japanese, Chinese)			
Technical Reference			
Specifications and Performance Verification Technical Reference			
Release Notes			

Accessory	Standard	Optional	Tektronix part number
Power Plug	•		Not applicable
NOTE. See the <i>International Power Plugs</i> list that follows this table for the type of power plug included with your instrument.			
WFM7F02, Portable cabinet with handle, feet, tilt bail, and front panel cover.		•	650-4393-XX
WFM7F05, Dual rackmount for WFM6100 series, WFM7000 series, WFM7100 series, 1700 Series, WFM601 series, WFM700 series, 760A, and 764. Each half of the rack can be ordered as either Option O or Option N. Option N is used for WFM700, WFM6100 series, WFM7000 series, and WFM7100 series monitors. Option O is used for 1700 Series, WFM601 Series, 760A and 764 instruments.		•	WFM7F05

International Power Plugs. Your instrument was shipped with one of the following power cord options. Power cords for use in North America are UL listed and CSA certified. Cords for use in areas other than North America are approved by at least one authority acceptable in the country to which the product is shipped.

- Opt. A0 – North America power
- Opt. A1 – Universal EUR power
- Opt. A2 – United Kingdom power
- Opt. A3 – Australia power
- Opt. A4 – 240 V, North America power
- Opt. A5 – Switzerland power
- Opt. A6 – Japan power
- Opt. A10 – China power
- Opt. A99 – No power cord or AC adapter

Connecting Power and Powering On/Off

This instrument operates from a single-phase power source with the neutral conductor at or near earth ground. The line conductor is fused for over-current protection. A protective ground connection through the grounding conductor in the power cord is essential for safe operation.

AC Power Requirements

The instrument operates from an AC line frequency of 50 or 60 Hz, over the range of 100-240 Volts, without the need for configuration, except the power cord. (See page 2, *International Power Plugs*.) The typical power draw is 50 Watts. Refer to the *Specifications and Performance Verification* document on the *User Documentation CD* for additional information on power and environmental requirements.

Connect the supplied power cord to the rear-panel power connector. The instrument will turn on as soon as you apply power. Press the Standby power button on the front panel to put the instrument in standby mode.

Installing in a Video System

The instrument can operate almost anywhere in the distribution system. The following diagrams for serial digital systems and for the analog composite inputs.

For monitoring the video bit stream of a serial receiver

1. Route the incoming serial signal into one of the instrument SDI inputs.

NOTE. See the *Specifications and Performance Verification manual on the User Documentation CD for maximum allowed cable lengths.*

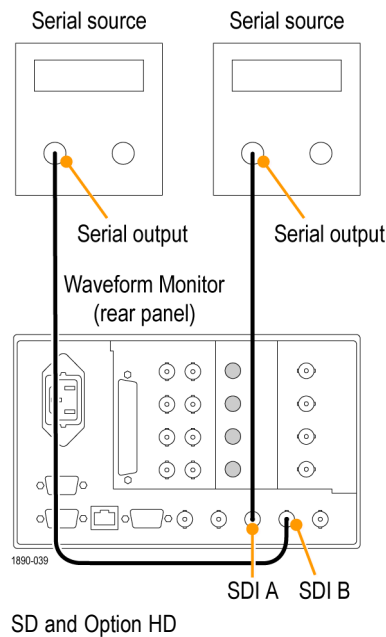
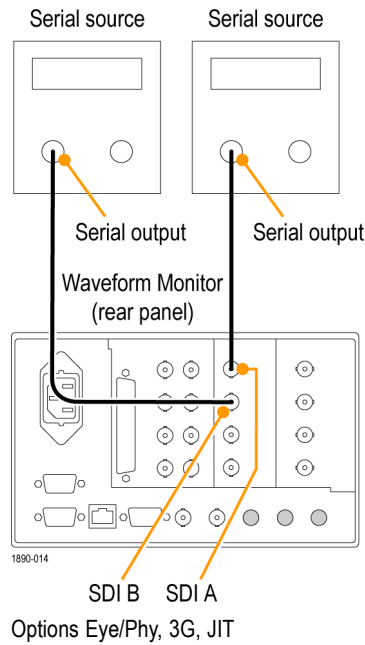

For monitoring composite signals

1. Connect your sources to the CMPST A or CMPST B loop-through inputs on the rear panel.

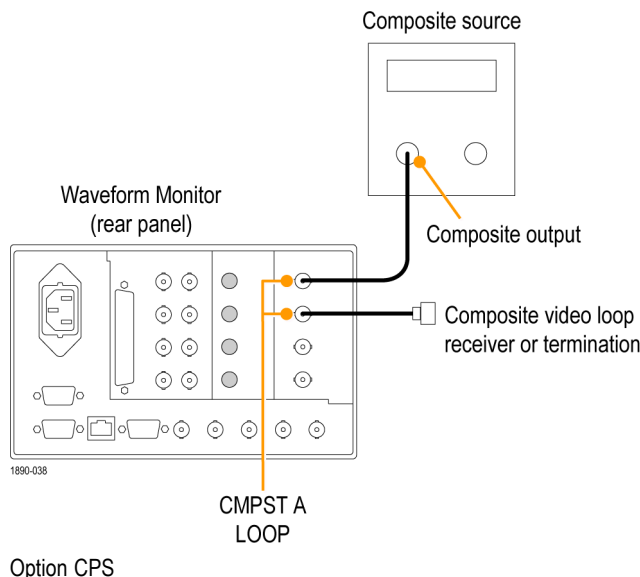

Line Termination

Your instrument uses passive loop-through analog and reference inputs. Accordingly, the loop-through inputs must be terminated externally. It is important that this external termination meets accuracy and return loss requirements.

If the instrument is installed to monitor an operating link, the destination receiver and the connecting cable serve as the termination. This monitoring connection checks the performance of the entire path. The return loss of the instrument is sufficiently high that, in most cases, the destination receiver sets the system return loss.

In cases where the instrument is placed at the end of a link, a BNC termination must be installed on one side of the loop-through analog or reference connector. The termination must be 75 Ω and DC coupled (good return loss extends to DC). An appropriate termination would be Tektronix part number 011-0102-00. It is a 75 Ω , End of Line termination.

Compatibility of BNC Center Pins

Most video equipment BNC connectors, whether 50 Ω or 75 Ω , use a 50 Ω standard center pin. Some laboratory 75 Ω BNC connectors use a smaller diameter center pin. The BNC connectors on the instrument are designed to work with the 50 Ω standard (large diameter) center pins.

Do not use connectors or terminators with the smaller center pins. They could cause intermittent connections.

Getting Acquainted With Your Instrument

Instrument Display

This instrument uses FlexVu™, which is a flexible, four-tiled display that can show four tiles at one time or a single, full-screen sized tile. Each tile can display a different measurement, effectively creating four independent instruments. In order to allow the tiles to function independently, most of the controls affect only one tile at a time.

1. To switch to tiled mode, toggle the **FULL** button until it is unlit and there are four displays shown.
2. To select a tile to control, push one of the numbered tile buttons.

Note that the button you select lights and that a light-blue outline surrounds the tile. Both the lit button and the light-blue outline indicate the active, selected tile. Tile 4 is shown selected here.

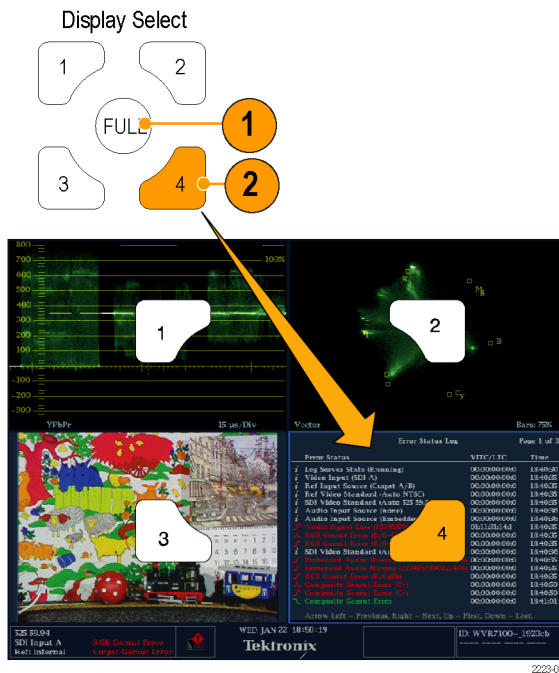

3. To display the selected tile full screen, toggle the **FULL** button until it is lit and the selected tile fills the screen.
In a full display, the displayed tile is always selected.
4. To select another tile, just push its button. The tile you select will replace the previously selected tile, displaying full screen.
5. Push the **FULL** button again to toggle to the four-tile display.

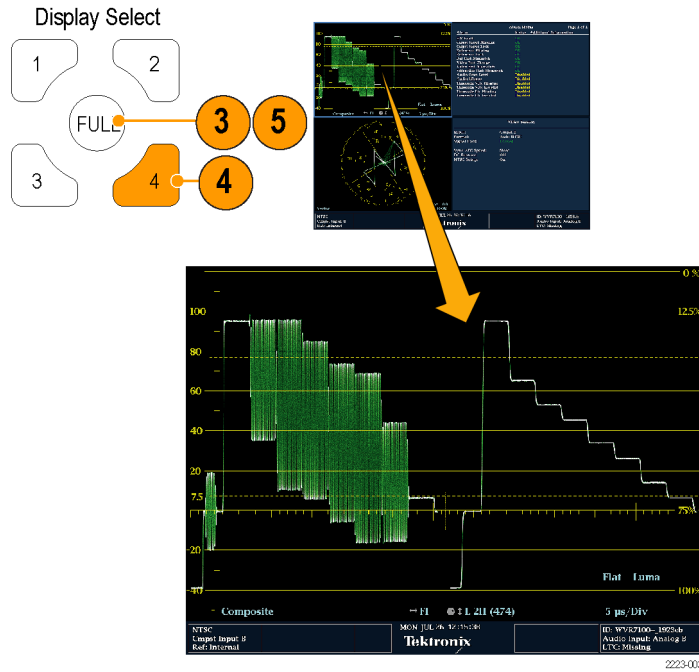

To Determine Status At-a-Glance

The Status Bar, located at the bottom of the instrument display, shows instrument status and monitored signal information. In Figure 1, the various elements detailed describe the conditions that you can see at a glance. Figure 2 shows how the status bar is configured when in simultaneous input monitoring mode (requires Option SIM).

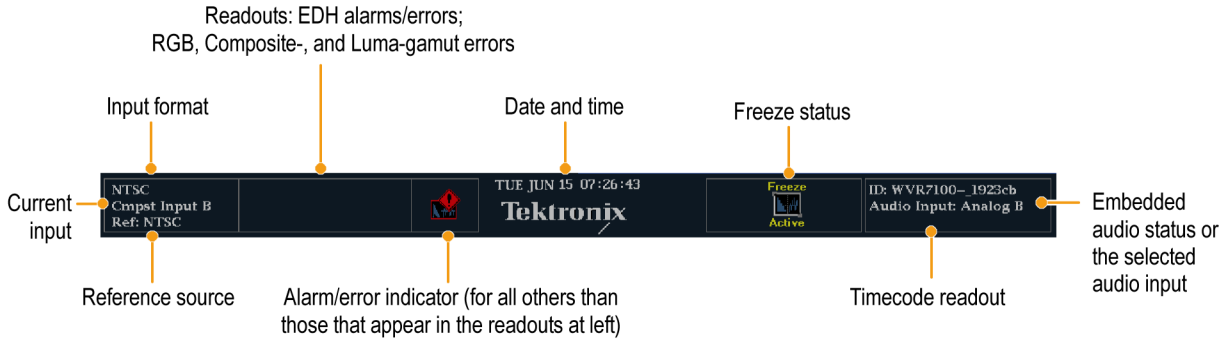

Figure 1: Status bar in single input mode



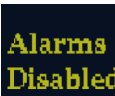



Figure 2: Status bar in simultaneous input mode

Display element	Description
Input Format	Text indicating the format of the signal on the selected input or whether signal is missing or unlocked.
EDH Error	A one-line area that is visible if EDH errors are present.
RGB Gamut Error	A one-line area that is visible if RGB gamut errors are present. NOTE. Because RGB and Composite Gamut messages appear on the same line in the display, if both RGB and Composite Gamut errors are present at the same time, the message "RGB and Cmpst Gamut" will appear.
Composite Gamut Error	A one-line area that is visible if Composite gamut (Arrowhead) errors are present. NOTE. Because RGB and Composite Gamut messages appear on the same line in the display, if both RGB and Composite Gamut errors are present at the same time, the message "RGB and Cmpst Gamut" will appear.
Luma Gamut Errors	A one-line area that is visible if Luma errors are present.
Alarm/Error Indicator	An icon visible when alarms of types other than those in the four readouts just listed occur.
Date and Time	Readout of the date and time (set in CONFIG > Utilities).
Instrument Name	Name assigned to the instrument in the CONFIG > Utilities menu.
Audio Status	A 16-character string indicating the selected audio input or the embedded audio channel status, when embedded audio is the selected input, in the latter case, each character shows the status of a specific channel: - for not present and p for present.

Display element	Description
Timecode Readout	A readout showing the selected time-code value.
Reference Source	Text indicating the source of the current reference. Possible references are: Ext., Internal. Also indicates format and whether the reference is missing or unlocked.
Current Input	Text indicating the selected input. Possible inputs are: SDI A, SDI B, Cmpst A, Cmpst B (depending on installed options). Also indicates if the current input is not in Auto mode and is unlocked.

Status Bar Icons

Display Icons	Description
	Warning - Appears when an error or an alarm that is mapped to the user interface triggers.
	Alarms Muted - Appears when the alarms are muted from the STATUS pop-up menu.
	Remote Access - Appears when the instrument is accessed from the network. For example, when sending commands to the instrument from the remote interface.
	Alarms Disabled - This text appears in the Status Bar when Alarms are disabled from the Configuration menu.
	Freeze Active - Appears when the tiles are frozen or captured.

Front-Panel Controls

NOTE. Some of the controls that this section covers are option dependant. For a list of the options that are installed on your instrument, press the **CONFIG** button. In the configuration menu, select the **Utilities** submenu. The **View Instruments Options** entry lists the options installed on your instrument.

Three Levels of Control

You control the instrument on three levels:

- **Frequently changed settings.** The front-panel buttons control the most commonly changed parameters, such as which measurement appears in each tile. The knobs are used to adjust levels and make selections.
- **Tile-specific settings.** Pop-up menus control parameters that are specific to the tile in which they are displayed. The pop-up menus control less frequently changed parameters such as the waveform display mode (for example, changing the waveform display mode from RGB to YPbPr). To display a pop-up menu, press and hold the desired **MEASURE SELECT** or **DISPLAY SELECT** button for about a second.
- **Instrument-wide settings.** The parameters in the Configuration menu are instrument-wide settings. The configuration menu controls settings that are changed only occasionally, such as changing waveform color or setting the network address.

Scope of Controls

Some controls are global and affect all tiles, while other controls only affect the active tile. Generally speaking, if a control is configured by front-panel buttons or by a pop-up menu, it is tile specific. (Exceptions are the Input buttons, and all audio features, both of which are global.) If control is configured by the **CONFIG** menu, selections are usually global.

Layout and Usage

The primary front panel elements shown below are described in the table that follows. The Usage Procedure column in the table refers you to a procedure in this manual that explains how to use the element. A reference of **None** means that the element is an indicator only or has no associated procedure.

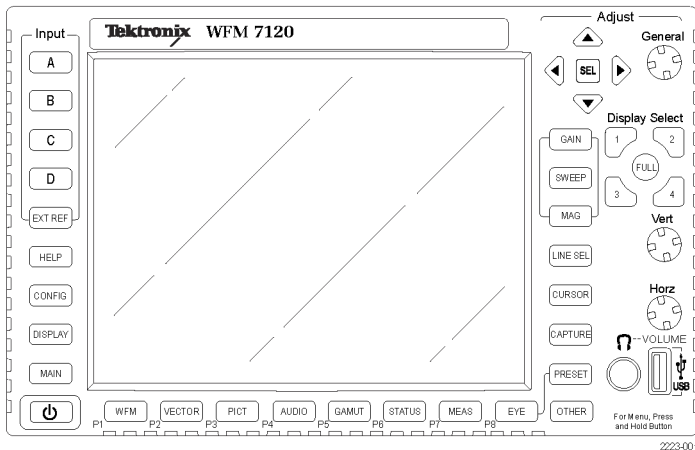

Control Element or Group	Usage Procedures
Display selection buttons	<i>Instrument Display</i> (See page 5.)
Measurement buttons	<i>Selecting a Measurement</i> (See page 20.) <i>Setting Measurement Parameters</i> (See page 21.)
Gain and Sweep Buttons	<i>Setting Gain and/or Sweep</i> (See page 30.)
Preset Buttons	<i>Using Presets</i> (See page 31.)
Input Selection Buttons	<i>Selecting Signal Inputs</i> (See page 22.)
Line Select button	<i>Setting Line Select Mode</i> (See page 37.)
EXT REF button	<i>Timing a Studio</i> (See page 115.)
Capture button	<i>Capturing the Display</i> (See page 34.)
Help button	<i>Using Online Help</i> (See page 38.)
Cursor button	<i>Measuring Waveforms with Cursors</i> (See page 32.)
Configuration button	<i>Configuring Your Instrument</i> (See page 38.)
Up/Down/Left/Right Arrow keys and SEL Button	Demonstrated in <i>Setting Measurement Parameters</i> (See page 21.)
General Knob	Demonstrated in <i>Selecting/Adjusting a Parameter</i> (See page 38.)

Control Element or Group	Usage Procedures
Vertical and Horizontal Knobs	Use to position waveforms when displayed in tiles or full screen. When the Audio tile is active, use the Horizontal knob to adjust the headphone volume.
Power standby button	Press to put instrument in standby mode.
Main button	Access to print capabilities.
Other button	LTC display mode.

Rear-Panel Connectors

The following figures shows the rear panel with optional connectors. Instruments without Options EYE or PHY have the SDI inputs located along the bottom-right portion of the rear panel. Instruments with Option EYE or PHY have the SDI inputs arranged vertically.

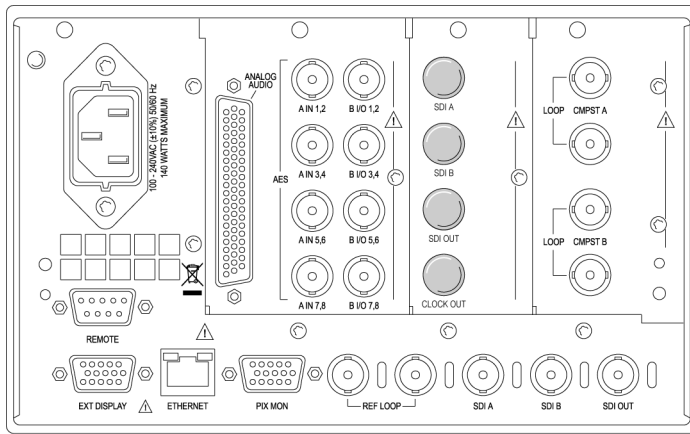

1890-042

Options SD/HD

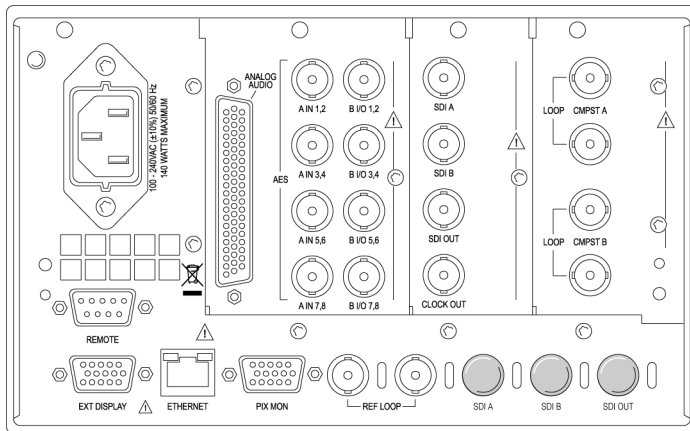

1890-041

Options Eye/Phy, 3G, JIT

Power Requirements

- A single-phase power source with one current-carrying conductor at or near earth-ground (the neutral conductor).
- The power source frequency must be 50 or 60 Hz, and a operating voltage range must be from 100 to 240 VAC, continuous.
- Systems with both current-carrying conductors live with respect to ground (such as phase-to-phase in multiphase systems) are not recommended as power sources.

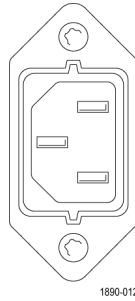

NOTE. Only the line conductor is fused for over-current protection. The fuse is internal.

Video Input Connectors

SDI inputs are self-terminating inputs. Reference and Composite inputs are passive inputs, compensated for 75 Ω and require termination.

1. **Ref Loop.** A synchronization input. The input signal can be analog black burst, analog composite video, or analog tri-level for HD. Requires termination.

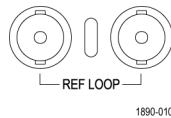

2. **SDI A.** The Digital A component serial digital input.
3. **SDI B.** The Digital B component serial digital input.
4. **SDI Out.** Digital version of RGB/YPbPr analog pix monitor output. Gamut and or line select bright-ups optionally displayable. Can also be selected to be a loop-through of the active SDI input.
5. **Clock Out** Recovered clock output. Options EYE, PHY, and JIT only.



SDI A



SDI B



SDI OUT



CLOCK OUT

1890-008

Options EYE/PHY and JIT



SDI A

SDI B

SDI OUT

1890-011

Option SD/HD

CMPST A and CMPST B composite inputs.

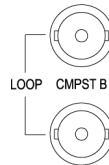
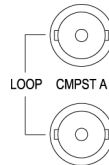

1890-009

Option CPS

AES A/B Connectors

1. These BNC connectors support AES audio inputs.

- A1-2 In
- A3-4 In
- A5-6 In
- A7-8 In
- B1-2 I/O ¹
- B3-4 I/O ¹
- B5-6 I/O ¹
- B7-8 I/O ¹

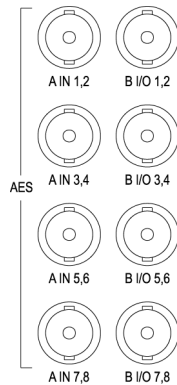

Options DS, AD, DDE

¹ The AES B connectors can be configured to output embedded audio channels, decoded Dolby, or the AES A inputs.

Analog Input/Output Connector

The Analog I/O connector is used to receive and send analog signals. The Analog I/O connector is a 62-pin, D-subminiature connector. Pin assignments and pin names are listed in the following figure and table.



CAUTION. Use care when connecting the Analog Audio Output. Refer to the instrument Specifications to ensure that the Audio Load and Output Power meet specifications. Exceeding Analog Audio Output Power may result in damage to the instrument.

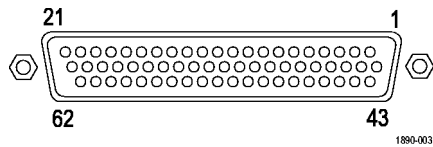

Option AD

Pin	Description
1 ANALOG_INPUT_A1_P	Balanced differential analog audio input- Ch. 1, line A, positive.
2 ANALOG_INPUT_B1_P	Balanced differential analog audio input- Ch. 1, line B, positive.
3 ANALOG_INPUT_A2_P	Balanced differential analog audio input- Ch. 2, line A, positive.
4 ANALOG_INPUT_B2_P	Balanced differential analog audio input- Ch. 2, line B, positive.
5 ANALOG_INPUT_A3_P	Balanced differential analog audio input- Ch. 3, line A, positive.
6 ANALOG_INPUT_B3_P	Balanced differential analog audio input- Ch. 3, line B, positive.
7 ANALOG_INPUT_A4_P	Balanced differential analog audio input- Ch. 4, line A, positive.
8 ANALOG_INPUT_B4_P	Balanced differential analog audio input- Ch. 4, line B, positive.
9 ANALOG_INPUT_A5_P	Balanced differential analog audio input- Ch. 5, line A, positive.

10 ANALOG_INPUT_B5_P	Balanced differential analog audio input- Ch. 5, line B, positive.
11 ANALOG_INPUT_A6_P	Balanced differential analog audio input- Ch. 6, line A, positive.
12 ANALOG_INPUT_B6_P	Balanced differential analog audio input- Ch. 6, line B, positive.
13 GND	
14 ANALOG_OUTPUT_1_P	Balanced differential analog audio output- Ch. 1, positive.
15 ANALOG_OUTPUT_2_P	Balanced differential analog audio output- Ch. 2, positive.
16 ANALOG_OUTPUT_3_P	Balanced differential analog audio output- Ch. 3, positive.
17 ANALOG_OUTPUT_4_P	Balanced differential analog audio output- Ch. 4, positive.
18 ANALOG_OUTPUT_5_P	Balanced differential analog audio output- Ch. 5, positive.
19 ANALOG_OUTPUT_6_P	Balanced differential analog audio output- Ch. 6, positive.
20 ANALOG_OUTPUT_7_P	Balanced differential analog audio output- Ch. 7, positive.
21 ANALOG_OUTPUT_8_P	Balanced differential analog audio output- Ch. 8, positive.
22 ANALOG_INPUT_A1_N	Balanced differential analog audio input- Ch. 1, line A, negative.
23 ANALOG_INPUT_B1_N	Balanced differential analog audio input- Ch. 1, line B, negative.
24 ANALOG_INPUT_A2_N	Balanced differential analog audio input- Ch. 2, line A, negative.
25 ANALOG_INPUT_B2_N	Balanced differential analog audio input- Ch. 2, line B, negative.
26 ANALOG_INPUT_A3_N	Balanced differential analog audio input- Ch. 3, line A, negative.
27 ANALOG_INPUT_B3_N	Balanced differential analog audio input- Ch. 3, line B, negative.
28 ANALOG_INPUT_A4_N	Balanced differential analog audio input- Ch. 4, line A, negative.
29 ANALOG_INPUT_B4_N	Balanced differential analog audio input- Ch. 4, line B, negative.
30 ANALOG_INPUT_A5_N	Balanced differential analog audio input- Ch. 5, line A, negative.
31 ANALOG_INPUT_B5_N	Balanced differential analog audio input- Ch. 5, line B, negative.
32 ANALOG_INPUT_A6_N	Balanced differential analog audio input- Ch. 6, line A, negative.
33 ANALOG_INPUT_B6_N	Balanced differential analog audio input- Ch. 6, line B, negative.
34 GND	
35 ANALOG_OUTPUT_1_N	Balanced differential analog audio output- Ch. 1, negative.
36 ANALOG_OUTPUT_2_N	Balanced differential analog audio output- Ch. 2, negative.
37 ANALOG_OUTPUT_3_N	Balanced differential analog audio output- Ch. 3, negative.
38 ANALOG_OUTPUT_4_N	Balanced differential analog audio output- Ch. 4, negative.
39 ANALOG_OUTPUT_5_N	Balanced differential analog audio output- Ch. 5, negative.
40 ANALOG_OUTPUT_6_N	Balanced differential analog audio output- Ch. 6, negative.
41 ANALOG_OUTPUT_7_N	Balanced differential analog audio output- Ch. 7, negative.
42 ANALOG_OUTPUT_8_N	Balanced differential analog audio output- Ch. 8, negative.
43—62	No connection.

Connecting Signals. When connecting audio signals to the Analog Input connector, you can use either balanced or unbalanced signals. If you connect unbalanced signals to the inputs, you do not have to ground the unused lead (grounding the unused lead can reduce noise).

When connecting the Analog Output connectors, you can connect them as balanced or unbalanced. However, if you connect the balanced outputs to an unbalanced input, you must ground the unused lead. You can ground either lead.

NOTE. Note that grounding the unused lead does not attenuate the output but it does halve the clipping level. Therefore, you must attenuate the output by at least 6 dB to avoid clipping. The output signal level in unbalanced mode is double the signal level in balanced mode.

Units that have both analog and digital capability can have AES or embedded inputs converted to analog and then routed to the six balanced outputs. Embedded audio can be output to the AES B connector (when it is configured as an output). AES A can also be routed to the AES B connector. Decoded Dolby can also be routed to the analog output connector.

EXT DISPLAY Connector Pin Assignment

This is the display output. The display resolution is 1024 x 768. The output is compatible with standard analog PC monitors, either CRT or LCD-based. The EXT DISPLAY connector is a 15-pin D-type connector with socket contacts.

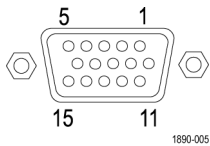

Pin	Pin name
1	Red Video
2	Green Video
3	Blue Video
4	Not connected
5	Ground
6	Red Ground
7	Green Ground
8	Blue Ground
9	+5 V (for monitor EEPROM)
10	Not Connected
11	Not Connected
12	ID Bit
13	Horizontal Sync
14	Vertical Sync
15	ID Clock

Pix Mon Connector Pin Assignment

This is the video picture output. The output is compatible with standard analog PC monitors, either CRT or LCD-based. The PIX MON connector is a 15-pin D-type connector with socket contacts.

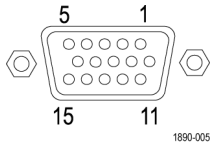

Pin	Pin name
1	Red Video
2	Green Video
3	Blue Video
4	Not connected
5	Ground
6	Red Ground
7	Green Ground
8	Blue Ground
9	Not Connected
10	Not Connected
11	Not Connected
12	Not Connected
13	Horizontal Sync
14	Vertical Sync
15	Not Connected

Remote Connector Pin Assignment

The REMOTE connector interface uses ground closures for remote control and indicating to external equipment when alarms have occurred. The input of LTC is through the REMOTE connector. The REMOTE connector is a 9-pin D-type connector with socket contacts.

NOTE. For more information on Preset recall, refer to the Technical Reference manual on the Product Documentation CD that was shipped with your instrument.

Hex	Binary Pins 9, 8, 7, 6	Direct mode selection	Encoded mode selection
F	1111	None	No action
E	1110	Preset 1	CPS B
D	1101	Preset 2	CPS A
C	1100		SDI B
B	1011	Preset 3	SDI A
A	1010		Channel B (In SIM, subsequent remote input selections apply to tiles 2 and 4)
9	1001		Channel A (In SIM, subsequent remote input selections apply to tiles 1 and 3)
8	1000		Preset 8
7	0111	Preset 4	Preset 7
6	0110		Factory Preset
5	0101		Preset 5
4	0100		Preset 4
3	0011		Preset 3
2	0010		Preset 2
1	0001		Preset 1
0	0000		Unused

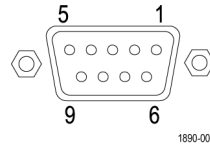

LTC Input Through Ground Closure and Pin Out

An LTC is input through the 9-pin **Remote** connector.

Pins	Function
1	GND (Out)
2	LTC IN +
3	LTC IN -
4	GND (Out)
5	GND Closure Out
6	Preset A1 (In)
7	Preset A2 (In)
8	Preset A3 (In)
9	Preset A4 (In)

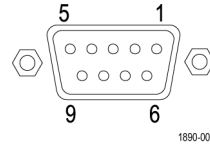

Ethernet Connector

The instrument provides a 10/100 BaseT Ethernet interface. The Ethernet connector is a standard RJ-45 connector.

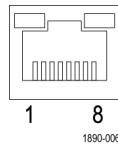

Selecting a Measurement

After you have selected a tile, you can choose what to display in it. The Measurement/Display type is independent for each tile.

1. Select a tile by pressing one of the numbered **DISPLAY SELECT** buttons.
2. Push a button corresponding to the measurement that you want to display in the selected tile:

- **WFM** - display of video waveform
- **PICT** - display of the picture generated by the video signal
- **GAMUT** - display selectable for three proprietary Tektronix views for checking the gamut of an SDI signal
- **VECTOR** - display of Vector or Lightning plots of color signals
- **AUDIO** - optional display of level (meters) and of a phase (plot) for monitoring audio signals. If option DDE is present, Surround Sound is also displayed
- **STATUS** - extensive displays views of signal status
- **MEAS** - a Tektronix proprietary display that simplifies timing correction. Includes Data List, AV Delay, Bowtie, and ANC Data displays (available on instruments with appropriate option(s) installed)
- **OTHER** - display for checking the LTC amplitude and noise, and verify LTC is locked to the video
- **EYE** - display for checking the transport layer of an SDI signal, including jitter (operation requires Option EYE)

3. Repeat steps 1 and 2 until you have selected measurement displays for all tiles that you want to define.

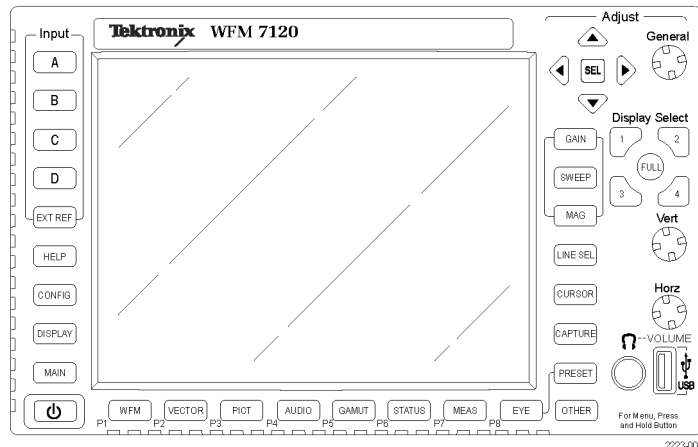

- To display the same measurements in more than one tile, select each tile in sequence, and then choose the same measurement for each one.

The display at right shows the display with **WFM** selected for three tiles.

NOTE. Audio and DataList displays can be displayed in only one tile at a time (unless Option SIM is installed).

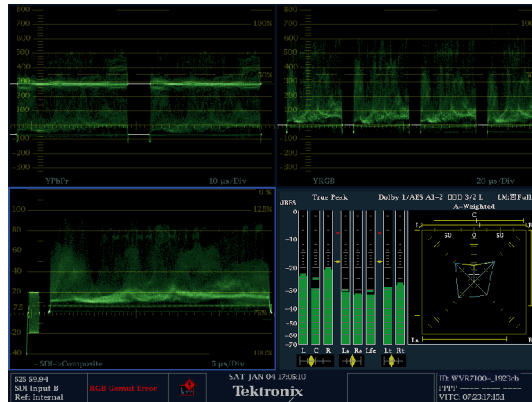

Setting Measurement Parameters

You can set up the measurements that you display using pop-up menus. Pop-up menus appear in the active tile. In general, they control only settings specific to the active tile. For example, the pop-up menu for the Waveform display enables you to set the Display Mode.

The pop-up menu will appear when called (see the procedure that follows), unless it is not appropriate for the current instrument setting (for example, trying to display the Gamut menu when viewing a composite input signal).

- Select a tile by pressing one of the numbered **DISPLAY SELECT** buttons.
- Push and hold the tile button for the measurement that you displayed in step 1.
- When the menu pops up, navigate it and make your selections as described in the steps that follow.

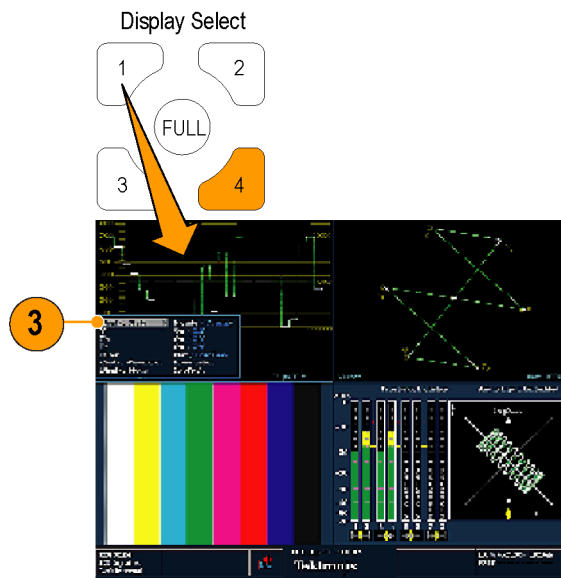

2223-004

4. Use the right and left keys to traverse between menu panels. The instrument surrounds the panel selected with a blue border.
5. Use the up and down arrow keys to select parameters in a menu.
6. Press **SEL** to set the selected parameter.

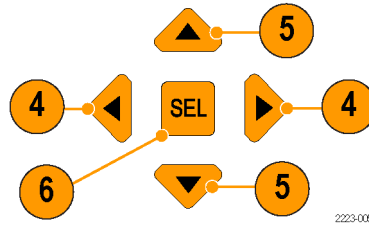

The **WFM** pop-up menu with display mode set to YPbPr is shown to the right.

NOTE. The selections in a pop-up menu can change depending on settings.

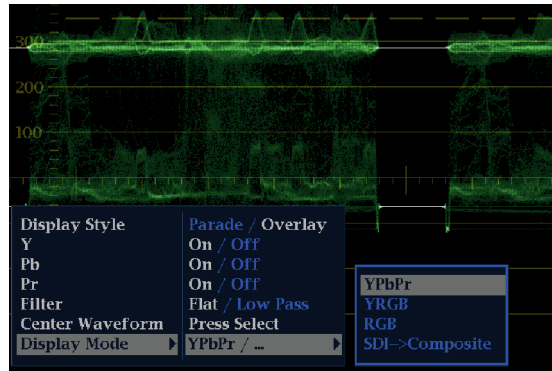

Selecting Signal Inputs

You can connect SDI (Serial Digital Interface) signals and select them for display. Depending on your instrument model and the options installed on it, you can also connect high definition component signals, standard definition component signals, and analog composite signals.

To Select an SDI Input

1. Connect digital component video signals to the SDI A and SDI B inputs on the rear panel.
 - Instruments with Option HD: The instrument automatically detects whether input is HD or SD.
 - Instruments with SD only: Connect SD signal only.

NOTE. The A and B inputs are separate inputs and cannot be used as a loop-through path.

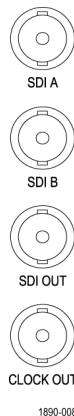

Options EYE/PHY, 3G

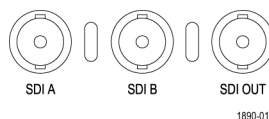

Option SD/HD

2. Connect analog composite signals to the A or B Composite inputs at the rear panel. (On Option CPS equipped instruments only.)
3. For the composite inputs, terminate the loop-through input properly at the rear panel for any inputs that are not routed to another device.



4. Press the **Input** button corresponding to the input that you want (SDI Input A shown).
5. Select a tile and measurement in which to display the input.

3 Gb/s Input Monitoring

With Option 3G installed, this instrument provides support for monitoring and measuring 1920 x 1080p/50/59.94/60 HD 3 Gb/s video formats. If your instrument also has Option JIT, it can generate a 3 Gb/s loop test signal as well as monitor a 3 Gb/s signal.

Three types of signals can be generated in Level A and Level B 3 Gb/s: 75% bars, 100% bars, and pathogenic. If you want to use a pathogenic signal, use Level A, if possible. For more information about 3 Gb/s signals, see the appropriate SMPTE standard. The following procedures show you how to set up your instrument for 3 Gb/s monitoring and generation.

To Set Up an External 3 Gb/s Input

NOTE. The factory default sets instruments with Option JIT so that the 3 Gb/s loop out test signal is OFF. If it has been turned ON, you need to turn it OFF before an external 3 Gb/s signal can be used.

1. Connect a 3 Gb/s video signal to the **SDI A** input at the rear panel.
2. Select a tile and measurement in which to display the input.

NOTE. If your instrument does not have Option JIT, you can use a second WFM with Option JIT to generate the 3 Gb/s signal. Connect the SDI OUT of the generating unit to the SDI A of the monitoring unit.

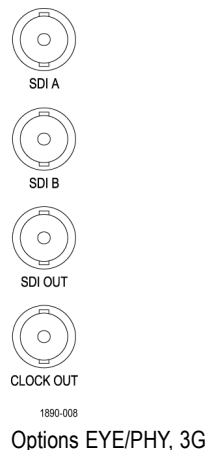

To Set Up Internal Generation of a 3 Gb/s Signal

1. Press the **CONFIG** button.
2. Select **Outputs > SDI Output > Loop Out Aor Loop Out B.**

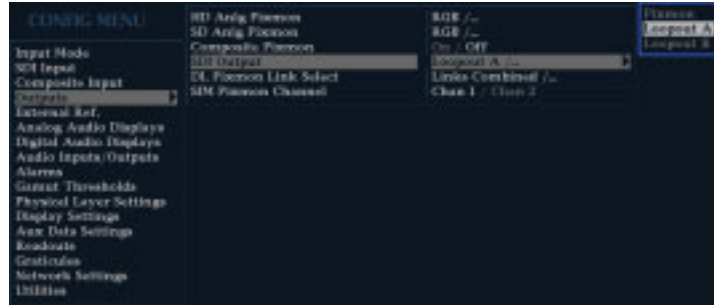

3. Connect the **SDI OUT** to the **SDI A** or **SDI B** input at the rear panel.
4. Select a tile and measurement in which to display the input.



1890-008

Options EYE/PHY, 3G

Dual Link Input Monitoring

With Option DL installed, this instrument provides greater capability for monitoring higher resolution signals than the traditional single link input. Instruments with this option use two HD SDI inputs to monitor a signal. The following procedure shows you how to set up your instrument for dual link monitoring.

To Set Up Dual Link Inputs

1. Connect a Dual Link SDI video signal to the A and B SDI inputs at the rear panel. SDI A is link A; SDI B is link B.

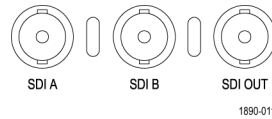

Option SD/HD configuration

2. Check that the two input buttons in use light up on the front panel. By default, the instrument automatically detects when a signal is present.

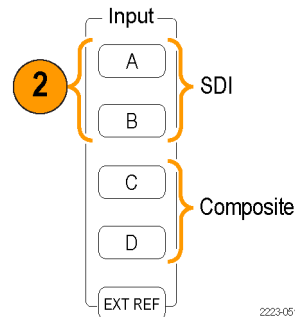

NOTE. If a SMPTE352–VPID Type 1 signal is present, the instrument will automatically detect it. If a Type 0 signal is present, you need to select Sample Structure from the SDI Input submenu of the Configuration menu. XYZ sample structures are supported. See the Specifications and Performance Verification Technical Reference on the Product Documentation CD for sample details.

3. Select a tile and measurement in which to display the input.

To Display a Dual Link Signal

1. Select a tile by pressing a numbered Display Select button.
2. Press a Measure Select button, such as WFM, to view the display you want.
3. Select each tile in turn and choose the desired display. Shown to the right is an example of a dual link display configuration.

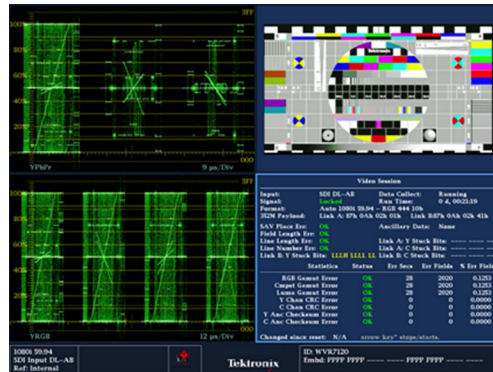

Your instrument will automatically detect the format on signals with SMPTE352M (VPID) while operating on dual link signals. You can then view combined Link A, Link B, and Alpha Channel information, which can help with the identification of correct content. Alpha Channel information will be visible, if present. The next image illustrates where this information appears in the waveform.



Simultaneous Input Monitoring

With Option SIM installed, this instrument can monitor two separate signals simultaneously. In this mode, the instrument display is divided into two sides, each with two tiles per input. This allows you to conveniently view measurement and status displays from two signals at the same time. For more detailed information about Option SIM, see the *User Technical Reference* on the *User Documentation CD* that shipped with your instrument.

To Set Up Simultaneous Input Monitoring

1. Connect a component video signal to the A and B SDI inputs at the rear panel:

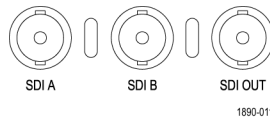

Option SD/HD

NOTE. Instruments with Option HD: The instrument automatically detects whether the input is HD or SD.

2. Connect any analog composite signals to the A or B Composite inputs at the rear panel (for Option CPS equipped instruments only).

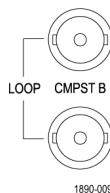
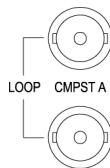

Option CPS

3. Terminate the loop-through inputs properly at the rear panel for any composite inputs that you connected.

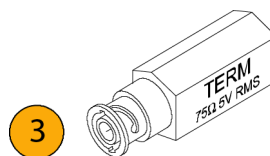

4. Press the **CONFIG** button, select **Input Mode**, press **SEL**, and then press the right arrow key to select **Simultaneous**.

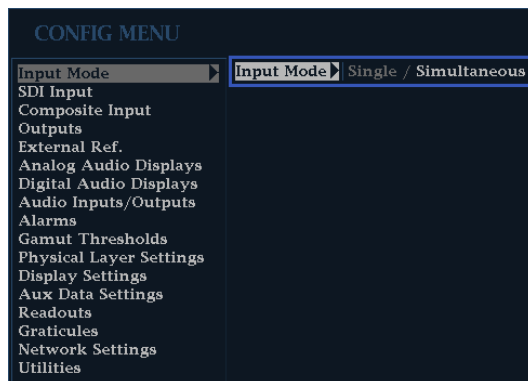

5. Select a tile for a specific channel and press the appropriate Measure Select button to view the display you want. Do this for each tile. The images to the right are examples configurations.



NOTE. The status bar at the bottom of the screen shows which side of the display is associated with which link.

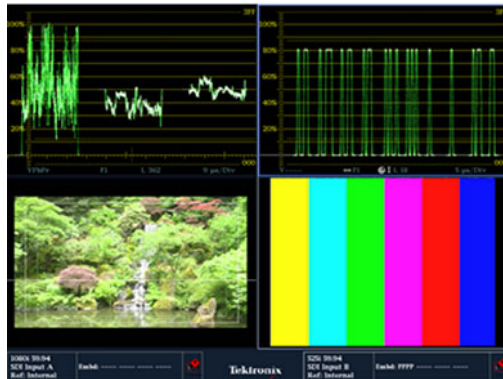

Measuring Audio/Video Delay

Option AVD lets you take audio/visual delay (AVD) measurements and display them in both numeric and graphical formats. AVD delay measurements require an appropriate AVD sequence signal source, such as from a Tektronix TG700 signal generator. This capability is useful for facility maintenance and setup applications because it allows for out-of-service testing to quickly ensure synchronization across a facility. AVD supports digital and composite inputs, and the following audio inputs: embedded, AES, and analog.

To Show the Audio/Video Delay Display

1. Select a tile by pressing a numbered Display Select button, and then press the **MEAS** button.
2. In the measurement menu that appears, select **AV Delay**.
3. When you are ready to take a measurement, select **AV Delay Enable** and press the right arrow key to highlight **On**.
4. Configure the other tiles as wanted. An example of a configured display is shown to the right.
5. To change the channels you want to monitor, activate the Audio Display tile, press the **AUDIO** button to display the Audio menu, and select **Phase Pair**. You can then select the channels you want.

NOTE. If you do not see numbers, but instead see an *Invalid* reading, after AV Delay in the AV Delay Display, this means that the AV Delay sequence was not detected. In this case, you would need to check your signal source to correct the problem.

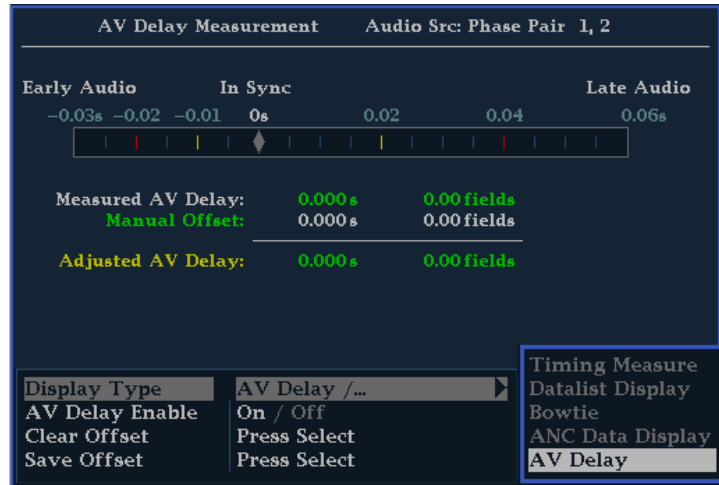

Setting Gain, Sweep, and Magnification

Each tile maintains its own settings independent of the other tiles. These settings include Gain, Sweep, Magnification, and Display Type (among others). For instance, when you switch a tile to a different measurement, the Gain and Sweep settings will be changed to what they were the last time the selected measurement was displayed in the tile. Gain, Sweep, and Magnification do not apply to all display types.

To Set Gain

1. Select a tile press the **WFM** button.
2. Press and hold the **GAIN** button.
3. If you enable **VAR Gain**, set the gain that you want using the **GENERAL** knob.
4. If you select **Gain Settings**, you can choose between x2, x5, or x10 gain.

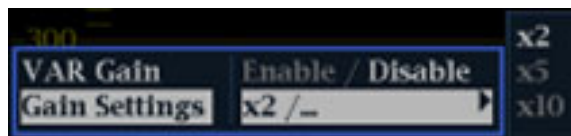
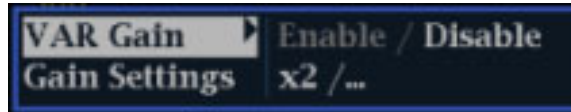

To Set Sweep

1. Press and hold the **Sweep** button.
2. Select the sweep setting that you want.



To Set Magnification

1. Press and hold the **MAG** button.
2. Select the magnification setting that you want.

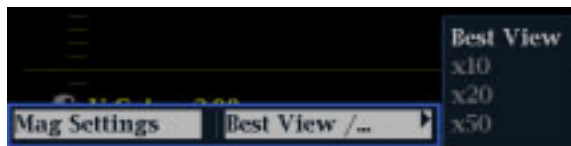

Using Presets

Presets let you save up to four groups (with eight custom setups per group) for later recall. You can also recall a factory predefined setup. The eight front panel preset buttons are defined by one of the four preset groups, selected in the Preset menu.

To Recall the Factory Preset

1. Press and hold the **PRESET** button to display the preset menu and select **Recall Preset** and then **Recall Factory Preset**.

The front panel setup will revert to default factory settings.

To Save a Setup to a Preset

2. Set up the instrument as you want it.
3. Press the **PRESET** button.
4. Press and hold the illuminated button of the measurement you want to save until the **Preset # saved** message pops up on the screen.

The setup will be stored for later recall.

To Recall an Existing Preset

5. Press the **PRESET** button and then press the numbered button for the preset you want to recall.

The front panel setup will switch to the saved preset corresponding to the button pressed.

To Clone a Setup Between Instruments

You can store presets as files using the USB drive and upload them to another waveform monitor. See *Cloning Setups (Presets)* in the *Technical Reference* (found on the *Product Documentation CD*) for more information.

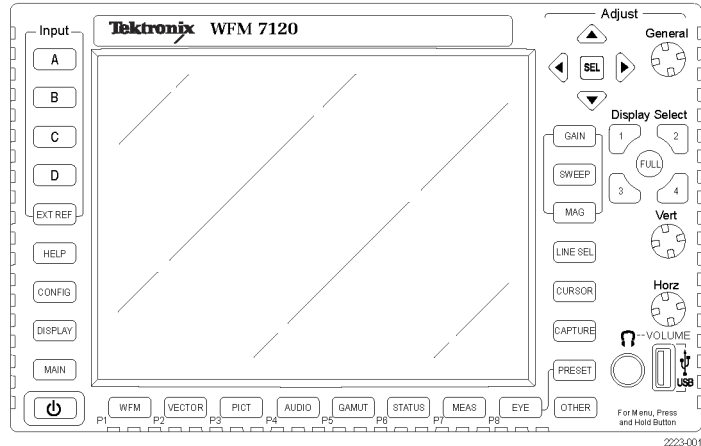

Measuring Waveforms with Cursors

Cursors enable you to measure time or voltage on a waveform. Cursors appear only in a tile set to Waveform mode. If the active tile is not in Waveform mode, then an error message is displayed.

To display and adjust cursors

1. Choose a tile that is currently displaying a waveform.
 2. Press and hold the **CURSOR** button to display the cursor menu and then select the cursor style you want: **Voltage**, **Time**, or **Voltage + Time**. (Once the cursors are activated and the pop-up menu is closed, pushing **CURSOR** again turns the cursors off.)
 3. Push the arrow keys to select the active cursor:
 - If Voltage or Time cursors are displayed, press any arrow key to activate a cursor.
 - If Voltage + Time cursors are both displayed, press either the up or down arrow key to select between voltage cursors. Press either the left or right arrow key to select between the time cursors.
 4. Turn the **GENERAL** knob to adjust the selected cursor on the waveform. The active cursor readout appears in yellow with a knob icon.
- NOTE.** To quickly center the active cursor on screen, press and hold the **SEL** button.
5. Repeat steps 3 and 4 to adjust the other cursor.
 6. Read the cursor measurement in the Cursors readout.

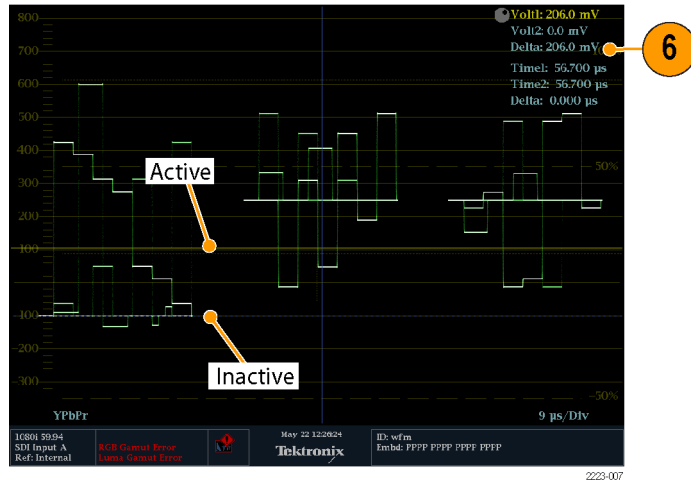

To Switch Among Cursor Styles

1. Press and hold **CURSOR** to display the Cursor pop-up menu.
2. Select **Cursor Style**, and press **SEL** to change the focus to the submenu.
3. Select the desired cursor style using the up/down arrow keys. The three styles of cursors available are:
 - **Voltage** – display the voltage level at each cursor and the voltage difference between the two cursors.
 - **Time** – display the position of each cursor relative to the start of the sweep and the difference between the two cursors.
 - **Voltage + Time** – displays both the Voltage and Time cursors.

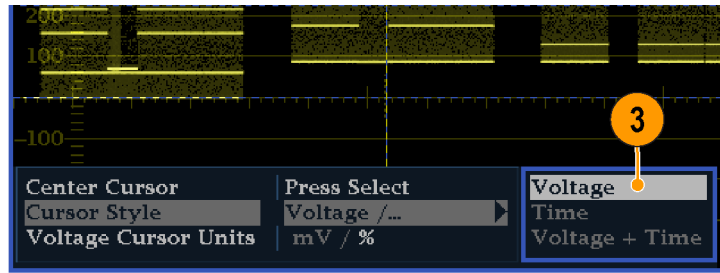

2223-008

Usage Tips

If you use other functions, such as Line Select, while cursors are active, the knob will be assigned to those other functions. Press **CURSOR** to transfer the knob control back to cursors.

You can display independent cursors in all four tiles at the same time.

Cursors track the live trace, so they may not be correctly registered on a frozen trace.

Cursors can be used with the Eye Display (Option EYE or PHY only) to measure electrical characteristics of an SDI signal. (See page 52, *Monitoring the SDI Physical Layer*.)

For cursor measurements, you can use any gain setting, including variable gain (the waveform and the cursors are equally affected). Higher gain settings help match the cursor to the waveform.

Capturing the Display

There are two modes of capturing: Freeze and Buffer. The first mode can freeze a single tile, or all tiles simultaneously, and saves it to memory while other displays and information continue to be live. For this type of capture, frozen information is lost when the power cycles.

The second mode, buffer capture mode, is only available with the WFM7120. Buffer capture captures and stores signal data for later recall to the instrument or to the USB drive for later analysis. The instrument can be set to buffer capture manually or using triggers. For procedures for copying the capture buffer to a USB drive, see the *Technical Reference* on the *Product Documentation CD* shipped with your instrument. Both modes are useful for comparing sources or capturing transient events.

NOTE. Both capture freeze and capture buffer information can be downloaded from the instrument Web page.

Capture freeze works in both four-tile and full-screen modes, however, if you freeze a trace in 4-tile mode, the image will not be shown if you go to full-screen mode. The image will still be available if you go back to 4-tile mode. Likewise, if you freeze a waveform image in a tile and then switch the tile to another measurement such as Vector, the frozen waveform image will be hidden. If you then change the tile back to waveform, the image will reappear.

NOTE. For waveform displays, the captured image is shown in a different color to distinguish it from the live image. For all displays, the instrument continues to log error status in the background while the display is captured.

To View the Freeze Display Mode

1. Push and hold the **Capture** button to display the pop-up menu.
2. Select **Freeze** as the Capture Type.
3. Use the navigation keys to select **Display Mode**, and then press **SEL** to set the freeze mode to one of the following:
 - **Live Only** allows you to keep a frozen image, but not display it.
 - **Frozen Only** allows you to see artifacts in the frozen trace more easily.
 - **Live + Frozen** allows comparisons and matching. (Status and Audio displays do not support this mode.)

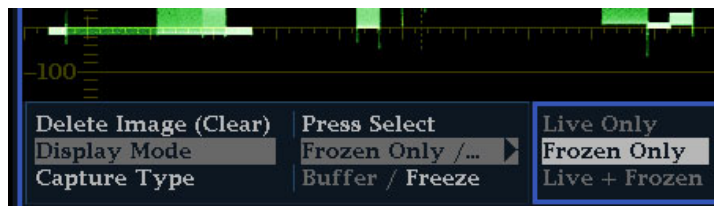

NOTE. The display mode chosen is specific to the tile selected, and can be set independently.

To View the Buffer Display Mode

1. Push and hold the **Capture** button to display the pop-up menu.
2. Use the navigation keys to select **Capture Type**, and then press **SEL** to set the type to **Buffer**.
3. From the **Display Mode** selection, choose from the following:
 - **Live Only** allows you to keep a captured image, but not display it.
 - **Buffer Only** allows you to see artifacts in the captured trace more easily.
 - **Live + Buffer** allows comparisons and matching.

NOTE. The capture type chosen is specific to the tile selected for FREEZE, but is universal for BUFFER.

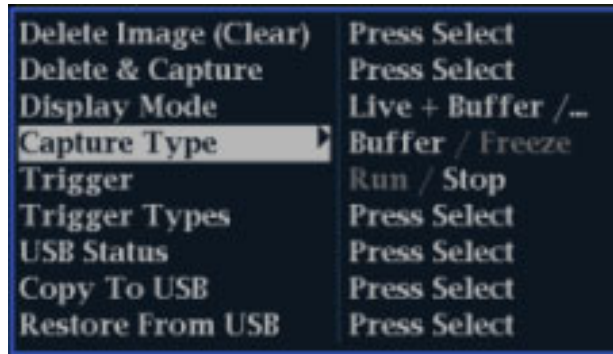

To Buffer Capture on a Trigger

1. Push and hold the **Capture** button to display the pop-up menu, and then set the capture type to **Buffer**.
2. Select **Trigger** and then press the **SEL** button to highlight **Run**.
3. Select **Trigger Types** and press the **SEL** button to view the trigger menu.
4. Select the boxes next to the triggers you want to buffer capture on.



To Copy a Buffer Capture to USB

1. Push and hold the **Capture** button to display the pop-up menu.
2. Select **Copy to USB** and then press the **SEL** button.
3. Use the arrow keys to name the file to copy, and then select **Accept**.

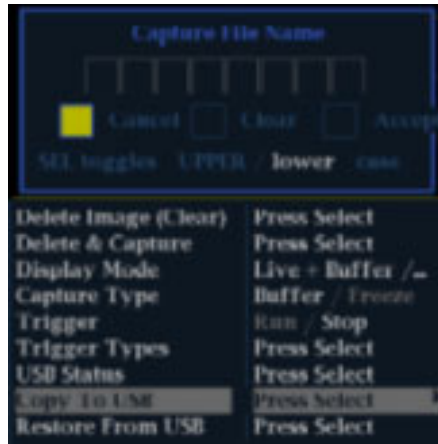

To Halt Display Update

1. Push the **CAPTURE** button. For most displays, this will stop updates.

To Delete the Capture Display

1. Select the display tile for the frozen display that you want to delete.

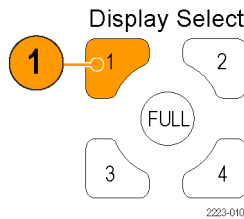

2. Press and hold the **Capture** button to display the pop-up menu. **Delete Image (Clear)** will already be selected.

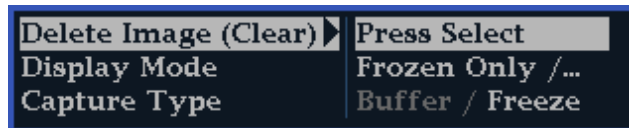

3. Press **SEL** to delete the frozen image. The pop-up menu is automatically removed from the display when the frozen image is deleted.

Usage Tips

Freeze capture can be configured to act on only the active tile or on all tiles. To adjust this setting, select **Display Settings > Freeze Effects** from the **CONFIG** menu.

Cursors track the live trace, so they may not be correctly registered on a frozen trace. If you change parameters such as position, sweep rate, or gain, then the cursors may not be accurate relative to a frozen trace.

Setting Line Select Mode

To Toggle Line Select Mode

1. Select the tile containing the display for which you want to set Line Select Mode.

NOTE. Line Select Mode can only be active on one tile at a time, but the line select brightup cursor does appear in other tiles and moves as you select lines in the active tile.

2. Press the **LINE SEL** button to toggle Line Select Mode on or off. When on, the tile displays the selected line information only.
3. Press the left or right arrow key to select F1 (field 1), F2 (field 2), F3 (field3), F4 (field 4), or All.
4. The line and field information will appear at the bottom of the display screen.
5. Turn the **GENERAL** knob to select the line you want to view.

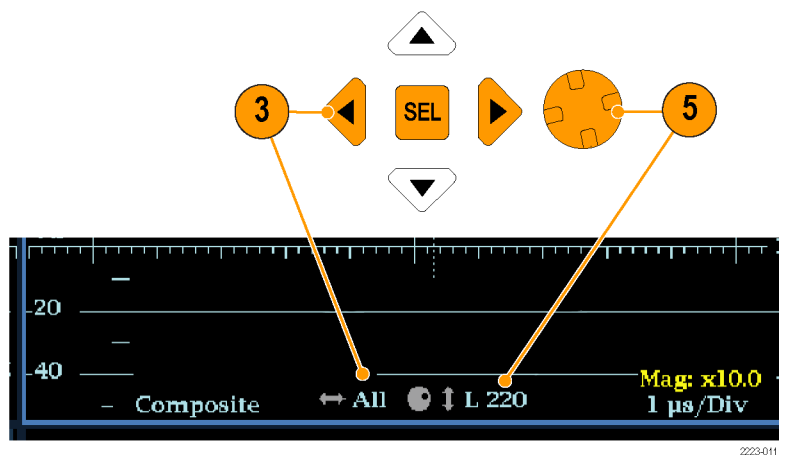
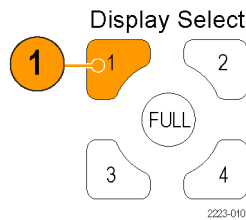

Configuring Your Instrument

The Configuration menu is used to change instrument settings that are changed only occasionally or settings that are not specific to a tile, such as printer settings. To change a setting, you must highlight it. The following procedures will introduce you to navigation of the configuration menu.

To Traverse the Menu Panes

1. Press the **CONFIG** button to display the Configuration menu.

The Configuration menu is displayed on the top or bottom half of the screen opposite the active tile.

2. Use the left/right arrow keys to move the selection back and forth among panels.

The selected, active pane has a blue outline.

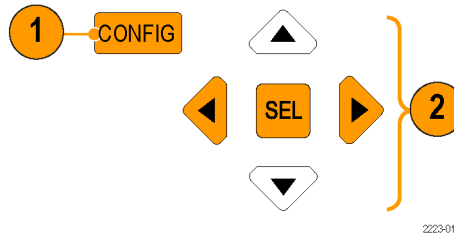

2223-019

Selecting/Adjusting a Parameter

3. Notice which pane is active. The selected, active menu item is highlighted by a white menu bar; the selected item in unselected menus is highlighted by a blue menu bar.

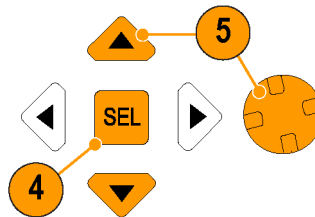

2223-014

4. Use the up/down arrow keys (or the General knob) to move the selection up and down the menu entries in the selected pane. Press the **SEL** button (or right-arrow key) to toggle between parameter settings.
5. If the menu item selected results in the knob icon appearing in the menu, use the General knob to adjust the selected parameter.

Using Online Help

The online help is both a quick reference to instrument operation and the exclusive reference for instrument operation details. The online help is:

- Context-sensitive. The topic displayed depends on what is displayed in the active tile when the online help is selected or what control is operated after help is selected.
- Navigable. The Contents and Topic Selector panes, along with Links within the topics, provide access to topics.

To Display and Navigate Online Help

1. Press **HELP**.
2. Use the **GENERAL** knob or the up/down arrow keys to highlight an entry in the Contents (entries never change).
3. Press **SEL** to select the highlighted category.

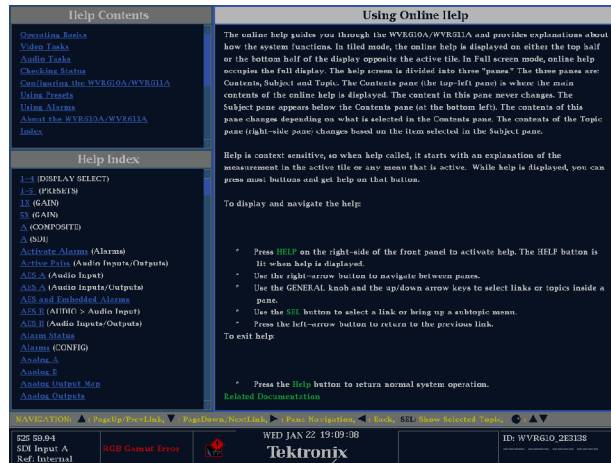

4. Press the right-arrow key to move selection to the Topic Selector pane (entries change with the selection made in steps 2 and 3).
5. Use the **GENERAL** knob and the up/down arrow keys to select among the topics listed for the heading selected in step 2.
6. Press **SEL** to display the selected topic.

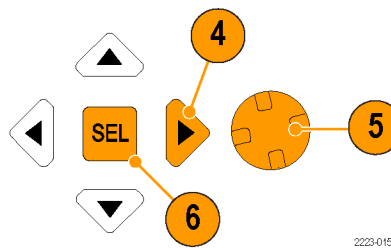

To Follow a Link Within a Help Topic

1. Press the right-arrow key to move selection to the Topic pane.
2. Highlight a link using the **GENERAL** knob or the up / down arrow key.
3. Press **SEL** to jump to the linked-to topic.
4. Press the left-arrow key to go back to the previous topic.

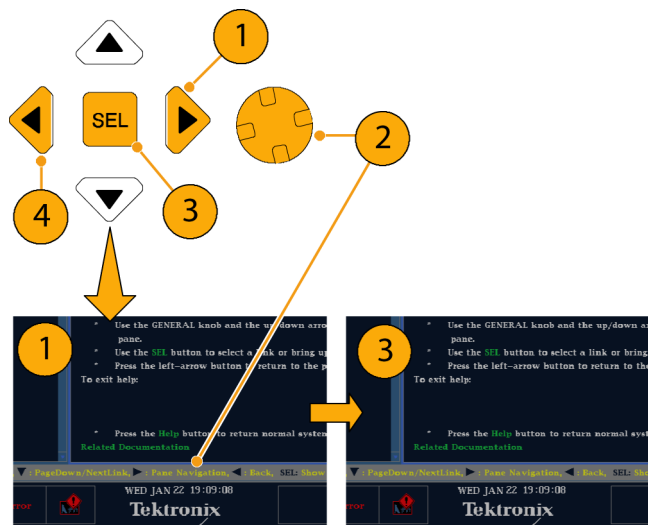

To Get Context Sensitive Help

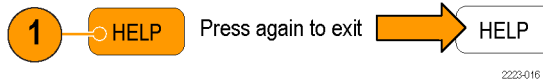

1. When a menu in the active tile is displayed, select the menu setting for which you want help information, press the **HELP** button, and help on that setting will appear.
2. You can also operate (press, select, or turn) a control for which you want help information and the help topic pane will display help on the control you used.
3. Press **HELP** again to exit online help.

NOTE. You can also access instrument online help through a computer network to the instrument. See *Remote Communication in the Technical Reference (located on the User Documentation CD) for more information on using the Web Browser from the remote Java Applet or Application.*

To Adjust Headphone Volume and Source



WARNING. To avoid damaging your hearing, always turn the volume down to the minimum before you put on headphones, and then turn it up slowly.

1. Press the **AUDIO** button to bring up the audio display in a tile.

NOTE. The headphone icon appears at the bottom of the Audio display.

2. Use the Horizontal knob to adjust the volume.
3. Adjust the headphone source by pressing the **AUDIO** button, selecting **Headphone Input**, and then selecting the source you want.



To Connect Directly to a PC

A common configuration is to connect the monitor directly to a PC.

1. Connect your waveform monitor to a PC through a HUB as shown (the actual IP addresses will depend on your network). A standard Cross-Over cable can be substituted for the HUB.
2. Set up the monitor as though you are going to connect to a network. Choose Manual IP mode and set the IP address manually. Be sure to set an address that is compatible with the setting of your PC.
3. Configure the SNMP setup, if used.

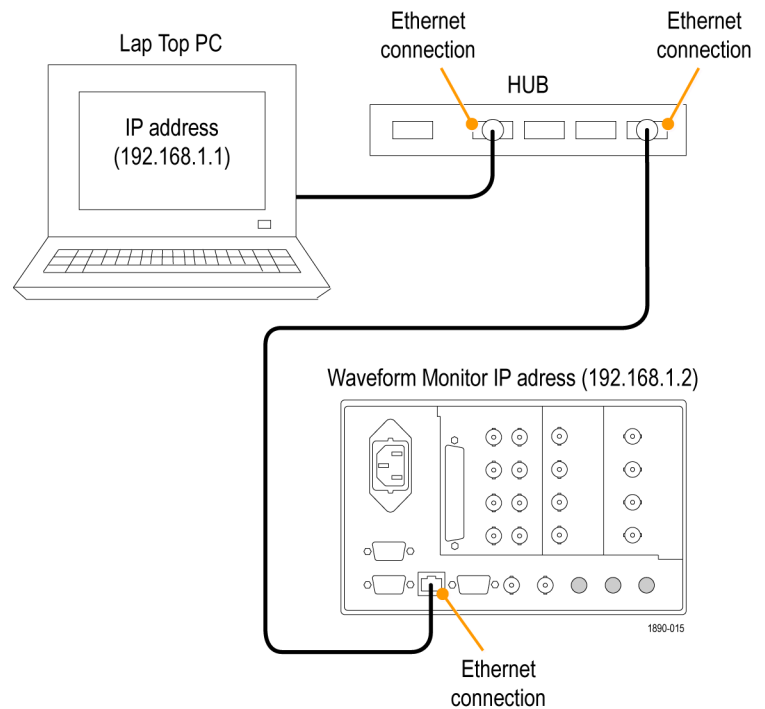

Checking Chroma/Luma Delay (Lightning Display)

The Lightning display can be used for interchannel timing measurements. If the color-difference signal is not coincident with luma, the transitions between the color dots will deviate from the center mark of a delay scale. The amount deviated represents the relative signal delay between luma and the color-difference signal.

1. Connect a signal containing color bar information, terminating the signal properly.
2. Select the input corresponding to the signal connected.
3. Select a tile.
4. Press and hold the **VECT** button to display the signal in a tile and pop up the Vector menu.
5. Use the Selection Keys and Button to set the menu in the steps that follow.
6. If Display Type is Vector, select **Lightning** in the menu.
7. Set BarTargets to match your input signal.
8. Select **Center Waveform**, and press **SEL** if you want center your waveform.
9. Press the **VECT** button to close the menu.

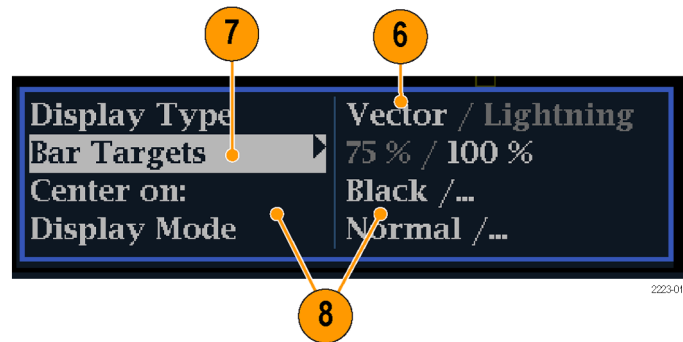
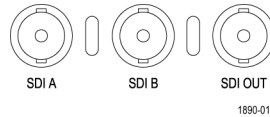

10. Determine where transitions intersect the delay scales and derive the timing error in nanoseconds, as deflected from the center mark:

- The center mark of the nine marks spanning each green-magenta transition is the zero error point.
- Alignment to a mark towards black means the color-difference signal lags with respect to luma.
- Alignment to a mark towards white means the color-difference signal leads the luma signal.
- The upper half of the display measures the Pb to Y timing; the bottom half measures the Pr to Y timing.

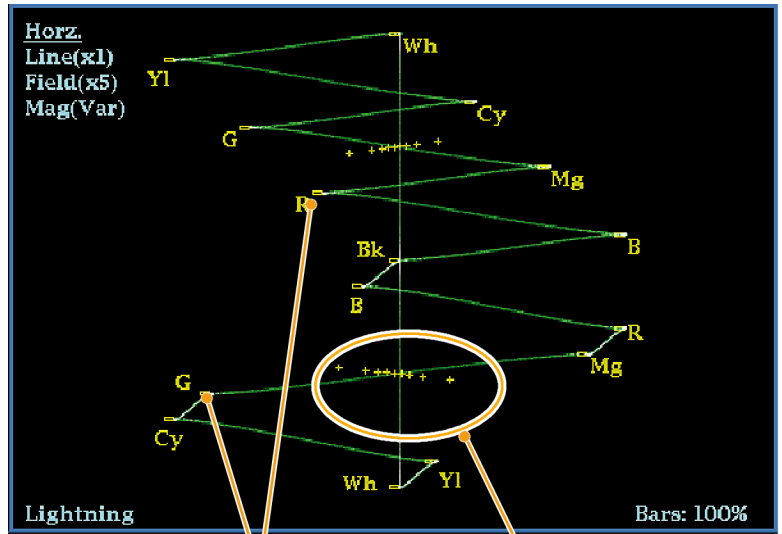

Green-to-Magenta transitions Delay scale

The + tic marks on the graticule indicate the following timing errors:

Tic Mark	SD Timing Error (ns)	HD Timing Error (ns)	1080p 50, 59.94, 60, 3Gbps (3 Gb/s and dual link formats) Timing Error (ns)
0 marks	0	0	0
1st	20	2	1
2nd	40	5	2.5
3rd	74 ¹	13.5	6.75
4th	148 ²	27	13.5

¹ Luma sample
² Chroma sample

Checking Gamut

Signals that are legal and valid in one signal representation may not be legal in another representation. Specifically, signals which are legal in the Digital YCbCr representation may not be legal if transcoded to RGB or encoded to NTSC / PAL. Any signal that fails this test is considered out of gamut.

Your instrument supports multiple displays and alarms to detect out of gamut signals. The flexible, tiled display allows you to simultaneously view several gamut measurements to learn which is most appropriate for a given application. The displays are and their uses follow:

- Diamond for checking that SDI signals conform to legal RGB gamut space
- Split Diamond separates the upper and lower diamonds to show excursions below black; otherwise it is identical to the Diamond display
- Arrowhead for checking if an SDI signal is legal for composite color space
- Composite Waveform modes for checking both SDI and composite signals for legality in composite color space

Diamond, Split Diamond, and Arrowhead have adjustable thresholds. If the signal goes outside the area defined by the thresholds, the signal is out of gamut. If these limits are exceeded, then the instrument can generate alarms if configured to do so. For composite waveforms, the legal limit is simply the maximum level allowed for the combination of luma and chroma. This limit depends on the application. For example, a video tape machine may be able to record and play out signals with higher luma and chroma components than a transmitter.

Setup for Gamut Checks

1. Connect a video signal and terminate it properly.
2. Select the input corresponding to the signal connected.
3. Select a tile.
4. Press and hold the **GAMUT** button to display the signal in a tile and pop up the GAMUT menu.
5. Use the arrow keys and **SEL** button to set the menu to one of these three gamut displays:
 - Diamond. Use to detect, isolate, and correct RGB component gamut errors.
 - Split Diamond. Use to reveal hard-to-find black gamut errors.
 - Arrowhead. Use to detect composite gamut errors, without employing a composite encoder.
6. Press the **GAMUT** button to close the menu.

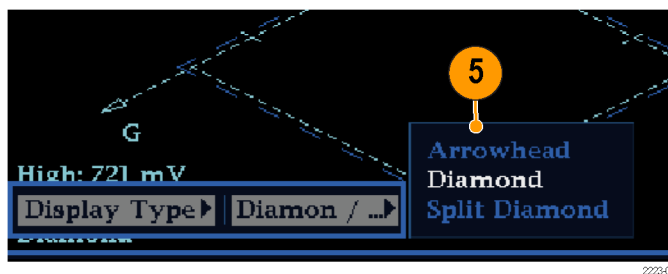
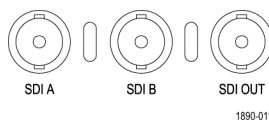

Checking RGB Gamut

The Diamond display effectively shows how the R, G, and B signals relate, making it a good tool for detecting gamut errors. The instrument converts the Y , P_b , and P_r components recovered from the serial signal to R, G, and B to form the Diamond display. To predictably display all three components, they must lie between peak white, 700 mV, and black, 0 V.

For a signal to be in gamut, all signal vectors must lie within the G-B and G-R diamonds. Conversely, if a signal vector extends outside the diamond, it is out of gamut. The direction of an excursion out of gamut indicates which signal is excessive. Errors in green amplitude affect both diamonds equally, while blue amplitude errors affect only the top diamond and red errors affect only the bottom diamond.

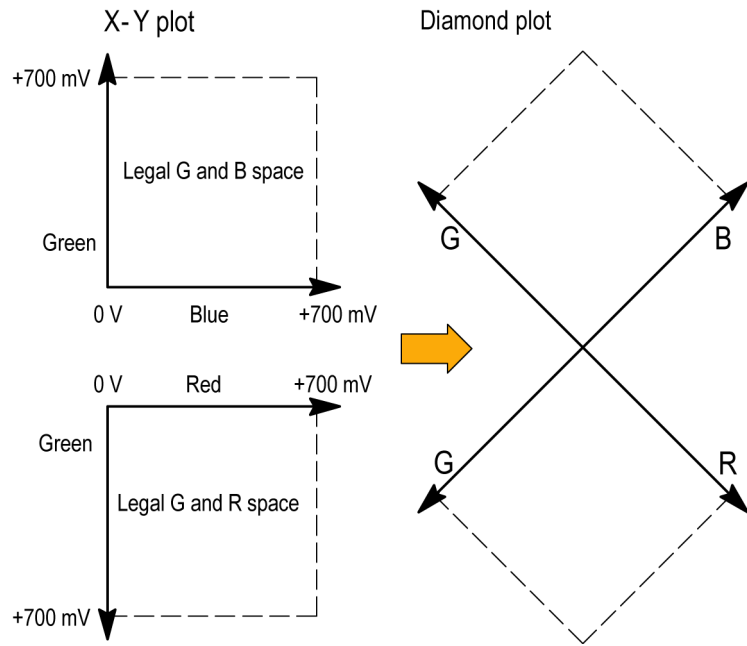

1. Perform the *Setup for Gamut Checks* procedure. Select **Diamond** in step 5. (See page 45.)
2. Compare the signal to the display to determine out of gamut components, noting the following:
 - The intensity of a vector indicates its duration.
 - A momentary out-of-gamut condition appears as a faint trace. Long duration violations show as a bright trace.

See the following step for some sample out-of-gamut signals.

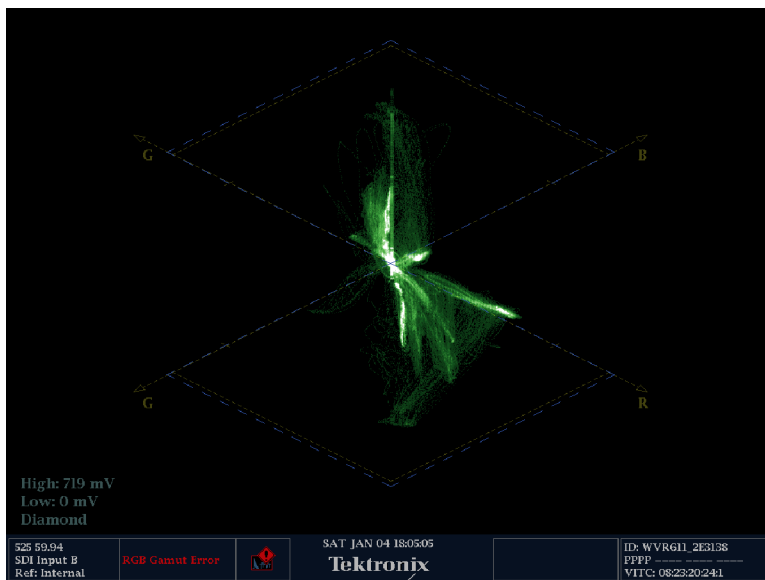

3. Consider the following examples when evaluating for out of gamut components:
 - A. Example A:
R - Ok
G > 700 mV
B - Ok
 - B. Example B:
R - Ok
G - Ok
B > 700 mV
 - C. Example C:
R - Ok
G - Ok, 350 mV
B < 0 mV

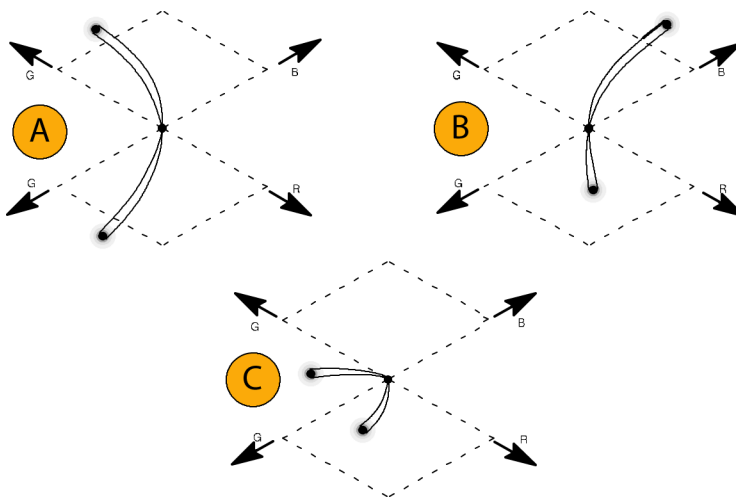

Usage Notes

As with the lightning display, bending of the transitions indicates timing delays. When a color bar signal is applied, the vertical axis becomes an indicator of delay errors.

On the Diamond display, monochrome signals appear as vertical lines. Nonlinear component processing, such as from a gamma corrector that alters white balance, can cause deviations along the vertical axis.

To isolate gamut bright-ups, try the following:

- Use the **LINE SEL** button to select individual lines
- Use the **PICT** display to examine the signal (turn on gamut bright-ups in the Display Settings submenu of the Configuration menu)

- Use the **Arrowhead %** setting (found in the Gamut Thresholds submenu of the Configuration menu) to specify a percentage of the screen to ignore for gamut violations.

Checking Composite Gamut

The Arrowhead gamut display plots luminance (Y) against chrominance (C) to check if the composite signal adheres to standard gamut. NTSC and PAL Arrowhead displays (75% Color bars) and indicates the values of the graticule lines. The arrowhead shape of the graticule results from overlaying the standard limits for luminance and luminance-plus-peak chrominance.

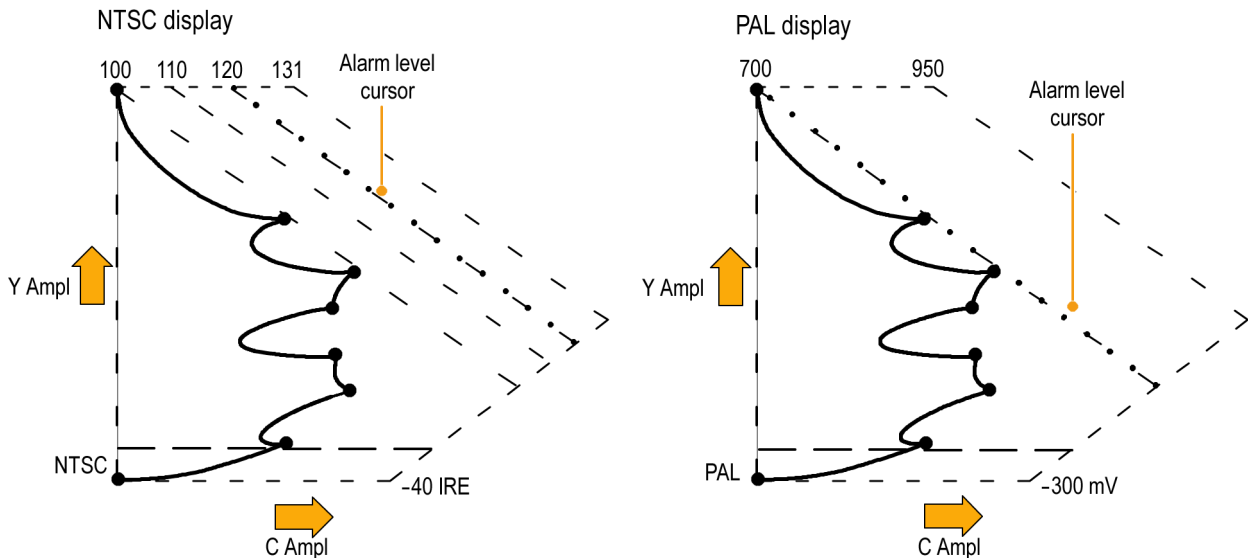

1. Perform the *Setup for Gamut Checks* procedure. Select **Arrowhead** in step 5. (See page 45.)
2. Compare the signal to the display to determine out of gamut composite components, noting the following:
 - Signals exceeding the luminance amplitude gamut extend above the top horizontal limit (top electronic graticule line).
 - Signals exceeding the luminance plus peak chrominance amplitude gamut extend beyond the upper and lower diagonal limits.
 - The bottom horizontal line shows the minimum allowed luminance level of 7.5 IRE for NTSC and 0 mV for PAL.

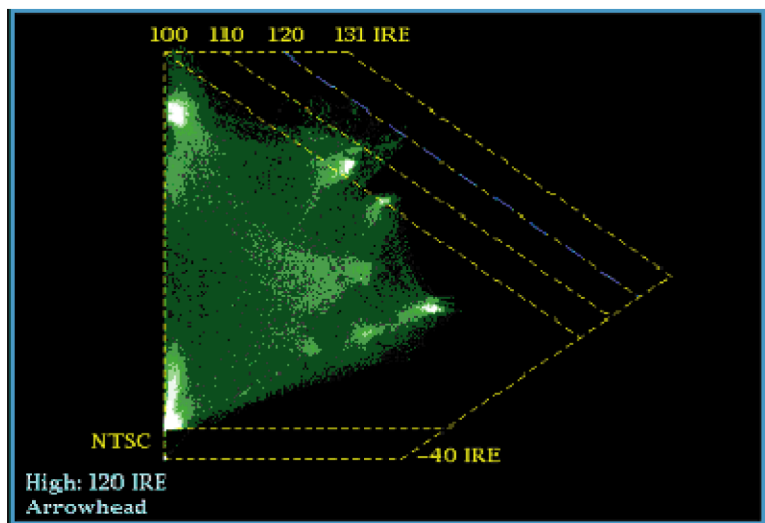

Usage Notes

- To adjust the IRE level limits, do the procedure *Adjusting Gamut Limits*. (See page 51.)
- To automate this check, do the procedure *Automating Gamut Checks*. (See page 50.)

Checking Luma Gamut

Luma limit thresholds can be configured for identifying luma exceeding threshold limits. They apply to both the incoming SDI and to the arrowhead representation of the SDI input as a composite signal. By defining these levels in percent, they automatically account for the presence or absence of setup. The thresholds are affected by your choice of set-up or no set-up for the Arrowhead display.

1. Perform the *Setup for Gamut Checks* procedure. Select **Arrowhead** in step 5. (See page 45.)
2. Compare the signal to display to determine out of gamut luminance. Note the following:
 - The adjustable thresholds are indicated by the dark blue horizontal graticule lines.
 - The thresholds are defined in terms of percent of full scale.
 - The range for the Upper limit is 90% to 108%.
 - The range to the Lower Limit is -6% to +5%.

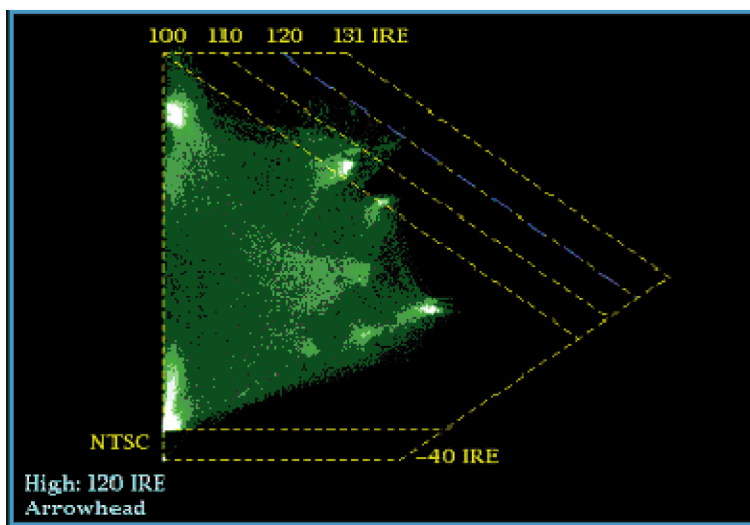

Another useful Arrowhead function is a measure of how well the active video signal is using the dynamic range of the video channel. A properly adjusted signal should be centered in the arrowhead graticule and have transitions that approach all the limits.

Automating Gamut Checks

You can use alarms to automatically monitor for out of gamut conditions:

1. Press the **CONFIG** button to display the Configuration menu.
2. Use the left/right arrow keys and **SEL** button to select **Alarms** and then **Video Content**.

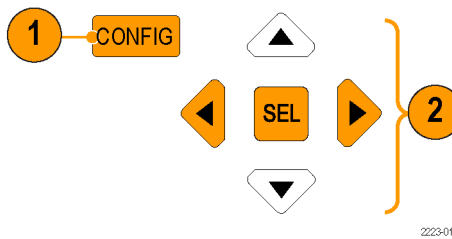

3. Use the up/down arrow keys to move to each the alarm that you want to set. Press **SEL** button to toggle the alarm on (X) or off.

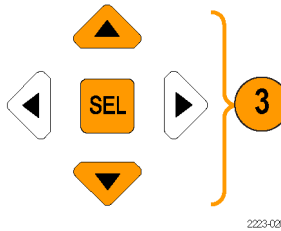

4. When you have configured the Alarms as you want them, move to the **Select here** box and select it.

VIDCONTENT	Screen	Logging	Beep	SNMP	Ground Closure
	Text / Icon			Trap	
RGB Gamut	<input checked="" type="checkbox"/>	<input checked="" type="checkbox"/>	<input type="checkbox"/>	<input type="checkbox"/>	<input type="checkbox"/>
Composite Gamut	<input checked="" type="checkbox"/>	<input checked="" type="checkbox"/>	<input type="checkbox"/>	<input type="checkbox"/>	<input type="checkbox"/>
Luma Gamut	<input checked="" type="checkbox"/>	<input checked="" type="checkbox"/>	<input type="checkbox"/>	<input type="checkbox"/>	<input type="checkbox"/>

Select here  returns to the Config Menu

4

5. Check that **Enable Alarms** is set to **On** in the Alarms menu before leaving the Alarms menu.

NOTE. For information on Alarms, press the **HELP** button while Alarms is selected in the configuration menu.

CONFIG MENU		
Input Mode	Enable Alarms	Off / On
SDI Input	Set all alarms to this mask	Press SEL
Composite Input	Video Content	Press SEL ▶
Outputs	Video Format	Press SEL
External Ref.	Reference and Composite Input	Press SEL
Analog Audio Displays	SDI Input	Press SEL
Digital Audio Displays	Timecode	Press SEL
Audio Inputs/Outputs	Audio Content	Press SEL
Alarms	AES/Embedded	Press SEL
Gamut Thresholds	Dolby Audio	Press SEL
Physical Layer Settings	Closed Captions/Teletext	Press SEL
Display Settings	Metadata	Press SEL
Aux Data Settings	Physical Layer	Press SEL
Readouts	System and Diagnostics	Press SEL
Graticules		
Network Settings		
Utilities		

5

6. Press **CONFIG** to exit the menu.

Adjusting Gamut Limits

1. Press the **CONFIG** button to display the Configuration menu.
2. Use the left/right arrow keys and **SEL** button to select Gamut Thresholds.
3. Press the **SEL** button to enter the submenu, and then use the arrow keys and **SEL** button (and General knob, when indicated) to select and set the various thresholds.

Note that you can also reset thresholds to defaults.

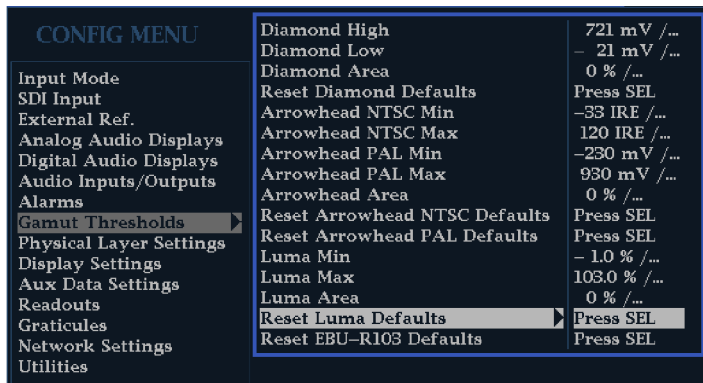

Monitoring the SDI Physical Layer

With Options EYE and PHY installed, your instrument can use an eye pattern display, eye measurements, a jitter display, jitter detection and measurement, and an SDI status display to monitor and measure the SDI physical layer.

With Option 3G installed, your instrument can monitor and measure the SDI physical layer but without the use of eye pattern displays or eye measurements. Option 3G cannot be installed with Option EYE or PHY.

Display Types

- **Eye Display.** This display allows you to use voltage and time measurement cursors and their readouts to monitor amplitude and timing measurements on an Eye waveform. You can configure your instrument to show multiple Eye displays, each of which is controlled by one of two jitter engines: The Jitter1 engine controls Eye displays in the top two tiles and the Jitter2 engine controls Eye displays in the bottom two tiles. The two jitter engines allow you to set different filter bandwidths in the upper and lower tiles so that you can monitor both timing and alignment jitter at the same time. There is also a jitter thermometer in the Eye display that graphically relates the jitter measurement to alarm limits, and there are readouts that display jitter magnitude.

When displaying the Eye waveform in a single, full-screen tile, the measurement results and a histogram display are included with the Eye waveform.

- **Jitter Display.** On this display, you can view additional time-domain information that is useful in separating sources of jitter, whether they are within a single circuit on a circuit board, or from various pieces of equipment in a system. This includes jitter components that are synchronous or nearly synchronous to video line or video frame. These components appear as stationary or near-stationary artifacts in line or field sweeps and the wave shape of the jitter as modified by the high-pass filter setting.
- **SDI Status Display.** This display shows both the Jitter1 and Jitter2 thermometers and a Cable Loss thermometer that indicates signal loss due to cable length. With Option PHY installed, this display also shows the eye amplitude, eye risetime, eye falltime, eye risetime overshoot, eye falltime overshoot, and eye rise-fall delta measurement values.

The Cable Loss Meter is not available with Option 3G installed.

Configuring Physical Layer Settings (Options EYE and PHY)

Before you use Eye or SDI Status displays to monitor the SDI physical layer, you will need to configure the eye and physical layer settings. These are initially set to factory defaults. For more detailed information about physical layer monitoring and measurement, see the *Technical Reference* on your *Customer Documentation CD*.

NOTE. For instruments with Option DL or SIM, your instrument can only monitor physical layer information on one input at a time. To make measurements, select the input you want to monitor and then proceed with the following steps.

1. Press the **CONFIG** button to display the configuration menu.
2. Use the selection (arrow) keys, the **SEL** button, and the **General** knob to make the menu selections in the steps that follow.
3. Select **Readouts**.
4. Set **Eye** to **On**.

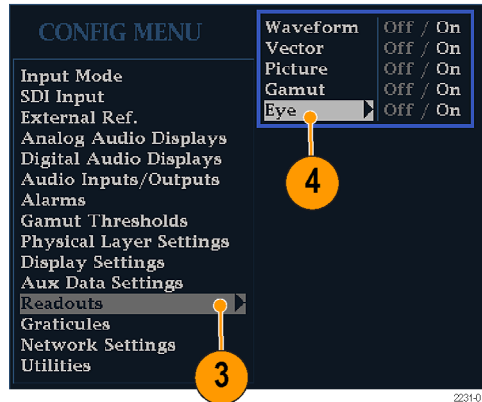

5. Select **Physical Layer Settings**.
6. Select **Cable Type** and select the best match for the type of cable that is connecting the SDI signal to the instrument.

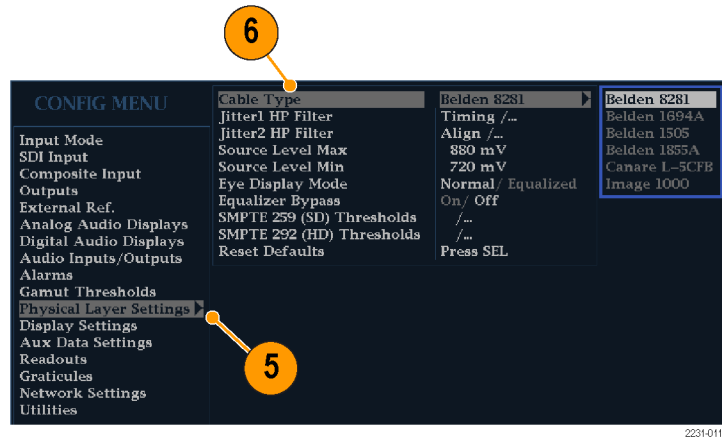

7. Select **Jitter1 HP Filter**.
8. Select a high-pass filter value for the Jitter1 engine controlling the top two tiles of the instrument display.
9. Select **Jitter2 HP Filter**.
10. Repeat step 8 for the Jitter2 engine controlling the bottom two tiles.

NOTE. The **Timing** filter selection sets the filter value to 10 Hz. The **Align** filter selection sets the filter value to 1 kHz for SD or 100 kHz for HD.

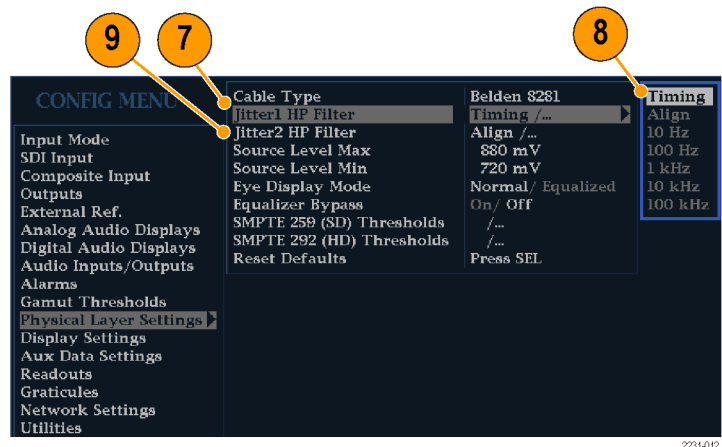

11. Select **Source Level Max**. Use the **General** knob to increase or decrease the setting.
12. Select **Source Level Min**. Use the **General** knob to increase or decrease the setting.

NOTE. The maximum value you can select is 1000 mV; the minimum value is 600 mV.

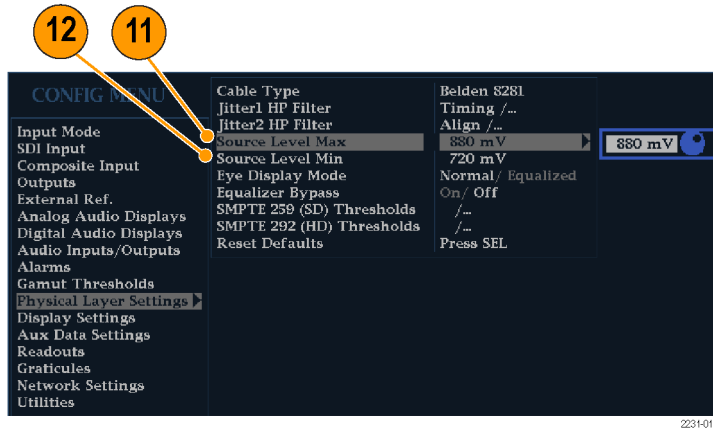

13. Select **Eye Display Mode**.

14. Select one of the following settings:

- **Normal.** The Eye display shows the SDI input signal directly.
- **Equalized.** The Eye display shows the SDI input signal after it has passed through the internal cable equalizer and comparator.

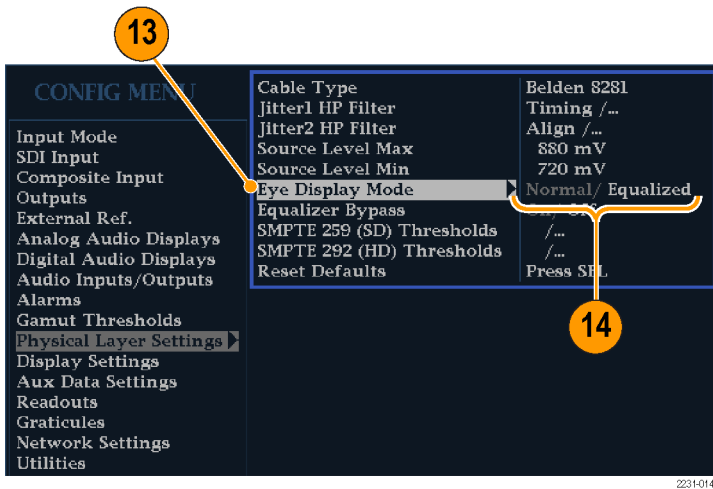

15. Select **Equalizer Bypass**.

16. Select one of the following settings:

- **On.** Bypass the equalizer when the instrument is connected to a signal with a short length of cable. This setting minimizes the jitter contributed by the internal equalizer and is generally used only with signals containing very low jitter.
- **Off.** Enables the equalizer, which enables operation with typical cable lengths and reduces jitter due to cable effects. Use this setting for most signals.

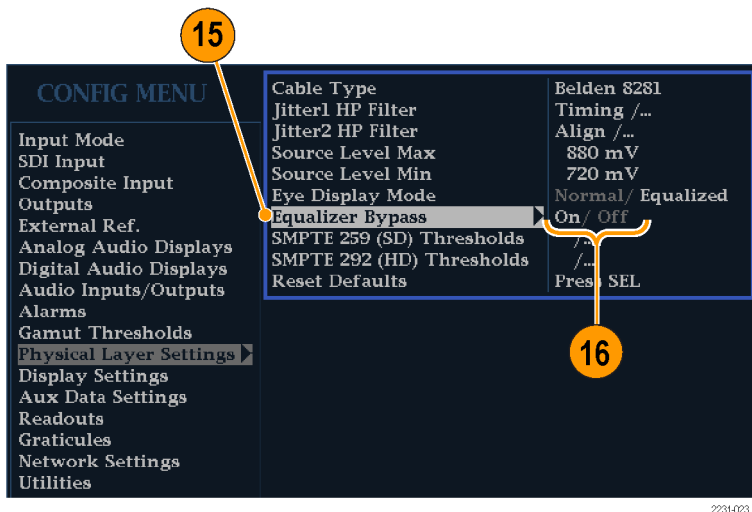

To Set SMPTE 259/292 Alarm Thresholds

17. To reset both the SMPTE 259 (SD) and SMPTE 292 (HD) alarm thresholds back to the factory-default values, select **Reset SMPTE259/292 Defaults** and press **SEL**.

NOTE. The following thresholds only appear in the menu when Option PHY is installed: Eye Amplitude Max/Min, Eye Risetime Max/Min, Eye Falltime Max/Min, and Eye Rise-Fall Delta.

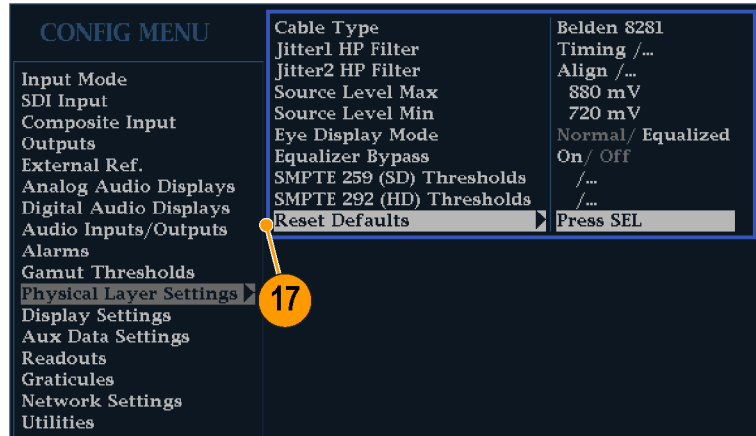

2231-024

18. To reset only the SD thresholds or the HD thresholds back to the factory-default values, select **SMPTE 259 (SD) Thresholds** or **SMPTE 292 (HD) Thresholds**, depending on which type of video signal you are monitoring.

19. Select **Reset Defaults** and press **SEL**.

NOTE. The steps and illustrations that follow show setting custom SD threshold values. The HD threshold names are the same as the SD thresholds, but the setting values and ranges may be different.



2231-025

20. To set custom threshold levels, select **SMPTE 259 (SD) Thresholds** or **SMPTE 292 (HD) Thresholds**, depending on which type of video signal you are monitoring.

21. Select **Jitter1 Level**. Use the **General** knob to increase or decrease the threshold level for the Jitter1 engine controlling the top two tiles of the instrument display.

The maximum level you can enter is 4.00 UI; the minimum level is 0.10 UI.

22. Select **Jitter2 Level**. Use the **General** knob to increase or decrease the threshold level for the Jitter2 engine controlling the bottom two tiles of the instrument display.



2231-015

23. Select **Cable Loss** to specify the threshold for signal loss (in dB) due to length of cable connecting the signal source to the instrument.

24. Use the **General** knob to increase or decrease the threshold level.

The maximum level you can enter is 30.0 dB; the minimum level is 0.0 dB.



25. Select **Cable Length** to specify the threshold for the length of the cable (in meters) connecting the signal source to the instrument.

26. Use the **General** knob to increase or decrease the cable length setting.

The maximum length you can enter is 300 meters; the minimum length is 0 meters.

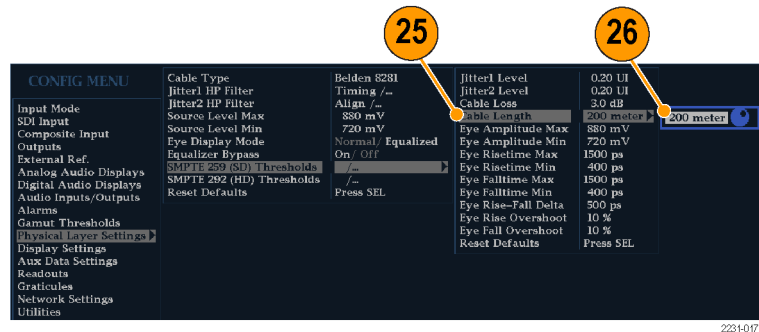

27. Option PHY Only. Select **Eye Amplitude Max**. Use the **General** knob to increase or decrease the setting.

The maximum amplitude you can enter is 1010 mV ; the minimum amplitude is 700 mV.

28. Option PHY Only. Select **Eye Amplitude Min**. Use the **General** knob to increase or decrease the setting.

The maximum amplitude you can enter is 10 mV below the current Eye Amplitude Max setting; the minimum amplitude is 530 mV.

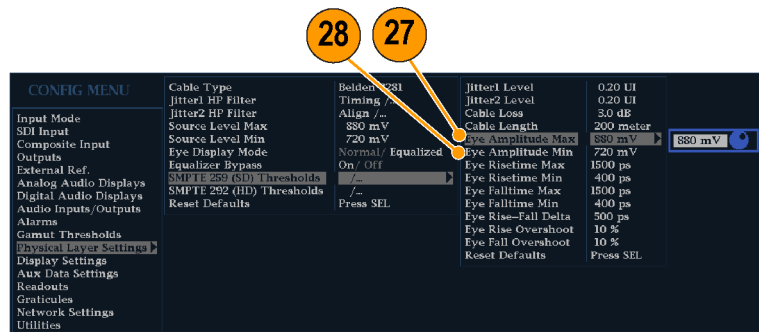

29. Option PHY Only. Select **Eye Risetime Max**. Use the **General** knob to increase or decrease the setting.

The maximum risetime you can enter is 3000 ps (SD) or 1000 ps (HD); the minimum risetime is 0 ps.

30. Option PHY Only. Select **Eye Risetime Min**. Use the **General** knob to increase or decrease the setting.



- 31. **Option PHY Only.** Select **Eye Falltime Max**. Use the **General** knob to increase or decrease the setting.

The maximum falltime you can enter is 3000 ps (SD) or 1000 ps (HD); the minimum falltime is 0 ps.

- 32. **Option PHY Only.** Select **Eye Falltime Min**. Use the **General** knob to increase or decrease the setting.

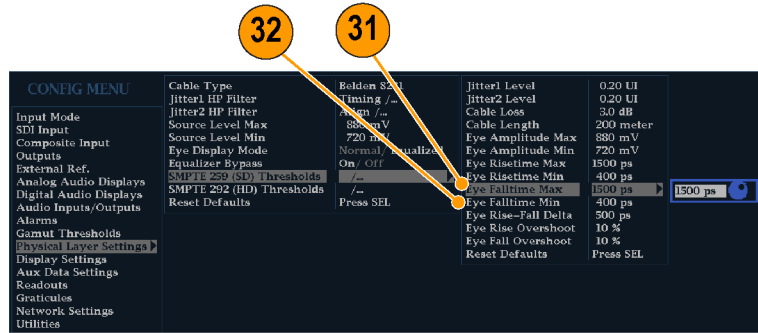

2231-020

- 33. **Option PHY Only.** Select **Eye Rise-Fall Delta**.

- 34. Use the **General** knob to increase or decrease the setting.

The maximum value you can enter is 1000 ps; the minimum value is 0 ps.

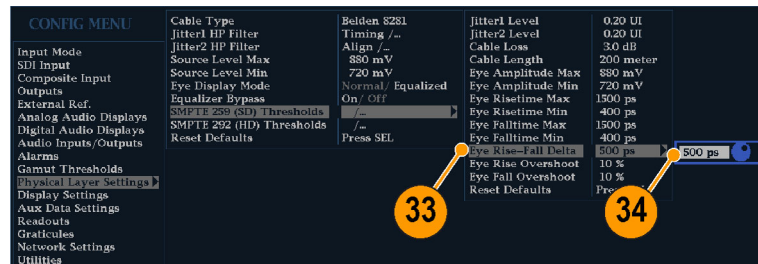

2231-021

To Configure Physical Layer Alarms

- 35. Press the **CONFIG** button to display the Configuration menu.
- 36. Use the selection (arrow) keys, the **SEL** button, and the **General** knob to make the menu selections in the steps that follow.
- 37. Select **Alarms** and then select **Physical Layer**.
- 38. Press **SEL** and set the response type for each of the Physical Layer alarms. (See page 110, *Using Alarms*.)

NOTE. For instruments with Option DL and SIM, only the single, currently selected input will be monitored.



2231-022

Configuring Physical Layer Settings (Option 3G or JIT)

Before you use SDI Status displays to monitor the SDI physical layer, you will need to configure the physical layer settings. These are initially set to factory defaults. For more detailed information about physical layer monitoring and measurement, see the *Technical Reference* on your *Customer Documentation CD*.

NOTE. Instruments with Option JIT only measure 3 Gb/s signals and not dual link or HD.

1. Press the **CONFIG** button to display the configuration menu.
2. Use the selection (arrow) keys, the **SEL** button, and the **General** knob to make the menu selections in the steps that follow.
3. Select **Physical Layer Settings**.
4. Select **Jitter1 HP Filter**.
5. Select a high-pass filter value for the Jitter1 engine controlling the top two tiles of the instrument display.
6. Select **Jitter2 HP Filter**.
7. Select a high-pass filter value for the Jitter2 engine controlling the top two tiles of the instrument display.



NOTE. The *Timing* filter selection sets the filter value to 10 Hz. The *Align* filter selection sets the filter value to 1 kHz for SD or 100 kHz for HD.

To Set SMPTE 425 Alarm Thresholds

8. To reset the SMPTE 425 alarm thresholds back to the factory-default values, select **Reset Defaults** and press **SEL**.

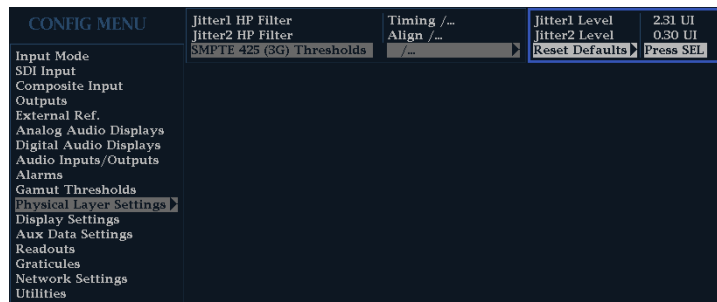

9. Select **Jitter1 Level**. Use the **General** knob to increase or decrease the threshold level for the Jitter1 engine controlling the top two tiles of the instrument display.

The maximum level you can enter is 4.00 UI; the minimum level is 0.10 UI.

10. Select **Jitter2 Level**. Use the **General** knob to increase or decrease the threshold level for the Jitter2 engine controlling the bottom two tiles of the instrument display.

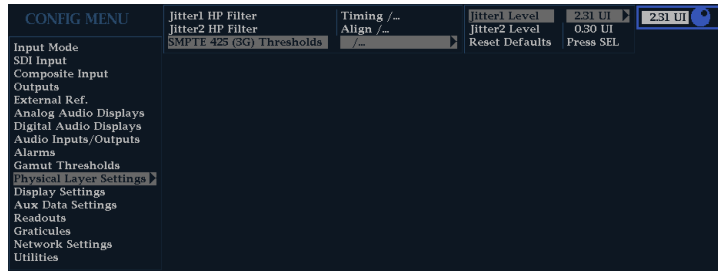

To Configure Physical Layer Alarms

11. Press the **CONFIG** button to display the Configuration menu.
12. Use the selection (arrow) keys, the **SEL** button, and the **General** knob to make the menu selections in the steps that follow.
13. Select **Alarms** and then select **Physical Layer**.
14. Press **SEL** and set the response type for each of the Physical Layer alarms. (See page 110, *Using Alarms*.)

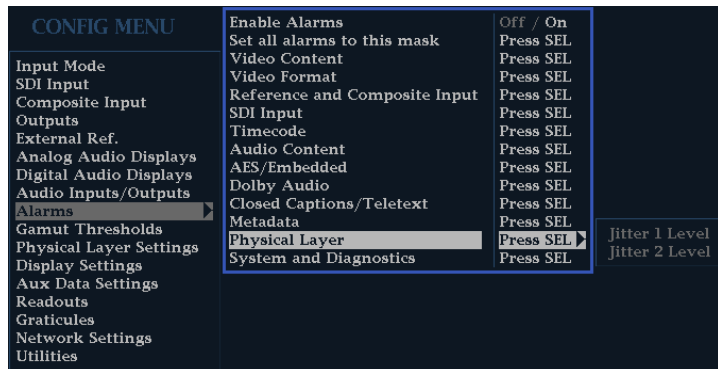

Taking Eye Measurements

After you have configured the instrument for Eye measurements, you can have the instrument perform automatic eye measurements (Option PHY only) or you can use the cursors to perform manual waveform measurements. The following procedures explain how to conduct both measurement types.

NOTE. Eye measurements are not available with Options 3G or JIT.

Setup for Eye Measurements

1. Configure your instrument to monitor the SDI physical layer. (See page 52, *Configuring Physical Layer Settings (Options EYE and PHY).*)
2. Connect a serial video-signal to your instrument using a 75Ω cable of two meters or less in length. Use high-quality, low-loss coaxial cable, such as Belden8281.
3. Press the **EYE** button.
4. Press the **GAIN** button to display the gain menu, select **VAR Gain**, and turn the **GENERAL** knob until the vertical gain is x1.00.

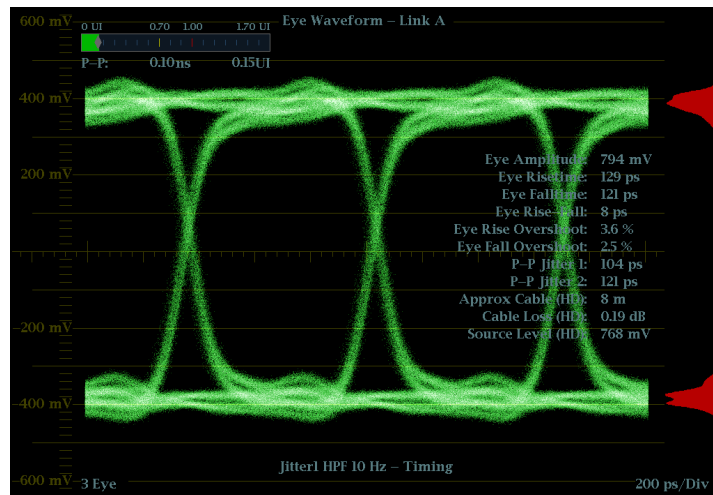

Manual Eye Measurements

The following procedures describe how to take manual measurements of the Eye waveform. If Option PHY is installed, the instrument can also take automatic eye measurements. (See page 63, *Automatic Eye Measurements.*)

NOTE. If you have Option PHY and you use the measurement cursors to manually measure the eye waveform, you may get a different result than that shown in the automatic eye measurements readout. This is because the automatic amplitude measurement uses histograms in order to be minimally affected by overshoot, ringing, and noise on the signal. Similarly, the automatic risetime and falltime measurements use histograms to find the centers of the distributions of 20% and 80% crossings. The difference between manual and automatic measurements is usually insignificant for clean, symmetrical signals.

Usage Notes

Use the **LINE SWEEP** button to change the sweep of the Eye display.

To Manually Measure Eye Amplitude

1. Perform the initial setup for Eye measurements. (See page 60, *Taking Eye Measurements*.)
2. Press the **CURSOR** button to display the measurement cursors.
3. Position one voltage cursor at the top part of the waveform, ignoring any overshoot or undershoot on the rising or falling edges.
4. Position the second voltage cursor at the bottom of the waveform, ignoring any overshoot or undershoot on the rising or falling edges.
5. Note the amplitude of the eye waveform that is displayed in the Voltage Cursor readout.

NOTE. Signal-source amplitudes outside of $\pm 10\%$ of 800 mVp-p can degrade receiver performance.

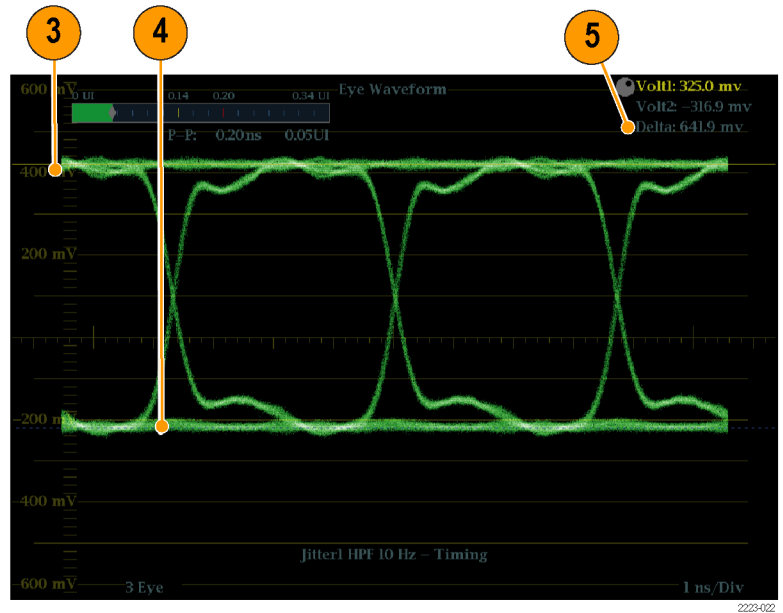

To Manually Measure Aberrations

1. Perform the initial setup for Eye measurements. (See page 60, *Taking Eye Measurements*.)
2. Press the **CURSOR** button to display the measurement cursors.
3. Position one voltage cursor at the peak of the overshoot at the top horizontal part of the waveform.
4. Position the second voltage cursor at the bottom of the top line of the waveform. Include any ringing (the oscillation following overshoot) in the measurement. Essentially, you are measuring the thickness of the top line of the waveform.
5. Note the amplitude of the aberration displayed in the Voltage Cursor readout.
6. Perform the same voltage-cursor measurement on the bottom line thickness, including any undershoot and ringing.

NOTE. Aberrations at the top or bottom line of the waveform should not exceed 10% of the signal amplitude. Automatic equalizer circuits in receivers may be sensitive to larger aberrations.

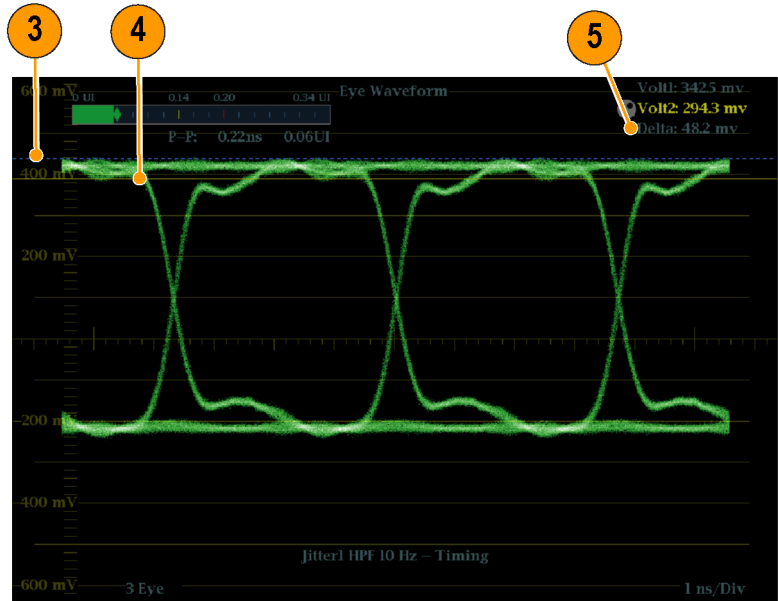

2223-024

To Manually Measure Risetime Using Variable Gain

1. Perform the initial setup for Eye measurements. (See page 60, *Taking Eye Measurements*.)
2. Press the **VAR** button to turn on variable gain.
3. Use the **General** knob to resize the waveform to 10 major divisions. Position the top and bottom of the waveform on graticule lines.
4. Press the **CURSOR** button to display the measurement cursors.
5. Position the first timing cursor at the crossing of the rising edge of the Eye waveform and the graticule line two divisions above the bottom of the waveform.
6. Position the second time cursor at the crossing of the rising edge of the Eye waveform and the graticule line two divisions below the top of the waveform.
7. Note the 20 – 80% rise time measurement displayed in the Delta time readout.

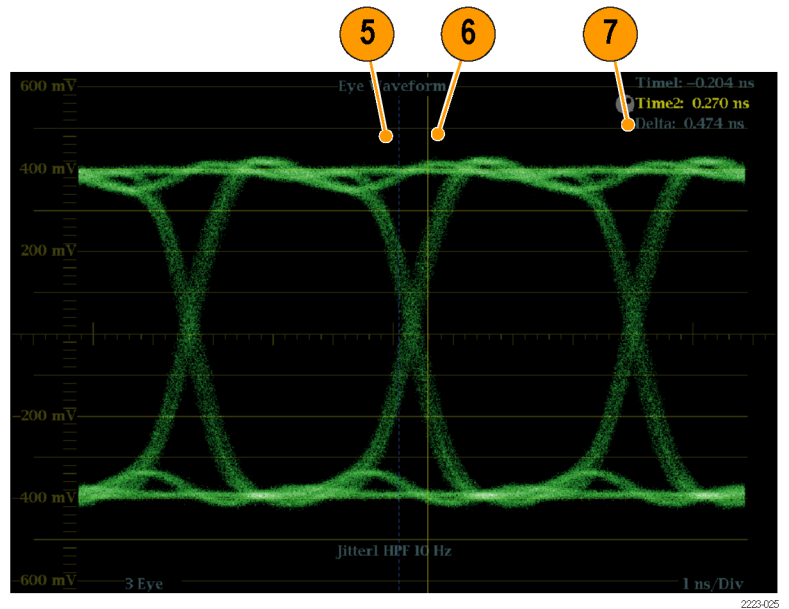

Automatic Eye Measurements

The following procedure describes how to take automatic measurements of the Eye waveform. (Available with Option PHY only.)

NOTE. If you use the measurement cursors to manually measure the eye waveform, you may get a different result than that shown in the automatic eye measurements readout. This is because the automatic amplitude measurement uses histograms in order to be minimally affected by overshoot, ringing, and noise on the signal. Similarly, the automatic risetime and falltime measurements use histograms to find the centers of the distributions of 20% and 80% crossings. The difference between manual and automatic measurements is usually insignificant for clean, symmetrical signals.

1. Perform the initial setup for Eye measurements. (See page 60, *Taking Eye Measurements.*)
2. Press the **STATUS** button to select the Status display mode.
3. Press and hold the **STATUS** button to display the pop-up menu.
4. Select **Display Type** and then select **SDI Status**.

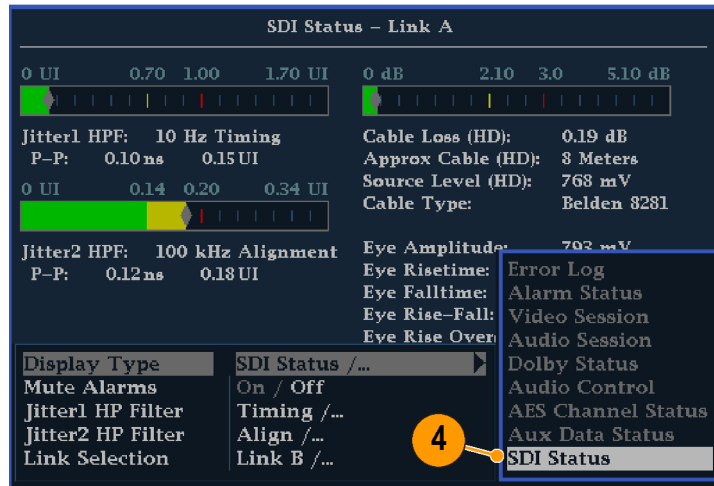

5. Note the Eye waveform measurements in the SDI Status display readouts.

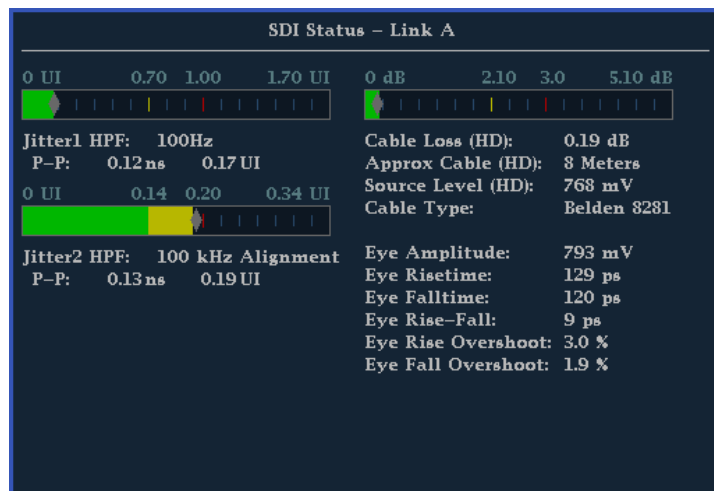

Automatic Eye measurements (and a histogram of the Eye waveform) are also displayed in the Eye Waveform display when expanded to the single, full-screen display.

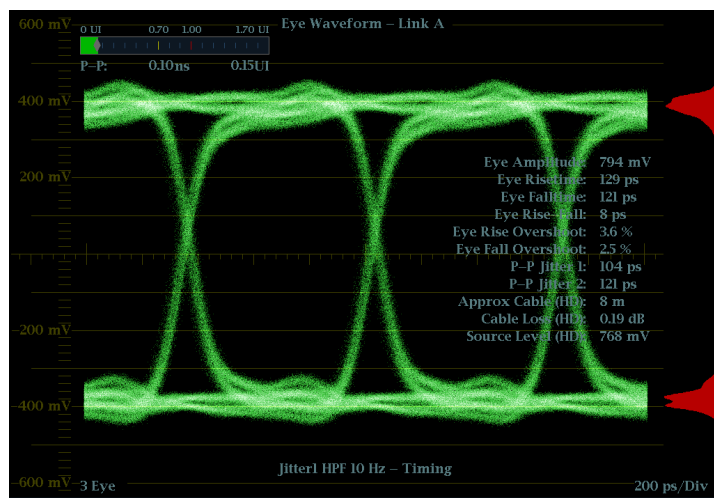

Taking Jitter Measurements

This section explains the procedures for taking jitter measurements. After you have configured the instrument for Eye or Jitter measurements, the instrument is also ready to take jitter measurements using one of the following displays:

- Measurement cursors on the Eye display
- SDI Status display
- Jitter display (Options PHY or JIT only)

NOTE. Eye measurements are not available with Option 3G or JIT.

NOTE. Many jitter problems in systems have resulted from genlocking clocks to other references, such as the horizontal synchronization pulse. Reference jitter transferred by genlocks into a serial system is typically between 20 and several hundred Hertz. Also, the phase detection process used by the genlock can add noise, which results in jitter in the 10 Hz to 1 kHz range. Use the appropriate BW Limit filter selection to include or reject genlock jitter from a measurement.

The simplest way to measure jitter is to use the jitter readout and jitter thermometer in the Eye display or SDI Status display. These are derived from the jitter waveform, even when shown in these displays. For more qualitative jitter information, use the Eye and Jitter displays to view the presence and magnitude of jitter and its potential for causing data errors as the eye closes. The Jitter display provides further analysis information including added time-domain information such as the wave shape of the jitter and whether there are jitter components that are synchronous or nearly synchronous to the video line or frame (these components appear as stationary or near-stationary artifacts in line or field sweeps).

Looking at jitter in both displays can help you separate jitter sources to determine whether they are within a single circuit on a circuit board or from various pieces of equipment in a system. If you are planning a composite D/A conversion, select the 10 Hz bandwidth filter to measure total broadband jitter.

Following is an example displaying a signal with a lot of jitter. (See Figure 3 on page 66.) In the top two tiles, the high-pass filter is set for 10 Hz so that all jitter above 10 Hz is displayed. In the lower two tiles, the high-pass filter is set for 100 Hz, removing most of the 30 Hz jitter and leaving the spikes. Both Jitter displays are set for two-field sweep. The upper Eye display shows a fairly even jitter spread, which suggests a moderately uniform statistical distribution of jitter. This jitter is from a sine wave component. Notice that there is no indication of jitter spikes. In the lower Eye display, the jitter is of a low-density haze, which suggests a less uniform jitter distribution. This is indicated by the spikes.

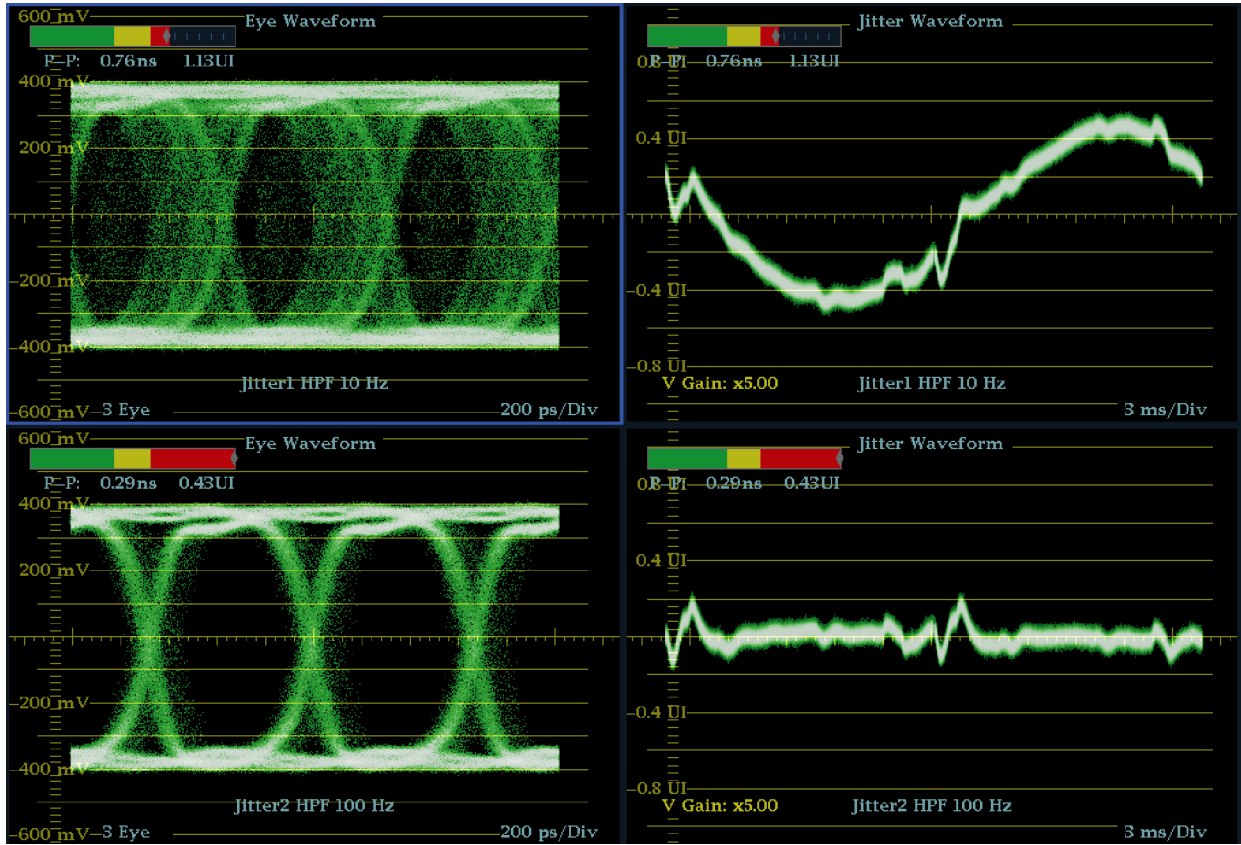

Figure 3: Measuring jitter

To Manually Measure Jitter Using the Eye Display

NOTE. If you use the measurement cursors to measure jitter, you may get a different result than that shown in the jitter thermometer for the following reasons:

- The internal peak detector does a better job of measuring jitter excursions than manually positioning the cursors.
- The noise floor is removed from the jitter measurement readout but not from the cursor delta readout.

1. Perform the initial setup for Eye measurements. (See page 60, *Taking Eye Measurements*.)
2. Use the **LINE SWEEP** button to select the 3EYE mode, which shows peak jitter at each eye crossing.
3. Use the Eye pop-up menu to set the jitter high-pass filter to one of the following:
 - To measure timing jitter, select the 10 Hz filter for both SD and HD signals, or select the Timing filter.
 - To measure alignment jitter, select the 1 kHz filter for SD signals or select the 100 kHz filter for HD signals, or select the Align filter.

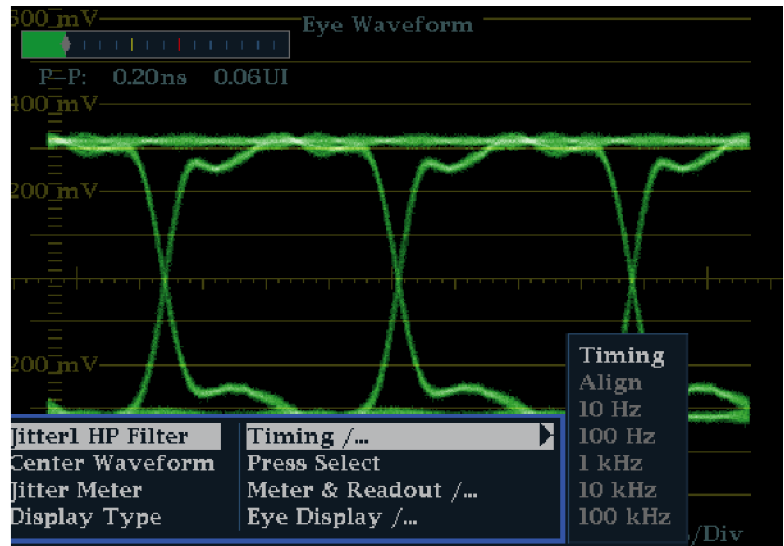

4. Press the **CURSOR** button to display the measurement cursors.

5. Position the first timing cursor at the left edge of the zero-crossing point of the Eye waveform.

NOTE. If necessary, use the Gain and Sweep controls for better vertical and horizontal resolution.

6. Position the second timing cursor at the right edge of the zero-crossing point of the Eye waveform.

7. Check that the Delta readout is less than the following:

SD Signals (per SMPTE 259M)

- Timing jitter (10 Hz filter): 740 ps (0.2 unit intervals).

- Alignment jitter (1 kHz filter): 740 ps (0.2 unit intervals).

HD Signals (per SMPTE 292M)

- Timing jitter (10 Hz filter): 673 ps (1.0 unit intervals).

- Alignment jitter (100 kHz filter): 134 ps (0.2 unit intervals).

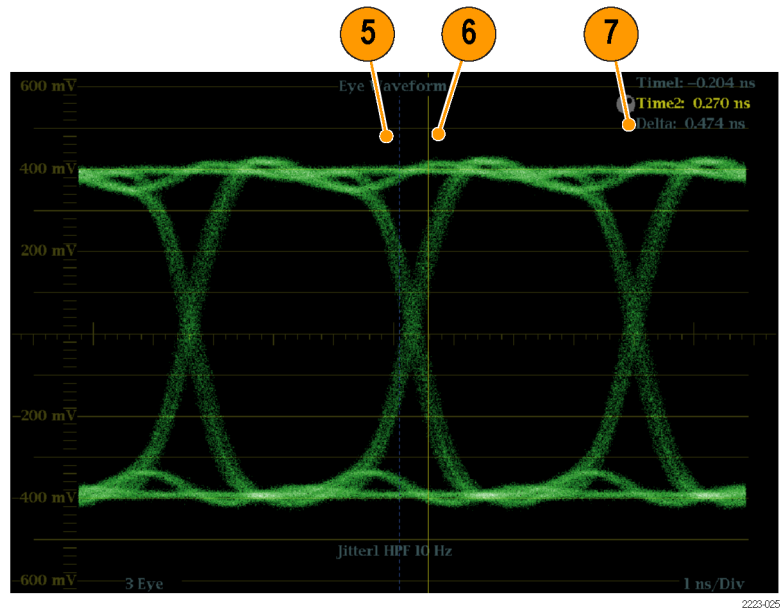

Taking Cable Loss Measurements

After you have configured the instrument for Eye measurements, you can take cable loss measurements using the SDI Status display.

NOTE. The accuracy of the Approx Cable (length) and Source Level readouts depends strongly on correctly setting the Cable Type and on the quality of the cable and connections in the signal path. These readouts are derived from the measured Cable Loss and the specified Cable Type. The Source Level readout of the SDI Status display indicates the calculated signal amplitude at the signal source, even when the signal level is greatly reduced at the instrument due to cable loss. Therefore, the automatic Eye Amplitude measurement (Option PHY only) may be significantly less than the indicated Source Level.

1. Perform the initial setup for Eye measurements. (See page 60, *Taking Eye Measurements*.)
2. Press the **STATUS** button to select the Status display.
3. Press and hold the **STATUS** button to display the pop-up menu.
4. Use the arrow keys and the **SEL** button to select the SDI Status display.

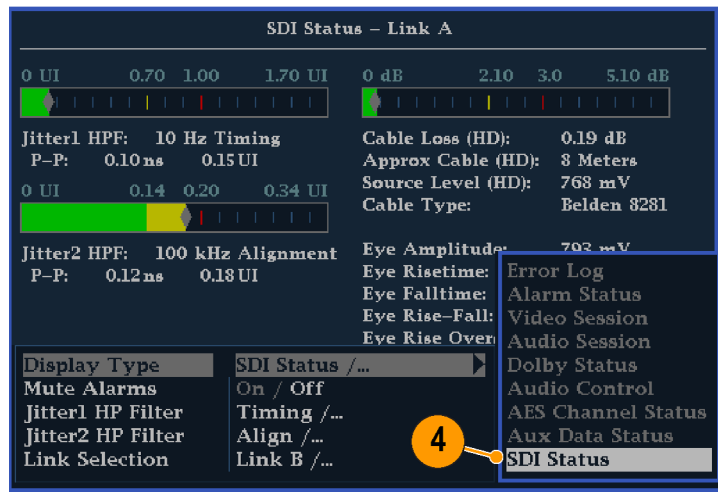

5. Use the Cable Loss thermometer and readouts to monitor the cable loss.

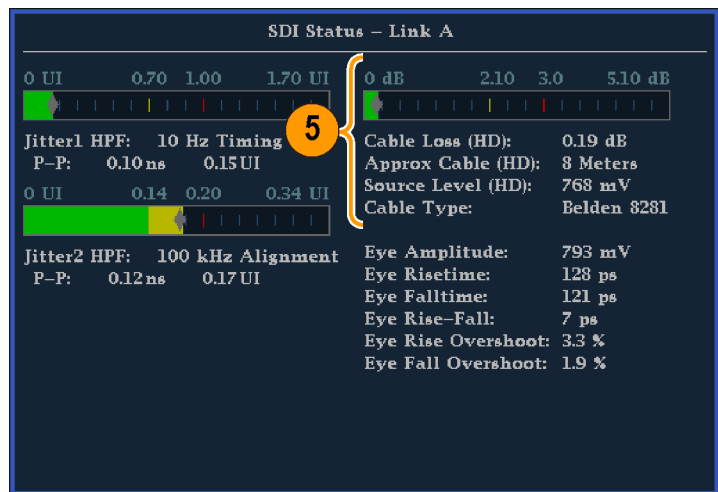

Using the ARIB Displays

Your instrument supports conformance to ARIB data standards contained in the signal source. This information is contained in the following screen displays:

- ARIB Status
- ARIB STD-B.39 Display
- ARIB STD-B.37 Display
- ARIB STD-B.35 Display
- ARIB TR-B.23 (1) Display
- ARIB TR-B.23 (2) Display
- ARIB TR-B.22 Display

The following DID and SDID values are defined for common types of ARIB-compliant data.

DID and SDID values for common ARIB data types

Ancillary data type	DID value	SDID value
ARIB TR-B.22, Sub Information of transmitting materials	0x5F	0xE0
ARIB TR-B.23, Line 20 User Data - 1	0x5F	0xFC
ARIB TR-B.23, Line 20 User Data - 2	0x5F	0xFB
ARIB STD-B.35 Trigger Signal for Data Broadcasting	0x5F	0xFD
ARIB STD-B.37 Closed Captioning		
Analog signal	0x5F	0xDD
SD signal	0x5F	0xDE
HD signal	0x5F	0xDF
ARIB STD-B.39 Inter Stationary Control Data		
ARIB specification	0x5F	0xFE
ITU specification	0x43	0x01

To Enable the ARIB Content Displays

1. Press the **CONFIG** button to display the Configuration menu.
2. Use the Arrow keys and the **SEL** button in the steps that follow to make selections.
3. Select **Aux Data Settings**.
4. Select **ARIB Content Display**.
5. Select **Enable** to access the ARIB displays and alarms; or **Disable** to block access.

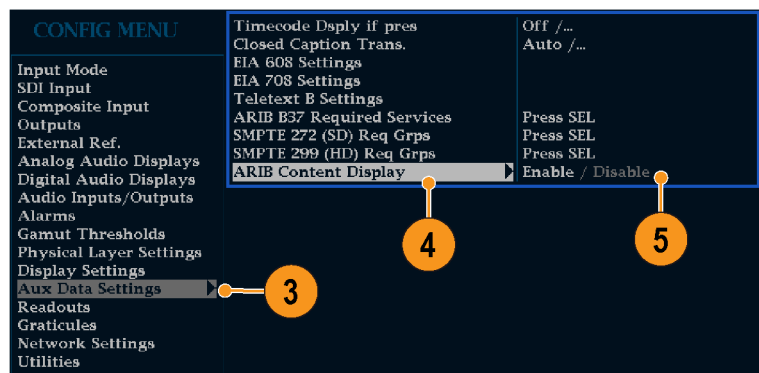

2223-001

ARIB Status

The ARIB Status display is a status summary screen for the signal. (See Figure 4.)

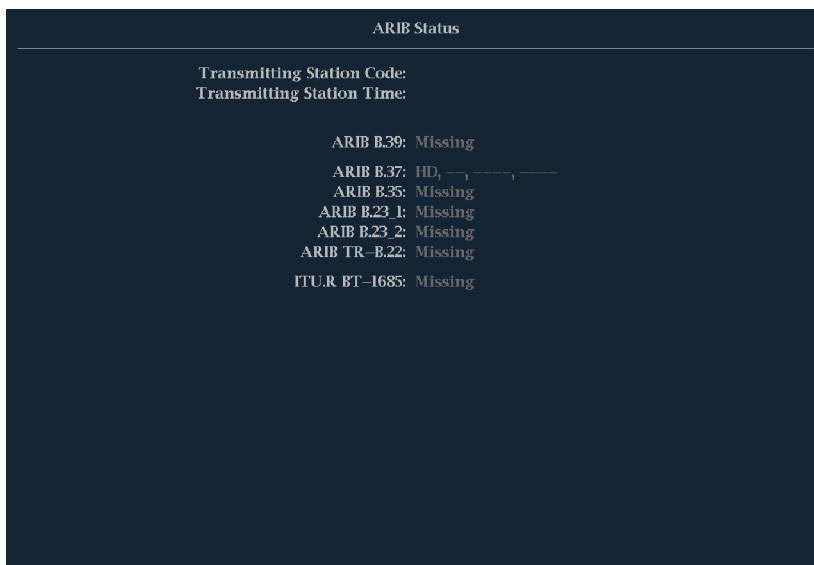

Figure 4: ARIB Status display, showing no data present

Use the ARIB Status display in conjunction with the other specific ARIB Display screens to quickly determine if the data you are interested in is present in the signal. If the data is present, use the STATUS > ARIB Display menu to select the specific ARIB data packet type to view.

The ARIB Status display shows the presence (or absence) of each of the following supported standards (STD) or technical reports (TR):

- Transmitting station code (unique identification code of the transmitting station)
- Transmitting station time (time of broadcast from the transmitting station)
- ARIB STD-B.39 (inter-stationary control data)
- ARIB STD-B.37 (closed caption data)
- ARIB STD-B.35 (trigger signal data)
- ARIB TR-B.23 (1) (guidelines for inter-stationary control data transport, group 1)
- ARIB TR-B.23 (2) (guidelines for inter-stationary control data transport, group 2)
- ARIB TR-B.22 (guidelines for ancillary data transport)

Additionally, the status of the following ITU standard is shown:

- ITU.R BT-1685 (inter-stationary Control Data conveyed by ancillary data packets)

ARIB STD-B.39 Display

The ARIB STD-B.39 display shows the decoded data for video signals using ancillary data compliant with ARIB STD-B.39. (See Figure 5.) When this display is selected, the instrument searches the signal for ARIB STD-B.39 packets using the DID/SDID combinations defined by either the ITU or ARIB standards organizations.

```

ARIB B.39 Display
-----
DID:          5F (25f)  Type:          2  SDID:          fe (1fe)  DC:          255 (2ff)
Field:
Status:      CHKSUM  Checksum:          x040  Should be:          x2ee
Format:      ARIB B.39 Inter-station Ctrl Data
Inter-Station Ctrl Header 00000011 (x03)
Transmitting Station Code  TEKテレビ

Transmitting Station Time 2004/13/31 (Inv) 06:59:39.123
Curr Video Mode          Unknown ?? x ?? 59.94 0.0
Next Video Mode          Unknown 1920x1080 119.881 16x9
Video Mode Countdown     002
Curr Downmix/Audio Mode  [A=1/SQRT(2)]          5.2M (S+D)
Next Downmix/Audio Mode  [A=1/2SQRT(2)]        3/2+5
Audio Mode Countdown     003
Trig Bits (Q8..Q1 Q16..Q9) 00000001 00000010
Trig Bits (Q24..Q17 Q32..Q25) 00000100 00001000
Trig Counter             016 032 064 128
Trig Countdown           017 033 065 129
Status Bits (S8..S1 S16..S9) 01000100 10001000
Error Correcting Code     x040 x040 x040 x040 x040 x040

```

```

ARIB Status
-----
Transmitting Station Code  TEKテレビ
Transmitting Station Time 2004/13/31 (Inv) 06:59:39.123

ARIB B.39: OK
ARIB B.37: ID, SD, Analog, Mobile
ARIB B.35: Missing
ARIB B.23 1: Missing
ARIB B.23 2: Missing
ARIB TR-B.22: Missing
ITU.R BT-1685: Missing

```

Figure 5: ARIB STD-B.39 display (with the associated ARIB Status display)

The decoded ancillary data includes the following:

- DID - Data Identifier of the requested inter-stationary control packet; can be any of the following:
 - ARIB specification - 0x5F
 - ITU Specification - 0x43
- Type - Type of the ANC Data packet. For ARIB B.39, this is always a Type 2 packet (DID less than 0x80), as defined by SMPTE 291M. The actual value (with parity bits added) is displayed in parentheses.
- SDID - Secondary Data Identifier of the requested interstationary control packet; can be any of the following:
 - ARIB specification - 0xFE
 - ITU Specification - 0x01
- Line - The line of the video (within the field) from which the packet was acquired.

- Stream - For HD (SMPTE 292M), indicates whether the ancillary packet was acquired from the Y or C data streams. For SD, N/A is displayed.
- Status - Indicates whether packet(s) of the desired type are present in the video; also indicates Checksum or CRC errors.
- Checksum - Indicates the checksum word that was recovered from the acquired packet.
- Should be - Indicates the checksum word computed by the instrument, based on the packet's data.
- Format - Indicates the name of the ancillary data type or standard.
- Inter-Station Ctrl Header - A header byte indicating packet continuity, and the presence or absence of the error correcting code.
- Transmitting Station Code - The name of the transmitting station. The instrument supports the display of Japanese characters.
- Transmitting Station Time - The broadcast time at the transmitting station.
- Current Video Mode - The video format of the current program.
- Next Video Mode - The video format of the next scheduled programming.
- Video Mode Countdown - A countdown timer indicating an upcoming change in video mode, which counts down from 254 (0xFE). A value of 0xFF indicates that no format change is pending within the next several seconds.
- Current Downmix/Audio Mode - Indicates the audio downmix and soundstage configuration of the current program.
- Next Downmix/Audio Mode - Indicates the audio downmix and soundstage configuration of the next scheduled program.
- Audio Mode Countdown - A countdown timer indicating an upcoming change in audio mode, which counts down from 254 (0xFE). A value of 0xFF indicates that no format change is pending within the next several seconds.
- Trigger Bits (Q8..Q1 Q16..Q9) - Together with trigger bits Q24..Q17 Q32..Q25, 32 bits that can be used to indicate changes in the program; usage is user-defined.
- Trigger Bits (Q24..Q17 Q32..Q25) - Together with trigger bits Q8..Q1 Q16..Q9; 32 bits that can be used to indicate changes in the program; usage is user-defined.
- Trigger Counter - Increments when bits Q1-Q4 go from 0 to 1. Wraps from 254 (0xFE) to zero. Value of 0xFF indicates the trigger counter is not used.
- Trigger Countdown - A countdown timer indicating an upcoming change in trigger bits Q1-Q4, which counts down from 254 (0xFE). A value of 0xFF indicates that no format change is pending within the next several seconds.
- Status Bits (S8..S1 S16..S9) - 16 user-defined status bits.
- Error Correcting Code - A six-word, Reed-Solomon error correcting code, which is used to verify the integrity of the ARIB B.39 or ITU-R BT.1685 packet.

ARIB STD-B.37 Display and Status Screens

The ARIB STD-B.37 display shows the decoded data for video signals using ancillary data compliant with ARIB STD-B.37. (See Figure 6.) When this display is selected, the instrument searches the signal for ARIB STD-B.37 packets using the DID/SDID combinations defined by ARIB.

ARIB B.37 Display				
DID:	5f (25f)	-- (---)	-- (---)	-- (---)
SDID:	df (ldf)	-- (---)	-- (---)	-- (---)
DC:	255 (2ff)	---	---	---
Field / Line	1 19	---	---	---
Format:	ARIB B.37 CC (HD)	No ARIB B.37	No ARIB B.37	No ARIB B.37
Checksum:	x1fe	---	---	---
Should be:	x1fe	---	---	---
Header 1st	00 0000 0000	-----	-----	-----
Header 2nd	00 0000 0000	-----	-----	-----
Header 3rd	00 0000 0001	-----	-----	-----
Header 4th	00 0000 0000	-----	-----	-----
ECC Status	Absent	----	----	----
Format ID	HD CC	----	----	----
Language	1st	----	----	----
CC Data ID	Ex Fmt CC	----	----	----
Send Mode	Sequential	----	----	----
Packet Flags	Intermediate	----	----	----
TR-B.23 Plcmt	OK	----	----	----

ARIB Status	
Transmitting Station Code:	
Transmitting Station Time:	
ARIB B.39:	Missing
ARIB B.37:	---, SD, Analog, Mobile
ARIB B.35:	Missing
ARIB B.23 1:	Missing
ARIB B.23 2:	Missing
ARIB TR-B.22:	Missing
ITU-R BT-1685:	Missing

Figure 6: ARIB STD-B.37 display (with the associated ARIB Status display)

The decoded ancillary data includes the following:

- DID - Data Identifier of the requested closed captioning packet; can be any of the following:
 - Analog signal - 0x5F
 - SD Signal - 0x5
 - HD Signal - 0x5F

- SDID - Secondary Data Identifier of the requested packet; can be any of the following:
 - Analog signal - 0xDD
 - SD Signal - 0xDE
 - HD Signal - 0xDF
 - Mobile signal - 0xDC
- Field/Line - The field or line of the video from which the packet was acquired. For progressive formats, 1 is displayed.

NOTE. *The Line field turns red if the ARIB B.37 packets are not on the line as defined by ARIB TR-B.23.*

- Format - Indicates the name of the ancillary data type or standard.
- Header 1st - Displays the first of four User Data Words of the corresponding packet, in binary.
- Header 2nd - Displays the second of four User Data Words of the corresponding packet, in binary.
- Header 3rd - Displays the third of four User Data Words of the corresponding packet, in binary.
- Header 4th - Displays the last of four User Data Words of the corresponding packet, in binary.
- ECC Status - Indicates the presence or absence of the Error Correcting Code information in the payload.
- Format ID - Indicate whether the packet is for HD, SD, Analog, or Mobile captions.
- Language - Indicates the language code (1st through 8th) of the packet.
- CC Data ID - Indicates the CC Data ID of the packet. Can be one of the following:
 - Exchange Format CC
 - Exchange Format PMI
 - Exchange Format Page 1
 - Exchange Format Page 2
 - Short Form Management Data
 - Short Form Text
 - Undefined or Dummy Data
- Set Mode - Mode can be either Sequential or Buffer.
- Packet Flags - Indicates whether the packet is Leading, End, Intermediate, or Single.
- Checksum - Indicates the checksum word that was recovered from the acquired packet.
- Placement - Can display either OK or ERROR, indicating whether the ARIB B.37 packets are present in the allowable configuration(s) specified in ARIB TR-B.23.

ARIB STD-B.35 Display and Status Screens

The ARIB STD-B.35 display shows the decoded data for video signals using ancillary data compliant with ARIB STD-B.35. (See Figure 7.) When this display is selected, the instrument searches the signal for ARIB STD-B.35 packets using the DID/SDID combinations defined by ARIB.

ARIB B.35 Display																		
DID:	5f (25f)					Type:	2					SDID:	fd (1fd)			DC:	255 (2ff)	
Field:	1					Line:						Stream:	Y					
Status:	PRESENT					Checksum:	x21b					Should be:	x21b					
Format:	ARIB B.35 Data Prog. Exchange																	
000	016	032	048	064	080	096	112	128	144	160	176	192	208	224	240			
140	140	140	140	140	140	140	140	140	140	140	140	140	140	140	140			
140	140	140	140	140	140	140	140	140	140	140	140	140	140	140	140			
140	140	140	140	140	140	140	140	140	140	140	140	140	140	140	140			
140	140	140	140	140	140	140	140	140	140	140	140	140	140	140	140			
140	140	140	140	140	140	140	140	140	140	140	140	140	140	140	140			
140	140	140	140	140	140	140	140	140	140	140	140	140	140	140	140			
140	140	140	140	140	140	140	140	140	140	140	140	140	140	140	140			
140	140	140	140	140	140	140	140	140	140	140	140	140	140	140	140			
140	140	140	140	140	140	140	140	140	140	140	140	140	140	140	140			
140	140	140	140	140	140	140	140	140	140	140	140	140	140	140	140			
140	140	140	140	140	140	140	140	140	140	140	140	140	140	140	140			
140	140	140	140	140	140	140	140	140	140	140	140	140	140	140	140			
140	140	140	140	140	140	140	140	140	140	140	140	140	140	140	140			
140	140	140	140	140	140	140	140	140	140	140	140	140	140	140	140			
140	140	140	140	140	140	140	140	140	140	140	140	140	140	140	140			
140	140	140	140	140	140	140	140	140	140	140	140	140	140	140	140			
140	140	140	140	140	140	140	140	140	140	140	140	140	140	140	140			
140	140	140	140	140	140	140	140	140	140	140	140	140	140	140	140			
140	140	140	140	140	140	140	140	140	140	140	140	140	140	140	140			
140	140	140	140	140	140	140	140	140	140	140	140	140	140	140	140			
140	140	140	140	140	140	140	140	140	140	140	140	140	140	140	140			

ARIB Status	
Transmitting Station Code:	
Transmitting Station Time:	
ARIB B.39:	Missing
ARIB B.37:	HD, SD, Analog, Mobile
ARIB B.35:	OK
ARIB B.23_1:	Missing
ARIB B.23_2:	Missing
ARIB TR-B.22:	Missing
ITU-R BT-1685:	Missing

Figure 7: ARIB STD-B.35 display (with the associated ARIB Status display)

The decoded ancillary data includes the following:

- DID - Data Identifier of the requested packet; permissible values range from 1 to 0xFF (255) inclusive.
- Type - Type of the ANC Data packet. For ARIB B.35, this is always a Type 2 packet (DID less than 0x80), as defined by SMPTE 291M. The actual value (with parity bits added) is displayed in parentheses.
- SDID - Secondary Data Identifier of the requested packet; permissible values range from 0 through 0xFF (255) inclusive. This field only appears when a Type 2 packet is selected (see above). The actual value (with parity bits added) is displayed in parentheses.
- DC - Data Count word of the acquired packet. The number of User Data words is displayed in decimal. The actual value (with parity bits added) is displayed in parenthesis, in hexadecimal.
- Field - The field of the video from which the packet was acquired. For progressive formats, 1 is displayed.

- Line - The line of the video (within the field) from which the packet was acquired.
- Stream - For HD (SMPTE 292M), indicates whether the ancillary packet was acquired from the Y or C data streams. For SD, N/A is displayed.
- Status - Indicates whether packet(s) of the desired type are present in the video; also indicates Checksum or CRC errors.
- Checksum - Indicates the checksum word that was recovered from the acquired packet.
- Should be - Indicates the checksum word computed by the instrument, based on the packet's data.
- Format - Indicates the name of the ancillary data type or standard.
- User Data Words - Contains the payload of the ancillary packet, displayed in hexadecimal. All 10 bits are displayed.

ARIB TR-B.23 (1) Display and Status Screens

The ARIB TR-B.23 (1) display shows the decoded data for video signals using ancillary data compliant with ARIB TR-B.23 (1). (See Figure 8.) When this display is selected, the instrument searches the signal for ARIB TR-B.23 (1) packets using the DID/SDID combinations defined by ARIB.

ARIB TR-B.23 (1) Display																
DID:	5f (25f)			Type:	2				SDID:	fc (2fc)				DC:	255 (2ff)	
Field:	1			Line:	20				Stream:	Y						
Status:	PRESENT			Checksum:	x11a				Should be:	x11a						
Format:	ARIB TR-B.23 User Data (f)															
000	016	032	048	064	080	096	112	128	144	160	176	192	208	224	240	
140	140	140	140	140	140	140	140	140	140	140	140	140	140	140	140	
140	140	140	140	140	140	140	140	140	140	140	140	140	140	140	140	
140	140	140	140	140	140	140	140	140	140	140	140	140	140	140	140	
140	140	140	140	140	140	140	140	140	140	140	140	140	140	140	140	
140	140	140	140	140	140	140	140	140	140	140	140	140	140	140	140	
140	140	140	140	140	140	140	140	140	140	140	140	140	140	140	140	
140	140	140	140	140	140	140	140	140	140	140	140	140	140	140	140	
140	140	140	140	140	140	140	140	140	140	140	140	140	140	140	140	
140	140	140	140	140	140	140	140	140	140	140	140	140	140	140	140	
140	140	140	140	140	140	140	140	140	140	140	140	140	140	140	140	
140	140	140	140	140	140	140	140	140	140	140	140	140	140	140	140	
140	140	140	140	140	140	140	140	140	140	140	140	140	140	140	140	
140	140	140	140	140	140	140	140	140	140	140	140	140	140	140	140	
140	140	140	140	140	140	140	140	140	140	140	140	140	140	140	140	
140	140	140	140	140	140	140	140	140	140	140	140	140	140	140	140	
140	140	140	140	140	140	140	140	140	140	140	140	140	140	140	140	
140	140	140	140	140	140	140	140	140	140	140	140	140	140	140	140	
140	140	140	140	140	140	140	140	140	140	140	140	140	140	140	140	
140	140	140	140	140	140	140	140	140	140	140	140	140	140	140	140	
140	140	140	140	140	140	140	140	140	140	140	140	140	140	140	140	
140	140	140	140	140	140	140	140	140	140	140	140	140	140	140	140	
140	140	140	140	140	140	140	140	140	140	140	140	140	140	140	140	
140	140	140	140	140	140	140	140	140	140	140	140	140	140	140	140	
140	140	140	140	140	140	140	140	140	140	140	140	140	140	140	140	
140	140	140	140	140	140	140	140	140	140	140	140	140	140	140	140	

ARIB Status	
Transmitting Station Code:	
Transmitting Station Time:	
ARIB B.39:	Missing
ARIB B.37:	HD, SD, Analog, Mobile
ARIB B.35:	Missing
ARIB B.23 1:	OK
ARIB B.23 2:	OK
ARIB TR-B.22:	Missing
ITU-R BT-1685:	Missing

Figure 8: ARIB TR-B.23 (1) display (with the associated ARIB Status display)

The decoded ancillary data includes the following:

- DID - Data Identifier of the requested packet; permissible values range from 1 to 0xFF (255) inclusive.
- Type - Type of the ANC Data packet. For ARIB TR-B.23-1, this is always a Type 2 packet (DID less than 0x80), as defined by SMPTE 291M. The actual value (with parity bits added) is displayed in parentheses.
- SDID - Secondary Data Identifier of the requested packet; permissible values range from 0 through 0xFF (255) inclusive. This field only appears when a Type 2 packet is selected (see above). The actual value (with parity bits added) is displayed in parentheses.
- DC - Data Count word of the acquired packet. The number of User Data words is displayed in decimal. The actual value (with parity bits added) is displayed in parenthesis, in hexadecimal.
- Field - The field of the video from which the packet was acquired. For progressive formats, 1 is displayed.
- Line - The line of the video (within the field) from which the packet was acquired.
- Stream - For HD (SMPTE 292M), indicates whether the ancillary packet was acquired from the Y or C data streams. For SD, N/A is displayed.
- Status - Indicates whether packet(s) of the desired type are present in the video; also indicates Checksum or CRC errors.
- Checksum - Indicates the checksum word that was recovered from the acquired packet.
- Should be - Indicates the checksum work computed by the instrument, based on the packet's data.
- Format - Indicates the name of the ancillary data type or standard.
- *User Data Words* - Contains the payload of the ancillary packet, displayed in hexadecimal. All 10 bits are displayed.

ARIB TR-B.23 (2) Display and Status Screens

The ARIB TR-B.23 (2) display shows the decoded data for video signals using ancillary data compliant with ARIB TR-B.23 (2). (See Figure 9.) When this display is selected, the instrument searches the signal for ARIB TR-B.23 (2) packets using the DID/SDID combinations defined by ARIB.

ARIB TR-B.23 (2) Display															
DID:	5f (25f)			Type:	2			SDID:	fb (1fb)			DC:	255 (2ff)		
Field:	1			Line:	20			Stream:	Y						
Status:	PRESENT			Checksum:	x219			Should be:	x219						
Format:	ARIB TR-B.23 User Data (2)														
000	016	032	048	064	080	096	112	128	144	160	176	192	208	224	240
140	140	140	140	140	140	140	140	140	140	140	140	140	140	140	140
140	140	140	140	140	140	140	140	140	140	140	140	140	140	140	140
140	140	140	140	140	140	140	140	140	140	140	140	140	140	140	140
140	140	140	140	140	140	140	140	140	140	140	140	140	140	140	140
140	140	140	140	140	140	140	140	140	140	140	140	140	140	140	140
140	140	140	140	140	140	140	140	140	140	140	140	140	140	140	140
140	140	140	140	140	140	140	140	140	140	140	140	140	140	140	140
140	140	140	140	140	140	140	140	140	140	140	140	140	140	140	140
140	140	140	140	140	140	140	140	140	140	140	140	140	140	140	140
140	140	140	140	140	140	140	140	140	140	140	140	140	140	140	140
140	140	140	140	140	140	140	140	140	140	140	140	140	140	140	140
140	140	140	140	140	140	140	140	140	140	140	140	140	140	140	140
140	140	140	140	140	140	140	140	140	140	140	140	140	140	140	140
140	140	140	140	140	140	140	140	140	140	140	140	140	140	140	140
140	140	140	140	140	140	140	140	140	140	140	140	140	140	140	140
140	140	140	140	140	140	140	140	140	140	140	140	140	140	140	140
140	140	140	140	140	140	140	140	140	140	140	140	140	140	140	140

ARIB Status	
Transmitting Station Code:	
Transmitting Station Time:	
ARIB B.39:	Missing
ARIB B.37:	HD, SD, Analog, Mobile
ARIB B.35:	Missing
ARIB B.23_1:	OK
ARIB B.23_2:	OK
ARIB TR-B.22:	Missing
ITU-R BT-1685:	Missing

Figure 9: ARIB TR-B.23 (2) display (with the associated ARIB Status display)

The decoded ancillary data includes the following:

- DID - Data Identifier of the requested packet; permissible values range from 1 to 0xFF (255) inclusive.
- Type - Type of the ANC Data packet. For ARIB TR-B.23-2, this is always a Type 2 packet (DID less than 0x80), as defined by SMPTE 291M. The actual value (with parity bits added) is displayed in parentheses.
- SDID - Secondary Data Identifier of the requested packet; permissible values range from 0 through 0xFF (255) inclusive. This field only appears when a Type 2 packet is selected (see above). The actual value (with parity bits added) is displayed in parentheses.
- DC - Data Count word of the acquired packet. The number of User Data words is displayed in decimal. The actual value (with parity bits added) is displayed in parenthesis, in hexadecimal.
- Field - The field of the video from which the packet was acquired. For progressive formats, 1 is displayed.
- Line - The line of the video (within the field) from which the packet was acquired.
- Stream - For HD (SMPTE 292M), indicates whether the ancillary packet was acquired from the Y or C data streams. For SD, N/A is displayed.
- Status - Indicates whether packet(s) of the desired type are present in the video; also indicates Checksum or CRC errors.

- Checksum - Indicates the checksum word that was recovered from the acquired packet.
- Should be - Indicates the checksum work computed by the instrument, based on the packet's data.
- Format - Indicates the name of the ancillary data type or standard.
- *User Data Words* - Contains the payload of the ancillary packet, displayed in hexadecimal. All 10 bits are displayed.

ARIB TR-B.22 Display and Status Screens

The ARIB TR-B.22 display shows the decoded data for video signals using ancillary data compliant with ARIB TR-B.22. (See Figure 10.) When this display is selected, the instrument searches the signal for ARIB TR-B.22 packets using the DID/SDID combinations defined by ARIB.

ARIB TR-B.22 Display

DID:	5f (25f)	Type:	2	SDID:	e0 (1e0)	DC:	80 (250)
Field:		Line:	1	Stream:	II		Y
Status:	PRESENT		Checksum:	x28f	Should be:	x28f	
Format:	ARIB TR-B.22 XMIT Material Info						

000	016	032	048	064	080	096	112	128	144	160	176	192	208	224	240
140	140	140	140	140											
140	140	140	140	140											
140	140	140	140	140											
140	140	140	140	140											
140	140	140	140	140											
140	140	140	140	140											
140	140	140	140	140											
140	140	140	140	140											
140	140	140	140	140											
140	140	140	140	140											
140	140	140	140	140											
140	140	140	140	140											
140	140	140	140	140											
140	140	140	140	140											
140	140	140	140	140											
140	140	140	140	140											
140	140	140	140	140											
140	140	140	140	140											
140	140	140	140	140											
140	140	140	140	140											
140	140	140	140	140											

ARIB Status

Transmitting Station Code:	
Transmitting Station Time:	
ARIB B.39:	Missing
ARIB B.37:	HD, SD, Analog, Mobile
ARIB B.35:	Missing
ARIB B.23_1:	Missing
ARIB B.23_2:	Missing
ARIB TR-B.22:	OK
ITU-R BT-1685:	Missing

Figure 10: ARIB TR-B.22 display (with the associated ARIB Status display)

The decoded ancillary data includes the following:

- DID - Data Identifier of the requested packet; permissible values range from 1 to 0xFF (255) inclusive.
- Type - Type of the ANC Data packet. For ARIB TR-B.22, this is always a Type 2 packet (DID less than 0x80), as defined by SMPTE 291M. The actual value (with parity bits added) is displayed in parentheses.

- SDID - Secondary Data Identifier of the requested packet; permissible values range from 0 through 0xFF (255) inclusive. This field only appears when a Type 2 packet is selected (see above). The actual value (with parity bits added) is displayed in parentheses.
- DC - Data Count word of the acquired packet. The number of User Data words is displayed in decimal. The actual value (with parity bits added) is displayed in parenthesis, in hexadecimal.
- Field - The field of the video from which the packet was acquired. For progressive formats, 1 is displayed.
- Line - The line of the video (within the field) from which the packet was acquired.
- Stream - For HD (SMPTE 292M), indicates whether the ancillary packet was acquired from the Y or C data streams. For SD, N/A is displayed.
- Status - Indicates whether packet(s) of the desired type are present in the video; also indicates Checksum or CRC errors.
- Checksum - Indicates the checksum word that was recovered from the acquired packet.
- Should be - Indicates the checksum work computed by the instrument, based on the packet's data.
- Format - Indicates the name of the ancillary data type or standard.
- *User Data Words* - Contains the payload of the ancillary packet, displayed in hexadecimal. All 10 bits are displayed.

Monitoring Audio

Your instrument provides several methods for monitoring audio signals. It can measure levels, monitor phase, display phase correlation, and monitor surround-sound audio. You can specify meter ballistics and scales, set test and peak program indicator levels, and specify how phase is displayed.

NOTE. The audio monitoring features described in this chapter require that the appropriate audio options are installed. For a list of the options currently installed on your instrument, press the **CONFIG** button. In the configuration menu, select **Utilities**. The **View Instruments Options** entry lists the installed options.

Configuring Audio Inputs

Audio inputs come set to factory defaults. As a result, you may need to configure them before performing the audio monitoring procedures in this section. The first procedure will help you configure the inputs. After you have completed that procedure, check that the alarms are configured as you want them. (See page 82, *Monitoring Audio*.) Your setup here determines, in part, which audio-signal characteristics are displayed.

To set up an Audio Input

1. Press the **CONFIG** button to display the configuration menu.
2. Use the Arrow keys and **SEL** button to make selections in the steps that follow.
3. Select **Audio Inputs/Outputs**.
4. Select the input to be configured.
5. Select from **Srnd (Surround)** for a 5.1 or 5.1+2 type display, or **Pairs** for a stereo with SAP and discrete channels type installation.

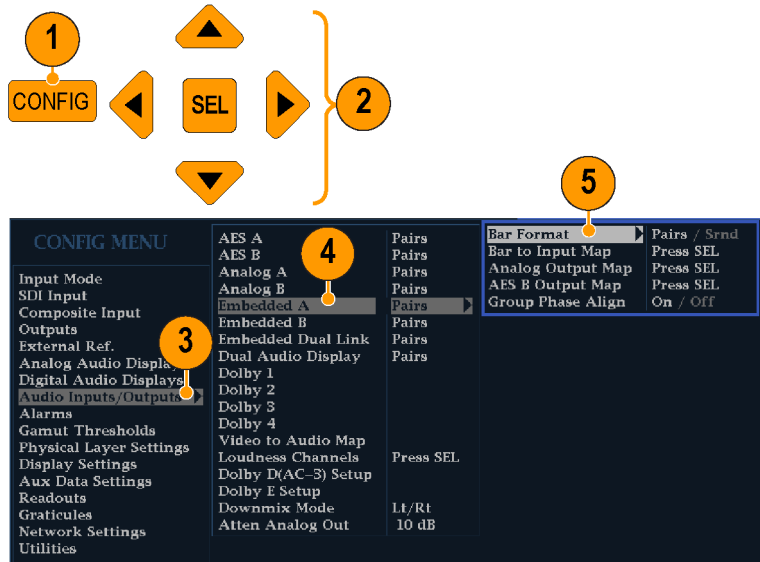

6. Select **Bar to Input Map** and specify which input pair should be displayed in each bar pair.
7. Specify which inputs will be allowed to generate alarms.
8. Select the box to return to the configuration menu.

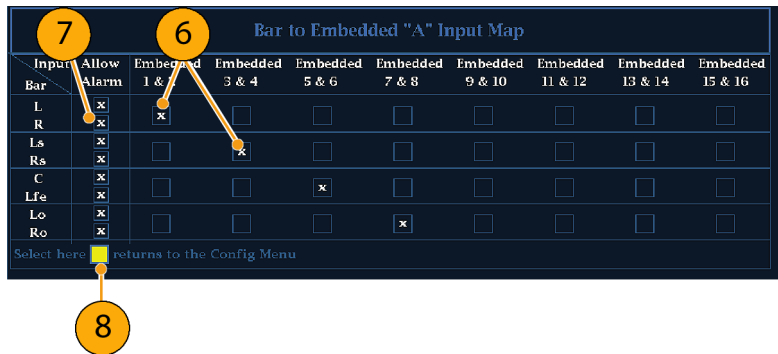

9. Select the **Analog Output Map** in the configuration menu.
10. Specify which inputs (if any) are routed to the analog outputs.
11. Select the box to return to the configuration menu.
12. Repeat steps 4 through 11 for other audio inputs, as needed.

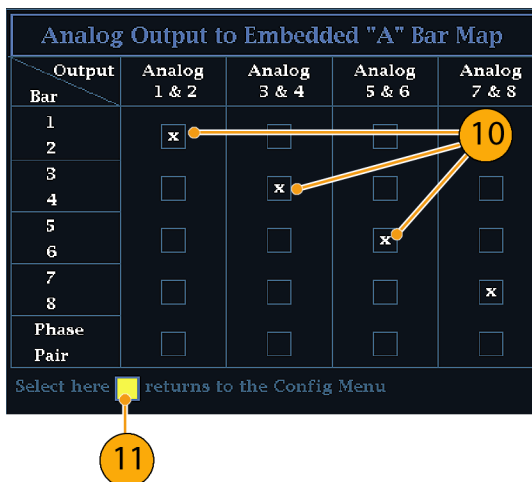

Selecting Audio Input

You select the audio input to be monitored from the front-panel **AUDIO** button pop-up menu. Note that the Audio display can appear in only one tile at a time.

1. Select a tile.
2. Press and hold the **Audio** button to open the Audio display in a tile and pop up the Audio menu.

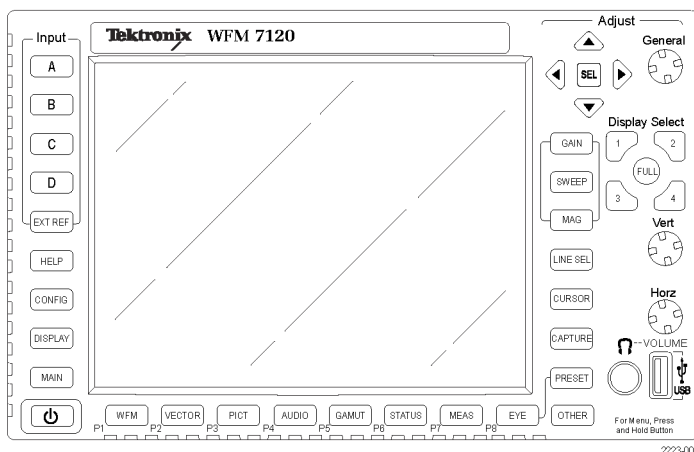

3. Use the Arrow Keys and **SEL** button to make selections in the steps that follow.
4. Select **Audio Input** and then select one of the audio input options shown.

NOTE. The available selections depend on the installed audio option. Selecting Follows Video selects the audio to video mapping set in the configuration menu. (See page 82.)

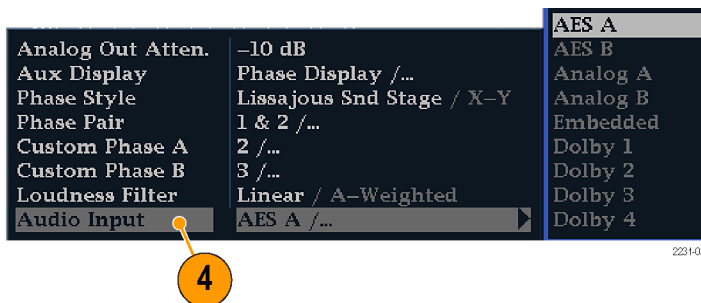

Checking Audio Level & Phase

Level meters are vertical bar graphs on which the height of the bar indicates the amplitude of the audio program in the corresponding input channel. You can change the input and turn on and off the Phase display from the Audio pop-up menu. Other meter characteristics such as ballistics, scale units, and program and test levels are configured through the Configuration menu.

If your instrument is equipped with optional audio features, it can display phase of one input pair as a Lissajous pattern, and display relative phase on all four pairs of inputs with correlation meters.

To Check Level

1. Open the audio display in one tile and select an input. (See page 83.)
2. Check the level meter bars for current audio levels, which are displayed according to the selected meter ballistics. Each bar displays three colors:

- Green – Indicates audio levels below the test level
- Yellow – Indicates audio levels between the test and peak program level
- Red – Indicates audio levels above the peak program level

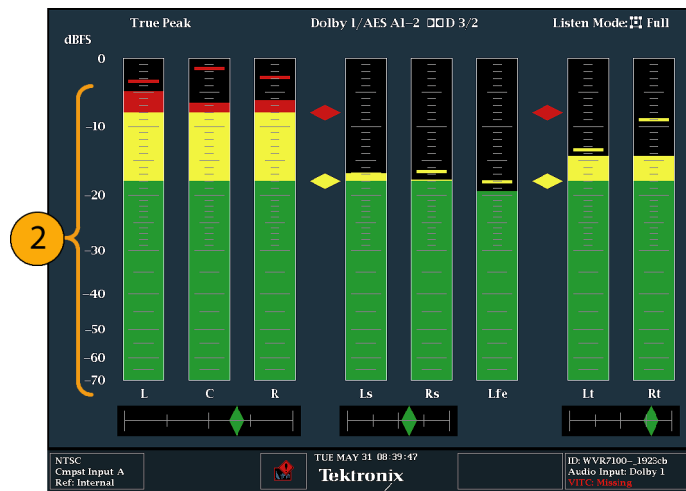

To Check Phase

1. Open the audio display in one tile. (See page 83.) Use the Arrow keys and **SEL** button to make selections in the steps that follow.
2. Select **Aux Display** and then select **Phase Display** to turn it on.
3. Select the **Phase Style**. Choose either a **Lissajous Soundstage** or **X-Y** orientation for the Lissajous signal. (See page 90, *Usage Notes*.)

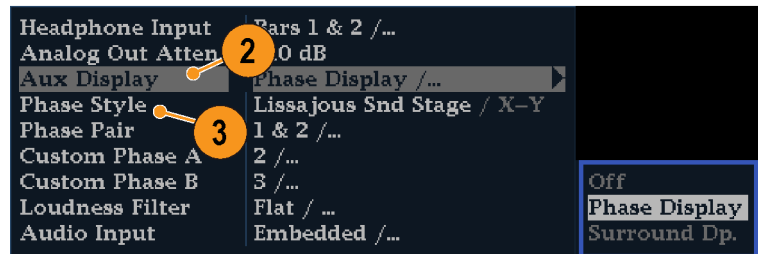

2223-003

4. Select the phase pair to be displayed, or select **Custom** and select independent channels using the Phase Channel A and Phase Channel B entries.
5. Set the Audio Input to match the signal that you are checking (or use the Audio Follows Video mode set in the CONFIG menu).

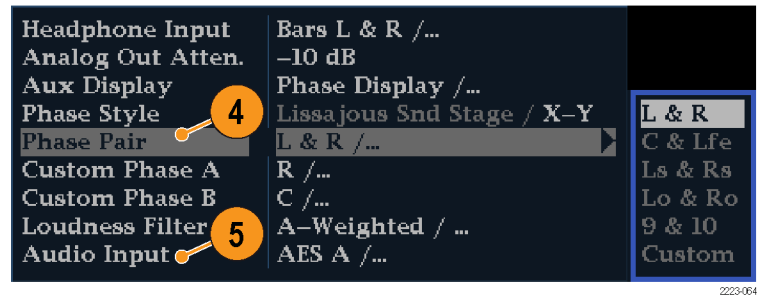

6. Check for Phase correlation of the signals, noting the following:
 - Phase correlation meters are located under the appropriate bars and one is duplicated under the phase display.
 - For correlated signals, the indicator will be green and will move to the right side.
 - For uncorrelated signals, the indicator will be yellow and will tend to stay in the middle.
 - For anticorrelated signals (one goes up when the other goes down), the indicator will be red and will move to the left side.

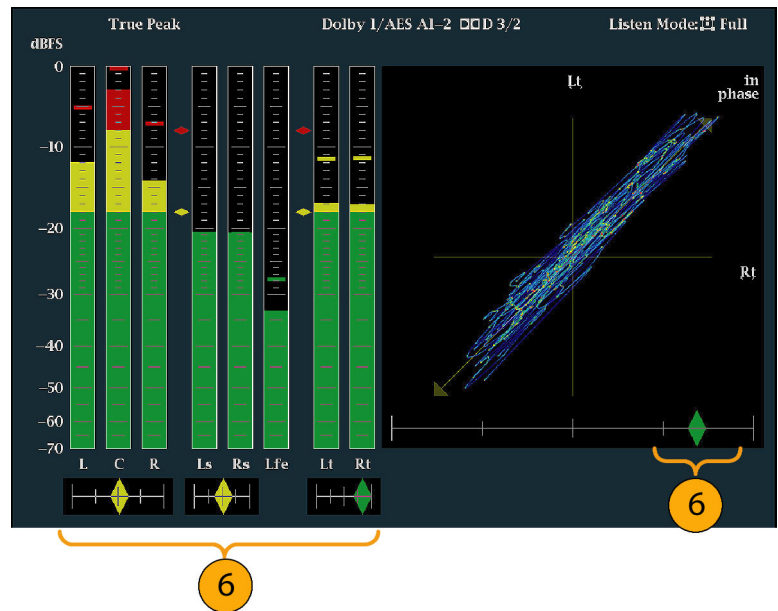

Usage Notes

- The Lissajous or phase display is a plot of one channel against another on an orthogonal pair of axes.
- Soundstage plots the two channels at 45 degree angles, with the mono combination appearing on the vertical axis—like a left-right image in a studio.
- X-Y plots left-channel data on the vertical axis and right channel data on the horizontal axis, emulating the X-Y display of an oscilloscope.

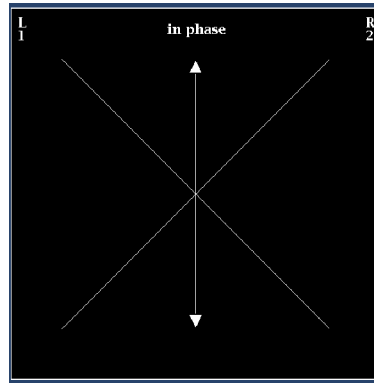

Lissajous sound stage

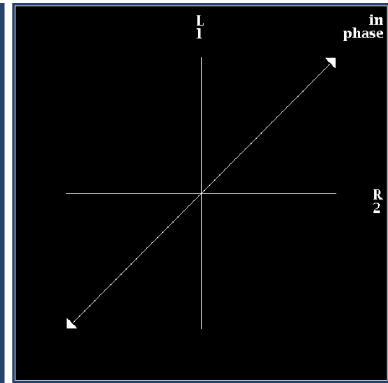

X-Y orientation

- The following response times of the correlation meters can be set from the Configuration menu.

Speed setting	Response averaging time (s)	Speed setting	Response averaging time (s)
1	0.0167	11	3.0
2	0.0333	12	3.5
3	0.0667	13	4.0
4	0.1333	14	4.5
5	0.2667	15	5.0
6	0.5333	16	5.5
7	1.0	17	6.0
8 (default)	1.5	18	6.5
9	2.0	19	7.0
10	2.5	20	7.5

Checking Surround Sound

Your instrument can also display the surround sound listening environment. The following procedures you will help you get started.

To Check Surround Sound

1. Open the audio display in one tile and select the input containing the surround audio. (See page 83.)
2. Select **Aux Display** and then select **Surround Sound Display**. Press **SEL** or the right-arrow key to turn the phase display on.
3. Set the Audio Input to match the signal that you are checking.

NOTE. If you want the level bars labeled with their surround sound channel names instead of channel numbers, select **Srnd** (Surround) when you configure the audio inputs. (See page 82.)

You can also set the Dolby Listening mode. (See page 91, Monitor Dolby-Based Surround Sound.)

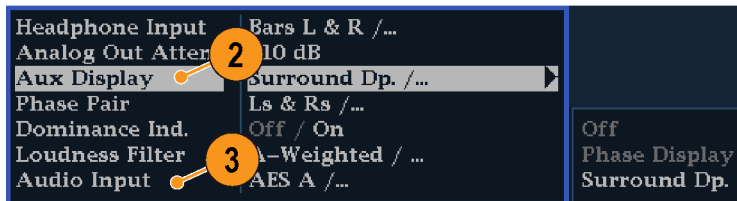

2223-065

4. Set the surround **Dominance indicator** to **ON** or **OFF**.
5. Set the **Loudness Filter** to the type preferred. A-Weighting biases the response towards that of human hearing.
6. Use the level bar display to monitor level control. (See page 84, *To Check Level*.)

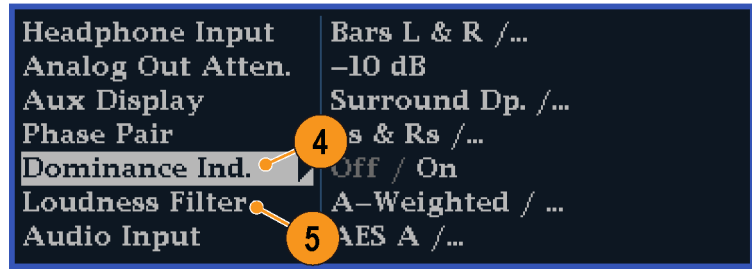

2223-066

7. Use the surround display to monitor relative loudness of the individual elements rendered in a surround-sound listening environment. Check the surround sound display for performance parameters and the indicators shown at right. (See page 90, *Usage Notes*.)

NOTE. The Audio Surround Sound display is courtesy of Radio-Technische Werkstaetten GmbH & Co. KG (RTW) of Cologne, Germany.

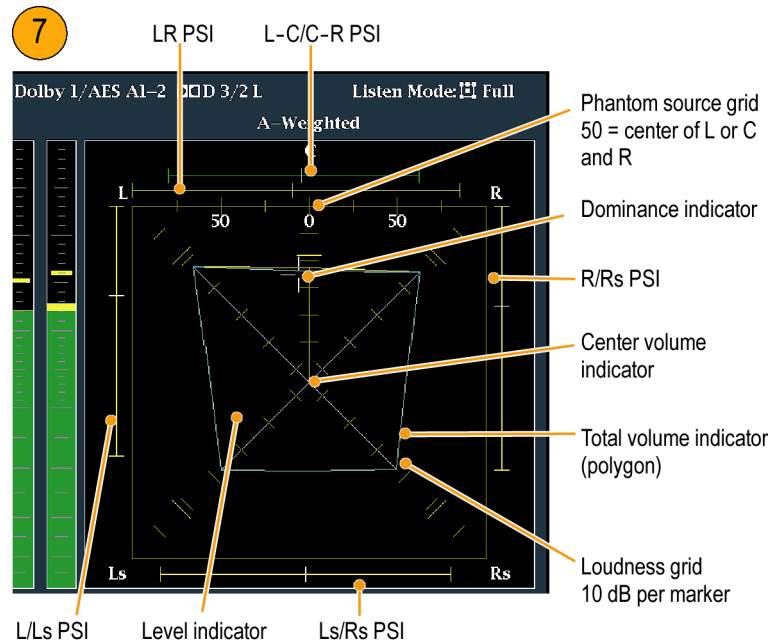

Surround Display Elements

- The Level Indicators – indicates the audio level balance among the left (L), right (R), left-surround (Ls), and right-surround (Rs) channels as cyan lines on the Loudness Grid.
- The Loudness Grid – the ruled scale, radiating from the center, on which the level indicators register their audio level and balance. The scale has tic marks at 10 dB intervals. An additional tic mark indicates the -18 dB level. The -18 dB and -20 dB levels are typically used for aligning audio levels.
- Total Volume Indicator – the cyan polygon formed by connecting the level indicator end points, showing the total sound volume of the L, R, Ls, and Rs channels. Each connecting line will bend away from the center if the two signals have a positive correlation, will bend towards the center if the signals have a negative correlation, and will not bend if the signals are uncorrelated.
- The Center Volume indicator – displays the sound volume of the center channel as a vertical yellow bar between the L and R channels, and connects the ends of the L, C, and R audio level indicators with straight lines.
- Channel-Pair Phantom Sound Indicators (PSIs) – located on each side of the Surround Sound display, indicate the location of potential phantom sound sources formed by adjacent channels. The white tic marks on these moving bar

indicators show the phantom source locations. The bar length indicates the correlation between the adjacent channels. A short-to-medium length green bar indicates positive correlation between the channels, forming a localized phantom sound source located at the white tic mark. The bar grows to full length and changes color to yellow as the correlation moves to zero, indicating a wide, non-localized sound image. The bar changes color to red for adjacent channels with significant negative correlation. For negative correlations, the ends of the PSI for the L and R channels will continue to grow at a 45 ° angle while the other PSIs remain at full length.

- Center-Pairs Phantom Sound Indicator – a fifth PSI at the top of the display shows potential phantom sources formed by the LC channel pair and the CR channel pair. If the L, R, and C channels all have the same signal level, the white tic mark on the bar will appear directly above the C level indicator. The white tic mark will move right or left depending on the relative balance between the three channels. A short bar to the left of the white tic mark indicates a positive correlation between L and C. The bar will grow as the correlation decreases. Like the L-R PSI, the bar will continue to grow at a 45° angle for negative signal correlations. The bar to the right of the white tic mark behaves in the same way, depending on the C-R correlation. This PSI indicator uses the same color coding as the other PSI indicators.

Usage Notes

The displays shown here are examples of how the surround sound waveform appears for some typical signal types.

1. Uncorrelated signals: same level in the L, C, R, Ls, and Rs channels.
2. Sine wave test tone: same level in the L, C, R, Ls, and Rs channels. All signals are in phase, creating phantom sources between the adjacent channels.

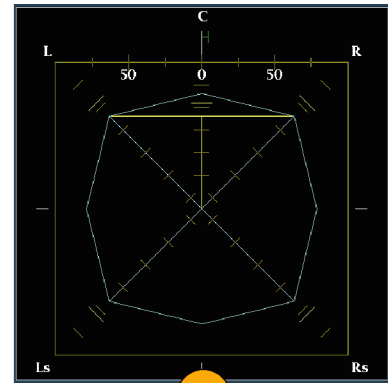
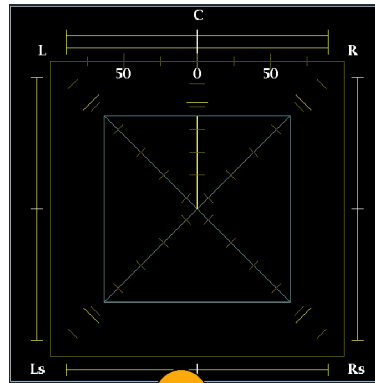

3. Same as 2, with the exception that Channel L is out of phase.
4. Surround sound program with strong center channel presence.

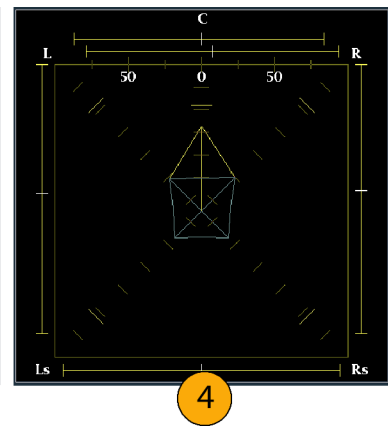
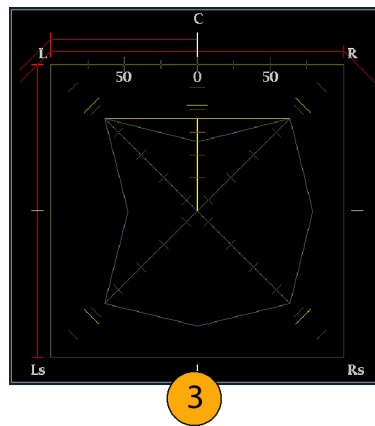

5. Surround sound program with weak center channel presence.
6. Monaural signal in channels Ls and Rs, creating a phantom source in the center, as in a 3.1 surround sound system.

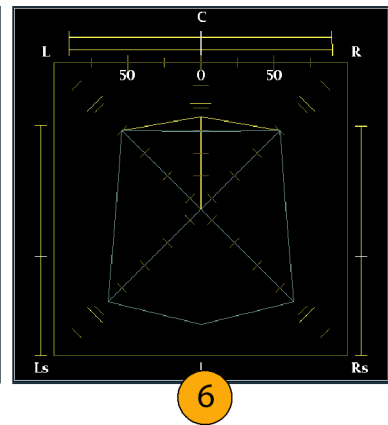
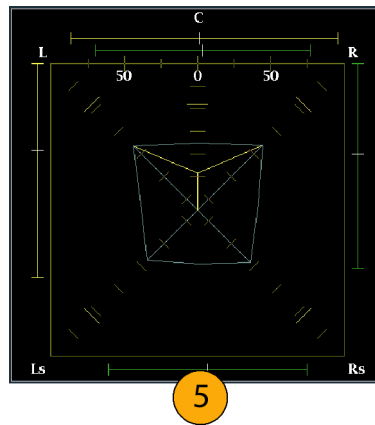

Monitor Dolby-Based Surround Sound

If your instrument has Dolby monitoring capabilities (Option DDE), it can decode and monitor audio signals that are based on Dolby digital surround sound formats. These formats are Dolby D (AC-3) compression (designed for distribution) and/or Dolby E compression (designed for production). You can specify and configure the Dolby input sources, measure signal levels and monitor phase between Dolby components, and display these relations in the Audio display.

NOTE. For a list of the options that are installed on your instrument, press the **CONFIG** button. In the configuration menu, select the **Utilities** submenu. The **View Instrument Options** entry lists the options installed on your instrument.

Configuring Dolby Inputs

Like other inputs, the Dolby inputs that you select and monitor from the Audio display may need to be configured before you use them. They will initially be set to factory defaults, which you can restore by pressing the **FACTORY** button on the instrument front-panel. The first procedure in this section will help you configure these inputs. After you have completed that procedure, check that the alarms are configured as you want them. Your setup here determines, in part, the Dolby audio-signal characteristics that are displayed.

To Set Up Dolby Input Parameters

1. Press the **CONFIG** button to display the Configuration menu.
2. Use the arrow keys and **SEL** button to make selections in the steps that follow.
3. Select **Audio Inputs/Outputs**.
4. Select the Dolby input that you want to configure (one of Dolby 1 - Dolby 4).
5. The Dolby parameters for the selected Dolby input are now displayed; select each parameter in turn and set up as described in the following steps.
6. Select **Dolby Source** and choose the embedded or AES input signal pair as the signal source to be decoded for the Dolby input selected in step 4.
7. Select **Format Expected** and choose the format condition that, when missing, triggers the Dolby Format Alarm.

NOTE. The instrument auto-selects and decodes the Dolby Format, depending on the Dolby option installed.

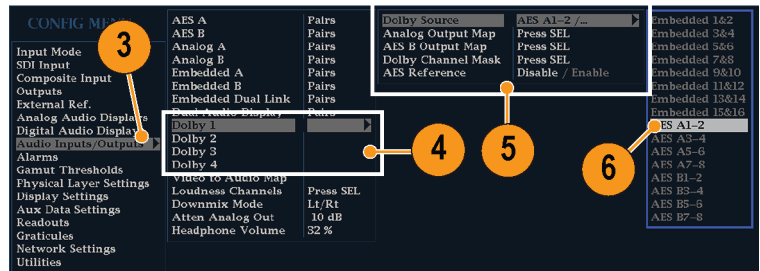

2223-169

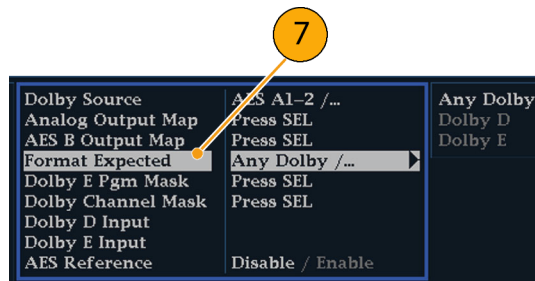

8. Select **Analog Output Map** and specify which inputs (if any) are routed to the analog outputs in the map that appears. (Map shown right.)

Output Bar	Analog 1 & 2	Analog 3 & 4	Analog 5 & 6	Analog 7 & 8
1	<input checked="" type="checkbox"/>	<input type="checkbox"/>	<input type="checkbox"/>	<input type="checkbox"/>
2	<input type="checkbox"/>	<input type="checkbox"/>	<input type="checkbox"/>	<input type="checkbox"/>
3	<input type="checkbox"/>	<input type="checkbox"/>	<input type="checkbox"/>	<input type="checkbox"/>
4	<input type="checkbox"/>	<input checked="" type="checkbox"/>	<input type="checkbox"/>	<input type="checkbox"/>
5	<input type="checkbox"/>	<input type="checkbox"/>	<input type="checkbox"/>	<input type="checkbox"/>
6	<input type="checkbox"/>	<input type="checkbox"/>	<input checked="" type="checkbox"/>	<input type="checkbox"/>
7	<input type="checkbox"/>	<input type="checkbox"/>	<input type="checkbox"/>	<input type="checkbox"/>
8	<input type="checkbox"/>	<input type="checkbox"/>	<input type="checkbox"/>	<input checked="" type="checkbox"/>
9	<input type="checkbox"/>	<input type="checkbox"/>	<input type="checkbox"/>	<input type="checkbox"/>
10	<input type="checkbox"/>	<input type="checkbox"/>	<input type="checkbox"/>	<input type="checkbox"/>
Phase Pair	<input type="checkbox"/>	<input type="checkbox"/>	<input type="checkbox"/>	<input type="checkbox"/>

9. Select the **AES B Output Map** and assign specific bar pairs to the AES B outputs in the map that appears. (The AES B bank must be configured as outputs.) (Map similar to that shown right.)

NOTE. When a Dolby input is active, channel labels (L, R, Ls, and so on) appear in addition to the channel numbers.

10. Select box to close maps.



11. Select **Dolby D Input** and select the AES channel for Dolby content in which the subframes carry two Dolby streams (in Dolby Professional 16-bit mode).

AES Chan	1	2
AES Stream	Auto	2

12. Select **Dolby D Input** and select the stream for Dolby Content in which there can be multiple Dolby Digital streams embedded.

AES Chan	1
AES Stream	Auto
	1
	2
	3
	4
	5
	6
	7

13. Select **Dolby E Pgm Mask** (Dolby E Program Mask), and navigate to each box for each program. Press the SEL key to toggle to Allow Alarm (X) or not (blank).

Program	1	2	3	4	5	6
Allow Alarm	<input checked="" type="checkbox"/>	<input checked="" type="checkbox"/>	<input checked="" type="checkbox"/>	<input checked="" type="checkbox"/>	<input checked="" type="checkbox"/>	<input checked="" type="checkbox"/>

14. Select this box to close the map.



15. Select **Dolby Chan Mask**, and choose which Dolby channels (L, R, C, Lfe, and so on) can trigger alarms based on the decoded content.

Channel	L	R	C	Lfe	Ls	Rs	Lb	Rb	Lo	Ro	Lt
Allow Alarm	<input checked="" type="checkbox"/>	<input checked="" type="checkbox"/>	<input checked="" type="checkbox"/>	<input type="checkbox"/>	<input checked="" type="checkbox"/>	<input checked="" type="checkbox"/>	<input checked="" type="checkbox"/>	<input checked="" type="checkbox"/>	<input checked="" type="checkbox"/>	<input checked="" type="checkbox"/>	<input checked="" type="checkbox"/>

16. Select the box to close the map.



17. Select **Dolby E Input**, and select the program from which the downmix is derived.

NOTE. Although 8 programs are listed, the number active depends on the Dolby E Program Configuration detected in the metadata of the Dolby input. (See page 101, *Audio Bar Mapping vs. Dolby E Metadata Program Configuration.*)



18. Set **AES Ref Enable** to **Disable** or **Enable**. If enabled, and the Dolby Source is set to an AES input, the instrument triggers the AES Frame Sync Alarm if the AES input is not locked to the AES reference.

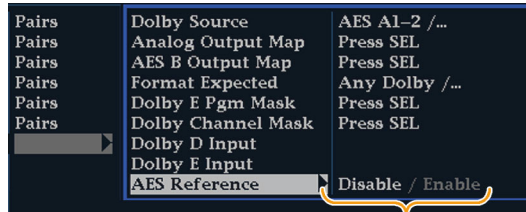

19. Repeat steps 4 through 18 for other Dolby inputs as needed.

To Set Up Dolby Global Parameters

Do the following steps to set parameters that apply to all four Dolby inputs:

1. Press the **CONFIG** button to display the Configuration menu.
2. Use the arrow keys and **SEL** button to set the menu in the steps that follow.
3. Select **Audio Inputs/Outputs**.
4. Select **Dolby D (AC-3) Setup** and make the following settings. The settings will apply to the input when Dolby D is detected for Dolby inputs.

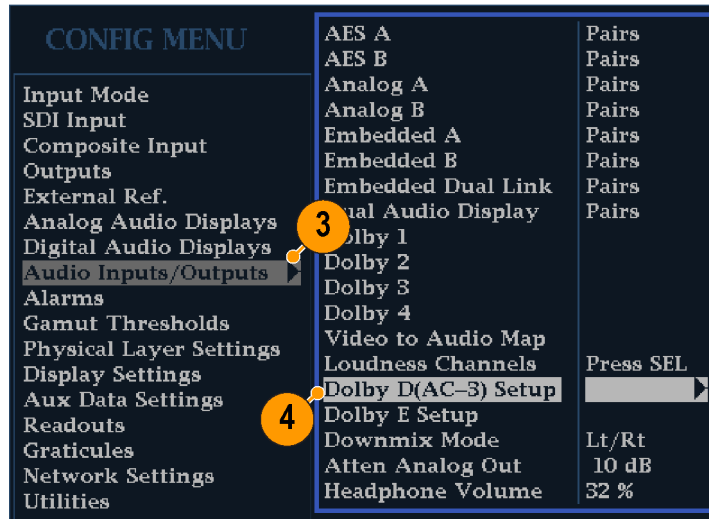

5. Select the Dolby D **Listening Mode**, which controls how the Dolby sound channels map to the level bars and surround-sound elements in the Audio Display and outputs.
6. Choose **Full** or a mode to which you want to downmix. (See page 98, *Usage Notes*.)

NOTE. Dolby content of the signal at the Dolby input must be sufficient to downmix to the mode selected or the setting has no effect.

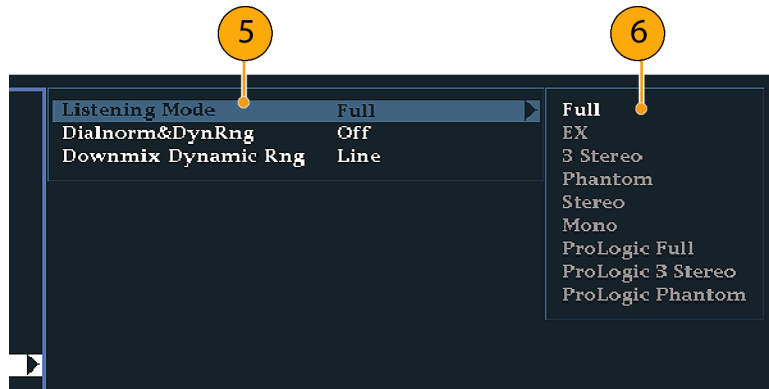

7. Select **Dialnorm&DynRng**.
8. Select **Off** or choose **Dialnorm Only**, **Dialnorm+RF**, or **DialNorm+Line**. RF and Line are modes of Dynamic Range Control (compression) factors that are applied when decoding Dolby content for monitoring or output.

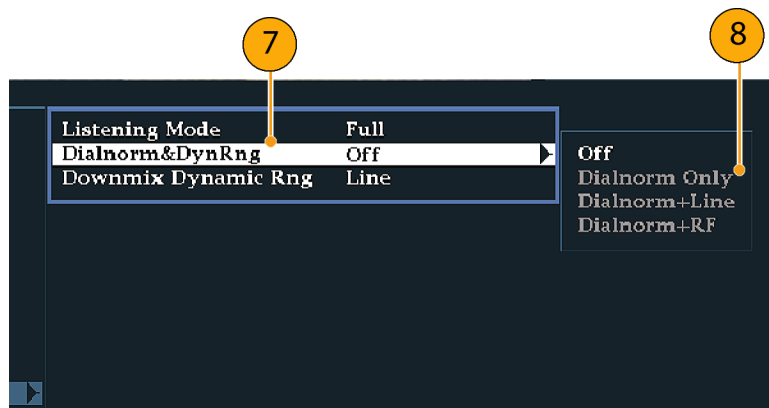

- 9. Select **Downmix Dynamic Rng.**
- 10. Toggle to **Line** or **RF**. These Dynamic Range Control (compression) factors are applied when downmixing to the various Dolby D Listening Modes.

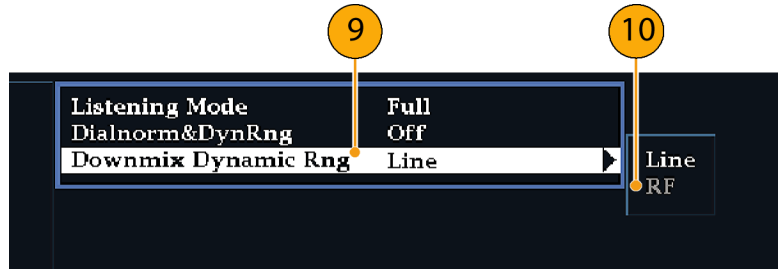

- 11. Select **Dolby E Setup**. The settings you make will apply to the input when Dolby E content is detected for the Dolby input selected.
- 12. Select **Dialnorm** and toggle to **On** or **OFF**. When On, the dialog normalization is applied to the audio bars and the analog and digital outputs.
- 13. Select **Pulldown Decoding** and toggle to **On** or **OFF**. When On, pulldown decoding is applied to the audio bars and the analog and digital outputs.

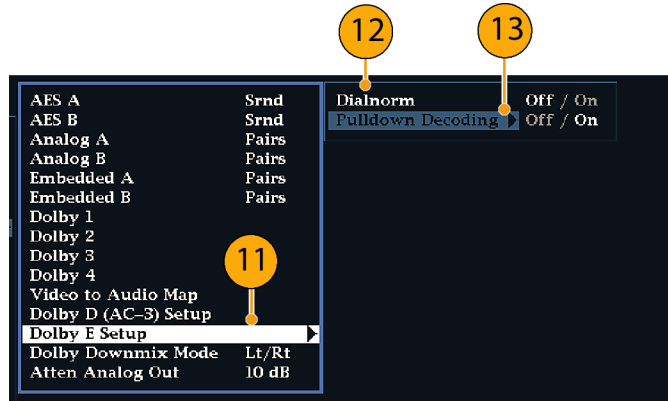

14. Select **Dolby Downmix Mode**. Each downmix mode combines multiple separate audio channels into a mix that provides compatibility for users with only mono or stereo systems, or with older analog surround sound systems.

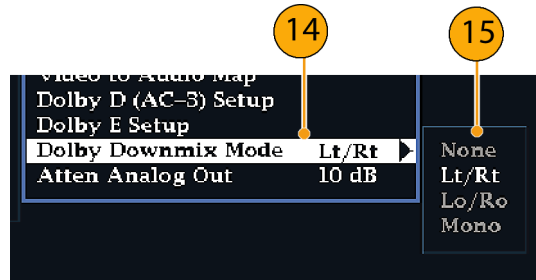

15. Choose one of the following modes to display as two bars in the Audio Display:

- Select **None** to get no downmix.
 - Select **Mono** to get the downmix shown right.
 - Select **Lo/Ro** (Left-only/Right only) to get a standard stereo downmix.
 - Select **Lt/Rt** (Left-total/Right-total) to get a Dolby Pro-Logic compatible stereo mix.
16. Press the **CONFIG** button to dismiss the Configuration menu.

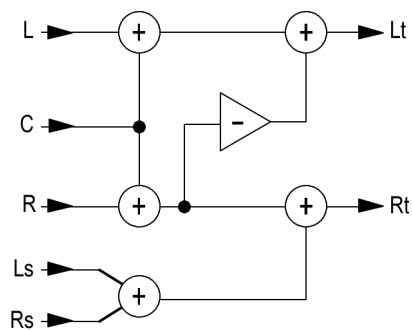
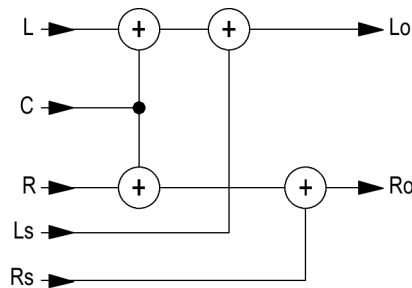
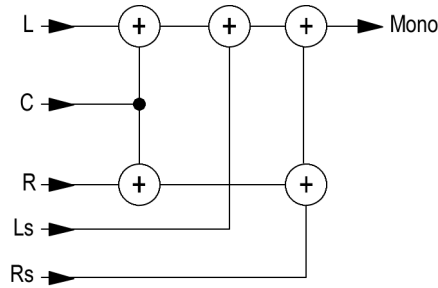

Displaying Dolby Inputs

After you have configured a Dolby input, you can display its levels and other characteristics in the Audio Display. (See page 91, *Configuring Dolby Inputs*.)

1. Open the audio monitor in one tile. (See page 83, *Selecting Audio Input*.)
2. Press and hold the **Audio** button to display the Audio menu.
3. Select **Audio Input** and select one of Dolby 1 through Dolby 4.

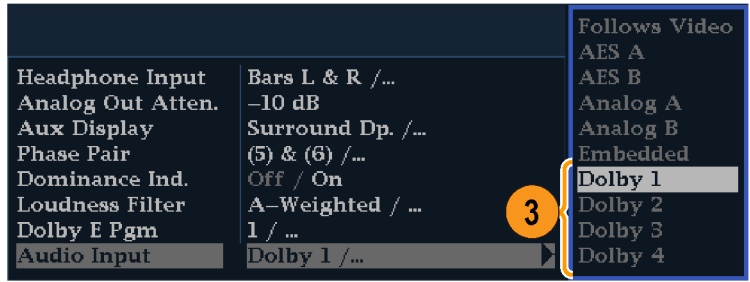

2223-096

The audio display for monitoring Dolby is shown to the right.

1. Level bars for Dolby channels. The Listening Mode selected determines channels/bars shown.
2. Levels bars for the selected Dolby Downmix mode.
3. Dolby setup information. (See page 97, *Dolby Display Readout*.)
4. Dolby Listening environment display. (See page 88, *Surround Display Elements*.)

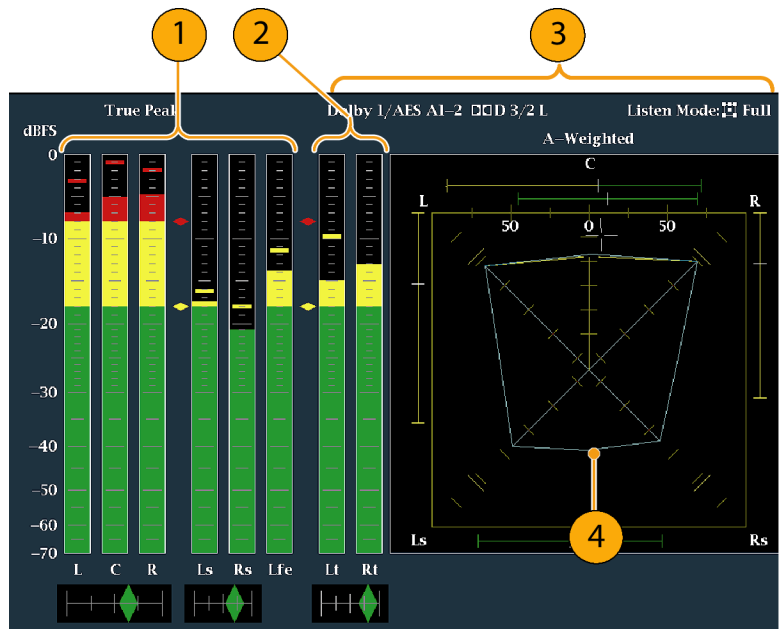

Dolby Display Readout

1. The selected Dolby input.
2. The selected Dolby Source for the input.
3. The Coding (Channel) Mode.
4. The Listening Mode setting.

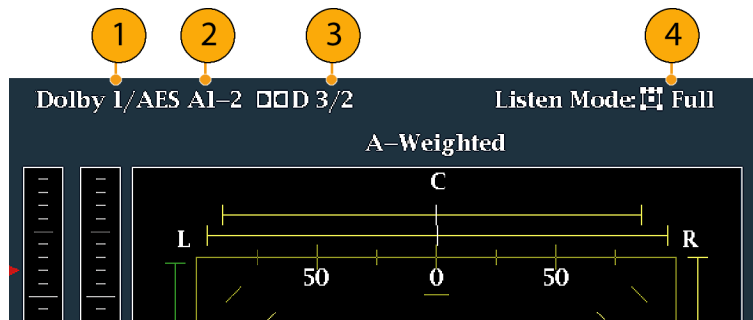

Viewing Dolby Metadata

If your instrument has Option DDE installed, it can decode and display selected metadata parameters present in the Dolby D, Dolby E bitstream, or in the vertical ancillary data in a Dolby Audio Status screen. To display the data for the currently selected input, do the following procedure:

1. Select a tile.
2. Press and hold the **STATUS** button to open the Status display in that tile and display the Status menu.
3. Use the arrow keys and **SEL** button to make selections in the steps that follow.
4. Select **Display Type** and then select **Dolby Status**, as shown. Note the following:
 - A Dolby option must be installed for the Dolby Audio Status to display.
 - The Dolby format will match that of the selected input.
5. To activate the display type selected, press **SEL**.
6. Select the Metadata Source (AES or VANC).

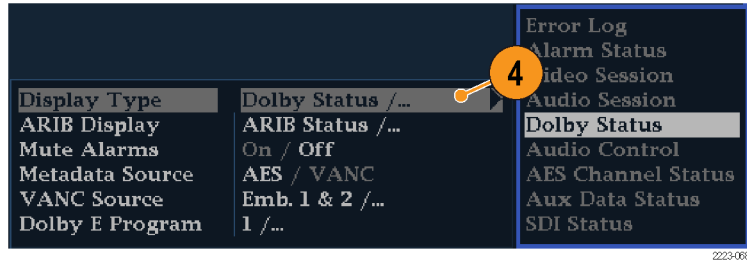

NOTE. If you select VANC at the metadata source, select the VANC source, as well.

Usage Notes

- Your instrument determines the downmix based on several parameters within the Dolby metadata and the Dolby downmix selection. For example, if the Dolby Audio Status screen shows Extended Bitstream information indicating that the preferred downmix is Lt/Rt, the center channel is attenuated by -3dB and the surround channels are attenuated by -6dB before they are combined into the stereo downmix.
- The listening modes can be used to monitor any multichannel Dolby Digital audio program with a user-selectable number of channels. You can select among several basic and Pro Logic listening modes, the descriptions of which follow. Depending on the Channel Mode, these listening modes affect the content displayed on the Audio Display level bars. (See Table 1 on page 100.)

Basic Listening Modes

EX. Use EX if the two surround channels have been matrix encoded with a back channel. If the EX listening mode is selected and there are two surround channels present, the bar display will add two back channels, Lb and Rb, to create a 7.1 channel display.

Full. Full does not modify the number of channels indicated by the channel mode in either the display or the outputs.

3 Stereo. Use 3 Stereo to monitor the Dolby Digital signal with only the left, center, and right channels. In this mode, if there are surround channels present, they are mixed into the left and right channels with the surround mix level attenuation.

Phantom. When using Phantom, the center channel, if present, gets attenuated with the center mix level value and is then added into the left and right channels.

Stereo. Stereo always creates a Lo/Ro downmix using the center and surround mix levels contained in the metadata. The Lfe is disabled.

Mono. Mono mode will always mix down to a single center channel, usually by creating a Lo/Ro downmix and adding Lo to Ro. The Lfe is disabled.

Pro Logic Listening Modes

Pro Logic listening modes perform different functions depending on what the source material is. If the source is a Dolby Digital stream with three or more channels, then a surround compatible Lt/Rt downmix is created and then decoded into a selectable number of channels. If the source is a 2/0 Dolby Digital stream, then these Pro Logic modes will do a Pro Logic decode to produce the number of channels requested by the listening mode. If the source is PCM, then a full Pro Logic decode is provided regardless of the specific Pro Logic mode selected.

Pro Logic Full. Pro Logic Full will create a Lt/Rt downmix of any input with three or more channels. This Lt/Rt downmix will then be Pro Logic decoded to produce a LCRS output where the surround channel is reduced 3dB and reproduced in both the Ls and Rs bars.

A 2/0 encoded Dolby stream will be assumed to be Pro Logic encoded already and will be Pro Logic decoded to produce a LCRS output. Again, the surround channel is reduced 3dB and reproduced in both the Ls and Rs bars.

Any PCM input will be decoded the same as a 2/0 Dolby Digital input.

Pro Logic 3 Stereo. Pro Logic 3 Stereo will create a Lt/Rt downmix of any input with three or more channels. This Lt/Rt downmix will then use Pro Logic decoding to produce a center channel and provide LCR bars.

A 2/0 encoded Dolby stream will be assumed to be Pro Logic encoded already and will be Pro Logic decoded to produce a LCR output.

Any PCM input will be decoded to provide LCRS channels where the surround channel is reduced 3dB and reproduced in both the Ls and Rs bars.

Pro Logic Phantom. Pro Logic Phantom will create a Lt/Rt downmix of any input with three or more channels. This Lt/Rt downmix will then use Pro Logic decoding to produce a surround channel and provide LCS surround channels. This surround channel is reduced 3dB and reproduced in both the Ls and Rs bars.

A 2/0 encoded Dolby stream will be assumed to be Pro Logic encoded already and will be Pro Logic decoded to produce a LRS output. Again, the surround channel is reduced 3dB and reproduced in both the Ls and Rs bars.

Any PCM input will be decoded to provide LCRS channels where the surround channel is reduced 3dB and reproduced in both the Ls and Rs bars.

Table 1: Channel Mode vs. Listening Modes

Channel Mode	Listening Mode	Main Channel Output Function
3/2	EX	All 3/2 channels + EX decode of back surround
	Full	All 3/2 channels
	3 Stereo	3 Stereo downmix of 3/2 channels
	Phantom	Phantom downmix of 3/2 channels
	Stereo	Lo/Ro downmix
	Mono	Lo+Ro
	PL Full	LCRS from Lt/Rt downmix
	PL 3 Stereo	3 Stereo from Lt/Rt
	PL Phantom	Phantom from Lt/Rt
2/2	EX	All 2/2 channels + EX decode of back surround
	Full	All 2/2 channels
	3 Stereo	Default to Stereo mode
	Phantom	Default to Full mode
	Stereo	Lo/Ro downmix
	Mono	Lo+Ro
	PL Full	LCRS from Lt/Rt downmix
	PL 3 Stereo	3 Stereo from Lt/Rt
	PL Phantom	Phantom from Lt/Rt
3/1	EX	Default to Full mode
	Full	All 3/1 channels
	3 Stereo	S mixed into L and R with smix coefficient
	Phantom	C mixed into L and R with cmix coefficient
	Stereo	Lo/Ro downmix
	Mono	Lo+Ro
	PL Full	LCRS from Lt/Rt downmix
	PL 3 Stereo	3 Stereo from Lt/Rt
	PL Phantom	Phantom from Lt/Rt
2/1	EX	Default to Full mode
	Full	All 2/1 channels
	3 Stereo	S mixed into L and R with smix coefficient
	Phantom	Default to Full mode
	Stereo	Lo/Ro downmix
	Mono	Lo+Ro
	PL Full	LCRS from Lt/Rt downmix
	PL 3 Stereo	3 Stereo from Lt/Rt
	PL Phantom	Phantom from Lt/Rt

Table 1: Channel Mode vs. Listening Modes (cont.)

Channel Mode	Listening Mode	Main Channel Output Function
3/0	EX	Default to 3 Stereo mode
	Full	Default to 3 Stereo mode
	3 Stereo	All 3/0 channels
	Phantom	C mixed into L and R with cmix coefficient
	Stereo	Lo/Ro downmix
	Mono	Lo+Ro
	PL Full	LCRS from Lt/Rt downmix
	PL 3 Stereo	3 Stereo from Lt/Rt
	PL Phantom	Phantom from Lt/Rt
2/0	EX	Default to Stereo mode
	Full	Default to Stereo mode
	3 Stereo	Default to Stereo mode
	Phantom	Default to Stereo mode
	Stereo	2/0 channels
	Mono	L+R
	PL Full	LCRS from 2/0 channels
	PL 3 Stereo	3 Stereo from 2/0 channels
	PL Phantom	Phantom from 2/0 channels
1/0	EX	Default to Mono mode
	Full	Default to Mono mode
	3 Stereo	Default to Mono mode
	Phantom	Default to Mono mode
	Stereo	Default to Mono mode
	Mono	Mono center channel output
	PL Full	Default to Mono mode
	PL 3 Stereo	Default to Mono mode
	PL Phantom	Default to Mono mode

Audio Bar Mapping vs. Dolby E Metadata Program Configuration

If your instrument has Option DDE installed and is decoding Dolby E audio, the bars in the Audio display are mapped as shown in the following table. The mapping derives from the Dolby E Program Configuration detected in the metadata of the Dolby input. If you select a Downmix Program, the two downmix level bars in the Audio display reflect that program selection.

Dolby E Program Configuration	Audio Bar Mapping ¹	Number of Programs Available
5.1 + 2	L, C, R, Ls, Rs, L _{FE} L1, R1	2
5.1 + 2x1	L, C, R, Ls, Rs, L _{FE} M2, M3	3
4 + 4	L1, C1, R1, S, L2, R2, C2, S	2
4 + 2 + 2	L1, C1, R1, S, L1, R1, L2, R2	3

Dolby E Program Configuration	Audio Bar Mapping ¹	Number of Programs Available
4 + 2 + 2x1	L1, C1, R1, S, L1, R1, M1, M2	4
4 + 4x1	L1, C1, R1, S, M2 M3 M4, M5	5
2 + 2 + 2 + 2	L1, R1, L2, R2, L3, R3, L4, R4	4
2 + 2 + 2 + 2x1	L1, R1, L2, R2, L3, R3, M4, M5	6
2 + 2 + 4x1	L1, R1, L2, R2, M3, M4, M5, M6	6
2 + 6x1	L1, R1, M2, M3, M4, M5, M6, M7	7
8x1 = 1+1+1+1+1+1+1+1	M1, M2, M3, M4, M5, M6, M7, M8	8
5.1	L, C, R, Ls, Rs, L _{FE}	1
4 + 2	L1, C1, R1, S, L2, R2	2
4 + 2x1	L1, C1, R1, S, M2, M3	3
2 + 2 + 2	L1, R1, L2, R2, L3, R3	3
2 + 2 + 2x1	L1, R1, L2, R2, M3, M4	4
2 + 4x1	L1, R1, M2, M3, M4, M5	5
6x1	M1, M2, M3, M4, M5, M6	6
4	L1, C1, R1, S	1
2 + 2x1	L1, R1, M2, M3	3
4x1	M1, M2, M3, M4	4
7.1	L, C, R, Ls, Rs, L _{FE} , Lb, Rb	1
7.1 Screen	L, C, R, Ls, Rs, L _{FE} , Le, Re	1

¹ L = Left, R = Right, C = Center, M = Mono, S = Surround, e = extra (Le and Re and Ex encoded channels), b = back, L_{FE} = Low Frequency Effects

Monitoring Closed Captioning (CC), Teletext, and Safe Area Compliance

Your instrument can monitor for CC data (including V-Chip ratings) present in the selected signal and display that data overlaid on the Picture display. (EIA 608 (VBI), EIA 608 (ANC), EIA (608/708), EIA 708, TeletextB (VBI), TeletextB OP47 SDP (ANC), and TeletextB OP47 Multi (ANC) closed caption transports are supported.

Your instrument can also display Safe Action and Safe Title graticules, allowing you to monitor for incorrect placements of graphics, logos, and other branding elements. This will help you ensure that those items do not obscure text or essential action. SMPTE, ITU, and ARIB TR-B.4 standards are supported.

Monitoring Closed Captioning and Teletext

To Configure Closed Captioning and Teletext

Before using Closed Captions, configure them in the Configuration menu by performing the following steps:

1. Press the **CONFIG** button to display the Configuration menu.
2. Use the arrow keys and **SEL** button to make selections in the steps that follow.
3. Select **Aux Data Settings**.
4. Select **Closed Caption Transport**.
5. Select one of the CC stream types or select **AUTO** to search for closed caption streams in the following order and present the text of the first stream type detected:

- For Composite:
 - EIA-608 (VBI)
 - TeletextB VBI for Composite (PAL)
- For SD:
 - TeletextB VBI for SD 625
 - EIA-608 (VBI)
 - EIA-608 (ANC)
 - EIA-608 (708)
 - EIA-708
- For HD:
 - EIA-608 (ANC)
 - EIA-608 (708)
 - EIA-708
 - TeletextB VBI
 - TeletextB OP47 SDP (ANC)
 - TeletextB OP47 Multi (ANC)

6. Define the alarms and settings for the CC stream type.

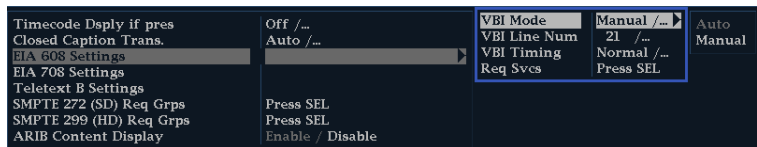
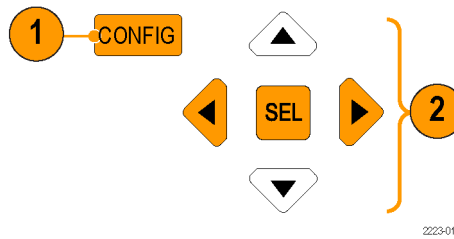

To View Closed Captioning Status and Subtitles

1. Press the **STATUS** button to select the Status display mode.
2. Press and hold the **STATUS** button to display the pop-up menu.
3. Select **Display Type** and then select **Aux Data Status**.

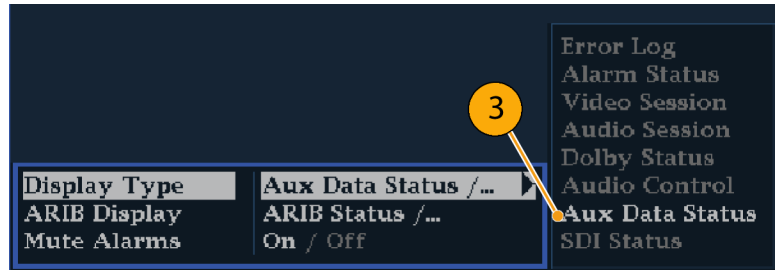

4. The Auxiliary Data Status display shows the status of the closed caption data.

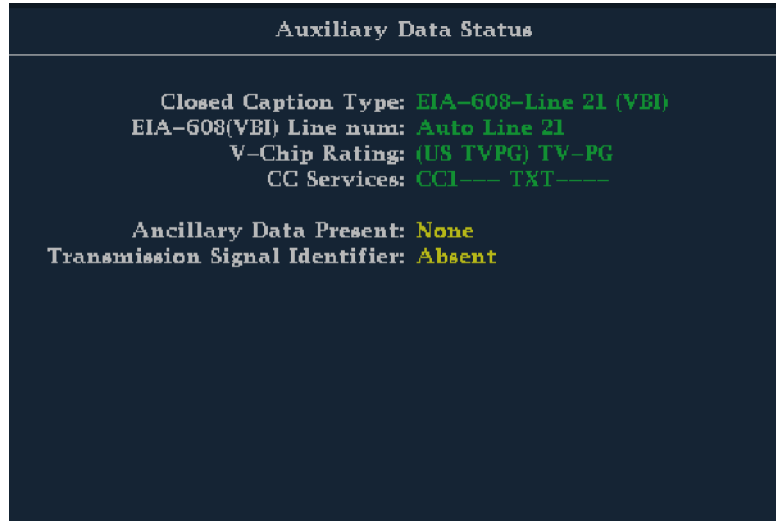

To Display Closed Captioning

1. Select a tile.
2. Press and hold the **PICT** button to display the Picture pop-up menu.
3. Select **Display Closed Captions** and toggle it to **On**.
4. Select a closed caption service.
EIA-608 shown selected.
5. Select the closed caption transport.
EIA-608 shown selected.

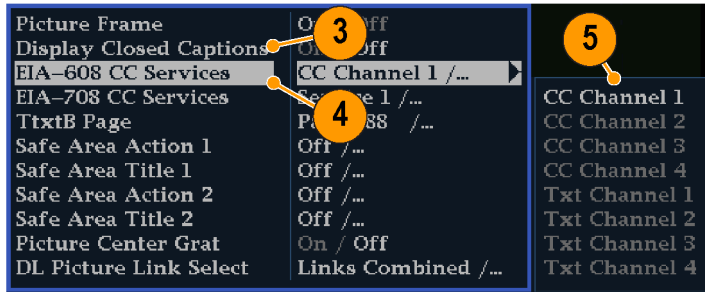

The Picture display includes Closed Captioning in the area designated by the Closed Caption data.

6. Press the **PICT** button again to dismiss the Picture menu.

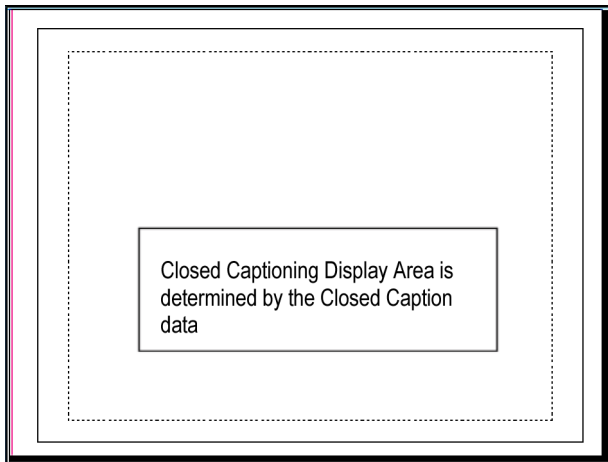

Usage Notes

- PICT displays in individual tiles allow their Services and Pages to be selected independently.
- CC text is not captured with the Picture image when using Freeze.
- CC/Teletext setups are also stored when saved with Presets and restored on power up.
- The CC alarms are available from the Configuration menu in the Alarms submenu under Closed Captions/Metadata.
- Teletext can be viewed as captions or as a whole page.

Monitoring for Safe Area Compliance

To display graticules for monitoring for incorrect placements of nonessential elements relative to essential ones, set global settings in the Configuration menu and turn on up to four Safe Area graticules, each with independent settings, in the Picture menu.

To Configure Safe Area Graticules

Before using Safe Area Graticules, configure them from the Configuration menu by performing the following steps:

1. Press the **CONFIG** button to display the Configuration menu.
2. Use the arrow keys and **SEL** button to make selections in the steps that follow.
3. Select **Graticules** and then select **Safe Area Graticule Standard**.
4. Choose from the **SMPTE**, **ITU**, or **ARIB TR-B.4** standards.

The selection you choose will be the graticule used when **AUTO** is chosen for any of the four Safe Area Graticules, accessed in the Picture menu.

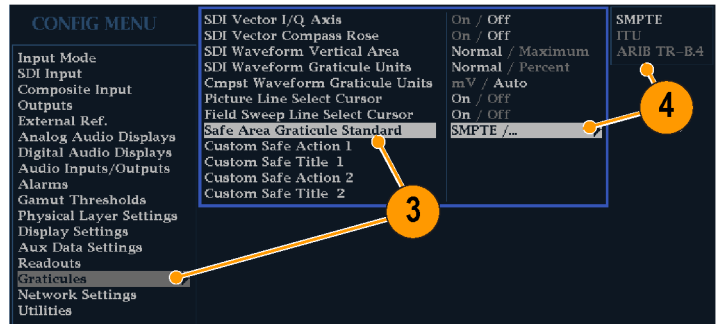

2231-061

5. If you want, to set the Height, Width, and Offsets of the title and action areas for Custom Safe Graticules 1 and 2, first select the title or action to change.
6. Select the parameter.
7. Set the percentage level for each of the parameters.
Parameters are set as a percentage of screen height or width, and you can watch the graticules update on the screen as you change them.
The custom parameters you set will be used when **Custom_1** or **Custom_2** is chosen for any of the four Safe Area Graticules accessed in the Picture menu.
8. Press the **CONFIG** button again to close the Configuration menu.

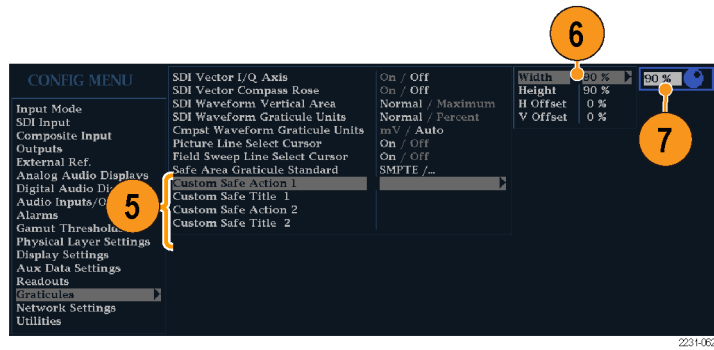

To Display Safe Area Graticules

1. Select a tile.
2. Press and hold the **PICT** button to display the Picture menu.
3. Select **Safe Area Action 1**.
4. Select one of the following:
 - **Auto** to let the instrument automatically select the size and offsets of the safe area.
 - **4x3, 14x9, or 16x9** to set the safe area size and offsets appropriate for these aspect ratios based on the selected standard.
 - **Custom_1** or **Custom_2** to set the safe area size and offsets to match the custom settings in the Graticules Configuration menu. (See the procedure *To Configure Safe Area Graticules*, step 5.)
5. Repeat step 4 for each Safe Area selection.
6. Press the **PICT** button again to dismiss the pop-up menu.

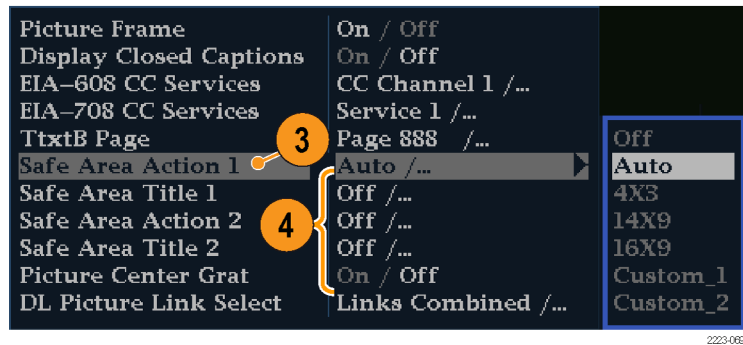

Usage Notes

- The Safe Action Area denotes the maximum image area within which all significant action should be contained; the Safe Title Area denotes the maximum image area within which all significant titles should be contained.
- Safe Area Graticules can globally be configured to comply to accepted standards in the Configuration menu.
- Custom selections for vertical and horizontal size and offset of the Save Areas can be set in the Configuration menu.

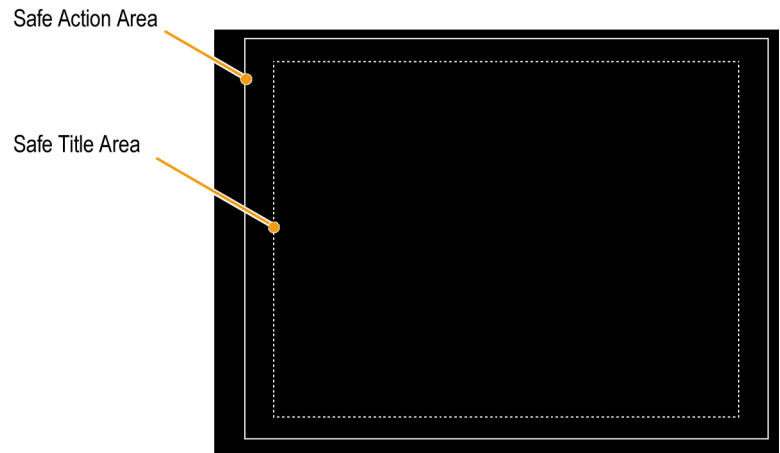

Using Alarms

Alarms can be configured so that your instrument automatically monitors parameters and reports when those parameter limits are exceeded. The procedures that follow describe how to configure response types for individual alarms, how to enable them, and how to monitor them.

Configuring Alarms

Alarms may need to be configured in the Configuration menu use. Alarms are initially set to factory defaults, which can be restored by pressing the **FACTORY** button on the front-panel of your instrument. Do the first procedure in this section (if alarm configuration is needed) before doing the audio monitoring procedures. (See page 82, *Monitoring Audio*.)

To Set Allowed Alarm Responses

1. Press the **CONFIG** button to display the Configuration menu.
2. Use the arrow keys and **SEL** button to make selections in the steps that follow.
3. Select **Alarms**.
4. Navigate to the alarm category that you want to configure. In the example to the right, **Video Format** alarms is highlighted.
5. Note that the alarms in the category you select appear to the right as you highlight the alarm category. Press **SEL** to display a table that allows you to set the responses for individual alarms.
6. For each alarm listed in the table, select the box to place (or remove) an X in the box under each response that you want enabled (or disabled) for that alarm. (See page 111, *Possible Alarm Responses*.)
7. Navigate to highlight the **Return** box, and press the **SEL** button to return to the Configuration menu.
8. Repeat steps 4 through 7 to configure as many types of alarms as you want.

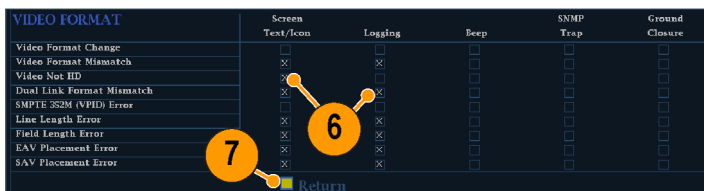
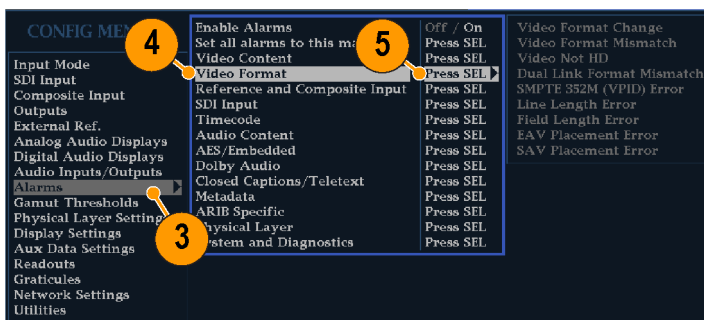

To Set Alarm Responses Globally

1. Press the **CONFIG** button to display the Configuration menu.
2. Use the arrow keys and **SEL** button to make selections in the steps that follow.
3. Select **Alarms**.
4. Navigate to **Set all Alarms to this Mask**.
5. Press **SEL** to display a table for setting the allowed responses for alarm settings to be applied to all alarm categories.
6. For each alarm listed in the table, select the box to place (or remove) an X in the box under each response that you want enabled (or disabled) for that alarm. (See page 111, *Possible Alarm Responses*.)
7. Navigate to highlight the **Return** box, and press the **SEL** button to return to the Configuration menu.
This sets alarms for all alarm categories to the setting on the global mask.

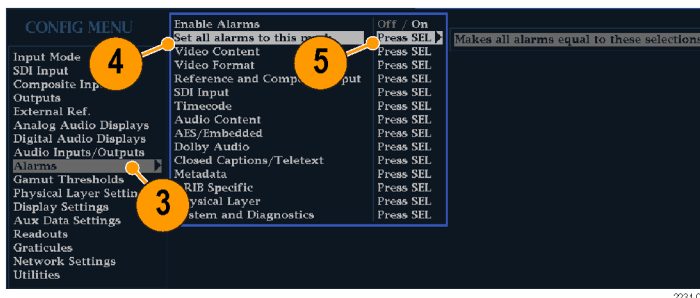

2231-061

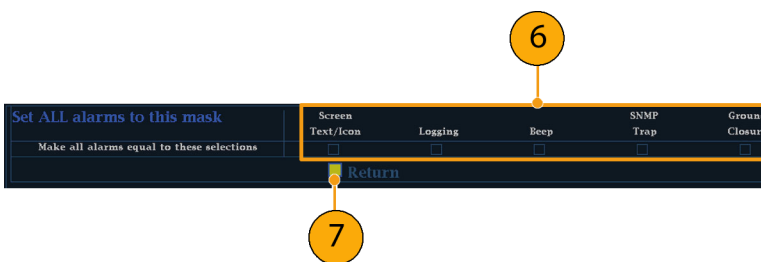

Possible Alarm Responses

For each available alarm, you can select up to four of the responses listed. If you do not select a notification method for an error, you will not be notified if that error occurs.

- **Screen Text/Icon.** An icon appears on the display. This notification method is disabled when the Configuration menu is open. This option also enables alarm reporting with color on the Status screen.
- **Logging.** The instrument makes an entry in the Event Log. Refer to *Status Display* in the *Display Information* section of the *User Technical Reference* manual.
- **Beep.** The instrument makes an audible alarm.
- **SNMP Trap.** The instrument sends an SNMP trap out the Ethernet port for a remote notification that an alarm condition occurred. You must enable and configure the instrument for SNMP control using the Network Settings submenu of the Configuration menu before SNMP traps can be sent. Refer to the *WFM, WVR, and AMM Management Information Base (MIB) Technical Reference* (located on your *User Documentation CD*) for more information about using SNMP alarm notifications.
- **Ground Closure.** The instrument sends a signal out the Remote port for a remote notification that an alarm condition occurred. You must enable the Remote Control Port in the Communications submenu of the Configuration menu before notifications can be sent.

NOTE. You can monitor alarm status. (See page 114, *Monitoring Alarms*.)

To Enable Alarms

The channels for which you enable alarms trigger your previously defined alarm responses. (See page 110, *To Set Allowed Alarm Responses*.)

1. Press the **CONFIG** button to display the Configuration menu.
2. Use the arrow keys and **SEL** button to make selections in the steps that follow.
3. To globally enable all alarms, select **Enable Alarms** and toggle it to **On**. This turns on all alarms that are individually enabled and provides a quick way to switch them on and off without changing their individual settings (see step 4).
4. Additionally, for Audio inputs, you must enable alarms individually by channels. To start, select **Audio Inputs/Outputs** in the Configuration menu.
5. Select each input shown in the box to individually enable its alarms. AES A is shown selected.

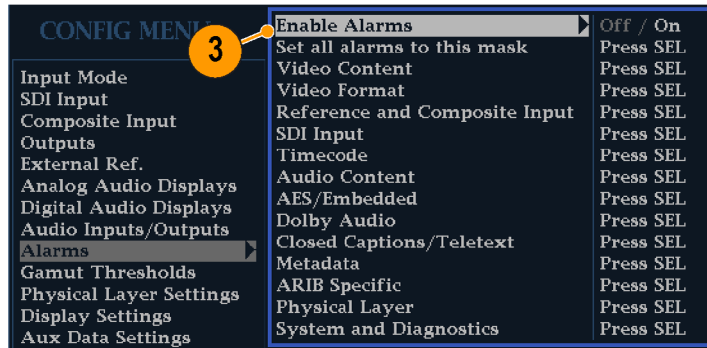

2231-062

6. For each of the AES, Analog, and Embedded inputs, select **Bar to Input Map** and press the **SEL** button to display the **Bar to Input map** menu.

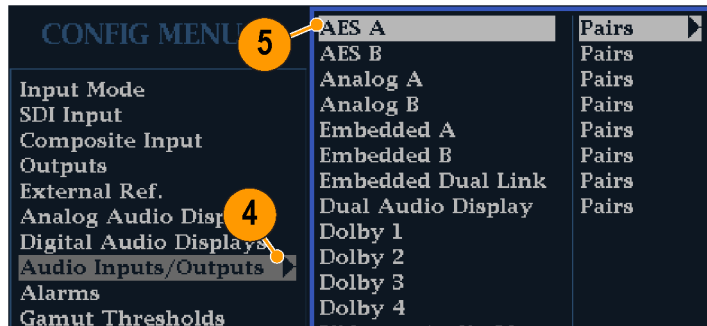

2231-063

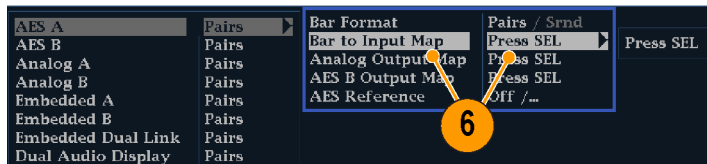

2231-054

7. Navigate to each box for each alarm that you want to allow. Press the **SEL** button to enable it (when enabled, there is an **X** in the box) or disable it (when disabled, the box is blank) for each channel displayed.
8. Select the box, and press the **SEL** button to return to the Configuration menu.

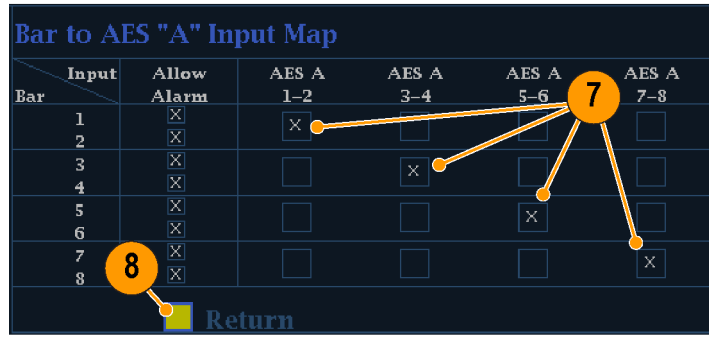

2231-055

9. For Dolby 1 - 4, you must also enable alarms individually.
10. Select the **Dolby Fmt Expected**, **Dolby E Pgm Mask** and/or **Dolby Chan** and configure them as you want.

Whether these selections are available depend on Dolby options installed. The procedure *To set up Dolby Input Parameters* provides instructions on configuring the alarms for the Dolby inputs. (See page 91.)

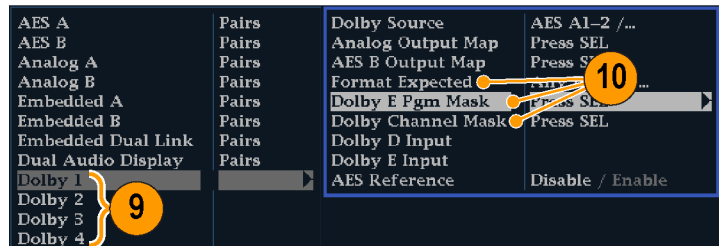

2231-056

To Set Limits or Qualifications

Some alarms also require setting a threshold or condition that triggers the alarm.

1. Select in turn **Analog Audio Displays**, **Digital Audio Displays**.
2. For each selection in step 1, set the following alarm levels that trigger an alarm when exceeded:



2231-057

- **Clip Samples:** number of consecutive samples at the all-high level.
- **Mute Samples:** number of consecutive all-zero samples.
- **Silence Level:** The level below which audio is considered not present.
- **Silence Duration:** The length of audio silence time allowed.
- **Over Level:** the too-loud audio level.
- **Over Duration:** The length of time limit for the too-loud audio.

3. For Closed Caption related alarms, select **Aux Data Settings**.
4. Select EIA608 Required Services and select the CC channels and/or Text channels that you want to trigger the CC Services Missing Alarm.

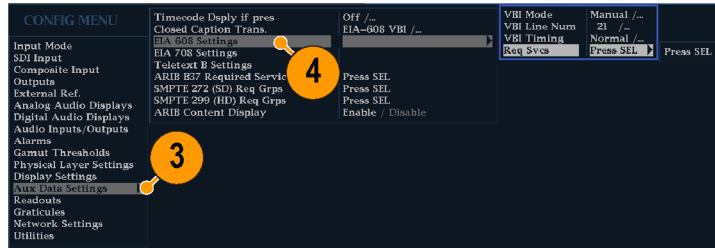

Monitoring Alarms

After defining and enabling alarms, you can quickly check if any error condition exists by looking (or listening) for the notification you defined (text, icon, logging, SNMP trap, beep). (See page 9, *Status Bar Icons*.) Selecting audible response (Beep) or the Ground Closure output response can help you notice alarms that you may miss if the notification is text or icon only. The latter can be used to drive a light or audible alarm when one or more alarms are triggered. (See page 110, *To Set Allowed Alarm Responses*.)

If you want to check the condition of a specific alarm, press the **STATUS** button. In the Status menu, select **Display Type** and then select **Alarm Status**. One or more of the following will appear:

Indicator	Description
Disabled (gray)	Alarm is not selected for reporting, but will still show if the error is present.
OK (green)	Alarm is enabled for reporting and has not detected errors for at least 5 seconds.
Error (yellow)	Alarm condition cleared for less than 5 seconds.
Error (red)	Alarm triggered now.

NOTE. To monitor alarms remotely, use a PC to monitor SNMP traps over the Ethernet port (the PC must have SNMP trap service installed). Before SNMP traps can be sent, you must enable and configure the instrument for SNMP control using the *Network Settings* submenu of the Configuration menu.

Application Example

Timing a Studio

Your instrument supports multiple methods and techniques for timing a studio, all of which require an external reference to your instrument. Timing a studio involves adjusting the references going to different sources so that their output feeds have the same timing when they arrive at a common point, such as a production switcher. For digital systems, timing typically only needs to be close, but not exact, because most switchers have some tolerance for timing errors. For analog composite systems, the timing may need to be matched within a small part of a subcarrier cycle to prevent hue shifts when switching between sources.

Following are procedures for timing a studio using various methods.

Using the Traditional Method

Your instrument makes the traditional method of comparing Horizontal and Vertical timing easier by providing flexible tiles and a Freeze function. To time a studio using the traditional method, you store an input as a baseline and compare signals that you time against the baseline.

1. Select a tile in which to time the active input. Select **WFM**.
2. Apply the first input signal to the appropriate input, terminate it properly, and select it.
3. Push and hold the **WFM** button. From the **Display Mode** submenu, select a display mode that is appropriate to the signal that you input.
4. Apply the house reference signal to the external reference input, terminating it properly.
5. Press the **EXT REF** button to select External Reference mode. (Connected to the house reference.)
6. Put the selected tile in line mode.
7. Use the **HORIZONTAL** knob to center the sync edge or the SAV pulse. (If using the SAV pulse, turn off Stripping EAV/SAV/ANC in the SDI Input setting of the Configuration Menu.)
8. Press the **MAG** button to increase the timing resolution.

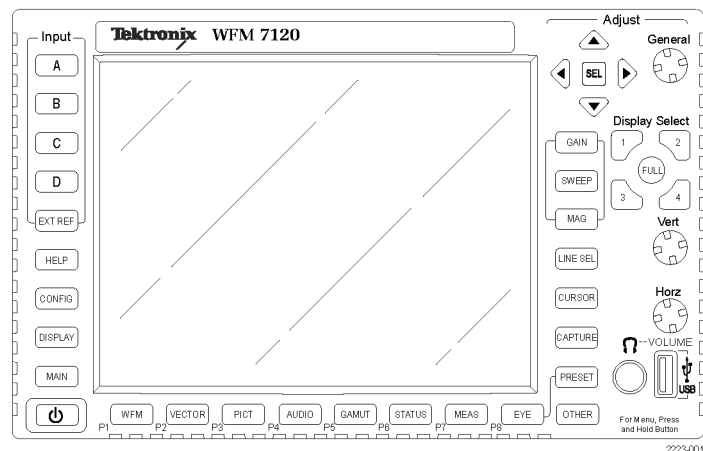

9. Select a second tile.
10. Press the **FIELD** button to put a second tile in field mode and choose an appropriate waveform mode.
11. Use the **HORIZONTAL** knob to center the vertical interval.
12. Press the **MAG** button to increase the timing resolution.
13. Press the **CAPTURE** button to save the waveform as a baseline.
14. Apply an input that needs to match timing of the first input.
15. Adjust the timing offset of the signal being timed to match the timing to the saved baseline.
16. Repeat steps 14 and 15 for any other required signals.

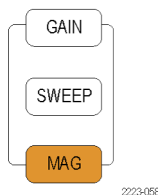

NOTE. Use the Cursors as markers or to measure timing differences between sources.

Other tiles can be used to set fine timing and check color frame alignment on composite signals. Alternatively, the other two tiles could be used for line and field rate displays without Mag active to show the location of significantly mistimed signals.

Using the Timing-Display Method

The Tektronix Timing Display provides a quick, easy way to measure the timing of an input relative to the external reference:

- The rectangular display automatically scales to match the input signal. For progressive signals, the display represents one field; for interlace signals, the display represents one frame; and for composite inputs, the display represents one color frame.
- The cross-hair in the center represents zero offset, and the circle represents the timing of the input signal. Lines of advance or delay are shown as vertical displacement, while timing errors of less than one line are shown as horizontal displacement. If the input is at the same time as the reference, then the circle will be centered on the cross-hair.
- The timing offset is also shown numerically as lines and micro-seconds of advance or delay in the boxes at the right side of the display.
- For input and reference signals with closely related frame rates, there is only one timing relationship, so a single circle is shown on the display to indicate the timing offset of the input signal.
- For input and reference combinations with more complex relationships, multiple circles are displayed to indicate all the possible interpretations of the timing offset, with the one that is closest to zero shown with emphasis. The numerical readouts will correspond to the timing indicator circle with the emphasis.

- The **Relative to:** box indicates the chosen zero point for the timing display. The default is Rear Panel. In this mode, the offset is zero when the input and reference are at the same timing at the rear panel of your instrument. The other choice is Saved Offset. In this mode, you can save the timing from one signal and then display the timing relative to that saved offset.

To Use the Timing Display to Time a Signal to a Reference.

1. Select a tile in which to time the active input.
2. Apply the input signal to be timed to the appropriate input, terminate it properly and select it.
3. Apply the house reference signal to the external reference input, terminating it properly.
4. Press the **EXT REF** button to select External Reference mode.
5. Press the **MEAS** button to select the Timing display for the tile selected in step 1.
6. If only one circle is displayed, adjust the timing offset of the black generator to match the timing to the external reference. Adjust for a perfect coincidence of the circle around the reference target (circle turns green at coincidence) and null values of the vertical and horizontal timing readouts.
7. If multiple circles are displayed, the timing is complex, and you must choose the one you want. The measurement that is closest to zero offset is displayed with emphasis and appears in the readouts.

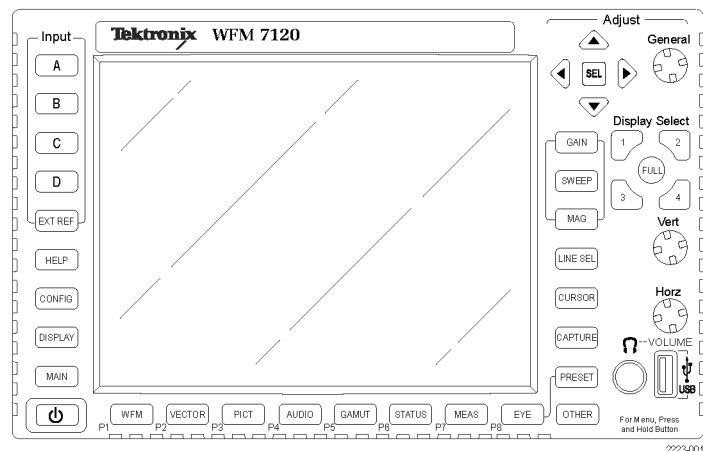

NOTE. See *Timing Displays for Simple Versus Complex Timing in the User Technical Reference on the User Documentation CD that came with your instrument for more information about complex timing displays and their elements.*

8. Repeat step 6 or 7 for any other signals.

NOTE. As you adjust timing, the circle representing the input timing may jump occasionally. This is because the color frame detection circuit can be temporarily disrupted as the signal shifts. The jump is often a multiple of the field time. The circle will settle back to the correct location in a second or so.

Usage Notes

- The resolution of the timing display for Composite and SD signals is one 27 MHz clock cycle or 37 ns. For HD signals, it is one clock at 74.25 MHz, which equates to about 13.5 ns. To get the greater accuracy needed for a composite signal, first use the timing display to get close, then use a vector display for the final burst phase alignment. Since this instrument can display both the timing display and a vector display simultaneously (each in its own tile), this process can still be easy and quick.
- For composite signals the definition of time aligned is obvious but for an SDI input relative to a analog reference the situation is more complex. For the timing display, the definition of zero offset on an SDI input uses the methodology described in SMPTE RP168. This method specifies the SDI signal will be converted to analog. The converted analog signal is then compared to the analog reference. For the conversion, a D/A converter with delay of about three microseconds is used.
- In the Relative to Rear Panel mode, this three microsecond conversion delay is accounted for in the displayed offset. In the Relative to Saved Offset mode, it has no effect.

Timing Multiple Inputs to a Router

You can also use the **Relative to:** function to set the offset between a master signal and a reference signal as the zero-point reference for time-down applications. The **Relative to:** box indicates the chosen zero point for the timing display:

- **Rear Panel.** In this mode (default), the offset is zero when the measured signal input and reference are at the same timing at the reference at the instrument rear panel. This setting was used in the Timing Display Method procedure.
- **Saved Offset.** In this mode, you can save the timing from a master signal relative to the reference as the zero point offset. Then route other inputs and measure relative to this saved offset.

To Time the Inputs to a Router.

1. Perform steps 1 through 5 of the previous procedure.
2. Route the signal you want as the master to the appropriate input, SDI or Composite, and terminate properly.
3. Route the reference signal to the reference input and terminate appropriately.
4. Save ¹ the timing offset for the master input (**MEAS > Save Offset > SEL**) and select the **Relative to: Saved Offset** mode from the pop-up menu.
5. Now select other inputs to the router to be connected to the instrument. For each input, the relative timing will be displayed.
6. Adjust the timing offset at the master sync source to time down the inputs to the router to match the master.

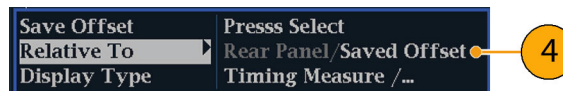

- ¹ You cannot save the timing offset if either the input or reference is missing or unlocked. You also cannot save a reference when in internal mode. Saving an offset in these conditions would lead to misleading results so it is not allowed by the instrument. A warning message will appear on the screen if you attempt to save the offset when it is not allowed.

Usage Notes.

- The resolution of the timing display is one 27 MHz clock cycle or 37 ns, for Composite and SD video. To get the greater accuracy needed for a composite signal, first use the timing display to get close, and then use a vector display for the final burst phase alignment. Since these two displays can be present simultaneously in separate tiles, this process is still easy and quick.
- For composite signals, the definition of time aligned is straight forward, but for an SDI input relative to an analog reference, the situation is more complex. For the timing display, the definition of zero offset on an SDI input assumes the SDI signal will be converted to composite. The converted composite signal is then compared to the analog reference. For the conversion, a half-band filter with a 33 clock-cycle delay and an analog reconstruction filter are assumed. This conversion introduces a delay of about 3 μ s.
- In the **Relative to: Rear Panel** mode, this 3 μ s conversion delay is removed from the measured offset before the display is generated. In the **Relative to: Saved Offset** mode, it has no effect.
- This timing relationship between input and reference is also compatible with the waveform mode. That is, if you have zero timing on the Timing display and change from internal to external reference, the displayed waveform will not shift position.
- When timing analog composite signals, adjust the system phase with the Vector display. The Vector display is described in *Timing Displays for Simple Versus Complex Timing* in the *Display Information* chapter of the *User Technical Reference* manual found on your *User Documentation CD*.

NOTE. *If you have an input and reference combination that requires multiple timing indicator circles, then it can be misleading to compare timing offsets between multiple inputs. Because the timing display chooses the smallest of the possible timing offsets, if a large timing difference exists between two inputs, then they may not be matched. This problem will also occur using traditional timing methods unless one uses something similar to the SMPTE318 10 field flag to identify a specific sub-multiple of the reference.*

Upgrading Instrument Software

An instrument software upgrade is performed across an Ethernet network using a PC to transfer the new software to the instrument. Visit www.Tektronix.com or see the *User Technical Reference* manual on the *User Documentation CD* that shipped with your instrument.

Index

Symbols and Numbers

3G

- generating a signal, 24
- monitoring a signal, 23

A

Accessories

- documents, 1
- optional, 1
- power cords, 2
- standard, 1

Active tile, 5

AES

- output map for Dolby, 92

AES connectors, 14

Alarm

- allowed responses, 111
- categories of, 110

Alarms

- configuring and using, 110
- enabled globally and individually, 112
- remote monitoring of, 114
- status display, 114
- to enable, 112
- to enable Dolby-related, 113
- to monitor, 114
- to set alarms globally, 111
- to set allowed responses, 110
- to set limits or qualify, 113

Analog audio

- connecting, 15

Analog Input/Output connector, 14

Analog output map

- Dolby, 92

Applications

- checking Chroma/Luma delay, 42
- timing a studio, 115

ARIB displays

- enabling or disabling, 70
- monitoring, 70

ARIB Status display, 71

ARIB STD-B.35 display, 76

ARIB STD-B.37 display, 74

ARIB STD-B39 display, 72

ARIB TR-B.22 display, 80

ARIB TR-B.23 (1) display, 77, 78

Arrowhead display, 44

- composite gamut, 48

Audio

- checking surround sound, 86
- configuring and monitoring, 82
- configuring and monitoring
 - Dolby, 91
- configuring inputs, 82
- optional breakout cable, 1
- options, xi
- selecting an input, 83

Audio input

- selecting, 83

Audio inputs

- allow alarms for, 82
- check level, 84
- check phase, 84
- configure for pairs or surround, 82
- map bars to input, 82
- specify mapping to analog outputs, 83

Audio level

- checking, 82, 84, 86, 91, 110

Audio phase

- checking, 84

Audio/Video Delay, 29

B

Basic operation, 5

Buffer Only

- Capture pop-up menu, 35

C

Cable loss measurements, 69

Cable type

- how to select, 53

Calibration

- service options, xii

Capture

- Buffer, 34, 35, 36
- copying to a flash drive, 36
- Freeze, 34
- Trace, 34
- Using the capture display, 34

Capture menu, 34, 35

Checking surround sound

- task description, 86

Chroma/Luma delay, 42

Closed captioning

- configuring and monitoring, 103

Closed captions

- to display, 106
- to select a CC service channel, 106
- to select services that trigger alarms, 104
- to select the transport, 104
- to set the transport selection mode, 104

Composite gamut

- diamond display, 48

Composite Input connectors, 13

Configuration menu, 38

Connecting AC power, 2

Connecting signals

- Line termination, 4

Connector

- Compatibility, 4

Connector(s)

- AES, 14
- Analog Input/Output, 14
- Ethernet, 19
- Pix, 16
- Power, 12
- Remote, 17
- Video input, 13
- XGA, 16

Controls, front panel, 9

Cursor menu, 33

Cursors

- displaying, 32
- how to use, 32

D

Delete Frozen Image

- Capture pop-up menu, 36

Diamond display, 44

- checking RGB gamut, 46
- construction of the diamond graticule, 46

- Display
 - how to control, 5
 - resolution, 16
 - status bar icons, 9
- Display connector See XGA Output connector
- Display select buttons, 5
- Documentation
 - conventions used in, xiii
 - purposes of, xiii
- Documents
 - included, 1
- Dolby
 - downmix mode, 98
- Dolby audio
 - configure global parameters, 94
 - display, 97
 - display readout, 97
 - select the downmix mode, 96
 - to configure AES B output map, 92
 - to configure analog output map, 92
 - to configure expected format alarm, 91
 - to configure input, 91
 - to configure source, 91
 - to display a Dolby input, 96
 - to select listening mode, 94
 - to specify Dolby D content channel, 92
 - to specify Dolby D stream, 92
 - to specify Dolby E channel mask (alarms), 92
 - to specify Dolby E downmix program, 93
 - to specify Dolby E program, 92
 - view metadata, 98
- Dolby D audio
 - to set dial normalization and dynamic range compression, 94
- Dolby E audio
 - to set dial normalization and pulldown coding, 95
- Dominance indicator
 - how to display, 88
- Dual link
 - how to set up, 25, 29
 - option, xi
- E**
- Errors
 - status indicators, 7
- Ethernet connector, 19
- Eye measurements, 60
- F**
- Factory defaults
 - how to set, 31
- Features
 - list of key, ix
- Flexview
 - defined, ix
- Freeze, 34
- Front-panel controls
 - layout and index to usage procedures, 10
 - levels of, 9
 - scope of, 10
- Frozen Only
 - Capture pop-up menu, 34
- G**
- Gain
 - how to select, 30
 - how to set, 30
- gamut
 - diamond display, 46
- Gamut
 - arrowhead display, 48
 - checking, 44
- Gamut display
 - checking RGB gamut, 46
 - composite arrowhead display, 48
- General alarms
 - configure, 110
- Ground closure connector, 17
- H**
- Headphone volume
 - adjusting, 40
- Histogram, 52, 64
- How to
 - ARIB data displays, 70
 - check surround sound, 86
 - configure and monitor audio, 82
 - configure and monitor Dolby, 91
 - configure and use alarms, 110
 - configure your instrument, 38
 - control the display, 5
 - determine status, 7
 - find more information, xiii
 - measure waveforms with cursors, 32
 - monitor alarms, 114
 - monitor closed captioning, 103
 - monitor the SDI physical layer, 52
 - select a measurement, 20
 - set gain and sweep, 30
 - set line select mode, 37
 - set measurement parameters, 21
 - set to factory default settings, 31
 - time a studio, 115
 - use online help, 38
 - use presets, 31
- How to...
 - capture the display, 34
 - connect to a network, 41
 - operate your waveform monitor, 5
 - select an input, 22
- I**
- Information
 - where to find more, xiii
- Inputs
 - dual link, 23, 25
 - How to select, 22
- Installation, 1
 - BNC connector compatibility, 4
 - Connecting power, 2
 - In a serial video system, 3
 - Line-termination requirements, 4
 - shipping package contents, 1
- J**
- Jitter measurements, 65

L

- Lightning display, 42
- Limits
 - gamut, 44
- Line Select mode
 - how to set, 37
- Lissajous display, 86
- Lissajous sound Sstage
 - phase style, 86
- Listening Mode
 - table of settings, 99
 - to select, 94
- Listening Modes
 - descriptions of, 98
- Live + Buffer Only
 - Capture pop-up menu, 35
- Live + Frozen Only
 - Capture pop-up menu, 34
- Luma/Chroma delay, 42

M

- Manuals
 - conventions used in, xiii
- Measure
 - how to, with cursors, 32
- Measurement
 - how to select, 20
 - how to set parameters, 21
- Measuring aberrations, 62
- Measuring eye amplitude, 61
- Measuring risetime, 63
- Menu
 - CONFIG, 38
- Monitoring
 - dual link, 23, 25
 - increased bandwidth, 23, 25
 - simultaneous inputs, 26
- Monitoring Audio
 - task description, 82
- Monitoring CC and safe area
 - compliance
 - task description, 103
- Monitoring Dolby audio
 - task description, 91

N

- Network
 - Connect to, 41

O

- Online help, 38
 - displaying, 39
 - Hhow to use, 38
 - navigating, 39
- Operation
 - Basic, 5
 - control levels (types), 9
- Optional accessories, 1
- Options, xi
 - power cords, 2

P

- Part numbers
 - user manual, 1
- Phase (audio)
 - choose channel pair, 85
 - correlation meter response
 - times, 86
 - custom channel pair, 85
 - select display style, 84
- Physical Layer
 - configuring and monitoring, 52
- Pix Mon Output connector, 16
- Pop-up menus, 21
 - Freeze capture, 34
- Power
 - AC requirements, 2
 - Connecting, 2
 - Connector, 12
 - Switch (none required), 2
- Power cord options, 2
- Power, connecting, 2
- Presets
 - how to save and recall, 31
- Product description, ix

R

- Rear-panel
 - Layout and description, 11
- Recall
 - settings (presets), 31
- Remote connector, 17
- Repair
 - service options, xii
- RGB gamut
 - diamond display, 46

S

- Safe area
 - to monitor for compliance, 107
 - to set custom parameters, 108
- Safe area graticules
 - description of, 109
 - to choose a standard, 107
 - to display, 108
- Safety Summary, iii
- Save
 - settings (presets), 31
- SDI input connectors, 13
- Selecting audio input, 83
- Selecting signal inputs, 22
- Service
 - options, xii
- Signal connection
 - Line-termination
 - requirements, 4
- Simultaneous input monitoring, 26
- Software Upgrade, 121
- Split Diamond display, 44
- Standard accessories, 1
 - documents, 1
 - power cord, 2
- Status
 - determining, 7
- Status bar, 7
- Surround filter
 - how to set, 88
- Surround sound
 - display elements of, 88
 - displaying and checking, 86
 - signal display examples, 90
 - to check performance, 88
 - to select the display, 87

T

- Teletext, 103
- Termination
 - Requirements for, 4
- Tile
 - mode, how to enter, 5
 - to select a, 5
- Time
 - Cursor menu, 33
- Timing
 - Chroma/Luma delay, 42

Timing a studio
 router inputs, 118
 task description, 115
 timing display method, 116
 traditional method, 115
Timing display, 116
Trigger, 35
 capture buffer, 35

U

Upgrade
 system software, 121

USB, 36
 copying a buffer capture to, 36
Using alarms
 task description, 110
Using the ARIB Displays
 task description, 70

V

Vector
 display, 42
Video
 options, xi

Video input connectors, 13
Voltage
 cursor menu, 33
Voltage + Time
 Cursor menu, 33
Volume
 adjusting, 40

X

X-Y
 phase style, 86, 97, 109
XGA Output connector, 16