

# Instructions



## **MTM4UP Upgrades MTM400 and MTM400A MPEG Transport Stream Monitors**

**075-0973-01**

### **Warning**

The servicing instructions are for use by qualified personnel only. To avoid personal injury, do not perform any servicing unless you are qualified to do so. Refer to all safety summaries prior to performing service.

**[www.tektronix.com](http://www.tektronix.com)**



075097301

Copyright © Tektronix. All rights reserved. Licensed software products are owned by Tektronix or its subsidiaries or suppliers, and are protected by national copyright laws and international treaty provisions.

Tektronix products are covered by U.S. and foreign patents, issued and pending. Information in this publication supercedes that in all previously published material. Specifications and price change privileges reserved.

TEKTRONIX and TEK are registered trademarks of Tektronix, Inc.

## **Contacting Tektronix**

Tektronix, Inc.  
14200 SW Karl Braun Drive  
P.O. Box 500  
Beaverton, OR 97077  
USA

For product information, sales, service, and technical support:

- In North America, call 1-800-833-9200.
- Worldwide, visit [www.tektronix.com](http://www.tektronix.com) to find contacts in your area.

# Table of Contents

<b>General Safety Summary</b> .....	<b>iii</b>
<b>Service Safety Summary</b> .....	<b>v</b>
<b>Kit Description</b> .....	<b>1</b>
Supported Products .....	2
Minimum Tool and Equipment List .....	3
Kit Parts Lists .....	5
<b>Application Firmware Upgrade</b> .....	<b>11</b>
RUI Versions .....	11
Firmware Upgrade (RUI v2.6.1 and Below) .....	14
Firmware Upgrade (RUI v3.0 and Above) .....	31
Command Line Firmware Upgrade .....	39
<b>Software Option Upgrade</b> .....	<b>41</b>
Option Keys .....	41
RUI Versions .....	42
Software Option Upgrade (RUI v2.6.1 and Below) .....	43
Software Option Upgrade (RUI v3.0 and Above) .....	48
Troubleshooting .....	53
Verifying the Software Option Upgrade .....	54
<b>Hardware Option Upgrade</b> .....	<b>57</b>
Preparation .....	58
Install the New Interface Card .....	59
Install the SFP Module (GbE interface Only) .....	72
Verify the Hardware Upgrade .....	73
<b>WebMSM Software Upgrade</b> .....	<b>81</b>
Upgrading the WebMSM Software .....	81
Technical Support .....	82



# General Safety Summary

Review the following safety precautions to avoid injury and prevent damage to this product or any products connected to it.

To avoid potential hazards, use this product only as specified.

*Only qualified personnel should perform service procedures.*

## To Avoid Fire or Personal Injury

**Use Proper Power Cord.** Use only the power cord specified for this product and certified for the country of use.

**Ground the Product.** This product is grounded through the grounding conductor of the power cord. To avoid electric shock, the grounding conductor must be connected to earth ground. Before making connections to the input or output terminals of the product, ensure that the product is properly grounded.

**Ground Equipment Connected to the Product.** Ensure that any equipment connected to this product is grounded and at the same potential.

**Observe All Terminal Ratings.** To avoid fire or shock hazard, observe all ratings and markings on the product. Consult the product manual for further ratings information before making connections to the product.

The inputs are not rated for connection to mains or Category II, III, or IV circuits.

**Power Disconnect.** The power cord disconnects the product from the power source. Do not block the power cord; it must remain accessible to the user at all times.

**Do Not Operate Without Covers.** Do not operate this product with covers or panels removed.

**Use Proper Fuse.** Use only the fuse type and rating specified for this product.

**Avoid Exposed Circuitry.** Do not touch exposed connections and components when power is present.

**Do Not Operate With Suspected Failures.** If you suspect there is damage to this product, have it inspected by qualified service personnel.

**Do Not Operate in Wet/Damp Conditions.**

**Do Not Operate in an Explosive Atmosphere.**

**Keep Product Surfaces Clean and Dry.**

**Provide Proper Ventilation.** Refer to the installation instructions for details on installing the product so it has proper ventilation.

**Terms in this Manual**

These terms may appear in this manual:



---

**WARNING.** *Warning statements identify conditions or practices that could result in injury or loss of life.*

---



---

**CAUTION.** *Caution statements identify conditions or practices that could result in damage to this product or other property.*

---

**Symbols and Terms on the Product**

These terms may appear on the product:

- DANGER indicates an injury hazard immediately accessible as you read the marking.
- WARNING indicates an injury hazard not immediately accessible as you read the marking.
- CAUTION indicates a hazard to property including the product.

The following symbol(s) may appear on the product:



# Service Safety Summary

Only qualified personnel should perform service procedures. Read this *Service Safety Summary* and the *General Safety Summary* before performing any service procedures.

**Do Not Service Alone.** Do not perform internal service or adjustments of this product unless another person capable of rendering first aid and resuscitation is present.

**Disconnect Power.** To avoid electric shock, switch off the instrument power, then disconnect the power cord from the mains power.

**Use Care When Servicing With Power On.** Dangerous voltages or currents may exist in this product. Disconnect power, remove battery (if applicable), and disconnect test leads before removing protective panels, soldering, or replacing components.

To avoid electric shock, do not touch exposed connections.

Use only Tektronix approved components when servicing the unit.





# Kit Description

This document provides instructions for installing MTM4UP software and hardware upgrades into an existing MTM400 or MTM400A MPEG Transport Stream Monitor. All MTM4UP upgrade kits include an application firmware CD-ROM that enables you to update your monitor with the latest version of the RUI (Remote User Interface).

Table 1 lists the MTM4UP upgrades that are supported by this document.

**Table 1: Supported software and hardware upgrades**

Product	Option	Description
MTM4UP	01	Software upgrade to add recording capability
	02	Software upgrade to add transport stream Service Information analysis (PSI/SI/PSIP/ARIB structure view and repetition graphs)
	03	Software upgrade to add template testing with template scheduling (for user-defined service plan testing)
	04	Software upgrade to add PCR analysis with graphical results views
	05	Software upgrade to add bit-rate testing including PID groups and PID variability
	06	Software upgrade to add service logging
	07	Software upgrade to add automatic channel changing for polling multiple streams
	CF	Hardware upgrade to add a COFDM interface card
	EP	Hardware upgrade to add a 8PSK/QPSK interface card
	GE	Hardware upgrade to add a IP Video Gigabit Ethernet (GbE) interface card
	LX	Hardware upgrade to add a 1310nm SFP, optical gigabit Ethernet port to the GbE interface
	QA	Hardware upgrade to add a QAM (Annex A) interface card
	QB2	Hardware upgrade to add a QAM (Annex B, Level 1 and 2) interface card
	QC	Hardware upgrade to add a QAM (Annex C) interface card
	SX	Hardware upgrade to add a 850nm SFP, optical gigabit Ethernet port to the GbE interface
	VS	Hardware upgrade to add a 8VSB interface card
	ZX	Hardware upgrade to add a 1550nm SFP, optical gigabit Ethernet port to the GbE interface

The upgrade process contains these main steps:

- Upgrade the application firmware version  
(all MTM4UP options)
- Apply the new option key  
(MTM4UP options 01, 02, 03, 04, 05, 06, 07, and QC only)
- Install the new interface card  
(MTM4UP options CF, EP, GE, QA, QB2, QC, and VS only)
- Install the optical gigabit Ethernet/Fibre Channel port on the GbE interface  
(MTM4UP options LX, SX, and ZX only)
- Reinstall the WebMSM software  
(all MTM4UP options; only if you upgraded the application firmware and use the WebMSM software)

## Supported Products

The following products are supported by this upgrade kit (except as noted under *MTM400 Monitor Serial Number Versions* below):

**MTM400 MPEG Transport Stream Monitor**  
**MTM400A MPEG Transport Stream Monitor**  
**WebMSM Web Monitoring System Manager**  
**WebMSM Configuration Editor**

---

**NOTE.** A fully licensed version of the WebMSM Monitoring System Manager is available to users of MTM400 or MTM400A monitors with RUI v3.0 or above installed. The WebMSM software enables you to monitor transport streams on multiple MTM400 and MTM400A monitors from a single PC.

The WebMSM software package for RUI v3.0 and above is available on the Tektronix Web site ([www.tektronix.com/software](http://www.tektronix.com/software)) and on the application firmware CD-ROM that was supplied with this upgrade kit.

---

### MTM400 Monitor Serial Number Formats

Two versions of the MTM400 monitor have been produced with different serial number formats as shown below. These upgrade instructions do not apply to MTM400 monitors that have the GB\* serial number format. If your monitor has a GB\* serial number, you will be advised of the correct upgrade procedure when you order an upgrade. The serial number of each monitor is printed on a label attached to the rear panel.

---

#### Serial number formats

---

GB400-xxxx (Example: GB400-1234)

---

Bxxxxxx (Example: B010100)

---

## Minimum Tool and Equipment List

This section lists the tools and equipment required to perform the MTM4UP upgrades described in this document.

### Firmware and Software Option Upgrades

To perform a firmware or a software option upgrade, you must use a PC to access the RUI (Remote User Interface) on the MTM400 or MTM400A monitor. The PC and the monitor must be connected to the same Ethernet network.

The system requirements of the PC depend on which version of the RUI is installed on your monitor. MTM400 monitors were shipped from the factory with RUI version 2.6.1 or below. MTM400A monitors are shipped with RUI version 3.0 or above.

The MTM400 and MTM400A monitors can operate using either version of the RUI. You will be able to determine if the factory-issued RUI version has been changed on your monitor when you attempt to log in:

- If your monitor has RUI v2.6.1 or below installed, the login screen will appear as shown in Figure 2 on page 15.
- If your monitor has RUI v3.0 or above installed, the login screen will appear as shown in Figure 15 on page 29.

Tables 2 and 3 list the system requirements for monitors operating with RUI v2.6.1 or below and RUI v3.0 or above.

**Table 2: PC system requirements for RUI v2.6.1 or below**

Characteristic	Description
Minimum specification	1 GHz Intel Pentium Processor (Preferred: 2 GHz)
Operating system	Microsoft Windows 2000 or Windows XP (Recommended: Windows XP Pro)
Disk space	2 GB free disk space
Ethernet	10/100-base T
Installed software	Microsoft Internet Explorer, Version 6.0 minimum; Microsoft Java Virtual Machine installed, Version 5.0 minimum
RAM	1 GB
CD-ROM drive	8x
Display	1024 x 768 pixel video monitor with 16 available colors

**Table 3: PC system requirements for RUI v3.0 or above**

<b>Characteristic</b>	<b>Description</b>
Minimum specification	1.2 GHz Intel Pentium Processor (Preferred: 2 GHz)
Operating system	Microsoft Windows 2000, Windows XP, and Windows Vista (Recommended: Windows XP Pro)
Disk space	2 GB free disk space
Ethernet	10/100-base T
Installed software	Microsoft Internet Explorer, Version 7.0 minimum; Sun Java Runtime Environment Version 6 Update 07 minimum (1.6.0_07)
RAM	1 GB
CD-ROM drive	8x
Display	1024 x 768 pixel video monitor with 16 available colors

**Signal Interface Hardware Upgrades**

You will need the equipment listed below to physically install the signal interface hardware upgrades.

<b>Required tools and equipment</b>	<b>Part number</b>
Anti-static wrist strap	NA
A screwdriver with T-10, T-15, and T-20 TORX tips	NA

To verify that the installed interface card is operating properly, you will need a PC meeting the requirements listed in Table 3 above and a suitable transport stream input for the interface type that you received with this upgrade kit.

## Kit Parts Lists

The following tables list the parts supplied with each of the upgrade kits.

**Table 4: MTM4UP 01, 02, 03, 04, 05, 06, and 07 parts list (software options)**

Quantity	Part number	Description
1 EA	NA	Option key document for a specified MTM400 or MTM400A monitor
1 EA	NA	Product Upgrade identification sticker
1 EA	063-4135-xx	MTM400A Product Documentation CD-ROM
1 EA	063-4136-xx	MTM400A Application Firmware CD-ROM
1 EA	071-2492-xx (071-2632-xx) (071-2493-xx)	MTM400A Quick Start User Manual (English) (German) (Japanese)
1 EA	075-0973-01	MTM4UP Upgrades Instructions

**Table 5: MTM4UP CF parts list (COFDM interface)**

Quantity	Part number	Description
1 EA	NA	Product Upgrade identification sticker
1 EA	015-0688-xx	Adapter, RF; BNC Jack to F Plug
1 EA	063-4135-xx	MTM400A Product Documentation CD-ROM
1 EA	063-4136-xx	MTM400A Application Firmware CD-ROM
1 EA	071-2191-xx	China RoHS Supplemental Information Sheet
1 EA	071-2492-xx (071-2632-xx) (071-2493-xx)	MTM400A Quick Start User Manual (English) (German) (Japanese)
1 EA	075-0973-01	MTM4UP Upgrades Instructions
1 EA	174-4782-xx	Power cable; 8 conductor, 15.9 L
1 EA	174-5063-xx	Serial cable; 1x5, 8.00 inches, Baseband to Processor
1 EA	174-5135-xx	RF cable; BNC to BNC, 75 Ohm
8 EA	211-0722-xx	Machine screw; 6-32 x 0.250, PNH, T-15 TORX
1 EA	672-1789-xx	COFDM and Baseband circuit board assembly; tested set

**Table 6: MTM4UP EP parts list (8PSK/QPSK interface)**

Quantity	Part number	Description
1 EA	NA	Product Upgrade identification sticker
1 EA	063-4135-xx	MTM400A Product Documentation CD-ROM
1 EA	063-4136-xx	MTM400A Application Firmware CD-ROM
1 EA	071-2191-xx	China RoHS Supplemental Information Sheet
1 EA	071-2492-xx (071-2632-xx) (071-2493-xx)	MTM400A Quick Start User Manual (English) (German) (Japanese)
1 EA	075-0973-01	MTM4UP Upgrades Instructions
1 EA	174-4782-xx	Power cable; 8 conductor, 15.9 L
1 EA	174-5063-xx	Serial cable; 1x5, 8.00 inches, Baseband to Processor
1 EA	174-5135-xx	RF cable; BNC to BNC, 75 Ohm
8 EA	211-0722-xx	Machine screw; 6-32 x 0.250, PNH, T-15 TORX
1 EA	672-1790-xx	8PSK/QPSK and Baseband circuit board assembly; tested set

**Table 7: MTM4UP GE parts list (IP Video Gigabit Ethernet interface)**

Quantity	Part number	Description
1 EA	NA	Product Upgrade identification sticker
1 EA	063-4135-xx	MTM400A Product Documentation CD-ROM
1 EA	063-4136-xx	MTM400A Application Firmware CD-ROM
1 EA	071-2191-xx	China RoHS Supplemental Information Sheet
1 EA	071-2492-xx (071-2632-xx) (071-2493-xx)	MTM400A Quick Start User Manual (English) (German) (Japanese)
1 EA	075-0973-01	MTM4UP Upgrades Instructions
1 EA	174-4782-xx	Power cable; 8 conductor, 15.9 L
1 EA	174-5063-xx	Serial cable; 1x5, 8.00 inches, Baseband to Processor
1 EA	174-5287-xx	RF cable; BNC to BNC, 75 Ohm
9 EA	211-0722-xx	Machine screw; 6-32 x 0.250, PNH, T-15 TORX
1 EA	671-6200-xx	GbE circuit board assembly, ASI/SDI; tested

**Table 8: MTM4UP LX parts list (1310nm SFP optical port for GbE interface)**

Quantity	Part number	Description
1 EA	NA	Product Upgrade identification sticker
1 EA	063-4135-xx	MTM400A Product Documentation CD-ROM
1 EA	063-4136-xx	MTM400A Application Firmware CD-ROM
1 EA	131-7957-xx	1310nm SFP optical gigabit Ethernet/Fibre Channel port
1 EA	071-2191-xx	China RoHS Supplemental Information Sheet
1 EA	071-2492-xx (071-2632-xx) (071-2493-xx)	MTM400A Quick Start User Manual (English) (German) (Japanese)
1 EA	075-0973-01	MTM4UP Upgrades Instructions

**Table 9: MTM4UP SX parts list (850nm SFP optical port for GbE interface)**

Quantity	Part number	Description
1 EA	NA	Product Upgrade identification sticker
1 EA	063-4135-xx	MTM400A Product Documentation CD-ROM
1 EA	063-4136-xx	MTM400A Application Firmware CD-ROM
1 EA	131-7834-xx	850nm SFP optical gigabit Ethernet/Fibre Channel port
1 EA	071-2191-xx	China RoHS Supplemental Information Sheet
1 EA	071-2492-xx (071-2632-xx) (071-2493-xx)	MTM400A Quick Start User Manual (English) (German) (Japanese)
1 EA	075-0973-01	MTM4UP Upgrades Instructions

**Table 10: MTM4UP ZX parts list (1550nm SFP optical port for GbE interface)**

Quantity	Part number	Description
1 EA	NA	Product Upgrade identification sticker
1 EA	063-4135-xx	MTM400A Product Documentation CD-ROM
1 EA	063-4136-xx	MTM400A Application Firmware CD-ROM
1 EA	131-7958-xx	1550nm SFP optical gigabit Ethernet/Fibre Channel port
1 EA	071-2191-xx	China RoHS Supplemental Information Sheet
1 EA	071-2492-xx (071-2632-xx) (071-2493-xx)	MTM400A Quick Start User Manual (English) (German) (Japanese)
1 EA	075-0973-01	MTM4UP Upgrades Instructions

**Table 11: MTM4UP QA parts list (QAM Annex A interface)**

Quantity	Part number	Description
1 EA	NA	Product Upgrade identification sticker
1 EA	063-4135-xx	MTM400A Product Documentation CD-ROM
1 EA	063-4136-xx	MTM400A Application Firmware CD-ROM
1 EA	071-2191-xx	China RoHS Supplemental Information Sheet
1 EA	071-2492-xx (071-2632-xx) (071-2493-xx)	MTM400A Quick Start User Manual (English) (German) (Japanese)
1 EA	075-0973-01	MTM4UP Upgrades Instructions
1 EA	174-4782-xx	Power cable; 8 conductor, 15.9 L
2 EA	174-4850-xx	RF cable; coaxial, RFD, 50 Ohm, 16.00 inches
7 EA	211-0722-xx	Machine screw; 6-32 x 0.250, PNH, T-15 TORX
1 EA	671-5608-xx	QAM (Annex A) circuit board assembly; tested



**Table 12: MTM4UP QB2 parts list (QAM Annex B interface)**

Quantity	Part number	Description
1 EA	NA	Product Upgrade identification sticker
1 EA	063-4135-xx	MTM400A Product Documentation CD-ROM
1 EA	063-4136-xx	MTM400A Application Firmware CD-ROM
1 EA	071-2191-xx	China RoHS Supplemental Information Sheet
1 EA	071-2492-xx (071-2632-xx) (071-2493-xx)	MTM400A Quick Start User Manual (English) (German) (Japanese)
1 EA	075-0973-01	MTM4UP Upgrades Instructions
1 EA	174-4782-xx	Power cable; 8 conductor, 15.9 L
1 EA	174-5063-xx	Serial cable; 1x5, 8.00 inches, Baseband to Processor
1 EA	174-5135-xx	RF cable; BNC to BNC, 75 Ohm
8 EA	211-0722-xx	Machine screw; 6-32 x 0.250, PNH, T-15 TORX
1 EA	672-1791-xx	QAM (Annex B2) and Baseband circuit board assembly; tested set

**Table 13: MTM4UP QC parts list (QAM Annex C interface)**

Quantity	Part number	Description
1 EA	NA	Option key document for a specified MTM400 or MTM400A monitor
1 EA	NA	Product Upgrade identification sticker
1 EA	063-4135-xx	MTM400A Product Documentation CD-ROM
1 EA	063-4136-xx	MTM400A Application Firmware CD-ROM
1 EA	071-2191-xx	China RoHS Supplemental Information Sheet
1 EA	071-2492-xx	MTM400A English Quick Start User Manual
1 EA	075-0973-01	MTM4UP Upgrades Instructions
1 EA	174-4782-xx	Power cable; 8 conductor, 15.9 L
2 EA	174-4850-xx	RF cable; coaxial, RFD, 50 Ohm, 16.00 inches
7 EA	211-0722-xx	Machine screw; 6-32 x 0.250, PNH, T-15 TORX
1 EA	671-5625-xx	QAM (Annex C) circuit board assembly; tested

**Table 14: MTM4UP VS parts list (8VSB interface)**

Quantity	Part number	Description
1 EA	NA	Product Upgrade identification sticker
1 EA	015-0688-xx	ADAPTER, RF; BNC JACK TO F PLUG
1 EA	063-4135-xx	MTM400A Product Documentation CD-ROM
1 EA	063-4136-xx	MTM400A Application Firmware CD-ROM
1 EA	071-2191-xx	China RoHS Supplemental Information Sheet
1 EA	071-2492-xx	MTM400A English Quick Start User Manual
1 EA	075-0973-01	MTM4UP Upgrades Instructions
1 EA	174-4782-xx	Power cable; 8 conductor, 15.9 L
1 EA	174-5063-xx	Serial cable; 1x5, 8.00 inches, Baseband to Processor
1 EA	174-5135-xx	RF cable; BNC to BNC, 75 Ohm
8 EA	211-0722-xx	Machine screw; 6-32 x 0.250, PNH, T-15 TORX
1 EA	672-1792-xx	8VSB and Baseband circuit board assembly; tested set

# Application Firmware Upgrade

All MTM4UP upgrade kits include an application firmware CD-ROM that enables you to update your MTM400 or MTM400A monitor with the latest version of the RUI (Remote User Interface). Firmware upgrades are required when you install one of the following signal interface hardware upgrades: MTM4UP options CF, EP, GE, QA, QB2, QC, and VS. The following MTM4UP upgrade options do not require a firmware upgrade:

- MTM4UP Options 01, 02, 03, 04, 05, 06, and 07. If you purchased only a software option upgrade and you do not want to upgrade the firmware version on your monitor, proceed to *Software Option Upgrade* on page 41.
- MTM4UP Options LX, SX, and ZX. If you purchased only an SFP optical port to add to your GbE interface card and you do not want to upgrade the firmware version on your monitor, proceed to *Install the SFP Module (GbE Interface Only)* on page 72.

---

**NOTE.** Review and comply with the following paragraphs, RUI Versions, before proceeding with a firmware upgrade.

---

This section describes how to upgrade the firmware using the RUI or the Command Line Firmware Upgrade program.



---

**CAUTION.** If you have the GE option (GbE interface) installed, you must use the Command Line Firmware Upgrade process, page 39. For other interface options, you can use either upgrade process.

---

## RUI Versions

The version number of the firmware installed on your monitor corresponds to the version number of the RUI. MTM400 monitors were shipped from the factory with RUI v2.6.1 or below installed. MTM400A monitors are shipped with RUI v3.0 or above installed.

Version 3.0 and above introduced new features and significant changes in the operation of the user interface.

The MTM400 and MTM400A monitors can be modified to operate using either version of the RUI. Figure 1 illustrates the MTM400 and MTM400A upgrade paths.

Use the firmware upgrade procedure that is appropriate for the RUI version that is currently installed on your monitor:

- If your MTM400 or MTM400A monitor is currently operating with RUI v2.6.1 or below, perform the procedure described in *Firmware Upgrade (RUI v2.6.1 and Below)* starting on page 14 to upgrade to RUI v3.0.

Even if you are upgrading to RUI v3.1 and above, you must upgrade to version 3.0 first (see Figure 1 for information).

- If your MTM400 or MTM400A monitor is currently operating with RUI v3.0 or above, perform the procedure described in *Firmware Upgrade (RUI v3.0 and Above)* starting on page 31.

---

**NOTE.** *If you want to change the RUI version on your monitor to v2.6.1 after you complete the upgrade installation, use the instructions that are located in the MTM400 and MTM400A RUI v3.0 Upgrade Technical Reference (Tektronix part number 071-2505-xx) that is supplied with this kit.*

---

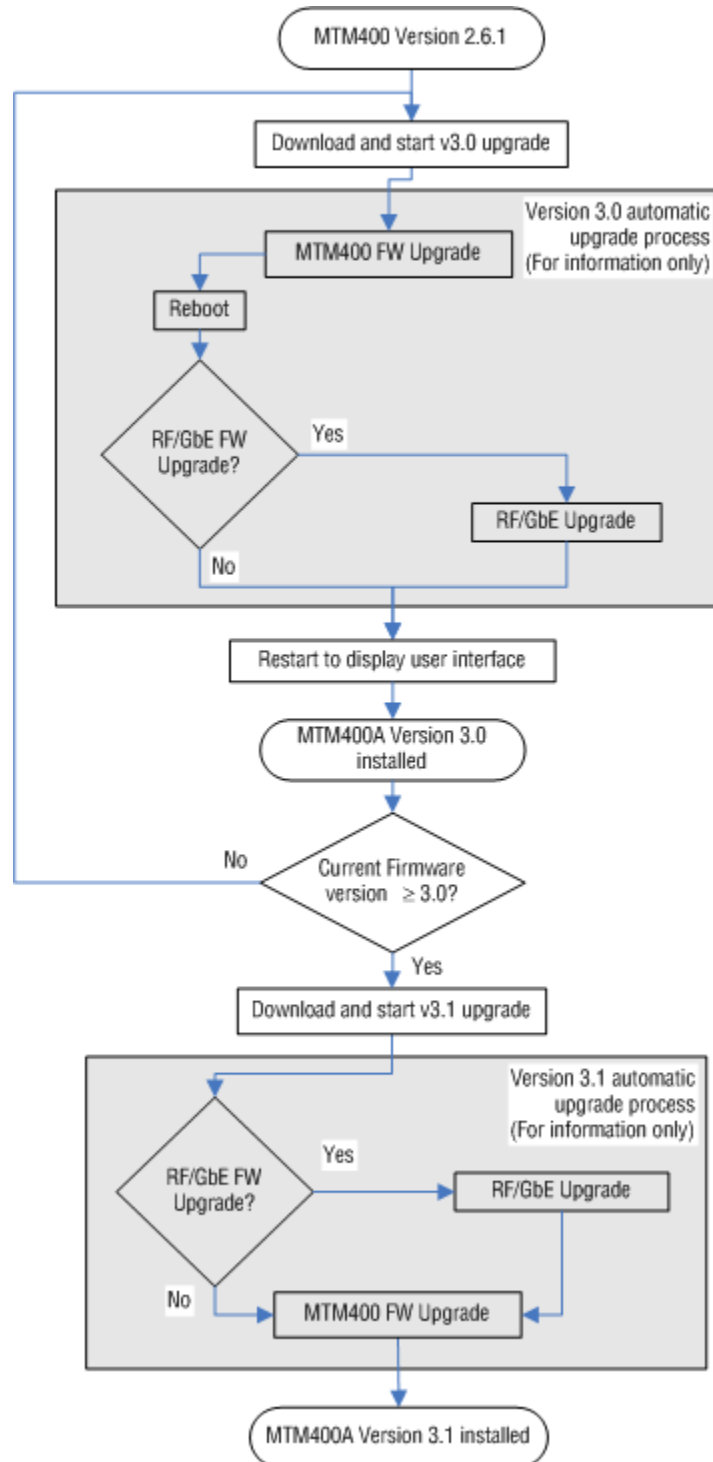


Figure 1: MTM400A upgrade path

## Firmware Upgrade (RUI v2.6.1 and Below)

If your MTM400 or MTM400A monitor has RUI v2.6.1 or below installed, perform the following procedure to upgrade the application firmware installed on your monitor.

If you are upgrading to RUI v3.1 and above, version 3.0 of the RUI must be installed first. You can then proceed to the procedure described in *Firmware Upgrade (RUI v3.0 and Above)* starting on page 31.

### Identify the Current BIOS and Firmware Versions

Perform the following steps to identify the BIOS and firmware versions that are installed on your monitor:

1. Power on the monitor and wait for it to initialize. When the initialization process is complete, the monitor beeps and the front-panel LEDs illuminate.
2. Using a PC that meets the requirements listed in Table 2 on page 3 and is connected to the same Ethernet network as the monitor, perform the following steps to open the monitor RUI:

---

**NOTE.** *This procedure uses Microsoft Internet Explorer to open the monitor RUI. You can also access the RUI using the Tektronix Web Monitoring Systems Manager (WebMSM). The instructions for using WebMSM are located in the WebMSM User Manual (Tektronix part number 077-0116-xx).*

---

- a. Launch Microsoft Internet Explorer.
- b. In the address bar of the Web browser, enter the network identity or IP address of the monitor, for example: `http://TSMonitor01` or `http://111.222.333.444`.
- c. Press **Enter**. A Java applet is downloaded from the monitor and launched. The file size is approximately 1.5 MB; the download time will depend on the network speed and traffic.

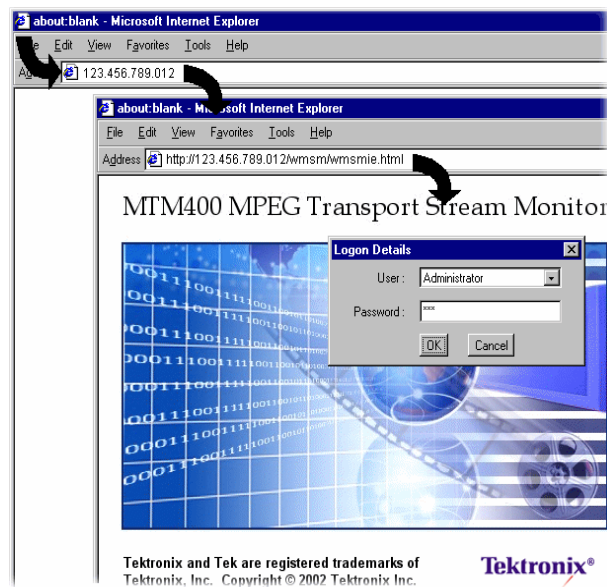


**CAUTION.** The Java applet will not run unless a temp directory is properly configured on the PC. A temp directory is set up by default in the Windows XP operating system; previous operating systems may require operator action.

The Java applet will not run unless the Microsoft Java Virtual Machine is installed. Type `jview` at the command prompt to verify that it is installed and that the version is 5.00.3809 or greater. If it is not installed, obtain the installation file from the Microsoft Web site.

If the Sun Virtual Machine has also been installed, the Sun Virtual Machine must not be set as the default in the Java control panel or Internet Explorer options, advanced tab.

3. After the Java applet is downloaded, the monitor splash screen will appear, and then be quickly overlaid by the Login Details dialog box. (See Figure 2.)

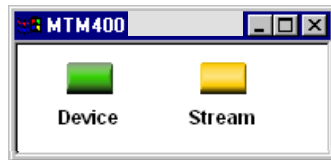


**Figure 2: Logging in to the monitor (RUI v2.6.1 and below)**

4. In the Login Details dialog box, select **Administrator** from the User drop-down list.

**NOTE.** You must log in to the monitor using the Administrator login type. The User login type does not have sufficient permissions to perform software option upgrades.

5. Enter the appropriate password, and then click **OK** to accept the login details. The default password for the Administrator login type is tek.
6. After you log on to the monitor, the Hotspot view is displayed. (See Figure 3.) Click **Device** to open the Device view.



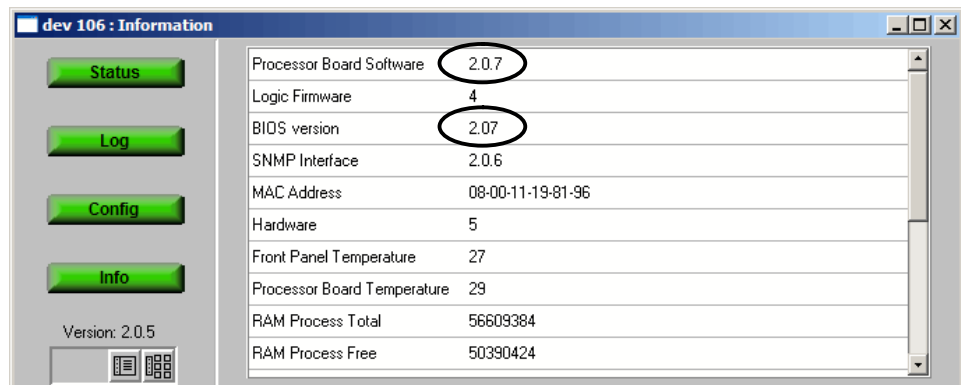
**Figure 3: Hotspot view (RUI v2.6.1 and below)**

7. In the Device view, click **Info** to open the Device Information view.

---

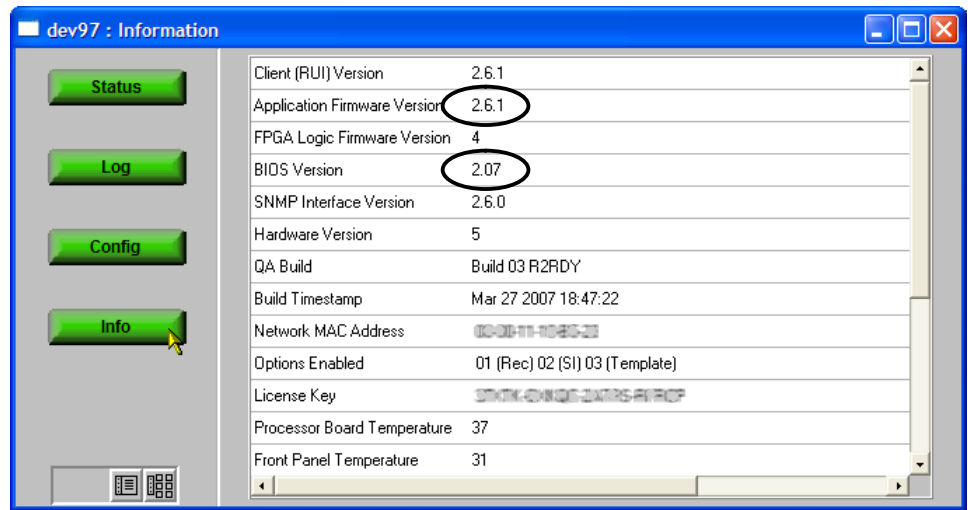
**NOTE.** For firmware versions 2.1.0 to 2.6.1, the information shown in the Device Information view differs from the previous firmware versions. The Device Information view for firmware versions 2.0.7 and earlier is shown in Figure 4. The view for firmware versions 2.1.0 and later is shown in Figure 5.

---



**Figure 4: Device Information view (RUI v2.0.7 and earlier)**





**Figure 5: Device Information view (RUI v2.1.0 to v2.6.1)**

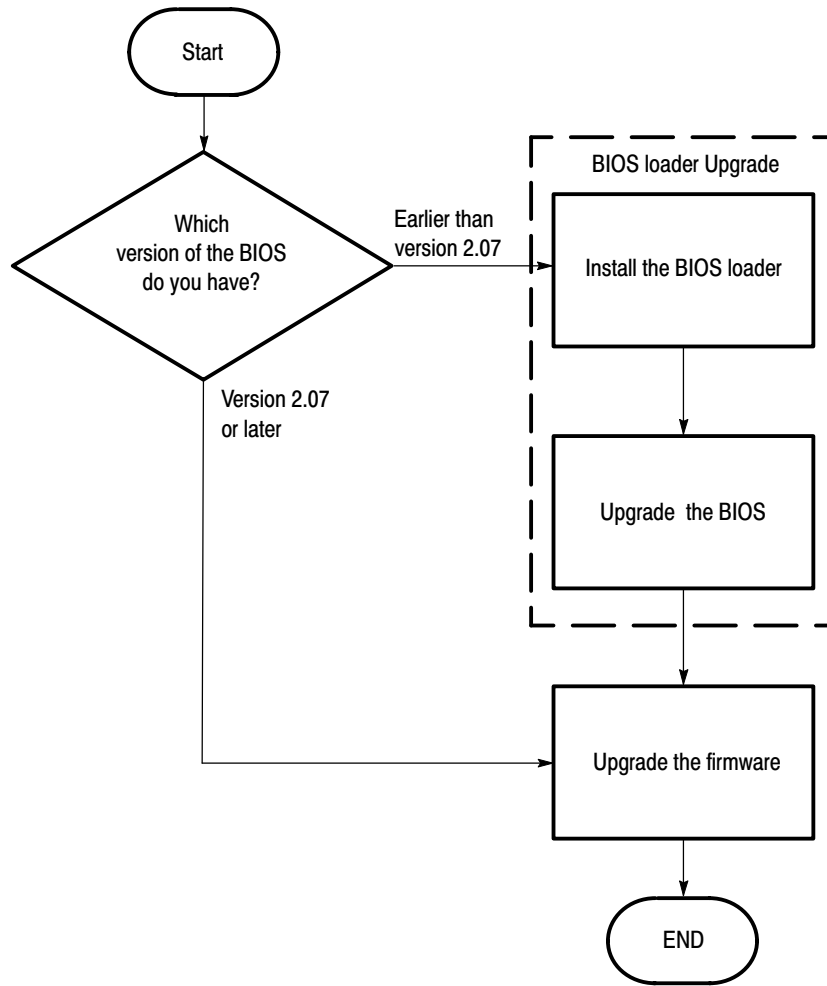
8. Note the version numbers displayed for the Processor Board Software (RUI v2.07 and earlier) or the Application Firmware Version (RUI v2.1.0 to v2.6.1), and the BIOS Version shown in the Device Information view.

---

**NOTE.** The Device Information view details the software and hardware build state of the monitor. The values shown in Figure 4 or Figure 5 will differ from the values shown for your monitor.

---

9. See Figure 6. Identify which upgrade steps are required for your monitor.



**Figure 6: Upgrade path (RUI v2.6.1 and below)**

## Install the Upgrade Files on the PC

Perform the following steps to copy the upgrade files from the application firmware CD-ROM to the hard drive of your PC:



---

**CAUTION.** For the firmware upgrade to be successful, the upgrade file(s) must be copied from the application firmware CD-ROM to a writable location such as the hard drive on your PC.

---

1. Insert the application firmware CD-ROM supplied with this kit into the CD-ROM drive of your PC.
2. If the BIOS installed on your monitor is version 2.07 or later (as noted in step 8 on page 17), locate and copy the application firmware file from the CD-ROM to the hard drive of your PC:

MTM400 <version number>.zip

For example: MTM400 v3.0.060 Build 702.zip

3. If the BIOS installed on your monitor is earlier than version 2.07, locate and copy the application firmware file listed above and the BIOS upgrade file listed below from the CD-ROM to the hard drive of your PC:

MTM400 v2.0.6.1 BIOSLDR v2.07.zip.

4. Unzip the upgrade file(s) that you copied to your PC. The name of the unzipped upgrade file(s) should be \*.hex.

## Remove Signal Sources



---

**CAUTION.** To prevent upgrade problems that might require that the monitor be returned to Tektronix service for reprogramming, disconnect all transport stream inputs and outputs from the monitor before performing the remaining portion of the firmware upgrade procedure.

---

### Upgrade the BIOS Version

If the BIOS version installed on your monitor is earlier than v2.07, then perform the following procedure to upgrade the BIOS version. Otherwise, proceed to *Upgrade the Monitor Firmware*. (See page 24.)

The BIOS is upgraded by installing a program (BIOS Loader) which, when activated, automatically installs the new BIOS.



**CAUTION.** *The BIOS upgrade is a critical process. If, for any reason, the BIOS upgrade procedure fails, the monitor might need to be returned to Tektronix service for reprogramming. Therefore, this procedure should only be carried out when monitoring is not required or when alternative arrangements can be made for system monitoring.*

*Do not remove power or manually reboot the monitor during the following procedures, unless instructed to do so.*

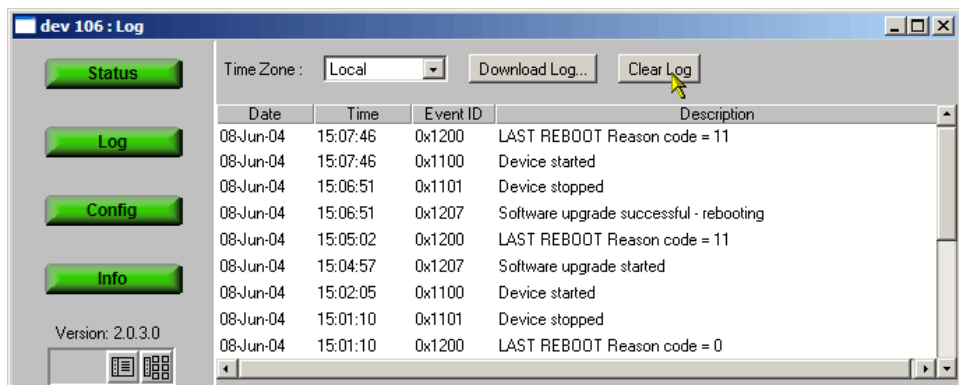
*Perform this procedure only if the BIOS version of your monitor is earlier than v2.07. (See Figure 6 on page 18.)*

**Install the BIOS Loader.** Perform the following steps to install the BIOS loader:



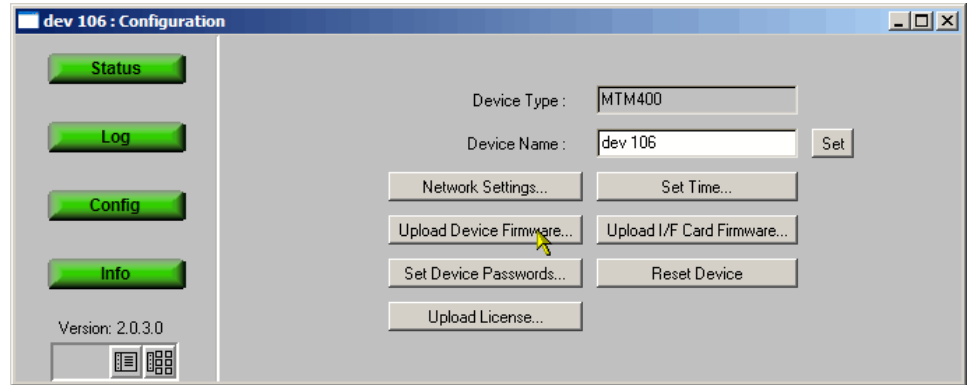
**CAUTION.** *To prevent upgrade problems that might require that the monitor be returned to Tektronix service for reprogramming, you must clear the Device Log immediately before uploading the firmware.*

1. In the Device view, click **Log** to display the Device Log view. (See Figure 7.)
2. In the Device Log view, click **Clear Log** to clear the device log. A message is displayed in the Device Log view confirming that the log has been cleared.



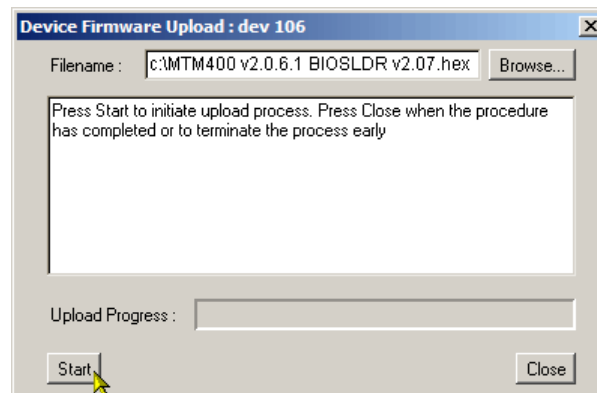
**Figure 7: Device Log view (RUI v2.6.1 and below)**

3. In the Device view, click **Config** to display the Device Configuration view. (See Figure 8.)



**Figure 8: Device Configuration view (RUI v2.6.1 and below)**

4. In the Device Configuration view, click **Upload Device Firmware**. This opens the Device Firmware Upload window. (See Figure 9.)



**Figure 9: Device Firmware Upload window (RUI v2.6.1 and below)**

5. Click **Browse** and navigate to the directory location where you copied the upgrade files. Select the unzipped BIOS loader file:

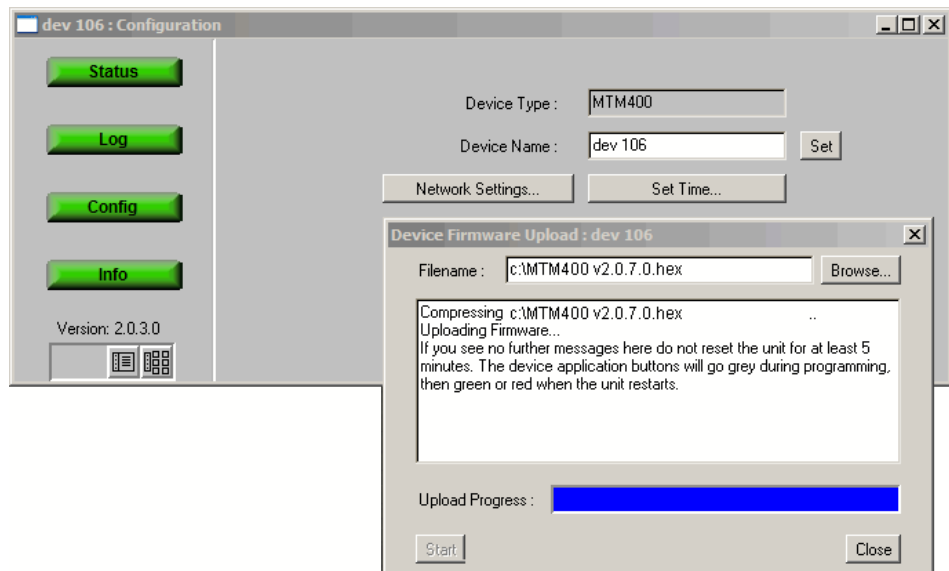
MTM400 v2.0.6.1 BIOSLDR v2.07.hex.

6. After you select the BIOS upgrade file, click **Start**. The BIOS loading process may take a few minutes. While the process completes, the four buttons in the Device view will be grayed. The monitor will automatically restart when the BIOS loading process completes.
7. When all four of the buttons in the Device view have been active (colored red, green, or yellow) for longer than 20 seconds, and the progress bar in the Device Firmware Upload dialog is full, the BIOS Loader is successfully loaded. (See Figure 10.)



**CAUTION.** To prevent upgrade problems that might require the monitor to be returned to Tektronix service for reprogramming, do not proceed until all four buttons in the Device view have been active (colored red, green, or yellow) for more than 20 seconds.

---



**Figure 10: Completed BIOS upload (RUI v2.6.1 and below)**

**Upgrade the BIOS.** After the BIOS Loader is successfully loaded into the monitor, perform the following steps to upgrade the BIOS:



---

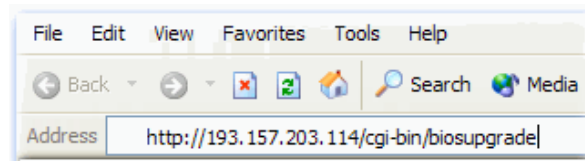
**CAUTION.** To prevent damage to the monitor that will require the monitor to be returned to Tektronix for repair, do not remove power or manually reboot the MTM400 during the following procedures.

---

8. On the PC, launch a second instance of Microsoft Internet Explorer Web browser.
9. In the address bar of the Web browser, enter the following command and then press the **Enter** key (see Figure 11):

<IP address>/cgi-bin/biosupgrade

where <IP address> is the IP address of the monitor that you are upgrading.



**Figure 11: Entering the BIOS upgrade command (RUI v2.6.1 and below)**

10. After you press Enter, the BIOS upgrade process starts. The process should take no longer than 15 seconds. After the BIOS upgrade process completes, a message is displayed in the Web browser window and the buttons in the Device view are active (colored red, green, or yellow).



---

**CAUTION.** Do not proceed until all four buttons in the Device view have been active (either red, green, or yellow) for more than 20 seconds.

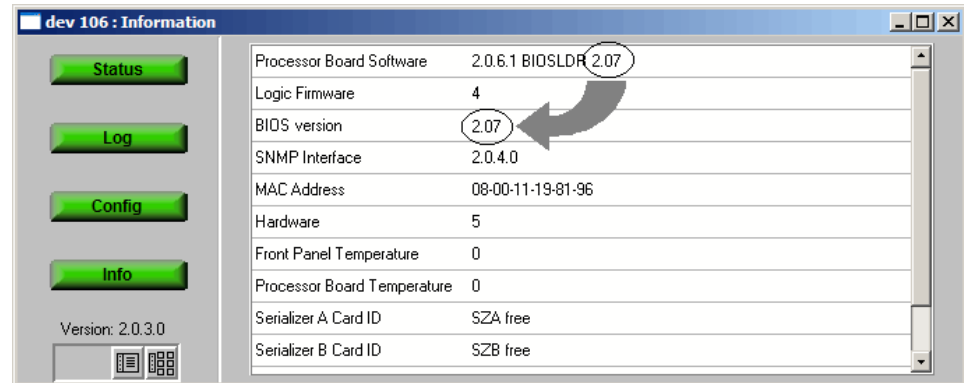
*If the upgrade is unsuccessful, the original BIOS will be reinstated, if possible, and the monitor will automatically restart.*

---

11. Close the Internet Explorer, and then close the Device Firmware Upload dialog box.

**Verify the BIOS Upgrade.** Perform the following step to verify that the BIOS version was upgraded:

12. In the Device view, click **Info** to open the Information view. (See Figure 12.)
13. In the Device Information view, verify that the BIOS version matches the BIOS uploader version.



**Figure 12: Verifying the BIOS version (RUI v2.6.1 and below)**

### Upgrade the Monitor Firmware

After you verify the BIOS version and upgrade it if necessary, perform the following steps to upgrade the application firmware installed on the monitor:

1. In the Device view, click **Log** to display the Device Log view. (See Figure 7 on page 20.)



**CAUTION.** To prevent upgrade problems that might require the monitor to be returned to Tektronix service for reprogramming, you must clear the Device Log immediately before uploading the firmware.

2. In the Device Log view, click **Clear Log** to clear the device log. A message is displayed in the Device Log view confirming that the log has been cleared.
3. In the Device view, click **Config** to display the Device Configuration view. (See Figure 8 on page 21.)
4. In the Device Configuration view, click **Upload Device Firmware**. This opens the Device Firmware Upload window. (See Figure 9 on page 21.)
5. In the Device Firmware Upload window, click **Browse** and navigate to the directory location where you copied the upgrade files. Select the unzipped firmware file, for example:

MTM400 v3.0.060 Build 702.hex.

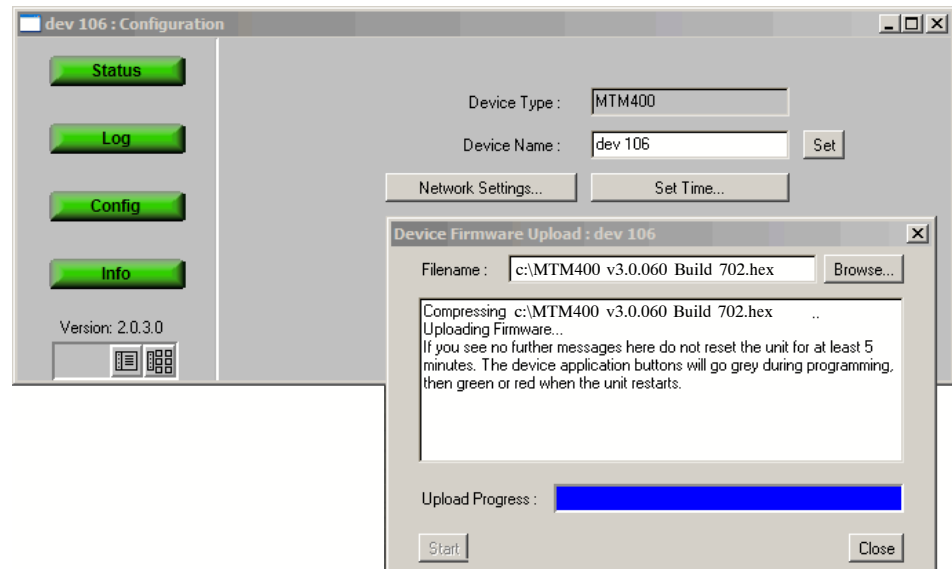


6. After you select the firmware upgrade file, click **Start**. The firmware upgrade process may take a few minutes. While the process completes, the four buttons in the Device view will be grayed. The monitor will automatically restart when the upgrade process completes.
7. When all four of the buttons in the Device view have been active (colored red, green, or yellow) for longer than 20 seconds, and the progress bar in the Device Firmware Upload dialog is full, the firmware is successfully loaded. (See Figure 13.)



**CAUTION.** To prevent upgrade problems that might require the monitor to be returned to Tektronix service for reprogramming, do not proceed until all four buttons in the Device view have been active (colored red, green, or yellow) for more than 20 seconds.

8. Click **Close** when the upgrade process is complete.



**Figure 13: Completing the firmware upload (RUI v2.6.1 and below)**

9. If there was an interface card installed in the monitor when you performed the upgrade, the interface card will be automatically reprogrammed as soon as the firmware has finished uploading.



---

**CAUTION.** *Programming of the interface card can take up to 20 minutes. Do not remove power from or restart the monitor during that time. If the process fails, programming will automatically restart.*

---

The progress of the programming can be observed in the Device Log view. The following messages will be displayed:

<Date> <Time> <Event ID> Interface card: CIP Firmware Programming Started

<Date> <Time> <Event ID> Interface card: CIP Firmware Programming Successful

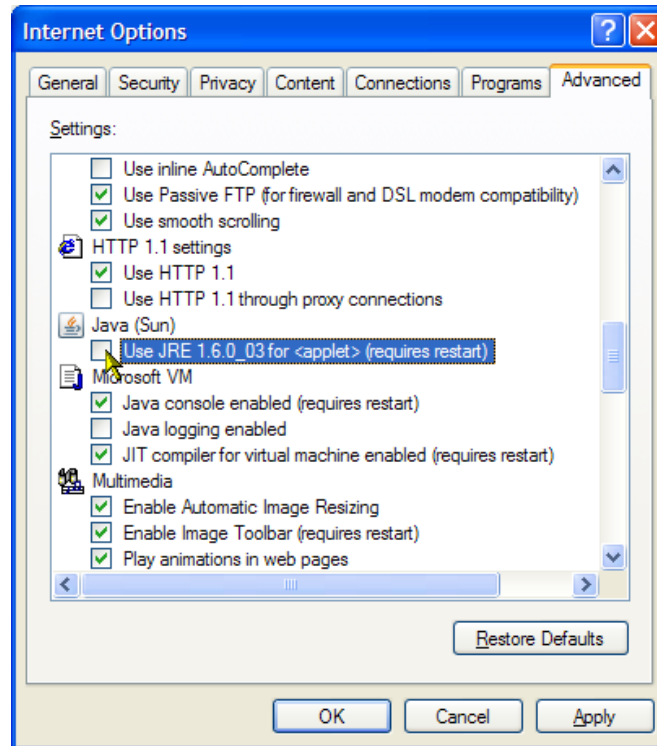
<Date> <Time> <Event ID> Interface card: CIP Card Startup

The Input Card button on the Stream view bar will not be displayed until programming of the interface card is complete.

### **Enable Java Runtime Environment**

Before the firmware upgrade can be verified, you must ensure that the Java Runtime Environment is available using the following steps:

1. Launch Microsoft Internet Explorer.
2. From the Internet Explorer menu bar, select **Tools > Internet Options...**, and then select the **Advanced** tab.
3. Locate the **Java (Sun)** node, and then select the **Use JRE** check box (see Figure 14). Note that your version of the JRE may be later.



**Figure 14: Internet Options dialog box**

4. Close the Internet Options dialog box.
5. Close and restart Internet Explorer.

### Verify the Firmware Upgrade

Perform the following steps to verify the firmware upgrade:

---

**NOTE.** By performing the preceding firmware upgrade procedure, the RUI on your monitor was upgraded to v3.0. To access the upgraded RUI, your PC must meet the requirements listed in Table 3 on page 4.

---

1. If necessary, close the Web browser window that you used to upgrade the firmware on your monitor.
2. If necessary, reconfigure your PC to meet the requirements listed in Table 3 on page 4.
3. If necessary, power on the monitor and wait for it to initialize. When the initialization process is complete, the monitor beeps and the front-panel LEDs illuminate.

4. Using a PC connected to the same Ethernet network as the monitor, perform the following steps to open the RUI:

---

**NOTE.** *This procedure uses Microsoft Internet Explorer to open the monitor RUI. You can also access the RUI using the Tektronix Web Monitoring Systems Manager (WebMSM). The instructions for using WebMSM are located in the WebMSM User Manual (Tektronix part number 077-0116-xx).*

---

- a. Launch Microsoft Internet Explorer.
- b. In the address bar of the Web browser, enter the network identity or IP address of the monitor, for example: `http://TSMonitor01` or `http://111.222.333.444`.
- c. Press **Enter**. A Java applet is downloaded from the monitor and launched. The file size is approximately 1.5 MB; the download time will depend on the network speed and traffic.



---

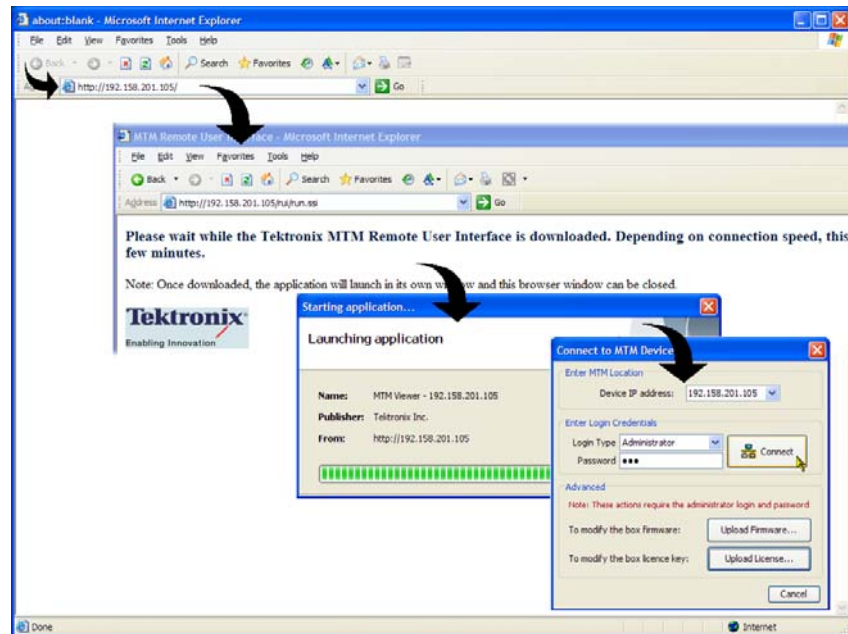
**CAUTION.** *The Java applet will not run unless a temp directory is properly configured on the PC. A temp directory is set up by default in the Windows XP operating system; previous operating systems may require operator action.*

*The Java applet will not run unless the Sun Java Virtual Machine is installed. Type `java -version` at the command prompt to verify that it is installed and that the version is 1.6.0\_03 or greater. If it is not installed, you can download the latest version from the Sun Web site, [www.java.com](http://www.java.com).*

*If you have to update the Java version on the PC, you will need to restart this procedure at step 4.*

---

5. After the Java applet is downloaded, the Connect to MTM Device dialog box is displayed. (See Figure 15.)



**Figure 15: Logging in to monitor (RUI v3.0 and above)**

6. In the Connect to MTM Device dialog box, select **Administrator** from the Login Type drop-down list, and then enter the password. The default password for Administrator login type is tek.
7. Click **Connect** to log in to the monitor and display the RUI window.
8. Click **Device** in the button bar of the RUI window to display the Device Information view. (See Figure 16.)

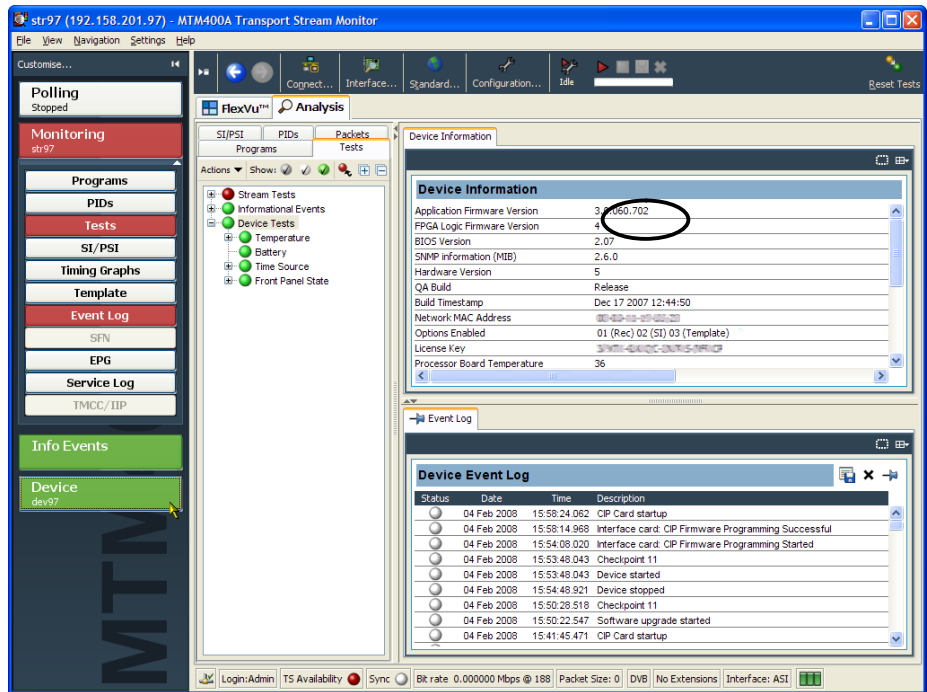
---

**NOTE.** The Device Information view details the software and hardware build state of the monitor. The values shown in Figure 16 may differ from the values shown on your display.

---

9. Verify that the Application Firmware Version shown in the Device Information view matches the firmware version number listed in the file name of the \*.hex file that you copied from the application firmware CD-ROM supplied with this kit.

**NOTE.** If the upgrade process fails,



**Figure 16: Device Information view (RUI v3.0 and above)**

10. After you verify that the firmware upgrade was successful, proceed as follows:

- If you are upgrading your monitor with software options or if you are installing an MTM4UP QC (QAM Annex C) hardware upgrade, proceed to *Software Option Upgrade* on page 41.
- If you are not upgrading your monitor with software options and are installing hardware options, proceed to *Hardware Option Upgrade* on page 57.
- If you are upgrading your monitor to firmware version 3.1 and above, proceed to *Firmware Upgrade (RUI v3.0 and Above)* on page 31.

---

**NOTE.** If you want to change the RUI version on your monitor to v2.6.1 after you complete the upgrade installation, use the instructions that are located in the MTM400 and MTM400A RUI v3.x Upgrade Technical Reference (Tektronix part number 077-0174-xx) that is supplied on the documentation CD-ROM accompanying this kit.

---

## Firmware Upgrade (RUI v3.0 and Above)

If your MTM400 or MTM400A monitor has RUI v3.0 or above installed, perform the following steps to upgrade the application firmware installed on your monitor.

### Identify the Current Firmware Version

Perform the following steps to identify the firmware version that is installed in your monitor:

1. Power on the monitor and wait for it to initialize. When the initialization process is complete, the monitor beeps and the front-panel LEDs illuminate.
2. Using a PC that meets the requirements listed in Table 3 on page 4 and is connected to the same Ethernet network as the monitor, perform the following steps to open the RUI:

---

**NOTE.** This procedure uses Microsoft Internet Explorer to open the monitor RUI. You can also access the RUI using the Tektronix Web Monitoring Systems Manager (WebMSM). The instructions for using WebMSM are located in the WebMSM User Manual (Tektronix part number 077-0116-xx).

---

- a. Launch Microsoft Internet Explorer.
- b. In the address bar of the Web browser, enter the network identity or IP address of the monitor, for example: `http://TSMonitor01` or `http://111.222.333.444`.
- c. Press **Enter**. A Java applet is downloaded from the monitor and launched. The file size is approximately 1.5 MB; the download time will depend on the network speed and traffic.



---

**CAUTION.** *The Java applet will not run unless a temp directory is properly configured on the PC. A temp directory is set up by default in the Windows XP operating system; previous operating systems may require operator action.*

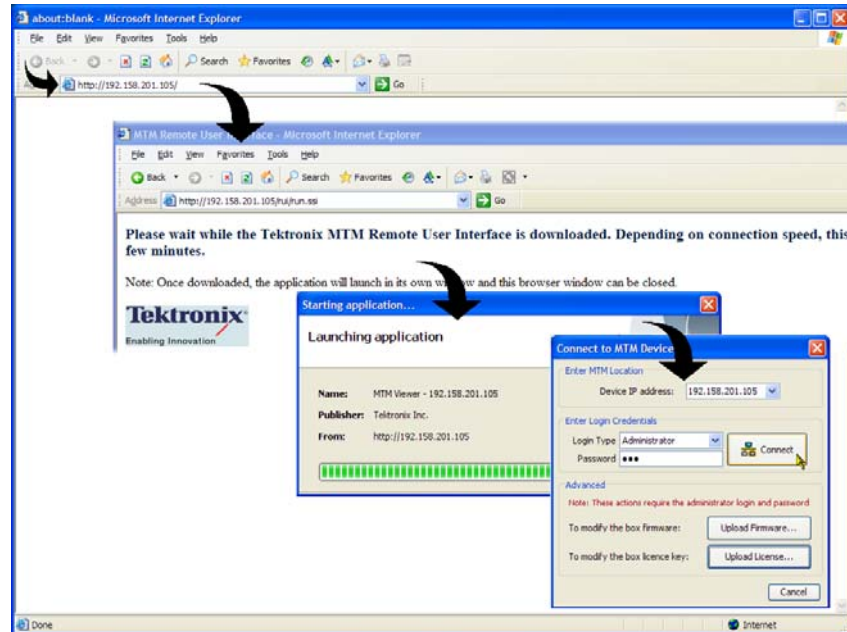
*The Java applet will not run unless the Sun Java Virtual Machine is installed. Type java -version at the command prompt to verify that it is installed and that the version is 1.6.0\_03 or greater. If it is not installed, you can download the latest version from the Sun Web site, [www.java.com](http://www.java.com).*

*If you have to update the Java version on the PC, you will need to restart this procedure at step 2.*

---



3. After the Java applet is downloaded, the Connect to MTM Device dialog box is displayed. (See Figure 17.)



**Figure 17: Logging in to the monitor (RUI v3.0 and above)**

4. In the Connect to MTM Device dialog box, select **Administrator** from the Login Type drop-down list, and then enter the password. The default password for Administrator login type is tek.

---

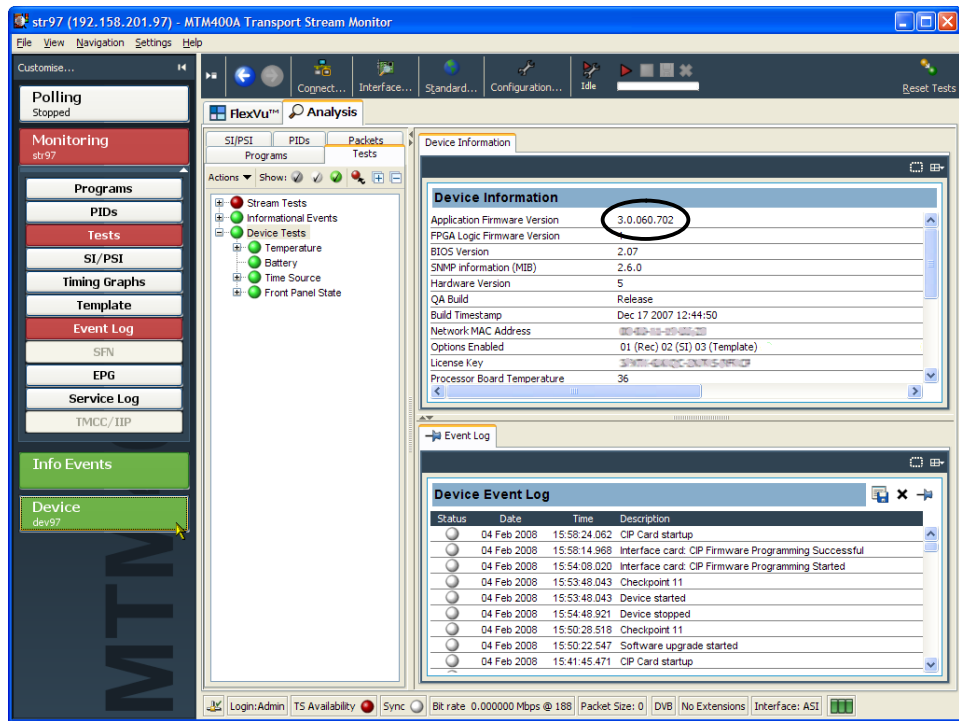
**NOTE.** You must log in to the monitor using the Administrator login type. The User login type does not have sufficient permissions to perform software option upgrades.

---

5. Click **Connect** to log in to the monitor and display the RUI window.

Read and accept the Tektronix MTM400A End User License Agreement (EULA) if necessary.

6. Click **Device** in the button bar of the RUI window to display the Device Information view. (See Figure 18.)



**Figure 18: Device Information view (RUI v3.0 and above)**

7. Note the Application Firmware Version value shown in the Device Information view and proceed as follows:

**NOTE.** The Device Information view details the software and hardware build state of the monitor. The values shown in Figure 18 will differ from the values shown for your monitor.

- If the displayed application firmware version is version 3.0 and the version listed on the application firmware CD-ROM supplied with this kit is later, proceed to *Install the Upgrade File on the PC* on page 35.
- If the displayed application firmware version is earlier than version 3.0, version 3.0 must be installed before any later version is installed. Perform the procedure described in *Firmware Upgrade (RUI v2.6.1 and Below)* starting on page 14.
- If the displayed application firmware version is the same version that is listed on the application firmware CD-ROM supplied with this kit, and you are upgrading your monitor with software options or if you are installing an MTM4UP QC (QAM Annex C) hardware upgrade, proceed to *Software Option Upgrade* on page 41.

- If the displayed application firmware version is the same version that is listed on the application firmware CD-ROM supplied with this kit, and if you are not upgrading your monitor with software options, and you are installing hardware options, proceed to *Hardware Option Upgrade* on page 57.

### Install the Upgrade File on the PC

Perform the following steps to copy the upgrade files from the application firmware CD-ROM to the hard drive of your PC:



---

**CAUTION.** *For the firmware upgrade to be successful, the upgrade file(s) must be copied from the application firmware CD-ROM to a writable location such as the hard drive on your PC.*

---

1. Insert the application firmware CD-ROM supplied with this kit into the CD-ROM drive of your PC.
2. Locate and copy the application firmware file from the CD-ROM to the hard drive of your PC:  
  
MTM400 <version number>.zip  
  
For example: MTM400 v3.0.060 Build 702.zip
3. Unzip the upgrade file that you copied to your PC. The name of the unzipped upgrade file should be MTM400 <version number>.hex.

### Remove Signal Sources



---

**CAUTION.** *To prevent upgrade problems that might require the monitor to be returned to Tektronix service for reprogramming, disconnect all transport stream inputs and outputs from the monitor before performing the remaining portion of the firmware upgrade procedure.*

---

## Upgrade the Monitor Firmware



Perform the following steps to upgrade the application firmware installed on the monitor:

---

**CAUTION.** *To prevent upgrade problems that might require the monitor to be returned to Tektronix service for reprogramming, you must clear the Device Log immediately before uploading the firmware.*

---

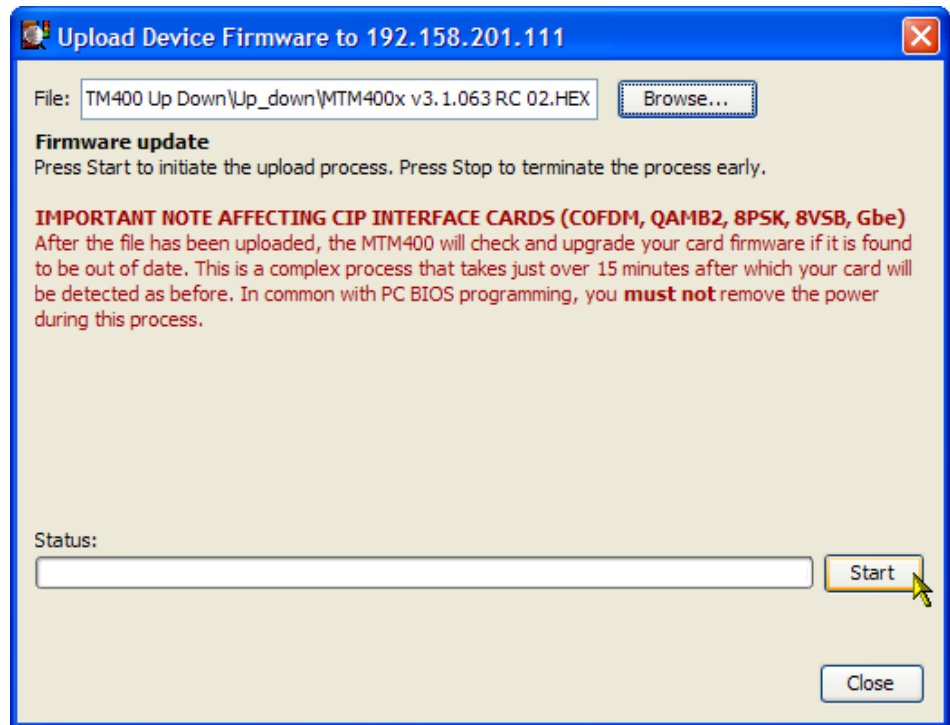
1. In the Device Event Log view, click **X** to clear the log. (See Figure 18 on page 34.)
2. Close the RUI browser window that you used to verify the firmware version installed on your monitor and the opening browser window (if still open).
3. Relaunch Microsoft Internet Explorer.
4. In the address bar of the Web browser, enter the network identity or IP address of the monitor, for example: `http://TSMonitor01` or `http://111.222.333.444`.
5. Press **Enter**. A Java applet is downloaded from the monitor and launched. The file size is approximately 1.5 MB; the download time will depend on the network speed and traffic.
6. After the Java applet is downloaded, the Connect to MTM Device dialog box is displayed. (See Figure 17 on page 33.)
7. In the Connect to MTM Device dialog box, select **Administrator** from the Login Type drop-down list, and then enter the password. The default password for Administrator login type is tek.

---

**NOTE.** *You must log in to the monitor using the Administrator login type. The User login type does not have sufficient permissions to perform software option upgrades.*

---

8. In the Connect to MTM Device dialog box, click **Upload Firmware** to open the Upload Device Firmware window. (See Figure 19.)



**Figure 19: Upload Device Firmware window (RUI v3.0 and above)**

9. In the Upload Device Firmware window, click **Browse** and navigate to the directory location where you copied the upgrade file. Select the unzipped firmware file, for example:

MTM400 v3.1.x.xxx Build xxx.hex



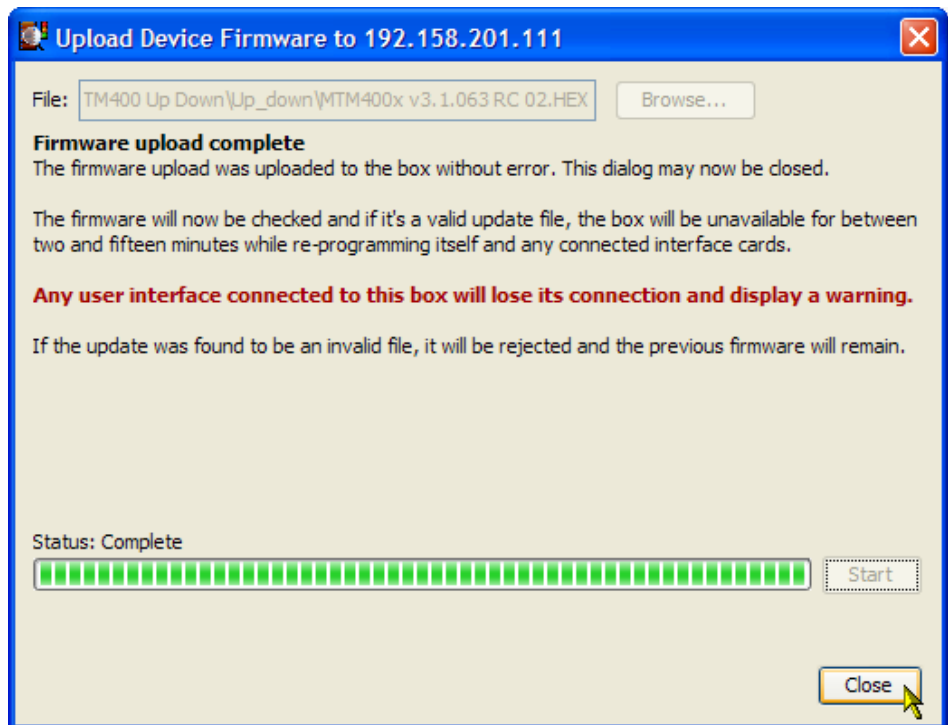
**CAUTION.** Do not remove power from the monitor during the reprogramming process. If power is removed during reprogramming, the monitor might be rendered unable to reboot, which will require that the monitor be returned to Tektronix for repair.

10. Click **Start** to upload the firmware. The firmware upgrade process may take a few minutes to complete.

**NOTE.** The version 3 upgrade processes are illustrated in Figure 1 on page 13. Although the firmware components are upgraded in different orders, you must allow at least 20 minutes for the process to complete.

11. When the firmware upload is complete, the message **Firmware upload complete** appears. (See Figure 20.)

As stated in the message, the uploaded firmware will be checked, and if valid, reprogramming will start.



**Figure 20: Completing the firmware upload (RUI v3.0 and above)**

12. Close the Upload Device Firmware dialog box.
13. Click **Connect** in the Connect to MTM dialog box.

The Initializing progress window is displayed.

If an interface card is installed in the monitor, it will be checked automatically and reprogrammed if necessary. During this process, an interim progress screen may be displayed before the RUI opens.

14. When the reprogramming process is complete, close the RUI, and if necessary, close the associated Web browser window.

### **Verify the Firmware Upgrade**

To verify the firmware upgrade, perform the procedure described in *Verify the Firmware Upgrade* starting on page 27.

## Command Line Firmware Upgrade

An alternative to upgrading the firmware using the MTM400A RUI is by using the command line firmware upgrade program supplied on the MTM400A Application Firmware CD-ROM. This program can be used to upgrade and downgrade the MTM400A firmware.



---

**CAUTION.** Review and comply with the RUI Versions section, page 11, before using the command line upgrade.

---

Use the following steps to upgrade the firmware from the command line:

1. Identify the current firmware version, refer to the Application Firmware Upgrade section, page 11.
  - a. Power on the monitor and wait for it to initialize. When the initialization process is complete, the monitor beeps and the front-panel LEDs illuminate.
  - b. Using a PC that meets the requirements listed in Table 3 on page 4 and is connected to the same Ethernet network as the monitor, open the RUI as previously described.
  - c. From the RUI, identify the Application Firmware Version.
  - d. Close the RUI.

Using this application firmware version information as a reference point, identify and locate the firmware upgrade file to be used, for example, “MTM400 v3.1.063.hex”.

2. At the PC, insert the MTM400A Application Firmware CD-ROM into the CD-ROM drive.
3. From the Windows desktop, open the Command window, **Start > Run > cmd.**
4. In the command window, change to the CD-ROM directory containing the program, mtmfwuploader.exe.
5. Enter the program command in the following format:  
mtmfwuploader.exe <mtm address> <firmware file>  
for example,  
mtmfwuploader.exe 10.0.0.1 “mtm400x v3.1.063.hex”

---

**NOTE.** When the firmware upload file name has spaces in it, enclose the name in quotation marks, as shown in this example.

---

- Execute the command by pressing the Enter key on your keyboard.

```

C:\WINDOWS\system32\cmd.exe
C:\MTM400 Up Down\Up_down>mtmfwuploader
Usage: UploadFirmware <mtm address> <firmware file> [force <optional: to force c
ip card upgrade>] [changeinput <to change input while uploading>]
C:\MTM400 Up Down\Up_down>mtmfwuploader 192.158.201.89 "mtm400 v3.0.060 Build 70
2.hex"
Generating Compressed File... Done
Calculating CRC... Done
Uploading Compressed File <forced card upgrade=false>
0%... 10%... 20%... 30%... 40%... 50%... 60%... 70%... 80%... 90%...
100%... Done
Deleting Compressed File.. Done
Waiting for interface card programming to complete <Percentage longest case: Gbe
~ 100%, RF cards ~ 30%, No card 10%>
5%... Done
Interface card programming complete - programming MTM400 now
0%... 24%... 48%... 72%... 96%... MTM400 and interface card is programmed now
C:\MTM400 Up Down\Up_down>
    
```

The firmware upload program will run.

- The firmware upload is complete when the following message is displayed: mtm400 and interface card is programmed now.

### Troubleshooting

The progress indicator following the “Waiting for interface programming to complete” message, may go beyond 100%. If this happens, note the following steps:

- Ensure that the signal input is disconnected and retry the process.
- Observe the SFP LINK LED on the GbE interface card rear panel.



**CAUTION.** If, with no input, the SFP LINK LED stays lit, rebooting the instrument could result in firmware corruption.

- If the LED is still lit after 15 minutes, then a reboot, by removing and reinstating power, can be tried.
- If the upgrade is still unsuccessful, contact Tektronix support ([www.tek.com](http://www.tek.com)).

### Verify the Firmware Upgrade

To verify the firmware upgrade, perform the procedure described in *Verify the Firmware Upgrade* starting on page 27.



# Software Option Upgrade

The following MTM4UP upgrades require that you apply the new option key that is supplied with the upgrade kit before the upgrade will be enabled:

- All software option upgrades (MTM4UP 01, 02, 03, 04, 05, 06, and 07)
- Hardware upgrade MTM4UP QC (QAM Annex C interface card)

## Option Keys

The option key is a unique string of alphanumeric characters of the form nnnnn–nnnnn–nnnnn–nnnnn. A single option key can enable one or more software options.

Each option key is unique and is generated for a specific MTM400 or MTM400A monitor using the serial number and MAC address of that monitor. An option key that is generated for one monitor will not work when applied to another monitor.

The serial number identifies a specific MTM400 or MTM400A monitor. The MAC address identifies the Transport Stream Processor board that is installed in the monitor. If there is a hardware failure and the Transport Stream Processor board is replaced, a new option key will need to be issued because the monitor will then have a different MAC address. The MAC address is printed on the label on the top cover of the monitor and above the network port on the rear panel.

If you ordered a software option upgrade, this kit includes both a document and a sticker with the new option key for your monitor. You will apply the sticker to the top cover of the monitor after you verify the upgrade.



---

**CAUTION.** *To avoid losing your software options, do not misplace the option key document or sticker that was included with this upgrade kit. If the battery-backed RAM in your MTM400 or MTM400A monitor is reset, you must reapply the option key to reenable any software options that were purchased for your monitor.*

---

## RUI Versions

The version number of the firmware installed on your monitor corresponds to the version number of the RUI. MTM400 monitors were shipped from the factory with RUI v2.6.1 or below installed. MTM400A monitors are shipped with RUI v3.0 or above installed. RUI v3.0 introduced new features and a significant change in the operation of the user interface. The MTM400 and MTM400A monitors can be modified to operate using either version of the RUI.

Use the software option upgrade procedure that is appropriate for the RUI version that is currently installed on your monitor:

- If you did not perform a firmware upgrade and if your MTM400 or MTM400A monitor is currently operating with RUI v2.6.1 or below, perform the procedure described in *Software Option Upgrade (RUI v2.6.1 and Below)* starting on page 43.
- If you performed a firmware upgrade or if your MTM400 or MTM400A monitor is currently operating with RUI v3.0 or above, perform the procedure described in *Software Option Upgrade (RUI v3.0 and Above)* starting on page 48.

If you change the RUI version on your monitor to v2.6.1 after you install the upgrade, you will not lose any of your software options. Instructions for changing the RUI version from v3.0 and above to v2.6.1 are located in the *MTM400 and MTM400A RUI v3.x Upgrade Technical Reference* (Tektronix part number 077-0174-xx) that is supplied on the documentation CD-ROM accompanying this kit.

## Software Option Upgrade (RUI v2.6.1 and Below)

If your MTM400 or MTM400A monitor has RUI v2.6.1 or below installed, perform the following procedure to apply the option key that was supplied with this kit:

1. Power on the monitor and wait for it to initialize. When the initialization process is complete, the monitor beeps and the front-panel LEDs illuminate.
2. Using a PC that meets the requirements listed in Table 2 on page 3 and is connected to the same Ethernet network as the monitor, perform the following steps to open the monitor RUI:

---

**NOTE.** *This procedure uses Microsoft Internet Explorer to open the monitor RUI. You can also access the RUI using the Tektronix Web Monitoring Systems Manager (WebMSM). The instructions for using WebMSM are located in the WebMSM User Manual (Tektronix part number 077-0116-xx).*

---

- a. Launch Microsoft Internet Explorer.
- b. In the address bar of the Web browser, enter the network identity or IP address of the monitor, for example: `http://TSMonitor01` or `http://111.222.333.444`.
- c. Press **Enter**. A Java applet is downloaded from the monitor and launched. The file size is approximately 1.5 MB; the download time will depend on the network speed and traffic.



---

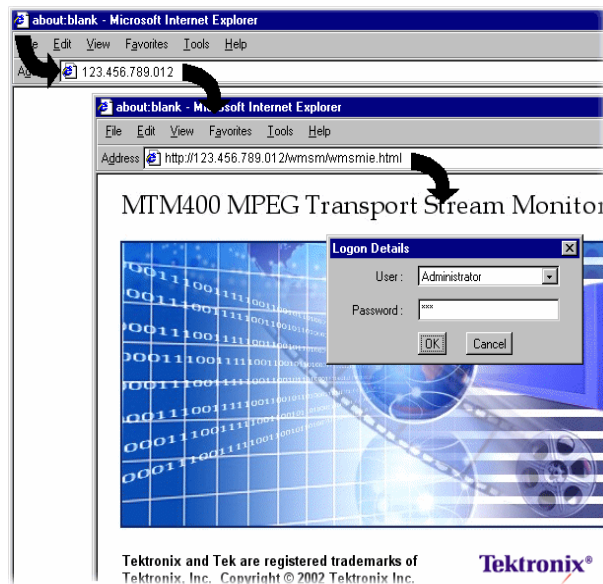
**CAUTION.** *The Java applet will not run unless a temp directory is properly configured on the PC. A temp directory is set up by default in the Windows XP operating system; previous operating systems may require operator action.*

*The Java applet will not run unless the Microsoft Java Virtual Machine is installed. Type `jview` at the command prompt to verify that it is installed and that the version is 5.00.3809 or greater. If it is not installed, obtain the installation file from the Microsoft Web site.*

*If the Sun Virtual Machine has also been installed, the Sun Virtual Machine must not be set as the default in the Java control panel or Internet Explorer options, advanced tab.*

---

3. After the Java applet is downloaded, the monitor splash screen will appear, and then be quickly overlaid by the Login Details dialog box. (See Figure 21.)



**Figure 21: Logging in to the monitor (RUI v2.6.1 and below)**

4. In the Login Details dialog box, select **Administrator** from the User drop-down list.

---

**NOTE.** You must log in to the monitor using the Administrator login type. The User login type does not have sufficient permissions to perform software option upgrades.

---

5. Enter the appropriate password, and then click **OK** to accept the login details. The default password for the Administrator login type is tek.
6. After you log in to the monitor, the Hotspot view is displayed. (See Figure 22.) Click **Device** to open the Device view.



**Figure 22: Hotspot view (RUI v2.6.1 and below)**

- In the Device view, click **Info** to open the Information screen.

**NOTE.** For firmware versions 2.1.0 to 2.6.1, the information shown in the Device Information view differs from the previous firmware versions. The Device Information view for firmware versions 2.0.7 and earlier is shown in Figure 23. The view for firmware versions 2.1.0 and later is shown in Figure 24.

- Verify that the Network MAC Address shown in the Information screen matches the Unique ID number listed on the option key document that was shipped with the upgrade kit.

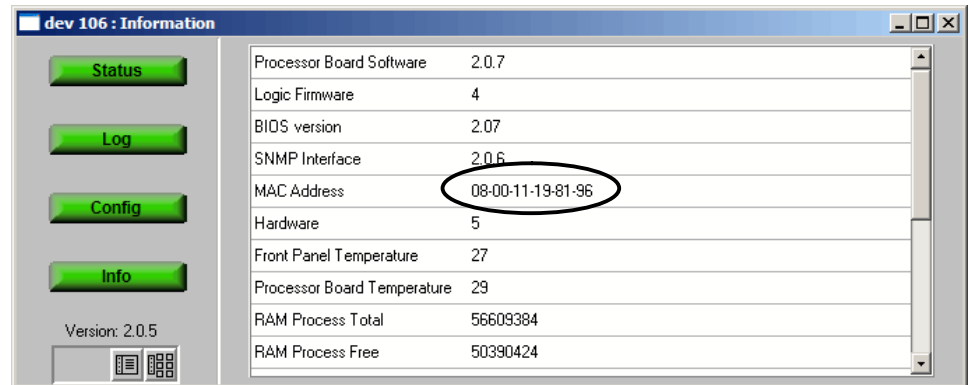


Figure 23: Device Information view (RUI v2.0.7 and earlier)

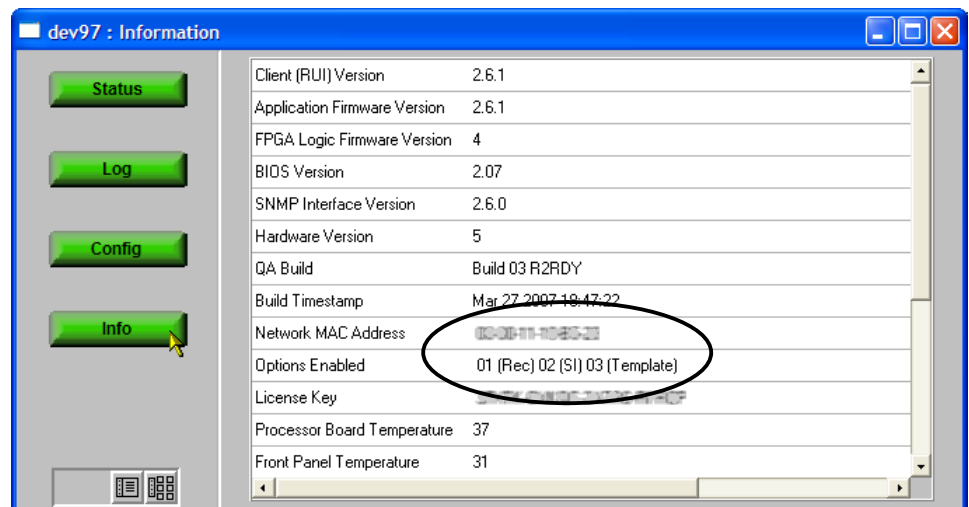


Figure 24: Device Information view (RUI v2.1.0 to v2.6.1)

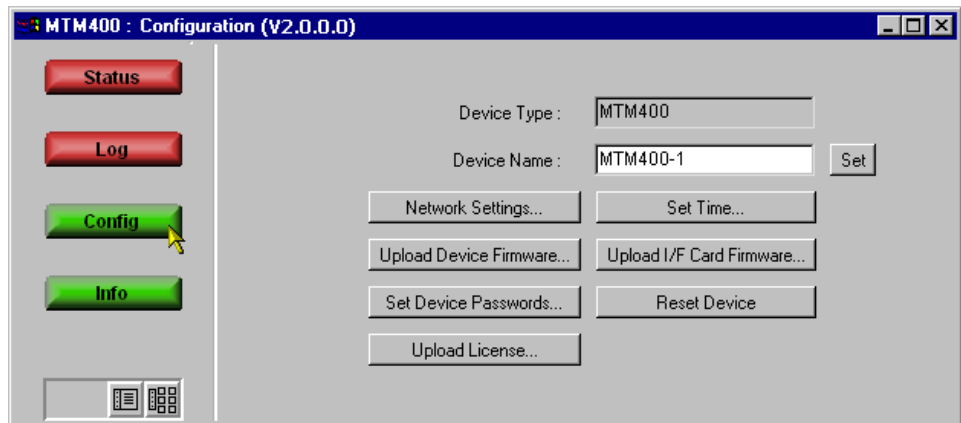
9. Make a note of the software options that are currently enabled on the monitor. Figure 24 shows that the monitor has software options 01, 02, and 03 enabled.

---

**NOTE.** After you upgrade the monitor, you will verify the upgrade by checking that all of the current software options are still enabled and that the new option(s) you purchased has been enabled.

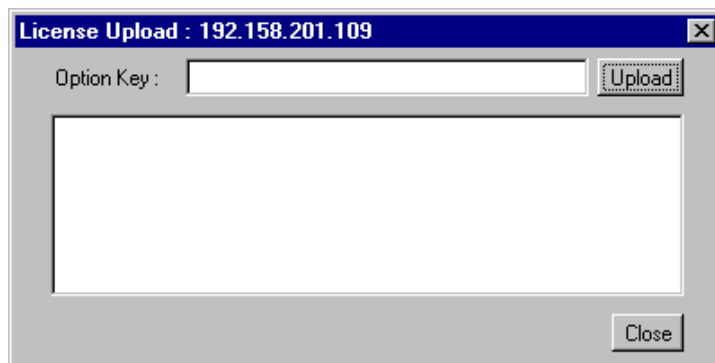
---

10. In the Device view, click **Config** to open the Configuration screen. (See Figure 25.)



**Figure 25: Device view Configuration screen (RUI v2.6.1 and below)**

11. In the Configuration screen, click **Upload License** to open the License Upload dialog box. (See Figure 26.)



**Figure 26: License Upload dialog box (RUI v2.6.1 and below)**




---

**CAUTION.** *The option key string is case-sensitive and must be entered exactly as it appears on the option key document, including any dashes.*

---

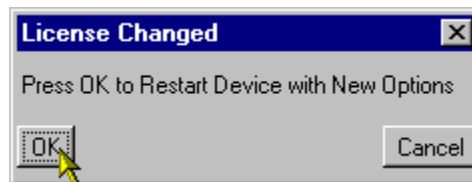
12. In the License Upload dialog box, enter the option key that was supplied with the upgrade kit, and then click **Upload**.
13. Progress messages will be displayed in the License Upload dialog box as the new option key is loaded into the monitor. When the message “License upload ok” is displayed, click the **Close** button.

---

**NOTE.** *If the option key is rejected, the message “License upload error – invalid license” will appear in the License Upload dialog box. Refer to Troubleshooting on page 53 for more information.*

---

14. The License Changed dialog box is displayed. (See Figure 27.) Click **OK** to restart the monitor.



**Figure 27: License Changed dialog box (RUI v2.6.1 and below)**

If the option key upload was accepted, the licensed software options enabled by the new option key will be implemented after the monitor restarts. If the option key upload was rejected, the restart will reinstate the software options (if any) that were enabled by the option key previously loaded in the monitor.

---

**NOTE.** *During the monitor restart, all of the RUI screens will remain open, but the buttons will be grayed out until the restart process is completed.*

---

15. If the option key upload was accepted, proceed to *Verifying the Software Option Upgrade* on page 54 after the monitor restarts.

## Software Option Upgrade (RUI v3.0 and Above)

If your MTM400 or MTM400A monitor has RUI v3.0 or above installed, perform the following procedure to apply the option key that was supplied with this kit:

1. Power on the monitor and wait for it to initialize. When the initialization process is complete, the monitor beeps and the front-panel LEDs illuminate.
2. Using a PC that meets the requirements listed in Table 3 on page 4 and is connected to the same Ethernet network as the monitor, perform the following steps to open the RUI:

---

**NOTE.** *This procedure uses Microsoft Internet Explorer to open the monitor RUI. You can also access the RUI using the Tektronix Web Monitoring Systems Manager (WebMSM). The instructions for using WebMSM are located in the WebMSM User Manual (Tektronix part number 077-0116-xx).*

---

- a. Launch Microsoft Internet Explorer.
- b. In the address bar of the Web browser, enter the network identity or IP address of the monitor, for example: `http://TSMonitor01` or `http://111.222.333.444`.
- c. Press **Enter**. A Java applet is downloaded from the monitor and launched. The file size is approximately 1.5 MB; the download time will depend on the network speed and traffic.



---

**CAUTION.** *The Java applet will not run unless a temp directory is properly configured on the PC. A temp directory is set up by default in the Windows XP operating system; previous operating systems may require operator action.*

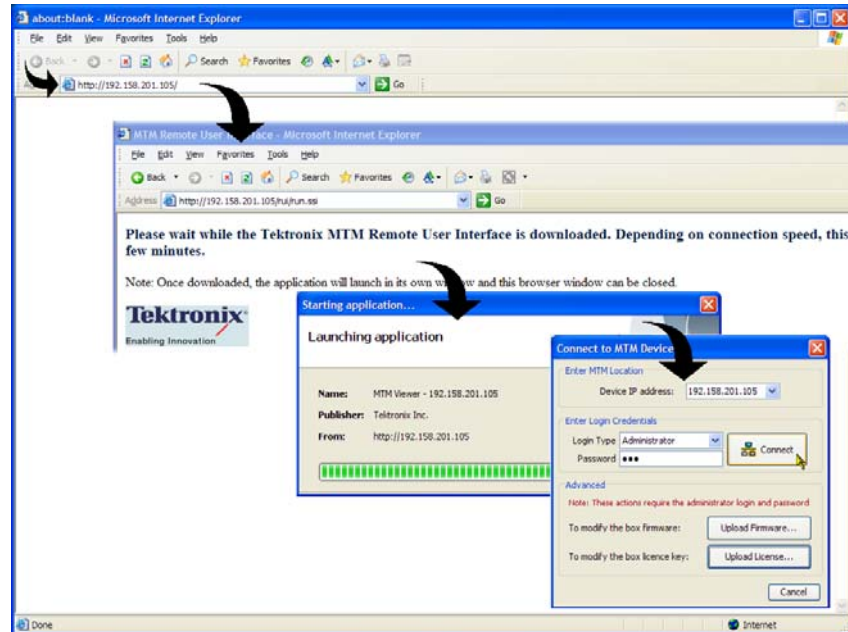
*The Java applet will not run unless the Sun Java Virtual Machine is installed. Type `java -version` at the command prompt to verify that it is installed and that the version is 1.6.0\_07 or greater. If it is not installed, you can download the latest version from the Sun Web site, [www.java.com](http://www.java.com).*

*If you have to update the Java version on the PC, you will need to restart this procedure at step 2.*

---



3. After the Java applet is downloaded, the Connect to MTM Device dialog box is displayed. (See Figure 28.)



**Figure 28: Logging on to MTM400A monitor (RUI v3.0 and above)**

4. In the Connect to MTM Device dialog box, select **Administrator** from the Login Type drop-down list, and then enter the password. The default password for Administrator login type is tek.

---

**NOTE.** You must log in to the monitor using the Administrator login type. The User login type does not have sufficient permissions to perform software option upgrades.

---

5. Click **Connect** to log on to the monitor and display the RUI window.

6. Click **Device** in the button bar of the RUI window to display the Device Information view. (See Figure 29.)
7. Verify that the Network MAC Address shown in the Device Information view matches the Unique ID number listed on the option key document that was shipped with the upgrade kit.
8. Make a note of the software options that are currently enabled on the monitor. The following illustration shows that the monitor has software options 01, 02, and 03 enabled.

**NOTE.** After you upgrade the monitor, you will verify the upgrade by checking that all of the current software options are still enabled and that the new option(s) you purchased has been enabled.

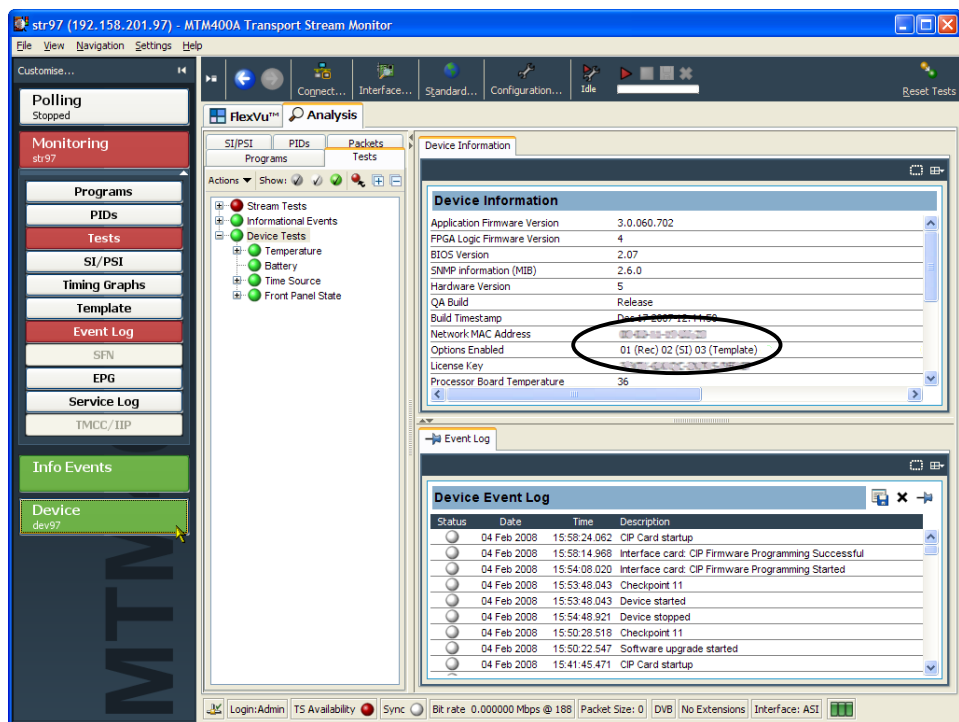


Figure 29: Device Information view (RUI v3.0 and above)

9. After you verify the MAC address and note the installed software options, close the RUI window, repeat steps 2 through 4 to redisplay the Connect to MTM Device dialog box, and then proceed to step 10.

---

**NOTE.** You should initiate the software options upgrade process from the Connect to MTM Device dialog box that appears before the monitor RUI is launched. Only advanced users should use the Connect to MTM Device dialog box that is accessed from the Connect button in the monitor RUI toolbar.

---

10. In the Connect to MTM Device dialog box, click **Upload License** to open the Upload License dialog box. (See Figure 30.)

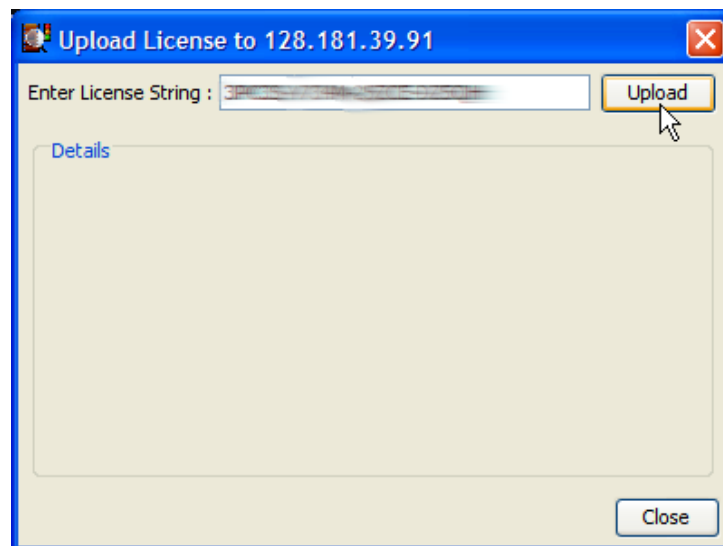


---

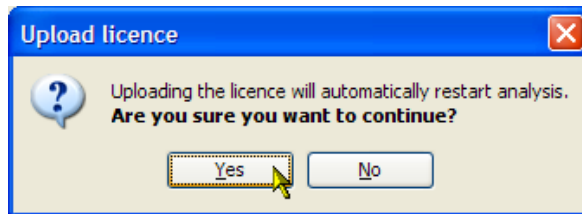
**CAUTION.** The option key string is case-sensitive and must be entered exactly as it appears on the option key document, including any dashes.

---

11. In the Upload License dialog box, enter the new option key that was supplied with this kit, and then click **Upload**.
12. Click **Yes** to confirm the upload in the Upload License message box. (See Figure 31.)



**Figure 30: Upload license dialog box (RUI v3.0 and above)**



**Figure 31: Upload license message box (RUI v3.0 and above)**

13. Progress messages will be displayed in the Upload License dialog box as the new option key is loaded into the monitor:
  - If the option key is accepted, the message “License upload ok” appears, and then the monitor automatically reboots. The reboot process implements the software options enabled by the new option key. The message “Reboot complete” appears after the monitor reboots.
  - If the option key is rejected, the message “License upload error – invalid license” appears in the Upload License dialog box. Refer to *Troubleshooting* on page 53 for more information.
14. If the option key was accepted, click **Close** to close the Upload License dialog box, and then proceed to *Verifying the Software Option Upgrade* on page 54.

## Troubleshooting

If the option key upload is rejected, the message “License upload error – invalid license” appears in the Upload License dialog box. Use the following steps to correct the problem:

- Reenter the option key in the Upload License dialog box. The option key string is case-sensitive and must be entered exactly as it appears on the option key document, including any dashes.
- Inspect the option key documentation that was supplied with the upgrade kit and verify that you are applying the option key to the MTM400 or MTM400A monitor listed in the documents.
- If you are upgrading a monitor that is connected to a network containing more than one MTM400 or MTM400A monitor, ensure that the RUI is viewing the correct monitor. Select Info in the Device view and verify that the MAC Address of the monitor matches the Unique ID number listed on the option key documentation supplied with the upgrade kit.

If the upgrade is still unsuccessful, contact Tektronix Technical Support with the following information available to you:

- Serial Number of the MTM400 or MTM400A monitor
- MAC Address of the TS processor board
- Option key string that was supplied with the upgrade kit
- Option key string that was previously assigned to the monitor (should be listed on the label attached to the top cover of the monitor)

## Verifying the Software Option Upgrade

Due to differences in the RUI versions that were shipped on the MTM400 and MTM400A monitors, separate verification instructions for the RUI versions are provided.

### Upgrade Verification (RUI v2.6.1 and below)

If RUI v2.6.1 or below is installed on your monitor, perform the following steps to verify the software option upgrade:

1. If you logged off the monitor after you performed the upgrade, perform steps 1 through 7 starting on page 43. Otherwise, in the Device view of the upgraded monitor, click **Info** to open the Information screen. (See Figure 32.)
2. Verify that all of the software options that were enabled on the monitor prior to the upgrade are still enabled.
3. Verify that the new software options you purchased with this upgrade are now enabled. Those options are listed on the option key documentation.

As an example, Figure 32 shows that options 04 and 05 have been enabled, and that options 01, 02, and 03 are still enabled as they were prior to the upgrade. (See Figure 24 on page 45.)



**CAUTION.** *When it is necessary after a repair, the Tektronix service center uses the option key listed on the monitor label to reenable the software options for your monitor. If you do not apply the new option key label supplied with the upgrade kit to the top cover of the monitor and your monitor is sent to Tektronix for repair, the monitor might be returned to you without all of your software options enabled.*

---

4. After you verify that the proper software options are enabled, apply the option-key label from the sticker that was supplied with the upgrade kit to the top cover of the monitor, covering over the previous option key listed on the monitor label.
5. Apply the option-upgrade label from the sticker that was supplied with the upgrade kit to the top cover of the monitor next to the options listed on the monitor label.

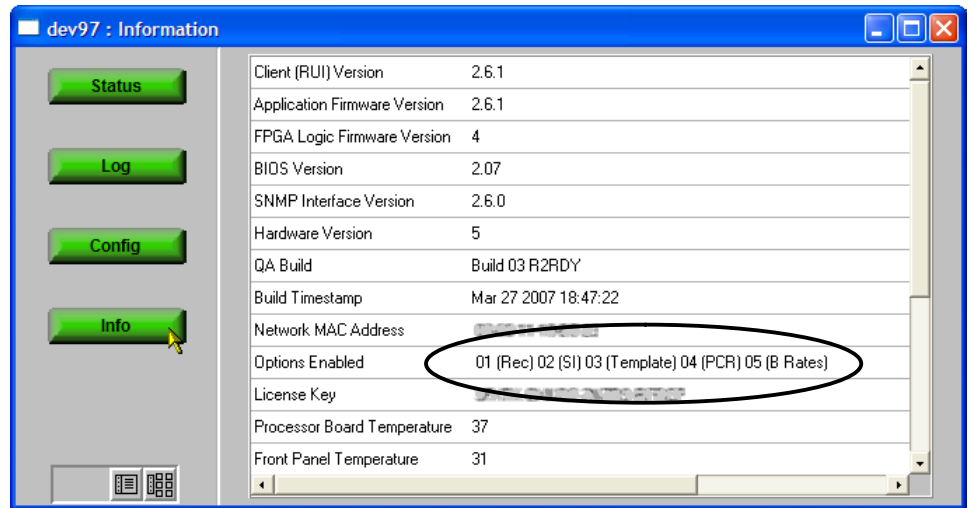


Figure 32: Device view Information screen (RUI v2.6.1 and below)

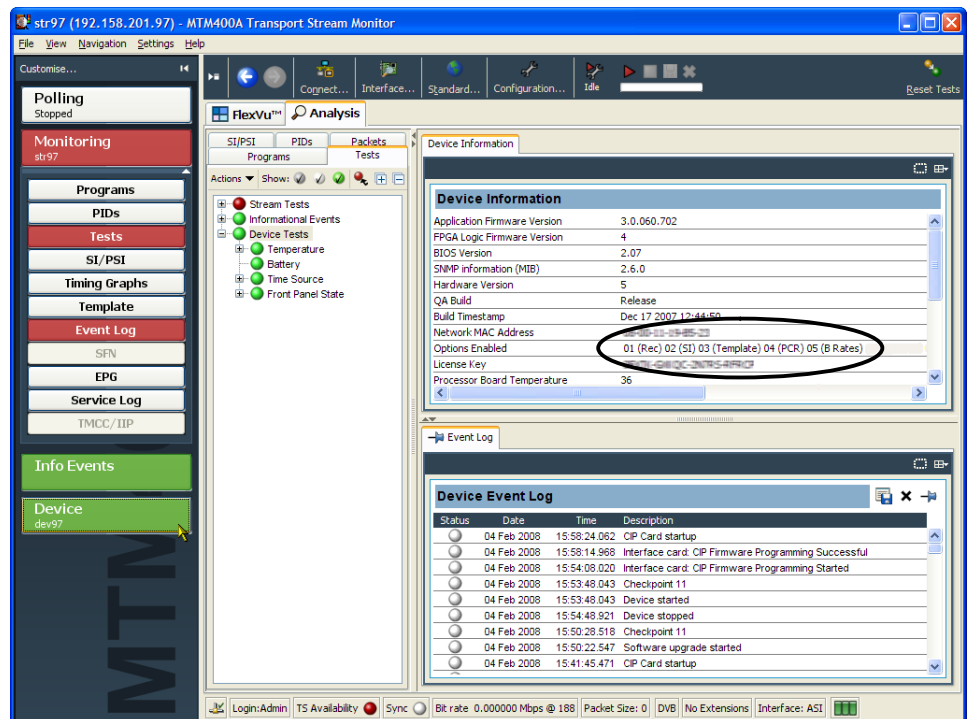


Figure 33: Device Information view (RUI v3.0 and above)

**Upgrade Verification  
(RUI v3.0 and above)**

If RUI v3.0 or above is installed on your monitor, perform the following steps to verify the software option upgrade:

1. Perform steps 1 through 6 starting on page 48 to display the Device Information view. (See Figure 33.)
2. Verify that all of the software options that were enabled on the monitor prior to the upgrade are still enabled.
3. Verify that the new software options you purchased with this upgrade are now enabled. Those options are listed on the option key documentation.

As an example, Figure 33 shows that options 04 and 05 have been enabled, and that options 01, 02, and 03 are still enabled as they were prior to the upgrade. (See Figure 29 on page 50.)



---

**CAUTION.** *Be sure to apply the option key label from the Product Upgrade sticker. When it is necessary after a repair, the Tektronix service center uses the option key listed on the monitor label to reenables the software options for your monitor. If you do not apply the new option key label supplied with the upgrade kit to the top cover of the monitor and your monitor is sent to Tektronix for repair, the monitor might be returned to you without all of your software options enabled.*

---

4. After you verify that the proper software options are enabled, apply the option-key label from the Product Upgrade sticker that was supplied with the upgrade kit to the top cover of the monitor, covering over the previous option key listed on the monitor label.
5. Apply the option-upgrade label from the Product Upgrade sticker to the top cover of the monitor next to the options listed on the monitor label.
6. If your upgrade includes the installation of a hardware option, proceed to *Hardware Option Upgrade* on page 57.
7. Otherwise, proceed to *WebMSM Software Upgrade*. (See page 81.)



# Hardware Option Upgrade

If you did not purchase a new interface card and only purchased an SFP module for your GbE interface card (MTM4UP options LX, SX, or ZX), proceed to *Install the SFP Module (GbE Interface Only)* on page 72.

The following instructions describe how to install the new interface card that was supplied with your hardware upgrade. If you need further details for disassembling or reassembling the product, contact your nearest Tektronix Service Center or Tektronix Factory Service for assistance.

There are older version interface cards that were available with the MTM400 monitor, which have been replaced with newer versions that are available with the MTM400A monitor. Those older version interface cards will continue to operate properly if they are installed in the MTM400A monitor. The following procedure includes instructions for replacing those older version interface cards. In the procedure, QAM (Annex B1) and QPSK (L-Band, old version) refer to the older version interface cards; QAM (Annex B2) and 8PSK/QPSK refer to the newer version interface cards.

Since only one signal-interface card can be installed at a time in the monitor, the installation instructions describe how to remove the currently installed signal-interface card if one exists in your monitor.

The steps involved to install or replace the interface cards are similar between the various cards; any differences are indicated in the procedure. You will perform the following activities to install the new interface card:

- If necessary, remove the existing interface card
- Install the new interface card
- If required for your interface card, install the RF cable
- If required for your GbE interface card, install the SFP optical-port module
- Configure the monitor for the new interface card (this will verify the hardware upgrade)
- Configure the new interface card

## Preparation

Before you install the new interface card supplied with the upgrade kit, perform the following preparatory steps:

1. Upgrade the monitor firmware. See *Application Firmware Upgrade* on page 11.



**CAUTION.** For MTM400 monitors only, to prevent installation failure of the GbE interface card, install the application firmware provided in the upgrade kit before you install the GbE interface card.

---

2. If necessary, disconnect any signal and power cables from the monitor, remove the monitor from the instrument rack, and then place the monitor on a static-free workbench.



**WARNING.** To prevent serious injury or loss of life from electrical shock, do not operate the monitor with the top cover or panels removed. Disconnect power from the monitor before removing the top cover or panels.

---



**CAUTION.** Only qualified personnel should perform the following procedure. Read the Service Safety Summary and the General Safety Summary at the front of this manual before performing this procedure.

*To prevent static discharge damage, service the product only in a static-free environment. Observe standard handling precautions for static-sensitive devices while installing this kit. Always wear a grounded wrist strap, grounded foot strap, and static resistant apparel while installing this kit.*

*Do not use unnecessary force to disconnect or insert connectors.*

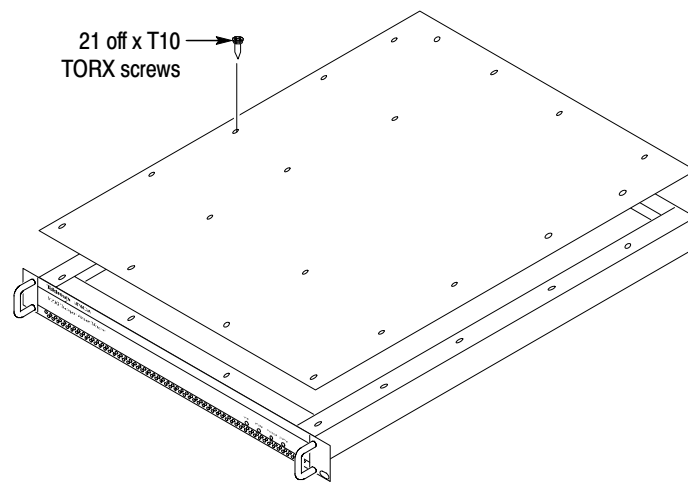
---

## Install the New Interface Card

After you complete the preparation procedure described on page 58, perform the following steps to install the interface card that was supplied with your upgrade kit:

### Remove the Monitor Cover

1. Remove the 21 cover retaining screws and set them aside. (See Figure 34.)
2. Lift the cover clear of the monitor.



**Figure 34: Removing the monitor cover**

### Remove the Installed Interface Card

3. Locate the interface card in your monitor. (See Figure 35 and Figure 36 on page 61.) The interface card is mounted on the right side of the monitor as viewed from the rear.
4. If your monitor does not have an interface card already installed, proceed to step 11 on page 66.
5. If your monitor has an interface card already installed, use Figure 35, Figure 36, and Figure 37 to determine which type of interface card is installed.



**CAUTION.** To avoid incorrectly installing the interface card, be sure to follow the removal directions for the type of interface card that is installed in your monitor. There are three types of interface cards as shown in Figure 35, Figure 36, and Figure 37. Each card type has different cable connections.

6. If a QAM (Annex A), QAM (Annex B1), QAM (Annex C), or QPSK (L-Band, old version) interface card is currently installed, perform the following steps. Table 15 describes the cable connections to these interface cards. Otherwise, proceed to step 7.
  - a. Disconnect the two coaxial cables from the SMB connectors labeled I/P and O/P (see Figure 35). These are push-fit connectors.
  - b. If you are going to install a QAM (Annex B2), 8PSK/QPSK, 8VSB, or COFDM interface card, completely remove the two coaxial cables by removing them from the connectors labeled I/P A and O/P A on the TS Processor card.

---

**NOTE.** Leave the two coaxial cables connected to the TS Processor card if you are going to install a QAM (Annex A), QAM (Annex B1), QAM (Annex C), or QPSK (L-Band, old version) interface card.

---

- c. Disconnect the eight-wire power cable from the connector labeled J7 on the interface card.
- d. Proceed to step 9 on page 63.

**Table 15: QAM (Annex A), QAM (Annex B1), QAM (Annex C), and QPSK (L-Band, old version) card connectors**

Interface card connection	Cable type	Connects to location	Function
P1	Eight wires	J7 on Power Distribution card	Power
O/P	Miniature coaxial	I/P A on TS Processor card	Data and control (serializer)
I/P	Miniature coaxial	O/P A on TS Processor card	Data and control (serializer)

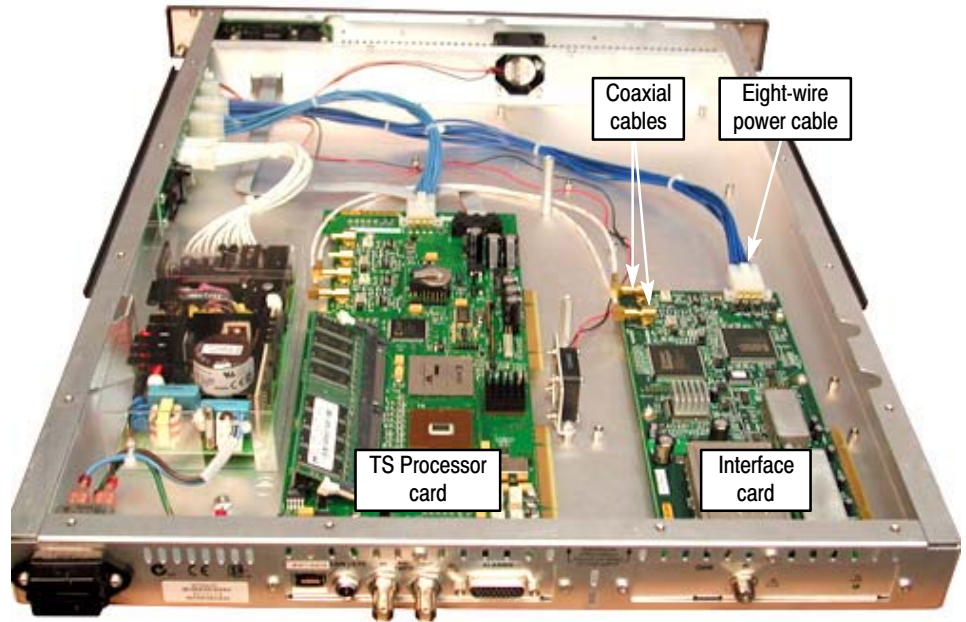


Figure 35: QAM (Annex A), QAM (Annex B1), QAM (Annex C), and QPSK (L-Band, old version) interface card location

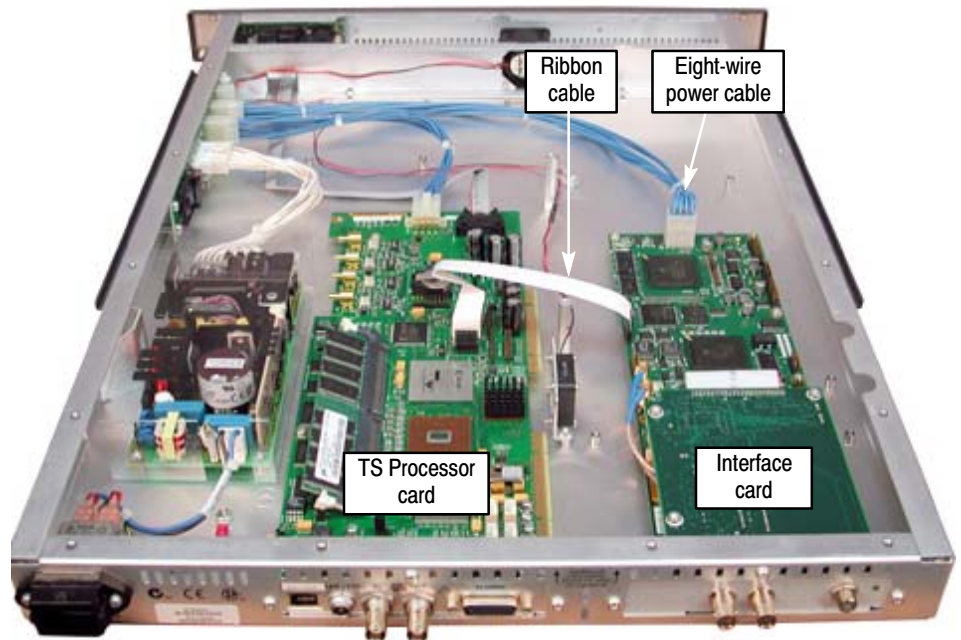
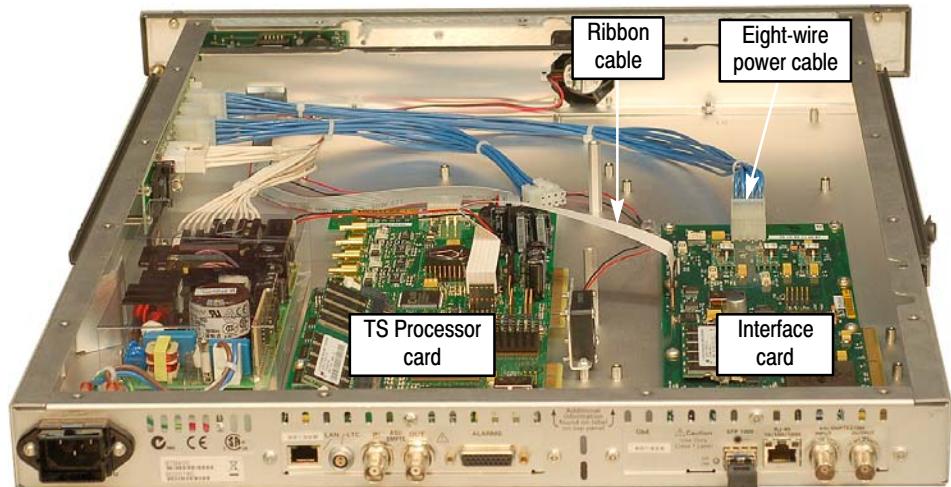


Figure 36: QAM (Annex B2), 8PSK/QPSK, 8VSB, and COFDM interface card location



**Figure 37: GbE interface card installation**

7. If a QAM (Annex B2), 8PSK/QPSK, 8VSB, or COFDM interface card is currently installed, perform the following steps. Table 16 describes the cable connections to these interface cards.
  - a. Disconnect the ribbon cable from the connector labeled J14 on the interface card (see Figure 36).
  - b. If you are going to install a QAM (Annex A), QAM (Annex B1), QAM (Annex C), or QPSK (L-Band, old version) interface card, completely remove the ribbon cable by removing it from the connector labeled J750 on the TS Processor card.

---

**NOTE.** Leave the ribbon cable connected to the TS Processor card if your are going to install a QAM (Annex B2), 8PSK/QPSK, 8VSB, or COFDM interface card.

---

- c. Disconnect the eight-wire power cable from the connector labeled JR1 on the interface card.
  - d. Proceed to step 9 on page 63.

**Table 16: QAM (Annex B2), 8PSK/QPSK, 8VSB, and COFDM interface card connectors**

Interface card connection (see Figure 36)	Cable type	Connects to location	Function
JR1	Eight wires	J7 on Power Distribution card	Power
J14	Ribbon	J750 on TS Processor card	Data and control

8. If a GbE interface card is currently installed, perform the following steps. Table 17 describes the cable connections to this interface card.
  - a. Disconnect the ribbon cable from the connector labeled J10 on the interface card (see Figure 37).
  - b. If you are going to install a QAM (Annex A), QAM (Annex B1), QAM (Annex C), or QPSK (L-Band, old version) interface card, completely remove the ribbon cable by removing it from the connector labeled J750 on the TS Processor card.

---

**NOTE.** Leave the ribbon cable connected to the TS Processor card if you are going to install a QAM (Annex B2), 8PSK/QPSK, 8VSB, or COFDM interface card.

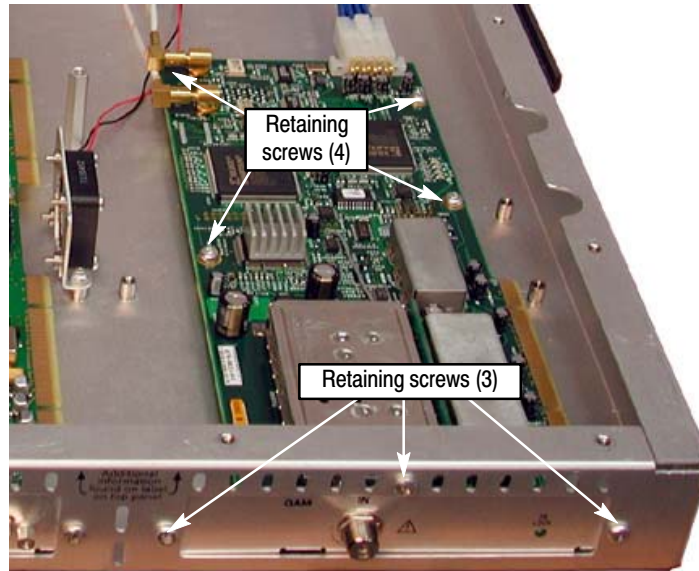
---

- c. Disconnect the eight-wire power cable from the connector labeled J8 on the interface card.

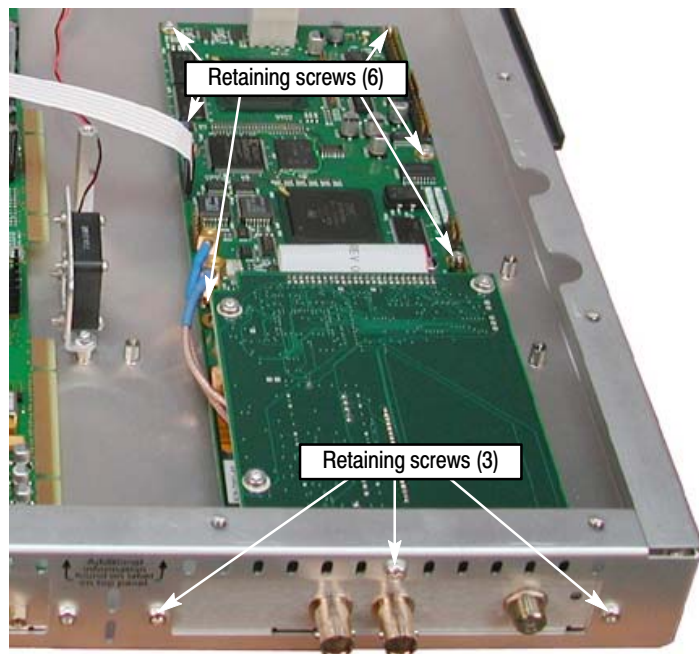
**Table 17: GbE interface card connectors**

Interface card connection	Cable type	Connects to location	Function
J8	Eight wires	J7 on Power Distribution card	Power
J10	Ribbon	J750 on TS Processor card	Control data

9. Remove the retaining screws from the interface card as described below:
  - a. For QAM (Annex A), QAM (Annex B1), QAM (Annex C), and QPSK (L-Band, old version) interface cards, remove the four retaining screws from the card and remove the three retaining screws from the rear panel as shown in Figure 38.
  - b. For QAM (Annex B2), 8PSK/QPSK, 8VSB, and COFDM interface cards, remove the six retaining screws from the card and remove the three retaining screws from the rear panel as shown in Figure 39.
  - c. For GbE interface cards, remove the six retaining screws from the card and remove the three retaining screws from the rear panel as shown in Figure 40.

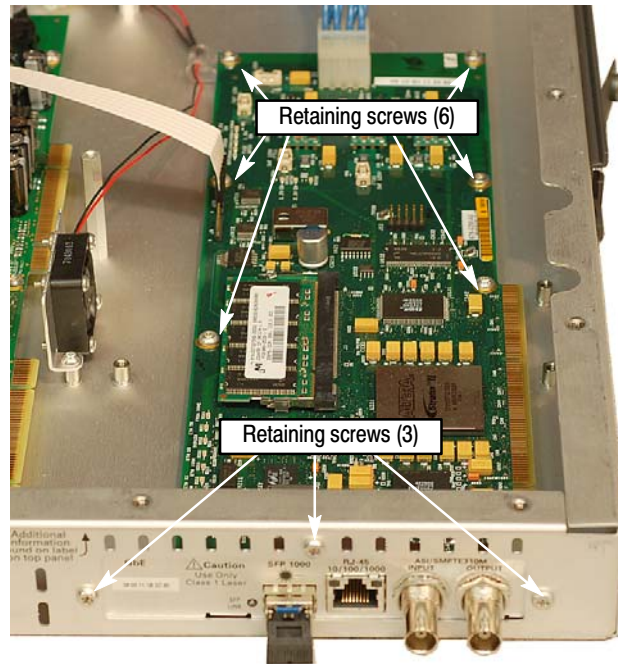


**Figure 38: Retaining screw locations for QAM (Annex A), QAM (Annex B1), QAM (Annex C), and QPSK (L-Band, old version) interface cards**



**Figure 39: Retaining screw locations for QAM (Annex B2), 8PSK/QPSK, 8VSB, and COFDM interface cards**





**Figure 40: Retaining screw locations for GbE interface card**

10. Lift the interface card clear of the monitor and place the card on a static-free surface.



**CAUTION.** To prevent static damage to the removed card, be sure to store the card in static-free packaging. Failure to properly store the card may result in the card needing repair before it will operate properly when reinstalled.

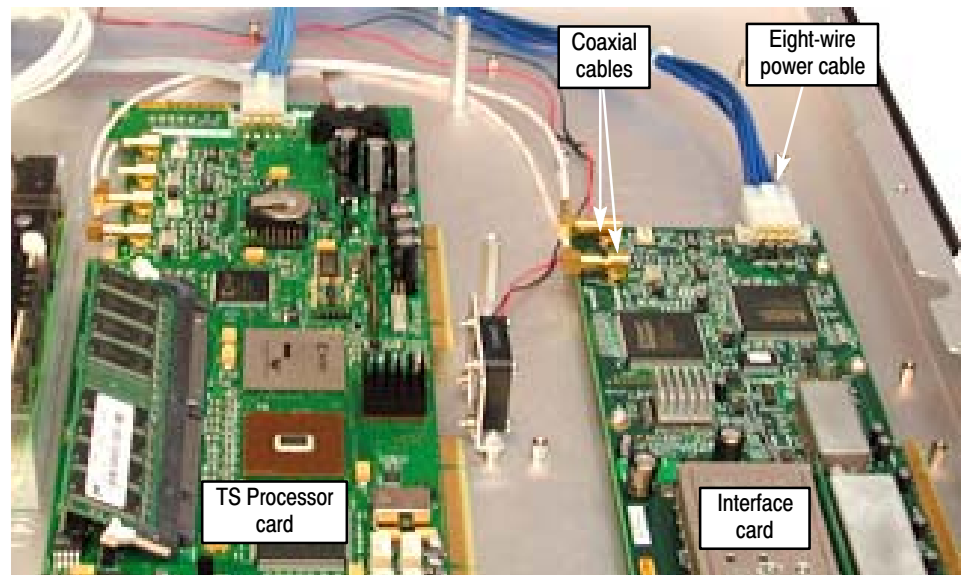
**Install the New Interface Card**

- 11.** If an interface card was not previously installed in the monitor, a blank cover is installed on the right side of the rear panel (as viewed from the rear of the monitor). If your monitor has a blank cover, remove the three retaining screws and remove the blank cover.
- 12.** Place the new interface card into the right side of the monitor (as viewed from the rear of the monitor). See Figure 35, Figure 36, and Figure 37 on page 61 and page 62.
- 13.** Line up the mounting points and install the retaining screws as described below:
  - a.** For QAM (Annex A), QAM (Annex B1), QAM (Annex C), and QPSK (L-Band, old version) interface cards, install the four retaining screws in the card and install the three retaining screws in the rear panel as shown in Figure 38.
  - b.** For QAM (Annex B2), 8PSK/QPSK, 8VSB, and COFDM interface cards, install the six retaining screws in the card and install the three retaining screws in the rear panel as shown in Figure 39.
  - c.** For GbE interface cards, install the six retaining screws in the card and install the three retaining screws in the rear panel as shown in Figure 40.

**14.** Connect the signal and power cables as follows:

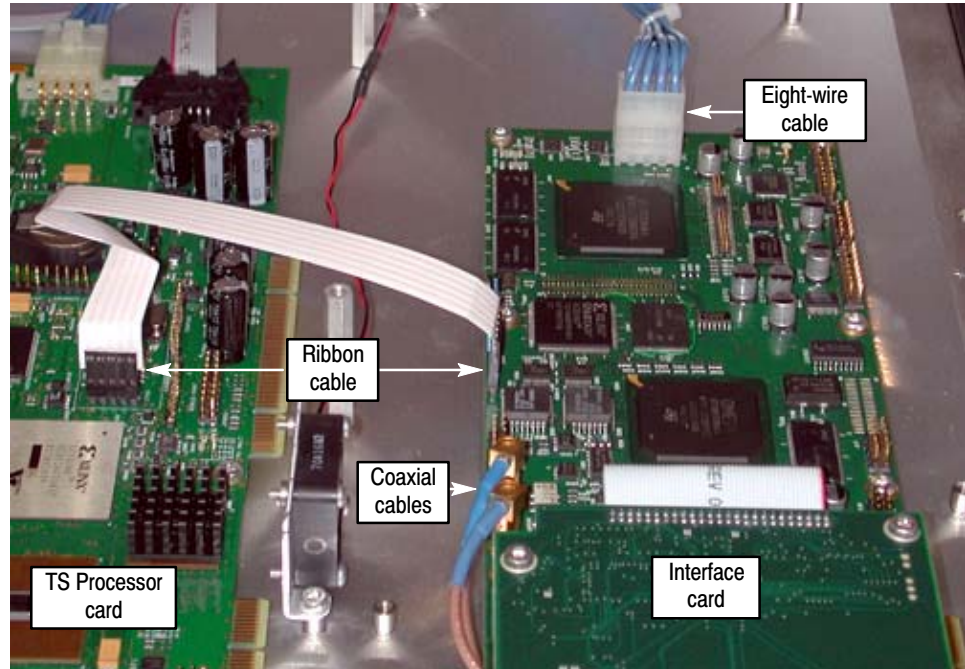
**CAUTION.** To prevent damage to the interface card connectors, do not use unnecessary force to connect the cables. All of the connectors are polarized and they will only fit into their respective socket in one way.

- a. For QAM (Annex A), QAM (Annex B1), QAM (Annex C), and QPSK (L-Band, old version) interface cards, make the following cable connections. Refer to Table 15 on page 60 for a description of the cable connections for these interface cards.
  - Connect one coaxial cable from the connector labeled O/P on the interface card to the connector labeled I/P A on the TS Processor card. This is a push-fit connector. See Figure 41 for cable locations.
  - Connect the other coaxial cable from the connector labeled I/P on the interface card to the connector labeled O/P A on the TS Processor card.
  - Connect the eight-wire power cable from P1 on the interface card to J7 on the Power Distribution card.



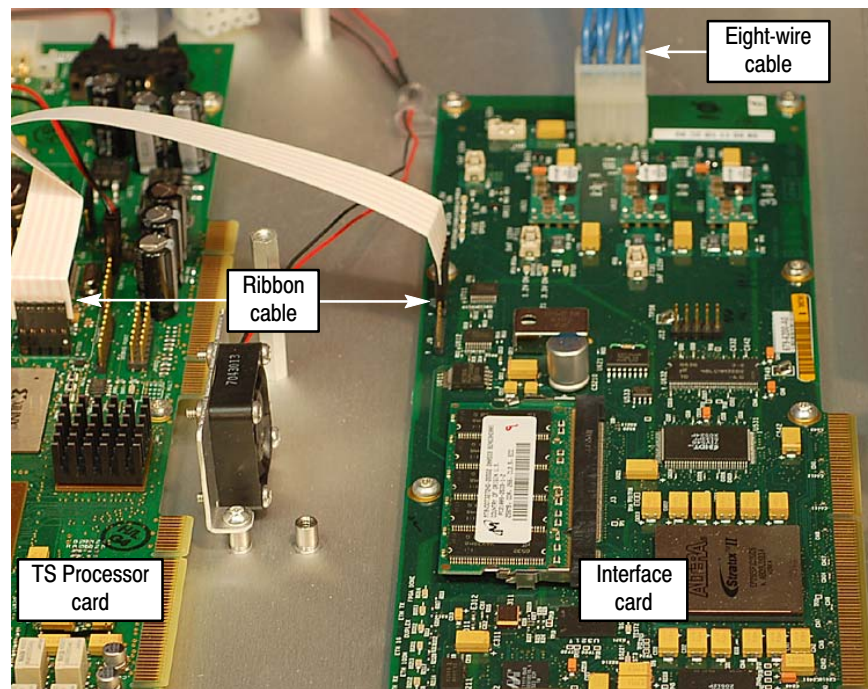
**Figure 41: Cable connections for QAM (Annex A), QAM (Annex B1), QAM (Annex C), and QPSK (L-Band, old version) interface cards**

- b. For QAM (Annex B2), 8PSK/QPSK, 8VSB, and COFDM interface cards, make the following cable connections. Refer to Table 16 on page 62 for a description of the cable connections for these interface cards.
  - Connect the ribbon cable from the connector labeled J14 on the interface card to the connector labeled J750 on the TS Processor card. See Figure 42 for cable locations.
  - Connect the eight-wire power cable from JR1 on the interface card to J7 on the Power Distribution card.
  - Verify that the two coaxial cables on the interface card are firmly attached to their connectors.



**Figure 42: Cable connections for QAM (Annex B2), 8PSK/QPSK, 8VSB, and COFDM interface cards**

- c. For GbE interface cards, make the following cable connections. Refer to Table 17 on page 63 for a description of the cable connections for these interface cards.
- Connect the ribbon cable from the connector labeled J10 on the interface card to the connector labeled J750 on the TS Processor card. See Figure 43 for cable locations.
  - Connect the eight-wire power cable from J8 on the interface card to J7 on the Power Distribution card.



**Figure 43: Cable connections for GbE interface card**

### **Reinstall the Monitor Cover**

15. Line up the monitor top cover and replace the 21 retaining screws (see Figure 34 on page 59).

### Connect the ASI Cable

The GbE interface card is shipped with an ASI cable that enables you to monitor ASI and IP signals. The QAM (Annex B2), 8PSK/QPSK, 8VSB, and COFDM interface cards are shipped with an ASI cable that enables you to monitor ASI and RF signals (for example, both the input and output of a modulator).

---

**NOTE.** The QAM (Annex A) and QAM (Annex C) interface cards do not need an external cable connection since these interface cards are connected to the Transport Stream Processor card inside the monitor.

---

16. For QAM (Annex A) and QAM (Annex C) interface cards only, proceed to *Verify the Hardware Upgrade.* (See page 73.)

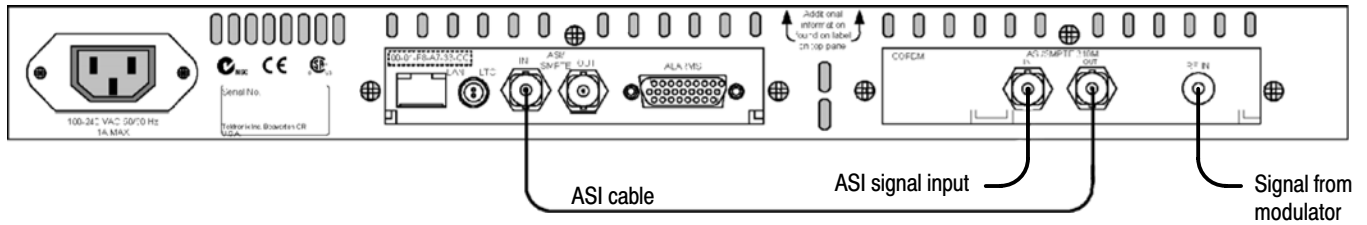
17. For GbE interface cards only:

- a. Connect the ASI cable supplied with this kit between the ASI/SMPTE310M Out connector on the interface card and the ASI In connector on the TS Processor card (see Figure 44).
- b. If you purchased an SFP module for the GbE interface card (MTM4UP options LX, SX or ZX), proceed to *Install the SFP Module (GbE Interface Only).* (See page 72.)
- c. If you did not purchase an SFP module, proceed to *Verify the Hardware Upgrade.* (See page 73.)



**Figure 44: Connecting the ASI cable - GbE interface**

18. For QAM (Annex B2), 8PSK, 8VSB, and COFDM interface cards only:
  - a. Connect the ASI cable supplied with this kit between the ASI/SMPTE310M Out connector on the interface card and the ASI In connector on the TS Processor card. (See Figure 45.)
  - b. Proceed to *Verify the Hardware Upgrade*. (See page 73.)



**Figure 45: Connecting the ASI cable - QAM (Annex B2), 8PSK, 8VSB, and COFDM interfaces**

## Install the SFP Module (GbE interface Only)

If you purchased an SFP module for your GbE interface card (MTM4UP options LX, SX, or ZX), perform the following steps to install the SFP module. Figure 46 shows an SFP module with the optical port plug.



---

**WARNING.** To prevent possible exposure to hazardous laser radiation, use only Class 1 lasers as defined in the USA Federal Regulations CDRH 21 CFR 1040 and IEC/EN 60825/A2:2001.

---



**Figure 46: SFP module and optical port plug**



---

**CAUTION.** To prevent damage to the SFP module, remove power from the monitor before removing or inserting the SFP module.

---

1. If necessary, remove power from the monitor.
2. Insert the SFP module into the rear-panel SFP 1000 connector as shown in Figure 47. When fully inserted, the SFP module is latched in position.

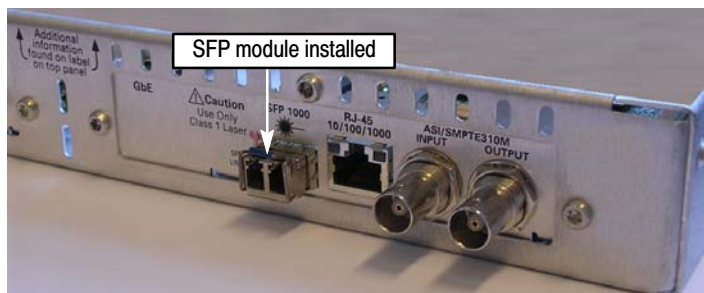


---

**WARNING.** To prevent possible exposure to hazardous laser radiation, be sure to install the optical port plug in the SFP module when no signal cable is connected to the SFP module.

---

3. Proceed to *Verify the Hardware Upgrade* on page 73.



**Figure 47: SFP module - installed**



## Verify the Hardware Upgrade

This section provides two procedures to verify the hardware upgrade:

- If you installed an interface card, perform the steps described in *Signal Interface Card Upgrades*.
- If you installed an SFP module in your GbE interface card, perform the steps described in *Verifying SFP Module Upgrades (GbE Interface Only)*. (See page 76.)

### Verifying Interface Card Upgrades

To verify that the new interface card you installed is functioning correctly, perform the following procedure:

---

**NOTE.** *This procedure assumes that you upgraded the monitor firmware to version 3.0 or above before installing the new interface card.*

---

1. Power on the monitor and log in as described in *Firmware Upgrade (RUI v3.0 and Above)* steps 1 through 5. (See page 31.)

When the monitor is first powered on after an interface card is installed, the firmware on the interface card will be checked, and if required, reprogramming of the monitor will start. The reprogramming process can take up to 15 minutes.




---

**CAUTION.** *Do not remove power from the monitor during the reprogramming process. If power is removed during reprogramming, the monitor might be rendered unable to reboot, which will require that the monitor be returned to Tektronix for repair.*

---

2. Connect a known good, transport stream input to the interface card in your monitor that is suitable for the type of interface card that you installed.

3. Click the **Interface** button in the toolbar to open the Interface dialog box. (See Figure 48.)
4. Select the desired interface from the Interface drop-down list. Figure 48 shows the 8VSB interface being selected.

**NOTE.** If the required interface type is not available in the drop-down list, one of the following events has occurred:

- *Insufficient time was allowed for the interface card to be detected and programmed. The reprogramming process must complete before the new interface card will be recognized.*
- *The start-up routine failed to detect the new interface card after 15 minutes. Remedy: Power down the monitor and reapply power.*
- *The interface card was not installed correctly in the monitor. Remedy: After powering down and disconnecting any cables, remove the top cover and verify the presence of the board and its connections. Replace the top cover, reconnect any cables to the monitor, and apply power.*

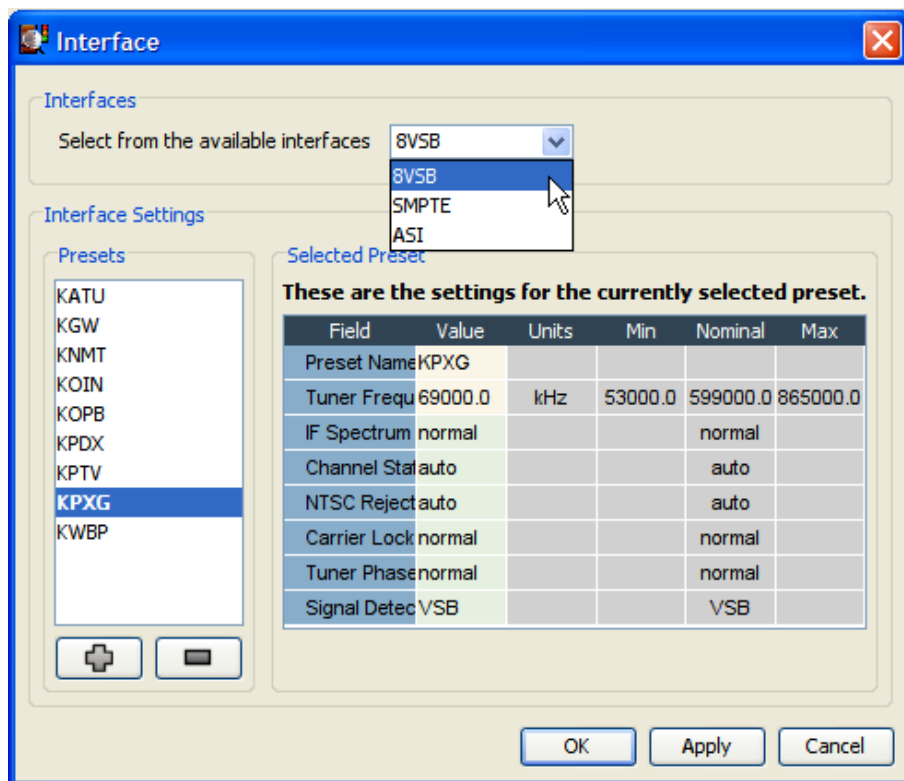


Figure 48: Interface dialog box (RUI v3.0 and above)

5. After you select the desired interface card type, you can configure the interface card for your specific monitoring application using the Interface Settings portion of the Interface dialog box. Make any changes in the Value column, and then click **OK** or **Apply**.

---

**NOTE.** Refer to the MTM400A MPEG Transport Stream Monitor Technical Reference for detailed information about the configuration settings for the type of interface card installed in your instrument.

Refer to the MTM400A MPEG Transport Stream Monitor Specifications and Performance Verification Technical Reference for information about the specifications for the type of interface card installed in your instrument.

---

6. When you successfully select the interface type that you installed from the Interface drop-down list, you have verified the installation of the new interface card. Apply the Option Upgrade label from the Product Upgrade sticker that was supplied with the upgrade kit to the top cover of the monitor next to the options listed on the monitor label.

---

**NOTE.** The following note applies only if you purchased a hardware option upgrade and did not purchase a software option upgrade with this kit.

The Product Upgrade sticker includes two labels: Option Key and Option Upgrade. For all hardware option upgrades except MTM4UP QC (QAM Annex C interface card), the option key listed on the Option Key label will match the last option key that was assigned to the monitor.

---

7. If you installed a GbE interface card and also purchased an SFP module (MTM4UP option LX, SX, or ZX), proceed to *Verifying SFP Module Upgrades (GbE Interface Only)*. (See page 76.)
8. Otherwise, proceed to *WebMSM Software Upgrade*. (See page 81.)

### Verifying SFP Module Upgrades (GbE Interface Only)

To verify that the new SFP module you installed in the GbE interface card is functioning correctly, perform the following procedure:

1. If necessary, connect an IP over optical signal to the GbE interface card:
  - a. Remove the optical port plug from the SFP module. (See Figure 46 on page 72.)
  - b. Insert the optical cable into the SFP module. When fully inserted, the cable connector is latched in position. (See Figure 49.)



**Figure 49: Optical cable connected to SFP module**

2. If necessary, power on the monitor and log in to open the RUI window as described in *Firmware Upgrade (RUI v3.0 and Above)* steps 1 through 5. (See page 31.)
3. After you open the RUI window, click the **Interface** toolbar icon to open the Interface dialog box.

4. In the Interface dialog box, select **GbE** from the Interfaces drop-down list, and then select **Auto 1000(Optical)** from the Select Speed drop-down list. (See Figure 50.)
5. Close the Interface dialog box.

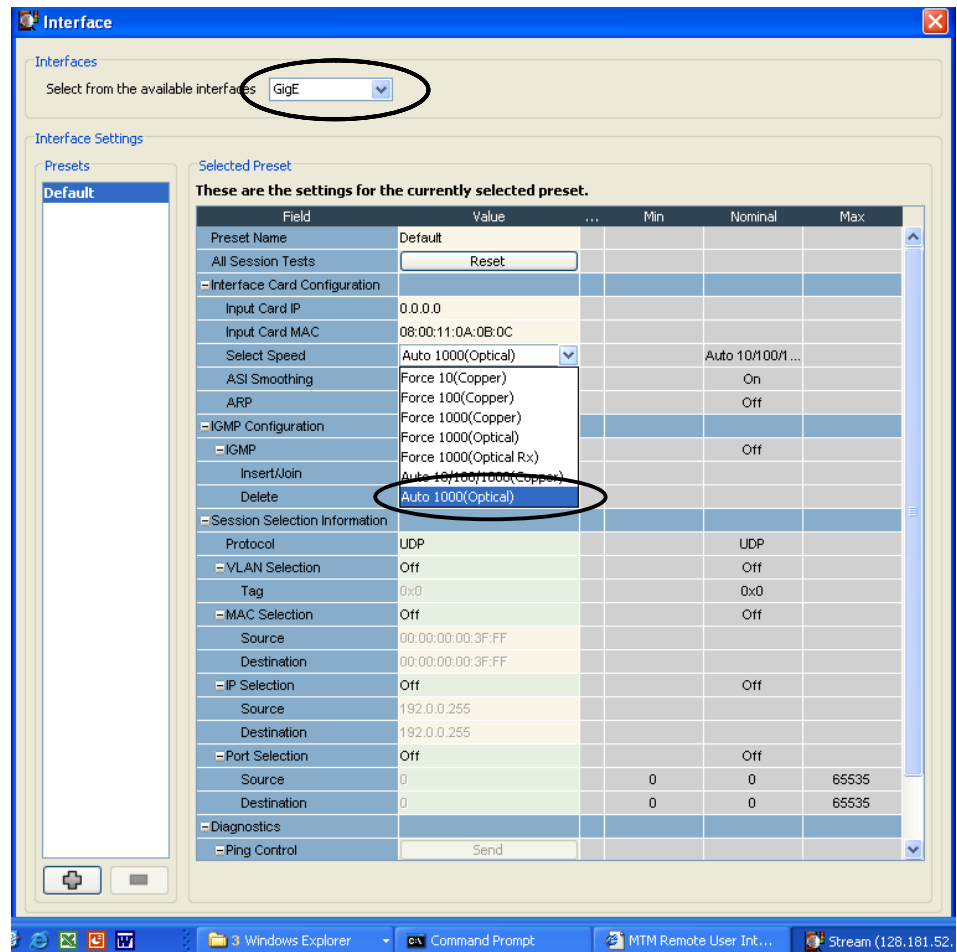


Figure 50: Selecting the interface card speed in the Interface dialog box

6. In the RUI window, click the **Analysis** tab, and then click the **Interface** tab.
7. Click **Add Graph** on the Graphs tab, and then select **Traffic** from the Available Graphs drop-down list. (See Figure 51.)

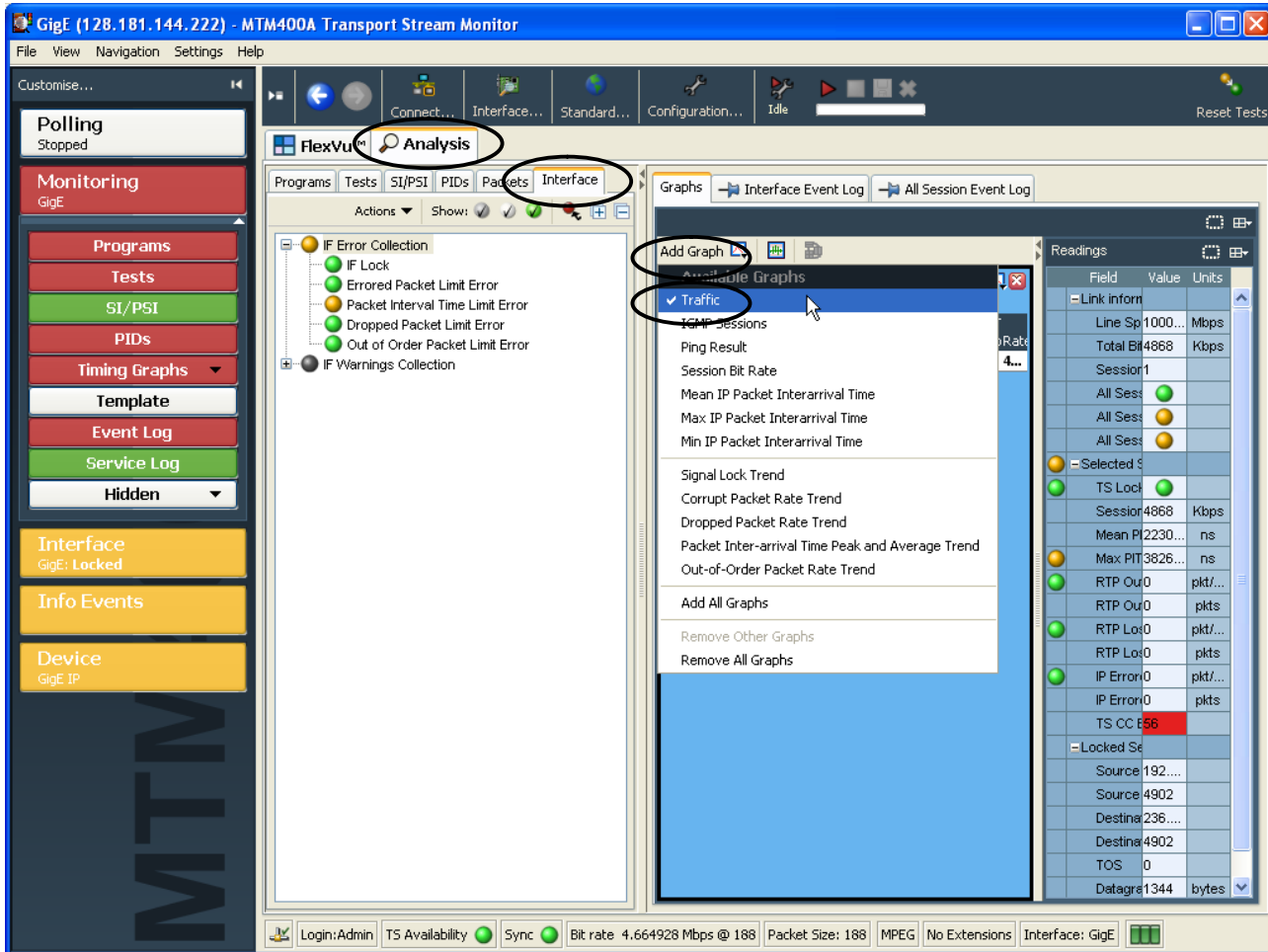


Figure 51: Selecting the Traffic graph

8. Verify that the monitor displays information about the program(s) contained on the transport stream signal in the Traffic graph. (See Figure 52.) The example transport stream in the illustration below contains one program.

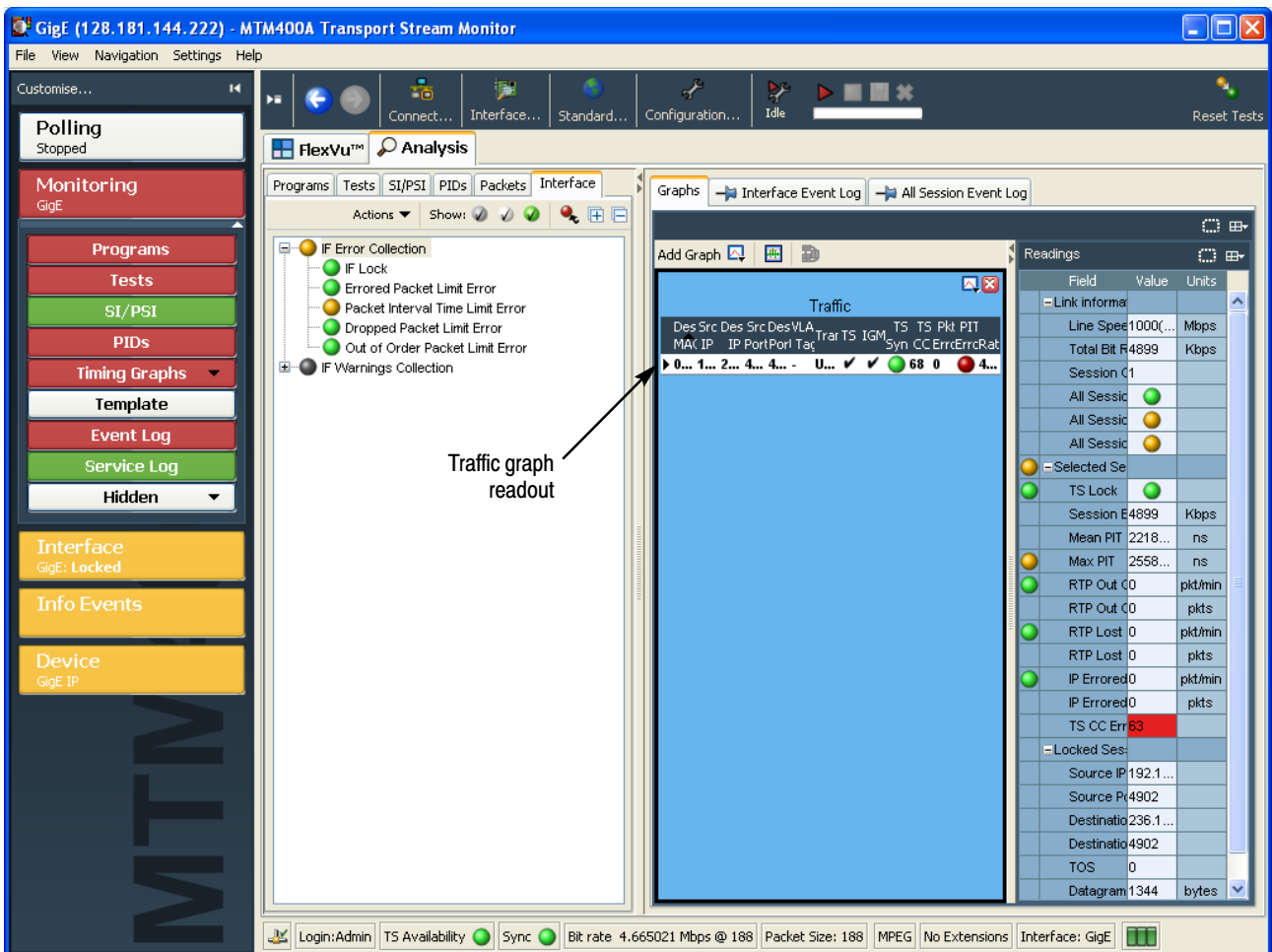


Figure 52: Viewing the Traffic graph

9. If the monitor displays information about the IP over optical signal in the Traffic graph, then the SFP module is installed and operating properly. Apply the Option Upgrade label from the Product Upgrade sticker that was supplied with the upgrade kit to the top cover of the monitor next to the options listed on the monitor label.
10. Proceed to *WebMSM Software Upgrade*. (See page 81.)





# WebMSM Software Upgrade

---

**NOTE.** A fully licensed version of the WebMSM Monitoring System Manager is available to users of MTM400 or MTM400A monitors with RUI v3.0 or above installed. The WebMSM software enables you to monitor transport streams on multiple MTM400 and MTM400A monitors from a single PC.

The WebMSM software package for RUI v3.0 and above is available on the Tektronix Web site ([www.tektronix.com/software](http://www.tektronix.com/software)) and on the application firmware CD-ROM that was supplied with this upgrade kit.

---

If you use the WebMSM software, and you upgrade the firmware on your monitor, you must reinstall WebMSM and the WebMSM Configuration Editor as part of the upgrade. All configuration files and enabled options will be retained.

## Upgrading the WebMSM Software

Perform the following steps to upgrade the WebMSM software:

### Download the WebMSM Software

1. On the PC that you use to connect to MTM400 or MTM400A monitors, download the latest WebMSM software package for RUI v3.0 or above from the Tektronix Web site: [www.tektronix.com/software](http://www.tektronix.com/software).

There are two software files to download: WebMSM Application and WebMSM Configuration Editor. You can also copy the files from the application firmware CD-ROM that was shipped with this upgrade kit.

2. If you have a version of WebMSM already installed on your PC, proceed to step 3. Otherwise, proceed to step 7.

### Uninstall the WebMSM Software

3. Run Setup for the WebMSM application.
4. Follow the on-screen instructions and remove the WebMSM application.
5. Run Setup for the WebMSM Configuration Editor application.
6. Follow the on-screen instructions and remove the WebMSM Configuration Editor application.

### **Install the WebMSM Software**

7. Run Setup for the WebMSM application.
8. Follow the on-screen instructions and install the WebMSM application using the upgrade files that you downloaded to your PC.
9. Run Setup for the WebMSM Configuration Editor application.
10. Follow the on-screen instructions and install the WebMSM Configuration Editor using the upgrade files that you downloaded to your PC.

## **Technical Support**

If you require further information regarding either WebMSM or the WebMSM Configuration Editor, refer to the *Web Monitoring System Manager User Manual* (Tektronix part number 077-0116-xx).

If the upgrade is unsuccessful, contact Tektronix Technical Support. Ensure that the serial number for your MTM400 or MTM400A monitor is available.

■ End of document ■