

Printable Help Document



TDSET3 Ethernet Compliance Test Software 077-0016-06

Adapted from the Online Help

Copyright © Tektronix. All rights reserved. Licensed software products are owned by Tektronix or its subsidiaries or suppliers, and are protected by national copyright laws and international treaty provisions.

Tektronix products are covered by U.S. and foreign patents, issued and pending. Information in this publication supercedes that in all previously published material. Specifications and price change privileges reserved.

TEKTRONIX and TEK are registered trademarks of Tektronix, Inc.

Contacting Tektronix

Tektronix, Inc.
14150 SW Karl Braun Drive
P.O. Box 500
Beaverton, OR 97077
USA

For product information, sales, service, and technical support:

- In North America, call 1-800-833-9200.
- Worldwide, visit www.tektronix.com to find contacts in your area.



Table of Contents

| | |
|---|------------|
| About TDSET3 | 1-1 |
| Using Online Help | 1-2 |
| Printing from the Online Help | 1-3 |
| Conventions | 1-3 |
| Feedback..... | 1-4 |
| Information through the Web site | 1-5 |
| Getting Started..... | 2-1 |
| Compatibility | 2-1 |
| Recommended Accessories | 2-1 |
| Requirements and Restrictions | 2-4 |
| About the Test Fixture..... | 2-6 |
| Starting the Application | 2-6 |
| Minimizing and Maximizing the Application | 2-7 |
| Returning to the Application..... | 2-9 |
| Exiting the Application | 2-9 |
| Application Directories and File Names | 2-10 |
| Application Software Default Layouts and Templates..... | 2-10 |
| Application Software Default Settings..... | 2-14 |
| Operating Basics | 3-1 |
| TDSET3 Application Window..... | 3-1 |
| TDSET3 Application Interface Controls..... | 3-1 |
| Menu bar | 3-2 |
| File Menu..... | 3-3 |
| Tests Menu | 3-3 |

| | |
|--|-------------|
| Results Menu | 3-4 |
| Utilities Menu | 3-4 |
| Help Menu | 3-5 |
| Selection pane | 3-5 |
| Speed pane | 3-6 |
| Client pane | 3-7 |
| 1000BASE-T Client pane | 3-7 |
| 100BASE-TX Client pane | 3-7 |
| 10BASE-T/ 10BASE-Te Client pane | 3-8 |
| Execution pane | 3-8 |
| Status bar | 3-9 |
| Result pane | 3-10 |
| Result Summary pane | 3-11 |
| Report Configuration pane | 3-12 |
| Dialog Boxes | 3-12 |
| Preferences dialog box | 3-12 |
| Advanced Report Configuration dialog box | 3-17 |
| Result Details dialog box | 3-18 |
| Locate Hits dialog box | 3-19 |
| Flash Hits dialog box | 3-20 |
| Show Segments dialog box | 3-21 |
| Manual Fit dialog box | 3-21 |
| Jig match dialog box | 3-23 |
| Virtual Keyboard dialog box | 3-28 |
| Virtual Keypad dialog box | 3-29 |
| Mask Setup dialog box | 3-30 |
| Smooth dialog box | 3-31 |

| | |
|---|-------------|
| Exit dialog box..... | 3-32 |
| How To Select Test Parameters | 4-1 |
| Selecting 1000BASE-T Test Parameters | 4-1 |
| Selecting 100BASE-TX Test Parameters | 4-2 |
| Selecting 10BASE-T/10BASE-Te Test Parameters | 4-3 |
| How To Configure Parameters | 5-1 |
| Configuring 1000BASE-T | 5-1 |
| Configuring 100BASE-TX..... | 5-6 |
| Configuring 10BASE-T/10BASE-Te..... | 5-9 |
| Making Connections | 6-1 |
| 1000BASE-T Connections..... | 6-1 |
| 1000BASE-T Template, Peak Volt, Droop, and Distortion | 6-1 |
| 1000BASE-T Jitter Master Filtered..... | 6-5 |
| 1000BASE-T Jitter Master Unfiltered..... | 6-9 |
| 1000BASE-T Jitter Slave Filtered | 6-12 |
| 1000BASE-T Jitter Slave Unfiltered | 6-17 |
| 1000BASE-T Return Loss..... | 6-21 |
| 1000BASE-T CM Voltage | 6-23 |
| 100BASE-TX Connections | 6-25 |
| 100BASE-TX All Tests except Return Loss..... | 6-25 |
| 100BASE-TX Return Loss..... | 6-26 |
| 10BASE-T/10BASE-Te Connections | 6-29 |
| 10BASE-T Link Pulse | 6-29 |
| 10BASE-T MAU..... | 6-31 |
| 10BASE-Te MAU | 6-32 |
| 10BASE-T /10BASE-Te TP_IDL | 6-34 |
| 10BASE-T Jitter with cable..... | 6-39 |

| | |
|--|------------|
| 10BASE-T Jitter without cable..... | 6-40 |
| 10BASE-T /10BASE-Te Differential Voltage | 6-42 |
| 10BASE-T /10BASE-Te Harmonic..... | 6-43 |
| 10BASE-T Return Loss..... | 6-44 |
| 10BASE-T CM Voltage..... | 6-46 |
| Set up the Signal..... | 7-1 |
| 1000BASE-T | 7-1 |
| 100BASE-TX..... | 7-1 |
| 10BASE-T/10BASE-Te | 7-2 |
| How To Test 1000BASE-T | 8-1 |
| 1000BASE-T Template | 8-1 |
| 1000BASE-T Peak Volt..... | 8-4 |
| 1000BASE-T Droop | 8-6 |
| 1000BASE-T Jitter Master Filtered | 8-7 |
| 1000BASE-T Jitter Master Unfiltered..... | 8-12 |
| 1000BASE-T Jitter Slave Filtered..... | 8-18 |
| 1000BASE-T Jitter Slave Unfiltered..... | 8-22 |
| 1000BASE-T Distortion..... | 8-30 |
| 1000BASE-T Return Loss..... | 8-33 |
| 1000BASE-T CM Voltage | 8-35 |
| How To Test 100BASE-TX..... | 9-1 |
| 100BASE-TX Template..... | 9-1 |
| 100BASE-TX Differential Output Voltage..... | 9-3 |
| 100BASE-TX Signal Amplitude Symmetry | 9-5 |
| 100BASE-TX Rise Time | 9-7 |
| 100BASE-TX Fall Time..... | 9-8 |
| 100BASE-TX Rise/Fall Time Symmetry..... | 9-10 |

| | |
|--|-------------|
| 100BASE-TX Waveform Overshoot..... | 9-12 |
| 100BASE-TX Jitter | 9-13 |
| 100BASE-TX Duty Cycle Distortion | 9-15 |
| 100BASE-TX Return Loss | 9-16 |
| How To Test 10BASE-T/10BASE-Te..... | 10-1 |
| 10BASE-T/10BASE-Te MAU | 10-1 |
| 10BASE-T Link Pulse..... | 10-4 |
| 10BASE-T/10BASE-Te TP_IDL..... | 10-8 |
| 10BASE-T/10BASE-Te Differential Voltage | 10-12 |
| 10BASE-T/10BASE-Te Harmonic..... | 10-13 |
| 10BASE-T Jitter with cable | 10-15 |
| 10BASE-T Jitter without cable..... | 10-18 |
| 10BASE-T Return Loss..... | 10-21 |
| 10BASE-T CM Voltage | 10-23 |
| View Waveform for 1000BASE-T | 11-1 |
| 1000BASE-T Template, Peak Volt, Droop..... | 11-1 |
| 1000BASE-T Jitter Master | 11-2 |
| 1000BASE-T Jitter Slave | 11-4 |
| 1000BASE-T Distortion..... | 11-5 |
| 1000BASE-T Return Loss..... | 11-6 |
| 1000BASE-T CM Voltage | 11-7 |
| View Waveform for 100BASE-TX..... | 12-1 |
| All 100BASE-TX Tests except Return Loss..... | 12-1 |
| 100BASE-TX Return Loss | 12-2 |
| View Waveform for 10BASE-T/10BASE-Te..... | 13-1 |
| 10BASE-T Link Pulse..... | 13-1 |
| 10BASE-T/10BASE-Te MAU | 13-2 |

| | |
|---|-------------|
| 10BASE-T/10BASE-Te TP_IDL | 13-3 |
| 10BASE-T Jitter with or without cable | 13-4 |
| 10BASE-T/10BASE-Te Differential Voltage | 13-5 |
| 10BASE-T/10BASE-Te Harmonic | 13-6 |
| 10BASE-T Return Loss | 13-7 |
| 10BASE-T CM Voltage | 13-8 |
| Generate Reports | 14-1 |
| About Report Generator | 14-2 |
| Automating AWG/AFG | 15-1 |
| Automate AWG/AFG | 15-1 |
| Connect the Equipment and Verify the Connections | 15-3 |
| Reference to Standards | 16-1 |
| 1000BASE-T | 16-1 |
| 1000BASE-T Template | 16-1 |
| 1000BASE-T Peak Voltage | 16-2 |
| 1000BASE-T Droop | 16-2 |
| 1000BASE-T Jitter (with TX_TCLK ACCESS)..... | 16-2 |
| 1000BASE-T Jitter (without TX_TCLK ACCESS)..... | 16-3 |
| 1000BASE-T Distortion | 16-5 |
| 1000BASE-T CM Voltage..... | 16-5 |
| 1000BASE-T Return Loss | 16-6 |
| 100BASE-TX | 16-6 |
| 100BASE-TX Template | 16-6 |
| 100BASE-TX Differential Output Voltage | 16-6 |
| 100BASE-TX Signal Amplitude Symmetry..... | 16-7 |
| 100BASE-TX Rise and Fall Time | 16-7 |
| 100BASE-TX Waveform Overshoot..... | 16-7 |

| | |
|--|--------------|
| 100BASE-TX Jitter | 16-8 |
| 100BASE-TX Duty Cycle Distortion..... | 16-8 |
| 100BASE-TX Return Loss..... | 16-8 |
| 10BASE-T/10BASE-Te | 16-9 |
| 10BASE-T/10BASE-Te MAU Ext | 16-9 |
| 10BASE-T/10BASE-Te MAU Int..... | 16-9 |
| 10BASE-T/10BASE-Te TP_IDL | 16-9 |
| 10BASE-T Link Pulse | 16-10 |
| 10BASE-T/10BASE-Te Differential Voltage | 16-10 |
| 10BASE-T/10BASE-Te Harmonic | 16-11 |
| 10BASE-T Jitter | 16-11 |
| 10BASE-T CM Voltage | 16-11 |
| 10BASE-T Return Loss..... | 16-12 |
| Remote GPIB | 17-1 |
| About Remote GPIB..... | 17-1 |
| Starting and Setting Up the Application Using GPIB..... | 17-1 |
| GPIB Command Syntax..... | 17-2 |
| TDSET3 Application Command Arguments and Queries | 17-2 |
| GPIB Commands for 1000BASE-T | 17-10 |
| GPIB Commands for 100BASE-TX..... | 17-13 |
| GPIB Commands for 10BASE-T/10BASE-Te..... | 17-16 |
| GPIB Commands for AWG/AFG Automation | 17-19 |
| Program Example | 17-19 |
| Guidelines to GPIB Programming | 17-31 |
| Note on Guidelines to GPIB Programming | 17-32 |
| Calibration for Return Loss | 18-1 |
| 1000BASE-T Return Loss..... | 18-1 |

| | |
|--|------------|
| 100BASE-TX Return Loss Transmitter | 18-4 |
| 100BASE-TX Return Loss Receiver | 18-7 |
| 10BASE-T Return Loss Transmitter | 18-10 |
| 10BASE-T Return Loss Receiver | 18-13 |
| Appendix A: Specification Range | A-1 |
| 1000BASE-T | A-1 |
| 100BASE-TX | A-2 |
| 10BASE-T/10BASE-Te | A-4 |
| Appendix B: Error Messages | B-1 |
| TDSET3 Error Messages | B-1 |
| Remote GPIB Error Messages | B-3 |

List of Figures

| | |
|--|------|
| Figure 1-1: TDSET3 splash screen | 1-1 |
| Figure 2-1: Run application | 2-6 |
| Figure 2-2: Application interface | 2-7 |
| Figure 3-1: Application window | 3-1 |
| Figure 3-2: File menu..... | 3-3 |
| Figure 3-3: Tests menu | 3-3 |
| Figure 3-4: Results menu | 3-4 |
| Figure 3-5: Utilities menu..... | 3-4 |
| Figure 3-6: Help menu | 3-5 |
| Figure 3-7: Selection pane | 3-5 |
| Figure 3-8: Speed pane | 3-6 |
| Figure 3-9: 1000BASE-T Client pane | 3-7 |
| Figure 3-10: 100BASE-TX Client pane..... | 3-7 |
| Figure 3-11: 10BASE-T Client pane | 3-8 |
| Figure 3-12: Execution pane | 3-8 |
| Figure 3-13: Status bar..... | 3-9 |
| Figure 3-14: Result pane for all tests | 3-10 |
| Figure 3-15: Result pane for Return Loss tests | 3-10 |
| Figure 3-16: Result Summary pane | 3-11 |
| Figure 3-17: Report Configuration pane | 3-12 |
| Figure 3-18: Preferences dialog box | 3-13 |
| Figure 3-19: Advanced Report Configuration dialog box..... | 3-17 |
| Figure 3-20: Result Details dialog box | 3-18 |
| Figure 3-21: Mask Segments dialog box | 3-19 |

List of Figures

| | |
|--|------|
| Figure 3-22: Flash Hits message box..... | 3-20 |
| Figure 3-23: Show Segments dialog box..... | 3-21 |
| Figure 3-24: 1000BASE-T Manual Fit dialog box..... | 3-22 |
| Figure 3-25: 100BASE-TX/10BASE-T Manual Fit dialog box..... | 3-22 |
| Figure 3-26: Jig Match dialog box for 1000-T Template/Peak Volt/Droop test..... | 3-23 |
| Figure 3-27: Jig Match dialog box for 1000-T Distortion test..... | 3-24 |
| Figure 3-28: Connections for Disturber compensation..... | 3-25 |
| Figure 3-29: Step 1 Connections of Test Fixture compensation..... | 3-26 |
| Figure 3-30: Step 2 Connections of Test Fixture compensation..... | 3-27 |
| Figure 3-31: Virtual keyboard..... | 3-28 |
| Figure 3-32: Virtual keypad..... | 3-29 |
| Figure 3-33: 100BASE-TX Mask Setup dialog box..... | 3-30 |
| Figure 3-34: 10BASE-T Mask Setup dialog box..... | 3-31 |
| Figure 3-35: Smooth dialog box..... | 3-31 |
| Figure 3-36: Exit dialog box..... | 3-32 |
| Figure 5-1: 1000BASE-T Configure pane..... | 5-1 |
| Figure 5-2: 100BASE-TX Configure pane..... | 5-6 |
| Figure 5-3: 10BASE-T/10BASE-Te Configure pane..... | 5-9 |
| Figure 6-1: 1000BASE-T Connections with disturbing signal for Template, Peak Volt, Droop, and Distortion..... | 6-1 |
| Figure 6-2: 1000BASE-T Connections without disturbing signal for Template, Peak Volt, Droop, and Distortion..... | 6-3 |
| Figure 6-3: 1000BASE-T Step 1 Connections for Jitter Master Filtered..... | 6-5 |
| Figure 6-4: 1000BASE-T Step 2 Connections for Jitter Master Filtered..... | 6-7 |
| Figure 6-5: 1000BASE-T Connections for Jitter Master Filtered..... | 6-8 |
| Figure 6-6: 1000BASE-T Connections for Jitter Master Unfiltered..... | 6-9 |
| Figure 6-7: 1000BASE-T Connections for Jitter Master Unfiltered..... | 6-11 |
| Figure 6-8: 1000BASE-T Step 1 Connections for Jitter Slave Filtered..... | 6-12 |
| Figure 6-9: 1000BASE-T Step 2 Connections for Jitter Slave Filtered..... | 6-14 |

| | |
|--|------|
| Figure 6-10: 1000BASE-T Connections for Jitter Slave Filtered | 6-15 |
| Figure 6-11: 1000BASE-T Connections for Jitter Slave Unfiltered | 6-17 |
| Figure 6-12: 1000BASE-T Connections for Jitter Slave Unfiltered (If you do not have access to TX_TCLK) | 6-19 |
| Figure 6-14: 1000BASE-T Return Loss setup using an Arbitrary Waveform Generator | 6-21 |
| Figure 6-15: 1000BASE-T Return Loss setup using an Arbitrary Function Generator | 6-22 |
| Figure 6-15: 1000BASE-T Connections for CM Voltage | 6-23 |
| Figure 6-16: All 100BASE-TX Connections except Return Loss | 6-25 |
| Figure 6-17: 100BASE-TX Return Loss setup using Arbitrary Waveform Generator | 6-26 |
| Figure 6-18: 100BASE-TX Return Loss setup using Arbitrary Function Generator | 6-27 |
| Figure 6-19: 10BASE-T Connections for Link Pulse without Twisted-pair model | 6-29 |
| Figure 6-20: 10BASE-T Connections for Link Pulse with Twisted-pair model | 6-30 |
| Figure 6-21: 10BASE-T Connections for MAU | 6-31 |
| Figure 6-22: 10BASE-Te Connections for MAU | 6-32 |
| Figure 6-23: 10BASE-T/10BASE-Te Connections for TP_IDL without Twisted-pair model | 6-34 |
| Figure 6-24: 10BASE-T Connections for TP_IDL with Twisted-pair model | 6-36 |
| Figure 6-25: 10BASE-Te Connections for TP_IDL with Twisted-pair model | 6-37 |
| Figure 6-26: 10BASE-T Connections for Jitter with cable | 6-39 |
| Figure 6-27: 10BASE-T Connections for Jitter without cable | 6-40 |
| Figure 6-28: 10BASE-T Connections for Differential Voltage | 6-42 |
| Figure 6-29: 10BASE-T Connections for Harmonic | 6-43 |
| Figure 6-30: 10BASE-T Return Loss setup using an Arbitrary Waveform Generator | 6-44 |
| Figure 6-31: 10BASE-T Return Loss setup using an Arbitrary Function Generator | 6-45 |
| Figure 6-32: 10BASE-T Connections for CM Voltage | 6-46 |
| Figure 8-1: Waveform for 1000BASE-T Template Points A, B, C, and D | 8-3 |
| Figure 8-2: Waveform for 1000BASE-T Template Points F and H | 8-3 |
| Figure 8-3: Waveform for 1000BASE-T Peak Volt Points A, B, C, and D | 8-5 |
| Figure 8-4: Waveform for 1000BASE-T Droop Points F and G | 8-7 |

List of Figures

| | |
|---|------|
| Figure 8-5: 1000BASE-T Jitter Master Filtered Step 1 | 8-9 |
| Figure 8-6: 1000BASE-T Jitter Master Filtered Step 2 | 8-10 |
| Figure 8-7: Waveform for 1000BASE-T Jitter Master Filtered..... | 8-10 |
| Figure 8-8: 1000BASE-T Jitter Master Filtered (without TX_TCLK)..... | 8-12 |
| Figure 8-9: TIE Waveform for 1000BASE-T Jitter Master Unfiltered | 8-14 |
| Figure 8-10: Histogram Waveform for 1000BASE-T Jitter Master Unfiltered..... | 8-15 |
| Figure 8-11: TIE Waveform for 1000BASE-T Jitter Master Unfiltered | 8-17 |
| Figure 8-12: Histogram Waveform for 1000BASE-T Jitter Master Unfiltered..... | 8-17 |
| Figure 8-13: 1000BASE-T Jitter Slave Filtered Step 1 | 8-19 |
| Figure 8-14: 1000BASE-T Jitter Slave Filtered Step 2 | 8-20 |
| Figure 8-15: Waveform for 1000BASE-T Jitter Slave Filtered..... | 8-20 |
| Figure 8-16: Waveform for 1000BASE-T Jitter Slave Filtered..... | 8-22 |
| Figure 8-17: TIE Waveform for 1000BASE-T Jitter Slave Unfiltered..... | 8-25 |
| Figure 8-18: Histogram Waveform for 1000BASE-T Jitter Slave Unfiltered | 8-25 |
| Figure 8-19: TIE Waveform for 1000BASE-T Jitter Slave Unfiltered..... | 8-29 |
| Figure 8-20: Histogram Waveform for 1000BASE-T Jitter Slave Unfiltered | 8-29 |
| Figure 8-21: 1000BASE-T Distortion user control | 8-31 |
| Figure 8-22: Waveform for 1000BASE-T Distortion..... | 8-32 |
| Figure 8-23: Waveform for 1000BASE-T Return Loss..... | 8-34 |
| Figure 8-24: Waveform for 1000BASE-T CM Voltage | 8-36 |
| Figure 9-1: Waveform for 100BASE-TX Template for positive polarity | 9-2 |
| Figure 9-2: Waveform for 100BASE-TX Template for negative polarity..... | 9-2 |
| Figure 9-3: Waveform for 100BASE-TX Differential Output Voltage for positive polarity | 9-4 |
| Figure 9-4: Waveform for 100BASE-TX Differential Output Voltage for negative polarity | 9-4 |
| Figure 9-5: Waveform for 100BASE-TX Amplitude Symmetry for positive polarity | 9-6 |
| Figure 9-6: Waveform for 100BASE-TX Amplitude Symmetry for negative polarity | 9-6 |
| Figure 9-7: Waveform for 100BASE-TX Rise Time for positive polarity | 9-8 |

| | |
|--|-------|
| Figure 9-8: Waveform for 100BASE-TX Rise Time for negative polarity | 9-8 |
| Figure 9-9: Waveform for 100BASE-TX Fall Time for positive polarity | 9-9 |
| Figure 9-10: Waveform for 100BASE-TX Fall Time for negative polarity | 9-10 |
| Figure 9-11: Waveform for 100BASE-TX Rise/Fall Time Symmetry for positive polarity | 9-11 |
| Figure 9-12: Waveform for 100BASE-TX Rise/Fall Time Symmetry for negative polarity..... | 9-11 |
| Figure 9-13: Waveform for 100BASE-TX Waveform Overshoot for positive polarity | 9-13 |
| Figure 9-14: Waveform for 100BASE-TX Waveform Overshoot for negative polarity | 9-13 |
| Figure 9-15: Waveform for 100BASE-TX Jitter for positive polarity..... | 9-14 |
| Figure 9-16: Waveform for 100BASE-TX Jitter for negative polarity..... | 9-15 |
| Figure 9-17: Waveform for 100BASE-TX Distortion..... | 9-16 |
| Figure 9-18: Waveform for 100BASE-TX Return Loss Transmitter | 9-18 |
| Figure 9-19: Waveform for 100BASE-TX Return Loss Receiver..... | 9-18 |
| Figure 10-1: 10BASE-T Template user control dialog box..... | 10-2 |
| Figure 10-2: Waveform for 10BASE-T MAU Ext | 10-3 |
| Figure 10-3: Waveform for 10BASE-T MAU Ext Inv | 10-3 |
| Figure 10-4: Waveform for 10BASE-T MAU Int | 10-3 |
| Figure 10-5: Waveform for 10BASE-T MAU Int Inv | 10-4 |
| Figure 10-6: 10BASE-T Template user control dialog box..... | 10-6 |
| Figure 10-7: Waveform for 10BASE-T Link Pulse timing..... | 10-7 |
| Figure 10-8: Waveform for 10BASE-T Link Pulse head | 10-7 |
| Figure 10-9: Waveform for 10BASE-T Link Pulse tail..... | 10-7 |
| Figure 10-10: 10BASE-T Template user control dialog box..... | 10-10 |
| Figure 10-11: Waveform for 10BASE-T TP_IDL head | 10-11 |
| Figure 10-12: Waveform for 10BASE-T TP_IDL tail..... | 10-11 |
| Figure 10-13: Waveform for 10BASE-T Differential Voltage..... | 10-13 |
| Figure 10-14: Waveform for 10BASE-T Harmonic | 10-15 |
| Figure 10-15: 10BASE-T Jitter with cable user control | 10-16 |

List of Figures

| | |
|--|-------|
| Figure 10-16: Waveform for 10BASE-T Jitter with Cable for Normal output timing jitter | 10-17 |
| Figure 10-17: Waveform for 10BASE-T Jitter with Cable for 8 BT output timing jitter | 10-17 |
| Figure 10-18: Waveform for 10BASE-T Jitter with Cable for 8.5 BT output timing jitter | 10-18 |
| Figure 10-19: 10BASE-T Jitter without cable user control | 10-19 |
| Figure 10-20: Waveform for 10BASE-T Jitter without Cable for Normal output timing jitter | 10-20 |
| Figure 10-21: Waveform for 10BASE-T Jitter without Cable for 8 BT output timing jitter | 10-20 |
| Figure 10-22: Waveform for 10BASE-T Jitter without Cable for 8.5 BT output timing jitter | 10-21 |
| Figure 10-23: Waveform for 10BASE-T Return Loss Transmitter | 10-23 |
| Figure 10-24: Waveform for 10BASE-T Return Loss Receiver | 10-23 |
| Figure 10-25: Waveform for 10BASE-T CM Voltage | 10-24 |
| Figure 11-1: 1000BASE-T View Waveform for Template, Peak Volt, and Droop with disturbing signal | 11-1 |
| Figure 11-2: 1000BASE-T View Waveform for Template, Peak Volt, and Droop without disturbing signal | 11-1 |
| Figure 11-3: 1000BASE-T View Waveform for Jitter Master Filtered (with TX_TCLK access) | 11-2 |
| Figure 11-4: 1000BASE-T View Waveform for Jitter Master Filtered (without TX_TCLK access) | 11-2 |
| Figure 11-5: 1000BASE-T View Waveform for Jitter Master Unfiltered (with TX_TCLK access)..... | 11-3 |
| Figure 11-6: 1000BASE-T View Waveform for Jitter Master Filtered (without TX_TCLK access) | 11-3 |
| Figure 11-7: 1000BASE-T View Waveform for Jitter Slave Filtered (with TX_TCLK access)..... | 11-4 |
| Figure 11-8: 1000BASE-T View Waveform for Jitter Master Filtered (without TX_TCLK access) | 11-4 |
| Figure 11-9: 1000BASE-T View Waveform for Jitter Slave Unfiltered (with TX_TCLK access)..... | 11-4 |
| Figure 11-10: 1000BASE-T View Waveform for Jitter Master Filtered (without TX_TCLK access) | 11-5 |
| Figure 11-11: 1000BASE-T View Waveform for Distortion | 11-5 |
| Figure 11-12: 1000BASE-T View Waveform for Return Loss | 11-6 |
| Figure 11-13: 1000BASE-T View Waveform for CM Voltage..... | 11-7 |
| Figure 12-1: 100BASE-TX View Waveform for all tests except Return Loss..... | 12-1 |
| Figure 12-2: 100BASE-TX View Waveform for Return Loss Transmitter..... | 12-2 |
| Figure 12-3: 100BASE-TX View Waveform for Return Loss Receiver | 12-2 |
| Figure 13-1: 10BASE-T View Waveform for Link Pulse | 13-1 |

| | |
|---|------|
| Figure 13-2: 10BASE-T View Waveform for MAU | 13-2 |
| Figure 13-3: 10BASE-T View Waveform for TP_IDL with TPM | 13-3 |
| Figure 13-4: 10BASE-T View Waveform for TP_IDL without TPM | 13-3 |
| Figure 13-5: 10BASE-T View Waveform for Jitter with cable | 13-4 |
| Figure 13-6: 10BASE-T View Waveform for Jitter without cable | 13-4 |
| Figure 13-7: 10BASE-T View Waveform for Differential Voltage | 13-5 |
| Figure 13-8: 10BASE-T View Waveform for Harmonic | 13-6 |
| Figure 13-9: 10BASE-T View Waveform for Return Loss | 13-7 |
| Figure 13-10: 10BASE-T View Waveform for CM Voltage | 13-8 |
| Figure 15-1: AWG/AFG Automation Setup | 15-1 |
| Figure 15-2: Connecting the AWG/AFG and the Oscilloscope | 15-3 |
| Figure 15-3: Verifying the instrument connections | 15-4 |
| Figure 15-4: TekVISA Resource Manager Configuration | 15-5 |
| Figure 15-5: TekVISA Resource Manager configuration (application version 3.0.0 and above) | 15-6 |
| Figure 18-1: Calibration for 1000BASE-T Return Loss | 18-1 |
| Figure 18-2: Connect pane of 1000BASE-T Return Loss | 18-2 |
| Figure 18-3: Waveform of 1000BASE-T Return Loss Open calibration | 18-2 |
| Figure 18-4: Waveform of 1000BASE-T Return Loss Short calibration | 18-3 |
| Figure 18-5: Waveform of 1000BASE-T Return Loss Load calibration | 18-3 |
| Figure 18-6: Calibration for 100BASE-TX Return Loss | 18-4 |
| Figure 18-7: Waveform of 100BASE-TX Return Loss Open calibration | 18-5 |
| Figure 18-8: Waveform of 100BASE-TX Return Loss Short calibration | 18-5 |
| Figure 18-9: Waveform of 100BASE-TX Return Loss Load calibration | 18-6 |
| Figure 18-10: Calibration for 100BASE-TX Return Loss | 18-7 |
| Figure 18-11: Waveform of 100BASE-TX Return Loss Open calibration | 18-8 |
| Figure 18-12: Waveform of 100BASE-TX Return Loss Short calibration | 18-8 |
| Figure 18-13: Waveform of 100BASE-TX Return Loss Load calibration | 18-9 |

List of Figures

| | |
|--|-------|
| Figure 18-14: Calibration for 10BASE-T Return Loss..... | 18-10 |
| Figure 18-15: Waveform of 10BASE-T Return Loss Open calibration | 18-11 |
| Figure 18-16: Waveform of 10BASE-T Return Loss Short calibration | 18-11 |
| Figure 18-17: Waveform of 10BASE-T Return Loss Load calibration..... | 18-12 |
| Figure 18-18: Calibration for 10BASE-T Return Loss..... | 18-13 |
| Figure 18-19: Waveform of 10BASE-T Return Loss Open calibration | 18-14 |
| Figure 18-20: Waveform of 10BASE-T Return Loss Short calibration | 18-14 |
| Figure 18-21: Waveform of 10BASE-T Return Loss Load calibration..... | 18-15 |

List of Tables

| | |
|--|------|
| Table 2-1: Recommended probes | 2-1 |
| Table 2-2: Application default directories | 2-10 |
| Table 2-3: 1000BASE-T default layouts and templates..... | 2-10 |
| Table 2-4: 100BASE-TX default layouts and templates..... | 2-11 |
| Table 2-5: 10BASE-T/10BASE-Te default layouts and templates..... | 2-12 |
| Table 2-6: Default settings..... | 2-14 |
| Table 3-1: Application interface controls | 3-1 |
| Table 3-2: File menu..... | 3-3 |
| Table 3-3: Tests menu..... | 3-4 |
| Table 3-4: Results menu | 3-4 |
| Table 3-5: Utilities menu | 3-5 |
| Table 3-6: Help menu | 3-5 |
| Table 3-7: Selection pane buttons | 3-6 |
| Table 3-8: Execution pane | 3-9 |
| Table 3-9: Result Summary pane buttons | 3-11 |
| Table 3-10: Report Configuration fields | 3-12 |
| Table 3-11: Preferences | 3-13 |
| Table 3-12: Advanced report configuration..... | 3-18 |
| Table 3-13: Result Details categorization | 3-19 |
| Table 4-1: Select 1000BASE-T test parameters | 4-1 |
| Table 4-2: Select 100BASE-TX test parameters..... | 4-2 |
| Table 4-3: Select 10BASE-T/10BASE-Te test parameters..... | 4-3 |
| Table 5-1: 1000BASE-T Configure parameters | 5-2 |
| Table 5-2: 1000BASE-T Configure parameter description | 5-3 |

List of Tables

| | |
|--|------|
| Table 5-3: 1000BASE-T Configuration default settings | 5-5 |
| Table 5-4: 100BASE-TX Configure parameters | 5-6 |
| Table 5-5: 100BASE-TX Configure parameter description | 5-7 |
| Table 5-6: 100BASE-TX Configuration default settings | 5-8 |
| Table 5-7: 10BASE-T/10BASE-Te Configure parameters | 5-10 |
| Table 5-8: 10BASE-T/10BASE-Te Configure parameter description | 5-10 |
| Table 5-9: 10BASE-T/10BASE-Te Configuration default settings..... | 5-13 |
| Table 7-1: Test and pattern description | 7-1 |
| Table 7-2: Test and pattern description | 7-1 |
| Table 7-3: Test and pattern description | 7-2 |
| Table 8-1: 1000BASE-T Template configuration options..... | 8-1 |
| Table 8-2: 1000BASE-T Peak Volt configuration options | 8-4 |
| Table 8-3: 1000BASE-T Droop configuration options..... | 8-6 |
| Table 8-4: 1000BASE-T Jitter Master Filtered configuration options | 8-8 |
| Table 8-5: 1000BASE-T Jitter Master Unfiltered configuration options | 8-13 |
| Table 8-6: 1000BASE-T Jitter Slave Filtered configuration options..... | 8-18 |
| Table 8-7: 1000BASE-T Jitter Master Unfiltered configuration options | 8-23 |
| Table 8-8: 1000BASE-T Distortion configuration options..... | 8-30 |
| Table 8-9: 1000BASE-T Return Loss configuration options | 8-33 |
| Table 8-10: 1000BASE-T CM Voltage configuration options..... | 8-35 |
| Table 9-1: 100BASE-TX Template configuration options..... | 9-1 |
| Table 9-2: 100BASE-TX Differential Output Voltage configuration options..... | 9-3 |
| Table 9-3: 100BASE-TX Amplitude Symmetry configuration options | 9-5 |
| Table 9-4: 100BASE-TX Rise Time configuration options | 9-7 |
| Table 9-5: 100BASE-TX Fall Time configuration options | 9-9 |
| Table 9-6: 100BASE-TX Rise/Fall Time Symmetry configuration options..... | 9-10 |
| Table 9-7: 100BASE-TX Waveform Overshoot configuration options | 9-12 |

| | |
|---|-------|
| Table 9-8: 100BASE-TX Jitter configuration options | 9-14 |
| Table 9-9: 100BASE-TX Distortion configuration options | 9-15 |
| Table 9-10: 100BASE-TX Return Loss configuration options | 9-17 |
| Table 10-1: 10BASE-T/10BASE-Te MAU configuration options | 10-1 |
| Table 10-2: 10BASE-T Link Pulse configuration options | 10-5 |
| Table 10-3: 10BASE-T/10BASE-Te TP_IDL configuration options | 10-9 |
| Table 10-4: 10BASE-T/10BASE-Te Differential Voltage configuration options | 10-12 |
| Table 10-5: 10BASE-T/10BASE-Te Harmonic configuration options | 10-14 |
| Table 10-6: 10BASE-T Jitter with cable configuration options..... | 10-15 |
| Table 10-7: 10BASE-T Jitter without cable configuration options | 10-18 |
| Table 10-8: 10BASE-T Return Loss configuration options..... | 10-21 |
| Table 10-9: 10BASE-T CM Voltage configuration options | 10-24 |
| Table 15-1: AWG/AFG configuration parameters and descriptions..... | 15-2 |
| Table 15-2: AWG/AFG configuration parameters and defaults | 15-2 |
| Table 17-1: Command arguments and queries..... | 17-2 |
| Table 17-2: 1000BASE-T GPIB commands..... | 17-10 |
| Table 17-3: 100BASE-TX GPIB commands..... | 17-13 |
| Table 17-4: Oscilloscope GPIB commands for 100Base-Tx..... | 17-15 |
| Table 17-5: 10BASE-T/10BASE-Te GPIB commands..... | 17-16 |
| Table 17-6: Oscilloscope GPIB commands for 10BASE-T..... | 17-18 |
| Table 17-7: AWG/AFG Automation GPIB commands | 17-19 |
| Table 17-8: Default test name and result details after multiple run | 17-33 |
| | |
| Table A-1:1000BASE-T specification range | A-1 |
| Table A-1: 100BASE-TX specification range | A-2 |
| Table A-1: 10BASE-T/10BASE-Te specification ranges..... | A-4 |

List of Tables

| | |
|---|-----|
| Table B-1: TDSET3 error messages | B-1 |
| Table B-1: Remote GPIB error messages | B-3 |

About TDSET3

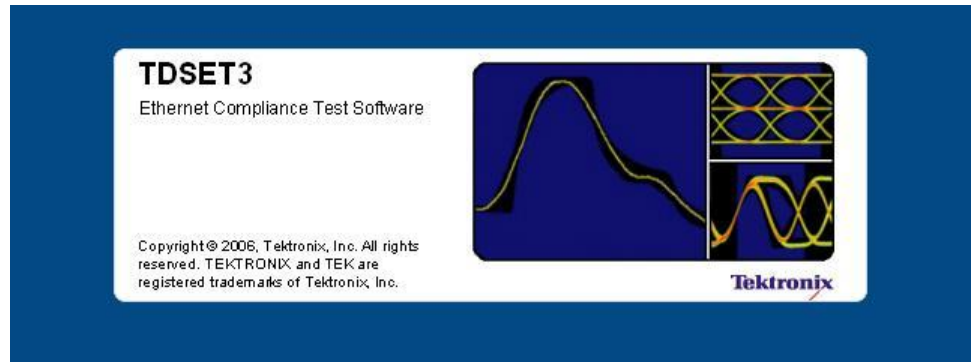

Figure 1-1: TDSET3 splash screen

The TDSET3 Ethernet Compliance Test Software tests the Ethernet's physical layer for — 1000BASE-T, 100BASE-TX, 10BASE-T, and 10BASE-Te in compliance with IEEE 802.3-2002, IEEE 802.3az, and ANSI X3.263-1995 standards. This version allows you to test each speed for various fields such as:

1000BASE-T

- Template
- Peak Voltage
- Droop
- Jitter Master Filtered
- Jitter Master Unfiltered
- Jitter Slave Filtered
- Jitter Slave Unfiltered
- Distortion
- Return Loss
- Common mode Voltage

100BASE-TX

- Template
- Differential Output Voltage
- Signal Amplitude Symmetry
- Rise Time
- Fall Time
- Rise / Fall Time Symmetry
- Waveform Overshoot
- Jitter
- Duty Cycle Distortion
- Return Loss

10BASE-T/10BASE-Te

Template MAU Ext (10BASE/10BASE-Te)
Template MAU Ext Inv (10BASE/10BASE-Te)
Template MAU Int (10BASE/10BASE-Te)
Template MAU Int Inv (10BASE/10BASE-Te)
Template Link Pulse (10BASE-T)
Template TP_IDL (10BASE/10BASE-Te)
Differential Voltage (10BASE/10BASE-Te)
Harmonic (10BASE/10BASE-Te)
Jitter with cable (10BASE-T)
Jitter without cable (10BASE-T)
Return Loss (10BASE-T)
Common mode Voltage (10BASE-T)

TDSET3 has a Report Generator tool that helps you create and print custom reports.

TDSET3 also supports Remote GPIB commands.

***Note:** Use the Select All button to test all the parameters of the selected speed.*

Using Online Help

The TDSET3 online help serves as a reference for using the TDSET3 Ethernet Compliance Test Software.

Contents: The Contents tab displays books and pages that represent the categories of information in the online Help system.

Index: The Index tab displays a multi-level list of keywords and keyword phrases. These terms are associated with topics in the Help system and direct you to specific topics.

Search: The Search tab enables you to search for keywords in the Help system and to locate topics containing those words. When the search is completed, a list of topics is displayed so that you can select a specific topic to view.

Back and Forward: The Back and Forward buttons allow you to browse through topics.

To print a topic: Select the Print button from the Help Topics menu bar.

Printing from the Online Help

While using the online help, you can print topics and information from the HTML Help viewer.

To print a single topic:

1. Find the topic in the Contents pane. Click Print.
2. Click Print the selected topic and click OK.

To print all topics in a selected TOC book:

1. Find the TOC book in the Contents pane. Click Print.
2. Click Print the selected heading and all subtopics and click OK.

Note: If topics include expanding or drop-down hotspots, click the hotspots to display the information before you print.

Hotspot is a clickable text that displays additional information below the link. Click on the hotspot text to show or hide the hotspot content.

Some online help topics have color in the examples of the displayed application. If you want to print this type of topic on a monochrome printer, some information may not print because of certain colors. Instead, you should print the topic from the PDF (portable document format) file that corresponds to the online help. You can find the file in the Documents directory on the *Optional Applications Software on Windows-Based Oscilloscopes CD-ROM*.

Conventions

Online help uses the following conventions:

- When steps require a sequence of selections using the application interface, the ">" delimiter marks each transition between a menu and an option. For example, **File > Minimize**
- DUT refers to the device transmitting the signal to be tested
- Two or more adjacent hyperlinks are separated with "|"
- Hotspot is a clickable text that displays additional information below the link. Click on the hotspot link to show or hide the hotspot content

The application uses this convention:

- Three dots "..." next to any menu item means that the dialog box that pops up requires user input

Feedback

Tektronix values your feedback on our products. To help us serve you better, please send us your suggestions, ideas, or comments on the application.

Direct your feedback via email to **techsupport@tektronix.com** or FAX at **(503) 627-5695** and include the following information. Please be as specific as possible.

General information:

- Instrument model number and hardware options, if any
- Probes used
- Your name, company, mailing address, phone number, FAX number, email id
- Please indicate if you would like to be contacted by Tektronix about your suggestion or comments

Application specific information:

- Software version number
- Description of the problem such that technical support can duplicate the problem
- The instrument setup file of the oscilloscope and the application is also required to identify the problem
- If possible, save the waveform on which you are performing the measurement as a .wfm file

Note: To know the software version number, click *Help > About* in the application.

Information through the Web site

You can find information about this and other applications at the Tektronix Inc. Web site, www.tektronix.com. Check this site for firmware updates and other information about our application. You can download a free trial version of the TDSET3 application that allows you a five-time trial.

Getting Started

Compatibility

For information on oscilloscope compatibility, refer to the *Optional Applications Software on Windows-Based Oscilloscopes Installation Manual*, Tektronix part number 077-0067-XX. The manual is also available as a PDF file.

Recommended Accessories

Table 2-1: Recommended probes

| Oscilloscope | Return Loss measurement | All other measurements |
|--|-------------------------|---------------------------------------|
| DPO7000/B/C, MSC5000 | P6248, P6247 | P6247, P6248, P6330, TDP1500, TDP3500 |
| DPO70000/B/C/D, DSA70000/B/C/D, MSO70000/C | P6248, P6247 | P6247, P6248, P6330, P7330, P7350 |
| TDS5000B | P6248, P6247 | P6247, P6248, P6330 |
| TDS6000/B and TDS6000C | P6248, P6247 | P6247, P6248, P6330, P7330, P7350 |
| TDS7054, TDS7104 | P6248, P6247 | P6247, P6248, P6330 |
| TDS7154, TDS7254, TDS7404 | P6248, P6247 | P6247, P6248, P6330, P7330, P7350 |
| TDS7000B | P6248, P6247 | P6247, P6248, P6330, P7330, P7350 |
| CSA7000/B | P6248, P6247 | P6247, P6248, P6330, P7330, P7350 |

Differential Probes

- P6247 — 1.0 GHz Differential Probe
- P6248 — 1.5 GHz Differential Probe
- P6330 — 3.5 GHz Differential Probe

***Note:** The P6247, P6248, and P6330 probes require the TPA-BNC adapter for interface to DPO7000 series oscilloscopes.*

- P7330 — 3.5 GHz Differential Probe (cannot be used with DPO7054, DPO7104, and DPO7254 oscilloscopes)
- P7350 — 5.0 GHz Differential Probe (cannot be used with DPO7054, DPO7104, and DPO7254 oscilloscopes)

***Note:** 10Base-T test without TPM and RL tests require P6247 and P6248 probes. Two probes are required for Return Loss tests.*

- P6243 and P6245 — 1 GHz or above depending on the oscilloscope (for 1000BASE-T Jitter tests)

Single Ended Probe

- TAP1500 (two probes needed for Slave Jitter Test and one probe for Master Jitter Test). Compatible with DPO7000 series oscilloscopes only. TAP1500 (single ended probe) to be used with TX_TCLK signal only.

Arbitrary Waveform Generator/Arbitrary Function Generator

- AWG410 — 200 MS/s, 16-Bit Arbitrary Waveform Generator
- AWG420 — 200 MS/s, 16-Bit Arbitrary Waveform Generator
- AWG430 — 200 MS/s, 16-Bit Arbitrary Waveform Generator
- AWG510 — 1 GS/s, 10-Bit Arbitrary Waveform Generator
- AWG520 — 1 GS/s, 10-Bit Arbitrary Waveform Generator
- AWG610 — 2.6 GS/s, 8-Bit Arbitrary Waveform Generator
- AWG710 — 4.0 GS/s, 8-Bit Arbitrary Waveform Generator
- AWG2021 — 250 MS/s, 12-Bit Arbitrary Waveform Generator (for Disturbing Signal Generator)
- AWG710B — 4.2 GS/s, 8-Bit Arbitrary Waveform Generator
- AWG7102 (Option 02) — 10 GS/s

- AWG5014 — 1.2 GS/s, 14-Bit Arbitrary Waveform Generator
- AFG3252 — 2 GS/s, 14-Bit Arbitrary Function Generator
- AFG3102 — 1 GS/s, 14-Bit Arbitrary Function Generator

Note: In the case of AWG 400 series, the 1000Base-T return loss test values after 98.5 MHz are extrapolated. Use AWG710 waveform files for AWG710B.

Note: AWG7102 with Option 02 supports all tests except the Distortion test.

Probe Positioner

- PPM100 Flexible Arm Probe Positioner

Differential Input Voltage of Differential Probes

- P6247 — $\pm 8.5 \text{ V} (\div 10)$
- P6248 — $\pm 8.5 \text{ V} (\div 10)$
- P6330 — $\pm 2 \text{ V}$
- P7330 — $\pm 2 \text{ V}$
- P7350 — $\pm 2.5 \text{ V}$

Requirements and Restrictions

Do not change the oscilloscope settings when the test is running. If you change the settings when the test is running, the application may give abnormal test results.

Prerequisites

- TekVisa must be installed in the oscilloscope
- A TDS7000/CSA7000/TDS6000 Series oscilloscope with Firmware version 2.2.0 or later
- A TDS7000B/CSA7000B oscilloscope with Firmware version 3.0.0 or later
- A TDS5000B Series oscilloscope with Firmware version 2.0.0 or later
- A TDS6000B Series oscilloscope with Firmware version 4.0.1 or later
- A TDS6000C Series oscilloscope with Firmware version 5.0.0 or later
- A DPO7000 Series oscilloscope with Firmware version V 5.2.1 or later
- A DPO/DSA70000 and DPO/DSA70000B Series oscilloscope with Firmware version V 5.2.1 or later
- An MSO70000 Series oscilloscope with Firmware version V 5.2.1 or later

For better and reliable results

- Prior to running any test, calibrate the probes, and oscilloscope for Signal Path Compensation¹
- Cable length between the DUT and the test fixture should not be more than two inches
- Use 500 waveforms for averaging 1000BASE-T
- Use 64 waveforms for averaging, and 200000 samples for mask testing 10BASE-T or 100BASE-TX wherever applicable
- Use 48 waveforms for averaging 10BASE-T harmonics
- If the signal is not connected and the noise level is below 50 mV, the application detects and gives a message as invalid signal

¹ To calibrate an oscilloscope, select **Utilities > Instrument Calibration** in the oscilloscope menu bar and select the **Calibrate** button

***Note:** If you do not install the latest version (Version 2.2.0 or above) of TDS7000 or CSA7000 Firmware, the application will not test the mask related parameters.*

Remember

- TDS5032B and TDS5052B are two-channel oscilloscopes. The drop-down list for any Data, Ref, or Math sources displays only two channels
- For 1000BASE-T Template test, the TDS5000B series oscilloscope displays the horizontal scale as 4 ns
- The two-channel oscilloscopes do not support the 1000BASE-T Jitter Slave Filtered test
- The TDS6000B and TDS7000B series oscilloscope do not support Flash Hits

About the Test Fixture

The TF-GBE test fixture, designed by Tektronix and manufactured and distributed by Crescent Heart Software, facilitates 1000BASE-T, 100BASE-TX and 10BASE-T Ethernet compliance testing when used with an appropriate supported oscilloscope and Tektronix TDSET3 Ethernet Compliance Test Software. These fixtures are available from both C.H.S and Tektronix.

The TF-GBE-EE test fixture, designed, manufactured, and distributed by Crescent Heart Software (C.H.S), facilitates 10BASE-Te Energy Efficient Ethernet (EEE) compliance testing when used with an appropriate supported oscilloscope and Tektronix TDSET3 Ethernet Compliance Test Software. The fixture is available from C.H.S.

For more information, visit Crescent Heart Software Web site www.c-h-s.com.

Starting the Application

1. From the oscilloscope menu, select File > Run Application > Ethernet Compliance Test Software or Analyze > Ethernet Compliance Test Software.

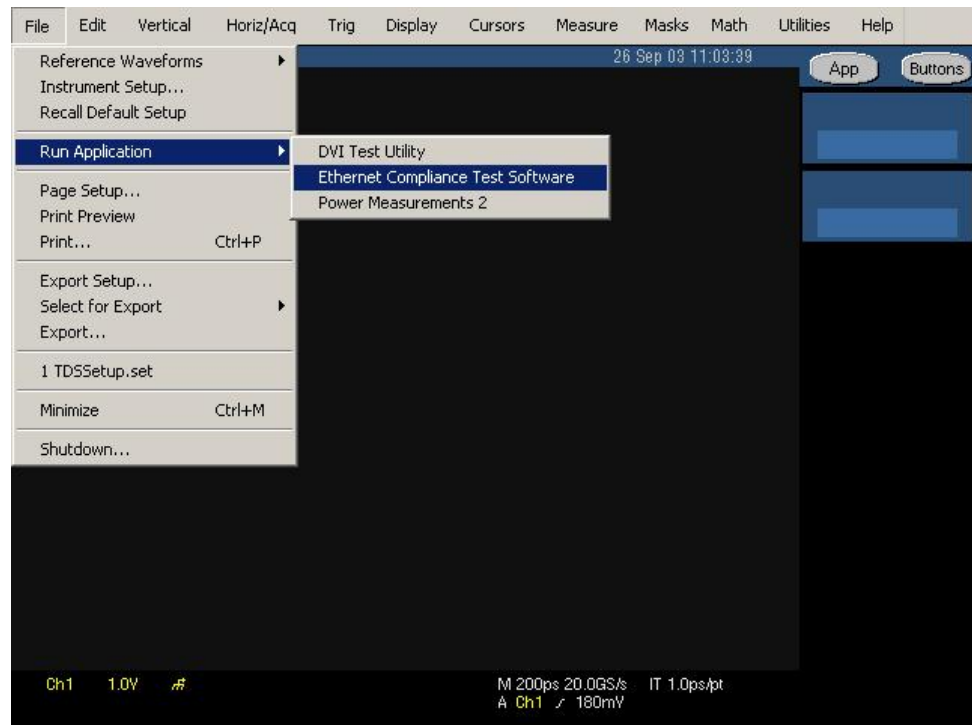
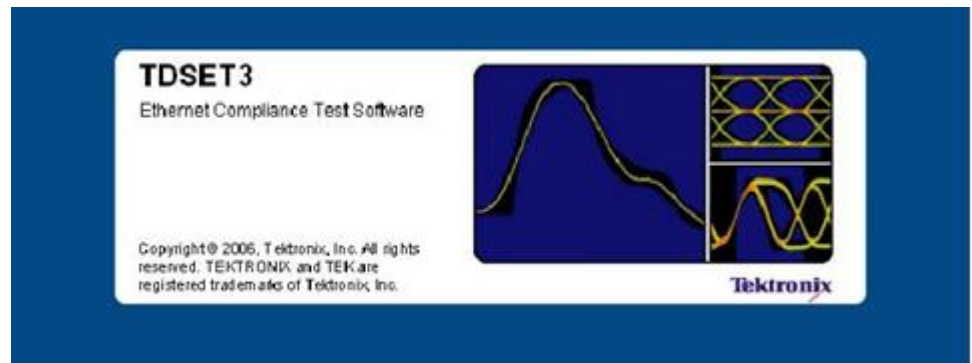

Figure 2-1: Run application

2. The splash screen appears.



3. The oscilloscope display resizes to fit the upper part of the screen and the lower part of the oscilloscope screen displays the TDSET3 application.

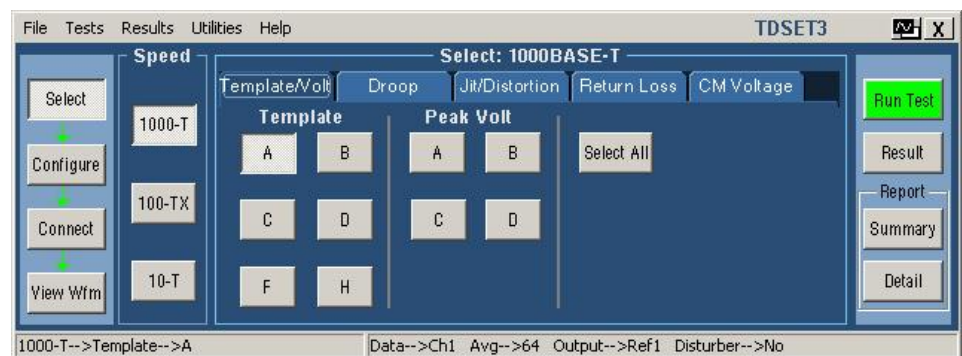

Figure 2-2: Application interface

4. The application is automatically set to its default settings.
5. If you access oscilloscope functions, the oscilloscope display appears in full screen and the TDSET3 application recedes to the background.
6. To return to the TDSET3 application, select the APP button in the oscilloscope display.

Minimizing and Maximizing the Application

The application appears even when you minimize the oscilloscope.

- To minimize the application, select **File > Minimize**. The TDSET3 window minimizes to the Windows taskbar and upper half screen has the oscilloscope display and lower half of the screen has the desktop
- To maximize the application, select Ethernet Compliance Test Software in the Windows taskbar

- To hide the application, select the **Hide** button  or select **File > Hide**

The Report Generator module windows are independent of the TDSET3 application. Select the **Minimize** button on the right hand corner of the relevant report generator window to minimize it

***Note:** If you select Hide button, the TDSET3 window goes to the background and the oscilloscope display resizes to the whole screen.*

Returning to the Application

When you access oscilloscope functions, the oscilloscope fills the display. You can access oscilloscope functions in the following ways:

- Choose the Menu bar or the Toolbar mode on the oscilloscope and access the menus
- Press front-panel buttons
- To return to the application, select the **APP** button on the top right of the oscilloscope display

Exiting the Application

To exit the application, do the following:

- Select **File > Exit** or select the **Exit** button 
- On exiting the application a message box "**Do you want to restore the oscilloscope settings to their state before starting this application?**" appears
- Select **Yes**, **No**, or **Cancel**. **Yes** is selected by default

Note: Using other methods to exit the application results in abnormal termination of the application.

Application Directories and File Names

The TDSET3 application uses directories to save and recall setup files and uses file name extensions to identify the file type. The next table lists the default directory names.

Table 2-2: Application default directories

| Directory | Action |
|---|---|
| C:\TekApplications\TDSET3\Setup | Stores the application settings to setup files. |
| C:\TekApplications\TDSET3\ReportGenerator\Templates | Stores the default templates of report generator. |
| C:\TekApplications\TDSET3\ReportGenerator\Reports | Stores the Reports for 10BASE-T, 10BASE-Te, 100BASE-TX, and 1000BASE-T. |
| C:\TekApplications\TDSET3\ReportGenerator\Layouts | Stores the Report Layouts for 10BASE-T, 100BASE-TX, and 1000BASE-T. |
| C:\TekApplications\TDSET3\AVG\Waveforms | Stores the AVG/AFG waveforms. |
| C:\TekApplications\TDSET3\Images | Stores all the images. |

Application Software Default Layouts and Templates

Table 2-3: 1000BASE-T default layouts and templates

| Test | Default template |
|--|--|
| 1000BASE-T (Default layout — 1000T.rpl) | |
| Coversheet | Coversheet for 1000BaseT.rgt Coversheet for 1000BaseT_2.rgt |
| Template | 1000T-TemplateA.rgt 1000T-TemplateB.rgt 1000T-TemplateC.rgt 1000T-TemplateD.rgt 1000T-TemplateF.rgt 1000T-TemplateH.rgt |
| Peak Volt | 1000T-PeakVoltA.rgt 1000T-PeakVoltB.rgt 1000T-PeakVoltC.rgt 1000T-PeakVoltD.rgt |

Table 2-3: 1000BASE-T default layouts and templates (cont)

| Test | Default template |
|---------------------|--|
| Droop | 1000T-DroopG.rgt 1000T-DroopJ.rgt |
| Jitter | 1000 Jitter Master filtered.rgt 1000 Jitter Master Unfiltered[TIE].rgt 1000 Jitter Master Unfiltered[HIS].rgt 1000 Jitter Slave filtered.rgt 1000 Jitter Slave Unfiltered[TIE].rgt 1000 Jitter Slave Unfiltered[HIS].rgt 1000T- Jitter master filtered_NOCLK.rgt 1000T- Jitter master unfiltered[HIS]_NOCLK.rgt 1000T- Jitter master unfiltered[TIE]_NOCLK.rgt 1000T- Jitter slave filtered_NOCLK.rgt 1000T- Jitter slave unfiltered[HIS]_NOCLK.rgt 1000T- Jitter slave unfiltered[TIE]_NOCLK.rgt |
| Distortion | 1000T-Distortion.rgt |
| Common mode Voltage | 1000T-Common mode Voltage.rgt |
| Return Loss | 1000T-Return Loss.rgt |

Table 2-4: 100BASE-TX default layouts and templates

| Test | Default template |
|--|--|
| 100BASE-TX (Default layout — 100TX.rpl) | |
| Coversheet | Coversheet for 100BaseTX.rgt |
| Template | 100-ACI Template.rgt |
| Differential Output Voltage | 100-Differential Output Voltage.rgt |
| Signal Amplitude Symmetry | 100-Signal Amplitude Symmetry.rgt |
| Rise Time | 100-Rise Time.rgt |
| Fall Time | 100-Fall Time.rgt |
| Rise/Fall Time Symmetry | 100-Rise Fall Time Symmetry.rgt |
| Waveform Overshoot | 100-Waveform Overshoot.rgt |
| Jitter | 100-Transmit Jitter.rgt |
| Duty Cycle Distortion | 100-Duty Cycle Distortion.rgt |
| Return Loss | 100-Tx Return Loss.rgt 100-Rx Return Loss.rgt |

Table 2-5: 10BASE-T/10BASE-Te default layouts and templates

| Test | Default template |
|--|--|
| 10BASE-T/10BASE-Te (Default layout — 10T.rpl) | |
| Coversheet | Coversheet for 10BaseT.rgt Coversheet for 10BaseTe.rgt |
| MAU Ext Template | 10 MAU ext template.rgt |
| MAU Ext Inv Template | 10 mau ext inv template.rgt |
| MAU Int Template | 10 mau int template.rgt |
| MAU Int Inv Template | 10 mau int inv template.rgt |
| Link Pulse Template Load with TPM | 10 Link Pulse Load1 with TPM template.rgt 10 Link Pulse Load2 with TPM template.rgt 10 Link Pulse 100 with TPM template.rgt |
| Link Pulse Template Load without TPM | 10 Link Pulse Load1 without TPM template.rgt 10 Link Pulse Load2 without TPM template.rgt 10 Link Pulse 100 without TPM template.rgt |
| Link Pulse Timing | 10 Link Pulse Timing.rgt |
| TP_IDL Template Load with TPM | 10 TP_IDL Load1 with TPM template.rgt 10 TP_IDL Load2 with TPM template.rgt 10 TP_IDL 100 with TPM template.rgt |
| TP_IDL Template Load without TPM | 10 TP_IDL Load1 without TPM template.rgt 10 TP_IDL Load2 without TPM template.rgt 10 TP_IDL 100 without TPM template.rgt |

Table 2-5: 10BASE-T/10BASE-Te default layouts and templates (cont)

| Test | Default template |
|---|--|
| Differential Output Voltage | 10 differential output voltage.rpt |
| Harmonic | 10 harmonic of all ones.rgt |
| Jitter with cable Normal output timing | 10 output timing jitter with cable.rgt |
| Jitter with cable 8.0 output timing | 10 8.0 output timing jitter with cable.rgt |
| Jitter with cable 8.5 output timing | 10 8.5 output timing jitter with cable.rgt |
| Jitter without cable Normal output timing | 10 output timing jitter without cable.rgt |
| Jitter without cable 8.0 output timing | 10 8.0 output timing jitter without cable.rgt |
| Jitter without cable 8.5 output timing | 10 8.5 output timing jitter without cable.rgt |
| Return Loss | 10 Tx Return Loss.rgt 10 Rx Return Loss.rgt |
| Common mode Voltage | 10 Common mode Voltage.rgt 10e Common mode output voltage.rgt |

Application Software Default Settings

The TDSET3 application is automatically set to the default settings. The next table lists the default settings with which the TDSET3 application starts.

Table 2-6: Default settings

| Parameter | Selection | Default setting |
|--------------------|--------------------|--|
| Speed | | 1000-T |
| Select > 1000-T | | Template/Volt tab |
| | Template/Volt tab | A |
| | Droop tab | G |
| | Jit/Distortion tab | Master Unfiltered |
| | Return Loss tab | Return Loss |
| | CM Voltage tab | CM Voltage |
| Select > 100-TX | | Parametric tab |
| | Parametric tab | Template (Both Polarity) |
| | Return Loss tab | Transmitter |
| Configure > 1000-T | Data | CH1 |
| | Master CLK | CH2 |
| | Slave CLK | CH3 |
| | Data (TM2) | CH1 |
| | Data (TM3) | CH2 |
| | TX_TCLK | CH1 |
| | # Averages | 64 |
| | Clock Edge | Rising |
| | Hi Resolution | 64 |
| | Output | Ref1 |
| | Disturbing Signal | No |
| | Filter | Int |
| | TX_TCLK | No |
| | LP Filter | Yes |
| | Meas Type | TIE |
| | Probe:P1 | CH1 |
| | Probe:P2 | CH2 |
| | Pair ID | A |
| | Load | 85, 100, 115 Ohm |
| | Smooth | 7 |
| | Record Length | Varies depending on the Memory option available on the oscilloscope. |
| | Hysteresis | 5.00 % |

Table 2-6: Default settings (cont)

| Parameter | Selection | Default setting |
|---------------------------|---|---|
| Configure > 100-TX | Data | CH1 |
| | Mask Setup Samples Fail Threshold | 50K 1 |
| | Mask Scale | Normal |
| | Acquisition | Sample/Average (depends on the parameter selected) Average is the default mode # Waveforms = 16 |
| | Pulse Width | 16 ns |
| | Probe:P1 / Probe:P3 | CH1 |
| | Probe:P2 / Probe:P4 | CH2 |
| | Load | 85, 100, 115 Ohm |
| | Smooth | 7 |
| | # Averages | 100 for Return Loss and 48 for other tests |
| Configure > 10-T | Data | CH1 |
| | Acquisition | Sample/Average (depends on the parameter selected) Average is the default mode # Waveforms = 16 |
| | Section | Both |
| | MAU Type | Internal |
| | MAU Scale | Normal |
| | Mask Setup Samples Fail Threshold | 50 K 1 |
| | Harmonic Ones Output # Averages Time/Scale | Math1 48 10 microseconds |
| | Sequence | Normal (NLP) |
| | Probe: P1 / Probe: P3 | CH1 |
| | Probe: P2 / Probe: P4 | CH2 |
| | Load | 85, 100, 115 Ohm |
| | Smooth | 7 |
| | Energy Efficient | No |
| Report > Report Generator | | Generate Report tab |

Operating Basics

TDSET3 Application Window

The TDSET3 application is a Windows-based application. The application window comprises the Menu bar, Selection pane, Speed pane, Client pane, Execution pane, and Status bar. The Client pane changes between Configuration pane, Parameter Selection pane, Connection pane, and View Waveform pane depending on what you have selected in the Selection pane. The Client pane changes to Result pane automatically after you run the test.

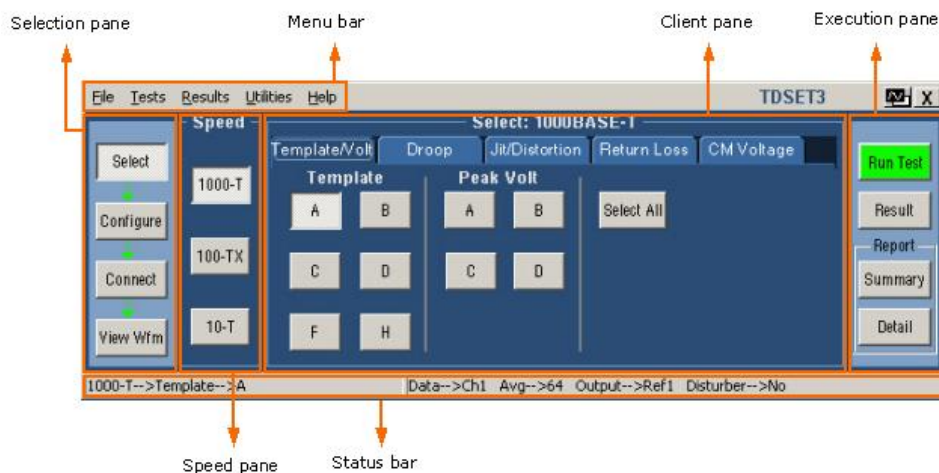

Figure 3-1: Application window

TDSET3 Application Interface Controls

The TDSET3 application interface uses the following controls:

Table 3-1: Application interface controls

| Controls | Description |
|----------|---|
| Menu bar | Located at the top of the application and has the TDSET3 menus. |
| Tab | Labeled group of options with similar items. |

Table 3-1: Application interface controls (cont)

| Controls | Description |
|--------------------|--|
| Pane | Enclosed visual frame with a set of related options. |
| Option button | Defines a particular command or task. |
| Drop-down list box | Lists the items from which you can select one item. |
| Field | Box that you can use to type in text or to enter a value with the keypad or a multipurpose knob. |
| Check Boxes | Square box that you can use to select or clear preferences. |
| Scroll bar | Vertical or horizontal bar at the side or bottom of a display area used to move around that area. |
| Browse | Displays a window where you can look through a list of directories and files. |
| Command button | Initiates an immediate action. |
| Keypad | Appears when you select a box and enter a value. |
| MP/GP knob | Displays a line between the knob and the box. You can turn the knob on the oscilloscope to select a value. |

Menu bar

The menu bar of TDSET3 has the following menus.

- File menu
- Tests menu
- Results menu
- Utilities menu
- Help menu

File Menu

The File menu appears as shown by the next figure:



Figure 3-2: File menu

The next table lists the menu selection and description for the File menu:

Table 3-2: File menu

| Menu selection | Description |
|----------------------|--|
| Recall Default Setup | Recalls the default settings for the application. |
| Recall Setup | Recalls the application settings from a setup file. |
| Save Setup | Saves the application settings to a setup file. |
| Preferences | Shows/Hides the message boxes displayed while running the test. |
| Minimize | Minimizes the Application window. |
| Hide | Hides the Application window. |
| Exit | Displays the Restore Settings dialog box and closes the Application. |

Tests Menu

The Tests menu appears as shown by the next figure:

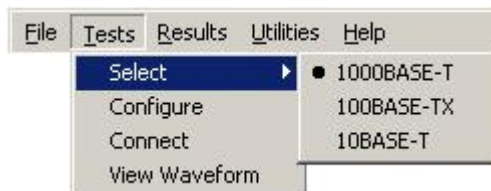

Figure 3-3: Tests menu

The next table lists the menu selection and description for the Tests menu:

Table 3-3: Tests menu

| Menu selection | Description |
|----------------------|---|
| Select | |
| 1000BASE-T | Displays the point and test parameter selections for 1000BASE-T in the Client pane. |
| 100BASE-TX | Displays the parameters for 100BASE-TX in the Client pane. |
| 10BASE-T | Displays the parameters for 10BASE-T in the Client pane. |
| Configure | Displays the configuration details for the selected speed and test. |
| Connect | Displays the connection instructions for the selected speed. |
| View Waveform | Displays the waveform based on the settings. |

Results Menu

The Results menu appears as shown by the next figure:

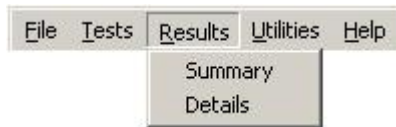

Figure 3-4: Results menu

The next table lists the menu selection and description for the Results menu:

Table 3-4: Results menu

| Menu selection | Description |
|----------------|---|
| Summary | Displays the results summary of last test conducted. |
| Details | Displays the detailed results of last test conducted. |

Utilities Menu

The Utilities menu appears as shown by the next figure:

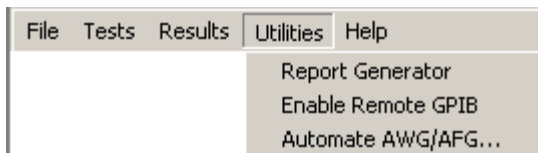

Figure 3-5: Utilities menu

The next table lists the menu selection and description for the Utilities menu:

Table 3-5: Utilities menu

| Menu selection | Description |
|--------------------|---|
| Report Generator | Displays the Report Generator window. |
| Enable Remote GPIB | Enables you to use remote GPIB commands to control the application. |
| Automate AWG/AFG | Enables you to automate file transfer and waveform setup on an Arbitrary Waveform Generator/Arbitrary Function Generator. |

Help Menu

The Help menu appears as shown by the next figure:

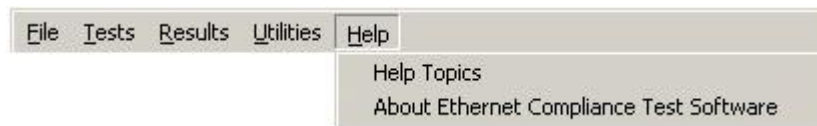

Figure 3-6: Help menu

The next table lists the menu selection and description for the Help menu:

Table 3-6: Help menu

| Menu selection | Description |
|---|--|
| Help Topics | Displays the help file for the TDSET3 application. |
| About Ethernet Compliance Test Software | Displays a dialog box with information about the current TDSET3 application. |

Selection pane

The Selection pane located to the left of the Application window allows you to navigate through the application.

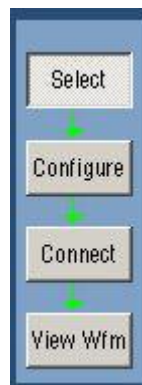

Figure 3-7: Selection pane

The next table lists the button and the task description:

Table 3-7: Selection pane buttons

| Button | Description |
|-----------|---|
| Select | Displays the test selection parameters in the Client pane for the selected speed. |
| Configure | Displays the configuration parameters in the Client pane for the selected test parameter. |
| Connect | Displays the connection details in the Client pane for the selected test parameter. |
| View Wfm | Displays the waveform in the Client pane for the selected test parameter. |

Speed pane

The Speed pane located to the left of the application window displays the speed to be selected.

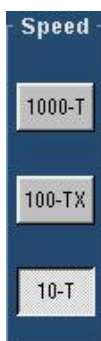

Figure 3-8: Speed pane

Select **1000-T** to test 1000BASE-T, **100-TX** to test 100BASE-TX, and **10-T** to test 10BASE-T and 10BASE-Te.

The Client pane displays the parameters of the selected speed.

Client pane

The Client pane located adjacent to the Speed pane displays the test parameters, configuration parameters, connections, view waveforms or results. Clicking on each tab changes the Client pane to display the relevant test parameters.

1000BASE-T Client pane

The following figure shows the Client pane of 1000BASE-T Template:

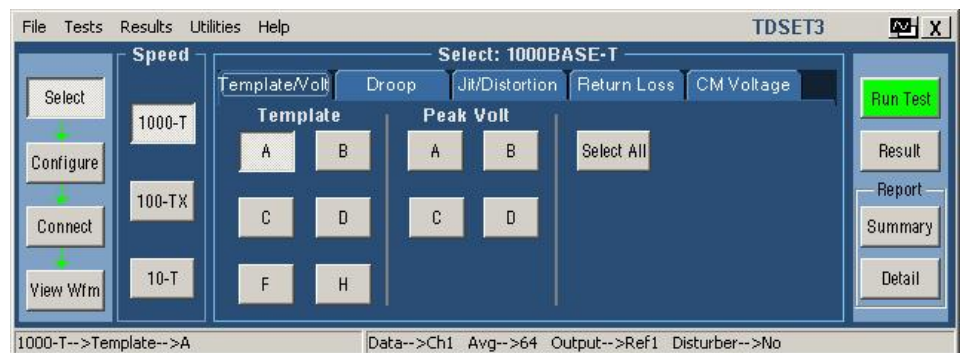

Figure 3-9: 1000BASE-T Client pane

100BASE-TX Client pane

The following figure shows the Client pane of 100BASE-TX Template:

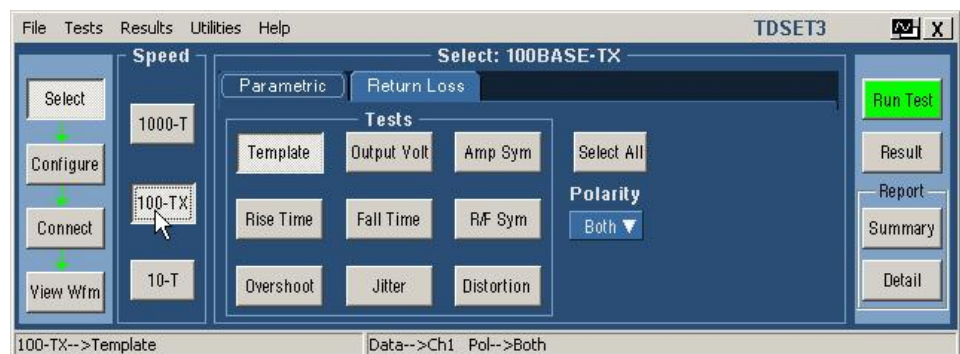

Figure 3-10: 100BASE-TX Client pane

**10BASE-T/
10BASE-Te
Client pane**

The following figure shows the Client pane of 10BASE-T/10BASE-Te Template:

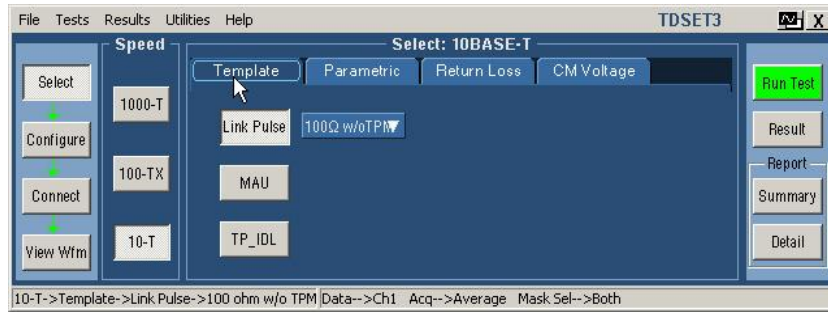

Figure 3-11: 10BASE-T Client pane

Execution pane





The Execution pane located to the right of the Application window displays the buttons Run Test and Result.



Figure 3-12: Execution pane

Clicking on each button performs a particular task. The following table lists the button and the task description:

Table 3-8: Execution pane

| Button | Button name | Description |
|---|----------------|--|
|  | Run Test | Runs the selected test or tests. |
|  | Result | Displays the Result pane that shows the test results. |
|  | Report Summary | Displays the location to which the report summary is saved. Click OK to store the result details in a .csv file. |
|  | Report Detail | Displays the location to which the detailed report is saved. Click OK to store the result details in a .rpt file depending on the layout selected in Report Configuration pane. |

Note: The report details are real time and no history is maintained. Ensure that you save the report details before you run another test.

Status bar

At the bottom of the application window is the status bar that displays the selected test and the important configuration parameters.

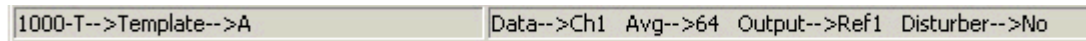

Figure 3-13: Status bar

Result pane

After you run a test, the Result pane automatically appears as shown by the following figure:

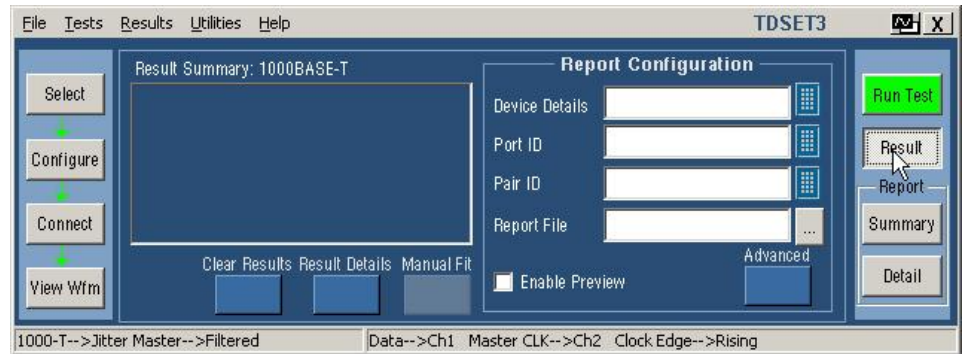

Figure 3-14: Result pane for all tests

After you run a Return Loss test, the Result pane automatically appears as shown by the following figure:

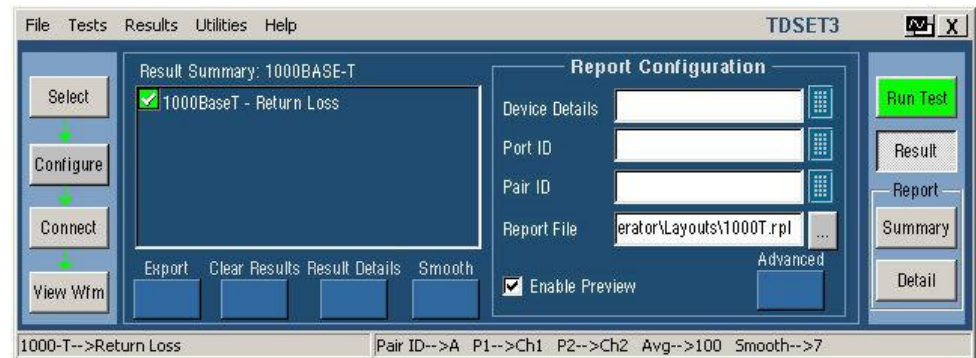

Figure 3-15: Result pane for Return Loss tests

The Result pane comprises Result Summary pane and Report Configuration pane.

**Result
Summary
pane**

The Result Summary pane displays the test results as Pass/Fail/Inconclusive.

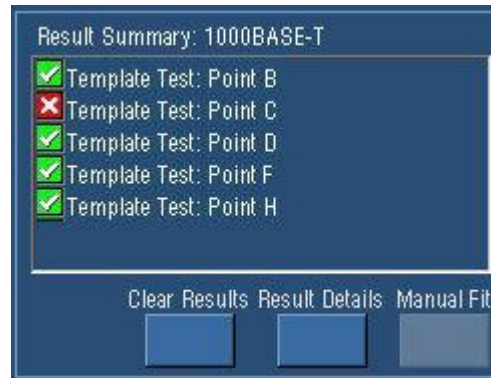





Figure 3-16: Result Summary pane

-  Indicates that the test has passed.
-  Indicates that the test has failed.
-  Indicates that the test is inconclusive.

The next table lists the buttons and the task descriptions:

Table 3-9: Result Summary pane buttons

| Button | Description |
|----------------|--|
| Export | Exports the return loss values in a .csv file. |
| Clear Results | Clears the results in the Result Summary pane. |
| Result Details | Displays the Result Details dialog box that shows the details of test results categorized as Description, Specification range, Measured Value, Pass/Fail/Inconclusive, and Remarks. |
| Manual Fit | Displays the Manual Fit dialog box that allows you to adjust the waveform to fit into the Mask. This button is enabled only when you test 1000BASE-T Template, 100BASE-TX Template or 10BASE-T Template. |
| Smooth | Displays the Smooth dialog box that allows you to smoothen the return loss waveform. This button is enabled only when you test Return Loss. |

Report Configuration pane

You can set the report details to identify and automatically generate the report. You can set a default report file.

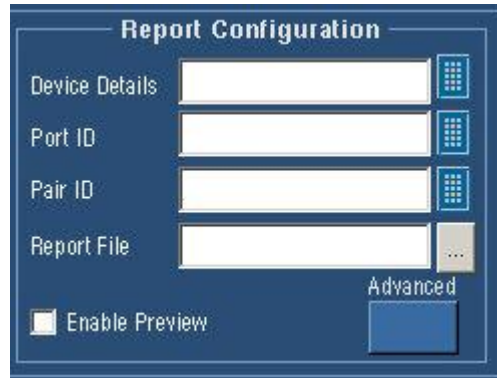

Figure 3-17: Report Configuration pane

The next table lists the report configuration fields and descriptions:

Table 3-10: Report Configuration fields

| Field | Description |
|--------------------|--|
| Device ID | To identify on which DUT the test was conducted by printing the Device ID on the generated report. |
| Device description | To identify on which DUT the test was conducted by printing the Device Description on the generated report. |
| Pair ID | To identify the unique pairs by printing the Device Description on the generated report. This field is enabled only for 1000BASE-T. |
| Report File | To specify the path and the file in which the generated report will be saved. A default file name and path displayed for the selected speed. |
| Enable Preview | To automatically preview the report after generation and have the option to save the report file. |
| Advanced button | Displays the Advanced Report Configuration dialog box. |

Dialog Boxes

Preferences dialog box

Use this dialog box to set the user preferences such as, show or hide the Overwrite Reference message box, Overwrite Math message box, 10Base-T user intervention for Template, 10Base-T user intervention for Jitter tests and 1000Base-T user intervention for Distortion test.

Click **File > Preferences** to display the Preferences dialog box.



Figure 3-18: Preferences dialog box

The next table lists the preferences and task description:

Table 3-11: Preferences

| Preference | Task description |
|--|---|
| Show or Hide the Overwrite Reference message box | <p>In Preference dialog box, select or clear the Show Ref overwrite check box.</p> <p>If you select Show Ref overwrite check box, the application displays the following warning every time you run 1000BASE-T Template, Peak Volt, Distortion, and Jitter tests. This dialog box also appears for Return Loss tests. This dialog box appears for 1000BASE-T Droop test only if Disturbing Signal is selected as Yes.</p>  |

Table 3-11: Preferences (cont)

| Preference | Task description |
|------------|------------------|
|------------|------------------|

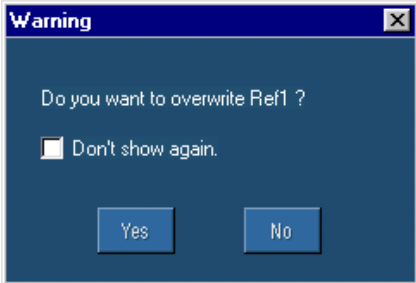

| | |
|---|---|
| <p>Show or Hide the Overwrite Math message box</p> | <p>In Preference dialog box, select or clear the Show Math overwrite check box.</p> <p>If you select Show Math overwrite check box, the application displays the following warning box every time you run 10BASE-T Harmonic Test.</p>  |
| <p>Show or hide 10Base-T user intervention for Template tests</p> | <p>In Preference dialog box, select or clear the Show 10Base-T Template user control check box.</p> <p>If you select the check box, the application displays the following warning box every time you run 10BASE-T Template Test.</p>  <p>Toggle Lock Mask to Wfm between On and Off to lock or unlock the mask to waveform when you zoom in or zoom out.</p> <p>Toggle Mask Autofit between On and Off to allow the oscilloscope to automatically fit the waveform to mask.</p> |

Table 3-11: Preferences (cont)

| Preference | Task description |
|------------|------------------|
|------------|------------------|

Show or hide 1000Base-T user intervention for Distortion test

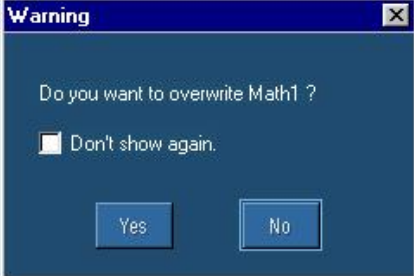
In Preference dialog box, select or clear the **Show 1000Base-T Distortion user control** check box.

If you select the check box, the application displays the following warning box every time you run **1000BASE-T Distortion Test**.

Ethernet Compliance Test Software

Ch1 17.1ns

M 5.0ns 20.0GS/s
A Width Ch1

50.0ps/pt

Does the signal look like this? If not,
1. Check for the polarity of the signal.
2. Turn the trigger level knob on front panel to adjust the trigger level for proper stable trigger.

Don't show again Click OK to continue.

Table 3-11: Preferences (cont)



| Preference | Task description |
|---|--|
| <p>Show or hide 10Base-T user intervention for Jitter tests</p> | <p>In Preference dialog box, select or clear the Show 10Base-T Jitter user control check box.</p> <p>If you select the check box, the application displays the following warning box every time you run 10BASE-T Jitter with cable Test.</p>  <p>If you select the check box, the application displays the following warning box every time you run 10BASE-T Jitter without cable Test.</p>  |

Table 3-11: Preferences (cont)

| Preference | Task description |
|---|---|
| Show or Hide the message for alternate 1000Base-T Jitter test | In Preference dialog box, select or clear the Show 1000Base-T Jitter message user control check box. If you select the check box, the application displays the following message every time you run 1000BASE-T JitterTest (Alternate Method) . |



Click **OK** to set the preferences.

Click **Cancel** to exit the Preference dialog box.

Advanced Report Configuration dialog box

Select **Results** in the Execution pane, and **Advanced** in the Report Configuration pane of the Result pane. The Advanced Report Configuration dialog box appears as shown in the next figure:

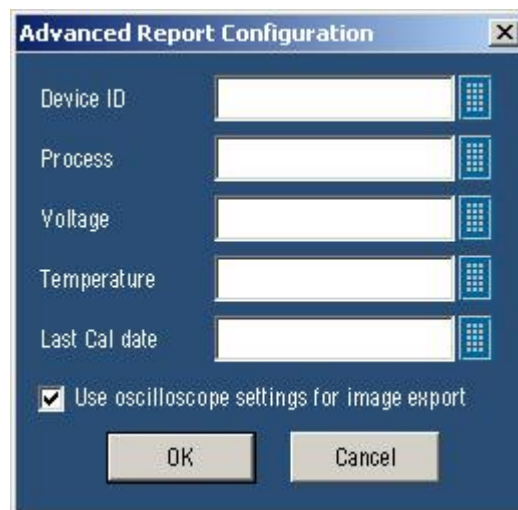

Figure 3-19: Advanced Report Configuration dialog box

The table lists the options that you can configure in the advanced report configuration dialog box:

Table 3-12: Advanced report configuration

| Field | Description |
|--|---|
| Device ID | Prints the Device Id on the generated report to help you identify on which DUT the test was conducted. |
| Process | Prints the Process on the generated report to help you identify the process used for DUT. |
| Voltage | Prints the Voltage on the generated report to help you identify the voltage values used while testing the DUT. |
| Temperature | Prints the Temperature on the generated report to help you identify the temperature values used while making the DUT. |
| Last Cal date | Prints the Last Cal date on the generated report to help you identify the date on which the oscilloscope was last calibrated. |
| Use oscilloscope settings for image report | Select this check box to use the oscilloscope settings for exporting images. |

Click **OK** to configure the report.

Click **Cancel** to exit the report setup.

Result Details dialog box Select **Result Details** button in Result pane to display the Result Details dialog box.

After you have completed the test and you want to see the result details, click on the **Result Details** button in Result pane. The Result Details dialog box appears as shown by the following figure. The title bar displays the selected speed.

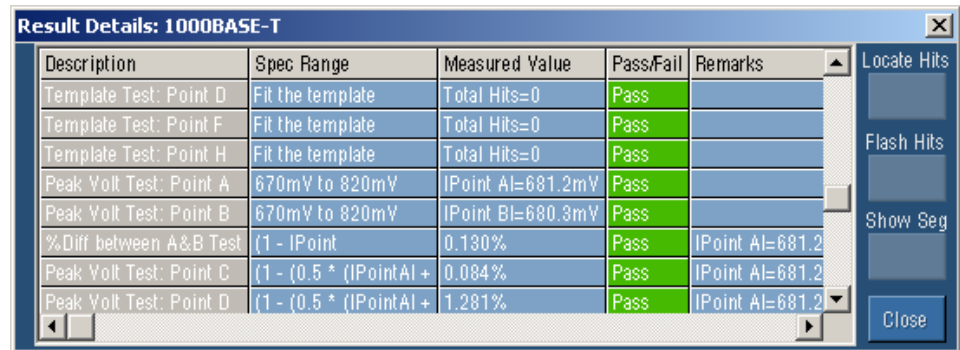

Figure 3-20: Result Details dialog box

The results are categorized as listed in the next table:

Table 3-13: Result Details categorization

| Category | Description |
|----------------|---|
| Description | Displays the selected test. |
| Spec Range | Displays the specification range. |
| Measured Value | Measured value of the selected test. |
| Pass/Fail | Test passed or failed or inconclusive as Pass , Fail , or Inconclusive . |
| Remarks | Additional information about the test. |

Note: Locate Hits, and Flash Hits are enabled only if a template test fails. The TDS5000B series oscilloscopes do not support Flash Hits.

Select **Locate Hits** to view and change the mask color and hit color.

Select **Flash Hits** to flash the hits on the oscilloscope display.

Select **Show Seg** to display the mask segments.

Select **Close** to close the dialog box.

Note: If you run all the tests together using Select All, the Locate Hits, Flash Hits, and Show Seg buttons are disabled.

Locate Hits dialog box

Select **Result Details** button in Result pane to display the Result Details dialog box. In the Result Details dialog box, select **Locate Hits** to display the Mask Hit Locator dialog box as shown by the following figure:

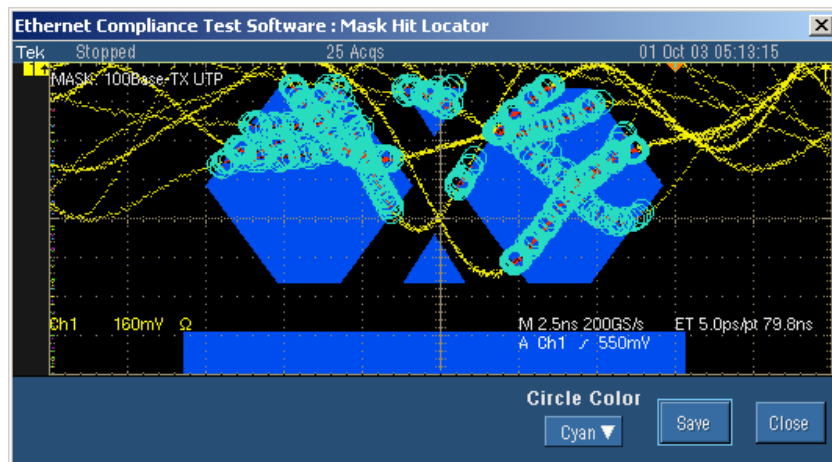

Figure 3-21: Mask Segments dialog box

1. Selecting **Locate Hits** changes the mask color and hit color. Closing the Locate Hits dialog box will set the Mask color to default.
2. In the **Circle Color** drop-down list, select the color in which you want to see the mask hits circled.
3. Select **Save** to save the mask-hit image as a jpg or a bmp file. The default directory is C:\TekApplications\TDSET3\Images.
4. Select **Close** to close the dialog box.

Flash Hits dialog box Select **Result Details** button in Result pane to display the Result Details dialog box. In the Result Details dialog box, select **Flash Hits** to flash the hits on the oscilloscope display. The Flash Hits message box appears as shown by the following figure:

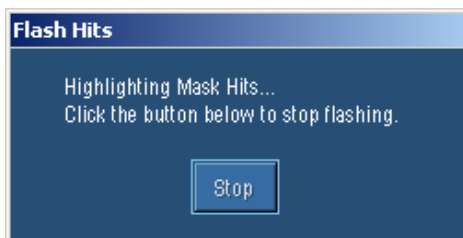

Figure 3-22: Flash Hits message box

Select **Stop** in the Flash Hits message box to stop flashing the mask hits.

Show Segments dialog box Select **Result Details** button in Result pane to display the Result Details dialog box. In the Result Details dialog box, select **Show Seg** to display the mask segments. The Show Segments dialog box appears as shown by the following figure:

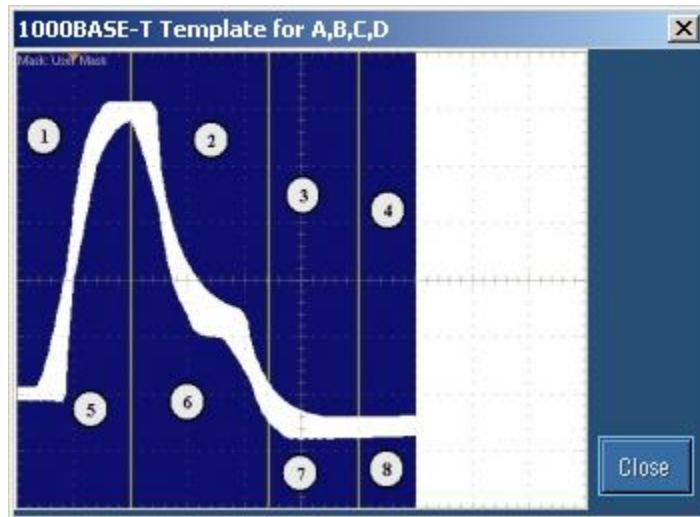

Figure 3-23: Show Segments dialog box

Show Seg is enabled only if you run the template test.

Select **Close** to close the dialog box.

Manual Fit dialog box Select **Result Details** button in Result pane to display the Result Details dialog box. In the Result Details dialog box, select **Manual Fit** to display the manual fit dialog box.

Note: If you select the Select All button, Manual Fit is not enabled.

If you are running 1000BASE-T Template test, the Manual Fit dialog box appears as shown by the next figure:

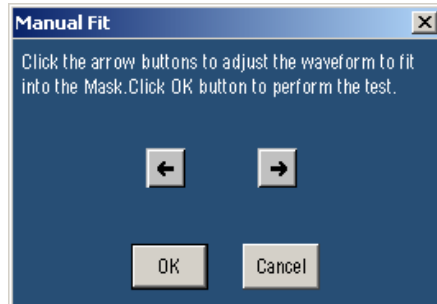

Figure 3-24: 1000BASE-T Manual Fit dialog box

When you test Template in 1000BASE-T, you can manually fit the waveform into the mask.

If the processed waveform does not lie within the mask, use **Manual Fit** to manually fit the waveform into the mask as described below:

1. Click the arrow buttons to adjust the waveform to fit into the Mask.
2. Click **OK** to perform the mask pass/fail test again. Click **Cancel** to exit the Manual Fit dialog box without performing the mask pass/fail test

If you are running 100BASE-TX or 10BASE-T Template tests, the Manual Fit dialog box appears as shown by the next figure:



Figure 3-25: 100BASE-TX/10BASE-T Manual Fit dialog box

When you test Template in 100BASE-TX, and 10BASE-T, you can manually fit the waveform into the mask.

If the processed waveform does not lie within the mask, use **Manual Fit** to manually fit the waveform into the mask as follows:

1. To adjust the waveform to fit into the Mask, change the horizontal position and vertical position using the general purpose knobs or Virtual Keyboard.
2. Click **OK** to perform the mask pass/fail test again.

Jig match dialog box If you are running 1000BASE-T Template test, the Jig Match button appears in the Connect pane. Click **Jig Match** to display the Jig Match dialog box.

1000-T > Template > Connect > Jig Match

Note: Jig Match is enabled only if you select Disturbing Signal as Yes.

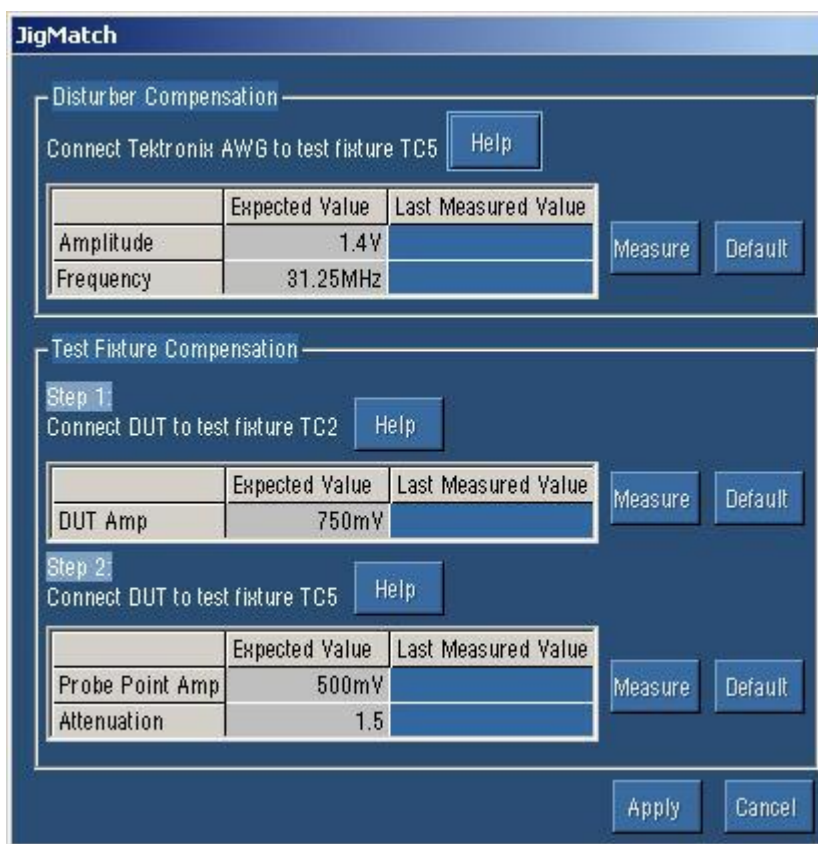

Figure 3-26: Jig Match dialog box for 1000-T Template/Peak Volt/Droop test

1000-T > Distortion > Connect > Jig Match

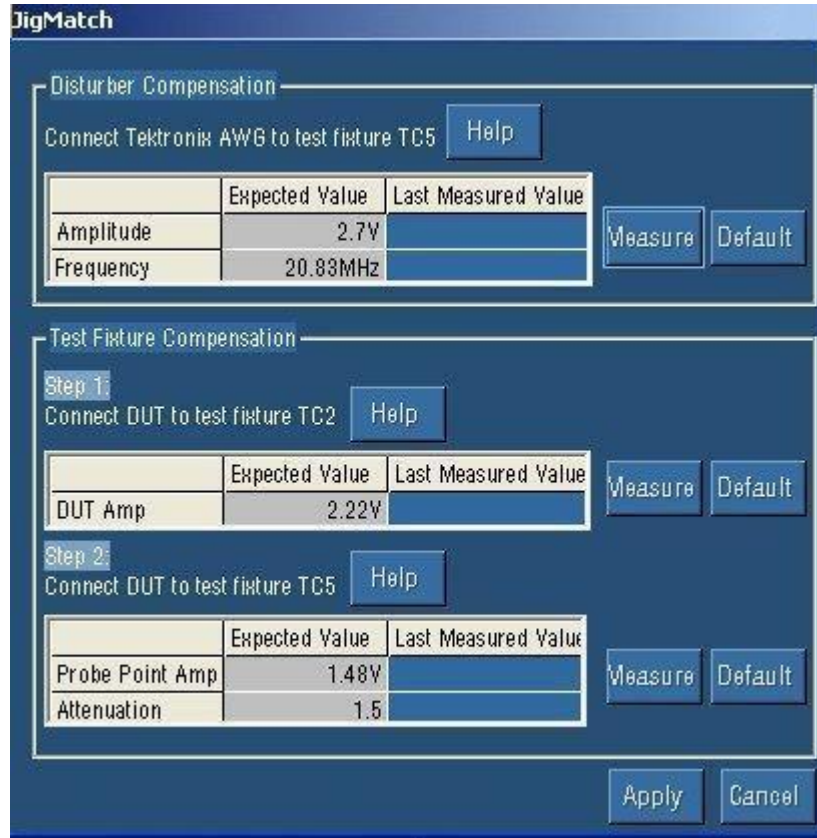

Figure 3-27: Jig Match dialog box for 1000-T Distortion test

Use Jig Match to effectively remove the disturbing signal and compensate for non-linearities in the disturber and the test fixture. You can measure the disturbing signal's Amplitude, and Frequency. You can also set the default values. The application measures and displays the values in Measured Value fields. You can validate the disturbing signal by comparing the Measured Value with the Expected Value.

To compensate for the Disturbing Signal, do the following:

1. Use TC5 of the test fixture for Disturber Compensation.
2. Make the connections as shown by the following figure:

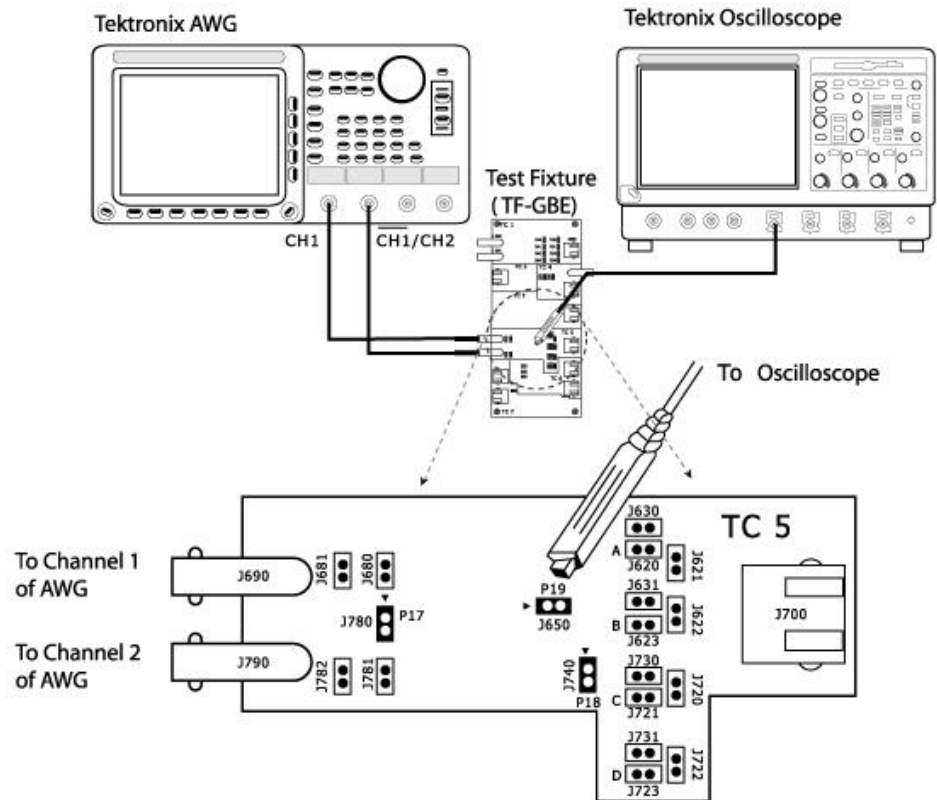

Figure 3-28: Connections for Disturber compensation

Note: Do not connect the Ethernet cable to J700 and the test port of the DUT.

3. Connect a BNC Cable to (AWG/AFG)+ and Channel 1 of Arbitrary Waveform Generator/Arbitrary Function Generator.
4. Connect a BNC Cable to (AWG/AFG)- and Channel 2 ($\overline{\text{CH1}}$) of Arbitrary Waveform Generator/Arbitrary Function Generator.
5. Short the jumpers J621, J630, J620, J623, J721, J723, J680, and J781.
6. Connect the Differential Probe to P19 and configured channel of the oscilloscope.

7. In the Jig Match dialog box, select Measure button in the Disturber Compensation pane.
8. Compare the Measured Value with the Expected Value.
9. If the Measured Value is not approximately equal to the Expected Value, modify the amplitude and clock frequency settings of the Arbitrary Waveform Generator/Arbitrary Function Generator. Then click Measure and compare the values to be approximately equal.

To compensate for the Test Fixture, do the following:

1. Use TC2 and TC5 of the test fixture for Test Fixture Compensation.
2. Make the connections as shown by the following figure:

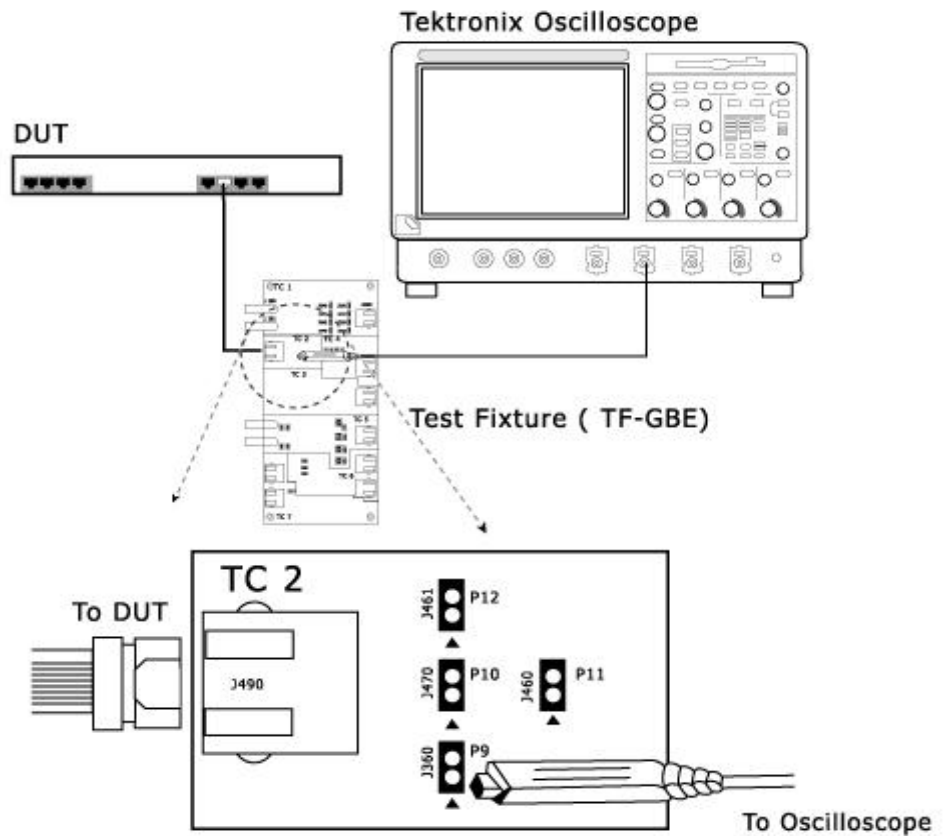

Figure 3-29: Step 1 Connections of Test Fixture compensation

3. For Template, Droop, and Peak Voltage tests, set the DUT to generate Test Mode 1 signal.
For Distortion test, set the DUT to generate Test Mode 4 signal.

4. Connect the Ethernet cable to J490 and the test port of the DUT.
5. Connect the Differential Probe to P9 and configured channel of the oscilloscope.
6. In the Jig Match dialog box, select Measure button in Step 1 in the Test Fixture Compensation pane.
7. Make the connections as shown by the following figure:

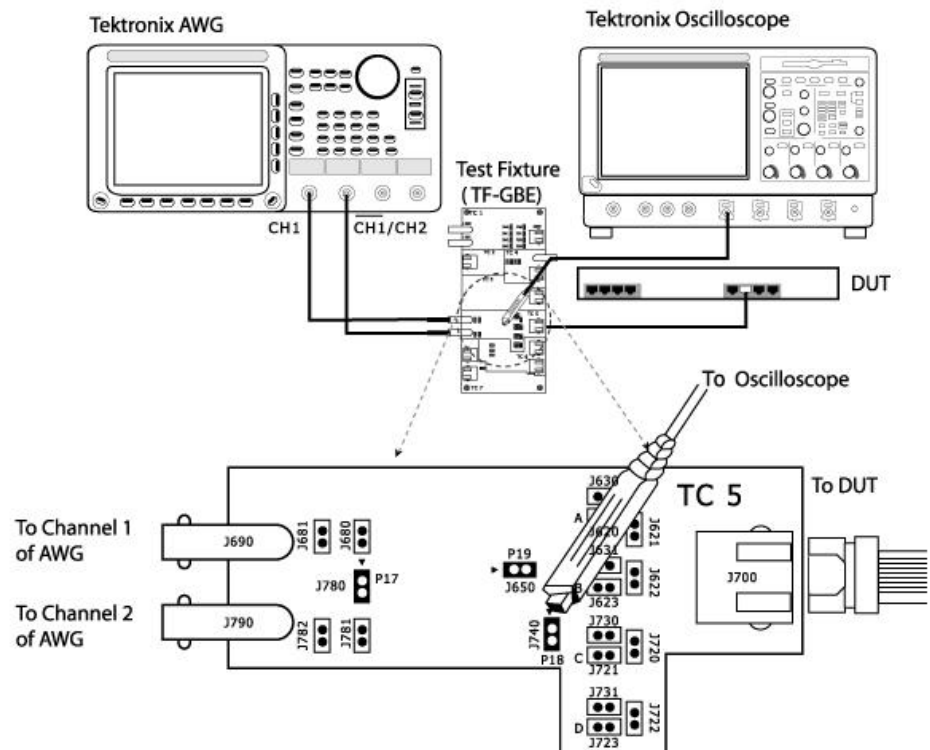

Figure 3-30: Step 2 Connections of Test Fixture compensation

8. For Template, Droop, and Peak Voltage tests, set the DUT to generate Test Mode 1 signal.
For Distortion test, set the DUT to generate Test Mode 4 signal.
9. Connect the Ethernet cable to J700 and test port of the DUT.
10. Connect a BNC Cable to (AWG/AFG)+ and Channel 1 of Arbitrary Waveform Generator/Arbitrary Function Generator.
11. Connect a BNC Cable to (AWG/AFG)- and Channel 2 ($\overline{\text{CH1}}$) of Arbitrary Waveform Generator/Arbitrary Function Generator.
12. Switch OFF the Arbitrary Waveform Generator/Arbitrary Function Generator.

13. Short the jumpers J621, J630, J623, J721, J723, J680, and J781.
14. Connect the Differential Probe to P18 and configured channel of the oscilloscope.
15. In the Jig Match dialog box, select Measure button in Step 2 in the Test Fixture Compensation pane.

**Virtual
Keyboard
dialog box**

Selecting  adjacent to any number field displays the Virtual Keyboard.



Figure 3-31: Virtual keyboard

The field on the top displays what you have selected. After you have selected the required number, select **Enter**.

- Selecting **Space** inserts a space
- Selecting **Enter** enters the value for the selected field
- Selecting **Backspace** deletes the value entered
- Selecting **Esc** exits the Virtual Keyboard

Virtual Keypad dialog box Select the knob or the keypad icon adjacent to any text field to display the Virtual Keypad dialog box.

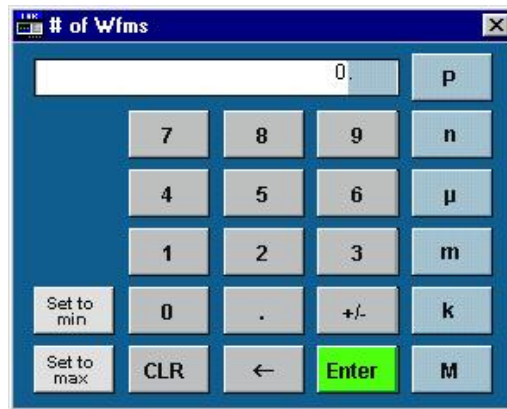

Figure 3-32: Virtual keypad

Use this dialog box to enter custom values.

- Selecting **Set to min** automatically displays the minimum value of the selected field
- Selecting **Set to max** automatically displays the maximum value of the selected field
- Selecting **CLR** clears the value for the field selected and returns to zero value
- Selecting **Enter** enters the value for the selected field

Mask Setup dialog box The **Mask Setup** button is available in the Configure pane and is enabled only when you run template tests.

If you are configuring 100BASE-TX Template test, click on Mask Setup button in the Configure pane to display the Mask Setup dialog box.



Figure 3-33: 100BASE-TX Mask Setup dialog box

In the Samples text box, enter the number of samples to use in the test. Entering the number of samples stops the test when that number has been reached. The accepted range of samples is between 5000 and 2,147,400,000. The default number of samples is 16,000.

In the Fail Thresh text box, enter the minimum number of samples that must fail for the test to fail. The accepted range of samples is between 1 and 2,147,483,647. The default fail threshold is 1.

Note: You can use the Virtual Keyboard or the General Purpose knobs to enter the values in the Samples and Fail Thresh fields.

If you are configuring 10BASE-T Template test, click on Mask Setup button in the Configure pane to display the Mask Setup dialog box.



Figure 3-34: 10BASE-T Mask Setup dialog box

In the # of Wfms text box, enter the number of waveforms to use in the test. Entering the number of waveforms stops the test when that number has been reached.

The accepted range of samples is between 1 and 2,147,483,647. The default number of samples is 16.

In the Fail Thresh text box, enter the minimum number of samples that must fail for the test to fail.

The accepted range of samples is between 1 and 2,147,483,647. The default fail threshold is 1.

Smooth dialog box

Select **Result Details** button in Result pane to display the Result Details dialog box. In the Result Details dialog box, select **Smooth** to smoothen the return loss waveform. This button is enabled only when you test Return Loss for all speeds.

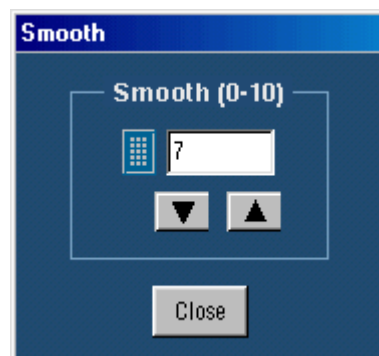

Figure 3-35: Smooth dialog box

After you test Return Loss, you can change the smoothness of the waveform. The accepted range is within 0 to 10. The default is 7.

Click the arrow buttons to increase or decrease the value and view the smoothness of the waveform. The waveform is automatically updated as you change the value.

Click **Close** to perform the pass/fail test again.

Exit dialog box Select **File > Exit** to display the following message box:



Figure 3-36: Exit dialog box

You can exit the application by restoring the oscilloscope settings to the previous state before starting the application or retaining the present oscilloscope settings.

- Select **File > Exit**
- Select **Yes** to restore the oscilloscope settings to their original state before starting the application and exit the application
or
Select **No** to retain the present oscilloscope settings and exit the application
or
Select **Cancel** to cancel the operation and return to the application

Note: Clicking **X** displays the Exit dialog box.

How To Select Test Parameters

Selecting 1000BASE-T Test Parameters

The following table lists how to select the 1000BASE-T test parameters:

Table 4-1: Select 1000BASE-T test parameters

| Test parameter | Selection |
|--------------------------|---|
| 1000BASE-T | Click Tests > Select > 1000BASE-T or select 1000-T in the Speed pane. |
| Template | In the Template/Volt tab, select a point in the <i>Template</i> group. |
| Peak Voltage | In the Template/Volt tab, select a point in the <i>Peak Volt</i> group. |
| Droop | In the Droop tab, select a point. |
| Jitter Master Filtered | In the Jit/Distortion tab, select Master Filtered. |
| Jitter Master Unfiltered | In the Jit/Distortion tab, select Master Unfiltered. |
| Jitter Slave Filtered | In the Jit/Distortion tab, select Slave Filtered. |
| Jitter Slave Unfiltered | In the Jit/Distortion tab, select Slave Unfiltered. |
| Distortion | In the Jit/Distortion tab, select Distortion. |
| Return Loss | In the Return Loss tab, select Return Loss. |
| CM Voltage | In the CM Voltage tab, select CM Voltage. |

Note: The TDS5000B series oscilloscopes do not support Jitter Slave Filtered test.

Selecting 100BASE-TX Test Parameters

The following table lists how to select the 100BASE-TX test parameters:

Table 4-2: Select 100BASE-TX test parameters

| Test parameter | Selection |
|-----------------------------|--|
| 100BASE-TX | Click Tests > Select > 100BASE-TX or select 100-TX in the Speed pane. |
| Template | In the <i>Parametric</i> tab, select Template. In the Polarity drop-down list, select Pos for positive, Neg for negative, or Both. For Positive polarity, the application tests segments 1, 2, 3, 6, and 7. For Negative polarity, the application tests segments 4, 5, 8, 9, and 10. For Both, the application tests all the segments. |
| Differential Output Voltage | In the <i>Parametric</i> tab, select Output Volt. In the Polarity drop-down list, select Pos for positive, Neg for negative, or Both. |
| Signal Amplitude Symmetry | In the <i>Parametric</i> tab, select Amp Sym. In the Polarity drop-down list, select Pos for positive, Neg for negative, or Both. |
| Rise Time | In the <i>Parametric</i> tab, select Rise Time. In the Polarity drop-down list, select Pos for positive, Neg for negative, or Both. |
| Fall Time | In the <i>Parametric</i> tab, select Fall Time. In the Polarity drop-down list, select Pos for positive, Neg for negative, or Both. |
| Rise/Fall Time Symmetry | In the <i>Parametric</i> tab, select R/F Sym. In the Polarity drop-down list, select Pos for positive, Neg for negative, or Both. |
| Waveform Overshoot | In the <i>Parametric</i> tab, select Overshoot. In the Polarity drop-down list, select Pos for positive, Neg for negative, or Both. |
| Jitter | In the <i>Parametric</i> tab, select Jitter. In the Polarity drop-down list, select Pos for positive, Neg for negative, or Both. |
| Duty Cycle Distortion | In the <i>Parametric</i> tab, select Distortion. Select Random or 010101 in the Pattern drop-down list. |
| Return Loss | In the <i>Return Loss</i> tab, select either Transmitter or Receiver. |

Selecting 10BASE-T/10BASE-Te Test Parameters

The following table lists how to select the 10BASE-T test parameters:

Table 4-3: Select 10BASE-T/10BASE-Te test parameters

| Test parameter | Selection |
|--|---|
| 10BASE-T | Click Tests > Select > 10BASE-T or select 10-T in the Speed pane. |
| 10BASE-T/ 10BASE-Te Template MAU | In the Template tab, select MAU and select Normal, Inverted or Both in the adjacent drop-down list. Select Configure in the Selection pane and select the MAU Type as External or Internal. |
| 10BASE-T Template Link Pulse | In the Template tab, select Link Pulse. In the adjacent drop-down list, select the load with or without TPM — Load1 w/o TPM, Load2 w/o TPM, 100 Ohm w/o TPM*, Load1 with TPM, Load2 with TPM, or 100 Ohm with TPM*. |
| 10BASE-T/ 10BASE-Te Template TP_IDL | In the Template tab, select TP_IDL. In the adjacent drop-down list, select the load with or without TPM — Load1 w/o TPM, Load2 w/o TPM, 100 Ohm w/o TPM*, Load1 with TPM, Load2 with TPM, or 100 Ohm with TPM*. |
| 10BASE-T/ 10BASE-Te Differential Voltage | In the Parametric tab, select Diff Volt. From the Peak drop-down list, select the peak value as Max or MinMax. |
| 10BASE-T/ 10BASE-Te Harmonic | In the Parametric tab, select Harmonic. |
| 10BASE-T Jitter with cable | In the Parametric tab, select With Cable in the <i>Jitter</i> group. Select Normal, 8BT, 8.5BT, or All in the adjacent drop-down list. |
| 10BASE-T Jitter without cable | In the Parametric tab, select w/o Cable in <i>Jitter</i> group. Select Normal, 8BT, 8.5BT, or All in the adjacent drop-down list. |
| 10BASE-T Return Loss | In the <i>Return Loss</i> tab, select either Transmitter or Receiver. |
| 10BASE-T CM Voltage | In the CM Voltage tab, select CM Voltage. |

*The loads 100 Ohm with TPM and 100 Ohm w/o TPM are optional and not required as per the 802.3-2002 standards (for 10BASE-Te, refer to 802.3az standard).

How To Configure Parameters

Configuring 1000BASE-T

Use this dialog box to configure 1000BASE-T for Source, # Averages, Output, Disturbing Signal, and Filter.

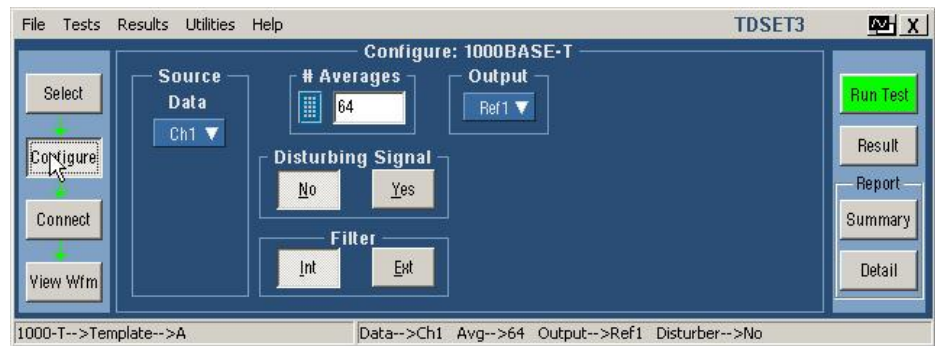

Figure 5-1: 1000BASE-T Configure pane

The following table shows the 1000BASE-T tests parameters you can configure:

Table 5-1: 1000BASE-T Configure parameters

| | Data | Master CLK | Slave CLK | TX_TCLK | Data (TM2) | Data (TM3) | # Averages | Clock Edge (Rising / Falling) | Disturbing Signal (Yes / No) | Filter (Int or Ext) | Hi Resolution | TX_TCLK (No / Yes) | Output | Meas Type (Histogram / TIE) | Probe: P1 | Probe: P2 | Pair ID |
|--------------------------|------|------------|-----------|---------|------------|------------|------------|-------------------------------|------------------------------|---------------------|---------------|--------------------|--------|-----------------------------|-----------|-----------|---------|
| Template | ✓ | | | | | | ✓ | | ✓ | ✓ | | | ✓ | | | | |
| Peak Volt | ✓ | | | | | | ✓ | | ✓ | ✓ | | | ✓ | | | | |
| Droop | ✓ | | | | | | ✓ | | ✓ | | | | ✓ | | | | |
| Jitter Master Filtered | ✓ | ✓ | | | ✓ | | | ✓ | | | | ✓ | | | | | |
| Jitter Master Unfiltered | | ✓ | | | ✓ | | | ✓ | | | | ✓ | | ✓ | | | |
| Jitter Slave Filtered | ✓ | ✓ | ✓ | | ✓ | ✓ | | ✓ | | | | ✓ | | | | | |
| Jitter Slave Unfiltered | | ✓ | ✓ | | ✓ | ✓ | | ✓ | | | | ✓ | | ✓ | | | |
| Distortion | ✓ | | | ✓ | | | ✓ | | ✓ | | ✓ | ✓ | ✓ | | | | |
| Return Loss | | | | | | | ✓ | | | | | | | | ✓ | ✓ | ✓ |
| CM Voltage | ✓ | | | | | | ✓ | | | | | | | | | | |

The following table describes the 1000BASE-T configuration parameters:

Table 5-2: 1000BASE-T Configure parameter description









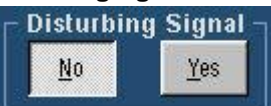

| Configure parameters | Description |
|---|--|
| <p>Source</p>  | <p>The Data source and CLK source should be mutually exclusive. The Data source, Master CLK source and Slave clock source should be mutually exclusive.</p> <p>Data — Select the channel to which the DUT signal is connected.</p> <p>Master CLK — Select the channel to which the master clock is connected.</p> <p>Slave CLK — Select the channel to which the slave clock is connected.</p> <p>TX_TCLK — Select the channel to which the TX_TCLK is connected.</p> <p>Data (TM2) — Select the channel to which data in Test Mode 2 is connected.</p> <p>Data (TM3) — Select the channel to which data in Test Mode 3 is connected.</p> <hr/> <p><i>Note: TX_TCLK drop-down list appears only for Distortion test and if you have selected TX_TCLK as Yes.</i></p> <hr/> <p>Data (TM2) and Data (TM3) drop-down lists appear only for Jitter tests if you have selected the TX_TCLK as No.</p> <p>Master CLK and Slave CLK drop-down lists appear only for Jitter tests if you have selected the TX_TCLK as Yes.</p> |
| <p># of Averages</p>  | <p>Enter the number of averages between 64 and 10000 depending on the noise present in the acquired waveform.</p> |
| <p>Clock Edge</p>  | <p>Select the clock edge on which the oscilloscope finds the trigger point.</p> |
| <p>Disturbing Signal</p>  | <p>Select Yes or No depending on whether the disturbing signal is added to the test mode signal.</p> |
| <p>Filter</p>  | <p>Select Int or Ext depending on whether the filter is applied internally or externally.</p> |
| <p>TX_TCLK</p>  | <p>Select Yes or No to perform the Distortion test with TX_TCLK.</p> |
| <p>Output</p>  | <p>Select the reference waveform on which the processed waveform will be stored.</p> |

Table 5-2: 1000BASE-T Configure parameter description (cont)

| Configure parameters | Description |
|---|--|
| <p>Meas Type</p>  | <p>Select the measurement type as either Time Interval Error (TIE) or Histogram.</p> |
| <p>Hi Resolution</p>  | <p>Enter the number of averages to be done in the vertical domain.</p> |
| <p>Return Loss</p>  | <p>Probe: P1 and Probe: P2 — Select the channels to which the probes are connected.</p> <hr/> <p><i>Note: Depending on the Pair ID selected, the sources will change from P1/P3/P5/P7 and P2/P4/P6/P8.</i></p> <hr/> <p>Load — Select the load as 85, 100, 115 Ohm or 100 Ohm. Pair ID — Select the Pair ID as A, B, C, or D. Depending on the Pair ID selected the sources will change from P1/P3/P5/P7 and P2/P4/P6/P8. Return Loss — Select the reference waveform on which the output waveform will be stored. 0 dB Marker — Select the reference waveform on which you want the 0 dB Marker to be indicated.</p> <hr/> <p><i>Note: Return Loss and 0 dB Marker fields appear only if you set Load as 100 Ohm.</i></p> <hr/> <p># Averages — Enter the number of waveforms you want to average. Smooth — Enter the smoothing factor.</p> |
| <p>Record Length</p>  | <p>Select the record length. This varies depending on the memory option available on the oscilloscope.</p> |
| <p>Low Pass Filter</p>  | <p>Select Yes or No. The Low Pass Filter has a cutoff frequency of 150 MHz and when applied, eliminates high frequency noise.</p> |
| <p>Hysteresis</p>  | <p>Enter the hysteresis percent value.</p> |

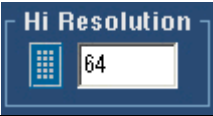
The following table lists the configuration parameters and default settings:

Table 5-3: 1000BASE-T Configuration default settings

| Parameter | Options | Default |
|-------------------|-------------------------|------------------|
| Data | CH1, CH2, CH3, CH4 | CH1 |
| Master CLK | CH1, CH2, CH3, CH4 | CH2 |
| Slave CLK | CH1, CH2, CH3, CH4 | CH3 |
| Data (TM2) | CH1, CH2, CH3, CH4 | CH1 |
| Data (TM3) | CH1, CH2, CH3, CH4 | CH2 |
| # Averages | 64 to 10000 | 64 |
| Clock Edge | Rising, Falling | Rising |
| Disturbing Signal | Yes, No | No |
| Filter | Int, Ext | Int |
| TX_TCLK | No, Yes | No |
| TX_TCLK | CH1, CH2, CH3, CH4 | CH2 |
| Output | Ref1, Ref2, Ref3, Ref4 | Ref1 |
| Meas Type | Histogram, TIE | TIE |
| Hi Resolution | 02 to 75 | 64 |
| Probe:P1/P3/P5/P7 | CH1, CH2, CH3, CH4 | CH1 |
| Probe:P2/P4/P6/P8 | CH1, CH2, CH3, CH4 | CH2 |
| Pair ID | A, B, C, D | A |
| Load | 85, 100, 115 or 100 Ohm | 85, 100, 115 Ohm |

Note: The TDS5052B oscilloscope displays the graticule only for 100 Ohm Load.

| | | |
|-----------------|-----------------|--|
| Smooth | 0 - 10 | 7 |
| Record Length | | Varies depending on the Memory option available on the oscilloscope. |
| Low Pass Filter | Yes, No | Yes |
| Hysteresis | 5.00% to 30.00% | 5.00% |

Configuring 100BASE-TX

Use this dialog box to configure 100BASE-TX for Data source, Acquisition, Rise/Fall Time Test, and Mask Setup.

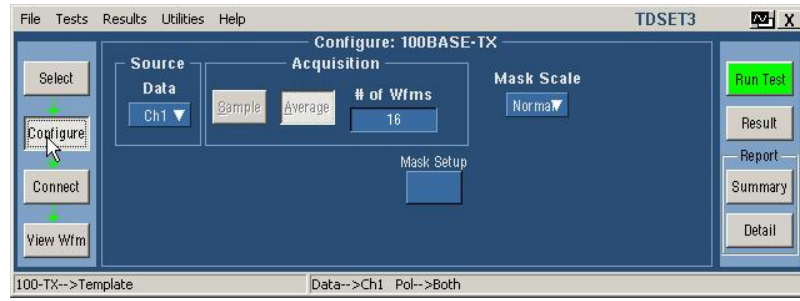

Figure 5-2: 100BASE-TX Configure pane

The following table shows parameters of 100BASE-TX that you can configure:

Table 5-4: 100BASE-TX Configure parameters

| | Data | Acquisition | Mask Scale | Mask Setup | Pulse Width | Probe:P1 | Probe:P2 | Probe:P3 | Probe:P4 | AWG/AFG | Load | # Averages |
|-----------------------------|------|-------------|------------|------------|-------------|----------|----------|----------|----------|---------|------|------------|
| Template | ✓ | | ✓ | ✓ | | | | | | | | |
| Differential Output Voltage | ✓ | ✓ | | | | | | | | | | |
| Amplitude Symmetry | ✓ | ✓ | | | | | | | | | | |
| Rise Time | ✓ | ✓ | | | ✓ | | | | | | | |
| Fall Time | ✓ | ✓ | | | ✓ | | | | | | | |
| Rise or Fall Time Symmetry | ✓ | ✓ | | | ✓ | | | | | | | |
| Waveform Overshoot | ✓ | ✓ | | | | | | | | | | |
| Jitter | ✓ | | | | | | | | | | | |
| Duty Cycle Distortion | ✓ | ✓ | | | | | | | | | | |
| Return Loss Transmitter | | | | | | ✓ | ✓ | | | ✓ | ✓ | ✓ |
| Return Loss Receiver | | | | | | | | ✓ | ✓ | ✓ | ✓ | ✓ |

The following table describes the 100BASE-TX configuration parameters:

Table 5-5: 100BASE-TX Configure parameter description









| Configure parameters | Description |
|--|--|
| Source  | Select the channel to which the Device Under Test (DUT) is connected. |
| Acquisition  | Select Sample or Average depending on the acquisition mode. The Acquisition is only enabled for some tests. If you select Average, enter the number of waveforms in <i># of Wfms</i> field. If you select Sample, the application assumes the number of waveforms as 1. You can use the virtual keyboard or the general-purpose knobs to enter the values in the Sample and Average text boxes. |
| Rise/Fall Time Test  | Select Pulse Width as 16 ns or 80 ns. You can only configure this parameter for Rise/Fall Time Symmetry, Rise Time, and Fall Time tests. |
| Mask Scale  | Select <i>Mask Scale</i> as Normal, 0.95, or 1.05 depending on the Mask scale factor. You can configure <i>Mask Scale</i> only for Template test. |
| Mask Setup  | You can configure the Samples and Fail Thresh. You can only configure these parameters for the template tests. |

Table 5-5: 100BASE-TX Configure parameter description (cont)

| Configure parameters | |
|--|---|
|  | <p>Probe: P1 and Probe: P2 — Select the channels to which the probes are connected on the fixture.</p> <p><i>Note: Depending on whether the Transmitter or Receiver is selected, the source will change from P1/P3 and P2/P4.</i></p> |
|  | <p>Return Loss — Select the reference waveform on which the output waveform will be stored.</p> <p>0 dB Marker — Select the reference waveform on which you want the 0 dB Marker to be indicated.</p> <p><i>Note: Return Loss and 0 dB Marker fields appear only if you set Load as 100 Ohm.</i></p> |
|  | <p><i>Note: Return Loss and 0 dB Marker fields appear only if you set Load as 100 Ohm.</i></p> |
|  | <p>AWG/AFG Series — Select the AWG/AFG Series to use. If you select the default value—Select—then the application considers all AWGs/AFGs other than the AWG 4xx series.</p> <p>Load — Select the load as 85, 100, 115 Ohm or 100 Ohm.</p> <p># Averages — Enter the number of waveforms you want to average.</p> <p>Smooth — Enter the smoothening factor.</p> |

The following table lists the configuration parameters and default settings:

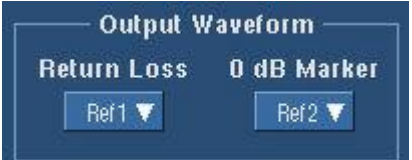
Table 5-6: 100BASE-TX Configuration default settings

| Parameter | Options | Default |
|-------------|--|--|
| Data | CH1, CH2, CH3, CH4 | CH1 |
| Acquisition | Sample, Average | If you select Sample, the default value is 1. If you select Average, the default # of Wfms is 16. |
| Mask Scale | Normal, 0.95, 1.05 | Normal |
| Mask Setup | | See Mask Setup for information on default Sample and Fail Thresh. |
| Pulse Width | 16 ns, 80 ns | 80 ns |
| Probe:P1/P3 | CH1, CH2, CH3, CH4 | CH1 |
| Probe:P2/P4 | CH1, CH2, CH3, CH4 | CH2 |
| AWG/AFG | Select, AWG 4xx, AWG 2021, AWG 5xx, AWG 6xx, AWG 7xx, AWG 5xxx, AWG 7xxx, AFG 3xxx | Select |

Table 5-6: 100BASE-TX Configuration default settings (cont)

| Parameter | Options | Default |
|-----------|-----------------------------|------------------|
| Load | 85, 100, 115 Ohm or 100 Ohm | 85, 100, 115 Ohm |
| Smooth | 0 - 10 | 7 |

Note: The two-channel oscilloscopes display the graticule only for 100 Ohm load.

Configuring 10BASE-T/10BASE-Te

Use this dialog box to configure 10BASE-T/10BASE-Te for Data source, Acquisition, Harmonic Ones, and Mask Setup.

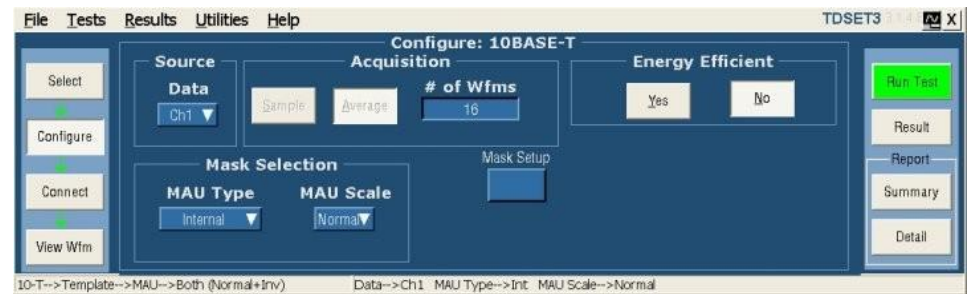

Figure 5-3: 10BASE-T/10BASE-Te Configure pane

Note: The 802.3az document includes the changes required to enable the Energy Efficient Ethernet (EEE) operation for many existing physical layers. One of the supported operations is twisted pair cabling. The PHY supports 100Base-TX, 1000Base T, 10Base-T, and other technologies. In addition to that EEE defines reduced amplitude operation for 10Base-T which is called 10BASE-Te. All the measurements of 100Base-TX and 1000Base T, and some of the measurements of 10Base-T are not affected when performing the 10BASE-Te measurements. The 10Base-T measurements that support the PHY tests for 10BASE-Te are modified with a separate configuration to select and perform.

The following table shows parameters of 10BASE-T/10BASE-Te to configure:

Table 5-7: 10BASE-T/10BASE-Te Configure parameters

| | Data | Acquisition | Mask Selection | | | Mask Setup | Sequence | Harmonic Ones | | | Probe:P1 | Probe:P2 | Probe:P3 | Probe:P4 | AWG/AFG | Load | # Averages | Smooth | Test options | Energy Efficient |
|-------------------------|------|-------------|----------------|----------|-----------|------------|----------|---------------|------------|-------------|----------|----------|----------|----------|---------|------|------------|--------|--------------|------------------|
| | | | Section | MAU Type | MAU Scale | | | Output | # Averages | Time/ Scale | | | | | | | | | | |
| Template Link Pulse | ✓ | ✓ | ✓ | | | ✓ | ✓ | | | | | | | | | | | | ✓ | |
| Template MAU | ✓ | | | ✓ | ✓ | ✓ | | | | | | | | | | | | | | ✓ |
| Template TP_IDL | ✓ | ✓ | ✓ | | | ✓ | | | | | | | | | | | | | | ✓ |
| Jitter with Cable | ✓ | | | ✓ | | | | | | | | | | | | | | | | |
| Jitter without Cable | ✓ | | | ✓ | | | | | | | | | | | | | | | | |
| Differential Voltage | ✓ | | | | | | | | | | | | | | | | | | | ✓ |
| Harmonic | ✓ | | | | | | | ✓ | ✓ | ✓ | | | | | | | | | | ✓ |
| Return Loss Transmitter | | | | | | | | | | | ✓ | ✓ | | | ✓ | ✓ | ✓ | | | |
| Return Loss Receiver | | | | | | | | | | | | | ✓ | ✓ | ✓ | ✓ | ✓ | | | |
| CM Voltage | ✓ | | | | | | | | | | | | | | | | | | | |

The following table describes the 10BASE-T/10BASE-Te configuration parameters:

Table 5-8: 10BASE-T/10BASE-Te Configure parameter description



| Configure parameters | Description |
|---|---|
| Source  | Select the channel to which the Device Under Test (DUT) is connected. |
| Acquisition  | <p>Select Sample or Average depending on the acquisition mode. The Acquisition is only enabled for some tests.</p> <p>If you select Average, enter the number of waveforms in <i># of Wfms</i> field.</p> <p>If you select Sample, the application assumes the number of samples as 1.</p> <p>You can use the virtual keyboard or the general-purpose knobs to enter the values in the Sample and Average text boxes.</p> |

Table 5-8: 10BASE-T/10BASE-Te Configure parameter description (cont)







| Configure parameters | Description |
|--|--|
| <p>Mask Selection</p>  | <p>Select <i>MAU Type</i> as Internal or External. Select <i>MAU Scale</i> as Normal, 0.9, or 1.1 depending on the MAU scale factor. Select <i>Section</i> as Both, Head or Tail depending on the section of mask to test. You can configure <i>MAU Type</i> and <i>MAU Scale</i> only for Template MAU tests. You can configure <i>Section</i> only for Template TP_IDL and Link Pulse tests.</p> |
| <p>Mask Setup</p>  | <p>You can configure the Samples and Fail Thresh. You can only configure these parameters for the template tests.</p> |
| <p>Harmonic all of ones</p>  | <p>Select the math waveform on which the processed waveform will be displayed. Enter the number of math waveforms to be averaged. Enter the time or scale depending on the packet length being transmitted.</p> |
| <p>Sequence</p>  | <p>You can set the sequence to Normal (NLP) or Fast (FLP). You can only configure this parameter for the Template Link Pulse test.</p> |
| <p>Test Options</p>  | <p>Select Both to perform Template and Timing tests, Template Only to perform Template tests, and Timing Only to perform Timing tests. Timing tests are available for normal link pulse.</p> |

Table 5-8: 10BASE-T/10BASE-Te Configure parameter description (cont)

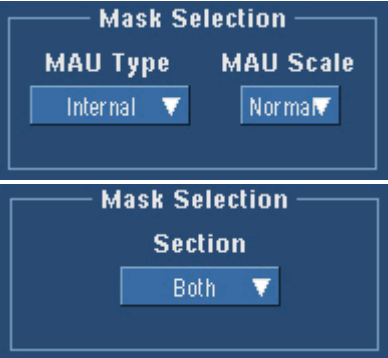
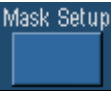
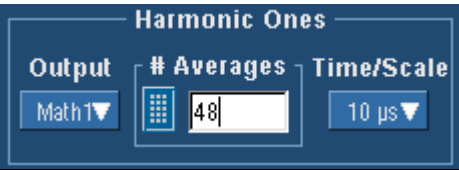
| Configure parameters | Description |
|---|---|
| <p>Return Loss</p>  | <p>Probe: P1 and Probe: P2 — Select the channels to which the probes are connected on the fixture.</p> <p><i>Note: Depending on whether the Transmitter or Receiver is selected, the source will change from P1/P3 and P2/P4.</i></p> |
|  | <p>Return Loss — Select the reference waveform on which the output waveform will be stored.</p> <p>0 dB Marker — Select the reference waveform on which you want the 0 dB Marker to be indicated.</p> <p><i>Note: Return Loss and 0dB Marker fields appear only if you set Load as 100 Ohm.</i></p> <p>AWG/AFG Series — Select the AWG/AFG Series to use. If you select the default value—Select—then the application considers all AWGs/AFGs other than the AWG 4xx series.</p> <p>Load — Select the load as 85, 100, 115 Ohm or 100 Ohm.</p> <p># Averages — Enter the number of waveforms you want to average.</p> <p>Smooth — Enter the smoothening factor.</p> |
|  | <p>Energy Efficient — Configure the test to run either in energy efficient mode or not.</p> |

The following table lists the configuration parameters and default settings:

Table 5-9: 10BASE-T/10BASE-Te Configuration default settings

| Parameter | Options | Default |
|--|--|---|
| Data | CH1, CH2, CH3, CH4 | CH1 |
| Acquisition | Sample, Average | If you select Sample, the default value is 1. If you select Average, the default # of <i>Wfms</i> is 16. |
| Section | Both, Head, Tail | Both |
| MAU Type | Internal, External | Internal |
| MAU Scale | Normal, 0.9, 1.1 | Normal |
| Mask Setup | | See Mask Setup for information on default Sample and Fail Thresh. |
| Sequence | Normal (NLP), Fast (FLP) | Normal (NLP) |
| Test Options | Both, Template Only, Timing Only | Both |
| Output | Math1, Math2, Math3, Math4 | Math1 |
| Time/Scale | 10 micro seconds, 1micro seconds | 10 micro seconds |
| # Averages | | 48 for other tests and 100 for Return Loss. |
| Probe:P1/P3 | CH1, CH2, CH3, CH4 | CH1 |
| Probe:P2/P4 | CH1, CH2, CH3, CH4 | CH2 |
| AWG/AFG | Select, AWG 4xx, AWG 2021, AWG 5xx, AWG 6xx, AWG 7xx, AWG 5xxx, AWG 7xxx, AFG 3xxx | Select |
| Load | 85, 100, 115 Ohm or 100 Ohm | 85, 100, 115 Ohm |
| <i>Note: The TDS5052B oscilloscope displays the graticule only for 100 Ohm Load.</i> | | |
| Smooth | 0 - 10 | 7 |
| Energy Efficient | Yes, No | No |

Making Connections

1000BASE-T Connections

1000BASE-T Template, Peak Volt, Droop, and Distortion

Use TC5 of the test fixture for these tests with disturbing signal and TC2 of the test fixture for these tests without disturbing signal.

With Disturbing Signal

Make the connections as shown by the following figure:

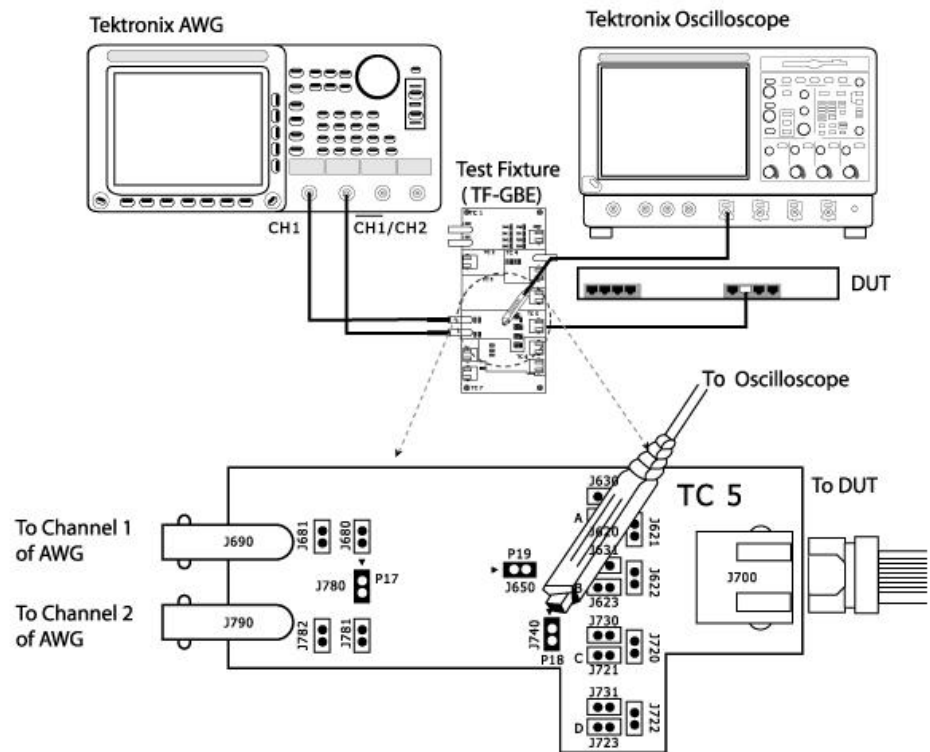

Figure 6-1: 1000BASE-T Connections with disturbing signal for Template, Peak Volt, Droop, and Distortion

For Template, Peak Volt, and Droop tests, set the DUT to generate a Test Mode 1 signal. For Distortion test, set the DUT to generate Test Mode 4 signal.

1. Connect the Ethernet cable to J700 and test port of the DUT.
2. Connect a BNC Cable to (AWG/AFG)+ and Channel 1 of Arbitrary Waveform Generator/Arbitrary Function Generator.
3. Connect a BNC Cable to (AWG/AFG)- and Channel 2 ($\overline{CH1}$) of Arbitrary Waveform Generator/Arbitrary Function Generator.

Note: The AWG/AFG waveforms are available in *C:\TekApplications\TDSET3\AWGWaveforms*. You can use relevant waveform files to generate the disturbing signal. Some of the AWG/AFG models do not support the .set file for automatic settings. Refer to the ReadMe.txt file for instructions to make those settings manually. **In particular, ensure that the AWG/AFG clock frequency is set to 250 MHz.** This file is available in the corresponding AWG waveform file folder. You can automate the AWG/AFG to transfer files and settings as described in Automate AWG/AFG.

4. To test Pair A, do the following:
 - Short the jumpers J621, J630, J623, J721, J723, J680, and J781
 - Ensure that the other jumpers are open
 - Connect the Differential Probe to P18 and configured channel of the oscilloscope
5. To test Pair B, do the following:
 - Short the jumpers J620, J622, J631, J721, J723, J680, and J781
 - Ensure that the other jumpers are open
 - Connect the Differential Probe to P18 and configured channel of the oscilloscope
6. To test Pair C, do the following:
 - Short the jumpers J620, J623, J720, J730, J723, J680, and J781
 - Ensure that the other jumpers are open
 - Connect the Differential Probe to P18 and configured channel of the oscilloscope

7. To test Pair D, do the following:
 - Short the jumpers J620, J623, J721, J722, J731, J680, and J781
 - Ensure that the other jumpers are open
 - Connect the Differential Probe to P18 and configured channel of the oscilloscope

Without Disturbing Signal

Make the connections as shown by the following figure:

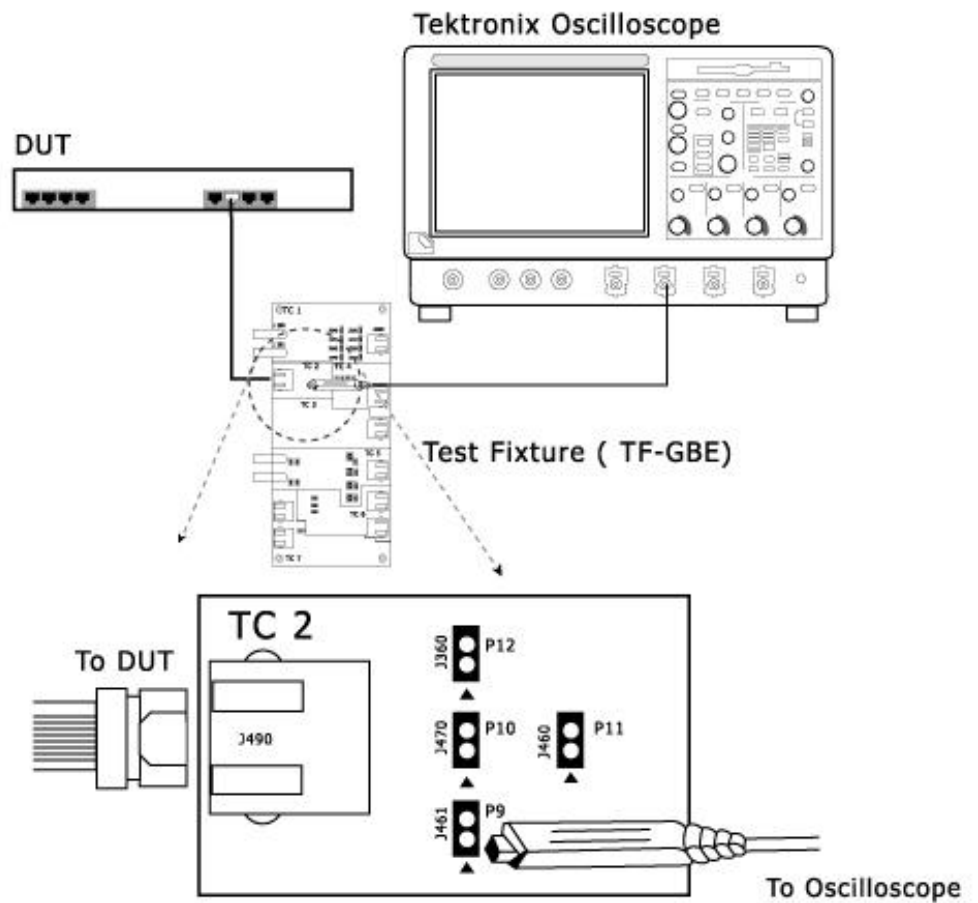

Figure 6-2: 1000BASE-T Connections without disturbing signal for Template, Peak Volt, Droop, and Distortion

1. For Template, Peak Volt, and Droop tests, set the DUT to generate a Test Mode 1 signal.
For Distortion test, set the DUT to generate a Test Mode 4 signal.

2. Connect the Ethernet cable to J490 and test port of the DUT.
3. To test Pair A, connect the Differential Probe to P9 and configured channel of the oscilloscope.
4. To test Pair B, connect the Differential Probe to P10 and configured channel of the oscilloscope.
5. To test Pair C, connect the Differential Probe to P11 and configured channel of the oscilloscope.
6. To test Pair D, connect the Differential Probe to P12 and configured channel of the oscilloscope.

Note: *Align the positive (+) probe-tip of the differential probe with the notch marked on the test fixture.*

1000BASE-T Jitter Master Filtered Step 1 If you have access to TX_TCLK

Use TC3 of the test fixture to calculate master clock jitter. Make the connections as shown by the following figure:

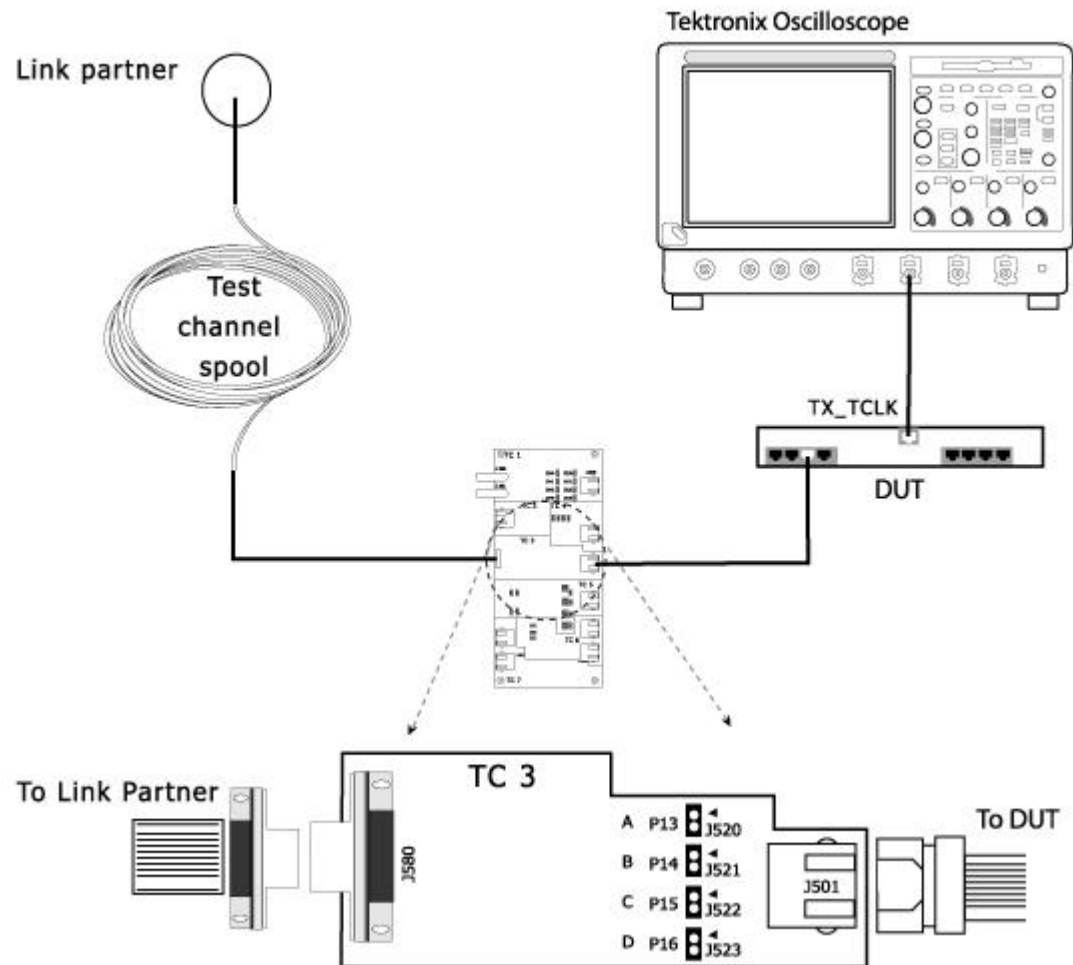

Figure 6-3: 1000BASE-T Step 1 Connections for Jitter Master Filtered

1. Set the DUT in Normal mode as Master.
2. Connect the Ethernet cable to J501 and test port of the DUT.
3. Connect the Test Channel spool to J580 and Link partner.

4. Connect the active probe from TX_TCLK of the DUT to the configured channel of the oscilloscope.
5. To test Pair A, connect the Differential Probe to P13 and configured channel of the oscilloscope.
6. To test Pair B, connect the Differential Probe to P14 and configured channel of the oscilloscope.
7. To test Pair C, connect the Differential Probe to P15 and configured channel of the oscilloscope.
8. To test Pair D, connect the Differential Probe to P16 and configured channel of the oscilloscope.

Step 2

Use TC2 of the test fixture to calculate data jitter with respect to master clock. Make the connections as shown by the following figure:

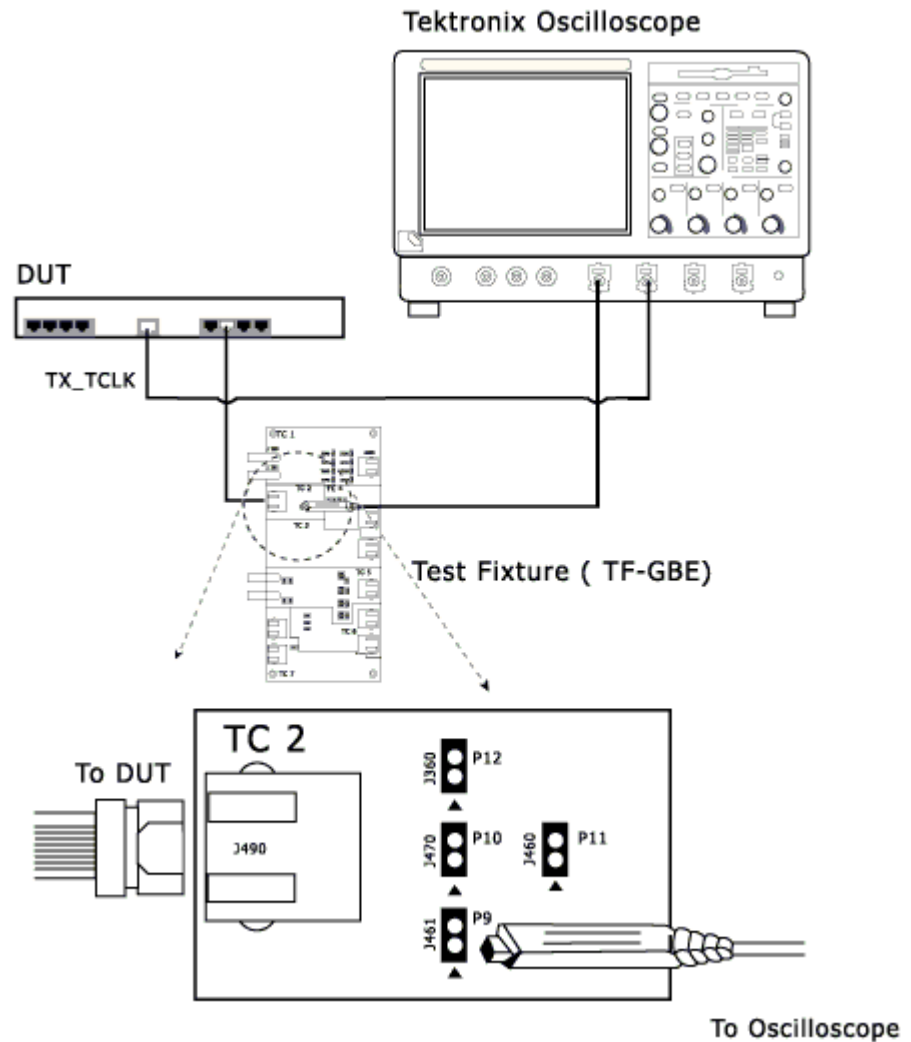

Figure 6-4: 1000BASE-T Step 2 Connections for Jitter Master Filtered

1. Set the DUT to generate a Test Mode 2 signal.
2. Connect the Ethernet cable to J490 and test port of the DUT.
3. Connect the active probe from TX_TCLK of the DUT to the configured channel of the oscilloscope.
4. To test Pair A, connect the Differential Probe to P9 and configured channel of the oscilloscope.

5. To test Pair B, connect the Differential Probe to P10 and configured channel of the oscilloscope.
6. To test Pair C, connect the Differential Probe to P11 and configured channel of the oscilloscope.
7. To test Pair D, connect the Differential Probe to P12 and configured channel of the oscilloscope.

If you do not have access to TX_TCLK

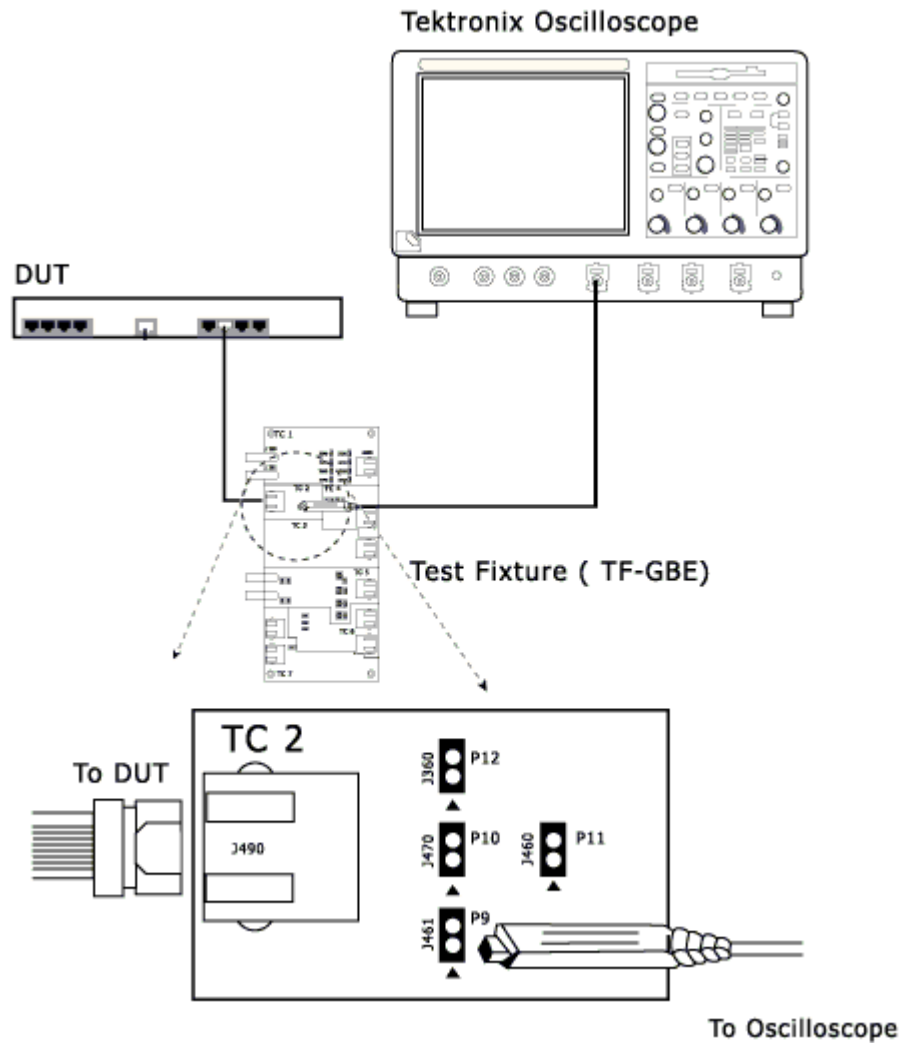

Figure 6-5: 1000BASE-T Connections for Jitter Master Filtered

1. Set the DUT to generate a Test Mode 2 signal.
2. Connect the Ethernet cable to J490 and test port of the DUT.

3. To test Pair A, connect the Differential Probe to P9 and configured channel of the oscilloscope.
4. To test Pair B, connect the Differential Probe to P10 and configured channel of the oscilloscope.
5. To test Pair C, connect the Differential Probe to P11 and configured channel of the oscilloscope.
6. To test Pair D, connect the Differential Probe to P12 and configured channel of the oscilloscope.

**1000BASE-T
Jitter Master
Unfiltered**

If you have access to TX_TCLK

Use TC3 of the test fixture to calculate master clock jitter. Make the connections as shown by the following figure:

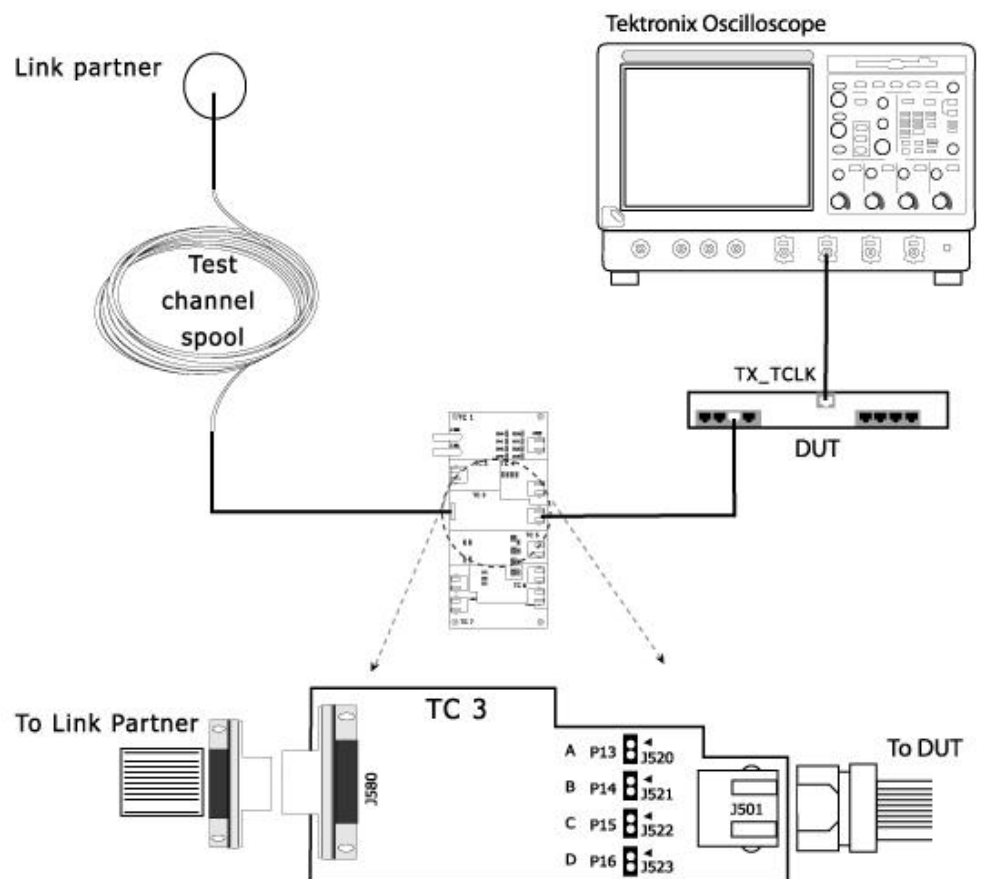

Figure 6-6: 1000BASE-T Connections for Jitter Master Unfiltered

1. Set the DUT to generate a Test Mode 2 signal.
2. Connect the Ethernet cable to J501 and test port of the DUT.
3. Connect the Test Channel spool to J580 and Link partner.
4. Connect the active probe from TX_TCLK of the DUT to the configured channel of the oscilloscope.
5. To test Pair A, connect the Differential Probe to P13 and configured channel of the oscilloscope.
6. To test Pair B, connect the Differential Probe to P14 and configured channel of the oscilloscope.
7. To test Pair C, connect the Differential Probe to P15 and configured channel of the oscilloscope.
8. To test Pair D, connect the Differential Probe to P16 and configured channel of the oscilloscope.

If you do not have access to TX_TCLK

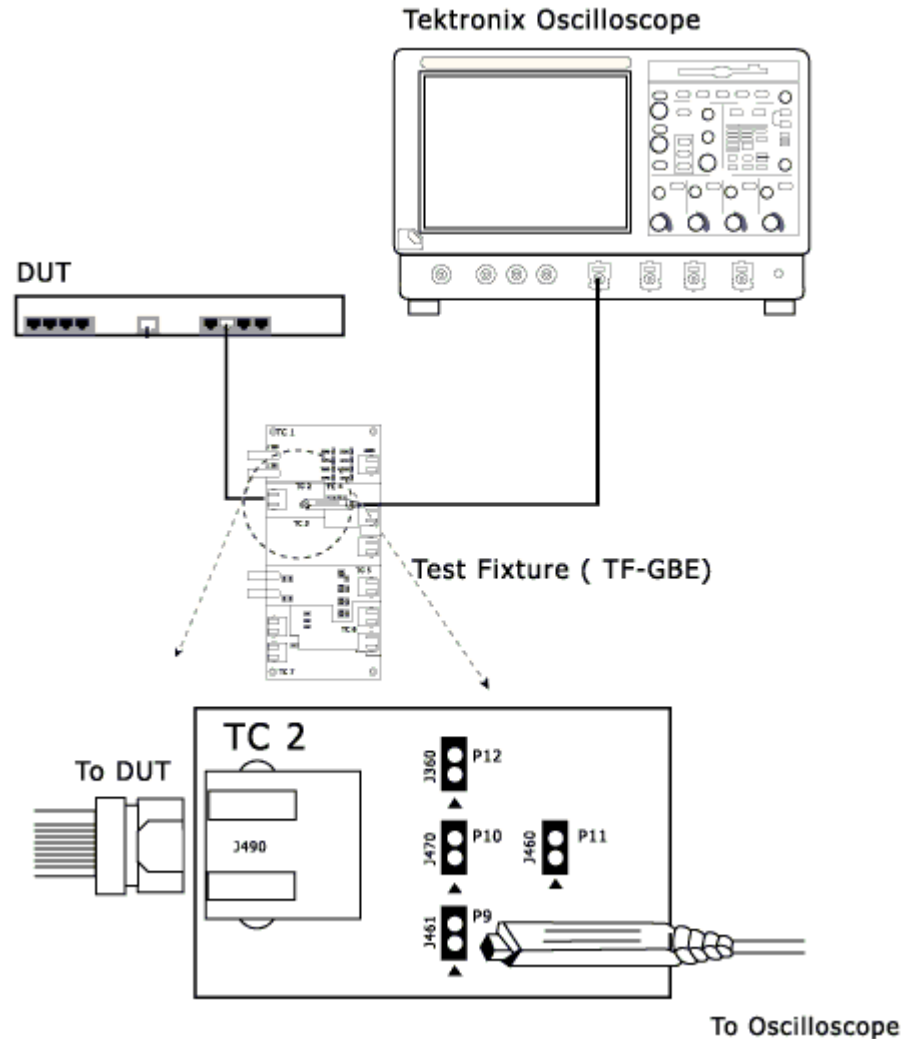

Figure 6-7: 1000BASE-T Connections for Jitter Master Unfiltered

1. Set the DUT to generate a Test Mode 2 signal.
2. Connect the Ethernet cable to J490 and test port of the DUT.
3. To test Pair A, connect the Differential Probe to P9 and configured channel of the oscilloscope.
4. To test Pair B, connect the Differential Probe to P10 and configured channel of the oscilloscope.
5. To test Pair C, connect the Differential Probe to P11 and configured channel of the oscilloscope.

6. To test Pair D, connect the Differential Probe to P12 and configured channel of the oscilloscope.

1000BASE-T Jitter Slave Filtered Step 1

Use TC3 of the test fixture to calculate master and slave clock jitter. Make the connections as shown by the following figure:

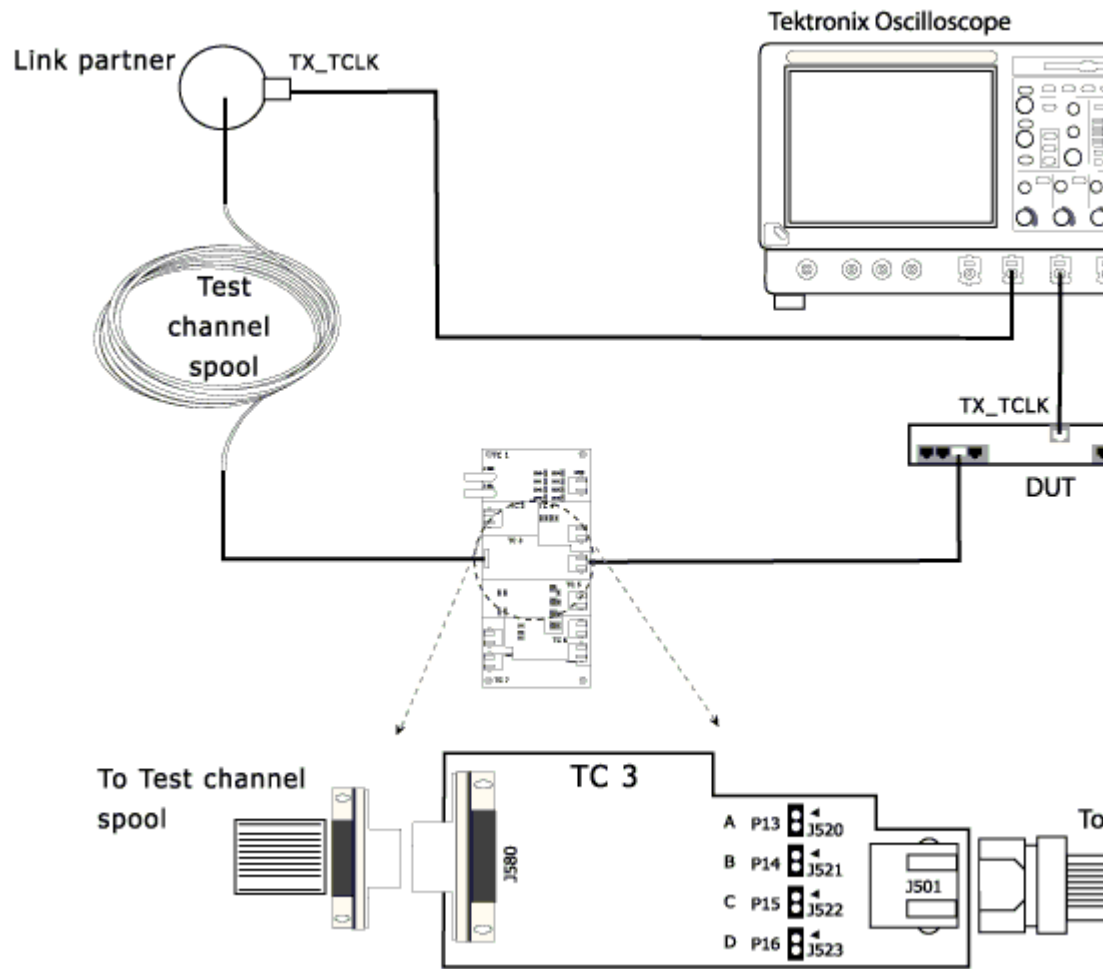

Figure 6-8: 1000BASE-T Step 1 Connections for Jitter Slave Filtered

1. Set the DUT in Normal mode as Slave.
2. Connect the Ethernet cable to J501 and test port of the DUT.
3. Connect the Test Channel spool to J580 and Link partner.

4. Connect the active probe from TX_TCLK of the DUT to the configured channel of the oscilloscope.
5. Connect the active probe from TX_TCLK of the Link Partner to the configured channel of the oscilloscope.
6. To test Pair A, connect the Differential Probe to P13 and configured channel of the oscilloscope.
7. To test Pair B, connect the Differential Probe to P14 and configured channel of the oscilloscope.
8. To test Pair C, connect the Differential Probe to P15 and configured channel of the oscilloscope.
9. To test Pair D, connect the Differential Probe to P16 and configured channel of the oscilloscope.

Step 2

Use TC2 of the test fixture to calculate data jitter with respect to slave clock. Make the connections as shown by the following figure:

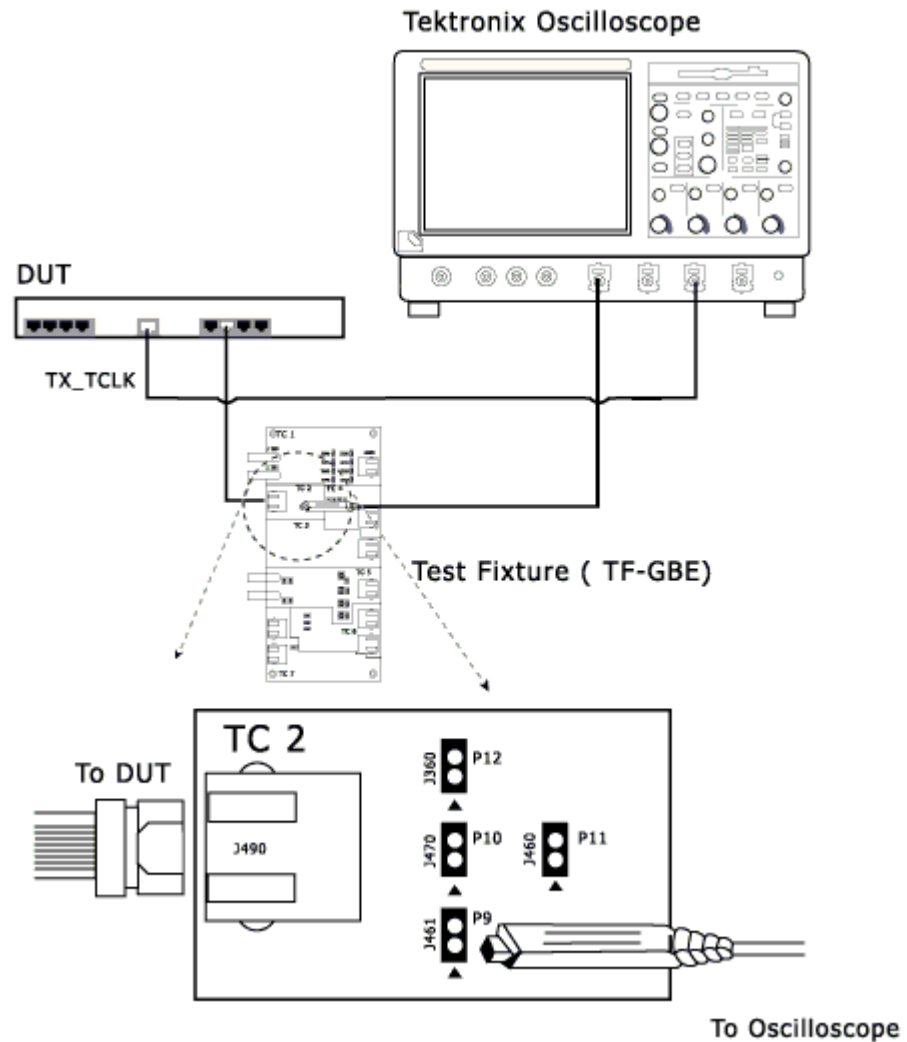

Figure 6-9: 1000BASE-T Step 2 Connections for Jitter Slave Filtered

1. Set the DUT to generate a Test Mode 3 signal.
2. Connect the Ethernet cable to J490 and test port of the DUT.
3. Connect the active probe from TX_TCLK of the DUT to the configured channel of the oscilloscope.
4. To test Pair A, connect the Differential Probe to P9 and configured channel of the oscilloscope.

5. To test Pair B, connect the Differential Probe to P10 and configured channel of the oscilloscope.
6. To test Pair C, connect the Differential Probe to P11 and configured channel of the oscilloscope.
7. To test Pair D, connect the Differential Probe to P12 and configured channel of the oscilloscope.

If you do not have access to TX_TCLK

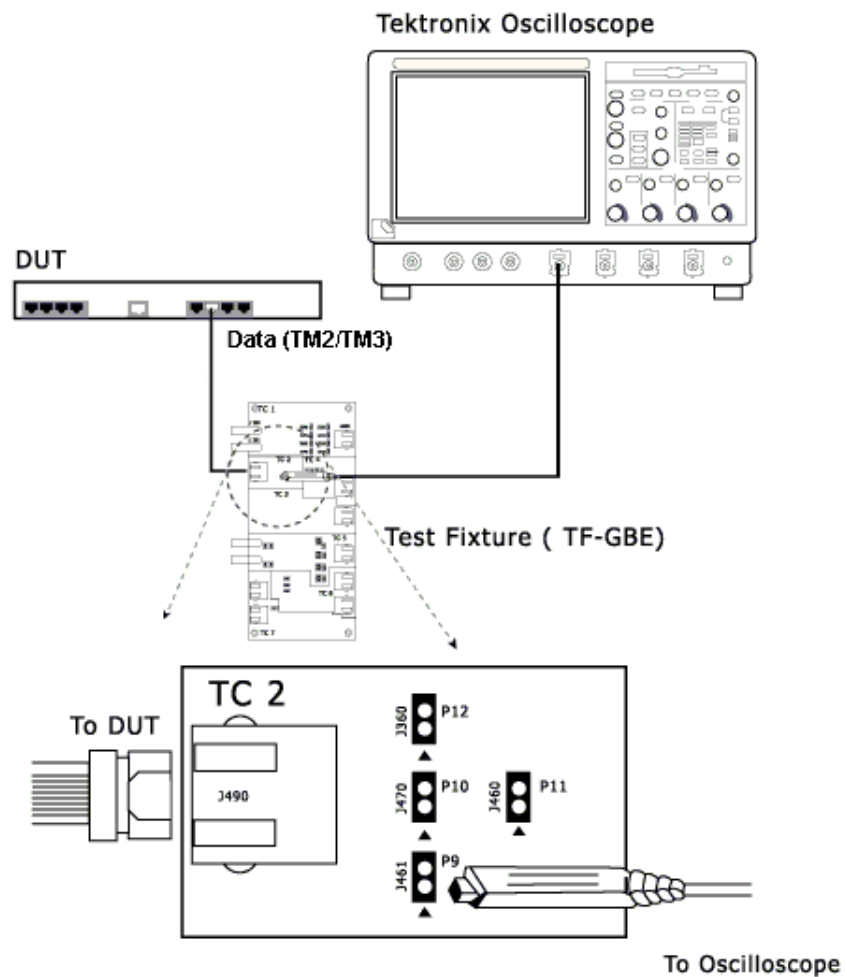

Figure 6-10: 1000BASE-T Connections for Jitter Slave Filtered

Step 1:

1. Set the DUT to generate test mode 2 signal.
2. Connect the Ethernet cable to J490 and test port of the DUT.
3. Connect the active probe from Data (TM2) to the configured channel of the oscilloscope.
4. To test Pair A, connect the Differential Probe to P9 and configured channel of the oscilloscope.
5. To test Pair B, connect the Differential Probe to P10 and configured channel of the oscilloscope.
6. To test Pair C, connect the Differential Probe to P11 and configured channel of the oscilloscope.
7. To test Pair D, connect the Differential Probe to P12 and configured channel of the oscilloscope.

Step 2:



1. Set the DUT to generate test mode 3 signal.
2. Connect the Ethernet cable to J490 and test port of the DUT.
3. Connect the active probe from Data (TM3) to the configured channel of the oscilloscope.
4. To test Pair A, connect the Differential Probe to P9 and configured channel of the oscilloscope.
5. To test Pair B, connect the Differential Probe to P10 and configured channel of the oscilloscope.
6. To test Pair C, connect the Differential Probe to P11 and configured channel of the oscilloscope.
7. To test Pair D, connect the Differential Probe to P12 and configured channel of the oscilloscope.

If you have access to TX_TCLK

1000BASE-T Jitter Slave Unfiltered

Use TC3 of the test fixture to calculate slave clock jitter. Make the connections as shown by the following figure:

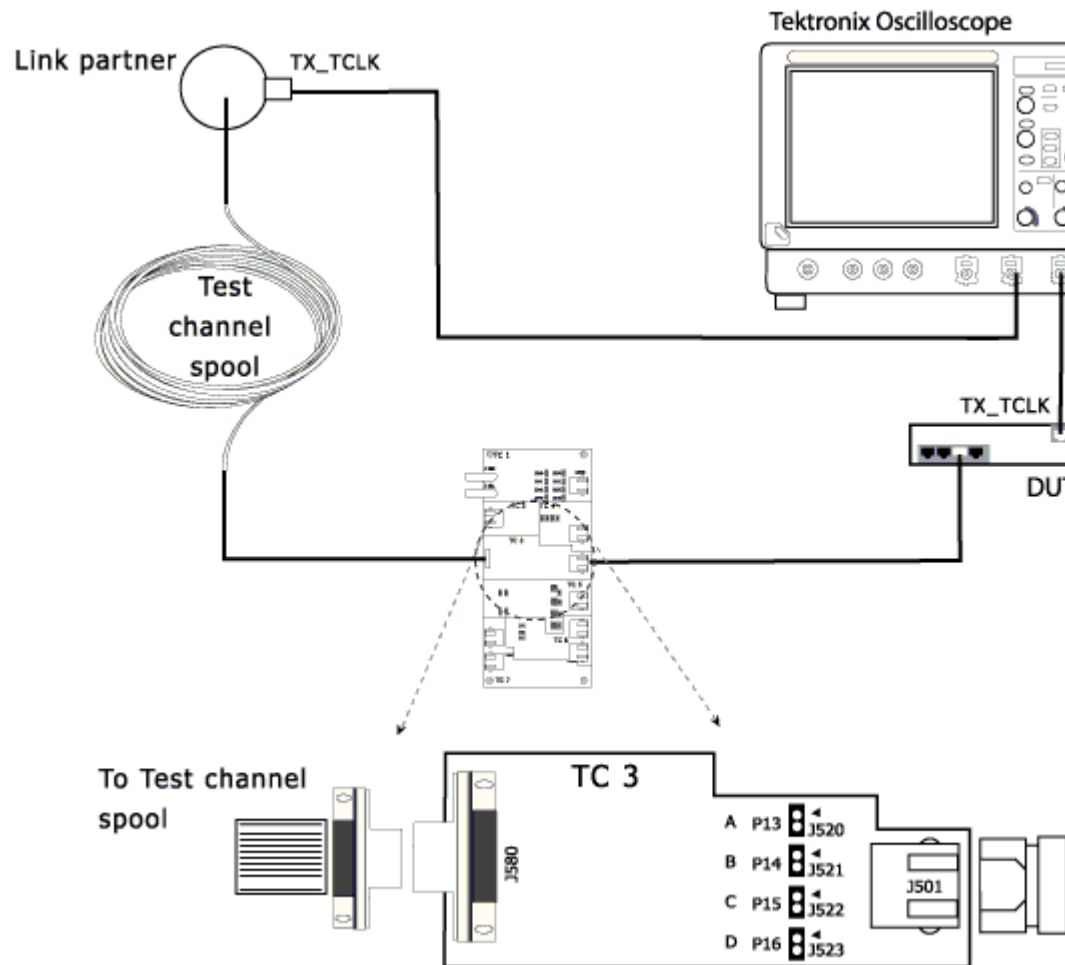

Figure 6-11: 1000BASE-T Connections for Jitter Slave Unfiltered

1. Set the DUT in Normal mode as Slave.
2. Connect the Ethernet cable to J501 and test port of the DUT.
3. Connect the Test Channel spool to J580 and Link partner.
4. Connect the active probe from TX_TCLK of the DUT to the configured channel of the oscilloscope.

5. Connect the active probe from TX_TCLK of the Link Partner to the configured channel of the oscilloscope.
6. To test Pair A, connect the Differential Probe to P13 and configured channel of the oscilloscope.
7. To test Pair B, connect the Differential Probe to P14 and configured channel of the oscilloscope.
8. To test Pair C, connect the Differential Probe to P15 and configured channel of the oscilloscope.
9. To test Pair D, connect the Differential Probe to P16 and configured channel of the oscilloscope.

If you do not have access to TX_TCLK

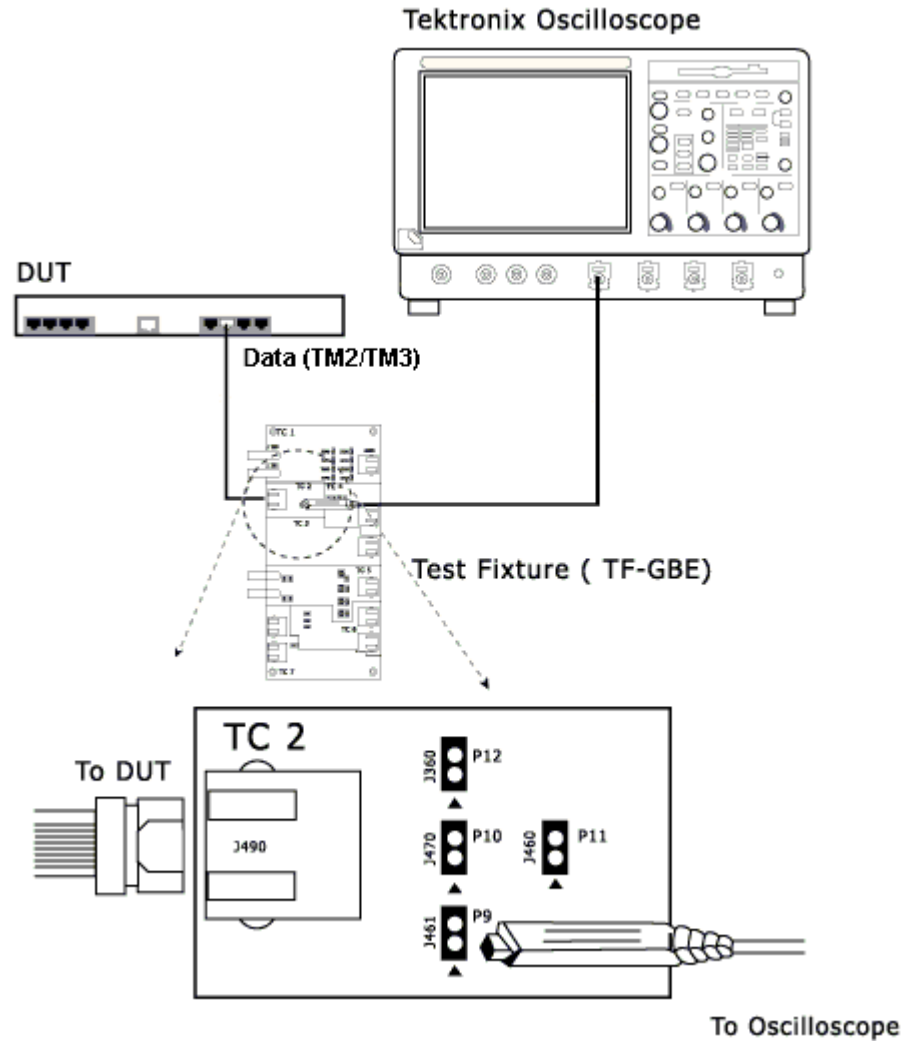

Figure 6-12: 1000BASE-T Connections for Jitter Slave Unfiltered (If you do not have access to TX_TCLK)

Step 1:

1. Set the DUT to generate test mode 2 signal.
2. Connect the Ethernet cable to J490 and test port of the DUT.
3. Connect the active probe from Data (TM2) to the configured channel of the oscilloscope.
4. To test Pair A, connect the Differential Probe to P9 and configured channel of the oscilloscope.
5. To test Pair B, connect the Differential Probe to P10 and configured channel of the oscilloscope.
6. To test Pair C, connect the Differential Probe to P11 and configured channel of the oscilloscope.
7. To test Pair D, connect the Differential Probe to P12 and configured channel of the oscilloscope.

Step 2:



1. Set the DUT to generate test mode 3 signal.
2. Connect the Ethernet cable to J490 and test port of the DUT.
3. Connect the active probe from Data (TM3) to the configured channel of the oscilloscope.
4. To test Pair A, connect the Differential Probe to P9 and configured channel of the oscilloscope.
5. To test Pair B, connect the Differential Probe to P10 and configured channel of the oscilloscope.
6. To test Pair C, connect the Differential Probe to P11 and configured channel of the oscilloscope.
7. To test Pair D, connect the Differential Probe to P12 and configured channel of the oscilloscope.

1000BASE-T Return Loss Use TC1 of the test fixture for this test. Make the connections as shown by the following figures:

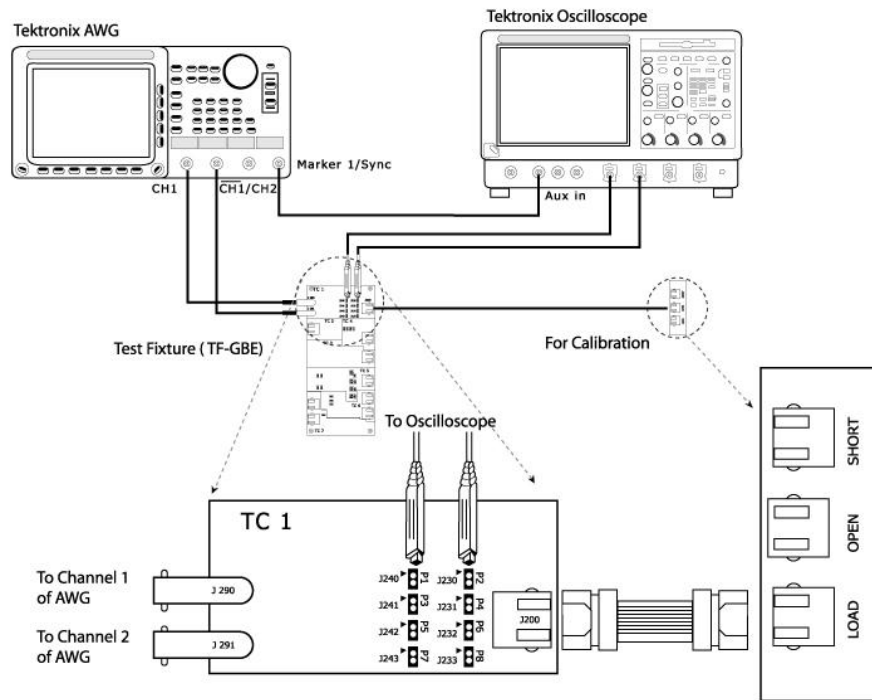

Figure 6-13: 1000BASE-T Return Loss setup using an Arbitrary Waveform Generator

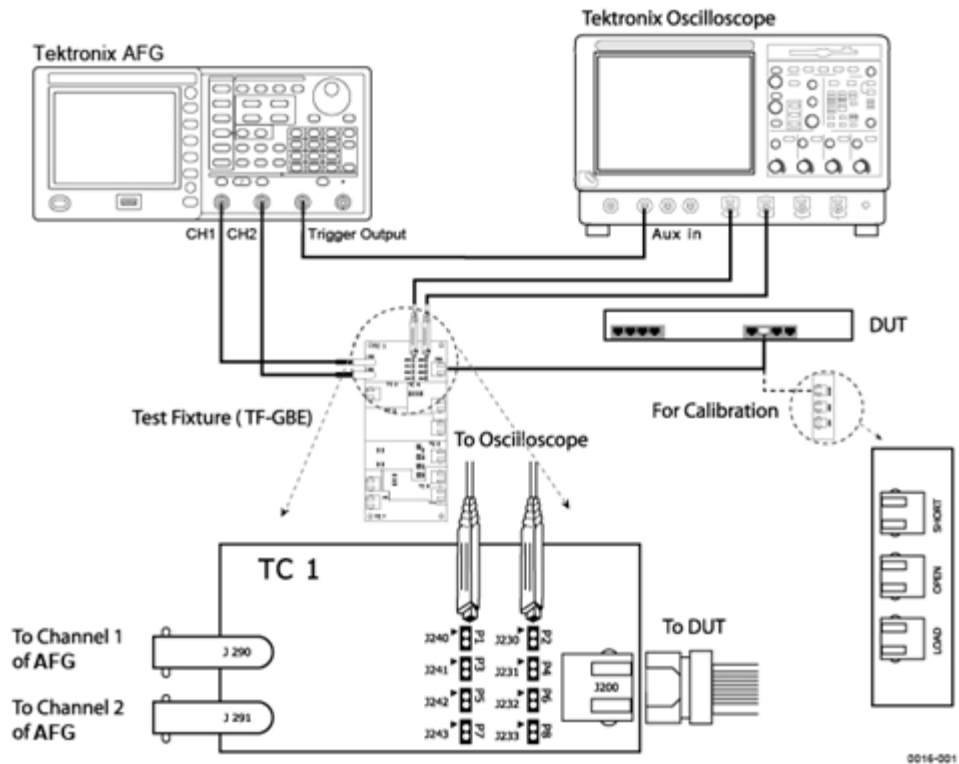

Figure 6-14: 1000BASE-T Return Loss setup using an Arbitrary Function Generator

1. Set the DUT to generate a Test Mode 4 signal.
2. Connect the Ethernet cable to J200 and test port of the DUT.
3. Connect a BNC Cable to (AWG/AFG)+ and Channel 1 of Arbitrary Waveform Generator/Arbitrary Function Generator.
4. Connect a BNC Cable to (AWG/AFG)- and Channel 2 ($\overline{\text{CH1}}$) of Arbitrary Waveform Generator/Arbitrary Function Generator.

Note: The AWG/AFG waveforms are available in `C:\TekApplications\TDSET3\AWGWaveforms`. Some of the AWG/AFG models do not support the `.set` file for automatic settings. Refer to the `ReadMe.txt` file for instructions to make those settings manually. In particular, ensure that the AWG/AFG clock frequency is set to 250 MHz. This file is available in the corresponding AWG waveform file folder. You can automate the AWG/AFG to transfer files and settings as described in `Automate AWG/AFG`.

5. To test Pair A, connect the Differential Probes to P1 (J240) and P2 (J230), and configured channels of the oscilloscope.
6. To test Pair B, connect the Differential Probe to P3 (J241) and P4 (J231), and configured channels of the oscilloscope.
7. To test Pair C, connect the Differential Probe to P5 (J242) and P6 (J232), and configured channels of the oscilloscope.
8. To test Pair D, connect the Differential Probe to P7 (J243) and P8 (J233), and configured channels of the oscilloscope.

1000BASE-T CM Voltage Use TC4 of the test fixture for this test. Make the connections as shown by the following figure:

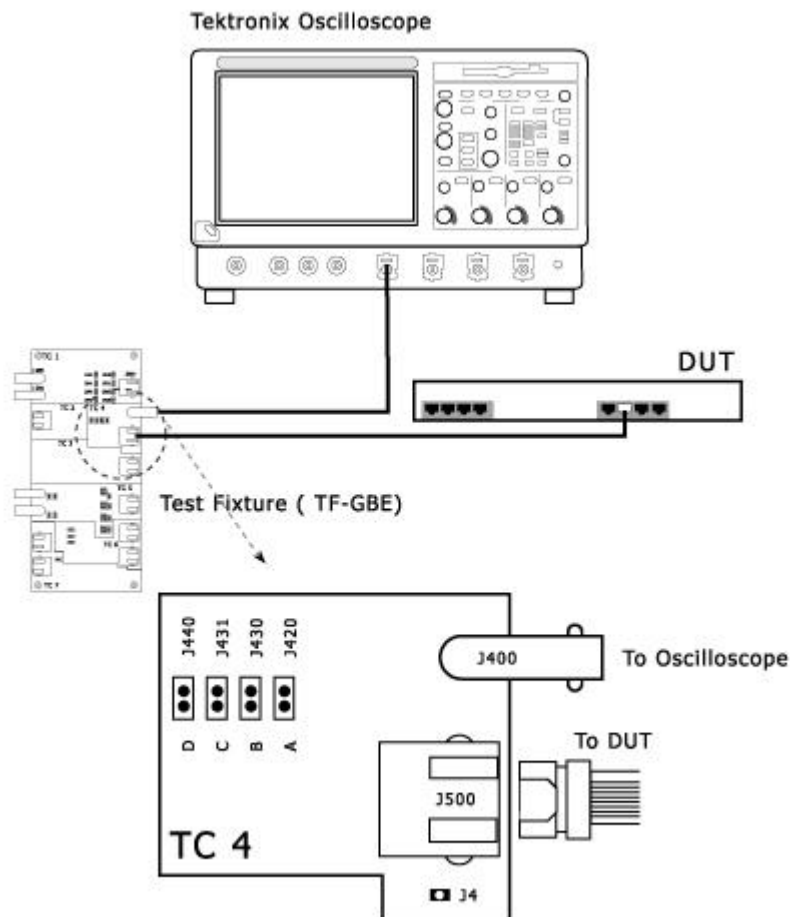

Figure 6-15: 1000BASE-T Connections for CM Voltage

1. Set the DUT to generate Test Mode 4 signal.
2. Connect the Ethernet cable to J500 and test port of the DUT.
3. Connect a BNC Cable to J400 and configured channel of the oscilloscope.
4. To test Pair A, short J420 using a jumper.
5. To test Pair B, short J430 using a jumper.
6. To test Pair C, short J431 using a jumper.
7. To test Pair D, short J440 using a jumper.

100BASE-TX Connections

100BASE-TX Template, Differential Output Voltage, Amplitude Symmetry, Rise Time, Fall Time, Rise/Fall Time Symmetry, Waveform Overshoot, Jitter, Duty Cycle
All Tests except Return Loss Distortion.
Loss Use TC2 of the test fixture for this test. Make the connections as shown by the following figure:

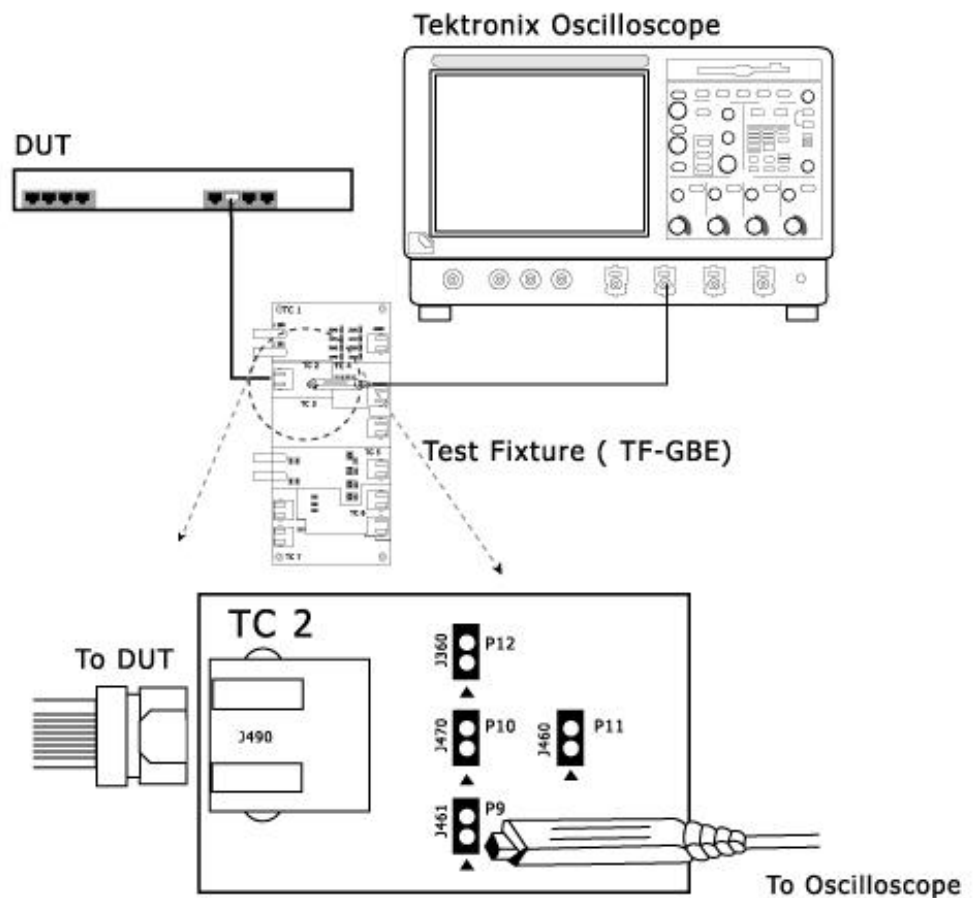

Figure 6-16: All 100BASE-TX Connections except Return Loss

1. Set the DUT to transmit scrambled idles.
2. Connect the Ethernet cable to J490 and test port of the DUT.
3. Connect the Differential Probe to P9 and configured channel of the oscilloscope.

100BASE-TX Return Loss Use TC1 of the test fixture for this test. Make the connections as shown by the following figure:

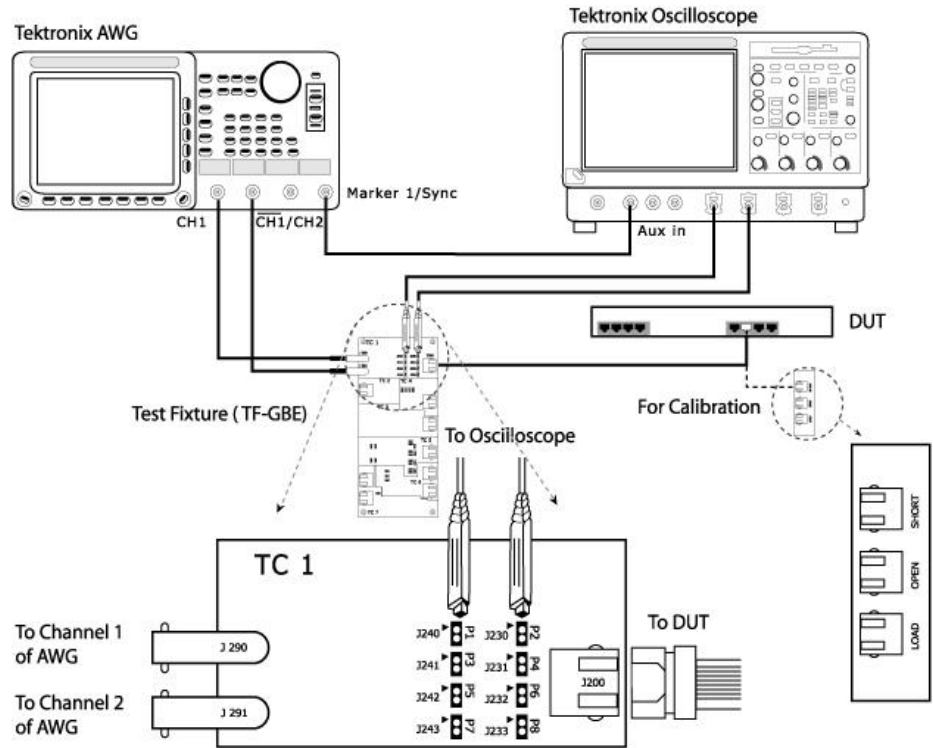

Figure 6-17: 100BASE-TX Return Loss setup using Arbitrary Waveform Generator

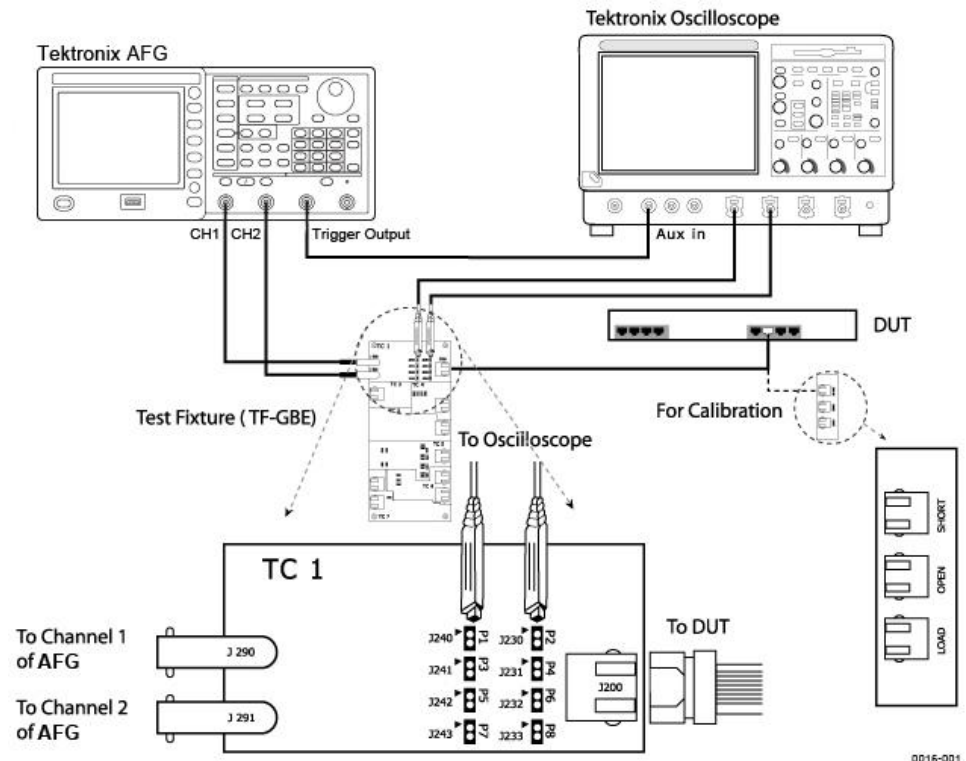

Figure 6-18: 100BASE-TX Return Loss setup using Arbitrary Function Generator

1. Set the DUT to generate scrambled idles.
2. Connect the Ethernet cable to J200 and test port of the DUT.
3. Connect a BNC Cable to (AWG/AFG)+ and Channel 1 of Arbitrary Waveform Generator/Arbitrary Function Generator.
4. Connect a BNC Cable to (AWG/AFG)- and Channel 2 ($\overline{\text{CH1}}$) of Arbitrary Waveform Generator/Arbitrary Function Generator.

Note: The AWG/AFG waveforms are available in `C:\TekApplications\TDSET3\AWGWaveforms`. Some of the AWG/AFG models do not support the `.set` file for automatic settings. Refer to the `ReadMe.txt` file for instructions to make those settings manually. **In particular, ensure that the AWG/AFG clock frequency is set to 250 MHz.** This file is available in the corresponding AWG waveform file folder. You can automate the AWG/AFG to transfer files and settings as described in Automate AWG/AFG.

5. To test Transmitter, connect the Differential Probes to P1 (J240) and P2 (J230), and configured channels of the oscilloscope.

6. To test Receiver, connect the Differential Probe to P3 (J241) and P4 (J231), and configured channels of the oscilloscope.

10BASE-T/10BASE-Te Connections

10BASE-T Link Pulse Use TC6 of the test fixture for this test without twisted-pair model and use TC7 of the test fixture for this test with twisted-pair model.

Without Twisted-pair model

Make the connections as shown by the following figure:

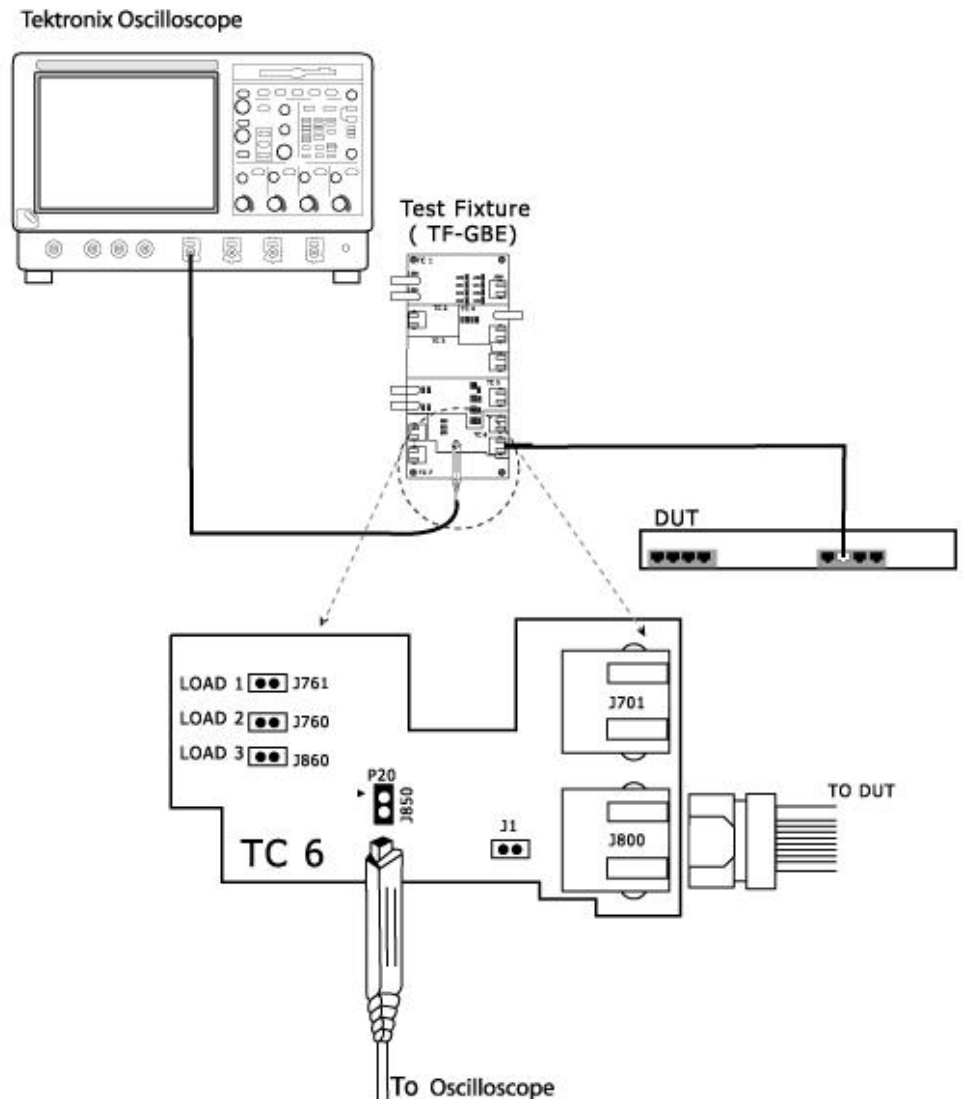

Figure 6-19: 10BASE-T Connections for Link Pulse without Twisted-pair model

1. Set the DUT to generate a link pulse signal.
2. Connect the Ethernet Cable to J800 and test port of the DUT.
3. Connect the differential probe to P20 and configured channel of the oscilloscope.
4. Using the jumpers, short the LOAD1, LOAD2 or LOAD3 (100 Ohm). Ensure that the jumper you have short and the LOAD you have selected in the application are the same.

Note: *LOAD3 (100 Ohm) is optional and not required as per the 802.3-2002 standards.*

With Twisted-pair model

Make the connections as shown by the following figure:

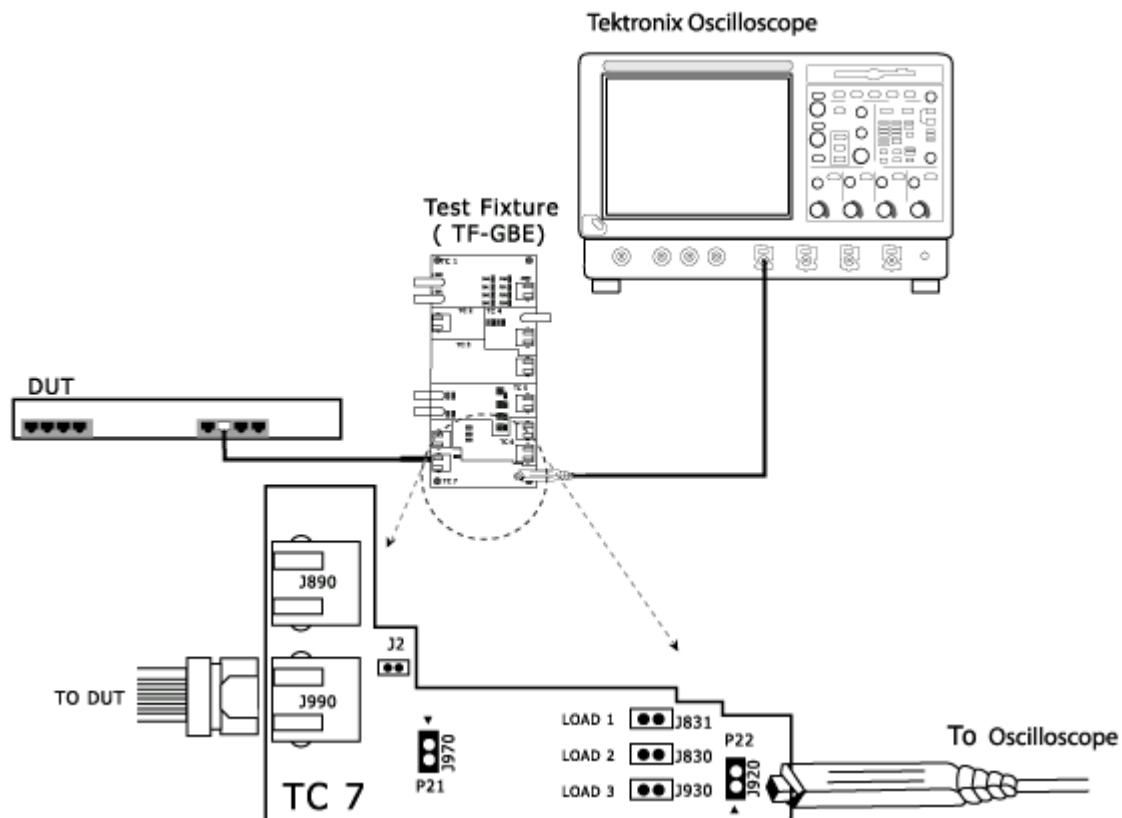

Figure 6-20: 10BASE-T Connections for Link Pulse with Twisted-pair model

1. Set the DUT to generate a link pulse signal.

2. Connect the Ethernet cable to J990 and the test port of the DUT.
3. Connect the differential probe to P22 and the configured channel of the oscilloscope.
4. Using the jumpers, short the LOAD1, LOAD2 or LOAD3 (100 Ohm). Ensure that the jumper you have short and the LOAD you have selected in the application are the same.

Note: LOAD3 (100 Ohm) is optional and not required as per the 802.3-2002 standards.

10BASE-T MAU Use TC7 of the test fixture for this test. Make the connections as shown by the following figure:

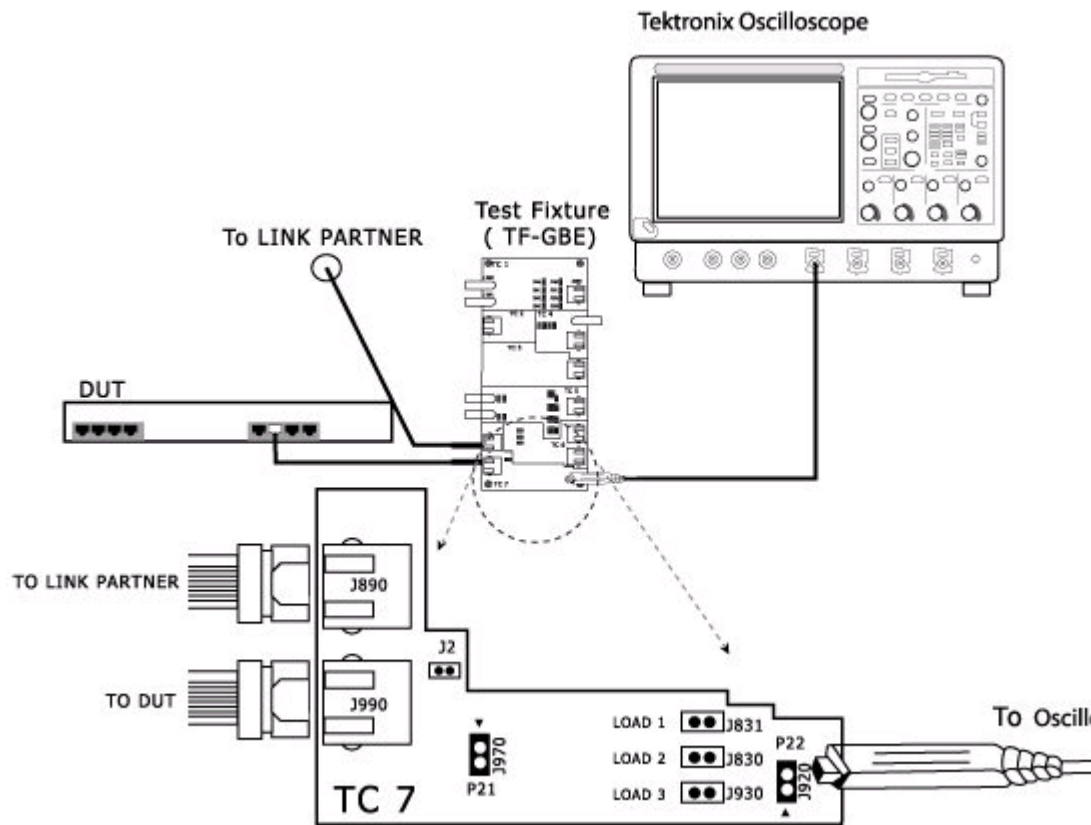

Figure 6-21: 10BASE-T Connections for MAU

1. Set the DUT to generate a pseudo-random sequence signal.
2. Connect the Ethernet Cable to J990 and test port of the DUT.

3. If you have a Link Partner, connect the Ethernet Cable to J890 and link partner.

If you do not have a Link Partner, short J2 using a jumper. If J2 is not present, go to the next step.

4. Connect the differential probe to P22 and configured channel of the oscilloscope.
5. Short LOAD3 (100 Ohm) using a jumper.

**10BASE-T_e
MAU**

Use TC8 test fixture for this test. Make the connections as shown by the following figure:

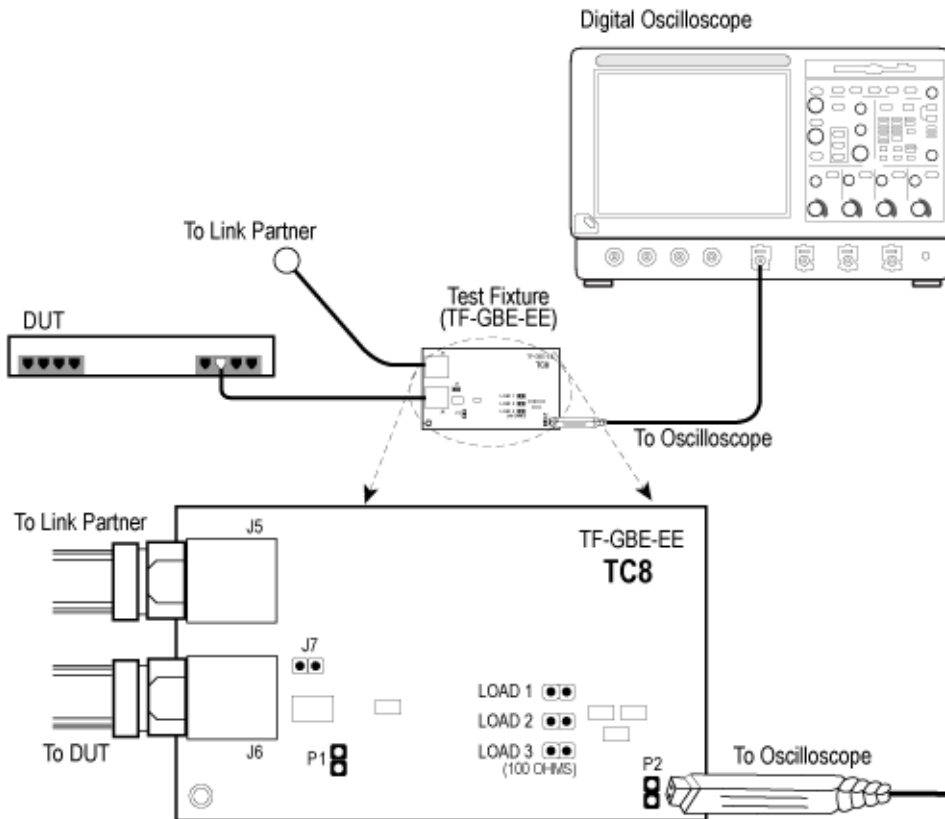

Figure 6-22: 10BASE-T_e Connections for MAU

1. Set the DUT to generate a pseudo-random sequence signal.
2. Connect the Ethernet Cable to J6 and test port of the DUT.
3. If you have a Link Partner, connect the Ethernet Cable to J5 and link partner.
If you do not have a link partner, short J7 using a jumper. If J7 is not present, go to the next step.
4. Connect the differential probe to P2 and configured channel of the oscilloscope.
5. Short LOAD3 (100 Ohm) using a jumper.

3. If you have a Link Partner, connect the Ethernet cable to J701 and link partner. If you do not have a link partner, short J1 using a jumper. If J1 is not present, go to the next step.
4. Connect the Differential Probe to P20 and configured channel of the oscilloscope.
5. Using the jumpers, short the LOAD1, LOAD2 or LOAD3 (100 Ohm). Ensure that the jumper you have short and the LOAD you have selected in the application are the same.

Note: LOAD3 (100 Ohm) is optional and not required as per the 802.3-2002 standards (for 10BASE-Te, refer to 802.3az standard).

With Twisted-pair model ((10BASE-T)

Use TC7 test fixture for this test. Make the connections as shown by the following figure:

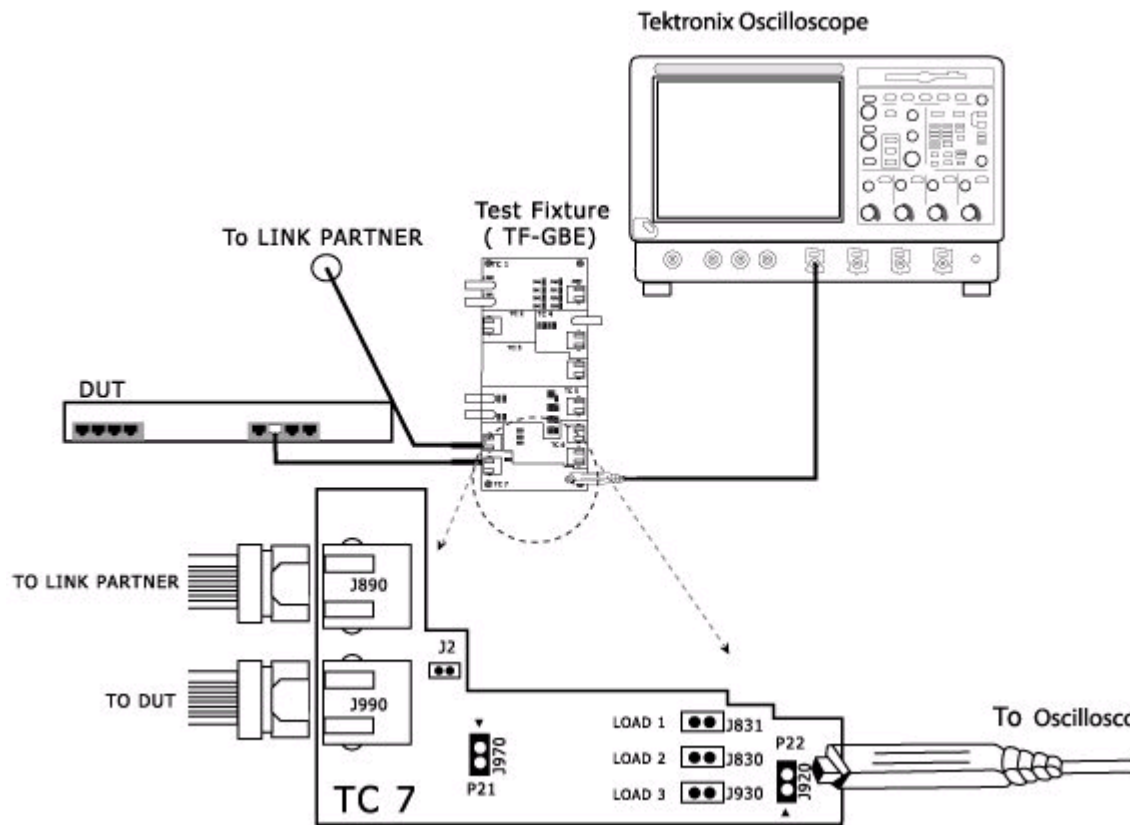

Figure 6-24: 10BASE-T Connections for TP_IDL with Twisted-pair model

1. Set the DUT to generate a pseudo-random sequence signal.
2. Connect the Ethernet cable to J990 and test port of the DUT.
3. If you have a Link Partner, connect the Ethernet cable to J890 and Link Partner.

If you do not have a link partner, short J2 using a jumper. If J2 is not present, go to the next step.

4. Connect the Differential Probe to P22 and configured channel of the oscilloscope.

5. Using the jumpers, short the LOAD1, LOAD2 or LOAD3 (100 Ohm). Ensure that the jumper you have short and the LOAD you have selected in the application are the same.

Note: LOAD3 (100 Ohm) is optional and not required as per the 802.3-2002 standards.

With Twisted-pair model (10BASE-Te)

Use TC8 test fixture for this test. Make the connections as shown by the following figure:

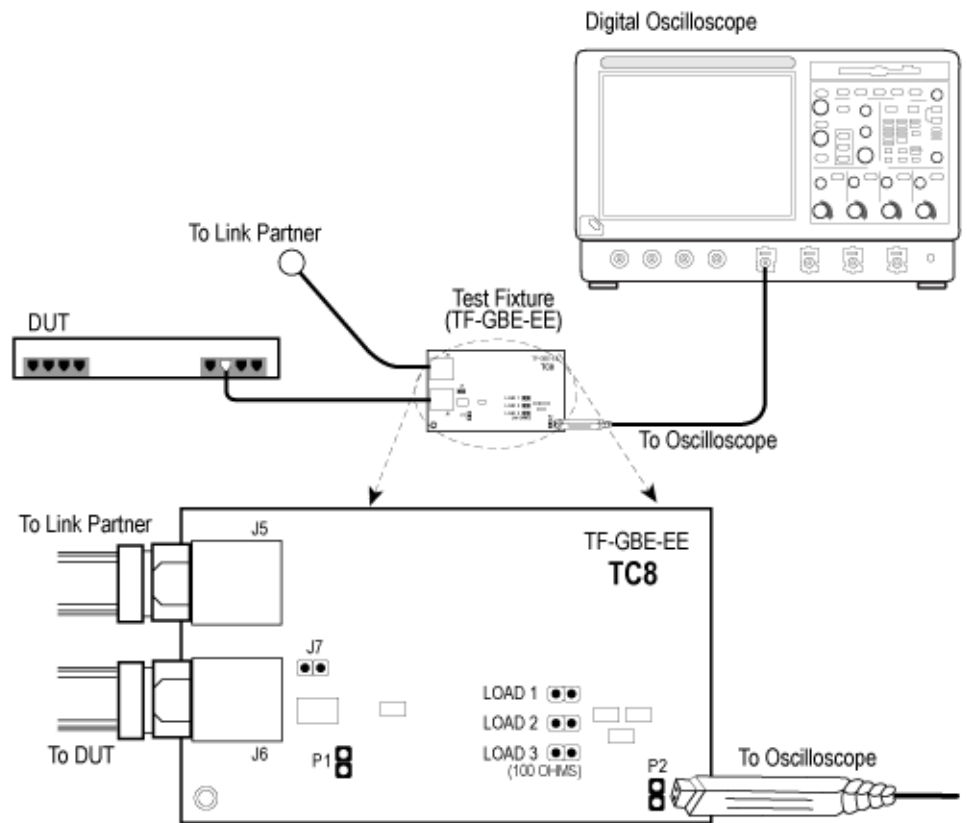

Figure 6-25: 10BASE-Te Connections for TP_IDL with Twisted-pair model

1. Set the DUT to generate a pseudo-random sequence signal.
2. Connect the Ethernet cable to J6 and test port of the DUT.
3. If you have a Link Partner, connect the Ethernet cable to J5 and Link Partner.

If you do not have a link partner, short J7 using a jumper. If J7 is not present, go to the next step.

4. Connect the Differential Probe to P2 and configured channel of the oscilloscope.
5. Using the jumpers, short the LOAD1, LOAD2 or LOAD3 (100 Ohm). Ensure that the jumper you have short and the LOAD you have selected in the application are the same.

Note: *LOAD3 (100 Ohm) is optional and not required as per the 802.3az standards.*

**10BASE-T
Jitter with
cable**

Use TC7 of the test fixture for this test. Make the connections as shown by the following figure:

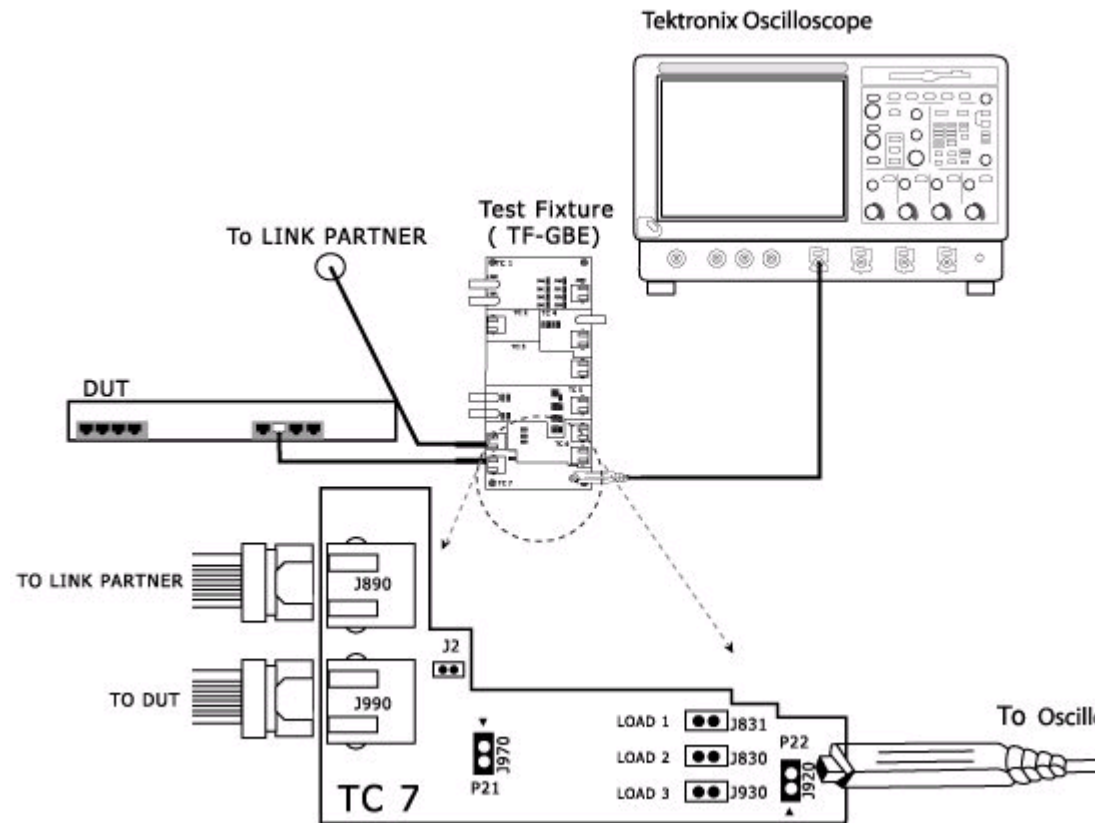

Figure 6-26: 10BASE-T Connections for Jitter with cable

1. Set the DUT to generate a pseudo-random sequence signal.
2. Connect the Ethernet cable to J990 and test port of the DUT.
3. If you have a Link Partner, connect the Ethernet Cable to J890 and Link Partner.

If you do not have a link partner, short J2 using a jumper. If J2 is not present, go to the next step.

4. Connect the Differential Probe to P22 and configured channel of the oscilloscope.
5. Short LOAD3 (100 Ohm) using a jumper.

**10BASE-T
Jitter without
cable**

Use TC6 of the test fixture for this test. Make the connections as shown by the following figure:

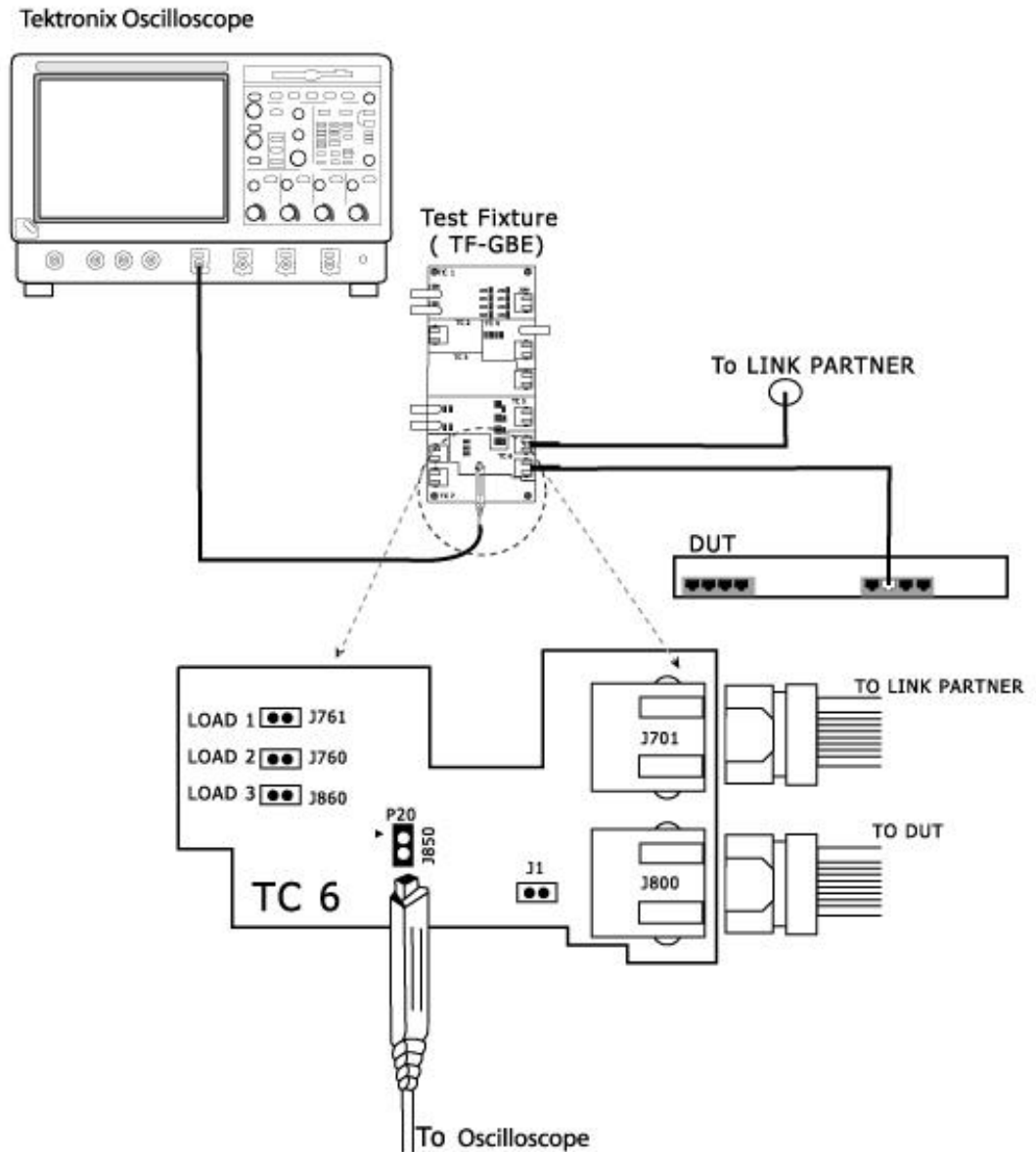

Figure 6-27: 10BASE-T Connections for Jitter without cable

1. Set the DUT to generate a pseudo-random sequence signal.
2. Connect the Ethernet cable to J800 and test port of the DUT.

3. If you have a Link Partner, connect the Ethernet Cable to J701 and Link Partner.

If you do not have a link partner, short J1 using a jumper. If J1 is not present, go to the next step.

4. Connect the Differential Probe to P20 and configured channel of the oscilloscope.
5. Short LOAD3 (100 Ohm) using a jumper.

**10BASE-T
/10BASE-Te
Differential
Voltage**

Use TC6 of the test fixture for this test. Make the connections as shown by the following figure:

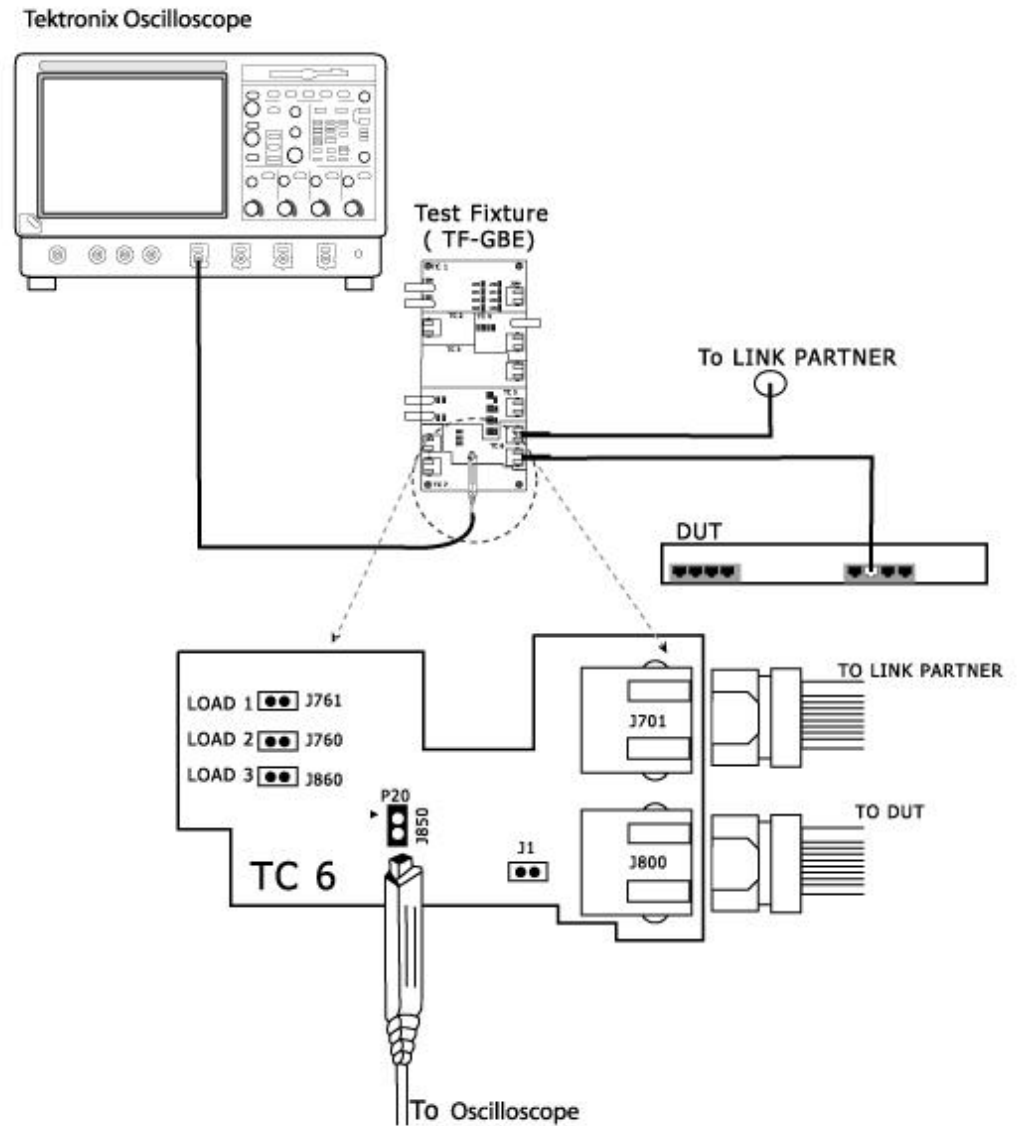

Figure 6-28: 10BASE-T Connections for Differential Voltage

1. Set the DUT to generate a pseudo-random sequence signal.
2. Connect the Ethernet cable to J800 and test port of the DUT.

3. If you have a Link Partner, connect the Ethernet Cable to J701 and Link Partner.

If you do not have a link partner, short J1 using a jumper. If J1 is not present, go to the next step.

4. Connect the Differential Probe to P20 and configured channel of the oscilloscope.
5. Short LOAD3 (100 Ohm) using a jumper.

**10BASE-T
/10BASE-Te
Harmonic**

Use TC6 of the test fixture for this test. Make the connections as shown by the following figure:

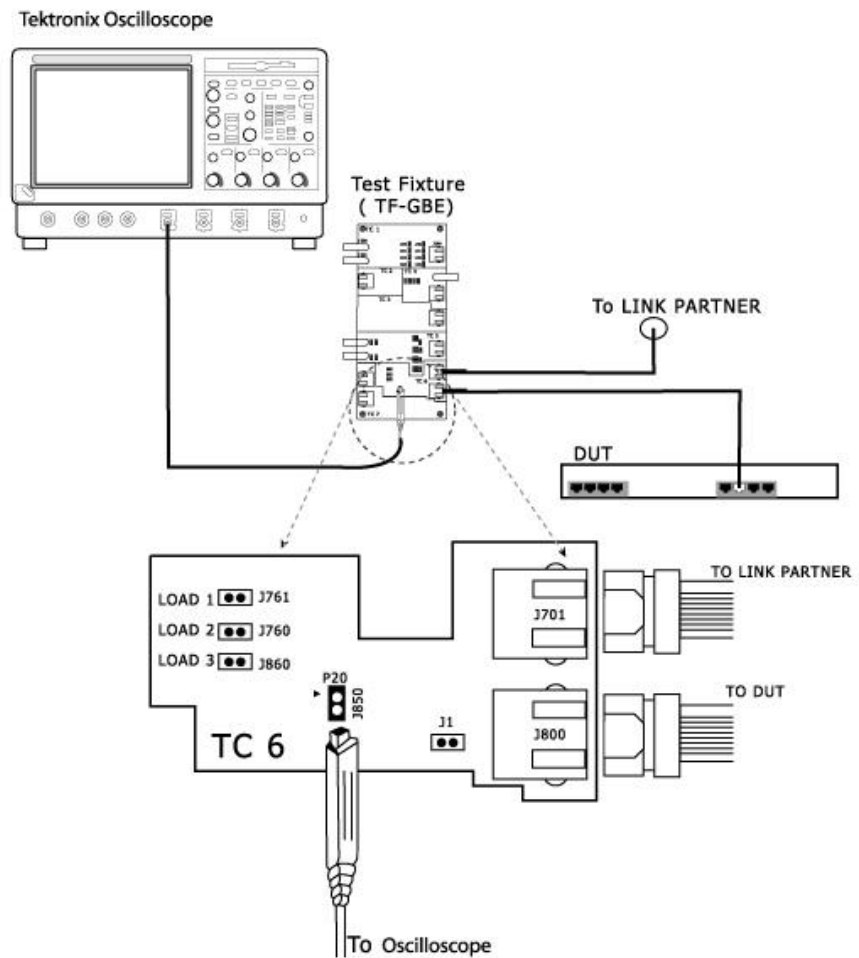

Figure 6-29: 10BASE-T Connections for Harmonic

1. Set the DUT to generate an all-one or an all-zero sequence signal.
2. Connect the Ethernet cable to J800 and test port of the DUT.
3. If you have a Link Partner, connect the Ethernet Cable to J701 and Link Partner.

If you do not have a link partner, short J11 using a jumper. If J11 is not present, go to the next step.

4. Connect the Differential Probe to P20 and configured channel of the oscilloscope.
5. Short LOAD3 (100 Ohm) using a jumper.

10BASE-T Return Loss Use TC1 of the test fixture for this test. Make the connections as shown by the following figures:

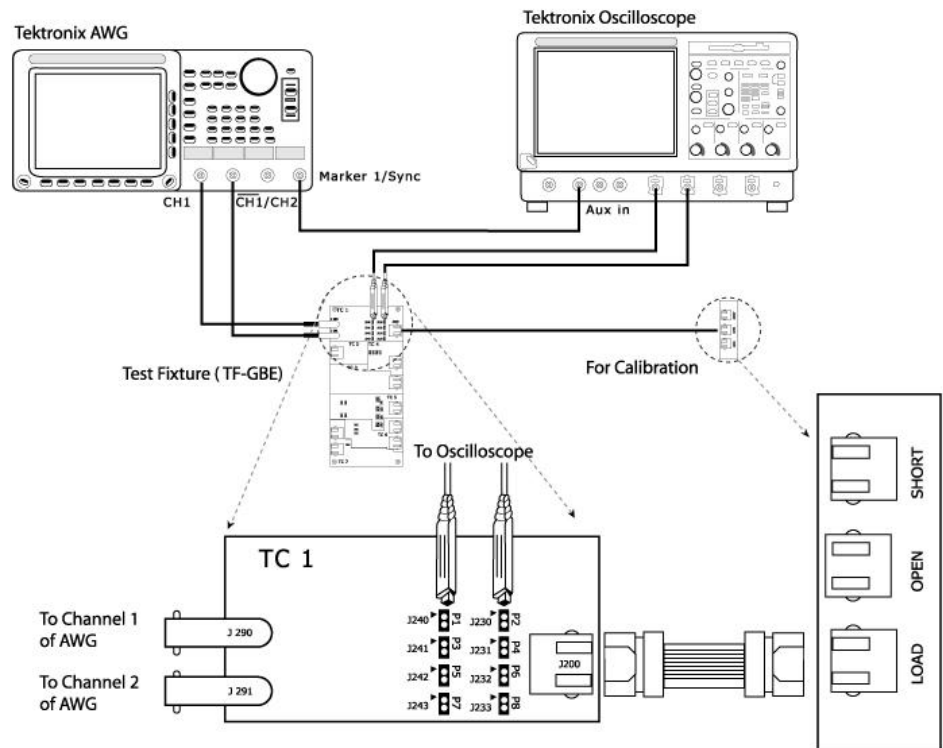

Figure 6-30: 10BASE-T Return Loss setup using an Arbitrary Waveform Generator

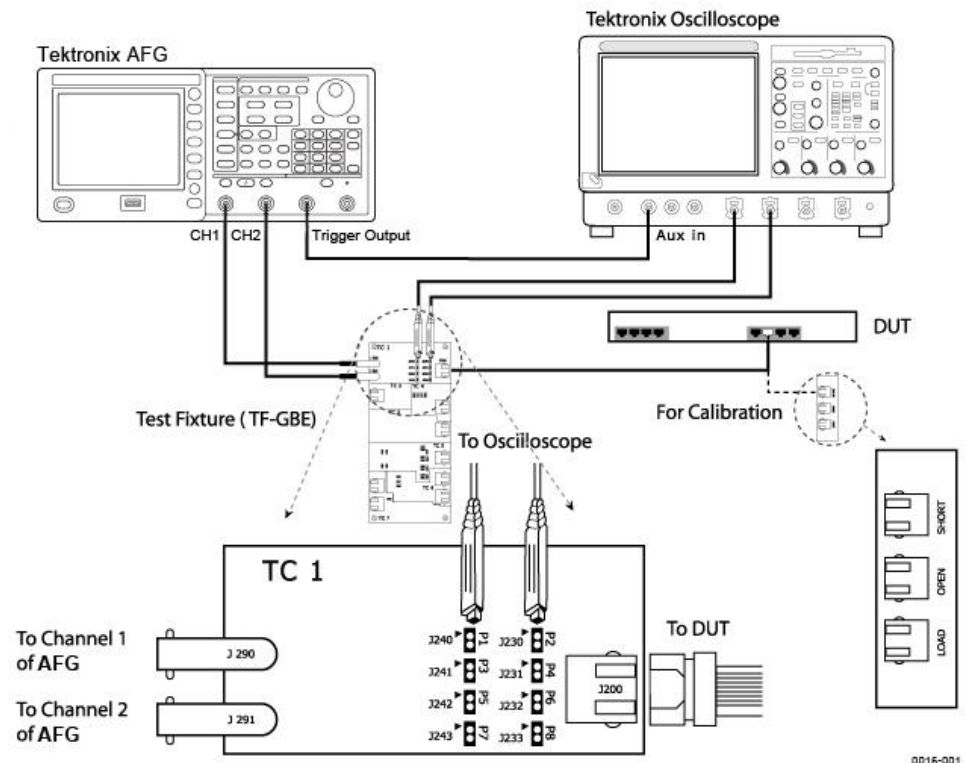

Figure 6-31: 10BASE-T Return Loss setup using an Arbitrary Function Generator

1. Connect the Ethernet cable to J200 and test port of the DUT.
2. Connect a BNC Cable to (AWG/AFG)+ and Channel 1 of Arbitrary Waveform Generator/Arbitrary Function Generator.
3. Connect a BNC Cable to (AWG/AFG)– and Channel 2 ($\overline{\text{CH1}}$) of Arbitrary Waveform Generator/Arbitrary Function Generator.

Note: The AWG/AFG waveforms are available in `C:\TekApplications\TDSET3\AWGWaveforms`. Some of the AWG/AFG models do not support the `.set` file for automatic settings. In particular, ensure that the AWG/AFG clock frequency is set to 250 MHz. Refer to the `ReadMe.txt` file for instructions to make those settings manually. This file is available in the corresponding AWG waveform file folder. You can automate the AWG/AFG to transfer files and settings as described in *Automate AWG/AFG*.

4. To test Transmitter, connect the Differential Probes to P1 (J240) and P2 (J230), and configured channels of the oscilloscope. Then, short the Jumper J241.

- To test Receiver, connect the Differential Probe to P3 (J241) and P4 (J231), and configured channels of the oscilloscope.

10BASE-T CM Voltage Use TC4 of the test fixture for this test. Make the connections as shown by the following figure:

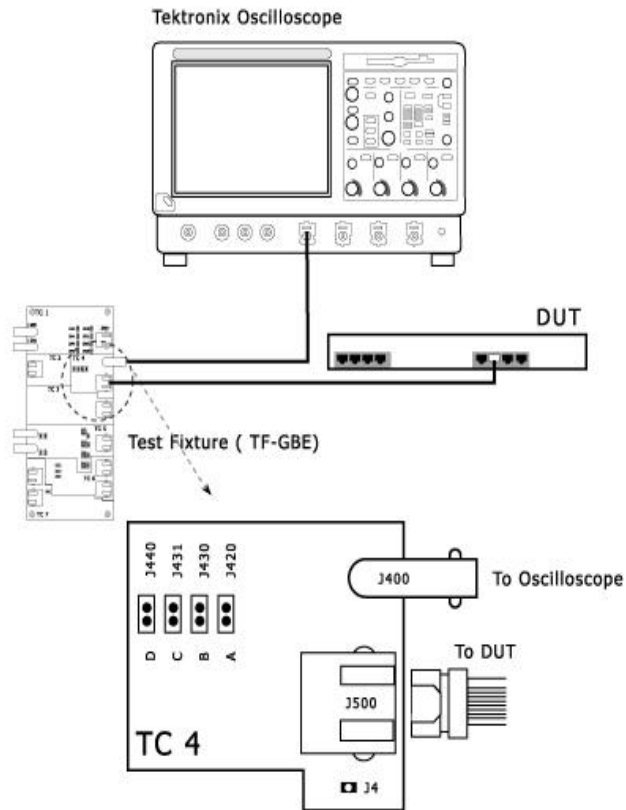

Figure 6-32: 10BASE-T Connections for CM Voltage

- Set the DUT to generate a pseudo-random sequence signal.
- Connect one end of the Ethernet Cable to J500 of Test Fixture TC4 and the other end to the test port of the DUT.
- Connect a BNC Cable between J400 of Test Fixture TC4 and configured channel of the oscilloscope.

Note: Do not use a TPA-BNC adapter at the oscilloscope.

- Short J420 of Test Fixture TC4 using a jumper.

Set up the Signal

1000BASE-T

The DUT needs to be set in different modes for various tests according to the following table:

Table 7-1: Test and pattern description

| Test | Pattern | BIT1 (9.15) | BIT2 (9.14) | BIT3 (9.13) |
|-------------------------------------|-------------|-------------|-------------|-------------|
| Template, Peak Volt, Droop | Test mode 1 | 0 | 0 | 1 |
| Jitter in Master mode | Test mode 2 | 0 | 1 | 0 |
| Jitter in Slave mode | Test mode 3 | 0 | 1 | 1 |
| Distortion, Return Loss, CM Voltage | Test mode 4 | 1 | 0 | 0 |
| Normal Operation | | 0 | 0 | 0 |

Contact your PHY vendor for a program that allows you to modify the bits 13, 14, 15 in the GMII Management Register 9.

100BASE-TX

The following table lists the signal pattern that needs to be generated for each of the 100BASE-TX tests:

Table 7-2: Test and pattern description

| Test | Pattern |
|-----------------------------|---------------------------------|
| Template | Scrambled idles |
| Differential Output Voltage | Scrambled idles |
| Signal Amplitude Symmetry | Scrambled idles |
| Rise Time | Scrambled idles |
| Fall Time | Scrambled idles |
| Rise/Fall Time Symmetry | Scrambled idles |
| Waveform Overshoot | Scrambled idles |
| Jitter | Scrambled idles |
| Duty Cycle Distortion | Scrambled idles or 0101 pattern |
| Return Loss | Scrambled idles |

If you are using a traffic generator to generate the signal, set the traffic generator to generate the signal pattern as listed in the table.

If you are not using a traffic generator to generate the signal, contact your PHY vendor for a special program to generate these patterns.

10BASE-T/10BASE-Te

The following table lists the signal pattern that needs to be generated for each of the 10BASE-T/10BASE-Te tests:

Table 7-3: Test and pattern description

| Test | Pattern |
|----------------------|------------------------|
| Link Pulse | Link Pulse |
| MAU | Pseudo-random sequence |
| TP_IDL | Pseudo-random sequence |
| Jitter | Pseudo-random sequence |
| Differential Voltage | Pseudo-random sequence |
| Harmonic | All 1s or 0s |
| Return Loss | Pseudo-random sequence |
| CM Voltage | Pseudo-random sequence |

***Note:** If you are using a Link Partner, ensure that you do not test the Link Pulse generated by the Link Partner, but test the Link Pulse generated by the DUT.*

If you are using a traffic generator to generate the signal, set the traffic generator to generate the signal pattern as listed in the table.

If you are not using a traffic generator to generate the signal, contact your PHY vendor for a special program to generate these patterns.

How To Test 1000BASE-T

1000BASE-T Template

1. Click Tests > Select > 1000BASE-T from the menu bar.
2. In Template/Volt tab, select a point in the *Template* group, for example, A.

Note: The status bar displays the major configuration details. If you do not want to change the configuration settings, you can skip Step 3.

3. To change the configuration settings, select **Tests > Configure** from the menu bar, or click the Configure button in the Selection pane.
4. In the Configuration window, select the following options:

Table 8-1: 1000BASE-T Template configuration options

| Parameter | Options | To do |
|-------------------|---------------------------|---|
| Data | CH1, CH2, CH3, or CH4 | Select the channel to which the DUT is connected. |
| # Averages | 64 to 10000 | Enter the number of waveforms you want to average. |
| Output | Ref1, Ref2, Ref3, or Ref4 | Select the reference waveform on which the processed waveform will be stored. |
| Disturbing Signal | Yes or No | Select the options depending on whether the Disturbing signal is present or not. <i>Note: Selecting Disturbing Signal as Yes, enables the Jig Match in Connect pane.</i> |
| Filter | Int or Ext | Select the options depending on whether the filter is applied or not. If you select Ext, the application assumes that the filter is applied externally. |

5. Select **Tests > Connect** or Connect in the Selection pane and make connections.
6. Select **View Wfm** in the Selection pane, to view and compare the waveform with the acquired waveform.
7. If the disturbing signal is present and you have configured **Disturbing Signal** as **Yes**, then click **Run Test**. The application does as described next.

- Displays a message box to confirm the overwrite of the reference waveform. Select **Yes** to continue
 - Checks whether the DUT is connected
 - Sets the trigger
 - Acquires, filters, and removes the disturbing signal
 - Normalizes the data
 - Displays the processed waveform on selected output (reference waveform) over the template mask
8. If the disturbing signal is not present and you have configured Disturbing Signal as **No**, and then click **Run Test**. The application does the following:
- Displays a message box to confirm the overwrite of the reference waveform. Select **Yes** to continue
 - Checks whether the DUT is connected
 - Sets the trigger
 - Acquires, filters, and normalizes the data
 - Displays the processed waveform on selected output (reference waveform) over the template mask

If the test fails, the application captures the waveform, circles the hits and saves the information to the report.

The following figure shows a typical processed waveform for Template Testing on Points A, B, C, and D:

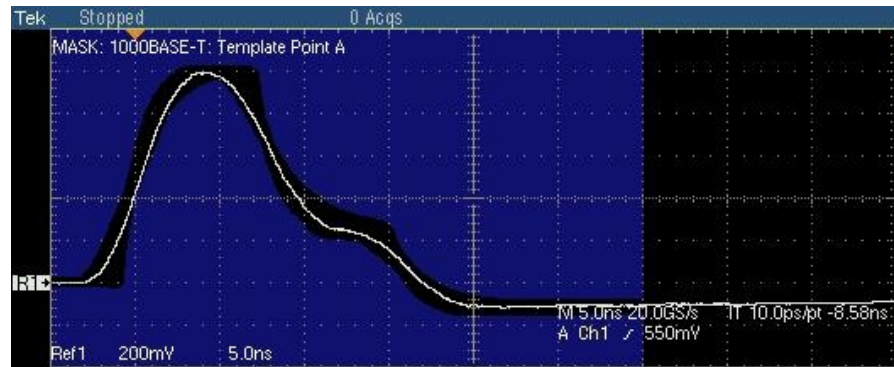

Figure 8-1: Waveform for 1000BASE-T Template Points A, B, C, and D

The following figure shows a typical processed waveform for Template Testing on Points F and H:

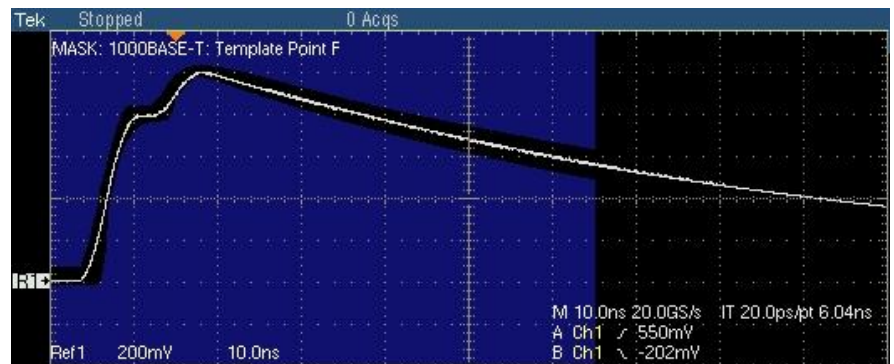

Figure 8-2: Waveform for 1000BASE-T Template Points F and H

Note: In TDS5000B series oscilloscopes, the horizontal scale is set to 4 ns.

The application also tests for mask and displays the results as pass or fail.

If the acquired waveform does not lie within the mask, click Manual Fit. Click the arrow buttons to adjust the Ref waveform to fit into the mask. This repeats the mask pass/fail test and displays the results in the **Results Summary** pane.

The application automatically displays the results as pass or fail. Select **Results** in the Execution pane and then click **Result Details** button to view the detailed results.

1000BASE-T Peak Volt

1. Click Tests > Select > 1000BASE-T from the menu bar.
2. In Template/Volt tab, select a point in the *Peak Volt* group, for example, A.

***Note:** The status bar displays the major configuration details. If you do not want to change the configuration settings, you can skip Step 3.*

3. To change the configuration settings, select **Tests > Configure** from the menu bar, or click the Configure button in the Selection pane.
4. In the Configuration window, select the following options:

Table 8-2: 1000BASE-T Peak Volt configuration options

| Parameter | Options | To do |
|-------------------|---------------------------|---|
| Data | CH1, CH2, CH3, or CH4 | Select the channel to which the DUT is connected. |
| # Averages | 64 to 10000 | Enter the number of waveforms you want to average. |
| Output | Ref1, Ref2, Ref3, or Ref4 | Select the reference waveform on which the processed waveform will be stored. |
| Disturbing Signal | Yes or No | Select the options depending on whether the Disturbing signal is present or not. |
| Filter | Int or Ext | Select the options depending on whether the filter is applied or not. If you select Ext, the application assumes that the filter is applied externally. |
| Weighted Average | 1 to 10 | Configure the weighted averages through the .ini file available at C:\Program Files\TekApplications\TDSET3\Default.ini |

5. Select **Tests > Connect** or Connect in the Selection pane and make connections.
6. Select View Wfm in the Selection pane, to view and compare the waveform with the acquired waveform.
7. If the disturbing signal is present and you have configured Disturbing Signal as **Yes**, and then click **Run Test**.

The application does the following:

- Displays a message box to confirm the overwrite of the reference waveform. Select **Yes** to continue

- Checks whether the DUT is connected
 - Acquires, filters, and removes the disturbing signal
 - Finds the peak value of the point selected after filtering
 - Compares with the specification range specified by the standard
 - Displays the processed waveform on the selected output
8. If the disturbing signal is not present and you have configured Disturbing Signal as **No**, and then click **Run Test**. The application does the following:
- Displays a message box to confirm the overwrite of the reference waveform. Select **Yes** to continue
 - Checks whether the DUT is connected
 - Acquires and filters the data
 - Finds the peak value of the point selected after filtering
 - Compares with the specification range specified by the standard
 - Displays the processed waveform on the selected output

The following figure displays a typical DUT waveform for Peak Voltage Testing on Points A, B, C, and D:

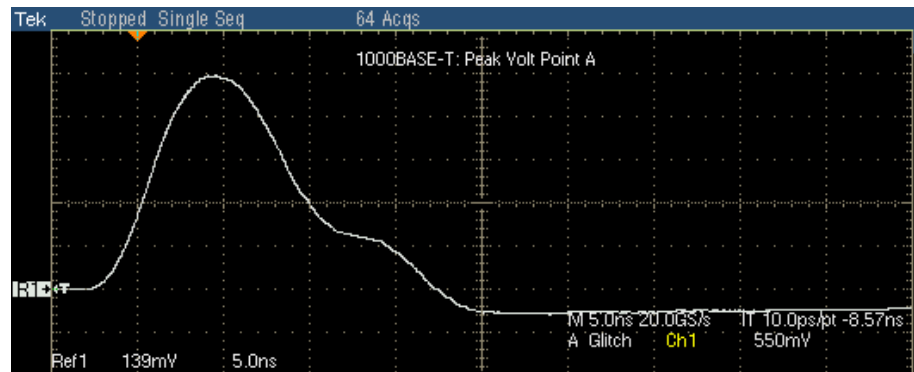

Figure 8-3: Waveform for 1000BASE-T Peak Volt Points A, B, C, and D

Note: In TDS5000B series oscilloscopes, the horizontal scale is set to 4 ns.

The application automatically displays the results as pass or fail. Select **Results** in the Execution pane and then click **Result Details** button to view the detailed results.

1000BASE-T Droop

1. Click Tests > Select > 1000BASE-T from the menu bar.
2. In the Droop tab, select a point, for example, G.

Note: The status bar displays the major configuration details. If you do not want to change the configuration settings, you can skip Step 3.

3. To change the configuration settings, select **Tests > Configure** from the menu bar, or click the Configure button in the Selection pane.
4. In the Configuration window, select the following options:

Table 8-3: 1000BASE-T Droop configuration options

| Parameter | Options | To Do |
|-------------------|---------------------------|--|
| Data | CH1, CH2, CH3, or CH4 | Select the channel to which the DUT is connected. |
| # Averages | 64 to 10000 | Enter the number of waveforms you want to average. |
| Output | Ref1, Ref2, Ref3, or Ref4 | Select the reference waveform on which the processed waveform will be stored. |
| Disturbing Signal | Yes or No | Select the options depending on whether the Disturbing signal is present or not. |

5. Select **Tests > Connect** or Connect in the Selection pane and make connections.
6. Select View Wfm in the Selection pane, to view and compare the waveform with the acquired waveform.
7. If the disturbing signal is present and you have configured Disturbing Signal as **Yes**, and then click **Run Test**.

The application does the following:

- Displays a message box to confirm the overwrite of the reference waveform. Select **Yes** to continue
- Checks whether the DUT is connected
- Acquires and removes the disturbing signal
- Displays the processed waveform on selected output and places vertical cursors at Point F and Point G

- Displays the cursor values – voltage, time, voltage difference and time difference – at the points F and G
8. If the disturbing signal is not present and you have configured Disturbing Signal as **No**, and then click **Run Test**. The application does the following:
- Checks whether the DUT is connected
 - Displays the acquired waveform and places vertical cursors at Point F and Point G
 - Displays the cursor values – voltage, time, voltage difference, and time difference – at the Point F and Point G

The following figure shows a typical DUT waveform showing points F and G:

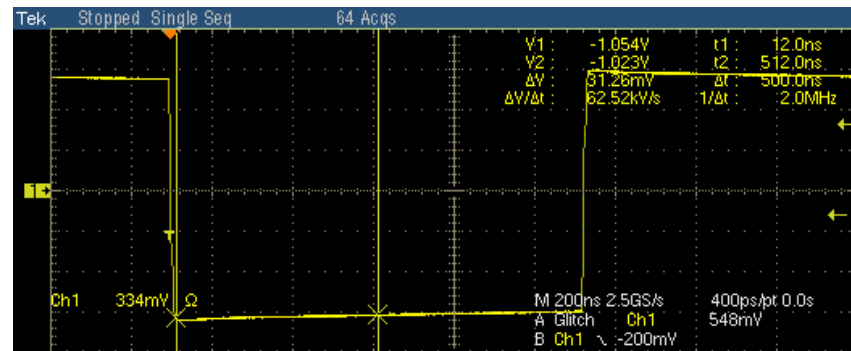

Figure 8-4: Waveform for 1000BASE-T Droop Points F and G

The application automatically displays the results as pass or fail. Select **Results** in the Execution pane and then click **Result Details** button to view the detailed results.

1000BASE-T Jitter Master Filtered

1. Click Tests > Select > 1000BASE-T from the menu bar.
2. In the Jit/Distortion tab, select **Master Filtered**.

Note: The status bar displays the major configuration details. If you do not want to change the configuration settings, you can skip Step 3.

3. To change the configuration settings, select **Tests > Configure** from the menu bar, or click the Configure button in the Selection pane.

- In the Configuration window, select the following options:

Table 8-4: 1000BASE-T Jitter Master Filtered configuration options

| Parameter | Options | To do |
|------------------|-----------------------|---|
| Data | CH1, CH2, CH3, or CH4 | Select the channel to which the DUT is connected. |
| Master CLK | CH1, CH2, CH3, or CH4 | Select the channel to which the Master TX_TCLK is connected. |
| Clock Edge | Rising or Falling | Select the clock edge on which the oscilloscope finds the trigger point. |
| Record Length | | Varies depending on the Memory option available on the oscilloscope. |
| TX_TCLK | Yes, No | Select Yes if you have access to TX_TCLK. Select No if you do not have access to TX_TCLK. |
| Data (TM2) | CH1, CH2, CH3, or CH4 | Select the channel to which the Test Mode 2 signal is connected. |
| Hysteresis | 5.00% to 30.00% | Enter the hysteresis percent value. |
| Jitter LP-Filter | 1 (Yes), 0 (No) | Configure the low pass filter through the .ini file available at C:\Program Files\TekApplications\TDSET3\Default.ini |

- Select **Tests > Connect** or Connect in the Selection pane and make connections.
- Select View Wfm in the Selection pane, to view and compare the waveform with the acquired waveform.

If you have access to TX_TCLK

Note: The application checks the frequency of the TX_TCLK. If it is within $\pm 5\%$ of 125 MHz or 62.5 MHz, the application proceeds to complete the test or else the application displays the error message E106.

7. Click Run Test. The application displays the following dialog box:

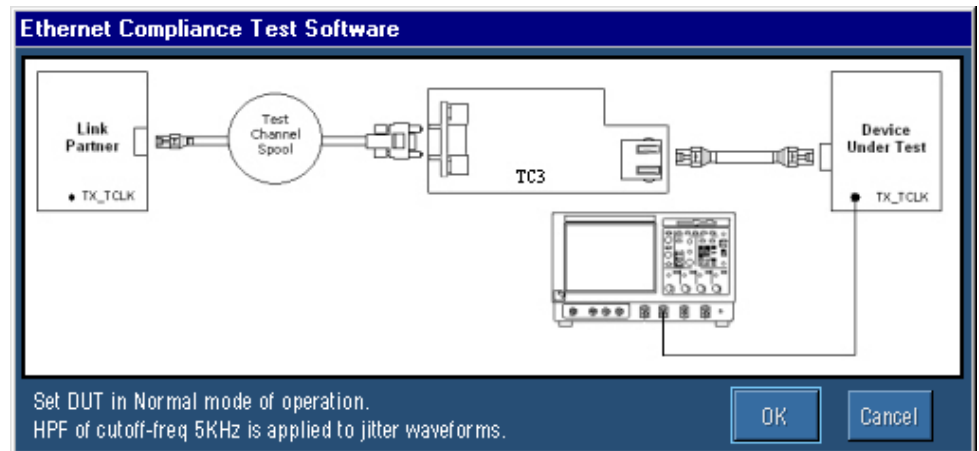

Figure 8-5: 1000BASE-T Jitter Master Filtered Step 1

8. Set the DUT in Normal mode as Master and connect to the Link Partner.
9. Click OK. The application does the following:
 - Checks whether the Master TX_TCLK is connected
 - Sets up the signal, where at least 10^5 edges (minimum of opt. 3M required) are available
 - Derives the jitter waveform, applies the filter
 - Determines the peak-to-peak value of the filtered waveform

10. The application displays the following dialog box:

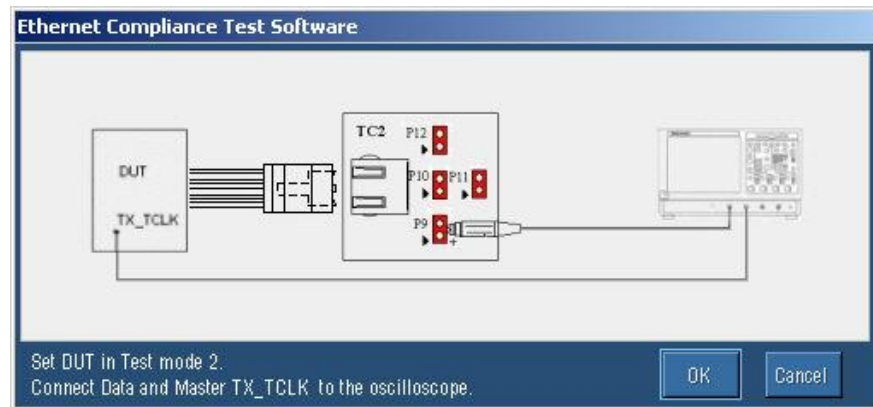

Figure 8-6: 100BASE-T Jitter Master Filtered Step 2

11. Set DUT in Test mode 2 and connect Data and Clock to the oscilloscope.
12. Click OK. The application checks whether the Data and Master CLK signal are connected and then measures jitter (Jtxout) of the data with respect to the Master CLK.
13. The application displays the TIE plot of the jitter waveform as shown by the following figure:

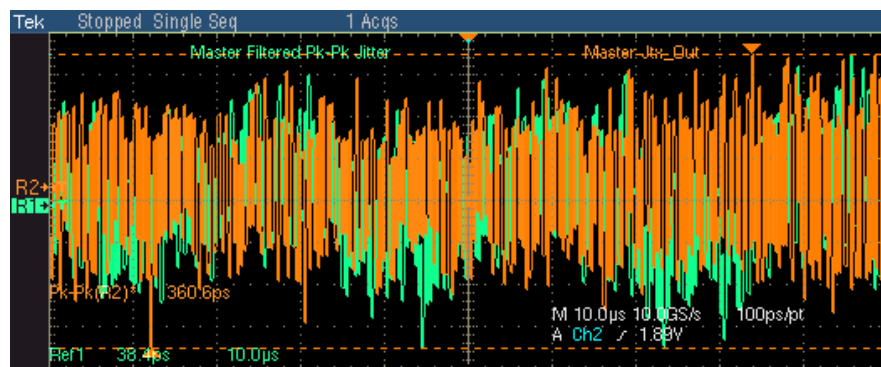

Figure 8-7: Waveform for 100BASE-T Jitter Master Filtered

Note: The TDS6604 and TDS6404 oscilloscopes acquire approximately 1250 edges.

The application automatically displays the results as pass or fail. Select **Results** in the Execution pane and then click **Result Details** button to view the detailed results.

If you do not have access to TX_TCLK (this is only an informative test and not a compliance test), ensure that TX_TCLK is set to No in the Configuration.

7. Click Run Test. A message box appears. Click OK to quit the message box and continue running the test.

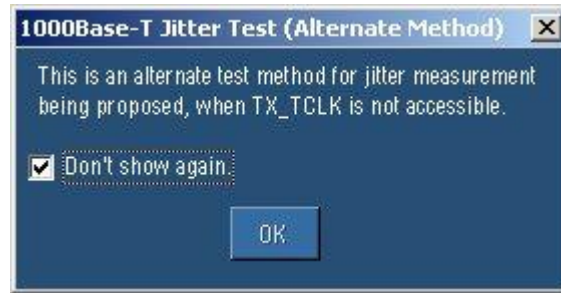

8. Set the DUT in Test Mode 2 and connect Data (TM2) to the oscilloscope.
9. Click OK. The application does the following:
 - Checks whether Data (TM2) is connected
 - Sets up the signal, where at least 105 edges (minimum of opt. 4M required) are available
 - Derives the jitter waveform, applies the filter
 - Determines the peak-to-peak value of the filtered waveform

10. The application displays the TIE plot of the jitter waveform as follows:

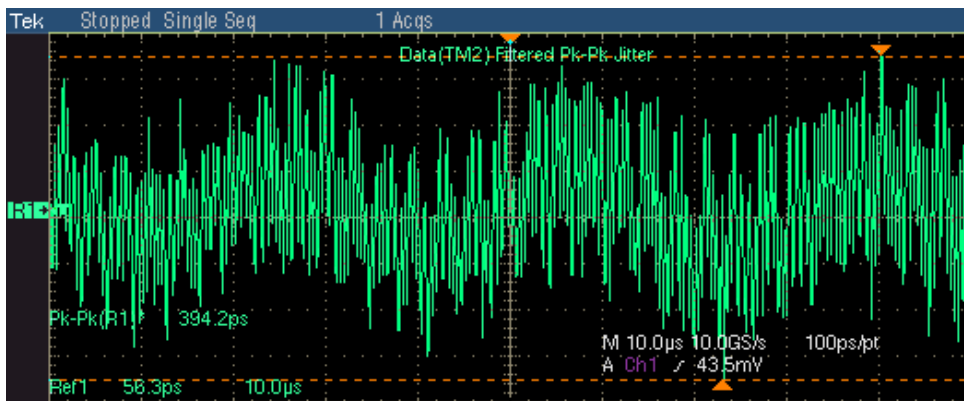

Figure 8-8: 1000BASE-T Jitter Master Filtered (without TX_TCLK)

Note: The TDS6604 and TDS6404 oscilloscopes acquire approximately 625 edges. This is an alternate test method for jitter measurement being proposed, when TX_TCLK is not accessible. This is an informal test method.

The application automatically displays the results as inconclusive or fail. Select Results in the Execution pane and then click Result Details button to view the detailed results.

1000BASE-T Jitter Master Unfiltered

1. Click Tests > Select > 1000BASE-T from the menu bar.
2. In the Jit/Distortion tab, select **Master Unfiltered**.

Note: The status bar displays the major configuration details. If you do not want to change the configuration settings, you can skip Step 3.

3. To change the configuration settings, select **Tests > Configure** from the menu bar, or click the Configure button in the Selection pane.

4. In the Configuration window, select the following options:

Table 8-5: 1000BASE-T Jitter Master Unfiltered configuration options

| Parameter | Options | To do |
|------------------|-----------------------|--|
| Master CLK | CH1, CH2, CH3, or CH4 | Select the channel to which the Master TX_TCLK is connected. |
| Clock Edge | Rising or Falling | Select the clock edge on which the oscilloscope finds the trigger point. |
| Meas Type | Histogram or TIE | Select the measurement type. |
| Record Length | | Varies depending on the Memory option available on the oscilloscope. <i>Note: The Record Length is enabled only if you select Meas Type as TIE.</i> |
| TX_TCLK | Yes, No | Select Yes if you have access to TX_TCLK. Select No if you do not have access to TX_TCLK. |
| Data (TM2) | CH1, CH2, CH3, or CH4 | Select the channel to which the Test Mode 2 signal is connected. |
| Hysteresis | 5.00% to 30.00% | Enter the hysteresis percent value. |
| Jitter LP-Filter | 1 (Yes), 0 (No) | Configure the low pass filter through the .ini file available at C:\Program Files\TekApplications\TDSET3\Default.ini |

5. Select **Tests > Connect** or Connect in the Selection pane and make connections.
6. Select View Wfm in the Selection pane, to view and compare the waveform with the acquired waveform.

If you have access to TX_TCLK

Note: The application checks the frequency of the TX_TCLK. If it is within $\pm 5\%$ of 125 MHz or 62.5 MHz, the application proceeds to complete the test or else the application displays the error message E106.

7. Select **Histogram** in the Configuration. Click **Run Test**. The application does the following for Histogram method:
- Checks whether the Master TX_TCLK is connected
 - Trigger on Master TX_TCLK clock signal at 50% of peak-to-peak amplitude
 - Sets up the oscilloscope horizontal and vertical scale based on Master clock signal

- Places a horizontal histogram on the pulse following the trigger pulse at the trigger level
 - Reads the peak-to-peak jitter from the histogram
 - Compares the read out values with the values specified in the standard
 - Takes approximately one minute to achieve approximately 13 million waveform acquisition
 - Displays the Master clock waveform
8. Select **TIE** in the Configuration. Click **Run Test**. The application does the following for TIE method:
- Checks whether the Master TX_TCLK is connected
 - Trigger on Master TX_TCLK clock signal at 50% of peak-to-peak amplitude
 - Derives the jitter waveform of the Master TX_TCLK with respect to unjittered reference.
 - Determines the Pk-Pk value of jitter waveform
 - Compares the read out values with the values specified in the standard
 - Displays the TIE plot of the jitter waveform

The following figure shows a typical TIE plot of Jitter waveform:

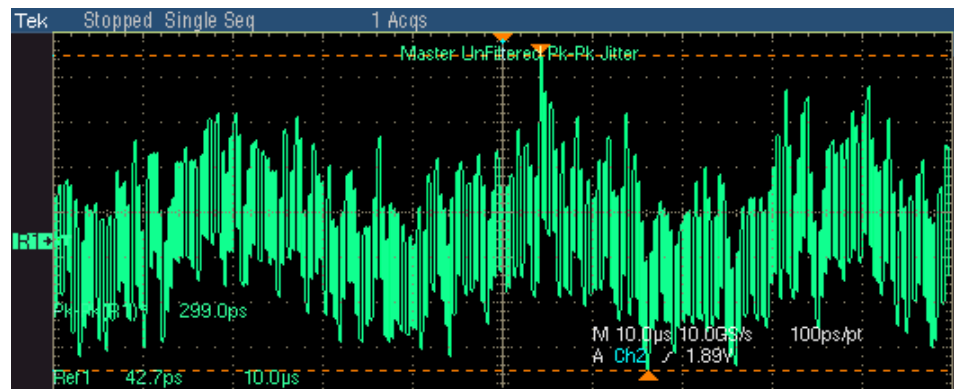

Figure 8-9: TIE Waveform for 1000BASE-T Jitter Master Unfiltered

Note: The TDS6604 and TDS6404 oscilloscopes acquire approximately 1250 edges.

The following figure shows a typical Histogram plot of Jitter waveform:

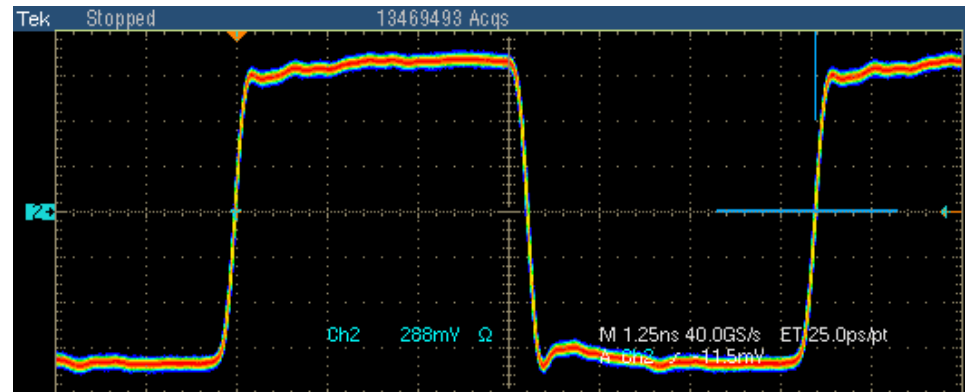

Figure 8-10: Histogram Waveform for 1000BASE-T Jitter Master Unfiltered

Note: In TDS6000 and DPO7000 series oscilloscopes, approximately 13,000,000 waveform database samples are acquired.

The application automatically displays the results as pass or fail. Select **Results** in the Execution pane and then click **Result Details** button to view the detailed results.

If you do not have access to TX_TCLK (this is only an informative test and not a compliance test), ensure that TX_TCLK is set to No in the Configuration.

7. Click **Run Test**. A message box appears. Click OK to quit the message box and continue running the test.



8. Set the DUT in Test Mode 2 and connect Data (TM2) to the oscilloscope.
9. Select **Histogram** in the Configuration. Click OK. The application does the following for Histogram method:
 - Checks whether Data (TM2) is connected
 - Trigger on Data (TM2) signal at 50% of peak-to-peak amplitude

- Sets up the oscilloscope horizontal and vertical scale based on Data (TM2) signal
- Places a horizontal histogram on the pulse following the trigger pulse at the trigger level
- Reads the peak-to-peak jitter from the histogram
- Compares the read out values with the values specified in the standard
- Takes approximately one minute to achieve approximately 13 million waveform acquisition
- Displays the Data (TM2) waveform.



10. Select **TIE** in the Configuration. Click **OK**. The application does the following for TIE method:

- Checks whether Data (TM2) is connected
- Trigger on Data (TM2) signal at 50% of peak-to-peak amplitude
- Derives the jitter waveform of Data (TM2) with respect to unjittered reference
- Determines the Pk-Pk value of jitter waveform
- Compares the read out values with the values specified in the standard
- Displays the TIE plot of the jitter waveform

The following figure shows a typical TIE plot of Jitter waveform:

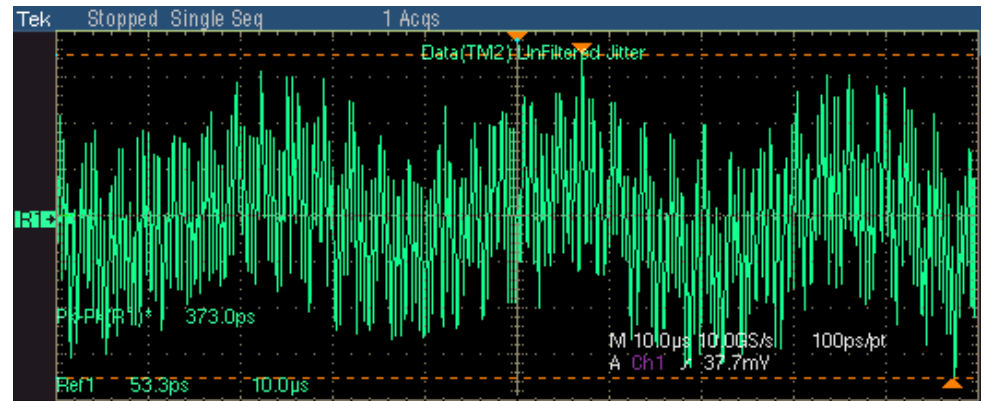

Figure 8-11: TIE Waveform for 1000BASE-T Jitter Master Unfiltered

Note: The TDS6604 and TDS6404 oscilloscopes acquire approximately 625 edges. This is an alternate test method for jitter measurement being proposed, when TX_TCLK is not accessible. This is an informal test method.

The following figure shows a typical Histogram plot of Jitter waveform:

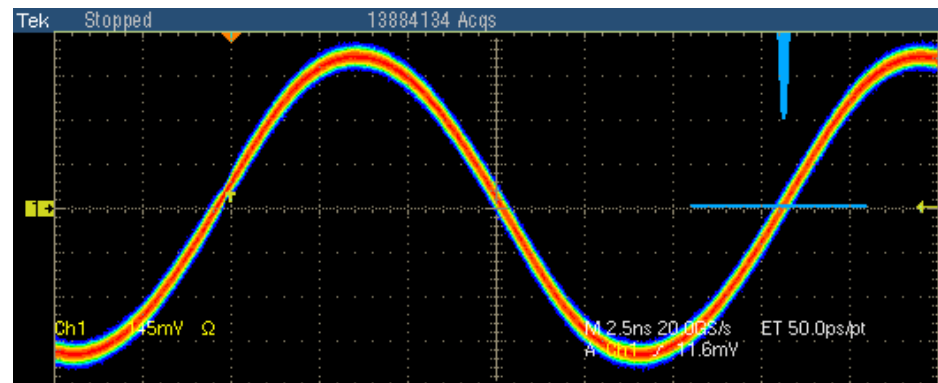

Figure 8-12: Histogram Waveform for 1000BASE-T Jitter Master Unfiltered

Note: In TDS6000 and DPO7000 series oscilloscopes, approximately 13,000,000 waveform database samples are acquired.

The application automatically displays the results as pass or fail. Select **Results** in the Execution pane and then click **Result Details** button to view the detailed results.

1000BASE-T Jitter Slave Filtered

Note: The two-channel oscilloscopes do not support the Jitter Slave Filtered test.

1. Click Tests > Select > 1000BASE-T from the menu bar.
2. In the Jit/Distortion tab, select **Slave Filtered**.

Note: The status bar displays the major configuration details. If you do not want to change the configuration settings, you can skip Step 3.

3. To change the configuration settings, select **Tests > Configure** from the menu bar, or click the Configure button in the Selection pane.
4. In the Configuration window, select the following options:

Table 8-6: 1000BASE-T Jitter Slave Filtered configuration options

| Parameter | Options | To do |
|------------------|-----------------------|---|
| Data | CH1, CH2, CH3, or CH4 | Select the channel to which the DUT is connected. |
| Master CLK | CH1, CH2, CH3, or CH4 | Select the channel to which the Master TX_TCLK is connected. |
| Slave CLK | CH1, CH2, CH3, or CH4 | Select the channel to which the Slave TX_TCLK is connected. |
| Clock Edge | Rising or Falling | Select the clock edge on which the oscilloscope finds the trigger point. |
| Record Length | | Varies depending on the Memory option available on the oscilloscope. |
| TX_TCLK | Yes, No | Select Yes if you have access to TX_TCLK. Select No if you do not have access to TX_TCLK. |
| Data (TM2) | CH1, CH2, CH3, or CH4 | Select the channel to which the Test Mode 2 signal is connected. |
| Data (TM3) | CH1, CH2, CH3, or CH4 | Select the channel to which the Test Mode 3 signal is connected. |
| Hysteresis | 5.00% to 30.00% | Enter the hysteresis percent value. |
| Jitter LP-Filter | 1 (Yes), 0 (No) | Configure the low pass filter through the .ini file available at C:\Program Files\TekApplications\TDSET3\Default.ini |

5. Select **Tests > Connect** or **Connect** in the Selection pane and make connections.
6. Select **View Wfm** in the Selection pane, to view and compare the waveform with the acquired waveform.

If you have access to TX_TCLK

Note: The application checks the frequency of the TX_TCLK. If it is within $\pm 5\%$ of 125 MHz or 62.5 MHz, the application proceeds to complete the test or else the application displays the error message E106.

7. Click **Run Test**. The application displays the following dialog box:

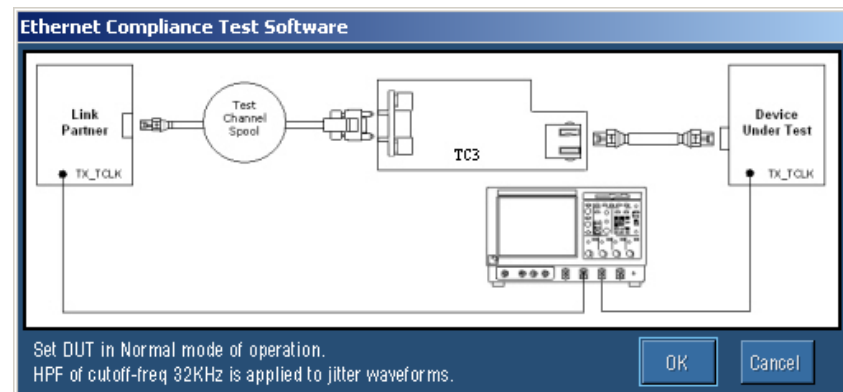

Figure 8-13: 1000BASE-T Jitter Slave Filtered Step 1

8. Set the DUT in Normal mode as Slave and connect to the Link Partner.
9. Click OK. The application does the following:
 - Checks whether the Master TX_TCLK and Slave TX_TCLK are connected
 - Sets up the signal, where at least 10^5 (minimum of opt. 3M required) edges are available
 - Derives the jitter waveform of Master TX_TCLK with respect tounjittered reference
 - Derives the jitter waveform of Slave TX_TCLK with respect to Master TX_TCLK
 - Applies the filter, and determines the peak-to-peak value of the filtered waveforms

10. The application displays the following dialog box:

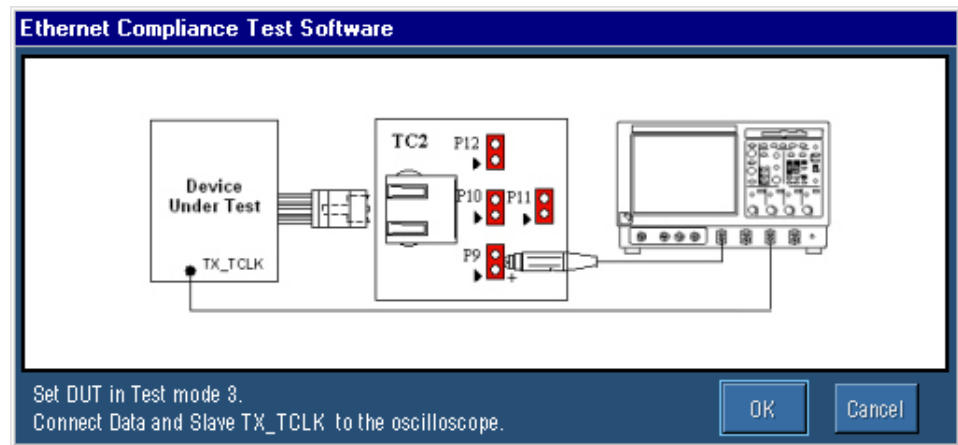

Figure 8-14: 1000BASE-T Jitter Slave Filtered Step 2

11. Set DUT in Test mode 3 and connect Data and Slave TX_TCLK to the oscilloscope.
12. Click OK. The application checks whether the Data and Slave TX_TCLK are connected.
13. Then, the application measures jitter (Jtxout) of the data with respect to the Slave TX_TCLK.

The application displays the TIE plot of the Jitter waveform as followse:

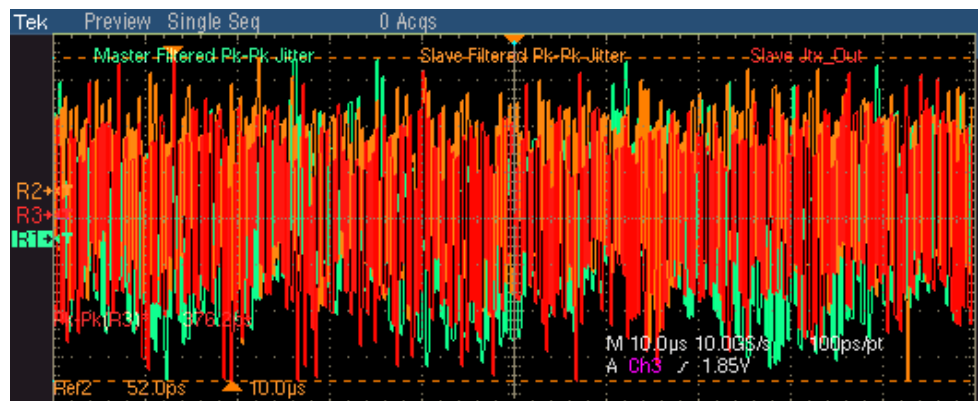

Figure 8-15: Waveform for 1000BASE-T Jitter Slave Filtered

Note: The TDS6604 and TDS6404 oscilloscopes acquire approximately 1250 edges.

The application automatically displays the results as pass or fail. Select **Results** in the Execution pane and then click **Result Details** button to view the detailed results.

If you do not have access to TX_TCLK (this is only an informative test and not a compliance test), ensure that TX_TCLK is set to No in the Configuration.

7. Click **Run Test**. A message box appears. Click OK to quit the message box and continue running the test.



8. Set the DUT to generate the signal in test mode 2.

9. Click OK. The application does the following:

Step 1:

- Checks whether Data (TM2) is connected
- Sets up the signal, where at least 10^5 edges (minimum opt. 4M required) are available
- Derives the jitter waveform of Data (TM2) with respect to unjittered reference
- Applies the filter, and determines the peak-to-peak value of the filtered waveforms

Step 2:



- Set the DUT to generate the signal in test mode 3
- Checks whether Data (TM3) is connected

- Sets up the signal, where at least 10^5 edges (minimum opt. 4M required) are available
- Derives the jitter waveform of Data (TM3) with respect to unjittered reference
- Applies the filter, and determines the peak-to-peak value of the filtered waveforms

The application displays the TIE plot of the Jitter waveform as shown by the next figure:

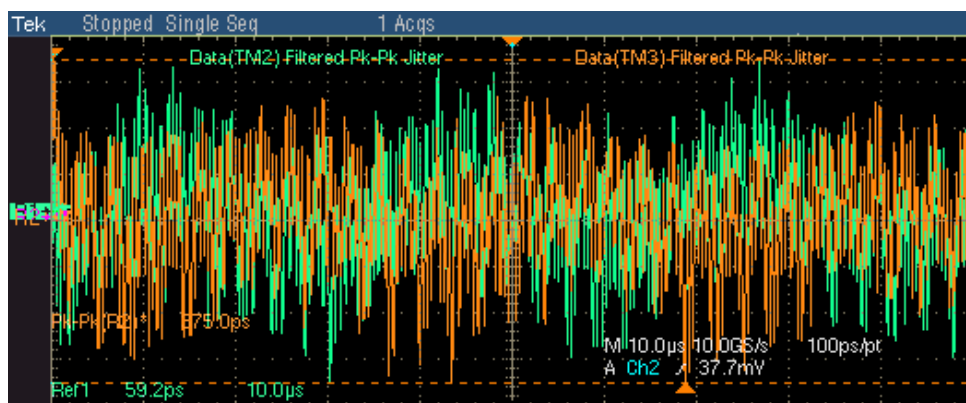

Figure 8-16: Waveform for 1000BASE-T Jitter Slave Filtered

Note: The TDS6604 and TDS6404 oscilloscopes acquire approximately 625 edges. This is an alternate test method for jitter measurement being proposed, when TX_TCLK is not accessible. This is an informal test method.

The application automatically displays the results as pass or fail. Select **Results** in the Execution pane and then click **Result Details** button to view the detailed results.

1000BASE-T Jitter Slave Unfiltered

1. Click Tests > Select > 1000BASE-T from the menu bar.
2. In the Jit/Distortion tab, select **Slave Unfiltered**.

Note: The status bar displays the major configuration details. If you do not want to change the configuration settings, you can skip Step 3.

3. To change the configuration settings, select **Tests > Configure** from the menu bar, or click the Configure button in the Selection pane.

4. In the Configuration window, select the following options:

Table 8-7: 1000BASE-T Jitter Master Unfiltered configuration options

| Parameter | Options | To do |
|------------------|-----------------------|--|
| Master CLK | CH1, CH2, CH3, or CH4 | Select the channel to which the Master TX_TCLK is connected. |
| Slave CLK | CH1, CH2, CH3, or CH4 | Select the channel to which the Slave TX_TCLK is connected. |
| Clock Edge | Rising or Falling | Select the clock edge on which the oscilloscope finds the trigger point. |
| Meas Type | Histogram or TIE | Select the measurement type. |
| Record Length | | Varies depending on the Memory option available on the oscilloscope. <i>Note: The Record Length is enabled only if you select Meas Type as TIE.</i> |
| TX_TCLK | Yes, No | Select Yes if you have access to TX_TCLK. Select No if you do not have access to TX_TCLK. |
| Data (TM2) | CH1, CH2, CH3, or CH4 | Select the channel to which the Test Mode 2 signal is connected. |
| Data (TM3) | CH1, CH2, CH3, or CH4 | Select the channel to which the Test Mode 3 signal is connected. |
| Hysteresis | 5.00% to 30.00% | Enter the hysteresis percent value. |
| Jitter LP-Filter | 1 (Yes), 0 (No) | Configure the low pass filter through the .ini file available at C:\Program Files\TekApplications\TDSET3\Default.ini |

5. Select Tests > **Connect** or Connect in the Selection pane and make connections.
6. Select View Wfm in the Selection pane, to view and compare the waveform with the acquired waveform.

If you have access to TX_TCLK

Note: The application checks the frequency of the TX_TCLK. If it is within $\pm 5\%$ of 125 MHz or 62.5 MHz, the application proceeds to complete the test or else the application displays the error message E106.

7. Select **Histogram** in the Configuration. Click **Run Test**. The application does the following for Histogram method:
- Checks whether the Master TX_TCLK and Slave TX_TCLK are connected

- Triggers on Master TX_TCLK clock signal at 50% of peak-to-peak amplitude
 - Sets up the oscilloscope horizontal and vertical scale based on Slave TX_TCLK signal
 - Places a horizontal histogram on the Slave TX_TCLK pulse following the trigger pulse at 50% of peak-to-peak amplitude
 - Measures the peak-to-peak jitter from the histogram
 - Compares the read out values with the values specified in the standard
 - Takes approximately one minute to achieve approximately 13 million waveform acquisition
 - Displays the Slave TX_TCLK waveform
8. Select **TIE** in the Configuration. Click Run **Test**. The application does the following for TIE method:
- Checks whether the Master TX_TCLK and Slave TX_TCLK are connected
 - Triggers on Master TX_TCLK clock signal at 50% of peak-to-peak amplitude
 - Derives the jitter waveform of the Slave TX_TCLK with respect to Master TX_TCLK
 - Determines the Pk-Pk value of jitter waveform
 - Compares the read out values with the values specified in the standard
 - Displays the TIE plot of the jitter waveform

The following figure shows a typical TIE plot of Jitter waveform:

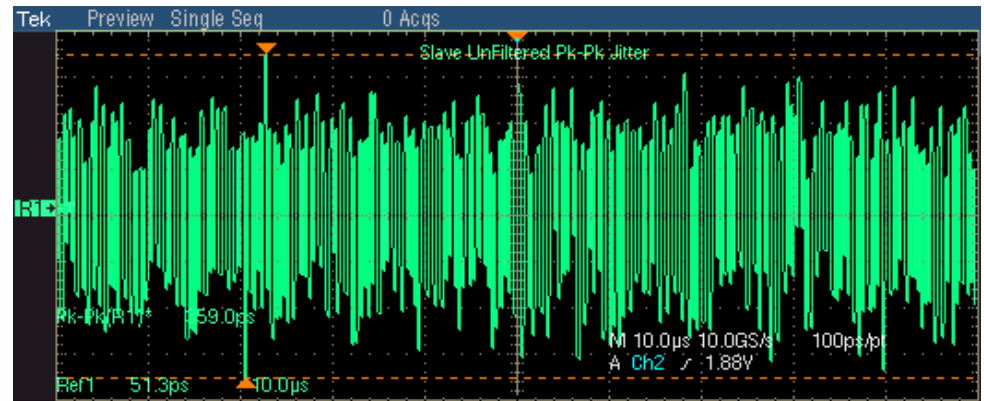

Figure 8-17: TIE Waveform for 1000BASE-T Jitter Slave Unfiltered

Note: The TDS6604 and TDS6404 oscilloscopes acquire approximately 1250 edges.

The following figure shows a typical Histogram plot of Jitter waveform:

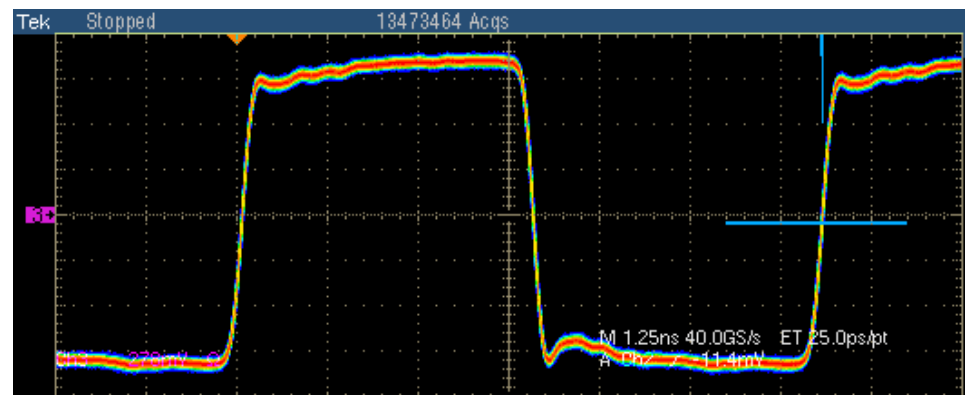

Figure 8-18: Histogram Waveform for 1000BASE-T Jitter Slave Unfiltered

Note: In TDS6000 and DPO7000 series oscilloscopes, approximately 13,000,000 waveform database samples are acquired

The application automatically displays the results as pass or fail. Select **Results** in the Execution pane and then click **Result Details** button to view the detailed results.

If you do not have access to TX_TCLK (this is only an informative test and not a compliance test), ensure that TX_TCLK is set to No in the Configuration.

For Histogram Method

7. Set the DUT to generate the signal in test mode 2.
8. Select **Histogram** in the Configuration. Click Run Test. A message box appears. Click OK to quit the message box and continue running the test.



The application does the following for Histogram method:

Step 1:

- Checks whether Data (TM2) is connected
- Triggers on Data (TM2) at 50% of peak-to-peak amplitude
- Sets up the oscilloscope horizontal and vertical scale based on Data (TM2)
- Places a horizontal histogram on the Data (TM2) pulse following the trigger pulse at 50% of peak-to-peak amplitude
- Measures the peak-to-peak Data (TM2) jitter from the histogram
- Takes approximately one minute to achieve approximately 13 million waveform acquisition
- Displays the Data (TM2) waveform

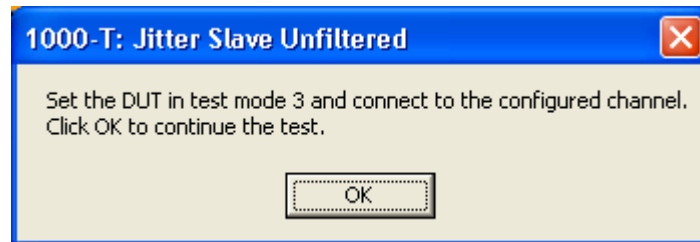
Step 2:

- Set the DUT to generate the signal in test mode 3
- Checks whether Data (TM3) is connected
- Triggers on Data (TM3) at 50% of peak-to-peak amplitude
- Sets up the oscilloscope horizontal and vertical scale based on Data (TM3)
- Places a horizontal histogram on the Data (TM3) pulse following the trigger pulse at 50% of peak-to-peak amplitude
- Measures the peak-to-peak Data (TM3) jitter from the histogram
- Compares the read out values with the values specified in the standard
- Takes approximately one minute to achieve approximately 13 million waveform acquisition
- Displays the Data (TM3) waveform

For TIE Method

7. Set the DUT to generate the signal in test mode 2.
8. Select **TIE** in the Configuration. Click Run Test. A message box appears. Click OK to quit the message box and continue running the test.



The application does the following for TIE method:

Step 1:

- Checks whether Data (TM2) is connected
- Triggers on Data (TM2) at 50% of peak-to-peak amplitude
- Derives the jitter waveform of the Data (TM2) with respect to unjittered reference
- Determines the Pk-Pk value of Data (TM2) jitter waveform
- Displays the TIE plot of the jitter waveform

Step 2:

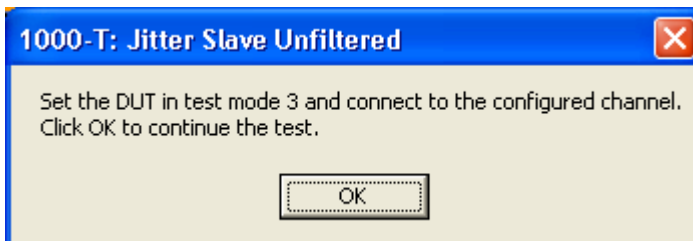

- Set the DUT to generate the signal in test mode 3
- Checks whether Data (TM3) is connected
- Triggers on Data (TM3) at 50% of peak-to-peak amplitude
- Derives the jitter waveform of the Data (TM3) with respect to unjittered reference
- Determines the Pk-Pk value of Data (TM3) jitter waveform

- Compares the read out values with the values specified in the standard
- Displays the TIE plot of the jitter waveform

The following figure shows a typical TIE plot of Jitter waveform:

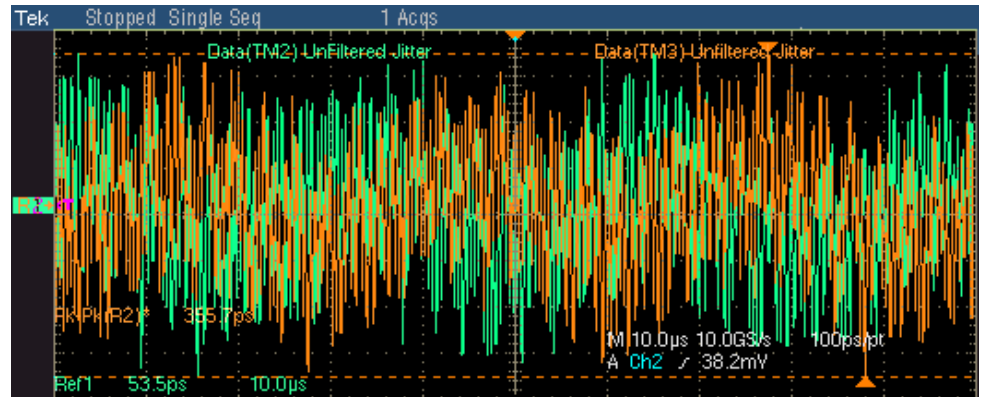

Figure 8-19: TIE Waveform for 1000BASE-T Jitter Slave Unfiltered

Note: The TDS6604 and TDS6404 oscilloscopes acquire approximately 625 edges. This is an alternate test method for jitter measurement being proposed, when TX_TCLK is not accessible. This is an informal test method.

The following figure shows a typical Histogram plot of Jitter waveform:

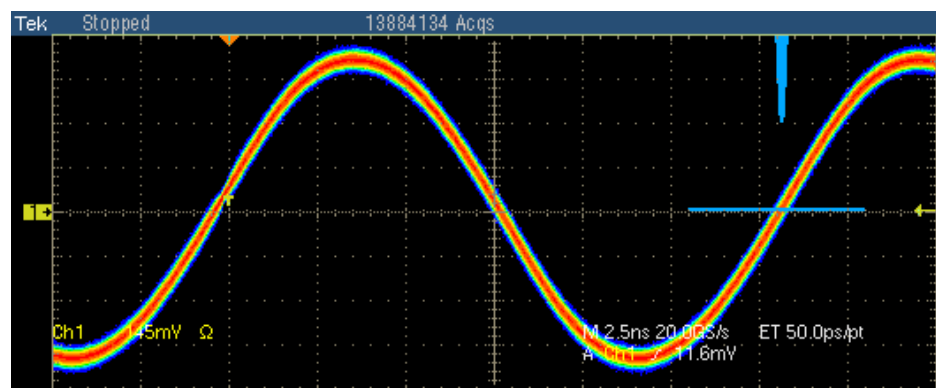

Figure 8-20: Histogram Waveform for 1000BASE-T Jitter Slave Unfiltered

Note: In TDS6000 and DPO7000 series oscilloscopes, approximately 13,000,000 waveform database samples are acquired

The application automatically displays the results as pass or fail. Select **Results** in the Execution pane and then click **Result Details** button to view the detailed results.

1000BASE-T Distortion

Note: The TDS5000 series oscilloscopes are not recommended for 1000BASE-T Distortion test.

1. Click Tests > Select > 1000BASE-T from the menu bar.
2. In the Jit/Distortion tab, select **Distortion**.

Note: The status bar displays the major configuration details. If you do not want to change the configuration settings, you can skip Step 3.

3. To change the configuration settings, select **Tests > Configure** from the menu bar, or click the Configure button in the Selection pane.
4. In the Configuration window, select the following options:

Table 8-8: 1000BASE-T Distortion configuration options

| Parameter | Options | To do |
|-------------------|---------------------------|--|
| Data | CH1, CH2, CH3, or CH4 | Select the channel to which the DUT is connected. |
| # Averages | 64 to 10000 | Enter the number of waveforms you want to average. |
| Output | Ref1, Ref2, Ref3, or Ref4 | Select the reference waveform on which the processed waveform will be stored. |
| Disturbing Signal | Yes or No | Select the options depending on whether the Disturbing signal is present or not. |
| TX_TCLK | CH1, CH2, CH3, or CH4 | Select the channel to which the clock source is connected. |
| Hi Resolution | 2 to 75 | Enter the number of averages to be done in the vertical domain. |
| Low Pass Filter | Yes, No | Select Yes or No depending on whether the noise elimination filter is required. |

5. Select **Tests > Connect** or Connect in the Selection pane and make connections.
6. Select View Wfm in the Selection pane, to view and compare the waveform with the acquired waveform.

7. If the disturbing signal is present and you have configured Disturbing Signal as Yes, and then click **Run Test**.
8. The application does the following:
 - Displays a message box to confirm the overwrite of the reference waveform. Select **Yes** to continue
 - Checks whether the DUT is connected
 - Sets the trigger
9. The application displays the following dialog box:

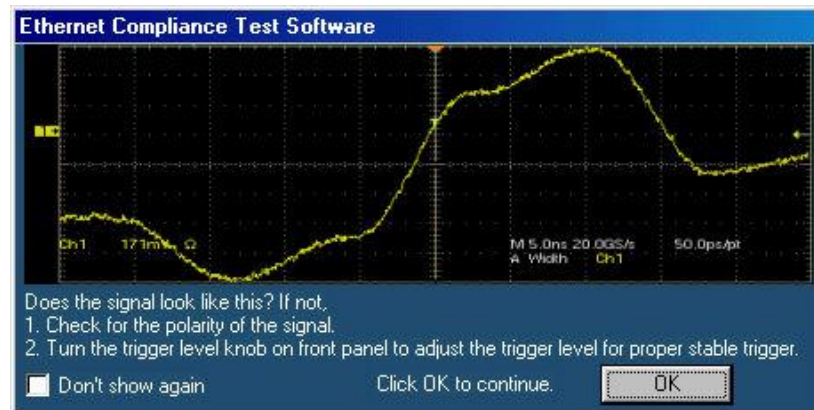

Figure 8-21: 1000BASE-T Distortion user control

Note: In TDS5000B series oscilloscopes, the horizontal scale is set to 10 ns.

- Check the polarity of the signal
 - If the trigger is not stable, adjust the trigger level for proper stable trigger. Then click **OK** to continue
10. The application does the following:
 - Acquires, filters, and removes the disturbing signal
 - If TX_TCLK is set as Yes, the application samples the differential signal output with the symbol rate of selected TX_TCLK source at an arbitrary phase and processes a block of 2047 consecutive samples
If TX_TCLK is set as No, the application samples the differential signal output with the symbol rate with the estimated clock frequency at an arbitrary phase and processes a block of 2047 consecutive samples

- Displays the error plot on selected output (reference waveform)
11. If the disturbing signal is not present and you have configured Disturbing Signal as No, and then click Run Test. The application does the following:
- Displays a message box to confirm the overwrite of the reference waveform. Select **Yes** to continue
 - Checks whether the DUT is connected
 - Sets the trigger
 - Acquires and filters the data
 - If TX_TCLK is set as Yes, the application samples the differential signal output with the symbol rate of selected TX_TCLK source at an arbitrary phase and processes a block of 2047 consecutive samples
 - If TX_TCLK is set as No, the application samples the differential signal output with the symbol rate with the estimated clock frequency at an arbitrary phase and processes a block of 2047 consecutive samples
 - Displays the error plot on selected output (reference waveform)

The following figure shows a typical error plot for Distortion:

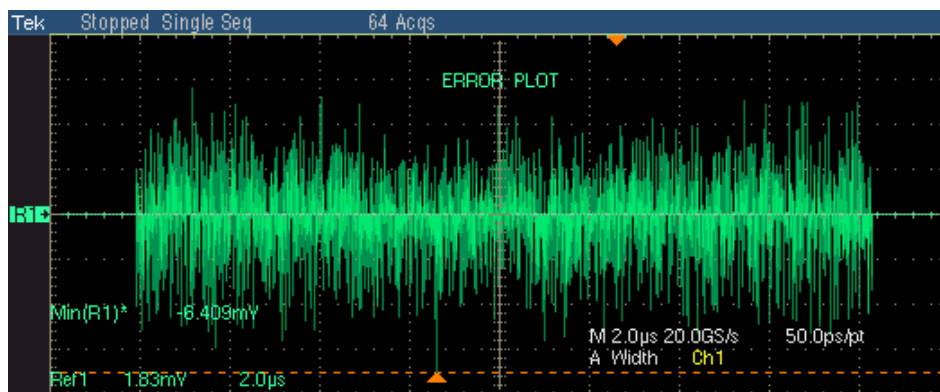

Figure 8-22: Waveform for 1000BASE-T Distortion

The application automatically displays the results as pass or fail. Select **Results** in the Execution pane and then click **Result Details** button to view the detailed results.

1000BASE-T Return Loss

1. Click Tests > Select > 1000BASE-T from the menu bar.
2. In the Return Loss tab, select **Return Loss**.

Note: The status bar displays the major configuration details. If you do not want to change the configuration settings, you can skip Step 3.

3. To change the configuration settings, select **Tests > Configure** from the menu bar, or click the Configure button in the Selection pane.
4. In the Configuration window, select the following options:

Table 8-9: 1000BASE-T Return Loss configuration options

| Parameter | Options | To do |
|---|--|---|
| Sources P1/P3/P5/P7 P2/P4/P6/P8 | CH1, CH2, CH3, or CH4 CH1, CH2, CH3, or CH4 | Select the channel to which the DUT is connected. |
| Output Waveform Return Loss 0 dB Marker | Ref1, Ref2, Ref3, or Ref4 Ref1, Ref2, Ref3, or Ref4 | Select the reference waveform on which the output waveform will be stored. Select the reference waveform on which you want the 0 dB Marker to be indicated. <i>Note: These fields appear only if you set Load as 100 Ohm.</i> |
| Pair ID | A, B, C, D | Depending on the Pair ID selected the sources will change from P1/P3/P5/P7 and P2/P4/P6/P8. |
| Load | 85, 100, 115 Ohm or 100 Ohm | Select the load as 85, 100, 115 Ohm or 100 Ohm. |
| #Averages | 100 to 10000 | Enter the number of waveforms you want to average. |
| Smooth | 0 to 10 | Enter the smoothening factor. |
| AWG/AFG | Select, AWG 4xx, AWG 2021, AWG 5xx, AWG 6xx, AWG 7xx, AWG 5xxx, AWG 7xxx, AFG 3xxx | Select the AWG/AFG Series to use. If you select the default value—Select—then the application considers all AWGs/AFGs other than the AWG 4xx series. |

5. Select Tests > **Connect or Connect** in the Selection pane and make connections.
6. Calibrate the test setup. If you do not calibrate the test setup before running the test, an error message Error 412: Calibration Data Not Available appears.
7. Click **Run Test**. The application does the following:
 - Displays a message box to confirm the overwrite of the reference waveform. Select Yes to continue
 - Sets the trigger
 - Acquires, and computes the return loss
 - Displays the return loss curve on selected output (reference waveform)

If the test fails, the application captures the waveform, circles the hits and saves the information to the report. The application obtains the hits information only for the 100 Ohm waveform.

The following figure shows a typical waveform for Return Loss:



Figure 8-23: Waveform for 1000BASE-T Return Loss

The application automatically displays the results as pass or fail. Select **Results** in the Execution pane and then click **Result Details** button to view the detailed results.

1000BASE-T CM Voltage

1. Click Tests > Select > 1000BASE-T from the menu bar.
2. In the CM Voltage tab, select **CM Voltage**.

Note: The status bar displays the major configuration details. If you do not want to change the configuration settings, you can skip Step 3.

3. To change the configuration settings, select **Tests > Configure** from the menu bar, or click the Configure button in the Selection pane.
4. In the Configuration window, select the following options:

Table 8-10: 1000BASE-T CM Voltage configuration options

| Parameter | Options | To do |
|-----------|-----------------------|---|
| Data | CH1, CH2, CH3, or CH4 | Select the channel to which the DUT is connected. |

5. Select Tests > Connect or Connect in the Selection pane and make connections.
6. Select View Wfm in the Selection pane, to view and compare the waveform with the acquired waveform.
7. Click Run Test. The application does the following:
 - Checks whether the DUT is connected and a valid signal is acquired
 - Sets the trigger
 - Measures the Output Voltage amplitude for positive and negative pulses of 96 ns
 - Compares the values with the Standard
 - Displays the DUT waveform for Common Mode Voltage testing

The following figure shows a typical waveform for Common mode Voltage:

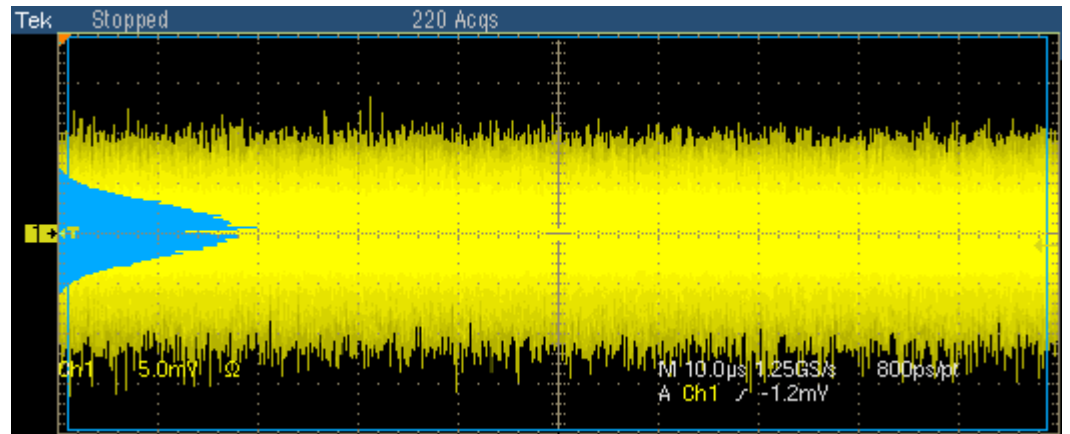

Figure 8-24: Waveform for 1000BASE-T CM Voltage

The application automatically displays the results as pass or fail. Select **Results** in the Execution pane and then click **Result Details** button to view the detailed results.

How To Test 100BASE-TX

100BASE-TX Template

1. Click Tests > Select > 100BASE-TX from the menu bar.
2. In the Parametric tab, select **Output Volt**.
3. Select **Pos** for positive, **Neg** for negative, or **Both** in the Polarity drop-down list.

Note: The status bar displays the major configuration details. If you do not want to change the configuration settings, you can skip Step 3.

4. To change the configuration settings, select Tests > Configure from the menu bar, or click the Configure button in the Selection pane.
5. In the Configuration window, select the following options:

Table 9-1: 100BASE-TX Template configuration options

| Parameter | Options | To do |
|-------------|-----------------------|---|
| Data | CH1, CH2, CH3, or CH4 | Select the channel to which the DUT is connected. |
| Acquisition | Sample or Average | Select the acquisition mode. If you select Average, # of Wfms appears. Enter the number of averages to test in the # of Wfms field. |

6. Select Tests > Connect or Connect in the Selection pane and make connections.
7. Select View Wfm in the Selection pane, to view and compare the waveform with the acquired waveform.
8. Click **Run Test**. The application does the following:
 - Checks whether the DUT is connected and a valid signal is acquired
 - Sets up the trigger
 - Loads the AOI template mask
 - Carries out the mask pass/fail test

If the test fails, the application captures the waveform, circles the hits and saves the information to the report.

The following figure shows a typical DUT waveform for AOI template test:

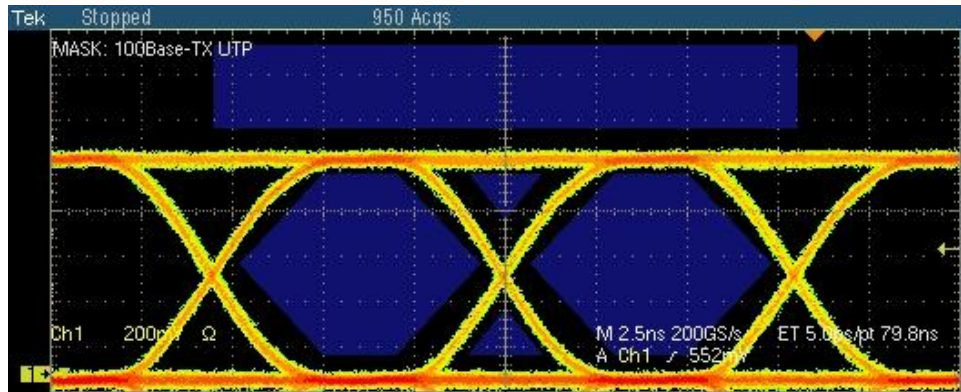

Figure 9-1: Waveform for 100BASE-TX Template for positive polarity

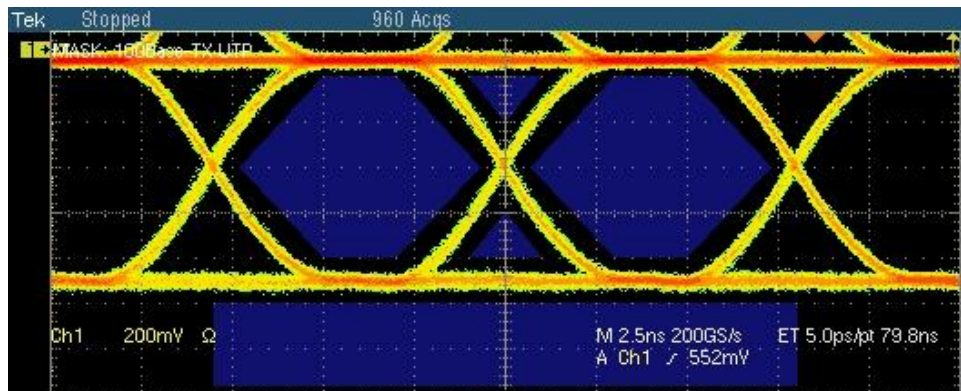

Figure 9-2: Waveform for 100BASE-TX Template for negative polarity

The application also tests for mask and displays the results as pass or fail.

If the acquired waveform does not lie within the mask, click Manual Fit. To adjust the waveform to fit into the Mask, change the horizontal position and vertical position using the general purpose knobs or the Virtual Keyboard. This repeats the mask pass/fail test and displays the results in the **Results Summary** pane.

The application automatically displays the results as pass or fail. Select **Results** in the Execution pane and then click **Result Details** button to view the detailed results.

100BASE-TX Differential Output Voltage

1. Click Tests > Select > 100BASE-TX from the menu bar.
2. In the Parametric tab, select **Output Volt**.
3. Select **Pos** for positive, **Neg** for negative, or **Both** in the Polarity drop-down list.

Note: The status bar displays the major configuration details. If you do not want to change the configuration settings, you can skip Step 3.

4. To change the configuration settings, select Tests > Configure from the menu bar, or click the Configure button in the Selection pane.
5. In the Configuration window, select the following options:

Table 9-2: 100BASE-TX Differential Output Voltage configuration options

| Parameter | Options | To do |
|-------------|-----------------------|---|
| Data | CH1, CH2, CH3, or CH4 | Select the channel to which the DUT is connected. |
| Acquisition | Sample or Average | Select the acquisition mode. If you select Average, # of Wfms appears. Enter the number of averages to test in the # of Wfms field. |

6. Select Tests > Connect or Connect in the Selection pane and make connections.
7. Select View Wfm in the Selection pane, to view and compare the waveform with the acquired waveform.
8. Click Run Test. The application does the following:
 - Checks whether the DUT is connected and a valid signal is acquired
 - Sets up the trigger
 - Measures the Output Voltage amplitude for positive and negative pulses of 96 ns

- Calculates the amplitude symmetry
- Compares the values with the standard

The following figure shows a typical waveform of Differential Output Voltage test for positive pulse:

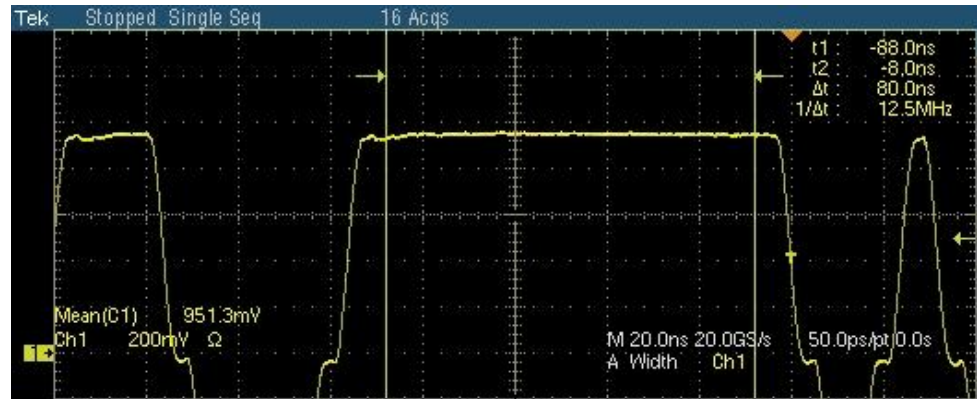

Figure 9-3: Waveform for 100BASE-TX Differential Output Voltage for positive polarity

The following figure shows a typical waveform of Differential Output Voltage test for negative pulse:

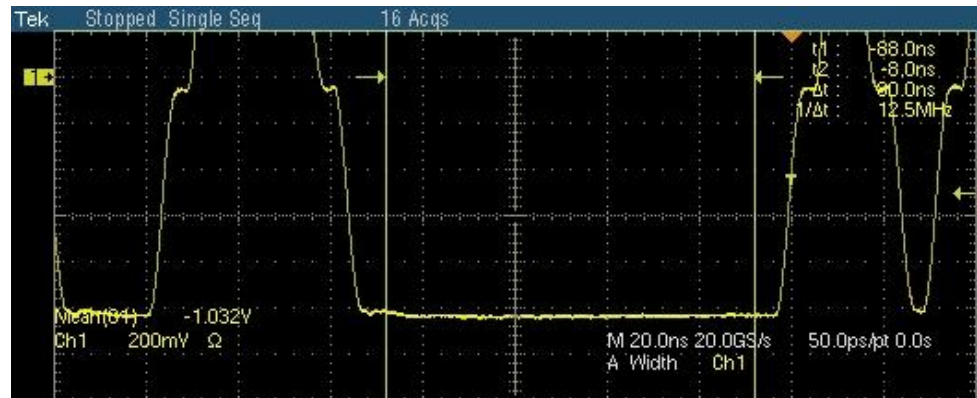

Figure 9-4: Waveform for 100BASE-TX Differential Output Voltage for negative polarity

The application automatically displays the results as pass or fail. Select **Results** in the Execution pane and then click **Result Details** button to view the detailed results.

100BASE-TX Signal Amplitude Symmetry

1. Click Tests > Select > 100BASE-TX from the menu bar.
2. In the Parametric tab, select **Amp Sym**.

Note: The status bar displays the major configuration details. If you do not want to change the configuration settings, you can skip Step 3.

3. To change the configuration settings, select Tests > Configure from the menu bar, or click the Configure button in the Selection pane.
4. In the Configuration window, select the following options:

Table 9-3: 100BASE-TX Amplitude Symmetry configuration options

| Parameter | Options | To do |
|-------------|-----------------------|---|
| Data | CH1, CH2, CH3, or CH4 | Select the channel to which the DUT is connected. |
| Acquisition | Sample or Average | Select the acquisition mode. If you select Average, # of Wfms appears. Enter the number of averages to test in the # of Wfms field. |

5. Select **Tests > Connect** or Connect in the Selection pane and make connections.
6. Select View Wfm in the Selection pane, to view and compare the waveform with the acquired waveform.
7. Click Run Test. The application does the following:
 - Checks whether the DUT is connected and a valid signal is acquired
 - Sets up the trigger
 - Measures the Output Voltage amplitude for positive and negative pulses of 96 ns
 - Calculates the amplitude symmetry
 - Compares the values with the standard

The following figure shows a typical waveform of Signal Amplitude Symmetry test:

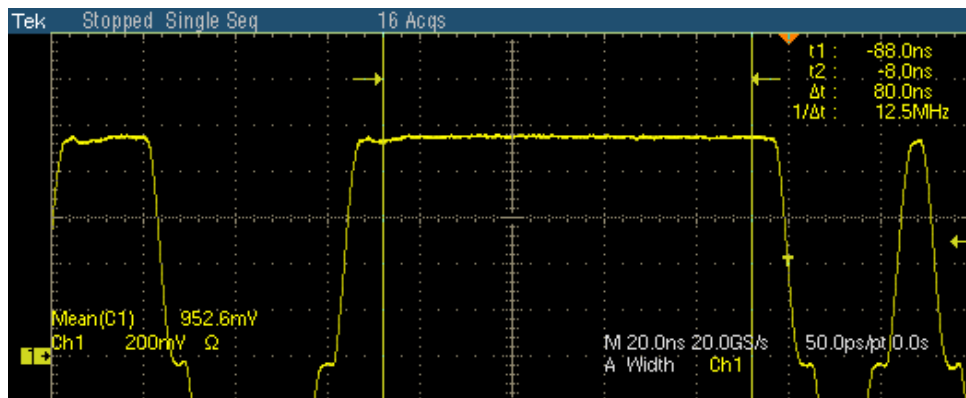

Figure 9-5: Waveform for 100BASE-TX Amplitude Symmetry for positive polarity

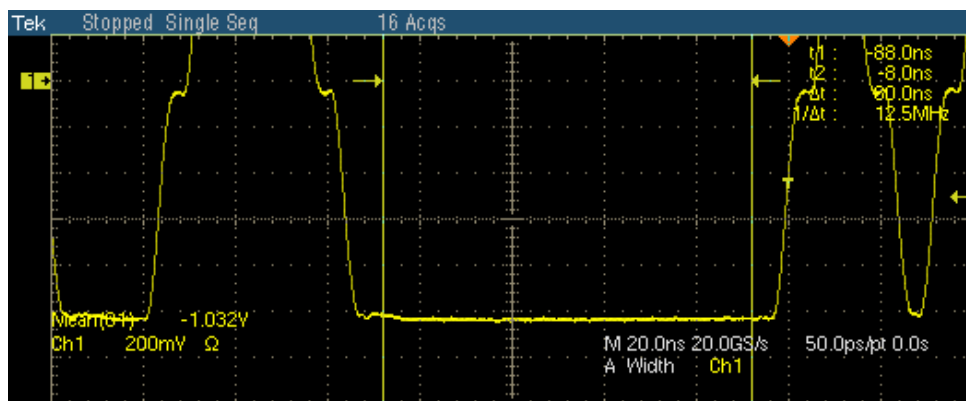

Figure 9-6: Waveform for 100BASE-TX Amplitude Symmetry for negative polarity

The application automatically displays the results as pass or fail. Select **Results** in the Execution pane and then click **Result Details** button to view the detailed results.

100BASE-TX Rise Time

1. Click **Tests > Select > 100BASE-TX** from the menu bar.
2. In the Parametric tab, select **Rise Time**.
3. Select **Pos** for positive, **Neg** for negative, or **Both** in the Polarity drop-down list.

Note: The status bar displays the major configuration details. If you do not want to change the configuration settings, you can skip Step 3.

4. To change the configuration settings, select **Tests > Configure** from the menu bar, or click the Configure button in the Selection pane.
5. In the Configuration window, select the following options:

Table 9-4: 100BASE-TX Rise Time configuration options

| Parameter | Options | To do |
|-------------|-----------------------|---|
| Data | CH1, CH2, CH3, or CH4 | Select the channel to which the DUT is connected. |
| Acquisition | Sample or Average | Select the acquisition mode. If you select Average, # of Wfms appears. Enter the number of averages to test in the # of Wfms field. |
| Pulse Width | 16ns or 80ns | Set Pulse Width to 16 ns or 80 ns. |

6. Select **Tests > Connect** or **Connect** in the Selection pane and make connections.
7. Select **View Wfm** in the Selection pane, to view and compare the waveform with the acquired waveform.
8. Click **Run Test**. The application does the following:
 - Checks whether the DUT is connected and a valid signal is acquired
 - Sets up the trigger
 - Measures the rise time of the positive and negative pulses of the configured pulse width
 - Compares the values with the standard

The following figure shows a typical waveform of Rise Time test:

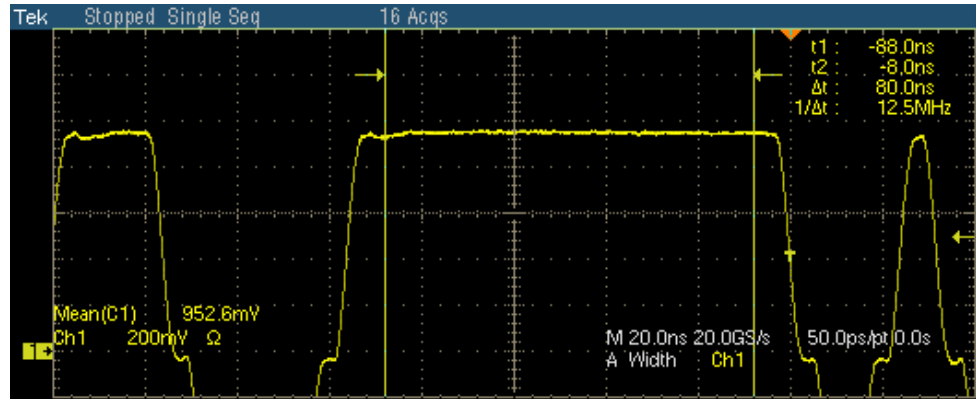

Figure 9-7: Waveform for 100BASE-TX Rise Time for positive polarity

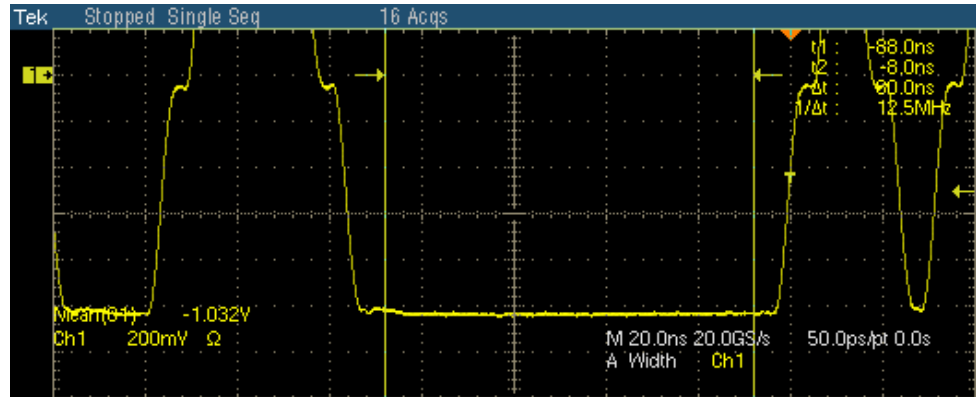

Figure 9-8: Waveform for 100BASE-TX Rise Time for negative polarity

The application automatically displays the results as pass or fail. Select **Results** in the Execution pane and then click **Result Details** button to view the detailed results.

100BASE-TX Fall Time

1. Click Tests > Select > 100BASE-TX from the menu bar.
2. In the Parametric tab, select **Fall Time**.
3. Select **Pos** for positive, **Neg** for negative, or **Both** in the Polarity drop-down list.

Note: The status bar displays the major configuration details. If you do not want to change the configuration settings, you can skip Step 3.

4. To change the configuration settings, select **Tests > Configure** from the menu bar, or click the Configure button in the Selection pane.
5. In the Configuration window, select the following options:

Table 9-5: 100BASE-TX Fall Time configuration options

| Parameter | Options | To do |
|-------------|-----------------------|---|
| Data | CH1, CH2, CH3, or CH4 | Select the channel to which the DUT is connected. |
| Acquisition | Sample or Average | Select the acquisition mode. If you select Average, # of Wfms appears. Enter the number of averages to test in the # of Wfms field. |
| Pulse Width | 16ns or 80ns | Set Pulse Width to 16 ns or 80 ns. |

6. Select **Tests > Connect** or Connect in the Selection pane and make connections.
7. Select View Wfm in the Selection pane, to view and compare the waveform with the acquired waveform.
8. Click **Run Test**. The application does the following:
 - Checks whether the DUT is connected and a valid signal is acquired
 - Sets up the trigger
 - Measures the fall time of the positive and negative pulses of the configured pulse width
 - Compares the values with the standard

The following figure shows a typical waveform of Fall Time test:

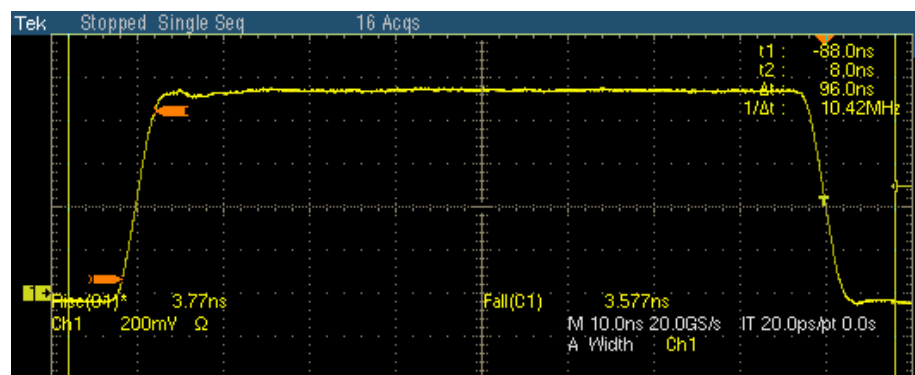

Figure 9-9: Waveform for 100BASE-TX Fall Time for positive polarity

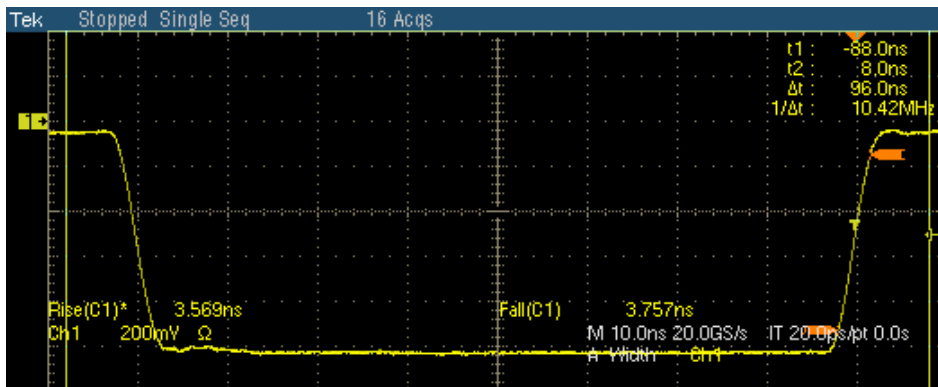

Figure 9-10: Waveform for 100BASE-TX Fall Time for negative polarity

The application automatically displays the results as pass or fail. Select **Results** in the Execution pane and then click **Result Details** button to view the detailed results.

100BASE-TX Rise/Fall Time Symmetry

1. Click Tests > Select > 100BASE-TX from the menu bar.
2. In the Parametric tab, select **R/F Sym**.
3. Select **Pos** for positive, **Neg** for negative, or **Both** in the Polarity drop-down list.

Note: The status bar displays the major configuration details. If you do not want to change the configuration settings, you can skip Step 3.

4. To change the configuration settings, select **Tests > Configure** from the menu bar, or click the Configure button in the Selection pane.
5. In the Configuration window, select the following options:

Table 9-6: 100BASE-TX Rise/Fall Time Symmetry configuration options

| Parameter | Options | To do |
|-------------|-----------------------|---|
| Data | CH1, CH2, CH3, or CH4 | Select the channel to which the DUT is connected. |
| Acquisition | Sample or Average | Select the acquisition mode. If you select Average, # of Wfms appears. Enter the number of averages to test in the # of Wfms field. |
| Pulse Width | 16ns or 80ns | Set Pulse Width to 16 ns or 80 ns. |

6. Select Tests > **Connect** or Connect in the Selection pane and make connections.
7. Select View Wfm in the Selection pane, to view and compare the waveform with the acquired waveform.
8. Click Run **Test**. The application does the following:
 - Checks whether the DUT is connected and a valid signal is acquired
 - Sets up the trigger
 - Measures the rise and fall time for the configured pulse width
 - Calculates the Rise/Fall Time Symmetry
 - Compares the values with the standard

The following figure shows a typical waveform of Rise/Fall Time Symmetry test:

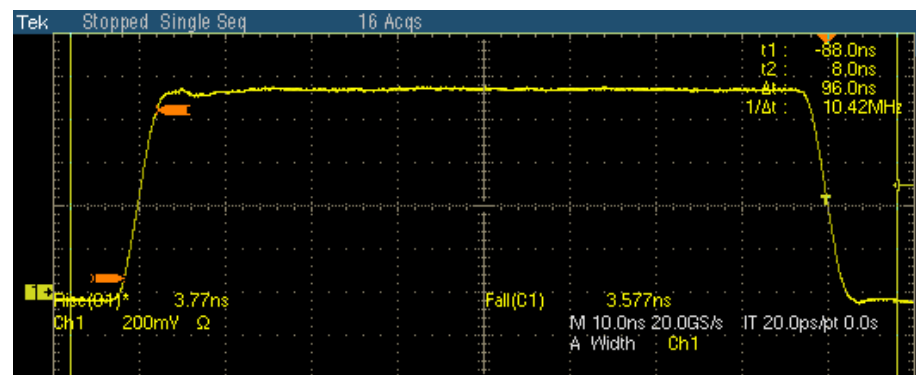

Figure 9-11: Waveform for 100BASE-TX Rise/Fall Time Symmetry for positive polarity

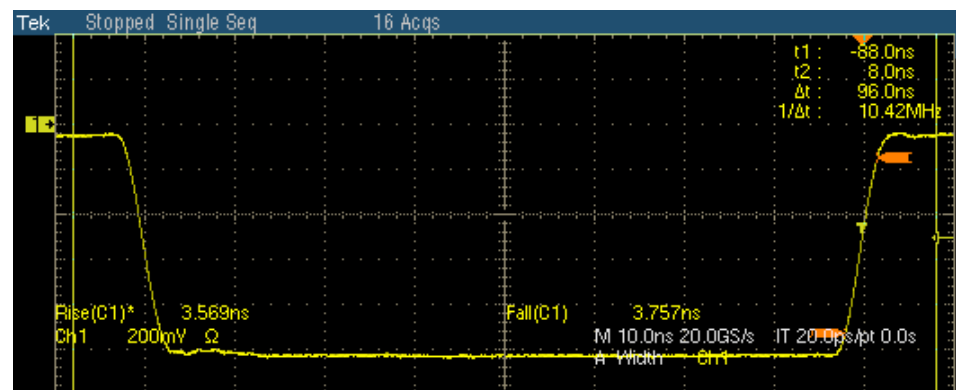

Figure 9-12: Waveform for 100BASE-TX Rise/Fall Time Symmetry for negative polarity

The application automatically displays the results as pass or fail. Select **Results** in the Execution pane and then click **Result Details** button to view the detailed results.

100BASE-TX Waveform Overshoot

1. Click Tests > Select > 100BASE-TX from the menu bar.
2. In the Parametric tab, select **Overshoot**.
3. Select **Pos** for positive, **Neg** for negative, or **Both** in the Polarity drop-down list.

Note: The status bar displays the major configuration details. If you do not want to change the configuration settings, you can skip Step 3.

4. To change the configuration settings, select **Tests > Configure** from the menu bar, or click the Configure button in the Selection pane.
5. In the Configuration window, select the following options:

Table 9-7: 100BASE-TX Waveform Overshoot configuration options

| Parameter | Options | To do |
|-------------|-----------------------|---|
| Data | CH1, CH2, CH3, or CH4 | Select the channel to which the DUT is connected. |
| Acquisition | Sample or Average | Select the acquisition mode. If you select Average, # of Wfms appears. Enter the number of averages to test in the # of Wfms field. |

6. Select Tests > **Connect** or Connect in the Selection pane and make connections.
7. Select View Wfm in the Selection pane, to view and compare the waveform with the acquired waveform.
8. Click Run **Test**. The application does the following:
 - Checks whether the DUT is connected and a valid signal is acquired
 - Sets up the trigger
 - Measures the Overshoot for positive and negative pulses of 96 ns
 - Compares the values with the standard

The following figure shows a typical waveform of Waveform Overshoot test:

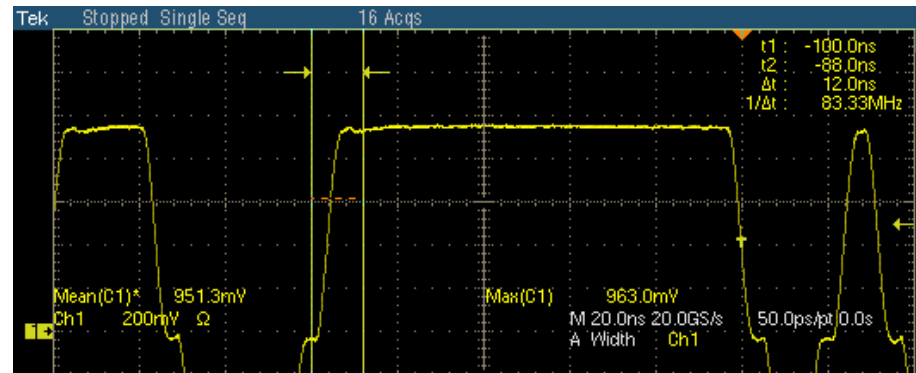

Figure 9-13: Waveform for 100BASE-TX Waveform Overshoot for positive polarity

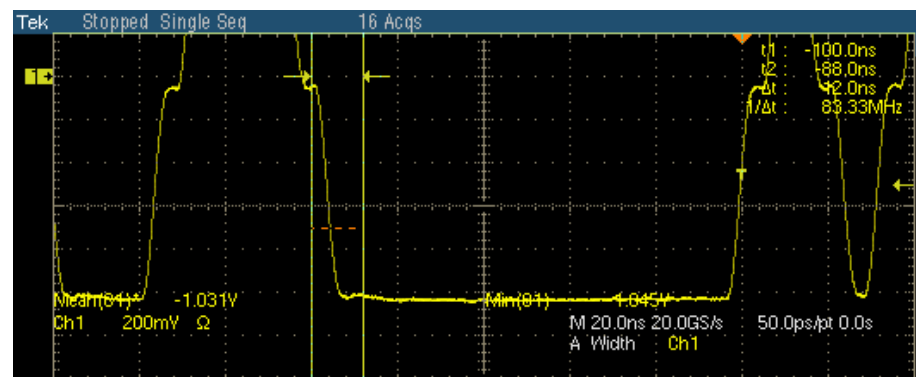

Figure 9-14: Waveform for 100BASE-TX Waveform Overshoot for negative polarity

The application automatically displays the results as pass or fail. Select **Results** in the Execution pane and then click **Result Details** button to view the detailed results.

100BASE-TX Jitter

1. Click Tests > Select > 100BASE-TX from the menu bar.
2. In the Parametric tab, select **Jitter**.

Note: The status bar displays the major configuration details. If you do not want to change the configuration settings, you can skip Step 3.

3. To change the configuration settings, select **Tests > Configure** from the menu bar, or click the Configure button in the Selection pane.

4. In the Configuration window, select the following options:

Table 9-8: 100BASE-TX Jitter configuration options

| Parameter | Options | To do |
|-----------|-----------------------|---|
| Data | CH1, CH2, CH3, or CH4 | Select the channel to which the DUT is connected. |

5. Select **Tests > Connect** or Connect in the Selection pane and make connections.
6. Select View Wfm in the Selection pane, to view and compare the waveform with the acquired waveform.
7. Click **Run Test**. The application does the following:
 - Checks whether the DUT is connected and a valid signal is acquired
 - Sets up the trigger
 - Acquires the signal
 - Places a horizontal histogram at the crossing
 - Reads the peak-top-peak jitter from the histogram
 - Compares the values with the standard

The following figure shows a typical waveform of Jitter test:

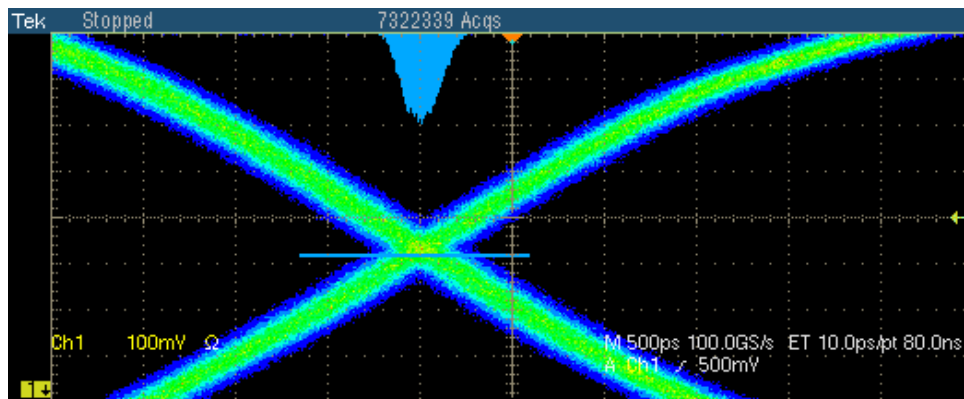

Figure 9-15: Waveform for 100BASE-TX Jitter for positive polarity

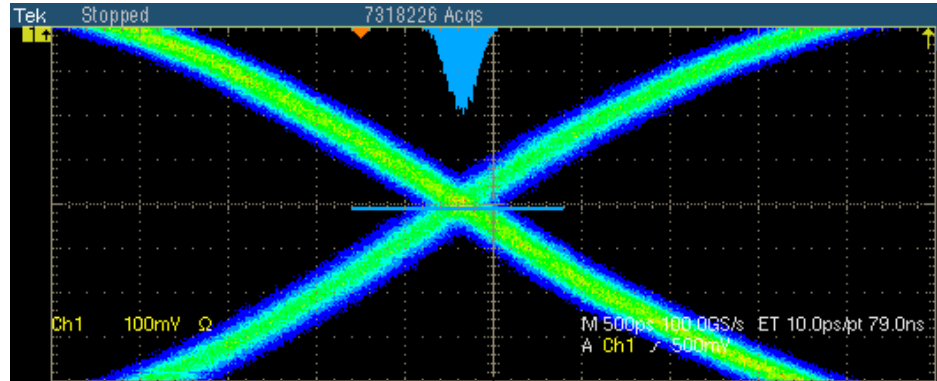

Figure 9-16: Waveform for 100BASE-TX Jitter for negative polarity

The application automatically displays the results as pass or fail. Select **Results** in the Execution pane and then click **Result Details** button to view the detailed results.

100BASE-TX Duty Cycle Distortion

1. Click Tests > Select > 100BASE-TX from the menu bar.
2. In the Parametric tab, select **Distortion**.
3. Select Random or **0101** in the Pattern drop-down list.

Note: The status bar displays the major configuration details. If you do not want to change the configuration settings, you can skip Step 3.

4. To change the configuration settings, select **Tests > Configure** from the menu bar, or click the Configure button in the Selection pane.
5. In the Configuration window, select the following options:

Table 9-9: 100BASE-TX Distortion configuration options

| Parameter | Options | To do |
|-------------|-----------------------|--|
| Data | CH1, CH2, CH3, or CH4 | Select the channel to which the DUT is connected. |
| Acquisition | Sample or Average | Select the acquisition mode. If you select Average, # of Wfms appears. Enter the number of waveforms to test in the # of Wfms field. |

6. Select **Tests > Connect** or Connect in the Selection pane and make connections.

7. Select View Wfm in the Selection pane, to view and compare the waveform with the acquired waveform.
8. Click **Run Test**. The application does the following:
 - Checks whether the DUT is connected and a valid signal is acquired
 - Sets up the trigger
 - Calculates the duty cycle distortion
 - Compares the values with the standard

The following figure shows a typical waveform of Distortion test:

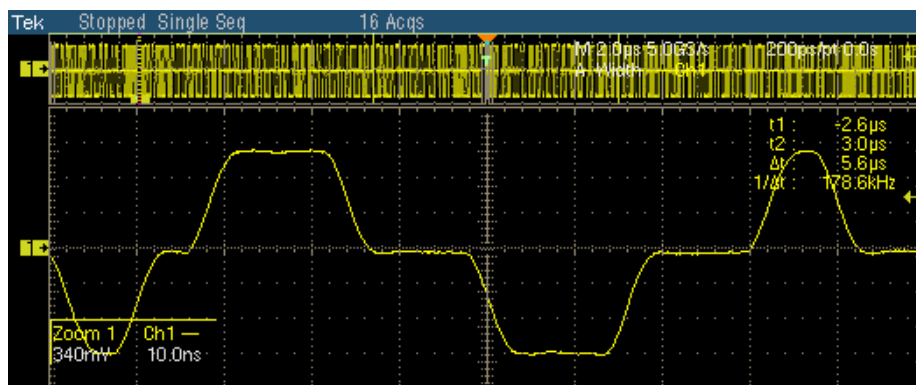

Figure 9-17: Waveform for 100BASE-TX Distortion

The application automatically displays the results as pass or fail. Select **Results** in the Execution pane and then click **Result Details** button to view the detailed results.

100BASE-TX Return Loss

1. Click Tests > Select > 100BASE-TX from the menu bar.
2. In the Return Loss tab, select **Transmitter** or **Receiver**.

***Note:** The status bar displays the major configuration details. If you do not want to change the configuration settings, you can skip Step 3.*

3. To change the configuration settings, select **Tests > Configure** from the menu bar, or click the Configure button in the Selection pane.

4. In the Configuration window, select the following options:

Table 9-10: 100BASE-TX Return Loss configuration options

| Parameter | Options | To do |
|---|---|---|
| Sources P1/P3 P2/P4 | CH1, CH2, CH3, or CH4 CH1, CH2, CH3, or CH4 | Select the channel to which the DUT is connected. <i>Note: Depending on whether the Transmitter or Receiver is selected, the sources will change from P1/P3 and P2/P4.</i> |
| Output Waveform Return Loss 0 dB Marker | Ref1, Ref2, Ref3, or Ref4 Ref1, Ref2, Ref3, or Ref4 | Select the reference waveform on which the output waveform will be stored. Select the reference waveform on which you want the 0 dB Marker to be indicated. <i>Note: These fields appear only if you set Load as 100 Ohm.</i> |
| Pair ID | A, B, C, D | Depending on the Pair ID selected the sources will change from P1/P3/P5/P7 and P2/P4/P6/P8. |
| Load | 85, 100, 115 Ohm or 100 Ohm | Select the load as 85, 100, 115 Ohm or 100 Ohm. |
| AWG/AFG | Select, AWG 4xx, AWG 2021, AWG 5xx, AWG 6xx, AWG 7xx, AWG5xxx, AWG7xxx, AFG3xxx | Select the AWG/AFG Series to use. If you select the default value–Select–then the application considers all AWGs/AFGs other than the AWG 4xx series. |
| #Averages | 100 to 10000 | Enter the number of waveforms you want to average. |
| Smooth | 0 to 10 | Enter the smoothing factor. |

5. Select **Tests > Connect** or **Connect** in the Selection pane and make connections.
6. Select **View Wfm** in the Selection pane, to view and compare the waveform with the acquired waveform.
7. Click Run Test. The application does the following:
- Displays a message box to confirm the overwrite of the reference waveform. Select Yes to continue
 - Sets up the trigger

- Acquires and computes the return loss
- Displays the return loss curve on selected output (reference waveform)

If the test fails, the application captures the waveform, circles the hits and saves the information to the report. The application obtains the hits information only for the 100 Ohm waveform.

The following figure shows a typical waveform for Return Loss Transmitter:



Figure 9-18: Waveform for 100BASE-TX Return Loss Transmitter

The following figure shows a typical waveform for Return Loss Receiver:



Figure 9-19: Waveform for 100BASE-TX Return Loss Receiver

The application automatically displays the results as pass or fail. Select **Results** in the Execution pane and then click **Result Details** button to view the detailed results.

How To Test 10BASE-T/10BASE-Te

10BASE-T/10BASE-Te MAU

1. Click **Tests > Select > 10BASE-T** from the menu bar.
2. In the **Template** tab, select **MAU**. In the adjacent drop-down list, select **Normal, Inverted, or Both**.

Note: The status bar displays the major configuration details. If you do not want to change the configuration settings, you can skip Step 3.

Note2: If you select Both and if the test fails, then Locate hits and Flash hits display the MAU Inverted failures.

3. To **change** the configuration settings, select **Tests > Configure** from the menu bar, or click the Configure button in the Selection pane.
4. In the **Configuration** window, select the following options:

Table 10-1: 10BASE-T/10BASE-Te MAU configuration options

| Parameter | Options | To do |
|------------------|--|--|
| Data | CH1, CH2, CH3, or CH4 | Select the channel to which the DUT is connected. |
| MAU Type | Internal, or External | Select the MAU Type. |
| MAU Scale | Normal, 0.9, 1.1 | Select the MAU scale factor. |
| Mask Setup | Samples and Fail Thresh | Select the number of samples, and the number of samples for fail thresh. |
| Energy Efficient | Yes, No | Configure the test to run either in energy efficient mode or not. |
| Report Setup | Device ID, Device Description, and Report File | Configure the options to identify the report. You can also choose to automatically preview a file. |

5. Select **Tests > Connect** or **Connect** in the Selection pane and make connections.
6. Select **View Wfm** in the Selection pane, to view and compare the waveform with the acquired waveform.

7. Click **Run Test**. The application does the following:

- Checks whether the DUT is connected and a valid signal is acquired
- Validates the DUT for noise and loads the mask
- Sets up the Vertical, Horizontal, and Trigger oscilloscope parameters

The application displays the following dialog box:



Figure 10-1: 10BASE-T Template user control dialog box

- Toggle **Lock Mask to Wfm** between On and Off to lock or unlock the mask to waveform when you zoom in or zoom out
- Toggle **Mask Autofit** between On and Off to allow the oscilloscope to automatically fit the waveform to mask
- Click **OK** to continue

The application then carries out the mask pass/fail test.

Note: The application introduces a gap in the mask where segments 1 and 5 merge.

If the test fails, the application captures the waveform, circles the hits and saves the information to the report.

The following figure shows a typical DUT waveform for Template testing of MAU Ext:

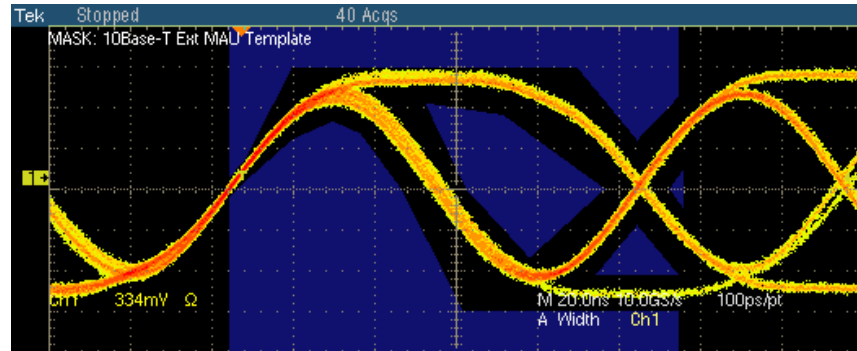

Figure 10-2: Waveform for 10BASE-T MAU Ext

The following figure shows a typical DUT waveform for Template testing of MAU Ext Inv:

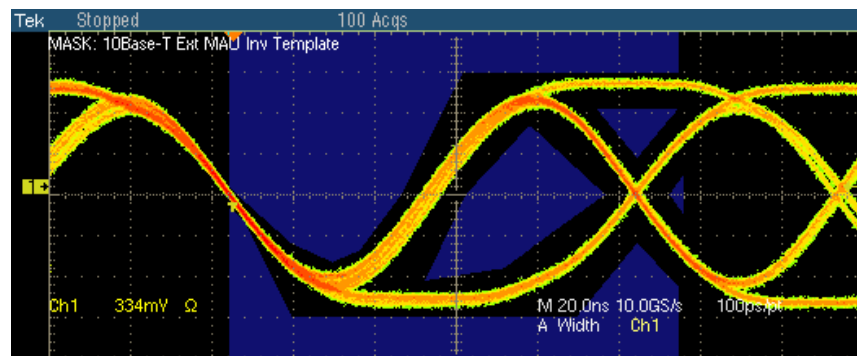

Figure 10-3: Waveform for 10BASE-T MAU Ext Inv

The following figure shows a typical DUT waveform for Template testing of MAU Int:

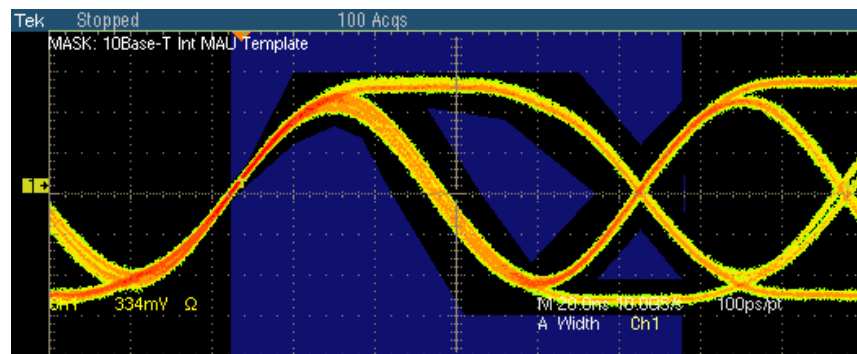

Figure 10-4: Waveform for 10BASE-T MAU Int

The following figure shows a typical DUT waveform for Template testing of MAU Int Inv:

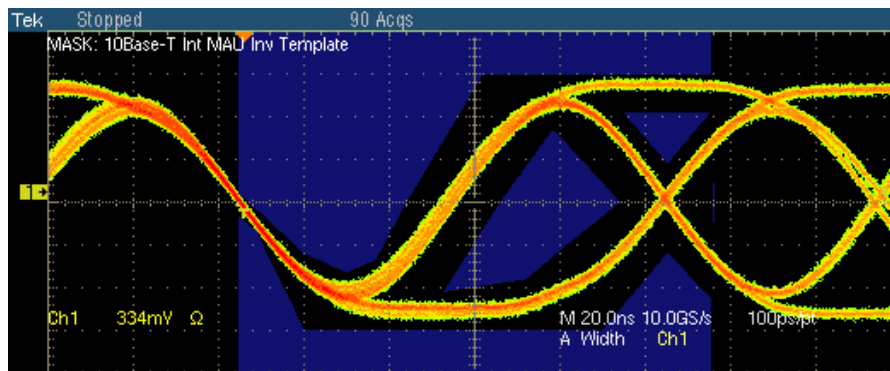

Figure 10-5: Waveform for 10BASE-T MAU Int Inv

If the acquired waveform does not lie within the mask, click **Manual Fit**. To adjust the waveform to fit into the Mask, change the horizontal position and vertical position using the general-purpose knobs or Virtual Keyboard. This repeats the mask pass/fail test and displays the results in the **Results Summary** pane.

The application automatically displays the results as pass or fail. Select **Results** in the Execution pane and then click **Result Details** button to view the detailed results.

10BASE-T Link Pulse

1. Click **Tests > Select > 10BASE-T** from the menu bar.
2. In the Template tab, select **Link Pulse**.
3. In the adjacent drop-down list, select the load with or without TPM — Load1 w/o TPM, Load2 w/o TPM, 100 Ω w/o TPM, Load1 with TPM, Load2 with TPM, or 100 Ω with TPM.

Note: The 100 Ohm load with TPM and 100 Ohm load without TPM are optional and not required according to the 802.3-2002 standards.

The status bar displays the major configuration details. If you do not want to change the configuration settings, you can skip Step 3.

4. To change the configuration settings, select **Tests > Configure** from the menu bar, or click the **Configure** button in the Selection pane.

5. In the Configuration window, select the following options:

Table 10-2: 10BASE-T Link Pulse configuration options

| Parameter | Options | To do |
|--------------|----------------------------------|--|
| Data | CH1, CH2, CH3, or CH4 | Select the channel to which the DUT is connected. |
| Acquisition | Sample or Average | Select the acquisition mode. If you select Average, # of Wfms appears. Enter the number of waveforms to test in the # of Wfms field. |
| Section | Both, Head, or Tail | Select the section of mask to test. <i>Note: If you select Both and if the test fails, then Locate hits and Flash hits display the Tail section failures.</i> |
| Mask Setup | # of Wfms and Fail Thresh | Select the number of waveforms to be tested and the number of waveforms that must fail for the test to fail. |
| Sequence | Normal (NLP), Fast (FLP) | Select the type of link pulse you want to test. |
| Test Options | Both, Template Only, Timing Only | Select Both to perform Template and Timing tests, Template Only to perform Template tests, and Timing Only to perform Timing tests. <i>Note: Timing tests are available only for normal link pulse.</i> |

6. Select **Tests > Connect** or **Connect** in the Selection pane and make connections.
7. Select **View Wfm** in the Selection pane, to view and compare the waveform with the acquired waveform.
8. Click **Run Test**. The application does the following:
- Checks whether the DUT is connected and a valid signal is acquired
 - Sets up the signal
 - Loads the front portion of the mask

9. The application displays the following dialog box:



Figure 10-6: 10BASE-T Template user control dialog box

- Toggle **Lock Mask to Wfm** between On and Off to lock or unlock the mask to waveform when you zoom in or zoom out
- Toggle **Mask Autofit** between On and Off to allow the oscilloscope to automatically fit the waveform to mask
- Click **OK** to continue

10. The application then carries out the mask pass/fail test.

***Note:** If you have selected the Section as Both, the application sets up the signal and loads the front portion of the mask for the Head. Then, the application sets up the signal and loads the tail portion of the mask. The application adds the pass/fail result of both Head and Tail.*

If the test fails, the application captures the waveform, circles the hits and saves the information to the report.

The following figure shows a typical DUT waveform for Link Pulse Timing test:

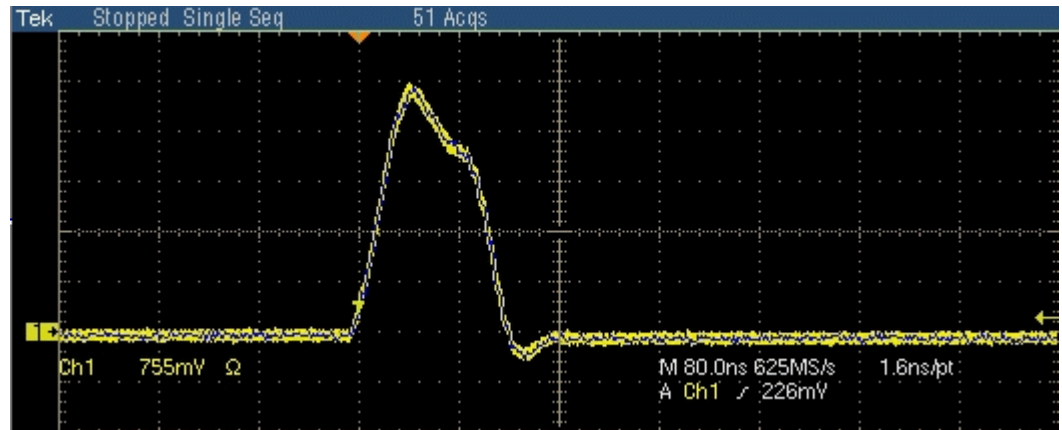

Figure 10-7: Waveform for 10BASE-T Link Pulse timing

The following figure shows a typical DUT waveform for Template testing of Link Pulse:

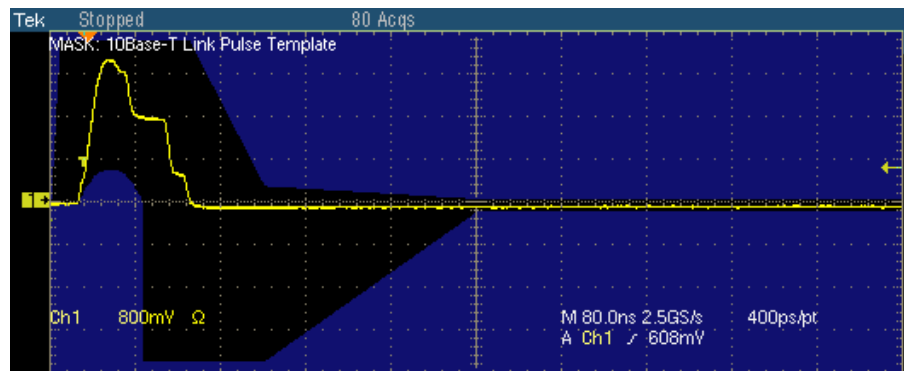

Figure 10-8: Waveform for 10BASE-T Link Pulse head

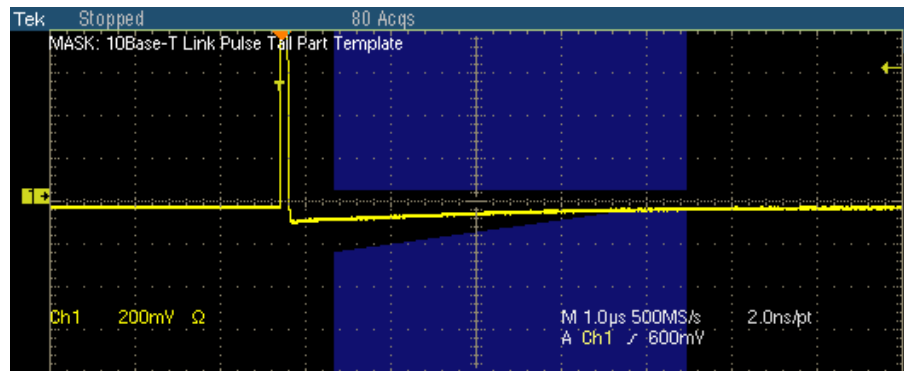

Figure 10-9: Waveform for 10BASE-T Link Pulse tail

If the acquired waveform does not lie within the mask, click **Manual Fit**. To adjust the waveform to fit into the Mask, change the horizontal position and vertical position using the general purpose knobs or the Virtual Keyboard. This repeats the mask pass/fail test and displays the results in the **Results Summary** pane.

The application automatically displays the results as pass or fail. Select **Results** in the Execution pane and then click **Result Details** button to view the detailed results.

Note: *The 100 Ohm load with TPM and 100 Ohm load without TPM are optional and not required according to the 802.3-2002 standards.*

Link Pulse Timing test is not available in TDS6604 and TDS6804 oscilloscopes.

10BASE-T/10BASE-Te TP_IDL

1. Click **Tests > Select > 10BASE-T** from the menu bar.
2. In the Template tab, select **TP_IDL**.
3. In the adjacent drop-down list, select the load with or without TPM — Load1 w/o TPM, Load2 w/o TPM, 100 Ω w/o TPM, Load1 with TPM, Load2 with TPM, or 100 Ω with TPM.

Note: *The 100 Ohm load with TPM and 100 Ohm load without TPM are optional and not required according to the 802.3-2002 standards (for 10BASE-Te, refer to 802.3az standard).*

The status bar displays the major configuration details. If you do not want to change the configuration settings, you can skip Step 3.

4. To change the configuration settings, select Tests > Configure from the menu bar, or click the Configure button in the Selection pane. In the Configuration window, select the following options:

Table 10-3: 10BASE-T/10BASE-Te TP_IDL configuration options

| Parameter | Options | To do |
|------------------|---------------------------|--|
| Data | CH1, CH2, CH3, or CH4 | Select the channel to which the DUT is connected. |
| Acquisition | Sample or Average | Select the acquisition mode. If you select Average, # of Wfms appears. Enter the number of waveforms to test in the # of Wfms field. |
| Section | Both, Head, or Tail | Select the section of mask to test. <i>Note: If you select Both and if the test fails, then Locate hits and Flash hits display the Tail section failures.</i> |
| Energy Efficient | Yes, No | Configure the test to run either in energy efficient mode or not. |
| Mask Setup | # of Wfms and Fail Thresh | Select the number of waveforms to be tested and the number of waveforms that must fail for the test to fail. |

5. Select **Tests > Connect** or **Connect** in the Selection pane and make connections.
6. Select **View Wfm** in the Selection pane, to view and compare the waveform with the acquired waveform.
7. Click **Run Test**. The application does the following:
 - Checks whether the DUT is connected and a valid signal is acquired
 - Sets up the signal
 - Loads the front portion of the mask

8. The application displays the following dialog box:



Figure 10-10: 10BASE-T Template user control dialog box

- Toggle **Lock Mask to Wfm** between On and Off to lock or unlock the mask to waveform when you zoom in or zoom out
- Toggle **Mask Autofit** between On and Off to allow the oscilloscope to automatically fit the waveform to mask
- Click **OK** to continue

9. The application then carries out the mask pass/fail test.

***Note:** If you have selected the Section as Both, the application sets up the signal and loads the front portion of the mask for the Head. Then, the application sets up the signal and loads the tail portion of the mask. The application adds the pass/fail result of both Head and Tail.*

If the test fails, the application captures the waveform, circles the hits and saves the information to the report.

The following figure shows a typical DUT waveform for Template testing of TP_IDL:

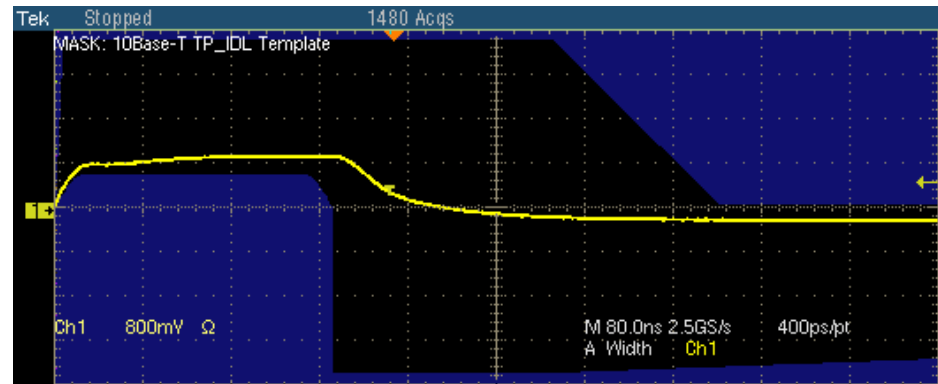

Figure 10-11: Waveform for 10BASE-T TP_IDL head

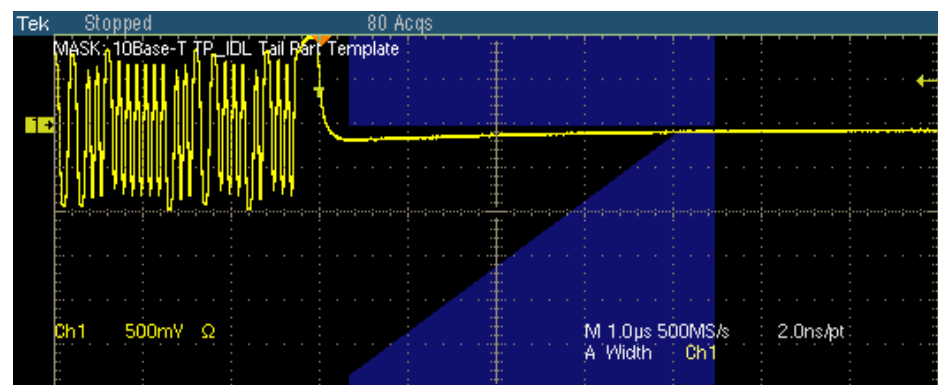

Figure 10-12: Waveform for 10BASE-T TP_IDL tail

If the acquired waveform does not lie within the mask, click **Manual Fit**. To adjust the waveform to fit into the Mask, change the horizontal position and vertical position using the general purpose knobs or Virtual Keyboard. This repeats the mask pass/fail test and displays the results in the **Results Summary** pane.

The application automatically displays the results as pass or fail. Select **Results** in the Execution pane and then click **Result Details** button to view the detailed results.

Note: The 100 Ohm load with TPM and 100 Ohm load without TPM are optional and not required according to the 802.3-2002 standards (for 10BASE-Te, refer to 802.3az standard).

10BASE-T/10BASE-Te Differential Voltage

1. Click Tests > Select > 10BASE-T from the menu bar.
2. In the Parametric tab, select Diff Volt. From the Peak drop-down list, select the peak value as Max or Min Max.

Note: The status bar displays the major configuration details. If you do not want to change the configuration settings, you can skip Step 3.

3. To change the configuration settings, select Tests > Configure from the menu bar, or click the Configure button in the Selection pane.
4. In the Configuration window, select the following options:

Table 10-4: 10BASE-T/10BASE-Te Differential Voltage configuration options

| Parameter | Options | To do |
|------------------|-----------------------|---|
| Data | CH1, CH2, CH3, or CH4 | Select the channel to which the DUT is connected. |
| Energy Efficient | Yes, No | Configure the test to run either in energy efficient mode or not. |

5. Select **Tests > Connect** or **Connect** in the Selection pane and make connections.
6. Select **View Wfm** in the Selection pane, to view and compare the waveform with the acquired waveform.
7. Click **Run Test**. The application does the following:
 - Checks whether the DUT is connected and a valid signal is acquired
 - Sets up the Vertical, Horizontal, Trigger oscilloscope parameters
 - Measures the maximum and minimum voltages on the waveform

The following figure shows a typical DUT waveform for Differential Voltage:

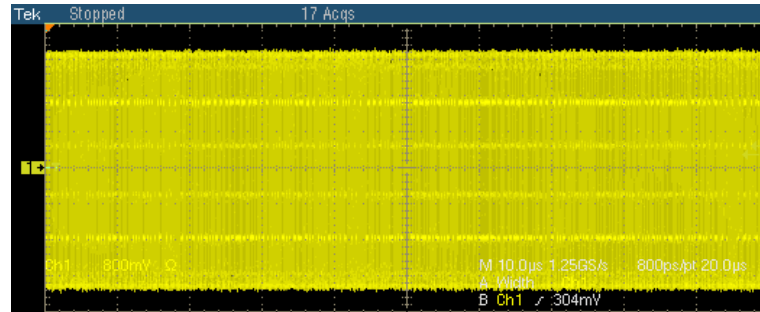

Figure 10-13: Waveform for 10BASE-T Differential Voltage

The application automatically displays the results as pass or fail. Select **Results** in the Execution pane and then click **Result Details** button to view the detailed results.

Note: The application displays the probe offset value in the Result Details dialog box.

10BASE-T/10BASE-Te Harmonic

1. Click **Tests > Select > 10BASE-T** from the menu bar.
2. In the **Parametric** tab, select **Harmonic**.

Note: The status bar displays the major configuration details. If you do not want to change the configuration settings, you can skip Step 3.

3. To **change** the configuration settings, select **Tests > Configure** from the menu bar, or click the **Configure** button in the Selection pane.

4. In the Configuration window, select the following options:

Table 10-5: 10BASE-T/10BASE-Te Harmonic configuration options

| Parameter | Options | To do |
|------------------|-------------------------------|---|
| Data | CH1, CH2, CH3, or CH4 | Select the channel to which the DUT is connected. |
| Harmonic Ones | | |
| Output | Math1, Math2, Math3, or Math4 | Select the math waveform on which the processed waveform will be stored. |
| # of Averages | | Enter the number of waveforms to be averaged. |
| Energy Efficient | Yes, No | Configure the test to run either in energy efficient mode or not. |
| Time/Scale | 1 or 10 microseconds | Enter the time or scale depending on the packet length being transmitted. |

5. Select **Tests > Connect** or **Connect** in the Selection pane and make connections.
6. Select **View Wfm** in the Selection pane, to view and compare the waveform with the acquired waveform.
7. Click **Run Test**. The application does the following:
 - Checks whether the DUT is connected and a valid signal is acquired
 - Sets up the Vertical, Horizontal, Trigger and Math Spectral oscilloscope parameters
 - Displays the Math waveform

The following figure shows a typical DUT waveform for Harmonic:

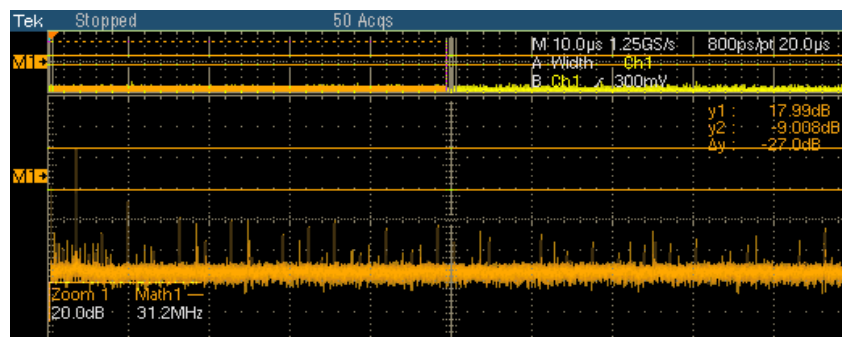

Figure 10-14: Waveform for 10BASE-T Harmonic

Note: The Harmonic result starts at 2 and ends at 25. If the calculated harmonic frequency value is not in the range of ± 0.5 MHz, then cursor-based readings of the harmonic value are used.

The application automatically displays the results as pass or fail. Select **Results** in the Execution pane and then click **Result Details** button to view the detailed results.

10BASE-T Jitter with cable

1. Click **Tests > Select > 10BASE-T** from the menu bar.
2. In the Parametric tab, select **With Cable** in the Jitter group. Select Normal, 8BT, 8.5BT, or All in the adjacent drop-down list.

Note: The status bar displays the major configuration details. If you do not want to change the configuration settings, you can skip Step 3.

3. To change the configuration settings, select **Tests > Configure** from the menu bar, or click the Configure button in the Selection pane.
4. In the Configuration window, select the following options:

Table 10-6: 10BASE-T Jitter with cable configuration options

| Parameter | Options | To do |
|-----------|-----------------------|---|
| Data | CH1, CH2, CH3, or CH4 | Select the channel to which the DUT is connected. |
| MAU Type | Internal, or External | Select the MAU Type as Internal or External. |

5. Select Tests > **Connect** or **Connect** in the Selection pane and make connections.
6. Select **View Wfm** in the Selection pane, to view and compare the waveform with the acquired waveform.
7. Click **Run Test**. The application checks whether the DUT is connected and a valid signal is acquired.
8. If you selected 8BT or 8.5BT or All (Refer Step 2), the following window appears:



Figure 10-15: 10BASE-T Jitter with cable user control

If the signal does not look like the one in the image, you can set up the oscilloscope. The signal may not match the one in the image if an interpacket interval is observed on the screen. Adjust these parameters in the oscilloscope:

- Increase the trigger level so that the interpacket interval is not considered. Trigger level is currently set to 60 mV accounting for the noise of 50 mV
- If the signal still does not match the one in the image, adjust the trigger hold off parameter. This adjustment will help in skipping the interpacket interval and get the stable trigger every time

9. The application does the following:
 - Sets up the signal
 - Places the horizontal histogram at the zero crossing
 - Reads the peak-to-peak jitter from the histogram
 - Compares the read out values with the standard
 - Acquires the signal for approximately 15 seconds

If you have selected Output Timing Jitter as **Normal**, the application displays the typical DUT waveform for Jitter with cable testing as shown in the following figure:

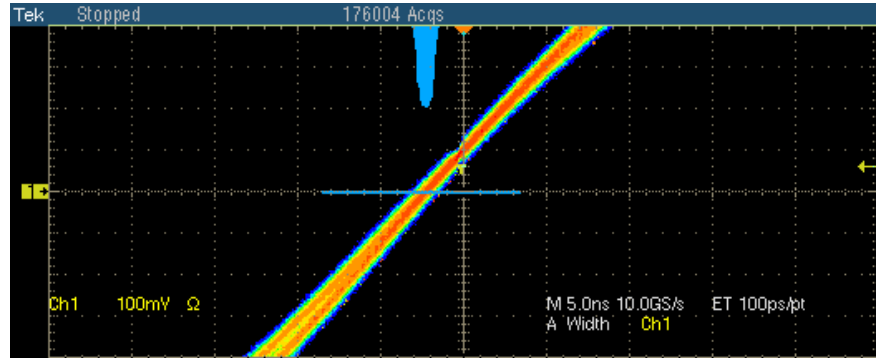

Figure 10-16: Waveform for 10BASE-T Jitter with Cable for Normal output timing jitter

If you have selected Output Timing Jitter as **8 BT**, the application displays the typical DUT waveform for Jitter with cable testing as shown in the following figure:

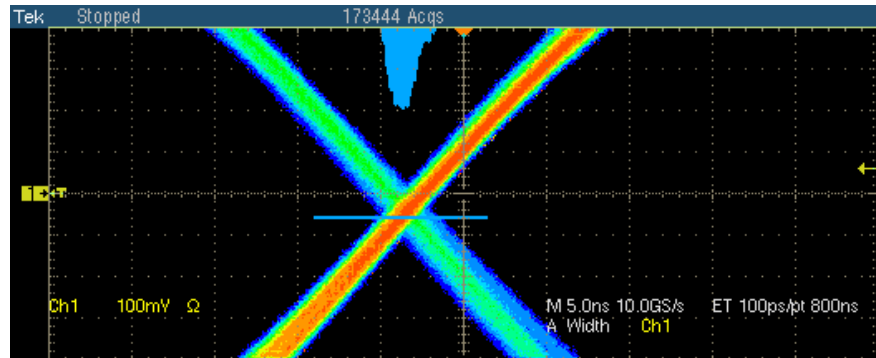

Figure 10-17: Waveform for 10BASE-T Jitter with Cable for 8 BT output timing jitter

If you have selected Output Timing Jitter as **8.5 BT**, the application displays the typical DUT waveform for Jitter with cable testing as shown in the following figure:

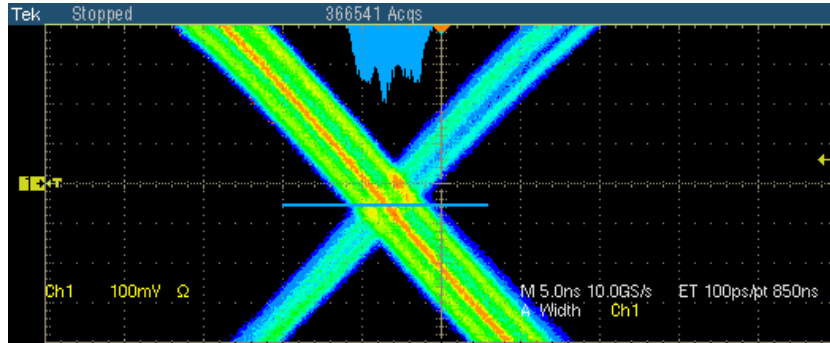

Figure 10-18: Waveform for 10BASE-T Jitter with Cable for 8.5 BT output timing jitter

The application automatically displays the results as pass or fail. Select **Results** in the Execution pane and then click **Result Details** button to view the detailed results.

10BASE-T Jitter without cable

1. Click **Tests > Select > 10BASE-T** from the menu bar.
2. In the Parametric tab, select **w/o Cable** in the Jitter group. Select **Normal**, **8BT**, **8.5BT**, or **All** in the adjacent drop-down list.

***Note:** The status bar displays the major configuration details. If you do not want to change the configuration settings, you can skip Step 3.*

3. To change the configuration settings, select **Tests > Configure** from the menu bar, or click the **Configure** button in the Selection pane.
4. In the Configuration window, select the following options:

Table 10-7: 10BASE-T Jitter without cable configuration options

| Parameter | Options | To do |
|-----------|-----------------------|---|
| Data | CH1, CH2, CH3, or CH4 | Select the channel to which the DUT is connected. |
| MAU Type | Internal, or External | Select the MAU Type as Internal or External. |

- 5.

6. Select Tests > **Connect** or **Connect** in the Selection pane and make connections.
7. Select View **Wfm** in the Selection pane, to view and compare the waveform with the acquired waveform.
8. Click Run **Test**. The application checks whether the DUT is connected and a valid signal is acquired.
9. If you selected 8BT or 8.5BT or All (Refer Step 2), the following window appears:



Figure 10-19: 10BASE-T Jitter without cable user control

If the signal does not look like the one in the image, you can set up the oscilloscope. The signal may not match the one in the image if an interpacket interval is observed on the screen. Adjust these parameters in the oscilloscope:

- Increase the trigger level so that the interpacket interval is not considered. Trigger level is currently set to 60 mV accounting for the noise of 50 mV
- If the signal still does not match the one in the image, adjust the trigger hold off parameter. This adjustment will help in skipping the interpacket interval and get the stable trigger every time

10. The application does the following:

- Sets up the signal
- Places the horizontal histogram at the zero crossing
- Reads the peak-to-peak jitter from the histogram
- Compares the read out values with the Standard

- Acquires the signal for approximately 15 seconds

If you have selected Output Timing Jitter as **Normal**, the application displays the typical DUT waveform for Jitter with cable testing as shown in the following figure:

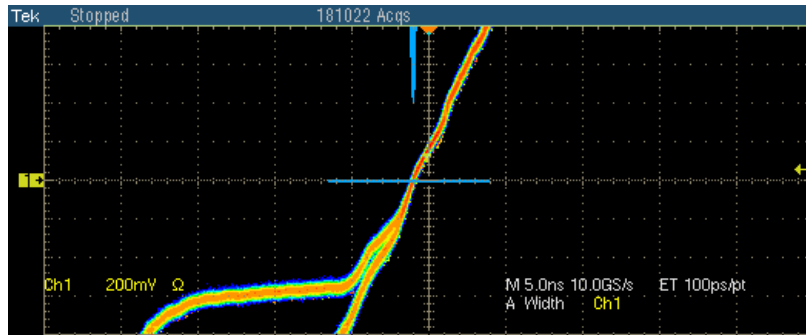

Figure 10-20: Waveform for 10BASE-T Jitter without Cable for Normal output timing jitter

If you have selected Output Timing Jitter as **8 BT**, the application displays the typical DUT waveform for Jitter with cable testing as shown in the following figure:

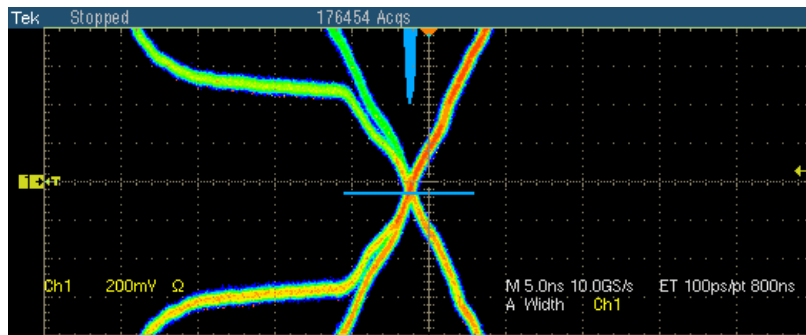

Figure 10-21: Waveform for 10BASE-T Jitter without Cable for 8 BT output timing jitter

If you have selected Output Timing Jitter as **8.5 BT**, the application displays the typical DUT waveform for Jitter with cable testing as shown in the following figure:

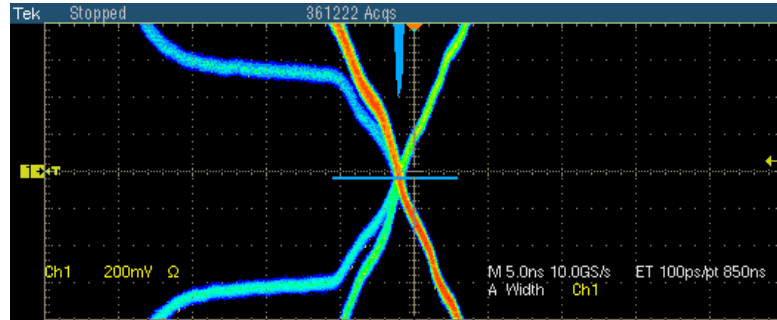

Figure 10-22: Waveform for 10BASE-T Jitter without Cable for 8.5 BT output timing jitter

The application automatically displays the results as pass or fail. Select **Results** in the Execution pane and then click **Result Details** button to view the detailed results.

10BASE-T Return Loss

1. Click **Tests > Select > 10BASE-T** from the menu bar.
2. In the Return Loss tab, select **Transmitter** or **Receiver**.

Note: The status bar displays the major configuration details. If you do not want to change the configuration settings, you can skip Step 3.

3. To change the configuration settings, select **Tests > Configure** from the menu bar, or click the Configure button in the Selection pane.
4. In the Configuration window, select the following options:

Table 10-8: 10BASE-T Return Loss configuration options

| Parameter | Options | To do |
|---------------------------|--|---|
| Sources P1/P3 P2/P4 | CH1, CH2, CH3, or CH4 CH1, CH2, CH3, or CH4 | Select the channel to which the DUT is connected. <i>Note: Depending on whether the Transmitter or Receiver is selected, the sources will change from P1/P3 and P2/P4.</i> |

Table 10-8: 10BASE-T Return Loss configuration options (cont)

| Parameter | Options | To do |
|---|---|---|
| Output Waveform Return Loss 0 dB Marker | Ref1, Ref2, Ref3, or Ref4 Ref1, Ref2, Ref3, or Ref4 | Select the reference waveform on which the output waveform will be stored. Select the reference waveform on which you want the 0 dB Marker to be indicated. <i>Note: These fields appear only if you set Load as 100 Ohm.</i> |
| AWG/AFG | Select, AWG 4xx, AWG 2021, AWG 5xx, AWG 6xx, AWG 7xx, AWG5xxx, AWG7xxx, AFG3xxx | Select the AWG/AFG Series to use. If you select the default value–Select–then the application considers all AWGs/AFGs other than the AWG 4xx series. |
| Load | 85, 100, 115 Ohm or 100 Ohm | Select the load as 85, 100, 115 Ohm or 100 Ohm. |
| #Averages | 100 to 10000 | Enter the number of waveforms you want to average. |
| Smooth | 0 to 10 | Enter the smoothing factor. |

5. Select **Tests > Connect** or **Connect** in the Selection pane and make connections.
6. Select View **Wfm** in the Selection pane, to view and compare the waveform with the acquired waveform.
7. Click Run Test. The application does the following:
 - Displays a message box to confirm the overwrite of the reference waveform. Select Yes to continue
 - Sets up the trigger
 - Acquires and computes the return loss
 - Displays the return loss curve on selected output (reference waveform)

If the test fails, the application captures the waveform, circles the hits and saves the information to the report. The application obtains the hits information only for the 100 Ohm waveform.

The following figure shows a typical waveform for Return Loss Transmitter:



Figure 10-23: Waveform for 10BASE-T Return Loss Transmitter

The following figure shows a typical waveform for Return Loss Receiver:

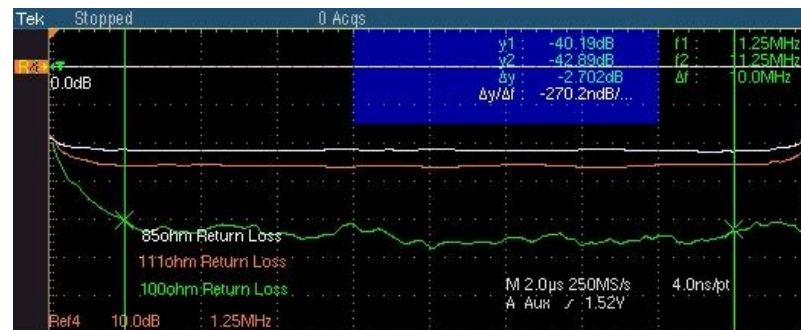

Figure 10-24: Waveform for 10BASE-T Return Loss Receiver

The application automatically displays the results as pass or fail. Select **Results** in the Execution pane and click **Result Details** button to view detailed results.

10BASE-T CM Voltage

1. Click **Tests > Select > 10BASE-T** from the menu bar.
2. In the CM Voltage tab, select **CM Voltage**.

Note: The status bar displays the major configuration details. If you do not want to change the configuration settings, you can skip Step 3.

3. To change the configuration settings, select **Tests > Configure** from the menu bar, or click the Configure button in the Selection pane.

4. In the Configuration window, select the following options:

Table 10-9: 10BASE-T CM Voltage configuration options

| Parameter | Options | To do |
|-----------|-----------------------|---|
| Data | CH1, CH2, CH3, or CH4 | Select the channel to which the DUT is connected. |

5. Select **Tests** > Connect or Connect in the Selection pane and make connections.
6. Select View Wfm in the Selection pane, to view and compare the waveform with the acquired waveform.
7. Click **Run Test**. The application does the following:
 - Checks whether the DUT is connected and a valid signal is acquired
 - Sets the trigger
 - Measures the maximum positive and negative voltage levels
 - Compares the values with the Standard
 - Displays the DUT waveform for Common mode Voltage testing

The following figure shows a typical waveform for Common mode Voltage:

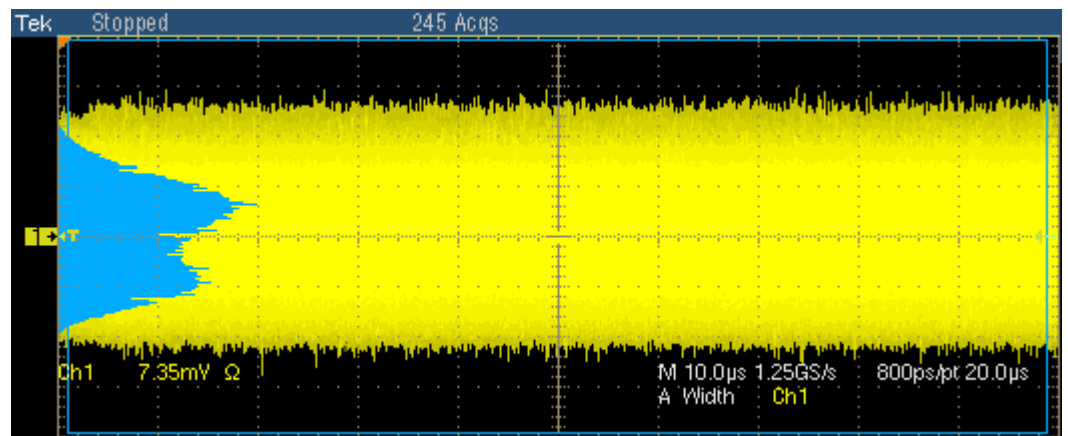

Figure 10-25: Waveform for 10BASE-T CM Voltage

The application automatically displays the results as pass or fail. Select **Results** in the Execution pane and then click **Result Details** button to view the detailed results.

View Waveform for 1000BASE-T

1000BASE-T Template, Peak Volt, Droop

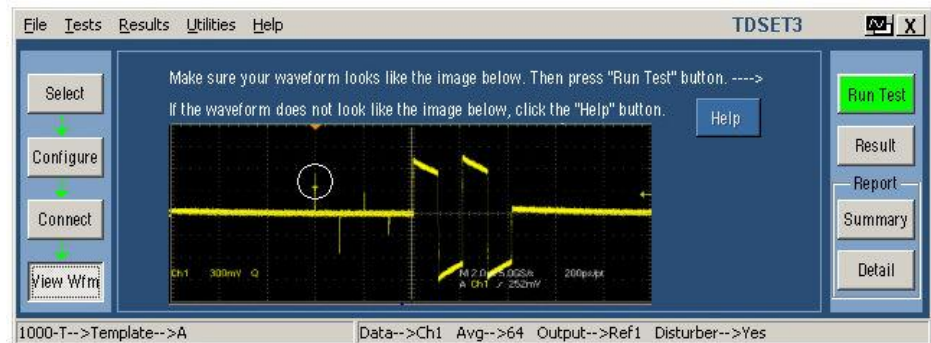

Figure 11-1: 1000BASE-T View Waveform for Template, Peak Volt, and Droop with disturbing signal

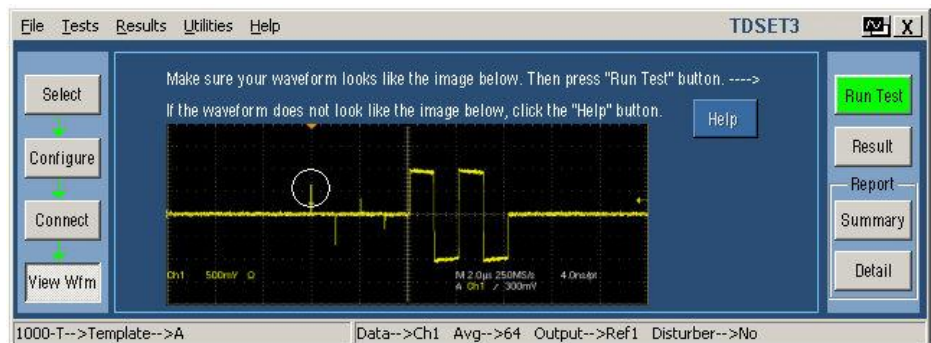

Figure 11-2: 1000BASE-T View Waveform for Template, Peak Volt, and Droop without disturbing signal

Ensure the waveform displayed by the application in the circled portion is similar to the acquired waveform.

If the waveform displayed by the application is not similar to the acquired waveform in the graticule, do the following:

- For Template, Peak Volt, and Droop tests, check if the DUT is set to transmit Test Mode 1 signal
- Check the polarity of the signal
- Check the correctness of jumper connections in the fixture

- Check the correctness of the probing point in the fixture

1000BASE-T Jitter Master

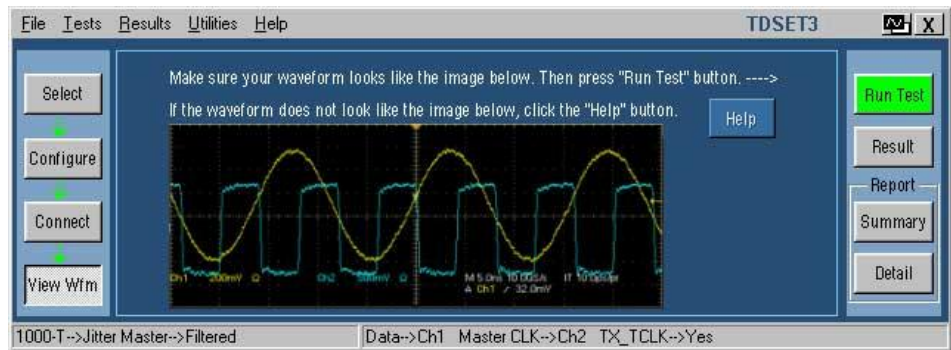

Figure 11-3: 1000BASE-T View Waveform for Jitter Master Filtered (with TX_TCLK access)

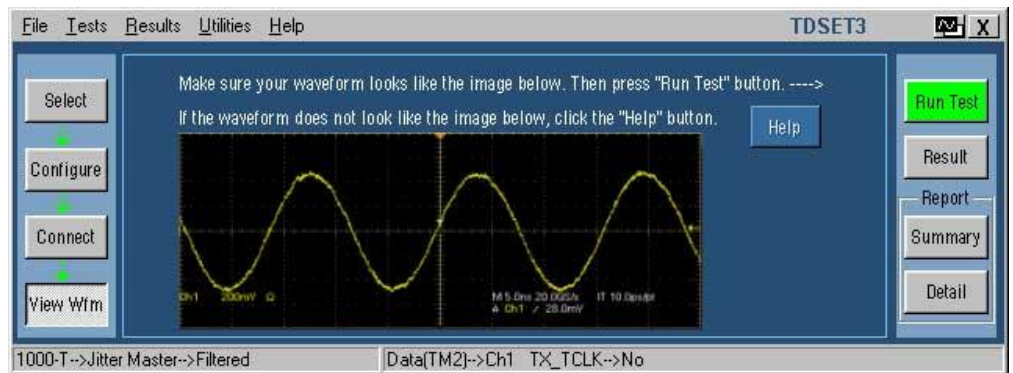

Figure 11-4: 1000BASE-T View Waveform for Jitter Master Filtered (without TX_TCLK access)

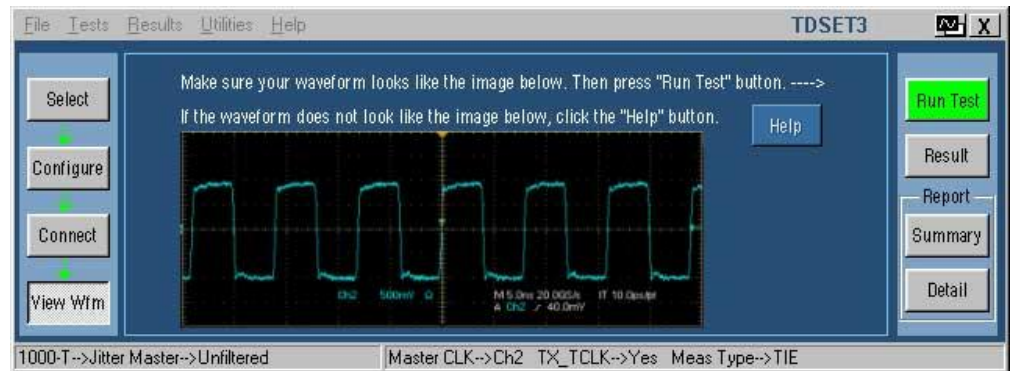

Figure 11-5: 1000BASE-T View Waveform for Jitter Master Unfiltered (with TX_TCLK access)

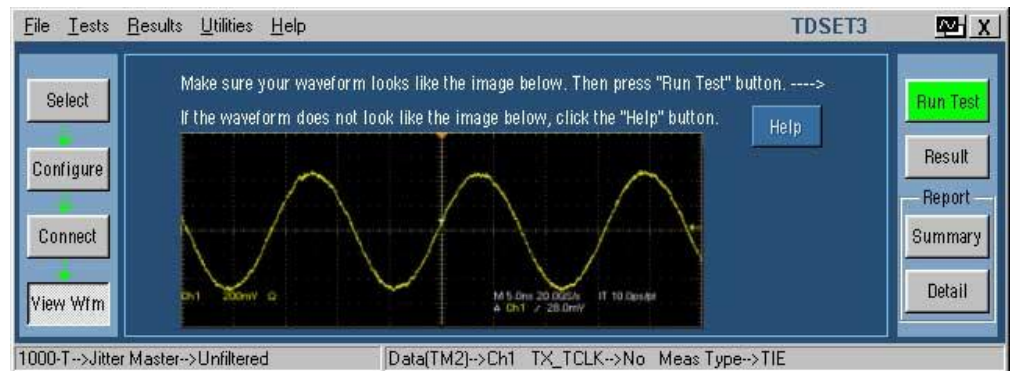

Figure 11-6: 1000BASE-T View Waveform for Jitter Master Filtered (without TX_TCLK access)

Note: In TDS5000B series oscilloscopes, the horizontal scale is set to 10 ns.

If the waveform displayed by the application is not similar to the acquired waveform in the graticule, do the following:

- Check if the DUT is set to transmit Test Mode 2 signal
- Check the correctness of test setup
- Check the correctness of the probing point in the fixture

1000BASE-T Jitter Slave

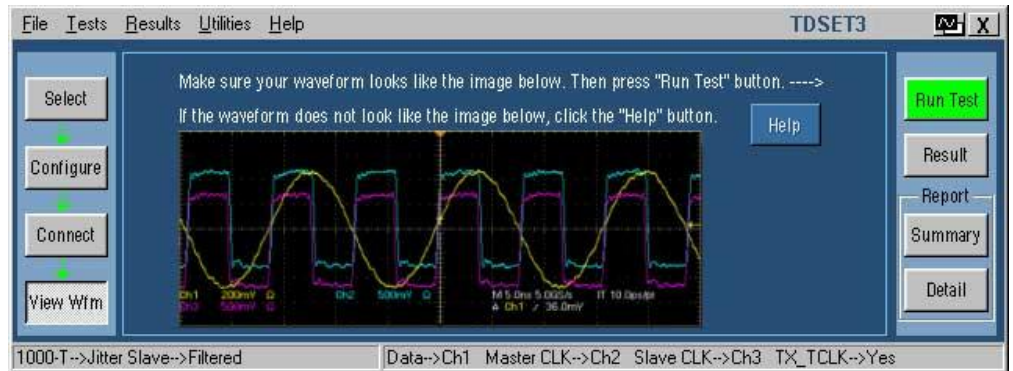

Figure 11-7: 1000BASE-T View Waveform for Jitter Slave Filtered (with TX_TCLK access)

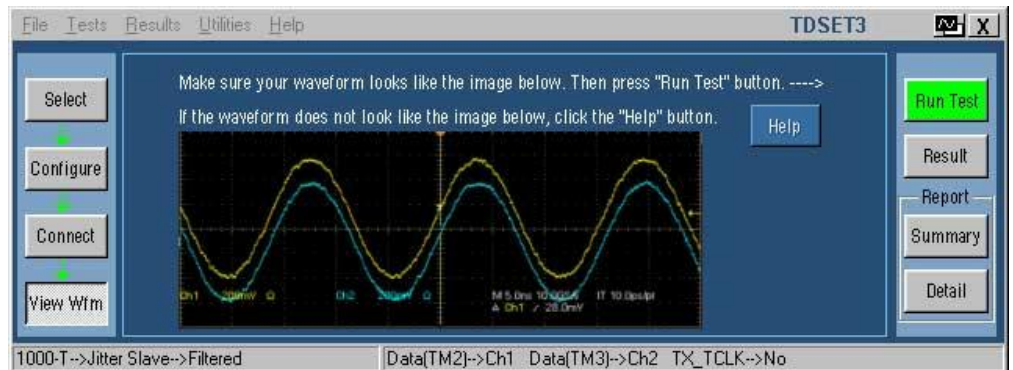

Figure 11-8: 1000BASE-T View Waveform for Jitter Master Filtered (without TX_TCLK access)

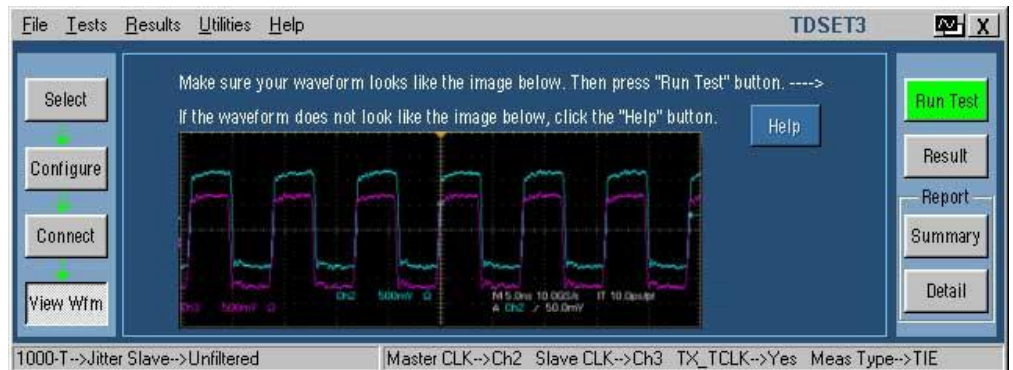

Figure 11-9: 1000BASE-T View Waveform for Jitter Slave Unfiltered (with TX_TCLK access)

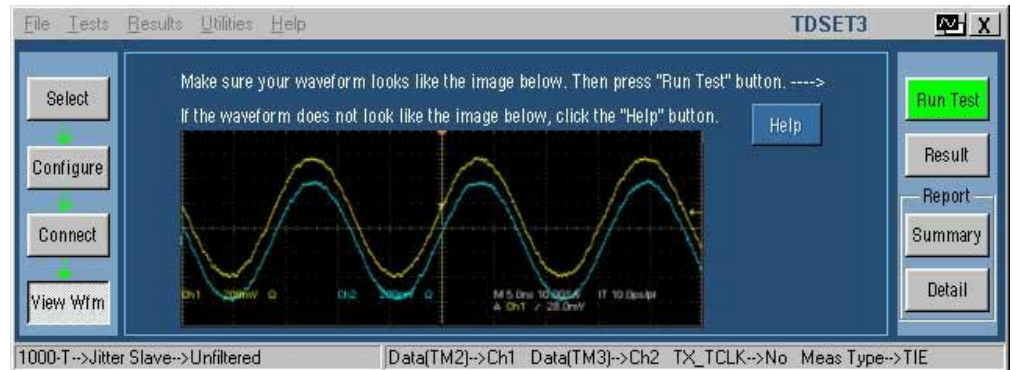

Figure 11-10: 1000BASE-T View Waveform for Jitter Master Filtered (without TX_TCLK access)

Note: In TDS5000B series oscilloscopes, the horizontal scale is set to 10 ns.

If the waveform displayed by the application is not similar to the acquired waveform in the graticule, do the following:

- Check if the DUT is set to transmit the appropriate Test Mode signal
- Check the correctness of test setup
- Check the correctness of the probing point in the fixture

1000BASE-T Distortion

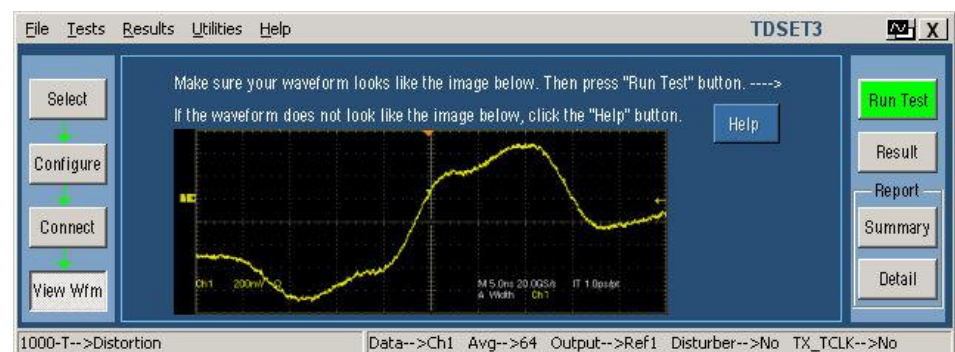

Figure 11-11: 1000BASE-T View Waveform for Distortion

Note: In TDS5000B series oscilloscopes, the horizontal scale is set to 10 ns.

If the waveform displayed by the application is not similar to the acquired waveform in the graticule, do the following:

- Check if the DUT is set to transmit Test Mode 4 signal
- Check the polarity of the signal
- Check the correctness of jumper connections in the fixture
- Check the correctness of the probing point in the fixture

1000BASE-T Return Loss

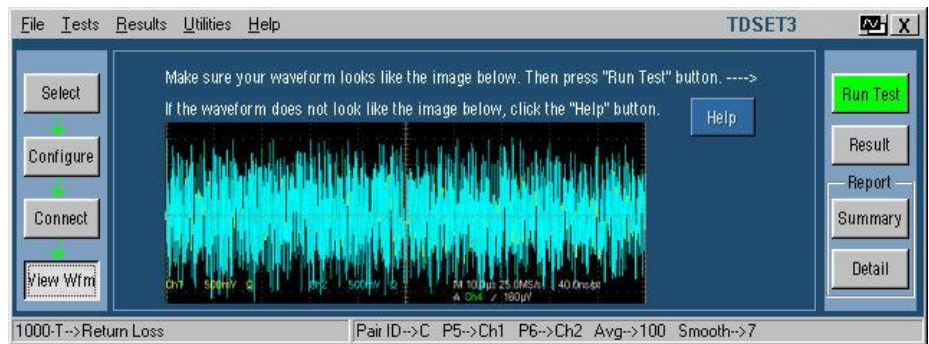

Figure 11-12: 1000BASE-T View Waveform for Return Loss

If the waveform displayed by the application is not similar to the acquired waveform in the graticule, do the following:

- Check if the DUT is set to transmit Test mode 4 signal
- Check if the polarity of probe connection is right
- Check the correctness of the probing point in the Test Fixture

1000BASE-T CM Voltage



Figure 11-13: 1000BASE-T View Waveform for CM Voltage

If the waveform displayed by the application is not similar to the acquired waveform in the graticule, do the following:

- Check if the DUT is set to transmit Test mode 4 signal
- Check if the probe is properly locked to the oscilloscope
- Check if all the connections are proper

View Waveform for 100BASE-TX

All 100BASE-TX Tests except Return Loss

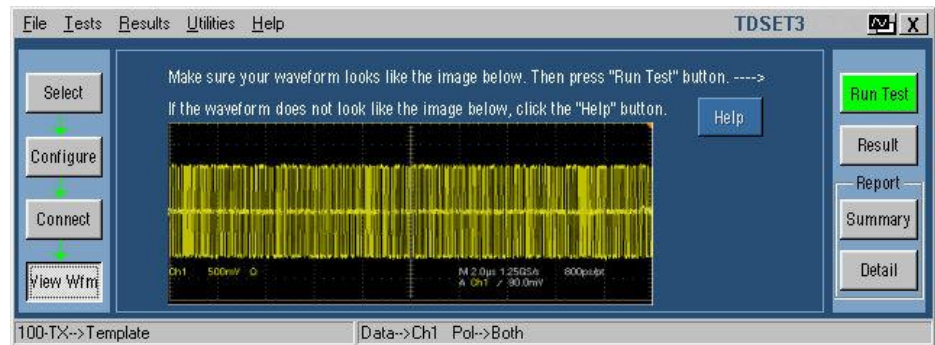

Figure 12-1: 100BASE-TX View Waveform for all tests except Return Loss

If the waveform displayed by the application is not similar to the acquired waveform in the graticule, do the following:

- Check if the DUT is set to transmit random sequence
- Check if the polarity of probe connection is right
- Check the correctness of the probing point in the Test Fixture

100BASE-TX Return Loss

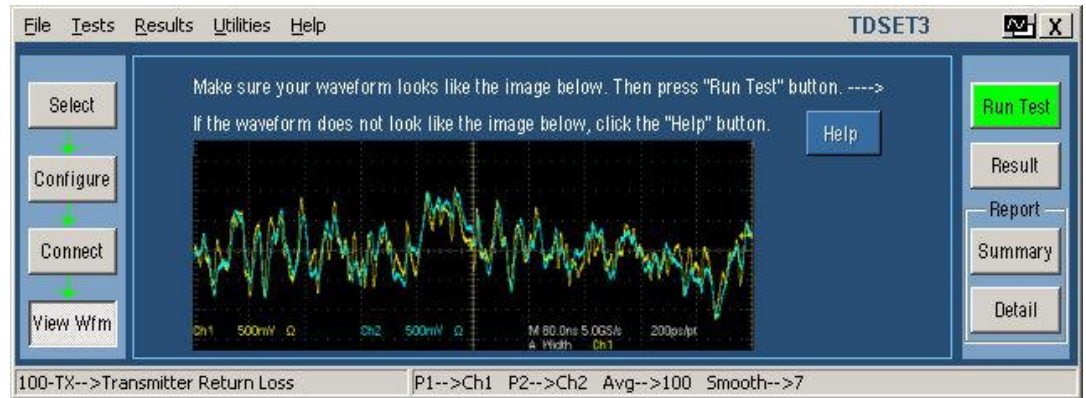

Figure 12-2: 100BASE-TX View Waveform for Return Loss Transmitter

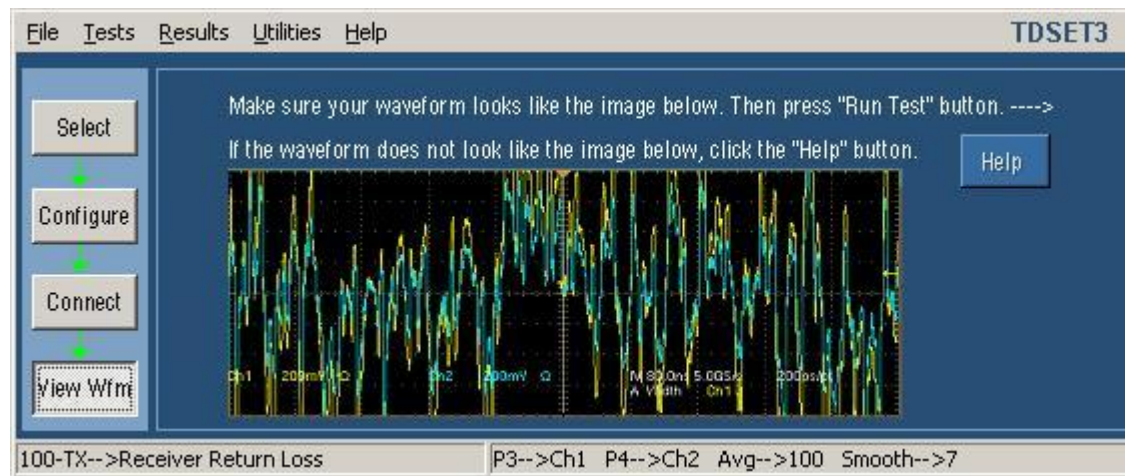

Figure 12-3: 100BASE-TX View Waveform for Return Loss Receiver

If the waveform displayed by the application is not similar to the acquired waveform in the graticule, do the following:

- Check if the DUT is set to transmit random sequence
- Check if the polarity of probe connection is right
- Check the correctness of the probing point in the Test Fixture

View Waveform for 10BASE-T/10BASE-Te

10BASE-T Link Pulse

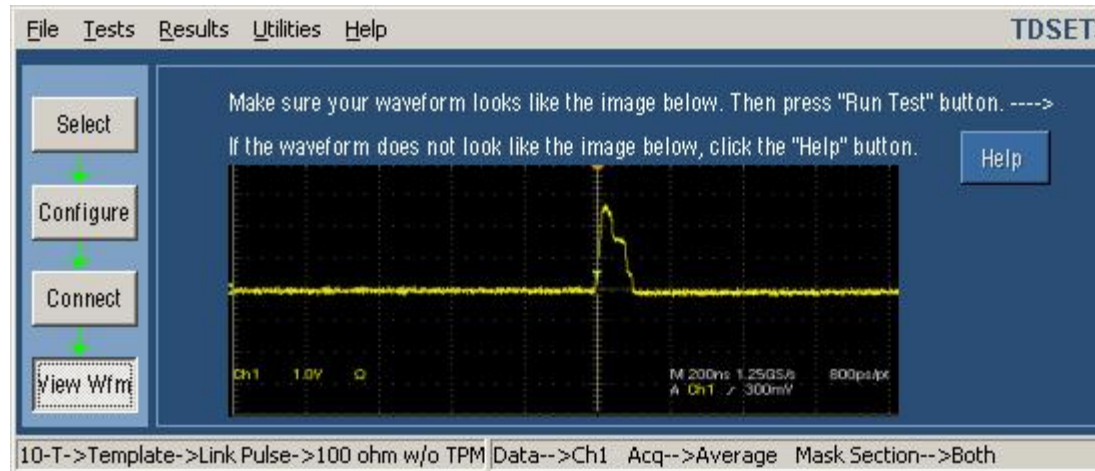

Figure 13-1: 10BASE-T View Waveform for Link Pulse

If the waveform displayed by the application is not similar to the acquired waveform in the graticule, do the following:

- Check if the DUT is transmitting the Link Pulse
- Check if the probe is properly locked to the oscilloscope
- Check if the polarity of probe connection is right
- Check if all the connections are proper

10BASE-T/10BASE-T_e MAU

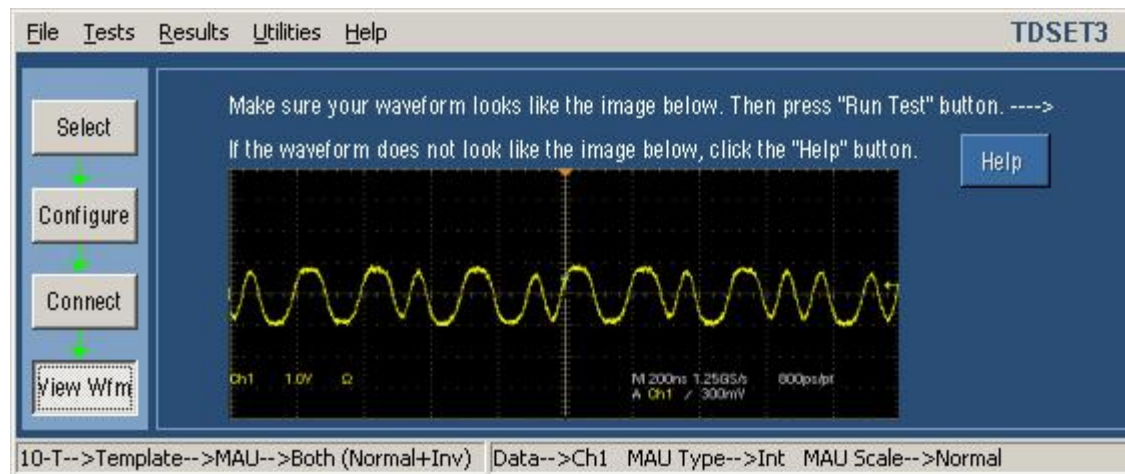

Figure 13-2: 10BASE-T View Waveform for MAU

If the waveform displayed by the application is not similar to the acquired waveform in the graticule, do the following:

- Check if the DUT is transmitting the Link Pulse
- Check if the probe is properly locked to the oscilloscope
- Check if the polarity of probe connection is right
- Check if all the connections are proper

10BASE-T/10BASE-Te TP_IDL

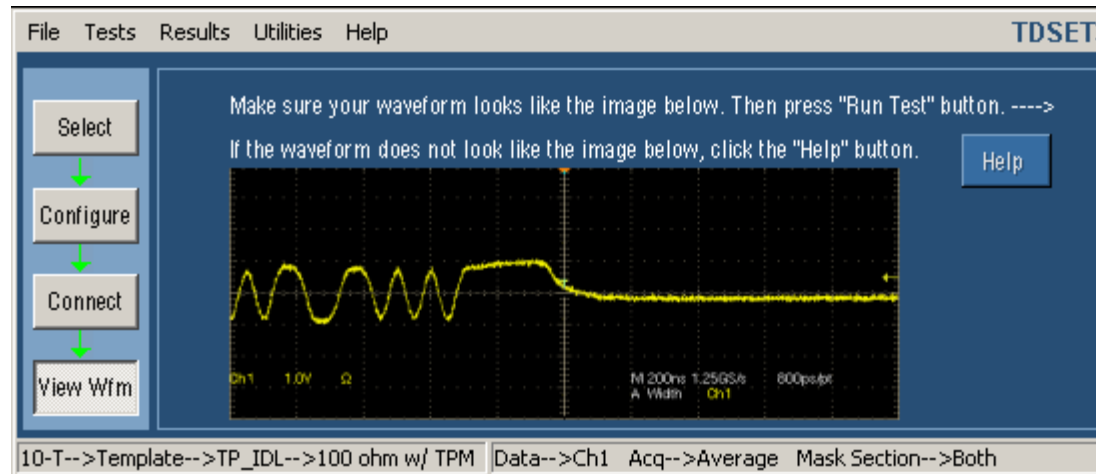

Figure 13-3: 10BASE-T View Waveform for TP_IDL with TPM

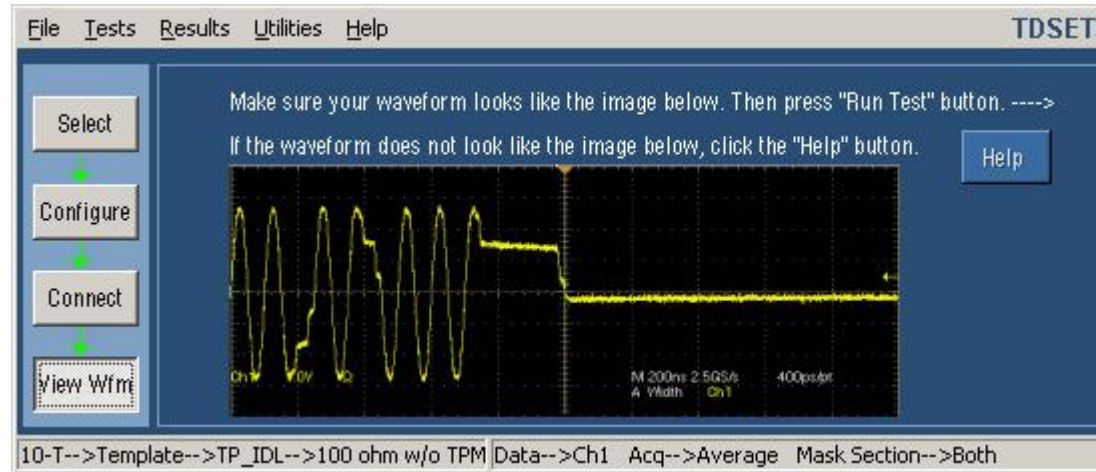

Figure 13-4: 10BASE-T View Waveform for TP_IDL without TPM

If the waveform displayed by the application is not similar to the acquired waveform in the graticule, do the following:

- Check if the DUT is transmitting 10Base-T packets
- Check if the polarity of probe connection is right
- Check if the probe is properly locked to the oscilloscope
- Check if all the connections are proper

10BASE-T Jitter with or without cable

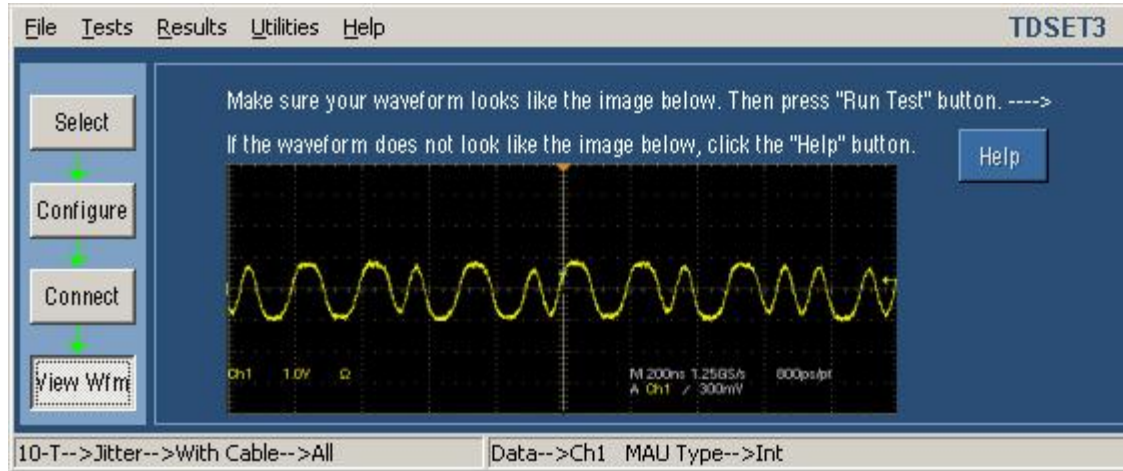

Figure 13-5: 10BASE-T View Waveform for Jitter with cable

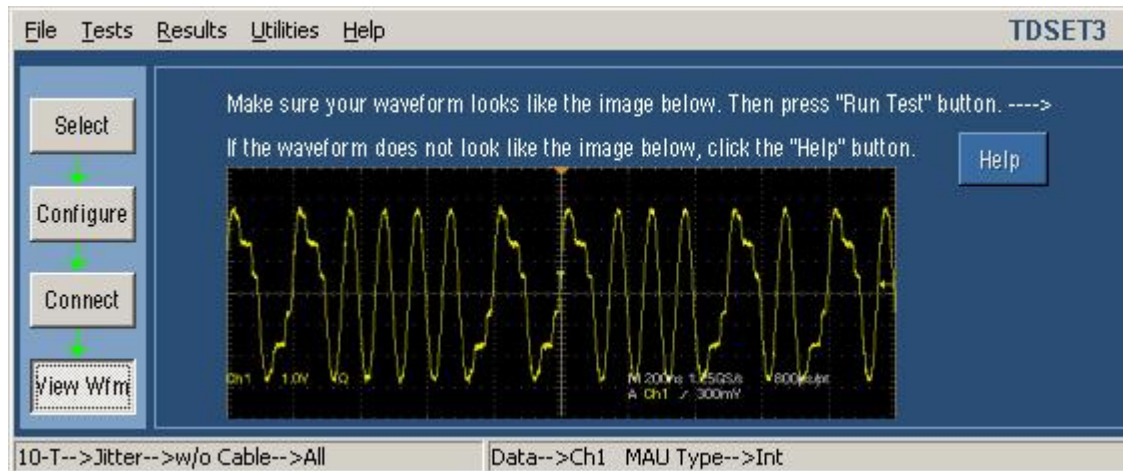

Figure 13-6: 10BASE-T View Waveform for Jitter without cable

If the waveform displayed by the application is not similar to the acquired waveform in the graticule, do the following:

- Check if the DUT is transmitting 10Base-T packets
- Check if the probe is properly locked to the oscilloscope
- Check if all the connections are proper

10BASE-T/10BASE-Te Differential Voltage

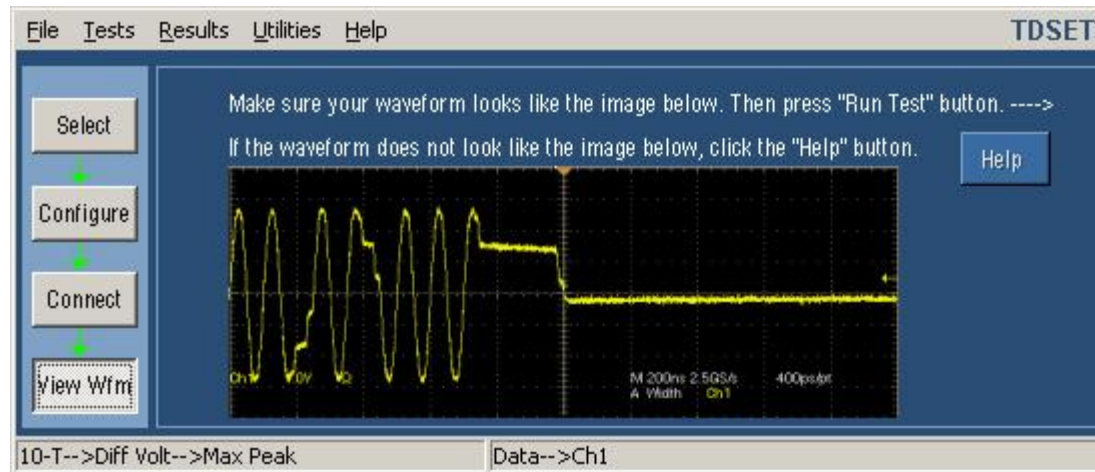

Figure 13-7: 10BASE-T View Waveform for Differential Voltage

If the waveform displayed by the application is not similar to the acquired waveform in the graticule, do the following:

- Check if the DUT is transmitting 10Base-T packets
- Check if the polarity of probe connection is right
- Check if the probe is properly locked to the oscilloscope
- Check if all the connections are proper

10BASE-T/10BASE-Te Harmonic

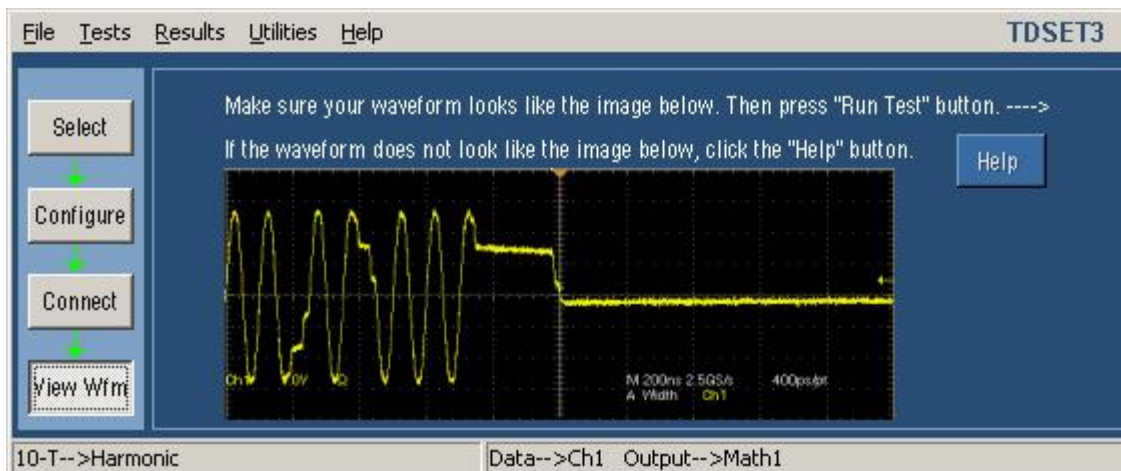

Figure 13-8: 10BASE-T View Waveform for Harmonic

If the waveform displayed by the application is not similar to the acquired waveform in the graticule, do the following:

- Check if the DUT is transmitting 10Base-T packets
- Check if the polarity of probe connection is right
- Check if the probe is properly locked to the oscilloscope
- Check if all the connections are proper

10BASE-T Return Loss

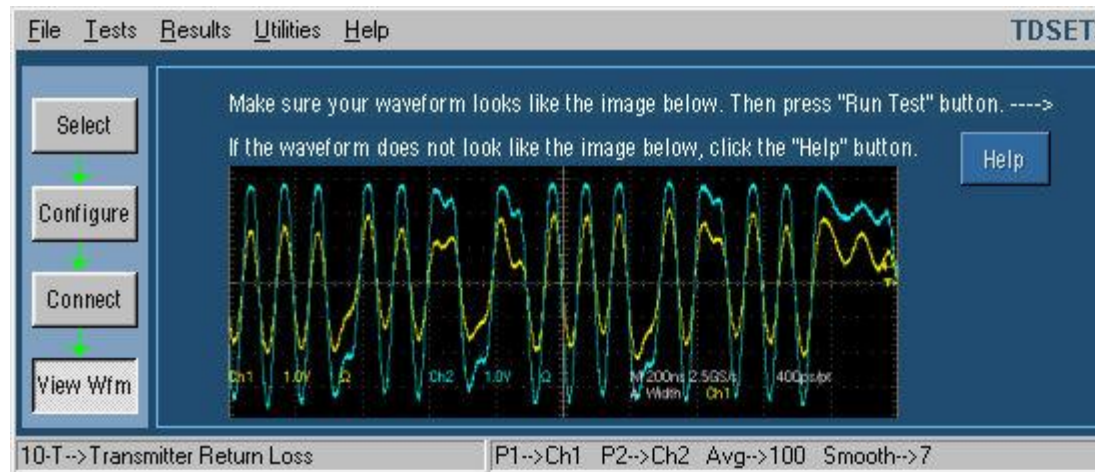

Figure 13-9: 10BASE-T View Waveform for Return Loss

If the waveform displayed by the application is not similar to the acquired waveform in the graticule, do the following:

- Check if the DUT is transmitting 10Base-T packets
- Check if the polarity of probe connection is right
- Check if the probe is properly locked to the oscilloscope
- Check if all the connections are proper

10BASE-T CM Voltage

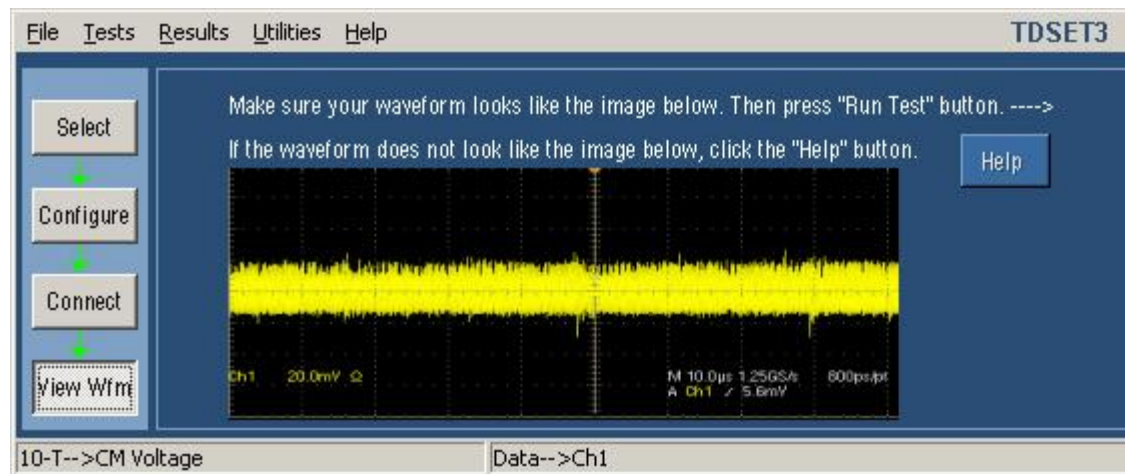

Figure 13-10: 10BASE-T View Waveform for CM Voltage

If the waveform displayed by the application is not similar to the acquired waveform in the graticule, do the following:

- Check if the DUT is transmitting 10Base-T packets
- Check if the probe is properly locked to the oscilloscope
- Check if all the connections are proper

Generate Reports

You can automatically generate reports using the **Report Summary** or *Details* button. You can use Report Configuration pane in the Result pane for configuring the DUT details and report file name.

Use Report Generator to manually generate the report. For more information, see the next section *About Report Generator*.

To manually generate the report, do the following:

1. From the application menu bar, select **Utilities > Report Generator** to display Report Generator window.
2. In the Generate Report tab, select **Browse**. The Open dialog box displays all the reports in the default directory **c:\TekApplications\TDSET3\Report Generator\Reports**.
3. In the Open dialog box, select the relevant tests, and then select **Open**.
4. In the Generate Report tab, select Generate Report, Print Report, or Load Report.
5. If you select Generate **Report**, the Assign Data to Report dialog box appears.
 - In the Assign Data to Report dialog box, select the test templates to assign the current data from your measurement application
 - Select **Assign**. The Report Viewer displays the report with current data from the application. You can choose to export to rtf format

If you select **Print Report**, the Report Viewer displays the selected report with current data from the application.

- If the page settings do not match the page settings for the report, a Page Size Mismatch message box displays a message — **The current page settings do not match the page settings for the Report. Do you want to continue?**
 - Click **Yes** to continue
 - Click **No** to stop printing the report
- If a printer is connected to the oscilloscope, the report is printed

If you select **View Report**, the Report Viewer displays the selected report with current data from the application.

You can also define test templates, and define report layouts.

About Report Generator

The Report Generator enables you to generate and print reports directly from the oscilloscope. It enhances the TDSET3 application capabilities by simplifying the process of creating and maintaining reports.

The Report Generator automates the process of compiling the test results and generating the reports. It allows you to set up the template layout using the factory default templates or custom templates. The Report Generator allows you to save files in the custom file formats such as .rgt, .rpl, or .rpt. The generated reports can also be saved as an .rtf file. The Report Generator is integrated with the TDSET3 application.

To generate a report in PDF format, you can use any tool that converts RTF to PDF. For converting the .RPT to PDF, there are several tools such as RoboPDF™, GhostWriter™ and so on.

For more information on Report Generator, [click here to view the Report Generator Printed Help Document](#).

You can also access the file – **ReportGenerator.pdf** at **C:\Program Files\TekApplications\TDSET3**.

Automating AWG/AFG

Automate AWG/AFG

Utilities > Automate AWG/AFG

This procedure will guide you through the process of connecting and configuring the AWG/AFG and the oscilloscope for automation.

You will need: Tektronix AWG/AFG, Tektronix digital oscilloscope, and National Instruments GPIB-USB-A cable with the included software (NI-488.2 for Windows) or GPIB-USB-B cable with pre-installed software.

1. Connect the equipment and verify the connection.
2. From the TDSET3 menu, select **Utilities > Automate AWG/AFG**. The following screen appears:

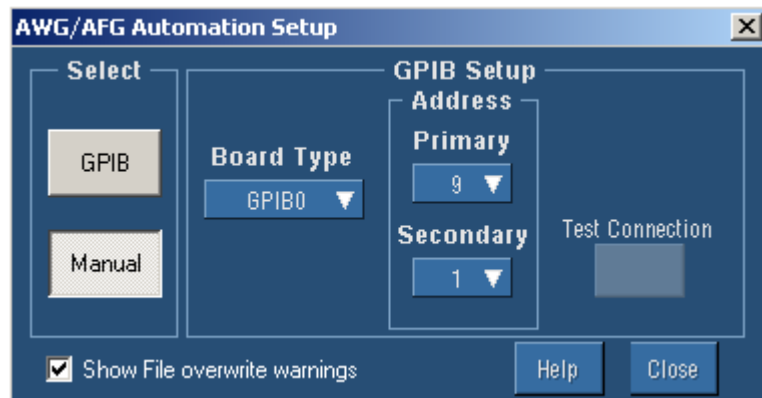

Figure 15-1: AWG/AFG Automation Setup

3. Select GPIB to automate the AWG/AFG and configure GPIB setup. The following table describes the AWG/AFG Automation configuration parameters:

Table 15-1: AWG/AFG configuration parameters and descriptions

| Configuration parameter | Description |
|------------------------------|--|
| GPIB, Manual | Select GPIB to automate file transfer and settings to the AWG/AFG. |
| Board Type | Select the Board Type that you are using. |
| Primary Address | Select the Primary GPIB Address. |
| Secondary Address | Select the Secondary GPIB Address. |
| Show File overwrite warnings | When checked, warns you before transferring files on the AWG/AFG while running a test. |

***Note:** While running a test, the oscilloscope transfers waveform and setup files to the AWG/AFG. Ensure that the AWG/AFG does not have files with the same name to avoid overwriting those files.*

4. Click Test Connection and look for a message that the connection is successful. Test Connection is enabled only for the GPIB mode.
5. RUN the selected test.

If you have selected Manual to set up the AWG/AFG and configure GPIB setup, you must:

- Copy the waveform files from C:\TekApplications\TDSET3\AWG Waveforms
- Load the appropriate waveform onto the proper channel
- Make the AWG/AFG settings according to the ReadMe.txt in the corresponding folder
- Then RUN the test

Configuration Parameters and Default Settings:

Table 15-2: AWG/AFG configuration parameters and defaults

| Parameter | Default |
|------------------------------|---------|
| Select: GPIB, Manual | Manual |
| Board Type | GPIB0 |
| Primary Address | 9 |
| Secondary Address | 1 |
| Show File overwrite warnings | Checked |

Connect the Equipment and Verify the Connections

Before you connect the equipment and verify the connection, ensure that you have installed NI-488.2 for Windows. If you are using the GPIB-USB-B cable verify that the software is pre-installed. Follow these steps to install NI-488.2 for Windows.

1. Install NI-488.2 for Windows on the oscilloscope.

During installation:

2. Ensure that NI-VISA is NOT installed.
3. Install the Measurement and Automation Explorer.
4. When prompted, enable the GPIB-USB-A/B interface.
5. Restart the oscilloscope.

Connect the Equipment

1. Connect the GPIB-USB-A/B to the USB port on the oscilloscope (the TDS7000B rear panel is shown here). The oscilloscope operating system will detect the USB-GPIB controller and install the appropriate driver for it.
2. Connect the other end of the cable GPIB-USB-A/B to the AWG/AFG.

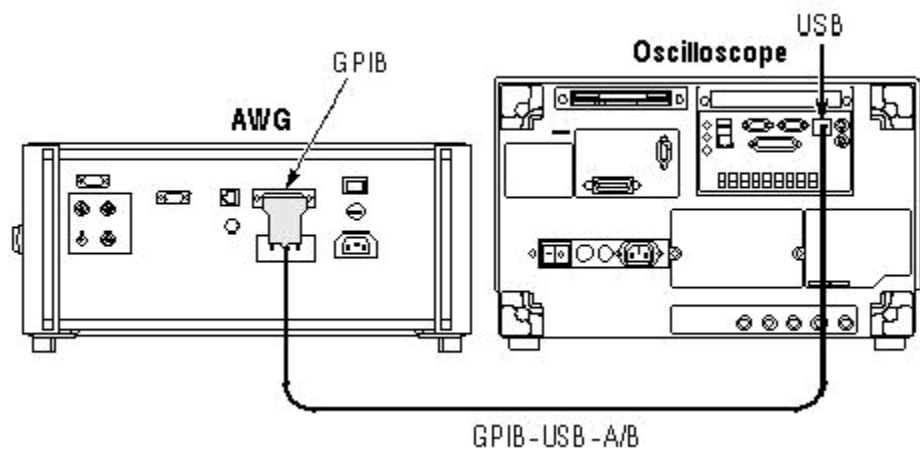

Figure 15-2: Connecting the AWG/AFG and the Oscilloscope

Verify the Equipment Connections

3. Open the Measurement and Automation Explorer that was installed with the NI-488.2 software.

4. In the Configuration pane, look under Devices and Interfaces for the GPIB device.

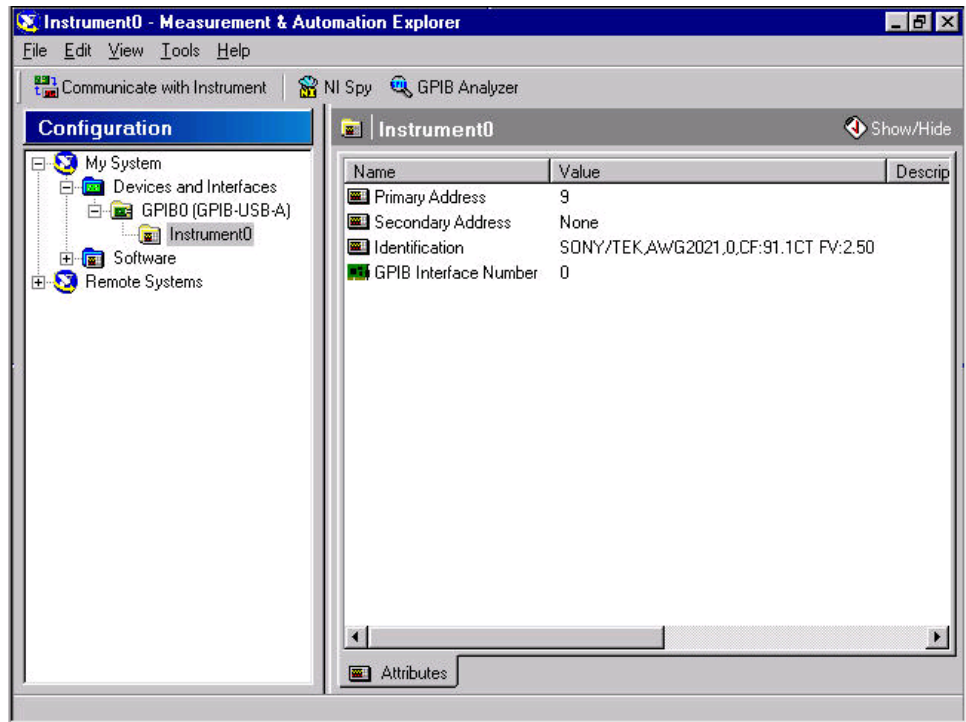

Figure 15-3: Verifying the instrument connections

5. Right-click on the GPIB device and click Scan for Instruments.
6. Note the GPIB Instrument Number and the Primary Address for configuring the instrument connection in the TDSET3 application.
7. Right click on the instrument (Instrument0 in this example) and click Communicate with Instrument.
8. In the NI-488.2 Communicator dialog box, click Query and check that *IDN? brings up a description of the correct equipment.
9. From the Tekscope menu, select Utilities> GPIB Configuration. In the GPIB Configuration, ensure that the Talk/Listen is selected and the primary address matches the GPIB instrument number.

10. Search for the TekVISA configuration on one of the following:

- Desktop
- Start\Program Files\TekVISA\Tek VISA configuration
- Start\Program Files\TekVISA\OpenChoice Instrument Manager configuration for application version 3.0.0 and above

If you cannot find TekVISA, rename the visa32.dll in C:\winnt\system32 and then install the latest TekVISA.

11. Click on the Find/Refresh button to refresh the list of devices connected to the oscilloscope.

Figure 15-4: TekVISA Resource Manager Configuration

For application version 3.0.0 and above, click "search criteria" in the Instrument Manager. To confirm that the AWG//AFG is connected over GPIB to the oscilloscope, select the "Search for GPIB" option and click Done. To update the list of devices connected to the oscilloscope, click Update.

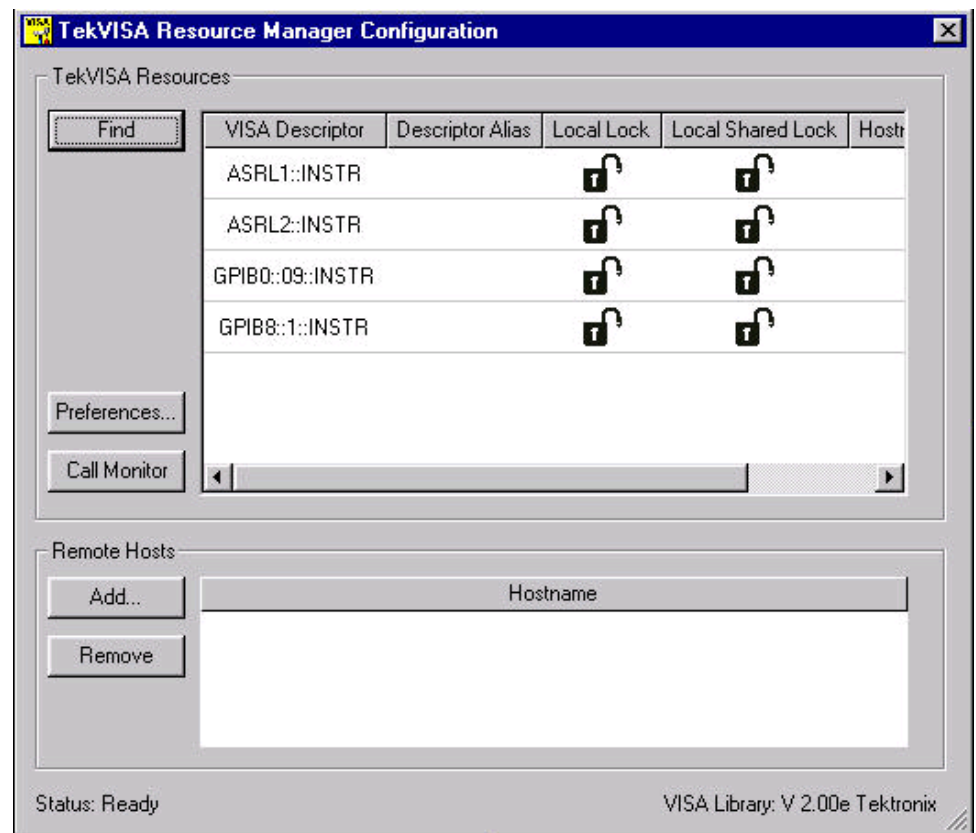
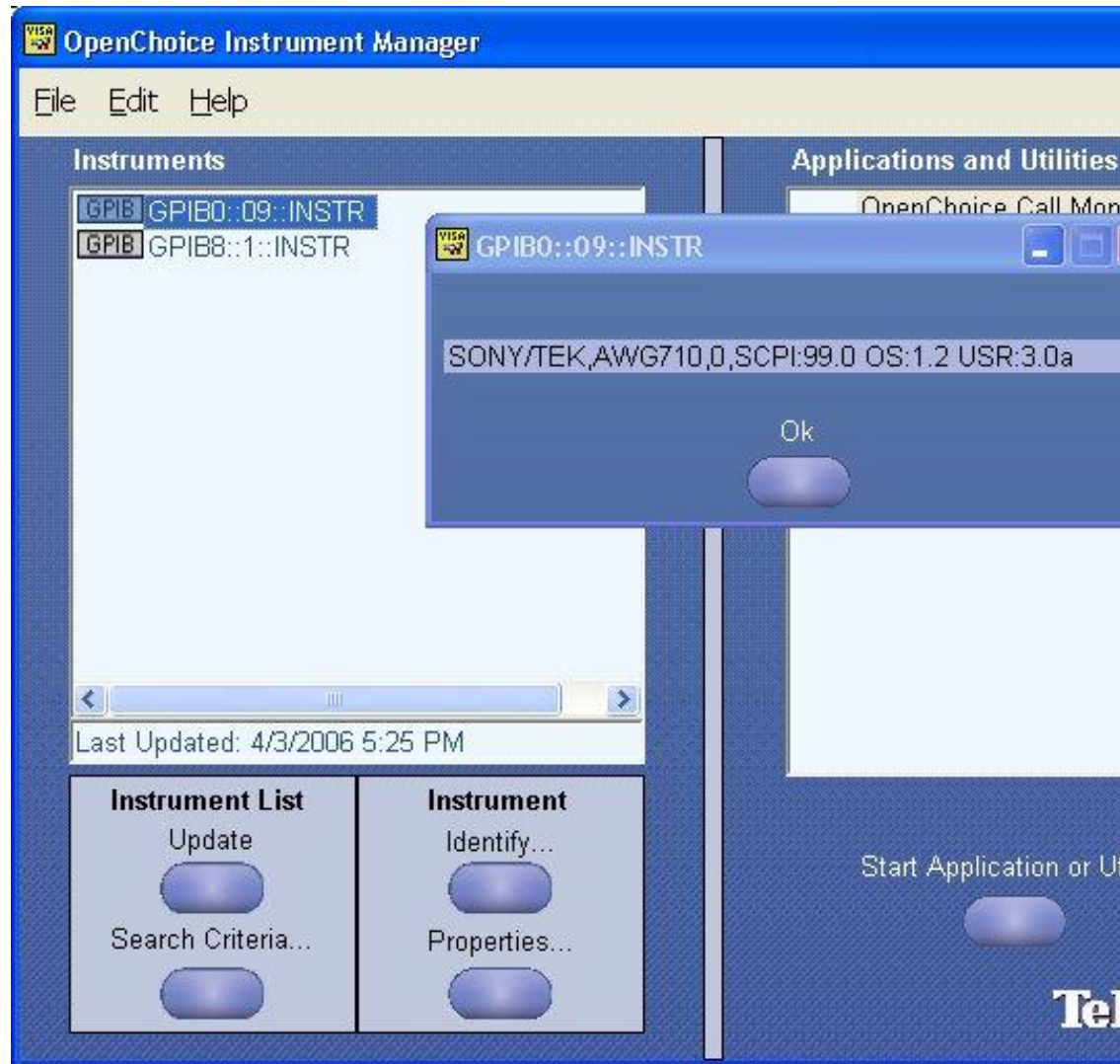

Figure 15-5: TekVISA Resource Manager configuration (application version 3.0.0 and above)

12. If the NI-488.2 GPIB settings and TekVISA configuration do not match, the connection/configuration might not be correct.

Note: If the AWG/AFG is not found listed in TekVISA (with the properties as in NI VISA), make sure that TekVISA detects the GPIB devices. Sometimes it could detect only those network devices that you see.

13. Start the application and continue with AWG/AFG automation.

Note: While running a test, the oscilloscope transfers waveform and setup files to the AWG/AFG. Ensure that the AWG does not have files with the same name to avoid overwriting those files.

Reference to Standards

1000BASE-T

1000BASE-T Template Purpose:

To verify that the transmitter output fits the time domains transmit templates.

Reference to Standard:

Subclause 40.6.1.2.3 of IEEE standard 802.3-2002 ab

What Standard says:

According to standard, the Test Mode 1 signal from the DUT needs to be normalized. This should be compared to the differential output templates shown in Figure 40-26 of the standard. The normalization factors to be applied to various points:

For Point A: Normalization with the peak voltage at point A.

For Point B: Normalization with the negative of peak voltage at point A.

For Point C: Normalization with 0.5 times the peak voltage at point A.

For Point D: Normalization with the negative of 0.5 times the peak voltage at point A.

For Point F and H: The waveform around points F and H are compared to time domain transmit template 2 after the following normalization factors are applied:

Normalization with the peak voltage at point F.

Normalization with the peak voltage at point H.

According to standard, the waveform can be shifted in time to fit the template.

**1000BASE-T
Peak Voltage** **Purpose:**

To verify correct transmitter output levels.

Reference to the Standard:

Subclause 40.6.1.2.1 of IEEE standard 802.3-2002 ab

What the Standard says:

According to standard, magnitude of peak differential output voltage measure at points A and B should be between 670 and 820 mV. Also, these conditions should be met:

$$|PeakVoltageB| - |PeakVoltageA| < 1\%$$

$$\left\{ \begin{array}{l} |PeakVoltageC| \\ |PeakVoltageD| \end{array} \right\} < 2\% \text{ of } 0.5 \text{ times } \left(\frac{|PeakVoltageA| + |PeakVoltageB|}{2} \right)$$

**1000BASE-T
Droop** **Purpose:**

To verify that the transmitter output level does not decay faster than the maximum specified rate.

Reference to the Standard:

Subclause 40.6.1.2.2 of IEEE standard 802.3-2002 ab

What the Standard says:

According to standard, the Point G and J are exactly 500 ns from Points F and H respectively. The magnitude of voltage at Point G should be greater than 73.1% magnitude of voltage at Point F and magnitude of voltage at Point J should be greater than 73.1% magnitude of voltage at Point H.

**1000BASE-T
Jitter (with
TX_TCLK
ACCESS)** **Purpose:**

To verify that the transmitter output level does not reduce faster than the maximum specified rate.

Reference to the Standard:

Subclause 40.6.1.2.5 of IEEE standard 802.3-2002 ab

What the Standard says:

Jitter Master Unfiltered — According to the standard, the peak-to-peak value of jitter waveform on MASTER TX_TCLK relative to unfiltered reference should be less than 1.4 ns.

Jitter Master Filtered — According to the standard, the peak-to-peak value of jitter

waveform on MASTER TX_TCLK when filtered by a high pass filter, $H_{J1}(f)$ with the transfer function below + JTx out of Data related to the corresponding edge of MASTER TX_TCLK should be less than 0.3 ns.

$$H_{J1}(f) = \frac{jf}{jf + 5000} \text{ } fnHz$$

Jitter Slave Unfiltered — According to the standard, the peak-to-peak value of jitter waveform on SLAVE TX_TCLK relative to unfiltered reference should be less than 1.4 ns.

Jitter Slave Filtered — According to the standard, the peak-to-peak value of jitter

waveform on SLAVE TX_TCLK when filtered by a high pass filter, $H_{J2}(f)$ with the transfer function below + JTx out of data related to the corresponding edge of SLAVE TX_TCLK should be less than 0.4 ns + peak-to-peak value of jitter

waveform on MASTER TX_TCLK when filtered by a high pass filter, $H_{J1}(f)$.

$$H_{J2}(f) = \frac{jf}{jf + 32000} \text{ } fnHz$$

Note: J denotes the square root of -1.

Purpose:

To provide an analysis of the Transmitter Timing Jitter test method defined in Clause 40.6.1.2.5 of IEEE 802.3-2002, and to propose an alternative method that may be used in cases where a device does not provide access to the TX_TCLK signal.

**1000BASE-T
Jitter (without
TX_TCLK
ACCESS)**

Reference:

1. IEEE standard 802.3-2002, subclause 40.6.1.1.1 – Test channel
2. Ibid., subclause 40.6.1.1.2, figure 40-20 – Test modes
3. Ibid., subclause 40.6.1.1.3, figure 40-25 – Test fixtures

4. Ibid., subclause 40.6.1.2.5 – Transmitter Timing Jitter
5. Test suite appendix 40.6.A – 1000BASE-T transmitter test fixtures

Note: The references mentioned here are proposed, and not part of a standard. This is an alternate test method for jitter measurement being proposed, when TX_TCLK is not accessible. This is an informal test method.

Transmitting Timing Jitter (Alternate Method):

Jitter Master Unfiltered — The peak-to-peak value of jitter waveform on data in Test Mode 2 relative to unjittered reference should be less than 1.4 ns (pass).

The peak-to-peak value of jitter waveform on data in Test Mode 2 relative to unjittered reference should be more than 1.4 ns (inconclusive).

Jitter Master Filtered — The peak-to-peak value of jitter waveform on data in Test Mode 2 relative to unjittered reference, when filtered by a high pass filter,

$H_{jn}(f)$ with the transfer function below should be less than 0.3 ns (pass).

The peak-to-peak value of jitter waveform on data in Test Mode 2 relative to unjittered reference, when filtered by a high pass filter, $H_{jn}(f)$ with the transfer function below should be more than 0.3 ns (inconclusive).

$$H_{jn}(f) = \frac{jf}{jf + 5000} \text{ } f \text{ in Hz}$$

Jitter Slave Unfiltered — The difference between the peak-to-peak value of jitter waveform on data in Test Mode 3 relative to unjittered reference and the peak-to-peak value of jitter waveform on data in Test Mode 2 relative to unjittered reference should be less than 1.4 ns (pass).

The difference between the peak-to-peak value of jitter waveform on data in Test Mode 3 relative to unjittered reference and the peak-to-peak value of jitter waveform on data in Test Mode 2 relative to unjittered reference should be more than 1.4 ns (fail).

Jitter Slave Filtered — The difference between the peak-to-peak value of jitter waveform on data in Test Mode 3 relative to unjittered reference, when filtered by a high pass filter,

$H_{j1}(f)$ with the transfer function below, and the peak-to-peak value of jitter waveform on data in Test Mode 2 relative to unjittered reference, when filtered by a high pass filter,

$H_{j1}(f)$ with the transfer function below, should be less than 0.4 ns (pass).

The difference between the peak-to-peak value of jitter waveform on data in Test Mode 3 relative to unjittered reference, when filtered by a high pass filter,

$H_{j1}(f)$ with the transfer function below, and the peak-to-peak value of jitter waveform on data in Test Mode 2 relative to unjittered reference, when filtered by a high pass filter,

$H_{j1}(f)$ with the transfer function below, should be more than 0.4 ns (fail).

$$H_{j1}(f) = \frac{jf}{jf + 5000} \text{ } f \text{ in Hz}$$

$$H_{jF2}(f) = \frac{jf}{jf + 32000} \text{ } f \text{ in Hz}$$

1000BASE-T Distortion Purpose:

To verify that the peak transmitter distortion of the DUT is less than 10 mV for at least 60% of the UI within the eye-opening.

References:

IEEE standard 802.3-2002, sub clause 40.6.1.2.4

PMA Test suite, version 2.5, Test 40.1.6

What the Standard says:

The peak distortion of the Test Mode 4 differential signal, when sampled with the symbol rate TX_TCLK at an arbitrary phase and processing this block of any 2047 consecutive samples, should be less than 10 mV.

1000BASE-T CM Voltage Purpose:

To verify that the common-mode voltage of the DUT is within the conformance limits.

Reference to Standard:

Subclause 40.8.3.3 of IEEE standard 802.3-2002

What Standard says:

The magnitude of the total common-mode output voltage, E_{cm_out} , on any transmit circuit, shall be less than 50 mV peak-to-peak when transmitting data.

**1000BASE-T
Return Loss**

Purpose:

To verify that the return loss of the device under test (DUT) is above the conformance limit.

Reference to Standard:

Subclause 40.8.3.1 of IEEE standard 802.3-2002 ab

What Standard says:

At least 16 dB over the frequency range of 1.0 MHz to 40 MHz and at least $10 - 20 \log_{10} (f/80)$ dB over the frequency range 40 MHz to 100 MHz (f in MHz).

100BASE-TX

**100BASE-TX
Template**

Purpose:

To verify that the transmitter output fits the time domains transmit templates.

Reference to the Standard:

Annex J of ANSIX3.263-1995

What the Standard says:

According to standard, Active Output Interface (AOI) transmitting scrambled Halt Line State should fit in the template.

**100BASE-TX
Differential
Output
Voltage**

Purpose:

To verify that the differential output voltage of the device under test (DUT) is within the conformance limits.

Reference to the Standard:

Subclause 9.1.2.2 of ANSI X3.263-1995

What the Standard says:

According to standard, differential output voltage (V_{out}) should lie in the range of 950 mV to 1050 mV in both positive and negative excursion.

100BASE-TX Signal Amplitude Symmetry **Purpose:**
To verify that the signal amplitude symmetry of the device under test (DUT) is within the conformance limits.

Reference to Standard:

Subclause 9.1.4 of ANSI X3.263-1995

What Standard says:

The ratio of the + V_{out} magnitude to - V_{out} magnitude shall be between the limits:

$$0.98 \leq |V_{out}| / |-V_{out}| \leq 1.02$$

100BASE-TX Rise and Fall Time **Purpose:**
To verify that the response times of the DUT are within the conformance limits.

Reference to Standard:

Subclause 9.1.6 of ANSI X3.263-1995

What Standard says:

Active Output Interface (AOI) rise and fall time shall be in the range of 3.0 ns and 5.0 ns. Rise and fall times are defined as time difference between 10% and 90% voltage levels. Both positive and negative rise/fall times should be validated.

The difference between the maximum and the minimum of all measured rise and fall times should be less than 0.5 ns.

100BASE-TX Waveform Overshoot **Purpose:**
To verify that the waveform overshoot of the DUT is below the conformance limit.

Reference to the Standard:

Subclause 9.1.3 of ANSI X3.263-1995

What the Standard says:

According to standard, Overshoot is the percentage excursion of the differential signal transition beyond V_{out} . Differential signal overshoot should not exceed 5%. Both positive and negative overshoot are to be measured.

**100BASE-TX
Jitter** **Purpose:**

To verify that the peak-to-peak jitter of the DUT is within the conformance limits.

Reference to the Standard:

Subclause 9.1.9 of ANSI X3.263-1995

What the Standard says:

According to standard, the peak-to-peak jitter should not exceed 1.4 ns.

**100BASE-TX
Duty Cycle
Distortion** **Purpose:**

To verify that the duty cycle distortion of the DUT is below the conformance limit.

Reference to the Standard:

Subclause 9.1.8 of ANSI X3.263-1995

What the Standard says:

According to standard, duty cycle distortion should be measured at the 50% voltage points on rise and fall transitions of the differential output waveform and should not exceed ± 0.25 ns.

**100BASE-TX
Return Loss** **Purpose:**

To verify that the return loss at the transmitter or receiver of the device under test (DUT) is above the conformance limit.

Reference to Standard:

Subclause 9.1.5 and 9.2.2 of ANSI X3.263-1995

What Standard says:

Greater than 16 dB from 2 MHz to 30 MHz

Greater than $(16 - 20 \log(f/30 \text{ MHz}))$ dB from 30 MHz to 60 MHz

Greater than 10 dB from 60 MHz to 80 MHz

10BASE-T/10BASE-Te

10BASE-T/10BASE-Te MAU Ext **Purpose:**
To verify that the transmitter output equalization meets standard specifications.

Reference to Standard:

Subclause 14.3.1.2.1 of IEEE standard 802.3-2002 (for 10BASE-Te, refer to IEEE standard 802.3az)

What Standard says:

According to standard, the transmitter waveform should lie within the template for all data sequences at the twisted-pair model's output with 100 Ohm termination.

10BASE-T/10BASE-Te MAU Int **Purpose:**
To verify that the transmitter output equalization meets standard specifications.

Reference to Standard:

Subclause 14.3.1.2.1 of IEEE standard 802.3-2002 (for 10BASE-Te, refer to IEEE standard 802.3az)

What Standard says:

According to standard, the transmitter waveform should lie within the template for all data sequences at the twisted-pair model's output with 100 Ohm termination.

10BASE-T/10BASE-Te TP_IDL **Purpose:**
To verify that the transmitter functions properly after a transition to the idle state.

Reference to Standard:

Subclause 14.3.1.2.1 of IEEE standard 802.3-2002 (for 10BASE-Te, refer to IEEE standard 802.3az)

What Standard says:

According to standard, the TP_IDL pulse should lie within the template. This test shall be done across each of the specified test loading Load 1, Load 2, and Load 3 with and without twisted-pair model.

**10BASE-T
Link Pulse Purpose:**

To verify that the link test pulse waveforms meet specification.

Reference to Standard:

Subclause 14.3.1.2.1 of IEEE standard 802.3-2002

What Standard says:

According to standard, the link test pulse should lie within the template. This test shall be done across each of the specified test loading Load 1, Load 2, and Load 3 with and without twisted-pair model.

**10BASE-
T/10BASE-Te
Differential
Voltage Purpose:**

To verify that the differential voltage of the DUT is within the conformance limits.

Reference to Standard:

Subclause 14.3.1.2.1 of IEEE standard 802.3-2002 (for 10BASE-Te, refer to IEEE standard 802.3az)

What Standard says:

Peak differential voltage of transmitter waveform when terminated with a 100 Ohm resistor should lie between 2.2 V and 2.8 V for all data sequences.

Note: For 10BASE-Te, the peak differential voltage of transmitter waveform when terminated with a 100 Ohm resistor should lie between 1.54 V and 1.96 V for all data sequences.

10BASE-T/10BASE-Te Harmonic **Purpose:**
To verify that the harmonic content of the DUT is within the conformance limits.

Reference to Standard:

Subclause 14.3.1.2.1 of IEEE standard 802.3-2002 (for 10BASE-Te, refer to IEEE standard 802.3az)

What Standard says:

Harmonic test is done when the DO circuit is driven by all ones. Each harmonic measured at the output of the transmitter shall be at least 27 dB below the fundamental.

10BASE-T Jitter **Purpose:**
To verify that the jitter of the DUT is within the conformance limits.

Reference to Standard:

Subclause 14.3.1.2.3 of IEEE standard 802.3-2002
Annexure B.4.3.3 Note for 14.3.1.2.3 of IEEE standard 802.3-2002

What Standard says:

The transmitter output jitter when measured at the output of the twisted-pair model should lie within ± 5.5 ns.
As per B.4.3.3 Note for 14.3.1.2.3 of IEEE standard 802.3-2002, failure of this test does not demonstrate noncompliance.

The transmitter output jitter when measured without the twisted-pair model should lie within ± 8.0 ns.

10BASE-T CM Voltage **Purpose:**
To verify that the common-mode voltage of the DUT is within the conformance limits.

Reference to Standard:

Subclause 14.3.1.2.5 of IEEE standard 802.3-2002

What Standard says:

The magnitude of the total common-mode output voltage of the transmitter, E_{cm} , shall be less than 50 mV peak.

**10BASE-T
Return Loss Purpose:**

To verify that the return loss at the transmitter or receiver of the device under test (DUT) is above the conformance limit.

Reference to Standard:

Subclause 14.3.1.2.2 of IEEE standard 802.3-2002 ab

What Standard says:

At least 15 dB over the frequency range of 5.0 to 10 MHz.

Remote GPIB

About Remote GPIB

To enable Remote GPIB, click **Utilities > Enable Remote GPIB**.

With knowledge of the GPIB command syntax, you can design a GPIB program to do the following tasks:

- Start the TDSET3 application
- Recall the saved setup, either default or the user defined
- Select the technology (speed) and the test
- Configure test parameters
- Run the test
- Retrieve the results for the conducted tests
- Generate reports
- Save the current setup
- Exit the application

Starting and Setting Up the Application Using GPIB

To start the TDSET3 application, you must send the oscilloscope the following GPIB command:

```
application:activate "Ethernet Compliance Test Software"
```

The application uses the GPIB VARIABLE:VALUE command with arguments to execute the supported features.

You must continually query for **application** status. If the status indicates **GPIB disabled**, you must manually enable Remote GPIB by clicking **Utilities > Enable Remote GPIB**.

GPIB Command Syntax

Description

This command accepts string arguments for a control or data variable and a value to which to set the argument.

Syntax

```
VARIABLE:VALUE "<variable name>", "<variable value>"
```

Note:

The arguments <variable name> and <variable value> are required in the order indicated.

VARIABLE:VALUE? <variable name> for query.

Note. Commands are case and space sensitive. All variables and values supported by the application are in lower case and without any spaces in between characters.

TDSET3 Application Command Arguments and Queries

Table 17-1: Command arguments and queries

| Group / Name | Value | Function | Query returns |
|--------------------|--|--|---------------------|
| Application | | | |
| recall | The setup file name which consists of any string from 1 to 40 characters from A to Z and, or 0 to 9 or special characters like "." or "default". "default" refers to the default file name. If file extension not specified, it is assumed to be .ini. | Recalls the settings for the application from the mentioned file. The directory location of the file is the default (C:\TekApplications\TDSET3\setup. If the file does not have appropriate setting values, the default settings will override the same. | Query is not valid. |
| save | The setup file name, which consists of any string from 1 to 40 characters from A to Z and, or 0 to 9 or special characters like "." If file extension not specified, it is assumed to be .ini. | Saves the current application settings in the file name specified. The directory location of the file is the default (C:\TekApplications\TDSET3\setup. | Query is not valid. |

Table 17-1: Command arguments and queries (cont)

| Group / Name | Value | Function | Query returns |
|---------------------------|---|--|---|
| application | exitwrecall, exitworecall | Exits the application. | The value of application variable. |
| application | Minimize | Minimizes the active application. | The value of application variable. |
| application | Hide | Hides the active application | The value of application variable. |
| application | Maximize | Maximizes the active application | The value of application variable. |
| application | Show | Shows the application, which was earlier hidden. | The value of application variable. |
| version | Query only | | The version number of the application. |
| Speed | | | |
| speed | 1000-T, 100-TX, 10-T | Sets the speed | The value of the set speed. |
| run | {on, off}*** | Runs the previously selected test if value is ON. Stops the currently running test, if any, if the value is OFF. | The value of test variable, on, off. |
| Results and Status | | | |
| getremblk | {n}**** where n >= 1 and n <= the value returned on querying for "remcounter" | Updates "resultrem" with the remark block asked for. Please read the note on Retrieving Remarks for further details. | |
| processdone | {no}** | Indicates that a set command follows. Please read note on processdone command for further details. | |
| resultsum | Query only | | The summary of the last test conducted, pass, fail. |
| resultstd | Query only | | Standard field of the result details, for the test queried. |
| resultmeas | Query only | | Measured field of the result details, for the test queried. |
| resultsts | Query only | | Status field of the result details, for the test queried. |
| resultrem | {Query only}**** | | Remark field of the result details, for the test queried. |
| remcounter | {Query only}**** | | Count of remarks block available for the last test run. |
| Status***** | Query only | | Returns the error code or "Test Stopped", "Test running", "Test Complete", "Change Mode Required" |

Table 17-1: Command arguments and queries (cont)

| Group / Name | Value | Function | Query returns |
|---------------|--|--|---|
| report | summary, detail | Invokes the report generation, summary or detailed. | Query not valid. |
| repname | The setup file name, which consists of any string from 1 to 40 characters from A to Z and/or 0 to 9 or special characters like “.” | During the next report generation, the application uses the layout in this file. <i>Note: Create a layout file manually before using the command.</i> | The file name of the report layout file. |
| deviceid | Any string from 1 to 40 characters from A to Z and/or 0 to 9 with valid Windows, Dos format. | Specifies the device ID field for report generation. This field is visible in several locations throughout the application independent of the report generations panel. Default setting is set to “ ” 1 space character. | The specified device ID. Applies to Compliance modules. |
| portid | Any printable character from the keyboard. | Sets the Port id. | The value of port id. |
| reppairid | Any printable character from the keyboard. | Sets the report pair id. | The report pair id. |
| devicedetails | Any printable character from the keyboard. | Sets the devicedetails parameter. | The device details. |
| process | Any printable character from the keyboard. | Sets the value for the process. | The value of process. |
| volt | Any printable character from the keyboard. | Sets the value for the voltage report config. | The value of voltage. |
| temp | Any printable character from the keyboard. | Sets the value for the temperature report config. | The value of temperature. |
| lastcaldate | Any printable character from the keyboard. | Sets the last calibration date. | The last calibration date. |
| imgport | {true,false} | Sets the image export. | The status of image export. |
| lastrepdet | Query only | | The last saved (detailed) report file name. |
| lastrepsum | Query only | | The last saved (summary) report file name. |

Table 17-1: Command arguments and queries (cont)

| Group / Name | Value | Function | Query returns |
|--|--|--|--|
| 100Base-T test values for "resultfor" variable | | | |
| resultfor | templatea, templateb, templatec, templated, templatef, templateh, peaka, peakb, peakc, peakd, droopg, droopj, jitmasterfilt, jitmasterunfilt, jitslavefilt, jitslaveunfilt, distortionm, returnloss1000, cmvolt1000 | Sets the result variables with appropriate result values for that particular test. | |
| 100Base-TX test values for "resultfor" variable | | | |
| resultfor | templatepos, templateneg, outputvoltpos, outputvoltneg, ampsym, risetimepos, risetimeneg, falltimepos, falltimeneg, rfsympos, rfsymneg, rfsymmaxmin, overshootpos, overshootneg, jitpos, jitneg, dcdrand, dcd0101, returnlosstx100, returnlossrx100 | Sets the result variables with appropriate result values for that particular test. | |
| 10Base-T test values for "resultfor" variable | | | |
| resultfor | maunorm, mauiuv, lpload1wotpm, lpload2wotpm, lp100wotpm, lpload1wtpm, lpload2wtpm, lp100wtpm, lptiming, tpidload1wotpm, tpidload2wotpm, tpid100wotpm, tpidload1wtpm, tpidload2wtpm, tpid100wtpm, diffvoltmaxpos, diffvoltmaxneg, diffvoltpos, diffvoltneg, harmonic, jitwcablenorm, jitwcable8bt, jitwcable85bt, jitwocablenorm, jitwocable8bt, jitwocable85bt, returnlosstx10, returnlossrx10, cmvolt10 | Sets the result variables with appropriate result values for that particular test. | |
| harmonics0 | Query only | | Harmonic test's result measured. Measured results from Harmonic2 to Harmonic5 can be got from this variable. |
| harmonics1 | Query only | | Harmonic test's result measured. Measured results from Harmonic6 to Harmonic9 can be got from this variable. |

Table 17-1: Command arguments and queries (cont)

| Group / Name | Value | Function | Query returns |
|--------------|------------|----------|--|
| harmonics2 | Query only | | Harmonic test's result measured. Measured results from Harmonic10 to Harmonic13 can be got from this variable. |
| harmonics3 | Query only | | Harmonic test's result measured. Measured results from Harmonic14 to Harmonic17 can be got from this variable. |
| harmonics4 | Query only | | Harmonic test's result measured. Measured results from Harmonic18 to Harmonic21 can be got from this variable. |
| harmonics5 | Query only | | Harmonic test's result measured. Measured results from Harmonic22 to Harmonic25 can be got from this variable. |

****Note on processdone command:**

Set commands are of the format `variable:value "<variable_name>","<value>"`
 Get or query commands are of the format `variable:value? "<variable_name>"`
 For TDSET3 versions later than 1.3.1, BEFORE every remote GPIB SET command, you must send `<variable:value "processdone","no">` and AFTER every set command, you have to wait on "processdone" variable until it returns a "yes", that is, you have to keep polling for `<Variable:value? "processdone">` and only after it returns a "yes", the next command, either set or get can be sent.

Please ensure that this order is followed for the command script to work correctly. A sample script is listed here. It recalls a default setting, selects TemplatePeakall test, runs the test, and query the result measured for peaka test.

```
variable:value "processdone","no"
variable:value "recall","default"
variable:value? "processdone"
"no"
.....keep polling until it returns a yes
variable:value? "processdone"
"yes"
variable:value "processdone","no"
variable:value test","templatepeakall"
variable:value? "processdone"
"no"
.....keep polling until it returns a "yes"
variable:value? "processdone"
"yes"
variable:value "processdone","no"
variable:value run","on"
variable:value? "processdone"
"no"
.....keep polling until it returns a "yes"
variable:value? "processdone"
"yes"
variable:value "processdone","no"
variable:value "resultfor","peaka"
variable:value? "processdone"
"no"
.....keep polling until it returns a "yes"
variable:value? "processdone"
"yes"
variable:value? "resultmeas"
```

***** Note on run command :**

After issuing a run command, you should wait for processdone command to return a "yes" and then query the "status". Once the status returns "Test Complete" then query for the result details.

Sometimes after the run command is issued and if the processdone command returns a "yes", the test may not be complete. The test could be stopped because of an error condition that caused the TDSET3 application to terminate the run operation and indicate processdone as "yes". Thus it is advisable to always wait on "processdone" before looking for results and ensure that the test is complete to query the status. If status returned does not indicate any error or test stopped, but that the test is complete then query for results.

******Note on Retrieving Remarks:**

Result remarks for some tests is lengthy and can not be retrieved by one query. Thus use the following code to retrieve all the remark blocks.

Each block is one chunk of remarks data.

```
variable:value? "remcounter"
```

```
"4"
```

//Returns the number of remark blocks available. This indicates there are four blocks of remarks for the last test run. If you want to retrieve first and second block of remarks, the following list of commands need to be sent.

```
Variable:value "processdone", "no"
```

```
variable:value "getremblk", "1"
```

//On receiving this command TDSET3 fills "resultrem" with the first block of remarks. Wait on "processdone" to return "yes", then query for result remarks.

```
variable:value? "processdone"
```

```
"yes"
```

```
variable:value? "resultrem"
```

```
"RMS = 1.48mV          SNR = 53.59dB"
```

```
Peak Distortion at symbol 1188 = - 5.427mV
```

```
Peak Distortion at symbol 1863 = + 4.855mV
```

```
Peak Disto"
```

//this will return the first block of remarks data.

```
variable:value "processdone", "no"
```

```
variable:value "getremblk", "2"
```

//On receiving this command TDSET3 fills "resultrem" with the second block of remarks

```
variable:value? "processdone"
```

```
"yes"
```

```
variable:value? "resultrem"
```

```
"rtion at symbol 222 = - 4.785mV"
```

```
TX_TCLK Freq = 125.0MHZ
```

```
TX_TCLK ppm = 0.000006% [0.057 ppm]
```

```
DC Offset Measured = -15.39mV"
```

******Note :**

If any of the following tests are run through remote GPIB,

<Variable:value "run", "on" > starts the test run. The "Status" indicates "Test running".

When the "status" indicates "Change Mode Required", the application waits until you switch the test mode and indicate the same by sending the command

<variable:value "changetestmode", "OK"> or <variable:value "changetestmode", "cancel">.

If the changetestmode is OK, the test continues and the "Status" indicates "Test Running". At the end of the test, results are available in the result field.

If changetestmode is "Cancel", the test is stopped, and the status is updated to indicate error.

This waiting on changetestmode applies only to the following Jitter tests:

Master filtered Jitter with TXT_CLK

Slave filtered Jitter with TXT_CLK

Slave filtered Jitter without TXT CLK

Slave unfiltered Jitter without TXT_CK for both TIE and Histogram option

GPIB Commands for 1000BASE-T

Table 17-2: 1000BASE-T GPIB commands

| Group / Name | Value | Function | Query returns |
|---|--|--|--|
| Selecting test parameters for 1000BASE-T | | | |
| test | templatea, templateb, templatel, templated, templatef, templateh | Selects the template test. | The value of test variable. |
| test | peaka, peakb, peakc, peakd | Selects the peak volt test. | The value of test variable. |
| test | Templatepeakall | Selects all the template and peak volt tests. | The value of test variable. |
| test | droopg, droopj, droopall | Selects the droop test. | The value of test variable. |
| test | Jitmasterfilt**, jitmasterunfilt** | Selects the jitter master test. | The value of test variable. |
| test | Jitslavefilt**, jitslaveunfilt** | Selects the jitter slave test. | The value of test variable. |
| test | Distortion | Selects the distortion test. | The value of test variable. |
| test | returnloss1000 | Select the return loss test. | The value of test variable. |
| test | cmvolt1000 | Select the CM voltage test. | The value of test variable. |
| Configuring test parameters for 1000BASE-T | | | |
| avgs:1000 | n >= 64 and n <= 10,000 | Configures the number of averages for template peak, and droop. | The number of averages. |
| avgs4distortion | n >= 64 and n <= 10,000 | Configuring the number of averages distortion 1000Base-T test. | The number of averages set for distortion test. |
| ckedge | rising/falling | Configures the clock edge for jitter tests. | The type of clock edge - rising or falling. |
| data:1000 | {ch1/ch2/ch3/ch4}* | Configures the source data for template, peak, droop, jitter, distortion, and cmvoltage tests. | The channel chosen for source data. |
| disturber | yes/no | Configures the disturber for template, peak, droop and distortion tests. | The status indicating if the disturber is included or not. |
| filter | int/ext | Configures the filter - internal or external - for template, and peak tests. | The type of the filter used, either internal or external. |
| masterclk | {ch1/ch2/ch3/ch4}* | Configures the master clock for jitter 1000Base-T test. | The value of the channel chosen for master clock. |
| meastype | TIE/Histogram | Configures the measure type for unfiltered jitter test. | The measure type. |
| slavedck | {ch1/ch2/ch3/ch4}* | Configures the slave clock for jitter slave test. | The value of the channel chosen for slave clock. |
| output:1000 | {ref1/ref2/ ref3/ref4}* | Configures the output for template, peak, droop and distortion tests. | The channel chosen for output. |

Table 17-2: 1000BASE-T GPIB commands (cont)

| Group / Name | Value | Function | Query returns |
|----------------|--|---|--|
| redlen | 100K, 1 Meg, 4 Meg, 7.5 Meg, 8 Meg, 10 Meg, 16 Meg, 20 Meg | Configuring the record length for jitter tests in 1000Base-T. This is not present for unfiltered jitter test with measurement type set to Histogram. Default value is max memory available on the Oscilloscope. | The value of record length previously set. |
| resolution | $n \geq 2$ and $n \leq 75$ | Configuring the resolution for the distortion test in 1000Base-T. | The value of the resolution previously set. |
| txtdksrc | {ch1, ch2, ch3, ch4}* | Configuring the clock, when distortion test is selected and distclk is set to yes, for 1000Base-T. | The channel chosen for txtdk source. |
| txtdk | yes, no | The status indicating if txtdk is included or not. | The status indicating if txtdk is included or not |
| distclk | yes, no | The status indicating if the clock is included or not. | The status indicating if the disturber is included or not. |
| lpfilter | yes, no | Status of the Low Pass filter for distortion tests. | The status of the Low Pass filter for distortion tests. |
| jitterlpfilter | yes/no | Status of the Jitter Low Pass filter for jitter tests. | Status of the Jitter Low Pass filter for jitter tests. |
| rlsrc:1000 | {ch1, ch2, ch3, ch4}* | Configuring the sources P1/P3/P5/P7 for the return loss test in 1000Base-T. | The value of the source1 for return loss. |
| rlsrc2:1000 | {ch1, ch2, ch3, ch4}* | Configuring the sources P2/P4/P6/P8 for the return loss test in 1000Base T. | The value of the source2 for return loss. |
| rloutput:1000 | {ref1, ref2, ref3, ref4}* | Configuring the source for the return loss test in 1000Base-T. | The value of the return loss for output waveform. |
| rlimit:1000 | {ref1, ref2, ref3, ref4}* | Configuring the source for the return loss test in 1000Base-T. | The value of the limit for output waveform of return loss. |
| avgtime:1000 | $n \geq 100$ and $n \leq 10,000$ | Configuring the average time for return loss test for 1000Base-T. | The value of average time. |
| smooth:1000 | $n \geq 00$ and $n \leq 10$ | Configuring the average frequency for return loss test for 1000Base-T. | The value of average frequency. |
| pairid | a, b, c, d | Configuring the pair id for return loss test for 1000Base -T. | The value of the pair id previously set. |
| load:1000 | "load85/100/115", "load100" | Configuring the load parameter for return loss test in 1000Base-T. | The value of the load parameter. |
| awg:1000 | {awgselect, awg4xx/awg2021/awg5xx/awg6xx/awg7xx/awg5xxx/awg7xxx/afg3xxx} | Configure the AWG/AFG being used for 1000Base-T return loss tests. | The AWG/AFG series being used for 1000Base-T return loss test. |
| datatm2 | {ch1, ch2, ch3, ch4}* | Configuring the data test mode 2 source for the jitter test in 1000Base -T. | The value of the test mode 2 source for jitter test. |
| datatm3 | {ch1, ch2, ch3, ch4}* | Configuring the data test mode 3 source for the jitter test in 1000Base-T. | The value of the test mode 3 source for jitter test. |
| hysteresis | {n} $n \geq 5.0$ and $n \leq 30.0$ | Configuring the hysteresis value for jitter 1000Base-T tests. | The value of hysteresis for jitter tests. |

Table 17-2: 1000BASE-T GPIB commands (cont)

| Group / Name | Value | Function | Query returns |
|-------------------------|---------------------------------|---|---|
| Jig Match | | | |
| jmmeas | jmdistall, jmdutamp, jmprobeamp | Measure the jig match parameters. | Query not valid. |
| jmdef | jmdistall, jmdutamp, jmprobeamp | Set the jig match parameters to default. | Query not valid. |
| jmLASTjM | Query only | | The last jig match parameter measured. |
| jmamp | Query only | | The value of the amp. |
| jmfreq | Query only | | The value of the freq. |
| jmdutamp | Query only | | The value of the DUT amp. |
| jmprobeamp | Query only | | The value of the probe point amp. |
| jmatten | Query only | | The value of the atten. |
| jmstatus | Query only | | The Jig Match status, either jmon/jmoff. ON indicates jig match measure is in progress. |
| jmaction | jmapply, jmcancel | | Applies the measured values or cancels the same. |
| Change test mode | | | |
| Changetest mode** | ok, cancel | Indicates the jitter test run to continue | |

***Note on channel selections:**

Channel 3 and Channel 4 can be chosen only on a 4-channel oscilloscope.

Ref 3 and Ref4 can be chosen only on a 4-channel oscilloscope.

Math3 and Math4 can be chosen only on a 4-channel oscilloscope.

****Note:**

If any of the following tests are run through remote GPIB,

<Variable:value "run", "on" > starts the test run. The "Status" indicates "Test running".

When the "status" indicates "Change Mode Required", the application waits until you switch the test mode and indicate the same by sending the command

<variable:value "changetestmode", "OK"> or <variable:value "changetestmode", "cancel">. If the changetestmode is OK, the test continues and the "Status" indicates "TestRunning". At the end of the test, results are available in the result field.

If changetestmode is "Cancel", the test is stopped, and the status is updated to indicate error.

This waiting on changetestmode applies only to the following Jitter tests:

Master filtered Jitter with TXT_CLK

Slave filtered Jitter with TXT_CLK

Slave filtered Jitter without TXT CLK

Slave unfiltered Jitter without TXT_CK for both TIE and Histogram option.

GPIB Commands for 100BASE-TX

Table 17-3: 100BASE-TX GPIB commands

| Group / Name | Value | Function | Query returns |
|---|--|--|-----------------------------|
| Selecting test parameters for 100BASE-TX | | | |
| test | template, templatepos, templateneg | Selects the template test and the polarity. | The value of test variable. |
| test | outputvoltboth, outputvoltpos, outputvoltneg | Selects the output volt test and the polarity. | The value of test variable. |
| test | ampsym | Selects the amp sym test. | The value of test variable. |

Table 17-3: 100BASE-TX GPIB commands (cont)

| Group / Name | Value | Function | Query returns |
|--------------|---|---|-----------------------------|
| test | risetimeboth, risetimepos, risetimeneg | Selects the rise time test and the polarity. | The value of test variable. |
| test | falltimeboth, falltimepos, falltimeneg | Selects the fall time test and the polarity. | The value of test variable. |
| test | rfsymboth, rfsympos, rfsymneg | Selects the rfsym test, with the polarity. | The value of test variable. |
| test | overshootboth, overshootpos, overshootneg | Selects the overshoot test, with the polarity. | The value of test variable. |
| test | jitboth, jitpos, jitneg | Selects the jitter test and the polarity. | The value of test variable. |
| test | dcdrand, dcd0101 | Selects the distortion test and pattern values. | The value of test variable. |
| test | all | Selects all the 100Base-Tx tests with polarity as "both" and pattern as "random". | The value of test variable. |
| test | returnlosstx100, returnlossrx100 | Select the return loss test. | The value of test variable. |

Configuring test parameters for 100BASE-TX

| | | | |
|--------------|-------------------------------|--|--|
| acq:100 | sample, avg | Configures the acquisition to sample or average for all 100Base-Tx tests except template and jitter. | The type of acquisition. |
| data:100 | {ch1, ch2, ch3, ch4}* | Configures the source data for tests. | The channel chosen for source data. |
| pulwidth | 16, 80 | Configures the pulse width for rise, fall time test, R/F sym test. | The pulse width value. |
| maskscale | norm,0.95,1.05 | Configuring the template scale for template tests of 100Base-Tx. | The value of template scale. |
| rlsrc1:100 | {ch1, ch2, ch3, ch4}* | Configuring the sources P1, P3 for the return loss test in 100Base-Tx. | The value of the source1 for return loss. |
| rlsrc2:100 | {ch1, ch2, ch3, ch4}* | Configuring the sources P2, P4 for the return loss test in 100Base-Tx. | The value of the source2 for return loss. |
| rloutput:100 | {ref1, ref2, ref3, ref4}* | Configuring the source for the return loss test in 100Base-Tx. | The value of the return loss for output waveform. |
| rllimit:100 | {ef1, ref2, ref3, ref4}* | Configuring the source for the return loss test in 100Base-Tx. | The value of the limit for output waveform of return loss. |
| avgtime:100 | n >= 100 and n <= 10,000 | Configuring the average time for return loss test for 100Base-Tx. | The value of average time. |
| smooth:100 | n >= 0 and n <= 10 | Configuring the average frequency for return loss test for 100Base-Tx. | The value of average frequency. |
| load:100 | "load85, 100, 115", "load100" | Configuring the load parameter for return loss test in 100Base-Tx. | The value of the load parameter. |

Table 17-3: 100BASE-TX GPIB commands (cont)

| Group / Name | Value | Function | Query returns |
|--------------|---|--|--|
| awg:100 | awg4xx, awg2021, awg5xx, awg6xx, awg7xx, awg5xxx, awg7xxx, afg3xxx | Configure the AWG/AFG being used for 100Base-Tx return loss tests. | The AWG/AFG series being used for 100Base-Tx return loss test. |

The following oscilloscope commands can be used to set or query the number of waveforms, horizontal position, and vertical position for 100Base-Tx tests.

Table 17-4: Oscilloscope GPIB commands for 100Base-Tx

| Group / Name | Value | Function | Query returns |
|-----------------------|---|--|--|
| ACQUIRE:NUMAVg x | $x \geq 2$ and $x \leq 10,000$ | Sets the number of waveforms for 100Base-Tx. | |
| ACQUIRE:NUMAVg ? | | Queries the number of waveforms for 100Base-Tx. | The number of waveforms. |
| HORIZONTAL:POSITION x | $x \geq 0$ and $x \leq 99.9$ | Sets the horizontal position for 100 BaseTx. | |
| HORIZONTAL:POSITION ? | | Queries the horizontal position for 100Base-Tx. | The value of the horizontal position. |
| CHx:POSITION y | $x \geq 1$ and $x \leq 4$ $y \geq 0.0$ and $y \leq 5.00$ | Sets the vertical position for the selected channel for 100Base-Tx. | |
| CHx:POSITION ? | | Queries the vertical position for the selected channel for 100Base-Tx. | The value of the vertical position for the selected channel. |

****Note on channel selections:***

Channel 3 and Channel 4 can be chosen only on a 4-channel oscilloscope.

Ref 3 and Ref4 can be chosen only on a 4-channel oscilloscope.

Math3 and Math4 can be chosen only on a 4-channel oscilloscope.

GPIB Commands for 10BASE-T/10BASE-Te

Table 17-5: 10BASE-T/10BASE-Te GPIB commands

| Group / Name | Value | Function | Query returns |
|---|---|--|--|
| Selecting test parameters for 10BASE-T | | | |
| test | mauboth, maunorm, mauinv | Selects the mau test with both, normal or inverted. | The value of test variable. |
| test | lpload1wotpm, lpload2wotpm, lp100wotpm, lpload1wotpm, lpload2wotpm, lp100wotpm | Selects the link pulse with load test. | The value of test variable. |
| test | tpidlload1wotpm, tpidlload2wotpm, tpidl100wotpm, tpidlload1wotpm, tpidlload2wotpm, tpidl100wotpm | Selects the tp idl with load test. | The value of test variable. |
| test | diffvoltmax, diffvoltall | Selects the diff volt test. | The value of test variable. |
| test | harmonic | Selects the harmonic test. | The value of test variable. |
| test | jitwcableall, jitwcablenorm, jitwcable8bt, jitwcable85bt, jitwocableall, jitwocablenorm, jitwocable8bt, jitwocable85bt | Selects the jitter test, with or without cable. | The value of test variable. |
| test | returnlosstx10, returnlossrx10 | Select the return loss test. | The value of test variable. |
| test | cmvolt10 | Select the CM voltage test. | The value of test variable. |
| Configuring test parameters for 10BASE-T/10BASE-Te | | | |
| acq:10 | sample, avg | Configures the acquisition to sample or average for link pulse and tp_idl tests. | The type of acquisition. |
| avgs:10 | n >= 2 and n <= 10,00,000 | Configures the number of averages for harmonic test. | The number of averages. |
| data:10 | {ch1, ch2, ch3, ch4}* | Configures the source data. | The channel chosen for source data. |
| masksel | both, head, tail | Configures the mask selection section for link pulse or TP_IDL tests. | The mask selection. |
| mauscale | norm, 0.9, 1.1 | Configures the MAU scale for MAU template test. | The mau scale value, either normal, 0.9, or 1.1. |

Table 17-5: 10BASE-T/10BASE-Te GPIB commands (cont)

| Group/ Name | Value | Function | Query returns |
|-------------|---|--|--|
| mautype | int, ext | Configures the mau type for jitter with, without cable (parameteric) and MAU (template) tests. | The MAU type, either internal or external. |
| timescale | 10, 1 | Configures the time scale for harmonic test. | The time scale value. |
| linkseq | norm, fast | Configuring the sequence for Link Pulse test in 10Base-T. | The type of sequencing. |
| testoptions | both, template, timing | Configuring the test options for the link pulse test in 10Base-T. | The test option chosen for the link pulse test. |
| output:10 | {math1, math2, math3, math4}*} | Configures the output for harmonic test. | The channel chosen for output. |
| risrc1:10 | {ch1, ch2, ch3, ch4}*} | Configuring the sources P1, P3 for the return loss test in 10Base -T. | The value of the source1 for return loss. |
| risrc2:10 | {ch1, ch2, ch3, ch}*} | Configuring the sources P2, P4 for the return loss test in 10Base -T. | The value of the source2 for return loss. |
| rloutput:10 | {ref1, ref2, ref3, ref4}*} | Configuring the source for the return loss test in 10Base-T. | The value of the return loss for output waveform. |
| rlimit:10 | {ref1, ref2, ref3, ref4}*} | Configuring the source for the return loss test in 10Base-T. | The value of the limit for output waveform of return loss. |
| avgtime:10 | $n \geq 100$ and $n \leq 10,000$ | Configuring the average time for return loss test for 10Base-T. | The value of average time. |
| smooth:10 | $n \geq 0$ and $n \leq 10$ | Configuring the average frequency for return loss test for 10Base -T. | The value of average frequency. |
| load:10 | "load85, 100, 115", "load100" | Configuring the load parameter for return loss test in 10Base-T. | The value of the load parameter. |
| awg:10 | awg4xx, awg2021, awg5xx, awg6xx, awg7xx, awg5xxx, awg7xxx, afg3xxx | Configure the AWG/AFG being used for 10Base-T return loss tests. | The AWG/AFG series being used for 10Base-T return loss test. |
| ee | yes, no | Configure the test to run either in energy efficient mode or not. | Returns a value indicating that the test mode is set either to energy efficient (Yes) or not (No). |

Note: The 802.3az document includes the changes required to enable the Energy Efficient Ethernet (EEE) operation for many existing physical layers. One of the supported operations is twisted pair cabling. The PHY supports 100Base-TX, 1000Base T, 10Base-T, and other technologies. In addition to that EEE defines reduced amplitude operation for 10Base-T which is called 10BASE-Te. All the measurements of 100Base-TX and 1000Base T, and some of the measurements of 10Base-T are not affected when performing the 10BASE-Te measurements. The 10Base-T measurements that support the PHY tests for 10BASE-Te are modified with a separate configuration to select and perform.

The following oscilloscope commands can be used to set or query the number of waveforms, fail threshold, horizontal position, and vertical position for 10Base-T tests.

Table 17-6: Oscilloscope GPIB commands for 10BASE-T

| Group / Name | Value | Function | Query returns |
|-----------------------|---|--|--|
| ACQUIRE:NUMAVG x | $x \geq 2$ and $x \leq 10,000$ | Sets the number of waveforms for 10Base-T. | |
| ACQUIRE:NUMAVG ? | | Queries the number of waveforms for 10Base-T. | The number of waveforms. |
| MASK:TEST:THRESHOLD x | $x \geq 1$ and $n \leq 2147483647$ | Sets the fail threshold for 10Base-T. | |
| MASK:TEST:THRESHOLD ? | | Queries the fail threshold for 10Base-T. | The value of the fail threshold. |
| MASK:TEST:WAVEFORM x | $x \geq 1$ and $n \leq 2147483647$ | Sets the number of waveforms for 10Base-T. | |
| MASK:TEST:WAVEFORM ? | | Queries the number of waveforms for 10Base-T. | The number of waveforms. |
| HORIZONTAL:POSITION x | $x \geq 0$ and $x \leq 99.9$ | Sets the horizontal position for 10Base-T. | |
| HORIZONTAL:POSITION ? | | Queries the horizontal position for 10Base-T. | The value of the horizontal position. |
| CHx:POSITION y | $x \geq 1$ and $x \leq 4$ $y \geq 0.0$ and $y \leq 5.00$ | Sets the vertical position for the selected channel for 10Base-T. | |
| CHx:POSITION ? | | Queries the vertical position for the selected channel for 10Base-T. | The value of the vertical position for the selected channel. |

****Note on channel selections:***

Channel 3 and Channel 4 can be chosen only on a 4-channel oscilloscope.

Ref 3 and Ref4 can be chosen only on a 4-channel oscilloscope.

Math3 and Math4 can be chosen only on a 4-channel oscilloscope.

GPIB Commands for AWG/AFG Automation

Table 17-7: AWG/AFG Automation GPIB commands

| Group / Name | Value | Function | Query returns |
|---------------------------|--|---|--|
| AWG/AFG Automation | | | |
| automate | gpiB, manual | Sets the AWG/AFG automation to GPIB mode or manual mode. | The current mode of automation. |
| boardtype | GPIB0, GPIB1, GPIB2, GPIB3, GPIB4, GPIB5, GPIB6, GPIB7, GPIB8, GPIB9 | Sets the GPIB board type to the specified value. This will be used if the AWG/AFG is automated. | The board type being used for automation of AWG/AFG. |
| priaddr | n, where n = 1 to 30 | Sets the primary address to the specified value. This will be used if the AWG/AFG is automated. | The primary address over which the oscilloscope talks to the AWG/AFG if the automation mode is GPIB. |
| secaddr | n, where n = 1 to 30 | Sets the secondary address to the specified value. This will be used if the AWG/AFG is automated. | The secondary address over which the oscilloscope talks to the AWG/AFG if the automation mode is GPIB. |
| testconn | start | Initiates the connection testing process. | No Query supported. "status" can be queried to know the result of test connection. |

Program Example

The program example shows how to communicate to the TDSET3 application using remote GPIB commands.

The oscilloscope hard disk and optional application compact disc both contain the file, **DefaultRun.c**. On the hard drive, the file resides in the *C:\TekApplications\TDSET3\GPIBExamples* directory.

The Program Example shows how a GPIB program executes the application to do the following tasks:

- Start the TDSET3 application
- Run the test
- Retrieve the results for the conducted tests
- Recall the default setup

In this example, you will recall the default setup. You can use the **File > Save** function in the application to save setup files.

```
#ifdef __cplusplus
extern "C"{
#endif

#include <windows.h>
#include <stdio.h>
#include <stdlib.h>
#include "decl-32.h"
#ifdef __cplusplus
}
#endif

/* Forward Declarations */
int start_application(int Oscilloscope);
int exit_application(int Oscilloscope);
int recall_setup(int Oscilloscope, char* filename);
int recall_defaultsetup(int Oscilloscope) ;
int run_single_test (int Oscilloscope);
void query_results(int Oscilloscope) ;
void GPIBCleanup(int ud, char* ErrorMessage);

// parameters needed to access the device driver handler
#define BDINDEX 0 // Board Index
#define PRIMARY_ADDR_OF_DMM 1 // Primary address of device
#define NO_SECONDARY_ADDR 0 // Secondary address of device
#define TIMEOUT T10s // Timeout value = 10 seconds
#define EOTMODE 1 // Enable the END message
#define EOSMODE 0 // Disable the EOS mode
```

```
#define APP_NOT_RUNNING -1
#define RGPIB_ENABLED 1
#define RGPIB_DISABLED 0

char ErrorMnemonic[21][5] = {"EDVR", "ECIC", "ENOL", "EADR", "EARG",
"ESAC", "EABO", "ENEB", "EDMA", "",
"EOIP", "ECAP", "EFSO", "", "EBUS",
"ESTB", "ESRQ", "", "", "", "ETAB"};

/*
 * After each GPIB call, the application checks whether the call
 * succeeded. If an NI-488.2 call fails, the GPIB driver sets the
 * corresponding bit in the global status variable. If the call
 * failed, this procedure prints an error message, takes
 * the device offline and exits.
 */
//-----

int main()
{
    int Dev;
    char write_buffer[100];
    int status;
    int nAppStatus = -1;
    Dev = ibdev (BDINDEX, PRIMARY_ADDR_OF_DMM, NO_SECONDARY_ADDR,
TIMEOUT, EOTMODE, EOSMODE);
    if (ibsta & ERR)
    {
        GPIBCleanup(Dev, "Unable to open device");
    }
}
```

```
else
{
    printf("My device id - %i", Dev);
}
sprintf(write_buffer, "%s", "header off");
status = ibwrt(Dev, write_buffer, strlen(write_buffer));
nAppStatus = start_application(Dev);
if ( nAppStatus == RGPIB_ENABLED )
{
    printf("\nApplication started..\n");
}
else if ( nAppStatus == RGPIB_DISABLED )
{
    printf("\nRGPIB is disabled, please enable it and then press
Enter to continue");
    getchar();
}
else if ( nAppStatus == APP_NOT_RUNNING )
{
    exit_application(Dev);
    // leave the device back elegantly
    printf("Cleanup: Taking device offline\n");
    ibonl(Dev, 0);
    exit(0);
}
run_single_test(Dev);
printf("\nRun single test complete now..\n");
```

```
    query_results(Dev);
    printf("\nQuery results complete now..\n");
    recall_defaultsetup(Dev);
    printf("\nRecall Default complete now..\n");
    printf("Cleanup: Taking device offline\n");
    ibonl(Dev, 0);

    printf("Press any key to exit this sample application..\n");
    getchar();
}
//-----
/* Start Ethernet Compliance Test Software application
*/
int start_application( int Oscilloscope )
{
char write_buffer[100];
char read_buffer[100];

int status;

int timer = 1;

/* Start the application */
sprintf(write_buffer, "%s", "Application:activate \"Ethernet
Compliance Test Software\");

status = ibwrt(scope, write_buffer, strlen(write_buffer));

if (ibsta & ERR)
{
    GPIBCleanup(scope, "Unable to start the application");
    return 0;
}
}
```

```
while (1)
{
    // Check whether application has started
    sprintf(write_buffer, "%s", "Variable:value? \"application\"");
    status = ibwrt(scope, write_buffer, strlen(write_buffer));
    status = ibrd(scope, read_buffer, sizeof(read_buffer));
    read_buffer[ibcnt] = '\\0';
    if ( strcmp(read_buffer, "\\GPIB Enabled\\\"\\n") == 0 )
    {
        return RGPIOB_ENABLED;
    }
    else if (strcmp(read_buffer, "\\GPIB Disabled\\\"\\n") == 0 )
    {
        return RGPIOB_DISABLED;
    }
    timer++;
    if (timer >500)
    {
        return 0;
    }
    Sleep(1000);
}
return APP_NOT_RUNNING;
}
//-----
int exit_application(int Oscilloscope)
{
```

```
char write_buffer[100];

printf("Exit Application ..\n");

sprintf(write_buffer, "%s", "Variable:value
\application\", \"exitworecall\");

ibwrt(scope, write_buffer, strlen(write_buffer));

return 1;
}

//-----

int recall_setup(int Oscilloscope, char* filename)
{
    char write_buffer[100];
    int status;

    /* recall setup */

    sprintf(write_buffer, "%s%s%s", "Variable:value \"recall\",\",
filename, "\");

    status = ibwrt(scope, write_buffer, strlen(write_buffer));

    if (ibsta & ERR)
    {
        GPIBCleanup(scope, "Unable to communicate with Oscilloscope");
        return 0;
    }

    return 1;
}

//-----

int recall_defaultsetup(int Oscilloscope)
{
    char write_buffer[100];
```

```
int status;
/* recall default setup */
sprintf(write_buffer, "%s", "Variable:value \"recall\\\", \"Default\\");
status = ibwrt(scope, write_buffer, strlen(write_buffer));
if (ibsta & ERR)
{
    GPIBCleanup(scope, "Unable to communicate with Oscilloscope");
    return 0;
}
return 1;
}
//-----
int run_single_test (int Oscilloscope)
{
    char write_buffer[100];
    char read_buffer[100];
    int timer;
    sprintf(write_buffer, "%s", "Variable:value \"run\\\", \"on\\");
    ibwrt(scope, write_buffer, strlen(write_buffer));
    printf("Executing Test..\n");
    Sleep(1000);
    // Wait for application to come to Ready State
    timer = 1;
    while (1)
    {
        timer++;
        if (timer > 500)
```



```
    {
        printf("*****Test Time Out *****\n");
        return 0;
    }
    sprintf(write_buffer, "%s", "Variable:value? \"run\"");
    ibwrt(scope, write_buffer, strlen(write_buffer));
    /* read the answer */
    ibrd(scope, read_buffer, 99);
    if (ibsta & ERR)
    {
        GPIBCleanup(scope, "Unable to write to device");
    }
    read_buffer[ibcnt - 1] = '\0';
    if (strcmp(read_buffer, "\"off\"") == 0)
    {
        printf("Test Completed or stopped ..\n");
        return 1;
    }
    Sleep(1000);
}
}
//-----
void query_results(int Oscilloscope)
{
    char write_buffer[100];
    char read_buffer[100];
    // Check for errors
```

```
    sprintf(write_buffer, "%s", "Variable:value? \"status\");
    ibwrt(scope, write_buffer, strlen(write_buffer));
    /* read the answer */
    ibrd(scope, read_buffer, 99);
    if (ibsta & ERR)
    {
        GPIBCleanup(scope, "Unable to write to device");
    }
    read_buffer[ibcnt - 1] = '\0';
    if (strcmp(read_buffer, "\"Test Complete\"") != 0)
    {
        printf("Error has Occured. %s\n", read_buffer);
    }
    else
    printf("\nstatus is %s\n", read_buffer);
    // If no error, check for results
    //result summary
    sprintf(write_buffer, "%s", "Variable:value? \"resultsum\");
    ibwrt(scope, write_buffer, strlen(write_buffer));
    /* read the answer */
    ibrd(scope, read_buffer, 99);
    if (ibsta & ERR)
    {
        GPIBCleanup(scope, "Unable to write to device");
    }
    read_buffer[ibcnt - 1] = '\0';
    printf("Result summary : %s\n", read_buffer);
```

```
//result standard
sprintf(write_buffer, "%s", "Variable:value? \"resultstd\");
ibwrt(scope, write_buffer, strlen(write_buffer));
/* read the answer */
ibrd(scope, read_buffer, 99);
if (ibsta & ERR)
{
    GPIBCleanup(scope, "Unable to write to device");
}
read_buffer[ibcnt - 1] = '\0';
printf("Result standard : %s\n",read_buffer);
//result measured
sprintf(write_buffer, "%s", "Variable:value? \"resultmeas\");
ibwrt(scope, write_buffer, strlen(write_buffer));
/* read the answer */
ibrd(scope, read_buffer, 99);
if (ibsta & ERR)
{
    GPIBCleanup(scope, "Unable to write to device");
}
read_buffer[ibcnt - 1] = '\0';
printf("Result Measured : %s\n",read_buffer);
//result remarks
sprintf(write_buffer, "%s", "Variable:value? \"resultrem\");
ibwrt(scope, write_buffer, strlen(write_buffer));
/* read the answer */
ibrd(scope, read_buffer, 99);
```

```
    if (ibsta & ERR)
    {
        GPIBCleanup(scope, "Unable to write to device");
    }
    read_buffer[ibcnt - 1] = '\\0';
    printf("Result Remarks : %s\\n",read_buffer);
    //result status
    sprintf(write_buffer, "%s", "Variable:value? \\\"resultsts\\\"");
    ibwrt(scope, write_buffer, strlen(write_buffer));
    /* read the answer */
    ibrd(scope, read_buffer, 99);
    if (ibsta & ERR)
    {
        GPIBCleanup(scope, "Unable to write to device");
    }
    read_buffer[ibcnt - 1] = '\\0';
    printf("Result Status : %s\\n",read_buffer);
}
//-----
void GPIBCleanup(int ud, char* ErrorMessage)
{
    printf("Error : %s\\nibsta = 0x%x iberr = %d (%s)\\n",
    ErrorMessage, ibsta, iberr, ErrorMnemonic[iberr]);
    if (ud != -1)
    {
        printf("Cleanup: Taking device offline\\n");
        ibonl(ud, 0);
    }
}
```

```
    }  
    exit(0);  
}  
//-----
```

Guidelines to GPIB Programming

The application includes an example file of a GPIB program. Your GPIB program should comply with the following guidelines:

- You need to manually enable Remote GPIB by clicking Utilities > Enable Remote GPIB. The Remote GPIB remains enabled or disabled until you manually change it
- You need to connect a separate GPIB cable between the PC and the oscilloscope for GPIB to work. GPIB commands do not work through LAN
- You need to ensure that the startup is complete before sending additional GPIB commands to the application
- After sending a GPIB command to activate the application, you can send a remote GPIB command to query for application variable to check if the application is activated or not and to know the GPIB status that is enabled or disabled
- If “processdone” command is not sent before every set command or waited upon until it returns a “yes” before sending the next command, you need to include delay between commands in the GPIB command script
- You can query for test results after the test is run and complete
- Before running the GPIB commands, you can query for *IDN? variable to identify the oscilloscope and ensure that the oscilloscope is responding
- You can query for the status variable to either know if the tests is complete or ensure that an error has not occurred
- Ensure that you are in the appropriate technology for which you are selecting or configuring test parameters
- You can query for lastrepdet variable to know where the last detailed report is saved

- You can query for lastrepsum variable to know where the last report summary is saved
- You can query for jmstatus variable to know if the application is compensating a disturber or test fixture. Do not query for Jig Match parameters if the jmstatus variable is ON
- You can query for variables harmonicres0 to harmonicres5 to view the harmonic test results

Note on Guidelines to GPIB Programming

- The application does not respond to commands that were sent before the application was activated
- GPIB commands do not work through LAN
- Remote GPIB commands does not support the View Waveform functionality
- When the application processes remote GPIB commands, all the relevant message boxes are disabled
- If you are in the Select pane while sending GPIB commands to configure a test parameter, the application does not display the configure pane. But if you are in the Configure pane while sending GPIB commands to select a test, the application will display the Select pane
- While running a test, the remote GPIB commands are not processed until the test is complete
- Do not operate User Interface and Front panel of the oscilloscope manually
- The application does not display the report irrespective of the preview option being enabled or disabled
- When a test is run, the results are available after the status indicates Test Complete. When multiple tests are run, one test result is made available. You can retrieve the results for other tests by setting "resultfor" with the test name and querying for results. For example, if "outputvoltboth" test is run then the result for the test "outputvoltpos" is made available and if 1000Base-T "templatepeakall" test is run then the result for the test "templatea" is made available

The following table gives the name of multiple tests the results of which are made available soon after the test is complete:

Table 17-8: Default test name and result details after multiple run

| Test name | Test result |
|---------------------|----------------|
| 1000-T tests | |
| templatepeakall | templatea |
| droopall | droopg |
| 100-Tx tests | |
| templateall | templatepos |
| outputvoltboth | outputvoltboth |
| risetimeboth | risetimepos |
| falltimeboth | falltimepos |
| rfsymboth | rfsympos |
| overshootboth | overshootpos |
| jitterboth | jitterpos |
| jitwcableall | jitwcablenorm |
| jitwocableall | jitwocablenorm |
| 10-T tests | |
| mauboth | maunorm |
| diffvoltall | diffvoltpos |
| diffvoltmax | diffvoltmaxpos |

Calibration for Return Loss

1000BASE-T Return Loss

Use TC1 of the test fixture for calibration. Make the connections as shown by the following figure:

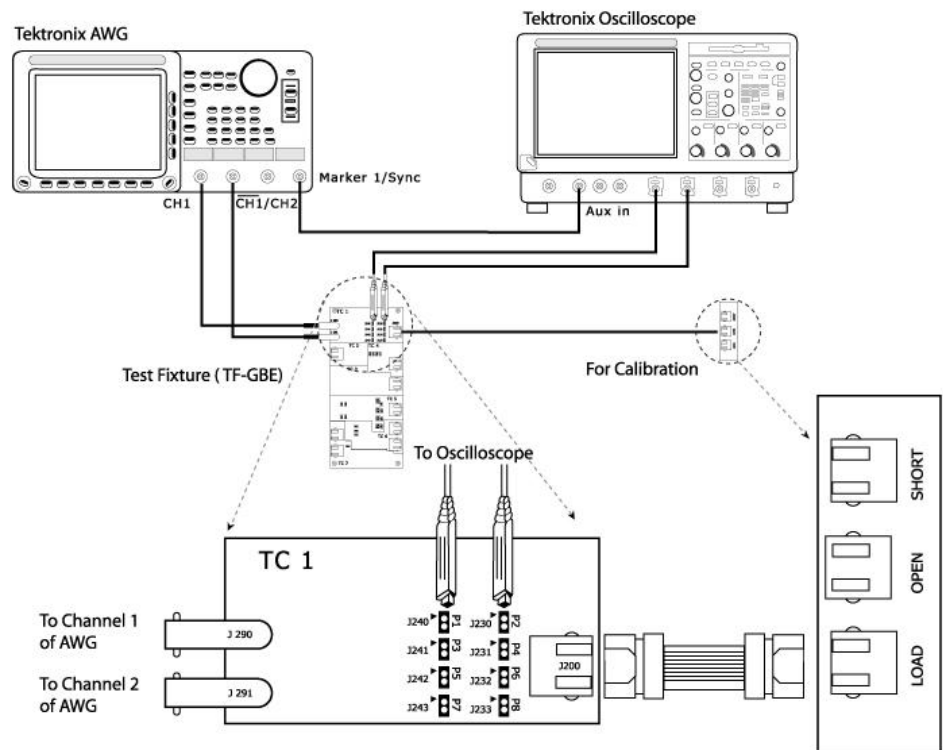

Figure 18-1: Calibration for 1000BASE-T Return Loss

1. Click Tests > Select > 1000BASE-T from the menu bar.
2. In the Return Loss tab, select **Return Loss**.
3. Select **Tests > Connect** or **Connect** to display the Connect pane.

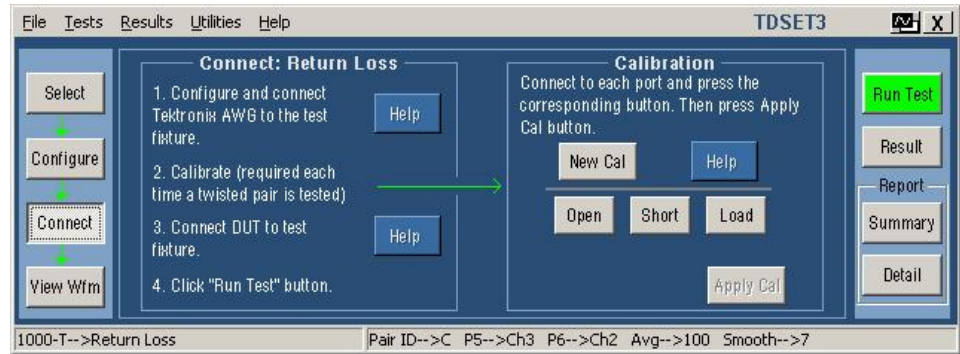

Figure 18-2: Connect pane of 1000BASE-T Return Loss

Note: The Open, Load and Short button are enabled only after you press New Cal.

4. Click on New Cal.
5. Connect CAT5 cable to J200 of TC1 and J702 (OPEN).
6. Click Open. Once the open calibration is complete, the string Done appears below the selected calibration. The following figure shows a typical waveform for Return Loss Open Calibration.

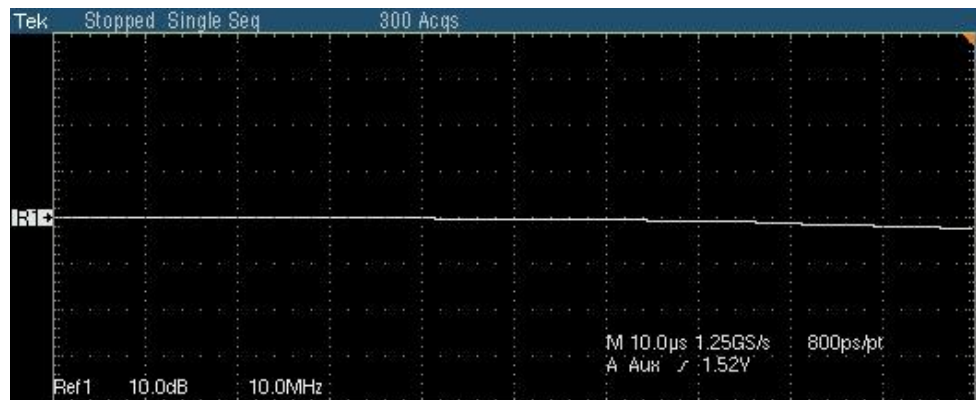

Figure 18-3: Waveform of 1000BASE-T Return Loss Open calibration

7. Connect CAT5 cable to J200 of TC1 and J703 (SHORT).
8. Click Short. Once the Short calibration is complete, the string Done appears below the selected calibration.

The following figure shows a typical waveform for Return Loss Short Calibration:

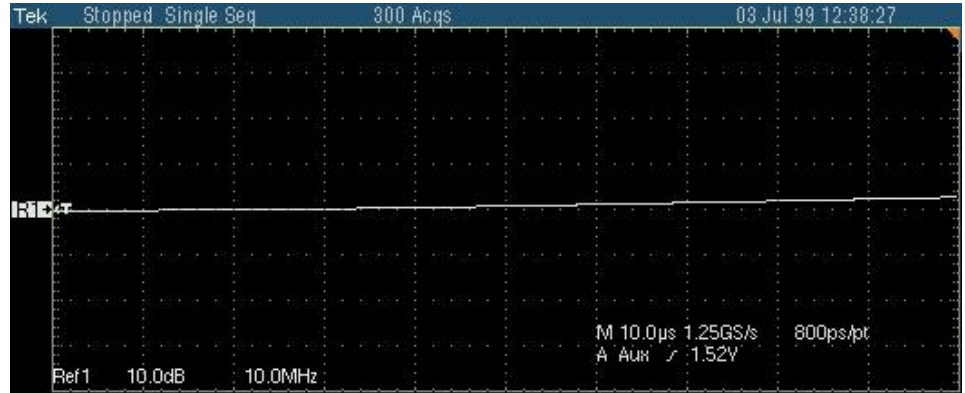

Figure 18-4: Waveform of 1000BASE-T Return Loss Short calibration

9. Connect CAT5 cable to J200 of TC1 and J704 (LOAD).
10. Click Load. Once the Load calibration is complete, the string Done appears below the selected calibration. The following figure shows a typical waveform for Return Loss Load Calibration:

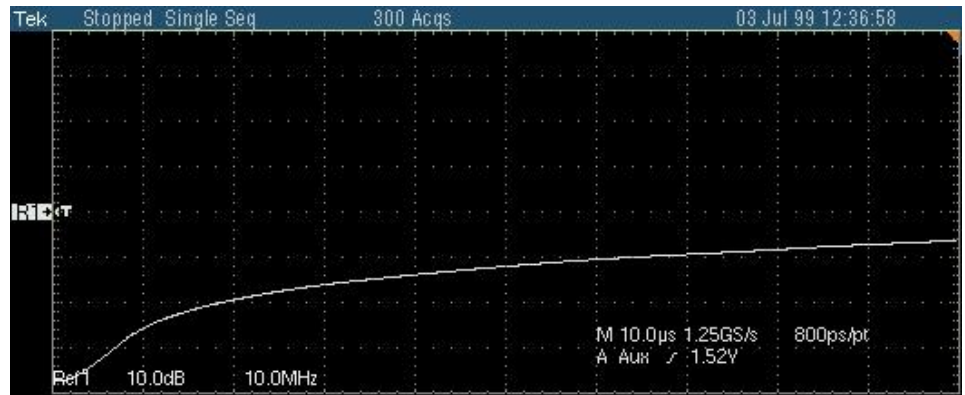

Figure 18-5: Waveform of 1000BASE-T Return Loss Load calibration

11. After all the calibrations are complete, the Apply Cal button is enabled.
12. Click Apply Cal. The calibration is complete.
13. To clear the calibrations and recalibrate, click on New Cal again.

100BASE-TX Return Loss Transmitter

Use TC1 of the test fixture for calibration. Make the connections as shown by the following figure:

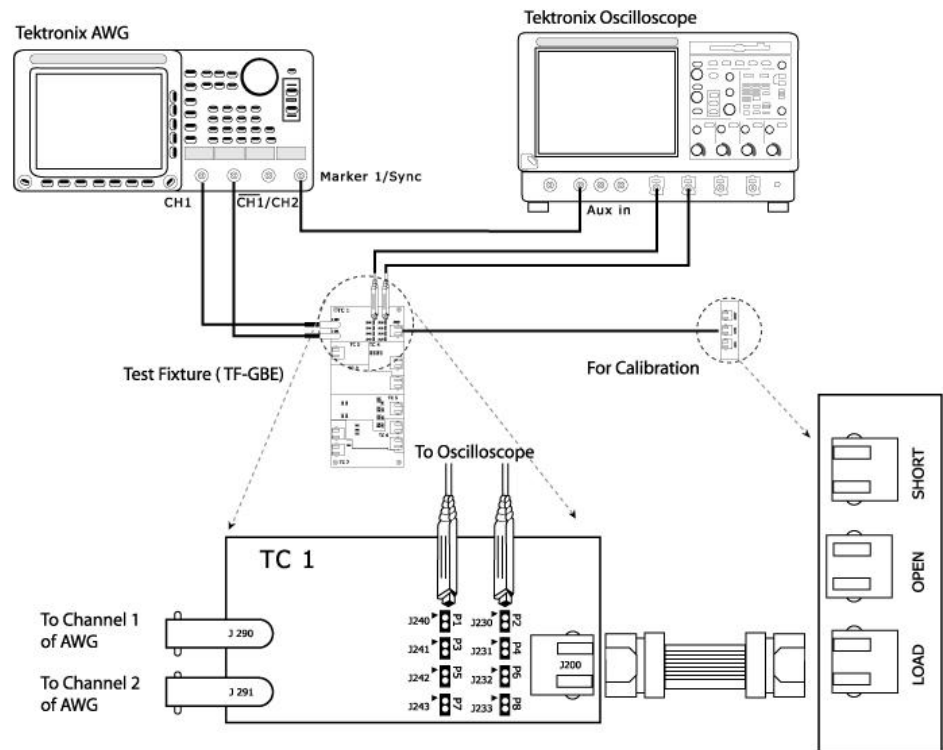

Figure 18-6: Calibration for 100BASE-TX Return Loss

1. Click Tests > Select > 100BASE-TX from the menu bar.
2. In the Return Loss tab, select **Transmitter**.
3. Select **Tests** > Connect or **Connect** to display the Connect pane.

Note: The Open, Load and Short button are enabled only after you press New Cal.

4. Click on New Cal.
5. Connect CAT5 cable to J200 of TC1 and J702 (OPEN).
6. Click Open. Once the open calibration is complete, the string Done appears below the selected calibration.

The following figure shows a typical waveform for Return Loss Open Calibration:

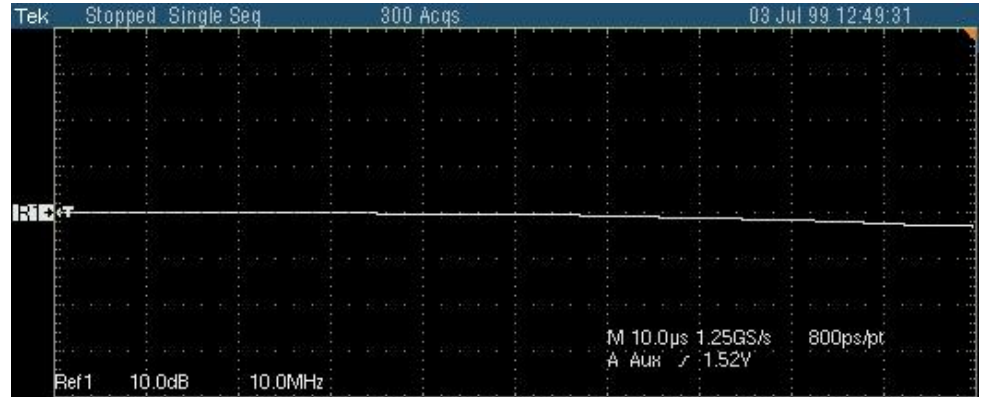

Figure 18-7: Waveform of 100BASE-TX Return Loss Open calibration

7. Connect CAT5 cable to J200 of TC1 and J703 (SHORT).
8. Click Short. Once the Short calibration is complete, the string Done appears below the selected calibration. The following figure shows a typical waveform for Return Loss Short Calibration:

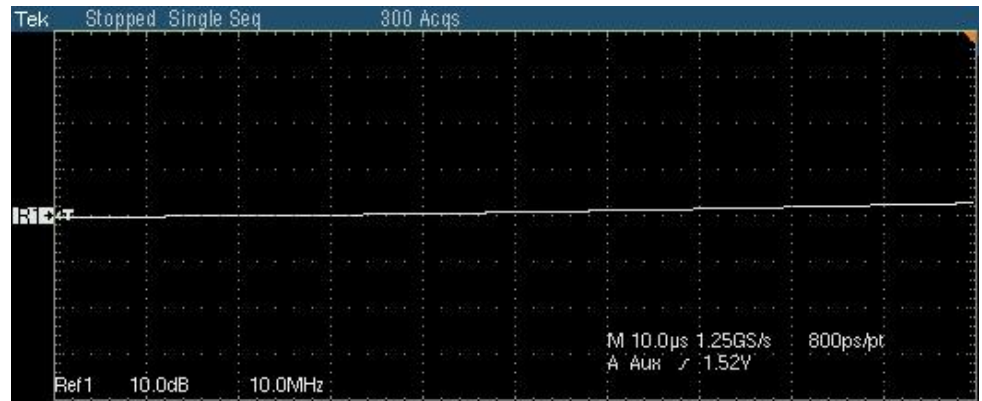

Figure 18-8: Waveform of 100BASE-TX Return Loss Short calibration

9. Connect CAT5 cable to J200 of TC1 and J704 (LOAD).
10. Click Load. Once the Load calibration is complete, the string Done appears below the selected calibration.

The following figure shows a typical waveform for Return Loss Load Calibration:

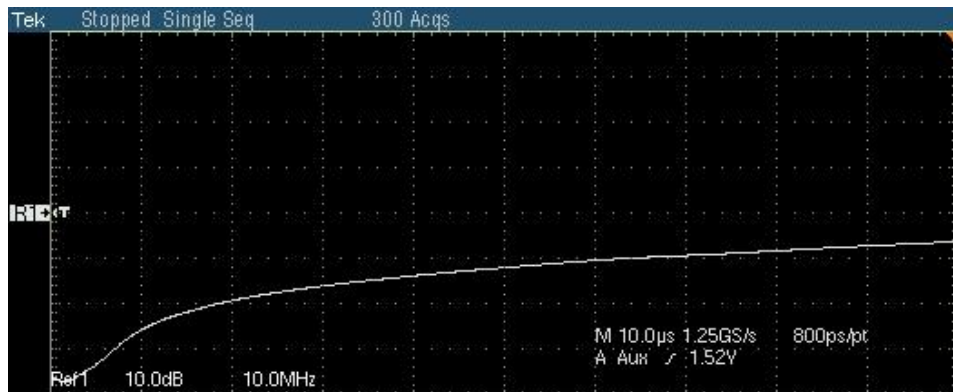

Figure 18-9: Waveform of 100BASE-TX Return Loss Load calibration

11. After all the calibrations are complete, the Apply Cal button is enabled.
12. Click Apply Cal. The calibration is complete.
13. To clear the calibrations and recalibrate, click on New Cal again.

100BASE-TX Return Loss Receiver

Use TC1 of the test fixture for calibration. Make the connections as shown by the following figure:

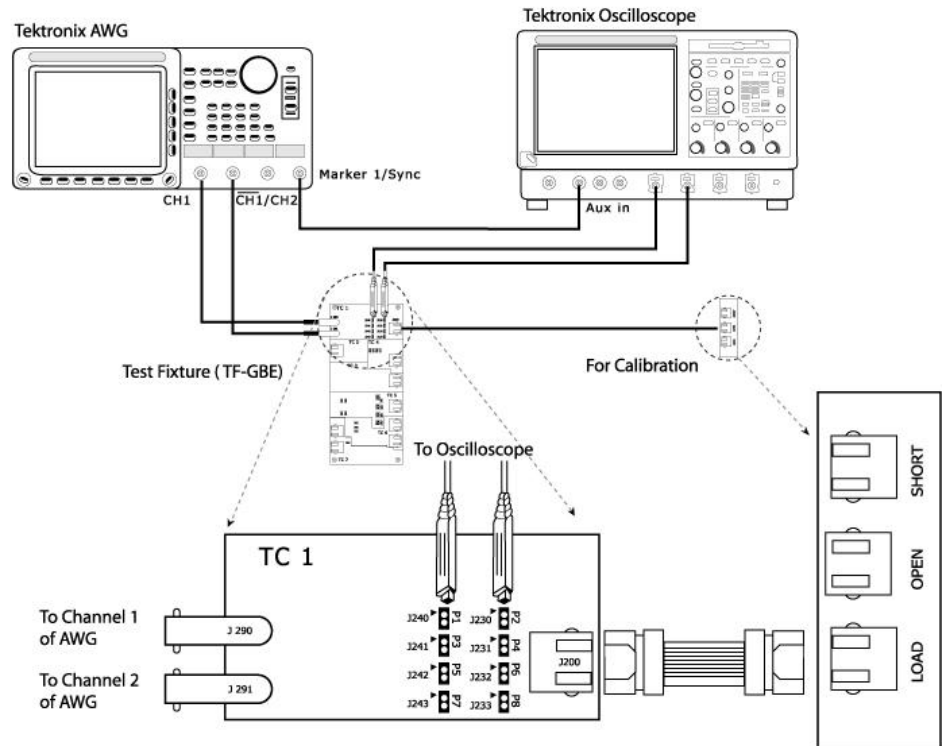

Figure 18-10: Calibration for 100BASE-TX Return Loss

1. Click Tests > Select > 100BASE-TX from the menu bar.
2. In the Return Loss tab, select **Receiver**.
3. Select Tests > **Connect** or **Connect** to display the Connect pane.

***Note:** The Open, Load and Short button are enabled only after you press New Cal.*

4. Click on New Cal.
5. Connect CAT5 cable to J200 of TC1 and J702 (OPEN).

6. Click Open. Once the open calibration is complete, the string Done appears below the selected calibration. The following figure shows a typical waveform for Return Loss Open Calibration:

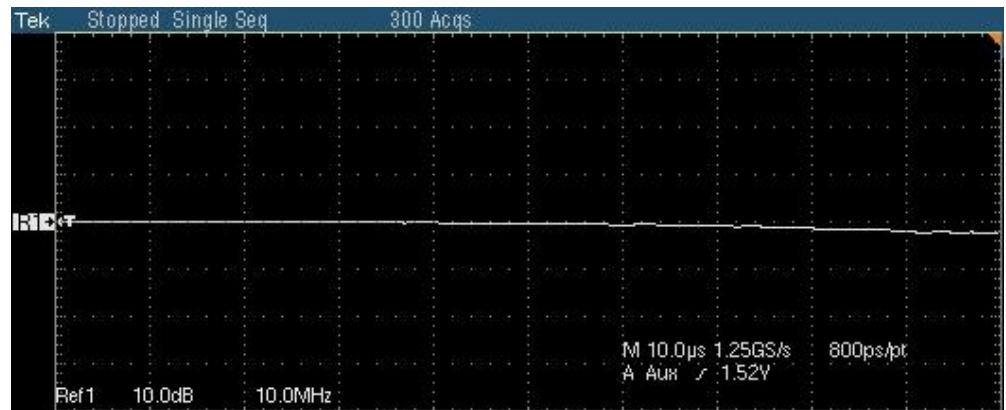

Figure 18-11: Waveform of 100BASE-TX Return Loss Open calibration

7. Connect CAT5 cable to J200 of TC1 and J703 (SHORT).
8. Click Short. Once the Short calibration is complete, the string Done appears below the selected calibration. The following figure shows a typical waveform for Return Loss Short Calibration:

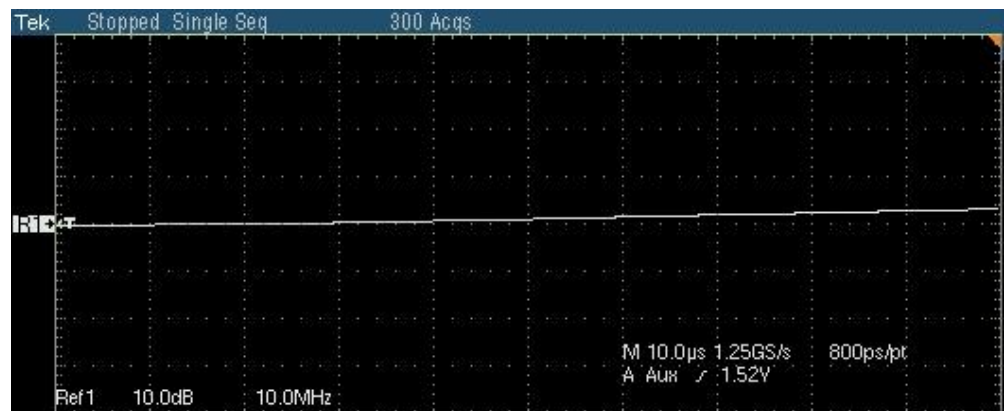

Figure 18-12: Waveform of 100BASE-TX Return Loss Short calibration

9. Connect CAT5 cable to J200 of TC1 and J704 (LOAD).
10. Click Load. Once the Load calibration is complete, the string Done appears below the selected calibration.

The following figure shows a typical waveform for Return Loss Load Calibration:

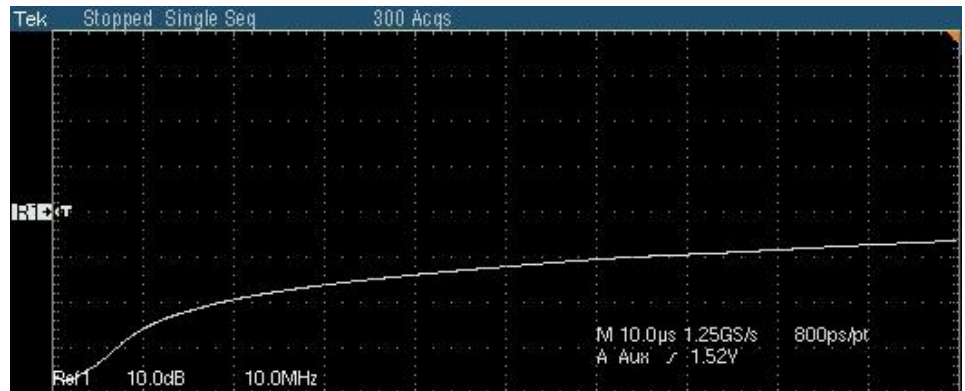

Figure 18-13: Waveform of 100BASE-TX Return Loss Load calibration

11. After all the calibrations are complete, the Apply Cal button is enabled.
12. Click Apply Cal. The calibration is complete.
13. To clear the calibrations and recalibrate, click on New Cal again.

10BASE-T Return Loss Transmitter

Use TC1 of the test fixture for calibration. Make the connections as shown by the following figure:

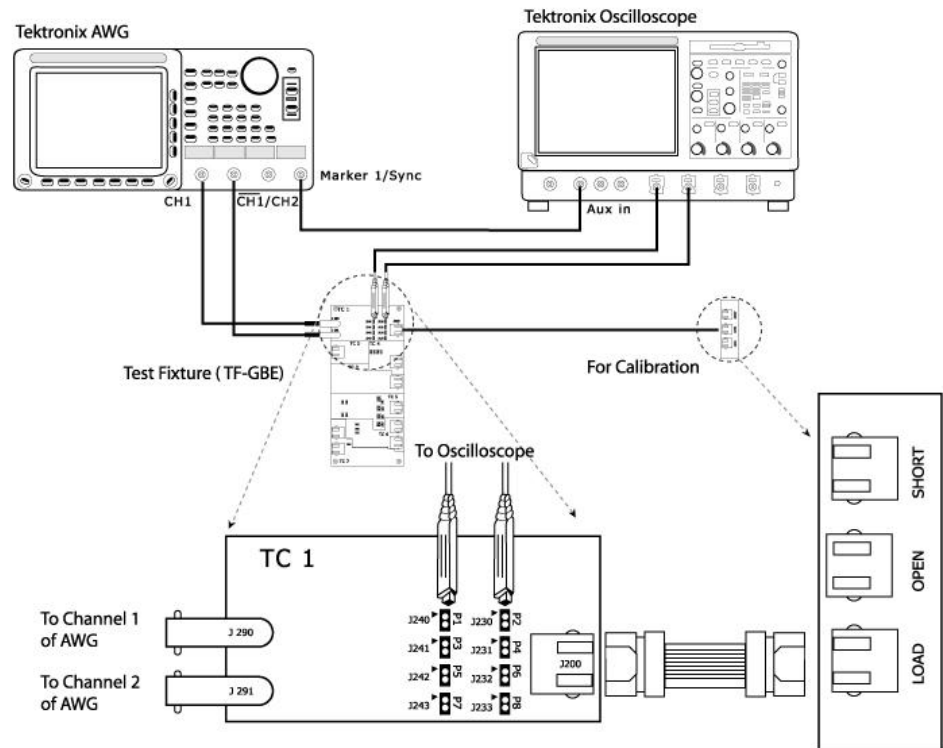

Figure 18-14: Calibration for 10BASE-T Return Loss

1. Click Tests > Select > 10BASE-T from the menu bar.
2. In the Return Loss tab, select **Transmitter**.
3. Select **Tests > Connect** or **Connect** to display the Connect pane.

Note: The Open, Load and Short button are enabled only after you press New Cal.

4. Click on New Cal.
5. Connect CAT5 cable to J200 of TC1 and J702 (OPEN).
6. Click Open. Once the open calibration is complete, the string Done appears below the selected calibration.

The following figure shows a typical waveform for Return Loss Open Calibration:

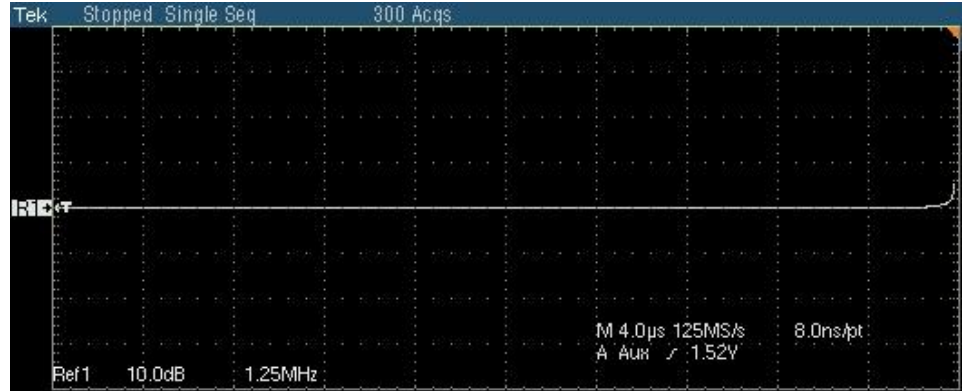

Figure 18-15: Waveform of 10BASE-T Return Loss Open calibration

7. Connect CAT5 cable to J200 of TC1 and J703 (SHORT).
8. Click Short. Once the Short calibration is complete, the string Done appears below the selected calibration. The following figure shows a typical waveform for Return Loss Short Calibration.

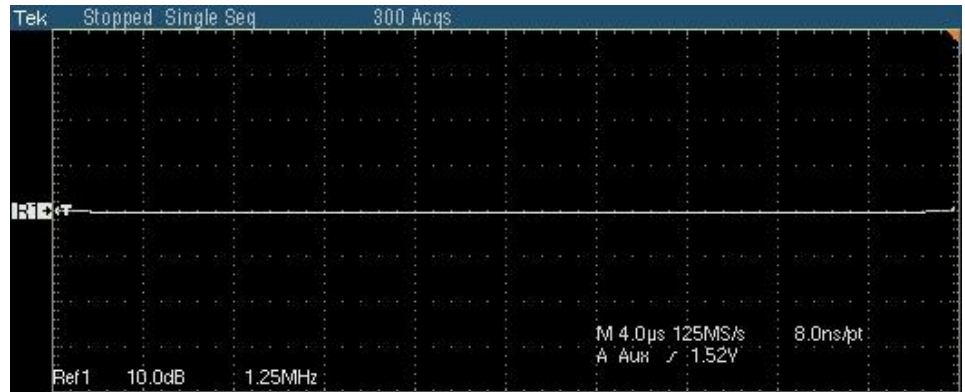

Figure 18-16: Waveform of 10BASE-T Return Loss Short calibration

9. Connect CAT5 cable to J200 of TC1 and J704 (LOAD).
10. Click Load. Once the Load calibration is complete, the string Done appears below the selected calibration.

11. The following figure shows a typical waveform for Return Loss Load Calibration:

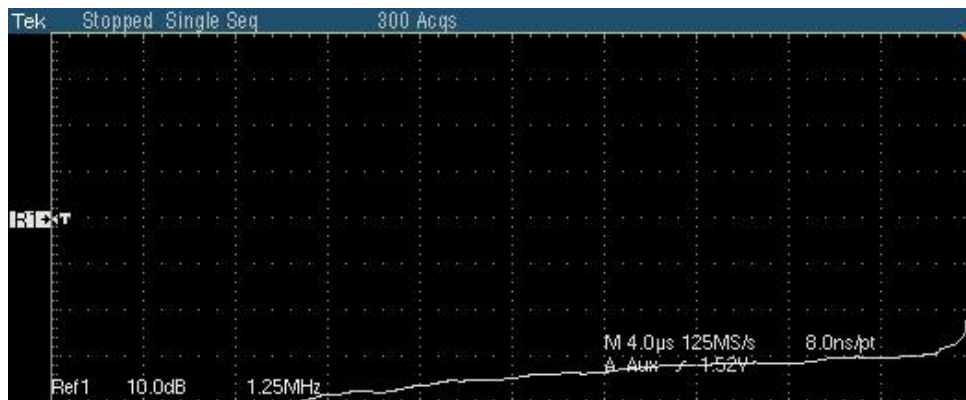

Figure 18-17: Waveform of 10BASE-T Return Loss Load calibration

12. After all the calibrations are complete, the Apply Cal button is enabled.
13. Click Apply Cal. The calibration is complete.
14. To clear the calibrations and recalibrate, click on New Cal again.

10BASE-T Return Loss Receiver

Use TC1 of the test fixture for calibration. Make the connections as shown by the following figure:

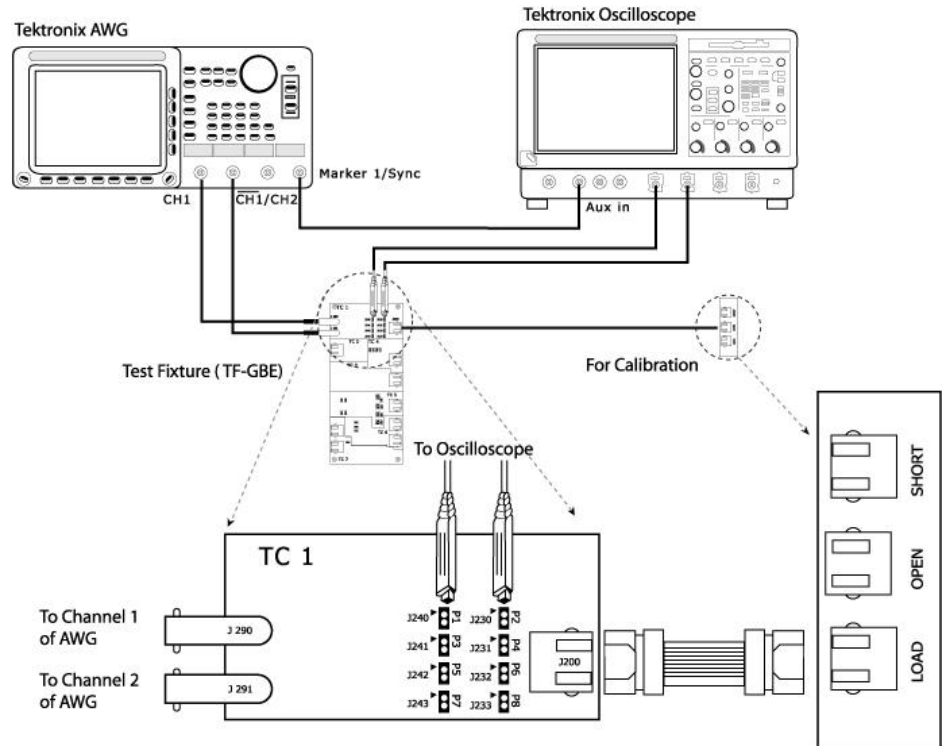

Figure 18-18: Calibration for 10BASE-T Return Loss

1. Click Tests > Select > 10BASE-T from the menu bar.
2. In the Return Loss tab, select **Receiver**.
3. Select **Tests > Connect** or **Connect** to display the Connect pane.

Note: The Open, Load and Short button are enabled only after you press New Cal.

4. Click on New Cal.
5. Connect CAT5 cable to J200 of TC1 and J702 (OPEN).
6. Click Open. Once the open calibration is complete, the string Done appears below the selected calibration.

The following figure shows a typical waveform for Return Loss Open Calibration:

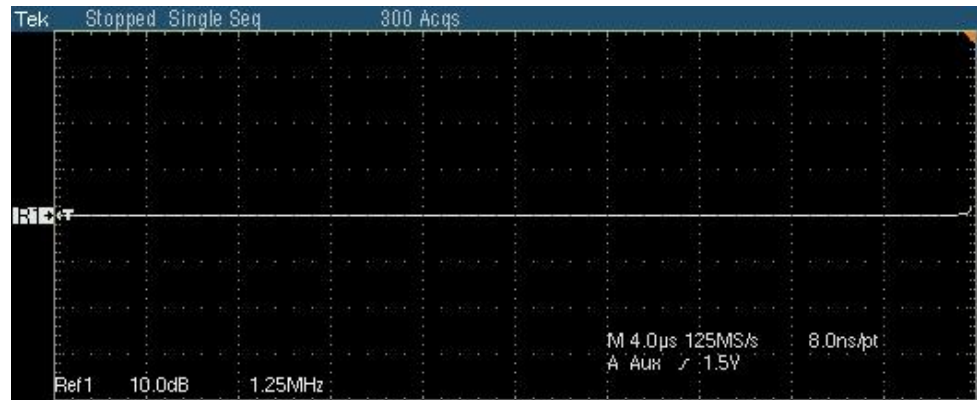

Figure 18-19: Waveform of 10BASE-T Return Loss Open calibration

7. Connect CAT5 cable to J200 of TC1 and J703 (SHORT).
8. Click Short. Once the Short calibration is complete, the string Done appears below the selected calibration. The following figure shows a typical waveform for Return Loss Short Calibration:

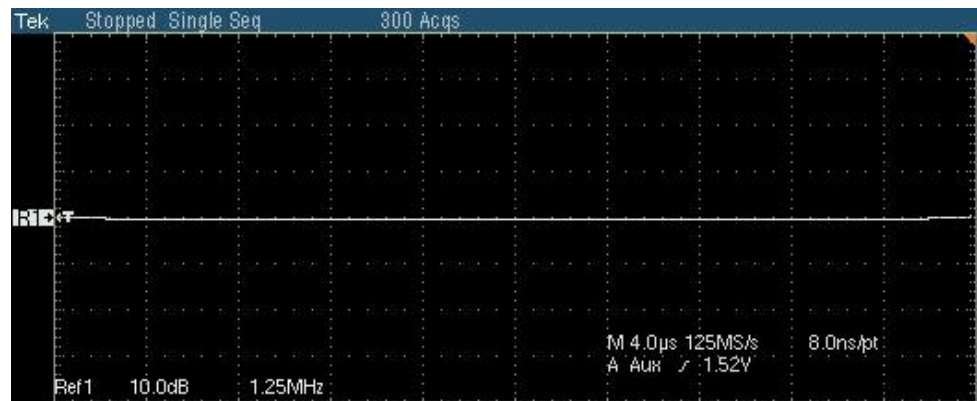

Figure 18-20: Waveform of 10BASE-T Return Loss Short calibration

9. Connect CAT5 cable to J200 of TC1 and J704 (LOAD).
10. Click Load. Once the Load calibration is complete, the string Done appears below the selected calibration.

The following figure shows a typical waveform for Return Loss Load Calibration:

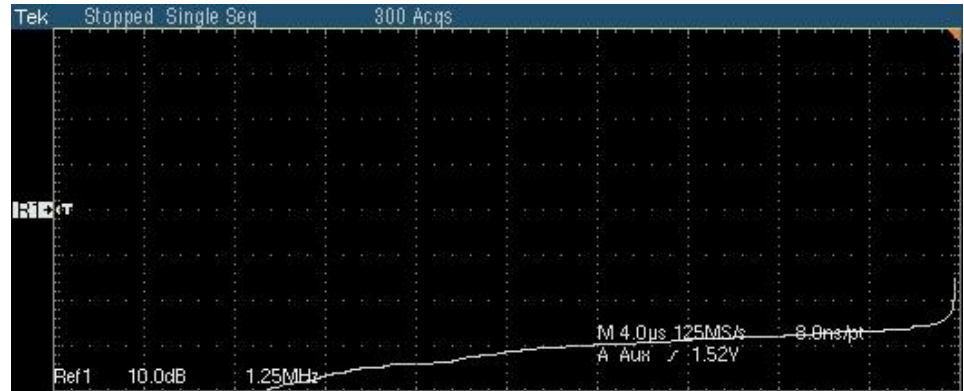

Figure 18-21: Waveform of 10BASE-T Return Loss Load calibration

11. After all the calibrations are complete, the Apply Cal button is enabled.
12. Click Apply Cal. The calibration is complete.
13. To clear the calibrations and recalibrate, click on New Cal again.

Appendix A: Specification Range

1000BASE-T

Each test result depends on whether the measured value is within the specification range.

The specification range for 1000BASE-T are listed in the following table:

Table A-1:1000BASE-T specification range

| Test | Specification range |
|---------------------------------|--|
| Template | |
| A | Fit the template |
| B | Fit the template |
| C | Fit the template |
| D | Fit the template |
| F | Fit the template |
| H | Fit the template |
| Peak Voltage | |
| A | 670 mV to 820 mV |
| B | 670 mV to 820 mV |
| % Difference between A & B Test | $(1 - Point A / Point B) * 100 < 1\%$ |
| C | $(1 - (0.5 * (Point A + Point B)/2)/ Point C) * 100\% < 2\%$ |
| D | $(1 - (0.5 * (Point A + Point B)/2)/ Point D) * 100\% < 2\%$ |
| Droop | |
| G | $(Point G/Point F) * 100\% > 73.1\%$ |
| J | $(Point H/Point J) * 100\% > 73.1\%$ |
| Jitter TX_TCLK (Yes) | |
| Master Filtered | Master Filtered Pk-Pk Jitter + Jtxout < 0.3 ns |
| Master Unfiltered | Master Unfiltered Pk-Pk Jitter < 1.4 ns |
| Slave Filtered | Slave Filtered Pk-Pk Jitter + Jtxout < 0.4 ns + Master Filtered Pk-Pk Jitter |
| Slave Unfiltered | Slave Unfiltered Pk-Pk Jitter < 1.4 ns |

Table A-1: 1000BASE-T specification range (cont)

| Test | Specification range |
|----------------------------|--|
| Jitter TX_TCLK (No) | |
| Master Filtered | Data (TM2) Filtered Pk-Pk Jitter < 0.3 ns - Inconclusive Data (TM2) Filtered Pk-Pk Jitter > 0.3 ns – Fail |
| Master Unfiltered | Data (TM2) Unfiltered Pk-Pk Jitter < 1.4 ns - Pass Data (TM2) Unfiltered Pk-Pk Jitter > 1.4 ns - Inconclusive |
| Slave Filtered | Data (TM3) Filtered Pk-Pk Jitter - Data (TM2) Filtered Pk-Pk Jitter < 0.4 ns - Pass Data (TM3) Filtered Pk-Pk Jitter - Data (TM2) Filtered Pk-Pk Jitter > 0.4 ns - Fail |
| Slave Unfiltered | Data (TM3) Unfiltered Pk-Pk Jitter - Data (TM2) Unfiltered Pk-Pk Jitter < 1.4 ns - Pass Data (TM3) Unfiltered Pk-Pk Jitter - Data (TM2) Unfiltered Pk-Pk Jitter > 1.4 ns - Fail |
| Distortion | < 10 mV |
| Return Loss | At least 16 dB over the frequency range of 1.0 MHz to 40 MHz and at least 10 -20log 10 (f /80) dB over the frequency range 40 MHz to 100 MHz (f in MHz) |
| Common Mode Voltage | < 50 mV Pk-Pk |

100BASE-TX

Each test result depends on whether the measured value is within the specification range.

The specification range for 100BASE-TX are listed in the following table:

Table A-1: 100BASE-TX specification range

| Test | Specification range |
|------------------------------------|---------------------|
| Template | |
| AOI Template | Fit the template |
| Differential Output Voltage | |
| Output Voltage (+Vout) | 950 mV to 1050 mV |
| Output Voltage (-Vout) | -950 mV to -1050 mV |
| Signal Amplitude Symmetry | |
| Signal Amplitude Symmetry | 0.98 to 1.02 |
| Rise Time | |
| Rise Time (+ve) | 3.0 ns to 5.0 ns |
| Rise Time (-ve) | 3.0 ns to 5.0 ns |

Table A-2: 100BASE-TX specification range (cont)

| Test | Specification range |
|--------------------------------|--|
| Fall Time | |
| Fall Time (+ve) | 3.0 ns to 5.0 ns |
| Fall Time (-ve) | 3.0 ns to 5.0 ns |
| Rise/Fall Time Symmetry | |
| Rise/Fall Symmetry (+ve) | <500 ps |
| Rise/Fall Symmetry (-ve) | <500 ps |
| Waveform Overshoot | |
| Overshoot(+ve) | <5% |
| Overshoot(-ve) | <5% |
| Jitter | |
| Transmit Jitter | <1.4ns |
| Duty Cycle Distortion | |
| Distortion | <500 ps(+/- 250 ps) |
| Return Loss | |
| | >16 dB from 2 MHz to 30 MHz |
| | >(16 - 20log(f/30 MHz)) dB from 30 MHz to 60 MHz |
| | >10 dB from 60 MHz to 80 MHz |

10BASE-T/10BASE-Te

Each test result depends on whether the measured value is within the specification range. The specification ranges for 10BASE-T/10BASE-Te tests are listed in the following table:

Note: The 802.3az document includes the changes required to enable the Energy Efficient Ethernet (EEE) operation for many existing physical layers. One of the supported operations is twisted pair cabling. The PHY supports 100Base-TX, 1000Base T, 10Base-T, and other technologies. In addition to that EEE defines reduced amplitude operation for 10Base-T which is called 10BASE-Te. All the measurements of 100Base-TX and 1000Base T, and some of the measurements of 10Base-T are not affected when performing the 10BASE-Te measurements. The 10Base-T measurements that support the PHY tests for 10BASE-Te are modified with a separate configuration to select and perform.

Table A-1: 10BASE-T/10BASE-Te specification ranges

| Test | Specification range |
|---|---|
| Template | |
| MAU Ext | Fit the Template |
| MAU Ext Inv | Fit the Template |
| MAU Int | Fit the Template |
| MAU Int Inv | Fit the Template |
| Link Pulse | Fit the Template |
| TP_IDL | Fit the Template |
| Differential Voltage | 10BASE-T Positive peaks - +2.2 V to +2.8 V Negative peaks - -2.2 V to -2.8 V 10BASE-Te Positive peaks - + 1.54 V to +1.96 V Negative peaks - - 1.54 V to -1.96 V |
| Harmonic | <Fundamental - 27 dB |
| Jitter (with cable) | |
| <i>Note: Jitter values are according to the Internal MAU measurement.</i> | |
| Normal | <11ns (\pm 5.5 ns) |
| 8.0BT | <22 ns (\pm 11 ns) |
| 8.5BT | <22 ns (\pm 11 ns) |

Table A-1: 10BASE-T/10BASE-Te specification range (cont)

| Test | Specification range |
|---|--|
| Jitter (without cable) | |
| Normal | <16 ns (\pm 8 ns) |
| 8.0BT | <40 ns (\pm 20 ns) |
| 8.5BT | <40 ns (\pm 20 ns) |
| <i>Note: Jitter values are according to the External MAU measurement.</i> | |
| Jitter (with cable) | |
| Normal | <7 (\pm 3.5 ns) |
| 8.0BT | <14 (\pm 7) |
| 8.5BT | <14 (\pm 7) |
| Jitter (without cable) | |
| Normal | <16 (\pm 8 ns) |
| 8.0BT | <32 (\pm 16 ns) |
| 8.5BT | <32 (\pm 16 ns) |
| Return Loss | At least 15 dB over the frequency range of 5.0 to 10 MHz |
| Common mode Voltage | <50 mV Peak |

Appendix B: Error Messages

TDSET3 Error Messages

Table B-1: TDSET3 error messages

| Code | Error message | Description | Possible solution |
|------|---|---|---|
| E101 | Few samples, edge finding failed. | The application is not able to detect valid clock signal. | Ensure that the correct signal is connected and the configuration parameters are correct. |
| E102 | The selected input sources should be mutually exclusive. | Data, Master CLK, Slave CLK cannot be configured to the same source. | Ensure that the oscilloscope channels that you configure for the input sources are mutually exclusive. |
| E103 | Invalid signal. The measured clock is out of range. | The estimated TX_TCLK for Distortion test is either very low or high. | Ensure that the correct signal is connected and the configuration parameters are correct. Ensure that the trigger level is adjusted to get a stable trigger. |
| E104 | The measured value is unstable. The previous values will be restored. | The application is not able to get stable measured values. | Ensure that the correct signal is connected and the configuration parameters are correct. |
| E105 | Not enough clock edges. | The application is not able to find sufficient clock edges for Distortion test. | Ensure that the correct clock signal is connected and the configuration parameters are correct. |
| E106 | Invalid clock frequency. | The measured TX_TCLK frequency is neither within $\pm 5\%$ of 125 MHz nor 62.5 MHz. | Ensure that the measured TX_TCLK frequency is within $\pm 5\%$ of 125 MHz or 62.5 MHz. |
| E401 | Cannot connect to the instrument. | The application is not able to communicate with the oscilloscope. | Reboot the oscilloscope. |
| E402 | This application requires firmware version 2.2.0 or above. Please install the latest firmware available at the Tektronix Web site. The application will exit now. | The application works only with Firmware version 2.2.0 or above. | Download the latest firmware from Tektronix Web site. |
| E403 | Default file does not exist. | The application's default settings file is not found. | Reinstall the application. |
| E404 | Unable to set the mask. | The Mask file is missing or corrupted. | Reinstall the application. |
| E405 | Enter a valid file name to generate a report. | The file name in the report setup is not valid. | Go to Report Setup dialog box and enter a valid file name. |
| E406 | Report data base file read failed. | The application's system file is missing/corrupted. | Reinstall the application. |

Table B-1: TDSET3 error messages (cont)

| Code | Error message | Description | Possible solution |
|------|---|---|---|
| E407 | System file exception. | If the oscilloscope has a file exception, this error is displayed at run time by the operating system. | Reboot the oscilloscope. |
| E408 | System memory exception. | If the oscilloscope has a memory exception, this error is displayed at run time by the operating system. | Reboot the oscilloscope. |
| E409 | Unknown exception. | If the oscilloscope has an unknown exception, this error is displayed at run time by the operating system. | Reboot the oscilloscope. |
| E410 | Invalid signal. Check whether the DUT is connected. | The application is not able to detect a valid signal. | Ensure the correct signal is connected and the configuration parameters are correct. |
| E411 | This application has not been enabled. To enable the application, select Utility>Option Installation to enter a key. To purchase a key, contact your Tektronix representative. Select Help>Technical Support to contact Tektronix representative. | The application is not purchased. | Contact your Tektronix representative. |
| E412 | Calibration Data unavailable. | Calibration is not complete for the selected test. | Complete all three Load, Short, Open calibration steps for the selected test. |
| E413 | Unable to find crossover. | Unable to find crossover to place the histogram while 100BASE-TX, and 10BASE-T Jitter tests. | For 100BASE-TX tests, re-run the test. For 10BASE-T tests, select the Show 10Base-T Jitter User Control check box in the Preference dialog box and then re-run the test. When the <i>10Base-T Jitter User Control</i> dialog box appears, adjust the <i>TiggerHoldOff</i> parameter of the oscilloscope. |
| E414 | The selected oscilloscope sources are mutually exclusive. | The same channel is selected for multiple input sources, which are not allowed. | Select separate channel for each input source. |
| E415 | The selected output sources are mutually exclusive. | The same Reference source is selected for output, which is not allowed. | Select separate Reference waveform for output. |
| E416 | External trigger unavailable. Check whether the 'sync Out' of the AWG is connected to the 'AUX IN' of the oscilloscope. In case of the AFG, check whether the 'TTL out' is connected to the 'AUX IN' of the oscilloscope. | The sync/marker1 of the AWG is not connected to the 'AUX IN' of the Oscilloscope. In case of the AFG, the 'TTL out' is not connected to the 'AUX IN' of the oscilloscope. | Connect the sync/marker1 of the AWG to the 'AUX IN' of the Oscilloscope. In case of the AFG, connect the 'TTL out' to the 'AUX IN' of the oscilloscope. |
| E417 | System failure. | There is a problem while allocating a system resource. | Reboot the oscilloscope. |
| E418 | Unknown Error. | If the application has an unknown error, this error message is displayed. | Reboot the oscilloscope. |

| | | | |
|------|--|---|---|
| E419 | Tekscope is not running. TDSET3 will now exit. | This error message appears if you click on Run Test button in the TDSET3 application after you have exit from the TekScope. | Launch the TekScope and then TDSET3 from RunApplication menu to work with TDSET3 application. |
|------|--|---|---|

Table B-1: TDSET3 error messages (cont)

| Code | Error message | Description | Possible solution |
|------|---|---|---|
| E420 | Change the probe attenuation to $\div 10$ before continuing | Probe attenuation switch is set to $\div 1$ and the measured values may be invalid. | Set the attenuation switch of the probe to $\div 10$ before you run the test. |

Note: The Error Message E419 appears only if you are running the TDSET3 application on a TDS5000B series oscilloscope.

Remote GPIB Error Messages

Table B-1: Remote GPIB error messages

| Code | Error message | Description | Possible solution |
|------|--|---|--|
| E601 | GPIB write failure | The oscilloscope did not accept the GPIB write command. | Reboot the oscilloscope. |
| E602 | GPIB read failure | The oscilloscope did not accept the GPIB read command. | Reboot the oscilloscope. |
| E603 | Unable to clear event queue | The oscilloscope event queue was not cleared. | Reboot the oscilloscope. |
| E604 | Invalid value set; variable reset to nearest limit value | The value set was not within the acceptable range. | The variable value has been reset. |
| E605 | Conversion error: value reset to the old value | The value set characteristics do not match. | The variable value has been reset. |
| E606 | Application setup file unavailable | The setup file is missing. | Resend the command with the appropriate file name. |
| E607 | Selected test to query the result details is invalid | Invalid test chosen for result details query. | Resend the command with the appropriate test name. |
| E608 | Selected test has not been run | Querying for a result before the test is run or the error E106 | Run the test and then query for the results. |
| E609 | Invalid value is set, old value will be reset | The value set characteristics do not match. | The variable value has been reset. |
| E610 | Test in progress, unable to retrieve the results | Querying for a result before the test is complete. | Query for results after the test is complete. |
| E611 | Character string too long | The value field is too long. | Resend the command with a value within the acceptable range. |
| E612 | Invalid test/configuration selected | The test or configuration selected does not correspond to the current technology. | Select the appropriate technology and then select the test or configuration. |
| E613 | Unable to save application settings | The application settings could not be saved to a default file. | Resend the command with a different file name. |

Table B-2: Remote GPIB error messages (cont)

| Code | Error message | Description | Possible solution |
|-------------|---|---|--|
| E614 | You cannot set values for query only commands | You cannot set values for query only commands. | Do not set value for query only commands. |
| E615 | Unable to retrieve remarks, test name unknown. | You seem to have tried to query for a remark block that does not exist. | Query for remarks block between 1 and x where x is the response for "remcounter". |
| E616 | Unable to retrieve remarks for specified block id | You are asking for remarks of some test that is not run yet. | Set the "resultfor" and "getremblk" appropriately in that order only and then query for "resultrem". |
| E700 | GPIB Time Out | GPIB command has timed out. | Reboot the oscilloscope. |