

**RSA6106A/RSA6114A (S/N B020000 and Above),
and RSA6120A
Real-Time Spectrum Analyzer
Service Manual**



077-0250-01

Tektronix

**RSA6106A/RSA6114A (S/N B020000 and Above),
and RSA6120A
Real-Time Spectrum Analyzer
Service Manual**

Copyright © Tektronix. All rights reserved. Licensed software products are owned by Tektronix or its subsidiaries or suppliers, and are protected by national copyright laws and international treaty provisions.

Tektronix products are covered by U.S. and foreign patents, issued and pending. Information in this publication supersedes that in all previously published material. Specifications and price change privileges reserved.

TEKTRONIX and TEK are registered trademarks of Tektronix, Inc.

Contacting Tektronix

Tektronix, Inc.
14200 SW Karl Braun Drive
P.O. Box 500
Beaverton, OR 97077
USA

For product information, sales, service, and technical support:

- In North America, call 1-800-833-9200.
- Worldwide, visit www.tektronix.com to find contacts in your area.

Warranty

Tektronix warrants that this product will be free from defects in materials and workmanship for a period of one (1) year from the date of shipment. If any such product proves defective during this warranty period, Tektronix, at its option, either will repair the defective product without charge for parts and labor, or will provide a replacement in exchange for the defective product. Parts, modules and replacement products used by Tektronix for warranty work may be new or reconditioned to like new performance. All replaced parts, modules and products become the property of Tektronix.

In order to obtain service under this warranty, Customer must notify Tektronix of the defect before the expiration of the warranty period and make suitable arrangements for the performance of service. Customer shall be responsible for packaging and shipping the defective product to the service center designated by Tektronix, with shipping charges prepaid. Tektronix shall pay for the return of the product to Customer if the shipment is to a location within the country in which the Tektronix service center is located. Customer shall be responsible for paying all shipping charges, duties, taxes, and any other charges for products returned to any other locations.

This warranty shall not apply to any defect, failure or damage caused by improper use or improper or inadequate maintenance and care. Tektronix shall not be obligated to furnish service under this warranty a) to repair damage resulting from attempts by personnel other than Tektronix representatives to install, repair or service the product; b) to repair damage resulting from improper use or connection to incompatible equipment; c) to repair any damage or malfunction caused by the use of non-Tektronix supplies; or d) to service a product that has been modified or integrated with other products when the effect of such modification or integration increases the time or difficulty of servicing the product.

THIS WARRANTY IS GIVEN BY TEKTRONIX WITH RESPECT TO THE PRODUCT IN LIEU OF ANY OTHER WARRANTIES, EXPRESS OR IMPLIED. TEKTRONIX AND ITS VENDORS DISCLAIM ANY IMPLIED WARRANTIES OF MERCHANTABILITY OR FITNESS FOR A PARTICULAR PURPOSE. TEKTRONIX' RESPONSIBILITY TO REPAIR OR REPLACE DEFECTIVE PRODUCTS IS THE SOLE AND EXCLUSIVE REMEDY PROVIDED TO THE CUSTOMER FOR BREACH OF THIS WARRANTY. TEKTRONIX AND ITS VENDORS WILL NOT BE LIABLE FOR ANY INDIRECT, SPECIAL, INCIDENTAL, OR CONSEQUENTIAL DAMAGES IRRESPECTIVE OF WHETHER TEKTRONIX OR THE VENDOR HAS ADVANCE NOTICE OF THE POSSIBILITY OF SUCH DAMAGES.

[W2 – 15AUG04]

Table of Contents

| | |
|------------------------------|-----|
| General Safety Summary | v |
| Service Safety Summary | vii |
| Preface | ix |
| Manual Content | ix |
| Manual Conventions | ix |
| Related User Documents | x |

Operating Information

| | |
|-----------------------------|-----|
| Operating Information | 1-1 |
|-----------------------------|-----|

Theory of Operation

| | |
|----------------------------------|-----|
| Theory of Operation | 2-1 |
| General | 2-1 |
| Signal Path and Processing | 2-1 |
| Display Panel | 2-2 |
| Front Panel | 2-2 |
| Rear Panel | 2-2 |
| Power Supply | 2-3 |
| Fans | 2-3 |

Adjustment Procedures

| | |
|----------------------------|-----|
| Adjustment Procedure | 3-1 |
| Running Alignments | 3-1 |

Maintenance

| | |
|--|------|
| Maintenance | 4-1 |
| Preventing ESD | 4-1 |
| Inspection and Cleaning | 4-2 |
| Restoring the Windows Operating System (OS) | 4-5 |
| Creating a Disk Backup Image | 4-6 |
| Restoring the Instrument Operating System | 4-7 |
| Formatting the Drive in Option 06/08 Instruments | 4-7 |
| Restoring the Operating System from the Instrument Hard Disk (Options 06/07) | 4-9 |
| Restoring the Hard Disk from a Backup Image | 4-9 |
| Removal and Installation Procedures | 4-11 |
| Preparation | 4-11 |
| Trim, Cabinet, and Module Removal | 4-13 |

| | |
|--------------------------------|------|
| Removal Procedures..... | 4-15 |
| Troubleshooting..... | 4-20 |
| Service Level..... | 4-20 |
| Check for Common Problems..... | 4-20 |
| Diagnostics..... | 4-23 |

Replaceable Parts

| | |
|---------------------------------------|-----|
| Replaceable Parts..... | 5-1 |
| Parts Ordering Information..... | 5-1 |
| Using the Replaceable Parts List..... | 5-3 |

List of Figures

| | |
|---|------|
| Figure 2-1: RSA6100A Series block diagram..... | 2-4 |
| Figure 4-1: Primary customer replaceable module locations..... | 4-14 |
| Figure 4-2: Status indicator locations..... | 4-22 |
| Figure 4-3: Diagnostics Power On Self Test results view..... | 4-24 |
| Figure 4-4: Diagnostics Failure Info tab..... | 4-24 |
| Figure 4-5: Event viewer initial display..... | 4-25 |
| Figure 4-6: Event viewer applications error view..... | 4-26 |
| Figure 4-7: Event Properties window, showing error log information..... | 4-26 |
| Figure 4-8: Starting Extended Diagnostics..... | 4-27 |
| Figure 4-9: Embedded Diagnostics Interface..... | 4-28 |
| Figure 4-10: Diagnostics test iteration control..... | 4-28 |
| Figure 5-1: External parts..... | 5-5 |
| Figure 5-2: Display, front panel, DVD, and removeable hard drive..... | 5-7 |
| Figure 5-3: Detail 1 of display, front panel, DVD, and removeable hard drive cabling..... | 5-8 |
| Figure 5-4: Detail 2 of display, front panel, and removable hard drive cabling..... | 5-9 |
| Figure 5-5: Detail 3 of display, front panel, DVD, and removeable hard drive cabling..... | 5-10 |
| Figure 5-6: Modules..... | 5-12 |
| Figure 5-7: Detail 1 of Slot PC cabling..... | 5-13 |
| Figure 5-8: Detail 2 of Slot PC cabling..... | 5-14 |
| Figure 5-9: Detail of RT/IQ Option 05 cabling..... | 5-15 |
| Figure 5-10: Power supply and internal hard drive..... | 5-17 |
| Figure 5-11: Detail 1 of power supply and internal hard drive cabling..... | 5-18 |
| Figure 5-12: Detail 2 of power supply and internal hard drive cabling..... | 5-19 |
| Figure 5-13: Upper and lower deck fans..... | 5-21 |
| Figure 5-14: Detail of cabling shown in Figure 5-13..... | 5-22 |
| Figure 5-15: RF interface board and cables..... | 5-24 |

List of Tables

| | |
|---|------|
| Table 2-1: Rear panel connectors | 2-2 |
| Table 4-1: External inspection checklist | 4-3 |
| Table 4-2: Internal inspection check list | 4-4 |
| Table 4-3: Tools required for module removal | 4-12 |
| Table 4-4: Legend for Accessing Modules table | 4-13 |
| Table 4-5: Accessing Modules | 4-13 |
| Table 4-6: Power conversion board connectors | 4-18 |
| Table 4-7: Failure symptoms and possible causes | 4-20 |
| Table 4-8: Power Converter board status indicators | 4-23 |
| Table 4-9: Digital Interface board status indicators | 4-23 |
| Table 4-10: Diagnostic error messages | 4-29 |
| Table 5-1: External parts | 5-4 |
| Table 5-2: Display, front panel, DVD, and removeable hard drive | 5-6 |
| Table 5-3: Modules | 5-11 |
| Table 5-4: Power supply and internal hard drive | 5-16 |
| Table 5-5: Upper and lower deck fans | 5-20 |
| Table 5-6: RF interface board and cables | 5-23 |

General Safety Summary

Review the following safety precautions to avoid injury and prevent damage to this product or any products connected to it.

To avoid potential hazards, use this product only as specified.

Only qualified personnel should perform service procedures.

While using this product, you may need to access other parts of a larger system. Read the safety sections of the other component manuals for warnings and cautions related to operating the system.

To Avoid Fire or Personal Injury

Use Proper Power Cord. Use only the power cord specified for this product and certified for the country of use.

Ground the Product. This product is grounded through the grounding conductor of the power cord. To avoid electric shock, the grounding conductor must be connected to earth ground. Before making connections to the input or output terminals of the product, ensure that the product is properly grounded.

Observe All Terminal Ratings. To avoid fire or shock hazard, observe all ratings and markings on the product. Consult the product manual for further ratings information before making connections to the product.

The inputs are not rated for connection to mains or Category II, III, or IV circuits.

Power Disconnect. The power cord disconnects the product from the power source. Do not block the power cord; it must remain accessible to the user at all times.

Do Not Operate Without Covers. Do not operate this product with covers or panels removed.

Do Not Operate With Suspected Failures. If you suspect that there is damage to this product, have it inspected by qualified service personnel.

Avoid Exposed Circuitry. Do not touch exposed connections and components when power is present.

Replace Batteries Properly. Replace batteries only with the specified type and rating.

Use Proper Fuse. Use only the fuse type and rating specified for this product.

Wear Eye Protection. Wear eye protection if exposure to high-intensity rays or laser radiation exists.

Do Not Operate in Wet/Damp Conditions.

Do Not Operate in an Explosive Atmosphere.

Keep Product Surfaces Clean and Dry.

Provide Proper Ventilation. Refer to the manual's installation instructions for details on installing the product so it has proper ventilation.

Terms in this Manual These terms may appear in this manual:



WARNING. *Warning statements identify conditions or practices that could result in injury or loss of life.*



CAUTION. *Caution statements identify conditions or practices that could result in damage to this product or other property.*

Symbols and Terms on the Product

These terms may appear on the product:

- DANGER indicates an injury hazard immediately accessible as you read the marking.
- WARNING indicates an injury hazard not immediately accessible as you read the marking.
- CAUTION indicates a hazard to property including the product.

The following symbol(s) may appear on the product:



Service Safety Summary

Only qualified personnel should perform service procedures. Read this *Service Safety Summary* and the *General Safety Summary* before performing any service procedures.

Do Not Service Alone. Do not perform internal service or adjustments of this product unless another person capable of rendering first aid and resuscitation is present.

Disconnect Power. To avoid electric shock, switch off the instrument power, then disconnect the power cord from the mains power.

Use Care When Servicing With Power On. Dangerous voltages or currents may exist in this product. Disconnect power, remove battery (if applicable), and disconnect test leads before removing protective panels, soldering, or replacing components.

To avoid electric shock, do not touch exposed connections.

Preface

This is the service manual for the RSA6100A Series Real-time Spectrum Analyzers.

Read this preface to learn how this manual is structured, what conventions it uses, and where you can find other information related to servicing this product.

Manual Content

This manual contains only information related to servicing an RSA6100A Series Real-time Spectrum Analyzer. For information related to installing and operating the instrument or for a list of instrument specifications, refer to the appropriate user document as described in *Related User Documents* on the following page.

Be sure to read the introductions to all procedures. These introductions provide important information needed to perform the service correctly, safely, and efficiently.

Manual Conventions

This manual uses certain conventions that you should become familiar with before attempting service.

Module The term module refers to a collection of items that are replaceable as a unit. A module may contain electrical and mechanical assemblies, circuit boards, and interconnecting cables.

Plug-in Module The term Plug-in Module refers to the units that plug into the Main Digital Interface board.

Replaceable Parts This manual refers to any field-replaceable assembly or mechanical part by its name or generically as a replaceable part. In general, a replaceable part is any circuit board or assembly that is listed in the Replaceable Parts section.

Safety Symbols and terms related to safety appear in the General Safety Summary found at the beginning of this manual. Be sure to read both the General Safety Summary and Service Safety Summary before performing any service to this instrument.

Related User Documents

The following related English user documents are available if you need more information about operating the instrument. These documents are located on the RSA6100A Series Real-time Spectrum Analyzer User Documentation CD-ROM or can be downloaded from the Tektronix Web site (www.tektronix.com/manuals).

- RSA6100A Series Real-time Spectrum Analyzer Quick Start User Manual. This document provides the basic information you need to install and operate the instrument. Included is a listing of the options and accessories available for the instrument.
- RSA6100A Series Real-time Spectrum Analyzer Series Specifications and Performance Verification Technical Reference (English). Contains the following technical information about the instrument:
 - Electrical and physical specifications, including a list of certifications and compliances.
 - A performance verification procedure to check instrument performance against guaranteed specifications.
- RSA6100A Series Real-time Spectrum Analyzer Programmer Manual (English). Describes the GPIB instrument programming commands and interface.
- RSA6100A Series Real-time Spectrum Analyzer Security and Declassification Instructions (English). Provides instruction on how customers with data security concerns can sanitize or remove memory devices from the instrument.

Operating Information

Operating Information

For information on installing and operating your RSA6100A Series Real-time Spectrum Analyzer, refer to the Quick Start User Manual.

Theory of Operation

Theory of Operation

This section provides a basic description of the Real-Time Spectrum Analyzer (RTSA) operation. A block diagram of the instrument is shown in this section. (See Figure 2-1 on page 2-4.)

General

A processor system controls the RSA6100A instrument. The instrument features an XGA resolution flat-panel display, a transparent touch-screen, and a front-panel with direct access to commonly used RTSA features. You can also use the RTSA with a mouse or other pointing device, and/or a keyboard.

The RTSA uses the Microsoft Windows XP operating system.

Signal Path and Processing

RF Signal Path An RF signal enters the RTSA through a direct coaxial connection (N-type for the RSA6106A and RSA6114A, 3.5 mm for the RSA6120A) to the input connector.

The RF signal path conditions the input signals and passes them to the acquisition system for sampling and processing. The RF signal path consists of three frequency conversion stages, band-limiting filters, and signal level adjustment stages. The purpose of the RF signal path is to translate a band-limited replica of a portion of the input signal range (9 kHz to 6.2 GHz for the RSA6106A, 9 kHz to 14 GHz for the RSA6114A, or 9 kHz to 20 GHz for the RSA6120A) to a intermediate frequency (IF) where it can be sampled by a high dynamic range A/D.

Control of the RF signal path is performed by the processor system.

Acquisition System The acquisition system samples the IF signal and converts it to digital signals. These digital signals are then filtered numerically and processed either for direct display or by measurement applications to provide metrics of signal quality to the user. The acquisition data processing is performed by one of several field-programmable gate arrays (FPGAs) under control of the processor. The processor performs measurement applications.

Processor System The processor system consists of a PCI-based processor board and a digital interface board that connects the processor to the acquisition board.

Trigger Inputs There are two coaxial trigger inputs. One is on the front panel below the display and the other is on the rear panel. Both trigger inputs connect directly to the digital interface board. Trigger signals are processed by an FPGA on the digital interface board. The information from the trigger system is combined with acquisition data by the processor system.

The Trigger Out signal is accessed below the display with a coaxial connection. The trigger out signal comes from the Acquisition Control FPGA via the digital interface board.

Display Panel

Waveforms, spectral traces, measurement results, and control menus are displayed on a 10.4 inch, color, active-matrix LCD display with touch panel.

Display system The display system consists of a display adapter board and inverter board, which sends text and waveform information to the display panel.

Touch Panel The display adapter board sends information from the touch panel to the processor. The touch panel appears as a USB HID device in the Window Device Manager tool.

Front Panel

The processor system reads the front-panel switches and encoder. Any changes in their settings are reported to the processor. The processor also turns the LEDs on and off.

The ON/STBY switch passes through the display adapter board, the digital interface board, and to the processor on the front panel board.

Communication between the processor system and the front panel is performed over an internal USB connection.

The DVD-RW, removable HDD (hard disk drive), or removable solid-state hard drive communicate over an IDE connection directly to the processor system.

Rear Panel

The following table describes the connectors available on the RTSA rear panel.

Table 2-1: Rear panel connectors

| Name | Input or Output | Connector type | Description |
|---------------|-----------------|--------------------|---|
| Reference In | Input | BNC | External time-base reference. See data sheet for signal quality requirements. |
| Reference Out | Output | BNC | 10 MHz output or loop-through of user Reference In signal |
| TekLink™ | Input/Output | Proprietary 40-pin | TekLink™ multi-instrument interface connector |
| LAN | Input/Output | RJ-45 | 10/100/1000baseT Ethernet connector |

Table 2-1: Rear panel connectors (cont.)

| Name | Input or Output | Connector type | Description |
|-------------|------------------------|-----------------------|--|
| USB | Input/Output | USB | Two USB 2.0 connectors |
| Keyboard | Input | PS/2 | Keyboard-only PS/2 connector |
| VGA | Output | D-Sub | External monitor connector |
| Serial | Input/Output | D-Sub | Serial communications port (COM2) to processor system |
| Trigger In | Input | BNC | TTL Gate/trigger input signal |
| Headset | Output | 3.5 mm stereo | External headphone connection |
| +28 V | Output | BNC | Noise source drive power |
| GPIB | Input/Output | IEEE-488 | General Purpose Interface Bus |
| IF Output | Output | BNC | 500 MHz Analog IF Output signal (Option 05) |
| Digital I/Q | Output | 2 x 50 | Two connectors for digital I and Q output signals. (Option 05) |

All connections except the IF Output and Digital I/Q are connected directly to the digital interface board. The IF Output and Digital I/Q outputs are connected to the Real-Time I/Q (RTIQ) option board.

Power Supply

The Power Conversion board provides instrument power. The Power Conversion board consists of several switching supplies that translate and balance the power taken from the power supply module.

Power is distributed from the Power Conversion board to both the RF Deck and the Digital Interface board.

The ON/STBY switch, located on the front panel, controls all of the power to the instrument except for the part of the circuitry in the standby power supply.

Fans

Seven individual fans provide cooling to the RTSA. Three fans are dedicated to the RF Deck and are controlled by the RF Interface. Two fans provide cooling for the digital side of the instrument.

The bulk power supply module has an internal fan. Control signals to the power supply fan are sent through the Power Conversion board from the Digital Interface board.

A seventh fan is resident on the processor board heat sink, and is controlled by the Slot PC board.

If Option 200 is installed, eight individual fans provided cooling to the RTSA.

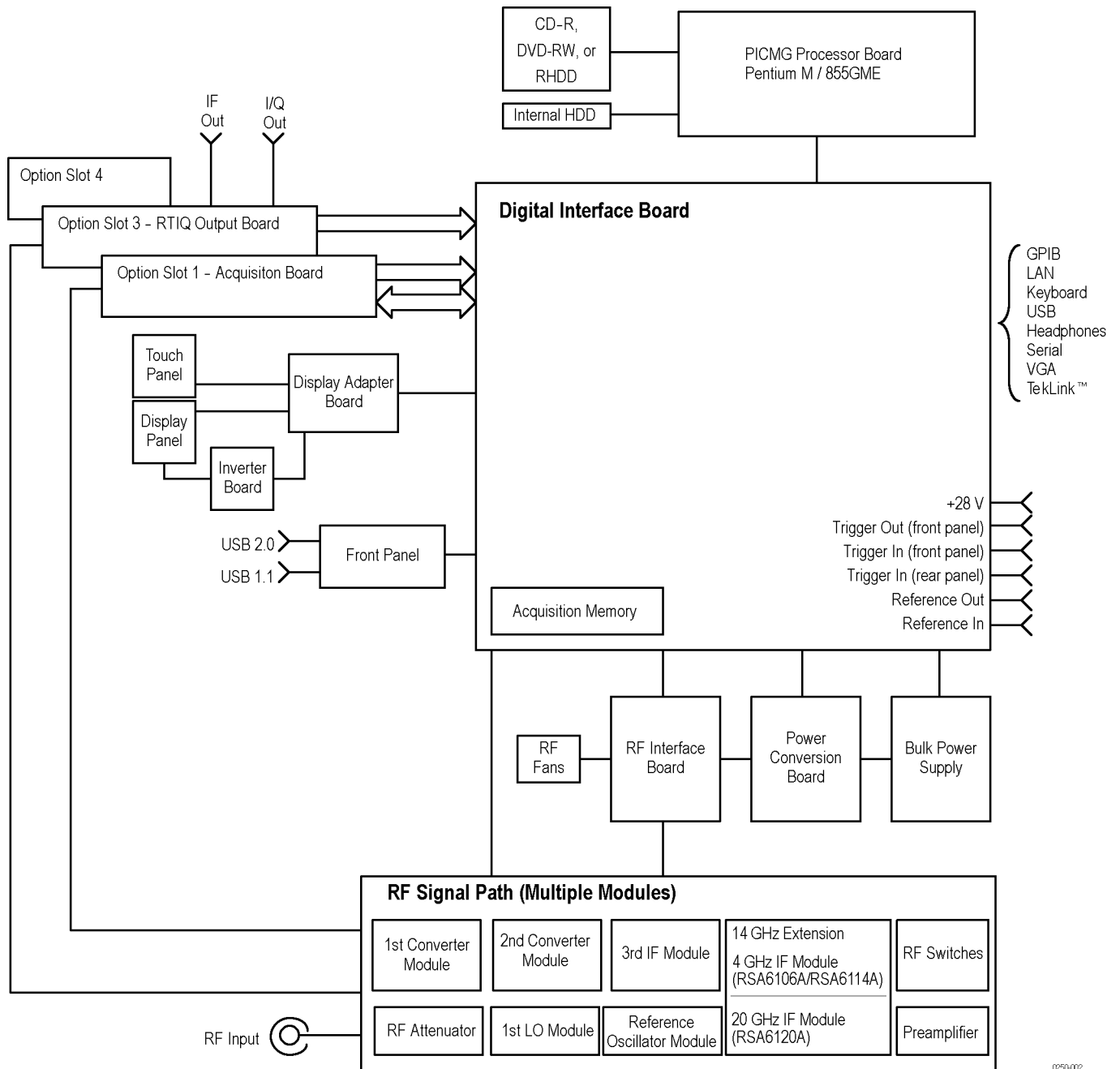

0250-002

Figure 2-1: RSA6100A Series block diagram

Adjustment Procedures

Adjustment Procedure

There are no physical user adjustment procedures for the RSA6100A Series instruments. However, you can run Alignments from the RSA6100A Series application. Alignments are software-controlled adjustment procedures.

Running Alignments

Alignments are adjustment procedures run by the instrument using internal reference signals and measurements, and do not require any external equipment or connections.

There are two settings for Alignments:

- Automatically align as needed (Auto mode)
- Run alignments only when the "Align Now" button is pressed

If **Automatically align as needed** is selected, alignments run whenever the spectrum analyzer detects a sufficient change in ambient conditions to warrant an alignment.

If **Run alignments only when "Align Now" button is pressed** is selected, the spectrum analyzer never runs an alignment unless you manually initiate an alignment using the Align Now button.

NOTE. *There are a few critical adjustments that must run occasionally even if Automatically align as needed is not enabled.*

Alignment Status

When the spectrum analyzer needs to run an alignment, it displays a message on screen. If no message is displayed, you can assume that the spectrum analyzer is properly aligned.

Initiating an Alignment

To initiate an alignment:

1. Select **Setup > Alignments**.
2. Select the **Align Now** button.

The spectrum analyzer will run an alignment procedure. Status messages are displayed while the alignment procedure is running. If the instrument fails the alignment procedure, an error message will be displayed. If the instrument fails an alignment, run Diagnostics (Tools > Diagnostics) to see if you can determine why the alignment failed.

NOTE. *While an alignment is running, both the IF and IQ outputs are disabled.*

Alignments During Warm-Up

Alignments are not run during the 20 minute warm-up period (except, for the RF oscillator alignments) because default alignment values are used, (if Auto mode is selected). During the specified period for warm-up, the instrument performance is not warranted.

Alignments During Normal Operation

Once the spectrum analyzer reaches operating temperature, a full alignment is then run every two hours (for up to two minutes). Alignments can run more frequently if the operating temperature changes. If an alignment becomes necessary during a measurement cycle (if Auto mode is selected), the measurement is aborted and an alignment procedure is run. Once an alignment procedure is completed, the measurement cycle restarts.

Alignments Are Not Calibrations

Alignments are adjustment procedures run by the instrument using internal reference signals and measurements. Calibrations can only be performed at a Tektronix service center and require the use of traceable test equipment (signal sources and measuring equipment) to verify the performance of the instrument.

Maintenance

Maintenance

This section contains the information needed to do periodic and corrective maintenance on the instrument. The following subsections are included:

- *Preventing ESD* — General information on preventing damage by electrostatic discharge.
- *Inspection and Cleaning* — Information and procedures for inspecting the instrument and cleaning its external and internal modules.
- *Removal and Installation Procedures* — Procedures for the removal of defective modules and replacement of new or repaired modules. Also included is a procedure for disassembly of the instrument for cleaning.
- *Troubleshooting* — Information for isolating and troubleshooting failed modules. Included are instructions for operating the instrument diagnostic routines and troubleshooting trees. Most of the trees make use of the internal diagnostic routines to speed fault isolation to a module.
- *Repackaging Instructions* — Information on returning an instrument for service.

Preventing ESD

Before servicing this product, read the *Safety Summary* and *Introduction* at the front of the manual and the ESD information below.



CAUTION. *Static discharge can damage any semiconductor component in this instrument.*

When performing any service that requires internal access to the instrument, adhere to the following precautions to avoid damaging internal modules and their components due to electrostatic discharge (ESD).

1. Minimize handling of static-sensitive circuit boards and components.
2. Transport and store static-sensitive modules in their static protected containers or on a metal rail. Label any package that contains static-sensitive boards.
3. Discharge the static voltage from your body by wearing a grounded antistatic wrist strap while handling these modules. Perform service of static-sensitive modules only at a static-free work station.
4. Do not allow anything capable of generating or holding a static charge on the work station surface.
5. Handle circuit boards by the edges when possible.

6. Do not slide the circuit boards over any surface.
7. Avoid handling circuit boards in areas that have a floor or work-surface covering capable of generating a static charge.

Inspection and Cleaning

Inspection and Cleaning describes how to inspect for dirt and damage. It also describes how to clean the exterior and interior of the instrument. Inspection and cleaning are done as preventive maintenance. Preventive maintenance, when done regularly, may prevent instrument malfunction and enhance its reliability.

Preventive maintenance consists of visually inspecting and cleaning the instrument and using general care when operating it.

How often preventive maintenance should be performed depends on the severity of the environment in which the instrument is used. A proper time to perform preventive maintenance is just before instrument adjustment.

General Care The cabinet helps keep dust out of the instrument and should normally be in place when operating the instrument.

Interior Cleaning Use a dry, low-velocity stream of air to clean the interior of the chassis. Use a soft-bristle, non-static-producing brush for cleaning around components. If you must use a liquid for minor interior cleaning, use a 75% isopropyl alcohol solution and rinse with deionized water.



WARNING. Before performing any procedure that follows, power down the instrument and disconnect it from line voltage. Failure to do so could cause personal injury, or death.

Exterior Cleaning Clean the exterior surfaces of the chassis with a dry lint-free cloth or a soft-bristle brush. If any dirt remains, use a cloth or swab dipped in a 75% isopropyl alcohol solution. Use a swab to clean narrow spaces around controls and connectors. Do not use abrasive compounds on any part of the chassis that may damage the chassis.

Clean the On/Standby switch using a dampened cleaning towel. Do not spray or wet the switch directly.



CAUTION. Avoid the use of chemical cleaning agents which might damage the plastics used in this instrument. Use only deionized water when cleaning the menu buttons or front-panel buttons. Use a 75% isopropyl alcohol solution as a cleaner and rinse with deionized water. Before using any other type of cleaner, consult your Tektronix Service Center or representative.

Inspection — Exterior. Inspect the outside of the instrument for damage, wear, and missing parts, using the following table as a guide. Immediately repair defects that could cause personal injury or lead to further damage to the instrument.

Table 4-1: External inspection checklist

| Item | Inspect for | Repair action |
|-----------------------------------|---|--|
| Cabinet, front panel, and cover | Cracks, scratches, deformations, damaged hardware | Repair or replace defective module |
| Front-panel knob | Missing, damaged, or loose knob | Repair or replace missing or defective knob |
| Connectors | Broken shells, cracked insulation, and deformed contacts; dirt in connectors | Repair or replace defective modules; clear or wash out dirt |
| Carrying handle, and cabinet feet | Correct operation | Repair or replace defective module |
| Accessories | Missing items or parts of items, bent pins, broken or frayed cables, and damaged connectors | Repair or replace damaged or missing items, frayed cables, and defective modules |

Flat Panel Display Cleaning

The display is a soft plastic display and must be treated with care during cleaning.



CAUTION. *Improper cleaning agents or methods can damage the flat panel display. Avoid using abrasive cleaners or commercial glass cleaners to clean the display surface. Avoid spraying liquids directly on the display surface. Avoid scrubbing the display with excessive force.*

Clean the flat panel display surface by gently rubbing the display with a clean-room wipe (such as Wypall Medium Duty Wipes, #05701, available from Kimberly-Clark Corporation).

If the display is very dirty, moisten the wipe with distilled water or a 75% isopropyl alcohol solution and gently rub the display surface. Avoid using excess force or you may damage the plastic display surface.



CAUTION. *To prevent moisture from getting inside the instrument during external cleaning, use only enough liquid to dampen the cloth or applicator.*

Inspection — Interior. To access the inside of the instrument for inspection and cleaning, refer to the *Removal and Installation Procedures* in this section.

Inspect the inside of the instrument for damage and wear, using the following table as a guide. Defects found should be repaired immediately.



CAUTION. *To prevent damage from electrical arcing, ensure that circuit boards and components are dry before applying power to the instrument.*

Table 4-2: Internal inspection check list

| Item | Inspect for | Repair action |
|--------------------|---|--|
| Circuit boards | Loose, broken, or corroded solder connections. Burned circuit boards. Burned, broken, or cracked circuit-run plating. | Remove and replace damaged circuit board. |
| Resistors | Burned, cracked, broken, blistered condition. | Remove and replace damaged circuit board. |
| Solder connections | Cold solder or rosin joints. | Resolder joint and clean with isopropyl alcohol. |
| Capacitors | Damaged or leaking cases. Corroded solder on leads or terminals. | Remove and replace damaged circuit board. |
| Wiring and cables | Loose plugs or connectors. Burned, broken, or frayed wiring. | Firmly seat connectors. Repair or replace modules with defective wires or cables. |
| Chassis | Dents, deformations, and damaged hardware. | Straighten, repair, or replace defective hardware. |

Cleaning Procedure — Interior. To clean the instrument interior, do the following steps:

1. Blow off dust with dry, low-pressure, deionized air (approximately 9 psi).
2. Remove any remaining dust with a lint-free cloth dampened in isopropyl alcohol (75% solution), and a clean lint-free cloth dampened in warm deionized water. (A cotton-tipped applicator is useful for cleaning in narrow spaces and on circuit boards.)

Lubrication. There is no lubrication required for this instrument.

Restoring the Windows Operating System (OS)

This section contains procedures that describe how to restore the operating system on some models of RSA6100A Series spectrum analyzers.

To determine if your system can use the procedures in this section, do the following:

1. On the spectrum analyzer, click Start > Control Panel.
2. Double-click the System icon.
3. Check the System software version to see if you are running Microsoft Windows XP Embedded or Windows XP Professional.
4. If your instrument is running Microsoft Windows XP Embedded, the restore procedure in this section will not work with your instrument. Use the operating system restore disk that shipped with your instrument to restore the operating system.
5. If your instrument is running Microsoft Windows XP Professional, check the Windows desktop for a shortcut to Acronis True Image.
 - a. If your instrument does not have a shortcut to Acronis True Image, the restore procedure in this section will not work with your instrument. Use the operating system restore disk that shipped with your system to restore the operating system.
 - b. If your instrument does have a shortcut to Acronis True Image, the restore procedure in this section works with your instrument. Follow the procedures in this section to restore the operating system on your instrument.

NOTE. *Some instruments did not ship with operating system restore disks. The procedures in this section apply only to instruments that did not ship with operating system restore disks.*

For Option 06/07 instruments, files to restore the operating system are located on a partition of the hard drive. For Option 08 instruments, you should use the Creating a Disk Backup Image procedure below, before placing the instrument into service, to create a file that you can use to restore the operating system. The Creating a Disk Backup Image procedure can also be used for Option 06/07 instruments.

For Option 08 instruments (and Option 06/07 if you use the Create a Disk Backup Image procedure), the restore procedure also restores the product software, thus, you do not have to restore the product software after performing the restore procedure.

Creating a Disk Backup Image

Use the following procedure to backup the hard drive or solid-state drive in your instrument as a disk backup image (for Option 08 instruments, this is the only way to create a backup of the drive). You will use the disk backup image to restore the hard drive or solid-state hard drive should the drive become corrupted.

Prerequisites

You will need:

- An external USB hard drive or a connection to a Local Area Network with write permissions on a server.

Create the Backup Image

To create a disk backup image:

1. Connect the instrument to a local area network.
2. On the instrument Microsoft Windows desktop, double-click the **Acronis TrueImage** icon.
3. Click **Backup** to run the Create Backup Wizard.
4. Click **Next**.
5. Click the check box for **Disk 1** if it is not checked.
6. Click **Next** to display the **Backup Archive Selection** screen.
7. Navigate to a location on the local network where you can save a disk backup image.
8. Type in a descriptive name for the backup (such as the instrument model number and serial number or corporate asset number).
9. Click **Next** to display the **Choose Backup Options** screen.
10. Do not change the default settings. Click **Next** to display the **Archive Comments** screen. Type in any comments you want to include with the backup.
11. Click **Next** to display a summary screen that shows the settings to be used to create the disk backup image.
12. Click **Proceed** to begin the backup process.
13. When the backup is complete, click **OK**. Exit the Acronis TrueImage application.

To verify that the disk backup image was created properly:

1. Locate the disk backup image on the local area network. The backup image appears as a single filename with a tib extension (for example, RSA6106A_backup.tib).
2. Double-click the icon for the disk backup image. Double-click the next icon that appears in the window.
3. Compare the files and folders that appear in the root directory of the backup image to the root directory of the solid-state drive. If the files and folders in the backup image are the same as the files and folders in the root directory of the solid-state drive, the backup completed correctly. If you do not see the same files and folders, repeat the disk backup procedure.

Restoring the Instrument Operating System

You can restore the instrument operating system from either a file on the instrument hard disk drive (Options 06/07 only), or from a disk backup image (all drive options).



CAUTION. *Using the restore process reformats the hard drive and reinstalls the operating system. All saved data will be lost. If possible, save important files to external media before performing a system restore.*

Formatting the Drive in Option 06/08 Instruments

To ensure a successful operating system restore on instruments with a removable hard drive (Option 06) or solid-state hard drive (Option 08), you should delete the partition before performing the operating system restore procedure. To perform this procedure, you will need a PC with internet access, a CD burner and disk burning software. You will also need an USB external CD drive and keyboard that you can connect to the RSA6100A Series instrument.

To delete the disk partition:

1. On a PC, use a web browser to go to:
<http://www.allbootdisks.com/download/iso.html>
2. Download the DOS6.0_bootdisk.iso image.
3. Burn the ISO image to a CD using disk burning software. Additional information on burning the image to disk is available on the Web page.
4. Attach an external CD drive to the instrument. Verify that the CD drive is set as the first boot device in the BIOS.
5. Attach a keyboard to the instrument.

6. Boot the instrument from the DOS boot disk that you created earlier in this procedure.
7. When the command prompt appears, type:
Fdisk and press **Enter**,
Type 3 and press **Enter**,
Type 4 and press **Enter**,
Type 1 and press **Enter**,
Type Y and press **Enter**,
Press the escape key twice to exit and reboot the instrument.
8. When the process is complete, restore the operating system to the instrument using the appropriate procedure.

Restoring the Operating System from the Instrument Hard Disk (Options 06/07)

On Option 06/07 instruments, an operating system restore file is saved on a separate partition of the hard drive. The following procedure uses that restore file to restore the operating system.

1. Attach a keyboard to the instrument.
2. Restart the instrument. During the boot-up process you will see the following message at the top of the screen:

Starting Acronis Loader...press F5 for Acronis Startup Recovery Manager

3. Repeatedly press the F5 key until the Acronis True Image Tool opens. There is a three-second time period from when the message appears until the instrument proceeds with the normal instrument startup. If the instrument does not open the Acronis application, power off the instrument, then power on the instrument and try again.
4. Within the Acronis TrueImage window, click **Restore**.
5. In the Confirmation dialog box, click **Yes** to restore the instrument operating system, or **No** to exit the restore process. The restore process takes approximately 30 minutes; the actual time depends on the instrument configuration.

Restoring the Hard Disk from a Backup Image

To restore the hard drive or solid-state hard drive from a backup image, you must be able to access the disk backup image from the instrument. The disk image can be on a network or USB hard drive or flash drive.

Prerequisites

You will need:

- An external USB CD-R/W drive (Option 06/08 only)
- Bootable Rescue Media CD (Tektronix part number 063-4180-XX, a standard accessory that ships with all instruments)
- Backup image of hard drive (See page 4-6, *Creating a Disk Backup Image*.)

To restore the hard drive:

1. Option 06/08: Connect the USB CD-R/W drive to a high-speed USB port on the rear panel.
2. Connect the instrument to the local area network or USB hard drive or flash drive on which the disk backup image is stored.
3. Insert the **Bootable Rescue Media CD** in to the CD drive.

4. Restart the instrument. The **Acronis TrueImage OEM Edition** window opens automatically.
5. Click **Recovery** to run the **Restore Data Wizard**.
6. Click **Next**.
7. Navigate to the location of the disk backup image. Click **Next** to display the **Partition or Disk to Restore** window.
8. Select **Disk 1**. Click **Next** to display the **Restored Hard Disk Drive Location** window.
9. Select **Disk 1** as the Restored Hard Drive. Click **Next** to begin the restore process.
10. Click **OK** when the restore process completes.
11. Remove the **Bootable Rescue Media** CD from the external CD drive and restart the instrument. The instrument opens into the operating system with its settings and appearance set as shipped from the factory.

Removal and Installation Procedures

This subsection contains procedures for the removal and installation of all customer-replaceable mechanical and electrical modules.

Preparation



WARNING. Before doing this or any other procedure in this manual, read the Safety Summary found at the beginning of this manual. Also, to prevent possible injury to service personnel or damage to the instrument components, read *Installation in the RSA6100A Series Real-Time Spectrum Analyzers Quick Start User Manual*, available on the Web at www.tektronix.com/manuals, and *Preventing ESD* in this section.

This subsection contains the following items:

- Preparatory information that you need to properly do the procedures that follow.
- List of tools required to remove and disassemble all modules.
- Procedures for removal and reinstallation of the electrical and mechanical modules.



WARNING. Before doing any procedure in this subsection, disconnect the power cord from the line voltage source. Failure to do so could cause serious injury or death.

NOTE. Read *Equipment Required* for a list of the tools needed to remove and install modules in this instrument. (See Table 4-3 on page 4-12.) Read the *cleaning procedure* before disassembling the instrument for cleaning.

Equipment Required. Most modules in the RSA6100A Series Real-Time Spectrum Analyzers can be removed with a screwdriver handle mounted with a size T15, TORX screwdriver tip. Other tools needed for complete disassembly are listed in the following table.

Table 4-3: Tools required for module removal

| Item no. | Name | Description | General tool number |
|-----------------|----------------------------------|--|----------------------------|
| 1 | Screwdriver handle | Accepts TORX-driver bits | 620-440 |
| 2 | T10 TORX tip | Used for removing instrument screws. TORX-driver bit for T10 size screw heads | 640-235 |
| 3 | T15 TORX tip | Used for removing most instrument screws. TORX-driver bit for T15 size screw heads | 640-247 |
| 4 | 1/8 inch flat-bladed screwdriver | Screwdriver for unlocking cable connectors | Standard tool |
| 5 | #0 Phillips screwdriver | Screwdriver for removing small phillips screws, CDRW, and hard drive | Standard tool |
| 6 | Angle-tip Tweezers | Used to remove front panel knobs | Standard tool |
| 7 | 3/16 inch open-end wrench | Used to remove nut posts | Standard tool |
| 8 | 5/16 inch open-end wrench | Used to remove nut posts | Standard tool |
| 9 | MA-800G Soldering Aid | Used to remove the front panel trim | Standard tool |

Trim, Cabinet, and Module Removal

Use the following two tables to determine items of the instrument that you will need to remove to access replaceable parts. The first table lists items that may need to be removed before you can access a replaceable module. The second table lists customer replaceable modules and which items must be removed to access the replaceable module. The approximate location of the primary customer replaceable modules is shown in the following figure. (See Figure 4-1 on page 4-14.)

Table 4-4: Legend for Accessing Modules table

| | | |
|--------------------------------|--|---------------------------------|
| A - Front Cover (if installed) | F - Internal Cover, top | K - Display Assembly |
| B - Front panel trim | G - Internal Cover, bottom | L - Front Panel |
| C - Pouch (if installed) | H - DVD Drive (if installed) | M - Internal HDD (if installed) |
| D - Cabinet, top | I - Removable HDD/Solid State Drive (if installed) | N - Power Conversion board |
| E - Cabinet, bottom | J - DVD Drive/Removable HDD Frame | O - Power Supply |

Table 4-5: Accessing Modules

| Modules to replace | Remove these items to access the module | | | | | | | | | | | | | | | |
|---|---|---|---|---|---|---|---|---|---|---|---|---|---|---|---|---|
| | A | B | C | D | E | F | G | H | I | J | K | L | M | N | O | |
| Display Assembly | ✓ | ✓ | | | | | | | | | | | | | | |
| Front Panel | ✓ | ✓ | | | | | | | | | | | | | | |
| DVD Drive (if installed) | ✓ | ✓ | | | | | | | | | | | | | | |
| Removable HDD Drive (if installed) | ✓ | ✓ | | | | | | | | | | | | | | |
| Removable Solid State Drive (if installed) | ✓ | ✓ | | | | | | | | | | | | | | |
| DVD Drive/ Removable HDD Frame | ✓ | ✓ | | ✓ | ✓ | ✓ | | | | | | | ✓ | | | |
| Digital Fan Tray (Upper Deck) | ✓ | ✓ | | ✓ | | ✓ | | | | | | | | | | |
| RF Deck Fan Tray | ✓ | ✓ | | | ✓ | | | ✓ | | | | | | | | |
| Real Time IQ/IF Output Acquisition board (if installed) | ✓ | ✓ | | ✓ | | ✓ | | | | | | | | | | |
| RTT/DPSA board | ✓ | ✓ | | ✓ | | ✓ | | | | | | | | | | |
| Slot PC | ✓ | ✓ | | ✓ | | ✓ | | | | | | | | | | |
| Internal HDD (if installed) | ✓ | ✓ | | ✓ | | ✓ | | | | | | | | | | |
| Power Conversion board | ✓ | ✓ | | ✓ | ✓ | ✓ | | ✓ | ✓ | | | | | | | |
| Power Supply | ✓ | ✓ | | ✓ | ✓ | ✓ | | ✓ | ✓ | | | | 1 | | | ✓ |
| RF Interface board | ✓ | ✓ | | ✓ | ✓ | ✓ | ✓ | | | | | | | | | |

¹ Display module does not need to be removed for earlier RSA6106A and RSA6114A models. See removal instructions.

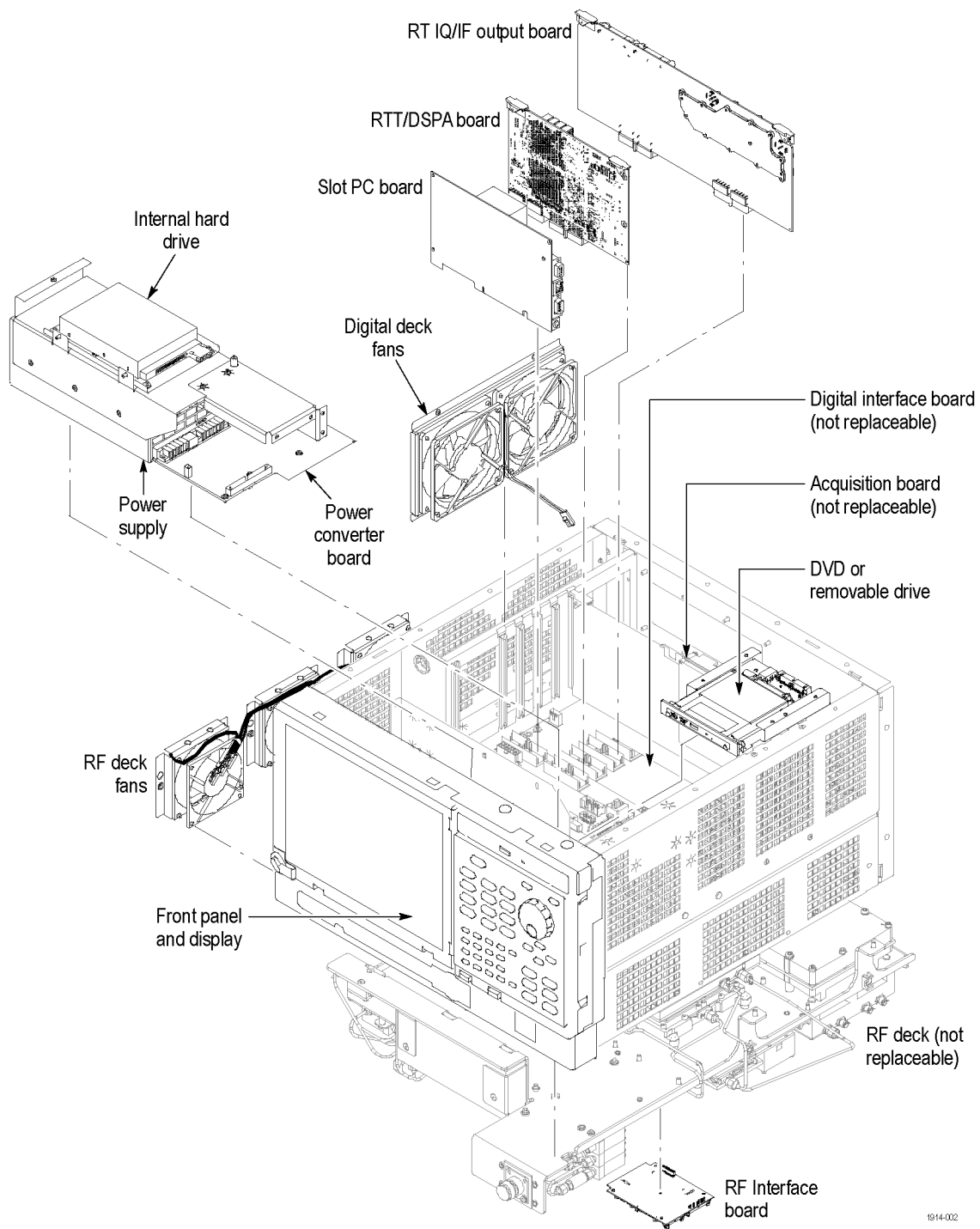

Figure 4-1: Primary customer replaceable module locations

Removal Procedures

NOTE. *Unless directed otherwise, installation is the reverse of the removal procedure.*

These procedures assume you have access to the module you are removing. Use the tables to determine which trim and/or modules to remove to gain access. (See Table 4-4 on page 4-13.) (See Table 4-5 on page 4-13.) A figure is also provided as a quick reference for customer replaceable module locations. (See Figure 4-1 on page 4-14.)



CAUTION. *When removing or installing the keypad, make sure you do not touch the switch contacts with your fingers. The oils in your fingers will degrade or damage the switch contacts. To help prevent damage to the keypad use cotton gloves when removing or installing the keyboard pad.*



CAUTION. *To avoid damage to the front panel Standby/On switch assembly, do not set the Display module assembly on a work surface. Sliding the instrument over the edge of the work surface could break off the On/Standby switch assembly.*

Display

Perform these steps to remove the Display module:

1. Remove the four screws securing the display to the Main chassis; two on the top and two on the left side.
2. Gently remove the Display module from the Main chassis.



CAUTION. *Be careful when removing and reinstalling the Display module cables. If the connectors have bent pins or are installed incorrectly the Display may be destroyed.*

3. Disconnect the smaller Display cable from J3 on the Display Adapter board.
4. Disconnect the larger Display cable from J2 on the Display Adapter board.

Front Panel

Perform these steps to remove the Front Panel:

1. Remove the six T15 screws that secure the Front Panel to the chassis; two on the top, two on the right side, and two on the front.
2. Pull the Front Panel assembly from the chassis.
3. Disconnect the Front Panel cable from connector J1 on the Front Panel circuit board.

Digital Deck Fans

Perform these steps to remove the fan assembly from the digital deck:

1. Unplug the fan control cable from the Main board connector, marked Fan1 and Fan2.
2. Remove the four T15 TORX screws securing the fan assembly, located on the left side of the instrument.
3. Lift the fan assembly up through the narrow slot between the side panel and the card cage.

NOTE. *You may have a DVD drive, solid-state drive, or a removable HDD mounted above the front panel. If you ordered a solid-state drive or a removable HDD, the instrument will not have an internal hard disk drive.*

DVD Drive

Follow these steps to remove the DVD drive (if installed):

1. Remove the two screws securing the DVD bezel, and remove the bezel.
2. Pull the DVD drive out from the Main chassis.
3. Remove the four screws securing the DVD drive and Adapter board to the DVD drive bracket.

Removable Hard Disk Drive / Solid State Drive

Perform these steps to remove the removable hard disk/solid state drive (if installed):

1. Loosen the thumbscrews securing the drive to the front panel.
2. Grasp the drive assembly by the thumb screws and pull until the handle is exposed. Grasp the handle and pull the assembly straight out of the instrument.
3. Pry the detents retaining the top cover apart, and remove the top cover.
4. Remove the four screws securing the hard drive/solid state drive to the bottom cover.
5. Separate the hard disk drive/solid state drive from the HDD Adapter board.

To Replace the Hard Drive.

1. Connect the hard disk drive/solid state drive to the HDD Adapter board.
2. Attach the hard disk drive/solid state drive to the bottom cover with the four screws removed in the previous procedure.
3. Snap the top cover onto the bottom cover.
4. Leaving the cover/handle extended, push the hard disk drive/solid state drive assembly into place until it stops, ensuring that it is straight. Push the assembly firmly to ensure that the connector is seated properly.

5. Slide the cover/handle in until it stops. It will be almost flush with the back panel.
6. Finger tighten the two thumb screws to ensure that the removable hard disk drive is properly seated.

CD-ROM Drive/Removable HDD Frame

Follow these steps to remove the frame used for the CD-ROM drive or removable hard disk drive:

1. Disconnect the IDE cable from the Slot PC to the CD Drive adapter board.
2. Remove the cable connected to P3 on the Drive Adapter board.
3. Remove the two T10 flathead screws securing the frame to the front of the chassis, through the access holes.
4. Remove the two T15 screws securing the drive frame to the right chassis rail.
5. Remove the drive frame by sliding it toward the back of the spectrum analyzer, and rotating the back of the frame to the left.

Slot PC board

Perform these steps to remove the Slot PC board

1. Lift the Slot PC board from the spectrum analyzer.
2. Disconnect the PC Network cable from the board.

Internal Hard Disk Drive

Follow these steps to remove the internal hard disk drive:

NOTE. *If you have a removable HDD mounted above the front panel you will not have an internal hard disk drive.*

1. Disconnect the IDE cable from the Slot PC to the hard disk drive.
2. Disconnect the DISP ADPTR CTRL and DISP ADPTR VID cables from the Main board.
3. Disconnect the power plug from the hard disk drive.
4. Remove the four T15 screws securing the hard disk drive assembly to the Power Supply shield.
5. Lift the hard disk drive up and remove it from the spectrum analyzer.

Power Conversion board

Perform these steps to remove the Power Conversion board:

1. Remove the cables connected to the Power Conversion board:

Table 4-6: Power conversion board connectors

| Connector | | Connector | |
|-----------|--------------|-----------|--------------------|
| Number | Name | Number | Name |
| J3 | ATX POWER | J6 | CD-ROM/HDD |
| J4 | ANALOG POWER | J7 | Line trigger sense |
| J5 | RF PWR CTRL | | |

2. Remove the four T15 screws securing the Power Converter board to the chassis.
3. Slide the Power Converter board to the right, to disengage the connector to the Power Supply.
4. Lift the Power Converter board from the spectrum analyzer.

Power Supply

Follow these steps to remove the Power Supply assembly:

1. Disconnect the mains wires from the Line Filter on the rear-panel.
2. Remove the RTT/DPSA board.
3. Remove the Slot PC board.
4. Remove the Power Conversion board.
5. Disconnect the EXT TRIG IN (J24) and TRIG OUT (J25) cables from the Main board.
6. Remove the three T15 screws securing the power supply shield tabs to the front chassis.
7. Remove the one T15 screw securing the power supply shield tab to the bottom chassis, toward the rear of the spectrum analyzer.
8. Remove the four T15 screws securing the power supply shield to the bottom chassis. These four are located in the Power Converter footprint, to the right of the power supply.
9. If the Power Supply will not move at this point you have a later model spectrum analyzer. You will need to remove the Display assembly before you can proceed. (See page 4-15, *Display*.)
10. If you had to remove the Display assembly in step 9, remove the two T15 screws that were revealed. These screws secure the power supply to the front chassis.

- 11.** Tip the Power Supply/shield assembly to lift the Power Supply (left) side out of the spectrum analyzer first.
- 12.** Remove the one T15 screw securing the ground wire to the power supply shield.

Troubleshooting



WARNING. Before doing this or any other procedure in this manual, read the Safety Summary found at the beginning of this manual. Also, to prevent possible injury to service personnel or damage to the instrument components, read *Installation in the RSA6100A Series Real-Time Spectrum Analyzers Quick Start User Manual*, available on the Web at www.tektronix.com/manuals, and *Preventing ESD in this section*.

Troubleshooting contains information and procedures designed to help you isolate faults to a module.

This subsection assumes that service personnel have the skills required to work on the Real-Time Spectrum Analyzer, including PC troubleshooting and Windows operating system skills. Details of PC and Windows operation and service are not in this manual.

For assistance, please contact your local Tektronix Service Center.

Service Level

This section contains information and procedures designed to help you isolate faulty modules in the RSA6100A Series Real-Time Spectrum Analyzer. If a module needs to be replaced, follow the *Removal and Installation Procedures*, located in this section.

Check for Common Problems

Use the following table to quickly isolate possible failures. The table lists problems and possible causes. The list is not exhaustive, but it may help you eliminate a problem that is quick to fix, such as a blown fuse or loose cable.

Table 4-7: Failure symptoms and possible causes

| Symptom | Possible cause(s) |
|------------------------------|---|
| Instrument will not power on | <ul style="list-style-type: none"> ■ Power cord not plugged in ■ Faulty power supply (check Status LEDs) ■ Faulty power conditioner board ■ Faulty front panel power switch ■ Faulty display adapter board |

Table 4-7: Failure symptoms and possible causes (cont.)

| Symptom | Possible cause(s) |
|--|--|
| Front panel light comes on (instrument powers on), but one or more fans will not operate | <ul style="list-style-type: none"> ■ Faulty fan cable ■ Defective fan assembly ■ Faulty power supply (check Status LEDs) ■ Faulty Slot PC ■ Faulty CPU ■ Digital Interface board problem |
| No beeps on startup or multiple beeps on startup (single beep is OK) | <ul style="list-style-type: none"> ■ Faulty Slot PC |
| Flat panel display blank | <ul style="list-style-type: none"> ■ BIOS setting not Advanced Chipset Features > - On Chip VGA > Enabled - Boot Display > CRT + LFP ■ Defective cable from Slot PC board to Digital Interface board ■ Defective cable from display adapter board to digital interface board ■ Defective cable from inverter board to display adapter board ■ Defective cable from inverter board to backlighting display lamp ■ Defective backlighting display lamp ■ Faulty display ■ Faulty digital interface board ■ Faulty inverter board ■ Faulty display adapter board |

Table 4-7: Failure symptoms and possible causes (cont.)

| Symptom | Possible cause(s) |
|----------------------------------|--|
| DVD-ROM related symptoms | <ul style="list-style-type: none"> ■ Defective DVD-ROM ■ Defective DVD-ROM drive cable ■ Defective DVD-ROM Adapter board ■ Incorrect DVD-ROM configuration in the BIOS setup |
| Hard disk drive related symptoms | <ul style="list-style-type: none"> ■ Defective hard disk drive ■ Incorrect hard disk type selected in the BIOS setup ■ Replaceable hard disk drive not installed ■ Power supply failure ■ Corrupted BIOS module firmware, reinstall firmware ■ Loose cable ■ Corrupted OS image |

Status Indicator LEDs

Check that the Status Indicator LEDs on the Power Converter and Digital Interface boards to ensure the power supplies are operating. (See Figure 4-2.) (See Table 4-8.) (See Table 4-9.)

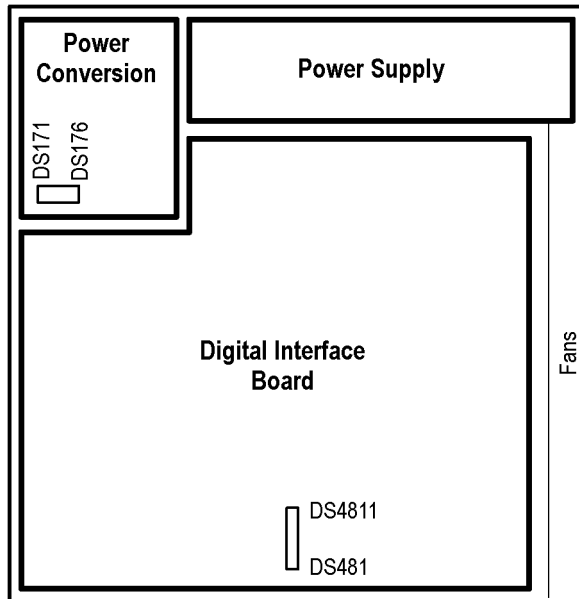

Figure 4-2: Status indicator locations

Table 4-8: Power Converter board status indicators

| LED | Status Indication |
|-------|-------------------|
| DS171 | STANDBY |
| DS172 | -15 V OK |
| DS173 | -8 V OK |
| DS174 | +8 V OK |
| DS175 | +15 V OK |
| DS176 | +30 V OK |

Table 4-9: Digital Interface board status indicators

| LED | Status Indication |
|--------|---------------------------|
| DS481 | CLOCK FAIL (normally off) |
| DS482 | +5 VSB OK |
| DS483 | +5 V OK |
| DS484 | +3.3 V OK |
| DS485 | +2.5 V OK |
| DS486 | +1.8 V OK |
| DS487 | +1.5 V OK |
| DS488 | FPGA INIT |
| DS489 | FPGA DONE |
| DS4810 | STATUS 0 |
| DS4811 | STATUS 1 (normally off) |

Diagnostics

This section describes how to use and interpret the embedded Diagnostics Interface for both the Power On Self Tests (POST) and the Extended Diagnostics tests. These tests are used to determine whether there has been a module failure in the instrument.

Power On Self Tests (POST)

The Power On Self Tests (POST) run automatically, every time the instrument is powered up. If a failure is detected during this process the POST Result view will be displayed to show which module(s) failed. (See Figure 4-3.)

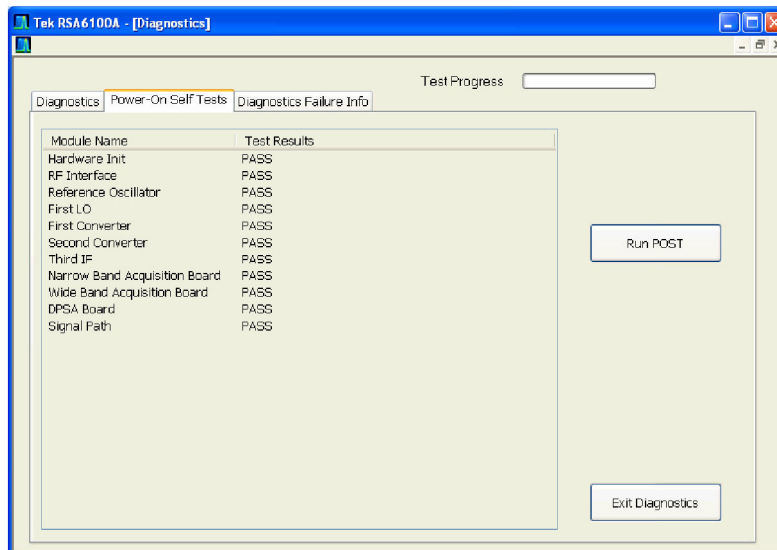

Figure 4-3: Diagnostics Power On Self Test results view

Further information about the failure can be obtained from the **Diags Failure Info** tab in the Diagnostics window. (See Figure 4-4.)

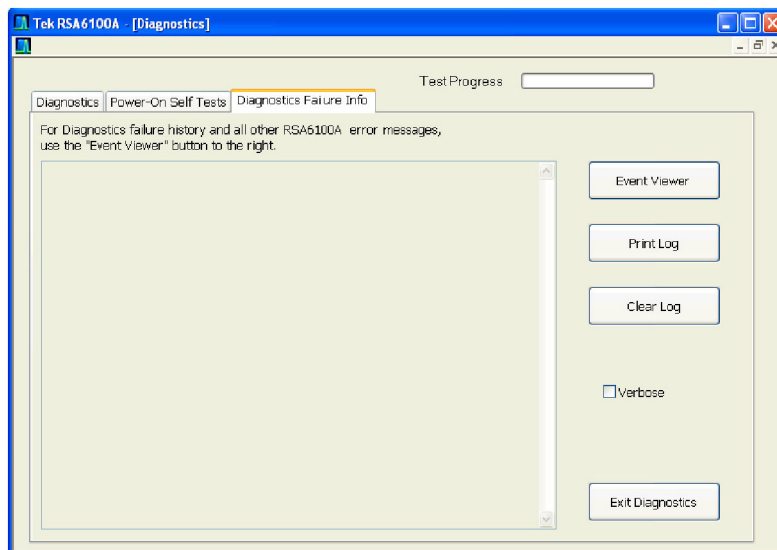

Figure 4-4: Diagnostics Failure Info tab

All failure information is logged in the Windows Event Viewer. You can access the Windows Event Viewer by clicking the Event Viewer button on the Diagnostics Failure Info tab. The Windows Event Viewer is also available in the Administrative Tools portion of the Windows Control Panel.

NOTE. Check the timestamp in the Event Viewer, as errors are stored on disk and may be from earlier power cycles.

Windows Event Viewer

The Windows Event Viewer maintains a permanent record of the Diagnostics Failure information, along with other messages regarding the operating system. If there is not a shortcut to the Event Viewer on the desktop you can access it by clicking the Event Viewer button on the Diagnostics Failure Info tab. (See Figure 4-5.)

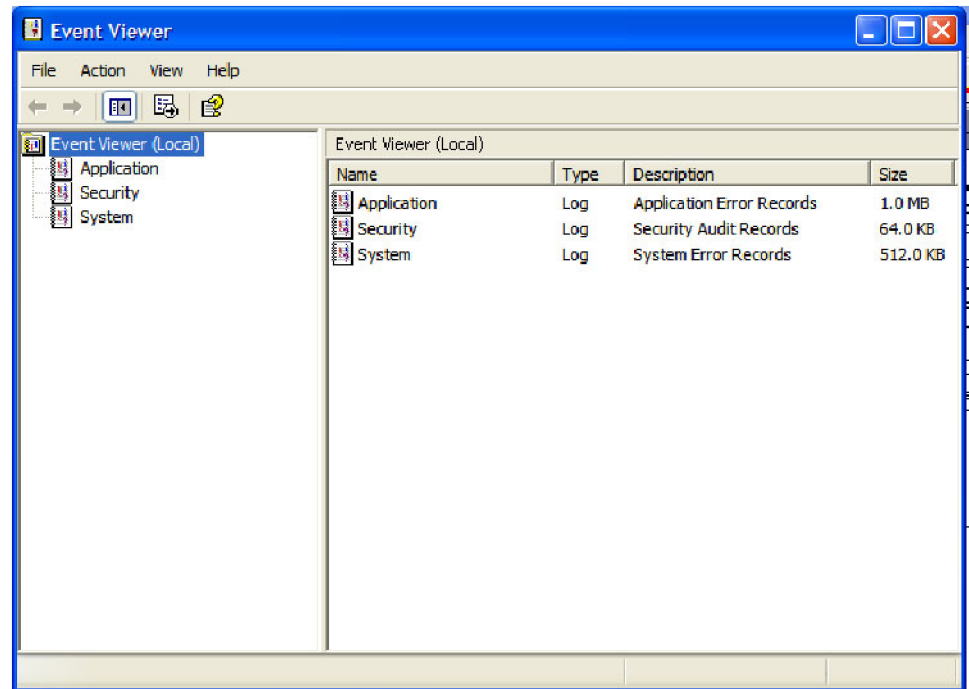

Figure 4-5: Event viewer initial display

To view the Diagnostics failure information, first click the Application icon in the left frame (under Event Viewer (Local)). The view changes to show the individual error reports, as shown in the following figure. Note that this view shows errors, warnings, and information for both the spectrum analyzer application and for the operating system. Pay attention to the date and time stamps, as the information is a permanent record and will show failure information from earlier diagnostic sessions.

Also note that the spectrum analyzer diagnostic errors will show TekRSA in the Source column, to differentiate them from operating system messages.

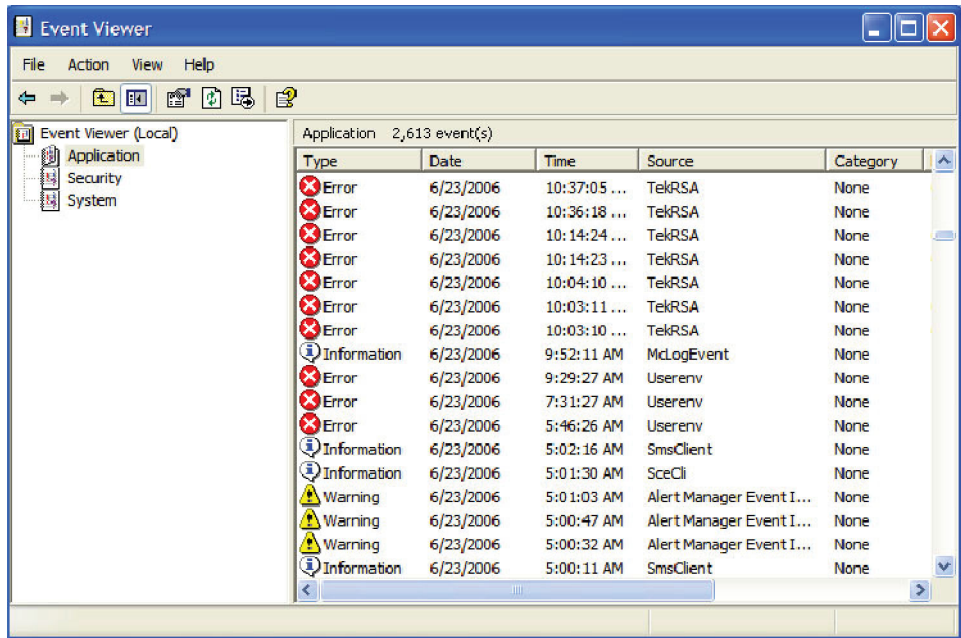

Figure 4-6: Event viewer applications error view

Double-click an error message and the Event Properties window opens for that error message. (See Figure 4-7.)

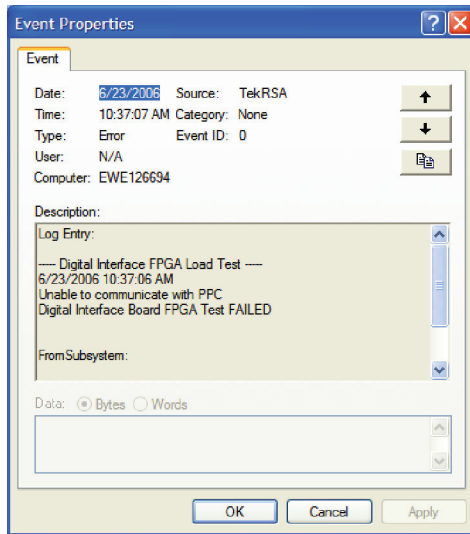

Figure 4-7: Event Properties window, showing error log information

The event properties window shows the date and time the error message was generated and the source of the error message. The text of the error message is shown in the Description area. The three buttons at the upper right are used to navigate through the error list (using the up and down arrows), or to send the record to the default printer.

If you scroll down in the error description, the event viewer always adds a line that says For more information, see Help and Support Center at and includes a link to Microsoft.com. **Do not use this link**, as Microsoft has no information on Tektronix instrument error messages.

Extended Diagnostics

The Extended Diagnostics allow you to run all of the diagnostics tests in the instrument, including the POST tests. Access the Extended Diagnostics by selecting Diagnostics in the Tools menu. (See Figure 4-8.)

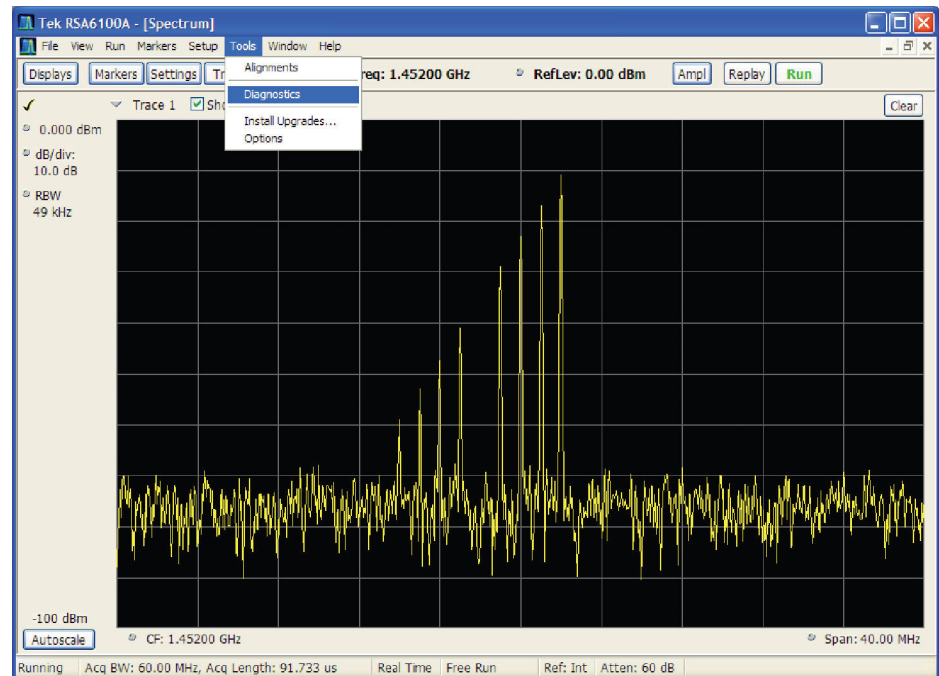

Figure 4-8: Starting Extended Diagnostics

This opens the Embedded Diagnostics Interface. (See Figure 4-9.)

The Diagnostics Interface allows you to select specific tests, and control how many times the selected tests are repeated.

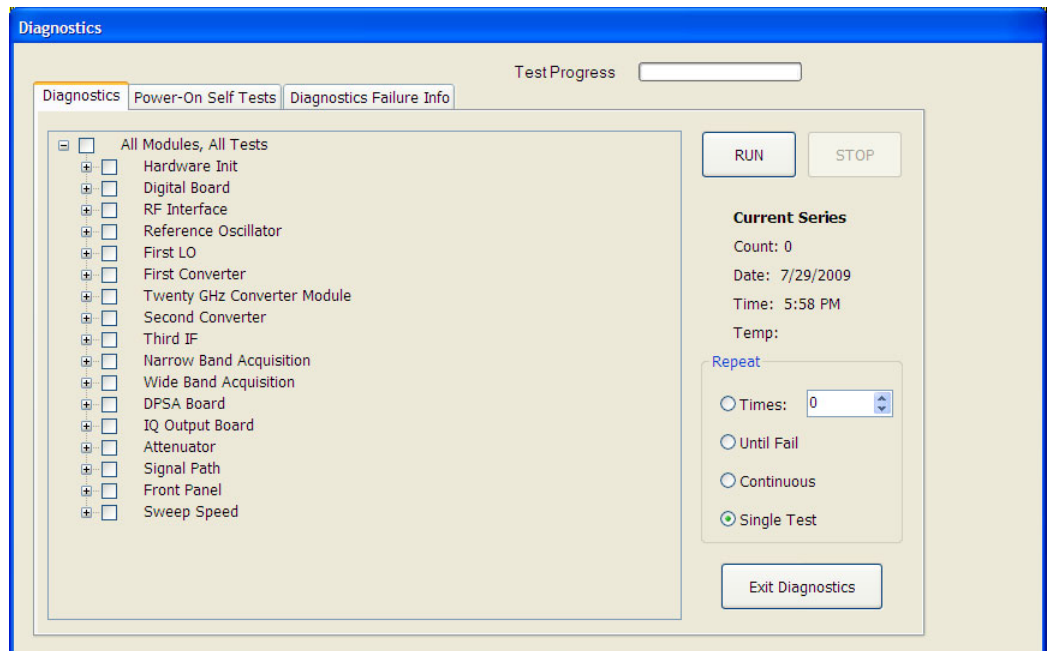

Figure 4-9: Embedded Diagnostics Interface

In the Repeat segment of the window (see the following figure), you can check the radio buttons to:

- A) Repeat the test(s) a specified number of times,
- B) Repeat the test(s) until a failure occurs,
- C) Repeat the test(s) continuously even if failures occur, or
- D) Run the test(s) only one time.

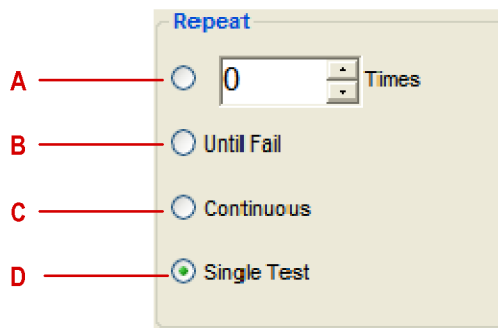

Figure 4-10: Diagnostics test iteration control

While the diagnostic tests are in process, a green dot is shown beside the test that is currently running. If the test completes successfully the green dot is replaced by a black check mark. If the test fails, the green dot is replaced by a red X.

Table 4-10: Diagnostic error messages

| Module | Test | Error message | Recommended action | |
|-------------------------|-------------------------------|--|---|---|
| Hardware | Hardware Init | Digital Interface Board Not Found. | The Slot PC is not communicating with the Digital Interface board. Restart the instrument and, if the problem persists, send the instrument to Tektronix Service Center for repair. | |
| | | Digital Discovery Failed. | Run digital tests in extended diagnostics. | |
| | | The Acquisition Board was not found. | Send the instrument to a Tektronix Service Center for repair. | |
| | | The Continuous Time Acquisition Board was not found. | Replace RTT/DPSA board. | |
| | | Load Digital Interface Board Failed. | Send the instrument to a Tektronix Service Center for repair. | |
| | | RF Interface Board not found or FPGA Load failed. | Replace RF Interface board. | |
| | | First LO not found or FPGA Load failed. | Send the instrument to a Tektronix Service Center for repair. | |
| | | Reference Oscillator not found or FPGA Load failed. | Send the instrument to a Tektronix Service Center for repair. | |
| | | Second Converter not found. | Send the instrument to a Tektronix Service Center for repair. | |
| | | The Third IF not found or FPGA Load failed. | Send the instrument to a Tektronix Service Center for repair. | |
| | | Device Driver Failed. | Possible Acquisition board problem. Restart the spectrum analyzer. If problem persists, return to Tektronix Service Center for repair. | |
| | | Read Programmable Part Versions | Error reading ID's. | Send the instrument to a Tektronix Service Center for repair. |
| | | | | Unable to communicate with PPC. |
| Digital Interface Board | Digital Board ID Verification | Digital Board ID Verification Failed. | Send the instrument to a Tektronix Service Center for repair. | |
| | | Hardware driver is not initialized | Restart the spectrum analyzer. If problem persists, return to Tektronix Service Center for repair. | |
| | Digital Board FPGA Load Test | Bad FPGA file path. | Reinstall the RSA6100A product software (use Tektronix part number 020-2715-XX). | |
| | | Done bit not returned high. | Send the instrument to a Tektronix Service Center for repair. | |

Table 4-10: Diagnostic error messages (cont.)

| Module | Test | Error message | Recommended action |
|---------------------------------|-------------|--|--|
| Digital Board Register R/W Test | | Read value did not match write value. | Send the instrument to a Tektronix Service Center for repair. |
| | | Unable to communicate with Digital Interface Board. | Send the instrument to a Tektronix Service Center for repair. |
| Digital Board SRAM Test | | SRAM memory failure at "memory address" | Send the instrument to a Tektronix Service Center for repair. |
| Hardware Discovery / PPC Load | | Digital Interface Board Not Found. | Restart the instrument and, if the problem persists, send the instrument to a Tektronix Service Center for repair. |
| | | Digital Discovery Failed. | Restart the instrument and, if the problem persists, send the instrument to a Tektronix Service Center for repair. |
| | | The Acquisition Board was not found. | Send the instrument to a Tektronix Service Center for repair. |
| | | The Continuous Time Acquisition Board was not found. | Replace RTT/DPSA board. |
| | | Load Acquisition Board Failed. | Send the instrument to a Tektronix Service Center for repair. |
| | | RF Interface Board not found or FPGA Load failed. | Restart the instrument and, if the problem persists, send the instrument to a Tektronix Service Center for repair. |
| | | First LO not found or FPGA Load failed | Send the instrument to a Tektronix Service Center for repair. |
| | | Reference Oscillator not found or FPGA Load failed. | Send the instrument to a Tektronix Service Center for repair. |
| | | Second Converter not found. | Send the instrument to a Tektronix Service Center for repair. |
| | | The Third IF not found or FPGA Load failed. | Send the instrument to a Tektronix Service Center for repair. |
| Digital FIFO Test | | Device Driver Failed. | Restart the spectrum analyzer. If problem persists, return to Tektronix Service Center for repair. |
| | | Invalid number of return words. | Send the instrument to a Tektronix Service Center for repair. |
| | | Bad value in returned buffer. | Send the instrument to a Tektronix Service Center for repair. |

Table 4-10: Diagnostic error messages (cont.)

| Module | Test | Error message | Recommended action |
|-----------------------------------|--------------------------|---|---|
| | PPC POST Results | PPC returned unknown status. | Send the instrument to a Tektronix Service Center for repair. |
| | | PPC did not return POST status. | Send the instrument to a Tektronix Service Center for repair. |
| | | PPC returned POST fail. | Send the instrument to a Tektronix Service Center for repair. |
| Digital Board Acquisition Test | | Error in returned Acquisition data. | Send the instrument to a Tektronix Service Center for repair. |
| Digital Board SDRAM Test | | Unexpected data in SDRAM memory. | Reseat the DIMM Acquisition memory module in the socket. If the problem persists, send the instrument to a Tektronix Service Center for repair. |
| Digital Board FLASH Test | | Unexpected data in Flash memory. | Send the instrument to a Tektronix Service Center for repair. |
| Digital Board 28 Volt Supply Test | | Verification of this supply is done by the operator. | If 28V is not present at the rear-panel BNC connector, check the +28V at the test point on the power conversion board. If the 28V is not present, replace the power conversion board. If the +28V is present on the power conversion board, send the instrument to a Tektronix Service Center for repair. |
| Digital Board Audio Test | | No audio was heard. | Verify that audio is not muted and level is set properly using Windows Volume control. If this does not correct the problem, send the instrument to a Tektronix Service Center for repair. |
| Narrow Band Acquisition Test | NB ID Verification | ID Verification Failed. | Send the instrument to a Tektronix Service Center for repair. |
| | NB FPGA Load Test | Bad FPGA file path. The file was not found in the directory. | Send the instrument to a Tektronix Service Center for repair. |
| | | FPGA Load Failed. | Send the instrument to a Tektronix Service Center for repair. |
| | | DCM Not locked. | Send the instrument to a Tektronix Service Center for repair. |
| NB Register R/W Test | Read /Write test failed. | Send the instrument to a Tektronix Service Center for repair. | |

Table 4-10: Diagnostic error messages (cont.)

| Module | Test | Error message | Recommended action |
|----------------------------|-------------------------------------|--|---|
| | NB ID, Load, R/W, and DCM Lock Test | Error reading Board ID. | Send the instrument to a Tektronix Service Center for repair. |
| | | FPGA Load Failed. | Send the instrument to a Tektronix Service Center for repair. |
| | | Bad FPGA File Path. File not found in directory. | If the FPGA file was not found, reinstall the RSA6100A Series product software (use Tektronix part number 020-2715-XX). |
| | | Diagnostic R/W Failed. | Send the instrument to a Tektronix Service Center for repair. |
| | | ADC DCM Not Locked. | Send the instrument to a Tektronix Service Center for repair. |
| | | Local Bus DCM Not Locked. | Send the instrument to a Tektronix Service Center for repair. |
| | NB LVDS Test | NB LVDS test failed. | Send the instrument to a Tektronix Service Center for repair. |
| | NB Free Run Trigger Test | Free run trigger test failed. | Send the instrument to a Tektronix Service Center for repair. |
| | NB Acq Pattern Test | Unexpected Acquisition data. | Send the instrument to a Tektronix Service Center for repair. |
| | | Trigger timeout occurred. | Send the instrument to a Tektronix Service Center for repair. |
| | NB Dither Test | Dither amplitude test failed. Dither frequency test failed. | Send the instrument to a Tektronix Service Center for repair. |
| | CW Acquisition Test | ADC Over range. | Signal too strong. Run signal path test. If the signal path test passes and this test fails, send the instrument to a Tektronix Service Center for repair. |
| | | Signal below -50dBm. | Verify that the IF cable from the RF deck to the Narrowband Acquisition board IF connector is firmly connected. Repeat the test, if the problem persists, send the instrument to a Tektronix Service Center for repair. |
| | | No signal found in acquired spectrum. | Verify Normalization source is functional by running the Signal Path test. If that test passes and this test still fails, send the instrument to a Tektronix Service Center for repair. |
| Wide Band Acquisition Test | WB ID Verification | ID Verification Failed. | Send the instrument to a Tektronix Service Center for repair. |

Table 4-10: Diagnostic error messages (cont.)

| Module | Test | Error message | Recommended action |
|-------------------------------------|----------------------|--|--|
| | WB FPGA Load Test | FPGA File Not Found. | Reinstall the RSA6100A Series product software (use Tektronix part number 020-2715-XX). |
| | | FPGA Load Failed. | Send the instrument to a Tektronix Service Center for repair. |
| | | DCM Not locked. | Send the instrument to a Tektronix Service Center for repair. |
| | WB Register R/W Test | Read / Write test failed. | Send the instrument to a Tektronix Service Center for repair. |
| | | Returns read and write values. | Send the instrument to a Tektronix Service Center for repair. |
| WB ID, Load, R/W, and DCM Lock Test | | Error reading board ID. | Send the instrument to a Tektronix Service Center for repair. |
| | | FPGA Load Failed. | Send the instrument to a Tektronix Service Center for repair. |
| | | FPGA File Not Found. | Reinstall the RSA6100A Series product software (use Tektronix part number 020-2715-XX). |
| | | Diagnostic R/W Failed. | Send the instrument to a Tektronix Service Center for repair. |
| | | ADC DCM Not Locked. | Send the instrument to a Tektronix Service Center for repair. |
| | | Local Bus DCM Not Locked. | Send the instrument to a Tektronix Service Center for repair. |
| WB LVDS Test | | WB LVDS test failed. | Send the instrument to a Tektronix Service Center for repair. |
| WB Free Run Trigger Test | | Free run trigger test failed. | Send the instrument to a Tektronix Service Center for repair. |
| WB Acq Pattern Test | | Unexpected Acquisition data. | Send the instrument to a Tektronix Service Center for repair. |
| | | Trigger timeout occurred. | Send the instrument to a Tektronix Service Center for repair. |
| WB Dither Test | | Dither amplitude test failed. Dither frequency test failed. | Send the instrument to a Tektronix Service Center for repair. |
| WB CW Acquisition Test | | ADC Overrange. | Signal too strong. Run signal path test, if that test passes, but this test still fails, send the instrument to a Tektronix Service Center for repair. |

Table 4-10: Diagnostic error messages (cont.)

| Module | Test | Error message | Recommended action |
|---------------|---------------------------------------|--|---|
| | | Signal below -50dBm. | Verify that the IF cable from the RF deck to the Narrowband Acquisition board IF connector is firmly connected. Repeat the test, if the problem persists, send the instrument to a Tektronix Service Center for repair. |
| | | No signal found in acquired spectrum. | Verify Normalization source is functional by running the Signal Path test. If that test passes and this test still fails, send the instrument to a Tektronix Service Center for repair. |
| DPSA Board | DPSA ID Verification | DPSA Board ID Verification Failed. | If ID was not found or a board other than the DPSA Board was found, Version/ID is nonfunctional. Replace the RTT/DPSA Board. |
| | DPSA and Power Trigger FPGA Load Test | Bad DPSA FPGA file path. The file was not found in the directory. | Reinstall the RSA6100A Series product software (use Tektronix part number 020-2715-XX). |
| | | Bad Power Trigger FPGA file path. The file was not found in the directory. | Reinstall the RSA6100A Series product software (use Tektronix part number 020-2715-XX). |
| | | DPSA FPGA Load Failed. | Replace the RTT/DPSA board. If the problem persists, send the instrument to a Tektronix Service Center for repair. |
| | | Power Trigger FPGA Load Failed. | Replace the RTT/DPSA board. If the problem persists, send the instrument to a Tektronix Service Center for repair. |
| | | DCM Not locked. | Replace the RTT/DPSA board. If the problem persists, send the instrument to a Tektronix Service Center for repair. |
| | DPSA Register R/W Test | Read /Write test failed. | Replace the RTT/DPSA board. If the problem persists, send the instrument to a Tektronix Service Center for repair. |
| | | Returns read and write values. | Replace the RTT/DPSA board. If the problem persists, send the instrument to a Tektronix Service Center for repair. |
| | DPSA Frame Transfer Test | FPGA File not found. | Reinstall the RSA6100A Series product software (use Tektronix part number 020-2715-XX). |

Table 4-10: Diagnostic error messages (cont.)

| Module | Test | Error message | Recommended action |
|-----------------|----------------------------|---|--|
| | | FPGA Load Failed. | Replace the RTT/DPSA board. If the problem persists, send the instrument to a Tektronix Service Center for repair. |
| | | Frame data test failed when looking for incrementing pattern. | Replace the RTT/DPSA board. If the problem persists, send the instrument to a Tektronix Service Center for repair. |
| | DPSA LVDS Test | The DPSA LVDS test failed. | Replace the RTT/DPSA board. If the problem persists, send the instrument to a Tektronix Service Center for repair. |
| | FM/AM Audio Test | No audio was heard. | Replace the RTT/DPSA board. If the problem persists, send the instrument to a Tektronix Service Center for repair. |
| First LO Module | First LO ID Test | Board not found. | Run the PPC load test. This will rerun hardware discovery. If error persists, send the instrument to a Tektronix Service Center for repair. |
| | First LO FPGA Load Test | FPGA Load failed. | Send the instrument to a Tektronix Service Center for repair. |
| | First LO Register R/W Test | Read /Write test failed. | Send the instrument to a Tektronix Service Center for repair. |
| | First LO ADC test | Offset loop error exceeds positive threshold. | Warning only. |
| | | Offset loop error exceeds negative threshold. | Warning only. |
| | | Yig loop is unlocked. | Send the instrument to a Tektronix Service Center for repair. |
| | | Coarse loop is unlocked. | Send the instrument to a Tektronix Service Center for repair. |
| | | Fine loop is unlocked. | Send the instrument to a Tektronix Service Center for repair. |
| | | 15V supply voltage is over/under voltage. | Run the RF Interface ADC test to verify a power supply problem. Check the Digital Interface board power supply status LEDs. (See Table 4-9.) |
| | | 8V supply voltage is over/under voltage. | Run the RF Interface ADC test to verify a power supply problem. Check the Digital Interface board power supply status LEDs. (See Table 4-9.) |

Table 4-10: Diagnostic error messages (cont.)

| Module | Test | Error message | Recommended action |
|----------------------------------|---|---|--|
| | | 20V supply voltage is over/under voltage. | Run the RF Interface ADC test to verify a power supply problem. Check the Digital Interface board power supply status LEDs. (See Table 4-9.) |
| First Converter Module | First LO ID Test | Board not found. | Run the PPC load test. This will rerun hardware discovery. If error persists, send the instrument to a Tektronix Service Center for repair. |
| | First LO FPGA Load Test | FPGA Load failed. | Send the instrument to a Tektronix Service Center for repair. |
| | First Converter ADC test | FLK027 IF Ampl Drain over/under Current. | Send the instrument to a Tektronix Service Center for repair. |
| | | FLK107 IF Amp Drain over/under Current. | Send the instrument to a Tektronix Service Center for repair. |
| | | HMC464 LO Amp Drain over/under Current. | Send the instrument to a Tektronix Service Center for repair. |
| | | UA5M20MC LO Amplifier Drain over/under Current. | Send the instrument to a Tektronix Service Center for repair. |
| | | UA5M20MC Doubler Amplifier Drain over/under Current. | Send the instrument to a Tektronix Service Center for repair. |
| | | 5V Supply Over/Under Voltage. | Run the RF Interface ADC test to verify a power supply problem. Check the Digital Interface board power supply status LEDs. (See Table 4-9.) |
| | | 8V Supply Over/Under Voltage. | Run the RF Interface ADC test to verify a power supply problem. Check the Power Conversion board power supply status LEDs. (See Table 4-9.) |
| | 10V Supply Over/Under Voltage. | Run the RF Interface ADC test to verify a power supply problem. Check the Power Conversion board power supply status LEDs. (See Table 4-9.) | |
| 11.5V Supply Over/Under Voltage. | Run the RF Interface ADC test to verify a power supply problem. Check the Power Conversion board power supply status LEDs; see table 4-9. | | |

Table 4-10: Diagnostic error messages (cont.)

| Module | Test | Error message | Recommended action |
|---|---|--|--|
| | | 3V Supply Over/Under Voltage. | Run the RF Interface ADC test to verify a power supply problem. Check the Digital Interface board power supply status LEDs. (See Table 4-9.) |
| | | -5V Supply Over/Under Voltage. | Run the RF Interface ADC test to verify a power supply problem. Check the Power Conversion board power supply status LEDs. (See Table 4-9.) |
| Second Converter Module | Second Converter ID Test | Board not found. | Run the PPC load test. This will rerun hardware discovery. If error persists, send the instrument to a Tektronix Service Center for repair. |
| | Second Converter ADC Test | LO2 Amplitude LOW | Send the instrument to a Tektronix Service Center for repair. |
| | | No LO2 PLL Beatnote. | Send the instrument to a Tektronix Service Center for repair. |
| | | LO2 not Phase Locked. | Send the instrument to a Tektronix Service Center for repair. |
| | | LO2 Frequency control DAC is set too High. | Send the instrument to a Tektronix Service Center for repair. |
| LO2 Frequency control DAC is set too Low. | Send the instrument to a Tektronix Service Center for repair. | | |
| Third IF Module | Third Converter ID Test | Board not found. | Run the PPC load test. This will rerun hardware discovery. If error persists, send the instrument to a Tektronix Service Center for repair. |
| | Third IF FPGA Load Test | FPGA Load failed. | Send the instrument to a Tektronix Service Center for repair. |
| | Third IF Register R/W Test | Read /Write test failed. | Send the instrument to a Tektronix Service Center for repair. |
| | | Returns read and write values. | Send the instrument to a Tektronix Service Center for repair. |
| | Third IF ADC Test | 3rd IF Offset Fine Step Pll not locked. | Send the instrument to a Tektronix Service Center for repair. |
| | | 3rd IF Offset Pll not locked. | Send the instrument to a Tektronix Service Center for repair. |
| | | 3rd IF Output Pll not locked. | Send the instrument to a Tektronix Service Center for repair. |
| | | 3rd IF Output Pll Tune voltage out of range. | Run the RF Interface ADC test to verify a power supply problem. |

Table 4-10: Diagnostic error messages (cont.)

| Module | Test | Error message | Recommended action |
|-----------------------------|--|---|--|
| | | The +5V supply to the 3rd IF board is under voltage. | Run the RF Interface ADC test to verify a power supply problem. Check the Digital Interface board power supply status LEDs. (See Table 4-9.) |
| | | The -12V supply to the 3rd IF board is over voltage. | Run the RF Interface ADC test to verify a power supply problem. |
| | | The 12V supply to the 3rd IF board is over voltage. | Run the RF Interface ADC test to verify a power supply problem. Check the Digital Interface board power supply status LEDs. (See Table 4-9.) |
| | | The 25V supply to the 3rd IF board is over voltage. | Run the RF Interface ADC test to verify a power supply problem. Check the Power Conversion board power supply status LEDs. (See Table 4-9.) |
| | | The +5VA supply to the 3rd IF board is under voltage. | Run the RF Interface ADC test to verify a power supply problem. Check the Digital Interface board power supply status LEDs. (See Table 4-9.) |
| | | The +5VA supply to the 3rd IF board over current. | Send the instrument to a Tektronix Service Center for repair. |
| | | The +5VB supply to the 3rd IF board over current. | Send the instrument to a Tektronix Service Center for repair. |
| | | The +5VC supply to the 3rd IF board over current. | Send the instrument to a Tektronix Service Center for repair. |
| Reference Oscillator Module | Reference Oscillator ID Test | Board not found. | Run the PPC load test. This will rerun hardware discovery. If error persists, send the instrument to a Tektronix Service Center for repair. |
| | Reference Oscillator FPGA Load Test | FPGA Load failed. | Send the instrument to a Tektronix Service Center for repair. |
| | Reference Oscillator Register R/W Test | Read /Write test failed. | Send the instrument to a Tektronix Service Center for repair. |
| | Reference Oscillator ADC test | VXCO is not locked. | Send the instrument to a Tektronix Service Center for repair. |
| | | External Ref PLL is unlocked. | Information only. |
| | | REF_OSC_CW_ALC_DAC is under/over voltage. | Send the instrument to a Tektronix Service Center for repair. |
| | | 100 MHz Tune Voltage is under/over voltage. | Send the instrument to a Tektronix Service Center for repair. |

Table 4-10: Diagnostic error messages (cont.)

| Module | Test | Error message | Recommended action |
|--------------------|-----------------------------|--|--|
| | | 10 MHz Tune Voltage is under/over voltage. | Send the instrument to a Tektronix Service Center for repair. |
| | | Oven is under/over current. | Send the instrument to a Tektronix Service Center for repair. |
| RF Interface Board | RF Interface ID Test | Board not found. | Run the PPC load test. This will rerun hardware discovery. If error persists, replace the RF Interface board. |
| | RF Interface FPGA Load Test | FPGA Load failed. | Replace RF Interface board. |
| | RF Interface ADC test | The 15 Volt supply is over voltage. | Replace the Power Conversion board. If the problem persists, replace the RF Interface board. If the problem persists, replace the power supply. If the problem persists, send the instrument to a Tektronix Service Center for repair. |
| | | The 15 Volt supply is under voltage. | Replace the Power Conversion board. If the problem persists, replace the RF Interface board. If the problem persists, replace the power supply. If the problem persists, send the instrument to a Tektronix Service Center for repair. |
| | | The 8 Volt supply is over voltage. | Replace the Power Conversion board. If the problem persists, replace the RF Interface board. If the problem persists, replace the power supply. If the problem persists, send the instrument to a Tektronix Service Center for repair. |
| | | The 8 Volt supply is under voltage. | Replace the Power Conversion board. If the problem persists, replace the RF Interface board. If the problem persists, replace the power supply. If the problem persists, send the instrument to a Tektronix Service Center for repair. |
| | | The 12 Volt supply is over voltage. | Replace the Power Conversion board. If the problem persists, replace the RF Interface board. If the problem persists, replace the power supply. If the problem persists, send the instrument to a Tektronix Service Center for repair. |

Table 4-10: Diagnostic error messages (cont.)

| Module | Test | Error message | Recommended action |
|---------------|-------------|--------------------------------------|--|
| | | The 12 Volt supply is under voltage. | Replace the Power Conversion board. If the problem persists, replace the RF Interface board. If the problem persists, replace the power supply. If the problem persists, send the instrument to a Tektronix Service Center for repair. |
| | | The 30 Volt supply is over voltage. | Replace the Power Conversion board. If the problem persists, replace the RF Interface board. If the problem persists, replace the power supply. If the problem persists, send the instrument to a Tektronix Service Center for repair. |
| | | The 30 Volt supply is under voltage. | Replace the Power Conversion board. If the problem persists, replace the RF Interface board. If the problem persists, replace the power supply. If the problem persists, send the instrument to a Tektronix Service Center for repair. |
| | | The -8 Volt supply is under voltage. | Replace the Power Conversion board. If the problem persists, replace the RF Interface board. If the problem persists, replace the power supply. If the problem persists, send the instrument to a Tektronix Service Center for repair. |
| | | The -8 Volt supply is under voltage. | Replace the Power Conversion board. If the problem persists, replace the RF Interface board. If the problem persists, replace the power supply. If the problem persists, send the instrument to a Tektronix Service Center for repair. |
| | | The -15 Volt supply is over voltage. | Replace the Power Conversion board. If the problem persists, replace the RF Interface board. If the problem persists, replace the power supply. If the problem persists, send the instrument to a Tektronix Service Center for repair. |

Table 4-10: Diagnostic error messages (cont.)

| Module | Test | Error message | Recommended action |
|---------------|-----------|---|--|
| | | The -15 Volt supply is under voltage. | Replace the Power Conversion board. If the problem persists, replace the RF Interface board. If the problem persists, replace the power supply. If the problem persists, send the instrument to a Tektronix Service Center for repair. |
| | | The -5 Volt supply is over voltage. | Replace the Power Conversion board. If the problem persists, replace the RF Interface board. If the problem persists, replace the power supply. If the problem persists, send the instrument to a Tektronix Service Center for repair. |
| | | The -5 Volt supply is under voltage. | Replace the Power Conversion board. If the problem persists, replace the RF Interface board. If the problem persists, replace the power supply. If the problem persists, send the instrument to a Tektronix Service Center for repair. |
| | | The 2.5 Volt supply is over voltage. | Replace the Power Conversion board. If the problem persists, replace the RF Interface board. If the problem persists, replace the power supply. If the problem persists, send the instrument to a Tektronix Service Center for repair. |
| | | The 2.5 Volt supply is under voltage. | Replace the Power Conversion board. If the problem persists, replace the RF Interface board. If the problem persists, replace the power supply. If the problem persists, send the instrument to a Tektronix Service Center for repair. |
| | | LNA current is too high Upper limit = .095A Current read = .xxA | Send the instrument to a Tektronix Service Center for repair. |
| | | LNA current is too low Lower limit = .055A Current read = .xxxA | Send the instrument to a Tektronix Service Center for repair. |
| 20 GHz Module | ID Test | Board Not Found | Send the instrument to a Tektronix Service Center for repair. |
| | FPGA Load | FPGA Load Failed | Send the instrument to a Tektronix Service Center for repair. |

Table 4-10: Diagnostic error messages (cont.)

| Module | Test | Error message | Recommended action |
|---------------|------------------|---|---|
| | Read/Write Test | Read/Write Test Failed | Send the instrument to a Tektronix Service Center for repair. |
| | Diag ADC Test | 5VA Supply Over Voltage | Send the instrument to a Tektronix Service Center for repair. |
| | | 5VA Supply Under Voltage | Send the instrument to a Tektronix Service Center for repair. |
| | | 5VC Supply Over Voltage | Send the instrument to a Tektronix Service Center for repair. |
| | | 5VC Supply Under Voltage | Send the instrument to a Tektronix Service Center for repair. |
| | | 5VPin Supply Over Voltage | Send the instrument to a Tektronix Service Center for repair. |
| | | 5VPin Supply Under Voltage | Send the instrument to a Tektronix Service Center for repair. |
| | | -40V Supply Under Voltage | Send the instrument to a Tektronix Service Center for repair. |
| | | -40V Supply Over Voltage | Send the instrument to a Tektronix Service Center for repair. |
| | | -5VPin Supply Over Voltage | Send the instrument to a Tektronix Service Center for repair. |
| | | -5VPin Supply Under Voltage | Send the instrument to a Tektronix Service Center for repair. |
| Signal Path | Signal Path Test | The attenuator test failed. | Send the instrument to a Tektronix Service Center for repair. |
| | | The 200 MHz CW normalization source to 3rd IF path test failed. | Send the instrument to a Tektronix Service Center for repair. |
| | | The PRN normalization source to 3rd IF path test failed. | Send the instrument to a Tektronix Service Center for repair. |
| | | The 100 MHz CW normalization source to 3rd IF path test failed. | Send the instrument to a Tektronix Service Center for repair. |
| | | The 3 GHz preamp path test failed. | Send the instrument to a Tektronix Service Center for repair. |
| | | The 200 MHz CW source to NB Acquisition Board path failed. | Send the instrument to a Tektronix Service Center for repair. |
| | | The 200 MHz CW source to WB Acquisition Board path failed. | Send the instrument to a Tektronix Service Center for repair. |

Table 4-10: Diagnostic error messages (cont.)

| Module | Test | Error message | Recommended action |
|---------------|------------------|--|---------------------------------|
| Front Panel | Front Panel Test | Front Panel LCD test failed. | Replace the LCD display. |
| | | Front Panel Button test failed. | Replace the front panel keypad. |
| | Sweep Speed Test | <p>Sweep Speed failed.</p> <p>A failure indicates that the sweep time is too long.</p> <p>Failure limits are set wide: the WB failure limit equals 5 seconds and NB failure limit equals 10 seconds.</p> | Information only. |

Replaceable Parts

Replaceable Parts

This section contains a list of the replaceable modules for the RSA6100A Series Real-time Spectrum Analyzers. Use this list to identify and order replacement parts.

Parts Ordering Information

Replacement parts are available through your local Tektronix field office or representative.

Changes to Tektronix products are sometimes made to accommodate improved components as they become available and to give you the benefit of the latest improvements. Therefore, when ordering parts, it is important to include the following information in your order:

- Part number
- Instrument type or model number
- Instrument serial number
- Instrument modification number, if applicable

If you order a part that has been replaced with a different or improved part, your local Tektronix field office or representative will contact you concerning any change in part number.

Module Servicing

Modules can be serviced by selecting one of the following three options. Contact your local Tektronix service center or representative for repair assistance.

Module Exchange. In some cases you may exchange your module for a remanufactured module. These modules cost significantly less than new modules and meet the same factory specifications. For more information about the module exchange program, call 1-800-833-9200. Outside North America, contact a Tektronix sales office or distributor; see the Tektronix Web site for a list of offices: www.tektronix.com.

Module Repair and Return. You may ship your module to us for repair, after which we will return it to you.

New Modules. You may purchase replacement modules in the same way as other replacement parts.

Using the Replaceable Parts List

This section contains a list of the mechanical and/or electrical components that are replaceable for the instrument. Use this list to identify and order replacement parts. The following table describes each column in the parts list.

| Column | Column name | Description |
|---------|-----------------------|--|
| 1 | Figure & index number | Items in this section are referenced by figure and index numbers to the exploded view illustrations that follow. |
| 2 | Tektronix part number | Use this part number when ordering replacement parts from Tektronix. |
| 3 and 4 | Serial number | Column three indicates the serial number at which the part was first effective. Column four indicates the serial number at which the part was discontinued. No entry indicates the part is good for all serial numbers. |
| 5 | Qty | This indicates the quantity of parts used. |
| 6 | Name & description | An item name is separated from the description by a colon (:). Because of space limitations, an item name may sometimes appear as incomplete. Use the U.S. Federal Catalog handbook H6-1 for further item name identification. |

Abbreviations Abbreviations conform to American National Standard ANSI Y1.1-1972.

Table 5-1: External parts

| Fig. & index number | Tektronix part number | Serial no. effective | Serial no. discont'd | Qty | Name & description |
|---------------------|-----------------------|----------------------|----------------------|-----|---|
| 5-1-1 | 016-1441-01 | | | 1 | ACCESSORY POUCH; BLACK CORDURA |
| -2 | 200-4971-00 | | | 1 | COVER; TOP COSMETIC,ALUM; SAFETY CONTROLLED |
| -3 | 367-0528-00 | | | 1 | HANDLE,CARRYING; DUAL DUROMETER MOLDED,POLYPROPYLENE,VINYL GRIP SECTION,SAFETY CONTROLLED |
| | | | | | **ATTACHED PARTS** |
| | 407-4887-00 | | | 1 | BRACKET; HANDLE BASE,PC/ABS ALLOY,BAYER BAYBLEND FR-110,TEK BLUE,SAFETY CONTROLLED |
| | | | | | **END ATTACHED PARTS** |
| -4 | 212-0234-00 | | | 2 | SCREW,MACHINE; 8-32X 1-1/2 PAN, TORX, ZINC PLATED STEEL, BLACK, 8C150MTPKZ |
| -5 | 211-0720-00 | | | 4 | SCR, ASSEM WSHR; 6-32 X 0.500, PNH, STEEL, ZINC FINISH, T15 TORX DR, MACHINE |
| -6 | 348-1648-00 | | | 4 | FOOT; REAR W/CORD WRAP,THERMO PLASTIC; SAFETY CONTROLLED |
| -7 | 200-4959-01 | | | 1 | COVER; BOTTOM,INTERNAL; SAFETY CONTROLLED |
| -8 | 200-4972-01 | | | 1 | COVER; BOTTOM COSMETIC; SAFETY CONTROLLED |
| -9 | 211-1050-00 | | | 34 | SCREW, MACHINE; 6-32 X 0.312 L, PNH, STEEL, ZINC FINISH, T15 |
| -10 | 200-4519-00 | | | 1 | COVER,FRONT; PC ABS,17.420L X 8.670W X 2.000TH,TEK BLUE |
| -11 | ----- | | | 1 | Replaced by item 19 in this list. |
| -12 | 211-1224-00 | | | 3 | SCREW, 6-32 X 0.375L, PNH, BLACK, T15, NYLOC |
| -13 | ---- | | | 1 | Replaced by item 19 in this list. |
| -14 | 200-4960-01 | | | 1 | COVER; TOP,INTERNAL; SAFETY CONTROLLED |
| -15 | 407-5182-00 | | | 2 | BRACKET,MOUNTING; CARRYING HANDLE, LANCER |
| -16 | 367-0525-00 | | | 2 | HANDLE, CARRYING; 0.375 AL, POWDER COAT, PEKING GRAY FULLER OBRIEN, SAFETY CONTROLLED |
| -17 | 211-1230-00 | | | 4 | SCREW; 10-32X.500 SOC CAP,18-8 ZINC PLATED STEEL |
| -18 | 212-0650-00 | | | 4 | SCREW,MACHINE; 10-32 X 0.437,FLH,100 DEG,SST PSVT,POZ |
| -19 | 333-4591-00 | | | 1 | COSMETIC FRONT (ACQUISITION TO TRIG AND TRIM) |
| not shown | 020-3016-00 | | | 1 | SOFTWARE;OS RESTORE DVD KIT, WINXP EMBEDDED;RSA61XXA SERIES |

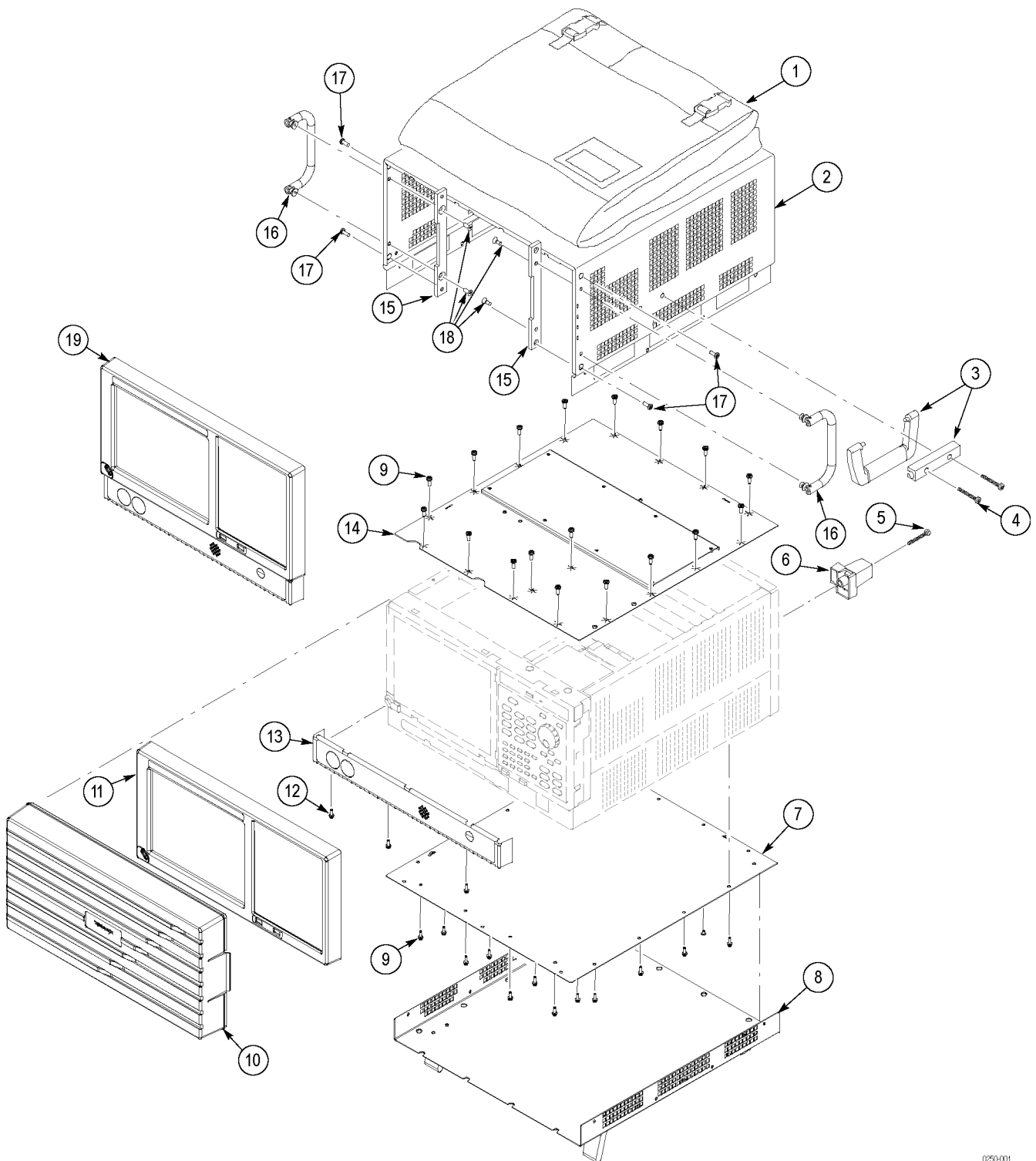

0250-001

Figure 5-1: External parts

Table 5-2: Display, front panel, DVD, and removeable hard drive

| Fig. & index number | Tektronix part number | Serial no. effective | Serial no. discont'd | Qty | Name & description |
|---------------------|-----------------------|----------------------|----------------------|-----|--|
| 5-2-1 | 441-2329-01 | | | 1 | CHASSIS ASSY; HD-FD-FRAME,SAFETY CONTROLLED |
| -2 | 065-0751-00 | | | 1 | DRIVE ASSEMBLY,WITH PACKAGING; REMOVEABLE HARD DISK DRIVE ASSY,650496200,PROGRAMMED, (OPT 06 ONLY) |
| -3 | 679-0221-00 | | | 1 | CKT BD SUBASSY; DVD-CD/RW ADAPTER |
| -4 | 129-1618-00 | | | 1 | SPACER; DVD-CD/RW SLIMLINE DRIVE ADAPTER,PLASTIC |
| -5 | 119-7123-00 | | | 1 | DISK DRIVE; OPTICAL,CD-RW/DVD-R/RW DVD+R/RW,16.7 MB/SEC,650MEG/8.5GIG,IDE/ATAPI;TEAC MODEL DV-W28E-793,ROHS CONV |
| -6 | 407-5070-00 | | | 1 | BRACKET,DVD-CD/RW; ADAPTER FOR DVD-CD/RW,SLIMLINE |
| -7 | 679-5705-00 | | | 1 | IDE1 ADAPTER BOARD |
| -8 | 211-1050-00 | | | 1 | SCREW,MACHINE; 6-32 X 0.312 L,PNH,STEEL, ZINC FINISH,T15 |
| -9 | 407-5057-00 | | | 1 | BRACKET; DVD-REMOVABLE HDD; SAFETY CONTROLLED |
| -10 | 614-1036-02 | | | 1 | FRONT PANEL CONTROL ASSY,(STD); |
| -11 | 174-5080-00 | | | 1 | CA ASSY,SP; IDC,RIBBON,FRT PANEL TO DIG INTF,2X10; SAFETY CONTROLLED |
| -12 | 679-5889-01 | | | 1 | CIRCUIT BD SUBASSY; FRONT PANEL BOARD; 389366300 |
| -13 | 260-2807-00 | | | 1 | SWITCH,KEYPAD; ELASTOMERIC,FRONT PANEL |
| -14 | 333-4511-01 | | | 1 | FRONT SUBPANEL; ASSEMBLY,INCLUDES BRACKET,BEZEL, & LABEL, SAFETY CONTROLLED |
| -15 | 366-0849-00 | | | 1 | KNOB; GENERAL PURPOSE |
| -16 | 259-0155-01 | | | 1 | FLEX CIRCUIT; POWER SWITCH,W/LED |
| -17 | 407-4955-01 | | | 1 | BRACKET,FRONT; DISPLAY,0.050 AL,TOUCH PANEL COMPATABLE,SAFETY CONTROLLED |
| -18 | 650-4470-03 | | | 1 | COMPONENT KIT; TOUCH SCEEN MODULE SUBASSEMBLY,STANDARD |
| -19 | 119-6845-00 | | | 1 | TOUCH SCREEN ; TOUCH PANEL;10.4 ACCUTOUCH, 5-WIRE INTERFACE |
| -20 | 119-6813-00 | | | 1 | DISPLAY MODULE; LCD;1024 X 768;10.4 INCHES DIAGONAL,TFT,CCFL DUAL LAMP EDGE BACK LIGHT 300 NITS,262144 COLORS,18-BIT,LVDS;NL10276BC20-04,SAFETY CONTROLLED |
| -21 | 119-6806-00 | | | 1 | POWER SUPPLY; INVERTER,1200VAC NO-LOAD & 600VAC @ 85KOHM LOADED OUTPUT; 12VDC INPUT,PWM LUMINANCE CONTROLER,65KHZ SWITCHING FREQ,8-PIN & 3-PIN CONNECTORS,USE WITH NEC NL10276BC20-04 DISPLAY(10.4 IN LCDS);105MM X 27MM X 10 MM,SAFETY CONTROLLED |
| -22 | 679-5497-02 | | | 1 | CIRCUIT BD SUB-ASSY; INTERCONNECT DISPLAY ADAPTER;389-3414-00 WIRED;TDS7XXXB |
| -23 | 174-4791-00 | | | 1 | CA ASSY; DISPLAY ADAPTER TO XGA DISPLAY,SAFETY CONTROLLED |
| -24 | 174-4794-00 | | | 1 | CA ASSY; DISPLAY ADAPTER TO INVERTOR,SAFETY CONTROLLED |
| -25 | 174-5087-00 | | | 1 | CA ASSY,SP; IDC,RIBBON,DISP ADAPT TO DIG INTERF,2MM,2X15; SAFETY CONTROLLED |
| -26 | 174-5086-00 | | | 1 | CA ASSY,SP; IDC,RIBBON,DISP ADAPT TO DIG INTERF,2MM,2X10; SAFETY CONTROLLED |
| -27 | 200-4997-00 | | | 1 | COVER; CD,SAFETY CONTROLLED |
| -28 | 211-0718-00 | | | 3 | SCREW, MACHINE; 6-32 X 0.312, FLH100, STEEL, ZINC FINISH, T10 TORX DR |
| -29 | 174-4370-00 | | | 1 | CA ASSY; DESCRETE,CPD,8,22AWG,10.0L,0.200CTR HDR BOTH ENDS,AT POWER |

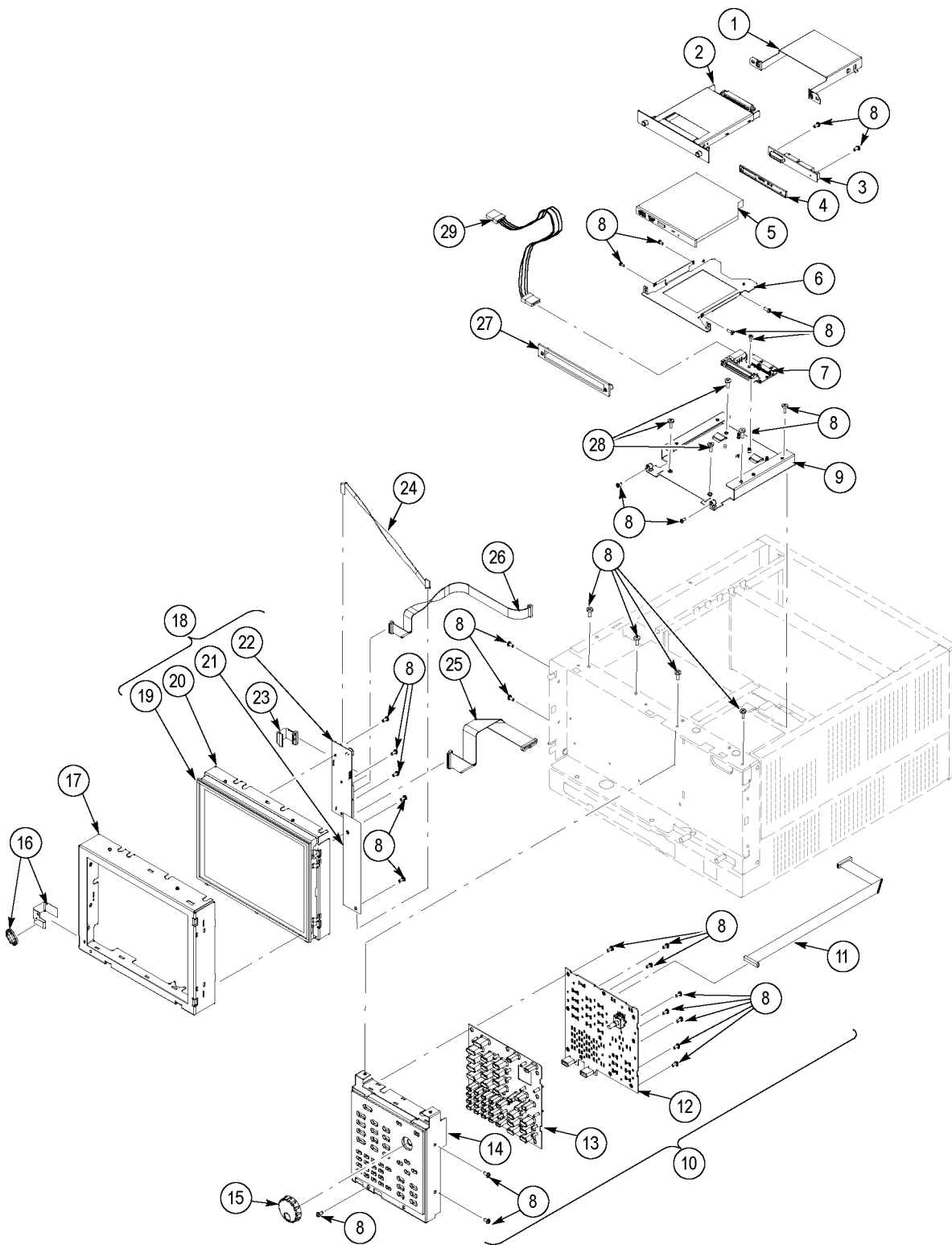

Figure 5-2: Display, front panel, DVD, and removable hard drive

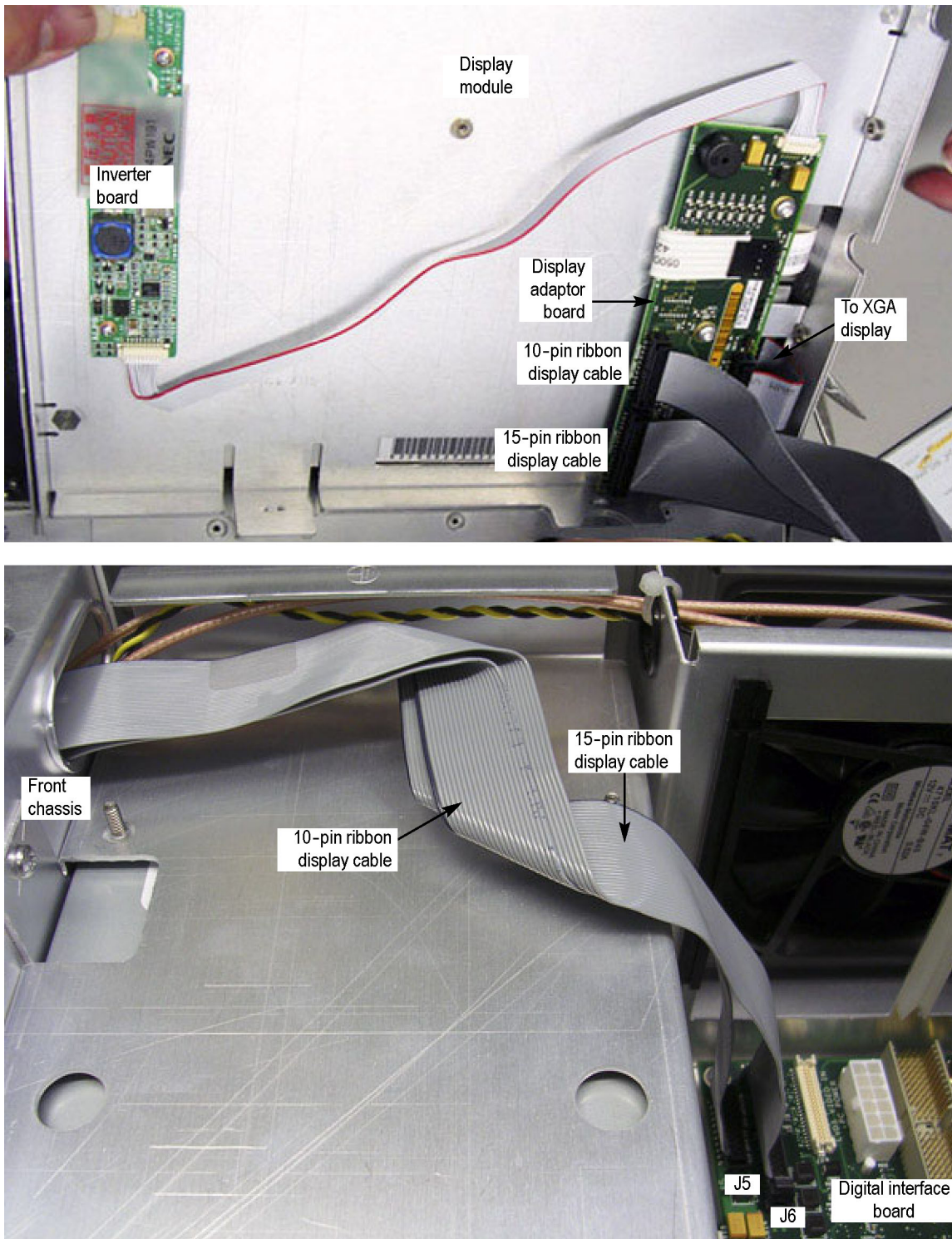

Figure 5-3: Detail 1 of display, front panel, DVD, and removable hard drive cabling

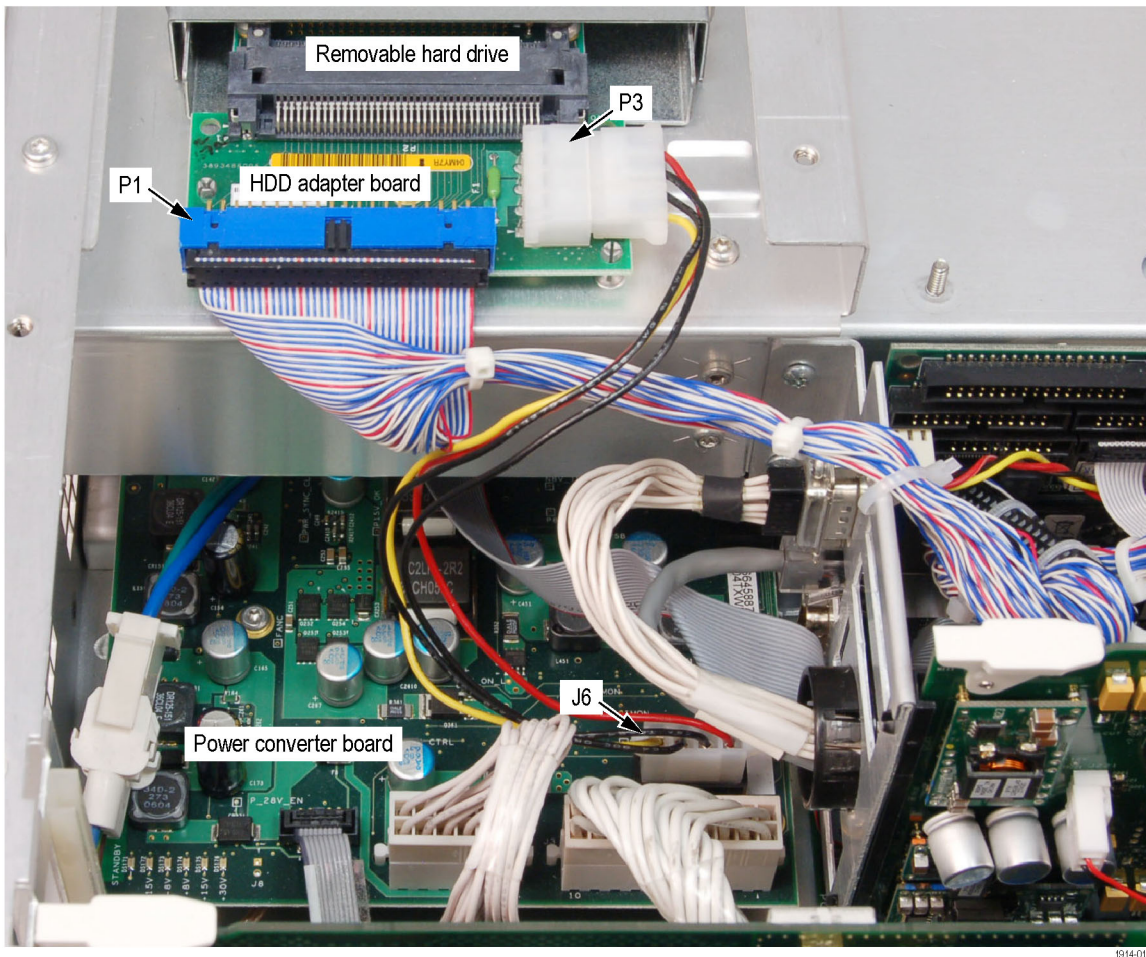

Figure 5-4: Detail 2 of display, front panel, and removable hard drive cabling

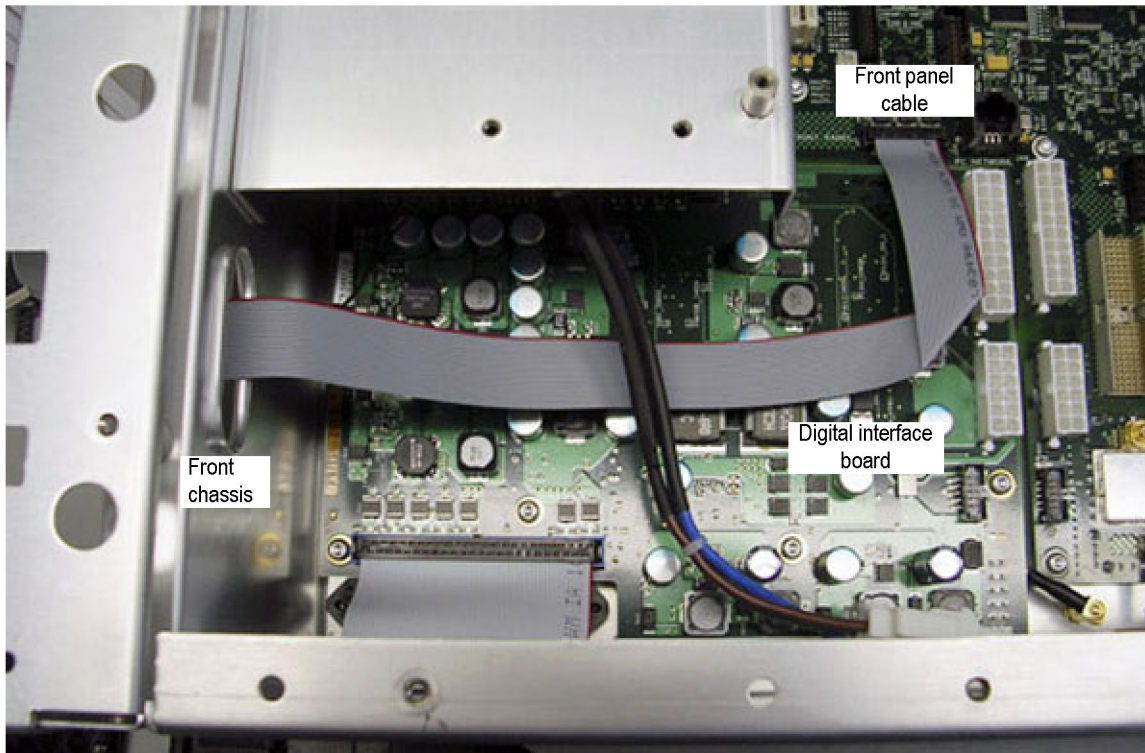
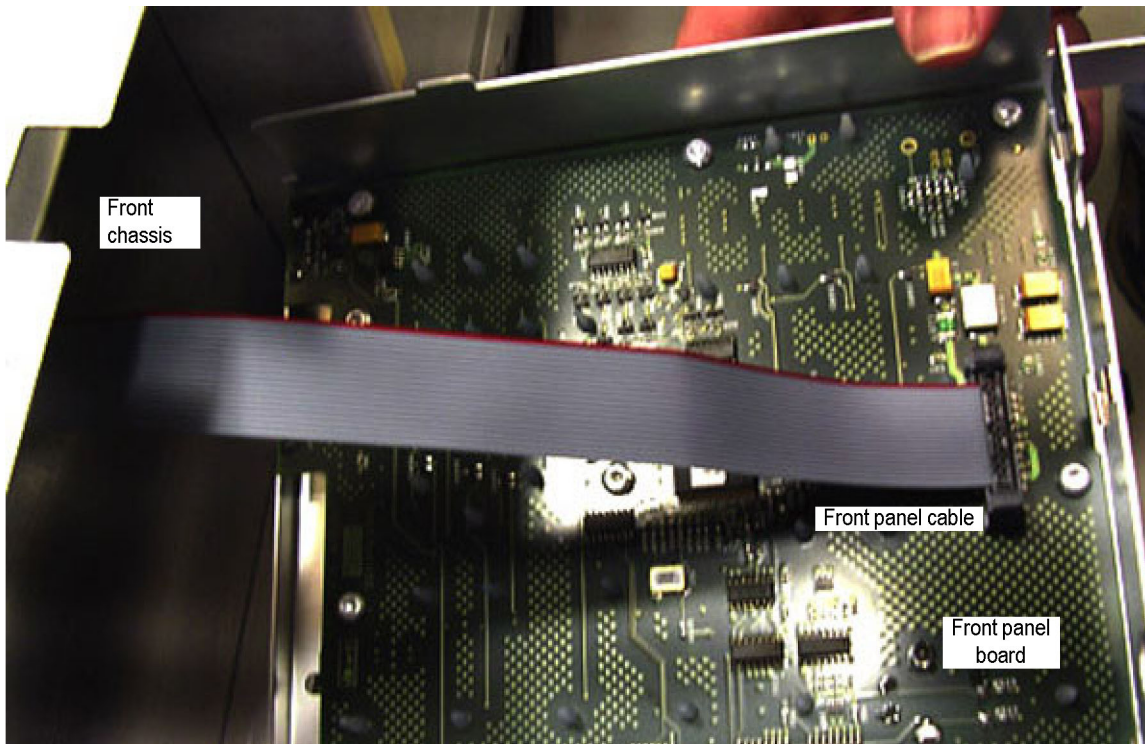

Figure 5-5: Detail 3 of display, front panel, DVD, and removable hard drive cabling

Table 5-3: Modules

| Fig. & index number | Tektronix part number | Serial no. effective | Serial no. discont'd | Qty | Name & description |
|---------------------|-----------------------|----------------------|----------------------|-----|--|
| 5-6-1 | 664-5898-00 | | | 1 | CIRCUIT BD ASSY; REALTIME I/Q OUTPUT, (OPT. 05 ONLY) |
| -2 | 863-0050-00 | | | 1 | CIRCUIT BD SUBASSY; RTT/DPX,389367101B BOMBUILD A;RSA6100A SERIES |
| | 863-0273-00 | | | 1 | CIRCUIT BD ASSY; RTT/DPX,PB-FREE,389367101 WIRED (Option 200) |
| -3 | 211-1050-00 | | | 8 | SCREW, MACHINE; 6-32 X 0.312 L, PNH, STEEL, ZINC FINISH, T15 |
| -4 | 200-4962-00 | | | 1 | COVER; REAR PANEL,OPTION(I&Q OUT,IF OUT); SAFETY CONTROLLED (OPT. 05 ONLY) |
| -5 | 200-4961-00 | | | 1 | COVER; REAR PANEL,OPTION(BLANK); SAFETY CONTROLLED (ALL EXCEPT OPT. 05) |
| -6 | 407-5181-00 | | | 1 | BRACKET, GROUNDING (LAN AND PS/2) |
| -7 | 174-5102-00 | | | 1 | CA ASSY,SP; DISCRETE,SLOT PC TO DIG INTERFACE 15 PIN VGA,2X7 HEADER,0.100; SAFETY CONTROLLED |
| -8 | 174-5103-00 | | | 1 | CA ASSY,SP; LAN,TW PAIR,MEGABIT LAN,RJ45,SLOTPC TO DIG INTF; SAFETY CONTROLLED |
| -9 | 211-0408-00 | | | 2 | SCR, ASSY, WSHR; 4-40 X 0.250, PNH, STEEL, ZINC FINISH, T10 TORX DR, SEMS |
| -10 | 174-5090-00 | | | 1 | CA ASSY,PWR; DISCRETE,DIG INTERFACE,2X6,20AWG; SAFETY CONTROLLED |
| -11 | 039-0177-00 | | | 1 | PROCESSOR MODULE; PCI 6881 WITH 1 GB RAM MODULE INSTALLED, SAFETY CONTROLLED |
| -12 | 174-5091-00 | | | 1 | CA ASSY,SP; IDC,RIBBON,FANOUT -4 SLOTPC TO DIG INTF 2X22,2MM; SAFETY CONTROLLED |
| -13 | 174-5099-01 | | | 1 | CA ASSY,SP; DISCRETE,LVDS VIDEO SLOTPC TO DIG INTF 2X20,1.25MM; SAFETY CONTROLLED |
| -14 | 174-5101-00 | | | 1 | CA ASSY,SP; IDC,RIBBON,AUDIO SLOTPC TO DIG INTERF,2X5,2MM; SAFETY CONTROLLED |
| -15 | 174-5088-00 | | | 1 | CA ASSY,SP; CRIMP,DISCRETE,PS/2,SLOT PC TO DIG INTF,1X5,2MM; SAFETY CONTROLLED |
| -16 | 174-4791-00 | | | 1 | CA ASSY,SP; RIBBON,IDC,28 AWG,7.0 L, |
| -17 | 211-0450-00 | | | 4 | SCREW, MACHINE; 2.5MM X 0.45 X 6MM, PNH, STEEL, ZINC PLATED, T8 TORX DRIVE (OPT. 05 ONLY) |
| -18 | 174-5106-01 | | | 1 | CA ASSY,SP; IDC,TW FLAT,I & Q OUTPUT TO REAR PANEL,50 POS; SAFETY CONTROLLED, (OPT. 05 ONLY) |
| -19 | 174-5104-00 | | | 1 | CA ASSY,RF,FLEX-COAX; IF OUT TO REAR PANEL,SMB,BNC; SAFETY CONTROLLED, (OPT. 05 ONLY) |

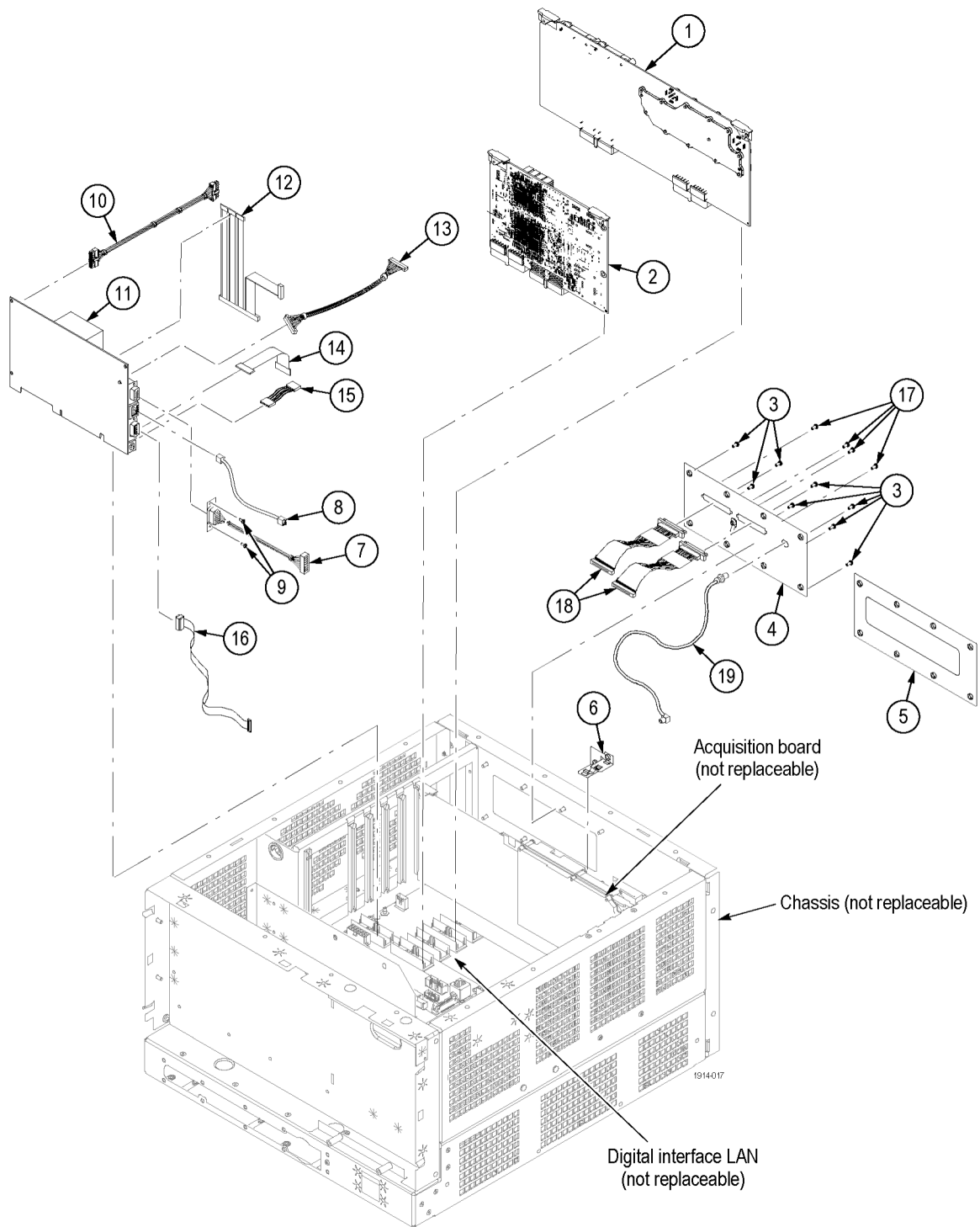

Figure 5-6: Modules

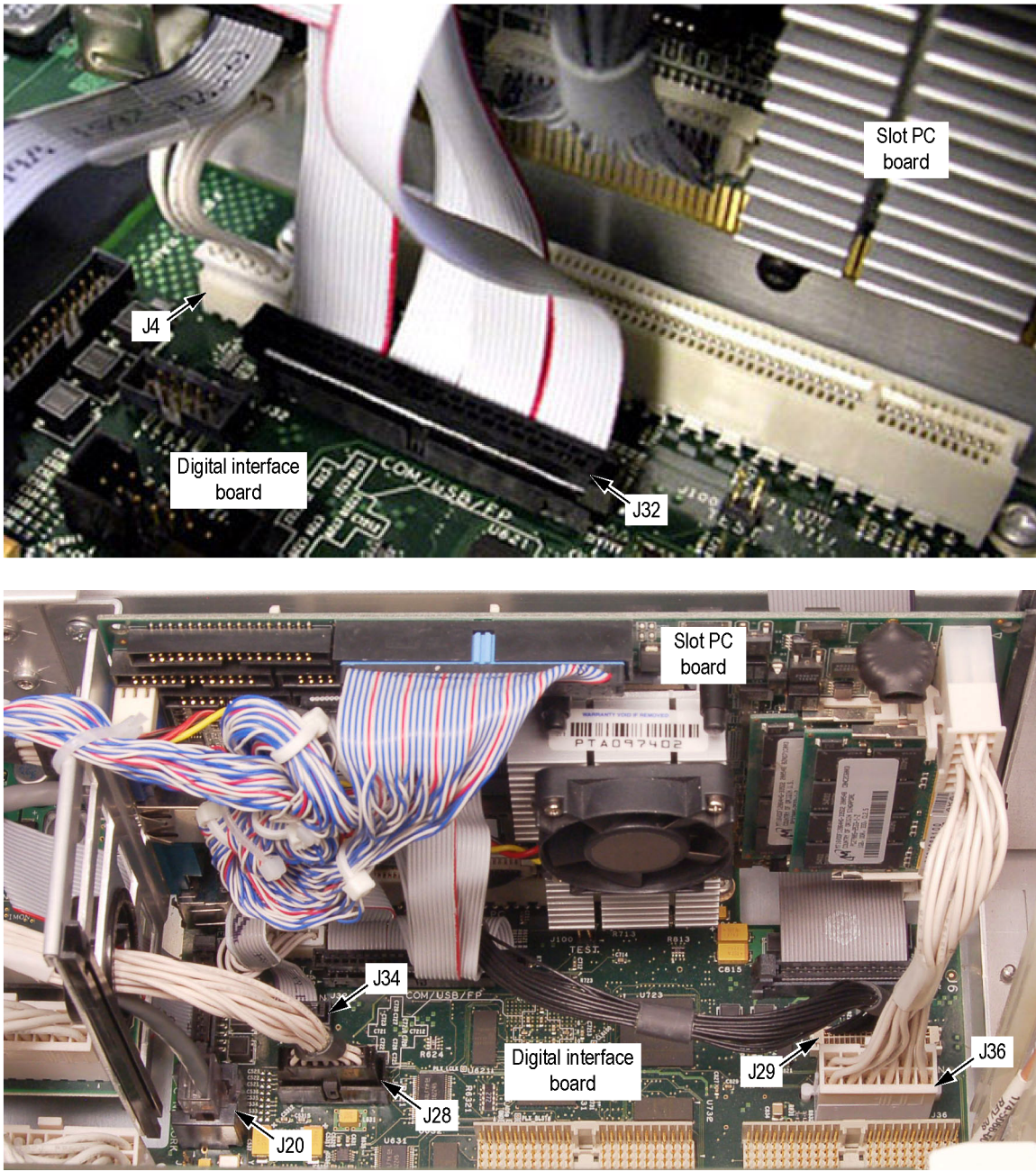
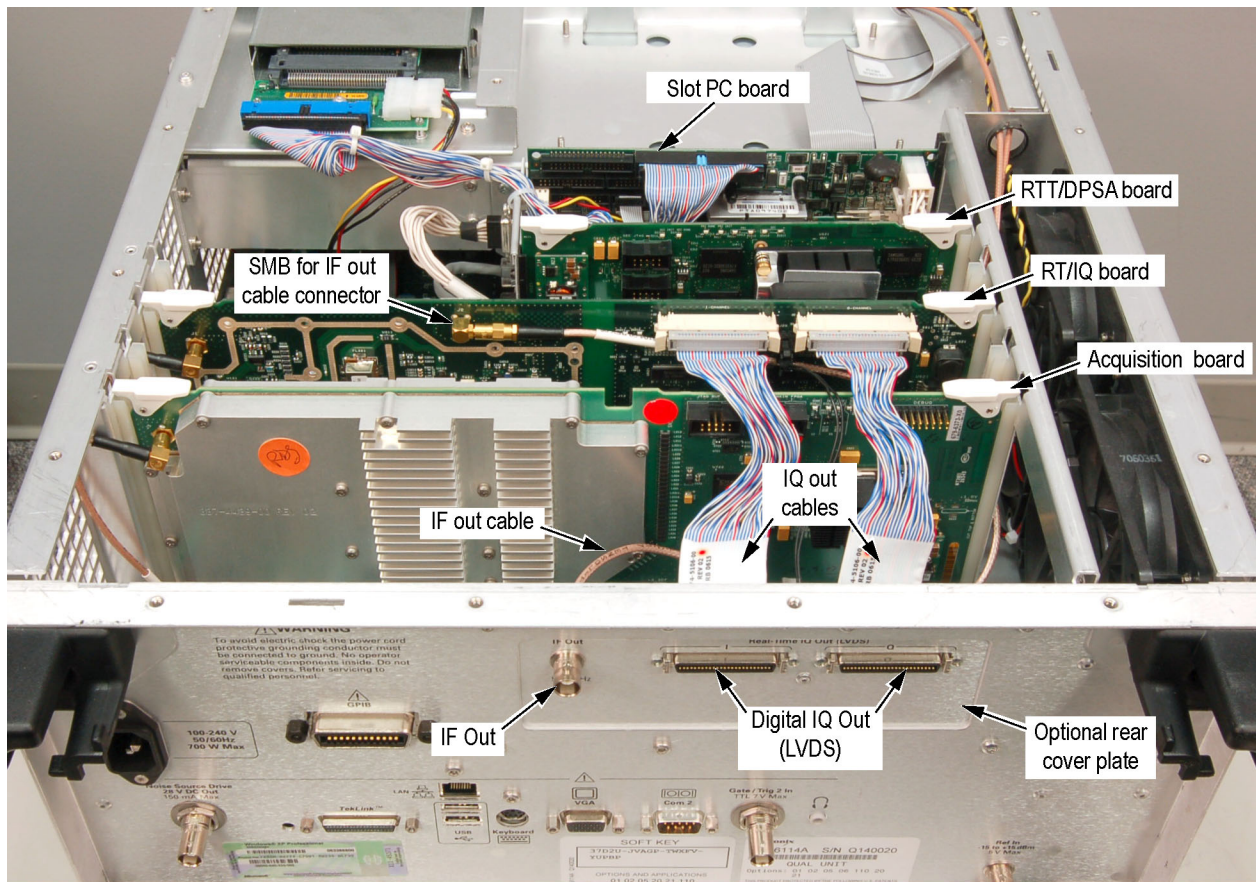

Figure 5-8: Detail 2 of Slot PC cabling



1914-020

Figure 5-9: Detail of RT/IQ Option 05 cabling

Table 5-4: Power supply and internal hard drive

| Fig. & index number | Tektronix part number | Serial no. effective | Serial no. discont'd | Qty | Name & description |
|---------------------|-----------------------|----------------------|----------------------|-----|---|
| 5-10-1 | 650-4924-13 | | | 1 | DISK DRIVE ASSY; PGRM, FIXED INTERNAL DRIVE |
| -2 | 174-5279-00 | | | 1 | CA ASSY; ATX DRIVE POWER; SAFETY CONTROLLED |
| -3 | 210-0457-00 | | | 1 | NUT, PL, ASSEM WA; 6-32 X 0.312, W/LOCKWASHER, STEEL, ZINC FINISH |
| -4 | 407-5093-00 | | | 1 | BRACKET, FIXED HDD, LANCER |
| -5 | 174-5098-00 | | | 1 | CA ASSY, SP; TW FLAT, RIBBON, IDE, SLOT PC, HARD DISK/CDD/RHDD, 2X20; SAFETY CONTROLLED |
| -6 | 211-0718-00 | | | 4 | SCREW, MACHINE; 6-32 X 0.312, FLH100, STEEL, ZINC FINISH, T10 TORX DR |
| -7 | ----- | | | 1 | BRACKET; POWER SUPPLY; LANCER; SAFETY CONTROLLED Replaced by item 19 in this list |
| -8 | 211-1050-00 | | | 4 | SCREW, MACHINE; 6-32 X 0.312 L, PNH, STEEL, ZINC FINISH, T15 |
| -9 | 407-5129-00 | | | 1 | BRACKET; POWER SUPPLY SUPPORT; SAFETY CONTROLLED |
| -10 | 174-5089-00 | | | 1 | CA ASSY, PWR; DISCRETE, DIG INTERFACE, 2X10, 18AWG; SAFETY CONTROLLED |
| -11 | ----- | | | 1 | POWER SUPPLY; AC-DC; 460W; +3.3V 40A, +5V 34A, +12V 25A, -12V 1A, +5VSB 2A; 90-264VAC, 47-63HZ; BERG 51624-XX001; 9.5X4.9X3.8IN, SAFETY CONTROLLED Replaced by item 19 in this list |
| -12 | 174-5090-00 | | | 1 | CA ASSY, PWR; DISCRETE, DIG INTERFACE, 2X6, 20AWG; SAFETY CONTROLLED |
| -13 | 664-5887-00 | | | 1 | CIRCUIT BD ASSY; POWER CONVERSION BOARD, TESTED, 664588700, 679588700, 389366100, WIRED |
| -14 | 174-5101-00 | | | 1 | CA ASSY, SP; IDC, RIBBON, AUDIO SLOT PC TO DIG INTERF, 2X5, 2MM; SAFETY CONTROLLED |
| -15 | 174-5100-00 | | | 1 | CA ASSY, PWR; IDC, RIBBON, PWR CONV TO BULKHEAD, 2X25, 0.100 CTR; SAFETY CONTROLLED |
| -16 | 174-5227-00 | | | 1 | CABLE ASSY; LINE FILTER; SAFETY CONTROLLED |
| | | | | | **ATTACHED PARTS** |
| | 119-7086-00 | | | 1 | FILTER, EMI; AC LINE CONNECTOR/INPUT FILTER; 6.0A, 120-250VAC, DC-400 HZ, 2.2 NF CY, 100 NF CX, IEC INPUT, FAST-ON/SOLDER LUG OUTPUT, CHASSIS MOUNT, SAFETY CONTROLLED; FN9222-6/06 (LINE FILTER) |
| | | | | | **END ATTACHED PARTS** |
| -17 | 211-0380-00 | | | 2 | SCREW, MACHINE; 4-40 X 0.375, FLH, STEEL, ZINC FINISH, T8 |
| -18 | 210-1543-00 | | | 4 | SCREW, SHOULDER, SPECIAL; 6-32 (USE WITH VIBE ISOLATION GROMMETT) |
| -19 | 050-3721-xx | | | 1 | SERVICE KIT; RSA6100 SERIES POWER SUPPLY W/ BRACKET |

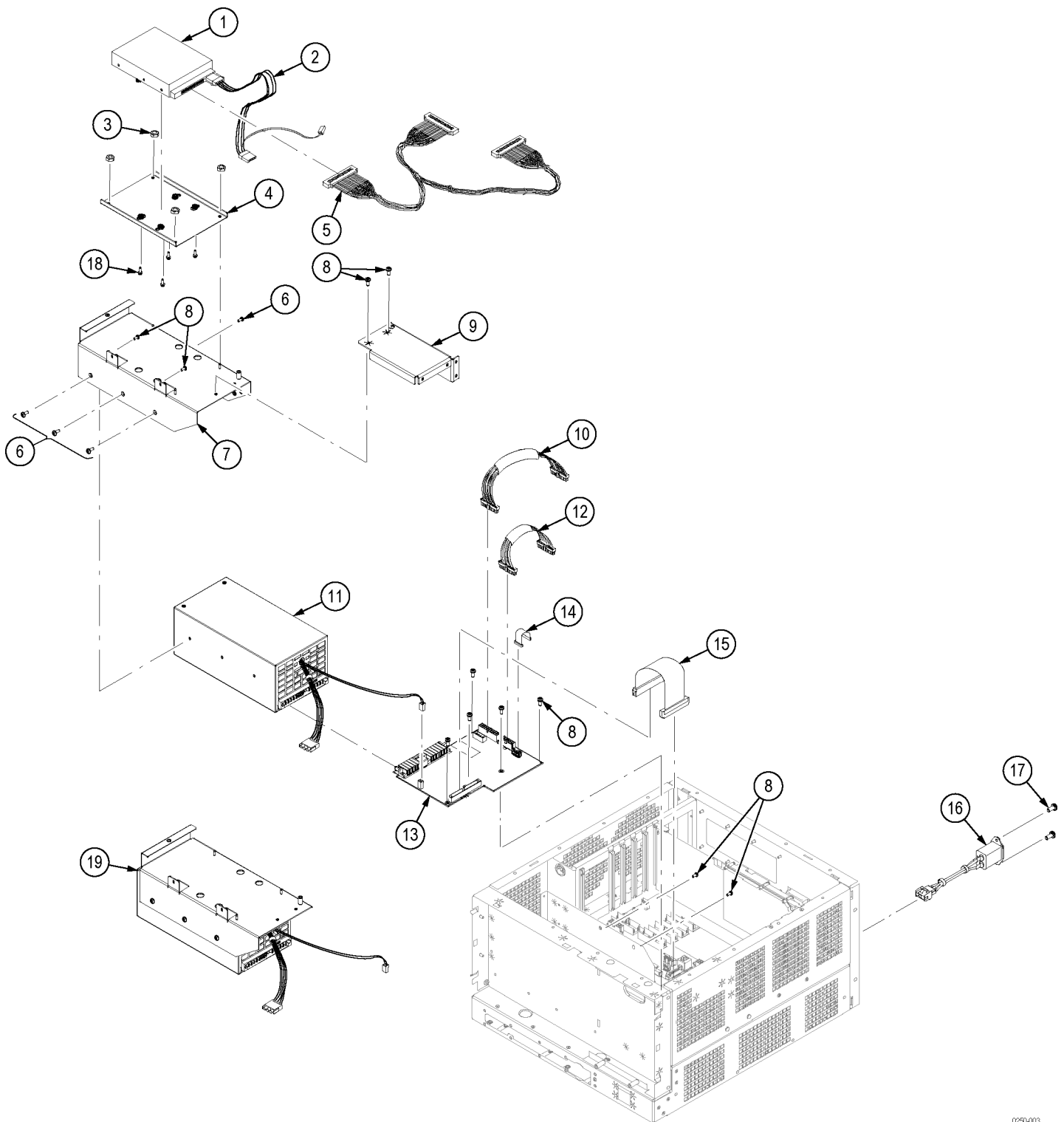

0250-003

Figure 5-10: Power supply and internal hard drive

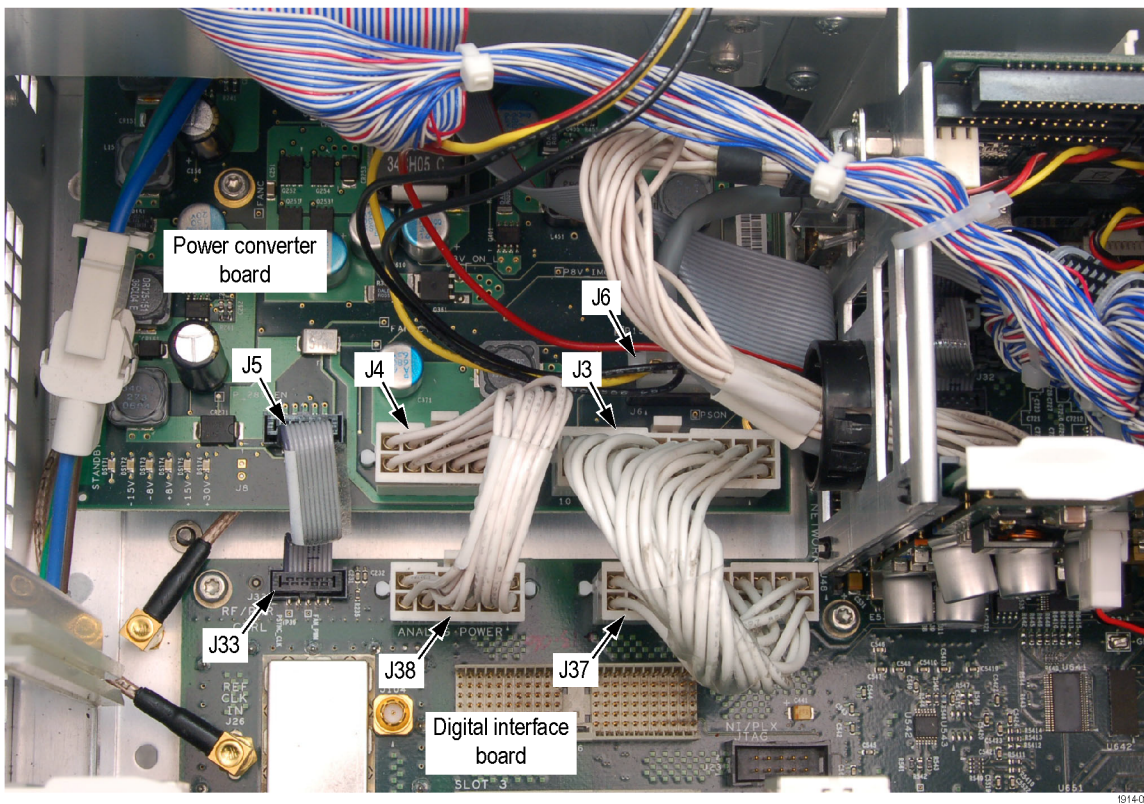
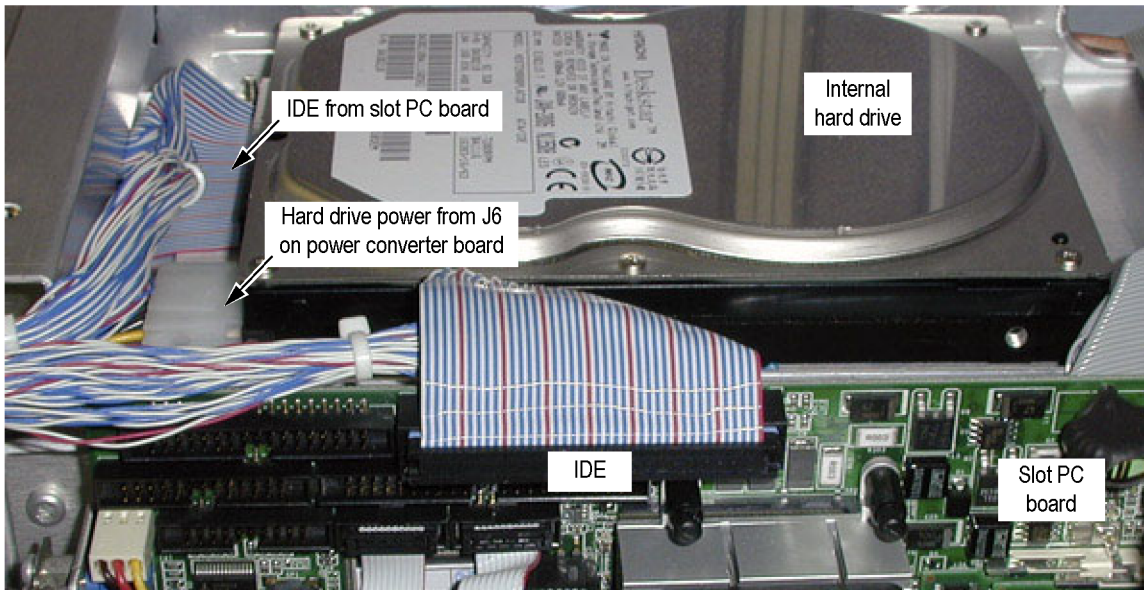

Figure 5-11: Detail 1 of power supply and internal hard drive cabling

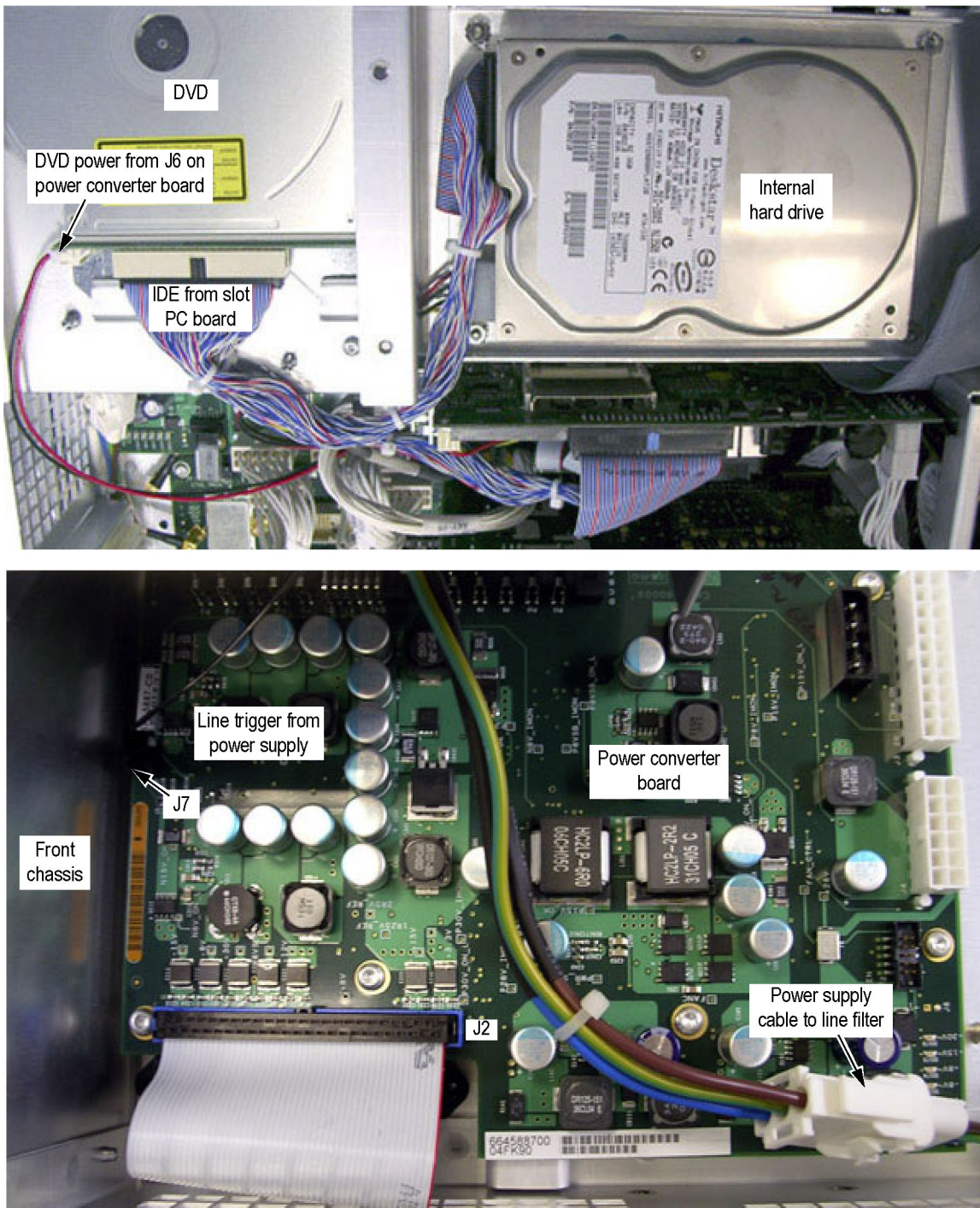

Figure 5-12: Detail 2 of power supply and internal hard drive cabling

Table 5-5: Upper and lower deck fans

| Fig. & index number | Tektronix part number | Serial no. effective | Serial no. discount'd | Qty | Name & description |
|-------------------------------|---------------------------|----------------------|-----------------------|-----|--|
| 5-13-1 | 436-0423-00 | | | 3 | ASSY,FAN TRAY; WITH FANS MOUNTED(RF DECK); SAFETY CONTROLLED |
| | 119-7183-00 | | | 1 | FAN, TUBEAXIAL; 12VDC, 0.23A, 2.76W, 3250RPM, 39CFM, 80MM X 25MM, LEADS W/CONN; SAFETY CONTROLLED (SUBPARTS OF 436-0423-00) |
| | 407-5052-00 | | | 1 | BRACKET; FAN MOUNTING,RF DECK (SUBPART OF 436-0423-00) |
| -2 | 211-1050-00 | | | 25 | SCREW,MACHINE; 6-32 X 0.312 L,PNH, STEEL, ZINC FINISH, T10, TORX |
| -3 | 436-0424-00 | | | 1 | ASSY,FAN TRAY; WITH FANS MOUNTED (UPPER DECK); SAFETY CONTROLLED |
| -3 | 119-7182-00 | | | 2 | FAN, TUBEAXIAL; 12VDC, 0.40A, 4.80W, 2500RPM, 100.6CFM, 120MM, LEADS W/CONN; SAFETY CONTROLLED (SUBPARTS OF 436-0424-00) |
| | 407-5062-00 | | | 1 | BRACKET; FAN MOUNTING,UPPER DECK; SAFETY CONTROLLED (SUBPART OF 436-0424-00) |
| -4 | 174-5201-00 | | | 1 | CA ASSY,SP; IDC,RIBBON,GPIB,DIG INTF TO REAR PANEL; SAFETY CONTROLLED |
| -5 | 174-5212-00 | | | 1 | CA ASSY,SP; IDC,RIBBON,CONTROL LINES,BULKHEAD TO RF INTERFACE,2X7,0.100CTR SAFETY CONTROLLED |
| -6 | 213-1061-00 | | | 2 | JACKSCREW; 6-32 EXT THD, M3.5 X 0.6-6 INT THD, 410 SS, PASSIVATE |
| -7 | 407-5055-00 | | | 1 | BRACKET ASSY; SPEAKER |
| -8 | 119-7172-00 | | | 1 | SPEAKER; DYNAMIC;28MM DIA,8 OHM,600-7KHZ,MYLAR CONE,MG ELECT 288BB20 WITH 28 INCH CABLE; |
| | **Attached Parts** | | | | |
| | 119-5660-00 | | | 1 | TRANSDUCER; PIEZOELECTRIC,AUDIO;IN 3 TO 25V P-P,OUT 70DB AT 10CM AT 3V P-P, FREQ 3.5-5.5KHZ,PKG DIA 13 MM X 7.8 MM H,5.0MM PIN SPACING,NOT MACHINE WASHABLE;PKM13EPY-4000-TF01,T&R |
| **End Attached Parts** | | | | | |
| -10 | 174-5066-00 | | | 1 | CA ASSY,RF,FLEX-COAX; FRONT PANEL ACQ |

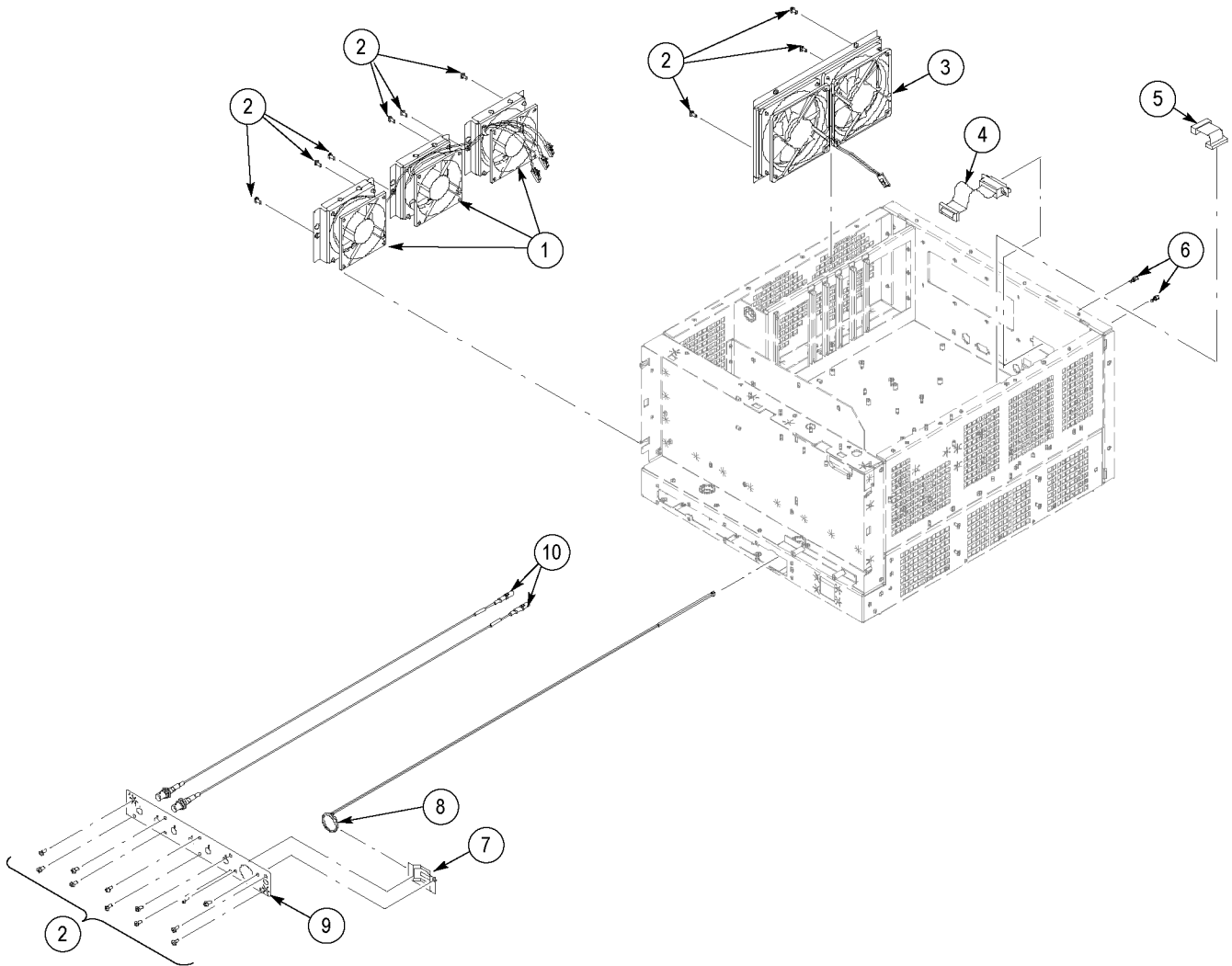

Figure 5-13: Upper and lower deck fans

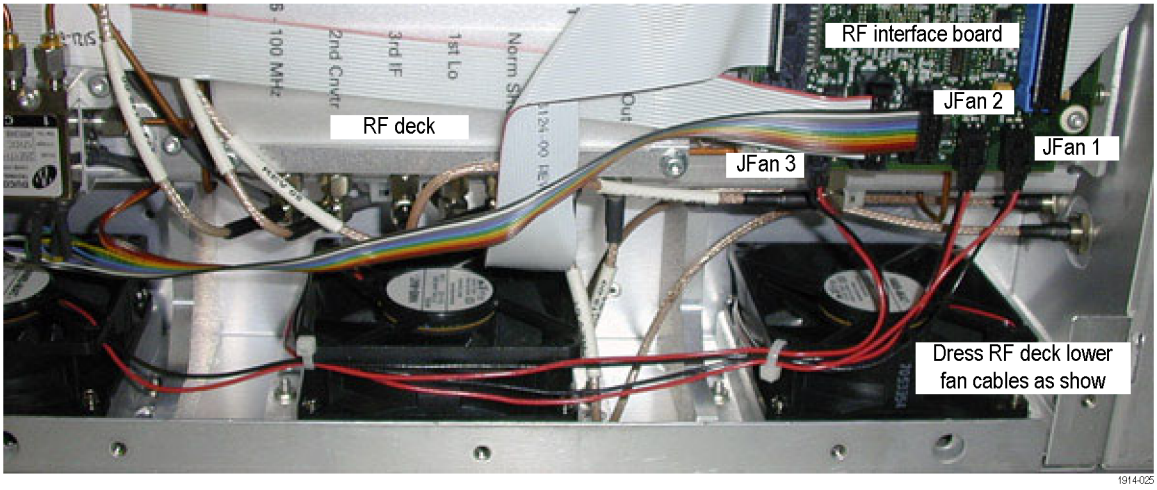
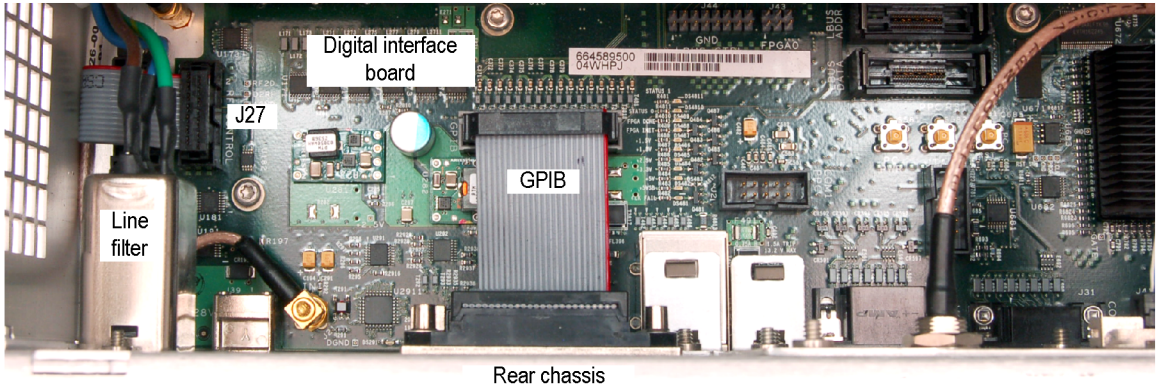
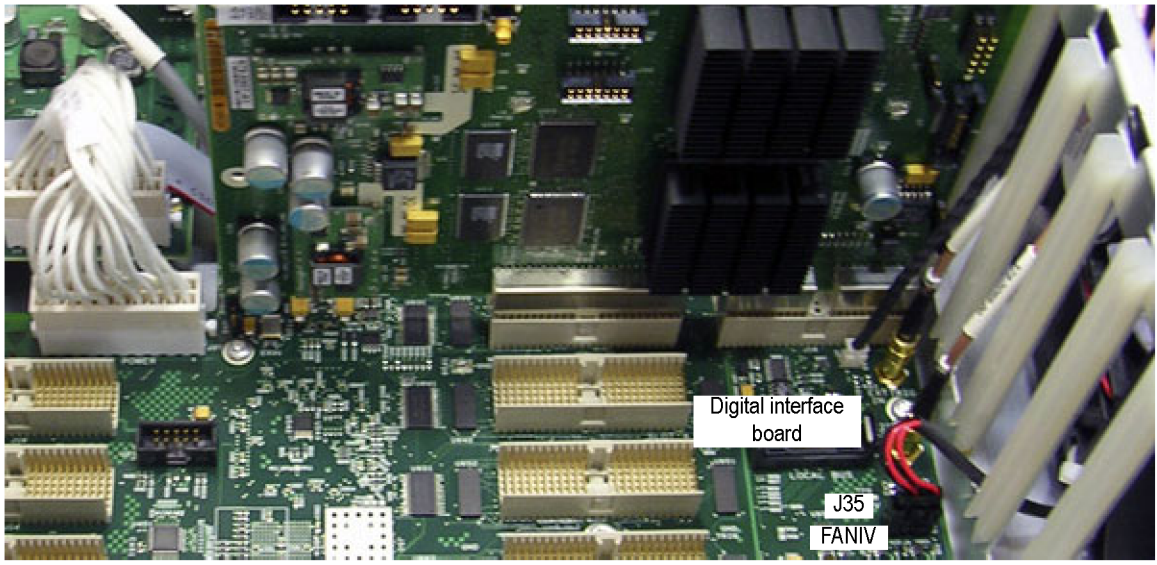

Figure 5-14: Detail of cabling shown in Figure 5-13

Table 5-6: RF interface board and cables

| Fig. & index number | Tektronix part number | Serial no. effective | Serial no. discont'd | Qty | Name & description |
|--------------------------------|------------------------------|-----------------------------|-----------------------------|------------|--|
| 5-15-1 | 679-5893-02 | | | 1 | CIRCUIT BD SUBASSY; RF INTERFACE BOARD; |
| -2 | 211-1050-00 | | | 5 | SCREW,MACHINE; 6-32 X 0.312 L,PNH,STEEL, ZINC FINISH, T15 |
| -3 | 174-5097-00 | | | 1 | CA ASSY,SP; IDC,RIBBON,CONTROL LINES,BULKHEAD TO RF INTERFACE,2X7; SAFETY CONTROLLED |
| -4 | 174-5119-00 | | | 1 | CA ASSY,PWR; IDC,RIBBON,BULKHEAD TO RF INTERF,2X25,0.100 CTR; SAFETY CONTROLLED |

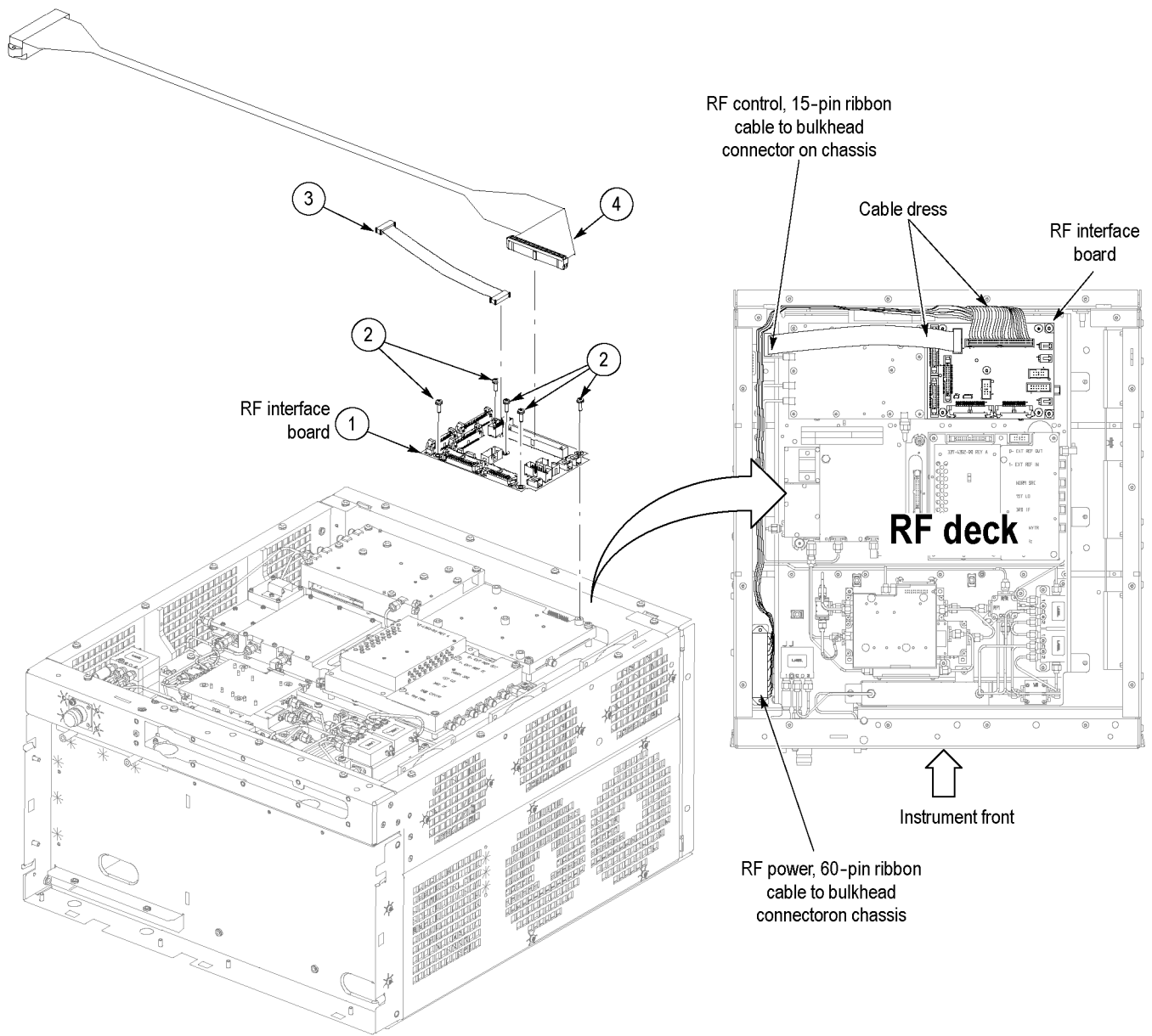

Figure 5-15: RF interface board and cables