

**WFM4000 and WFM5000
Waveform Monitors
User Manual**



**WFM4000 and WFM5000
Waveform Monitors
User Manual**

Revision A

www.tektronix.com

077-2438-02

Tektronix

Copyright © Tektronix. All rights reserved. Licensed software products are owned by Tektronix or its subsidiaries or suppliers, and are protected by national copyright laws and international treaty provisions.

Tektronix products are covered by U.S. and foreign patents, issued and pending. Information in this publication supersedes that in all previously published material. Specifications and price change privileges reserved.

TEKTRONIX and TEK are registered trademarks of Tektronix, Inc.

Contacting Tektronix

Tektronix, Inc.
14150 SW Karl Braun Drive
P.O. Box 500
Beaverton, OR 97077
USA

For product information, sales, service, and technical support:

- In North America, call 1-800-833-9200.
- Worldwide, visit www.tektronix.com to find contacts in your area.

Warranty

Tektronix warrants that this product will be free from defects in materials and workmanship for a period of one (1) year from the date of shipment. If any such product proves defective during this warranty period, Tektronix, at its option, either will repair the defective product without charge for parts and labor, or will provide a replacement in exchange for the defective product. Parts, modules and replacement products used by Tektronix for warranty work may be new or reconditioned to like new performance. All replaced parts, modules and products become the property of Tektronix.

In order to obtain service under this warranty, Customer must notify Tektronix of the defect before the expiration of the warranty period and make suitable arrangements for the performance of service. Customer shall be responsible for packaging and shipping the defective product to the service center designated by Tektronix, with shipping charges prepaid. Tektronix shall pay for the return of the product to Customer if the shipment is to a location within the country in which the Tektronix service center is located. Customer shall be responsible for paying all shipping charges, duties, taxes, and any other charges for products returned to any other locations.

This warranty shall not apply to any defect, failure or damage caused by improper use or improper or inadequate maintenance and care. Tektronix shall not be obligated to furnish service under this warranty a) to repair damage resulting from attempts by personnel other than Tektronix representatives to install, repair or service the product; b) to repair damage resulting from improper use or connection to incompatible equipment; c) to repair any damage or malfunction caused by the use of non-Tektronix supplies; or d) to service a product that has been modified or integrated with other products when the effect of such modification or integration increases the time or difficulty of servicing the product.

THIS WARRANTY IS GIVEN BY TEKTRONIX WITH RESPECT TO THE PRODUCT IN LIEU OF ANY OTHER WARRANTIES, EXPRESS OR IMPLIED. TEKTRONIX AND ITS VENDORS DISCLAIM ANY IMPLIED WARRANTIES OF MERCHANTABILITY OR FITNESS FOR A PARTICULAR PURPOSE. TEKTRONIX' RESPONSIBILITY TO REPAIR OR REPLACE DEFECTIVE PRODUCTS IS THE SOLE AND EXCLUSIVE REMEDY PROVIDED TO THE CUSTOMER FOR BREACH OF THIS WARRANTY. TEKTRONIX AND ITS VENDORS WILL NOT BE LIABLE FOR ANY INDIRECT, SPECIAL, INCIDENTAL, OR CONSEQUENTIAL DAMAGES IRRESPECTIVE OF WHETHER TEKTRONIX OR THE VENDOR HAS ADVANCE NOTICE OF THE POSSIBILITY OF SUCH DAMAGES.

[W2 – 15AUG04]

Table of Contents

General Safety Summary	iii
Environmental Considerations	v
Preface	vi
Key Features	vi
Instrument Options	viii
Where to Find More Information	ix
Conventions Used in this Manual	ix
Installation	1
Before Installation	1
Connecting Power and Powering On/Off	3
Battery Power	3
Installing in a Video System	4
Getting Acquainted With Your Instrument	6
Instrument Display	6
Front-Panel Controls	9
Rear-Panel Connectors	11
Selecting a Display	14
Setting Display Parameters	15
Selecting Signal Inputs	16
Setting 4-Tile and Full-Tile Modes	16
Setting Gain, Sweep, and Magnification	18
Using Waveform/Vector Display Overlay	20
Using Presets	21
Freezing the Display	22
Setting Line Select Mode	24
Configuring Your Instrument	25
Using Online Help	26
Adjusting Headphone Volume and Source	28
Checking Chroma/Luma Delay (Lightning Display)	29
Checking Gamut	32
Setup for Gamut Checks	32
Checking RGB Gamut	33
Checking Composite Gamut	35
Checking Luma Gamut	36
Automating Gamut Checks	37
Adjusting Gamut Limits	38
Timing Display	39
Monitoring Audio	44
Configuring Audio Inputs	44
Selecting Audio Input	45
Checking Audio Level and Phase	46

Table of Contents

Monitoring Safe Area Graticule	48
Monitoring for Safe Area Graticule	48
Using Alarms.....	51
Configuring Alarms.....	51
Monitoring Alarms.....	55
Upgrading Instrument Software	56
Index	

General Safety Summary

Review the following safety precautions to avoid injury and prevent damage to this product or any products connected to it.

To avoid potential hazards, use this product only as specified.

Only qualified personnel should perform service procedures.

To Avoid Fire or Personal Injury

Use proper power cord. Use only the power cord specified for this product and certified for the country of use.

Ground the product. This product is grounded through the grounding conductor of the power cord. To avoid electric shock, the grounding conductor must be connected to earth ground. Before making connections to the input or output terminals of the product, ensure that the product is properly grounded.

Observe all terminal ratings. To avoid fire or shock hazard, observe all ratings and markings on the product. Consult the product manual for further ratings information before making connections to the product.

Do not apply a potential to any terminal, including the common terminal, that exceeds the maximum rating of that terminal.

Power disconnect. The power cord disconnects the product from the power source. Do not block the power cord; it must remain accessible to the user at all times.

Do not operate without covers. Do not operate this product with covers or panels removed.

Do not operate with suspected failures. If you suspect that there is damage to this product, have it inspected by qualified service personnel.

Avoid exposed circuitry. Do not touch exposed connections and components when power is present.

Replace batteries properly. Replace batteries only with the specified type and rating.

Recharge batteries properly. Recharge batteries for the recommended charge cycle only.

Use proper AC adapter. Use only the AC adapter specified for this product.

Do not operate in wet/damp conditions.

Do not operate in an explosive atmosphere.

Keep product surfaces clean and dry.

Provide proper ventilation. Refer to the manual's installation instructions for details on installing the product so it has proper ventilation.

Terms in This Manual

These terms may appear in this manual:



WARNING. *Warning statements identify conditions or practices that could result in injury or loss of life.*



CAUTION. *Caution statements identify conditions or practices that could result in damage to this product or other property.*

Symbols and Terms on the Product

These terms may appear on the product:

- DANGER indicates an injury hazard immediately accessible as you read the marking.
- WARNING indicates an injury hazard not immediately accessible as you read the marking.
- CAUTION indicates a hazard to property including the product.

The following symbol(s) may appear on the product:



CAUTION
Refer to Manual

Environmental Considerations

This section provides information about the environmental impact of the product.

Product End-of-Life Handling

Observe the following guidelines when recycling an instrument or component:

Equipment Recycling. Production of this equipment required the extraction and use of natural resources. The equipment may contain substances that could be harmful to the environment or human health if improperly handled at the product's end of life. In order to avoid release of such substances into the environment and to reduce the use of natural resources, we encourage you to recycle this product in an appropriate system that will ensure that most of the materials are reused or recycled appropriately.

The symbol shown below indicates that this product complies with the European Union's requirements according to Directive 2002/96/EC on waste electrical and electronic equipment (WEEE). For information about recycling options, check the Support/Service section of the Tektronix Web site (www.tektronix.com).



Perchlorate Materials

This product contains one or more type CR lithium coin cell batteries. According to the state of California, CR lithium ion cells are classified as perchlorate materials and require special handling. See www.dtsc.ca.gov/hazardouswaste/perchlorate for additional information.

Restriction of Hazardous Substances

This product has been classified as Monitoring and Control equipment, and is outside the scope of the 2002/95/EC RoHS Directive.

Preface

This manual describes the installation and basic operation of the following instruments:

- WFM5000 series waveform monitors
- WFM4000 series waveform monitors

Key Features

Tektronix waveform monitors can help you monitor SD SDI or HD SDI signals. The following table includes key features of these instruments.

Feature	Description
Flexible tile displays: Full, TandemVu®, and Quad Tile	<p>Quad Tile (4-Tile): View four measurement displays at once, one in each tile.</p> <p>TandemVu®: Patented display allows you to overlay the Waveform and Vector or Waveform and Lightning displays, plus Picture Thumbnail, in a single, full-tile display.</p> <p>Full: View a Waveform measurement display that is active in tile 1 full screen.</p>
Thumbnail display	Thumbnail display of the picture in the selected Waveform, Gamut, Audio, or Vector measurement displays.
Presets	Customizable presets allow you to quickly save and recall commonly used configurations.
Full digital processing	Full digital processing allows for accurate, repeatable, drift-free operation that surpasses traditional analog designs.
Waveform display	Traditional waveform displays allow signals to be overlaid or paraded. Waveform/Vector or Waveform/Lightning overlay display is also available.
Timing display	Timing display shows the timing relationship between video input and the external reference.
Vector display	Traditional and Lightning Vector displays are available. The latter shows both luma and chroma amplitudes, as well as quantifying inter-channel timing. Includes Vector display with Composite and Component Compass Rose graticules, and Vector/Waveform and Lightning/Waveform overlay; as well as gain, sweep, and magnification controls.
Gamut monitoring	Arrowhead, Diamond, and Split Diamond displays offer user-selectable gamut thresholds so that you can set monitoring limits appropriate to a specific operation. Gamut monitoring is fully integrated with the alarm logging and reporting capabilities.
Picture area	Support for standard and custom Safe Graticules of Picture displays for monitoring the incorrect placements of graphics and logos. Two Safe Area graticules and Safe Title graticules are supported.
Audio monitoring	<p>Lissajous display lets you monitor audio channel inputs.</p> <p>Support and options for viewing and monitoring both levels of normal channel pairs for AES and embedded audio, and many popular audio scales, including BBC scales.</p> <p>Provides Audio Control Packet information, which is ancillary data used to describe the number of channels, audio frame rate, and audio channel delay.</p>
Status screens	The following status displays provide content status: Alarm, Event/Error Log, Video Session, Audio Session, and Audio Control.

Feature	Description
Error tracking	Configurable alarms and error logging.
Ground closure	Signal sent out of the GCI port of the instrument for a remote notification that an alarm condition occurred.

Instrument Options

You can add the following service options to any instrument:

- Option C3. Adds 3 years of Calibration Service.
- Option C5. Adds 5 years of Calibration Service.
- Option D1. Adds a Calibration Data Report.
- Option D3. Adds 3 years of Calibration Data Report (when ordered with option C3).
- Option D5. Adds 5 years of Calibration Data Report (when ordered with option C5).
- Option R3. Adds 3 years of Repair Service (including the period under warranty).
- Option R5. Adds 5 years of Repair Service (including period under warranty).

Where to Find More Information

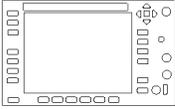
Item	Purpose	Location
User manual (this manual)	Installation procedures and procedures for instrument operation	  www.Tektronix.com
Online help	In-depth instrument operation and UI help	
Specifications and performance verification technical reference	Specifications and procedures for checking instrument performance	  www.Tektronix.com
WFM, WVR, and AMM Management Information Database technical reference	Programming commands for WFM, WVR, and AMM instruments	  www.Tektronix.com
Service manual	Optional manual supporting module-level servicing of the instrument	 www.Tektronix.com

Conventions Used in this Manual

The following icons are used throughout this manual:

Sequence Step



Installation

To install your instrument in a cabinet, rack, or carrying case, follow the instructions that are included with the optional accessory kits that are available for each type of installation.



CAUTION. Do not install this instrument in any cabinet except those that are listed in the Accessories table. Attempting to do so can damage the instrument and the cabinet.

If you install your instrument in a custom application, such as a console, be sure to provide adequate airflow. Do not block the ventilation holes.



CAUTION. Failure to provide adequate airflow to the instrument could cause the instrument to shut down. If the airflow is blocked and the instrument does not shut down, the instrument could be seriously damaged.

Before Installation

Unpack the instrument and check that you have received all of the items listed as standard accessories. You may want to save the shipping carton and packing materials (including the anti-static bag) in case you need to ship the instrument.

Accessories

The table below shows which items are standard accessories and which items are optional accessories. Check the Tektronix Web site (www.tektronix.com) for the most current information on accessories.

Accessory	Standard	Optional	Tektronix part number
WFM4000 and WFM5000 Waveform Monitors Quick Start Reference	•		071-2476-XX
WFM4000 and WFM5000 Waveform Monitors Release Notes	•		077-2444-XX
WFM4000 and WFM5000 Waveform Monitors Product Documentation CD kit This CD contains the following documents in PDF format. (All documents are in English unless noted otherwise): User Manual (English, Japanese, Chinese) Specifications and Performance Verification Technical Reference System Integrator Technical Reference WFM, WVR, AMM Management Information Database (MIB) Technical Reference	•		020-2918-XX
Power Plug and Adapter NOTE. See the International Power Plugs list that follows this table for the type of power plug included with your instrument	•		Not applicable
WFM4000 and WFM5000 Waveform Monitors Service Manual		•	077-2442-XX
WFM50F01, Portable cabinet with handle, feet, and front panel cover		•	WFM50F01

Accessory	Standard	Optional	Tektronix part number
WFM50F02, Dual rackmount for the WFM5000 series and WFM4000 series		●	WFM50F02
WFM50FGM Anton Bauer battery adapter mounting plate for the WFM4000 and WFM5000 NOTE. Battery and charger must be ordered separately.		●	WFM50FGM
Anton Bauer Battery Pack for the WFM4000 and the WFM5000. For use with the WFM50FGM.		●	146-0156-00
Anton Bauer Battery Charger for the WFM4000 and the WFM5000. For use with the Anton Bauer Battery Pack.		●	016-2005-00
WFM50FVM Sony IDX battery adapter mounting plate NOTE. Battery and charger not available.		●	WFM50FVM
WFM50FSC Soft carrying case for the WFM5000 and WFM4000.		●	WFM50FSC

International Power Plugs. Your instrument was shipped with one of the following power cord options. Power cords for use in North America are UL listed and CSA certified. Cords for use in areas other than North America are approved by at least one authority acceptable in the country to which the product is shipped.

- Opt. A0 – North America power
- Opt. A1 – Universal EUR power
- Opt. A2 – United Kingdom power
- Opt. A3 – Australia power
- Opt. A5 – Switzerland power
- Opt. A6 – Japan power
- Opt. A10 – China power
- Opt. A11 – India power
- Opt. A99 – No power cord and AC adapter

Connecting Power and Powering On/Off

AC Power Requirements

The instrument operates from an AC line frequency of 50 or 60 Hz, over the range of 100-240 Volts, without the need for configuration, except the power cord. (See page 2, *International Power Plugs*.) The typical power draw is 22 Watts. Refer to the *Specifications and Performance Verification* document on the *Product Documentation CD* for additional information on power and environmental requirements.

Connect the supplied power cord to the AC adapter and then connect it to the rear panel power connector. After you connect the power supply to your power source, the instrument will not turn on until you perform the following procedure.

Powering On/Off the instrument

The Power button performs the following functions when connected to a 12 V DC input.

- Press the **Power** button to turn on the instrument.
- Press the **Power** button again to turn off the instrument.

Battery Power

This instrument can be powered by a 12 V DC input or by a 14.4 V standard camera battery. If you are using a battery with this instrument, read the following battery safety notices. This instrument was designed to be used with an Anton Bauer battery. It can also be used with a Sony IDX battery.



CAUTION. Before using the Anton Bauer Power Tap feature, refer to the product information included with the battery. If that information is not available, contact the battery manufacturer for information.



WARNING. Fire can cause personal injury and/or property damage. To prevent risk of fire, when using a 12 V DC source other than the provided AC adapter, ensure that it has a current limiting device (such as a fuse) below 50 Amps.



WARNING. Risk of personal injury and/or property damage from falling instrument. This instrument was not designed to be used with batteries of a different shape or weight than the battery available for this product from Tektronix. Other batteries may make the unit too heavy in the back, causing the instrument to tip backward.

Installing in a Video System

The instrument can operate almost anywhere in the distribution system. Refer to the following diagrams for serial digital system inputs.

For monitoring the video bit stream at the end of a link

If the instrument is placed at the end of a link, this setup can be used.

1. Connect a cable to a serial signal source.
2. Terminate the loop-through on the SDI connector you will use on the instrument.
3. Connect the cable from the serial source output to the one of the SDI inputs on the rear panel of the instrument.

NOTE. See the *Specifications and Performance Verification manual on the Product Documentation CD for maximum allowed cable lengths.*

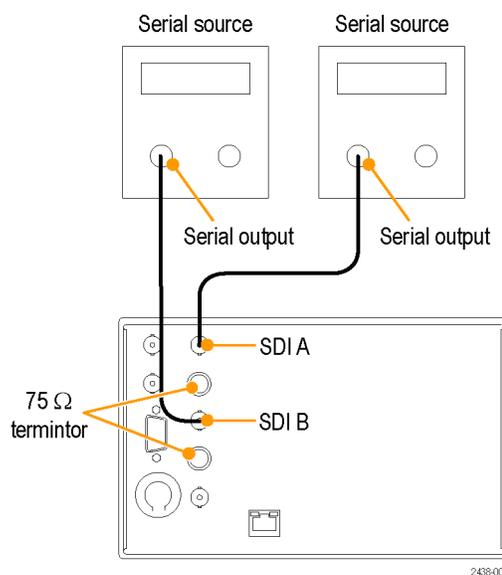

For monitoring within an operating link

If the instrument is installed to monitor an operating link, the destination receiver and the connecting cable serve as the termination. This monitoring connection checks the performance of the entire path. The return loss of the instrument is sufficiently high that, in most cases, the destination receiver sets the system return loss.

4. Connect a cable to a serial signal source.
5. Connect the other end of that cable to one of the SDI inputs on the rear panel of the instrument.
6. Connect a cable from a serial receiver to the SDI loop-through on the instrument.

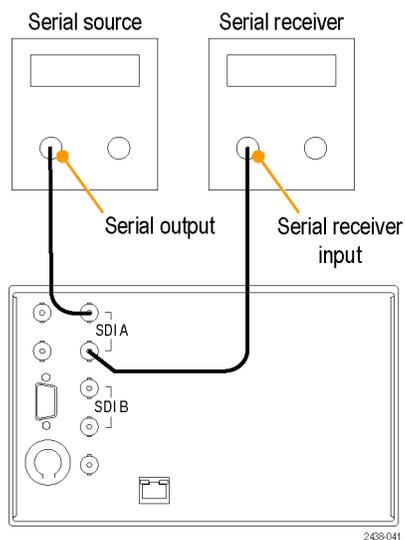

Line Termination

Your instrument uses passive loop-through analog and reference inputs. Accordingly, the loopthrough inputs must be terminated externally. It is important that this external termination meets accuracy and return loss requirements. Terminations for loop-throughs on SDI or reference connectors in end-of-link setups must be 75 Ω and DC coupled (good return loss extends to DC). An appropriate termination would be a 75 Ω End of Line terminator, Tektronix part number 011-0163-XX.

Compatibility of BNC Center Pins

Most video equipment BNC connectors, whether 50 Ω or 75 Ω , use a 50 Ω standard center pin. Some laboratory 75 Ω BNC connectors use a smaller diameter center pin. The BNC connectors on the instrument are designed to work with the 50 Ω standard (large diameter) center pins.

Do not use connectors or terminators with the smaller center pins. They could cause intermittent connections.

Getting Acquainted With Your Instrument

Instrument Display

This instrument supports the following displays:

- Waveform: Normal, Display Overlay modes
- Vector: Normal, SDI—> Composite, Lightning, Display Overlay modes
- Gamut: Arrowhead, Diamond, Split Diamond
- Picture
- Audio: Bars, Lissajous, or both
- Status: Timing Display, Alarm Status, Event/Error Log, Video Session, Audio Session, Audio Control

Picture Thumbnail Display

The picture thumbnail feature displays the thumbnail of the picture in the selected measurement display. This allows you to view the modified picture without losing visibility of the selected display.

When the instrument is in Full-tile mode, pressing the **Thumbnail** button makes the Thumbnail display appear over a part of the selected measurement display. When the instrument is in 4-Tile mode, pressing the **Thumbnail** button displays the thumbnail image in tile 1. If a picture display is present in one of the four tiles, then no thumbnail picture will be displayed.

1. Push one of the measurement buttons to select a measurement of your choice.

2. To display the picture thumbnail, toggle the **Thumbnail** button until it is lit.

The thumbnail option can also be selected from the **CONFIG > Display Settings > Thumbnail** menu.



3. Push the **Thumbnail** button again to turn off the picture thumbnail.

NOTE. The Picture Thumbnail is available for all displays except Picture.

To Determine Status At-a-Glance

The Status Bar, located at the bottom of the instrument display, shows the instrument status and the monitored signal information. The following table describes the display elements shown on the status bar.

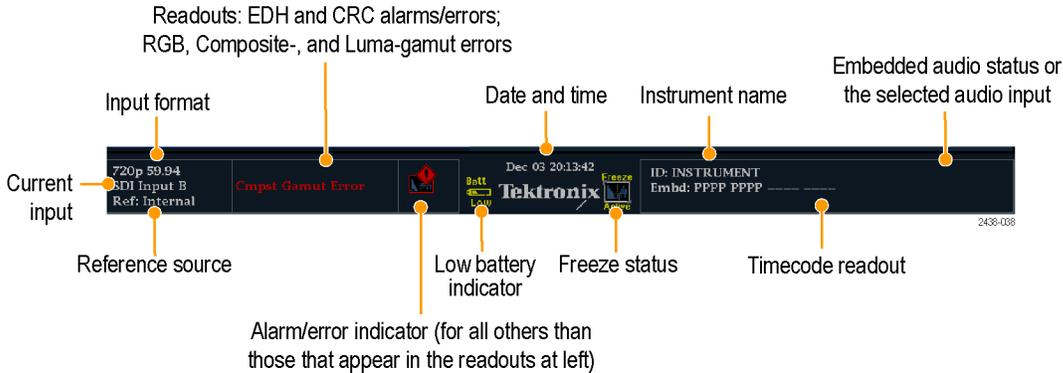

Display element	Description
Input Format	Text indicating the format of the signal on the selected input or whether signal is missing or unlocked.
Reference Source	Text indicating the source of the current reference. Possible references are: External, Internal. Also indicates format and whether the reference is missing or unlocked.
Current Input	Text indicating the selected input. Possible inputs are: SDI A and SDI B. Also indicates if the current input is not in Auto mode and is unlocked.
EDH or CRC Error	A one-line area that is visible if EDH or CRC errors are present.
RGB Gamut Error	A one-line area that is visible if RGB gamut errors are present. NOTE. Because RGB and Composite Gamut messages appear on the same line in the display, if both RGB and Composite Gamut errors are present at the same time, the message "RGB and Cmpst Gamut" will appear.
Composite Gamut Error	A one-line area that is visible if Composite gamut (Arrowhead) errors are present. NOTE. Because RGB and Composite Gamut messages appear on the same line in the display, if both RGB and Composite Gamut errors are present at the same time, the message "RGB and Cmpst Gamut" will appear.
Luma Gamut Errors	A one-line area that is visible if Luma errors are present.
Alarm/Error Indicator	An icon visible when alarms of types other than those in the four readouts just listed occur.
Date and Time	Readout of the date and time (set in CONFIG > Utilities).
Freeze Status	An icon visible when the trace of the display is in the active frozen state.
Instrument Name	Name assigned to the instrument in the CONFIG > Utilities menu.
Audio Status	A 16-character string indicating the selected audio input or the embedded audio channel status, when embedded audio is the selected input, in the latter case, each character shows the status of a specific channel: - for not present and p for present.
Timecode Readout	A readout showing the selected time-code value.
Low Battery Indicator	Appears when the battery level has no more than 10 minutes of operating power remaining.

Status Bar Icons

Display icons	Description
	Warning - Appears when an error or an alarm that is mapped to the user interface triggers.
	Alarms Muted - Appears when the alarms are muted from the STATUS pop-up menu.
	Alarms Disabled - This text appears in the Status Bar when Alarms are disabled from the Configuration menu.
	Freeze Active - Appears when the display is frozen.
	Battery Low - This icon appears only on instruments using an external battery as a power source. This icon appears when the battery has 10 minutes or less of operating power remaining.

Front-Panel Controls

NOTE. Some of the controls that this section covers are option-dependent. For a list of the options that are installed on your instrument, press the **CONFIG** button. In the Configuration menu, select the **Utilities** submenu. The **View Instruments Options** entry lists the options installed on your instrument.

Three Levels of Control

You control the instrument on three levels:

- **Frequently changed settings.** The front-panel buttons control the most commonly changed parameters. The knobs are used to adjust levels and make selections.
- **Display specific settings.** Pop-up menus control parameters that are specific to the displayed options. The pop-up menus control less frequently changed parameters such as the waveform display mode (for example, changing the waveform display mode from RGB to YPbPr). To display a pop-up menu, press and hold the desired Display button for about a second.
- **Instrument-wide settings.** The parameters in the Configuration menu are instrument-wide settings. The configuration menu controls settings that are changed only occasionally, such as changing waveform color or setting the network address.

Layout and Usage

The primary front panel elements shown below are described in the table that follows. The Usage Procedure column in the table refers you to a procedure in this manual that explains how to use the element. A reference of **None** means that the element is an indicator only or has no associated procedure.

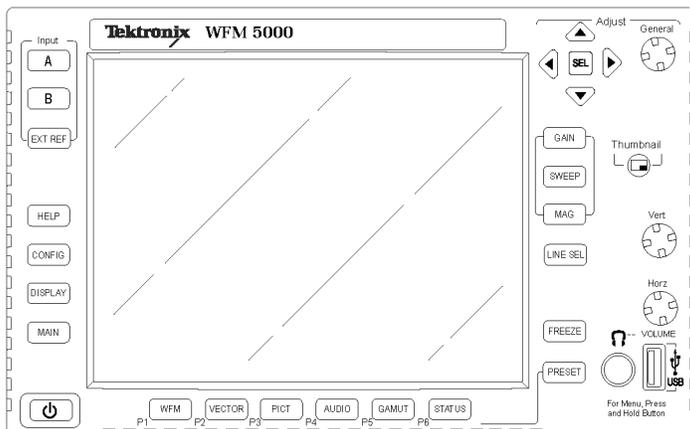

Control element or group	Usage procedures
Display selection buttons	Controlling the display (See page 6.)
Display buttons	Selecting a display (See page 14.) Setting display parameters (See page 15.)
Gain, Sweep, and Mag buttons	Setting gain, sweep, and magnification (See page 18.)

Control element or group	Usage procedures
Preset button	Using presets (See page 21.)
Input Selection buttons	Selecting signal inputs (See page 16.)
Line Select button	Setting line select mode (See page 24.)
EXT REF button	Selecting signal inputs (See page 16.)
Freeze button	Freezing the display (See page 22.)
Help button	Using online help (See page 26.)
Configuration button	Configuring your instrument (See page 25.)
Up/Down/Left/Right Arrow keys and SEL button	Demonstrated in <i>Setting Display Parameters</i> (See page 15.)
General knob	Demonstrated in <i>To Select/Adjust a Parameter</i> (See page 25.)
Vertical and Horizontal knobs	Used to position waveforms when displayed in full screen. When the Audio display is active, use the Horizontal knob to adjust the headphone volume.
Power button	Press to turn the instrument on or off.
Main button	Access to 4-Tile (Quad Tile) mode and to the USB drive. Demonstrated in <i>4-Tile and Full-Tile Modes</i> (See page 16.)

Rear-Panel Connectors

The following figure shows the rear panel.

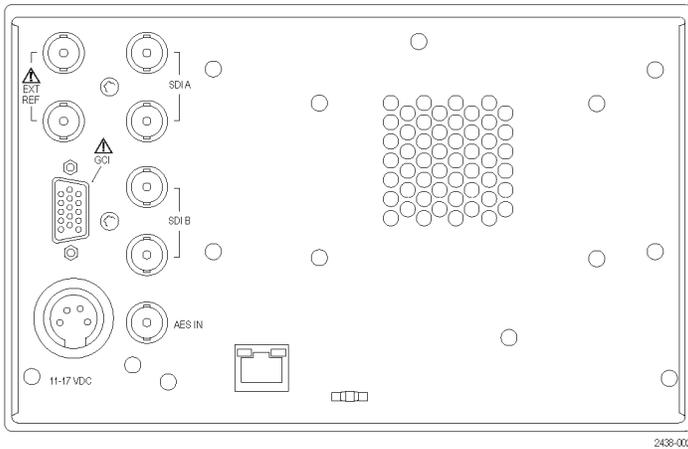

Power Requirements When Using an AC Converter

- A single-phase power source with one current-carrying conductor at or near earth-ground (the neutral conductor).
- The power source frequency must be 50 or 60 Hz, and an operating voltage range must be from 100 to 240 VAC, continuous.
- Systems with both current-carrying conductors live with respect to ground (such as phase-to-phase in multiphase systems) are not recommended as power sources.

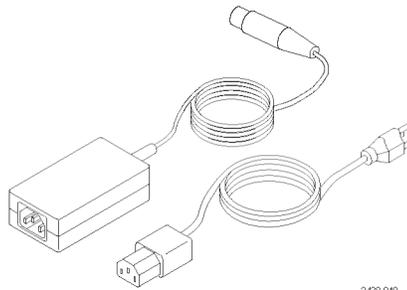

NOTE. Only the line conductor is fused for over-current protection. The fuse is internal and self-resetting.

Video Input Connectors

All SDI inputs are passive inputs compensated for 75 Ω and require termination.

- 1. Ref Loop.** A synchronization input. The input signal can be analog black burst, analog composite video, or analog tri-level for HD. Requires 75 Ω termination.

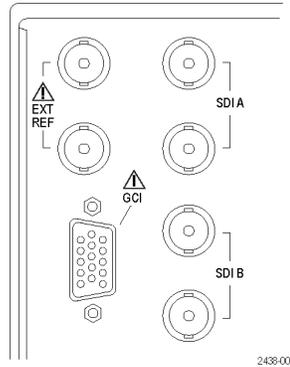

- 2. SDI A.** The Digital A component serial digital input is compensated for 75 Ω and requires termination.
- 3. SDI B.** The Digital B component serial digital input is compensated for 75 Ω and requires termination.

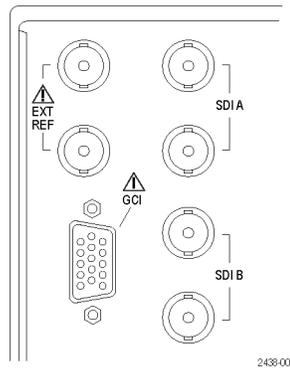

AES IN Connector

- 1.** This BNC connector supports AES IN audio input.

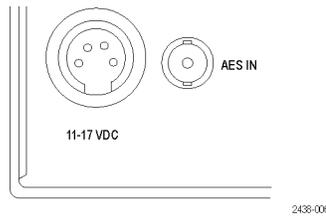

Ground Closure Interface Connector Pin Assignment

The ground closure interface (GCI) connector uses ground closures for remote control and indicating to external equipment when alarms have occurred. The input of LTC is through the GCI connector. The GCI connector is a 15-pin D-type connector with socket contacts.

Table 1: Remote Port

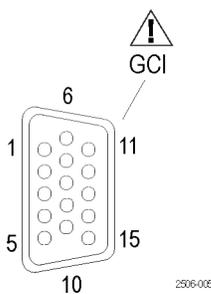
Characteristic	Performance requirement	Reference information			
		Hex	Binary Pins 15, 14, 13, 12, 11, 10	Direct mode selection	Encoded mode selection
 <p>Connector Pin Assignments</p>	1 GND (In)	F	111111	none	No action
	2 Reserved (I/O)	E	XX1110	Preset 1	No action
	3 Reserved (I/O)	D	XX1101	Preset 2	No action
	4 Reserved (In)	C	XX1100		SDI B
	5 Reserved (In)	B	XX1011	Preset 3	SDI A
	6 GND (In)	A	XX1010		No action
	7 Time Code Positive (LTC In)	9	XX1001		No action
	8 Time Code Negative (LTC In)	8	XX1000		Preset 8
	9 Ground Closure (Alarm Out)	7	XX0111	Preset 4	Preset 7
	10 Preset 1 (In)	6	XX0110		Preset 6
	11 Preset 2 (In)	5	XX0101		Preset 5
	12 Preset 3 (In)	4	XX0100		Preset 4
	13 Preset 4 (In)	3	XX0011		Preset 3
	14 Preset 5 (In)	2	XX0010		Preset 2
	15 Preset 6 (In)	1	XX0001		Preset 1
	0	XX0000		Unused	
	N/A	101111	Preset 5	N/A	
	N/A	011111	Preset 6	N/A	

Ethernet Connector

The instrument provides a 10/100 BaseT Ethernet interface. The Ethernet connector is a standard RJ-45 connector.

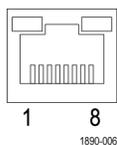

Selecting a Display

Perform the following procedure to select a display from the front panel of the instrument.

1. Push a button corresponding to the display that you want to view:
 - **WFM** - display of video waveform
 - **PICT** - display of the picture generated by the video signal
 - **GAMUT** - display selectable for three proprietary Tektronix views for checking the gamut of an SDI signal
 - **VECTOR** - display of Vector plots of color signals
 - **AUDIO** - display of level (meters) and of a phase (plot) for monitoring audio signals
 - **STATUS** - Extensive views of signal status, Error Log, and Timing display
 - **MAIN** - provides access to USB drive, 4-Tile mode, and Full-tile mode

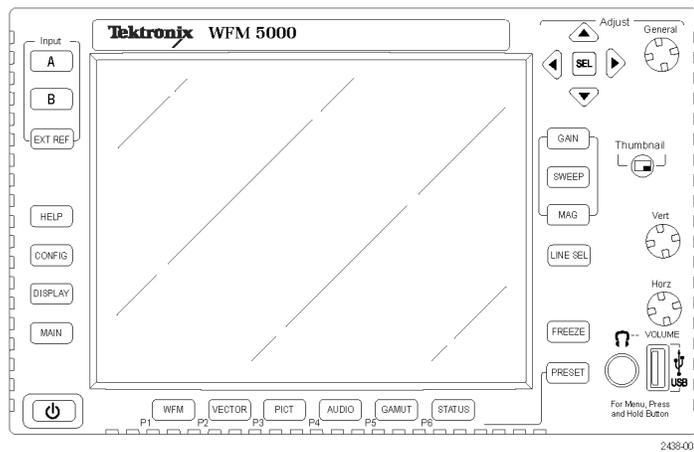

The selected display will appear.



Setting Display Parameters

You can set up the display parameters using the pop-up menus. In general, they control only settings specific to the active display type. For example, the pop-up menu for the Waveform display enables you to set the Display Mode.

The pop-up menu will appear when selected (see the procedure that follows), unless it is not appropriate for the current instrument setting (for example, trying to display the Gamut menu when viewing a composite input signal).

1. Push and hold the display button for which the settings need to be set or modified.
2. When the menu pops up, navigate through and make your selections as described in the steps that follow.

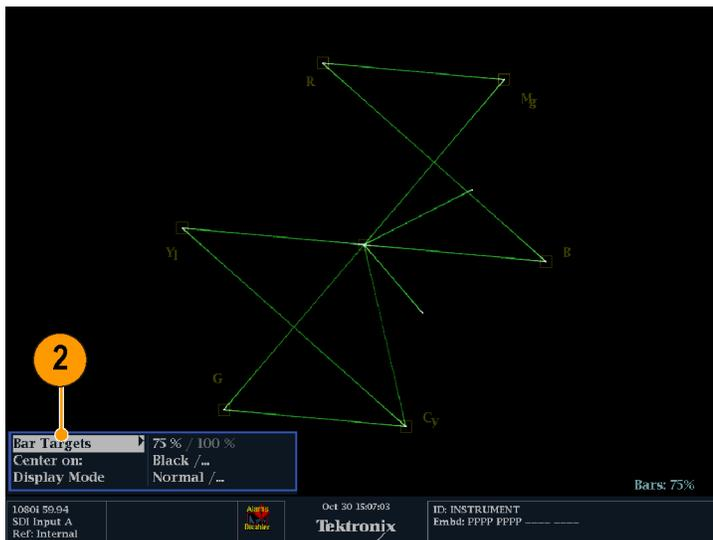

2438-031

3. Use the right and left keys to traverse between the menu panels.
4. Use the up/down arrow keys to select the parameters in a menu.
5. Press **SEL** to set the selected parameter.

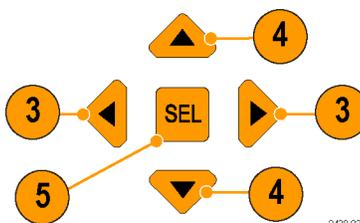

2438-035

The **VECTOR** display with the Bar Targets set to 75% is shown.

NOTE. *The selections in a pop-up menu can change depending on the settings.*

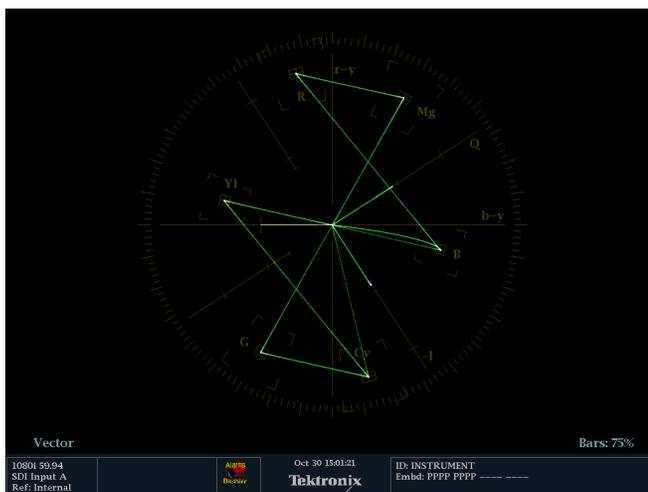

Selecting Signal Inputs

You can connect SDI (Serial Digital Interface) signals and select them for display. Depending on your instrument model and the options installed on it, you can also connect High Definition (HD) component signals and Standard Definition (SD) component signals.

To Select an SDI Input

1. Connect digital component video signals to the SDI A and SDI B inputs on the rear panel.
 - HD (WFM5000 series): The instrument automatically detects whether input is HD or SD.
 - SD (WFM4000 series): Connect SD signal only.

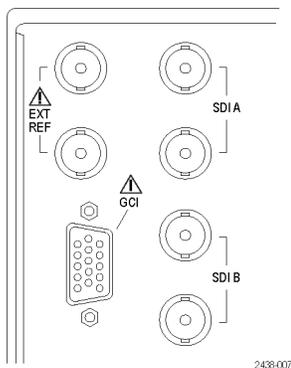

2. Press the **Input** button corresponding to the input that you want (SDI Input A shown).
3. Select a display to view the input.

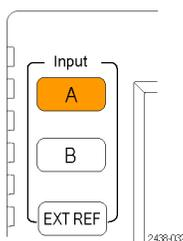

Setting 4-Tile and Full-Tile Modes

You can access the 4-Tile and Full-Tile functions from the **MAIN** button. 4-Tile mode allows you to view four displays at the same time. Each display will appear in one of four tiles on the display screen. Full-tile mode allows you to view the display in tile 1 at full screen.

When you press the **MAIN** button, a pop-up menu will appear allowing you access to the 4-Tile and Full-Tile settings. To set up the instrument to view four tiles simultaneously, perform the following procedure.

1. Press and hold the **MAIN** button to view the pop-up menu.
2. Press the up or down arrow key to navigate to **Tile Display** and then press the right arrow key to highlight **4-Tile**. This will select 4-Tile mode and the screen will display four separate tiles.

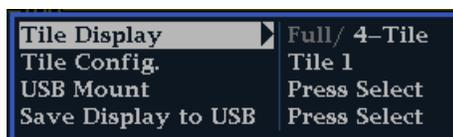

- Press the down arrow key to highlight **Tile Config.**, and then press the right arrow key to select **Tile 1**. Only a waveform (**WFM** button) display can be viewed in this tile.



NOTE. The **Tile Config.** menu option is only available when 4-Tile mode is selected.

- Press the down arrow key to highlight **Tile 2**, and then press the right arrow key to navigate to the submenu. The available displays will be shown in the submenu. Select the one you want to display in tile 2 using the up and down arrow keys.



- Press the left arrow key to return to the tile selection menu.

- Press the down arrow key to highlight **Tile 3**, and then press the right arrow key to navigate to the submenu. The available displays will be shown in the submenu. Select the one you want to display in tile 3 using the up and down arrow keys.

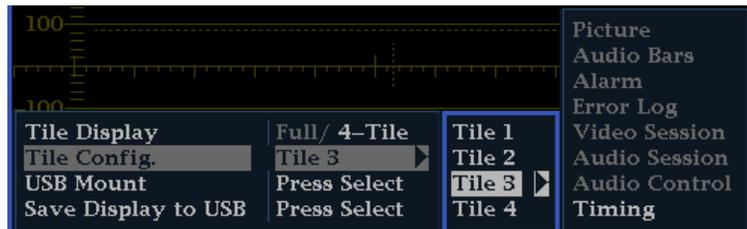

- Press the down arrow key to highlight **Tile 4**, and then press the right arrow key to navigate to the submenu. The available displays will be shown in the submenu. Select the one you want to display in tile 4 using the arrow keys.

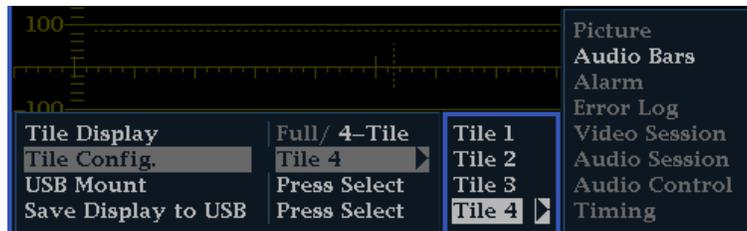

NOTE. Switch between Full-Tile and 4-Tile mode by pressing the **MAIN** button.

Navigating Between Tiles

Once you have configured the four tiles in your instrument, you can navigate between tiles by pressing the measurement button related to the type of display in the tile. You can configure the display of any active tile by pressing and holding the related measurement button to bring up its pop-up menu.

Navigating between tiles of different display types. If you have a waveform display in tile 1, press the **WFM** button, and tile 1 will be outlined by a blue line. This indicates that the tile is active. If you then want to activate another display in a different tile, press the related front panel button. For example, if you have a vector display in tile 2, pressing the **VECTOR** button will activate tile 2. The blue line will move from tile 1 to tile 2, indicating that tile 2 is now the active tile.

Navigating between tiles of the same display type. If the same measurement display is shown in two separate tiles, pressing the related measurement button will activate first one and then the other tile. For example, if a Picture display is shown in tile 3 and tile 4, pressing the **PICT** button will alternately make tile 3 and then tile 4 active.

Configuring displays in different tiles. You can configure the display of any active tile by pressing and holding the related measurement button to bring up its pop-up menu. For example, if you want to configure a waveform display in tile 1, press the **WFM** button to activate tile 1, and then press and hold the **WFM** button to view the **WFM** pop-up menu. You can then select or change configurable settings.

NOTE. Read about which displays are activated by which front panel buttons in the *Instrument Display* section of this manual. (See page 6.)

Setting Gain, Sweep, and Magnification

You can set the gain, sweep mode, and sweep rate using the **GAIN**, **SWEEP**, and **MAG** buttons. When you use the Waveform/Vector (WFM & VEC) Display Overlay feature, Gain, Sweep, and Magnification apply to the active display. A lit front-panel button denotes an active display.

NOTE. Gain, Sweep, and Magnification do not apply to all display types.

To Set Gain

1. Select the **WFM** measurement. (See page 14, *Selecting a Display*.)
2. Press and hold the **GAIN** button to display the gain settings.
3. If you enable **VAR Gain**, set the gain using the **GENERAL** knob.
4. If you select **Gain Settings**, choose the gain (x2, x5, x10) of your choice.

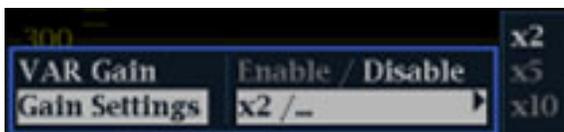
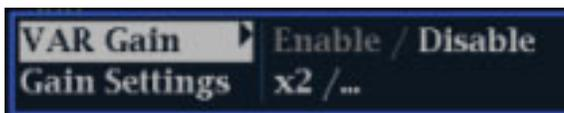

To Set Sweep

1. Press the **WFM** button. The default display style is Parade.
2. Press and hold the **Sweep** button to display the sweep settings.
3. Select the setting (1 Line or 1 Field) of your choice.



NOTE. If the Waveform display style is set to Overlay, the menu selections will include 2 Line and 2 Field.

To Set Magnification

1. Press the **WFM** button.
2. Press and hold the **MAG** button to display the magnification settings.
3. Select the setting (Best View, x10, x20, x30) of your choice.

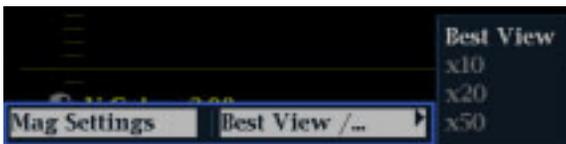

Using Waveform/Vector Display Overlay

TandemVu® is a patented display that allows you to overlay the Waveform and Vector or Waveform and Lightning displays, plus Picture Thumbnail, in a single, full-tile display. You can then view waveform and vector displays, or waveform and Lightning displays, at the same time. This feature allows you maximum visibility of each trace.

To set up WFM/Vector display overlay

NOTE. You can overlay the Vector display on the WFM display or the WFM display over the Vector display. Both overlay options are selected in the display pop-up menus. If you want to overlay the Lightning display, first select Lightning from the Vector menu, and then proceed to select overlay.

The following procedure shows how to set up the Vector over WFM overlay. To set up the WFM over Vector overlay, select the Vector button instead of the WFM button.

1. Press and hold the **WFM** button to view the WFM display and the WFM pop-up menu.
2. In the pop-up menu, navigate to **Display Overlay** and select **WFM & VEC**.
The Vector display will be overlaid on the WFM display.
3. Press the WFM button to dismiss the pop-up menu.

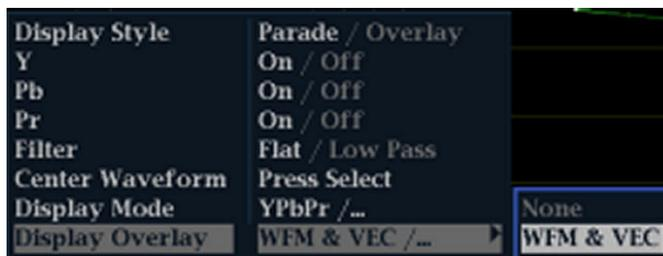

Using Presets

Presets let you save up to eight custom setups for later recall. You can also recall a factory predefined setup.

To Recall an Existing Preset

1. Press the **PRESET** button briefly and the display buttons on the bottom of the front panel will light up and named presets will appear at the bottom of the display screen.
2. Press the lit display button that corresponds to the named preset on the screen.

The front panel setup will switch to the saved preset corresponding to the button pressed.

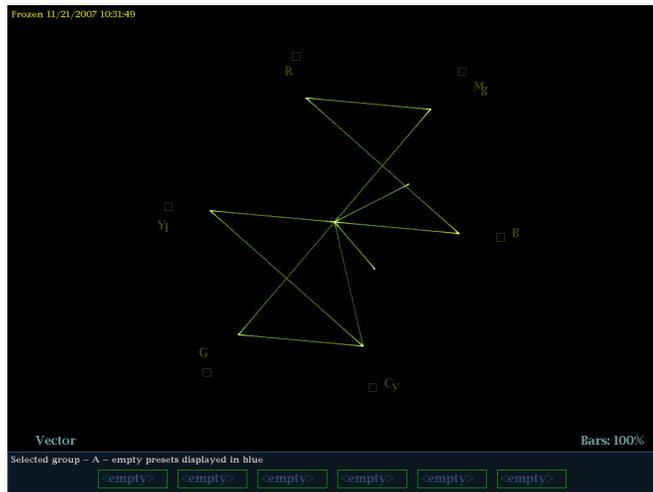

To Recall the Factory Preset

1. Press and hold the **PRESET** button to display the preset menu.
2. Select **Recall Preset > Recall Factory Preset**.

The front panel setup will revert to the default factory settings.

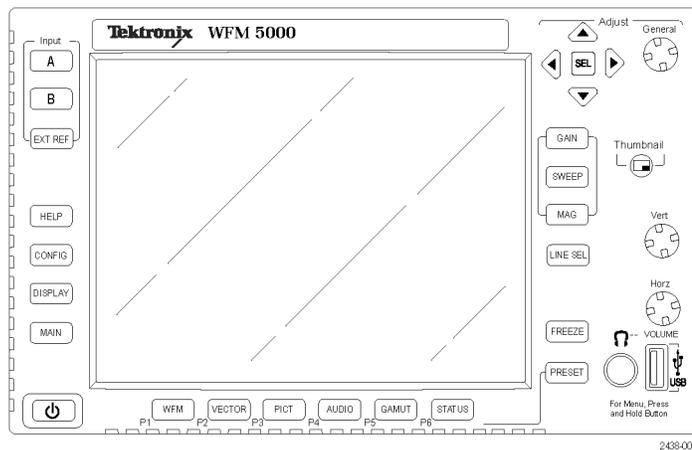

To Save a Setup to a Preset

1. Set up the instrument according to your requirements.
2. From the Preset menu, select **Save Preset** and select the name to which you want to map the new preset. This name corresponds to one of the six numbered preset buttons. The setup will be stored for later recall.

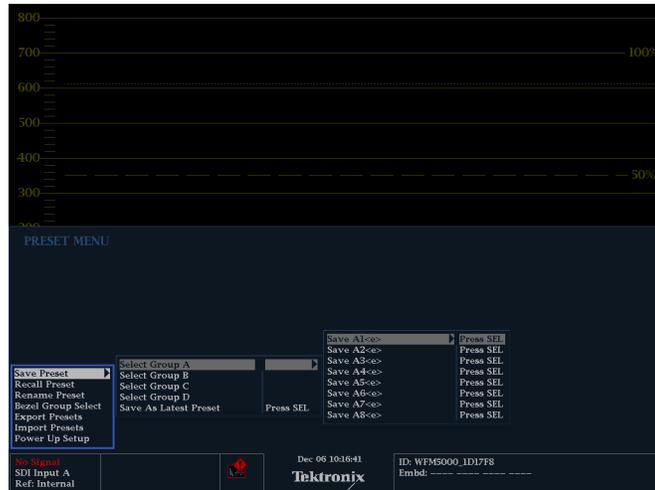

Freezing the Display

Freeze allows you to capture the current image for traces (waveform, gamut, and vector), as well as picture, status, and audio displays. This function is useful for comparing sources or capturing transient events.

NOTE. For waveform displays, the captured image is shown in a different color to distinguish it from the live image. For all displays, the instrument continues to log error status in the background while the display is frozen.

To Select the Freeze Display Mode

1. Push and hold the **FREEZE** button to display the pop-up menu.
2. Use the navigation keys to select the desired mode, and then press **SEL** to set the Freeze display mode:
 - **Live Only** allows you to keep a frozen image, but not display it.
 - **Frozen Only** allows you to see artifacts in the frozen trace more easily.
 - **Live + Frozen** allows comparisons and matching. (Status and Audio displays do not support this mode.)

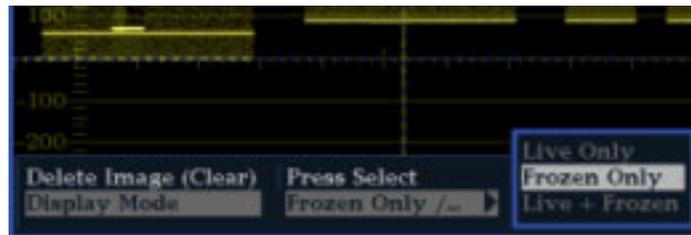

To Halt Display Update

Push the **FREEZE** button to stop a display update. For most displays, this will stop updates.

To Delete the Freeze Display

1. Select the frozen display that you want to delete.
2. Press and hold the **FREEZE** button to display the pop-up menu. By default, the **Delete Image (Clear)** will be selected.
3. Press **SEL** to delete the frozen image. The pop-up menu automatically disappears when the frozen image is deleted.



To Save a Display to a USB Device

You can capture a full screen image of any display, whether the instrument is in Full or 4-Tile mode, using the following procedure.

1. Configure the display you want to capture.
2. Press and hold the **MAIN** button to display the pop-up menu.
3. Use the down arrow to navigate to **Save Display to USB**.
4. Press the **SEL** button and follow the on-screen instructions.



Usage Tips

To adjust this setting, select **Display Settings > Freeze Effects** from the **CONFIG** menu.

Cursors track the live trace, so they may not be correctly registered on a frozen trace. If you change parameters such as position, sweep rate, or gain, then the cursors may not be accurate relative to a frozen trace.

Setting Line Select Mode

To Toggle Line Select Mode

1. Select the measurement display for which you want to set the Line Select mode.
2. Press the **LINE SEL** button to toggle Line Select mode On or Off. When On, it displays the line information.

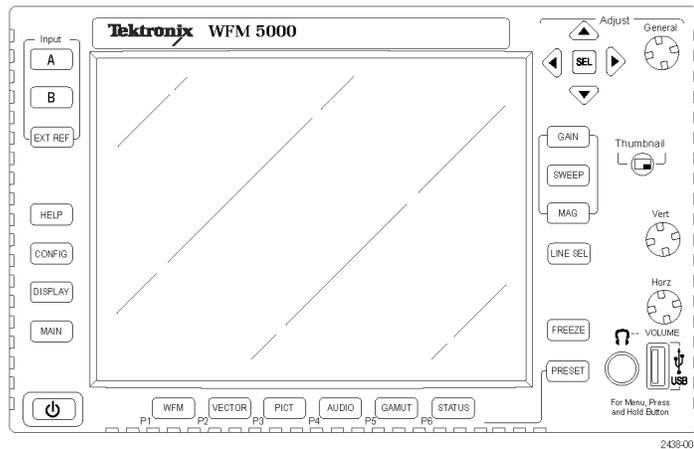

3. Press the left or right arrow key to select F1 (field 1), F2 (field 2), or All.
4. The line and field information will appear at the bottom of the display screen.
5. Turn the **GENERAL** knob to select the line you want to view.

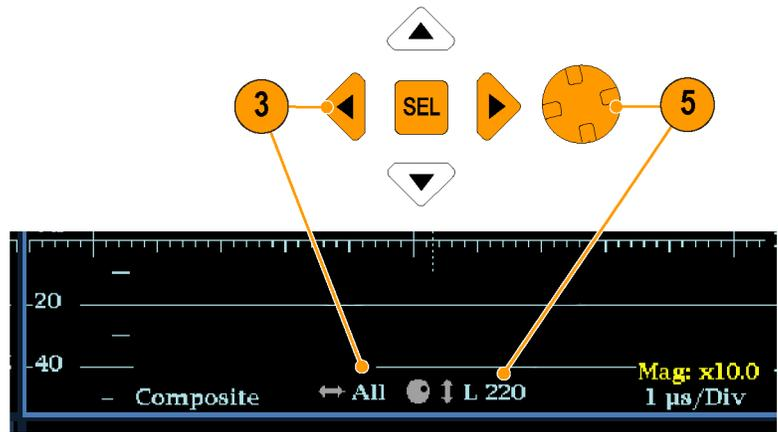

Configuring Your Instrument

The Configuration menu is used to change the instrument settings that are changed occasionally such as printer settings. To change a setting, you must first highlight it. The following procedures help you to navigate through the configuration menu.

To Traverse the Menu Panes

1. Press the **CONFIG** button to display the Configuration menu.
The Configuration menu is displayed on the top or bottom half of the screen.

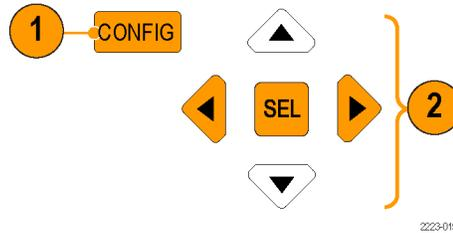

2. Use the left/right arrow keys to move the selection back and forth among panes.
The selected, active pane has a blue outline.

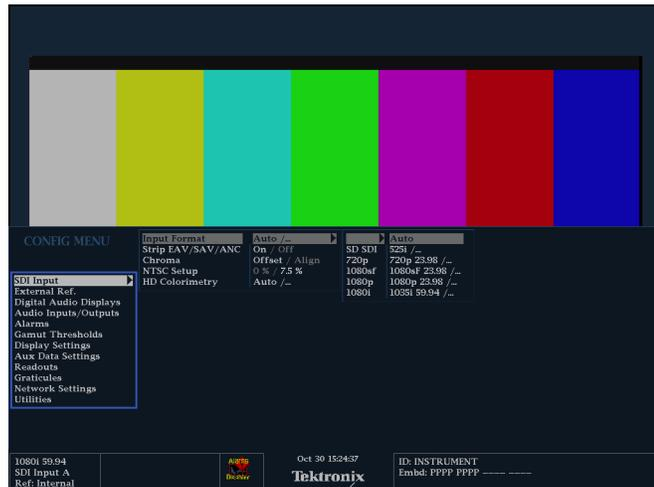

To Select/Adjust a Parameter

3. Use the up/down arrow keys (or the General knob) to move the selection up and down the menu entries in the selected pane.
Notice which pane is active. The selected, active menu item is highlighted by a white menu bar; and the selected item in the inactive pane is highlighted by a gray menu bar.
4. Press the **SEL** button (or right-arrow key) to toggle between and set the desired parameter settings.
5. If the menu item selected results in the knob icon appearing in the menu, use the General knob to adjust the selected parameter.

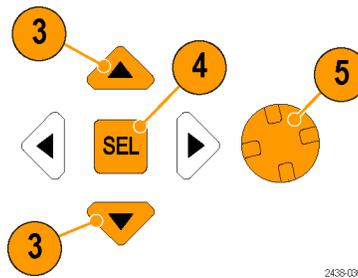

Using Online Help

The online help is both a quick and an exclusive reference for instrument operation details. The online help is:

- Context-sensitive. The topic displayed depends on what is displayed when the online help is selected or what control is operated after help is selected.
- Navigable. The Contents and Topic Selector panes, along with Links within the topics, provide access to topics.

To Display and Navigate Online Help

1. Press **HELP**.
2. Use the **GENERAL** knob or the up/down arrow keys to highlight an entry in the Contents (entries never change).
3. Press **SEL** to select the highlighted category.



4. Press the right-arrow key to move selection to the Topic Selector pane (entries change with the selection made in steps 2 and 3).
5. Use the **GENERAL** knob and the up/down arrow keys to select among the topics listed for the heading selected in step 2.
6. Press **SEL** to display the selected topic.

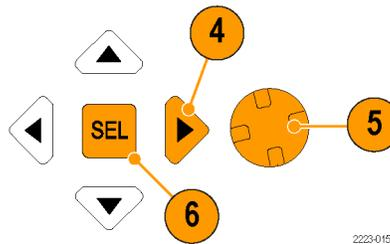

2223-015

To Follow a Link Within a Help Topic

1. Press the right-arrow key to move selection to the Topic pane.
2. Highlight a link using the **GENERAL** knob or the up/down arrow key.
3. Press **SEL** to jump to the linked-to topic.
4. Press the left-arrow key to go back to the previous topic.

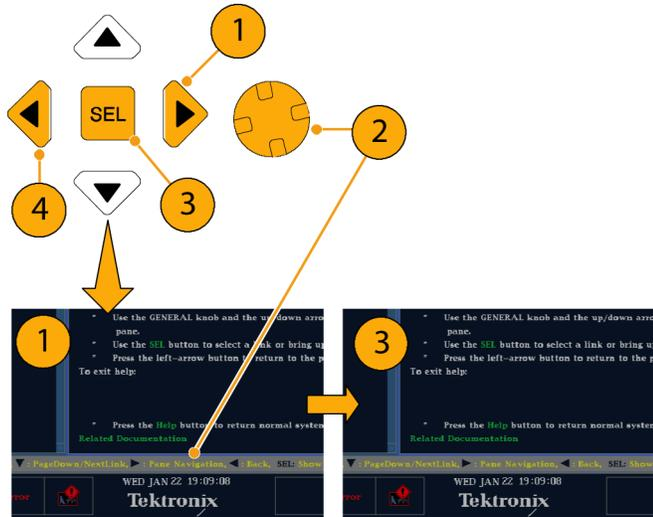

To Get Context Sensitive Help

1. When a menu is displayed, select the menu setting for which you want help information, press the **HELP** button, and help on that setting will appear.
2. You can also operate (press, select, or turn) a control for which you want help information and the help topic pane will display help on the control you used.
3. Press **HELP** again to exit online help.

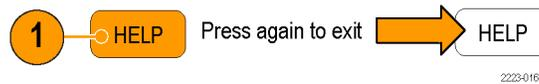

2223-016

Adjusting Headphone Volume and Source

When an audio tile is active, the headphone volume can be adjusted using the Horizontal knob. To adjust the audio source, perform the following procedure.

NOTE. The headphone icon appears at the bottom of the Audio display.



WARNING. To avoid hearing damage, always turn the volume down to the minimum before you put on headphones, and then turn it up slowly.

1. Press the **AUDIO** button to bring up the audio display or make an existing audio display active in 4-Tile mode.
2. Press and hold the **AUDIO** button to display the Audio menu.
3. Select **Phase/Headphone Pair**, and then select the headphone source of your choice.

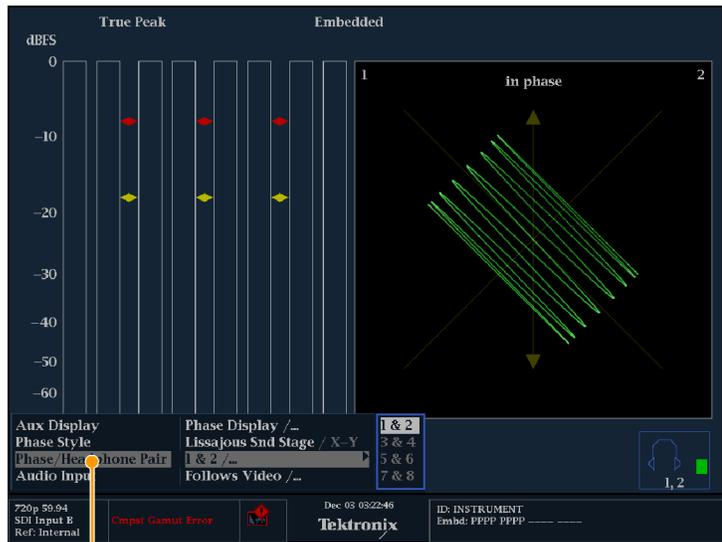

2438-021

Checking Chroma/Luma Delay (Lightning Display)

The Lightning display can be used for interchannel timing measurements. When the color-difference signal is not coincident with luma, the transitions between the color dots will deviate from the center mark of a delay scale. The amount of deviation represents the relative signal delay between luma and the color-difference signal.

1. Connect a signal containing color bar information, terminating the signal properly.

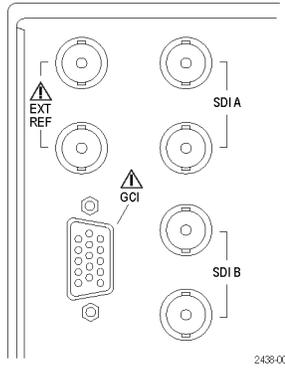

2. Press and hold the **VECT** button to display the signal and the Vector pop-up menu.

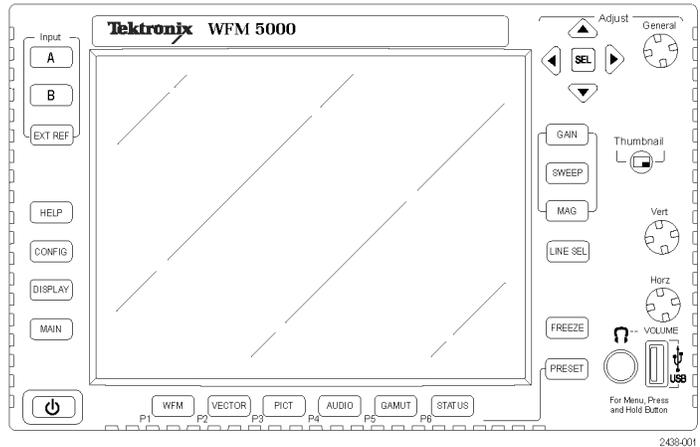

3. Use the arrow keys and the **SEL** button to set the menu in the steps that follow.
4. Set the Display Type to **Lightning**.

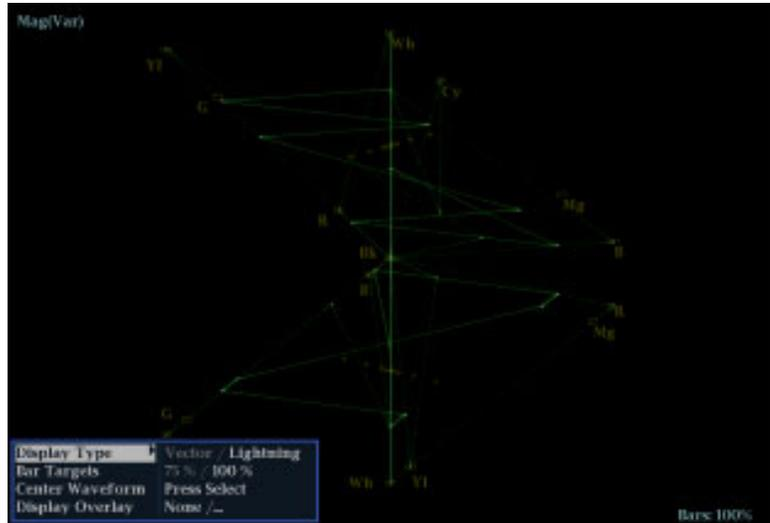

5. Set **BAR TARGETS** to match your input signal.
6. Select **Center Waveform**, and press **SEL** if you want to center the waveform.
7. Press the **VECT** button to close the pop-up menu.
8. Determine where transitions intersect the delay scales and derive the timing error in nanoseconds, as deflected from the center mark:

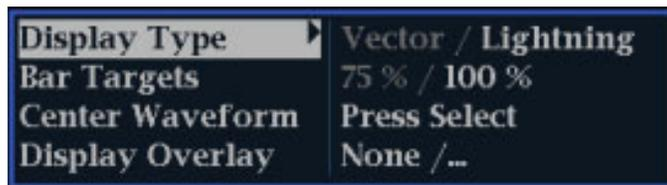

- The center mark of the nine marks spanning each green-magenta transition is the zero error point.
- Alignment to a mark towards black means the color-difference signal lags with respect to luma.
- Alignment to a mark towards white means the color-difference signal leads the luma signal.
- The upper half of the display measures the Pb to Y timing; the bottom half measures the Pr to Y timing.

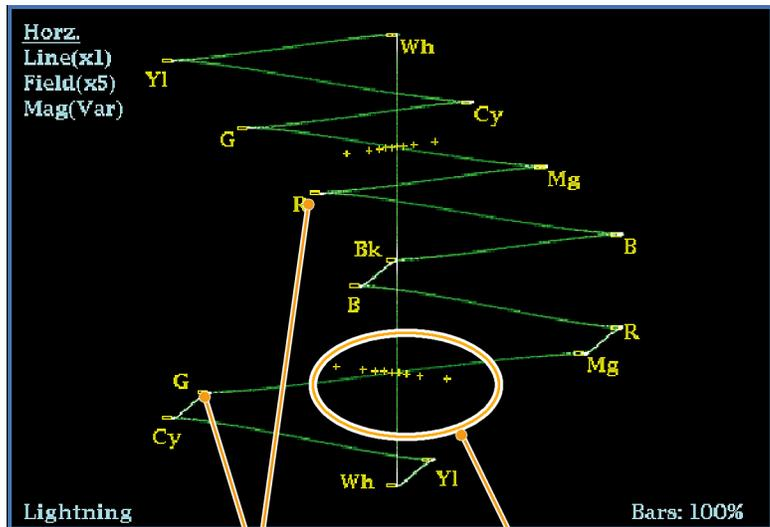

Green-to-Magenta transitions

Delay scale

The + tic marks on the graticule indicate the following timing errors:

Tic mark	SD timing error (ns)	HD timing error (ns)	1080p 50, 59.94, 60 (dual link formats) timing error (ns)
0 marks	0	0	0
1st	20	2	1
2nd	40	5	2.5
3rd	74 ¹	13.5	6.75
4th	148 ²	27	13.5

¹ Luma sample
² Chroma sample

Checking Gamut

Signals that are legal and valid in one signal representation may not be legal in another representation. Specifically, signals which are legal in the Digital YCbCr representation may not be legal if transcoded to RGB or encoded to NTSC/PAL. Any signal that fails this test is considered outofgamut.

Your instrument supports multiple displays and alarms to detect outofgamut signals. The displays and their uses are as follows:

- Diamond for checking that SDI signals conform to legal RGB gamut space
- Split Diamond separates the upper and lower diamonds to show excursions below black; otherwise it is identical to the Diamond display
- Arrowhead for checking if an SDI signal is legal for composite color space

Diamond, Split Diamond, and Arrowhead have adjustable thresholds. If the signal goes outside the area defined by the thresholds, the signal is outofgamut. If these limits are exceeded, the instrument can generate alarms if configured to do so.

Setup for Gamut Checks

1. Connect a video signal and terminate it properly.
2. Select the input corresponding to the signal connected.

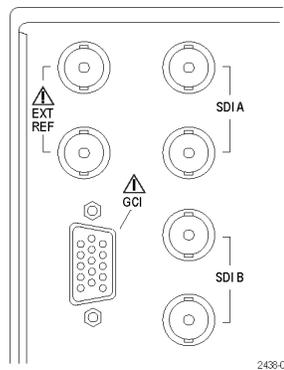

3. Press and hold the **GAMUT** button to display the signal and the GAMUT pop-up menu.

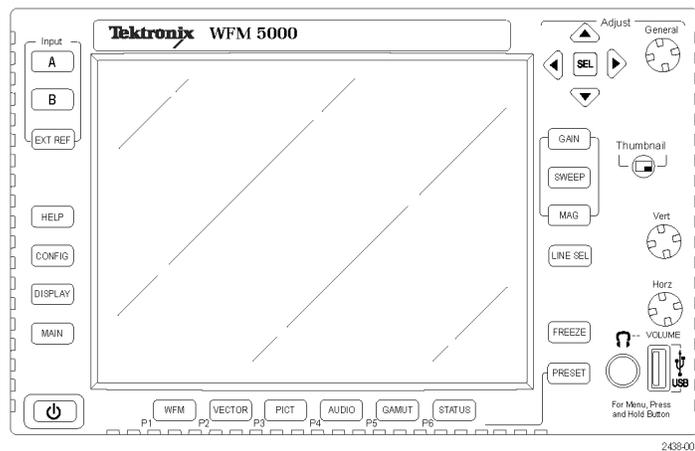

4. Use the arrow keys and **SEL** button to set the menu to one of these three gamut displays:

- Diamond. Use to detect, isolate, and correct RGB component gamut errors.
- Split Diamond. Use to reveal hard-to-find black gamut errors.
- Arrowhead. Use to detect composite gamut errors, without employing a composite encoder.



5. Press the **GAMUT** button to close the menu.

Checking RGB Gamut

The Diamond display effectively shows how the R, G, and B signals relate, making it a good tool for detecting gamut errors. The instrument converts the Y, P_b, and P_r components recovered from the serial signal to R, G, and B to form the Diamond display. To predictably display all three components, they must lie between peak white, 700 mV, and black, 0 V.

For a signal to be in gamut, all signal vectors must lie within the G-B and G-R diamonds. Conversely, if a signal vector extends outside the diamond, it is outofgamut. The direction of an excursion outofgamut indicates which signal is excessive. Errors in green amplitude affect both diamonds equally, while blue amplitude errors affect only the top diamond and red errors affect only the bottom diamond.

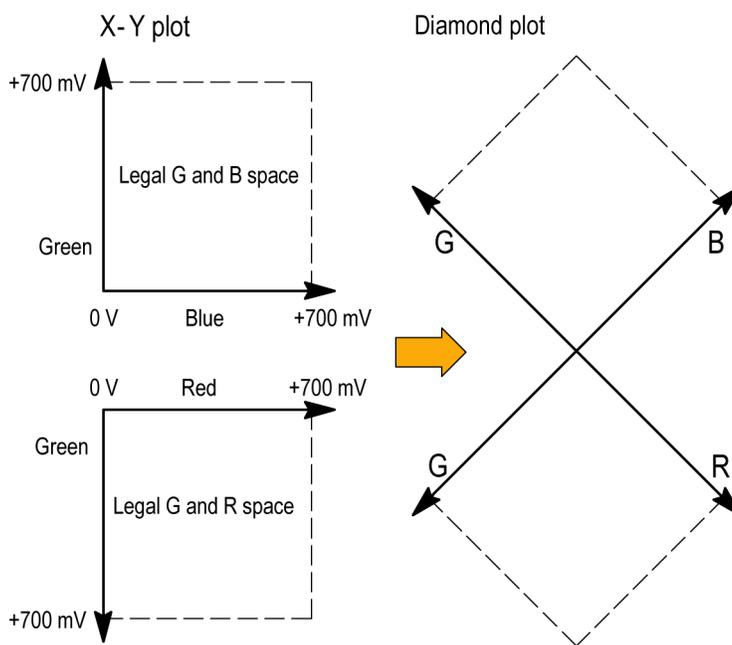

1. Perform the *Setup for Gamut Checks* procedure. Select **Diamond** in step 4. (See page 32.)
2. Compare the signal to the display to determine out-of-gamut components, and note the following:

- The intensity of a vector indicates its duration.
- A momentary out-of-gamut condition appears as a faint trace. Long duration violations show as a bright trace.

See the following step for some sample out-of-gamut signals.



3. Consider the following examples when evaluating for outofgamut components:

- A. Example A:
 R - Ok
 G > 700 mV
 B - Ok
- B. Example B:
 R - Ok
 G - Ok
 B > 700 mV
- C. Example C:
 R - Ok
 G - Ok, 350 mV
 B < 0 mV

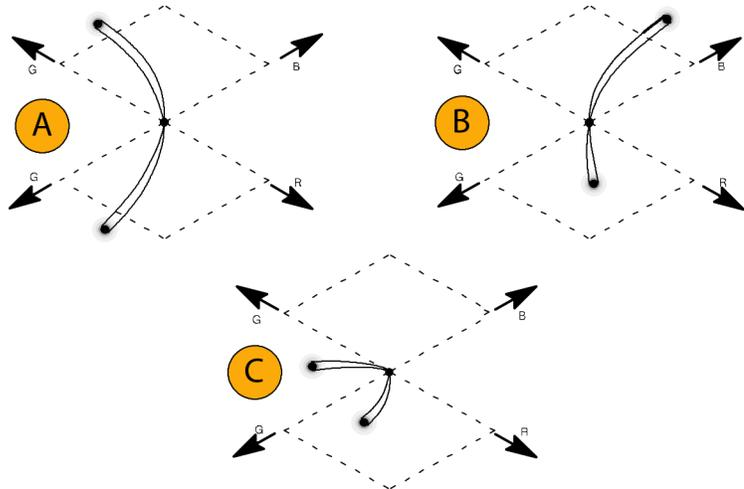

Usage Notes

On the Diamond display, monochrome signals appear as vertical lines. Nonlinear component processing, such as from a gamma corrector that alters white balance, can cause deviations along the vertical axis.

To isolate gamut bright-ups, try the following:

- Use the **LINE SEL** button to select individual lines
- Use the **PICT** display to examine the signal (turn on gamut bright-ups in the Display Settings submenu of the Configuration menu)
- Use the **Arrowhead %** setting (found in the Gamut Thresholds submenu of the Configuration menu) to specify a percentage of the screen to ignore for gamut violations.

Checking Composite Gamut

The Arrowhead gamut display plots luminance (Y) against chrominance (C) to check if the composite signal adheres to standard gamut. NTSC and PAL Arrowhead displays (75% Color bars) show the values of the graticule lines. The arrowhead shape of the graticule results from overlaying the standard limits for luminance and luminance-plus-peak chrominance.

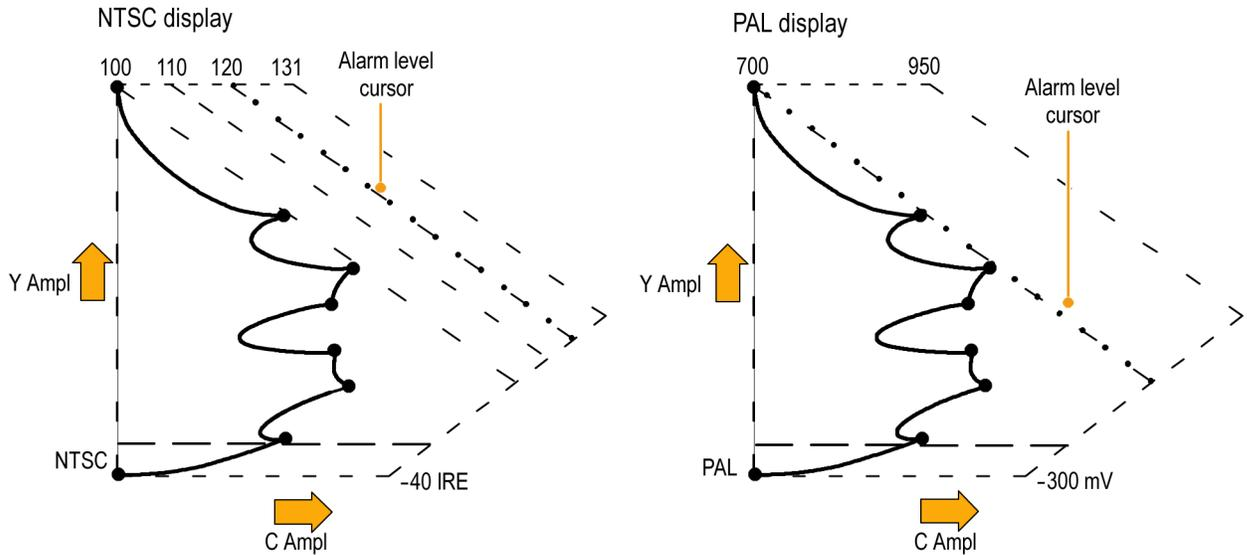

1. Perform the *Setup for Gamut Checks* procedure. Select **Arrowhead** in step 4. (See page 32.)
2. Compare the signal to the display to determine out-of-gamut composite components, noting the following:
 - Signals exceeding the luminance amplitude gamut extend above the top horizontal limit (top electronic graticule line).
 - Signals exceeding the luminance-plus-peak chrominance amplitude gamut extend beyond the upper and lower diagonal limits.
 - The bottom horizontal line shows the minimum allowed luminance level of 7.5 IRE for NTSC and 0 mV for PAL.

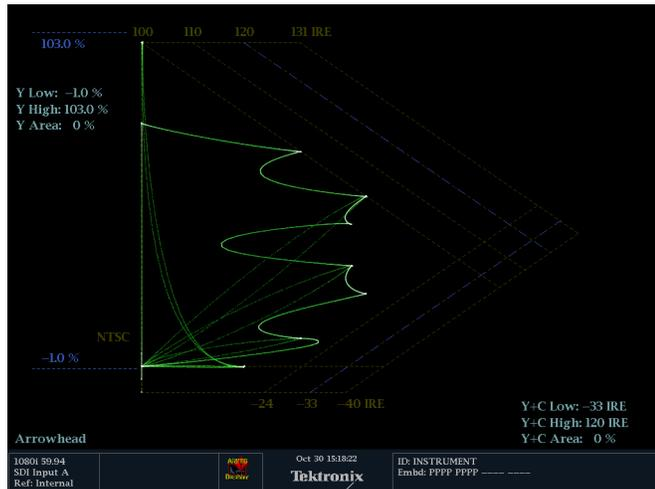

Usage Notes

- To adjust the IRE level limits, do the procedure *Adjusting Gamut Limits*. (See page 38, *Adjusting Gamut Limits*.)
- To automate this check, do the procedure *Automating Gamut Checks*. (See page 37, *Automating Gamut Checks*.)

Checking Luma Gamut

Luma limit thresholds can be configured for identifying luma exceeding threshold limits. They apply to both the incoming SDI and to the arrowhead representation of the SDI input as a composite signal. By defining these levels in percent, they automatically account for the presence or absence of setup. The thresholds are affected by your choice of setup or no setup for the Arrowhead display.

1. Perform the *Setup for Gamut Checks* procedure. Select **Arrowhead** in step 4. (See page 32.)
2. Compare the signal to display to determine out-of-gamut luminance. Note the following:
 - The adjustable thresholds are indicated by the dark blue horizontal graticule lines.
 - The thresholds are defined in terms of percent of full scale.
 - The range for the Upper limit is 90% to 108%.
 - The range to the Lower Limit is -6% to +5%.

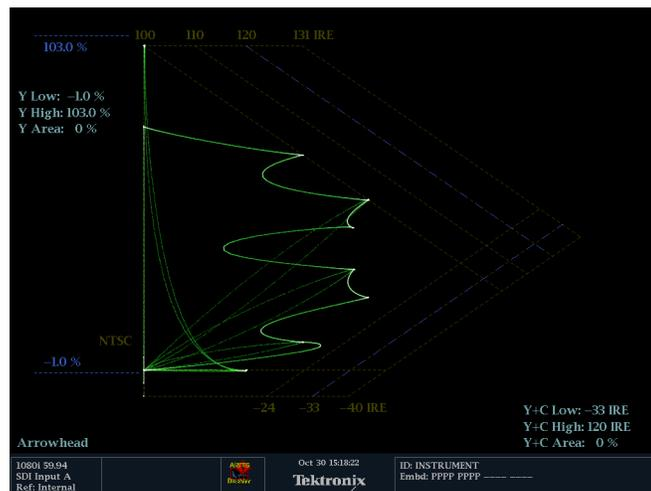

Another useful Arrowhead function is a measure of how well the active video signal is using the dynamic range of the video channel. A properly adjusted signal should be centered in the arrowhead graticule and have transitions that approach all the limits.

Automating Gamut Checks

You can use alarms to automatically monitor for out-of-gamut conditions:

1. Press the **CONFIG** button to display the Configuration menu.
2. Use the arrow keys and **SEL** button to select **Alarms** and then **Video Content**.

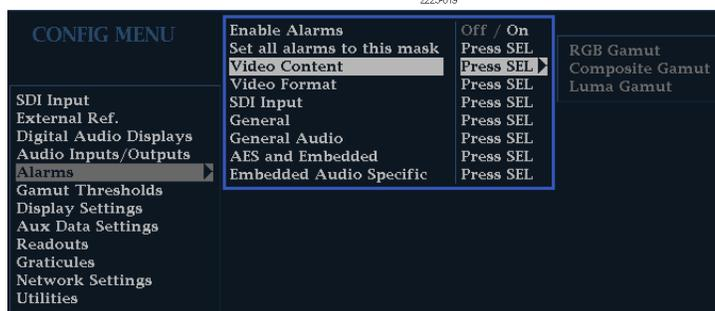
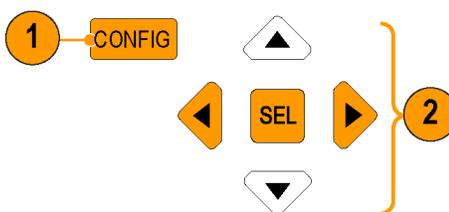

3. Use the arrow keys to move to each of the alarm that you want to set. Press **SEL** button to toggle the alarm on (X) or off.

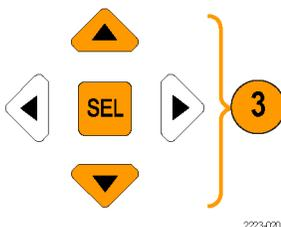

4. When you have configured the Alarms, move to the **Return** box and select it.

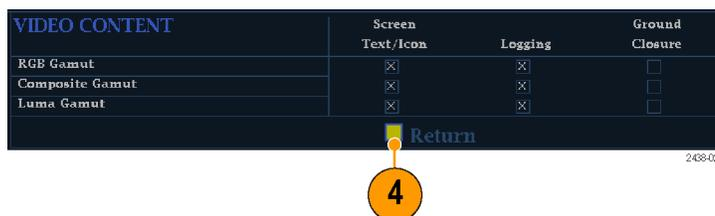

5. Check that **Enable Alarms** is set to **On** in the Alarms menu before leaving the Alarms menu.

NOTE. For information on Alarms, press the **HELP** button while Alarms is selected in the configuration menu.

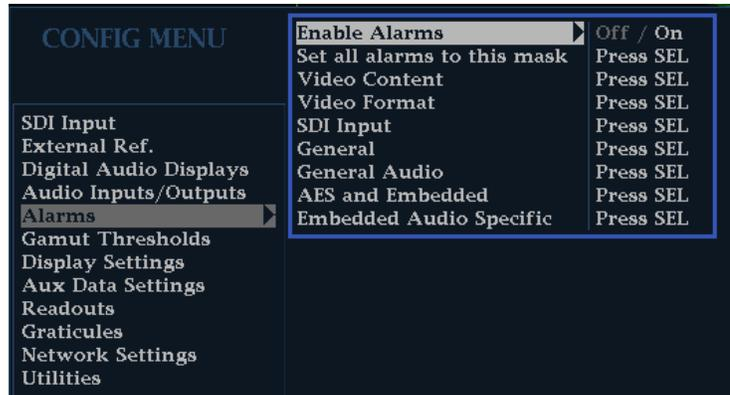

6. Press **CONFIG** to exit the menu.

Adjusting Gamut Limits

1. Press the **CONFIG** button to display the Configuration menu.
2. Use the left/right arrow keys and **SEL** button to select Gamut Thresholds.
3. Press the **SEL** button to enter the submenu, and then use the arrow keys and **SEL** button (and General knob, when indicated) to select and set the various thresholds.

Note that you can also reset thresholds to defaults.



Timing Display

The Timing display is a Tektronix proprietary display that simplifies measuring the timing difference between two signals as the timing is corrected. You can access this display from the **STATUS** button. Using the Timing display enables you to easily compare and correct the timing between two signals. (See Figure 1.)

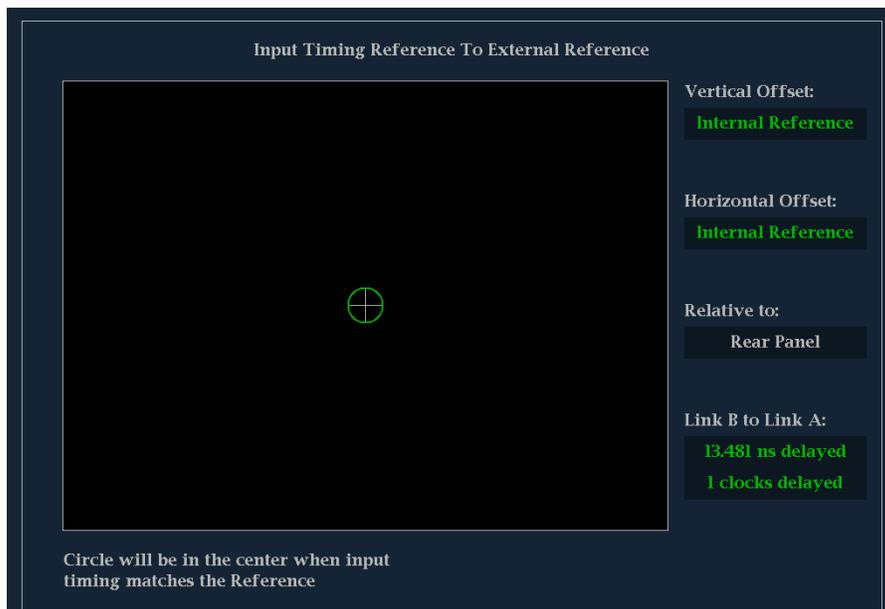

Figure 1: Timing display

Timing Display Elements

- **Input Signal Indicator:** A single circle representing timing of input signal relative to the reference.¹
 - **Reference Indicator:** A cross-hair indicator centered in the display represents the reference signal.
 - **Vertical Offset:** The timing difference between the reference and input signal.
 - **Horizontal Offset:** The timing difference between the reference and input signal.
 - **Relative to:** Indicates the chosen zero point for the timing display.²
 - **Link B to Link A:** Indicates the timing reference relationship when the instrument is in simultaneous input mode. (Available with WFM4000 models only)
- ¹ More complex timing relationships display multiple circles. See *Timing Displays for Simple Versus Complex Timing*. (See page 40.)
- ² Rear Panel is the default setting, where offset is shown as zero when the input and reference are at the same timing at the rear panel of the instrument. If you select *Saved Offset*, you can save the timing from one signal, and then display the timing relative to that saved offset.

Timing Pop-up Menu

Once you have selected **Timing Measure** from the **STATUS** button pop-up menu, pop-up menu enables you to save a timing setting for comparison with another signal and specify the zero point of the timing display.

To save the timing of the current input as an offset to the timing display, use the **Save Offset** menu entry. The current timing becomes the zero point for the saved offset mode of the timing display. This applies to both the cross-hair target in the middle of the display and the numeric readouts.

NOTE. You cannot save the timing offset if either the input or reference is missing or unlocked. You also cannot save a reference when in internal mode. Saving an offset in these conditions would lead to misleading results so it is not allowed by the instrument. A warning message will appear on the screen if you attempt to save the offset when it is not allowed.

Save Offset allows you to measure the timing between inputs or to match multiple signals. To select the definition for the zero timing offset, use the **Relative To:** menu entry to select one of the following:

- **Rear Panel** means the timing offset will be shown as zero when the two signals are timed down at the rear of the instrument.
- **Saved Offset** means that the timing will be shown as zero offset when the input signal matches the timing of the signal that was present when the offset was saved using the Save Offset menu entry.

This selection changes both the numeric readouts and the target in the middle of the timing display.

Timing Displays for Simple Compared to Complex Timing

The number of circles, with each representing a time offset, varies with the complexity of the timing between the reference and input signals.

Integer multiples of reference rates. If you are timing input signals with rates that are integer multiples of the reference rates, the instrument can measure the timing deterministically and displays the relationship as one circle (offset) relative to the cross-hair. (See Figure 2.)

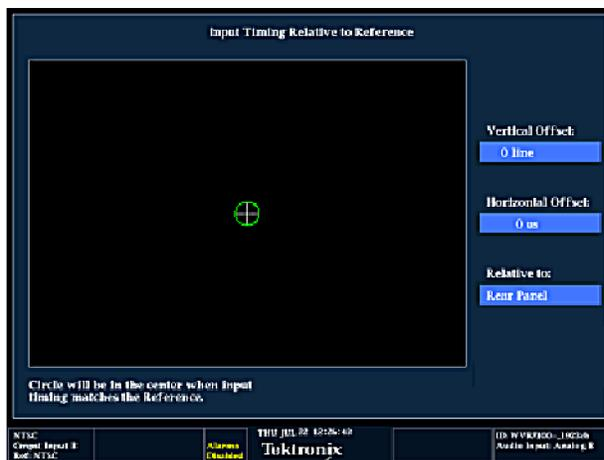

Figure 2: Timing display of integer multiples of reference rates

Such cases include timing an NTSC input (multiplier of 1) or a 525 SDI input whose frame time is 33.36 ms (multiplier of 2), against an NTSC reference, which has a frame time of 66.73 ms.

Non-integer multiples of reference rates. If you time input rates that are not integer multiples of the reference rates, the instrument cannot measure the timing deterministically, so it displays the relationships as several circles. Each circle represents a possible timing offset measurement relative to the reference cross-hair. Display emphasis is given to the circle that times closest to zero offset and the numerical readouts track this pair. (See Figure 3.)

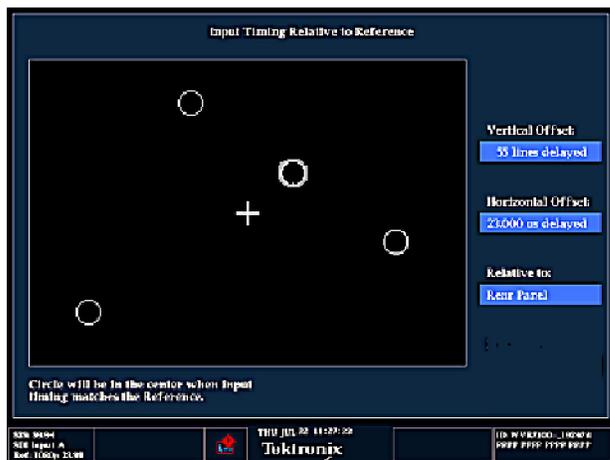
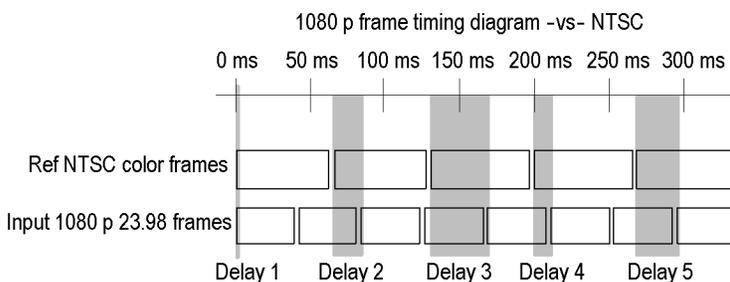

Figure 3: Timing display of non-integer multiples of reference rates

Nondeterministic cases include timing of slow rate inputs against fast frame-rate references or when timing video against film rates.

Multiple relationships. For a case where multiple relationships would display, consider an input of 1080p/23.98 Hz with a reference of NTSC/59.94 Hz:

- The different rates result in timing relationships between the signals that repeat once for every four fields of the input and five frames of the reference.
- Because this allows for five possible ways to measure timing between these two signals, the timing display shows four circles, with emphasis and readouts as previously described above.



Supported Video Formats

The following table shows which video formats are supported. If a specific format is only supported by a specific instrument model, it is referenced in a footnote.

Table 2: Supported video formats

Supported formats	External reference inputs									
	NTSC	PAL	720p			1080p/sF		1080i		
	59.94 Hz	50 Hz	50 Hz	59.94 Hz	60 Hz	23.98 Hz	24 Hz	50 Hz	59.94 Hz	60 Hz
483i, 59.94 Hz (525), BT601	x			x					x	
576i, 50 Hz (625), BT601		x	x					x		
720p, 23.98 Hz ¹				x		x			x	
720p, 24 Hz ¹					x		x			x
720p, 25 Hz ¹		x	x					x		
720p, 29.97 Hz ¹	x			x					x	
720p, 30 Hz ¹					x					x
720p, 50 Hz ¹		x	x					x		
720p, 59.94 Hz ¹	x			x		x			x	
720p, 60 Hz ¹					x		x			x
1035i, 59.94 Hz ¹	x			x					x	
1035i, 60 Hz ¹					x		x			x
1080i, 50 Hz ¹		x	x					x		
1080i, 59.94 Hz ¹				x					x	
1080i, 60 Hz ¹					x		x			x
1080p, 23.98 Hz ¹	x			x		x			x	
1080p, 24 Hz ¹					x		x			x
1080p, 25 Hz ¹		x	x					x		
1080p, 29.97 Hz ¹	x			x					x	
1080p, 30 Hz ¹					x					x
1080sf, 23.98 Hz ¹	x			x		x			x	
1080sf, 24 Hz ¹					x		x			x

Table 2: Supported video formats (cont.)

Supported formats	External reference inputs									
	NTSC	PAL	720p			1080p/sF		1080i		
	59.94 Hz	50 Hz	50 Hz	59.94 Hz	60 Hz	23.98 Hz	24 Hz	50 Hz	59.94 Hz	60 Hz
1080sf, 25 Hz ¹	x	x						x		
1080sf, 29.97 Hz ¹				x					x	
1080sf, 30 Hz ¹					x					x

¹ Available with the WFM5000 only.

Monitoring Audio

Your instrument provides several methods for monitoring audio signals. It can measure levels, phase, and phase correlation. You can specify meter ballistics and scales, set test and peak program indicator levels, and specify how phase is displayed.

Configuring Audio Inputs

Audio inputs are initially set to factory defaults. As a result, you may need to configure them before performing the audio monitoring procedures in this section. The first procedure will help you configure the inputs. After you have completed that procedure, check that the alarms are configured as you want them. (See page 44, *Monitoring Audio*.) Your setup here determines, in part, which audio-signal characteristics are displayed.

To set up an Audio Input:

1. Press the **CONFIG** button to display the Configuration menu.
2. Use the Arrow keys and **SEL** button to make selections in the steps that follow.

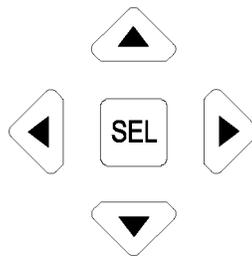

3. Select **Audio Inputs/Outputs**.
4. Select the input to be configured.



5. Select **Bar to Input Map** and specify which input pair should be displayed in each bar pair.
6. Specify which inputs will be allowed to generate alarms.
7. Select the **Return** box to return to the Configuration menu.

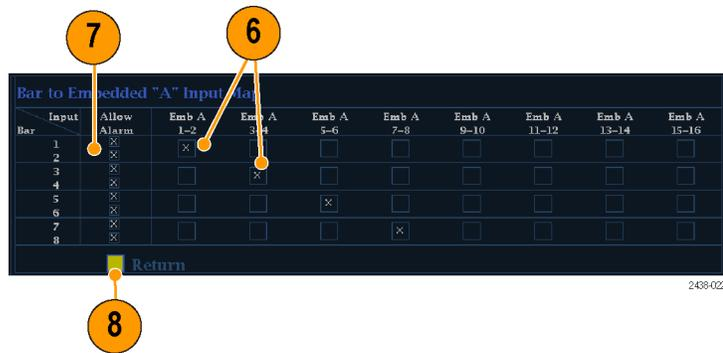

8. Repeat steps 4 through 7 for other audio inputs, as needed.

Selecting Audio Input

Select the audio input to be monitored from the front-panel **AUDIO** button pop-up menu.

1. Press and hold the **Audio** button to open the Audio display and pop-up the Audio menu.

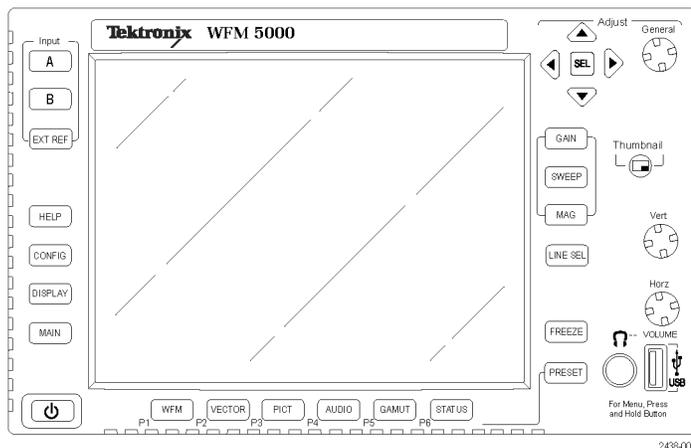

2. Use the Arrow Keys and **SEL** button to make selections in the steps that follow.
3. Select **Audio Input** and then select one of the audio input options shown.

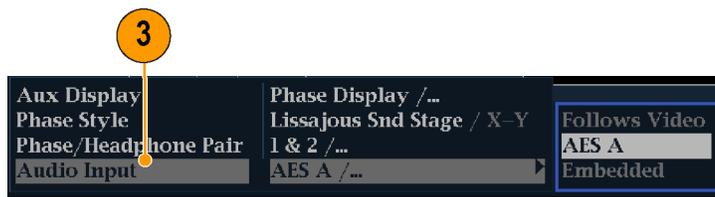

Checking Audio Level and Phase

Level meters are vertical bar graphs on which the height of the bar indicates the amplitude of the audio program in the corresponding input channel. You can change the input and turn on and off the Phase display from the Audio pop-up menu. Other meter characteristics such as ballistics, scale units, and program and test levels are configured through the Configuration menu.

Your instrument can display phase of one input pair as a Lissajous pattern, and display correlation of all pairs.

To Check Level

1. Open the audio display and select an input. (See page 45.)
2. Check the level meter bars for current audio levels, which are displayed according to the selected meter ballistics. Each bar displays three colors:
 - Green – Indicates audio levels below the test level
 - Yellow – Indicates audio levels between the test and peak program level
 - Red – Indicates audio levels above the peak program level



2438-016

To Check Phase

1. Open the audio display. (See page 45.) Use the Arrow keys and **SEL** button to make selections in the steps that follow.
2. Select **Aux Display** and then select **Phase Display** to turn it on.
3. Select the **Phase Style**. Choose either a **Lissajous Soundstage** or **X-Y** orientation for the Lissajous signal.
4. Select the phase pair that has to be displayed from the **Phase/Headphone Pair**.
5. Set the **Audio Input** to match the signal that you are checking.



2438-017



2438-024

6. Check for Phase correlation of the signals, noting the following:
- Phase correlation meters are located under the appropriate bars and one is duplicated under the phase display.
 - For correlated signals, the indicator will be green and will move to the right.
 - For uncorrelated signals, the indicator will be yellow and will tend to stay in the middle.
 - For anticorrelated signals (one goes up when the other goes down), the indicator will be red and will move to the left.

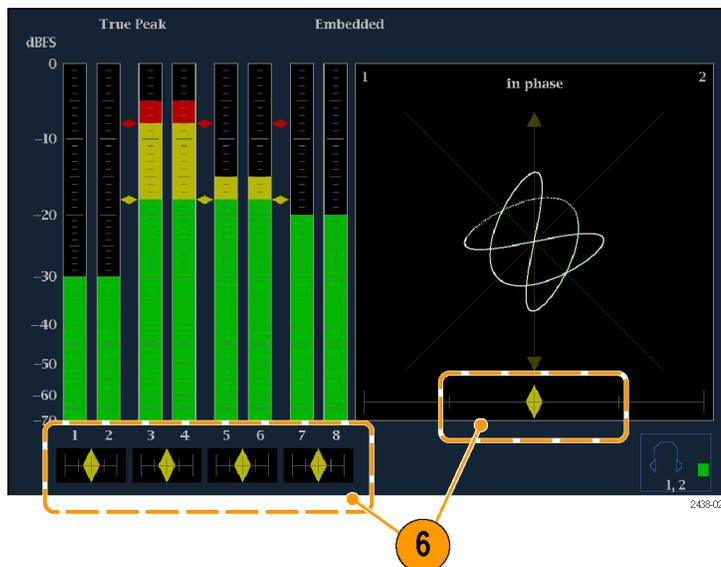

Usage Notes

- The Lissajous or phase display is a plot of one channel against another on an orthogonal pair of axes.
- Soundstage plots the two channels at 45 degree angles, with the mono combination appearing on the vertical axis, like a left-right image in a studio.
- X-Y plots left-channel data on the vertical axis and right channel data on the horizontal axis, emulating the X-Y display of an oscilloscope.

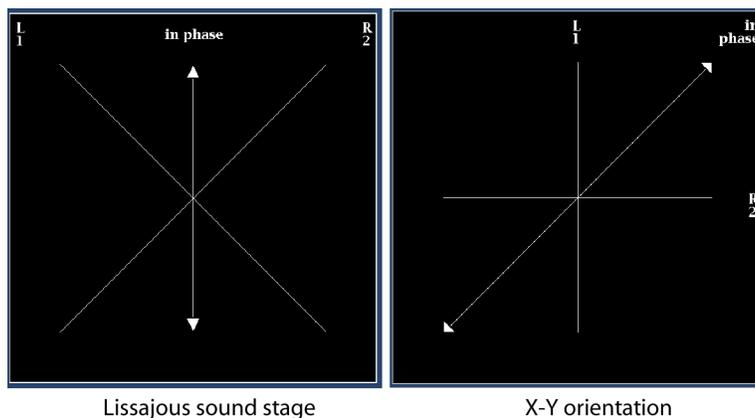

- The following response times of the correlation meters can be set from the Configuration menu.

Speed setting	Response averaging time (s)	Speed setting	Response averaging time (s)
1	0.0167	11	3.0
2	0.0333	12	3.5
3	0.0667	13	4.0
4	0.1333	14	4.5
5	0.2667	15	5.0
6	0.5333	16	5.5
7	1.0	17	6.0
8 (default)	1.5	18	6.5
9	2.0	19	7.0
10	2.5	20	7.5

Monitoring Safe Area Graticule

Your instrument can also display Safe Action and Safe Title graticules, allowing you to monitor incorrect placements of graphics, logos, and other branding elements. This will help you ensure that those items do not obscure text or essential action. SMPTE and ITU standards are supported.

Monitoring for Safe Area Graticule

To display graticules for monitoring incorrect placements of nonessential elements relative to essential ones, set global settings in the Configuration menu and turn on up to four Safe Area graticules, each with independent settings, in the Picture menu.

To Configure Safe Area Graticules

Before using Safe Area Graticules, configure them from the Configuration menu by performing the following steps:

1. Press the **CONFIG** button to display the Configuration menu.
2. Use the arrow keys and **SEL** button to make selections in the steps that follow.
3. Select **Graticules** and then select **Safe Area Graticule Standard**.
4. Choose from the **SMPTE** or **ITU** standards.

The selection you choose will be the graticule used when **AUTO** is chosen for any of the four Safe Area Graticules, accessed in the Picture menu.

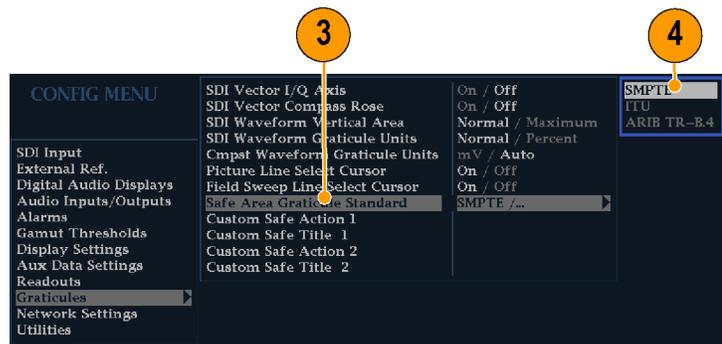

2438/027

5. If you want to set the Height, Width, and Offsets of the title and action areas for Custom Safe Graticules 1 and 2, first select the title or action to change.
6. Select the parameter.
7. Set the percentage level for each of the parameters.
Parameters are set as a percentage of screen height or width, and you can watch the graticules update on the screen as you change them.
The custom parameters you set will be used when **Custom_1** or **Custom_2** is chosen for any of the four Safe Area Graticules accessed in the Picture menu.
8. Press the **CONFIG** button again to close the Configuration menu.



2438-026

To Display Safe Area Graticules

1. Press and hold the **PICT** button to display the Picture menu.
2. Select **Safe Area Action 1**.
3. Select one of the following:
 - **Auto** to let the instrument automatically select the size and offsets of the safe area.
 - **4x3**, **14x9**, or **16x9** to set the safe area size and offsets appropriate for these aspect ratios based on the selected standard.
 - **Custom_1** or **Custom_2** to set the safe area size and offsets to match the custom settings in the Graticules Configuration menu. (See the procedure *To Configure Safe Area Graticules*, step 5.)
4. Repeat step for each Safe Area selection.
5. Press the **PICT** button again to close the pop-up menu.

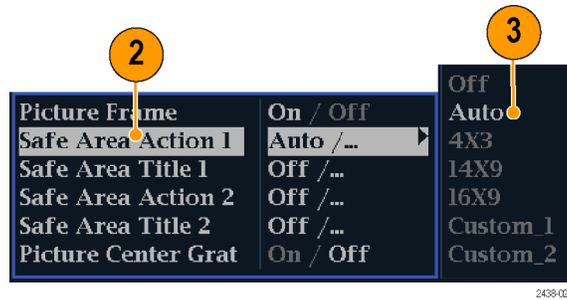

2438-025

Usage Notes

- The Safe Action Area denotes the maximum image area within which all significant action should be contained; the Safe Title Area denotes the maximum image area within which all significant titles should be contained.
- Safe Area Graticules can globally be configured to comply to accepted standards in the Configuration menu.
- Custom selections for vertical and horizontal size and offset of the Safe Areas can be set in the Configuration menu.

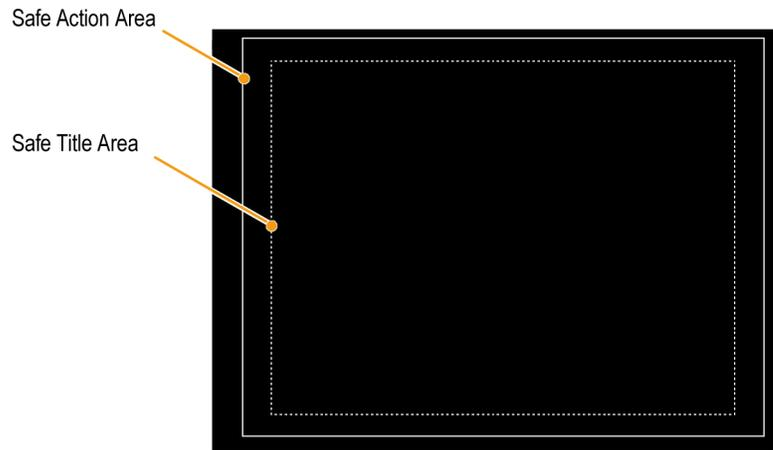

Using Alarms

Alarms can be configured so that your instrument automatically monitors parameters and reports when those parameter limits are exceeded. The procedures that follow describe how to configure response types for individual alarms, how to enable them, and how to monitor them.

Configuring Alarms

Alarms may need to be configured in the Configuration menu. Alarms are initially set to factory defaults, which can be restored by pressing the **PRESET** button on the front-panel of your instrument, selecting **Recall Preset > Recall Factory Preset**, and then pressing the **SEL** button. Follow the first procedure of this section (if alarm configuration is needed) before performing the audio monitoring procedures. (See page 44, *Monitoring Audio*.)

You can select alarms, set error conditions to be monitored, and the notification method for an error event for the following categories:

- Video Content
- Video Format
- SDI Input
- General Audio
- AES and Embedded
- Embedded Audio Specific
- General

To Set Allowed Alarm Responses

1. Press the **CONFIG** button to display the Configuration menu.
2. Use the arrow keys and **SEL** button to make selections in the steps that follow.
3. Select **Alarms**.
4. Navigate to the alarm category that you want to configure. In the example to the right, **Video Format** alarms is highlighted.
5. Note that the alarms in the category you select appear to the right as you highlight the alarm category. Press **SEL** to display a table that allows you to set the responses for individual alarms.

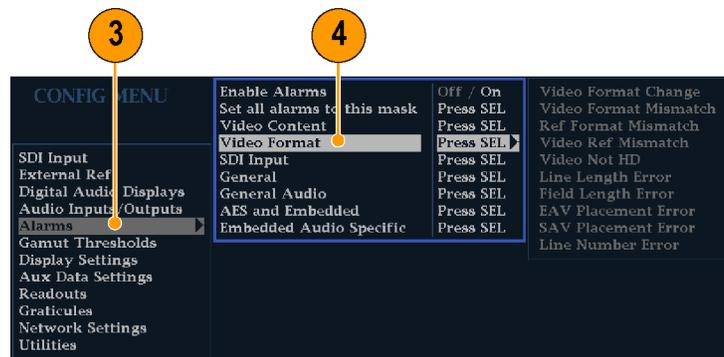

2438-013

- For each alarm listed in the table, press the **SEL** button to enable (when enabled, there is an **X** in the box) or disable (when disabled, the box is blank) it. (See page 53, *Possible Alarm Responses*.)
- Navigate to highlight the **Return** box, and press the **SEL** button to return to the Configuration menu.
- Repeat steps 4 through 7 to configure as many types of alarms as you want.



To Set Alarm Responses Globally

- Press the **CONFIG** button to display the Configuration menu.
- Use the arrow keys and **SEL** button to make selections in the steps that follow.
- Select **Alarms**.
- Navigate to **Set all alarms to this mask**.
- Press **SEL** to display a table for setting the allowed alarm responses that will be applied to all the alarm categories.
- For each alarm listed in the table, press the **SEL** button to enable (when enabled, there is an **X** in the box) or disable (when disabled, the box is blank) it. (See page 53, *Possible Alarm Responses*.)
- Navigate to highlight the **Return** box, and press the **SEL** button to return to the Configuration menu.
This sets alarms for all alarm categories to the setting on the global mask.

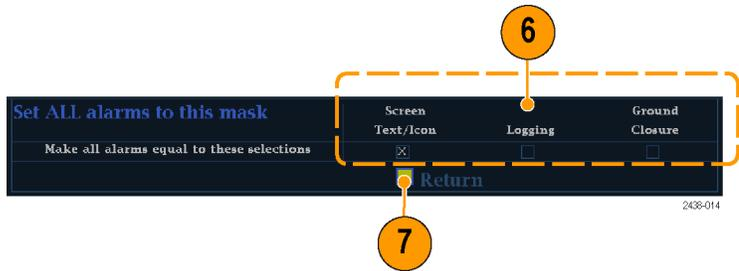
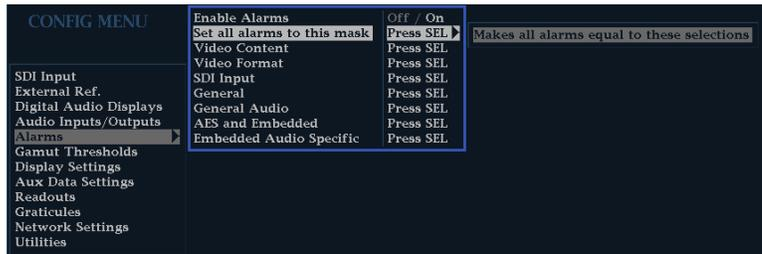

Possible Alarm Responses

For each available alarm, you can select up to four of the responses listed. If you do not select a notification method for an error, you will not be notified when the error occurs.

- **Screen Text/Icon.** An icon appears on the display. This notification method is disabled when the Configuration menu is open. This option also enables alarm reporting with color on the Status screen.
- **Logging.** The instrument makes an entry in the Event Log. Refer to *Status Display* in the *Display Information* section of the *User Technical Reference* manual.
- **Ground Closure.** The instrument sends a signal out the Remote port for a remote notification that an alarm condition occurred. You must enable the Remote Control Port in the Communications submenu of the Configuration menu before notifications can be sent.

NOTE. You can monitor alarm status. (See page 55, *Monitoring Alarms*.)

To Enable Alarms

The channels for which you enable alarms trigger your previously defined alarm responses. (See page 51, *To Set Allowed Alarm Responses*.)

1. Press the **CONFIG** button to display the Configuration menu.
2. Use the arrow keys and **SEL** button to make selections in the steps that follow.
3. To globally enable all alarms, select **Enable Alarms** and toggle it to **On**. This turns on all alarms that are individually enabled and provides a quick way to switch them on and off without changing their individual settings (see step 4).
4. Additionally, for Audio inputs, you must enable alarms individually by channels. To start, select **Audio Inputs/Outputs** in the Configuration menu.
5. Select each input shown in the box to individually enable its alarms. In this example, AES A is selected.

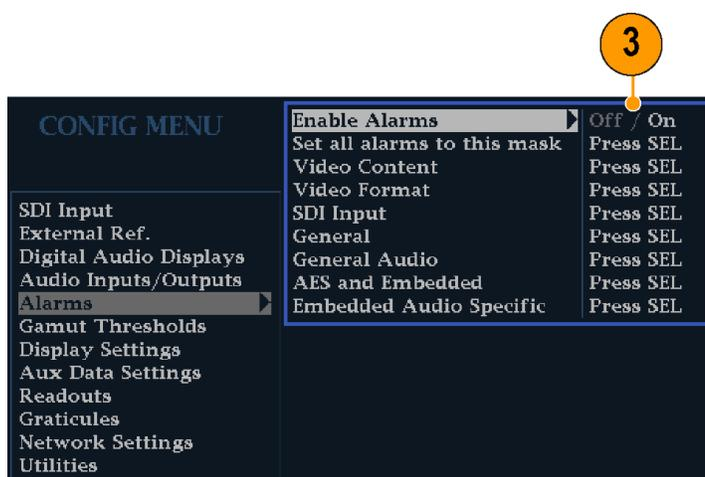

2438-019

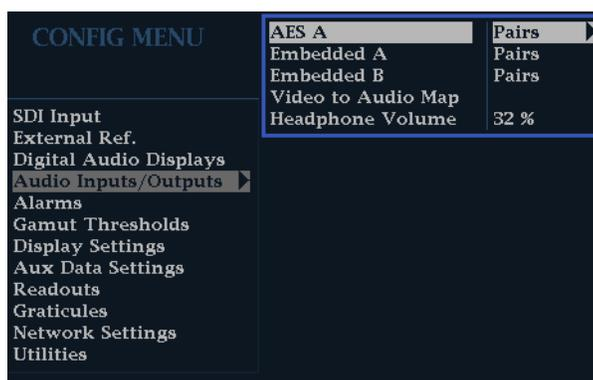

- For each of the AES and Embedded inputs, select **Bar to Input Map** and press the **SEL** button to display the **Bar to Input map** menu.

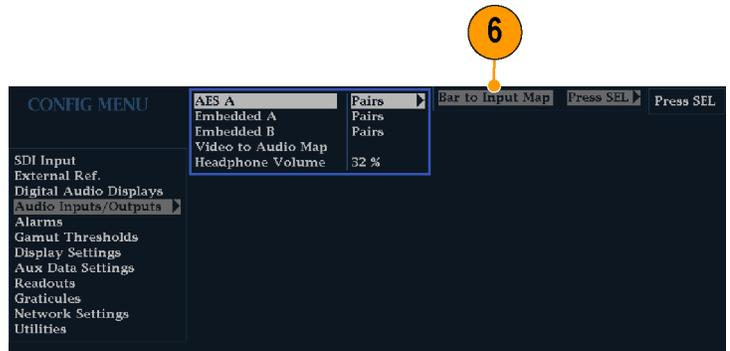

2438-012

- Navigate to each box for each alarm that you want to allow. Press the **SEL** button to enable (when enabled, there is an **X** in the box) or disable (when disabled, the box is blank) it for each channel displayed.

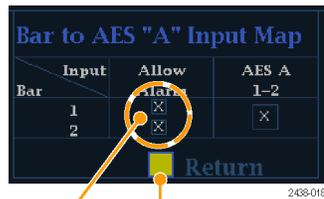

2438-018

- Select the box, and press the **Return** button to return to the Configuration menu.

To Set Limits or Qualifications

Some alarms require a threshold setting or condition that triggers the alarm.

- Select **Digital Audio Displays > Alarm Thresholds** from the Config menu.
- Set the following alarm levels that trigger an alarm when exceeded:

- **Clip Samples:** number of consecutive samples at the all-high level.
- **Mute Samples:** number of consecutive all-zero samples.
- **Silence Level:** the level below which audio is considered not present.
- **Silence Duration:** the length of audio silence time allowed.
- **Over Level:** the too-loud audio level.
- **Over Duration:** the length of time limit for the too-loud audio.

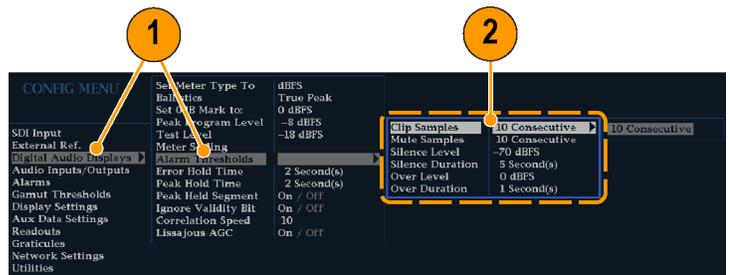

2438-015

Monitoring Alarms

After defining and enabling alarms, you can quickly check if any error condition exists by looking for the notification you defined (text, icon, or logging). (See page 8, *Status Bar Icons*.) Selecting the Ground Closure output response can help you notice alarms that you may miss if the notification is text or icon only. Ground Closure can be used to drive an external alarm when one or more alarms are triggered. (See page 51, *To Set Allowed Alarm Responses*.)

If you want to check the condition of a specific alarm, press the **STATUS** button. In the Status menu, select **Display Type** and then select **Alarm Status**. One or more of the following will appear:

Indicator	Description
Disabled (gray)	Alarm is not selected for reporting, but will still show if the error is present.
OK (green)	Alarm is enabled for reporting and has not detected errors for at least 5 seconds.
Error (yellow)	Alarm condition cleared for less than 5 seconds.
Error (red)	Alarm triggered now.

Upgrading Instrument Software

System Upgrade (CONFIG > Utilities > System Upgrade) is used to upgrade the system software of this instrument. You can upgrade the instrument software using a PC or through the USB drive on the instrument. An Ethernet connection is required for either upgrade option. The following procedures explain how to do both.

NOTE. The data-transfer utility for upgrading the instrument runs on these PC systems: Windows 98, Windows NT 4.0, Windows ME, Windows 2000, and Windows XP. The data-transfer utility also requires Winsock 2.0, an ethernet interface, and that 10 MB of free disk space be present on the PC system.

USB Upgrade

Download the latest version of the instrument software to a USB memory device by performing the following procedure:

1. Using an Ethernet connection on a PC, navigate to the Tektronix Web site at <http://www.tektronix.com>.
2. Find the *Downloads* heading located on the right-hand side of the Web page.
3. Enter your instrument model number in the top field, select *Software* from the drop-down menu in the bottom field, then click *Go*.
4. Click on *Sort by DATE* to find the most recent software release.
5. Download the file and save it to a USB memory device that is compatible with your instrument.
6. Save the package into a directory named WfmUpgrd.

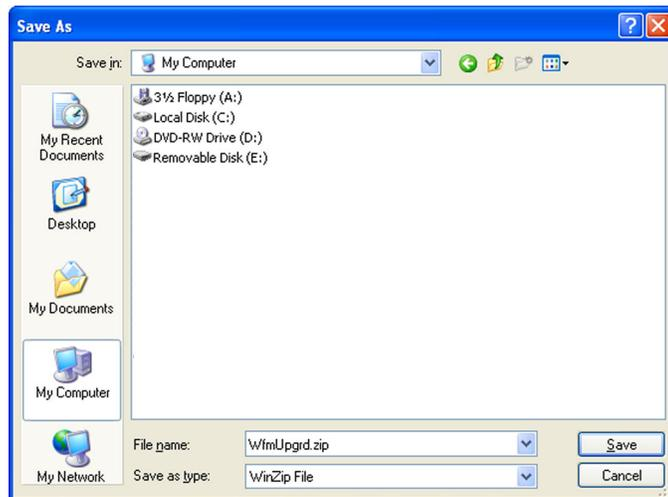

Download the firmware onto your instrument from the USB memory device by performing the following procedure:

7. Insert the USB memory device containing the WfmUpgrd folder with the firmware.pkg file into the USB drive of the instrument.
8. Press **CONFIG > Utilities > System Upgrade > Upgrade Options > USB Upgrade**.
9. Press the right arrow key to highlight **Press SEL** and then press the **SEL** button to start the upgrade process.
When the software upgrade completes, reboot the instrument by disconnecting the power supply and then pressing the Power button.

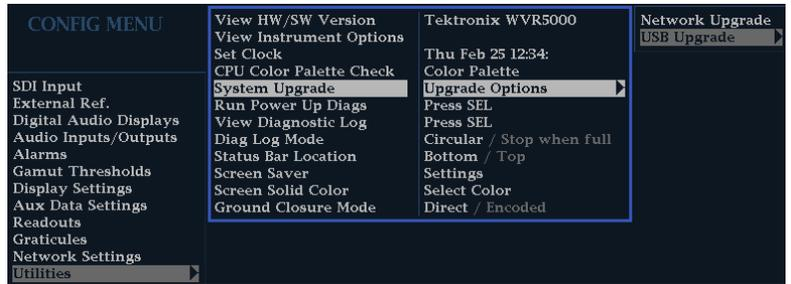

Network Upgrade

1. Repeat step 1 through step 4 in the previous procedure.
2. Download the selected software to a PC.
3. Click the downloaded archive and extract the archived files into a directory of your choice.
4. Extract the following files: transfer.exe, firmware.pkg and readme.txt.
5. From the **CONFIG > NETWORK SETTINGS** menu, write down the number listed for the **IP Address**. This address will also appear on the update screen.

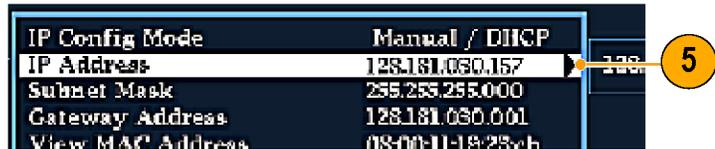
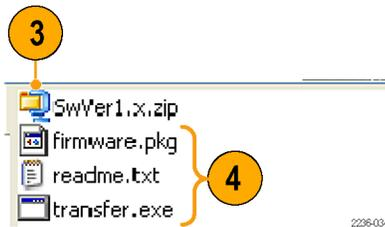

- On the instrument, press **CONFIG > Utilities > System Upgrade > Upgrade Options > Network Upgrade** and then press the **SEL** button. This displays the System Software Upgrade window.

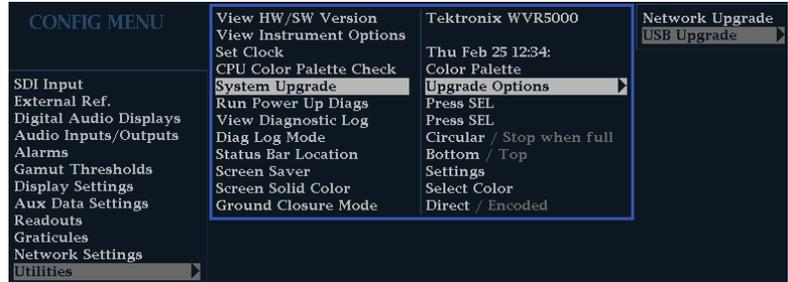

- To continue with the upgrade, press the right-arrow key to select **Continue** and press **SEL**.

The monitor display goes to black and displays upgrade progress information.

- On the PC, double-click the **transfer.exe** file to launch the transfer program. This displays the window shown at right.

- Type the network address (for example: 128.181.221.002) or DNS name of the instrument you want to update. Make sure to delete any leading zeroes, as shown in the example.



Press **Enter**.

- The transfer utility displays **done** when the software upgrade completes.

When the software upgrade completes, reboot the instrument by disconnecting the power supply and then pressing the Power button.

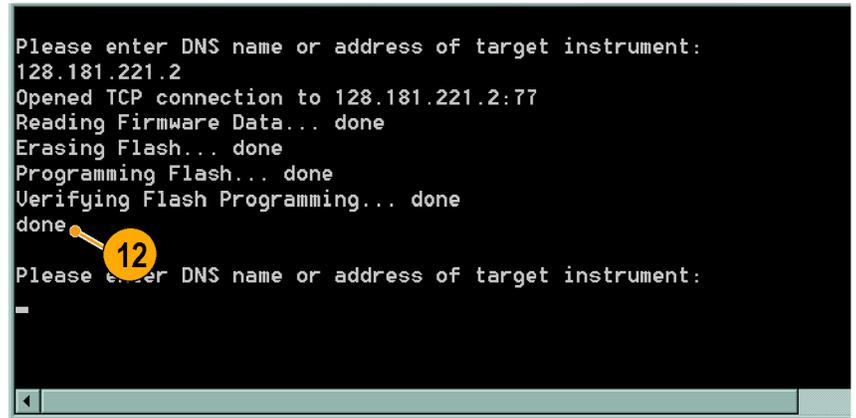

- To update another instrument, type the IP address of that instrument at the prompt and press **Enter** on your PC keyboard to start the software upgrade. If you will not be updating another instrument, press **Enter** to exit the transfer utility.

Upgrading Multiple Instruments

You can upgrade several instruments in one session, one at a time, if you have determined their addresses. To upgrade, use the Windows Command Prompt. Enter the following line in a Command Prompt window (substituting the addresses of your machines):

```
transfer.exe 192.181.115.1 192.181.115.2 192.181.115.3
```

Separate the addresses with a space.

Alternatively, you can use file redirection to input the IP addresses to the transfer.exe utility. To do this, create a text file containing a carriage-return delimited list of IP addresses or DNS names for the instruments to be updated. If you created a text file named HOSTS.TXT, you would enter the following command to update a group of instruments:

```
transfer.exe < HOSTS.TXT
```

Verifying the Upgrade

After you have completed the software upgrade, the instrument will reboot and come up in an operational mode.

To verify the functional performance of your instrument, perform the *Incoming Inspection* procedures.

NOTE. See the *Readme.txt* file that is included with the software-upgrade package to determine whether all of the current Configuration menu and instrument-mode settings were preserved through upgrading.

Index

Symbols and Numbers

- 4-Tile
 - using thumbnail display, 6
- 4-tile mode, 16

A

- Accessories
 - documents, 1
 - optional, 1
 - power cords, 2
 - standard, 1
- AES connector, 12
- Alarms
 - categories of, 51
 - configuring and using, 51
 - enabled globally and individually, 53
 - remote monitoring of, 55
 - status display, 55
 - to enable, 53
 - to monitor, 55
 - to set alarms globally, 52
 - to set allowed responses, 51, 53
 - to set limits or qualify, 54
- Applications
 - checking Chroma/Luma delay, 29
- Arrowhead display, 32
 - composite gamut, 35
- Audio
 - configuring and monitoring, 44
 - configuring inputs, 44
 - selecting an input, 45
- Audio input
 - selecting, 45
- Audio inputs
 - allow alarms for, 44
 - check level, 46
 - check phase, 46
 - map bars to input, 44
- Audio level
 - checking, 44, 46, 51
- Audio phase
 - checking, 46

B

- Basic operation, 6
- Battery
 - optional, 3
 - safety, 3

C

- Calibration
 - service options, viii
- Chroma/Luma delay, 29
- Composite gamut
 - diamond display, 35
- Configuration menu, 25
- Connecting AC power, 3
- Connecting signals
 - Line termination, 5
- Connector
 - Compatibility, 5
- Connector(s)
 - AES, 12
 - Ethernet, 13
 - ground closure, 13
 - LTC, 13
 - Power, 11
 - Video input, 12
- Controls, front panel, 9

D

- Delete Frozen Image, 23
- Diamond display, 32
 - checking RGB gamut, 33
 - construction of the diamond graticule, 33
- Display
 - 4-tile, 16
 - full-tile, 16
 - how to select, 14
 - how to set parameters, 15
 - Lightning, 29
 - overlay, 20
 - status bar icons, 8
 - Thumbnail, 6
 - using a, 6
- Documentation
 - conventions used in, ix
 - purposes of, ix

- Documents
 - included, 1

E

- Errors
 - status indicators, 7
- Ethernet connector, 13

F

- Factory defaults
 - how to set, 21
- Features
 - list of key, vi
- Freeze, 22
- Front-panel controls
 - layout and index to usage procedures, 9
 - levels of, 9
- Frozen Only (Freeze function), 22
- Full-tile mode, 16

G

- Gain
 - how to select, 18
 - how to set, 18
- Gamut
 - arrowhead display, 35
 - checking, 32
 - diamond display, 33
- Gamut display
 - checking RGB gamut, 33
 - composite arrowhead display, 35
- General alarms
 - configure, 51
- Ground closure interface, 13

H

- Headphone volume
 - adjusting, 28
- Horizontal Offset
 - Timing display, 39

How to

- configure and monitor audio, 44
- configure and use alarms, 51
- configure your instrument, 25
- control the display, 6
- determine status, 7
- find more information, ix
- freeze the display, 22
- monitor alarms, 55
- monitor safe area, 48
- navigate between tiles, 17
- save a display to USB, 23
- select a display, 14
- select an input, 16
- set display parameters, 15
- set gain and sweep, 18
- set line select mode, 24
- set to factory default settings, 21
- set up 4-tile mode, 16
- use online help, 26
- use presets, 21

I

Information

- where to find more, ix

Inputs

- How to select, 16

Installation, 1

- BNC connector compatibility, 5
- Connecting power, 3
- In a serial video system, 4
- Line-termination requirements, 5
- shipping package contents, 1

Installing software, 56

L

Lightning display, 29

Lightning display overlay, 20

Limits

- gamut, 32

Line Select mode

- how to set, 24

Lissajous display, 47

Lissajous sound stage

- phase style, 47

Live + Frozen Only (Freeze function), 22

Live Only (Freeze function), 22

LTC, 13

Luma/Chroma delay, 29

M

Magnification, 19

Manuals

- conventions used in, ix

Menu

- CONFIG, 25

Monitoring Audio

- task description, 44

O

Online help, 26

- context sensitive, 27
- displaying, 26
- how to use, 26
- navigating, 26

Operation

- Basic, 6
- control levels (types), 9

Optional accessories, 1

Options

- power cords, 2

Overlay

- waveform/vector display, 20

P

Part numbers

- user manual, 1

Phase (audio)

- choose channel pair, 46
- correlation meter response times, 47
- custom channel pair, 46, 47
- select display style, 46

Pop-up menus, 15

Power

- AC requirements, 3
- battery, 3
- Connecting, 3
- Connector, 11

Power cord options, 2

Presets

- how to save and recall, 21

Product description, vi

Q

Quad Tile mode, 16

R

Rear-panel

- Layout and description, 11

Recall

- settings (presets), 21

Repair

- service options, viii

RGB gamut

- diamond display, 33

S

Safe area

- to monitor for compliance, 48
- to set custom parameters, 49

Safe area graticules

- description of, 50
- to choose a standard, 48
- to display, 49

Safety Summary, iii

Save

- settings (presets), 21

Saving a display to USB, 23

SDI input connectors, 12

Selecting audio input, 45

Selecting signal inputs, 16

Service

- options, viii

Signal connection

- Line-termination requirements, 5

Split Diamond display, 32

Standard accessories, 1

- documents, 1
- power cord, 2

Status

- determining, 7

Status bar, 7

Status button

- Timing display, 39

Sweep, 18

System Upgrade

- Utilities, 56

T

Termination

- Requirements for, 5

Thumbnail display, 6

Timing

- Chroma/Luma delay, 29

Timing display
 description, 39
 horizontal offset, 39
 supported video formats, 41
Timing measurement
 relative to, 40
 save offset, 40
 simple compared to
 complex, 40

U

Upgrading software, 56

USB
 saving a display to, 23
Using alarms
 task description, 51

V

Vector
 display, 29
Vector display overlay, 20
Video input connectors, 12

W

Waveform display overlay, 20

X

X-Y
 phase style, 47, 50