

KEITHLEY

MODEL 740
SYSTEM SCANNING
THERMOMETER

QUICK REFERENCE GUIDE



INTRODUCTION

This reference and programming guide contains condensed specifications, descriptions of various features and information for operating the Model 740. Also included are programming examples using various controllers.

CONTENTS

CONDENSED SPECIFICATIONS	3
FRONT PANEL OPERATION	6-24
FRONT PANEL PROGRAMS	25
EXTERNAL TRIGGERING	27
IEEE-488 PROGRAMMING	28
PROGRAMS	38
Logging Programs Using HP-85	39
Scanning Operation Using 7057A and HP-85	40
IBM XT or PC	41
APPLE II	43
HP-85	45
HP-9825A	46
HP-9816	48
DEC LSI 11	50
PET/CBM 2001	52

CONDENSED SPECIFICATIONS

ACCURACY*

Type	Range	1 Year 18°-28°C (65°-82°F)
mV	-99.999 to 100.000mV	±(0.02% + 3μV)
J	-100.0°C to + 760.0°C -148.0°F to +1400.0°F	±0.4°C ±0.8°F
K	-100.0°C to +1372.0°C -148.0°F to +2501.0°F	±0.5°C ±0.9°F
T	-100.0°C to + 400.0°C -148.0°F to + 752.0°F	±0.5°C ±0.8°F
E	-100.0°C to +1000.0°C -148.0°F to +1832.0°F	±0.5°C ±0.9°F
R	0 °C to +1780°C + 32 °F to +3236°F	±1°C ±2°F
S	0 °C to +1780°C + 32°F to +3236°F	±1°C ±2°F
B	+350°C to +1820°C +662°F to +3308°F	±1°C ±2°F
EXTENDED RANGE (Types J, K, T, E):		
	-200.0°C to -100.1°C	±0.6°C
	-328.0°F to -148.0°F	±1.0°F

*Excludes thermocouple errors (Specifications include for either 7057A or internal reference junction errors).

TEMPERATURE COEFFICIENT: 0-18°C & 28-50°C

Less than 0.1 × rated accuracy/°C.

GENERAL

MAXIMUM ALLOWABLE INPUT: 250V rms, 350V peak (for one minute).

MAXIMUM COMMON MODE VOLTAGE: 200V peak to earth.

SCANNING RATE: > 20 channels/second - filter disabled.
> 5 channels/second - filter enabled.

LOGGING INTERVAL: 50ms to 1 hour or triggered (User selectable).

SCANNING INTERVAL: 500ms to 1 hour or triggered (User selectable).

BENCH READING RATE: 8 readings/second, filter disabled.
4 readings/second, filter enabled.

REAL-TIME CLOCK ACCURACY: < 1 min/month typ.

WARMUP: 1 hour to rated accuracy.

CAPACITY: Single channel or 10 channels (including reference junction), using one 7057A thermocouple card.

EXPANSION: Up to 90 channels (including reference junctions), using 8 additional 7057A thermocouple cards.

SAFETY PRECAUTIONS

The following precautions apply to situations where a voltage potential may come in contact with a thermocouple. These precautions should be observed before operating the Model 740:

To avoid a shock hazard, never pull out the Input Card or a scanner card while power is connected to any instrument in the measurement system. Also, make sure that connected TCs do not come in contact with external live circuitry.

When using the internal channel, never connect more than one thermocouple to the Input Card of the instrument. Otherwise, erroneous readings and a potential safety hazard will result.

When using one or more scanner cards, never connect a thermocouple directly to the Input Card of the instrument. Otherwise, erroneous readings and a potential safety hazard will result.

This instrument is intended for use by qualified personnel who recognize shock hazards and are familiar with the safety precautions required to avoid possible injury. Read over the manual carefully before operating this instrument.

Inspect the insulation of the thermocouple wires for possible wear, cracks or breaks. If any defects are found, replace the thermocouple assembly.

For optimum safety, do not touch the thermocouple wires while power is applied to the device under test.

Do not touch any object which could provide a current path to the thermocouple or power line (earth) ground. Always make measurements with dry hands while standing on a dry, insulated surface capable of withstanding the voltage present.

Do not exceed the instrument's maximum allowable input as defined in the specifications.

CONTROL GROUP

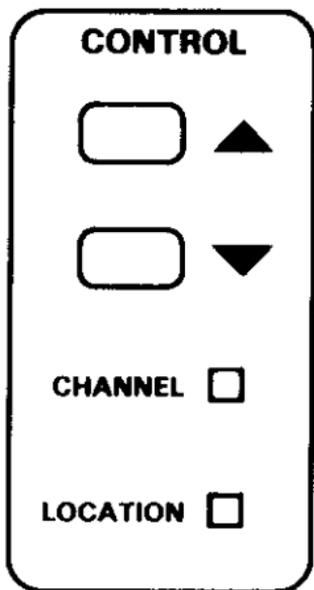

CHANNEL Indicator

Displayed information pertains to the current channel. The last two display characters identify the channel number. When these two characters are blank, the internal measurement channel is selected.

LOCATION Indicator

Displayed information pertains to the memory location that is displayed. The last two display characters identify the memory location.



These buttons are used to increment and decrement channels and memory locations, select data store intervals, and select various program parameters.

MODIFIER GROUP

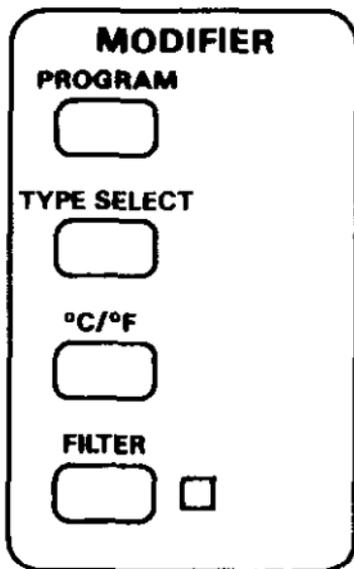

PROGRAM

Places the instrument in the front panel program mode. Each press of this button selects the next program segment.

TYPE SELECT

Used to configure the available channels for a TC type, mV measurements or to be OFF.

°C/°F

Toggles the temperature scale of the display between °C and °F.

FILTER

Toggles the filter on and off. The filter stabilizes readings of a noisy input level. Considerations of filter usage include:

1. Typically, it takes 100ms to achieve a settled reading.
2. Scanning rate is decreased to five channels per second.
3. NMR is increased by 20dB at 50 and 60Hz.

DATA STORE GROUP

The following information briefly describes the controls associated with data store operation.

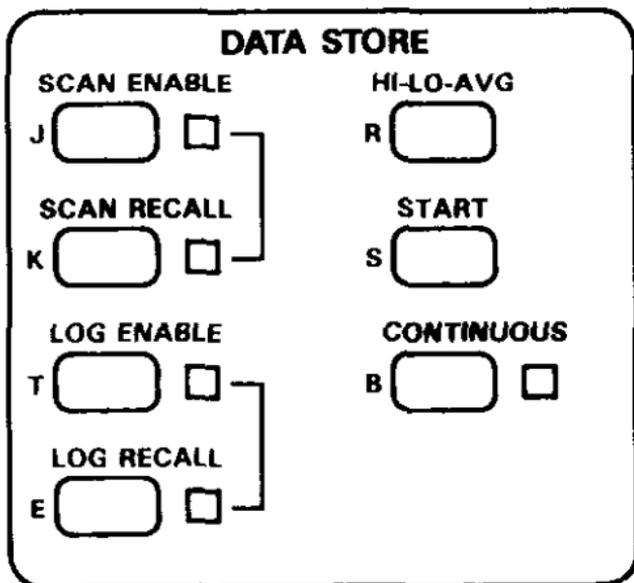

SCAN ENABLE (J)

Places the Model 740 in the scan enable mode. Indicator stops flashing when the instrument is scanning. When the instrument is in the type select mode, the function of this button is to configure channels for Type J TCs.

SCAN RECALL (K)

Allows scanned channels, stored in the scan buffer, to be displayed. When the instrument is in the type select mode, the function of this button is to configure channels for Type K TCs.

LOG ENABLE (T)

Places the Model 740 in the log enable mode. Indicator light stops flashing when the instrument is logging readings. When the instrument is in the type select mode, this button is used to configure channels for Type T TCs.

LOG RECALL (E)

Allows logged readings of a single channel to be displayed. When the instrument is in the type select mode, the function of this button is to configure channels for Type E TCs.

HI-LO-AVG (R)

When in the scan recall mode, this button displays the highest and lowest reading in the scan buffer. When in the log recall mode, this button displays the highest, lowest and average reading in the log buffer. When in the type select mode, this button configures channels for Type R TCs.

START (S)

When the instrument is in the scan or log enable mode, this button can be used to start the scanning or logging process. When in the type select mode, this button configures channels for Type S TCs.

CONTINUOUS (B)

Toggles the instrument between the continuous and single scan/log modes. In the single scan mode, one reading of each channel will be stored in the scan buffer. In the continuous scan mode, scans continue to occur at the selected interval. Each scan will overwrite *the previous reading on each channel*. In the single log mode, logging will stop after the log buffer fills (100 readings). In the continuous log mode, readings will continue to be logged after the buffer fills. When the instrument is in the type select mode, this button is used to configure channels for Type B TCs.

DISPLAY GROUP

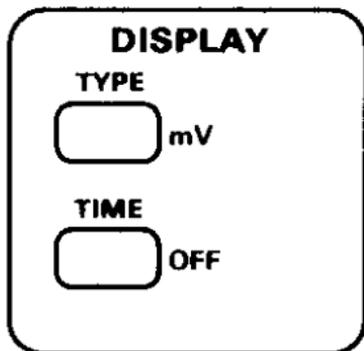

TYPE (mV)

Used to display the configuration of the selected channel. When the instrument is in the type select mode, this button configures channels for mV measurements.

TIME (OFF)

Used to display the current time of day and, when in recall, the time of day that a reading was scanned or logged. Also, when a trigger time is set, the message "ON" will be displayed. When in the type select mode, this button configures channels to be OFF.

ENTER

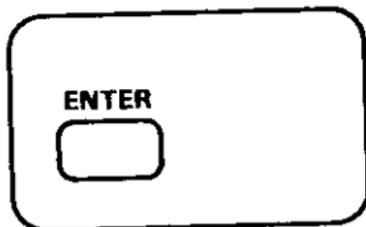

This button is used to enter various operating and front panel program parameters, and returns the display to the previous state when TIME or TYPE is checked.

LOCAL



This button allows the user to return control to the front panel when the instrument is being controlled over the IEEE-488 bus. This button will have no effect if local lockout (LLO) was asserted over the bus.

ERROR MESSAGES

Message	Explanation
SCANENBL	Displayed briefly when invalid button pressed while in scan enable mode.
LOG ENBL	Displayed briefly when invalid button pressed while in log enable mode.
LOGGING	Displayed briefly if invalid button pressed while 740 is logging.
SCANNING	Displayed briefly if invalid button pressed while 740 is scanning.
OPENTC 02	TC not connected to displayed channel or TC is open.
SHORT	740 cannot log or scan at selected interval. 740 will log or scan as fast as the setup allows.
-----00	Displayed when trying to recall the log of an "off" channel.
CARD OUT	Input card or scanner card not installed.
RJ ERR	Reference junction outside of -10°C to $+70^{\circ}\text{C}$ range.
NO LOOP	Serial loop broken. Close loop and cycle power on 740.
TRIGOVER	Displayed when a trigger occurs while the instrument is displaying current channel measurements, or single log or single scan measurements.

SET UP PROCEDURES

When setting up a measurement system, disconnect power from all instrumentation and make sure any connected TCs do not come in contact with external voltages.

Internal Channel

1. Pull out the Input Card.
2. Refer to Figure 1 and connect the appropriate TC to the pair of terminals marked "INT". The negative wire of the TC has red insulation.
3. Reinstall the Input Card and power-up the instrument.

NOTE: Never connect more than one TC or the output of a scanner card to the Input Card when using the internal channel.

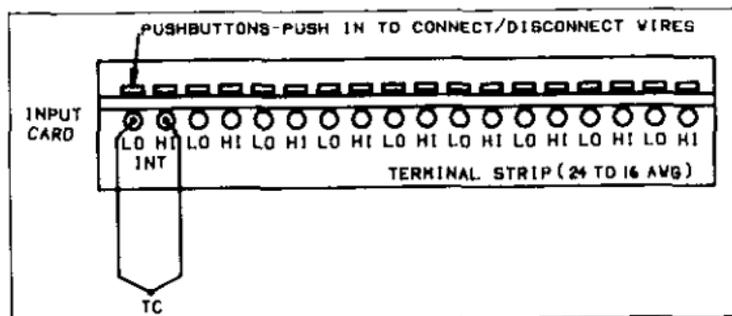

Figure 1. Setup Using Internal Channel

Channels 1—10

Channels 1 through 10 are available when a Model 7057A scanner card is installed in the Model 740 mainframe. Refer to Figure 2.

1. Connect one to nine TCs to a Model 7057A scanner card. The negative wires of the TCs have red insulation.
2. Connect two wires to the OUTPUT terminals of the scanner card and note the polarity of each wire.
3. Install the scanner card into the Model 740.
4. Pull out the Input Card and connect the two output wires of the scanner card to any pair of terminals. Be sure to observe the proper polarity.
5. Reinstall the Input Card and power-up the instrument.

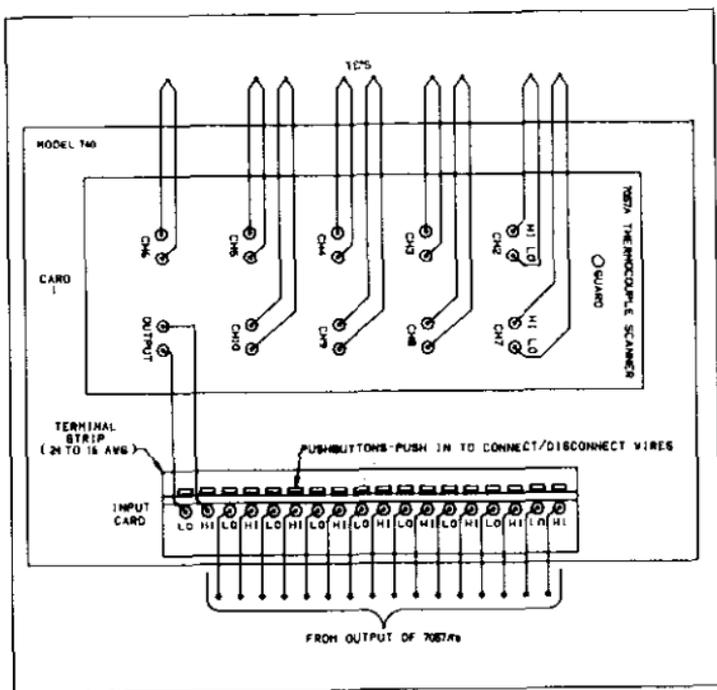

Figure 2. Setup Using Up To Nine Scanner Cards

Channels 11—90

Channels 11 through 90 are available when up to eight additional Model 7057A scanner cards are connected to the measurement system using Model 705 scanners or a Model 706 scanner. Refer to Figure 2.

1. The Model 740 must be set to operate with the Model 705 or Model 706 scanner. Cycle power on the Model 740 to check the current loop setting. To select the alternate setting, utilize Program LOOP.
2. Turn off the power, disconnect the line cord and make sure that any connected TCs do not come in contact with external voltages.
3. Set up each scanner card as explained in steps one and two of the Channels 1 through 10 Setup.
4. Install the scanner cards in the Model 705s or in a Model 706.
5. Pull out the Input Card and connect each pair of output wires from the scanner cards to the input terminal. Be sure to observe the proper polarity.
6. Daisy-chain the Model 740 to the scanner(s) using BNC to BNC cables to connect SERIAL OUT to SERIAL IN.
7. Power-up and program each scanner to be a slave.
8. Lastly, power-up the Model 740.

BASIC MEASUREMENTS

1. Set up the desired measurement system as previously explained.
2. Configure the channel(s) as follows:
 - A. Display channel to be configured. Use the ▲ and ▼ buttons for multi-channel measurement systems.
 - B. Press the TYPE SELECT button. The current channel configuration will be displayed.

Note: If it is desired to configure all channels to be the same, press the TYPE SELECT button again.
 - C. To change the TC type, press the J, K, T, E, R, S or B button. To configure for millivolt measurements, press the mV button. If the channel(s) is not to be used, press the OFF button.
 - D. Repeat steps A through C to configure the rest of the available channels.
3. Press the ENTER button. The reading on the last selected channel will be displayed.
4. For multichannel systems, use the ▲ and ▼ buttons to display the readings on the other channels.

DATA STORE OPERATION

As a scanner, the instrument stores one reading of each channel in the scan buffer. As a logger, the instrument stores up to 100 readings of one channel in the log buffer.

Data Store Intervals

Interval	Scan	Log
50ms		*
100ms		*
500ms	*	*
1s	*	*
5s	*	*
10s	*	*
30s	*	*
1min	*	*
5min	*	*
15min	*	*
30min	*	*
1hr	*	*
One-shot**		*

*Listed interval available.

**One reading stored in log buffer every time START is pressed.

SCANNING CHANNELS

1. If the scan is to be started by a clock trigger, set the trigger time with Program TRIG.
2. If it is desired to select the alternate scan mode, press the CONTINUOUS button.
3. Press the SCAN ENABLE button. Indicator light will start flashing. If in the continuous mode, the current scan interval will be displayed.
4. If in the single scan mode, proceed to step 5. Otherwise, display the desired scan interval using the ▲ and ▼ buttons and press the ENTER button.
5. The scanning process will start at the programmed trigger time or by pressing the START button.

Note: To take the instrument out of the scan mode, press the SCAN ENABLE button.

RECALLING SCANNED CHANNELS

1. Press the SCAN RECALL button. The stored temperature reading for the first reference junction will be displayed.
2. To display the highest and lowest temperature reading stored in the scan buffer, proceed as follows:
 - A. Press the HI-LO-AVG button. The highest reading will be displayed.
 - B. To display the lowest reading, press the HI-LO-AVG button again.
 - C. To exit from HI/LO recall, press the ENTER button. The instrument will return to the normal recall state on the channel that was previously displayed.
3. Stored readings on all channels can be displayed by pressing the ▲ and ▼ buttons.
4. To exit from the recall mode, press the SCAN RECALL button.

NOTE: While in recall, press the TIME button to check the time that a channel was scanned. Press the ENTER button to return to the recall mode.

LOGGING READINGS

1. If the log is to be started by a clock trigger, set the trigger time with Program TRIG.
2. If it is desired to select the alternate log mode, press the CONTINUOUS button.
3. Press the LOG ENABLE button. Indicator light will start flashing and the current log interval will be displayed.
4. Display the desired interval using the ▲ and ▼ buttons, and press the ENTER button.
5. The logging process will start at the programmed trigger time or by pressing the START button.

NOTE: To take the instrument out of the log mode, press the LOG ENABLE button.

RECALLING LOGGED READINGS

1. Press the LOG RECALL button. The last stored reading and the memory location will be displayed.
2. To display the highest, lowest and average reading stored in the log buffer, proceed as follows:
 - A. Press the HI-LO-AVG button. The highest reading along with the location will be displayed.
 - B. To display the lowest reading along with the location, again press the HI-LO-AVG button.
 - C. To display the average reading along with the number of readings used in the calculation, again press the HI-LO-AVG button.
 - D. To exit the HI/LO/AVG mode, press the ENTER button. The instrument will return to the normal recall state.
3. Stored readings in all memory locations can be displayed by using the ▲ and ▼ buttons.
4. To exit from the recall mode, press the LOG RECALL button.

NOTES:

1. Overranged readings are not included in the AVG calculation.
2. While in recall, press the TIME button to check the time that a reading was logged. Press the ENTER button to return to the recall mode.

FRONT PANEL PROGRAMS

Program	Description
TRIG	Used to check and set a trigger time that will start a scan or log.
TIME	Used to set the 24-hour clock.
IEEE	Used to check or change the IEEE address or Smart-Print mode.
LINE	Used to check or change the line frequency setting of the instrument.
LOOP	Used to check or change the loop setting (705 or 706) of the instrument. The loop setting must match the scanner(s) being used.

Front Panel Programs Program Selection and Data Entry:

The program mode is selected by pressing the PROGRAM button. Once in the program mode, the PROGRAM button is used to scroll through the program components and their parameters. To change a program parameter, press the PROGRAM button until the desired program component is displayed and use the ▲ and ▼ buttons to select the desired program parameter. Altered program parameters are not entered until the ENTER button is pressed.

Program TRIG

Used to set a trigger time for the scanner and logger. The scan/log process will start at the programmed trigger time. The first component of this program sets the trigger hour and the second component sets the trigger minute. Setting a trigger hour of 24 disables the clock trigger.

Program TIME

Used to set the time of the 24 hour clock. The first component of this program sets the hour and the second component sets the minute. The clock does not reset to a new time until the RESET button is pressed.

Program IEEE

Used to check or change the IEEE primary address of the instrument or select one of three Smart-Print modes. The factory power-up default IEEE address is 14, but can be set to any address from 0 to 30. Setting one of the following IEEE values, selects a Smart-Print mode:

- 40 = Smart-Print with the entire data string.
(i.e. DEGC 23.6E+0,8C36,11:29:57)
- 41 = Smart-Print without the buffer channel/location or time.
(i.e. DEGC 23.6E+0)
- 42 = Smart-Print with only the reading.
(i.e. 23.6E+0)

Program LINE

The instrument must be set to match the frequency of the available line power. This program is used to check the line frequency setting of the Model 740 and select the alternate setting. The instrument can be set to either 50Hz or 60Hz.

Program LOOP

When using external scanners (Model 705s or a 706), the instrument must be set to match the scanners. This program is used to check the current loop setting and to select the alternate setting. The two available settings are 705 and 706.

EXTERNAL TRIGGERING

An external trigger pulse can be used to trigger a reading(s), or start the scan or log process. On power-up, the instrument is in a continuous trigger mode. In this mode, a trigger pulse (like the START button) will start the scan or log process. In the one-shot logging mode, each trigger pulse will store one reading in the log buffer.

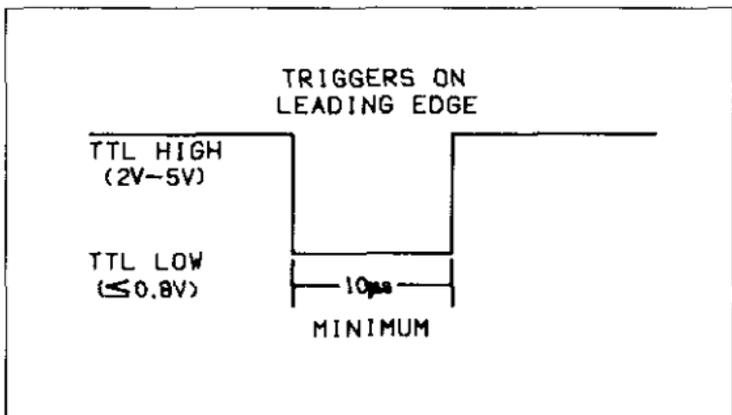

Figure 3. External Trigger Pulse Specifications

OPERATION

1. Place the instrument in the SCAN ENABLE or LOG ENABLE mode.
2. Connect an appropriate trigger pulse source (see Figure 3) to the EXTERNAL TRIGGER input on the rear panel.
3. Apply a pulse to the instrument. The scanning or logging process will start. If in the one-shot logging mode, each pulse will cause one reading to be stored in the log buffer.

IEEE-488 PROGRAMMING

The information in this section concerns operation over the IEEE-488 bus. Complete detailed information on the bus is located in Sections 3 and 4 of the Model 740 Instruction Manual.

EXECUTE	
X	<i>Execute other device-dependent commands</i>

TYPE	
N0	Set current channel OFF
N1	Set current channel for Type J
N2	Set current channel for Type K
N3	Set current channel for Type E
N4	Set current channel for Type T
N5	Set current channel for Type R
N6	Set current channel for Type S
N7	Set current channel for Type B
N8	Set current channel for Millivolts
N9	Same as N0
N10	Set all channels OFF
N11	Set all channels for Type J
N12	Set all channels for Type K
N13	Set all channels for Type E
N14	Set all channels for Type T
N15	Set all channels for Type R
N16	Set all channels for Type S
N17	Set all channels for Type B
N18	Set all channels for Millivolts

INITIALIZE	
I0	Initialize for 705s
I1	Initialize for 706

CHANNEL	
Cnn	Close channel nn
C91	Close internal reference channel
C92	Close internal measurement channel

SCALE	
00	Degrees Celsius
01	Degrees Fahrenheit

FILTER	
P0	Filter off
P1	Filter on

HI-LIMIT	
H±	Set HI-Limit to ±nnnn.n °C or °F

LO-LIMIT	
L±n	Set LO-Limit to ±nnnn.n °C or °F

DISPLAY	
D0	Temperature or millivolts
D1	Time

TIME	
Shh.mm	Set time, where hh=hour, mm=min.

INTERVAL	
W0	One-shot
W1	0.05s
W2	0.1s
W3	0.5s
W4	1s
W5	5s
W6	10s
W7	30s
W8	1min
W9	5min
W10	15min
W11	30min
W12	1hr

TRIGGER TIME	
Qhh.mm	Set time to trigger on clock, where hh=hour, mm=min.

TRIGGERS	
T0	Continuous on talk
T1	One-shot on talk
T2	Continuous on GET
T3	One-shot on GET
T4	Continuous on X
T5	One-shot on X
T6	Continuous on External Trigger or Clock
T7	One-shot on External Trigger or Clock

FUNCTION	
F0	Current channel
F1	Log enabled
F2	Scan enabled

READ MODE	
B0	Current channel
B1	Log buffer
B2	Scan buffer

RECALL	
Rnn	Recall from buffer channel/location nn

DATA FORMAT	
G0	Single output with prefix and with suffix
G1	Single output with prefix and without suffix
G2	Single output without prefix and without suffix
G3	Complete output with prefix and with suffix
G4	Complete output with prefix and without suffix
G5	Complete output without prefix and without suffix

SRQ	
M0	Clear SRQ mask
M1	Reading overflow or open TC
M2	Log buffer full or scan complete
M4	Temperature reading out of limits
M8	Reading done
M16	Ready
M32	Error

STATUS

U0	Send machine status word
U1	Send error status word
U2	Send data status word
U3	Send calibration date
U4	Send HI-Limit
U5	Send LO-Limit
U6	Send high reading in log buffer
U7	Send low reading in log buffer
U8	Send average reading in log buffer
U9	Send high reading in scan buffer
U10	Send low reading in scan buffer
U11	Send card 1 status
U12	Send card 2 status
U13	Send card 3 status
U14	Send card 4 status
U15	Send card 5 status
U16	Send card 6 status
U17	Send card 7 status
U18	Send card 8 status
U19	Send card 9 status
U20	Send time and date
U21	Send trigger time

EOI AND BUS HOLD-OFF

K0	Enable EOI and bus hold-off on X
K1	Disable EOI, enable bus hold-off on X
K2	Enable EOI, disable bus hold-off on X
K3	Disable both EOI and bus hold-off on X

TERMINATOR

Y0	CR LF
Y1	LF CR
Y2	CR
Y3	LF
Y4	None

SELF-TEST	
J0	Clear J byte in U0 status word
J1	Perform self-test

CALIBRATION	
Vn	First V command calibrates ZERO (n = -0.099 to 0.101) Second V command calibrates GAIN (n = -0.099 to 0.101) Third V command calibrates Reference Junction (n = 10°C/14°F to 70°C/158°F)

DATE	
Amn.dd	American format (mn=month, dd=day)
Add.mn	European for (dd=day, mn=month)

DATE FORMAT	
Z0	American date format (mn.dd)
Z1	European date format (dd.mn)

General Data Format

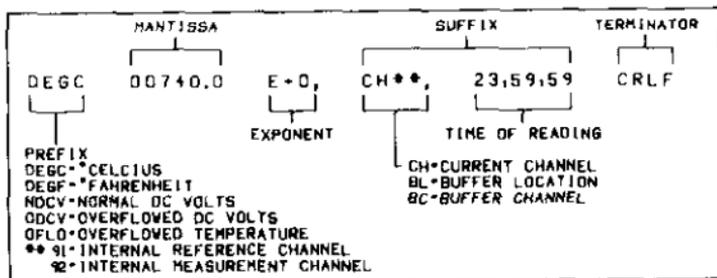

Serial Poll Byte

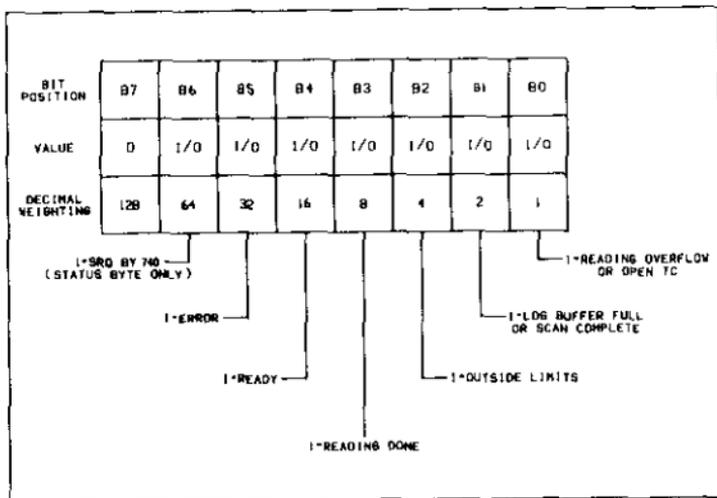

Machine Status Word

(Default Conditions Shown)

740 BOC**DOFOGOI*JOKOM00N*O*P*ROOT6W**YOZ*

*Value determined by setup.

Error Status Word (U1)

MODEL			NO	SELF	TRIGGER	STATE	BROKEN	CARD
NO.	IDDC	IDDCO	REMOTE	TEST	OVERRUN	ERROR	LOOP	OUT
740	1/0	1/0	1/0	1/0	1/0	1/0	1/0	1/0

Trigger to Reading Ready Times

Configuration*	Time (Typical)
Thermocouple measurement filter off (N1P0)	114ms
Thermocouple measurement filter on (N1P1)	230ms
Millivolt measurement filter off (N8P0)	98ms
Millivolt measurement filter on (N8P1)	216ms

*All times are measured using T1 (one-shot on talk) trigger.

SMART PRINT

In the Smart Print mode, the Model 740 will output data to an addressable or listen-only printer. When in Smart Print, data is released over the bus when readings are logged or channels are automatically scanned.

OPERATION

1. Connect an IEEE addressable or listen-only printer to the Model 740. The printer must be the only device on the bus.
2. Using front panel Program IEEE, select one of the Smart Print modes:
 - 40 - Rdgs. with prefix and suffix
(i.e. DEGC 38.2E+0,BL00,13:45:26).
 - 41 - Rdgs. with prefix and without suffix (i.e. DEGC 38.2E+0).
 - 41 - Rdgs. without prefix and without suffix (i.e. 38.2E+0).
3. Set the Model 740 to scan or log. When the scan or log starts, the printer will start printing the readings from the respective buffer.

PROGRAMS

The following programs are designed to be a simple aid to the user. They are not intended to suit specific needs. Detailed programming information can be found in the manual.

The first program demonstrates how to log readings on one channel and to read the contents of the log buffer using the HP-85 computer. One hundred readings stored in the log buffer will be displayed.

The second program demonstrates how to scan available channels and to read the contents of the scan buffer using the HP-85 computer.

The rest of the programs display one reading at the output of the controller. Each program provides an ASCII string variable output of the form:

```
DEGC 00740.0E+0,CH92,23:59:59 CR LF
```

The note at the end of some programs indicate modifications to provide a numeric variable in exponential form:

```
00740.0E+0
```

LOGGING OPERATION USING HP-85

The following program will fill the log buffer and obtain and display 100 readings on the computer CRT.

DIRECTIONS

1. Turn the Model 740 off and disconnect the line cord.
2. Connect the Model 740 to the HP82937A IEEE interface.
3. Connect a thermocouple (TC) to the internal channel.
4. Power-up the Model 740 and configure the internal channel accordingly.
5. Using front panel Program IEEE, set the primary address on the Model 740 to 14.
6. Enter the following program using the END LINE key after each line is typed.
7. Press the HP-85 RUN key. The program will enable the logger, wait for the buffer to fill, turn on the buffer output, and then request and display 100 readings.

PROGRAM	COMMENTS
10 DIM A#[4000]	
20 REMOTE 714	Send remote enable.
30 CLEAR 714	
40 OUTPUT 714: 'W1T3F1X'	Set log parameters.
50 TRIGGER 714	Start log.
60 S=SPOLL(714)	Serial poll the 740.
70 IF NOT BIT(S,1) THEN 60	If buffer not full, wait.
80 OUTPUT 714: 'B1G3X'	Send B1G3 commands.
90 ENTER 714:A#	Get all readings from buffer.
100 DISP A#	Display all readings from buffer.
110 END	

SCANNING OPERATION USING MODEL 7057A and HP-85

The following program will scan 10 channels and store the readings in the scan buffer, and then obtain and display the readings on the computer CRT.

DIRECTIONS

1. Turn the power off on the Model 740 and disconnect the line cord.
2. Connect the Model 740 to the HP82937A interface.
3. Connect one to nine TCs to the Model 7057A scanner card and install the card in the Model 740.
4. Power-up the Model 740 and configure the channels accordingly.
5. Using front panel Program IEEE, set the primary address of the Model 740 to 14.
6. Press the HP-85 RUN key. The program will scan the 10 channels, store the readings in the scan buffer, and then request and display the readings.

PROGRAM	COMMENTS
10 DIM A# [400]	
20 REMOTE 714	Send remote enable.
30 CLEAR 714	
40 OUTPUT 714: 'T3F2X'	Set scan parameters.
50 TRIGGER 714	Start scan.
60 S=SPOLL (714)	Serial poll the 740.
70 IF NOT BIT (S,1) THEN 60	If buffer not full, wait.
80 OUTPUT 714: 'B2G3X'	Send B2 and G3 commands.
90 ENTER 714:A#	Get readings from buffer.
100 DISP A#	Display readings.
110 END	

IBM XT or PC

(Keithley Model 8573 GPIB Interface)

The following program sends a command string to the Model 740 from an IBM PC or XT computer and displays the instrument reading on the CRT. The computer must be equipped with a Keithley Instruments Model 8573 GPIB IEEE interface and the DOS 2.0 operating system. The GPIB software and hardware must be configured per the Keithley Instruments Model 8573 instruction manual.

DIRECTIONS

1. With the power off, connect the Model 740 to the IEEE-488 interface installed in the IBM computer.
2. Connect a TC to the internal channel of the Model 740.
3. Power-up the Model 740 and configure the internal channel accordingly. Do not configure the channel to be OFF, as the instrument will not talk and will lock up the bus.
4. Using front panel Program IEEE, set the primary address of the Model 740 to 14.
5. Type in the command BASICA on the IBM keyboard to get into the IBM interpretive BASICA language.
6. Place the interface software disc in the default drive, type LOAD "DECL", and press the return key.
7. Enter the following program into the computer, pressing the return key after each line is typed. Lines 1-6 are part of the DECL program previously loaded and need not be typed in. However, lines 1 and 2 will have to be altered. See the Model 8573 Instruction Manual.
8. Run the program and type in the desired command string when prompted. For example: to place the Model 740 into the one-shot on talk trigger mode, and in the current channel function and read mode, type in F0B0T1X and press the return key.
9. The display will show the Model 740 reading string on the CRT.
10. To exit the program type EXIT and press return.

PROGRAM	COMMENTS
10 CLS	
20 NA\$=' GPIB0' : CALL IBFIND (NA\$, BRD0%)	Find the board number.
30 NA\$=' DEV1' : CALL IBFIND (NA\$, M740%)	Find the 740 number.
40 U%=14 : CALL IBPAD (M740%, U%)	Change to primary address 14.
50 U%=1 : CALL IBSRE (BRD0%, U%)	Set REN true.
60 INPUT ' COMMAND' : CMD\$	Prompt for command string.
70 IF CMD\$=' EXIT' THEN 150	See if program is to be halted.
80 IF CMD\$=' ' THEN 60	If null command string, go back and get another.
90 CALL IBWRT(M740%, CMD\$)	Address 740 to listen and send command string.
100 RD\$=SPACE\$(50)	Assign reading input buffer.
110 CALL IBRD(M740%, RD\$)	Address 740 to talk and input reading string.
120 RD\$=LEFT\$(RD\$, IBCNT%)	Trim string to proper size.
130 PRINT RD\$	Display the reading on the CRT.
140 GOTO 60	Repeat.
150 U%=0 : CALL IBONL (BRD0%, U%)	Close the board file.
160 CALL IBONL(M740%, U%)	Close the instrument file.
170 END	

NOTE: Lines 1-6 of this program are not shown and need not be typed in. They are contained in the floppy disc. When the command LOAD"DECL" is entered these lines are already there.

NOTE: If conversion to numeric variable is desired, change lines 120 and 130 as follows:

```
120 RD=VAL(MID$(RD$, 5, 16))
130 PRINT RD
```

APPLE II (APPLE Interface)

The following program obtains one reading from the Model 740 and displays the reading on the APPLE II screen, using an APPLE IEEE-488 Interface installed in slot 3.

DIRECTIONS

1. Turn off the Model 740 and disconnect the line cord.
2. Connect the Model 740 to the APPLE II and APPLE IEEE-488 Interface.
3. Connect a TC to the internal channel of the Model 740.
4. Power-up the Model 740 and configure the internal channel accordingly. Do not configure the channel to be OFF, as the instrument will not talk and will lock up the bus.
5. Using front panel Program IEEE, set the primary address of the Model 740 to 14.
6. Enter the following program using the RETURN key after each line.
7. Type in RUN and depress the RETURN key.

NOTE

This program will not recognize the commas and colons in the G3 data string of the Model 740. Thus, the Model 740 must be in G1 or G2 in order to use this program.

8. The display will read "TEST SETUP?". To place the Model 740 in the current channel function and read mode, type in G1 FOBOTIX and press the RETURN key.
9. The display will show the Model 740 reading string on the CRT.

PROGRAM	COMMENTS
10 Z#=CHR\$(26)	Terminator.
20 INPUT "TEST SETUP? "; B#	Enter programming command.
30 PR#3	Send output to IEEE bus.
40 IN#3	Get input from IEEE bus.
50 PRINT "RA"	Turn remote on.
60 PRINT "WT. "; Z#; B#	Write B\$ to 740.
70 PRINT "LF1"	Linefeed on.
80 PRINT "RDN"; Z#; : INPUT " "; A#	Read data from 740.
90 PRINT "UT"	
100 PR#0	Send output to CRT
110 IN#0	Get input from keyboard
120 PRINT A#	
130 GO TO 20	Repeat

NOTE: If conversion to numeric variable is needed, add the following:

```
124 A=VAL(MID$(A#,5,16))
126 PRINT A
```

HP-85

The following program obtains one reading from the Model 740 and displays the reading on the HP-85 CRT screen, using the 82937A GPIB interface and an I/O ROM.

DIRECTIONS

1. Turn off the Model 740 and disconnect the line cord.
2. Connect the Model 740 to the HP82937A IEEE interface.
3. Connect a TC to the internal channel of the Model 740.
4. Power-up the Model 740 and configure the internal channel accordingly. Do not configure the channel to be off, as the instrument will not talk and will lock up the bus.
5. Using front panel IEEE, set the primary address of the Model 740 to 14.
6. Enter the following program using the END LINE key after each line is typed.
7. Press the RUN key. The display will read "TEST SETUP".
8. To place the Model 740 in the current channel function and read mode, type in F0B0T1X and press the END LINE key.
9. The display will show the Model 740 reading string on the CRT.

PROGRAM	COMMENTS
10 DIM A\$(40), B\$(40)	
20 REMOTE ?14	Set to remote.
30 DISP "TEST SETUP"	Prompt for test setup.
40 INPUT B\$	
50 OUTPUT ?14; B\$	Program the 740.
60 ENTER ?14; A\$	Get data from 740.
70 DISP A\$	
80 GO TO 30	Repeat.
90 END	

NOTE: If conversion to numeric variable is needed, change line 70 as follows:

```
70 DISP VAL(A$(5))
```

HP 9825A

The following program obtains one reading from the Model 740 and displays the reading on the HP 9825A using a 98034A HPiB interface and a 9872A extended I/O ROM.

DIRECTIONS

1. Turn off the Model 740 and disconnect the line cord.
2. Connect the Model 740 to the HP 9825A and the 98034A HPiB interface.
3. Connect a TC to the internal channel of the Model 740.
4. Power-up the Model 740 and configure the internal channel accordingly. Do not configure the channel to be OFF, as the instrument will not talk and will lock up the bus.
5. Using front panel Program IEEE, set the primary address of the Model 740 to 14.
6. Enter the following program using the STORE key after each line is typed. Line numbers are automatically assigned by the 9825A.
7. Press the RUN key. The display will read "TEST SETUP".
8. To place the Model 740 in the current channel function and read mode, type in F0BOT1X and press the CONTINUE key.
9. The print out will show the Model 740 reading string.

PROGRAM	COMMENTS
0 dim A\$(40), B\$(40)	Dimension data strings.
1 dev "740", 714	Define Model 740 address 14.
2 rem "740"	Set to remote.
3 ent "TEST SETUP", B\$	Enter programming command.
4 wrt "740", B\$	Output program command to 740.
5 red "740", A\$	Read data from 740.
6 prt A\$	Print data on hard copy printer.
7 gto 3	Repeat.

NOTE: If conversion to numeric variable is desired, omit lines 6 and 7 and substitute:

6 "e" --A\$(13,13):flt5	Convert to numeric variable.
7 prt val(A\$(5))	
8 gto 3	Repeat.

HP 9816

The following program sends a command string to the Model 740, reads data and displays the data on the HP 9816 CRT, using BASIC 2.0

DIRECTIONS

1. Turn off the Model 740 and disconnect the line cord.
2. Connect the Model 740 to the HP 9816 and HP 82937A GPIB interface.
3. Connect a TC to the internal channel of the Model 740.
4. Power-up the Model 740 and configure the internal channel accordingly. Do not configure the channel to be OFF, as the instrument will not talk and will lock up the bus.
5. Using Program IEEE, set the primary address of the Model 740 to 14.
6. On the 9816, type EDIT and press the EXEC key.
7. Enter the following program using the ENTER key after each line is typed.
8. Press the RUN key. The display will read "TEST SETUP".
9. To place the Model 740 in the current channel and read mode, type in F0B0T1X and press the ENTER key.
10. The display will show the Model 740 reading string on the CRT.

PROGRAM	COMMENTS
10 REMOTE 714	Set to remote.
15 DIM B\$(50)	
20 INPUT "TEST SETUP" ; A\$	Prompt for test setup.
30 OUTPUT 714 ; A\$	Send command string to 740.
40 ENTER 714 ; B\$	Get data string from 740.
50 PRINT B\$	Display data string.
60 GO TO 20	Repeat.
70 END	

NOTE: If conversion to numeric variable is desired, change lines 40 and 50 as follows:

```
40 ENTER 714 : B
50 PRINT B
```

DEC LSI 11

The following program obtains one reading from the Model 740 and displays the reading on the DEC LSI 11 microcomputer CRT terminal. The LSI 11 must be configured with 16K words of RAM and an IBV-11 IEEE interface. The software must be configured with IB software as well as the FORTRAN and the RT 11 operating system.

DIRECTIONS

1. Turn off the Model 740 and disconnect the line cord.
2. Connect the Model 740 to the IBV 11 IEEE cable.
3. Connect a TC to the internal channel of the Model 740.
4. Power-up the Model 740 and *configure the internal channel accordingly*. Do not configure the channel to be OFF, as the instrument will not talk and will lock up the bus.
5. Using Program IEEE, set the primary address of the Model 740 to 14.
6. Enter the following program using the editor under RT 11 and the name IEEE.
7. Compile using the fortran compiler as follows: LINK IEEE,IBLIB.
8. Type RUN IEEE and press the RETURN key.
9. The display will read "ENTER ADDRESS".
10. Type in 14 and press the RETURN key.
11. The display will read "TEST SETUP". To place the Model 740 in the current channel function and read mode, type in F0BOT1X and press the RETURN key.
12. The display will show the Model 740 reading string on the CRT.

PROGRAM**COMMENTS**

```
INTEGER*2 PRIADR
LOGICAL*1 MSG(80), INPUT(80)
DO 2 I = 1, 10
CALL IBSTER(I, 0)
2 CONTINUE
CALL IBSTER(15, 5)
CALL IBTIMO(120)

CALL IBTERM(10)
CALL IBREN
4 TYPE 5
5 FORMAT(1X, 'ENTER
ADDRESS: ', $) ACCEPT 10 PRIADR
10 FORMAT(I2)
12 TYPE 15
15 FORMAT(1X, 'TEST SETUP: ', $)

CALL GETSTR(5, MSG, 72)
CALL IBSEOI(MSG, -1, PRIADR)
18 I=IBRECU(INPUT, 80, PRIADR)
INPUT(I+1) = 0
CALL PUTSTR(7, INPUT, '0')
CALL IBUNT
GO TO 12
END
```

!Turn off IB errors.

!Allow 5 error 15's.

!Allow 1 second bus
timeout.

!Set LF as terminator

!Turn remote on.

!Input the address
14.!Prompt for the test
setup.

!Get the test setup.

!Program the 740.

!Untalk the 740.

!Repeat.

PET/CBM 2001

The following program obtains one reading from the Model 740 and displays the reading on the PET/CBM 2001 screen.

DIRECTIONS

1. Turn off the Model 740 and disconnect the line cord.
2. Connect the Model 740 to the PET/CBM 2001 IEEE interface.
3. Connect a TC to the internal channel of the Model 740.
4. Power-up the Model 740 and configure the internal channel accordingly. Do not configure the channel to be OFF, as the instrument will not talk and will lock up the bus.
5. Using Program IEEE, set the primary address of the Model 740 to 14.
6. Enter the following program using the RETURN key after each line.
7. Type RUN and press the RETURN key. The display will read "TEST SETUP".

NOTE

This program will not recognize the commas and colons in the G3 data string of the Model 740. Thus, use GO or G1 in the command string.

8. To place the Model 740 in the current channel function and read mode, type G1F0BOT1X and press the RETURN key.
9. The display will show the Model 740 reading string on the CRT.

PROGRAM	COMMENTS
10 OPEN 6,14	Open file 6, primary address 14.
20 INPUT 'TEST SETUP'; B\$	Enter programming command.
30 PRINT#6, B\$	Output to IEEE bus.
40 INPUT#6, A\$	Read data from 740.
50 IF ST = 2 THEN 40	If time out, input again.
60 PRINT A\$	Print data.
70 GO TO 20	Repeat.

NOTE: If conversion to numeric variable is desired, omit line 70 and type the following:

```

70 A = VAL(MID$(A$, 5, 15))   Convert to numeric variable.
80 PRINT 'A=' ; A
90 GO TO 20                   Repeat.

```

KEITHLEY

Test Instrumentation Group
28775 Aurora Road / Cleveland, Ohio 44139
