

MSO3000 and DPO3000 Series Digital Phosphor Oscilloscopes Service Manual



071-2667-00

Tektronix

MSO3000 and DPO3000 Series Digital Phosphor Oscilloscopes Service Manual

This document applies to firmware version 2.00 and above.

Warning

The servicing instructions are for use by qualified personnel only. To avoid personal injury, do not perform any servicing unless you are qualified to do so. Refer to all safety summaries prior to performing service.

Revision B

www.tektronix.com

071-2667-00

Tektronix

Copyright © Tektronix. All rights reserved. Licensed software products are owned by Tektronix or its subsidiaries or suppliers, and are protected by national copyright laws and international treaty provisions.

Tektronix products are covered by U.S. and foreign patents, issued and pending. Information in this publication supersedes that in all previously published material. Specifications and price change privileges reserved.

TEKTRONIX and TEK are registered trademarks of Tektronix, Inc.

TekLink is a trademark of Tektronix, Inc.

Tektronix is an authorized licensee of the CompactFlash® trademark.

Contacting Tektronix

Tektronix, Inc.
14150 SW Karl Braun Drive
P.O. Box 500
Beaverton, OR 97077
USA

For product information, sales, service, and technical support:

- In North America, call 1-800-833-9200.
- Worldwide, visit www.tektronix.com to find contacts in your area.

Table of Contents

General safety summary	iv
Service safety summary	vi
Preface	vii
Manual Conventions.....	vii
Related Documentation	vii
Operating Information	1
Theory of Operation.....	3
Block Diagram	3
Power Supply.....	4
I/O Board	4
Attenuator Board.....	4
Main Board	4
Front-Panel Board	5
Adjustment Procedures	7
Required Equipment.....	7
Overview of the Adjustment Process.....	8
Factory Adjustment Procedure	9
Completing the Procedure	12
Maintenance.....	17
Preventing ESD	17
Inspection and Cleaning.....	17
Overview of Removal Procedures	21
Removal Procedures.....	22
Troubleshooting.....	28
Troubleshooting Procedure	29
Unpacking and Repacking Instructions	31
Replaceable Parts List.....	33
Parts Ordering Information	33
Using the Replaceable Parts List.....	35
Index	

List of Figures

Figure 1: Oscilloscope module interconnections	3
Figure 2: Rear panel.....	9
Figure 3: Utility page menu	10
Figure 4: Calibration selection.....	10
Figure 5: Factory information dialog.....	11
Figure 6: Digital channel input (MSO only)	14
Figure 7: Locator for internal modules.....	21
Figure 8: Reconnecting the fan cable	24
Figure 9: Fan cable dress	24
Figure 10: Disconnecting the main board	26
Figure 11: Display cable shield in place	27
Figure 12: Exploded view: rear case and rear chassis.....	37
Figure 13: Exploded view: I/O and main boards	39
Figure 14: Exploded view: Front panel and power supply	41
Figure 15: Exploded view: Front panel labels	43
Figure 16: Exploded view: Main board shield and attenuator board	45
Figure 17: Exploded view: Front chassis and LCD assembly.....	47
Figure 18: Exploded view: front panel board and front case.....	49

List of Tables

Table 1: External inspection check list.....	19
Table 2: Internal inspection check list.....	20
Table 3: Replaceable parts list: Rear case and rear chassis.....	36
Table 4: Replaceable parts list: I/O and main boards.....	38
Table 5: Replaceable parts list: Front panel and power supply.....	40
Table 6: Replaceable parts list: Front panel labels.....	42
Table 7: Replaceable parts list: Attenuator.....	44
Table 8: Replaceable parts list: Front chassis and LCD.....	46
Table 9: Replaceable parts list: Front panel and front case.....	48
Table 10: Replaceable parts list: Standard accessories.....	50
Table 11: Replaceable parts list: Optional accessories.....	50

General safety summary

Review the following safety precautions to avoid injury and prevent damage to this product or any products connected to it.

To avoid potential hazards, use this product only as specified.

Only qualified personnel should perform service procedures.

To avoid fire or personal injury

Use proper power cord. Use only the power cord specified for this product and certified for the country of use.

Connect and disconnect properly. Do not connect or disconnect probes or test leads while they are connected to a voltage source.

Ground the product. This product is grounded through the grounding conductor of the power cord. To avoid electric shock, the grounding conductor must be connected to earth ground. Before making connections to the input or output terminals of the product, ensure that the product is properly grounded.

Observe all terminal ratings. To avoid fire or shock hazard, observe all ratings and markings on the product. Consult the product manual for further ratings information before making connections to the product.

Connect the probe reference lead to earth ground only.

Do not apply a potential to any terminal, including the common terminal, that exceeds the maximum rating of that terminal.

Power disconnect. The power cord disconnects the product from the power source. Do not block the power cord; it must remain accessible to the user at all times.

Do not operate without covers. Do not operate this product with covers or panels removed.

Do not operate with suspected failures. If you suspect that there is damage to this product, have it inspected by qualified service personnel.

Avoid exposed circuitry. Do not touch exposed connections and components when power is present.

Do not operate in wet/damp conditions.

Do not operate in an explosive atmosphere.

Keep product surfaces clean and dry.

Provide proper ventilation. Refer to the manual's installation instructions for details on installing the product so it has proper ventilation.

Terms in this manual These terms may appear in this manual:



WARNING. *Warning statements identify conditions or practices that could result in injury or loss of life.*



CAUTION. *Caution statements identify conditions or practices that could result in damage to this product or other property.*

Symbols and terms on the product

These terms may appear on the product:

- DANGER indicates an injury hazard immediately accessible as you read the marking.
- WARNING indicates an injury hazard not immediately accessible as you read the marking.
- CAUTION indicates a hazard to property including the product.

The following symbol(s) may appear on the product:



CAUTION
Refer to Manual



Protective Ground
(Earth) Terminal



Chassis Ground



Standby

Service safety summary

Only qualified personnel should perform service procedures. Read this *Service safety summary* and the *General safety summary* before performing any service procedures.

Do not service alone. Do not perform internal service or adjustments of this product unless another person capable of rendering first aid and resuscitation is present.

Disconnect power. To avoid electric shock, switch off the instrument power, then disconnect the power cord from the mains power.

Use care when servicing with power on. Dangerous voltages or currents may exist in this product. Disconnect power, remove battery (if applicable), and disconnect test leads before removing protective panels, soldering, or replacing components.

To avoid electric shock, do not touch exposed connections.

Preface

This service manual provides information that you need to troubleshoot, disassemble, and replace parts on the Tektronix MSO3000 and DPO3000 Series Digital Phosphor Oscilloscopes.

Manual Conventions

This manual uses certain conventions that you should become familiar with before attempting service.

Modules Throughout this manual, any replaceable component, assembly, or part is referred to by the term *module*.

A module is composed of electrical and mechanical assemblies, circuit boards, interconnecting cables, and user-accessible controls.

Replaceable Parts This manual refers to any field-replaceable assembly or mechanical part specifically by its name or generically as a replaceable part. In general, a replaceable part is any circuit board or assembly, such as the hard disk drive, or a mechanical part, such as the I/O port connectors, that is listed in the replaceable parts list.

Safety Symbols and terms related to safety appear in the *General Safety Summary*

Related Documentation

To read about	Use these documents
Installation and Operation	<i>MSO3000 and DPO3000 Series Oscilloscopes User Manual</i> (available in 11 languages)
Specifications and Performance	<i>MSO3000 and DPO3000 Series Technical Reference</i> (PDF only)
Programmer Commands	<i>MSO3000 and DPO3000 Series Programmer Manual</i> (PDF only)
Analysis and Connectivity Tools	<i>Getting Started with OpenChoice® Solutions Manual</i>
Installing and testing applications modules	<i>Tektronix 3000 Series Application Module Installation Instructions Manual</i>
Oscilloscope calibrator	<i>Fluke Oscilloscope Calibrator Manual</i> at http://us.fluke.com

Operating Information

For information on installing and operating your MSO3000 or DPO3000 Series Oscilloscope, refer to the *MSO3000 and DPO3000 Series Oscilloscopes User Manual*.

This manual is available, in 11 languages, on the Web at www.tektronix.com.

Theory of Operation

This chapter describes the electrical operation of the oscilloscope to the module level. The following figure shows the oscilloscope module interconnections.

Block Diagram

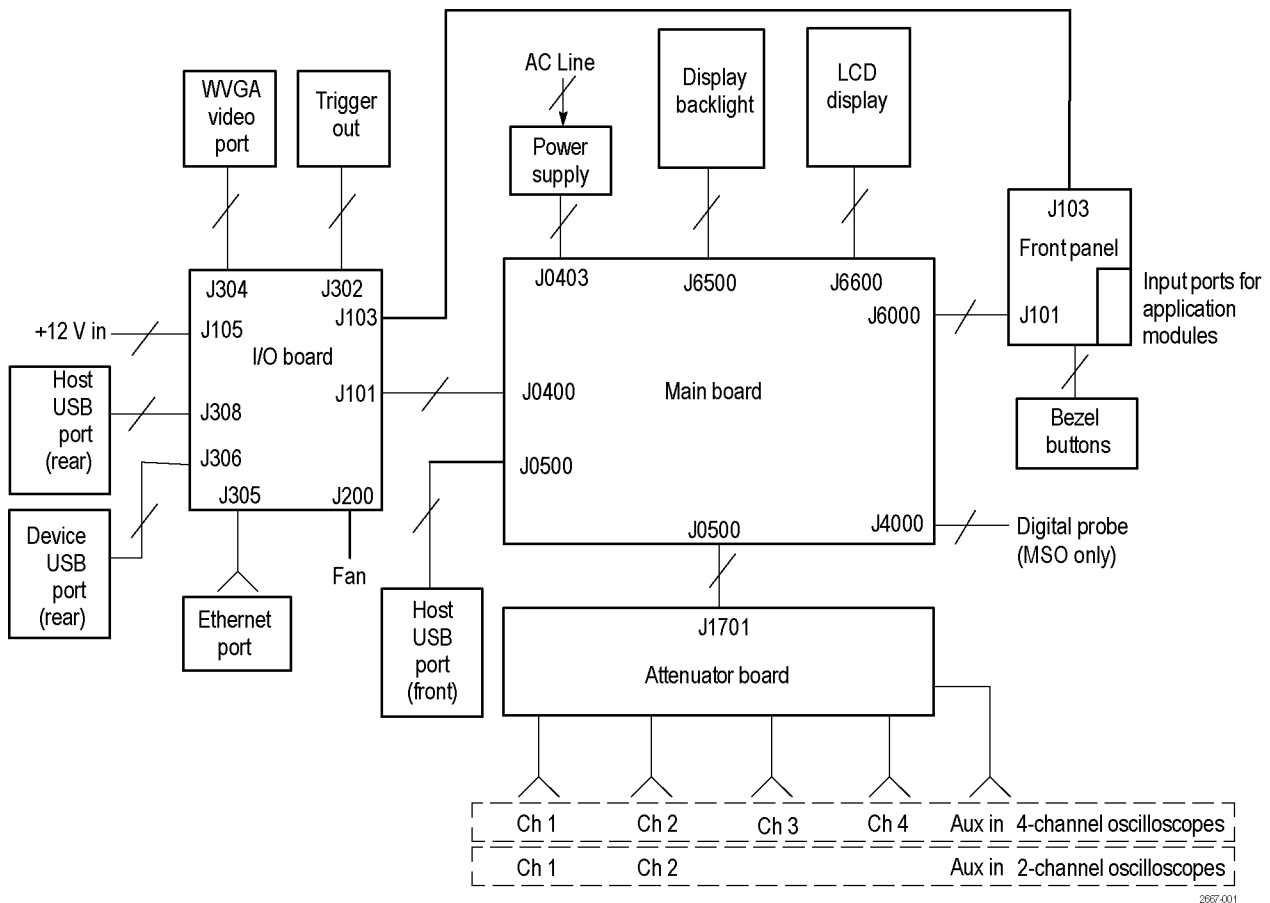

Figure 1: Oscilloscope module interconnections

Power Supply

The Power Supply board converts AC line voltage to +12 V and +6 V to power all internal circuits.

I/O Board

The I/O board contains two USB ports (one host port and one device port), an Ethernet port (LAN), a WVGA Video port, and a Trigger Out BNC connector.

Attenuator Board

The Attenuator board contains the analog portions of the acquisition system. The Acquisition system begins with the analog signal path, on the Attenuator board, and ends with a digitized signal in memory, on the Main board.

The signal enters a channel input, and then passes through an attenuator and preamplifier. The signal is then passed to the Main board.

Main Board

The Main board module contains the following functions:

Acquisition System

The Acquisition system begins with the analog signal path, on the Attenuator board and ends with a digitized signal in memory, on the Main board. The analog signal from each preamplifier on the Attenuator board goes through a digitizer, a time base controller, and then into acquisition memory. The analog signal from each preamplifier is also distributed to a trigger circuit.

Trigger System

The Trigger system processes the analog signals from the preamplifiers on the Attenuator board, and sends trigger information to the time-base controller. Advanced trigger functions are enabled only when the appropriate application modules and supporting software are installed.

Display System

The Display system combines live waveform data from acquisition memory with menus and text, and stores this information in display memory. It then uses this data to refresh the XGA display module (LCD).

Processor System

The Processor system contains a 440EP Power PC microprocessor that controls the entire instrument. The processor system also contains FLASH ROM, system RAM, and interfaces to the USB ports.

- Power Converter** The Power Converter receives the +12 V and +6 V from the main power supply and generates voltages for the analog and digital circuitry on the Main board.
- Digital Channels** The MSO3000 series main board also includes threshold DACs and comparators for the digital channels.

Front-Panel Board

The Front Panel board contains a microprocessor that reads the front-panel buttons and controls, and then sends this information to the processor system on the Main board. The Front Panel board also generates the probe compensation output signal and provides an interface to the application modules.

Adjustment Procedures

This chapter contains the factory adjustment procedure for the MSO3000 and DPO3000 Series oscilloscopes. Only qualified personnel should perform adjustment procedures. Read the *Service Safety Summary* and the *General Safety Summary* before performing any service procedures.

NOTE. *The voltage references inside the oscilloscope are very stable over time and should not require routine adjustment. Before performing any procedure in this chapter, do the Performance Verification procedures to check whether the oscilloscope meets specifications. See the MSO3000 and DPO3000 Series Specifications and Performance Verification Technical Reference.*

Successful completion of this adjustment procedure automatically updates the stored time and date of the latest successful adjustment. Completion of the Performance Verification procedure does not update this date and time. If no adjustment is needed, there is also no need to update the time and date of the adjustment.

Required Equipment

The following equipment, or a suitable equivalent, is required to complete these procedures.

The following table specifies required equipment for adjusting the oscilloscope.

Description	Minimum requirements	Example
DC voltage source	50 mV to 70 V, $\pm 0.1\%$ amplitude accuracy	Fluke or Wavetek 9500 Oscilloscope Calibrator with 9530 active heads
Sine Generator	1 kHz 1 GHz	Fluke or Wavetek 9500 Oscilloscope Calibrator with one 9510 Output Module
Edge Generator	1 kHz with < 50 ps ch-ch skew	Fluke or Wavetek 9500 Oscilloscope Calibrator with one 9510 Output Module
50 Ω BNC cable	BNC male to BNC male, about 10 in (25 cm.) long	Tektronix part number 012-0208-00
Adjustment tool	Non-conducting shaft with diameter = 0.1 in. (= 2.5 mm)	Tektronix part number 003-1433-00

Overview of the Adjustment Process

Before performing adjustment procedures, you must warm up the oscilloscope for at least 30 minutes in an ambient temperature between 20 °C and 30 °C. Adjustments performed before warm-up or outside this temperature range may result in poor performance or calibration failure.

The factory adjustment procedure consists of a series of steps; as you move through these steps, the oscilloscope display provides instructions that describe the specific input signal requirements for each step. If the oscilloscope passes the step, it moves on to the next step. If the oscilloscope fails, you can repeat the step or choose to abort the procedure.

If you have difficulty completing the steps, refer to the *Completing the Procedure* section for specific instructions and troubleshooting information. (See page 12.)

To complete the calibration procedure, you must know how to operate the oscilloscope calibrator. Please refer to the user manual, which can be found at <http://us.fluke.com>.

NOTE. *Do not turn any knobs or push any front-panel buttons other than the Next Step or Previous Step buttons during the adjustment procedure. Doing so will cause the oscilloscope to abort the adjustment procedure. The oscilloscope uses the previous calibration constants if the adjustment procedure is aborted or fails.*

The screen does not display the actual oscilloscope settings (such as channel input impedance, or vertical and horizontal settings) during the adjustment procedure. The oscilloscope automatically sets the instrument settings, but these settings may not read out correctly on the display.

During some steps, the instrument may appear to be idle for several minutes while it is processing information internally.

If the oscilloscope completes all steps in the procedure successfully, a "Pass" message is displayed and the new calibration constants take effect. If the oscilloscope does not pass a step, you can repeat the step. To cancel the calibration procedure, press the **Menu Off** front panel button on the oscilloscope. This reverts the oscilloscope to the old calibration constants.

Factory Adjustment Procedure

To perform the factory adjustment procedure, complete these steps:

1. Connect the oscilloscope to an AC power source.

NOTE. *You must connect the oscilloscope and the test equipment to the same AC power circuit. Connect the oscilloscope and test instruments to a common power strip if you are unsure of the AC power circuit distribution. Connecting the oscilloscope and test instruments to separate AC power circuits can result in offset voltages between the equipment, which can invalidate the adjustment procedure.*

2. Power on the oscilloscope and warm it up for 30 minutes.
3. Power on the oscilloscope calibrator and warm it up for 30 minutes.
4. Connect the active heads from the calibrator to the oscilloscope, ensuring that Channel 1 on the calibrator connects to Channel 1 on the oscilloscope, and so on.

NOTE. *For the DPO3000, there will be either 2 or 4 channels to connect. For the MSO3000, there will be either 2 or 4 channels to connect, plus an additional channel connection for the digital probe. Plug the digital probe into the Channel 5 active head on the calibrator, but do not plug the probe into the oscilloscope until you begin a Deskew test.*

5. Power off the oscilloscope. Locate the hole in the rear panel that provides access to the CAL switch.

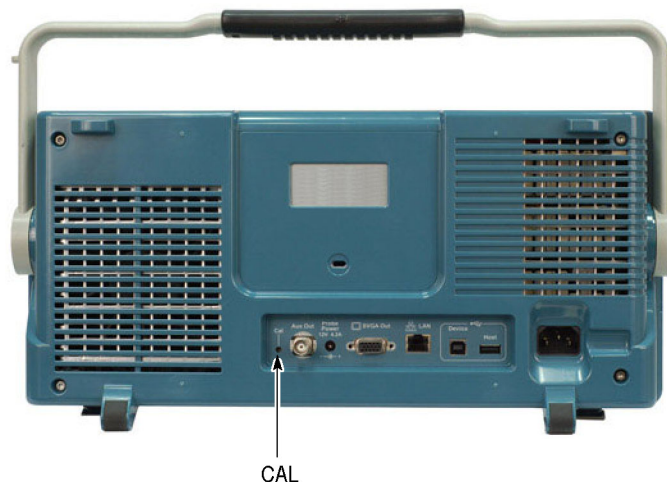

Figure 2: Rear panel

6. Insert the adjustment tool into the CAL switch hole. Use the tool to push and hold the CAL switch in while you power on the oscilloscope. Keep holding the switch until the oscilloscope shows the "Power-on self test passed" message with the oscilloscope graticule in the background. This can take up to a minute.
7. Push the **Default Setup** button on the front panel of the oscilloscope.
8. Push the **Utility** button on the front panel of the oscilloscope.
9. Push the **Utility Page** lower-bezel button. The utility page menu appears.

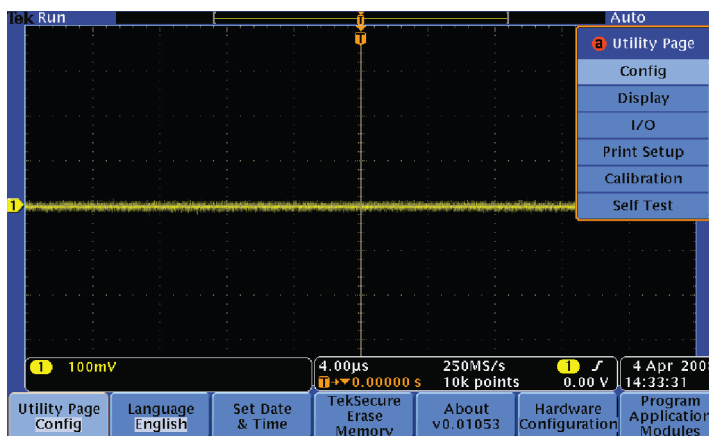

Figure 3: Utility page menu

10. Use the **Multipurpose a** knob to select **Calibration**.

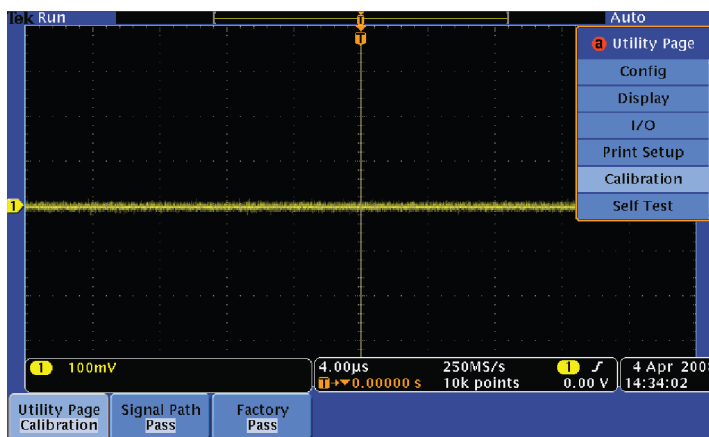

Figure 4: Calibration selection

11. Push the **Factory** lower-bezel button. The information dialog appears.

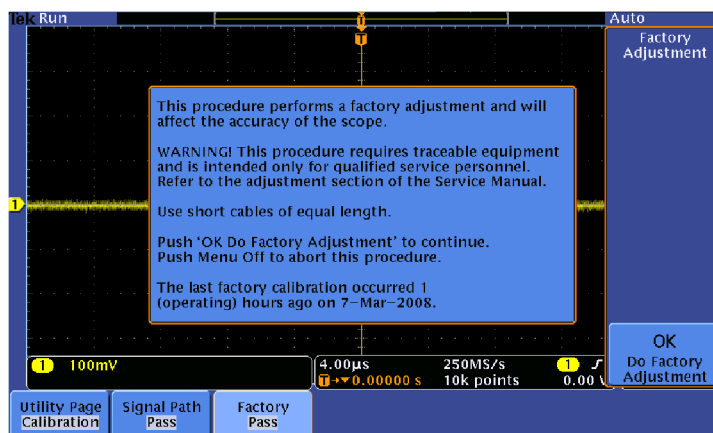

Figure 5: Factory information dialog

12. Push the **OK Do Factory Adjustment** side-bezel button to start the adjustment process. Prompts appear on the oscilloscope screen to indicate the signal type and the channels to which it should be connected.

NOTE. *The oscilloscope adjusts itself automatically using the calibrator signal as a reference. You do not need to make any adjustments.*

*If you make an error, such as connecting the wrong input signal, you can repeat the last step by pushing the **Return to Previous Screen** side bezel button.*

13. For each step, refer to the next table to identify the signal type, and then carefully follow the instructions for that signal type on the specified page.

Signal type	Example prompt	Procedure to follow	Parameters to set
DC Voltage	Apply 0 V DC 50 Ω termination signal to 3.	(See page 12, <i>DC Voltage</i> .)	Waveform type, voltage, termination, channel
Time Mark	Apply 500 mV Pk-Pk 625 Hz 50 Ω termination time mark signal to 3.	(See page 14, <i>Time Mark</i> .)	Waveform type, voltage, frequency, termination, channel
Deskew	Apply 1.0 V Pk-Pk 1 kHz 50 Ω termination deskew signal to 3.	(See page 14, <i>Deskew (MSO Only)</i> .)	Waveform type, voltage, frequency, termination, channel
Sine Signal	Apply 2.0 V Pk-Pk 164M 50 Ω termination sine signal to 3.	(See page 15, <i>Sine Signal</i> .)	Waveform type, voltage, frequency, termination, channel

NOTE. *The oscilloscope screen will not provide you with all of the information that you need to complete the steps successfully, so it is critical that you follow the steps outlined in the *Completing the Procedure* section. Each time a new prompt appears, refer to the table above to identify the signal type, and then ensure that you are following every step that is outlined for that specific signal type.*

14. Continue with the adjustment process until it is complete and you receive the **Pass** notification. You can cancel the process at any time by pushing the **MENU OFF** button.
15. Complete the performance verification tests to verify that the adjustment procedure has correctly calibrated the oscilloscope. (See the *MSO3000 and DPO3000 Series Specification and Performance Verification Technical Reference*.) Incorrect use of calibration equipment can cause the oscilloscope to pass the Calibration Procedure but fail Performance Verification.



Completing the Procedure

Instructions follow for completing the DC Voltage, Time Mark, Deskew, and Sine Signal tests. For each step in the calibration procedure, start at the beginning of the numbered instructions for the specific test type, and carefully complete each step.



If the oscilloscope fails a step, consult the *Troubleshooting* section at the end of this chapter, revert to the previous step and try again. If the step fails again, return to the first step in the calibration procedure and try the entire procedure again. If the procedure fails, there could be problem with the oscilloscope. Consider seeking customer support.

DC Voltage

The DC Voltage test is the first test to appear on the prompts, and it usually makes up the majority of the calibration procedure tests. For each DC Voltage test, complete all 8 steps listed below to best ensure that the test will pass.

1. Push the **DC/Square**  button.
2. Push the **WAVEFORM** lower-bezel button, and then push the **DC Positive**  right-bezel button.
3. Push the **CHANNEL SELECT** lower-bezel button.
4. Push the **LOAD** lower-bezel button to highlight either **1M Ω** or **50 M Ω**.
5. Select the specified channels, by using the side-bezel buttons, and then click the **EXIT** lower-bezel button.
6. If the amplitude field is not selected, use the front panel scroll buttons. Type the specified voltage, and then push the appropriate unit in the right-bezel menu.
 - **For 0 V:** ground the signal by pushing the grounding  lower-bezel button. When this is active, you will not be able to make a channel selection, so in some cases you might need to temporarily deselect the grounding option while you make a channel selection. If the prompt

requires all channels and the signal is grounded, The calibrator screen will default to Channel 1.

- **For any nonzero voltage:** Before you select the voltage, you must first ensure that the calibrator is in direct mode. Push the  lower-bezel button until 1.0 is selected.
- **For 6 V or -6 V:**
 - a. Push the AUX front panel button.
 - b. Push the  side-bezel button for a 6 V signal or push the  side-bezel button for a -6 V signal. The polarity will be indicated only by the icon that appears in the upper-left corner of the calibrator screen.
 - c. Set the amplitude to either 6 V or -6 V.
 - d. Set the Pulse/Energy setting to 7.2 Joules (the time should show 10s).
 - e. When all of the parameters are set and you ensure that the output is ON, push the **Trig Pulse** side-bezel and IMMEDIATELY push the **OK Do Next Step** side-bezel button on the oscilloscope.



CAUTION. Once you push the **Trig Pulse** button on the calibrator, you have only 9 seconds to push the **OK Do Next Step** button on the oscilloscope. If the instrument fails one of these tests, go all the way back to the first 6 V test (6 V on channel 1) and start that sequence over again.

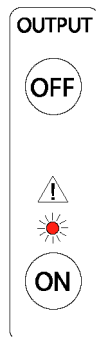

7. Ensure that the red light is illuminated to indicate that the output is on. If not, push the **ON** button, as shown below:



8. On the oscilloscope, push the **OK Do Next Step** side-bezel button.

Time Mark

The Time Mark test is often the second test type to appear in the prompts. When you receive a time mark prompt, complete the following steps:

1. Push the **Markers**  front-panel button.
2. Push the **WAVEFORM** lower-bezel button, and then push the  side-bezel button.

NOTE. If a 625 Hz signal is required, set the time marker to 1.6 ms.

3. Select the **Amplitude** field using the front panel scroll buttons, and then change the voltage by using the large front panel knob on the calibrator.
4. Ensure that the red light is illuminated to indicate that the output is on. If not, push the **ON** button.
5. On the oscilloscope, push the **OK Do Next Step** right-bezel button.

Deskew (MSO Only)

If you are using the MSO3000 Series oscilloscope, and you receive a prompt for a deskew test, complete the following steps:

1. Plug the probe, notch down, into the digital channel input, as shown in the following figure. Ensure that it snaps into place. Keep the probe plugged in for the remainder of the calibration procedure.





Figure 6: Digital channel input (MSO only)

2. Push the **Aux** front-panel button, and then push the **Zero skew**  side-bezel button.
3. Set the specified voltage, frequency, and termination.
4. Push the **CHANNEL SELECT** button and ensure that all channels are selected, including Channel 5.
5. Ensure that the red light is illuminated to indicate that the output is on. If not, push the **ON** button.
6. On the oscilloscope, push the **OK Do Next Step** right-bezel button. In some cases, this can take several minutes.



CAUTION. *Keep the digital probe plugged in to the oscilloscope. Unplugging the probe may result in aborting the test.*

Sine Signal When a Sine Signal prompt appears, complete the following steps:

1. Push the **Sine**  front panel button.
2. To ensure that the voltage is in direct mode, push the  lower-bezel button and select **1.0**.
3. Push the **CHANNEL SELECT** lower-bezel button, and then ensure that Channel 5 is selected.
4. Ensure that the red light is illuminated to indicate that the output is on. If not, push the **ON** button.
5. On the oscilloscope, push the **OK Do Next Step** right-bezel button.

Troubleshooting

Refer to the following table for common issues encountered during the calibration procedure.

Problem	Things to try
The instrument fails a test	Are the channels hooked up properly, routed to the right channels, and turned on Is the signal set to the correct waveform, frequency, and termination (if applicable to the test) Is the output set to ON (the red light will be illuminated) If you make a correction or find that everything appears to be correct, click the Go back a step button to try the test again.
I can't set the amplitude to 0 V, as specified in the prompt	Ground the signal by pushing the  lower-bezel button.
I can't find the parameters that I need to set	Is the waveform set correctly Is the grounding button on? When this is active, you will not be able to make a channel selection, so in some cases you might need to temporarily deselect the grounding option while you make a channel selection. If you can find the termination settings, click the CHANNEL SELECT lower-bezel button.
I can't set the voltage to 625 Hz	Set the time marker to 1.6 Ms. This will automatically set the voltage to 625 Hz.
I can't set the signal to all channels	If you are unable to set the signal to all channels, try setting the signal to Channel 1.
I'm having trouble with tests that require 6 V or -6 V	Follow the steps for 6 V and -6 V that appear in Step 6 of the DC Voltage test. (See page 12, <i>DC Voltage</i> .) Ensure that the polarity is correct, by referring to the icon that appears in the upper-left corner of the calibrator screen. If the instrument fails a test, go all the way back to the first 6 V test (6 V on Channel 1) and start the sequence over again.
The Sine Signal test failed	If the prompt specified Channel 4, try setting the signal to Channel 5, instead.

Maintenance

This section contains the information needed to do periodic and corrective maintenance on the oscilloscope, as well as repackaging instructions if you need to return the oscilloscope to Tektronix for service.

Preventing ESD

Before servicing this product, read the Safety Summary and Introduction at the front of the manual and the electrostatic discharge (ESD) information below.



CAUTION. *Static discharge can damage any semiconductor component in this oscilloscope*

When performing any service that requires internal access to the oscilloscope, adhere to the following precautions to avoid damaging internal modules and their components due to electrostatic discharge.

1. Minimize handling of static-sensitive circuit boards and components.
2. Transport and store static-sensitive modules in their static protected containers or on a metal rail. Label any package that contains static-sensitive boards.
3. Discharge the static voltage from your body by wearing a grounded antistatic wrist strap while handling these modules. Service static-sensitive modules only at a static-free work station.
4. Do not place anything capable of generating or holding a static charge on the work station surface.
5. Handle circuit boards by the edges when possible.
6. Do not slide the circuit boards over any surface.
7. Avoid handling circuit boards in areas that have a floor or work-surface covering capable of generating a static charge.

Inspection and Cleaning

Inspection and cleaning are done as preventive maintenance. Preventive maintenance, when done regularly, may prevent oscilloscope malfunction and enhance its reliability.

Preventive maintenance consists of visually inspecting and cleaning the oscilloscope and using general care when operating it.

How often you do maintenance depends on the severity of the environment in which the oscilloscope is used. A proper time to perform preventive maintenance is just before oscilloscope adjustment.

General Care The cabinet helps keep dust out of the oscilloscope and should normally be in place when operating the oscilloscope.

Flat Panel Display Cleaning The display is a soft plastic display and must be treated with care during cleaning.



CAUTION. *Improper cleaning agents or methods can damage the flat panel display.*

Avoid using abrasive cleaners or commercial glass cleaners to clean the display surface.

Avoid spraying liquids directly on the display surface.

Avoid scrubbing the display with excessive force.

Clean the flat panel display surface by gently rubbing the display with a clean-room wipe (such as Wypall Medium Duty Wipes, #05701, available from Kimberly-Clark Corporation).

Interior Cleaning Use a dry, low-velocity stream of air to clean the interior of the chassis. Use a soft-bristle, non-static-producing brush for cleaning around components. If you must use a liquid for minor interior cleaning, use a 75% isopropyl alcohol solution and rinse with deionized water.



WARNING. *To avoid injury, power down the instrument and disconnect it from line voltage before performing any procedure that follows.*

Exterior Cleaning Clean the exterior surfaces and knobs of the instrument with a dry lint-free cloth or a soft-bristle brush. If any dirt remains, use a cloth or swab dipped in a 75% isopropyl alcohol solution. Use a swab to clean narrow spaces around controls and connectors. Do not use abrasive compounds on any part of the instrument case that may damage the case.

Clean the On/Standby switch using a dampened cleaning towel. Do not spray or wet the switch directly.



CAUTION. Avoid the use of chemical cleaning agents, which might damage the plastics used in this oscilloscope. Use only deionized water when cleaning the menu buttons or front-panel buttons. Use a 75% isopropyl alcohol solution as a cleaner and rinse with deionized water. Before using any other type of cleaner, consult your Tektronix Service Center or representative.

Lubrication. There is no periodic lubrication required for this oscilloscope.

Exterior Inspection

Inspect the outside of the oscilloscope for damage, wear, and missing parts, using the following table as a guide. Immediately repair defects that could cause personal injury or lead to further damage to the oscilloscope.

Table 1: External inspection check list

Item	Inspect for	Repair action
Cabinet, front panel, and cover	Cracks, scratches, deformations, damaged hardware.	Repair or replace defective module.
Front-panel knobs	Missing, damaged, or loose knobs.	Repair or replace missing or defective knobs.
Connectors	Broken shells, cracked insulation, and deformed contacts. Dirt in connectors.	Repair or replace defective modules. Clear or wash out dirt.
Carrying handle, and cabinet feet	Correct operation.	Repair or replace defective module.
Accessories	Missing items or parts of items, bent pins, broken or frayed cables, and damaged connectors.	Repair or replace damaged or missing items, frayed cables, and defective modules.

If the display is very dirty, moisten the wipe with distilled water or a 75% isopropyl alcohol solution and gently rub the display surface. Avoid using excess force or you may damage the plastic display surface.



CAUTION. To prevent getting moisture inside the oscilloscope during external cleaning, use only enough liquid to dampen the cloth or applicator.

Interior Inspection

To access the inside of the oscilloscope for inspection and cleaning, refer to the Removal Procedures in this section.

Inspect the internal portions of the oscilloscope for damage and wear, using the following table as a guide. Repair any defects immediately.

If any circuit board is repaired or replaced, check the table to see if it is necessary to adjust the oscilloscope.



CAUTION. *To prevent damage from electrical arcing, ensure that circuit boards and components are dry before applying power to the oscilloscope.*

Table 2: Internal inspection check list

Item	Inspect for	Repair action
Circuit boards	Loose, broken, or corroded solder connections. Burned circuit boards. Burned, broken, or cracked circuit-run plating.	Remove and replace damaged circuit board.
Resistors	Burned, cracked, broken, blistered condition.	Remove and replace damaged circuit board.
Solder connections	Cold solder or rosin joints.	Resolder joint and clean with isopropyl alcohol.
Capacitors	Damaged or leaking cases. Corroded solder on leads or terminals.	Remove and replace damaged circuit board.
Wiring and cables	Loose plugs or connectors. Burned, broken, or frayed wiring.	Firmly seat connectors. Repair or replace modules with defective wires or cables.
Chassis	Dents, deformations, and damaged hardware.	Straighten, repair, or replace defective hardware.

Cleaning Procedure — Interior. To clean the oscilloscope interior, do the following steps:

1. Blow off dust with dry, low-pressure, deionized air (approximately 9 psi).
2. 2. Remove any remaining dust with a lint-free cloth dampened in isopropyl alcohol (75% solution) and rinsed with warm deionized water. (A cotton-tipped applicator is useful for cleaning in narrow spaces and on circuit boards.)

NOTE. *If, after doing steps 1 and 2, a module is clean upon inspection, skip the following steps.*

If there is still dust or dirt on the module, the oscilloscope may be spray washed using a solution of 75% isopropyl alcohol by doing the following steps:

1. Gain access to the parts to be cleaned by removing easily accessible shields and panels (see Removal Procedures).
2. Spray wash dirty parts with the isopropyl alcohol and wait 60 seconds for the majority of the alcohol to evaporate.
3. Use hot (120 °F to 140 °F) deionized water to thoroughly rinse them.
4. Dry all parts with low-pressure, deionized air.
5. Dry all components and assemblies in an oven or drying compartment using low-temperature (125 °F to 150 °F) circulating air.

Overview of Removal Procedures

The following figure shows the location of modules that you are removing or installing.

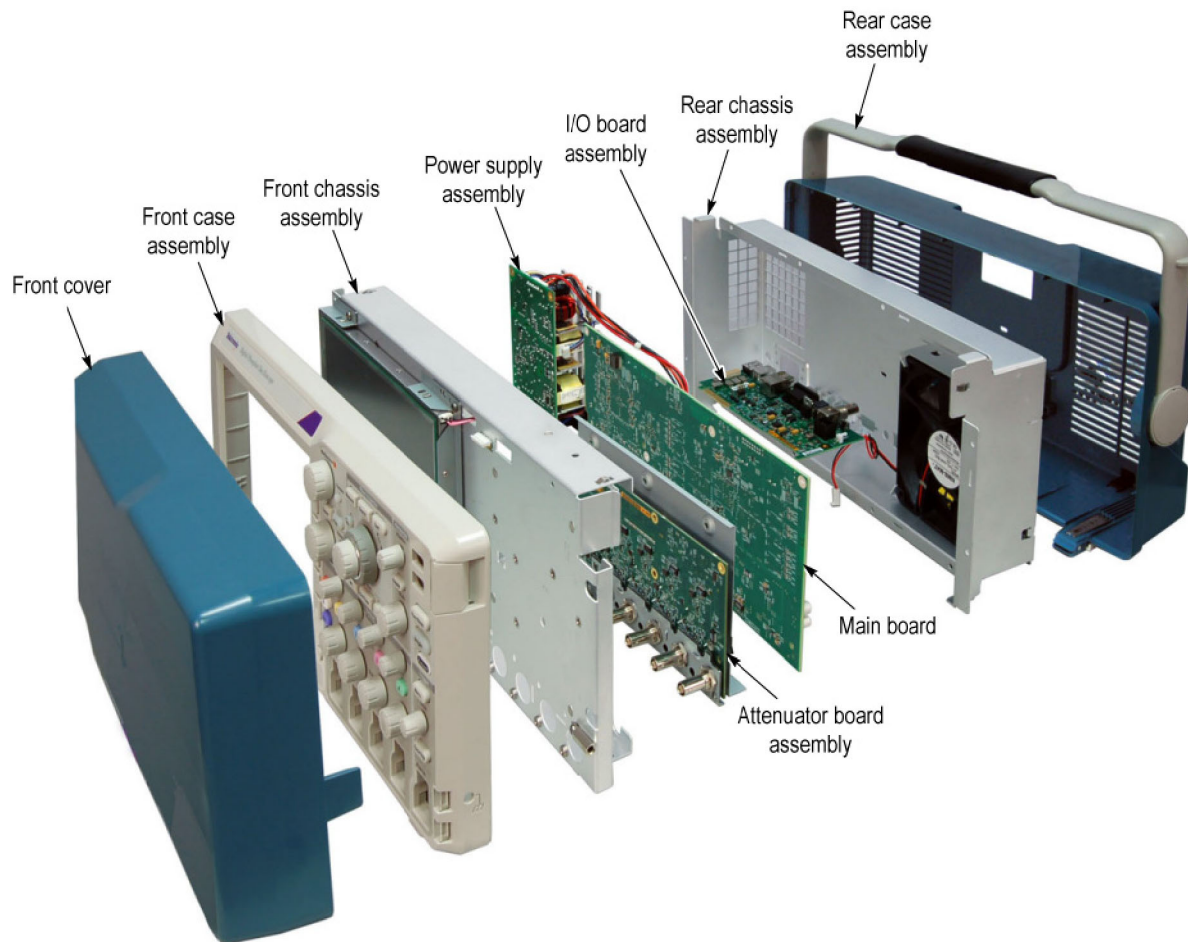

Figure 7: Locator for internal modules

List of Modules The *Replaceable Parts List* chapter provides a list of all replaceable modules. Any replaceable component, assembly, or part is referred to as a module.



WARNING. Only qualified personnel should perform service procedures. Before doing this or any other procedure in this manual, read the *General Safety Summary and Service Safety Summary* located at the beginning of this manual. Also, take precautions to prevent ESD damage to electrical components. (See page 17, *Preventing ESD.*)

Tools Required You will need the following tools to remove and replace all the modules in the instrument.

- Torque-limiting screwdriver, 12 in-lb (1.3 N-m) range with TORX T15 tips. If you are using a magnetic screwdriver with interchangeable bits, the T15 bit must be a long bit, at least 5 cm. (2 in) overall length.
- Screwdriver with 1/8 inch flat blade
- 3/16 inch nut driver
- 5/16 in. wrench
- 5/8 in. wrench
- Needle-nose pliers
- X-ACTO knife or other razor knife

Removal Procedures

Beginning with the rear case, remove modules as necessary to gain access to the module you need to remove.



WARNING. Before doing any procedure in this subsection, disconnect the power cord from the line voltage source. Failure to do so could cause serious injury or death.



CAUTION. When removing or installing the keypad, do not touch the switch contacts with your fingers. The oils on your fingers will degrade or damage the switch contacts. To help prevent damage to the keypad, use cotton gloves when removing or installing the keyboard pad.



CAUTION. To avoid damage to the front panel standby/on switch assembly, do not set the display module assembly on a work surface. Sliding the oscilloscope over the edge of the work surface could break off the on/standby switch assembly.

Rear Case Follow these steps to remove the rear case assembly. Use a TORX T15 screwdriver tip. (See Figure 12 on page 37.)

1. Place the oscilloscope face down on the work surface.
2. Remove the four T15 screws from the back of the rear case assembly. When reinstalling the rear case torque these screws to 8.0 in/lb.
3. Grasp the case and pull outwards to remove it.

Rear Chassis Follow these steps to remove the rear chassis assembly. You will need a $\frac{5}{8}$ in. wrench, a $\frac{3}{16}$ in. nutdriver, a $\frac{5}{16}$ in. wrench, and a TORX T15 screwdriver tip. (See Figure 12 on page 37.)

1. Remove the $\frac{5}{8}$ in. nut from the Aux Out BNC. When reinstalling torque this nut to 25 in/lb.
2. Remove the two $\frac{3}{8}$ in. jackscrews from the WVGA Video connector. When reinstalling torque these to 4.0 in/lb.
3. Remove the two T15 screws attaching the power connector. When reinstalling torque these screws to 8.0 in/lb.
4. Remove the 12 T15 screws attaching the rear chassis to the front chassis. When reinstalling torque these screws to 8.0 in/lb.
5. Lift the rear chassis from the oscilloscope, and unplug the fan power cable from the I/O board. When reinstalling the rear chassis there are several steps to follow:
 - a. Make sure the captured nuts are still in place, in the black plastic bracket that holds the IEC power connector.
 - b. Make sure the connectors from the I/O board line up with their respective holes in the rear chassis.
 - c. Make sure the two guide pins on the power connector line up with their positioning holes.
 - d. Thread the fan power cable through the hole in the rear chassis closest to the fan, so that it goes to the outside of the rear chassis.
 - e. After the rear chassis is reattached to the front chassis, use a spudger or a pair of needle-nose pliers to insert the fan power connector back through the hole and onto J200 on the I/O board. (See Figure 8.)
 - f. Push the rest of the fan power cable into the hole, so that the entire cable is inside the Rear Chassis. (See Figure 8.)

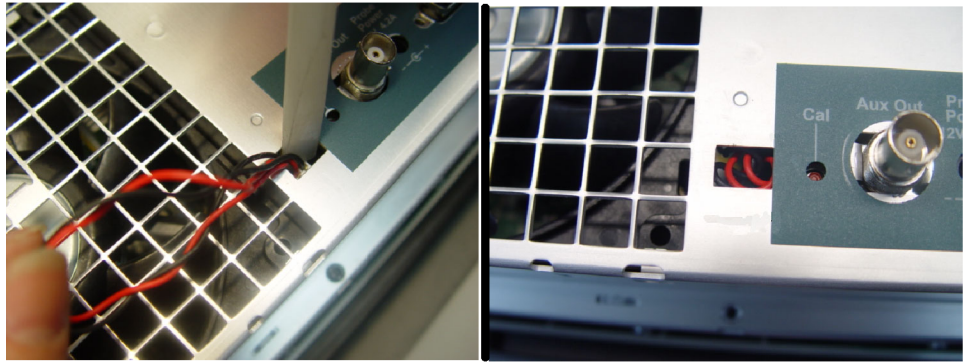

Figure 8: Reconnecting the fan cable

Fan Follow these steps to remove the fan assembly. You need to have previously removed the rear case assembly and rear chassis. Use a pair of pliers. (See Figure 13 on page 39.)

1. Use a pair of pliers to bend the tabs that hold the fan in the chassis.
2. Slide the fan assembly out and away from the chassis.
3. When reinstalling, dress the fan power cable carefully. (See Figure 9.)

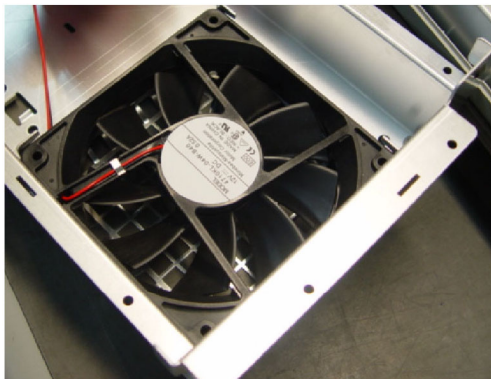

Figure 9: Fan cable dress

I/O Board Follow these steps to remove the I/O board. You need to have previously removed the rear case assembly and rear chassis. (See Figure 13 on page 39.)

1. Disconnect the power cable from J104 on the I/O board.
2. Rock the board slightly while pulling straight up to disconnect the board from the edge connector.
3. Disconnect the cable from J103 on the I/O board and lift the board away.
4. Place the board on a static-free surface.

Power Supply Module

Follow these steps to remove the power supply module. You need to have previously removed the rear case assembly rear chassis, and I/O board. Use a TORX T15 screwdriver tip. (See Figure 14 on page 41.)

1. Disconnect the power cable from J104 on the I/O board (if still attached) and from J0403 on the Main board.
2. Disconnect the cable from the Power Supply module to J0401 on the Main board.
3. Disconnect the power connector ground lead from the chassis.
4. Remove the five T15 screws that attach the Power Supply module to the chassis. When reinstalling torque these screws to 8.0 in/lb.
5. Lift the Power Supply module, including the power connector, off of the chassis and place it on a static-free surface.

Main Board

Follow these steps to remove the main board. You need to have previously removed the rear case assembly, rear chassis, power supply, and I/O board. Use a TORX T15 screwdriver tip. (See Figure 13 on page 39.)

1. Disconnect the Front Panel cable from J6000 on the main board.
2. Disconnect the display backlight cable from the J6500 on the main board.
3. Disconnect the front panel cable from J0400 on the main board.
4. Disconnect the power supply control cable from J0401 on the main board.
5. Disconnect the LCD display cable from the J6600 on the main board.
6. Disconnect the front panel USB cable from J0501 on the main board.
7. Disconnect the power supply cable from J0403 on the main board.
8. Remove the seven T15 screws that connect the main board to the chassis. When reinstalling torque these screws to 8.0 in/lb.
9. Use a screwdriver or other bar to pry the main board up, to disconnect the connection to the Attenuator board. Place the point of the screwdriver under the middle heat sink spring and use the chassis edge as the fulcrum. (See Figure 10.)

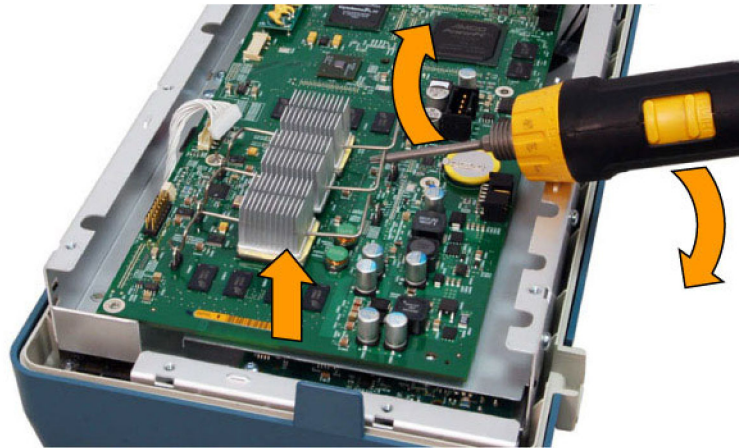

Figure 10: Disconnecting the main board

10. Lift the main board out of the chassis and place it on a static-free surface.
11. When reinstalling make sure to align the main board and attenuator board connectors and press down until the connector snaps together. (See Figure 13 on page 39.) Then use a spudger or small screwdriver to make sure that J101 is firmly seated on the front panel board. (See Figure 17 on page 47.)

For MSO3000 Series oscilloscopes, make sure that the Digital Probe Guide is in place before reinstalling the main board.

Attenuator Board

Follow these steps to remove the attenuator board. You need to have previously removed the rear case assembly, rear chassis, power supply, I/O board, and main board. Use a TORX T15 screwdriver tip. (See Figure 16 on page 45.)

1. Remove the six T15 screws that connect the main board shield to the chassis. Note that there are two lengths; the shorter ones go through the side rail. When reinstalling torque these screws to 8.0 in/lb.
2. Remove the main board shield and set it aside.
3. Remove the nine T15 screws that connect the attenuator board to the chassis. Note that there are two lengths; the shorter ones go through the side rail. When reinstalling torque these screws to 8.0 in/lb.
4. Remove the attenuator board and place it on a static-free surface.

Front Chassis Follow these steps to remove the front chassis. You need to have previously removed the rear case assembly, rear chassis, power supply, I/O board, main board, and attenuator board. Use a TORX T15 screwdriver tip. (See Figure 17 on page 47.)

1. Disconnect the cables connected to J101 and J103 on the front panel board.
2. Remove the eight T15 screws that connect the front chassis to the front case. When reinstalling torque these screws to 8.0 in/lb.
3. Lift the front chassis from the front case and place it on a static-free surface with the LCD assembly facing up.

Display Module Follow these steps to remove the display module. You need to have previously removed the rear case assembly, rear chassis, power supply, I/O board, main board, attenuator board, and front chassis. Use a TORX T15 screwdriver tip. (See Figure 17 on page 47.)

1. Place the front chassis on a soft, static-free surface with the LCD assembly down.
2. Remove the four $\frac{5}{16}$ in nuts that connect the display cable shield to the front chassis, and remove the display cable shield. When reinstalling torque these nuts to 8.0 in/lb. (See Figure 11.)

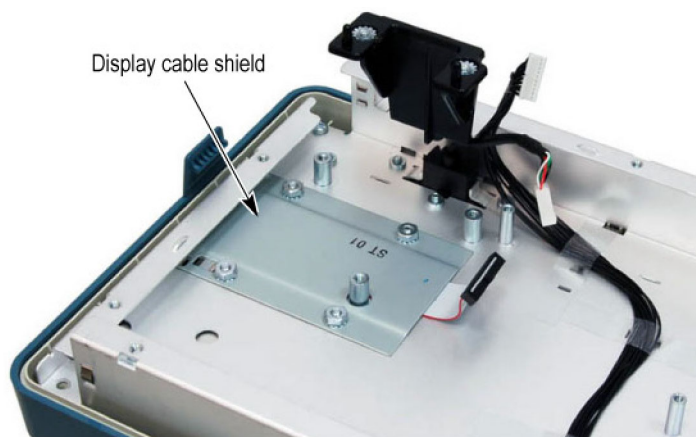

Figure 11: Display cable shield in place

3. Turn the front chassis over and remove the eight T15 screws that connect the display to the front chassis. (See Figure 17 on page 47.) When reinstalling torque these screws to 8.0 in/lb.
4. Gently lift the display up and off of the chassis.



CAUTION. Be careful when removing and reinstalling the Display module cables. If the connectors have bent pins or are installed incorrectly, the Display may be destroyed.

Front-panel USB Connector

Use this procedure to remove the front-panel USB connector. You must have previously removed the rear case assembly, rear chassis, power supply, I/O board, main board, attenuator board, and front chassis. Use a TORX T15 screwdriver tip, needle-nose pliers, and a razor knife. (See Figure 17 on page 47.)

1. Place the front chassis on the work surface with the LCD facing up.
2. Remove the two T15 screws that connect the USB lower bracket to the chassis, and remove the bracket and its attached EMI clip.
3. Use a pair of needle nose pliers to remove the upper EMI clip from the front chassis.
4. Turn the front chassis over and use the razor knife to trim off the plastic ears on both sides of the USB connector. (See Figure 17.)
5. Slide the USB connector and cable out toward the front of the chassis. When reinstalling slide the new USB cable and housing in from the front of the chassis and push the connector in until it snaps into place.

Front Panel Module

Follow these steps to remove the Front Panel module. You need to have previously removed the rear case assembly, rear chassis, power supply, I/O board, main board, attenuator board, and front chassis. Use a TORX T15 screwdriver tip. (See Figure 14 on page 41.) (See Figure 18 on page 49.)

1. Remove all the front panel knobs.
2. Remove the 14 T15 screws (10 with ground spring contacts) holding the Front Panel board to the chassis. When reinstalling torque these screws to 8.0 in/lb.
3. Lift the Front Panel board off of the chassis.



CAUTION. *Do not touch the keypad switch contacts with your fingers. The oils on your fingers will degrade or damage the switch contacts. To help prevent damage to the keypad, use cotton gloves.*

Troubleshooting

This section contains information and procedures to help you isolate a defective module in the oscilloscopes.



WARNING. *Before doing this or any other procedure in this manual, read the General Safety Summary and Service Safety Summary found at the beginning of this manual. Also, take precautions to prevent ESD damage to electrical components. (See page 17, Preventing ESD.)*

Adjustment After Repair If you replace the Main board, you must adjust the instrument after repair. (See page 7, *Adjustment Procedures*.)

Required Tools and Equipment You need the following equipment to troubleshoot the instrument.

Tools and Equipment	Example
DMM	3.5 digits or greater

Troubleshooting Procedure

The following diagrams are troubleshooting procedure flowcharts. Beginning with Flowchart 1, use them to troubleshoot an instrument failure.

WARNING. Before removing the cabinet, disconnect the power cord from the line voltage source. Failure to do so could cause serious injury or death.

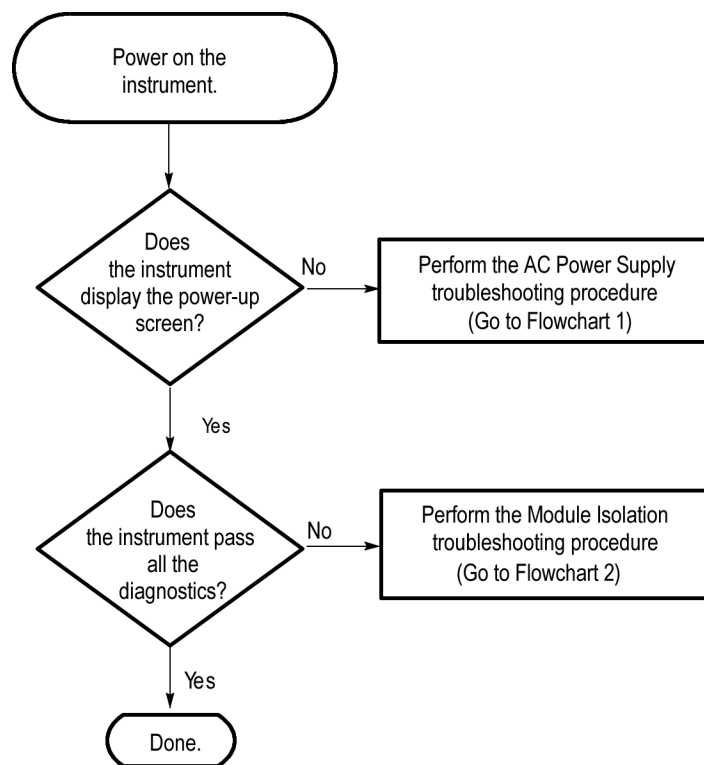

Flowchart 1 — Primary troubleshooting procedure

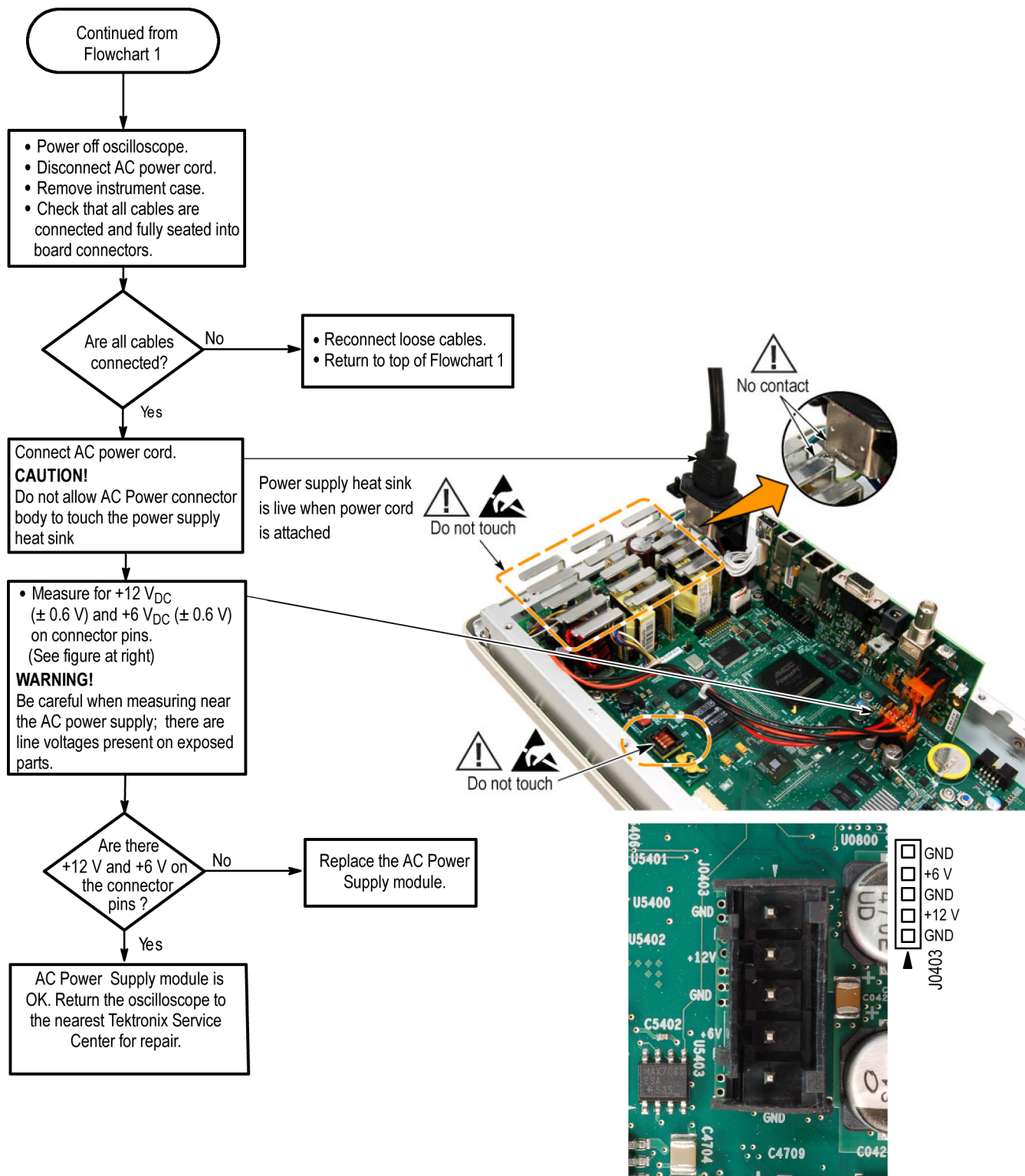

Flowchart 2 — AC power supply troubleshooting procedure

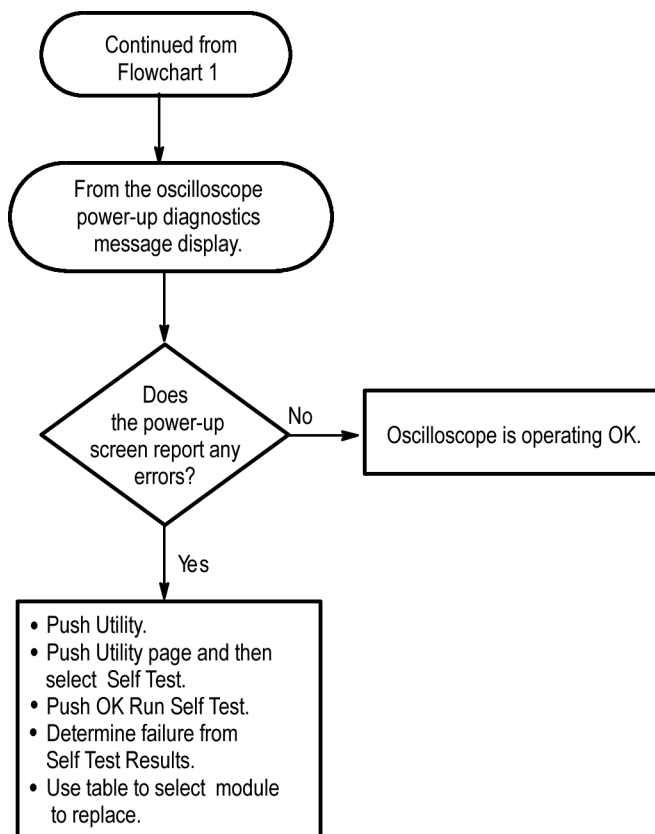

Failed Test	Most Likely Cause
Acquisition	Main board
CPU	Main board
Display	Main board
Front Panel	Front Panel (or Main board)
I/O	Comm module (or Main board)
ROM	Main board
App Modules	Front Panel (or App Keys)

Flowchart 3 — Module isolation troubleshooting procedure

Unpacking and Repacking Instructions

This section contains the information needed to unpack the oscilloscope and repack it for shipment or storage.

Unpacking

The oscilloscope and its standard accessories are carefully packed at the factory in a shipping carton. If, upon receipt, damage to the shipping carton is evident, notify the shipper. Tektronix, Inc. is not responsible for damage caused during shipping.

If you have not already done so, carefully remove the oscilloscope and its accessories from the shipping carton and inspect them for damage. Save the shipping carton for repacking or storage.

Repacking

Use a corrugated cardboard shipping carton having a test strength of at least 275 pounds (125 kg) and with an inside dimension at least six inches (15.25 cm) greater than the instrument dimensions.

If the instrument is being shipped to a Tektronix Service Center, enclose the following information:

- The owner's address
- Name and phone number of a contact person
- Type and serial number of the instrument
- Reason for returning
- A complete description of the service required

Seal the shipping carton with an industrial stapler or strapping tape.

Mark the address of the Tektronix Service Center and also your own return address on the shipping carton in two prominent locations. See www.tektronix.com/service to find a service center near you.

Storage

The oscilloscope should be stored in a clean, dry environment. The following environmental characteristics apply for both shipping and storage:

- Temperature range: -20 °C to +60 °C
- Altitude: To 15,000 m

See the *MSO3000 and DPO3000 Series Specifications and Performance Verification Technical Reference* for a complete listing of the environmental characteristics.

Replaceable Parts List

This chapter contains a list of the replaceable modules for the MSO3000 and DPO3000 Series Oscilloscopes. Use this list to identify and order replacement parts.

Parts Ordering Information

Replacement parts are available through your local Tektronix field office or representative.

Changes to Tektronix products are sometimes made to accommodate improved components as they become available and to give you the benefit of the latest improvements. Therefore, when ordering parts, it is important to include the following information in your order.

- Part number (see *Part Number Revision Level* below)
- Instrument type or model number
- Instrument serial number
- Instrument modification number, if applicable

If you order a part that has been replaced with a different or improved part, your local Tektronix field office or representative will contact you concerning any change in part number.

Change information, if any, is located at the rear of this manual.

Part Number Revision Level

Tektronix part numbers contain two digits that show the revision level of the part. For some parts in this manual, you will find the letters XX in place of the revision level number.



When you order parts, Tektronix will provide you with the most current part for your product type, serial number, and modification (if applicable). At the time of your order, Tektronix will determine the part number revision level needed for your product, based on the information you provide.

Module Servicing

Modules can be serviced by selecting one of the next three options. Contact your local Tektronix service center or representative for repair assistance.

Module Exchange. In some cases you may exchange your module for a remanufactured module. These modules cost significantly less than new modules and meet the same factory specifications. For more information about the module exchange program, call 1-800-833-9200, extension 2.

Module Repair and Return. You may ship your module to us for repair, after which we will return it to you.

New Modules. You may purchase replacement modules in the same way as other replacement parts.

Using the Replaceable Parts List

This section contains a list of the mechanical and/or electrical components that are replaceable for the instrument. Use this list to identify and order replacement parts. The following table describes each column in the parts list.

Column	Column name	Description
1	Figure & Index Number	Items in this section are referenced by figure and index numbers to the exploded view illustrations that precede the list.
2	Tektronix Part Number	Use this part number when ordering replacement parts from Tektronix.
3 and 4	Serial Number	Column three indicates the serial number at which the part was first effective. Column four indicates the serial number at which the part was discontinued. No entries indicates the part is good for all serial numbers.
5	Qty	This indicates the quantity of parts used.
6	Name & Description	An item name is separated from the description by a colon (:). Because of space limitations, an item name may sometimes appear as incomplete. Use the U.S. Federal Catalog handbook H6-1 for further item name identification.

Abbreviations Abbreviations conform to American National Standard ANSI Y1.1-1972.

Exploded Views The following figures show the module-level exploded views of the MSO3000 and DPO3000 Series oscilloscopes. Each exploded view is indexed by the numbers in the figure.

Table 3: Replaceable parts list: Rear case and rear chassis

Fig. & index number	Tektronix part number	Serial no. effective	Serial no. discount'd	Qty	Name & description
12-1	065089300				MODULE ASSY;SERVICE REPLACEMENT KIT,REAR CASE ASSEMBLY
	202-0462-00			1	CASE, REAR ASSEMBLY
	367-0548-XX			1	HANDLE; CARRYING; SAFETY CONTROLLED
	348-1909-XX			2	FOOT REAR; SAFETY CONTROLLED
-2	211-1275-00			4	SCREW,MACHINE; W/HEAVY PATCH THREADLOCKING MATERIAL; 6-32 X 0.312 L,PNH,STL CAD PLT,T15
-3	441-2509-00			1	CHASSIS, REAR
-4	211-1272-00			12	SCREW,MACHINE; 6-32 X 0.250,PNH,STL,ZNPL, T-15 TORX
-5	210-1039-00			1	WASHER,LOCK; 0.521 ID,INT,0.025 THK,410 SS, PASSIVATED
-6	220-0265-00			1	NUT,PLAIN,HEX; 0.5-28 X 0.625 HEX,BRS,NKL PL
-7	214-3903-00			2	SCREW, JACK; 4-40 X 0.312 LONG, 0.188 H HEX HEAD STAND OFF, 4-40 INT THD, X 0.312 THD EXT 4-40, STEEL, SN PLATED
-8	211-1276-00			2	SCREW, MACHINE; 6-32 X 0.375, PNH, STL,ZNPL, T-15 TORX DR
-9	348-1910-00			2	FOOT FRONT CABINET HINGED FSN.PRT
-10	335-1875-00			1	LABEL, REAR, IO; SAFETY CONTROLLED

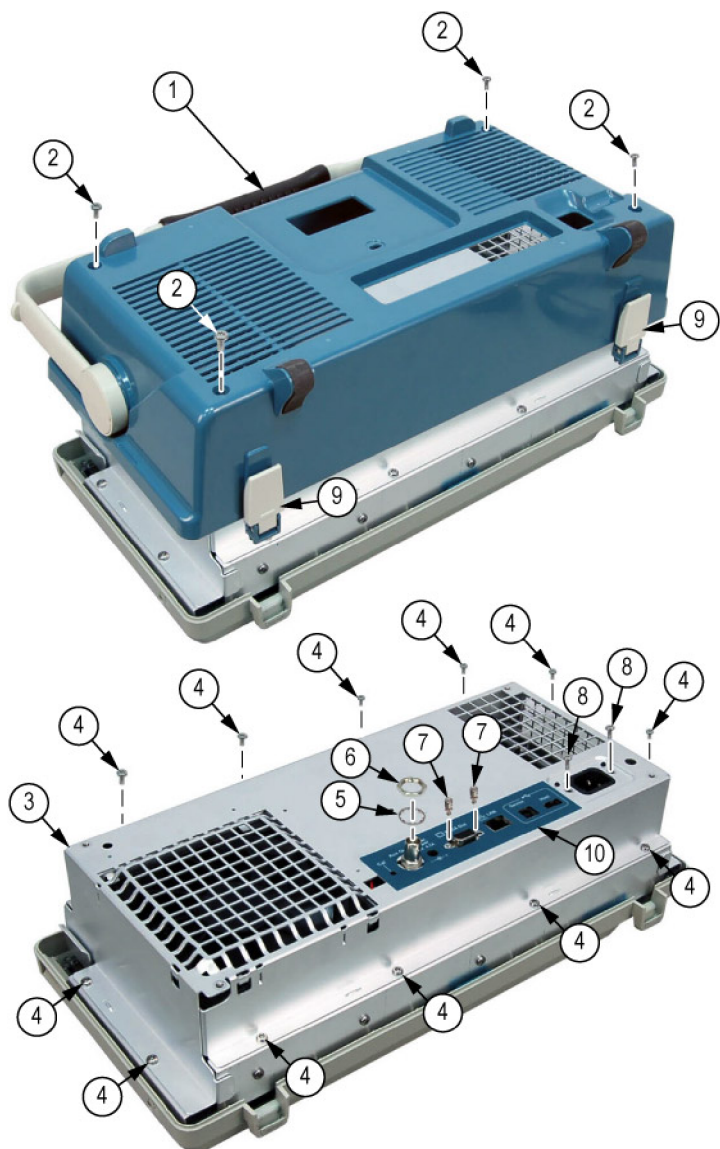

Figure 12: Exploded view: rear case and rear chassis

Table 4: Replaceable parts list: I/O and main boards

Fig. & index number	Tektronix part number	Serial no. effective	Serial no. discount'd	Qty	Name & description	
13-1	119-7365-00			1	FAN; 120MM, TUBEAXIAL, 12 VDC; SAFETY CONTROLLED	
-2	870-0015-01			1	CIRCUIT BOARD ASSY;2 & 4 CH I/O MAIN;389378600;TESTED;DPO3000	
-3	870-0407-00			1	CIRCUIT BD ASSY;4 CH ACQUISITION BD MAIN;3894164XX;TESTED MSO3054	
	870-0406-00			1	CIRCUIT BD ASSY;4 CH ACQUISITION BD MAIN;3894164XX;TESTED MSO3034	
	870-0408-00			1	CIRCUIT BD ASSY;2 CH ACQUISITION BD MAIN; 3894164XX; TESTED MSO3032	
	870-0263-00			1	CIRCUIT BD ASSY;4 CH ACQUISITION BD MAIN;3894164XX;TESTED MSO3014	
	870-0264-00			1	CIRCUIT BD ASSY;2 CH ACQUISITION BD MAIN; 3894164XX; TESTED MSO3012	
	870-0237-00			1	CIRCUIT BOARD ASSY;4 CH ACQUISITION BD;379377900;TESTED;DPO3054	
	870-0236-00			1	CIRCUIT BOARD ASSY;2 CH ACQUISITION BD;379377900;TESTED;DPO3052	
	870-0235-00			1	CIRCUIT BOARD ASSY;4 CH ACQUISITION BD;379377900;TESTED;DPO3034	
	870-0234-00			1	CIRCUIT BOARD ASSY;2 CH ACQUISITION BD;379377900;TESTED;DPO3032	
	870-0019-00			1	CIRCUIT BOARD ASSY;4 CH ACQUISITION BD;389377900;TESTED;DPO3014	
	870-0016-00			1	CIRCUIT BOARD ASSY;2 CH ACQUISITION BD;379377900;TESTED;DPO3012	
	-4	211-1275-01			8	SCREW, MACHINE; W/HEAVY PATCH THREADLOCKING MATERIAL; 6-32 X 0.312 L, PNH,STL,ZNPL, T15

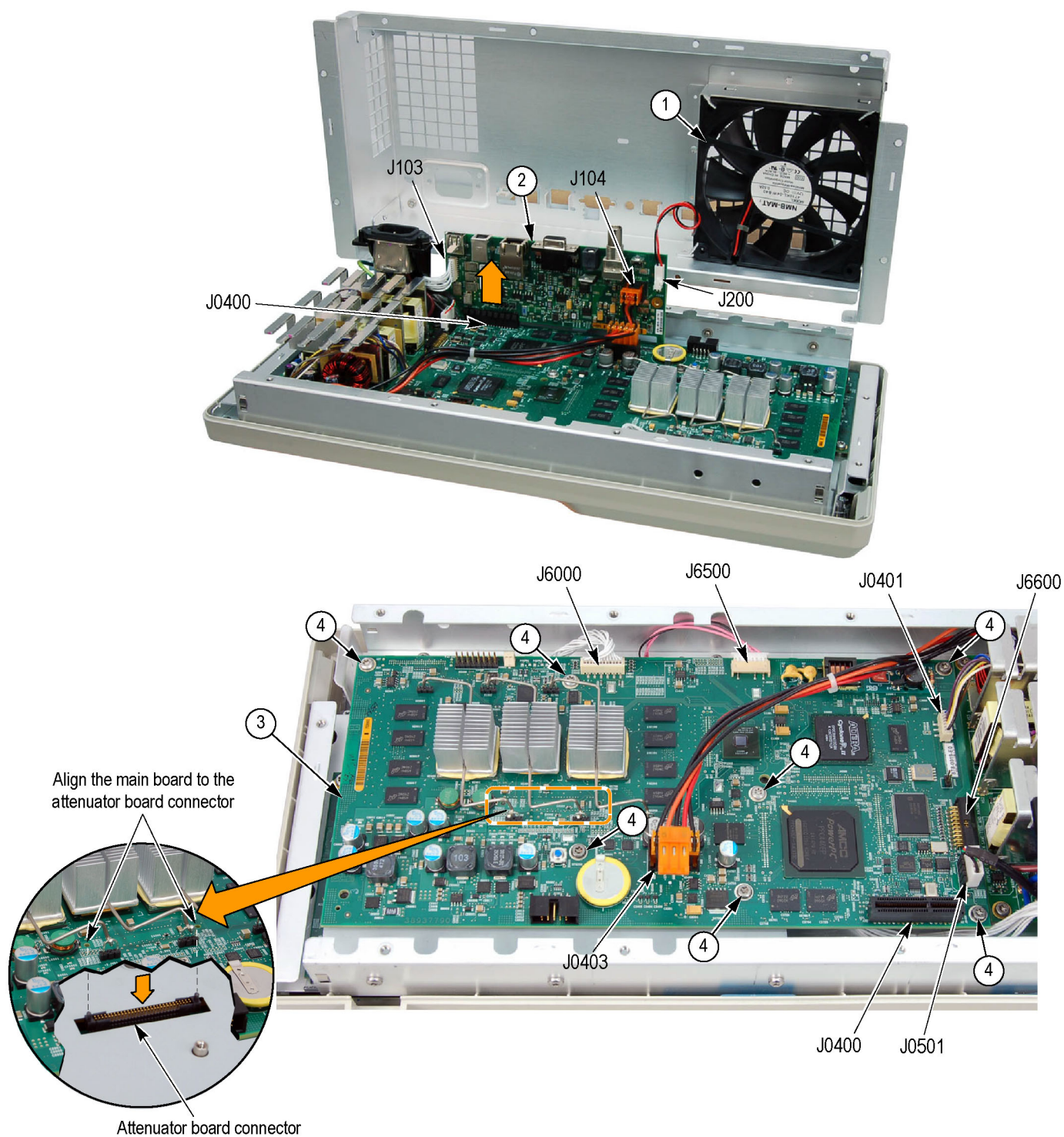

Figure 13: Exploded view: I/O and main boards

Table 5: Replaceable parts list: Front panel and power supply

Fig. & index number	Tektronix part number	Serial no. effective	Serial no. discont'd	Qty	Name & description
14-1	119-7281-00			1	POWER SUPPLY; CUSTOM,MALIBU,AC-DC;85-275 VAC 45-440HZ IN;+6VDC 6A,12V 4A OUT;PLUS SOFT SWITCH & LINE TRIGGER OUTPUT;SAFETY CONTROLLED
-2	211-1275-01			5	SCREW, MACHINE; W/HEAVY PATCH THREADLOCKING MATERIAL; 6-32 X 0.312 L, PNH,STL,ZNPL, T15
-3	211-1273-00			1	SCREW,PT; K35-1.57,PAN HEAD,STL,ZNPL,T-15
-4	366-0865-00			1	KNOB, JOG
-5	358-0883-00			1	BUSHING (JOG SHUTTLE KNOB)
-6	366-0867-01			1	KNOB, SHUTTLE
-7	366-0861-01			2	KNOB, .925 DIA, SOFT TOUCH
-8	366-0859-01			6	KNOB, .470 DIA, SOFT TOUCH (4-CHANNEL MODELS)
	366-0859-01			4	KNOB, .470 DIA, SOFT TOUCH (2-CHANNEL MODELS)
-9	366-0860-01			5	KNOB, .685 DIA, SOFT TOUCH (4-CHANNEL MODELS)
	366-0860-01			3	KNOB, .685 DIA, SOFT TOUCH (2-CHANNEL MODELS)

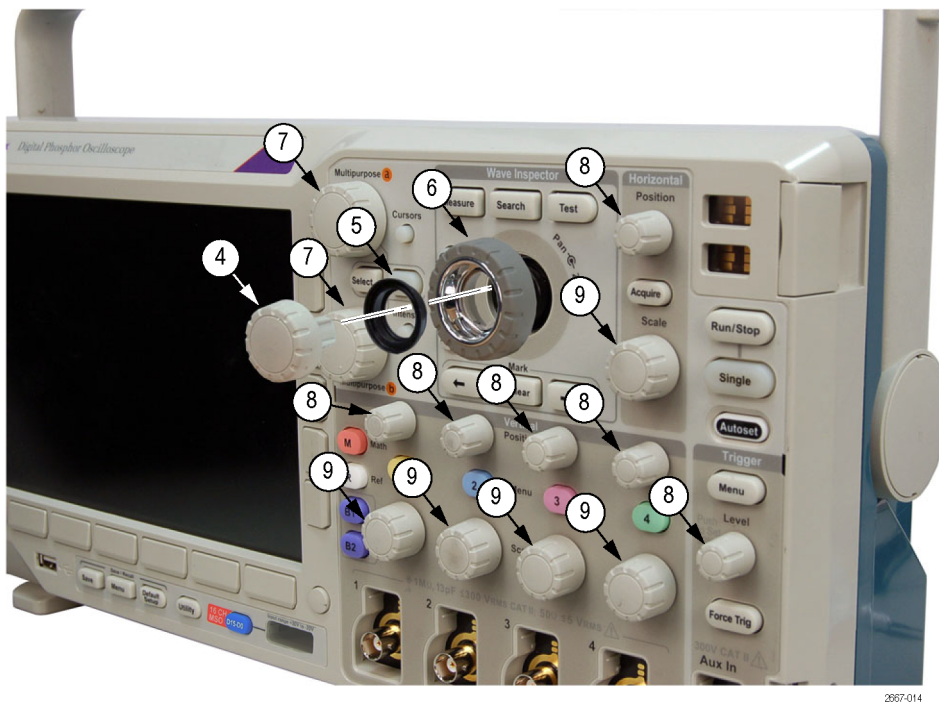
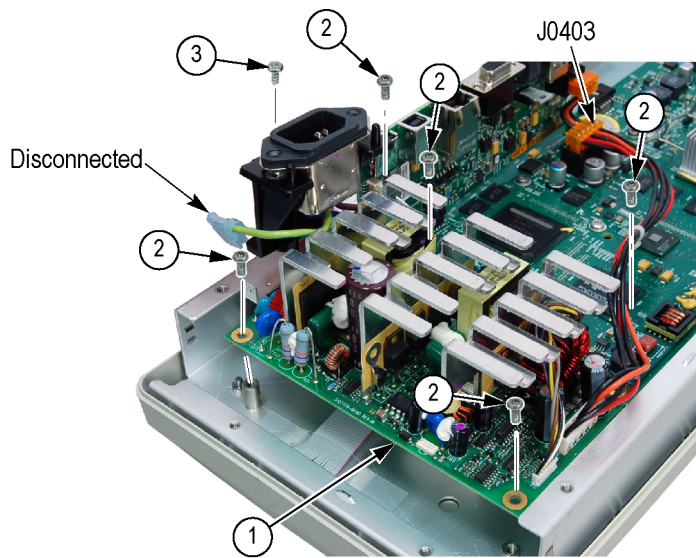

Figure 14: Exploded view: Front panel and power supply

Table 6: Replaceable parts list: Front panel labels

Fig. & index number	Tektronix part number	Serial no. effective	Serial no. discount'd	Qty	Name & description
15-1	335-1926-00			1	LABEL. FRONT PANEL, OVERLAY, RUSSIAN
	335-1925-00			1	LABEL. FRONT PANEL, OVERLAY, KOREAN
	335-1924-00			1	LABEL. FRONT PANEL, OVERLAY, STD CHINESE
	335-1923-00			1	LABEL. FRONT PANEL, OVERLAY, SIM CHINESE
	335-1922-00			1	LABEL. FRONT PANEL, OVERLAY, PORTUGUESE
	335-1921-00			1	LABEL. FRONT PANEL, OVERLAY, JAPANESE
	335-1920-00			1	LABEL. FRONT PANEL, OVERLAY, SPANISH
	335-1919-00			1	LABEL. FRONT PANEL, OVERLAY, GERMAN
	335-1918-00			1	LABEL. FRONT PANEL, OVERLAY, ITALIAN
	335-1917-00			1	LABEL. FRONT PANEL, OVERLAY, FRENCH
-2	200-5049-00			1	COVER; DOOR, APP KEY

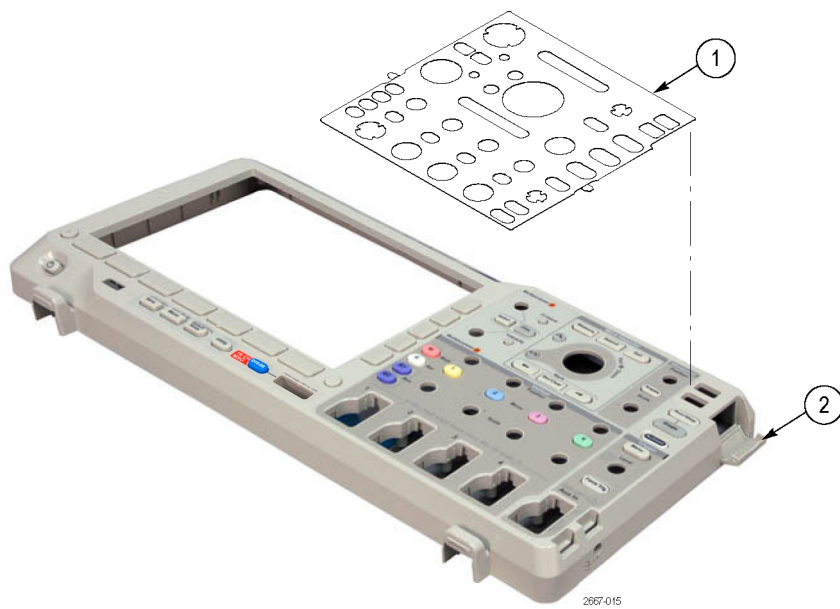

Figure 15: Exploded view: Front panel labels

Table 7: Replaceable parts list: Attenuator

Fig. & index number	Tektronix part number	Serial no. effective	Serial no. discont'd	Qty	Name & description
16-1	050-3715-xx		C011120	1	SHIELD, MAINBOARD, DPO3054 Only
			C010308	1	SHIELD, MAINBOARD, DPO3052 Only
			C011322	1	SHIELD, MAINBOARD, DPO3034 Only
			C010537	1	SHIELD, MAINBOARD, DPO3032 Only
			C011228	1	SHIELD, MAINBOARD, DPO3014 Only
			C010712	1	SHIELD, MAINBOARD, DPO3012 Only
337-4462-00		C011121		1	SHIELD, MAINBOARD, DPO3054 Only
		C010309		1	SHIELD, MAINBOARD, DPO3052 Only
		C011323		1	SHIELD, MAINBOARD, DPO3034 Only
		C010538		1	SHIELD, MAINBOARD, DPO3032 Only
		C011229		1	SHIELD, MAINBOARD, DPO3014 Only
		C010713		1	SHIELD, MAINBOARD, DPO3012 Only
Order by description				1	SHIELD, MAINBOARD, MSO3000 Series
					ATTACHED PART
				1	GASKET, FOAM, CONDUCTIVE, W/ADHESIVE, 5.0 INCH of 348-1863-00
					END ATTACHED PART
-2	211-1275-00			7	SCREW, MACHINE; W/HEAVY PATCH THREADLOCKING MATERIAL; 6-32 X 0.312 L, PNH,STL,ZNPL, T15
-3	211-1272-00			8	SCREW,MACHINE; 6-32 X 0.250,PNH,STL,ZNPL,T-15 TORX DR
-4	351-1130-00			1	DIGITAL PROBE GUIDE (MSO3000 SERIES ONLY)
-5	870-0030-00			1	ATTENUATOR CIRCUIT BD ASSY;TESTED;8780030XX,3893928XX WIRED (4-CHANNEL MODELS)
	870-0032-01			1	ATTENUATOR CIRCUIT BD ASSY;TESTED;8780030XX,3893928XX WIRED (2-CHANNEL MODELS)

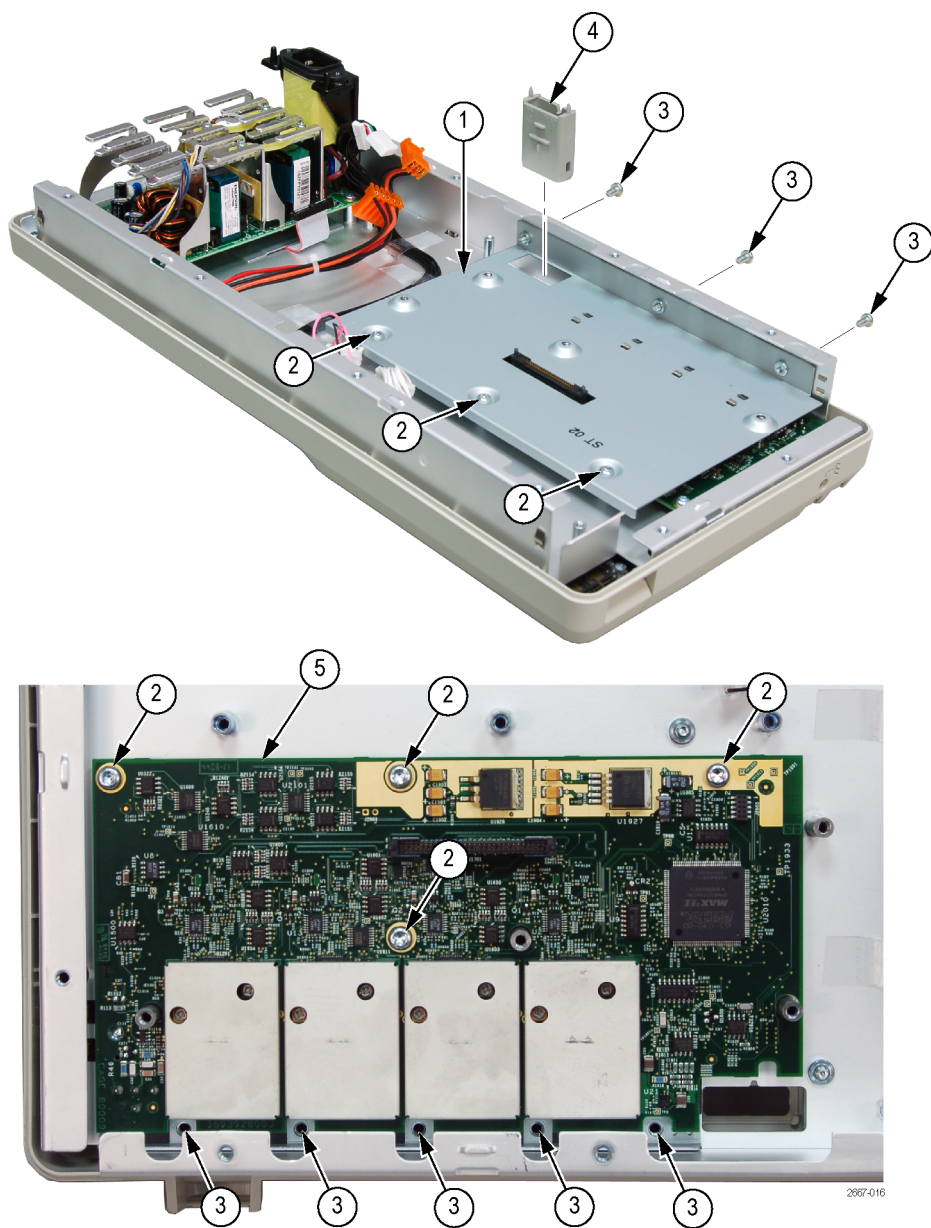

Figure 16: Exploded view: Main board shield and attenuator board

Table 8: Replaceable parts list: Front chassis and LCD

Fig. & index number	Tektronix part number	Serial no. effective	Serial no. discont'd	Qty	Name & description
17-1	050-3715-xx		C011120	1	CHASSIS, FRONT; SAFETY CONTROLLED, DPO3054 Only
			C010308		CHASSIS, FRONT; SAFETY CONTROLLED, DPO3052 Only
			C011322		CHASSIS, FRONT; SAFETY CONTROLLED, DPO3034 Only
			C010537		CHASSIS, FRONT; SAFETY CONTROLLED, DPO3032 Only
			C011228		CHASSIS, FRONT; SAFETY CONTROLLED, DPO3014 Only
			C010712		CHASSIS, FRONT; SAFETY CONTROLLED, DPO3012 Only
441-2570-00		C011121		CHASSIS, FRONT; SAFETY CONTROLLED, DPO3054 Only	
		C010309		CHASSIS, FRONT; SAFETY CONTROLLED, DPO3052 Only	
		C011323		CHASSIS, FRONT; SAFETY CONTROLLED, DPO3034 Only	
		C010538		CHASSIS, FRONT; SAFETY CONTROLLED, DPO3032 Only	
		C011229		CHASSIS, FRONT; SAFETY CONTROLLED, DPO3014 Only	
		C010713		CHASSIS, FRONT; SAFETY CONTROLLED, DPO3012 Only	
					CHASSIS, FRONT; SAFETY CONTROLLED, MSO3000 Series
-2	211-1273-00			8	SCREW, PT; K35-1.57, PAN HEAD, STL, ZNPL, T-15
-3	850-0043-00			1	LCD DISPLAY ASSEMBLY
-4	211-1272-00			8	SCREW,MACHINE; 6-32 X 0.250,PNH,STL,ZNPL,T-15 TORX DR
-5	174-5411-00			1	CABLE EXTENSION, USB-HOST; SAFETY CONTROLLED
-6	131-7622-00			1	CONN,RCPT;GROUND JACK

Table 9: Replaceable parts list: Front panel and front case

Fig. & index number	Tektronix part number	Serial no. effective	Serial no. discount'd	Qty	Name & description
18-1	878-0323-01			1	CIRCUIT BOARD SUBASSY;4 CH FRONT PANEL;UNTESTED,389423000 (MSO 4-CHANNEL MODELS)
	878-0322-01			1	CIRCUIT BOARD SUBASSY;2 CH FRONT PANEL;UNTESTED,389423000 (MSO 2-CHANNEL MODELS)
	878-0029-01			1	CIRCUIT BOARD ASSY;4 CH FRONT PANEL;TESTED,389378100 (DPO 4-CHANNEL MODELS)
	878-0028-01			1	CIRCUIT BOARD ASSY;2 CH FRONT PANEL;TESTED,389378000 (DPO 2-CHANNEL MODELS)
-2	211-1273-00			18	SCREW,PT; K35-1.57,PAN HEAD,STL,ZNPL,T-15
-3	131-8139-00			10	CONTACT, SPRING; FRONT PANEL ELEC
-4	260-2853-00			1	SWITCH, KEYPAD, ELASTOMERIC FRONT PANEL, 4 CHANNEL
-5	050-3717-00			1	PARTS REPL KIT; 4CH FRONT PANEL ASSY; MSO3014/3034/3054
	050-3716-00			1	PARTS REPL KIT; 2 CH FRONT PANEL ASSY; MSO3012/3032
	050-3700-00			1	PARTS REPL KIT; 2 CH FRONT PANEL ASSY; DPO3012/3032/3052
	050-3701-00			1	PARTS REPL KIT; 4CH FRONT PANEL ASSY; DPO3014/3034/3054

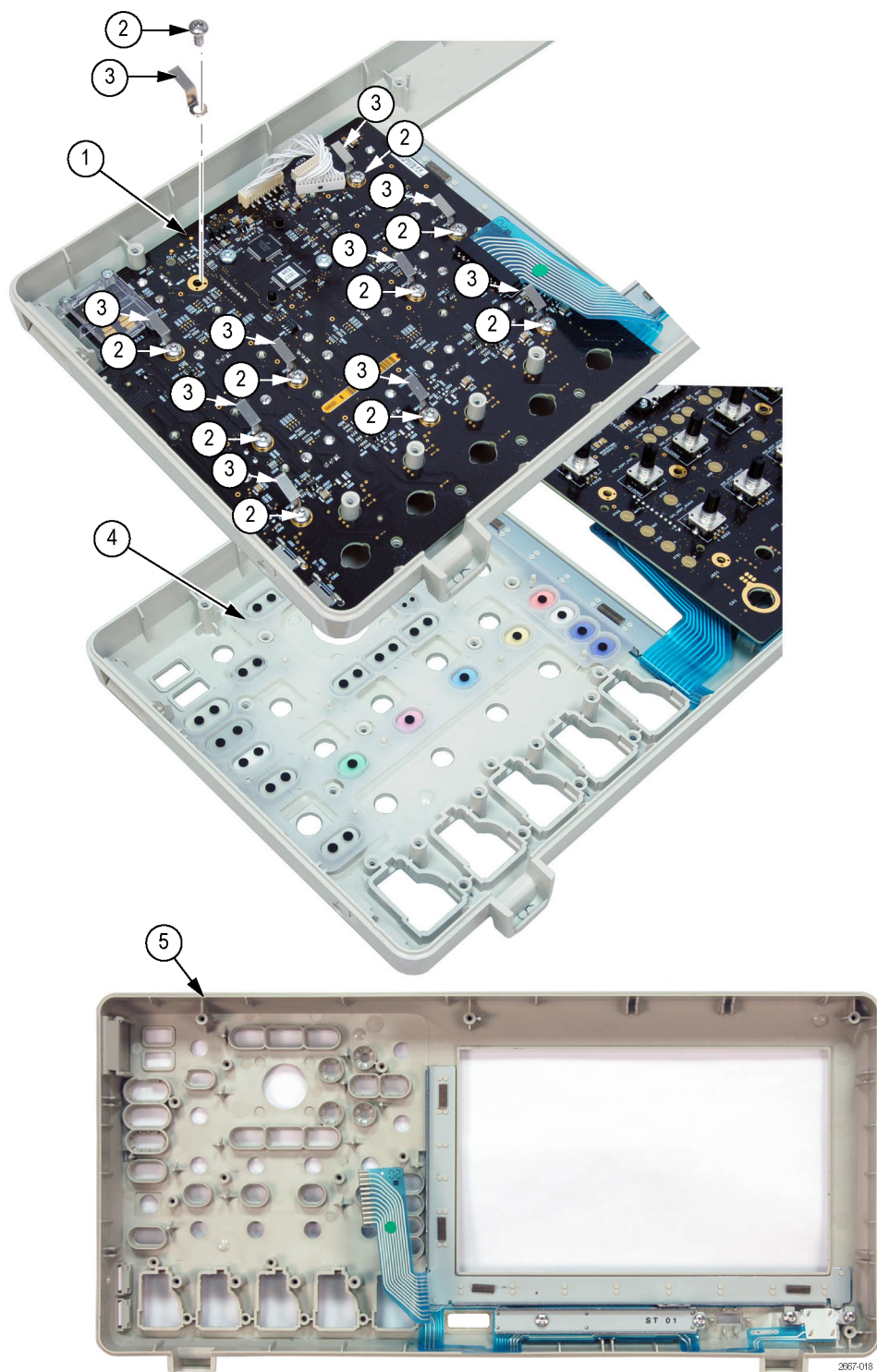

Figure 18: Exploded view: front panel board and front case

Table 10: Replaceable parts list: Standard accessories

Fig. & index number	Tektronix part number	Serial no. effective	Serial no. discont'd	Qty	Name & description
	200-5052-00			1	COVER, FRONT, PROTECTIVE
	See Description			1	CABLE ASSY, POWER:
					<i>Option Country Part number</i>
					A0 NORTH AMERICA 161-0348-00
					A1 UNIVERSAL EURO 161-0343-00
					A2 UNITED KINGDOM 161-0344-00
					A3 AUSTRALIA 161-0346-00
					A5 SWITZERLAND 161-0347-00
					A6 JAPAN 161-0342-00
					A10 CHINA 161-0341-00
					A11 INDIA 161-0349-00
	016-1967-00			1	POUCH, PLASTIC:POUCH
	010-6316-01			1	MSO PROBE; 16 CHANNEL DIGITAL PROBE, GENERAL PURPOSE; P6316

Table 11: Replaceable parts list: Optional accessories

Tektronix part number	Serial no. effective	Serial no. discont'd	Name & description
800-0042-xx			DPO3AUTO Replacement Module
800-0043-xx			DPO3COMP Replacement Module
800-0044-xx			DPO3EMBD Replacement Module
800-0045-xx			DPO3VID Replacement Module
119-7465-xx			TekVPI external power supply (required when probe power exceeds 20W)
067-6316-xx			MSO Test Probe (use with 679-6240-XX)
679-6240-xx			MSO Test Probe BNC Input Fixture
679-6353-xx			P6316 MSO Probe Functional test Board

Index

A

- acquisition system, description, 4
- adjustment procedure, 8
 - factory, 9, 12
- adjustments, 7
- application modules, vii
- attenuator board removal, 26

C

- calibration switch, 9
- circuit description, 3
- connectivity, vii

D

- description
 - circuit theory, 3
- diagram, 3
- display module removal, 27
- display system, description, 4
- documentation, vii

F

- factory adjustment, 8
- fans removal, 24
- flowcharts
 - troubleshooting, 29

- front chassis removal, 27
- front panel removal, 28
- front panel, description, 5

I

- I/O board connections, 4
- I/O board removal, 24
- internal modules, 21

M

- main board functions, 4
- main board removal, 25
- manual conventions, vii
- manuals, vii
- module interconnections, 3

P

- power converter, description, 5
- power supply, 4
- power supply removal, 25
- probe compensation, 5
- processor system, description, 4

R

- rear case removal, 23

- rear chassis removal, 23
- removal procedures, 21, 22
 - attenuator board, 26
 - display module, 27
 - fans, 24
 - front chassis, 27
 - front panel, 28
 - I/O board, 24
 - main board, 25
 - power supply, 25
 - rear case, 23
 - rear chassis, 23
- replaceable part, definition, vii

S

- Safety Summary, iv

T

- trigger system, description, 4
- troubleshoot, 28

U

- user manual, 1