



**PRISM MPI
Media Analysis Platform
Installation and Safety
Instructions**



071-3500-04



**PRISM MPI
Media Analysis Platform
Installation and Safety
Instructions**

This document supports software version 1.5 and above.

Register now!

Click the following link to protect your product.

► www.tek.com/register

www.tek.com

071-3500-04

Copyright © Tektronix. All rights reserved. Licensed software products are owned by Tektronix or its subsidiaries or suppliers, and are protected by national copyright laws and international treaty provisions.

Tektronix products are covered by U.S. and foreign patents, issued and pending. Information in this publication supersedes that in all previously published material. Specifications and price change privileges reserved.

TEKTRONIX and TEK are registered trademarks of Tektronix, Inc.

Contacting Tektronix

Tektronix, Inc.
14150 SW Karl Braun Drive
P.O. Box 500
Beaverton, OR 97077
USA

For product information, sales, service, and technical support:

- In North America, call 1-800-833-9200.
- Worldwide, visit www.tek.com to find contacts in your area.

Warranty

Tektronix warrants that this product will be free from defects in materials and workmanship for a period of one (1) year from the date of shipment. If any such product proves defective during this warranty period, Tektronix, at its option, either will repair the defective product without charge for parts and labor, or will provide a replacement in exchange for the defective product. Parts, modules and replacement products used by Tektronix for warranty work may be new or reconditioned to like new performance. All replaced parts, modules and products become the property of Tektronix.

In order to obtain service under this warranty, Customer must notify Tektronix of the defect before the expiration of the warranty period and make suitable arrangements for the performance of service. Customer shall be responsible for packaging and shipping the defective product to the service center designated by Tektronix, with shipping charges prepaid. Tektronix shall pay for the return of the product to Customer if the shipment is to a location within the country in which the Tektronix service center is located. Customer shall be responsible for paying all shipping charges, duties, taxes, and any other charges for products returned to any other locations.

This warranty shall not apply to any defect, failure or damage caused by improper use or improper or inadequate maintenance and care. Tektronix shall not be obligated to furnish service under this warranty a) to repair damage resulting from attempts by personnel other than Tektronix representatives to install, repair or service the product; b) to repair damage resulting from improper use or connection to incompatible equipment; c) to repair any damage or malfunction caused by the use of non-Tektronix supplies; or d) to service a product that has been modified or integrated with other products when the effect of such modification or integration increases the time or difficulty of servicing the product.

THIS WARRANTY IS GIVEN BY TEKTRONIX WITH RESPECT TO THE PRODUCT IN LIEU OF ANY OTHER WARRANTIES, EXPRESS OR IMPLIED. TEKTRONIX AND ITS VENDORS DISCLAIM ANY IMPLIED WARRANTIES OF MERCHANTABILITY OR FITNESS FOR A PARTICULAR PURPOSE. TEKTRONIX' RESPONSIBILITY TO REPAIR OR REPLACE DEFECTIVE PRODUCTS IS THE SOLE AND EXCLUSIVE REMEDY PROVIDED TO THE CUSTOMER FOR BREACH OF THIS WARRANTY. TEKTRONIX AND ITS VENDORS WILL NOT BE LIABLE FOR ANY INDIRECT, SPECIAL, INCIDENTAL, OR CONSEQUENTIAL DAMAGES IRRESPECTIVE OF WHETHER TEKTRONIX OR THE VENDOR HAS ADVANCE NOTICE OF THE POSSIBILITY OF SUCH DAMAGES.

[W2 – 15AUG04]

TEKTRONIX SOFTWARE LICENSE AGREEMENT

THE PROGRAM, OR PROGRAMS, ENCODED OR INCORPORATED WITHIN EQUIPMENT OR ACCOMPANYING THIS AGREEMENT, IS FURNISHED SUBJECT TO THE TERMS AND CONDITIONS OF THIS AGREEMENT. RETENTION OF THE PROGRAM FOR MORE THAN THIRTY DAYS OR USE OF THE PROGRAM IN ANY MANNER WILL BE CONSIDERED ACCEPTANCE OF THE AGREEMENT TERMS. IF THESE TERMS ARE NOT ACCEPTABLE, THE UNUSED PROGRAM AND ANY ACCOMPANYING DOCUMENTATION SHOULD BE RETURNED PROMPTLY TO TEKTRONIX FOR A FULL REFUND OF THE LICENSE FEE PAID. (FOR INFORMATION REGARDING THE RETURN OF PROGRAMS ENCODED OR INCORPORATED WITHIN EQUIPMENT, CONTACT THE NEAREST TEKTRONIX SALES OFFICE.)

DEFINITIONS.

"Tektronix" means Tektronix, Inc., an Oregon corporation, or local Tektronix' legal entity that is supplying the equipment.

"Program" means the Tektronix software product (executable program and/or data) enclosed with this Agreement or included within the equipment with which this Agreement is packed.

"Customer" means the person or organization in whose name the Program was ordered.

LICENSE.

Customer may:

1. Use the Program on a single machine at any one time; and
2. Copy the Program for archival or backup purposes, provided that no more than one (1) such copy is permitted to exist at any one time.

Each copy of the Program made by Customer must include a reproduction of any copyright notice or restrictive rights legend appearing in or on the copy of the Program as received from Tektronix.

Customer may not:

1. Use the Program on more than one machine at any one time;
2. Transfer the Program to any person or organization outside of Customer or the corporation of which Customer is a part without the prior written consent of Tektronix, except in connection with the transfer of the equipment within which the programs are encoded or incorporated;
3. Export or re-export, directly or indirectly, the program, any associated documentation, or the direct product thereof, to any country to which such export or re-export is restricted by law or regulation of the United States or any foreign government having jurisdiction without the prior authorization, if required, of the Office of Export Administration, Department of Commerce, Washington, D.C. and the corresponding agency of such foreign government;
4. Modify the Program, create derivative works, or merge the Program with another program;
5. Reverse compile or disassemble the Program for any purpose, beyond the extent that such activity is expressly permitted by applicable open source licenses or applicable law notwithstanding this limitation; or
6. Copy the documentation accompanying the Program.

For Programs designed to reside on a single-machine and support one or more additional machines, either locally or remotely, without permitting the Program to be transferred to an additional machine for local execution, the additional machines shall be considered within the definition of "single machine." For programs permitting the Program to be transferred to an additional machine for local execution, a separate license shall be required for each such machine with which the Program may be used.

Title to the Program and all copies thereof, but not the media on which the Program or copies may reside, shall be and remain with Tektronix or others for whom Tektronix has obtained a respective licensing right.

Customer shall pay when due all property taxes that may now or hereafter be imposed, levied or assessed with respect to the possession or use of the Program or this license and shall file all reports required in connection with such taxes.

If the Program or any related documentation is acquired by or for an agency of the U.S. Government, the Program and documentation shall be considered "commercial computer software" or "commercial computer software documentation" respectively, as those terms are used in 48 CFR §12.212, 48 CFR §227.7202, or 48 CFR §252.227-7014, and are licensed with only those rights as are granted to all other licensees as set forth in this Agreement.

THE PROGRAM MAY NOT BE USED, COPIED, MODIFIED, MERGED, OR TRANSFERRED TO ANOTHER EXCEPT AS EXPRESSLY PERMITTED BY THESE TERMS AND CONDITIONS. UPON TRANSFER OF ANY COPY, MODIFICATION, OR MERGED PORTION OF THE PROGRAM, THE LICENSE GRANTED HEREIN IS AUTOMATICALLY TERMINATED WITH RESPECT TO THE PARTY THAT TRANSFERS THE PROGRAM.

TERM.

The license granted herein is effective upon acceptance by Customer, and shall remain in effect until terminated as provided herein. The license may be terminated by Customer at any time upon written notice to Tektronix. The license may be terminated by Tektronix or any third party from whom Tektronix may have obtained a respective licensing right if Customer fails to comply with any term or condition and such failure is not remedied within thirty (30) days after notice hereof from Tektronix or such third party. Upon termination by either party, Customer shall return to Tektronix or destroy, the Program and all associated documentation, together with all copies in any form.

LIMITED WARRANTY.

The Program is provided "as is" without warranty of any kind, either express or implied. Tektronix does not warrant that the functions contained in the Program will meet Customer's requirements or that the operation of the Program will be uninterrupted or error-free.

TEKTRONIX AND ITS VENDORS DISCLAIM ANY IMPLIED WARRANTIES OF MERCHANTABILITY OR FITNESS FOR A PARTICULAR PURPOSE.

LIMITATION OF LIABILITY, IN NO EVENT SHALL TEKTRONIX OR OTHERS FROM WHOM TEKTRONIX HAS OBTAINED A LICENSING RIGHT BE LIABLE FOR ANY INDIRECT, SPECIAL, INCIDENTAL, OR CONSEQUENTIAL DAMAGES ARISING OUT OF OR CONNECTED WITH CUSTOMER'S POSSESSION OR USE OF THE PROGRAM, EVEN IF TEKTRONIX OR SUCH OTHERS HAS ADVANCE NOTICE OF THE POSSIBILITY OF SUCH DAMAGES.

THIRD-PARTY DISCLAIMER.

Except as expressly agreed otherwise, third parties from whom Tektronix may have obtained a licensing right do not warrant the program, do not assume any liability with respect to its use, and do not undertake to furnish any support or information relating thereto.

GENERAL.

This Agreement contains the entire agreement between the parties with respect to the use, reproduction, and transfer of the Program. Neither this Agreement nor the license granted herein is assignable or transferable by Customer without the prior written consent of Tektronix.

This Agreement and the license granted herein shall be governed by the laws of the state of Oregon.

All questions regarding this Agreement or the license granted herein should be directed to the nearest Tektronix Sales Office.

Table of Contents

Important safety information	iii
General safety summary.....	iii
Service safety summary	iv
Terms in this manual	v
Symbols and terms on the product.....	v
Preface.....	vi
Product description.....	vi
Documentation	viii
Conventions Used in This Manual.....	viii
Installation.....	1
Initial product inspection	1
Accessories	2
Operating requirements.....	4
Portable cabinet and dual rack cabinet installation	7
Connectors	8
SFP module installation.....	10
Power-on and power-off procedures	11
Operation.....	14
Display elements	14
Methods of operation	15
Compliance information	20
EMC compliance	20
Safety compliance.....	21
Environmental considerations	22

Important safety information

This manual contains information and warnings that must be followed by the user for safe operation and to keep the product in a safe condition.

To safely perform service on this product, additional information is provided at the end of this section. (See page iv, *Service safety summary*.)

General safety summary

Use the product only as specified. Review the following safety precautions to avoid injury and prevent damage to this product or any products connected to it. Carefully read all instructions. Retain these instructions for future reference.

Comply with local and national safety codes.

For correct and safe operation of the product, it is essential that you follow generally accepted safety procedures in addition to the safety precautions specified in this manual.

The product is designed to be used by trained personnel only.

Only qualified personnel who are aware of the hazards involved should remove the cover for repair, maintenance, or adjustment.

Before use, always check the product with a known source to be sure it is operating correctly.

This product is not intended for detection of hazardous voltages.

While using this product, you may need to access other parts of a larger system. Read the safety sections of the other component manuals for warnings and cautions related to operating the system.

When incorporating this equipment into a system, the safety of that system is the responsibility of the assembler of the system.

To avoid fire or personal injury

Use proper power cord. Use only the power cord specified for this product and certified for the country of use.

Do not use the provided power cord for other products.

Power disconnect. The power cord disconnects the product from the power source. See instructions for the location. Do not position the equipment so that it is difficult to operate the power cord; it must remain accessible to the user at all times to allow for quick disconnection if needed.

Use proper AC adapter. Use only the AC adapter specified for this product.

Observe all terminal ratings. To avoid fire or shock hazard, observe all ratings and markings on the product. Consult the product manual for further ratings information before making connections to the product.

Do not apply a potential to any terminal, including the common terminal, that exceeds the maximum rating of that terminal.

The measuring terminals on this product are not rated for connection to mains or Category II, III, or IV circuits.

Do not operate without covers. Do not operate this product with covers or panels removed, or with the case open. Hazardous voltage exposure is possible.

Avoid exposed circuitry. Do not touch exposed connections and components when power is present.

Do not operate with suspected failures. If you suspect that there is damage to this product, have it inspected by qualified service personnel.

Disable the product if it is damaged. Do not use the product if it is damaged or operates incorrectly. If in doubt about safety of the product, turn it off and disconnect the power cord. Clearly mark the product to prevent its further operation.

Before use, inspect test leads and accessories for mechanical damage and replace when damaged. Do not use test leads if they are damaged, if there is exposed metal, or if a wear indicator shows.

Examine the exterior of the product before you use it. Look for cracks or missing pieces.

Use only specified replacement parts.

Do not operate in wet/damp conditions. Be aware that condensation may occur if a unit is moved from a cold to a warm environment.

Do not operate in an explosive atmosphere.

Keep product surfaces clean and dry. Remove the input signals before you clean the product.

Provide proper ventilation. Refer to the installation instructions in the manual for details on installing the product so it has proper ventilation.

Slots and openings are provided for ventilation and should never be covered or otherwise obstructed. Do not push objects into any of the openings.

Provide a safe working environment. Always place the product in a location convenient for viewing the display and indicators.

Avoid improper or prolonged use of keyboards, pointers, and button pads. Improper or prolonged keyboard or pointer use may result in serious injury.

Be sure your work area meets applicable ergonomic standards. Consult with an ergonomics professional to avoid stress injuries.

Use only the Tektronix rackmount hardware specified for this product.

Service safety summary

The *Service safety summary* section contains additional information required to safely perform service on the product. Only qualified personnel should perform service procedures. Read this *Service safety summary* and the *General safety summary* before performing any service procedures.

To avoid electric shock. Do not touch exposed connections.

Do not service alone. Do not perform internal service or adjustments of this product unless another person capable of rendering first aid and resuscitation is present.

Disconnect power. To avoid electric shock, switch off the product power and disconnect the power cord from the mains power before removing any covers or panels, or opening the case for servicing.

Use care when servicing with power on. Dangerous voltages or currents may exist in this product. Disconnect power, remove battery (if applicable), and disconnect test leads before removing protective panels, soldering, or replacing components.

Verify safety after repair. Always recheck ground continuity and mains dielectric strength after performing a repair.

Terms in this manual

These terms may appear in this manual:



WARNING. Warning statements identify conditions or practices that could result in injury or loss of life.



CAUTION. Caution statements identify conditions or practices that could result in damage to this product or other property.

Symbols and terms on the product

These terms may appear on the product:

- DANGER indicates an injury hazard immediately accessible as you read the marking.
- WARNING indicates an injury hazard not immediately accessible as you read the marking.
- CAUTION indicates a hazard to property including the product.



When this symbol is marked on the product, be sure to consult the manual to find out the nature of the potential hazards and any actions which have to be taken to avoid them. (This symbol may also be used to refer the user to ratings in the manual.)

The following symbol(s) may appear on the product:



CAUTION
Refer to Manual

Preface

This manual describes how to install the PRISM Media Analysis Platform and provides basic safety and operating information.

Product description

The PRISM Media Analysis Platform provides flexible options and field-installable upgrades to monitor a diverse variety of IP statistics as well as video and audio content. The comprehensive feature set, along with an intuitive and simplified graphical presentation of IP statistics, including video quality and diagnostic information, enables engineers to ensure the delivery of superior QoS levels in an increasingly complex broadcast environment involving compressed / uncompressed video transmission through SDI/IP signal paths. PRISM is an ideal solution for monitoring SDI/IP hybrid environments including master control rooms, production studios, OB vans, and signal contribution/distribution centers.



Figure i: PRISM Media Analysis Platform shown with the optional portable cabinet

Features and benefits for analysis of hybrid IP/SDI infrastructures

- A comprehensive analysis and monitoring tool for a hybrid IP/SDI broadcast systems that provides system evaluation for long term system quality monitoring and reporting
- Real time IP/SDI analysis and monitoring to quickly identify the issue to determine the root cause
- Graphical displays that show the traffic present in the 10G Ethernet link, allowing engineers to understand what is on their network and to easily select the stream of interest
- Select a stream to view and monitor the content using the Picture, Waveform, and Audio applications, and listen to audio with headphones for conformance monitoring
- Detect IP packet errors, monitor the packet inter arrival time (PIT) and time stamped delay factor (TS-DF) to allow engineers to observe issues that may cause intermittent loss of Video, Audio or Data
- Analysis tools coupled with historical data give engineers the ability to understand and resolve complex and intermittent problems quickly
- Monitor PTP trend graphs to ensure proper IP system setup for robust sync system
- Tektronix patented Timing display showing the relative timing of the input signal and PTP reference that makes facility timing easy
- 1 PPS output when the instrument is locked to a PTP reference
- Simultaneous two paths monitoring to ensure proper SMPTE 2022-7 redundant system operation
- API to control PRISM from system management software
- Multipoint or remote site monitoring allowing one engineer to quickly respond to issues from multiple points in the system
- Build an extensive monitoring solution with the SDI signal decoded from SMPTE 2022-6 streams reconstructed from streams compliant to SMPTE 2022-7
- 10GE line rate packet capture for offline analysis
- The Picture application provides a full HD 9-inch screen that can be used for confidence monitoring
- All-in-one instrument within 3RU half rack platform that can be used for either portable application or rack mount application

Features and benefits for production tools supporting 4K/UHD, WCG and HDR content creation

- A comprehensive production tool set supporting 4K / WCG / HDR content creation
- SDI / IP hybrid interface supporting up to 4K resolution, up to 2160p60 format support with 12G-SDI / Quad 3G-SDI interface, and up to 1080p60 format with SMPTE 2022-6/7
- Integrated 9-inch 1920×1080 display
- Stop display for monitoring video signals with a variety of transfer functions in a consistent manner
- Vector display equipped with a 3D LUT conversion, allowing operators to match skin tones of video signals to standard BT.709 vector locations and verify wide color gamut compatibility to BT.709 color gamut
- Flexible display configuration with Full / Quad / Vertical extended tile modes
- 12G-SDI physical layer measurements to check SDI signal quality and integrity

Documentation

Table i: Product documentation

Document	Tektronix part number	Description	Availability	
			Print	Web
Installation and Safety Instructions	071-3500-xx	Describes how to install the instrument and provides basic safety and operating information	√	√
User Manual	077-1290-xx	Provides detailed operating information		√
Specifications and Performance Verification	077-1291-xx	Lists the product specifications and provides procedures for verifying product performance		√
Release Notes	077-1293-xx	Describes the new features, improvements, and limitations of the instrument firmware		√
Dual Rack Cabinet Installation Instructions	071-3501-xx	Describes how to install the instrument in a 19" equipment rack using the optional MPI-RACK-MM or MPI-RACK-MW dual rack cabinet	√	√
Field Upgrade Kit Instructions	075-1095-xx	Describes how to install post-purchase field upgrades in the instrument	√	√

Conventions Used in This Manual

The following icons may be used throughout this manual.

Sequence Step



Front panel power



Connect power

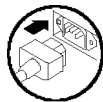

Network

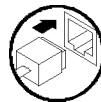

SVGA

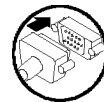

USB

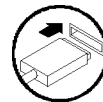

Installation

Initial product inspection

Perform the following product inspection procedure when you receive your instrument:

1. Inspect the shipping carton for external damage, which may indicate damage to the instrument.
2. Remove the PRISM monitor from the shipping carton, and then check that the instrument has not been damaged in transit. Prior to shipment the instrument is thoroughly inspected for mechanical defects. The exterior should not have any scratches or impact marks.

NOTE. Save the shipping carton and packaging materials for instrument repackaging in case shipment becomes necessary.

3. Verify that the shipping carton contains the instrument, the standard accessories, and any optional accessories that you ordered. (See page 2, *Accessories*.)
4. Verify that all of the product options you ordered are installed:
 - a. After you install and power-on the instrument, touch or click the **Settings** icon.
 - b. Touch or click the **Utilities** bar.
 - c. Touch or click the **Options** bar.
 - d. The display will list all installed product options (for example, MPI-IP-STD and/or MPI-IP-MEAS). The display will read "None" if no options are installed.

Exterior cleaning

The instrument exterior was inspected for debris when it was shipped. If necessary, you can clean the exterior of the instrument as follows.



WARNING. To prevent injury or death, power off the instrument and disconnect it from line voltage before cleaning.

Clean the exterior surfaces of the chassis with a dry lint-free cloth or a soft-bristle brush. If any dirt remains, use a cloth or swab dipped in a 75% isopropyl alcohol solution. Use a swab to clean narrow spaces around controls and connectors. Do not use abrasive compounds on any part of the instrument that may be damaged by it.



CAUTION. Avoid the use of chemical cleaning agents that might damage the plastics used in the instrument. Use only deionized water when cleaning the front-panel buttons. Use a glass cleaner to clean the LCD. For the rest of the instrument, use a 75% isopropyl alcohol solution as a cleaner and rinse with deionized water. Before using any other type of cleaner, consult your Tektronix Service Center or representative.

Accessories

Table 1: Standard and optional accessories

Accessory	Std.	Opt.	Tektronix part number
PRISM Installation and Safety Instructions	√		071-3500-xx
AC adapter with power plug (See page 3, <i>International power cords.</i>)	√		NA
SFP and transceiver modules:			
SD/HD/3G Optical (1310 nm) SDI SFP transmitter module (to be installed into SDI SFP+ cage for optical SDI loop through output)		√	MP-SFP Opt. 3GTO
SD/HD/3G DIN SDI SFP transmitter module (to be installed into SDI SFP+ cage for SDI loop through output with DIN coaxial connector)		√	MP-SFP Opt. 3GTD
SD/HD/3G HDBNC SDI SFP transmitter module (to be installed into SDI SFP+ cage for SDI loop through output with HDBNC coaxial connector)		√	MP-SFP Opt. 3GTH
10G Ethernet short range (850 nm) transceiver module (to be installed into 10GbE SFP+ cage); requires Option MPI-IP-STD		√	MP-SFP Opt. 10GESR
10G Ethernet long range (1310 nm) transceiver module (to be installed into 10GbE SFP+ cage); requires Option MPI-IP-STD		√	MP-SFP Opt. 10GELR
Portable cabinet		√	MPI-PTBL
Dual rack cabinet (19 inch, 3RU) ¹			
For one MPI unit or two MPI units side-by-side		√	MPI-RACK-MM
For one MPI unit or one MPI unit in a side-by-side installation with a WFM52x0, WFM7200, WFM8x00 instrument		√	MPI-RACK-MW

¹ The dual rack cabinet kit includes the *PRISM Dual Rack Cabinet Installation Instructions*, Tektronix part number 071-3501-xx.

International power cords. Your instrument was shipped with one of the following power cord options. Power cords for use in North America are UL listed and CSA certified. Cords for use in areas other than North America are approved by at least one authority acceptable in the country to which the product is shipped.

- Opt. A0 – North America power cord
- Opt. A1 – Universal EUR power cord
- Opt. A2 – United Kingdom power cord
- Opt. A3 – Australia power cord
- Opt. A4 – 240 V, North America power cord
- Opt. A5 – Switzerland power cord
- Opt. A6 – Japan power cord
- Opt. A10 – China power cord
- Opt. A11 – India power cord
- Opt. A12 – Brazil power cord
- Opt. A99² – No power cord

² When ordering the A99 option, it is the responsibility of the end user to ensure that a certified power cord, for the country or region it is installed, is used with this instrument.



CAUTION. To reduce risk of fire and shock, use the certified power cord provided with the product.

Operating requirements

This section provides the environmental and power operating requirements for the instrument. See the *PRISM Specifications and Performance Verification Technical Reference* for additional information on product environmental and power specifications.

Environmental operating requirements

Check that the location of your installation has the proper operating environment as listed in the following table.



CAUTION. *Damage to the instrument can occur if this instrument is powered on at temperatures outside the specified temperature range.*

Table 2: Environmental requirements

Parameter	Description	
Temperature	Operating	0 °C to +40 °C
	Non Operating	-20 °C to +60 °C
Humidity	Operating	20% to 80% relative humidity (% RH) at up to +40 °C, non-condensing
	Non Operating	5% to 90% relative humidity (% RH) at up to 40 °C and derated linearly to 45% RH at 60 °C, non-condensing
Altitude	Operating	To 3,000 m (10,000 feet) Maximum operating temperature decreases 1 °C each 300 m above 1.5 km
	Non Operating	To 12,000 m (40,000 feet)
Cooling	Internal fans provide forced air circulation. Do not block ventilation openings.	
	Bare Instrument (no optional sleeves)	To ensure proper airflow, there must be at least 2 inches of clearance on both sides of the instrument, at least 2 inches of clearance from the rear of the instrument, and at least a 1/2 inch of clearance from the top of the instrument.
	Portable Cabinet	Use only the Tektronix portable cabinet, MPI-PTBL, to ensure proper airflow with this instrument. When using the portable cabinet, the same minimum clearances as the Bare Instrument apply.
	Rack Cabinet	Use only the Tektronix Dual Rack Adapter, MPI-RACK-MM or MPI-RACK-MW, to install this instrument in an equipment rack. To ensure proper airflow when installing the Dual Rack Adapter in a closed rack with solid walls, there must be at least 2 inches of clearance from both sides of the rack adapter frame to the rack side walls, at least 3 inches of clearance from the rear of the rack adapter frame to the rack's back wall, and at least a 1/2 inch of clearance from the top of the rack adapter to another rack adapter or installed instrument. The rack intake air to the side vents must not exceed 40 °C.

Electrical power requirements

The instrument operates from a DC power input that is supplied by an AC power adapter. An AC adapter is provided as a standard accessory with the instrument. Check that your location provides the proper electrical power requirements as listed in the following tables.

AC line power. Use the proper power cord with the AC adapter. (See page 3, *International power cords*.) The following table lists the power requirements for the AC adapter supplied with the instrument.

Table 3: AC line power requirements for the AC adapter

Parameter	Description
Line voltage range	100 - 240 VAC \pm 10%
	 WARNING. To reduce the risk of fire and shock, ensure that the mains supply voltage fluctuations do not exceed 10% of the operating voltage range.
Line frequency	50/60 Hz
Maximum power	200 W

DC input power. This instrument is intended to be powered by a 48 VDC input. However, the instrument will operate from any regulated DC voltage between 45.6 V and 50.4 V. The following table lists the power requirements for the DC power input on the instrument.



WARNING. Fire can cause personal injury and/or property damage. To prevent risk of fire, when using an external DC source other than the provided AC adapter, make sure that it has a suitable current limiting device (such as a fuse).

In the instrument, only the line conductor is fused for over-current protection. The fuse is internal and not user replaceable. Do not attempt to replace the fuse. If you suspect the fuse has blown, return the unit to an authorized service center for repair.

Table 4: DC input power requirements

Parameter	Description
Power source	Single-phase with one current-carrying conductor at or near earth-ground (the neutral conductor)
	 CAUTION. Systems with both current-carrying conductors live with respect to ground (such as phase-to-phase in multiphase systems) are not recommended as power sources
Regulated voltage range	48 VDC \pm 5%
Typical power draw	100 W

Physical characteristics

The following table lists the physical characteristics of a bare instrument that is not installed in one of the optional portable or dual rack mount cabinets.

Table 5: Physical characteristics

Parameter	Description
Dimensions	
Height	13.72 cm (5.4 in.)
Width	Chassis: 20.83 cm (8.2 in.)
	Bezel: 22.10 cm (8.7 in.)
Depth	29.85 cm (11.75 in.)
Weight	
Net	Approximately 3.3 kg (7.3 lb.)
Shipping	Typically 10.64 kg (23.4 lb.)

Portable cabinet and dual rack cabinet installation

Portable cabinet installation

If you ordered the optional portable cabinet (MPI-PTBL), install the PRISM monitor into the cabinet as shown below. Secure the instrument in the cabinet by installing the two supplied screws in the rear of the instrument. The front feet on the bottom of the cabinet can fold out to aid your viewing of the display. (See Figure i on page vi.)

The protective front cover is designed to protect the screen from damage when the instrument is being transported. To install the front cover, push the cover onto the instrument until the tabs on both sides click into place. No fasteners are required. To remove the front cover, gently pull outward on the side tabs and slide the cover off of the instrument.

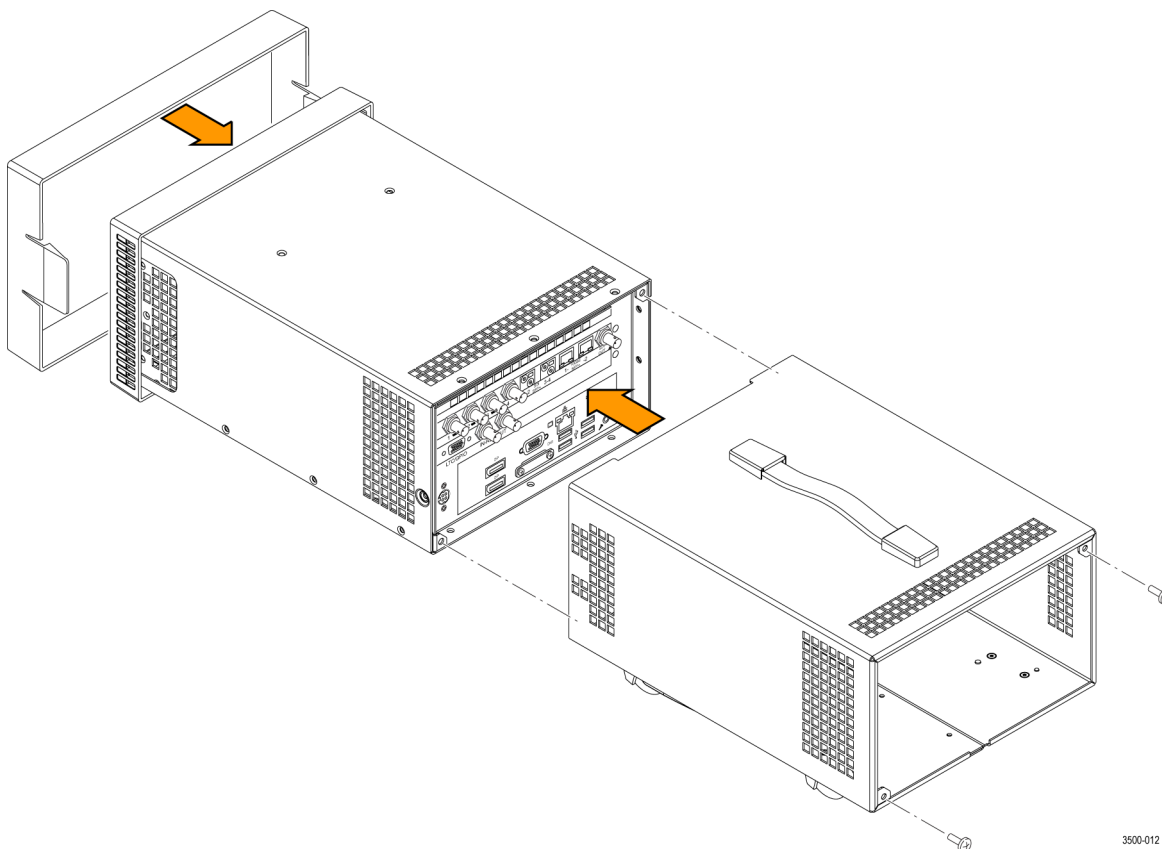

3500-012

Figure 1: Installing the portable cabinet

Dual rack cabinet installation

There are two optional dual rack cabinets (19", 3RU) available for the PRISM monitor. Each of the cabinet kits include the *PRISM Dual Rack Cabinet Installation Instructions* document (Tektronix part number 071-3501-xx).

- **MPI-RACK-MM.** Allows you to install one MPI unit or two MPI units side-by-side. The front of the cabinet has two USB ports and a headphone jack for each MPI unit.
- **MPI-RACK-MW.** Allows you to install one MPI unit or one MPI unit in a side-by-side installation with a WFM52x0, WFM7200, or WFM8x00 instrument. The front of the cabinet has two USB ports and a headphone jack for one MPI unit.

Connectors

The following figure shows the external connections to the instrument. A description of each connector is provided in the following table.

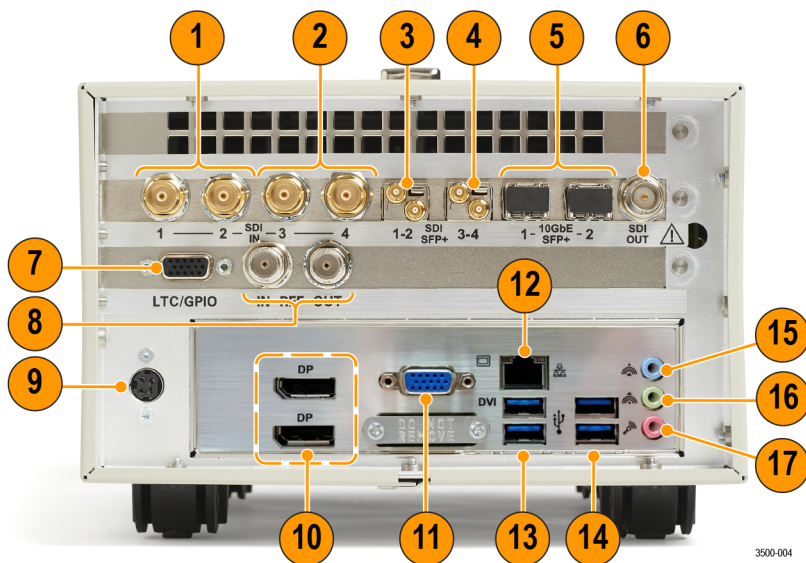
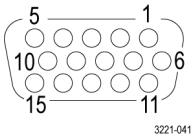

Figure 2: PRISM rear panel

Item number (See Figure 2.)	Description
1	<p>SDI IN 1-2. Two BNC inputs that can operate in the following modes:</p> <ul style="list-style-type: none"> ■ Single SD/HD/3G/12G-SDI link (Option MP-FMT-4K is required for 12G support). When used as a single link, only one of the SDI 1-4 inputs is active at a time. ■ Quad 4K links when used in conjunction with the SDI 3-4 inputs (Option MP-FMT-4K only). When used as Quad 4K links, all four SDI inputs are active. ■ Single 12G Eye link on SDI 1 input only for physical layer measurements, including automated measurement of 12G-SDI Eye pattern parameters (requires Options MP-FMT-4K and PHY-12G).
2	<p>SDI IN 3-4. Two BNC inputs that can operate in the following modes:</p> <ul style="list-style-type: none"> ■ Single SD/HD/3G-SDI link. When used as a single link, only one of the SDI 1-4 inputs is active at a time. ■ Quad 4K links when used in conjunction with the SDI 1-2 inputs (Option MP-FMT-4K only). When used as Quad 4K links, all four SDI inputs are active.
3	<p>SDI SFP+ 1-2. Two optional SFP+ outputs for SD/HD/3G-SDI signals (HD-BNC transmitter SFP+ modules shown).</p>
4	<p>SDI SFP+ 3-4. Two optional SFP+ outputs for SD/HD/3G-SDI signals (HD-BNC transmitter SFP+ modules shown).</p>
5	<p>10 GbE SFP+ 1-2. Two optional SFP+ ports for 10 GbE Ethernet applications.</p>

Item number (See Figure 2.)	Description
6	SDI OUT. BNC output of the selected SDI or 10 GbE input.
7	LTC/GPIO. 15-pin, D-type connector is for future functionality.
	
8	IN – REF – OUT. The REF IN connector is for future use. The REF OUT connector outputs a 1 PPS (Pulse Per Second) signal when the instrument is locked to a PTP reference.
9	DC power input. Power connector for 48 VDC input.
10	Display port (DP). Two display port outputs for external monitors. The output video format is 1920 x 1080.
11	<p>PC MONITOR. 15-pin, D-type connector for 1920×1080 analog video output of the instrument display.</p> <ul style="list-style-type: none"> ■ Pin 1: Red video ■ Pin 2: Green video ■ Pin 3: Blue video ■ Pin 4: Not connected ■ Pin 5: GND ■ Pin 6: Red GND ■ Pin 7: Green GND ■ Pin 8: Blue GND ■ Pin 9: Not connected ■ Pin 10: Not connected ■ Pin 11: Not connected ■ Pin 12: VGA_b_DDAT ■ Pin 13: Horizontal sync ■ Pin 14: Vertical sync ■ Pin 15: VGA_b_DCLK
12	Ethernet port 1. Standard RJ-45 connector for 10/100/1000Base-T Ethernet cable.
13	USB ports. USB 3.0 ports for connecting a mouse and keyboard, importing or exporting instrument presets, upgrading the instrument firmware, or saving screen and stream captures.
14	USB ports. USB 3.0 ports for connecting a mouse and keyboard, importing or exporting instrument presets, or for upgrading the instrument firmware.
15	Audio input. This connector is for future use.

Item number (See Figure 2.)	Description
16	Audio output. 3.5 mm line out port for using headphones to listen to the selected audio channel pair.
17	Mic input. This connector is for future use.

SFP module installation

There are several types of optional SFP modules available. (See Table 1 on page 2.)

To install the SFP module, you will first need to remove the plug from the SFP connector. Insert the SFP module into the SFP connector as shown below (optical SFP module shown). The module will latch into place when fully inserted.

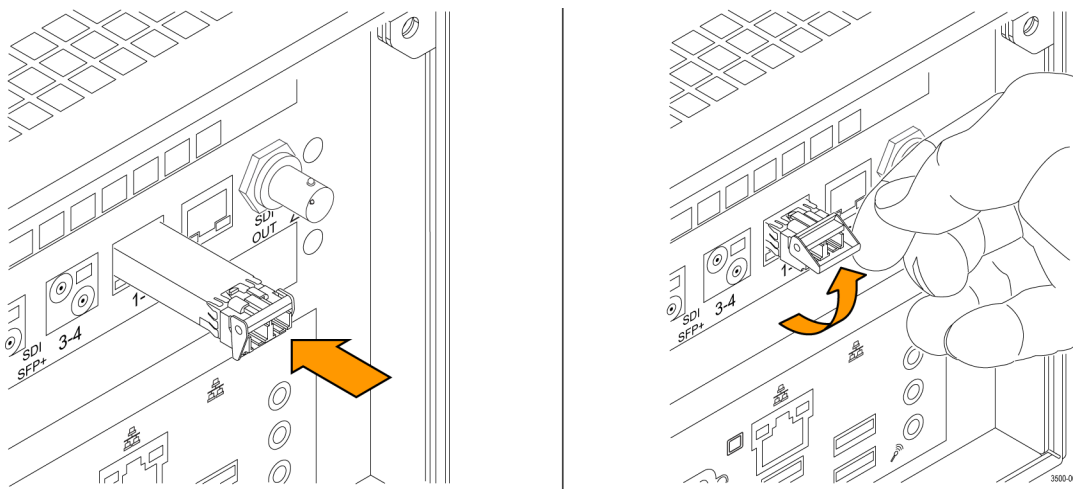

Figure 3: Installing and removing an optical SFP module

To remove the optical SFP module, lift up on the latch and then pull the module out of the SFP connector as shown above (optical SFP module shown).

NOTE. An optical SFP module is shown above. Other types of SFP modules may have different latching mechanisms.

SFP module transportation



CAUTION. To prevent static damage to the SFP module, if you remove the SFP module from the instrument, always transport the SFP module in a anti-static bag or container.

Power-on and power-off procedures

This section describes how to apply power to the instrument and how to power-on and power-off the instrument.

Power cord installation

This instrument is powered by the DC output of an AC power adapter. Connect the AC adapter to the power connector on the rear panel of the instrument as shown below. The power connector is keyed to be directional, with the flat portion of the power cord housing facing the left of the instrument (as viewed from the rear). When fully inserted, the power cord housing latches onto the instrument power connector.



CAUTION. To minimize the risk of damage to the instrument, it is strongly recommended that the AC adapter be connected to the instrument before the adapter is connected to the AC power source.

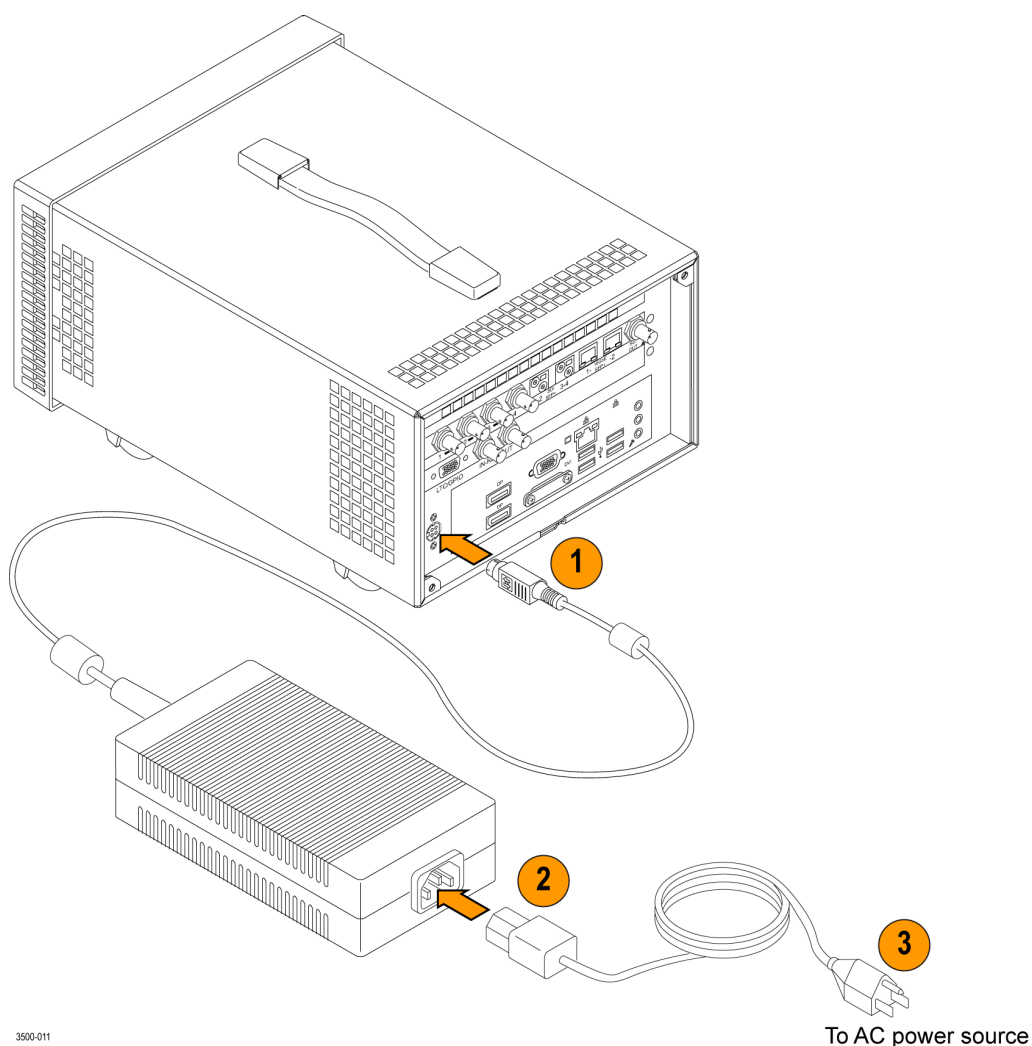

3500-011

Figure 4: Connecting the power cord to the instrument

Power cord removal

The power cord housing latches onto the instrument power connector when fully inserted. To remove the power cord, grasp the connector housing as shown below and firmly pull the cord away from the instrument.



CAUTION. To prevent damage to the power cord or to the instrument power connector, do not attempt to disconnect the power cord by pulling on the cable. You must pull on the connector housing to disengage the locking mechanism.

To minimize the risk of damage to the instrument, it is strongly recommended that the AC adapter be disconnected from the AC power source before the adapter is disconnected from the instrument.

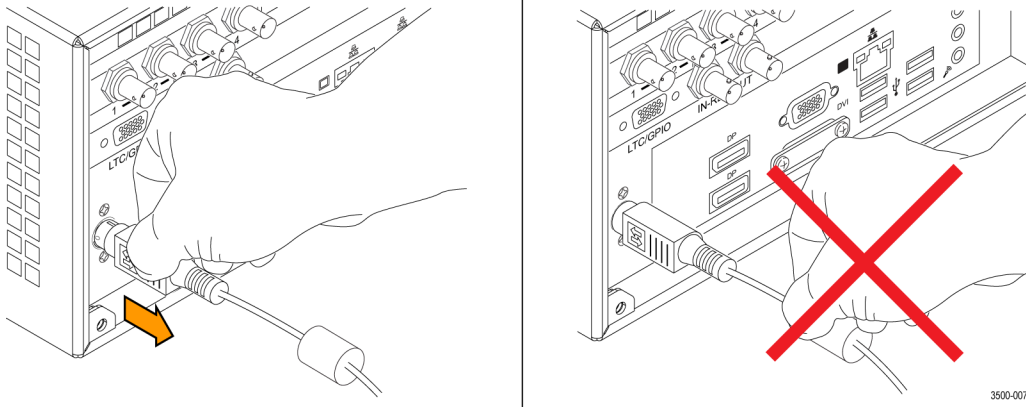

Figure 5: Disconnecting the power cord

Power-on procedure

1. Apply power to the instrument. (See page 11, *Power cord installation*.)

NOTE. If the PRISM monitor was previously powered off by a power interruption or by removing the power cord from the rear of the instrument, the instrument will power on when power is reapplied.

2. Press the **Power/Standby** button on the instrument front panel to turn the instrument on.

NOTE. The Power/Standby button illuminates during the power-on sequence and then turns off during normal instrument operation.



Power-off procedure

1. Press the **Power/Standby** button on the instrument front panel to turn the instrument off.



CAUTION. To prevent data loss, it is strongly recommended that you first shut down the instrument using the power button or the Settings > Utilities > Power submenu before disconnecting the power cord.

To minimize the risk of damage to the instrument, it is strongly recommended that the AC adapter be disconnected from the AC power source before the adapter is disconnected from the instrument.

2. To completely remove power from the instrument, disconnect the power cord from the instrument. (See page 12, *Power cord removal*.)

Operation

Display elements



Figure 6: Elements of the front panel

Item number (See Figure 6.)	Description
1	Application name. Lists the name of the displayed application.
2	Application tile 1. ¹
3	Application tile 3. ¹
4	Status bar. The right side of the Status bar lists instrument status such as the selected input, type of input signal, selected signal reference (internal or external), audio channel status, and the real time clock setting. The left side of the Status bar has icons with links to various instrument setting menus, presets, audio volume control, and status readouts. Use the Home icon to exit any displayed menus.
5	Power / Standby button. Press the button to turn the instrument on or off. To completely remove power from the instrument, remove the power cord.
	 CAUTION. To prevent data loss, it is strongly recommended that you first shut down the instrument using the power button or the Settings > Utilities menu before disconnecting the power cord.
6	Application tabs. Some applications have selectable tabs (highlighted readouts) you can use to display additional information.
7	Application tile 4. ¹
8	Application tile 2. ¹

¹ The application panels can be shown in four-tile mode, full screen mode, or in vertical extended tile mode.

Methods of operation

This section describes the four primary methods of operating the instrument:

- Front panel touchscreen
- Keyboard and mouse
- External touchscreen display
- Remote control via VNC

Front panel touchscreen operation

The following figure shows the instrument display with an open menu for one of the applications.

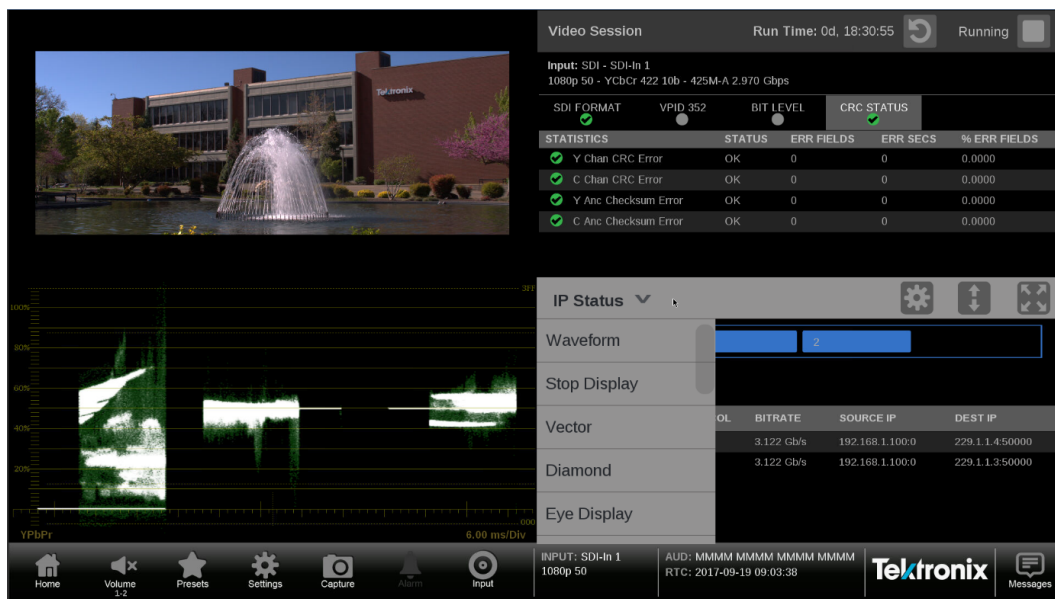







Figure 7: PRISM display in four-tile mode

Supported touchscreen gestures. You can use the following touchscreen gestures to control the instrument:

- Touch or tap the screen to select display elements.
- Press and hold on an application panel to open the application menu.
- Double tap an application panel to toggle the display between four-tile and a full-screen display of the tapped application panel.
- Swipe up/down or left/right as necessary to navigate menus and preset listings and to view additional application information.

How to select or control an application to display.

1. Press and hold on an open application to open the application menu.
2. If necessary, touch the menu down arrow to open the list of available applications. (See Figure 7.)
3. Swipe the application list up or down to locate the desired application.
4. Touch the name of the desired application to display that application.
5. If available, touch or tap the  icon in the menu bar to open the settings menu for the application.
6. Touch or tap the  icon in the menu bar to change the selected application display to full screen.
7. Touch or tap the  icon in the menu bar to change the selected application display to vertical extended mode. The vertical extended mode is useful for when you want to view two application displays side-by-side. When an application display is in vertical extended mode, touch or tap the  icon in the menu bar to return to quarter tile mode.
8. If available, touch or tap the  icon to clear or reset the selected display.

Keyboard and mouse operation

You can use a USB keyboard and mouse to operate the instrument. The mouse needs to have a scrolling wheel in order to access all of the menu selections. Click or click and hold on applications to perform actions like you would on the touch panel.

Connect the keyboard and mouse as follows:

- Use the USB ports on the rear panel of the instrument
- Use the USB port on the front of the optional dual rack cabinet (MPI-RACK-MM or MPI-RACK-MW)

External touchscreen display operation

You can use an external touchscreen display to control the instrument. Two connections are required:

- Connect the Display Port output from the PRISM monitor to the input on the external device.
- Connect the output of the external device to one of the USB ports on the PRISM monitor.

Remote control via VNC operation

When the PRISM monitor is connected to an Ethernet network, you can use a computer connected to the same network to remotely control the instrument via VNC. Use the following steps to connect to the PRISM monitor via VNC:

NOTE. When using VNC for extended periods of time, it is recommended to use a VNC client such as VNC Viewer.

1. On the PRISM monitor, open the **Settings > Network** page to view the **Control IP Port** address of the instrument to which you are going to connect.
2. On your computer, enter the following in the URL box of your web browser, where xxx.xxx.xxx.xxx is the IP address of the Control IP Port of the instrument.

`http://xxx.xxx.xxx.xxx:6080/vnc.html`

3. This opens a login Web page as shown below.



4. In the Control bar, click the **Settings** icon to open the Settings dialog.

5. In the Settings dialog, use the Scaling Mode drop-down list to select **Local Scaling**, and then click **Apply**.

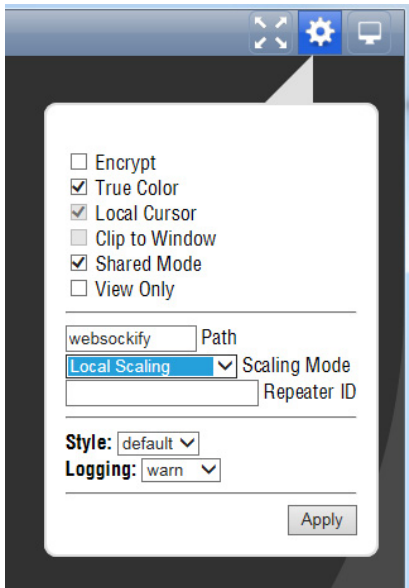

6. In the Control bar, click the **Connect** icon to open the Connect dialog.
7. In the Settings dialog, enter the default password **PRISM**, and then click **Connect**.

NOTE. You can use the **WEB REMOTE** tab of the **PRISM Settings > Network** menu to change the default password for the remote Web connection.

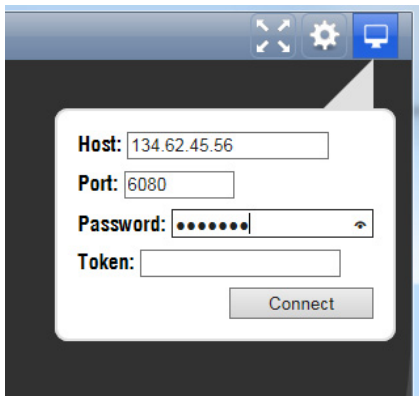

8. The Web browser connects to the instrument with the browser display appearing exactly like the instrument display, but with a slower update rate.

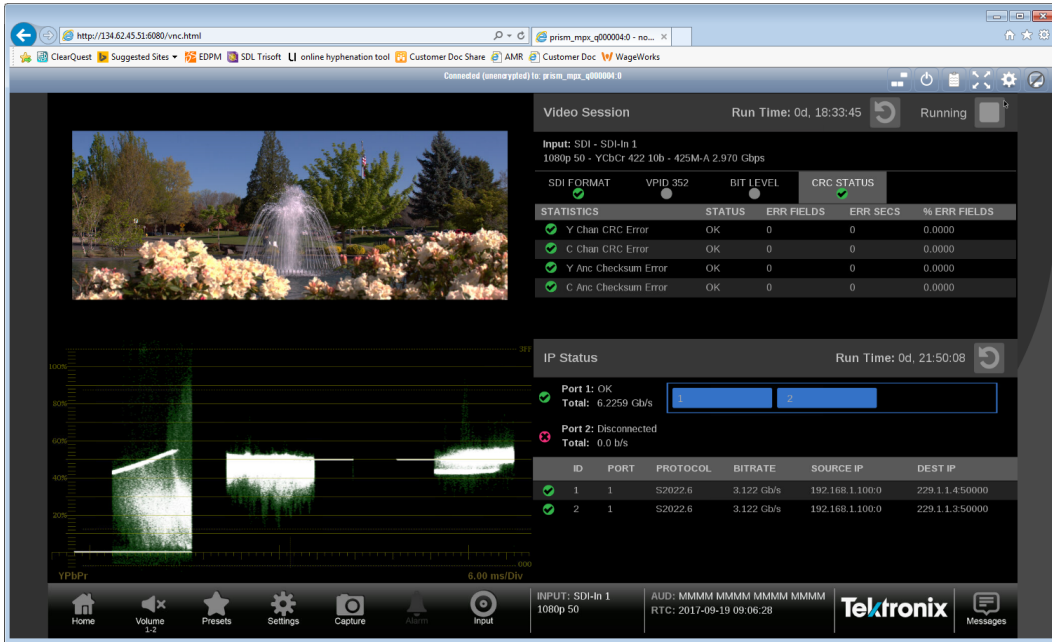

Compliance information

This section lists the EMC (electromagnetic compliance), safety, and environmental standards with which the instrument complies.

EMC compliance

European Union

EMC Directive 2014/30/EU.

- EN 55032 Class A. Product Family Standard for Multimedia Equipment -- Emissions ^{1 2}
- EN 55103-2 Environment E2. Product Family Standard for Audio, Video, Audio-Visual. Industrial and Light Commercial. Part 2: Immunity.
 - IEC 61000-4-2+A1+A2. Electrostatic discharge immunity
 - IEC 61000-4-3+A1. RF electromagnetic field immunity
 - IEC 61000-4-4. Electrical fast transient / burst immunity
 - IEC 61000-4-5. Power line surge immunity
 - IEC 61000-4-6+A1+A2. RF conducted immunity
 - IEC 61000-4-11. Power line voltage fluctuation immunity
- EN 61000-3-2. AC power line harmonic emissions
- EN 61000-3-3. Voltage changes, fluctuations, and flicker

European contact.

Mfr. Compliance Contact
Tektronix, Inc. PO Box 500, MS 19-045
Beaverton, OR 97077, USA
www.tek.com

¹ This product is intended for use in nonresidential areas only. Use in residential areas may cause electromagnetic interference.

² For compliance with the EMC standards listed here, high quality shielded interface cables should be used.

Australia / New Zealand Declaration of Conformity – EMC

Complies with the EMC provision of the Radiocommunications Act per the following standard, in accordance with ACMA:

- EN 55022. Radiated and conducted emissions, Class A, in accordance with EN 55032.

Australia / New Zealand contact.

Fluke Australia PTY LTD
Unit 26, 7 Anelia Avenue
Castle Hill, NSW, Australia 2154

Russian Federation

This product is approved by the Russian government to carry the GOST mark.

NOTE. GOST approval is currently in progress and is not complete.

Safety compliance

Equipment type

Test and measuring equipment.

Pollution degree descriptions

A measure of the contaminants that could occur in the environment around and within a product. Typically the internal environment inside a product is considered to be the same as the external. Products should be used only in the environment for which they are rated.

- Pollution degree 1. No pollution or only dry, nonconductive pollution occurs. Products in this category are generally encapsulated, hermetically sealed, or located in clean rooms.
- Pollution degree 2. Normally only dry, nonconductive pollution occurs. Occasionally a temporary conductivity that is caused by condensation must be expected. This location is a typical office/home environment. Temporary condensation occurs only when the product is out of service.
- Pollution degree 3. Conductive pollution, or dry, nonconductive pollution that becomes conductive due to condensation. These are sheltered locations where neither temperature nor humidity is controlled. The area is protected from direct sunshine, rain, or direct wind.
- Pollution degree 4. Pollution that generates persistent conductivity through conductive dust, rain, or snow. Typical outdoor locations.

Pollution degree rating

Pollution degree 2 (as defined in IEC 61010-1). Rated for indoor, dry location use only.

IP rating

IP20 (as defined in IEC 60529).

Measurement and overvoltage category descriptions

Measurement terminals on this product may be rated for measuring mains voltages from one or more of the following categories (see specific ratings marked on the product and in the manual).

- Category II. Circuits directly connected to the building wiring at utilization points (socket outlets and similar points).
- Category III. In the building wiring and distribution system.
- Category IV. At the source of the electrical supply to the building.

NOTE. Only mains power supply circuits have an overvoltage category rating. Only measurement circuits have a measurement category rating. Other circuits within the product do not have either rating.

Mains overvoltage category rating

Overvoltage category II (as defined in IEC 61010-1).

Environmental considerations

This section provides information about the environmental impact of the product.

Product end-of-life handling

Observe the following guidelines when recycling an instrument or component:

Equipment recycling. Production of this equipment required the extraction and use of natural resources. The equipment may contain substances that could be harmful to the environment or human health if improperly handled at the product's end of life. To avoid release of such substances into the environment and to reduce the use of natural resources, we encourage you to recycle this product in an appropriate system that will ensure that most of the materials are reused or recycled appropriately.



This symbol indicates that this product complies with the applicable European Union requirements according to Directives 2012/19/EU and 2006/66/EC on waste electrical and electronic equipment (WEEE) and batteries. For information about recycling options, check the Tektronix Web site (www.tek.com/productrecycling).

Perchlorate materials. This product contains one or more type CR lithium batteries. According to the state of California, CR lithium batteries are classified as perchlorate materials and require special handling. See www.dtsc.ca.gov/hazardouswaste/perchlorate for additional information.