

SPECMON3 Real-Time Spectrum Analyzer SPECMON6 Real-Time Spectrum Analyzer

Printable Help



077-0740-00

Tektronix

SPECMON3 Real-Time Spectrum Analyzer
SPECMON6 Real-Time Spectrum Analyzer
Printable Help

Copyright © Tektronix. All rights reserved. Licensed software products are owned by Tektronix or its subsidiaries or suppliers, and are protected by national copyright laws and international treaty provisions.

Tektronix products are covered by U.S. and foreign patents, issued and pending. Information in this publication supersedes that in all previously published material. Specifications and price change privileges reserved.

TEKTRONIX and TEK are registered trademarks of Tektronix, Inc.

Online help version: 3.0

Contacting Tektronix

Tektronix, Inc.
14150 SW Karl Braun Drive
P.O. Box 500
Beaverton, OR 97077
USA

For product information, sales, service, and technical support:

- In North America, call 1-800-833-9200.
- Worldwide, visit www.tektronix.com to find contacts in your area.

Table of Contents

Welcome

Welcome	1
---------------	---

About Tektronix Analyzers

Your Tektronix Analyzer	3
Product Software	4
Accessories	
Standard Accessories	4
Recommended Accessories	6
Options	
Options	7
Documentation and Support	
Documentation	7

Orientation

Front Panel Connectors	9
Front-Panel Controls	9
Touch Screen	13
Touch-Screen Actions	13
Elements of the Display	15
Rear-Panel Connectors	19
Setting Up Network Connections	19

Operating Your Instrument

Restoring Default Settings	21
Running Alignments	21
Presets	22
Setting Options	27
Operating System Restore	30

Using the Measurement Displays

Selecting Displays	31
--------------------------	----

Taking Measurements

Measurements	
Available Measurements	33

General Signal Viewing

Overview	39
DPX	
DPX Primer	39
DPX Display Overview	62
DPX Display	62
DPX Settings	70
Time Overview	
Time Overview Display	88
Time Overview Settings	90
Spectrum	
Spectrum Display	94
Spectrum Settings	95
Spectrogram	
Spectrogram Display	97
Spectrogram Settings	99
Amplitude Vs Time	
Amplitude Vs Time Display	103
Amplitude Vs Time Settings	104
Frequency Vs Time	
Frequency Vs Time Display	105
Frequency Vs Time Settings	106
Phase Vs Time	
Phase Vs Time Display	107
Phase Vs Time Settings	108
RF I & Q Vs Time	
RF I & Q vs Time Display	109
RF I & Q vs Time Settings	110
Common Controls for General Signal Viewing Displays	
General Signal Viewing Shared Measurement Settings	112

Analog Modulation

Overview	125
AM	
AM Display	125
AM Settings	126
FM	
FM Display	132
FM Settings	134
PM	
PM Display	140
PM Settings	142

RF Measurements

Overview	149
Chan Power and Strength	
Channel Power and Strength Display.....	149
Channel Power & Strength Settings	153
MCPR	
MCPR (Multiple Carrier Power Ratio) Display	156
MCPR Settings.....	159
Occupied BW & x dB BW	
Occupied BW & x dB BW Display.....	165
Occupied BW & x dB BW Settings	168
Spurious	
Spurious Display.....	169
Spurious Display Settings.....	173
CCDF	
CCDF Display.....	180
CCDF Settings	181
Phase Noise	
Phase Noise Display	182
Phase Noise Settings	186
Settling Time Measurements	
Settling Time Measurement Overview	189
Settling Time Displays	
Settling Time Displays	193
Settling Time Settings	200
Common Controls for Settling Time Displays	
Settling Time Displays Shared Measurement Settings	201
SEM (Spectrum Emission Mask)	
SEM Display	208
Spectrum Emission Mask Settings.....	211
Common Controls for RF Measurements Displays	
RF Measurements Shared Measurement Settings.....	218

OFDM Analysis

Overview	227
OFDM Chan Response	
OFDM Channel Response Display	227
OFDM Channel Response Settings.....	229
OFDM Constellation	
OFDM Constellation Display	230
OFDM Constellation Settings	231
OFDM EVM	

OFDM EVM Display	231
OFDM EVM Settings	232
OFDM Mag Error	
OFDM Magnitude Error Display	233
OFDM Magnitude Error Settings	234
OFDM Phase Error	
OFDM Phase Error Display	235
OFDM Phase Error Settings	236
OFDM Power	
OFDM Power Display	237
OFDM Power Settings	238
OFDM Summary	
OFDM Summary Display	239
OFDM Summary Settings	241
OFDM Symb Table	
OFDM Symbol Table Display	242
OFDM Symbol Table Settings	243
Common Controls for OFDM Analysis Displays	
OFDM Analysis Shared Measurement Settings	243

Pulsed RF

Overview	251
Pulse Table Display	
Pulse Table Display	251
Pulse Table Settings	252
Pulse Trace Display	
Pulse Trace Display	253
Pulse Trace Settings	255
Pulse Statistics	
Pulse Statistics Display	255
Pulse Statistics Settings	257
Common Controls for Pulsed RF Displays	
Pulsed RF Shared Measurement Settings	257

Audio Analysis

Overview	269
Audio Spectrum	
Audio Spectrum Display	269
Audio Spectrum Settings	270
Audio Summary	
Audio Summary Display	271
Audio Summary Settings	272

Common Controls for Audio Analysis Displays	
Audio Analysis Measurement Settings	272
GP Digital Modulation	
Overview	283
Constellation	
Constellation Display	284
Constellation Settings	285
Demod I & Q vs Time	
Demod I & Q vs Time Display	286
Demod I & Q vs Time Settings	288
EVM vs Time	
EVM vs Time Display	288
EVM vs Time Settings	289
Eye Diagram	
Eye Diagram Display	290
Eye Diagram Settings	291
Frequency Deviation vs Time	
Frequency Deviation vs Time Display	292
Frequency Deviation vs Time Settings	294
Magnitude Error vs Time	
Magnitude Error vs Time Display	294
Magnitude Error vs Time Settings	296
Phase Error vs Time	
Phase Error vs Time Display	296
Phase Error vs. Time Settings	298
Signal Quality	
Signal Quality Display	298
Signal Quality Settings	303
Symbol Table	
Symbol Table Display	304
Symbol Table Settings	305
Trellis Diagram	
Trellis Diagram Display	305
Trellis Diagram Settings	307
Common Controls for GP Digital Modulation Displays	
GP Digital Modulation Shared Measurement Settings	307
Standard Settings Button	308
Symbol Maps	
Symbol Maps	324
User Filters	
Overview: User Defined Measurement and Reference Filters	329

User Filter File Format 330

Marker Measurements

Using Markers

- Using Markers 333
- Controlling Markers with the Touchscreen Actions Menu 333
- Measuring Signal Density, Frequency and Power on a DPX Bitmap Trace 334
- Measuring Frequency and Power in the Spectrum Display 336

Common Marker Actions

- Marker Action Controls 337
- Peak 337
- Next Peak 337
- Marker to Center Frequency 337

Define Markers Control Panel

- Enabling Markers and Setting Marker Properties 337

Markers Toolbar

- Using the Markers Toolbar 339

Noise Markers in the Spectrum Display

- Using Noise Markers in the Spectrum Display 340

Search (Limits Testing)

- The Search Tool (Limits Testing) 343
- Search (Limits Testing) Settings 343
- Define Tab (Search) 343
- Actions Tab 347

Analyzing Data

Analysis Settings

- Analysis Settings 349
- Analysis Time Tab 349
- Spectrum Time Tab 351
- Frequency Tab 351
- Units Tab 355

Analyzing Data Using Replay

- Replay Overview 355
- Replay Menu 357
- Acq Data 358
- DPX Spectra 358
- Replay All Selected Records 358
- Replay Current Record 359
- Replay from Selected 359
- Pause 359

Stop.....	359
Select All	359
Select Records from History.....	359
Replay Toolbar	360

Amplitude Corrections

Amplitude Settings	363
Internal Settings Tab	363
External Gain/Loss Correction Tab.....	366
External Gain Value	367
Apply External Corrections To.....	367
External Loss Tables	368
External Probe Correction Tab	370

Controlling the Acquisition of Data

Acquisition Controls in the Run Menu	
Continuous Versus Single Sequence.....	371
Run	371
Resume.....	371
Abort	371
Acquisition Controls in the Acquire Control Panel	
The Acquire Control Panel	372
Sampling Parameters Tab	372
Advanced Tab (Acquire).....	374
FastSave	375
FastSave Tab	377
Using Triggers to Capture Just What You Want	

Managing Data, Settings, and Pictures

Saving and Recalling Data, Settings, and Pictures.....	379
Data, Settings, and Picture File Formats	381
Printing Screen Shots	385

Reference

Online Help	387
About the Tektronix RTSA	387
Connecting Signals	
Configure In/Out Settings.....	388
Connecting an RF Signal	388
Connecting a Signal Using a TekConnect Probe	390
Connecting External Trigger Signals	390
Digital I/Q Output	391

IQ Outputs	391
Other Outputs	392
Mapping Measurements	
Mapping Measurements.....	392
Menus	
Menu Overview	393
File Menu	
File Menu	394
More Presets.....	398
View Menu	
View Menu	398
Run Menu	
Run Menu.....	400
Replay	
Replay Menu	401
Markers Menu	
Markers Menu.....	401
Setup Menu	
Setup Menu	401
Tools Menu	
Tools Menu	402
Window Menu	
Arranging Displays	404
Help Menu	
Help Menu.....	405
Troubleshooting	
Error and Information Messages	405
Displaying the Windows Event Viewer	411
Dealing with Sluggish Instrument Operation.....	413
On/Standby Switch	
On/Standby Switch	413
Upgrading the Instrument Software	
How to Find Out If Instrument Software Upgrades Are Available.....	414
Changing Settings	
Settings.....	414

Glossary

Index

Welcome

This help provides in-depth information on how to use the SPECMON3 and SPECMON6 Real-Time Spectrum Analyzers. This help contains the most complete descriptions of how to use the analyzer. For a shorter introduction to the Signal Analyzer, refer to the *SPECMON3 Real Time Signal Analyzer and SPECMON6 Series Real-Time Signal Analyzer Quick Start User Manual*. To see tutorial examples of how to use your analyzer to take measurements in different application areas, refer to the *SPECMON3 Real Time Spectrum Analyzer and SPECMON6 Real-Time Spectrum Analyzer Application Examples Reference*.

Your Tektronix Analyzer

The SPECMON3 and SPECMON6 Analyzers will help you troubleshoot the toughest transient interference issues by eliminating the guess work when using conventional instrument. Built-in mapping supports both manual and automatic “drive test”. The revolutionary DPX display offers an intuitive live color view of signal transients changing over time in the frequency domain, giving you immediate confidence in the stability of your design, or instantly displaying a fault when it occurs. This live display of transients is impossible with other signal analyzers. Once a problem is discovered with DPX, the Tektronix Analyzers can be set to trigger on the event, capture a continuous time record of changing RF events and perform time-correlated analysis in all domains. You get the functionality of a wideband vector signal analyzer, a spectrum analyzer and the unique trigger-capture-analyze capability of a Real-Time Analyzer – all in a single package.

Discover

- DPX Minimum Event Time Capture: 3.7 μ s (Option 110), 3.7 μ s (Option 85), 3.9 μ s (Option 40), 4 μ s (standard).

Trigger

- Patented DPX Density Trigger (Option 200), Frequency Mask Trigger (Option 52) and advanced triggering allows signal capturing with as short as 3.7 μ s in frequency domain and 9.1 ns in time domain, best in its class

Capture

- All signals within a 110 MHz bandwidth span are captured into memory (Option 110 only, 85 MHz acquisition bandwidth with Option 85, 40 MHz acquisition bandwidth with Option 40, and 25 MHz standard)

Analyze

- Extensive time-correlated multi-domain displays connect problems in time, frequency, phase and amplitude for quicker understanding of cause and effect when troubleshooting.
- Power measurements and signal statistics help you characterize components and systems: ACLR, Multi-Carrier ACLR, Power vs. Time, CCDF, Phase Noise, and Spurious.

- Advanced Measurement Suite (Option 20): Pulse measurements including rise time, pulse width, duty, ripple, power, frequency and phase provide deep insight into pulse train behavior.
- General Purpose Digital Modulation Analysis (Option 21): Provides vector signal analyzer functionality.

Product Software

The instrument includes the following software:

- SPECMON System Software: The SPECMON product software runs on Windows 7. As with standard Windows 7 installations, you can install other compatible applications, but the installation and use of non-Tektronix software is not supported by Tektronix. If you need to reinstall the operating system, follow the procedure in the *Restoring the Operating System* chapter in the SPECMON3 Real-Time Spectrum Analyzer and SPECMON6 Real-Time Spectrum Analyzer Quick Start User Manual (Tektronix part number 071-3064-XX, English). You can download a PDF version of the Quick Start User Manual at www.tektronix.com/manuals. Do not substitute any version of Windows that is not specifically provided by Tektronix for use with your instrument.
- Product Software: The product software is the instrument application. It provides the user interface (UI) and all other instrument control functions. You can minimize or even exit/restart the instrument application as your needs dictate.

Occasionally new versions of software for your instrument may become available at our Web site. Visit www.tektronix.com/software for information.

Software and Hardware Upgrades

Tektronix may offer software or hardware upgrade kits for this instrument. Contact your local Tektronix distributor or sales office for more information.

Standard Accessories

The standard accessories for the RSA6100B Series and RSA5100A Series instruments are shown below. For the latest information on available accessories, see the [Tektronix Web site](http://www.tektronix.com).

Quick Start User Manual

- English - Option L0, Tektronix part number 071-3064-XX
- Japanese - Option L5, Tektronix part number 071-3068-XX
- Russian, Option L10, Tektronix part number 071-3070-XX
- Simplified Chinese - Option L7, Tektronix part number 071-3066-XX

Applications Instructions

- English – Tektronix part number 071-3065-XX
- Simplified Chinese - Option L7, Tektronix part number 071-3067-XX
- Japanese - Option L5, Tektronix part number 071-3069-XX
- Russian, Option L10, Tektronix part number 071-3071-XX

Product Documentation CD-ROM

The Product Documentation CD-ROM contains PDF versions of all printed manuals. The Product Documentation CD-ROM also contains the following manuals, some of which are available only in PDF format:

- SPECMON3 Real-Time Spectrum Analyzer and SPECMON6 Real-Time Spectrum Analyzer Declassification and Security Instructions manual PDF, Tektronix part number 077-0754-XX
- RSA5100A Series and SPECMON Series Service Manual PDF, Tektronix part number 077-0755-XX
- SPECMON3 Real-Time Spectrum Analyzer and SPECMON6 Real-Time Spectrum Analyzer Programmer Manual PDF, Tektronix part number 077-0741-XX
- SPECMON3 Real-Time Spectrum Analyzer and SPECMON6 Real-Time Spectrum Analyzer Specifications and Performance Verification PDF, Tektronix part number 077-0742-XX
- Other related materials

NOTE. To check for updates to the instrument documentation, browse to www.tektronix.com/manuals and search by your instrument's model number.

Important Documents Folder

- Certificate of Calibration documenting NIST traceability, 2540-1 compliance, and ISO9001 registration

Power Cords

- North America - Option A0, Tektronix part number 161-0104-00)
- Universal Euro - Option A1, Tektronix part number 161-0104-06
- United Kingdom - Option A2, Tektronix part number 161-0104-07
- Australia - Option A3, Tektronix part number 161-0104-05
- 240V North America - Option A4, Tektronix part number 161-0104-08
- Switzerland - Option A5, Tektronix part number 161-0167-00
- Japan - Option A6, Tektronix part number 161-A005-00
- China - Option A10, Tektronix part number 161-0306-00

- India - Option A11, Tektronix part number 161-0324-00
- No power cord or AC adapter - Option A99

Optical Wheel Mouse

Product Software CD

Recommended Accessories

The recommended accessories for the SPECMON Series instruments are shown in the following table. For the latest information on available accessories, see the [Tektronix Web site](#).

Item	Ordering part number
Additional Removable Hard Drive (Windows 7 and instrument software installed)	065-0924-00
Transit Case	016-2026-XX
Rackmount Installation Kit	RSA56KR
Additional Quick Start User Manual (paper)	071-3064-XX
Additional Documents CD (all manuals in PDF format)	063-4468-XX

Options

To view a listing of the software options installed on your instrument, select **Help > About Your Tektronix Real-Time Analyzer**. There is a label on the rear-panel of the instrument that lists installed hardware options.

Options can be added to your instrument. For the latest information on available option upgrades, see the [Tektronix Web site](#).

Documentation

In addition to the help, the following documents are available:

- **Quick Start User Manual** (071-3064-XX - English). The Quick Start User Manual has information about installing and operating your instrument. The Quick Start User Manual is also available in Simplified Chinese (071-3066-XX), Japanese (071-3068-XX), and Russian (071-3070-XX).
- **Application Examples Reference** (071-3065-XX). The Application Examples Reference provides examples of specific application problems and how to solve those problems using a SPECMON Series Signal Analyzer. The Application Examples Reference is also available in Simplified Chinese (071-3067-XX), Japanese (071-3069-XX), and Russian (071-3071-XX).
- **Programmer Manual** (077-0741-XX). The Programmer Manual is provided as a printable PDF file, which is located on the Documents CD. See the Documents CD-ROM for installation information.
- **Service Manual** (RSA5100A Series and SPECMON Series: 077-0755-XX). The Service manual is provided as a printable PDF file, which is located on the Documents CD. See the Documents CD-ROM for installation information. The Service manual includes procedures to service the instrument to the module level and restore the operating system.
- **Specifications and Performance Verification Technical Reference Manual** (SPECMON Series: 077-0742-XX). This is a PDF-only manual that includes both the specifications and the performance verification procedure. It is located on the Documents CD.
- **Declassification and Security Instructions** (SPECMON Series: 077-0754-XX) This document helps customers with data security concerns to sanitize or remove memory devices from the instrument. It is located on the Documents CD.

The most recent versions of the product documentation, in PDF format, can be downloaded from www.tektronix.com/manuals. You can find the manuals by searching on the product name.

Other Documentation

Your instrument includes supplemental information on CD-ROM:

- Documents CD (Tektronix part number 063-4468-XX)

Front Panel Connectors

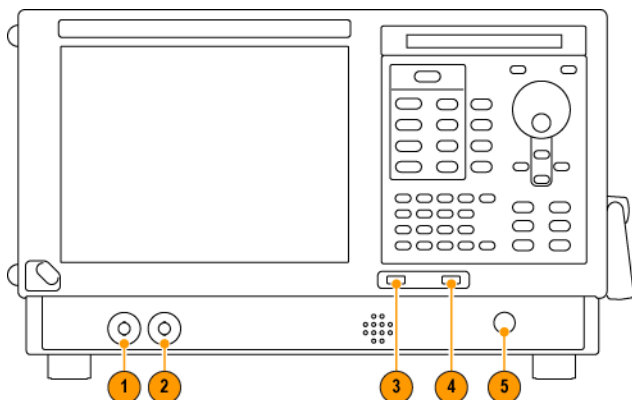

Item	Connector	Description
1	Trig Out	Trigger output connector. 50 Ω, BNC, High > 2.0 V, Low < 0.4 V, (output current 1 mA).
2	Trig In	External Trigger input connector, -2.5 V to +2.5 V (user settable).
3	USB 2.0	USB 2.0 connector.
4	USB 2.0	USB 2.0 connector.
5	RF Input	RF input connector 50 Ω.

Front-Panel Controls

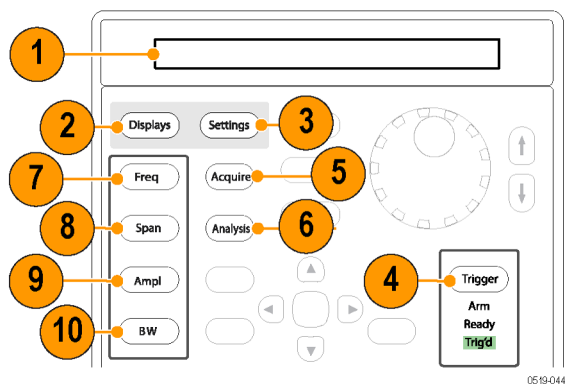

0519-044

Reference	Item	Function	Menu Equivalent
1	Media	DVD-RW or removable hard disk drive.	
2	Displays	Opens the Displays dialog box enabling you to select which displays to open.	Setup > Displays
3	Settings	Opens/closes the Settings control panel for the selected display.	Setup > Settings
4	Trigger	Opens/closes the Trigger control panel. On the RSA5100A Series, this button lights when the trigger mode is set to Triggered.	Setup > Trigger
5	Acquire	Opens/closes the Acquire control panel.	Setup > Acquire
6	Analysis	Opens/closes the Analysis control panel.	Setup > Analysis
7	Freq	Press to adjust the measurement frequency.	Setup > Analysis > Frequency
8	Span (Spectrum)	Press to adjust the span or press and hold to display the Freq & Span control panel for the General Signal Viewing displays.	
9	Amplitude	Opens/closes the Amplitude control panel.	Setup > Amplitude
10	BW (Spectrum)	Press to adjust the bandwidth or press and hold to display the BW control panel for the General Signal Viewing displays.	

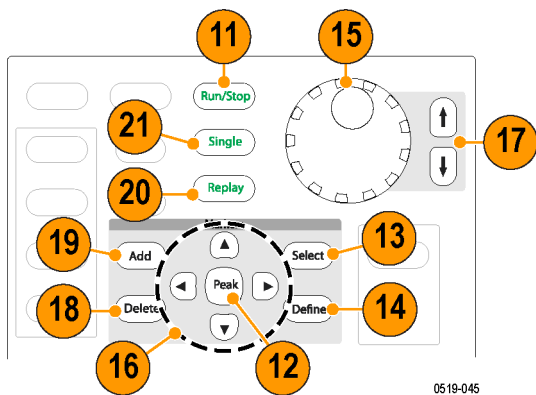

Reference	Item	Function	Menu Equivalent
11	Run/Stop	Starts and stops acquisitions.	Run > Start Run > Stop
12	Peak (Markers section)	Moves the active marker to the maximum peak of the trace in the selected display. If markers are turned off, the marker reference (MR) will appear at the maximum peak.	Markers > Peak
13	Select (Markers section)	Selects the next marker. If markers are turned off, the MR marker (marker reference) will appear.	
14	Define (Markers section)	Opens the Markers control panel. If markers are turned off, the MR marker (reference) will appear.	
15	Control knob	Changes values in numeric and list controls. Pressing the knob (clicking it) is the same as pressing the Enter key on a keyboard.	
16	Arrow keys	Move the Markers. The Up arrow moves the selected marker to the next highest peak. The down arrow moves the selected marker to the next lower peak value. The right and left arrows move the selected marker to the next peak.	
17	Increment/decrement keys	Increments or decrements the selected value	
18	Delete, (Markers section)	Deletes the selected marker	
19	Add, (Markers section)	Add a marker to the selected trace	
20	Replay	Replays the current acquisition record	
21	Single	Sets the Run mode to Single Sequence	

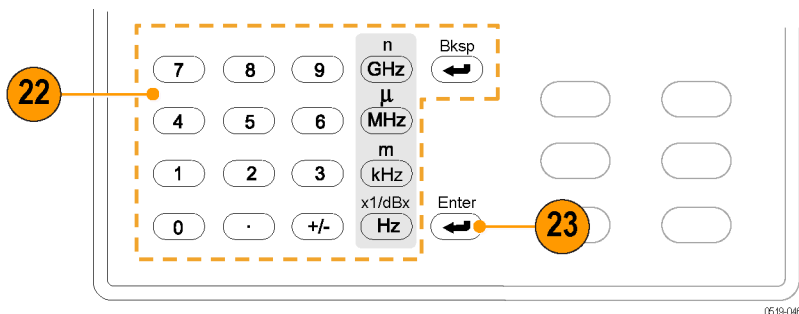

Reference	Item	Function	Menu Equivalent
22	Keypad	Enters values in numeric controls.	
23	Enter	Completes data entry in controls. Same as pressing the Enter key on an external keyboard.	

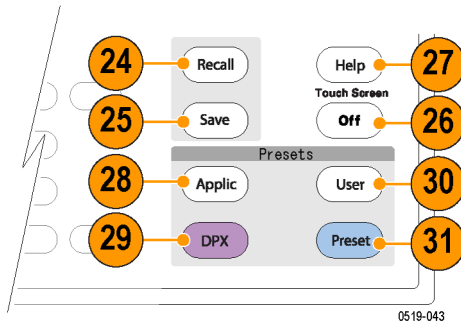

Reference	Item	Function	Menu Equivalent
24	Recall	Opens the Recall dialog box.	File > Recall
25	Save	Opens the Save As dialog box.	File > Save As
26	Touch Screen Off	Turns the touch screen on and off. It is off when lighted.	
27	Help	Displays the help.	Help > Online Manual
28	Applic	Sets the instrument to the selected Application Preset values.	Setup > More Presets > Application
29	DPX	Sets the instrument to the selected DPX Preset values.	Setup > More Presets > DPX
30	User	Sets the instrument to the selected User Preset values.	Setup > More Presets > User
31	Preset	Returns the instrument to the default or preset values.	Setup > Preset

Touch Screen

You can use touch to control the instrument in addition to the front-panel controls, mouse, or extended keyboard. Generally, touch can be used anywhere that click is mentioned in this help.

To disable the touch screen, push the front-panel **Touch Screen Off** button. When the touch screen is off, the button is lighted. You can still access the on-screen controls with a mouse or keyboard.

You can adjust the touch screen operation to your personal preferences. To adjust the touch screen settings, from Windows, select **Start > Control Panel > Touch Screen Calibrator**.



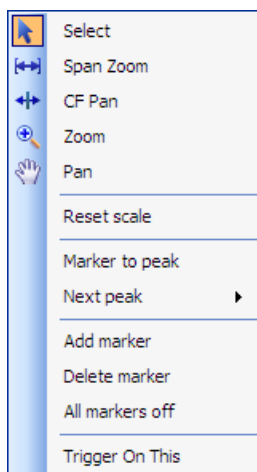

NOTE. *If the instrument is powered on in Windows Safe Mode, the touch screen is inoperative. You will need to use a mouse or keyboard to restore normal operation.*

Touch-Screen Actions

You can use the touch screen to change marker settings and how waveforms are displayed by using the Touch-screen Actions menu.



To use the Touch-screen Actions menu, touch the display in a graph area and hold for one second, then remove your finger. You can also use a mouse to display the Touch-screen Action menu by clicking the right mouse button.

Icon	Menu	Description
	Select	Selects markers and adjusts their position.
	Span Zoom	Zooms the graph area about the selected point. Touch the graph display at a point of interest and drag to increase or decrease the span about the point of interest. Span Zoom adjusts the span control and can affect the acquisition bandwidth.
	CF Pan	Adjusts the Center Frequency according to horizontal movement.
	Zoom	Adjusts horizontal and vertical scale of the graph. The first direction with enough movement becomes the primary scale of adjustment. Adjustment in the secondary direction does not occur until a threshold of 30 pixels of movement is crossed. Dragging to the left or down zooms out and displays a smaller waveform (increases the scale value). Dragging to the right or up zooms in and displays a larger waveform (decreases the scale value).
	Pan	Adjusts horizontal and vertical position of the waveform. The first direction with enough movement becomes the primary direction of movement. Movement in the secondary direction does not occur until a threshold of 30 pixels of movement is crossed.
-	Reset Scale	Returns the horizontal and vertical scale and position settings to their default values.
-	Marker to peak	Moves the selected marker to the highest peak. If no marker is turned on, this control automatically adds a marker.
-	Next Peak	Moves the selected marker to the next peak. Choices are Next left, Next right, Next lower (absolute), and Next higher (absolute).
-	Add marker	Defines a new marker located at the horizontal center of the graph.
-	Delete marker	Removes the last added marker.
-	All markers off	Removes all markers.
-	Trigger On This	Use to visually define trigger parameters in the DPX display (present only in the DPX Spectrum display).

Touch-Screen Menu for Spurious Display

The Touch-screen actions menu in the Spurious display has some minor changes compared to the standard version used in other displays.

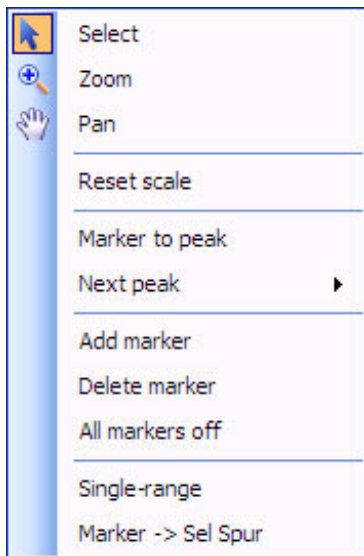

Icon	Menu	Description
-	Single-range	Changes the current multi-range display to a single range display. The displayed range is the range in which you display the touchscreen-actions menu. Selecting Single-range from the menu is equivalent to selecting Single on the Settings > Parameters tab.
-	Multi-range	Changes the current single-range display to a multi-range display. Selecting Multi-range from the menu is equivalent to selecting Multi on the Settings > Parameters tab.
-	Marker -> Sel Spur	Moves the selected marker to the selected spur.

Elements of the Display

The main areas of the application window are shown in the following figure.

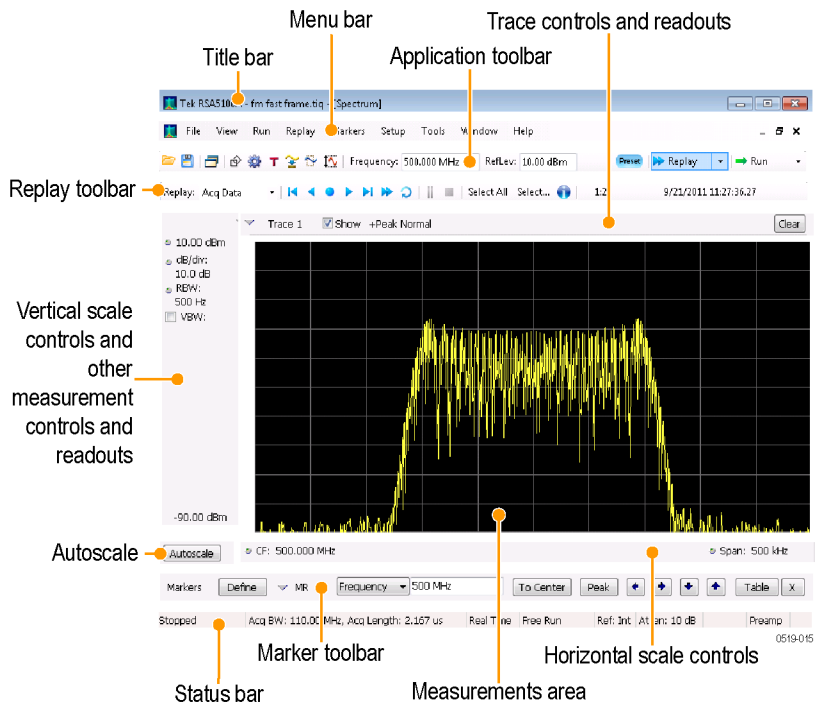

Specific elements of the display are shown in the following figure.

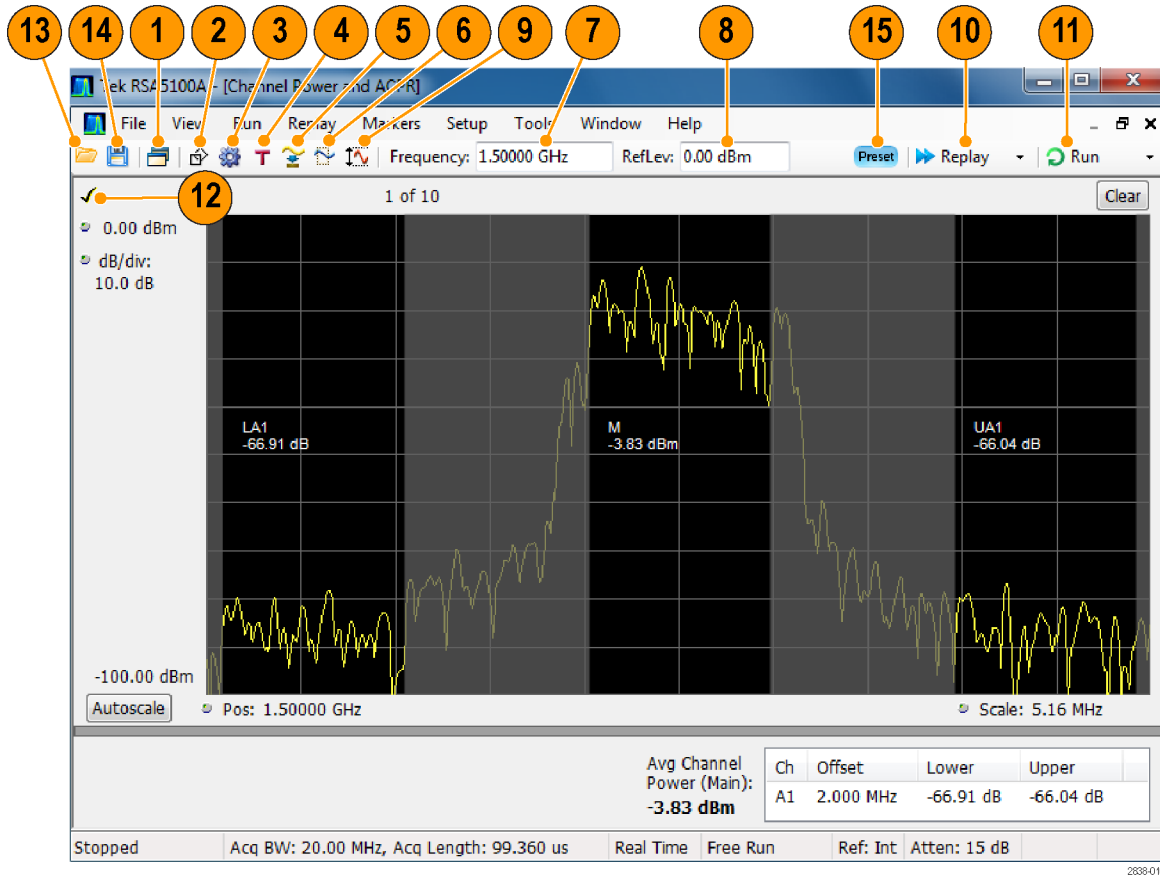

2838-010

Ref number	Setting	Description
1	Displays	Opens the Select Displays dialog box so that you can select measurement displays.
2	Markers	Opens or closes the Marker toolbar at the bottom of the window.
3	Settings	Opens the Settings control panel for the selected display. Each display has its own control panel.
4	Trigger	Opens the Trigger control panel so that you can define the trigger settings.
5	Acquire	Opens the Acquire control panel so that you can define the acquisition settings.
6	Analysis	Opens the Analysis control panel so that you can define the analysis settings such as frequency, analysis time, and units.
7	Frequency	Displays the frequency at which measurements are made. For spectrum displays, this is called "Center Frequency". To change the value, click the text and use the front panel knob to dial in a frequency. You can also enter a frequency with the front panel keypad or use the front panel up and down buttons.
8	Reference Level	Displays the reference level. To change the value, click the text and enter a number from the keypad or use the front panel up and down buttons.
9	Amplitude	Opens the Amplitude control panel so that you can define the Reference Level, configure internal attenuation, and enable/disable the (optional) Preamplifier.
10	Replay	Runs a new measurement cycle on the last acquisition data record using any new settings.
11	Run	Starts and stops data acquisitions. When the instrument is acquiring data, the button label has green lettering. When stopped, the label has black lettering. You can specify the run conditions in the Run menu. For example, if you select Single Sequence in the Run menu, when you click the Run button, the instrument will run a single measurement cycle and stop. If you select Continuous, the instrument will run continuously until you stop the acquisitions.
12	Check mark indicator	The check mark indicator in the upper, left-hand corner of the display indicates the display for which the acquisition hardware is optimized.
13	Recall	Displays the Open window in order to recall setup files, acquisition data files, or trace files.
14	Save	Opens the Save As dialog in order to save setup files, pictures (screen captures), acquisition data files, or export measurement settings or acquisition data.
15	Preset	Recalls the Preset (Main) (see page 402) preset.

Rear-Panel Connectors

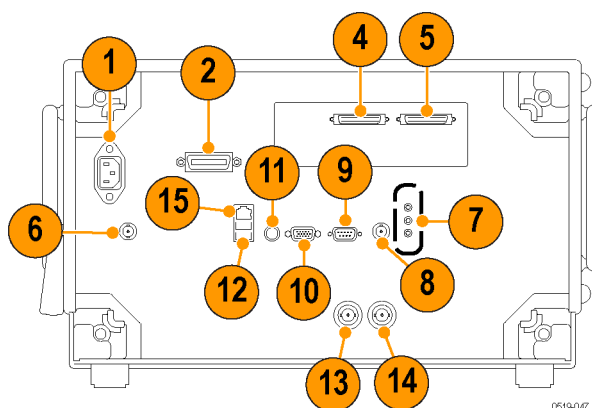

Ref number	Connector, Description
1	AC Input, main power connector
2	GPIB
4, 5	Real Time IQ Out (Option 55)
6	+28 VDC output, switched
7	Microphone in, Headphone, audio output; and Line In connectors
8	External Trigger 2 Input
9	COM 2, serial port for connecting peripherals
10	VGA external monitor output (resolution not limited to VGA)
11	PS2 Keyboard input
12	USB 2.0 ports for mouse and other peripherals (printers, external hard disks)
13	Ref Out, reference frequency output
14	Ref In, reference frequency input
15	LAN, Ethernet network connector

Setting Up Network Connections

Because the instrument is based on Windows, you configure network connections for the instrument the same way you would for any PC based on Windows. See **Help and Support** in the Windows **Start** menu to access the Windows Help System for information on setting up network connections.

Restoring Default Settings

To restore the instrument to its factory default settings:

- Select **File > Preset (Main)** to return the analyzer to its default settings.

Preset resets all settings and clears all acquisition data. Settings and acquisition data that have not been saved will be lost.

Running Alignments

Alignments are adjustment procedures. Alignments are run by the instrument using internal reference signals and measurements and do not require any external equipment or connections.

There are two settings for Alignments:

- Automatically align as needed
- Run alignments only when the **Align Now** button is pressed

If **Automatically align as needed** is selected, alignments run whenever the signal analyzer detects a sufficient change in ambient conditions to warrant an alignment.

If **Run alignments only when "Align Now" button is pressed** is selected, the signal analyzer never runs an alignment unless you manually initiate an alignment using the Align Now button.

NOTE. *There are a few critical adjustments that must run occasionally even if Automatically align is not enabled.*

Alignment Status

When the signal analyzer needs to run an alignment, it displays a message on screen. If no message is displayed, you can assume that the signal analyzer is properly aligned.

NOTE. *If you must use the instrument before it has completed its 20-minute warm-up period, you should perform an alignment to ensure accurate measurements.*

Initiating an Alignment

1. Select **Setup > Alignments**.
2. Select the **Align Now** button.

The signal analyzer will run an alignment procedure. Status messages are displayed while the alignment procedure is running. If the instrument fails the alignment procedure, an error message will be displayed.

If the instrument fails an alignment, run Diagnostics (Tools > Diagnostics) to see if you can determine why the alignment failed.

NOTE. *While an alignment is running, both the IF and IQ outputs are disabled.*

Alignments during warm-up. During the 20-minute warm-up period, the signal analyzer will use the alignment data generated during the previous use of the instrument as it warms to operating temperature (if Auto mode is selected). During the specified period for warm-up, the instrument performance is not warranted.

Alignments during normal operation. Once the signal analyzer reaches operating temperature ± 3 degrees C (as detected inside the instrument), an alignment will be run. If an alignment becomes necessary during a measurement cycle (if Auto mode is selected), the measurement is aborted and an alignment procedure is run. Once an alignment procedure is completed, the measurement cycle restarts.

NOTE. *The first time the instrument runs after a software upgrade (or reinstall), the instrument will perform a full alignment after the 20-minute warm-up period. This alignment cannot be aborted and it occurs even if alignments are set to run only when manually initiated.*

Alignments Are Not Calibrations

Alignments are adjustment procedures run by the instrument using internal reference signals and measurements. Calibrations can only be performed at a Tektronix service center and require the use of traceable test equipment (signal sources and measuring equipment) to verify the performance of the instrument.

Presets

Menu Bar: File > More presets > Preset options

Application Preset	Description
Modulation Analysis	The Modulation Analysis setup application preset provides you with the most common displays used during modulation analysis. Only present when Option 21 is installed.
Phase Noise	The Phase Noise application preset opens the Phase Noise display, and makes changes to the default parameters to settings better optimized for phase noise analysis. Only present when Option 11 is installed.
Pulse Analysis	The Pulse Analysis application preset provides you with the most common displays used during pulse analysis, and makes changes to the default parameters to settings better optimized for pulsed signal analysis. Only present when Option 20 is installed.
Spectrum Analysis	The Spectrum Analysis application preset provide you with the settings commonly used for general purpose spectrum analysis.
Spur Search Multi Zone 9k-1GHz	The Spur Search application preset configures the instrument to show the Spurious display with the frequency range set to 9 kHz to 1 GHz.
Time-Frequency Analysis	The Time-Frequency preset configures the instrument with settings suited to analyzing signal behavior over time.
DPX Preset	Description
Open the DPX display	The Open the DPX display opens the DPX display without closing existing displays.
Real Time	The DPX Real Time Preset displays the DPX Spectrum display with the center frequency set to 1.5 GHz and the span set to the maximum available real-time bandwidth.
Swept	The DPX Swept Preset displays the DPX Spectrum display with the center frequency set to 1.5 GHz and the span set to 3 GHz.
Zero Span (instruments with Option 200)	The DPX Zero Span Preset displays the DPX Zero Span display with the center frequency set to 1.5 GHz and the sweep set to 1 ms.
Main Presets	Description
Current	This Preset sets the instrument to display a Spectrum display with settings matched to show a Spectrum display with settings appropriate for typical spectrum analysis tasks. This preset was updated from the original factory preset with version 2.4 of the instrument software.
Original	This Preset is the original factory preset used with software versions 1.0 through 2.3. This version of the factory preset is included to allow users to maintain compatibility with existing remote control software.
User	Description
User Preset 1	This Preset is provided as a example for you to create your own Presets. This preset displays the Spectrum, Spectrogram, Frequency vs Time, and Time Overview displays.
User Preset 2	This Preset is provided as a example for you to create your own Presets. This preset displays the Spurious display configured to test for Spurious signals across four ranges.

Modulation Analysis

The Modulation Analysis application preset opens the following displays:

- **Signal Quality:** Shows a summary of modulation quality measurements (EVM, rho, Magnitude Error, Phase Error, and others).
- **Constellation:** Shows the I and Q information of the signal analyzed in an I vs. Q format.
- **Symbol Table:** Shows the demodulated symbols of the signal.

To use the Modulation Analysis preset (assuming that Modulation Analysis is the selected preset on the list of Application Presets and Preset action is set to Recall selected preset):

1. Select **File > More presets > Application**.
2. Set the measurement frequency using the front-panel knob or keypad. Your signal should appear in the DPX display.
3. Set the reference level so that the peak of your signal is about 10 dB below the top of the DPX display.
4. Set the modulation parameters for your signal. This includes the Modulation Type, Symbol Rate, Measurement Filter, Reference Filter and Filter Parameter. All of these settings are accessed by pressing the Settings button.

For most modulated signals, the Modulation Analysis application preset should present a stable display of modulation quality. Additional displays can be added by using the Displays button, and other settings can be modified to better align with your signal requirements.

Phase Noise

The Phase Noise application preset opens the Phase Noise display.

Pulse Analysis

The Pulse Analysis application preset opens the following displays:

- DPX: The DPX display is opened with the maximum available span.
- Time Overview: Shows amplitude vs. time over the analysis period.
- Pulse Trace: Shows the trace of the selected pulse and a readout of the selected measurement from the pulse table.
- Pulse Measurement Table: This shows a full report for the user-selected pulse measurements.

You can make a selected pulse and measurement appear in the Pulse Trace display by highlighting it in the Pulse Measurement Table. Key pulse-related parameters that are set by the Pulse Analysis application preset are:

- Measurement Filter: No Filter.
- Measurement Bandwidth: This is set to the maximum real-time bandwidth of the instrument (25 MHz in a SPECMON3, 85 MHz in SPECMON6, and 110 MHz in instruments with Option 110). Note: The label on the “Measurement Bandwidth” setting is just “Bandwidth”. Like the main instrument Preset command and the other application presets, the Pulse Analysis application preset also sets most other instrument controls to default values.
- Analysis Period: This is set to 2 ms to ensure a good probability of catching several pulses for typical signals.

To use the Pulse Analysis preset (assuming that Pulse Analysis is the selected preset on the list of Application Presets and Preset action is set to Recall selected preset):

1. Select **File > More presets > Application**. Click **OK**.
2. Set the Center Frequency control to the carrier frequency of your pulsed signal.
3. Set the Reference Level to place the peak of the pulse signal approximately 0-10 dB down from the top of the Time Overview display.

You may need to trigger on the signal to get a more stable display. This is set up in the Trigger control panel. (“Trig” button). Using the Power trigger type with the RF Input source works well for many pulsed signals.

4. Set the Analysis Period to cover the number of pulses in your signal that you want to analyze. To do this, click in the data entry field of the Time Overview window and set the analysis length as needed.

Spectrum Analysis

The Spectrum Analysis application preset opens a Spectrum display and sets several parameters. The Spectrum Analysis preset sets the analyzer as follows.

- **Spectrum Analysis** : Sets the frequency range to maximum for the analyzer, and sets the RF/IF optimization to **Minimize Sweep Time**.

To use the Spectrum Analysis preset (assuming that Spectrum Analysis is the selected preset on the list of Application Presets and Preset action is set to Recall selected preset):

1. Select **File > More Presets > Application**.
2. Set the measurement frequency using the front-panel knob or keypad.
3. Adjust the span to show the necessary detail.

Time-Frequency Analysis

The Time-Frequency Analysis application preset opens the following displays:

- **Time Overview**: Shows a time-domain view of the analysis time ‘window’.
- **Spectrogram**: Shows a three-dimensional view of the signal where the X-axis represents frequency, the Y-axis represents time, and color represents amplitude.
- **Frequency vs. Time**: This display's graph plots changes in frequency over time and allows you to make marker measurements of settling times, frequency hops, and other frequency transients.
- **Spectrum**: Shows a spectrum view of the signal. The only trace showing in the Spectrum graph after selecting the Time-Frequency Analysis preset is the Spectrogram trace. This is the trace from the Spectrogram display that is selected by the active marker. Stop acquisitions with the Run button because it's easier to work with stable results. In the Spectrogram display, move a marker up or down to see the spectrum trace at various points in time.

The analysis period is set to 5 ms.

To use the Time-Frequency Analysis preset (assuming that Time-Frequency Analysis is the selected preset on the list of Application Presets and Preset action is set to Recall selected preset):

1. Select **File > More presets > Application**.
2. When the preset's displays and settings have all been recalled and acquisitions are running, adjust the center frequency and span to capture the signal of interest.
3. Set the Reference Level to place the peak of the signal approximately 0-10 dB down from the top of the Spectrum graph.
4. If the signal is transient in nature, you might need to set a trigger to capture it. For more information on triggering in the time and frequency domain, see [Triggering](#)

When the signal has been captured, the spectrogram shows an overview of frequency and amplitude changes over time. To see frequency transients in greater detail, use the Frequency vs. Time display.

The Time-Frequency Analysis preset sets the analysis period to 5 ms. The Spectrum Span is 40 MHz. The RBW automatically selected for this Span is 300 kHz. For a 300 kHz RBW, the amount of data needed for a single spectrum transform is 7.46 μs. A 5 ms Analysis Length yields 671 individual spectrum transforms, each one forming one trace for the Spectrogram to display as horizontal colored lines. This preset scales the Spectrogram time axis (vertical axis) to -2, which means that the Spectrogram has done two levels of time compression, resulting in one visible line for each four transforms. This results in 167 lines in the Spectrogram for each acquisition, each covering 29.84 μs.

Creating User Presets

You can add your own presets to the list that appears in the User Presets dialog box. Configure the analyzer as needed for your application and create a Setup file in **C:\SPECMON Files\User Presets**. The name you give the file will be shown in the User Presets list on the Presets tab of the Options control panel. For instructions on how to save a Setup file, see [Saving Data \(see page 379\)](#).

Configuring How Presets Are Recalled

Recalling Presets results in either of two actions. One action is to immediately execute a Preset. The second action displays a list of Presets from which you select the Preset you want to recall. You specify which action occurs when you recall a preset using the Presets tab on the Options control panel.

Configuring how a preset is recalled. To configure how a preset is recalled:

1. Select **File > More presets > Preset options** This displays the Presets tab of the Options control panel.

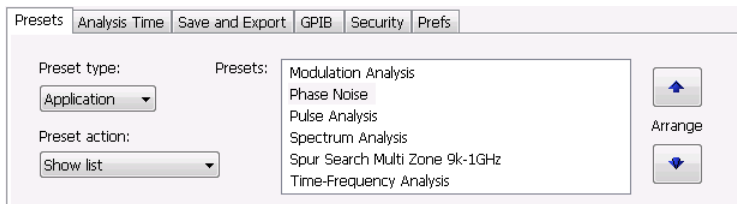

2. Select the **Preset type** from the drop-down list that you want to configure. For each type listed there are unique presets that appear in the **Presets** box.
3. Select the **Preset action** from the drop-down list.

4. If you select **Recall selected preset** from the Preset action list, click in the Presets list box on the preset you wish to recall.

The selected preset, indicated by a tan background highlight, is the Preset that is recalled; you can also press one of the Preset buttons on the front panel.

5. Set the measurement frequency using the front-panel knob or keypad.
6. Adjust the span to show the necessary detail.

Recalling a Preset

To recall the factory defaults Preset:

- Press the **Preset** button on the front panel, select the Preset icon in the menu bar, or select **File > Preset (Main)**.

To recall a named preset (an Application, DPX, or User Preset) from a menu:

- Select **File > More presets > “Preset type”**. The Preset at the top of the Presets list for the selected Preset type will be recalled (if Preset action is set to Recall named preset).

To recall a named preset from the front panel:

- Press the button on the front panel matching the preset type you want to recall. For example, to recall a DPX preset type, press the DPX button.

Setting Options

Menu Bar: Tools > Options

There are several settings you can change that are not related to measurement functions. The Option settings control panel is used to change these settings.

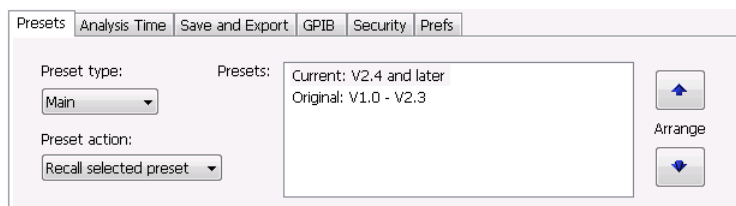

Settings tab	Description
Presets	Use this tab to configure Presets. You can specify the action to take when a preset is recalled and which preset to recall when the Preset button is selected.
Analysis Time	Use this tab to specify the method used to automatically set the analysis and spectrum offsets when the Time Zero Reference (see page 349) is set to Trigger.
Save and Export	Use this tab to specify whether or not save files are named automatically and what information is saved in acquisition data files.
GPIB	Use this tab to set the primary GPIB address for the instrument.
Security	Selecting the Hide Sensitive readouts check box causes the instrument to replace measurement readouts with a string of asterisks.
Prefs	Use this tab to select different color schemes for the measurement graphs and specify how markers should react when dragged.

Presets

The Presets tab allows you to specify actions taken when you press the Preset button.

Preset type. You can choose from the following preset types:

- **Main** – There are two choices: Current: 2.4 and later and Original: V1.0-V2.3. Choose Current unless you have existing tests or procedures that depend on values set by the older version of Preset.
- **Application** – There are several application presets, depending on installed options. Each preset selects a group of displays suited to the selected application type.
- **DPX** – There are four DPX preset types: Open the DPX display, Swept, Real Time, and Zero Span.
- **User** – These are setup files that have been saved by users in the folder C:\SPECMON Files\User Presets.

Preset action. The Preset action list allows you to specify what the instrument should do when you request a preset. The choices are:

- **Recall selected preset** – This action sets up the instrument to immediately recall the preset selected in the Preset box without any further input from the user.
- **Show list** – This action sets up the instrument to display a list box from which the user can select a preset to recall.

Presets. This list box displays the available presets for the selected Preset type. The preset highlighted in the list is the preset that will be recalled when Preset action is set to Recall selected preset.

Arrange. Use the Arrange buttons to change the order in which presets appear in the Presets dialog box when Preset action is set to Show list.

Analysis Time

The Analysis Time tab in the Options control panel is used to specify the method used to automatically set the analysis and spectrum offsets when the [Time Zero Reference \(see page 349\)](#) is set to Trigger. The available settings are:

- Include trigger point – Selects an algorithm that uses the measurements to determine how far in advance of the trigger to set the analysis offset. The analyzer tries to ensure that data about the trigger point is included in the analyses.
- Start at trigger point (legacy) – The method used by the instrument in prior versions, which sets the Analysis Offset to zero when possible. The analyzer tries to ensure that data following the trigger point is included in the analyses. Use this method if your measurements or procedures depend on past behavior of the Auto Analysis Offset function.

Save and Export

The Save and Export tab allows you to specify whether or not files are saved with an automatically generated name, and how much data is saved in an acquisition data file.

All files. The Automatically increment filename/number function can automatically name saved files by appending a number to a base file name. Use this tab to enable/disable automatic naming of files. For example, if **Automatically Increment Filename Number** is disabled, when you select Save from the File menu, you will have to enter a name for the file.

Acquisition data files. This setting specifies whether saved data files include the entire acquisition record or only the data for the analysis length (a subset of the acquisition record).

TIQ acquisition data files. Specifies which data records to save. You can choose from the following:

- Current acquisition: Saves the current acquisition.
- Current frame: If Fast Frame is enabled, saves only the current frame. The current frame is the one most recently analyzed.
- Selected frames: If Fast Frame is enabled, saves the specified frames.
- All in history: Saves all acquisition records in the history.
- Save TIQ file now: Invokes the Save As dialog box with the Save as type drop-down list set to TIQ.

Prefs

The Prefs tab enables you to set properties that apply to all displays.

Color scheme. The Color scheme setting provides three color schemes for the measurement graphs. The color scheme setting does not change the overall instrument application or Windows color scheme.

- Thunderstorm – This scheme displays graphs in shades of blue. This provides a less vibrant color scheme than the default setting.
- Blizzard – This scheme displays graphs with a white background to save ink when printing.
- Classic – The default setting. This scheme displays the graph area with a black background.

Markers snap to peaks when dragged. When selected, this setting causes markers to automatically jump to the [next peak \(see page 338\)](#) when you drag them. When this setting is deselected, you can drag a marker to any point on the trace.

Operating System Restore

The instrument contains an operating system restore file on a separate partition of the hard drive.

The preferred method to restore the instrument operating system is to use the hard disk restore file.



CAUTION. *Using the restore process reformats the hard drive and reinstalls the operating system. All saved data is lost. If possible, save important files to external media before performing a system restore.*

1. Restart the instrument. During the boot-up process you will see the following message at the top of the screen: Starting Acronis Loader... press F5 for Acronis Startup Recovery Manager.

NOTE. *To successfully complete the system restore, you must use the Windows version of the Acronis software. Using a generic MAC keyboard starts the DOS version of the Acronis software. Do not use a MAC keyboard.*

2. Repeatedly press the F5 key until the Acronis True Image Tool opens. There is a 5-second time period from when the message appears until the instrument proceeds with the normal instrument startup. If the instrument does not open the Acronis application, power off the instrument, then power on the instrument and try again.
3. Click Restore.
4. In the Confirmation dialog box, click **Yes** to restore the instrument operating system, or **No** to exit the restore process. The restore process takes approximately 30 minutes; the actual time depends on the instrument configuration.

Selecting Displays

Menu Bar: Setup > Displays

Application Toolbar:

Use the **Select Displays** dialog to choose the displays that appear on the screen.

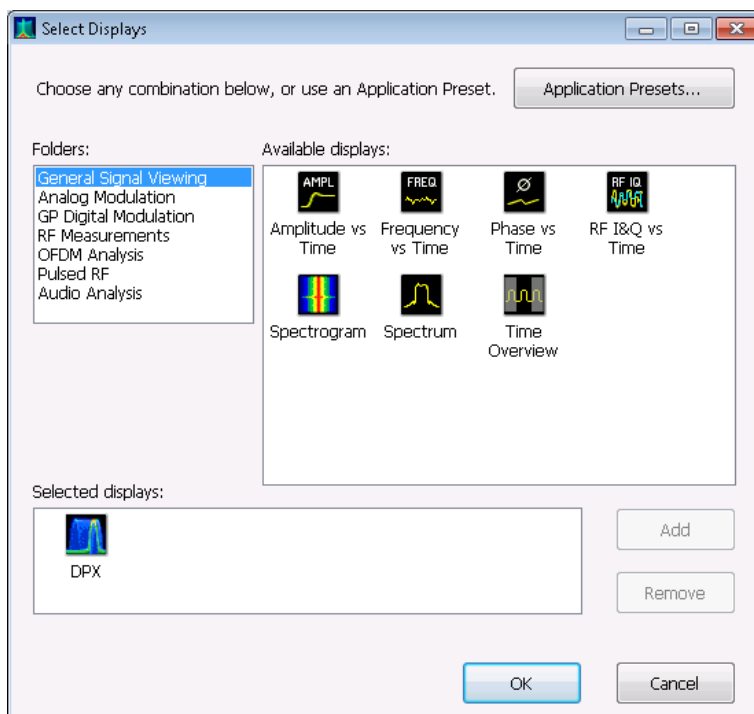

To select displays:

1. Press the **Displays** button or select **Setup > Displays**.
2. Select one of the choices under **Folders**. The folder chosen determines the choices available in **Available displays**.
3. Double-click the desired display in the **Available displays** box or select the desired display and click **Add**.
4. Click **OK**.

Interactions Between Displays

Different displays can require different settings, for example acquisition bandwidth, analysis length, or resolution bandwidth, to achieve optimum results. The application automatically adjusts some settings to optimize them for the selected display. The check mark indicator in the upper, left-hand corner of the

display indicates the display for which the application is optimized. Depending on application settings, some displays might stop displaying results if they are not the selected display.

Available Measurements

The automatic measurements available include RF power measurements, analog modulation measurements, digital modulation measurements, and pulse measurements.

Power Measurements

Measurement	Description
Channel Power	The total RF power in the selected channel (located in the Channel Power & Str display).
Adjacent Channel Power Ratio	Measure of the signal power leaking from the main channel into adjacent channels.
Multi-Carrier Power Ratio	The ratio of the signal power in the reference channel or group of channels to the power in adjacent channels.
Peak/Avg Ratio	Ratio of the peak power in the transmitted signal to the average power in the transmitted signal (located in the CCDF display).
CCDF	The <i>Complementary Cumulative Distribution Function</i> (CCDF). CCDF shows how much time a signal spends at or above a given power level relative to the average power of a measured signal.

Digital Modulation Measurements

Measurements for all modulation types except nFSK, C4FM, OQPSK and SOQPSK

Measurement	Description
EVM	The normalized RMS value of the error vector between the measured signal and the ideal reference signal over the analysis length. The EVM is generally measured on symbol or chip instants and is reported in units of percent and dB. EVM is usually measured after best-fit estimates of the frequency error and a fixed phase offset have been removed. These estimates are made over the analysis length. Displays RMS and Peak values with location of Peak value.
Phase Error	The RMS phase difference between the measured signal and the ideal reference signal. Displays RMS and Peak values with location of Peak value.
Mag Error	The RMS magnitude difference between the measured signal and the reference signal magnitude. Displays RMS and Peak values with location of Peak value.
MER (RMS)	The MER is defined as the ratio of I/Q signal power to I/Q noise power; the result is indicated in dB.
IQ Origin Offset	The magnitude of the DC offset of the signal measured at the symbol times. It indicates the magnitude of the carrier feed-through signal.
Frequency Error	The frequency difference between the measured carrier frequency of the signal and the user-selected center frequency of the instrument.
Gain Imbalance	The gain difference between the I and Q channels in the signal generation path. Constellations with gain imbalance show a pattern with a width that is different from height.
Quadrature Error	The orthogonal error between the I and Q channels. The error shows the phase difference between I and Q channels away from the ideal 90 degrees expected from the perfect I/Q modulation. Not valid for BPSK modulation type.
Rho	The normalized correlated power of the measured signal and the ideal reference signal. Like EVM, Rho is a measure of modulation quality. The value of Rho is less than 1 in all practical cases and is equal to 1 for a perfect signal measured in a perfect receiver.

Measurements for QPSK and SOQPSK modulation types

Measurement	Description
EVM	The normalized RMS value of the error vector between the measured signal and the ideal reference signal over the analysis length. The EVM is generally measured on symbol or chip instants and is reported in units of percent and dB. EVM is usually measured after best-fit estimates of the frequency error and a fixed phase offset have been removed. These estimates are made over the analysis length. Displays RMS and Peak values with location of Peak value.
Offset EVM	Offset EVM is like EVM except for a difference in the time alignment of the I and Q samples. For EVM, I and Q samples are collected at the same time, for every symbol decision point (twice the symbol rate for offset modulations). For Offset EVM, the I and Q symbol decision points are time-aligned before collecting the I and Q samples. In this case, one I and one Q sample is collected for each symbol (half as many samples as the same number of symbols for (non-offset) EVM).
Phase Error	The RMS phase difference between the measured signal and the ideal reference signal. Displays RMS and Peak values with location of Peak value.
Mag Error	The RMS magnitude difference between the measured signal and the reference signal magnitude. Displays RMS and Peak values with location of Peak value.
MER (RMS)	The MER is defined as the ratio of I/Q signal power to I/Q noise power; the result is indicated in dB.
IQ Origin Offset	The magnitude of the DC offset of the signal measured at the symbol times. It indicates the magnitude of the carrier feed-through signal.
Frequency Error	The frequency difference between the measured carrier frequency of the signal and the user-selected center frequency of the instrument.
Gain Imbalance	The gain difference between the I and Q channels in the signal generation path. Constellations with gain imbalance show a pattern with a width that is different from height.
Quadrature Error	The orthogonal error between the I and Q channels. The error shows the phase difference between I and Q channels away from the ideal 90 degrees expected from the perfect I/Q modulation. Not valid for BPSK modulation type.
Rho	The normalized correlated power of the measured signal and the ideal reference signal. Like EVM, Rho is a measure of modulation quality. The value of Rho is less than 1 in all practical cases and is equal to 1 for a perfect signal measured in a perfect receiver.

Measurements for nFSK modulation types

Measurement	Description
Peak FSK err	Peak value of the frequency deviation error at the symbol point.
RMS FSK Err	RMS value of the frequency deviation error at the symbol point.
Peak Mag Err	The Peak magnitude difference between the measured signal and the reference signal magnitude.
RMS Mag Err	The RMS magnitude difference between the measured signal and the reference signal magnitude.
Freq Error	The frequency difference between the measured carrier frequency of the signal and the user-selected center frequency of the instrument.
Freq Deviation	Frequency distance from the center frequency at the symbol point.
Symbol Rate Error	This compares the user-entered symbol rate to the instrument calculated symbol rate of the analyzed signal.
Symbol Rate	When in Auto-symbol rate, the instrument calculates the symbol rate of the signal and the instrument calculates the error between the user entered value and the instrument calculated value.

Measurements for C4FM modulation type

Measurement	Description
RMS Error Magnitude	RMS value of the frequency deviation error at the symbol point.
Carrier Frequency Error	Frequency difference between averaged signal frequency and the center frequency.
Deviation	Frequency distance from the center frequency at the symbol point.
Length	Number of symbols in the analysis area.

Analog Modulation Measurements**Measurements for AM modulation**

Measurement	Description
+AM	Positive peak AM value.
-AM	Negative peak AM value.
Total AM	Total AM value, which is equal to the peak-peak AM value divided by 2.

Measurements for FM modulation

Measurement	Description
+Pk	Positive peak frequency deviation.
-Pk	Negative peak frequency deviation.
RMS	RMS value of the frequency deviation.
Pk-Pk/2	Peak-to-peak frequency deviation divided by 2.
Pk-Pk	Peak-to-peak frequency deviation.

Measurements for PM modulation

Measurement	Description
+Pk	Positive peak phase deviation.
-Pk	Negative peak phase deviation.
RMS	RMS value of the phase deviation.
Pk-Pk	Peak-to-peak phase deviation.

Pulse Measurements

Measurement	Description
Average ON Power	The average power transmitted during pulse on.
Peak Power	Maximum power during pulse on.
Average Transmitted Power	The average power transmitted, including both the time the pulse is on and the time it is off, and all transition times.
Pulse Width	The time from the rising edge to the falling edge at the -3 dB / -6 dB level (50%) of the user selected 100% level. Level is user selectable for Volts or Watts.
Rise Time	The time required for a signal to rise from 10% to 90% (or 20% to 80%) of the user selected 100% level.
Fall Time	The time required for a signal to fall from 90% to 10% (or 80% to 20%) of the user selected 100% level.
Repetition Interval	The time from a pulse rising edge to the next pulse rising edge.
Repetition Rate	The inverse of repetition interval.
Duty Factor (%)	The ratio of the width to the pulse period, expressed as a percentage.
Duty Factor (Ratio)	The ratio of the pulse width to the pulse period.
Ripple	Ripple is the peak-to-peak ripple on the pulse top. It does not include any preshoot, overshoot, or undershoot. By default, the first 25% and the last 25% of the pulse top is excluded from this measurement to eliminate distortions caused by these portions of the pulse. If the Amplitude units selected in the Amplitude panel (affects all amplitude measurements for the analyzer) are linear, the Ripple results will be in %Volts. For log units, the Ripple results will be in %Watts. The default for the general Units control is dBm, so the Ripple results default is %Watts. See also Ripple (see page 429) .
Ripple dB	The Ripple measurement expressed in dB.
Droop	Droop is the power difference between the beginning and the end of the pulse On time. A straight-line best fit is used to represent the top of the pulse. The result is a percentage referenced to the Average ON Power.
Droop dB	The Droop measurement expressed in dB.
Overshoot	The amount by which the signal exceeds the 100% level on the pulse rising edge. Units are %Watts or %Volts.
Overshoot dB	The Overshoot measurement expressed in dB.
Pulse-Pulse Phase Difference	The phase difference between the selected pulse and the first pulse in the analysis window. The instantaneous phase is measured at a user-adjustable time following the rising edge of each pulse.

Measurement	Description
Pulse-Pulse Freq Difference	The difference between the frequency of the current pulse and frequency of the previous pulse. The instantaneous frequency is measured at a user-adjustable time following the rising edge of each pulse.
RMS Freq Error	The RMS Frequency Error measurement is the RMS average of the Freq Error vs. Time trace, computed over the Measurement Time.
Max Freq Error	The maximum frequency error is the difference between the measured carrier frequency of the signal and the user-selected center frequency of the analyzer.
RMS Phase Error	The RMS Phase Error measurement is the RMS average of the Phase vs Time trace, computed over the Measurement Time.
Max Phase Error	The phase is measured at each point during the pulse's ON time. The phase error for each point is the difference between the measured phase value and the calculated ideal phase value. After the phase error is calculated for all points in the acquisition record, the largest error in the positive direction and the largest in the negative direction are determined. Whichever of these two values has the greater absolute value is designated the Max Phase Error.
Freq Deviation	The Frequency Deviation measurement is the difference between the maximum and minimum measured values of the signal frequency during the Measurement Time.
Phase Deviation	The Phase Deviation is the difference between the maximum and minimum Phase values measured during the ON time of a pulse.
Impulse Response Amplitude	The difference in dB between the levels of the main lobe and highest side lobe.
Impulse Response Time	The difference in time between the main lobe and highest side lobe.
Time	This is the time in seconds relative to the time reference point in the first acquisition record in the data set.

Overview

The displays in the General Signal Viewing folder (Displays > Folders > General Signal Viewing) are:

- Amplitude vs Time
- DPX Spectrum
- Frequency vs Time
- Phase vs Time
- RF I & Q vs Time
- Spectrogram
- Spectrum
- Time Overview

These displays provide extensive time-correlated multi-domain views that connect problems in time, frequency, phase and amplitude for enabling you to more quickly understand cause and effect when troubleshooting.

DPX Primer

NOTE.

With the DPX display (which displays only DPX waveforms saved by SPECMON/RSA5000/RSA6000 Series Analyzers) you can detect and accurately measure transients as brief as 3.7 μ s (instruments with Option 200). The instrument computes up to 292,000 spectrums per second (up to 48,833 without Option 200) of the digitized input signal. Then it displays all these spectrums as a color-graded bitmap that reveals low-amplitude signals beneath stronger signals sharing the same frequency at different times.

The strong signal in the DPX spectrum graph, shown in Figure 1, is a repeating pulse at a fixed frequency. There is also a lower-power CW signal that steps very quickly through the same span. During the pulse's on time, the power of the two signals is additive, resulting in nearly undetectable differences in the pulse envelope shape. But during the time the pulse is off, the sweeping signal is detected and shown in its true form. Both signals are visible in the bitmap because at least one full cycle of their activities occurs within a single DPX display update.

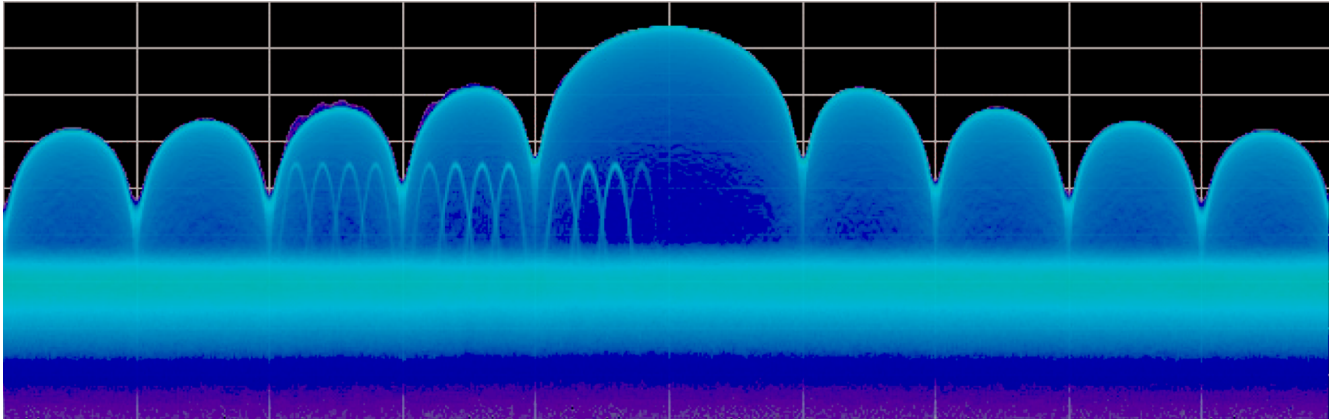

Figure 1

Compare the display of a traditional swept spectrum analyzer (Figure 2) and that of a real-time signal analyzer with a DPX display (Figure 3). The signal captured is a typical WLAN interchange between a nearby PC and a more-distant network access point (AP). The laptop signal is nearly 30 dB stronger than the AP's signal because it is closer to the measuring antenna.

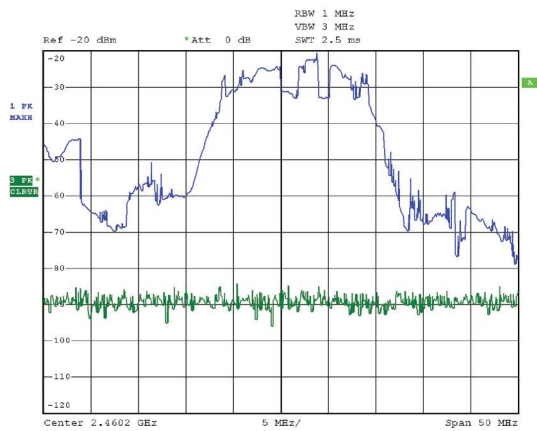

Figure 2

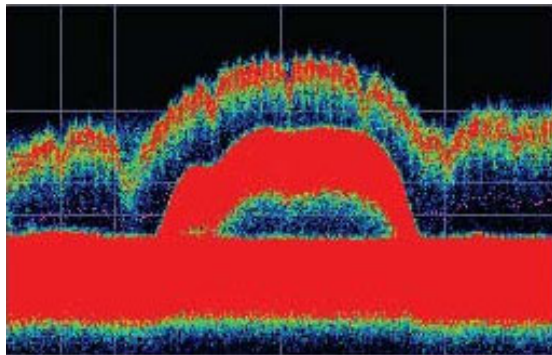

Figure 3

The traditional swept spectrum analyzer display, Figure 2, uses line traces that can show only one level for each frequency point, representing the largest, the smallest or the average power. After many sweeps, the Max Hold trace shows a rough envelope of the stronger laptop signal. +Peak detection was selected for the other trace in an attempt to capture the weaker but more frequent AP signal, but the bursts are very brief, so the likelihood of seeing one in any particular sweep is small. It will also take a long time to statistically capture the entire spectrum of a bursted signal due to the architecture of the swept spectrum analysis.

The DPX display, Figure 3, reveals much more insight on the same signal. Since it is a bitmap image instead of a line trace, you can distinguish many different signals occurring within each update period and/or different version of the same signal varying over time. The heavy band running straight across the lower third of the graph is the noise background when neither the laptop nor the AP is transmitting. The red lump of energy in the middle is the ON shape of the AP signal. Finally, the more delicate spectrum above the others is the laptop transmissions. In the color scheme used for this demonstration (“Temperature”), the hot red color indicates a signal that is much more frequent than signals shown in cooler colors. The laptop signal, in yellow, green and blue, has higher amplitude but doesn't occur nearly as often as the AP transmissions because the laptop was downloading a file when this screen capture was taken.

How DPX Works

This section explains how DPX displays are created. The input RF signal is conditioned and down-converted as usual for a signal analyzer, then digitized. The digitized data is sent through an FPGA that computes very fast spectral transforms, and the resulting frequency-domain waveforms are rasterized to create the bitmaps.

The DPX bitmap that you see on screen is composed of pixels representing x, y, and z values for frequency, amplitude, and Density (instruments without Option 200 provide hit count as the z-axis value in place of Density). A multi-stage process, shown in Figures 4a - 4d, creates this bitmap, starting with analog-to-digital conversion of the input signal.

Simplified Flow of Multi-stage Processing from RF Input Through to Spectrum Processing:

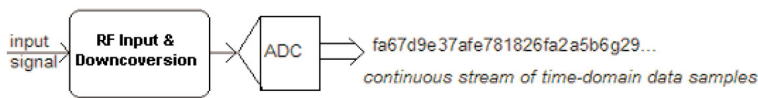

Figure 4a. RF signals are downconverted and sampled into a continuous data stream.

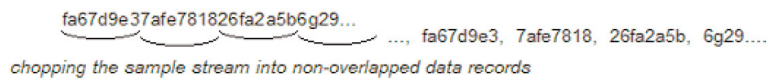

Figure 4b. Samples are segmented into data records for FFT processing based on the selected resolution bandwidth.



Figure 4c. Data records are processed in the DPX transform engine

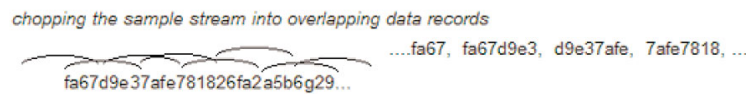

Figure 4d. Overlapping the FFTs shortens the minimum event duration required for 100% probability of intercept.

Collecting spectral data. Sampling and digitization is continuous. The digitized data stream is chopped into data records whose length is based on the desired resolution bandwidth (RBW). An additional requirement is placed on FFT length by the desired number of points in a trace (instruments with Option 200). Table 1 shows this relationship and the FFT length is reported in the display if desired. Then the DPX transform engine performs a discrete Fourier transform on each record, continually producing spectral waveforms.

- RF signals are downconverted and sampled into a continuous data stream.
- Samples are segmented into data records for FFT processing based on the selected resolution bandwidth.
- Data records are processed in the DPX transform engine.
- Overlapped processing is used to improve minimum event duration performance.

Table 1: Minimum FFT length versus trace length – independent of span and RBW (RSA6100B Series and RSA5100A Series with Option 200)

Trace length (points)	Minimum FFT length
801	1,024
2,401	4,096

Table 1: Minimum FFT length versus trace length – independent of span and RBW (RSA6100B Series and RSA5100A Series with Option 200) (cont.)

Trace length (points)	Minimum FFT length
4,001	8,192
10,401	16,384

As long as spectral transforms are performed faster than the acquisition data records arrive, the transforms can overlap each other in time, so no events are missed in between. Minimum event length for guaranteed capture depends on the length of the data records being transformed. An event must last through two consecutive data records in order for its amplitude to be accurately measured. Shorter events are detected and visible on screen, but may be attenuated. The DPX Spectrum RBW setting determines the data record length; narrow RBW filters have a longer time constant than wide RBW filters. This longer time constant requires longer FFTs, reducing the transform rate. Additional detail on minimum signal duration is provided in [Guaranteed Capture of Fast Events \(see page 49\)](#).

The spectral waveforms are plotted onto a grid of counting cells called the “bitmap database”. The number held by each database cell is the z-axis count. For simplicity, the small example grid used here in Figure 6 is 11x10, so our spectral waveforms will each contain 11 points. A waveform contains one (y) amplitude value for each (x) frequency. As waveforms are plotted to the grid, the cells increment their values each time they receive a waveform point.

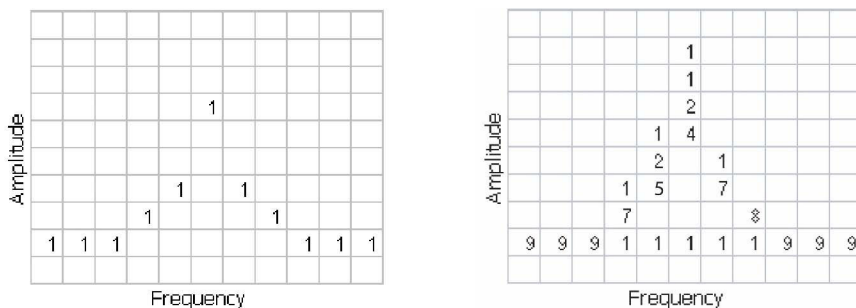

Figure 5. Example 3-D Bitmap Database after 1 (left) and 9 (right) updates. Note that each column contains the same total number of “hits”.

The grid on the left shows what the database cells might contain after a single spectrum is plotted into it. Blank cells contain the value zero, meaning that no points from a spectrum have fallen into them yet.

The grid on the right shows values that our simplified database might contain after an additional eight spectral transforms have been performed and their results stored in the cells. One of the nine spectrums happened to be computed as a time during which the signal was absent, as you can see by the string of “1” occurrence counts at the noise floor.

Frame updates. The maximum rate for performing the variable-length frequency transforms that produce those waveforms can be greater than 292,000 per second. Measurement settings that slow this transform rate include narrowing the RBW and increasing the number of points for the line traces available in the DPX display along with the bitmap. Even at their slowest, spectral transforms are performed orders of magnitude faster than a physical display can respond, and also too fast for humans to see, so there's no

need to update the screen or measurements at this rate. Instead, the grid collects thousands of waveforms into “frames”, each covering about 50 milliseconds (ms). A 50 ms frame contains the counts from up to 14,600 waveforms. After each frame's waveforms have been mapped into the grid, the cell occurrence counts are converted to colors and written to the DPX bitmap, resulting in a bitmap update rate of around 20 per second.

Frame length sets the time resolution for DPX measurements. If the bitmap shows that a -10 dBm signal at 72.3 MHz was present for 10% of one frame's duration (5 ms out of 50 ms), it isn't possible to determine just from the DPX display whether the actual signal contained a single 5 ms pulse, one hundred 50 microsecond (μ s) pulses, or something in between. For this information, you need to examine the spectral details of the signal or use another display with finer time resolution, such as Frequency vs. Time or Amplitude vs. Time.

Converting occurrence counts to color. About 20 times per second, the grid values are transferred to the next process step, in which the z-axis values are mapped to pixel colors in the visible bitmap, turning data into information (Figure 6). In this example, warmer colors (red, orange, yellow) indicate more occurrences. The color palette is user-selectable, but for now we will assume the default “temperature” palette.

Number of Occurrences	Color
0	black
1	blue
2	light blue
3	cyan
4	green blue
5	green
6	yellow
7	orange
8	red orange
9	red

Figure 6. Example Color-mapping algorithm

The result of coloring the database cells, Figure 7, according to the number of times they were written into by the nine spectrums, one per pixel on the screen, creates the DPX displays.

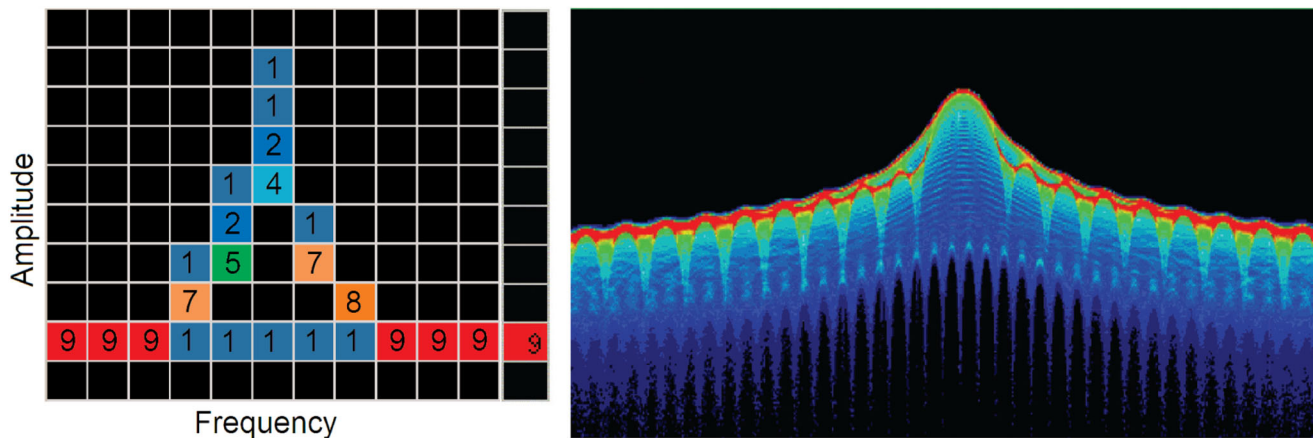

Figure 7. Color-coded low-resolution example (left) and a real DPX display (right).

In addition to the choice of palette, there are z-axis scaling adjustments for Maximum, Minimum, and Curve. Maximum sets the occurrence value that will be mapped to the highest color in the palette. Minimum sets the occurrence value for the lowest color. In the “temperature” palette, the highest color is deep red and the lowest is dark blue. Occurrence values less than the selected Minimum are represented with black pixels, while pixels that exceed the selected Maximum are red in hue but somewhat transparent. Values between Maximum and Minimum are represented by the other colors of the palette.

Adjusting the Minimum above the black default allows you to concentrate most of your color resolution over a small range of medium or higher occurrence rates to visually discriminate between different signals that have nearly equal probability values.

To see why adjustable color scaling is useful compare Figures 8 and 9. On the Scale tab, the Max control is set to 100% in Figure 8. The range of colors now covers the full z-axis range of densities from 0 to 100%. The signals used to create this bitmap are fairly diffused in both frequency and amplitude, so most pixels have low occurrence counts or density values and the upper half of the color palette is unused.

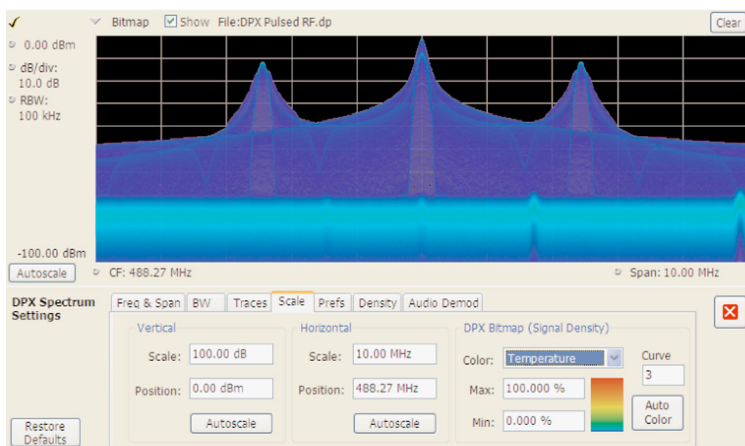

Figure 8. DPX spectrum bitmap with default color scale settings.

When the Auto Color button is selected, the Maximum control's value is set to the highest pixel value in the current bitmap, shown in Figure 9. Now none of the available colors remain unused. The entire palette is mapped to the occurrence values present at the time the button is selected, providing better visual resolution for low densities. Selecting the Autoscale button in the DPX display scales all three axes based on current results.

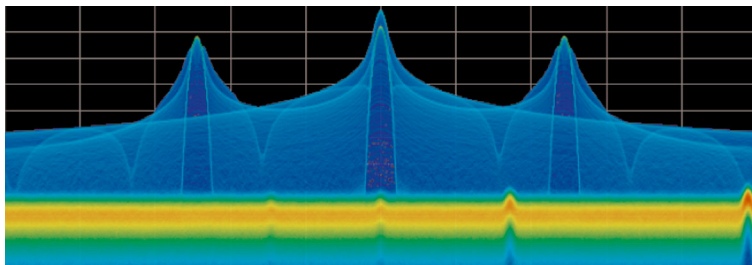

Figure 9. The Auto Color function optimizes the color scale settings.

Color Mapping Curves

The mapping between z-axis values and color does not have to be linear. The Curve control lets you choose the shape of the mapping equation. A Curve setting of 1 selects the straight-line relationship. Higher Curve numbers pull the curve upwards and to the left, concentrating color resolution on lower densities. Settings less than 1 invert the curve, moving the focus of the color range towards higher density values. Figure 10 shows the mapping curves.

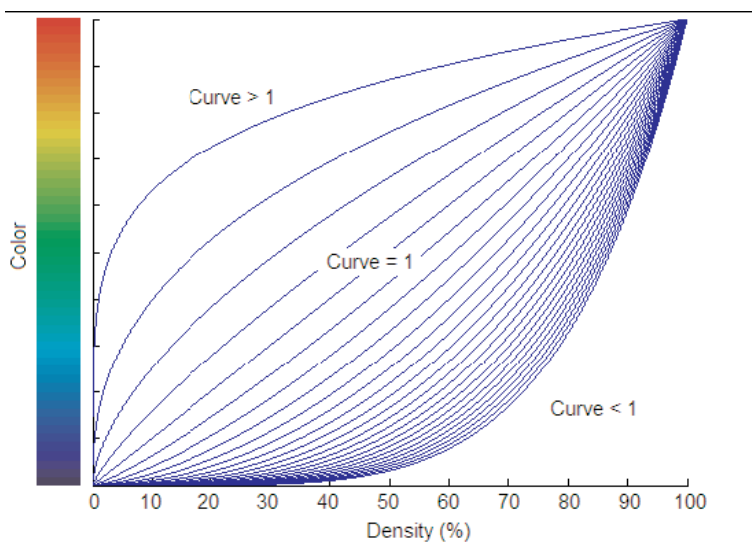

Figure 10. Representative color mapping curves for the “Temperature” palette.

Using the same signal shown in Figures 8 and 9, the impact of the Curve control can be observed. With the Curve control set to 1 in the Scale tab, shown in Figure 11, the mapping between color and density is linear, so the colors spread evenly across the full density range. The color distribution is visible in the colored palette illustration to the left of the Curve control in the Settings panel.

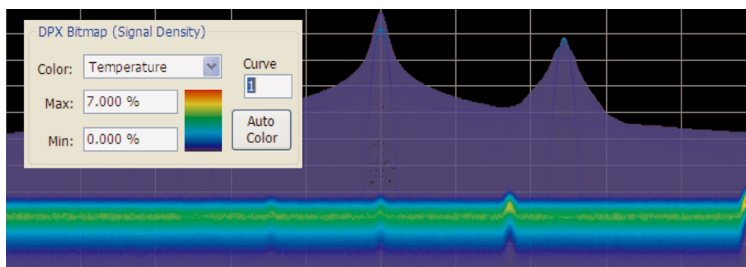

Figure 11. Over a narrow Signal Density range, the color curve is set to 1.

When the Curve control is set to 0.5, as shown in Figure 12, the best color resolution is in the upper half of the density range, and only the dark blues are assigned to densities below 50%. Note the difference in the palette illustration.

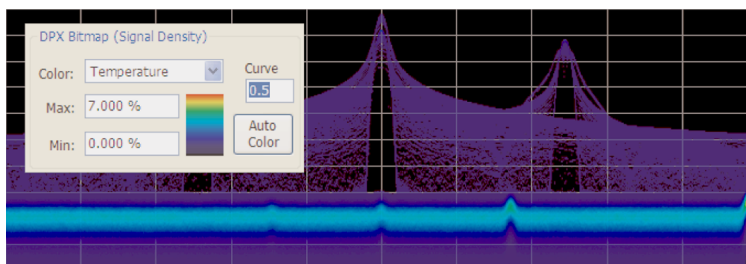

Figure 12. Adjusting to values less than 1, increases the contrast for viewing events in the top half of the selected density range.

In Figure 13, the Curve control is increased to 3. The majority of colors shifts to the lower half of the density scale, but various shades of orange and red are still available for densities above 50%.

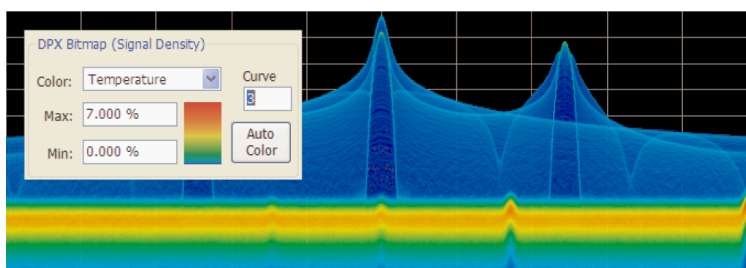

Figure 13. For color curve settings greater than 1, better contrast is provided for events near the low end of the density range.

Swept DPX

DPX Spectrum is not limited in span by its real-time bandwidth. Like the regular Spectrum display, DPX Spectrum steps through multiple real-time frequency segments, building a wide-span display with line traces and the bitmap (instruments with Option 200). See Figure 14.

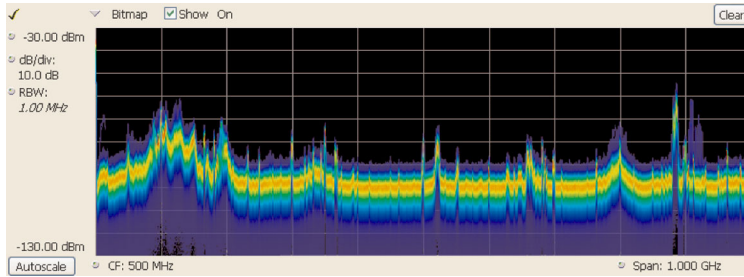

Figure 14. Off-air ambient signals over a 1 GHz span in the swept DPX display.

The analyzer “dwells” in each frequency segment for one or more DPX frames, each containing the results of up to 14,600 spectral transforms. Dwell time is adjustable, so you can monitor each segment of the sweep for up to 100 seconds before moving to the next step. While dwelling in a segment, the probability of intercept for signals within that frequency band is the same as in normal, real-time spans: 100% capture of events as short as 10.3 μ sec.

A full pixel bitmap is created for every segment and compressed horizontally to the number of columns needed for displaying the frequency segment. Compression is done by averaging pixel densities of the points being combined together. The final swept bitmap contains a representation of the same pixel bitmap resolution, just like the non-swept bitmaps. Line traces are also created in full for each segment, and then horizontally compressed to the user-selected number of trace points for the full span.

A complex algorithm for determining the number and width of each frequency segment has been implemented. The variables in the equation include user-adjustable control settings like Span, RBW, and number of trace points, RF and IF optimization, and Acquisition BW. Installed hardware options also can affect the span segmentation. The number of segments ranges from 10 to 50 for each 1 GHz in a sweep.

A helpful piece of information for operators is the actual Acquisition Bandwidth used for capturing each segment. “Acq BW” is shown in the Acquire control panel on the Sampling Parameters tab. Acq BW is typically set automatically by the instrument, based on the needs of all the open displays, but can also be set manually. In either case, the displayed bandwidth is used for every frequency segment in the swept DPX display, though in practice, the displayed portion of the segment is somewhat narrower than the actual Acquisition BW, for performance reasons.

The entire instrument frequency range of many GHz can be covered in a DPX sweep. The Dwell Time control sets the amount of time DPX spends in each segment. This control, circled in Figure 15, can be set between 50 ms and 100 seconds.

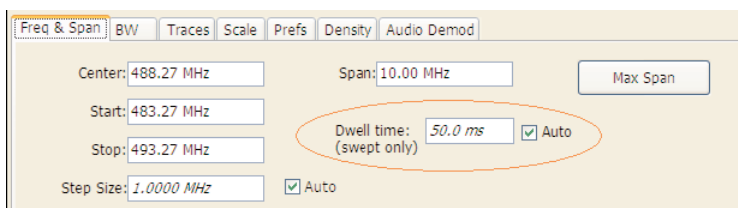

Figure 15. During swept DPX operation, the Dwell time control adjusts the observation time of each frequency segment used to construct the composite DPX display.

Guaranteed Capture of Fast Events

The main reason that swept-tuned and step-tuned spectrum analyzers can't provide 100% Probability of Intercept, POI, for a signal that isn't continuously present is that they spend only a short period of time tuned to each segment of their frequency span during each sweep. If something happens in any part of the span other than where it is tuned at that instant, that event will not be detected or displayed. There is also a period of time between sweeps, retrace time, during which the analyzer is not paying attention to the input signal. FFT-based analyzers, including vector signal analyzers, also miss signals during the time between acquisitions. Their POI depends on a combination of factors including span, number of FFT points, acquisition time, memory read/write time, and signal processing speed. Vector analyzers process information sequentially, so when read/write from data and processing is occurring, data is not being acquired.

RSAs, on the other hand, capture data across all frequencies within their real-time span during every acquisition. With Tektronix' exclusive Frequency Mask trigger and DPX Density trigger, POI increases to 100%, insuring capture of any spectral event matching the trigger definition. When operating in free run as a simple signal analyzer, the RSA has a POI similar to other FFT-based analyzers, with gaps between each acquisition. Processing is done concurrent with the acquisitions.

Guaranteed Capture in DPX Real-Time Spans

The DPX display captures any signal that is at least 10.3 microseconds long (instruments with Option 200) and within the real-time bandwidth. This performance is possible because the SPECMON computes up to 292,000 spectrum transforms per second. The faster the spectrum updates, the shorter the time between acquisitions and the greater the probability that any signal will be detected.

Table 1 shows the specified minimum signal duration (MSD) for 100% probability of intercept under various combinations of Span and RBW in DPX for a representative RSA model. As you can see, MSD is affected by multiple factors.

Table 2: Minimum signal duration specifications for RSA6100B series signal analyzers ¹

Span (MHz)	RBW (kHz)	Span/RBW Ratio	FFT Length	Spectrum/sec	MSD for 100% POI (µs)
110	10000	11	1024		3.7
110	1000	110	1024	292,969	5.8
110	300	367	2048	146,484	14.8
110	100	1100	4096	73,242	37.6
110	30	3667	16384	18,311	134.6
110	20	5500	32768	9,155	229.2

¹ With Options 110 under various combinations of control parameters.

To demonstrate the POI in action, a challenging bi-stable signal is used. A CW sinusoid sits at 2.4453 GHz most of the time, but every 1.28 seconds, its frequency changes for about 100 µs before returning to normal. The duty factor of this transient is less than 0.01%.

Figure 16 shows a swept analyzer set up for a 5-second sweep of its MaxHold trace. It shows that there is something occurring around the signal. This sweep rate was empirically determined to be the optimum rate

for reliable capture of this signal in the shortest time. Faster sweep times can reduce the probability of intercept and result in fewer intersections of the sweep with the signal transient.

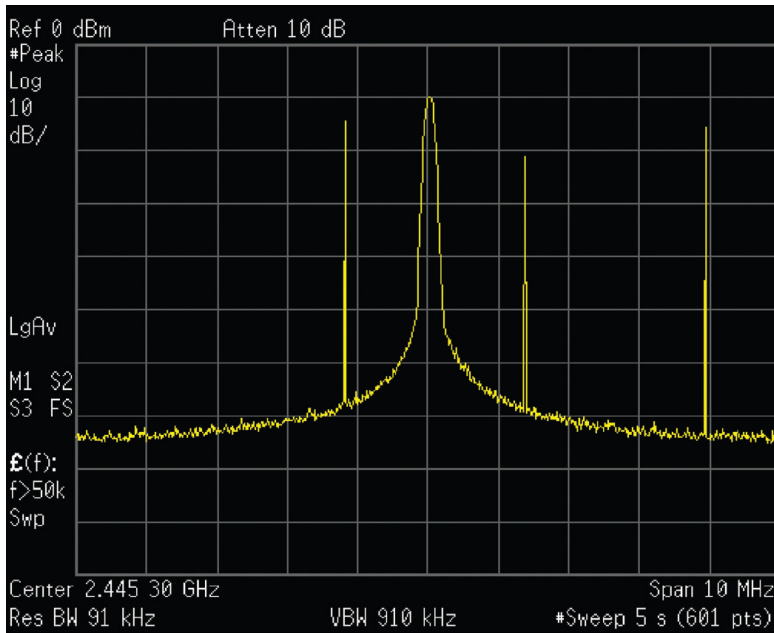

Figure 16. Swept spectrum display of the infrequent transient.

The DPX display shown in Figure 17 shows the exact same event, also captured over a 5 second period. A lot more information can be discovered about the transient. It is obvious at first glance that the signal is hopping by about 3 MHz, with 1.2 MHz of frequency overshoot on transitions

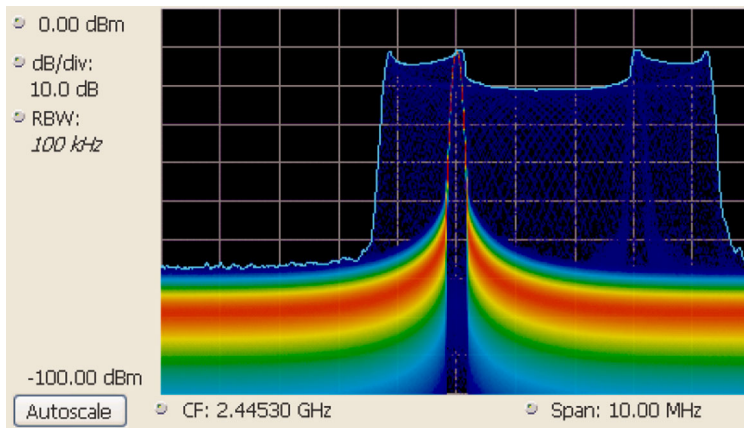

Figure 17. The DPX spectrum display after 5 seconds. The MaxHold trace is cyan.

Guaranteed Capture in DPX Swept Spans

Probability of intercept (POI) for signals within a single segment, while DPX is dwelling in that segment, is the same as for non-swept DPX operation (POI = 100% for events as brief as 10.3 microseconds). But just as in traditional swept analyzers, during the time the acquisition is tuned to any one segment, the analyzer is not monitoring signals in any of the other segments, so probability of capture in segments other than the current one is zero. Because of the wide real-time bandwidth, the number of segments needed to cover the span is much less than for swept analyzers, so the overall probability of intercept is significantly better for DPX sweeps.

Another factor affecting POI is number of trace points. The bitmap is always 801 points wide, but the line traces allow user selection for number of points. 801 is the default and the other choices are 2401, 4001, and 10401. Frequency transforms for traces containing more than 801 points take longer, and this lower waveform update rate increases the minimum signal duration proportionally. This caution applies for swept and non-swept operation. The trace length control is on the Prefs tab in the DPX control panel.

DPX Density Measurements

“Density” is a measure of the amount of time during a defined measurement period during which signals are present within a particular area of the DPX Spectrum bitmap. A clean CW tone gives a 100% reading, while a pulse that is on for one microsecond out of every millisecond reads 0.1%. This section describes how density is computed from hit counts.

If we plot 41 more waveforms into the example grid we used previously in Figure 6 (in addition to the nine we already plotted), each column ends with a total of 50 hits (Figure 18). The density for any one cell in a column is its own count value divided by 50, expressed in percent as shown in Figure 19. The math is very simple: a cell with 24 counts has a 48% density. In practice, instead of batches of 50 waveforms, we collect a frame of thousands of waveforms before each update to the density bitmap.

					4					
					6					
					13					
					18					
				1	3	1				
		1	2	4		4				
1	2	1	43	41	2	38	6	1	2	2
47	46	47	5	4	3	7	43	47	46	47
2	2	1			1		1	2	2	1

Figure 18. Grid showing cell counts after 50 waveforms. For each column, the sum of z-axis values is 50.

0%	0%	0%	0%	0%	0%	0%	0%	0%	0%	0%
0%	0%	0%	0%	0%	8%	0%	0%	0%	0%	0%
0%	0%	0%	0%	0%	12%	0%	0%	0%	0%	0%
0%	0%	0%	0%	0%	26%	0%	0%	0%	0%	0%
0%	0%	0%	0%	0%	36%	0%	0%	0%	0%	0%
0%	0%	0%	0%	2%	6%	2%	0%	0%	0%	0%
0%	0%	2%	4%	8%	0%	8%	0%	0%	0%	0%
2%	4%	2%	86%	82%	4%	76%	12%	2%	4%	4%
94%	92%	94%	10%	8%	6%	14%	86%	94%	92%	94%
4%	4%	2%	0%	0%	2%	0%	2%	4%	4%	2%

Figure 19. Grid after converting occurrence counts to percent density values. The sums of the cell density measurements within each column are all 100%.

Measuring Density with Markers

Hit counts are cleared after every frame update, as long as Persistence is not turned on. The density value for any pixel is simply the percent of time it was occupied during the most recent 50 ms frame. Markers can be used to see the Density value for one or more individual points on the screen, enabling measurements of the signal density at any interesting point in the DPX display.

In Figure 20, Wireless LAN signals are analyzed in the presence of a Bluetooth radio signal in the 2.4 GHz ISM band.

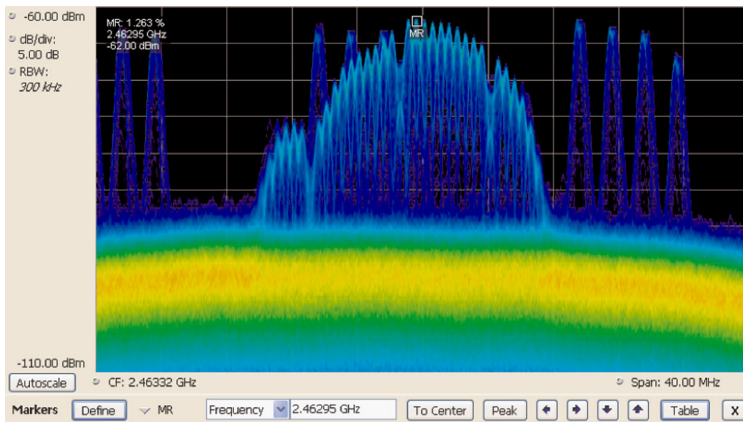

Figure 20. DPX display of WLAN and Bluetooth signals, with a marker on the highest signal.

The “Marker to Peak” function was used to find the peak signal recorded in the display. The marker readout in the upper left corner of Figure 20 shows the Density, Amplitude, and Frequency for the pixel you selected with the marker. By adding additional markers, you can measure the signal density differences between multiple signals of interest.

Marker Peak Search in the DPX Bitmap

Markers on the DPX bitmap can search for peaks, similar to marker peak searching on spectrum line traces. For a human, it is pretty easy to discern “signals” in the bitmap picture. Your brain intuitively identifies strings of contiguous bright pixels. This isn't so easy for a computer. The first thing the RSA must do for any peak search is analyze pixel density values to identify apparent signals. Then it can sift through these density peaks for the amplitude peaks you want to find.

Z-axis density values for the pixels in each column of the bitmap are internally converted into histograms to find density peaks indicating the presence of signals. Table 2 shows the five middle columns from the example grid we used to illustrate density measurements in a previous section (Figure 19). The density values for each pixel in the middle, highlighted column are plotted on the y axis in the bar chart in Figure 21. The bar chart x axis is bitmap row number, numbering from the top of the table.

Table 3: Bitmap section showing density values.

0%	0%	0%	0%	0%
0%	0%	8%	0%	0%
0%	0%	12%	0%	0%
0%	0%	26%	0%	0%
0%	0%	36%	0%	0%
0%	2%	6%	2%	0%
4%	8%	0%	8%	0%
86%	82%	4%	76%	12%
10%	8%	6%	14%	86%
0%	0%	2%	0%	2%

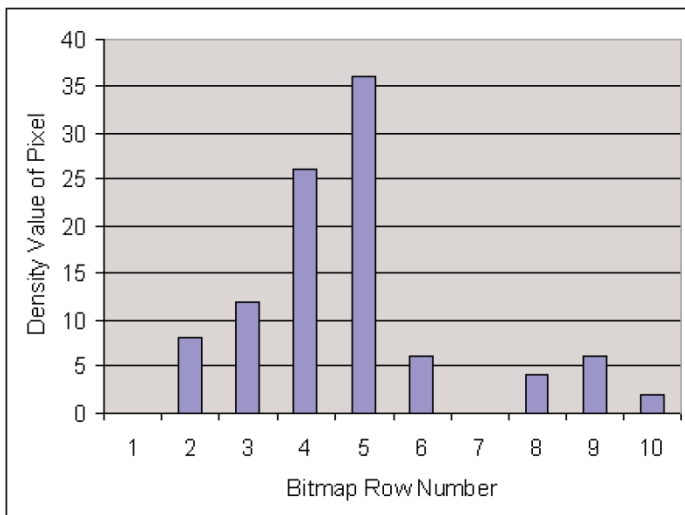

Figure 21. Bar chart of the density values in the bolded column of Table 2.

Assume that Density Threshold is set to 5% and Density Excursion to 5% also. Starting with x=1 in the bar chart, test each bar against the threshold. The threshold criteria is met at x=2. Keep testing until you

find a bar that is shorter than the previous bar by at least the Excursion setting. In this case it is $x=6$. This tells us that a “signal” covers rows 2 through 5. Its density peak is at row 5.

Now you can look for another peak. Continue looking at bars to the right and you will find a density value at row 9 that meets the threshold criteria, but since there are no bars to the right of it that meet the excursion criteria, we can't declare row 9 a signal because it fails to meet the excursion criteria. If row 1 had 1% density, then row 9 would be a density peak.

Once density peaks are found for all columns in the bitmap, we can start looking for the amplitude peaks. When the **Peak** button is selected, the analyzer checks the histograms of every column in the bitmap and finds the density peak with the highest amplitude. The amplitude search has its own versions of Threshold and Excursion settings, but in dBm and dB units. When **Next Peak Down** command is given, the search will scan inside the current column for the next density peak. **Next Peak Right** examines each column to the right of the current marker location to locate density peaks that also meet the amplitude peak criteria.

To demonstrate the value of marker peak search in the DPX bitmap, we will use the time-multiplexed signals showing multiple amplitude levels from an example earlier in this manual. The **Peak** button and its menu equivalent place the active marker on the peak signal in Figure 22. The peak signal is the density peak of highest amplitude in the bitmap.

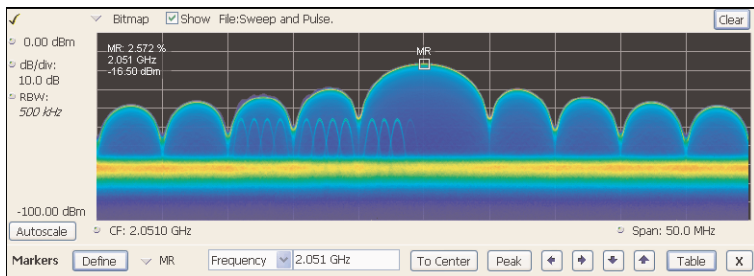

Figure 22. The marker was positioned by selecting the Peak button. Density, frequency, and amplitude measurements at the marker are displayed in the upper left corner of the graph.

The Marker Toolbar, at the bottom of Figure 22, allows easy navigation of peak signals (**Peak Left**, **Peak Right**, **Next Peak Up**, or **Next Peak Down**). Selecting the arrow keys enables the marker to search for amplitude/density peaks at other frequencies, while the **Next Peak Up** and **Next Peak Down** arrows enable the marker to search for other high-density points at the same frequency.

In the Define Peaks tab of the Define Markers control panel, Figure 24, you can adjust the density threshold and excursion controls to modify search behavior. The amplitude threshold and excursion controls also apply to DPX marker searches. Smoothing keeps the marker from finding multiple peaks within the same apparent signal by averaging an adjustable number of pixel densities together, but it does not affect the single-pixel measurement readout displayed by the marker.

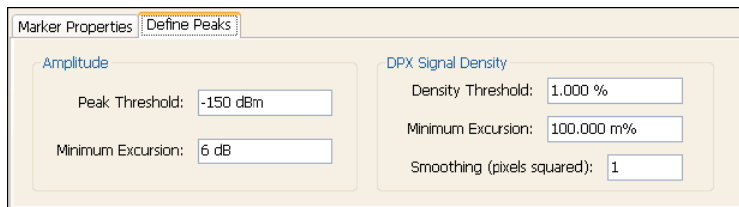

Figure 24. Amplitude and Signal Density controls can be adjusted to define Peak search behavior.

Density Measurements over an Adjustable Area (“The Box”)

The density for a single pixel is its ratio of actual hits vs. possible hits over a defined time period, and markers display these density values. For measuring density over an area larger than one pixel, the DPX display (instruments with Option 200) includes a measurement box you can resize and drag around in the DPX display with your mouse or finger.

If you could make the box so narrow that it contained only points within a single column of pixels, the density of this area would be the sum of the included pixels' density values. For example, if the box was three pixels tall and the density values for these pixels were 4, 2, and 7% respectively, the overall density for the three-pixel area would be 13%. Imagine a box one pixel wide and as tall as the graph. Assume that the input signal's amplitude was such that all hits fell at or near the vertical center of the screen. Since 100% of the waveforms written to the bitmap passed through the box, the density for the box is 100%.

$$\text{Density of an area} = \frac{(\text{Sum of densities of all pixels})}{(\text{Number of columns})}$$

When you widen the box to cover a broader range of frequencies, software computes the density sum for the included pixels in each column inside the box. The aggregate density value for this box is the average density, calculated by adding the column density sums then dividing by the number of columns. For a 100% result, there must not be any hits above the top edge of the box or below its bottom edge. In other words, every waveform drawn across the graph entered the box through its left side and exited the box through its right side, with no excursions out the top or bottom. Figure 24 demonstrates this principle on a CW signal. As you can see on the left-hand side, no amplitudes exist above or below the box; the density of the signal is 100%. On the right hand side, there are signals below the box, therefore the density is less than 100%.

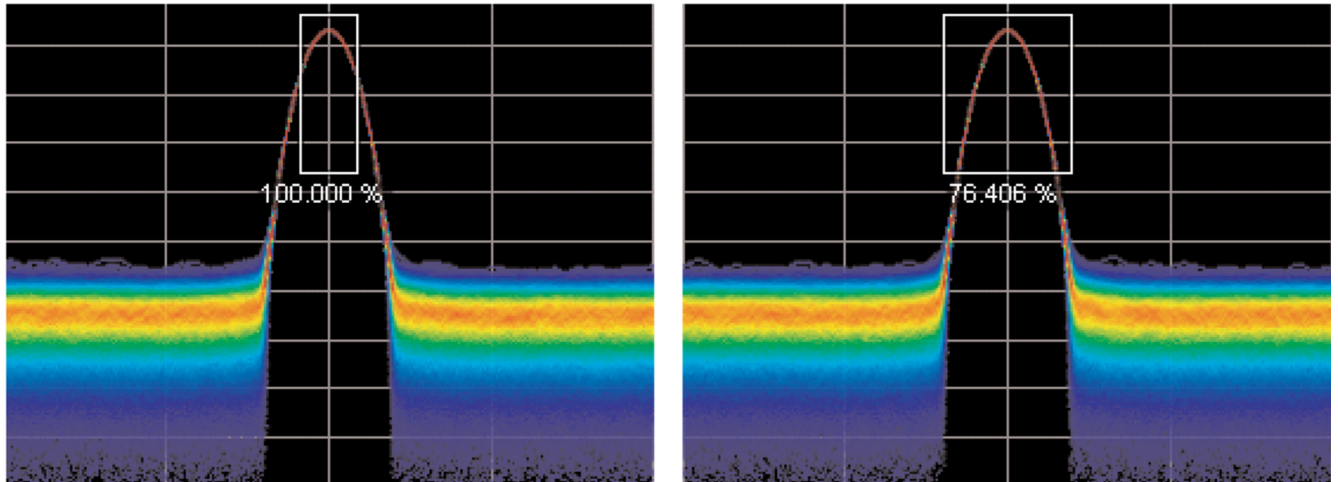

Figure 24. Density of signals defined within an area. Left: Correct measurement of a CW signal. All columns in the box include the signal. Right: Incorrect measurement area. The measurement is accurate, but probably not what you expected. Some columns in the box contain no hits, so they contribute zeros to the calculation of average density.

The density measurement box' vertical size and location are always set in dB and dBm, no matter what units you have selected for measurements. (Amplitude control panel > Units tab) The box is not draggable when the selected units are linear (such as Amps, Volts, Watts...), though you can still adjust its size and location using the Frequency and Amplitude controls in both the DPX Settings > Density and Trigger > Event tabs. Since the vertical scale is non-linear, a box of constant amplitude changes visual height as it changes vertical position, a disconcerting effect if you are trying to drag it.

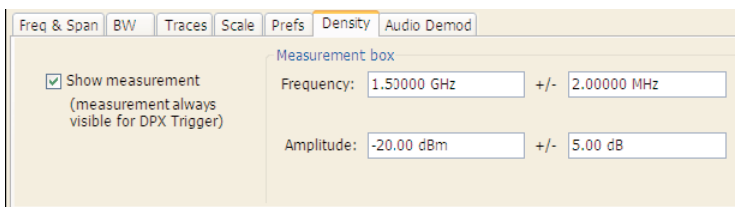

Figure 25. DPX Density control panel is used to define the area of interest for DPX density measurements.

A readout will appear somewhere in the graph. If the box is off-screen, the readout will be accompanied by an arrow pointing towards the invisible box. Grab this readout with your mouse or finger and drag the density readout to the area you want to measure.

To adjust the box size, a mouse is the easiest way to drag the sides and corners of the rectangle. For precise settings, use the knob, arrow keys, or keyboard to adjust frequency and amplitude values for the rectangle. These controls are located in the right half of the Density tab in the control panel.

Persistence

Previous sections of this topic have assumed that persistence was not applied to the DPX bitmap. Without persistence, hit counts in the grid are cleared after each frame update. Now we will describe how

persistence modifies this behavior, starting with infinite persistence because it is simpler than variable persistence.

Hit counts are not cleared between frames if infinite persistence is enabled. When the instrument is set up for continuous acquisitions, hits keep collecting until you stop acquisitions or click the Clear button above the DPX display. Software keeps track of the total number of waveforms computed during the entire collection period. Density equals the total number of hits to a cell divided by the total number of waveforms.

Variable persistence is trickier. A single-occurrence signal shown in the bitmap does not disappear suddenly upon the next frame update, nor does it linger forever. It fades gradually away. The user sets a time constant for the Dot Persistence control which determines how long it takes for signals to fade. Fading is accomplished by reducing the hit count in every cell, after each frame update, by a factor based on the persistence time constant. The longer the time constant, the less the hit counts are reduced.

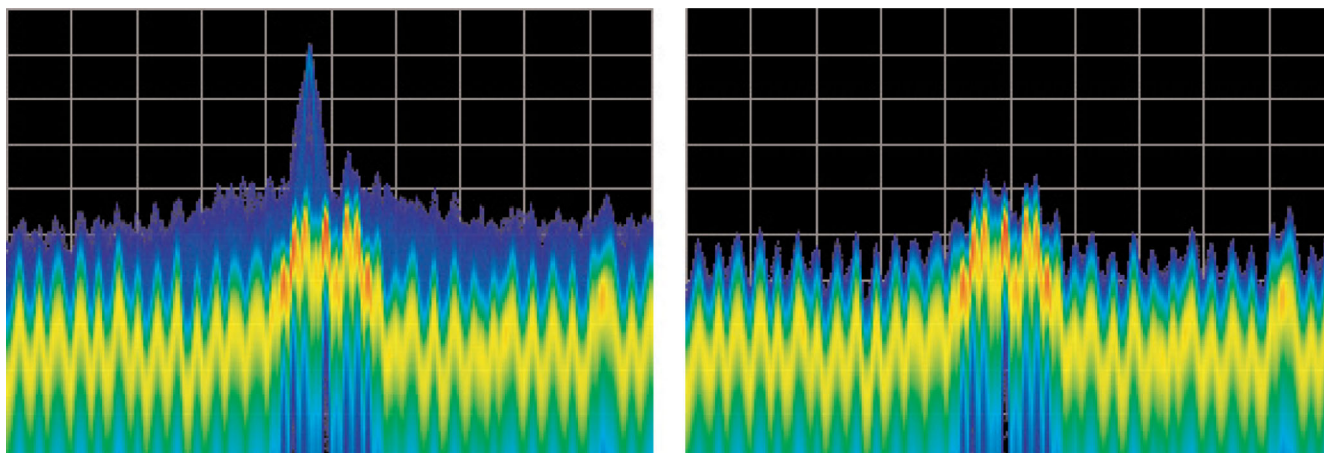

Figure 26. Example of fast transient discovery with and without variable persistence turned on. In the display on the left, with variable persistence of 10 seconds, the occasional sub-second transient that spikes up above the normal signals is held in the display rather than disappearing as soon as the signal goes away. The display on the right, with persistence turned off, requires watching the display continually to see the brief signal.

Not only are single-occurrence signals allowed to remain in the display for awhile by variable persistence, additional hits keep piling on. The result is that cell values are no longer pure hit counts; they include counts due to new hits from waveforms plus proportionally reduced counts from prior frames. As part of translating hit counts into density values, a new software algorithm uses a finite-series equation to discriminate between the effects of persistence and the arrival of new hits. The inflationary effects of persistence on cell counts are removed, so density readings represent the true ratio of actual hits to possible hits over the persistence interval.

The density computation for variable persistence is a very good estimate of true signal density, with errors of less than 0.01%. For exact density measurements, use either no persistence or infinite persistence.

Another subtlety of persistence is its smoothing effect on the density measurement of intermittent signals. Consider a pulse that is on for 10 ms and off for 90 ms of each 100 ms cycle. We'll make the simplifying assumption that the pulse ON time always falls entirely within a single DPX frame update (50 ms). If persistence is not applied, the density measurement is computed on each individual frame. The results will be 20% for each frame containing the ON time and 0% for the other frames. If infinite persistence

is enabled, however, the density measurement will settle to 10% after the second frame, and remain at this value for as long as the pulsing continues. With persistence, the density is effectively computed over many frames.

Persistence Effects on Density

Persistence does not alter colors in a density-based bitmap. Its effect is to extend the amount of time over which densities are calculated, leaving signal events visible for the persistence duration.

Before the introduction of density measurements and extra-long hit counters, persistence caused colors to “bloom”, becoming more and more intense over time as the hit counts increased. Longer persistence intervals caused increased blooming, turning crisp signals into fat red stripes. When hit counts are converted to density values (instruments with Option 200), the display is not subject to this effect. As long as the input signals maintain reasonably stable repetition rates and duty ratios, their density values will also remain stable despite ever-increasing hit counts in the underlying grid cells.

If you are accustomed to the original hit-count-based persistence displays, it may seem counter-intuitive that repeating signals in a density-based bitmap will not get brighter and redder over time with infinite persistence. A quick review of the density algorithm explains why: the hit count is divided by the total number of waveforms over the persistence interval. For example, if a signal occupies a pixel 50% of the time over a period of 15 minutes, the density reading will be 50% throughout the entire 15 minutes, though the underlying hit count is steadily increasing.

Z-Axis Resolution

Another factor that can cause color bloom is overflow of the hit counters. If a pixel could only count up to 1000 hits, its density and color values would clip at 100% after just 1000 hits, even if waveform points continue to arrive in the same pixel location. With waveform points being written to the bitmap at rates approaching 300k/sec, counts add up really fast for highly-repetitive signals. Deeper counters permit higher hit counts, so overflow happens much later, as shown in Table 3.

Table 4: Comparison of DPX z-axis resolution and its effect on saturation.

	SPECMON Series with Option 200
Hit Count	36-bit custom float (equivalent to 33-bit integer)
Maximum Hit Count	2^{33}
Minimum Time until Overflow (for pixels with 100% density)	8.1 hours

Clipping due to overflow of the counters in one or more cells will not occur until hours have passed, or even days.

One more benefit to having deeper hit counters is better visual resolution of density. RSAs with the highest-performance DPX hardware installed use floating-point numbers to count hits, allowing us to count billions of waveforms while retaining one-hit resolution, providing better than 99 dB of dynamic range for density measurements. Density measurements in $\mu\%$, $n\%$, and even $f\%$ ranges are quite possible for extremely rare signals captured with infinite persistence.

With straight-line mapping between density and color (Curve setting of 1), resolution is fixed by the number of colors in the palette. For non-linear mappings (Curve settings higher or lower than 1), most

of the colors are concentrated at either the low or high end of the density scale, so you can visually discriminate finer differences between density values in that range.

Persistence Adjustments

Dot Persistence can be enabled for the “Bitmap” trace using the Settings control panel. The Persistence can be displayed as Infinite or Variable. For Variable Persistence, you can select the time constant for fading in seconds as shown in Figure 27.

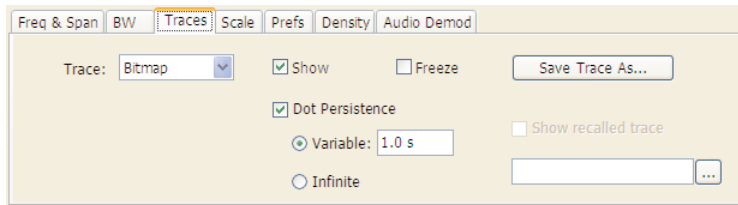

Figure 27. The trace settings control panel allows user control of persistence parameters.

Figure 28 demonstrates the observed behavior of variable persistence when a CW signal, represented in the first frame, is turned off. Even if the event was instantaneous and was confined within a single frame, you will observe the color changing to indicate lower and lower density values, until the signal finally disappears entirely.

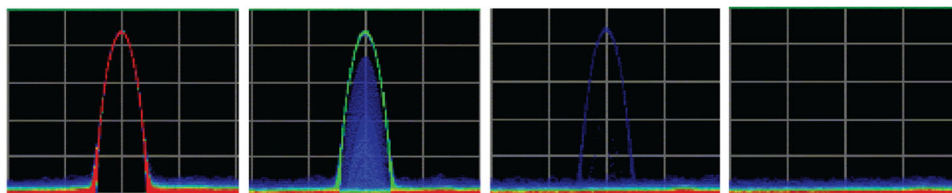

Figure 28. With variable persistence, a brief CW signal captured by DPX remains in the display for an adjustable period of time before fading away.

DPX Density Trigger

The standard DPX display shows you a clear picture of transients and other hard-to-find signals. The version of DPX in instruments with option 200 goes well beyond helping you discover these difficult to find signals by actually triggering on their appearance to capture them into acquisition memory for in-depth analysis. If you can see it in the DPX bitmap, you can trigger on it.

Other trigger methods can detect signals that exceed an amplitude threshold, or even a sophisticated amplitude-vs-frequency mask, but they can't find a signal at a particular frequency if another signal of higher amplitude is sometimes present at that same frequency. The Runt trigger addresses some of these signal-under-signal cases, but not all. As shown in Figure 29, the DPX Density trigger can discriminate signals within a precise amplitude-frequency range without the operator having to know any characteristics of the target signal besides where it might show up in the DPX Spectrum graph.

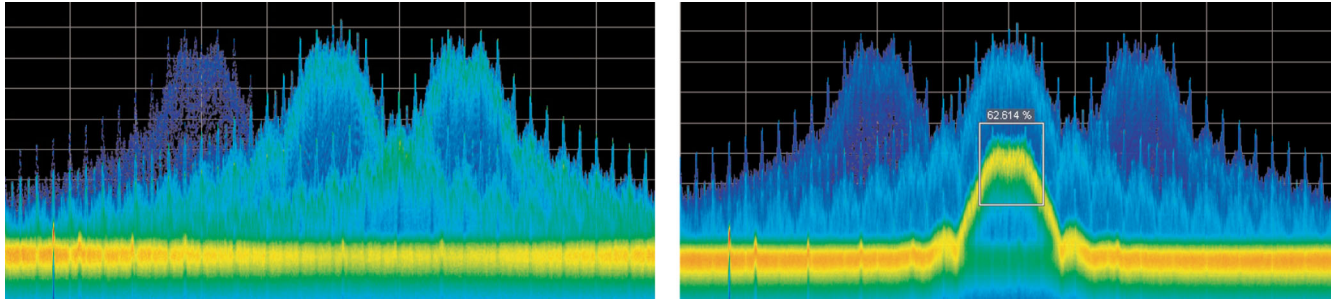

Figure 29. Example of Density Trigger. Left: A free-run DPX display showing pulses with varying frequency. Occasionally, a short pulse in the middle appears for a split instant, but it is hard to capture it with just a Run/Stop button. Right: The triggered DPX displays shows the low-amplitude pulse that was not apparent in the untriggered display. The analyzer was set to trigger whenever the average density in the user-drawn box measured 50% or higher.

The DPX Density trigger uses the same screen-based measurement box as the DPX Density measurement. While the target signal is absent, the density measurement characterizes the “normal” signals within the box. When the target signal finally appears, the density value increases. The trigger system monitors the density measurement and activates a trigger whenever the density value exceeds the adjustable density threshold. The only thinking you have to do is to set this threshold to a level somewhere between the normal density readings and the density due to the trouble-making signal. However, the instrument software can compute the threshold value automatically.

Trigger On This™

The Trigger On This™ function allows you to point and click to set up the DPX Density trigger. By right-clicking on a spot within the DPX display, or pressing and holding your finger on the touchscreen display for about a second, a menu selection will appear. Selecting **Trigger On This** causes a DPX Density box to appear and automatically adjusts the threshold. The DPX display will now only update whenever the automatic threshold is exceeded. Subsequently, if needed for your signal, open the Trigger control panel to adjust the density threshold or the size of the measurement box until the event is reliably captured.

Automatic Threshold Adjustment by Trigger On This™

The trigger density threshold automatically set by Trigger On This is 80% of the measured value. If the signal was present at the moment you selected Trigger On This, the threshold will be 20% less than the signal density, so the next time the signal is present long enough (or present enough times) to exceed the threshold density, it will cause a trigger. If the signal happened to be missing when you selected Trigger On This, the threshold value will be even lower. If you clicked in a part of the display with no signal activity at all, the threshold will be set to zero. Any signal that shows up here will fire the trigger, as shown in Figure 32.

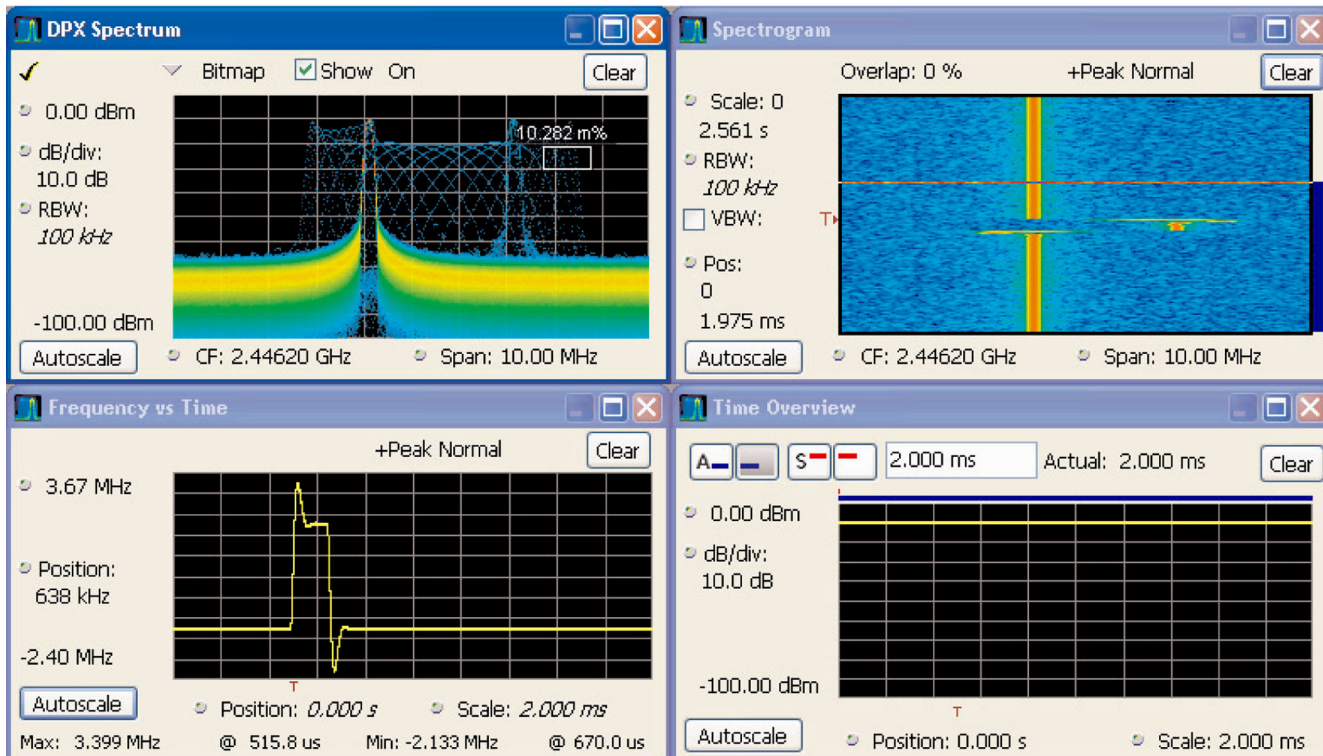

Figure 30. The analyzer triggered when the density in the DPX measurement box exceeded the threshold set by Trigger On This. You can see in the Spectrogram and Frequency-vs-Time displays that the signal event which caused the trigger was a quick frequency hop. The Time Overview shows that the signal amplitude never changed, so a power level trigger would not have worked.

DPX Density Trigger Timing

The time resolution for DPX density measurements is the frame length, around 50 ms. A basic implementation of the DPX Density trigger concept is also frame-based, so a trigger event that occurs anywhere within a frame will not be recognized until the end of the frame. Therefore, the worst case trigger uncertainty is 50 ms.

DPX Density trigger doesn't always have to wait until the end of a frame before firing. For the common configuration of triggering when the measured density is higher than the threshold, the density measurement in the trigger can be computed many times within each frame and it can fire the trigger as soon as the threshold is exceeded.

Consider the case where the threshold is zero. As soon as a single waveform causes a hit within the measurement box, we know that the density is greater than zero. It takes a little longer to test for a 5 or 10% density, and even more time for thresholds at or near 100%.

The DPX Density trigger can also be set to fire when the measured density is below the threshold value. This is useful when you suspect that your signal is missing some of the time. For a signal that is supposed to be CW, you can set the trigger controls to acquire when the density measurement of the signal peak drops below 100%. When using the “lower than” form of the DPX Density trigger, the time resolution is

one frame because of the following logic: We can't be sure the actual density is less than, say, 15% until at least 85% of the full test time has elapsed. In order to keep things simple and fast in the trigger module, the RSA just waits until the end of each 50 ms frame to do the "lower than" comparisons.

Persistence and DPX Density Trigger

The smoothing effect of persistence on density measurements can help in determining a good threshold value. With persistence turned off, an infrequent signal's density reading jumps between higher and lower values as it turns on and off, and it can be hard to read these flashing numbers. By turning persistence on, you instruct the instrument to average the density over a longer time period. This density result is somewhere between the ON and OFF density values - the very definition of a good trigger threshold.

Unlike the DPX Density measurement, the DPX Density trigger is not affected in any way by persistence. Density calculations in the trigger system are made with hit count data received from each individual DPX frame, before any persistence is applied. Even when the density measurement reading in the display is averaged over many frames due to persistence, the trigger is computing density for each frame and comparing these quick snapshots against the threshold setting.

DPX Display Overview

The DPX display enables you to see how traces change over time and thus displays signal events that cannot be seen on a swept spectrum analyzer. A DPX Spectrum indicates how traces change in two ways. First, it uses color shading to show how consistent the shape of a trace is. Second, it uses persistence to hold signals on the screen so you can see them longer.

DPX Display

The DPX display works by using a two-dimensional array to represent points on the display. Each time a trace writes to a point on the display, a counter in the array is incremented. A color is assigned to each point in the display based on the value of its counter. Thus, as acquisitions occur over time, a colored waveform, the Bitmap, develops on the display that shows how frequently each display point has been written to.

An important feature of the DPX display is dot persistence. Dot persistence sets how long a point on the display will be visible. You can set the Dot Persistence to be Variable or Infinite. In variable persistence mode, you specify a decay period that limits how long a point will be displayed. In infinite persistence mode, once a point in the display has been written to, it will remain visible indefinitely.

The DPX display can plot the trace in the following views:

To display a DPX view:

1. From the **Folders** box, select **General Signal Viewing**.
2. Select **DPX** from the **Available displays** box.

3. Click the **Add** button. This will add the DPX icon to the Selected Displays box (and remove it from the Available displays box).
4. Click the **OK** button. This displays the DPX Spectrum view.

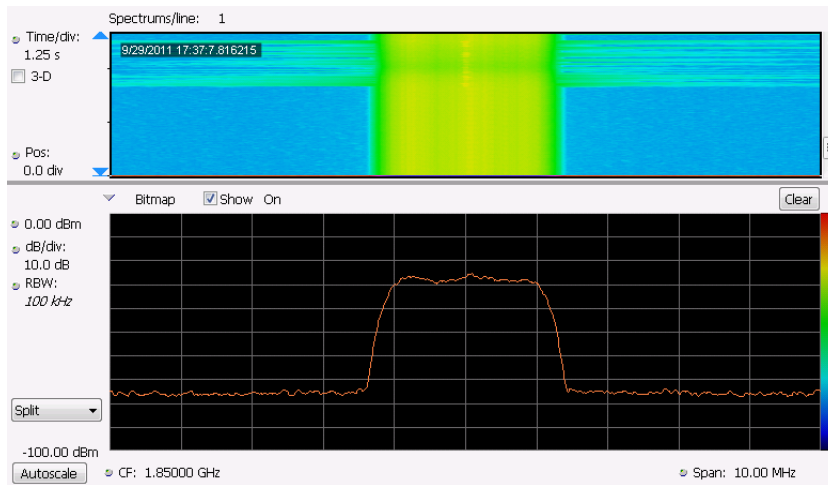

DPX Split View

Elements of the DPX Display

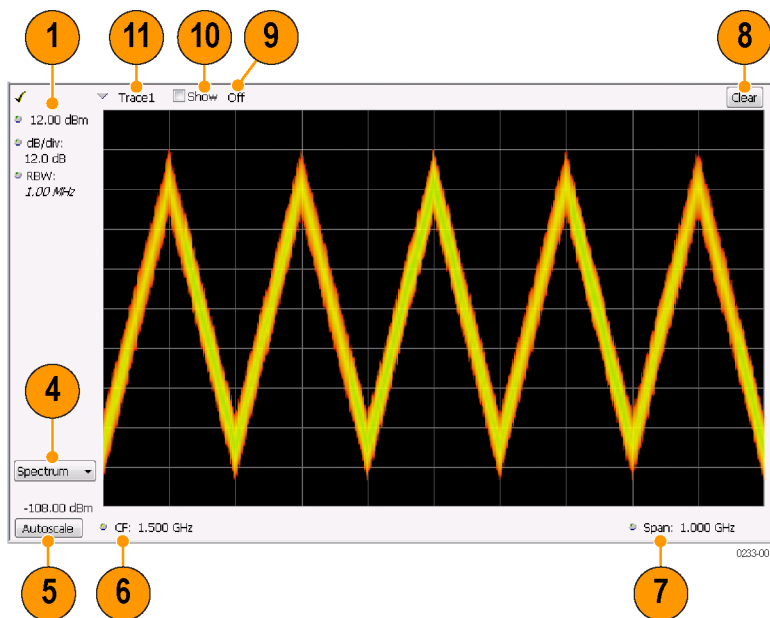

Item	Display element	Description
1	Vert Position	Sets the top of graph value. This is only a visual control for panning the graph. The Reference Level is adjusted in the Toolbar and the Ampl control panel. By default, Vert Position = Ref Level.
2	dB/div	Sets the vertical scale value. The maximum value is 20.00 dB/division.
3	RBW	Sets the resolution bandwidth. Note that when the RBW is set to Auto, its value is italicized.
4	DPX view	Selects the DPX view. Choices are Spectrum, Zero Span, Frequency, Phase, DPXogram, and Split.
5	Autoscale	Adjusts the Vertical and Horizontal scaling to display the entire trace on screen.
6	Pos/CF	Spectrum: Center Frequency - Adjusts the analyzer center frequency. For Zero Span, Frequency, or Phase the Position is in seconds.
7	Span/Scale, Sweep/Scale	Spectrum display: Span - Adjusts frequency range of the measurement. Scale - If Horizontal scale has been manually adjusted in Settings > Scale, then this control adjusts the visual graph scaling without affecting the Span. Zero Span, Frequency, Phase displays: Sweep - adjusts the trace duration in seconds. Scale - adjusts the visual graph scaling without affecting the Sweep time.
8	Clear	Erases the bitmap and traces in the graph and restarts multi-trace functions (Avg, Hold).
9	Function	Readout of the Detection and Function selections for the selected trace.
10	Show	Controls whether the selected Trace is visible or not. When trace is Off, the box is not checked.
11	Trace	Selects a trace. Touching here pops up a context menu listing the available traces, whether they are enabled or not. If user selects a trace that is not currently enabled, it will be made enabled.

Additional Elements of the DPXogram Split Display

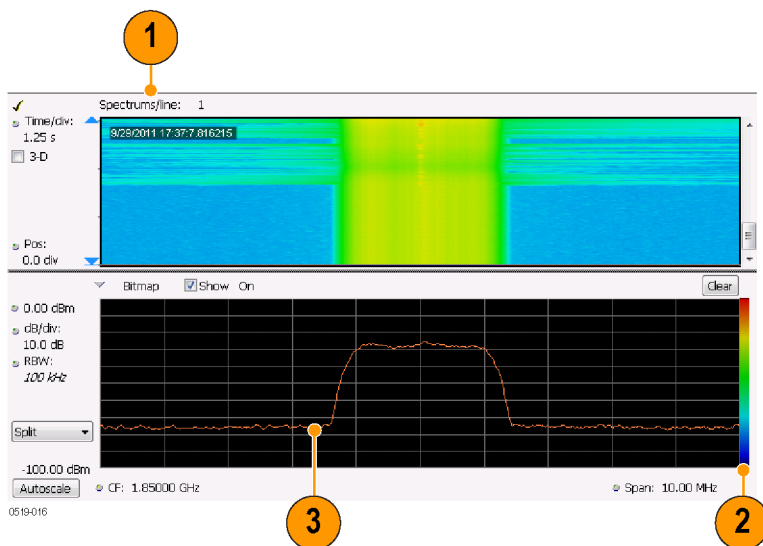

Item	Display element	Description
1	Spectrums/line	Appears only when the display is stopped. Readout of the number of spectrum lines represented by each line of the DPXogram display. This value changes when the Time/div or Time resolution settings are changed.
2	Color scale	Legend at the right side of the DPX Spectrum display. This element illustrates the relationship between the colors in the DPXogram plot and the amplitude axis of the DPX Spectrum plot. This scale changes with Color (DPXogram) palette selection and Max and Min settings on the Ampl Scale tab.
3	DPXogram trace	The selected line in the DPXogram graph can be shown in the DPX Spectrum graph of the Split view. The most recent DPXogram line, usually at the bottom of the graph, is selected by default. If any markers are on, the selected marker determines the selected line.

Time Resolution of DPXogram Display

Due to the large amount of data produced by the DPX hardware during acquisitions, a compressed version of the plot is shown while running. This plot is limited to 500 lines, with each line having 267 points. However, a much longer record, with higher frequency resolution is being collected. As soon as the instrument is stopped, this underlying data is shown, replacing the temporary version. There are 50 lines in each vertical division of the 2-D DPXogram plot, so the time resolution of the graph is Time/div divided by 50. However, you can set the instrument to collect multiple spectra per line, allowing you to zoom in later on this high-time-resolution data.

$$\text{Time Resolution} = \frac{10 \times \text{Time/Division}}{500}$$

When the DPXogram display is stopped, the analyzer can display the full resolution of the captured data. The Time Resolution readout applies only when the DPXogram is running.

Effects of Changing Time Resolution. The Time Resolution control affects acquisition parameters for the DPX hardware. This means that if you change the Time Resolution value while the instrument is stopped, the new value applies to the NEXT acquisition, and might not represent the results currently shown in the display.

Time resolution can be changed either directly, by manually adjusting the Time Resolution control, or automatically, by changing the Time/div control. Auto is the default, yielding one spectrum per line in the display. When the Time Resolution is decreased below its auto value, multiple spectra are collected to create each line in the DPXogram graph. Once you stop the instrument, you can decrease the Time/div value or use Zoom to see increased time resolution.

If the time resolution is set to a very small number while the Time/div is set to a large value, you might notice that there is a limit to the number of spectra that can be collected. This limit depends on the number of trace points selected. For 801-point spectra, 60,000 underlying spectra can be collected. The number of 2401-point spectra collected is 20,000, and for 4001-point spectra the number is 12,000. When the limit is reached, the oldest spectra are discarded as newer spectra are captured.

Touchscreen Actions on Markers in the Graph Area

Action	Description
Mouse click within 1/2 div. of a marker	Selects the marker and updates the marker display to show the selected marker's values.
Touch marker to select and then use knob, or arrow keys	Adjust the setting associated with the Marker.
Touch and drag a marker	Changes marker position to the "drop point". You can use Tools > Options > Prefs to change whether markers jump from one peak to the next while dragging or move smoothly along the trace.

Available Traces for Display – Standard Instrument

Five traces can be shown in the DPX display– one bitmap and four line traces. The default traces are Bitmap and +Peak detection. The other three traces are –Peak detection, average detection, and math.

Trace	Description
Bitmap	Displays the density of acquired data. The number of data points acquired at each pixel (representing a particular amplitude level at a specific frequency at a point in time) is indicated by color.
+Peak detected	Line trace. Displays the maximum values acquired in each update. Normal and Hold functions are available for this trace.
–Peak detected	Line trace. Displays the minimum values acquired in each update. Normal and Hold functions are available for this trace.
Average detected	Line trace. Displays the average of all the values acquired in each update. Normal and Hold functions are available for this trace.
Math Trace	Line trace. Displays the difference between two traces. The two traces used are set in the Traces tab of the Settings panel.

Determining Which Trace Types Are Displayed

You can see the status of all the traces by selecting the Trace drop-down list. Traces that are not displayed are preceded by "Enable". In the following figure, you can tell that the Bitmap and -Peak Trace traces are displayed but the +Peak, Average, and Math Traces are not displayed.

Selecting **Enable -Peak Trace** from the Trace list displays the -Peak detected values trace.

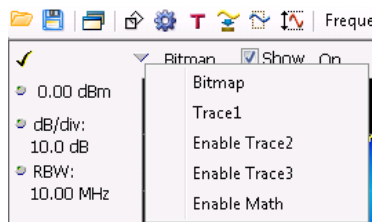

You can see whether a trace is enabled by looking at its **Show** check box. The "selected trace" is selected in the Trace list. The Show check box is checked when the selected trace is enabled. To the right of the

show box are readouts for detection of the selected trace (+Pk, Avg (VRMS),) and its function (Hold, Normal,). You can enable/disable the selected trace by checking or unchecking **Show**.



Selecting Traces for Display – Standard Instrument

To select a trace for display:

1. Use the Settings control panel:
 - Select **Setup > Settings** or click the **Settings** button.
 - Select the **Traces** tab.
 - Select the trace from the drop-down menu.
 - Select the **Show** check box.
2. Select a trace from the Trace drop-down list.

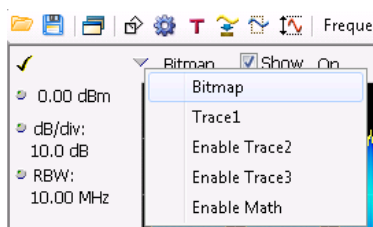

Specifying How +Peak, –Peak, and Average Traces Are Displayed

You control how the +Peak, –Peak and Average (Avg (VRMS)) traces are displayed from the Traces tab of the Settings control panel. From the Traces tab, you can also specify whether these traces display results from single updates or results collected over multiple updates.

To change how the traces are displayed:

1. Select **Setup > Settings** or click the **Settings** button.
2. Select the **Traces** tab.
3. Select the trace type from the drop-down list.

4. If you select +Peak Trace or -Peak Trace, use the **Function** drop-down list to select either **Normal** or **Hold**.
 - a. Select **Normal** to set the trace to display the maximum/minimum values acquired in each individual update.
 - b. Select **Hold** to set the trace to display the maximum/minimum values acquired over time. The trace values are updated only if they exceed the existing values.
5. If you select Avg (VRMS) or Avg (of logs), use the **Function** drop-down list to select either **Normal**, **Average (VRMS)**, or **Avg (of logs)**.
 - a. Select Normal to set the trace to display the average values acquired in each update.
 - b. Select Average (VRMS) or Avg (of logs) to set the trace to display an average of the average values. Use the Count box to enter the number of times the trace is averaged.

Available Traces for Display (Instruments with Option 200)

Five traces can be shown in the DPX Spectrum, Zero Span, Frequency, and Phase displays— one bitmap and four line traces. The default traces are Bitmap and Trace 1. The other three traces are 2, 3, and Math. Line traces 1, 2, and 3 have user-selectable Detection and Function settings. The final line trace is Math, allowing you to subtract one line trace from another.

For the DPXogram display, only one trace is available — the DPXogram trace.

For the Split display, which consists of a DPXogram display on the top half and a DPX Spectrum display on the bottom half, you can display the Bitmap trace, Trace 1, Trace 2, Trace 3, Math trace, and Ogram Line (the selected line from the DPXogram display) on the bottom half of the display.

Selecting Traces for Display (Instruments with Option 200)

This is done almost the same as with the standard instrument, except that the choices available for Trace are different. Instead of +Pk, -Pk, and Avg traces, you select Trace 1, 2, and 3 and independently set the Detection method for each of these traces to +Pk, -Pk, Avg (VRMS), or Avg (of logs).

Reference. [Changing the DPX Spectrum Display Settings \(see page 270\)](#)

Tx BER Testing in the DPX Frequency View

The Transmit Bit Error Rate Testing (Tx BER) function measures the bit error rate in a data stream modulated on a carrier. The modulation type supported is a 2-level FSK signal (2FSK) with a symbol rate of 16 kHz. Tx BER is available only in the DPX Frequency plot.

The Center Frequency must be set to the carrier frequency. The RBW or Measurement BW must be set high enough to pass the full frequency deviation of the modulated signal. The vertical scaling on the display does not affect the measurement. The measurement is also unaffected by trigger settings.

The 16k symbol/second rate has a tolerance of ± 10 ppm. The data patterns supported are PRBS-9, PRBS-11, PRBS-15, and User.

The User pattern is a user-defined fixed pattern of arbitrary length up to 30 seconds in duration. The synchronization pattern (of length “n”) can be specified to be up to 32 bits, and is the first "n" bits of the user's pattern. The test duration with User pattern can be one time through or repeating. If PRBS lengths other than the three listed above are needed, the User pattern can be used in repeating mode to get any PRBS length up to PRBS-18.

When a test is started, the incoming data is sampled to seed the PRBS receiver or find the starting pattern for User pattern. If errors are occurring in the signal, it is possible to get a spurious match at test start time, resulting in an invalid measurement. In this case, for a PRBS pattern the error rate will be 50%, and for User pattern the rate will be pattern-dependent. If this happens, the test can be restarted with the **Clear results** function. The symbol count, error count, and error rate (BER) are displayed on the screen. For a User pattern, the measurement starts after the synchronization pattern has been seen, so the synchronization pattern symbols are not included as part of the symbol count, although they are included in the pattern length.

To measure Tx BER, see [Tx BER Tab \(see page 83\)](#).

DPX Settings

Menu Bar: Setup > Settings

Front Panel / Application Toolbar: Settings

The measurement settings for the DPX display are shown in the following table.

Settings tab	Description
Freq & Span (see page 113)	Sets frequency and span parameters for the DPX display. This tab appears for the Spectrum and DPXogram displays.
Params (see page 71)	Sets sweep time and scroll settings. This tab appears only for the DPX Zero Span, DPX Frequency and DPX Phase displays.
Freq & BW (see page 72)	The Freq & BW tab specifies frequency and bandwidth parameters for the DPX Zero Span, DPX Frequency, and DPX Phase views.
BW (see page 118)	Sets Resolution Bandwidth.
Traces (Bitmap) Tab (see page 72)	Allows you to configure the Bitmap Trace.
Traces Tab (see page 75)	Allows you to select the number and types of traces to display and their functions.
Traces (Math) Tab (see page 117)	Allows you to configure the Math Trace.
Horiz & Vert Scale Tab (see page 78)	Sets the vertical and horizontal scale parameters for all the DPX views.
Bitmap Scale Tab (see page 79)	Sets the DPX Bitmap display parameters.
Amplitude Scale Tab (see page 80)	The Amplitude Scale tab allows you to change the vertical scale and offset, enable the 3-D Waterfall display, and set the color scheme used for the DPXogram trace.
Time & Freq Scale Tab (see page 81)	The Time and Freq Scale tab allows you to change the vertical and horizontal scale settings, number of points in the trace, and Time resolution.
Prefs (see page 120)	Specifies whether certain display elements are visible.
Density (see page 82)	Specifies location and size for the DPX Density measurement box. (Spectrum display only; instruments with Option 200 only)
Tx BER Tab (see page 83)	Specifies BER testing parameters. (Frequency plot only).
Audio Demod (see page 86)	Enables and sets parameters for audio demodulation function.

Params Tab – DPX Zero Span, DPX Frequency and DPX Phase Views

The Params tab sets the sweep time for the DPX Zero Span, Frequency and Phase views. Use the Params tab to set the scroll mode settings for the DPX Zero Span, Frequency and Phase views. In Scroll mode, points of the trace are plotted as they occur, as opposed to normal mode where the trace is plotted after an acquisition is completed.

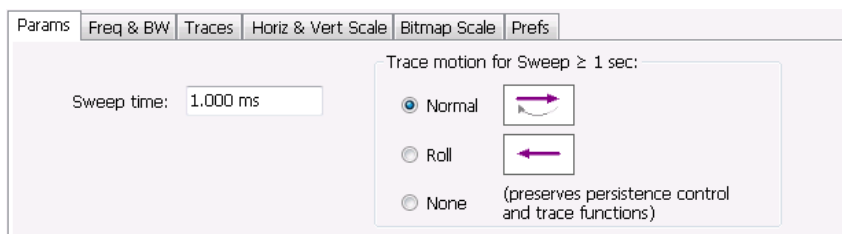

Params tab settings Zero Span, Frequency and Phase views

Setting	Description
Sweep time	Sets the time period for the measurement. By default, the Horizontal Scale is equal to Sweep time and the sweep covers 10 divisions. When the graph is zoomed in, the sweep time extends beyond the left and/or right edges of the graph. Range: 100 ns – 2000 s. Default: 1 ms.
Trace motion for Sweep ≥ 1 sec	Specifies how the trace is displayed when the sweep time is equal to or greater than 1 second.
Normal	Select Normal to scroll the position at which data points are added to the trace. In this mode, a caret (^) moves below the graph to indicate the latest position.
Roll	Select Roll to scroll the trace as points are added at the right side of the graph. When Roll is selected, the trace moves to the left as points are added to the trace at the right side of the graph.
None	Select None to display the trace without motion.

Freq & BW Tab – DPX Zero Span, DPX Frequency and DPX Phase Views

The Freq & BW tab specifies frequency parameters for some of the DPX display views.

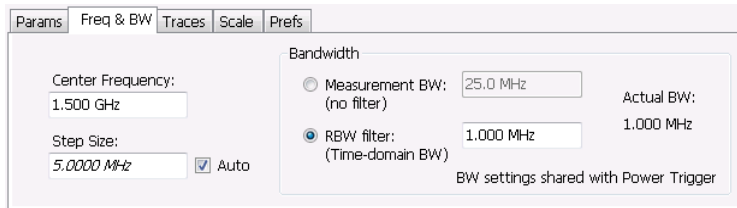

Freq & BW tab settings for the bitmap trace (Standard and option 200)

Setting	Description
Center Frequency	Sets the frequency at the center of the measurement bandwidth.
Step Size	Sets the increment size when changing the Frequency using the knob or mouse wheel. Arrow keys have an increment 10 times this setting.
Auto	When Auto is enabled, the step size is adjusted automatically based on Spectrum's span setting.
Measurement BW, no filter	Specifies the measurement bandwidth.
RBW (Time-domain BW) filter	RBW (Time-domain BW) is a filter used to process the input signal before the system analyzes the signal. The filter value determines the acquisition bandwidth that the view requires. Range: 1 HZ to 60 MHz.
Actual BW	Shows the actual bandwidth being used for the display.

Traces Tab – Bitmap

The Traces Tab allows you to set the display characteristics of displayed traces in the DPX display. The Traces tab for the DPX display has two versions: one for the DPX Bitmap trace (described in this topic) and one [for line traces \(see page 75\)](#).

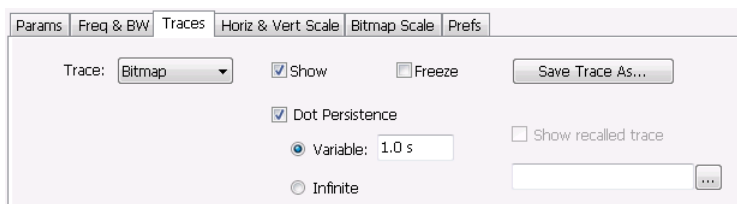

Traces tab – Bitmap trace (Instruments with Option 200)



Traces tab – DPXogram trace (Instruments with Option 200)

Traces tab settings for the bitmap trace (Instruments with Option 200)

Setting	Description
Trace	Select Bitmap or DPXogram to set the parameters of the DPX Bitmap or DPXogram trace.
Show	Specifies whether or not the selected trace is displayed.
Detection (DPXogram trace only)	Sets the Detection method (see page 114) used for the trace. Available detection methods are +Peak, -Peak, and Avg (VRMS).
Intensity (standard instrument only)	Use Intensity to control the visibility of events. An increased intensity level allows a single, short event to be seen. This also makes such an event subject to the persistence controls. This allows you to see the effect of the Persistence controls on infrequent events. Range is 1-100%. Resolution: 1.
Dot Persistence	Allows a dot to remain visible if it is not updated with new data. Choices for this setting are Variable and Infinite. (Not available for the DPXogram trace.)
Variable	The Variable dot persistence setting controls how long a point in the display is visible before fading (not available for the DPXogram trace). This setting has no units associated with it. Range: 1–1000. Resolution 0.1. Instruments with Option 200 Range: 50 ms –100 s.
Infinite	The Infinite dot persistence setting prevents a point in the display from fading (not available for the DPXogram trace).
Freeze	Halts updates to the selected trace.
Save Trace As	Saves the selected trace to a file for later recall and analysis.
Show Recalled Trace	Displays a saved trace instead of a live trace (not available for the DPXogram trace).

Dot Persistence

Dot Persistence is the characteristic of the DPX display that determines how long a pixel in the display remains visible.

To set the Persistence:

1. Select **Setup > Settings**.
2. Select the **Traces** tab.
3. Select **Dot Persistence**.

4. Select either **Infinite** or **Variable**.
5. If you select Variable, enter a value in the text box. The Variable persistence value can be set from 0.05 to 100 seconds (instruments with Option 200) and 1 to 1000 in instruments without option 200.

Saving Traces

To save a trace for later analysis:

1. Select the **Save Trace As** button. This displays the Save As dialog box.

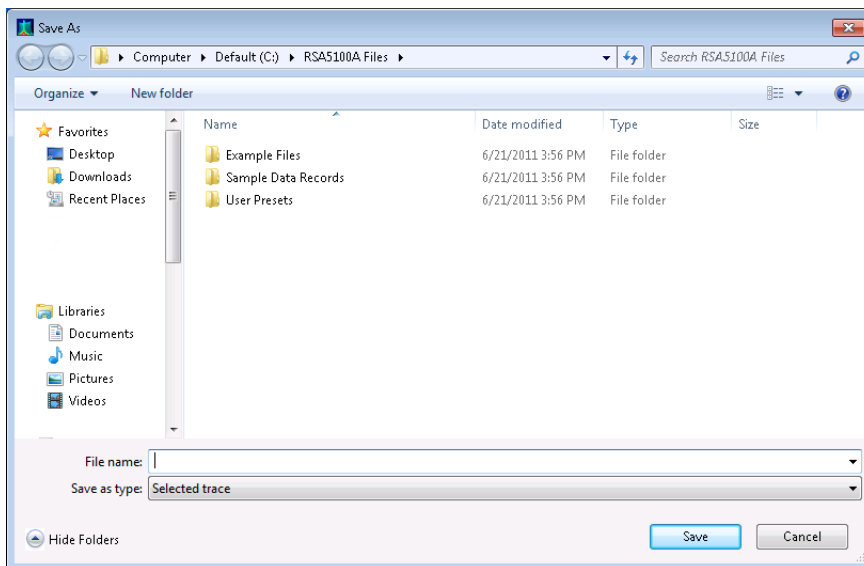

2. Navigate to the location where you want to save the file.
3. Type a name for the saved trace and click **Save**.

Show Recalled Trace

You can recall a previously saved trace for comparison to a live trace. First, specify a trace for recall and second, enable Show Recalled Trace.

To select a trace for recall:

1. Select the ... button to display the Open dialog box.

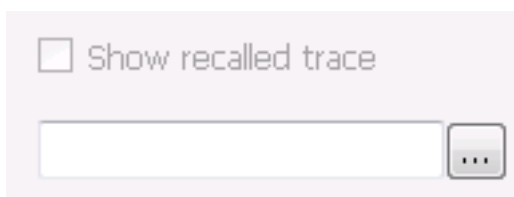

2. In the Open dialog, navigate to the location of the saved trace.
3. Select the desired trace file.
4. Select **OK** to complete your selection.
5. Select the **Show recalled trace** check box.
6. Verify that the trace's **Show** check box is selected (either on this tab or next to the drop-down list located at the top-left corner of the graph).

Traces Tab

The Traces Tab allows you to set the display characteristics of displayed traces in the DPX display. The Traces tab for the DPX display has two versions. One for non-Bitmap traces (described in this topic) and one for [the DPX Bitmap trace \(see page 72\)](#).

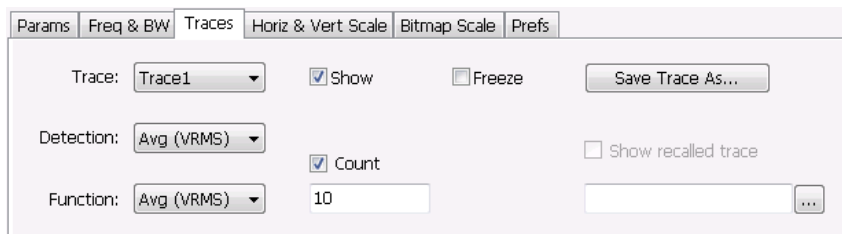

Traces tab (instruments with Option 200)

Setting	Description
Trace drop-down list	Selects which trace to configure. The available traces are Bitmap, Trace 1, Trace 2, Trace 3, and Math (instruments with Option 200). For instruments without Option 200, the available traces are Bitmap, +Peak detected, -Peak detected, Average, and Math.
Show	Specifies whether or not the trace shown in the Trace setting is displayed.
Freeze	Halts updates to the selected trace.
Detection (instruments with Option 200)	Sets the Detection method used for the trace. Available detection methods are +Peak, -Peak, and Avg (VRMS). Not all detection methods are available in all displays.
Function	Selects the trace processing method. Available settings are: Normal, Average, and Hold.
Save Trace As	Saves the selected trace to a file for later recall and analysis.
Show Recalled Trace	Displays a saved trace instead of a live trace.
Count	Enables user adjustable number of averages. This setting is only present when Function = Average.

Detection

Trace Detection occurs when the trace is being decimated by the measurement. For example, if the maximum number of trace points is 100,000, and the selected analysis region is 200,000 samples, the

measurement must decimate the 200,000 resulting trace points by 2 to prevent exceeding the 100,000 trace point limit. Since only one value can be selected for each trace point, an algorithm must be used to select (detect) the appropriate value to use.

The available detection methods are:

- **+Peak** – Each point on the trace is the result of detecting the positive peak value present in the set of IQ samples available to that trace point.
- **-Peak** – Each point on the trace is the result of detecting the negative peak value present in the set of IQ samples available to that trace point.
- **Avg (VRMS)** [Average V_{RMS}] – Each point on the trace is the result of determining the RMS Voltage value for all of the IQ samples available to the trace point. When displayed in either linear (Volts, Watts) or Log (dB, dBm), the correct RMS value results. When the averaging function is applied to a trace, the averaging is performed on the linear (Voltage) values, resulting in the correct average for RMS values.

NOTE. *The Detection setting does not affect the trace until the spectrum length is longer than the Auto setting.*

DPX Trace Processing

The +Peak, -Peak, and Average traces can be processed to display in different ways. The Function setting controls trace processing.

- **Hold** - Displays the value in the trace record for each display point. Each new trace display point is compared to the previous maximum value and the greater value is retained for display and subsequent comparisons. Available for traces using +Peak or -Peak detection.
- **Normal** - Displays the trace record for each display point without additional processing. Available for all detection selections.
- **Average** - Default setting for the Average. Multiple traces are averaged together to generate the displayed trace. There is one vertical value for each underlying frequency data point. Once the specified number of traces have been acquired and averaged to generate the displayed trace, each new trace takes the place of the oldest trace in the calculation. The **Count** setting specifies how many traces are averaged. Available for traces using Average detection.

Trace averaging uses the exponential method. If Count = 10, the newest trace's contribution to the averaged trace is 10%. When Count is not checked, the algorithm assumes the maximum number of traces contributing to the average is 2^{32} .

Saving Traces

To save a trace for later analysis:

1. Select the **Save Trace As** button. This displays the Save As dialog box.

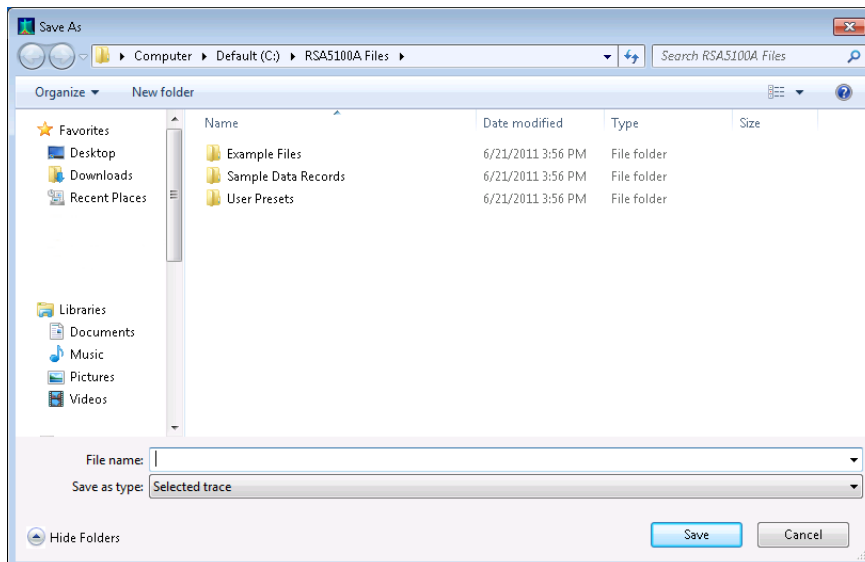

2. Type a name for the saved trace and click **Save**.

Recalling Traces

You can recall a previously saved trace for comparison to a live trace. First, specify a trace for recall and second, enable Show Recalled Trace.

To select a trace for recall:

1. Click the ... button to display the Open dialog box.

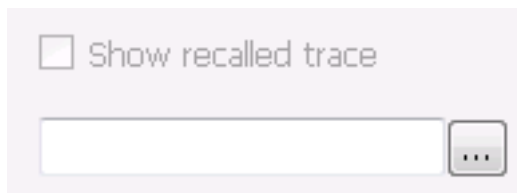

2. Navigate to the desired file and click **Open**.
3. Check the **Show Recalled Trace** check box.
4. Verify that the trace's **Show** check box is selected (either on this tab or next to the drop-down list located at the top-left corner of the graph).

Horiz & Vert Scale Tab

The Horiz & Vert Scale tab allows you to change the vertical scale settings used for the Bitmap trace. Changing the scale settings changes how the trace appears on the display but does not change control settings such as Measurement Frequency.

Setting	Description
Vertical	Controls the vertical position and scale of the trace display.
Scale	Changes the vertical scale.
Offset	Adjusts the Reference Level away from the top of the trace display.
Reset Scale	Sets Scale to its default value and Offset to zero. Disabled when Units (Setup > Analysis > Units) is set to Watts or Volts.
Autoscale	Resets the scale of the vertical axis to contain the complete trace. Disabled when Units (Setup > Analysis > Units) is set to Watts or Volts.
Horizontal	Controls the horizontal position and scale of the trace display.
Scale	Changes the horizontal scale.
Position	Adjusts the horizontal position of the signal. This does not change the center frequency.
Autoscale	Resets the scale of the horizontal axis to contain the complete trace.

Bitmap Scale Tab

The Bitmap Scale tab allows you to set the color scheme used for the Bitmap trace. Changing the DPX bitmap Color, Max and Min scale settings changes how the trace appears on the display but does not change control settings such as Measurement Frequency.

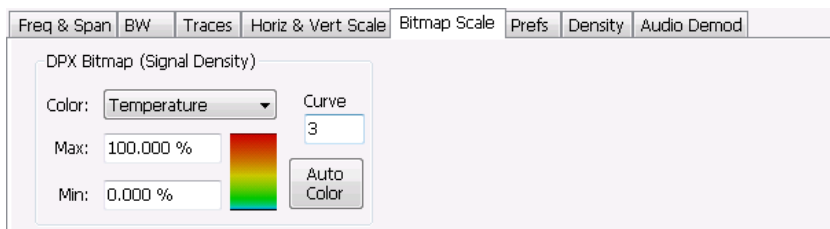

Setting	Description
DPX Bitmap (Signal Density)	Controls the appearance and scale of the DPX Bitmap trace.
Color	Allows you to select the color palette used for the DPX Bitmap trace.
Max	Sets the hit density represented by the top of the color scale. "Clipping" occurs for densities greater than this value. Range: 1p% - 100%; Default: 100%.
Min	Sets the hit density represented by the bottom of the color range. Range: 0 - 80%; Default: 0.
Curve	Adjusts how colors are mapped to the signal density. The mapping can be linear (Curve = 1), or it can be set to concentrate the resolution on the lower level of the range (Curve > 1) or the mapping can be set to show the best resolution on the upper range of density or hit count (Curve < 1).
Auto Color	Adjusts the Max and Min settings to display the broadest range of colors.

Amplitude Scale Tab

The Amplitude Scale tab allows you to change the vertical and horizontal scale settings, enable the 3-D Waterfall display, and set the color scheme used for the DPXogram trace.

Setting	Description
Height	Height controls apply only to the 3-D Waterfall display.
Scale	Changes the vertical scale for trace Amplitude in the graph (not the vertical scale for Time).
Position	Specifies the level displayed at the bottom edge of the graph. (Bottom front edge in the 3-D view).
Autoscale	Adjusts the vertical position bottom for linear units like Amps and Volts. Adjust the vertical position top for log units like dBm. dBm is the default.
3-D Waterfall	Displays the DPXogram in a 3-D format.
Northeast	Shifts the perspective of the 3-D graph so that the oldest traces move back and to the right.
Northwest	Shifts the perspective of the 3-D graph so that the oldest traces move back and to the left.
Reset Scale	Resets the Height and Color settings to their default values.
Color (DPXogram)	
Color	Displays a drop-down list that allows you to set the color scheme used for the DPXogram trace.
Max	Sets the power level represented by the top of the color scale.
Min	Sets the power level represented by the bottom of the color scale.

Time & Freq Scale Tab

The Time and Freq Scale tab allows you to change the vertical and horizontal scale settings, set the time resolution and number of trace points of the DPXogram display.

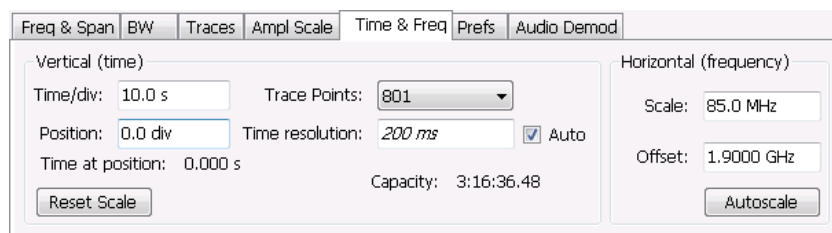

Setting	Description
Vertical (time)	
Time/div	For most Spectrogram applications. Primary time scale control is Time/div. Time scale can be zoomed in or out when acquisitions are stopped.
Position	The position of the DPXogram record at the bottom of the display. Position cannot be changed while acquisitions are active, and is reset to zero when acquisitions are started again.
Time at position	Displays the time of the DPXogram line shown at the bottom of the graph. This time is relative to the Time Zero Reference of the current acquisition. If Position is set to a negative value, the Time at position readout will be blanked.
Reset Scale	Sets the Time/div and Position settings to their default values.
Trace Points	Sets the number of trace points computed for each DPXogram line. These are the points used for marker measurements and for results export.
Time resolution	Specifies the length of time represented by each line in the graph.
Auto	Sets the time represented by each line in the graph to be adjusted by the analyzer (checked) or manually (when unchecked). When Auto is enabled, Time Resolution change based on Time/div.
Capacity	Readout of the total length of time that can be captured. This readout is provided so that you can see how changing the Trace Points and Time resolution affects the amount of data that can be captured. Capacity is represented in the format dd:hh:mm:ss.
Horizontal (frequency)	
Scale	Sets the displayed frequency range of the graph. This control affects only visual scaling, and does not change the acquisition or analysis parameters.
Position	Sets the frequency displayed at the center of the graph. Changing this value does not change the Frequency setting.
Autoscale	Sets the frequency scale to the Spectrogram Span value.

Density Tab – (instruments with Option 200)

The Density tab specifies the parameters of the measurement box used for measuring average signal density of an area in the bitmap. The measurement box is also used by DPX Density triggering.

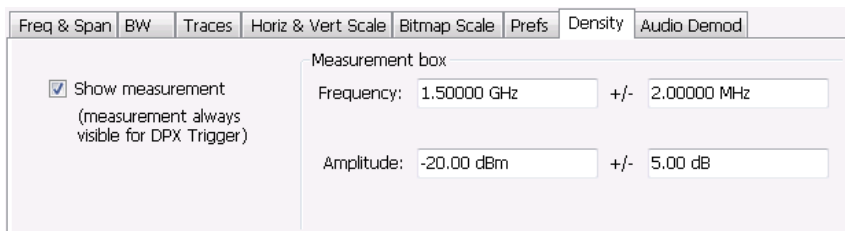

To measure the average signal density over a rectangular portion of the DPX bitmap, you can adjust the size and location of the measurement area using these controls, or by dragging the measurement box in the graph. You move the box by dragging the readout. You adjust the size of the box by dragging the corners or edges.

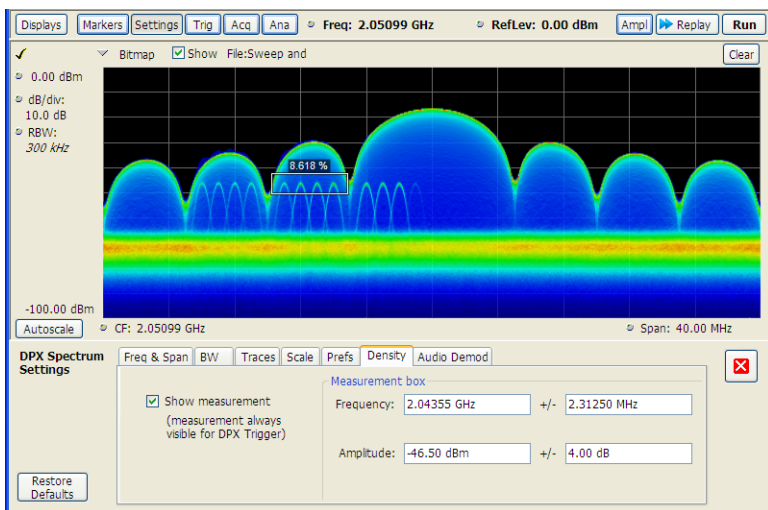

Setting	Description
Show Measurement	Shows or hides the measurement box in the graph when Triggering is not set to DPX Density. If Triggering is set to DPX Density, the measurement box is always visible.
Frequency	Specifies the frequency at the center of the measurement box. The +/- value specifies the width of the measurement box.
Amplitude	Specifies the amplitude of the center of the measurement box. The +/- value specifies the height of the measurement box.

Tx BER Tab

The Transmit Bit Error Rate Testing (Tx BER) function enables you to perform bit error rate testing on a modulated carrier. Tx BER testing is accessed from the Tx BER tab of the [DPX Frequency plot \(see page 68\)](#) display settings.

To measure Tx BER:

1. Select **Freq** and use the front panel knob or number keys to set the measurement frequency to the carrier frequency.
2. Select the **Displays** button or **Setup > Displays**.
3. From the **Folders** box in the Select Displays window, select **General Signal Viewing**.
4. Select **DPX** from the **Available displays** box.
5. Click the **Add** button. This will move the DPX icon to the Selected Displays box from the Available displays box.
6. Click the **OK** button. This displays the DPX Spectrum view.
7. Select the **Frequency** view from the **Plot** drop-down list on the left side of the graph.
8. Click the Settings icon or select **Setup >Settings** from the menu bar.
9. Set the Data Pattern as needed. Select **User** if you want specify a data pattern that is not shown in the Data Pattern drop-down list.
10. Set the RBW, at the left side of the display, so that it is high enough to pass the full frequency deviation of the modulated signal.
11. Click the **Enable BER** checkbox so that it is checked.

When you enable BER testing, the Tx BER readout will appear.

Tx BER:	Active
BER:	9.90916598E-1%
Bits:	1211
Errors:	12

Readout	Description
Tx BER	Displays status of BER test. Status is either Sync or Active. Sync indicates the instrument is in the process of syncing with the data pattern. Active indicates that testing is in progress.
BER	Readout of the Bit Error Rate.
Bits	Readout of the number of symbols counted.
Error	Readout of the number of errors counted.

Elements of the Tx BER Tab

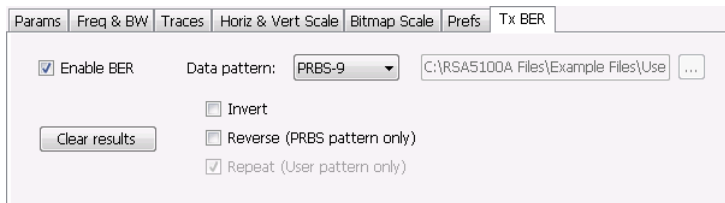

Setting	Description
Enable BER	Starts and stops BER testing.
Data pattern	Specifies the data pattern as PRBS-9, PRBS-11, PRBS-15, or User defined.
Invert	Specifies whether the data pattern is normal or inverted.
Reverse (PRBS pattern only)	Specifies whether or not the data pattern is in normal order or reversed.
Repeat (user pattern only)	Select to specify the test duration for a User Pattern. A User Pattern test duration can be one time through or it can repeat.
...	Use the ellipsis button to select a User Pattern file to specify a custom data pattern.

Creating a User Pattern File

A User Pattern file is a CSV file that defines the data pattern used in a signal. Use a User Pattern when your signal does not use one of the predefined data patterns.

A User pattern is a user-defined fixed pattern of arbitrary length up to 30 seconds in duration. The synchronization pattern (of length “n”) can be specified to be up to 32 bits, and is the first "n" bits of the user's pattern. The test duration with User pattern can be one time through or repeating. If PRBS lengths other than PRBS-9, PRBS-11, or PRBS-15 are needed, the User pattern can be used in repeating mode to get any PRBS length up to PRBS-18.

The following table contains the keywords required in the User Pattern file. The keywords are specified in the listed order. The keywords are case insensitive.

Keyword	Value	Description
[parameters]	—	Parameters group
Radix	Hex, binary	Specify if the symbols are in hex or binary format. For example, the symbol data is: 4A (Hex), 01001010 (Binary)
[Trace]	—	Symbol group

Keyword	Value	Description
NumberSymbols	16 – 491520	Total number of symbols including User and Sync symbols in the file.
NumberSyncSymbols	1 – 32	Number of Sync symbols

The Sync symbols are specified immediately after the NumberSyncSymbols line, followed by the User symbols. Blank line is not allowed within the symbol data. The Tx BER measurement only supports 2FSK modulation, so the symbol data should be either 0 or 1.

When a user pattern is started, the circuit stays in the Sync state until the synchronization symbols are seen, it then enters the Active state. If the pattern is repeating, the circuit stays in the Active state. If the pattern is not repeating, after one time through the symbols, the Done state is entered.

The following text is an example of the content of a User Pattern file.

[Parameters]

Radix,Hex

[Trace]

NumberSymbols,16

NumberSyncSymbols,1

0

0

0

0

1

0

0

0

0

1

0

0

1

1

0

0

Audio Demod Tab

Audio demodulation can help you identify unknown radio signals. You control the audio demodulation function with the Audio Demod tab. You access the Audio Demod tab from the Settings control panel of the DPX display.

NOTE. *Audio Demodulation is available only in real-time acquisition mode (not swept acquisition), and the Trigger mode must be set to Free Run (not Triggered).*

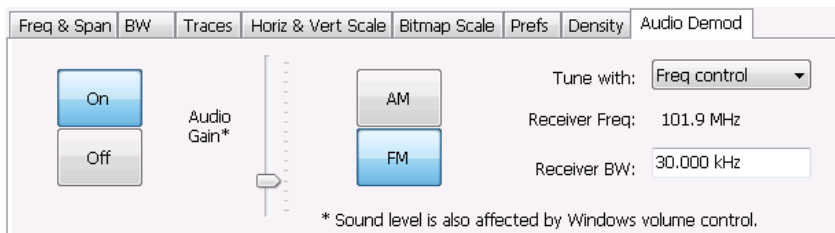

Setting	Description
On/Off	Enables/disables audio demodulation.
Audio Gain	Adjusts the volume of the demodulated audio.
AM	Selects Amplitude Modulation as the demodulation method.
FM	Selects Frequency Modulation as the demodulation method.
Tune with	Specifies how the frequency to be demodulated is specified. You can select markers or the frequency control.
Receiver Freq	Readout of the frequency to be demodulated.
Receiver BW	Adjusts the equivalent receiver bandwidth for the audio demodulation. The range of values is 1 kHz to 500 kHz.

AM / FM

Note that these buttons select the demodulation method; they do not specify a frequency band.

Tune with

The choices for this setting are: one of the markers (MR, M1, M2, M3, M4) or the Frequency control (either the front-panel knob or the Freq control in the application).

To use a marker to specify the frequency to be demodulated:

1. Select **Markers > Define Markers** to display the Define Markers control panel.
2. Select **Add** to turn on the next marker.

NOTE. The first marker defined will always be **MR**. The MR marker is the reference for delta marker readouts.

3. Select the trace to which the marker should be attached from the drop-down list.
4. Click **Add** to add additional markers. Assign them to the appropriate trace.
5. Click the close button to remove the Define Markers control panel.

Select markers. Select one of the markers in the Tune with drop-down list and then set the location of the marker to the frequency you want to demodulate. If the marker you select is not enabled, the analyzer will tune to the frequency the marker was last set to.

Receiver BW

The Receiver BW setting will not change the acquisition bandwidth. Thus, if the acquisition bandwidth is too narrow, audio demodulation will be disabled. The following three cases illustrate the relationship between the Acquisition BW, Receiver Frequency, and Receiver BW.

Case 1. In this case, the upper limit of the Receiver BW exceeds the upper limit of the acquisition bandwidth. When this occurs, audio demodulation is disabled and an error message is displayed.

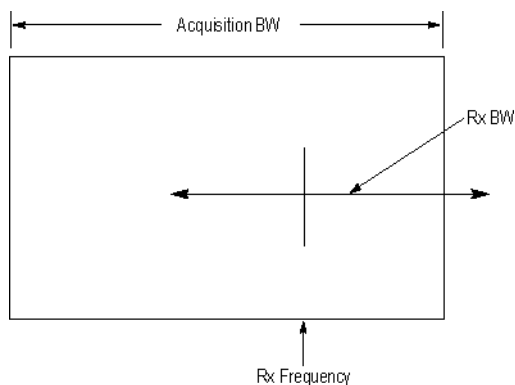

Case 2. In this case, the upper and lower limits of the Receiver BW exceed the upper and lower limits of the acquisition bandwidth. When this occurs, audio demodulation will be disabled and an error message is displayed.

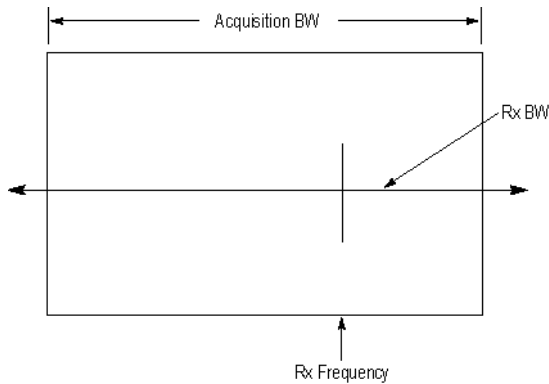

Case 3. In this case, the upper and lower limits of the Receiver BW fall within the upper and lower limits of the acquisition bandwidth. This is the desired relationship between the three settings, and audio demodulation is enabled.

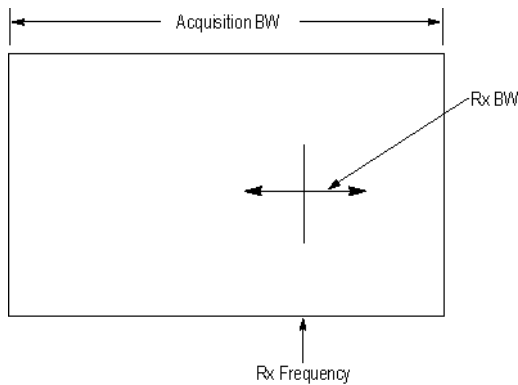

Time Overview Display

The Time Overview display shows the entire acquisition record and shows you how the spectrum time and analysis time fit within the acquisition record. This enables you to see how you can adjust the spectrum time and analysis time to measure portions of the data.

You can specify the maximum number of trace points in the Time Overview display. You can set the maximum number of trace points to 1K, 10K, 100K, 1M points or to Never decimate. If the Acquisition Length includes more than 10,000 sample points (and Max trace points is not set to Never decimate), the trace is decimated (using the +Peak method, similar to +Peak detection in a Spectrum display) to 10,000 points. This decimated trace is what is used for marker measurements.

The Time Overview window displays the Spectrum Length and Analysis Length. The Spectrum Length is the period of time within the acquisition record over which the spectrum is calculated. The Analysis Length is the period of time within the acquisition record over which all other measurements (such as Amplitude vs. Time) are made. The Spectrum Length and Analysis Length can be locked together so that the data used to produce the Spectrum display is also used for measurement displays; however, they

do not have to be tied together. They are by default specified separately and used to analyze different parts of the acquisition record.

Elements of the Display

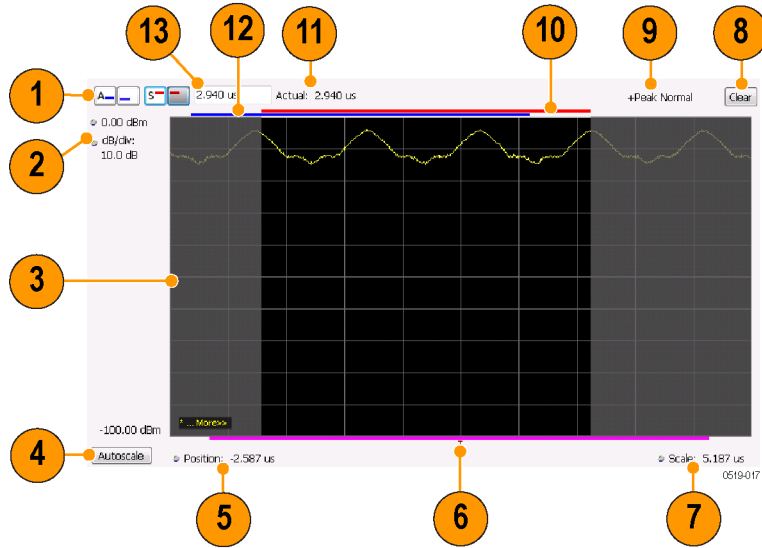

Item	Element	Description
1	Analysis Time Control	Click a button to select the value to be adjusted. In order, the buttons represent Analysis Offset, Analysis Length, Spectrum Offset, and Spectrum Length.
2	Position and Scale	Adjusts the vertical scale and position.
3	Amplitude vs. Time graph	The trace represents the entire acquisition record (at full horizontal scale). The graph indicates the Analysis Length or Spectrum Length on the graph with a darker background.
4	Autoscale button	Resets the horizontal scale to display the entire acquisition record and the vertical scale to show all trace points.
5	Horizontal Offset	Adjusts the horizontal offset.
6	Results Timeline	This fuchsia line indicates the portion of the record actually used for calculating the selected result. For example: if a pulse measurement is selected, it shows the period of the specific pulse. For a constellation display, it shows the points included in the demodulation.
7	Horizontal Scale	Adjusts the span of the graph. By decreasing the scale, the graph essentially becomes a window that you can move over the acquisition record by adjusting the offset.
8	Spectrum Length and Offset Indicator	This red line indicates the Spectrum Length and Offset. The longer the time, the longer the bar. Adjusting the offset shifts the bar left or right.
9	Function	This readout displays the Function setting (Setup > Settings > Trace).
10	Detection	This readout displays the Detection setting (Setup > Settings > Trace).
11	Actual length display	Displays the actual time for the selected value. If the user-adjusted length extends past the end of the acquisition record, the realizable analysis length is less than requested.
12	Analysis Length and Offset Indicator	This blue line indicates the Analysis Length and Offset. The longer the time, the longer the bar. Adjusting the offset shifts the bar left or right.
13	Setting Adjustment box	Click in this box to adjust the value selected by the Analysis Time Control buttons.

NOTE. The area with black background (not gray) in the Amplitude vs. Time Graph highlights the control selected in the Analysis Time Control drop-down list.

[Changing the Time Overview Display Settings \(see page 90\)](#)

Time Overview Settings

Menu Bar: Setup > Settings

Front Panel : Settings

Application Toolbar: 

The Setup settings for Time Overview are shown in the following table.

Settings tab	Description
Scale (see page 120)	Adjusts the vertical and horizontal scale and offset of the display.
Trace (see page 91)	Allows you to select the types of trace to display and its function.
Prefs (see page 120)	Specifies whether or not certain display elements are shown.

Trace Tab

The Trace Tab allows you to set the display characteristics of displayed traces.

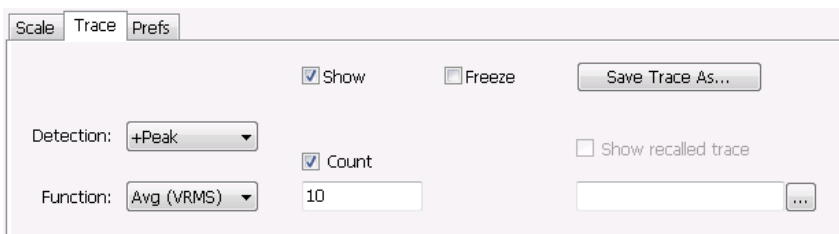

Setting	Description
Show	Shows / hides the selected trace.
Detection	Sets the Detection method used for the trace. Not available for saved traces. Available detection methods are +Peak, -Peak, +/-Peak, Avg (VRMS), and Sample. Not all detection methods are available in all displays.
Function	Selects the trace processing method. Available settings are: Normal, Average, Max Hold, and Min Hold.
(Number of Traces)	Sets the number of traces averaged to generate the displayed trace. (Present only when Function is set to Average.)
Freeze	Halts updates to the selected trace.
Save Trace As	Saves the selected trace to a file for later recall and analysis.
Show Recalled trace	Displays a saved trace instead of a live trace.

Detection

Trace Detection occurs when the trace is being decimated by the measurement. For example, if the maximum number of trace points is 100,000, and the selected analysis region is 200,000 samples, the measurement must decimate the 200,000 resulting trace points by 2 to prevent exceeding the 100,000 trace point limit. Since only one value can be selected for each trace point, an algorithm must be used to select (detect) the appropriate value to use.

The IQ samples in a data acquisition can be detected in a variety of ways. The number of IQ samples available to each trace point varies with both analysis length and trace length. For example, with Spectrum Length set to 'Auto' in the Analysis menu, the instrument analyzes just enough samples to produce one IQ sample pair per trace point. In this case, the detection method chosen has very little effect, as the

+Peak, -Peak, Avg (VRMS) and Sample values are all equal. Changing the Spectrum Length causes the available detection methods to differ in value because they have a larger set of samples for the various detection methods to process.

The available detection methods (depending on the display) are:

- **+Peak** – Each point on the trace is the result of detecting the positive peak value present in the set of IQ samples available to that trace point.
- **-Peak** – Each point on the trace is the result of detecting the negative peak value present in the set of IQ samples available to that trace point.
- **+/-Peak** – Selects the highest and lowest values of all the samples contained in two consecutive acquisition intervals.
- **Avg (VRMS)** [Average V_{RMS}] – Each point on the trace is the result of determining the RMS Voltage value for all of the IQ samples available to the trace point. When displayed in either linear (Volts, Watts) or Log (dB, dBm), the correct RMS value results. When the averaging function is applied to a trace, the averaging is performed on the linear (Voltage) values, resulting in the correct average for RMS values.
- **Sample** – The result is calculated based on the first sample available in the set of IQ samples for each trace point.

Trace Processing

Traces can be processed to display in different ways. The Function setting controls trace processing.

- **Normal** - Each new trace is displayed and then replaced by the next trace. Each data point contains a single vertical value.
- **Average** - Multiple traces are averaged together to generate the displayed trace. There is one vertical value for each underlying frequency data point. Once the specified number of traces have been acquired and averaged to generate the displayed trace, each new trace takes the place of the oldest trace in the calculation. The **Number of Traces** setting specifies how many traces averaged.
- **Max Hold** - Displays the maximum value in the trace record for each display point. Each new trace display point is compared to the previous maximum value and the greater value is retained for display and subsequent comparisons.
- **Min Hold** - Displays the minimum value in the trace record for each display point. Each new trace display point is compared to the previous minimum value and the lesser value is retained for display and subsequent comparisons.

Saving Traces

To save a trace for later analysis:

1. Select the Save icon . This displays the Save As dialog box.

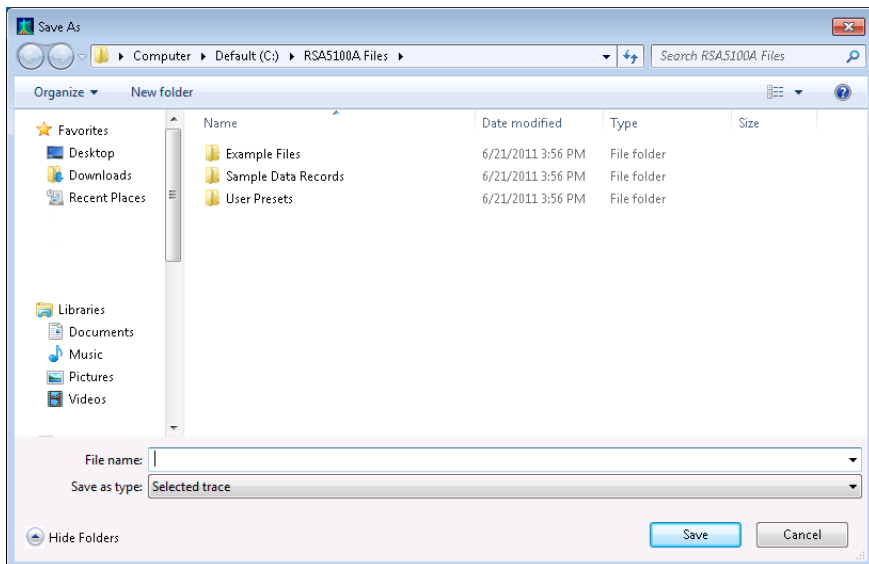

2. Navigate to the desired folder or use the default.
3. Type a name for the saved trace and click **Save**.

Recalling Traces

You can recall a previously saved trace for analysis or comparison to a live trace.

To select a trace for recall:

1. Select the trace into which the recalled trace will be loaded, from the Trace drop-down list.
2. Check the **Show** check box.
3. Click the ... button to display the Open dialog box.

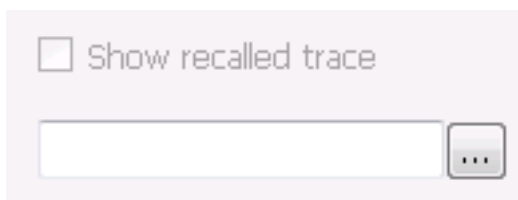

4. Navigate to the desired file and click **Open**.
5. Check the **Show Recalled Trace** check box.
6. Verify that the trace's **Show** check box is selected (either on this tab or next to the drop-down list located at the top-left corner of the graph).

Spectrum Display

To display a spectrum:

1. Click the **Displays** button or select **Setup > Displays**.
2. From the Folders box, select **General Signal Viewing**.
3. Double-click the **Spectrum** icon in the **Available displays** box. This adds the Spectrum icon to the **Selected displays** box (and removes it from the Available displays box). Alternatively, you can click the Spectrum icon and then click the Add button to select Spectrum for display.
4. Click the **OK** button.

Elements of the Spectrum Display

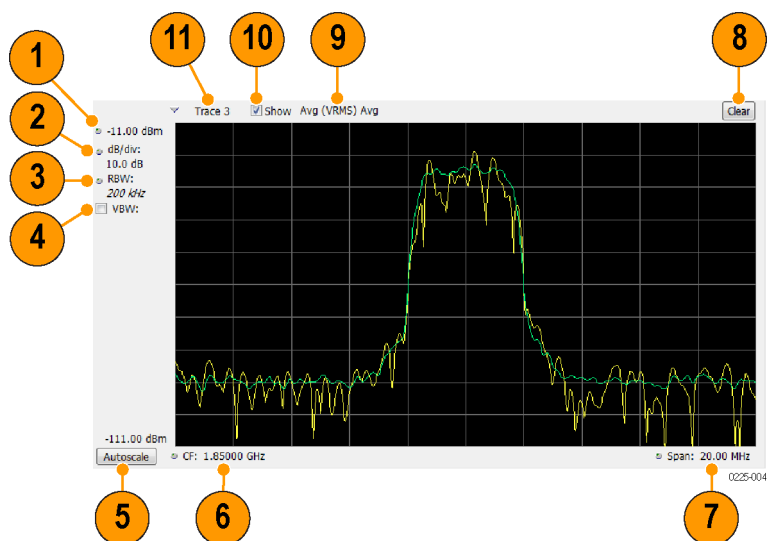

Item	Display element	Description
1	Vert Position	Sets the top of graph value. This is only a visual control for panning the graph. The Reference Level is adjusted in the Toolbar and the Ampl control panel. By default, Vert Position = Ref Level.
2	dB/div	Sets the vertical scale value. The maximum value is 20.00 dB/division.
3	RBW	Sets the resolution bandwidth. Note that when the RBW is set to Auto, its value is italicized.
4	VBW	Enables the VBW (Video Bandwidth) filter. See Setup > Settings > BW Tab (see page 118) .
5	Autoscale	Adjusts the Vertical and Horizontal scaling to display the entire trace on screen.
6	Position	Default function is CF - center frequency (equivalent to the Freq setting). If Horizontal scaling has been manually adjusted in Settings > Scale, then Offset will replace CF as the setting at the bottom-left corner of the screen.
7	Span / Scale	Default function is Span - frequency difference between the left edge of the display and the right edge. If Horizontal scaling has been manually adjusted in Settings > Scale, then Scale will replace Span as the setting at the bottom-right corner of the screen.
8	Clear	Restarts multi-trace functions (Avg, Hold).
9	Function	Readout of the Detection and Function selections for the selected trace.
10	Show	Controls whether the selected Trace is visible or not. When trace is Off, the box is not checked.
11	Trace	Selects a trace. Touching here pops up a context menu listing the available traces, whether they are enabled or not. If user selects a trace that is not currently enabled, it will be made enabled.

Touchscreen Actions on Markers in the Graph Area

Action	Description
Mouse click within 1/2 div. of a marker	Selects the marker and updates the marker display to show the selected marker's values.
Touch marker to select and then use knob, or arrow keys	Adjust the setting associated with the Marker.
Touch and drag a marker	Changes marker position to the "drop point".

[Changing the Spectrum Display Settings \(see page 95\)](#)

Spectrum Settings

Menu Bar: Setup > Settings

Front Panel: Settings

Application Toolbar: 

The settings for the Spectrum display are shown in the following table.

Settings tab	Description
Freq & Span (see page 113)	Sets frequency and span parameters for the Spectrum Analysis display.
BW (see page 118)	Sets Resolution Bandwidth and windowing parameters.
Traces (see page 114)	Sets Trace display parameters.
Traces (Math) (see page 117)	Sets the traces used to create the Math trace.
Scale Tab (see page 96)	Sets vertical and horizontal scale and position parameters.
Prefs Tab (see page 120)	Specifies whether or not certain display elements are shown.

Scale Tab

The Scale tab allows you to change the vertical and horizontal scale settings. Changing the scale settings changes how the trace appears on the display but does not change control settings such as Measurement Frequency. In effect, these controls operate like pan and zoom controls.



Setting	Description
Vertical	
Scale	Changes the vertical scale.
Position	Vertical Position adjusts the top of graph amplitude value. This control allows you to move (“pan”) the traces up and down in the graph without changing the Reference Level.
Autoscale	Resets the Offset so that the trace appears below the top of the graph.
Horizontal	
Scale	Allows you to change the range of frequencies shown in the graph without changing the span or measurement frequency.
Position	Allows you pan the graph.
Autoscale	Resets Scale to the Span setting.
Reset Scale	Resets all settings to their default values.
Log scale	Resets the display to show the frequency axis in a logarithmic scale.

Spectrogram Display

The Spectrogram is a display with the vertical axis (time) composed of successive spectral displays, each having the amplitude represented by color or intensity. The horizontal axis represents frequency. The most recently acquired spectrum results are added to the bottom of the spectrogram. The addition of a new spectrum can occur at the fastest rate that new spectra can be plotted, or, if you choose, new spectra can be added at a timed rate. The spectrogram view is well-suited to displaying long-term trends of spectral data. The maximum number of lines that can be displayed in a spectrogram is 125,000.

The spectrogram can also be displayed in a 3-D waterfall format. In the 3-D waterfall format, the spectrogram displays the time axis along a simulated Z-axis.

NOTE. Spectrogram data is shared with the Spectrum display. There is no linkage between DPX and Spectrogram.

To display a Spectrogram:

1. Select the **Displays** button or select **Setup > Displays**. This displays the **Select Displays** dialog box.
2. From the **Folders** box, select **General Signal Viewing**.
3. Double-click the **Spectrogram** icon in the **Available Displays** box. This adds the Spectrogram icon to the Selected displays box.
4. Click the **OK** button. This displays the spectrogram view.
5. To display a 3-D version of the spectrogram, select the 3-D checkbox.

Elements of the Spectrogram Display

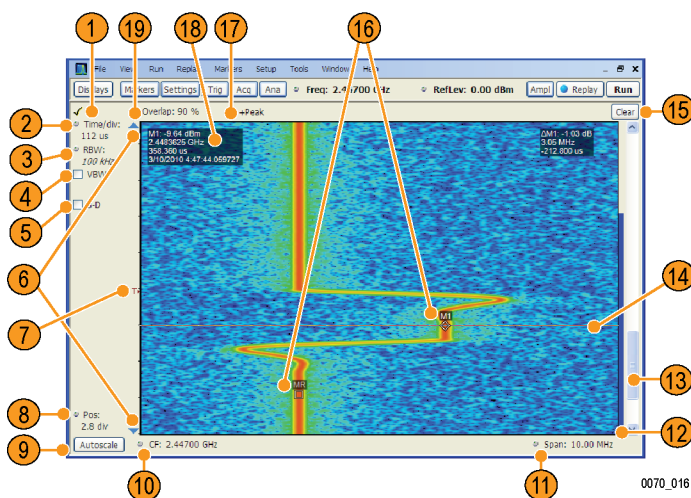

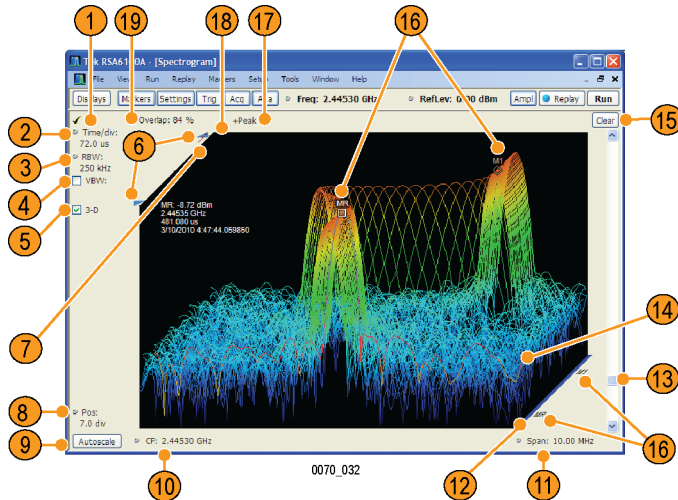

Item	Display element	Description
1	Check mark indicator	The check mark indicator in the upper, left-hand corner of the display shows when the Spectrogram display is the optimized display.
2	Time/div	Sets the length of time represented by each vertical division. Divisions are indicated by tick marks along the left edge of the graph.
3	RBW	Sets the resolution bandwidth. Note that when the RBW is set to Auto, its value is italicized.
4	VBW	Enables the VBW (Video Bandwidth) filter. See Setup > Settings > BW Tab (see page 118).
5	3-D check box	Enables and disables the 3-D view.
6	Selected records indicators	Shows the positions of the start and stop records selected on the Select data records tab. Drag the indicators to select which records will be played by Replay All. Note that these are not visible while acquisitions are running; the instrument must be stopped for the indicators to be visible.
7	T	Trigger indicator. This icon indicates the trigger point within the current acquisition.
8	Pos	Position indicates the bottom line visible in graph. Changing this setting scrolls the window up and down through the displayed acquisition records.
9	Autoscale	Resets Vertical and Horizontal scale and Pos to default values.
10	CF	Sets the Center Frequency.
11	Span	Sets the span of the spectrogram display.
12	Current data record indicator	A blue line indicates the current data record. When the analysis length is short, the blue line appears as a thin line much like the selected indicator line. When the analysis length is relatively long, the blue line appears more like a blue bar.
13	Position scroll bar	Changes the position of the trace in the window. Changing the position scroll bar is the same as adjusting the Pos setting.
14	Selected indicator	This inverse-colored line indicates the Spectrogram line that will appear in the Spectrum display when the Spectrogram trace is enabled. This line is attached to the selected marker.

Item	Display element	Description
15	Clear	Clears the spectrogram display; however, data records in acquisition history remain in memory and are available for replay. To clear memory, select File > Acquisition Data Info > Delete All Data .
16	Marker indicators	These icons indicate the position of markers in the spectrogram. You can move markers by dragging the desired marker indicator.
17	Detection setting	Displays the selected Detection method (see Settings > Trace (see page 100) tab).
18	Marker readout	Marker readout for the selected marker. In the Spectrogram display, the marker readout includes a date and timestamp. The time is displayed in a 24-hour format. The timestamp readout can be shown or hidden independently of the other marker readouts (see Settings > Prefs (see page 120)).
19	Time Scale status readout	Three readouts can appear here depending on settings: Time/update, Spectrums/line, and Overlap. See Time Scale Status Readout (see page 99) .

Time Scale Status Readout

Three types of readouts can appear in the display depending on settings:

- Time/update – Displays minutes:seconds when Spectrum Monitor is selected in the **Settings > Time & Freq Scale** tab in the **Vertical (Time)** section.
- Spectrums/line – Displays an integer number when vertical scale is Normal and each line contains the results from one or more frequency transforms (whether zoomed out or not).
- Overlap – Displays the overlap percentage when vertical scale is Normal and each line's transform shares some points with the transforms of lines before and after it (zoomed in). Overlap can only be done when the Analysis Length > 2x RBW frame length.

The Spectrogram can show results from one or multiple acquisitions and it can show one or multiple lines for each acquisition.

[Changing the Spectrogram Display Settings \(see page 99\)](#)

Spectrogram Settings

Menu Bar: Setup > Settings

Front Panel: Settings

Application Toolbar: 

The Setup settings for the Spectrogram display are visible when Spectrogram is the selected display.

Settings tab	Description
Freq & Span (see page 113)	Sets frequency and span parameters for the Spectrogram display.
BW (see page 118)	Sets Resolution Bandwidth and windowing parameters.
Trace (see page 100)	Sets Trace display parameters.
Amplitude Scale (see page 101)	Selects between 2-D and 3-D, sets height scale, position and orientation for 3-D display. Sets color parameters for the spectrogram trace.
Time & Freq Scale (see page 101)	Sets the vertical and horizontal scale parameters for the spectrogram trace. The Spectrum Monitor controls are also on this tab.
Prefs (see page 120)	Specifies whether or not certain display elements are shown.

Trace Tab

The Spectrogram Trace tab controls let you specify the Detection method, save traces, and recall saved traces for display. The Spectrogram Trace tab does not have all the controls that other Trace tabs contain, however, it does have a unique display element, the Selected Line readout. For details on Detection, Freeze, and saving and recalling traces, see the [Traces Tab \(see page 114\)](#).

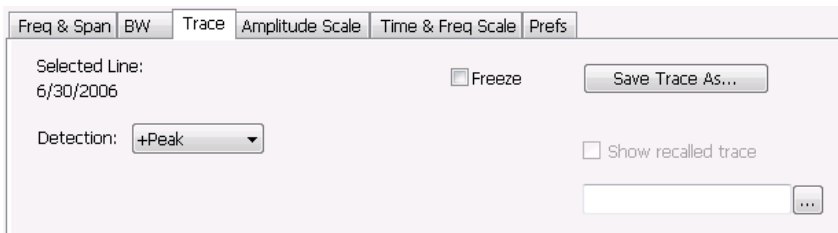

Selected Line

Displays the time at the Selected Line. If Markers are enabled, the selected line is positioned by the selected marker. If no markers are enabled, the selected line is the first line in the current analysis period.

Amplitude Scale Tab

The Amplitude Scale tab allows you to change the vertical and horizontal scale settings, enable the 3-D Waterfall display, and set the color scheme used for the spectrogram trace.

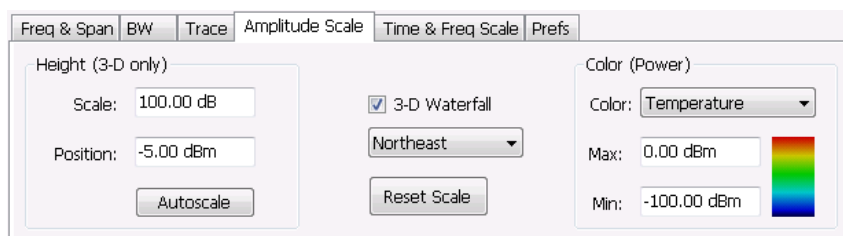

Setting	Description
Height (3-D only)	
Scale	Changes the vertical scale for trace Amplitude in the graph (not the vertical scale for Time).
Position	Specifies the level displayed at the bottom edge of the graph. (Bottom front edge in the 3-D view).
Autoscale	Adjusts the vertical position and scale of the trace lines to bring them into the visible portion of the graph.
3-D Waterfall	Displays the spectrogram in a 3-D format.
Northeast	Shifts the perspective of the 3-D graph so that the oldest traces move back and to the right.
Northwest	Shifts the perspective of the 3-D graph so that the oldest traces move back and to the left.
Reset Scale	Resets the Height and Color settings to their default values.
Color (Power)	
Color	Displays a drop-down list that allows you to set the color scheme used for the spectrogram trace.
Max	Sets the maximum power level represented by the top of the color scale.
Min	Sets the minimum power level represented by the bottom of the color scale.

Time & Freq Scale Tab

The Time and Freq Scale tab allows you to change the vertical and horizontal scale settings, enable the 3-D Waterfall display, and set the color scheme used for the spectrogram trace.

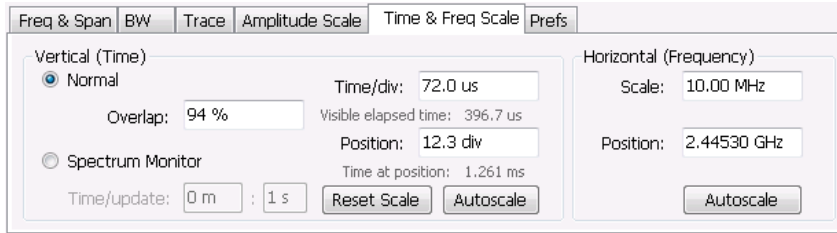

Setting	Description
Vertical (Time)	
Normal	For most Spectrogram applications. Primary time scale control is Time/div. Time scale can be zoomed in or out.
Spectrum Monitor	For long-term signal monitoring applications. In spectrum monitor mode, each line in the spectrogram represents the period of time specified by the Time/update parameter. Time scale can be zoomed out, but not zoomed in (no overlap).
Time/update	Sets the time, in minutes and seconds, represented by each line of the spectrogram. Only available in Spectrum Monitor.
Reset Scale	Resets the Time/div and Pos settings to their default values.
Autoscale	Scales the vertical (time) axis to compress all existing trace lines into the visible area of the graph. Resets the Position value to zero, placing the most recent spectrogram line at the bottom of the spectrogram display. Only Position is affected by Autoscale when Spectrum Monitor is selected.
Time/div	Sets the time displayed per division.
Visible elapsed time	Displays the length of time visible in the display. This does not represent the total time available to view.
Position	Adjusts vertical position of the trace within the graph area. Setting represents the offset, in divisions, between the bottom of the graph and the bottom (most recent) line in the results trace.
Time at position	Displays the time of the spectrogram line shown at the bottom of the graph. This time is relative to the Time Zero Reference of the current acquisition.
Horizontal (Frequency)	
Scale	Sets the frequency range of the graph without changing the Span value.
Position	Sets the frequency displayed at the center of the graph. Changing this value does not change the Freq setting.
Autoscale	Sets the frequency scale to the Spectrogram Span value.

Spectrum Monitor

Spectrum Monitor performs long term monitoring. The monitor mode compresses time into each line of the spectrogram, which enables you to monitor long periods of time (from 1 second per line up to 600 minutes per line). With extended memory (Option 02) installed in the instrument, you can capture up to 125,000 lines. With standard memory installed in the instrument, the maximum number of lines you can capture is 31,250.

During each line's collection period, spectrum transforms are computed for each acquisition taken by the instrument. As each transform completes, it is incorporated into the current spectrogram line. How each

line of the spectrogram is created in spectrum monitor mode depends on the detection setting (Settings > Trace). For example, if Detection is set to +Peak, each spectrogram line is effectively a peak hold display of all the spectral data captured since the prior line.

Amplitude Vs Time Display

The Amplitude vs. Time display plots the signal amplitude against time. The amplitude appears on the vertical axis while time is plotted along the horizontal axis.

Note that the trace(s) in the Amplitude vs. Time display can be set to a maximum of 100,000 points (however, the actual number of trace points can extend up to 1,000,000 points if Max trace points is set to Never Decimate). If the Analysis Length includes more than the selected Max trace points value, the trace is decimated (using the method specified with the Detection control) to be equal to or less than the Max trace points setting (except when Max trace points is set to Never Decimate). This decimated (or undecimated) trace is what is used for marker measurements and for results export. You can set the Max trace points on the **Settings > Prefs** tab.

To show Amplitude vs. Time display:

1. Press the **Displays** button or select **Setup > Displays**.
2. In the **Select Displays** dialog, select **General Signal Viewing** in the **Folders** box.
3. In the **Available displays** box, double-click the **Amplitude vs. Time** icon or select the icon and click **Add**. The Amplitude vs. Time icon will appear in the **Selected displays** box and will no longer appear under Available displays.
4. Click **OK**.

Elements of the Display

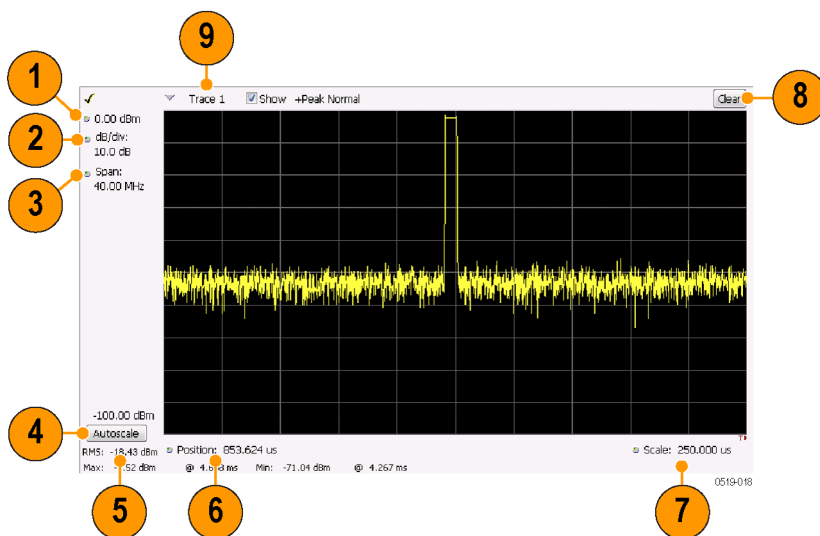

Item	Display element	Description
1	Vert Position	Adjusts the vertical display offset.
2	Vertical scale adjustment	Adjusts the vertical scaling.
3	Span	Adjust the bandwidth of the data to be analyzed. (Not the period of time shown in the display.)
4	Autoscale	Adjusts the vertical and horizontal settings to provide the best display.
5	Offset	Adjust the horizontal offset.
6	Max and Min readouts	Displays the maximum and minimum amplitudes, as well as when those values occur.
7	Scale	Sets the time spanned by the graph.
8	Clear button	Restarts multi-trace functions (Avg, Hold).
9	Trace function	Displays the current trace function setting (Settings > Trace tab > Function).

Reference. [Changing Amplitude vs Time Display Settings \(see page 104\)](#)

Amplitude Vs Time Settings

Menu Bar: Setup > Settings

Front Panel: Settings

Application Toolbar: 

The settings for the Amplitude vs. Time display are shown in the following table.

Settings tab	Description
BW (see page 105)	Sets the Bandwidth Method used for setting the measurement bandwidth.
Traces (see page 114)	Allows you to select the type of trace to display and their functions.
Traces (Math) (see page 117)	Sets the traces used to create the Math trace.
Scale (see page 120)	Sets the vertical and horizontal scale parameters.
Prefs (see page 120)	Specifies whether certain display elements are visible.

Freq & BW Tab

The Freq & BW (Bandwidth) tab allows you to specify the measurement frequency the bandwidth parameters used for setting measurement bandwidth. This determines what Acq BW the measurement will request.

Settings	Description
Span	The frequency span used for analysis in the Amplitude vs. Time display. If the spectrum display is open, the span is automatically set to the analyzer bandwidth.

Frequency Vs Time Display

The Frequency vs. Time Display shows how the signal frequency varies with time.

Note that the trace(s) in the Frequency vs. Time display can be set to a maximum of 100,000 points (however, the actual number of trace points can extend up to 1,000,000 points if Max trace points is set to Never Decimate). If the Analysis Length includes more than the selected Max trace points value, the trace is decimated (using the method specified with the Detection control) to be equal to or less than the Max trace points setting (except when Max trace points is set to Never Decimate). This decimated (or undecimated) trace is what is used for marker measurements and for results export. You can set the Max trace points on the **Settings > Prefs** tab.

To display the Frequency vs. Time Display:

1. Select the **Displays** button or **Setup > Displays**.
2. In the **Select Displays** dialog, select **General Signal Viewing** in the **Folders** box.
3. In the **Available displays** box, double-click the **Frequency vs. Time** icon or select the icon and click **Add**. The Frequency vs. Time icon will appear in the **Selected displays** box and will no longer appear under Available displays.
4. Click **OK** to display the Freq vs. Time display.

Elements of the Display

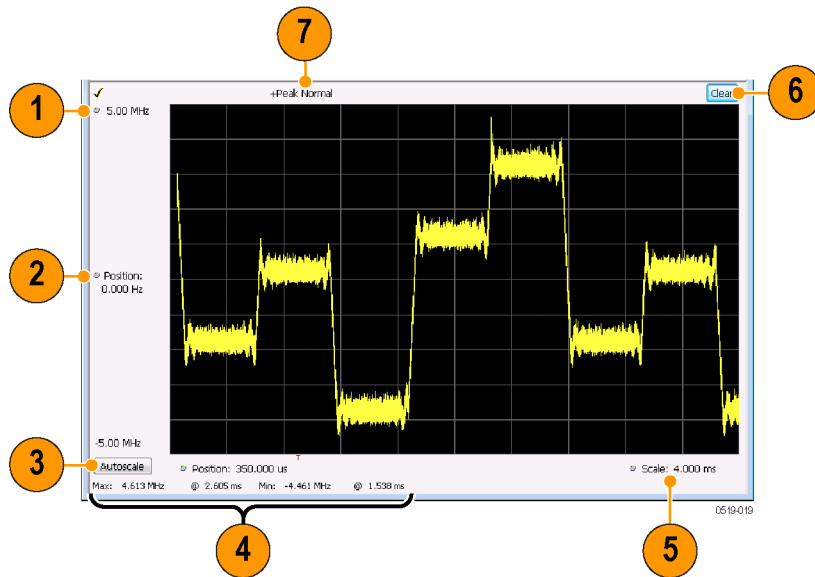

Item	Display element	Description
1	Top of graph adjustment	Use the knob to adjust the frequency range displayed on the vertical axis.
2	Offset adjustment	Adjusts the frequency shown at the center of the display.
3	Autoscale button	Adjusts the offset and range for both vertical and horizontal to provide the best display.
4	Maximum and Minimum frequency readouts	Displays the maximum and minimum values, as well as when those values occur.
5	Horizontal Scale	Sets the time spanned by the graph.
6	Clear button	Restarts Average trace.
7	Trace function	Displays the current trace function setting (Settings > Trace > Function).

[Changing Frequency vs Time Display Settings \(see page 106\)](#)

Frequency Vs Time Settings

Menu Bar: Setup > Settings

Front Panel: Settings

Application Toolbar: 

The Setup settings for Frequency vs. Time are shown in the following table.

Settings tab	Description
Freq & Span (see page 113)	Sets the frequency and span parameters.
Trace (see page 114)	Sets the trace display parameters.
Scale (see page 120)	Sets the Vertical and Horizontal scale and offset parameters.
Prefs (see page 120)	Specifies whether certain display elements are visible.

Phase Vs Time Display

The Phase vs. Time display plots the signal phase against time. The phase appears on the vertical axis while time is plotted along the horizontal axis.

Note that the trace(s) in the Phase vs. Time display can be set to a maximum of 100,000 points (however, the actual number of trace points can extend up to 1,000,000 points if Max trace points is set to Never Decimate). If the Analysis Length includes more than the selected Max trace points value, the trace is decimated (using the method specified with the Detection control) to be equal to or less than the Max trace points setting (except when Max trace points is set to Never Decimate). This decimated (or undecimated) trace is what is used for marker measurements and for results export. You can set the Max trace points on the **Settings > Prefs** tab.

To display Phase vs. Time:

1. Press the **Displays** button or select **Setup > Displays**.
2. In the **Select Displays** dialog, select **General Signal Viewing** in the **Folders** box.
3. In the **Available displays** box, double-click the **Phase vs. Time** icon or select the icon and click **Add**. The Phase vs. Time icon will appear in the **Selected displays** box and will no longer appear under Available displays.
4. Click **OK** to show the Phase vs. Time display.

Elements of the Display



Item	Display element	Description
1	Top of graph adjustment	Adjusts the vertical scale. Use the knob to adjust the value of the top of the graph.
2	Vertical offset adjustment	Adjusts the phase error shown at the vertical center of the display.
3	Autoscale button	Adjusts the vertical and horizontal settings so that the entire trace fits in the view.
4	Horizontal Offset	Adjusts the horizontal position of the trace.
5	Max and Min readouts	Displays the maximum and minimum value of the phase error within the analysis times and the times at which they occurred.
6	Horizontal Scale	Sets the time spanned by the graph.
7	Clear button	Restarts multi-trace functions (Avg, Hold).
8	Trace function	Shows the trace function as set on the Settings > Trace tab.

[Changing the Phase vs Time Display Settings \(see page 108\)](#)

Phase Vs Time Settings

Menu Bar: Setup > Settings

Front Panel: Settings

Application Toolbar: 

The settings for the Phase vs. Time display are shown in the following table.

Settings tab	Description
Freq & Span (see page 113)	Sets the frequency and span parameters.
Trace (see page 114)	Sets the trace display parameters.
Scale (see page 120)	Sets the Vertical and Horizontal scale and offset parameters.
Prefs (see page 120)	Specifies whether certain display elements are visible.

RF I & Q vs Time Display

This is a plot of the baseband In-Phase (I) and Quadrature (Q) components of a modulated carrier. The plot is in the time domain, with I and/or Q values the Y-axis.

Note that the trace(s) in the RF I & Q vs. Time display can be set to a maximum of 100,000 points (however, the actual number of trace points can extend up to 1,000,000 points if Max trace points is set to Never Decimate). If the Analysis Length includes more than the selected Max trace points value, the trace is decimated (using the method specified with the Detection control) to be equal to or less than the Max trace points setting (except when Max trace points is set to Never Decimate). This decimated (or undecimated) trace is what is used for marker measurements and for results export. You can set the Max trace points on the **Settings > Prefs** tab.

To display an RF I & Q vs. Time display:

1. Select the **Displays** button or select **Setup > Displays**. This shows the **Select Displays** dialog box.
2. From the **Folders** box, select **General Signal Viewing**.
3. Double-click the **RF I&Q vs. Time** icon in the **Available Displays** box. This adds the RF I & Q vs. Time icon to the **Selected displays** box.
4. Click the **OK** button.

Elements of the Display

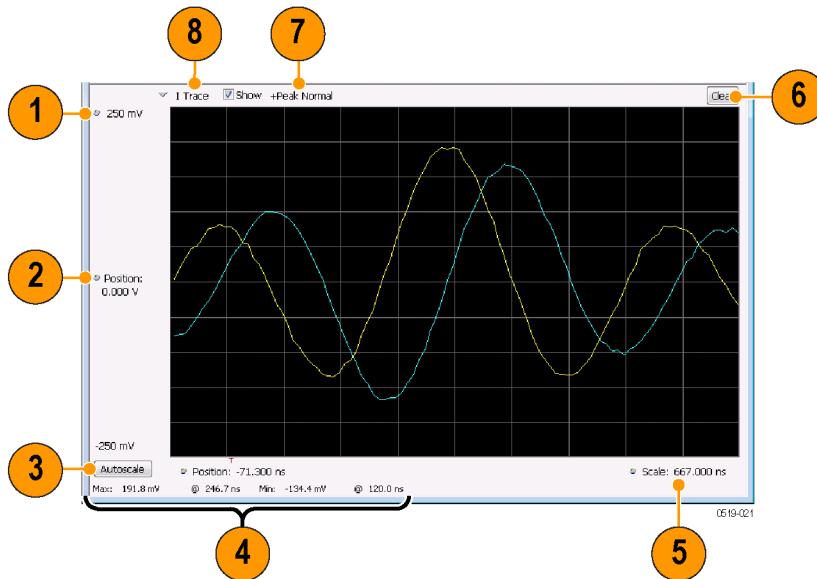

Item	Display element	Description
1	Top of Graph adjustment	Use the knob to adjust the vertical scaling.
2	Vertical offset adjustment	Adjusts the level shown at the center of the display.
3	Autoscale button	Adjusts the offset and scale for both vertical and horizontal to provide the best display.
4	Maximum and Minimum level readouts	Displays the maximum and minimum values, within the Analysis Time, as well as the times at which they occurred.
5	Scale	Sets the time spanned by the graph.
6	Clear button	Restarts multi-trace functions (Avg, Hold).
7	Trace function	Displays the current trace function setting (Settings > Trace > Function). If the traces are averaged, the number of averages is displayed.
8	Trace Control	Selects which trace is displayed (using the drop-down list) and which trace is active (click on the trace name to display a menu).

[Changing the RF I & Q vs Time Display Settings \(see page 110\)](#)

RF I & Q vs Time Settings

Menu Bar: Setup > Settings

Front Panel: Settings

Application Toolbar: 

The Setup settings for RF I&Q vs. Time are shown in the following table.

Settings tab	Description
Freq & BW (see page 112)	Sets the frequency and span parameters.
Trace (see page 114)	Sets the trace display parameters.
Scale (see page 120)	Sets the Vertical and Horizontal scale and offset parameters.
Prefs (see page 120)	Specifies whether certain display elements are visible.

General Signal Viewing Shared Measurement Settings

The control panel tabs in this section are identical or very similar for each of the displays in the General Signal Viewing folder (Setup > Displays). Some tabs are shared by all the displays, some tabs are shared by only a couple of displays.

For some tabs, the control values are shared across all the General Signal Viewing displays. For other control values, each display has unique values for the controls. Details are provided for the specific tabs.

Common controls for general signal viewing displays

Settings tab	Description
Freq & Span (see page 113)	Sets the frequency and span parameters.
Trace (see page 114)	Sets the trace display parameters.
Traces – Math (see page 117)	Sets the traces used to create the Math trace.
BW (see page 118)	Sets the Bandwidth Method used for setting the measurement bandwidth.
Scale (see page 120)	Sets the Vertical and Horizontal scale and offset parameters.
Prefs (see page 120)	Specifies whether certain display elements are visible.

Freq & BW Tab — RF I & Q Vs. Time Display

The Freq & BW tab provides access to settings that control frequency settings for the RF I & Q vs Time display.

Setting	Description
Measurement Freq	The frequency at the which measurements are made. This value is the same as the setting for Frequency in the Application bar.
Measurement BW	This control limits the bandwidth of measurements. You use the measurement bandwidth setting to improve the signal-to-noise ratio of the measurement, resulting in lower measurement uncertainty. However, if the measurement bandwidth is set too low, resulting in fewer samples per second, it can reduce the number of points within the measurement length below the 256 stable samples required, thus causing the analysis to fail.
Link to Span	When enabled, the measurement bandwidth of the RF I & Q display is determined by the span of the analyzer. When unchecked, the measurement bandwidth is specified by the user, and no additional filter is applied.
Set to max BW	Sets the measurement bandwidth to the maximum acquisition bandwidth of the instrument.

Freq & Span Tab

The Freq & Span tab provides access to settings that control frequency settings for the trace display. The control values set in this tab are shared by all the General Signal Viewing displays.

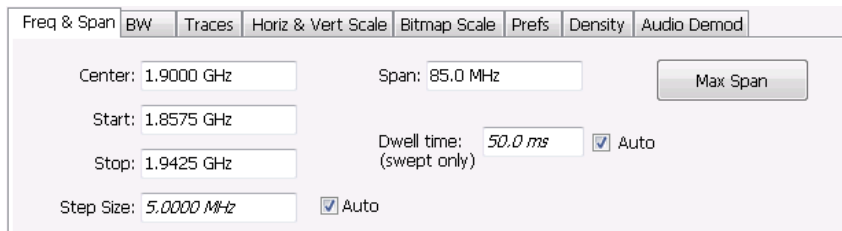

Setting	Description
Center	The frequency at the center of the selected Span.
Start	The lowest frequency in the span.
Stop	The highest frequency in the span.
Step Size	Sets the increment/decrement size for Center, Start and Stop values.
Span	The difference between the start and stop frequencies. This is the measurement bandwidth for the general signal viewing displays.
Dwell time (DPX display only)	The amount of time the DPX sweep remains in a frequency segment collecting data and updating the bitmap and traces before moving on to the next higher frequency segment. The minimum Dwell Time setting is 50 ms, the normal update rate for DPX computations. Maximum Dwell Time per frequency segment is 100 s. The number of frequency segments and their start/stop frequencies are internally determined based on span, acquisition bandwidth, RBW and other parameters.
Max Span	Sets the Span to the maximum value.

Center, Start, Stop, and Span Frequencies Are Correlated

Changing the values for Center frequency, Start frequency, Stop frequency or Span will change the values for the other settings, depending on which setting you change. For example, if you change the Center frequency, the Start and Stop frequencies will be adjusted automatically to maintain the same Span.

Note however that if the Start and Stop frequencies are changed so that they are closer than the minimum span setting, the Start and Stop frequencies will be adjusted to maintain the minimum Span setting.

Setting Changed Manually	Settings Changed Automatically As a Result	Setting Not Automatically Changed
Start	Center, Span	Stop
Stop	Center, Span	Start
Center	Start, Stop	Span
Span	Start, Stop	Center

Traces Tab

The Traces Tab allows you to set the display characteristics of displayed traces.



Setting	Description
Trace	Selects a trace. (This setting is not present for every display.)
Show	Shows / hides the selected trace.
Detection	Sets the Detection method used for the trace. Not available for saved traces. Available detection methods are +Peak, -Peak, +/-Peak, Avg (VRMS), Sample, CISPR Avg, CISPR Pk, and CISPR QPk. Not all detection methods are available in all displays.
Function	Selects the trace processing method. Available settings are: Normal, Average, Max Hold, and Min Hold.
Count	Sets the number of traces averaged to generate the displayed trace. (Present only when Function is set to Average, Min Hold, or Max Hold.)
Freeze	Halts updates to the selected trace.
Save Trace As	Saves the selected trace to a file for later recall and analysis.
Show Recalled trace	Displays a saved trace instead of a live trace.

Trace

Available traces for Spectrum are: Trace 1, Trace 2, Trace 3, Math, and Spectrogram. Other displays support fewer traces. Traces 1-3 are based on the input signal and enable you to display the input signal using different processing. For example, you could display Trace 1 with Function set to Normal, Trace 2 with Function set to Max Hold and Trace 3 with Function set to Min Hold.

The Math trace is the result of subtracting one trace from another.

The Spectrogram trace applies only to the Spectrum display and is available only if the Spectrogram display is shown. The Spectrogram trace shows the trace selected in the Spectrogram as a spectrum trace.

Detection

Trace Detection is used to reduce the results of a measurement to the desired number of trace points. For example, if the maximum number of trace points is 100,000, and a measurement over the selected analysis length yields 200,000 points, the measurement must decimate these 200,000 trace points by 2 to prevent exceeding the 100,000 trace point limit. Since only one value can be represented for each trace point, an algorithm must be used to select (detect) the appropriate value to use.

The results array from an analysis can be detected (or “decimated”) in a variety of ways. The number of results points produced for each trace point varies with both analysis length and trace length. For example, the frequency transform used for the Spectrum display produces just one output value for each desired trace point. In this case, the detection method chosen has no effect, as no decimation is required. Increasing the Analysis Length (or for the Spectrum display, the Spectrum Length), causes the available detection method's output traces to differ from each other because they have a larger set of samples for the various detection methods to process.

The available detection methods (depending on the display) are:

- **+Peak** – The highest value is selected from the results to be compressed into a trace point.
- **-Peak** – The lowest value is selected from the results to be compressed into a trace point.
- **+/-Peak** – Both the highest and lowest values are selected from the results to be compressed into a trace point.
- **Avg (VRMS)** [Average V_{RMS}] – Each point on the trace is the result of determining the RMS Voltage value for all of the results values it includes. When displayed in either linear (Volts, Watts) or Log (dB, dBm), the correct RMS value results.
- **Avg (of logs)** – The detector is used to emulate legacy spectrum analyzer results and for the specification of displayed average noise level. In older swept analyzers, a voltage envelope detector is used in the process of measuring signal level, and the result is then converted to Watts and then to dBm. Averaging is then applied to the resultant traces.

For CW signals, this method results in an accurate power measurement. However, with random noise and digitally modulated carriers, errors result from this 'average of logs' method. For random noise, the average of logs methods results in power levels -2.51 dB lower than that measured with a power meter, or with a signal analyzer that measures the rms value of a signal, and performs averaging on the calculated power in Watts and not dBm or other log-power units.

This detector should be used when following a measurement procedure that specifies it, or when checking the Displayed Averaged Noise Level (DANL) of the instrument. The 'average of logs' detection and trace function is used for DANL specification to provide similar results to other spectrum/signal analyzers for comparison purposes. Use of the Average of Logs method of measurement is not recommended for digitally modulated carriers, as power measurement errors will occur.

NOTE. *The Detection setting does not affect the trace until the spectrum length is longer than the Auto setting.*

- **Sample** – The first value is selected from the set of results to be compressed into a trace point.
- **CISPR Peak** – The trace value is calculated by the methods described for peak detectors in the CISPR documents.

Trace Processing

Traces can be processed to display in different ways. The Function setting controls trace processing.

- **Normal** - Each new trace is displayed and then replaced by the next trace. Each data point contains a single vertical value.
- **Average** - Multiple traces are averaged together to generate the displayed trace, which will contain just one vertical value for each underlying frequency data point. Once the specified number of traces have been acquired and averaged to generate the displayed trace, additional traces contribute to the running average, except in Single Sequence run mode. In the case of Single Sequence, the instrument stops running after the specified number of traces have been averaged together. The **Number of Traces** setting specifies how many traces are averaged. The averaging is performed on the linear (Voltage) values, resulting in the correct RMS average).
- **Max Hold** - Displays the maximum value in the trace record for each display point. Each new trace's display point is compared to the previous maximum value and the greater value is retained for display and subsequent comparisons.
- **Min Hold** - Displays the minimum value in the trace record for each display point. Each new trace's display point is compared to the previous minimum value and the lesser value is retained for display and subsequent comparisons.

Saving Traces

To save a trace for later analysis:

1. Select the **Save Trace As** button. This displays the Save As dialog box.

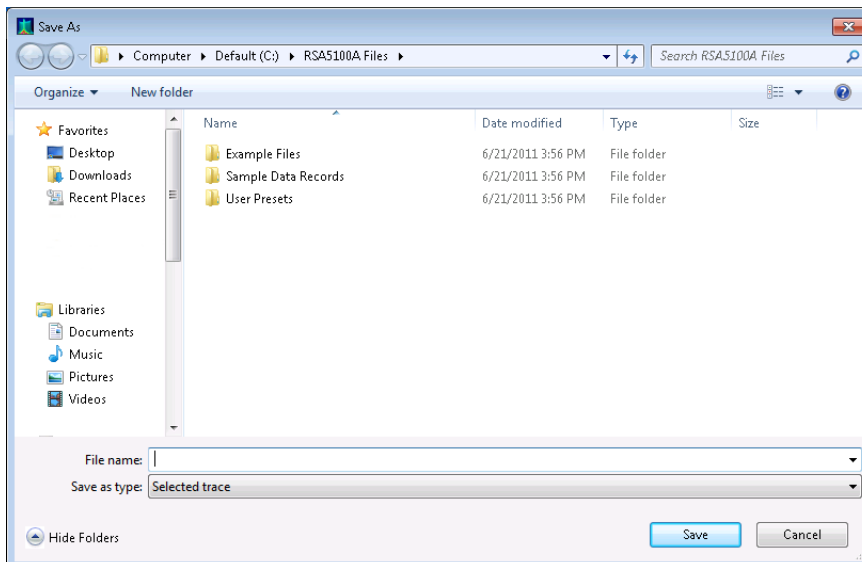

2. Navigate to the desired folder or use the default.
3. Type a name for the saved trace and click **Save**.

Recalling Traces

You can recall a previously saved trace for analysis or comparison to a live trace.

To select a trace for recall:

1. Select the trace into which the recalled trace will be loaded, from the Trace drop-down list.
2. Check the **Show** check box.
3. Click the ... button to display the Open dialog box.

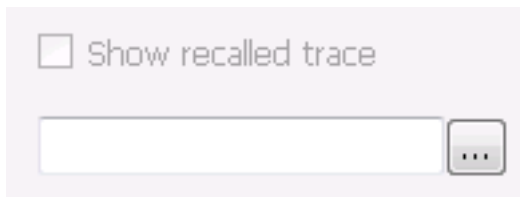

4. Navigate to the desired file and click **Open**.
5. Check the **Show Recalled Trace** check box.
6. Verify that the trace's **Show** check box is selected (either on this tab or next to the drop-down list located at the top-left corner of the graph).

Traces Tab – Math Trace

This tab is not a distinct tab, it is just how the Traces tab appears when Math is selected in the Traces drop-down list.



Trace 4 is a mathematically-derived trace defined as Trace A minus Trace B. You can select Trace 1, 2, or 3 to serve as either Trace A or Trace B.

Setting	Description
Trace	When set to Trace 4 (Math), this tab is displayed.
Show	Shows / hides the selected trace.
Freeze	Halts updates to the selected trace.
Save Trace As	Saves the selected trace to a file for later recall and analysis.
Trace minus Trace	Selects which traces serve as Trace A and Trace B.

BW Tab

The BW (bandwidth) tab allows you to change Resolution Bandwidth and Video Bandwidth settings, and set the windowing method used by the transform process by selecting a filter shape (not present for all displays).

The screenshot shows the 'BW' tab interface with the following settings:

- RBW:** 500 kHz (with an *Auto* checkbox checked)
- Span/RBW ratio:** 100
- Filter Shape:** Kaiser (RBW) (selected from a dropdown menu)
- VBW:** 500 kHz (with a checked checkbox)

Setting	Description
RBW	Sets the Resolution Bandwidth value to be used in the spectrum analysis view. The value is italicized when Auto is selected.
Auto	When Auto is checked, the RBW is calculated as a percentage of the Span. Kaiser is selected as the windowing method. When Auto is unchecked, the RBW is set by the user. Selecting any Window other than Kaiser changes the RBW setting to manual.
Span/RBW ratio	If Auto is checked, this value is used to calculate the RBW. If Auto is unchecked, this setting is not selectable.
Filter Shape	Specifies the windowing method used for the transform (when Auto is unchecked). (Spectrum and Spectrogram displays only.)
VBW	Adjusts the VBW (Video Bandwidth) value. (Spectrum and Spectrogram displays only.)

Filter Shape Settings

In the analyzer, computationally efficient discrete Fourier transform algorithms such as FFT (Fast Fourier Transform) or CZT (Chirp-Z Transform) are generally employed to transform time-domain signals into frequency-domain spectra. There is an assumption inherent in the mathematics of Discrete Fourier Transforms that the data to be processed is a single period of a periodically repeating signal. The discontinuities between successive frames will generally occur when the periodic extension is made to the signal. These artificial discontinuities generate spurious responses not present in the original signal, which can make it impossible to detect small signals in the presence of nearby large ones. This phenomenon is called spectral leakage.

Applying a filter, such as Kaiser, to the signal to be transformed is an effective method to combat the spectral leakage problem. Generally the filter has a bell shape. Multiplying the transform frame by the filter function eliminates or reduces the discontinuities at the ends of the frame, however, at the expense of increased RBW.

Filter Shape Characteristics

The choice of filter shape depends on its frequency response characteristics such as side-lobe level, equivalent noise bandwidth and maximum amplitude error. Use the following guidelines to select the best filter shape.

Filter Shape	Characteristics
Kaiser (RBW)	Best side-lobe level, shape factor closest to the traditional Gaussian RBW.
-6dB RBW (MIL)	These filters are specified for bandwidth at their -6 dB point, as required by military EMI regulations.
CISPR	These filters comply with the requirements specified in the P-CISPR 16 -1-1 document for EMI measurements.
Blackman-Harris 4B	Good side-lobe level.
Uniform (None)	Best frequency resolution, poor side-lobe level and amplitude accuracy.
Flat-Top	Best amplitude accuracy, best representation of brief events captured near the beginning or end of the time-domain data frame, poor frequency resolution.
Hanning	Good frequency resolution, high side-lobe roll-off rate.

VBW

The VBW setting enables/disables the Video Bandwidth filter. VBW is used in traditional swept analyzers to reduce the effect of noise on the displayed signal. The VBW algorithm in the analyzer emulates the VBW filters of traditional swept analyzers.

The maximum VBW value is the current RBW setting. The minimum VBW value is 1/10,000 of the RBW setting. VBW is disabled when the Filter shape is set to CISPR.

NOTE. *If you are following a procedure that says to "set VBW to three times the RBW value or greater", it means that the test should be conducted with no VBW effects. In the analyzer, this condition is met by disabling the VBW function.*

Scale Tab

The Scale tab allows you to change the vertical and horizontal scale settings. Changing the scale settings changes how the trace appears on the display but does not change control settings such as Measurement Frequency. In effect, these controls operate like pan and zoom controls.

The Scale tab values are unique to each display. Also, note that each display uses horizontal and vertical units that are appropriate for the display. For example, for the Spectrum display uses power (dBm) units and frequency (Hz) units; the Amplitude vs. Time display uses power (dBm) and time (seconds) units; and the Phase vs. Time display uses phase (degrees) and time (seconds) units.



Setting	Description
Vertical	Controls the vertical position and scale of the trace display.
Scale	Changes the vertical scale.
Offset	Vertical Offset adjusts the reference level away from top of the graph.
Autoscale	Resets the scale of the vertical axis to contain the complete trace.
Horizontal	Controls the span of the trace display and position of the trace.
Zoom Start	Sets the starting frequency for ...
Zoom Stop	Sets the stop frequency for ...
Log	Resets the scale of the horizontal axis to contain the complete trace.
Reset Scale	Resets all settings to their default values.

Prefs Tab

The Prefs tab enables you to change parameters of the measurement display. The parameters available on the Prefs tab vary depending on the selected display, but include such items as enabling/disabling Marker Readout, switching the Graticule display on/off, and Marker Noise mode.

Each of the General Signal Viewing displays maintains its own separate values for the controls that appear on the Prefs tab. Some parameters appear with most displays while others appear with only one display. For example, the Show Marker readout in graph check box appears in the Prefs tab for every display. However, the Show Power Trigger level check box only appears on the Amplitude vs Time Prefs tab.

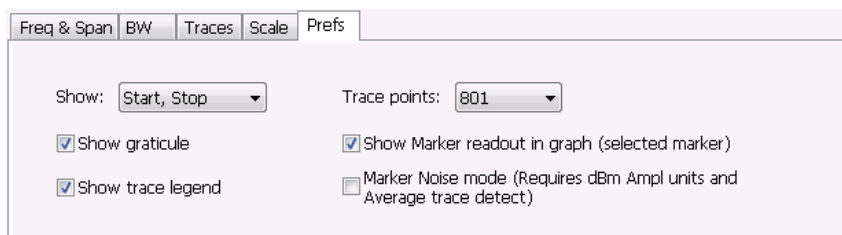

The following table explains the controls that can appear on the Prefs tab.

Setting	Description
Show:	Selects the horizontal settings that appear below the graph area. You can choose Start, Stop or Center, Span.
Trace points	Sets the number of trace points used for marker measurements and for results export.
Show trace legend	Enables display of a legend in the measurements area that shows the Detection method and Function setting for displayed traces. The color of the legend text matches the color of the associated trace.
Show graticule	Select to display or hide the graticule.
Show Parameter Readouts	For the DPX display, enables/disables the display of DPX parameters. The parameters readout shows 100% Probability of Intercept, Transforms/s, and FFT Points.
Show Marker readout in graph (selected marker)	Shows or hides the readout for the selected marker in the graph area.
Show timestamp in graph (selected line)	For spectrogram displays, this readout shows or hides the timestamp associated with the selected line or marker position.
Show Power Trigger Level	Displays or hides a green line in the graph that indicates the level at which the power trigger is set. The line is not displayed if Trigger is set to Free Run.
Marker Noise mode	Select to enable or disable the Marker Noise mode. Use this mode to measure noise on the trace. See Using Noise Markers in the Spectrum Display (see page 340) .

Show Parameter Readouts (DPX Spectrum Only)

The elements of the Show Parameter Readouts are:

- 100% POI – This is the minimum event duration required to ensure 100% Probability of Intercept or event capture. This duration depends on interaction between span, RBW, and FFT length. You can

use the POI time value to determine if you are at risk of either missing a narrow transient or of its captured amplitude being less than the actual signal.

Minimum signal duration vs. RBW

Span	RBW (kHz)	FFT length	Spectrums/s	Minimum signal duration for 100% POI, μ s
110 MHz	10000	1024		3.7
	1000	1024	292,969	5.8
	300	2048	146,484	14.8
	100	4096	73,242	37.6
	30	16,384	18,311	134.6
	20	32,768	9,155	229.2
85 MHz	1000	1024	292,969	5.8
	300	2048	146,484	11.4
	100	4096	73,242	37.6
	30	16384	18,311	134.6
	20	16384	18,311	174.6
40 MHz	1000	1024	292,969	5.8
	300	1024	292,969	11.4
	100	2048	146,484	30.8
	30	4096	73,242	93.6
	20	8192	36,621	147.3
	10	16384	18,311	294.5
25 MHz	300	1024	292,969	11.4
	100	1024	292,969	27.5
	30	4096	73,242	93.8
	20	4096	73,242	133.9
	10	8192	36,621	267.8

- Transforms/s – This is the number of transforms/second being performed by the DPX engine. It is a function of the selected resolution bandwidth and number of trace points. The desired RBW determines the number of points required in each transform, which alters the transform rate. Additionally, the selected trace length may place requirements on the number of points required in the transform independent of the selected resolution bandwidth.
- FFT Points – The approximate number of points in the FFT of the input signal. FFT points provides an indication of frequency resolution, but it is not an exact measurement. Note that higher numbers for FFT points mean that the instrument is taking a longer string of input samples for each FFT, which decreases the time resolution.

Minimum FFT length versus trace length - independent of span and RBW (instruments with option 200)

Trace length (points)	Minimum FFT length
801	1,024
2,401	4,096
4,001	8,192
10,401	16,384

Overview

The displays in the Analog Modulation folder (Displays > Folders > Analog Modulation) are:

- AM
- FM
- PM

The Analog Modulation displays provide measurements and time-domain trace displays.

AM Display

The Amplitude Modulation Display is a graph of Modulation Factor vs Time. The AM display includes three numeric readouts.

To show the AM display:

1. Select the **Displays** button or select **Setup > Displays**. This shows the **Select Displays** dialog box.
2. From the **Folders** box, select **Analog Modulation**.
3. Double-click the **AM** icon in the **Available Displays** box. This adds the AM icon to the **Selected displays** box.
4. Click the **OK** button. This shows the AM display.

Elements of the Display

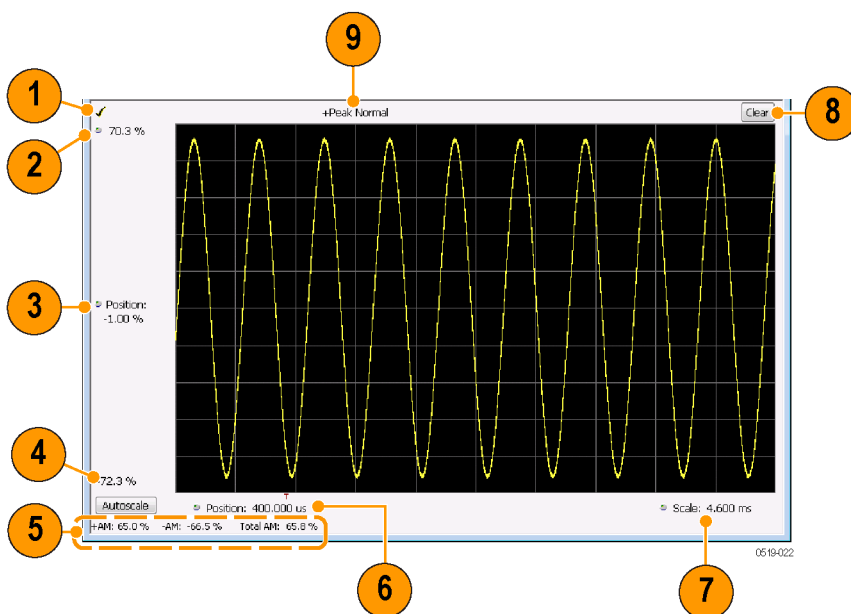

Item	Element	Description
1	Check mark indicator	The check mark indicator in the upper, left-hand corner of the display shows when the AM display is the optimized display.
2	Top of Graph	Sets the %AM indicated at the top of the graph by increasing or decreasing the vertical scale. Changing the top value affects the bottom of graph value because the graph scales about vertical center. Also, note that the top of graph setting interacts with the internal vertical scale setting (which is not user settable).
3	Position	Specifies the %AM shown at the center of the graph display.
4	Bottom Readout	Displays the value of the modulation factor shown at the bottom of graph.
5	Measurement readouts	Displays numeric values for the +AM (positive modulation factor), -AM (negative modulation factor), and Total AM.
6	Position	Specifies the horizontal position of the trace on the graph display.
7	Scale	Adjusts the horizontal range of the graph. By decreasing the scale (time across the entire graph), the graph essentially becomes a window that you can move over the trace by adjusting the position.
8	Clear	Erases the trace from the graph.
9	Trace Detection readout	Displays the Settings > Trace > Detection setting.

[Changing the AM Settings \(see page 126\)](#)

AM Settings

Menu Bar: Setup > Settings

Application Toolbar: 

The AM Settings control panel provides access to settings that control parameters of the AM Display.

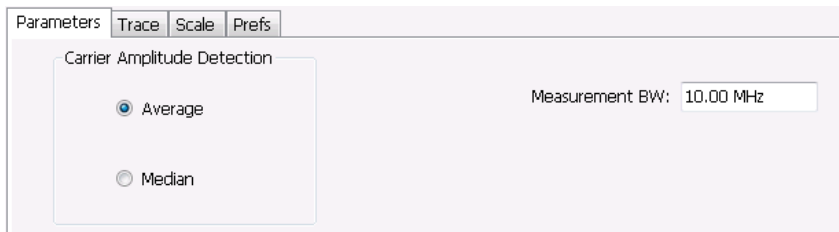

Setting	Description
Parameters (see page 127)	Sets the Carrier Amplitude Detection method. You can choose either Average or Median.
Trace (see page 128)	Sets Trace display parameters.
Scale (see page 131)	Sets vertical and horizontal scale and position parameters.
Prefs (see page 132)	Specifies whether or not certain display elements are shown. Specifies the maximum number of points shown in the display graph.

Parameters Tab

The Parameters tab enables you to specify two parameters that control the carrier amplitude detection.

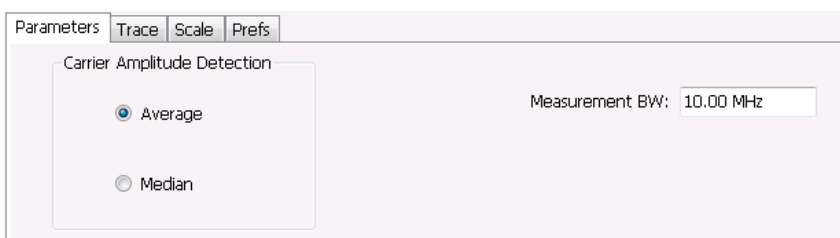

Setting	Description
Average	Selects the Average method for computing the average baseline for measurements.
Median	Selects the Median method for computing the average baseline for measurements.
Measurement BW	Specifies the bandwidth about the center frequency at which measurements are made.

AM Modulation

An amplitude modulated carrier can be described mathematically by:

$$X(t) = [A + a(t)] \cos \omega_0 t$$

A, in the above equation, represents the carrier amplitude, a(t) represents the time-varying modulation and ω_0 represents the carrier frequency.

The signal modulation envelope is given by:

$$E_M(t) = A + a(t)$$

There are several ways to express the AM modulation depth, expressed as a percentage.

Peak method

$$AM\text{ModulationDepth} = \frac{\text{Max}[A + a(t)]}{A}$$

Trough Method

$$AM\text{ModulationDepth} = \frac{\text{Min}[A + a(t)]}{A}$$

Max-Min Method

$$AMModulationDepth = \frac{Max [A + a (t)] - Min [A + a (t)]}{2A}$$

In each case, the value of the carrier amplitude, *A*, needs to be estimated from the input signal.

The instrument represents signals in a sampled form. The sampled envelope can be expressed as a function of sample index *K* and sampling period *T* as:

$$E_M [KT] = A + a [KT]$$

The instrument allows the choice of two methods for estimating the carrier amplitude:

Average Method

$$A = Average \{E_M [KT]\}$$

Median Method

$$A = Median \{E_M [KT]\}$$

In both cases, the instrument computes the average and the median over the analysis period. It should be noted that the two methods give the same result for sinusoidal modulation where the sampling frequency is much higher than the modulation frequency.

Trace Tab

The Trace Tab allows you to set the display characteristics of a trace.



Setting	Description
Show	Shows/hides the trace. If the instrument continues to run, the measurement results below the graph display continue to update even if the trace is hidden.
Detection	Sets the Detection method used for the trace. Available detection methods are +Peak, -Peak, and Avg (VRMS). Not available for saved traces.
Function	Selects the trace processing method. The only available setting is Normal.
Freeze	Halts updates to the trace.
Save Trace As	Saves the trace to a file for later recall and analysis.
Show recalled trace	Displays a saved trace instead of a live trace.

Detection

Detection refers to the method of processing the data acquisition points when creating a trace. The IQ samples in a data acquisition can be detected in a variety of ways. The number of IQ samples available to each trace point varies with both analysis length and trace length. For example, with Spectrum Length set to 'Auto' in the Analysis menu, the instrument analyzes just enough samples to produce one IQ sample pair per trace point. In this case, the detection method chosen has very little effect, as the +Peak, -Peak, and Avg (VRMS) are all equal. Changing the Spectrum Length causes the available detection methods to differ in value because they have a larger set of samples for the various detection methods to process.

The available detection methods are:

- **+Peak** – Each point on the trace is the result of detecting the positive peak value present in the set of IQ samples available to that trace point.
- **-Peak** – Each point on the trace is the result of detecting the negative peak value present in the set of IQ samples available to that trace point.
- **Avg (VRMS)** [Average V_{RMS}] – Each point on the trace is the result of determining the RMS Voltage value for all of the IQ samples available to the trace point. When displayed in either linear (Volts, Watts) or Log (dB, dBm), the correct RMS value results. When the averaging function is applied to a trace, the averaging is performed on the linear (Voltage) values, resulting in the correct average for RMS values.

Trace Processing

Traces can be processed to display in different ways. The Detection setting controls trace decimation, when needed. When the trace points each cover more than one sample data point, the vertical results values for multiple data points are combined into each trace point. Each trace point ends up with a single vertical value.

- **Average** - Each trace point is computed by averaging together the multiple results points it represents.
- **+Peak** - Each trace point represents the highest vertical value among the results it includes.
- **-Peak** - Each trace point represents the lowest vertical value among the results it includes.

Saving Traces

To save a trace for later analysis:

1. Select the **Save Trace As** button. This displays the Save As dialog box.

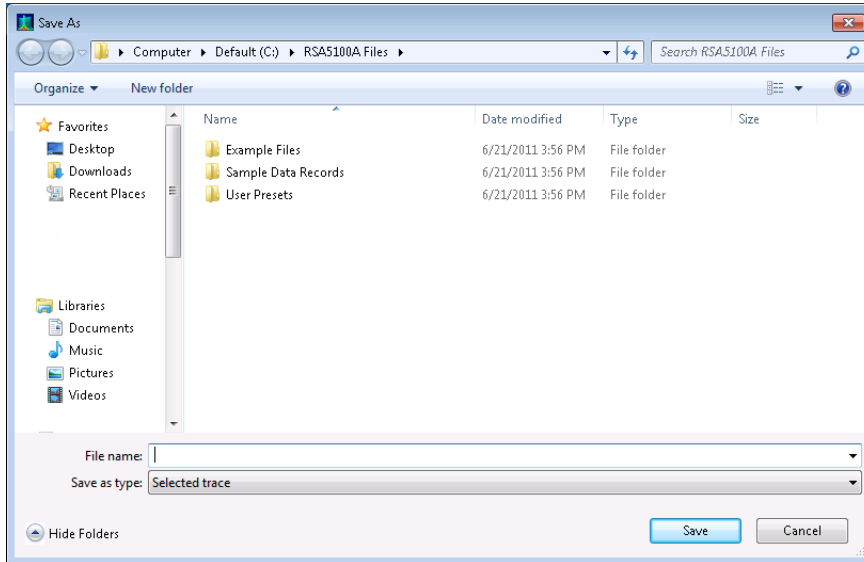

2. Navigate to the desired folder or use the default.
3. Type a name for the saved trace and click **Save**.

Recalling Traces

You can recall a previously saved trace for analysis or comparison to a live trace.

To select a trace for recall:

1. Click the ... button to display the Open dialog box.
2. Navigate to the desired file and click **Open**.
3. Check the **Show Recalled Trace** check box.
4. Verify that the **Show** check box is selected.

Scale Tab

The Scale tab allows you to change the vertical and horizontal scale settings. Changing the scale settings changes how the trace appears on the display but does not change control settings such as Measurement Frequency. In effect, these controls operate like pan and zoom controls.

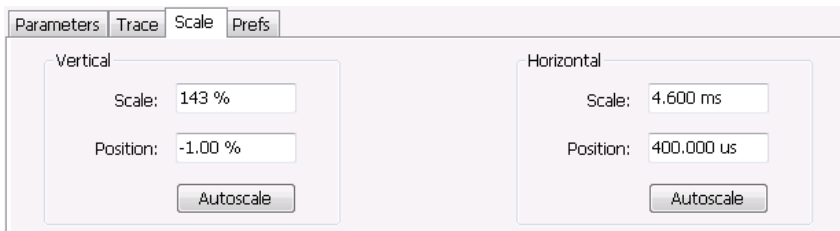

Setting	Description
Vertical	
Scale	Changes the range shown between the top and bottom of the graph.
Position	Adjusts the level shown at the center of the graph.
Autoscale	Resets the Position so that the entire trace is in the graph.
Horizontal	
Scale	Changes the range shown between the left and right sides of the graph.
Position	Adjusts the position of the acquisition record shown at the left edge of the graph.
Autoscale	Resets the Scale and Position settings to provide the optimum display.

Prefs Tab

The Prefs tab enables you to change appearance characteristics of the AM display.

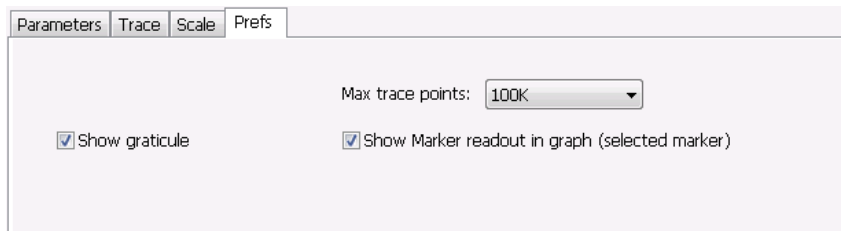

Setting	Description
Show graticule	Shows or hides the graticule.
Show Marker readout in graph (selected marker)	Shows or hides the readout for the selected marker in the graph area.
Max trace points	The trace in the AM display can be set to a maximum of 100,000 points (however, the actual number of trace points can extend up to 500,000 points if Max trace points is set to Never Decimate). If the Analysis Length includes more than the selected Max trace points value, the trace is decimated (using the method specified with the Detection control) to be equal to or less than the Max trace points setting (except when Max trace points is set to Never Decimate). This decimated (or undecimated) trace is what is used for marker measurements and for results export.

FM Display

The Frequency Modulation Display shows Frequency Deviation vs. Time. The vertical axis units are Hertz and the horizontal axis units are seconds. When taking measurements, only the first burst in the Analysis period is analyzed. No trace points are shown for data outside the first detected burst, nor are measurements made on data outside the first detected burst.

To show the FM display:

1. Select the **Displays** button or select **Setup > Displays**. This shows the **Select Displays** dialog box.
2. From the **Folders** box, select **Analog Modulation**.
3. Double-click the **FM** icon in the **Available Displays** box. This adds the FM icon to the **Selected displays** box.
4. Click the **OK** button. This shows the FM display.

Elements of the Display

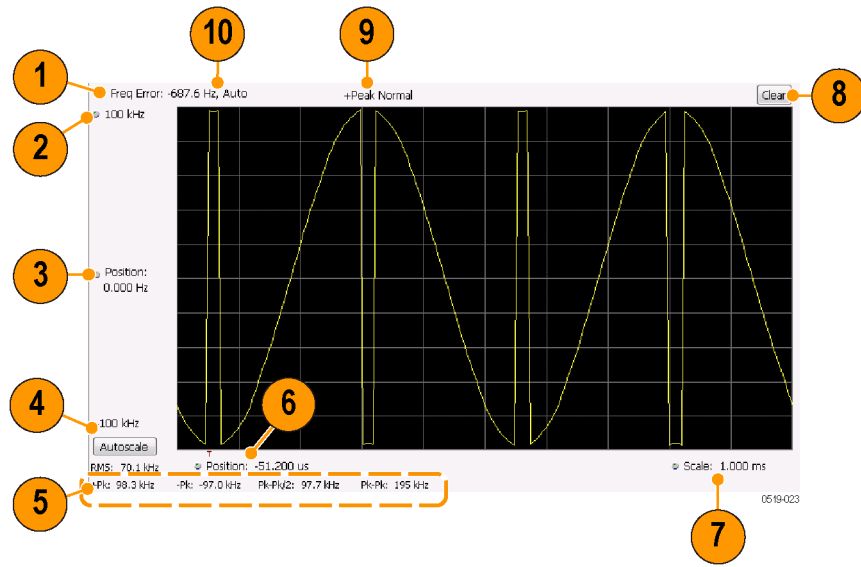

Item	Element	Description
1	Check mark indicator	The check mark indicator in the upper, left-hand corner of the display shows when the FM display is the optimized display.
2	Top of Graph control	Sets the frequency indicated at the top of the graph. Since the Position value at the vertical center of this graph remains constant as the Top of Graph value is adjusted, the Vertical Scale increases as the Top of Graph value increases, which also affects the bottom of graph readout. Vertical Scale can also be controlled from the Settings control panel's Scale tab.
3	Position	Specifies the frequency shown at the center of the graph display. Changing this value moves the trace up and down in the graph, which affects the Top of Graph and Bottom of Graph values as well.
4	Bottom of Graph Readout	Displays the frequency value at the bottom of the graph.
5	Measurement readouts	Displays numeric values for the +Pk (positive frequency deviation), -Pk (negative frequency deviation), RMS (RMS value of the deviation), Pk-Pk (peak-to-peak frequency deviation), and Pk-Pk/2 (peak-to-peak frequency deviation divided by two).
6	Position	Specifies the horizontal position of the trace on the graph display.
7	Scale	Adjusts the time range of the graph. By decreasing the scale (full-scale time over 10 divisions), the graph essentially becomes a window that you can move over the acquisition record by adjusting the horizontal position.
8	Clear	Clears the trace and numeric measurement results.
9	Trace Detection readout	Displays the Settings > Trace > Detection setting.
10	Freq Error	This readout can show Freq Error or Freq Offset. When it displays Freq Error, it shows the difference between the instrument Frequency setting and the measured value of the signal's carrier frequency. When it displays Freq Offset, it shows the frequency offset specified on the Settings > Parameters tab. If Freq Error is displayed, it also indicates that the Carrier frequency detection setting is Auto. If Freq Offset is displayed, it indicates that the Carrier frequency detection setting is manual.

[Changing the FM Settings \(see page 134\)](#)

FM Settings

Menu Bar: Setup > Settings

Application Toolbar: 

The FM Settings control panel provides access to settings that control parameters of the FM Display.

Parameters	Trace	Scale	Prefs
Burst detect threshold:	-100 dBc		
Measurement BW:	100.0 kHz	Frequency offset:	-50.54 Hz <input checked="" type="checkbox"/> Auto
			<input type="button" value="Load from marker"/>

Setting	Description
Parameters (see page 273)	Sets the burst detection threshold, measurement bandwidth, and carrier frequency detection method.
Trace (see page 137)	Sets Trace display parameters.
Scale (see page 139)	Sets vertical and horizontal scale and position parameters.
Prefs (see page 140)	Specifies whether or not certain display elements are shown. Specifies the maximum number of points shown in the display graph.

Parameters Tab

The Parameters tab enables you to specify parameters for carrier detection.

The screenshot shows a software interface with a 'Parameters' tab selected. Below the tab are three sub-tabs: 'Trace', 'Scale', and 'Prefs'. The main area contains several input fields and a button:

- 'Burst detect threshold:' with a text box containing '-100 dBc'.
- 'Measurement BW:' with a text box containing '100.0 kHz'.
- 'Frequency offset:' with a text box containing '-50.54 Hz' and a checked 'Auto' checkbox.
- A button labeled 'Load from marker'.

Setting	Description
Burst detect threshold	This parameter specifies the power level used to determine whether a burst is present. A valid burst is required to take measurements. The burst detected first is used for the analysis. The units for burst detect threshold are dBc, relative to the maximum acquisition sample data points level.
Measurement BW	Specifies the bandwidth about the center frequency at which measurements are made.
Frequency offset	Displays the carrier signal's offset from the instrument's measurement frequency. Auto is used to select the method for determining the carrier frequency. When Auto is selected, the instrument determines the carrier frequency by analyzing the signal. When Auto is deselected, you can set the carrier frequency offset using Frequency Offset.
Load from Marker	Pressing this button sets the frequency offset to the frequency offset of the selected marker. (Pressing this button automatically deselects Auto.)

Frequency Offset

In Auto (Auto is selected), the instrument scans the measurement bandwidth about the measurement frequency and looks for the highest-powered signal. This is defined as the carrier frequency. In Manual (Auto is deselected), the carrier frequency is specified by adding/subtracting the specified Frequency offset from the measurement frequency. Range: $-(\text{Measurement BW} \times 1.1)/2$ to $+(\text{Measurement BW} \times 1.1)/2$. If the **Load Δ from marker** button is pressed, the frequency offset is determined from the phase difference between the two markers on screen compared to the time between the two markers. This function is useful for removing frequency slope from the phase modulated signal.

Load from Marker

When the Auto check box is selected, the instrument scans the measurement bandwidth about the center frequency and looks for the highest-powered signal. This is defined as the carrier frequency. When the Auto check box is deselected, the carrier frequency is specified by adding/subtracting the specified Frequency offset from the center frequency. Pressing the Load from marker button loads the marker frequency into the Frequency offset box.

Trace Tab

The Trace Tab allows you to set the display characteristics of displayed trace.



Setting	Description
Show	Shows / hides the trace. If the instrument continues to run, the measurement results below the graph display continue to update even if the trace is hidden.
Detection	Sets the Detection method used for the trace. Available detection methods are +Peak, -Peak, and Avg (VRMS). Not available for saved traces.
Function	Selects the trace processing method. The only available setting is Normal.
Freeze	Halts updates to the trace.
Save Trace As	Saves the trace to a file for later recall and analysis.
Show Recalled trace	Displays a saved trace instead of a live trace.

Detection

Detection refers to the method of processing the data acquisition points when creating a trace. The IQ samples in a data acquisition can be detected in a variety of ways. The number of IQ samples available to each trace point varies with both analysis length and trace length. For example, with Spectrum Length set to 'Auto' in the Analysis menu, the instrument analyzes just enough samples to produce one IQ sample pair per trace point. In this case, the detection method chosen has very little effect, as the +Peak, -Peak, and Avg (VRMS) are all equal. Changing the Spectrum Length causes the available detection methods to differ in value because they have a larger set of samples for the various detection methods to process.

The available detection methods are:

- **+Peak** – Each point on the trace is the result of detecting the positive peak value present in the set of IQ samples available to that trace point.
- **-Peak** – Each point on the trace is the result of detecting the negative peak value present in the set of IQ samples available to that trace point.
- **Avg (VRMS)** [Average V_{RMS}] – Each point on the trace is the result of determining the RMS Voltage value for all of the IQ samples available to the trace point. When displayed in either linear (Volts, Watts) or Log (dB, dBm), the correct RMS value results. When the averaging function is applied to a trace, the averaging is performed on the linear (Voltage) values, resulting in the correct average for RMS values.

Trace Processing

Traces can be processed to display in different ways. The Function setting controls trace processing.

- **Normal** - Each new trace is displayed and then replaced by the next trace. Each data point contains a single vertical value.
- **Average** - Each trace point is computed by averaging together the multiple results points it represents.
- **+Peak** - Each trace point represents the highest vertical value among the results it includes.
- **-Peak** - Each trace point represents the lowest vertical value among the results it includes.

Saving Traces

To save a trace for later analysis:

1. Select the **Save Trace As** button. This displays the Save As dialog box.

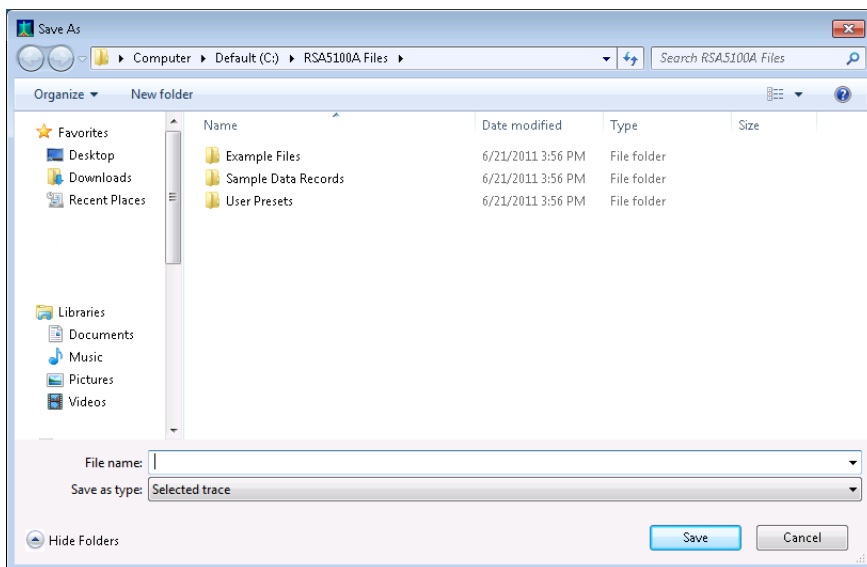

2. Navigate to the desired folder or use the default.
3. Type a name for the saved trace and click **Save**.

Recalling Traces

You can recall a previously saved trace for analysis or comparison to a live trace.

To select a trace for recall:

1. Click the **...** button to display the Open dialog box.
2. Navigate to the desired file and click **Open**.

3. Check the **Show Recalled Trace** check box.
4. Verify that the **Show** check box is selected.

Scale Tab

The Scale tab allows you to change the vertical and horizontal scale settings. Changing the scale settings changes how the trace appears on the display but does not change control settings such as Measurement Frequency. In effect, these controls operate like pan and zoom controls.

The screenshot shows the Scale Tab interface with two main sections: Vertical and Horizontal. Each section has a Scale input field, a Position input field, and an Autoscale button.

Section	Scale	Position	Autoscale
Vertical	10.0 kHz	0.000 Hz	Autoscale
Horizontal	35.280 us	92.160 us	Autoscale

Setting	Description
Vertical	
Scale	Changes the range shown between the top and bottom of the graph.
Position	Adjusts the frequency shown at the center of the graph.
Autoscale	Resets the Position so that the entire trace fits within the graph.
Horizontal	
Scale	Changes the range shown between the left and right sides of the graph.
Position	Adjusts the position of the acquisition record shown at the left edge of the graph.
Autoscale	Resets the Scale and Position settings to provide the optimum display.

Prefs Tab

The Prefs tab enables you to change appearance characteristics of the FM display.

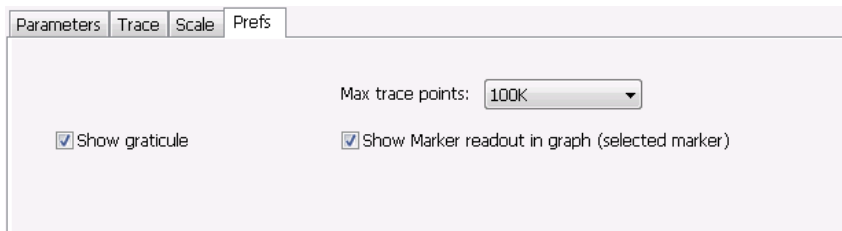

Setting	Description
Show graticule	Shows or hides the graticule.
Show Marker readout in graph (selected marker)	Shows or hides the readout for the selected marker in the graph area.
Max trace points	The trace in the FM display can be set to a maximum of 100,000 points (however, the actual number of trace points can extend up to 500,000 points if Max trace points is set to Never Decimate). If the Analysis Length includes more than the selected Max trace points value, the trace is decimated (using the method specified with the Detection control) to be equal to or less than the Max trace points setting (except when Max trace points is set to Never Decimate). This decimated (or undecimated) trace is what is used for marker measurements and for results export.

PM Display

The Phase Modulation Display shows Phase vs. Time. The vertical axis units are degrees and the horizontal axis units are seconds. When taking measurements, only the first burst in the Analysis period is analyzed. No trace points are shown for data outside the first detected burst, nor are measurements made on data outside the first detected burst.

Elements of the Display

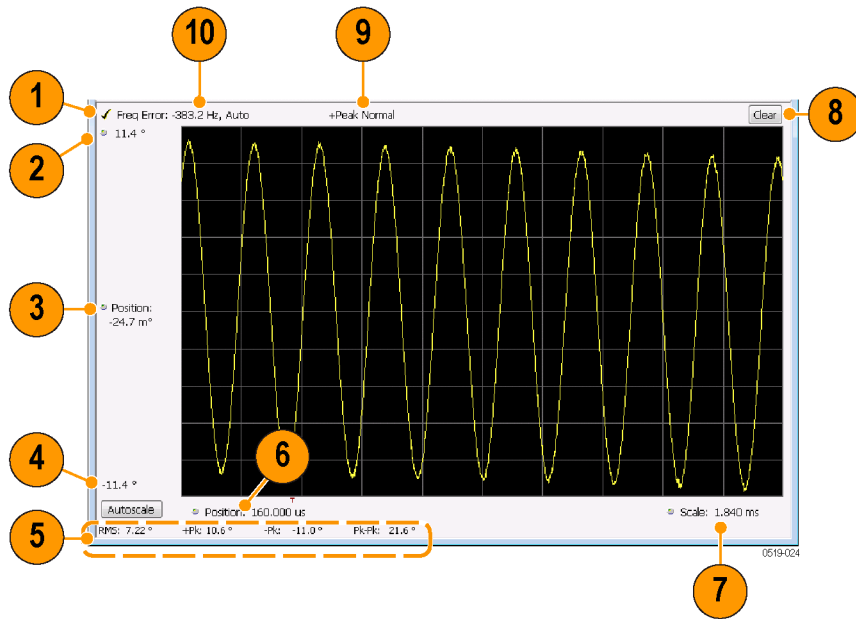

Item	Element	Description
1	Check mark indicator	The check mark indicator in the upper, left-hand corner of the display shows when the PM display is the optimized display.
2	Top of Graph control	Sets the phase value indicated at the top of the graph. Since the Position value at the vertical center of this graph remains constant as the Top of Graph value is adjusted, the Vertical Scale increases as the Top of Graph value increases, which also affects the bottom of graph readout. Vertical Scale can also be controlled from the Settings control panel's Scale tab.
3	Position	Specifies the phase shown at the center of the graph display. Changing this value moves the trace up and down in the graph, which affects the Top of Graph and Bottom of Graph values as well.
4	Bottom of Graph Readout	Displays the phase value at the bottom of the graph.
5	Measurement readouts	Displays numeric values for the +Pk (positive phase deviation), -Pk (negative phase deviation), Pk-Pk (peak-to-peak phase deviation), and RMS (RMS value of the phase deviation).
6	Position	Specifies the horizontal position of the trace on the graph display.
7	Scale	Adjusts the time range of the graph. By decreasing the scale (full-scale time over 10 divisions), the graph essentially becomes a window that you can move over the acquisition record by adjusting the horizontal position.
8	Clear	Clears the measurement results.
9	Trace Detection readout	Displays the Trace Detection setting (see Settings > Trace > Detection).
10	Freq Error	This readout can show Freq Error or Freq Offset. When it displays Freq Error, it shows the difference between the instrument Frequency setting and the measured value of the signal's carrier frequency. When it displays Freq Offset, it shows the frequency offset specified on the Settings > Parameters tab. If Freq Error is displayed, it also indicates that the Carrier frequency detection setting is Auto. If Freq Offset is displayed, it indicates that the Carrier frequency detection setting is manual.

[Changing the PM Settings \(see page 142\)](#)

PM Settings

Menu Bar: Setup > Settings

Application Toolbar: 

The PM Settings control panel provides access to settings that control parameters of the PM Display.

Parameters | Trace | Scale | Prefs

Burst detect threshold:

Measurement BW:

Frequency offset: Auto

Phase offset: Auto

Setting	Description
Parameters (see page 143)	Sets the Carrier Frequency Detection method. You can choose either Automatic or Manual. Sets burst threshold and phase detection method.
Trace (see page 144)	Sets Trace display parameters.
Scale (see page 147)	Sets vertical and horizontal scale and position parameters.
Prefs (see page 148)	Specifies whether or not certain display elements are shown. Specifies the maximum number of points shown in the display graph.

Parameters Tab

The Parameters tab enables you to specify parameters that control the carrier frequency and phase detection.

Parameters | Trace | Scale | Prefs

Burst detect threshold:

Measurement BW:

Frequency offset: Auto

Phase offset: Auto

Setting	Description
Burst detect threshold	Specifies the power level used to determine whether a burst is present. A valid burst is required to take measurements. The burst detected first is used for the analysis. The units for burst detect threshold are dBc, relative to the maximum acquisition sample data points level.
Measurement BW	Specifies the bandwidth about the center frequency at which measurements are made.
Frequency offset	Displays the carrier signal's frequency offset from the instrument's Measurement Frequency. Auto is used to select the method for determining the carrier frequency. When Auto is selected, the instrument determines the carrier frequency by analyzing the signal. When Auto is deselected, you can set the carrier frequency offset using Frequency Offset.
Load Δ from Marker	Pressing this button disables the Auto Frequency Offset function and sets the Frequency offset to the frequency offset calculated from the difference between MR (the marker reference) and the selected marker (or M1 if MR is currently the selected marker).
Phase offset	Displays the phase offset. When Auto is selected, the instrument determines the phase offset. When Auto is deselected, the user sets the phase offset with this control.
Load from marker	Pressing this button sets the phase offset to the phase offset of the selected marker. (Pressing this button automatically deselected Auto.)

Frequency Offset

In Auto (Auto is selected), the instrument scans the measurement bandwidth about the Measurement Frequency and looks for the highest-powered signal. This is defined as the carrier frequency. In Manual (Auto is deselected), the carrier frequency is specified by adding/subtracting the specified Frequency offset from the Measurement Frequency. Range: $-(\text{Measurement BW} * 1.1) / 2$ to $+(\text{Measurement BW} * 1.1) / 2$. If the **Load Δ from marker** button is pressed, the frequency offset is determined from the phase difference between the two markers on screen compared to the time between the two markers. This function is useful for removing frequency slope from the phase modulated signal.

Phase Offset

In Auto (Auto is selected), the instrument sets the phase offset to fit the waveform to the screen centering 0° phase on the vertical axis. The actual phase offset is indicated on the Phase Offset readout. In Manual (Auto is deselected), the instrument sets the phase offset using the value specified in Phase offset. For example, when Phase offset is set to 10° , the waveform shifts upward by 10° on screen. Selecting **Load from marker** sets the phase offset to the value of the selected marker. Range: -180 to $+180^\circ$.

Trace Tab

The Traces Tab allows you to set the display characteristics of displayed trace.



Setting	Description
Show	Shows / hides the trace. If the instrument continues to run, the measurement results below the graph display continue to update even if the trace is hidden.
Detection	Sets the Detection method used for the trace. Available detection methods are +Peak, -Peak, and Avg (VRMS). Not available for saved traces.
Function	Selects the trace processing method. The only available setting is Normal.
Freeze	Halts updates to the trace.
Save Trace As	Saves the trace to a file for later recall and analysis.
Show Recalled trace	Displays a saved trace instead of a live trace.

Detection

Detection refers to the method of processing the data acquisition points when creating a trace. The IQ samples in a data acquisition can be detected in a variety of ways. The number of IQ samples available to each trace point varies with both analysis length and trace length. For example, with Spectrum Length set to 'Auto' in the Analysis menu, the instrument analyzes just enough samples to produce one IQ sample pair per trace point. In this case, the detection method chosen has very little effect, as the +Peak, -Peak, and Avg (VRMS) are all equal. Changing the Spectrum Length causes the available detection methods to differ in value because they have a larger set of samples for the various detection methods to process.

The available detection methods are:

- **+Peak** – Each point on the trace is the result of detecting the positive peak value present in the set of IQ samples available to that trace point.
- **-Peak** – Each point on the trace is the result of detecting the negative peak value present in the set of IQ samples available to that trace point.
- **Avg (VRMS)** [Average V_{RMS}] – Each point on the trace is the result of determining the RMS Voltage value for all of the IQ samples available to the trace point. When displayed in either linear (Volts, Watts) or Log (dB, dBm), the correct RMS value results. When the averaging function is applied to a trace, the averaging is performed on the linear (Voltage) values, resulting in the correct average for RMS values.

Trace Processing

Traces can be processed to display in different ways. The Function setting controls trace processing.

- **Normal** - Each new trace is displayed and then replaced by the next trace. Each data point contains a single vertical value.
- **Average** - Each trace point is computed by averaging together the multiple results points it represents.
- **+Peak** - Each trace point is represents the highest vertical value among the results it includes.
- **-Peak** - Each trace point is represents the lowest vertical value among the results it includes.

Saving Traces

To save a trace for later analysis:

1. Select the **Save Trace As** button. This displays the Save As dialog box.

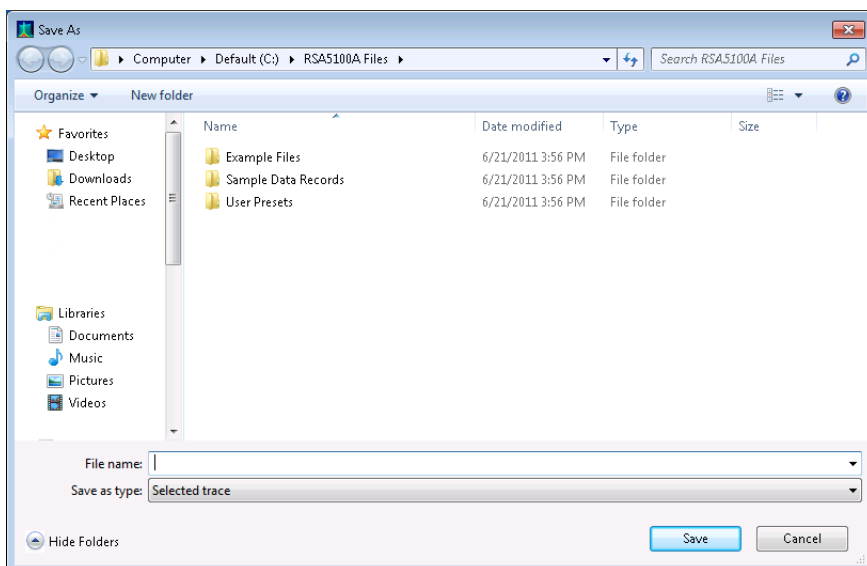

2. Navigate to the desired folder or use the default.
3. Type a name for the saved trace and click **Save**.

Recalling Traces

You can recall a previously saved trace for analysis or comparison to a live trace.

To select a trace for recall:

1. Click the **...** button to display the Open dialog box.
2. Navigate to the desired file and click **Open**.
3. Check the **Show Recalled Trace** check box.
4. Verify that the **Show** check box is selected.

Scale Tab

The Scale tab allows you to change the vertical and horizontal scale settings. Changing the scale settings changes how the trace appears on the display but does not change control settings such as Measurement Frequency. In effect, these controls operate like pan and zoom controls.

The screenshot shows the 'Scale' tab in a software interface. It has four tabs: 'Parameters', 'Trace', 'Scale', and 'Prefs'. The 'Scale' tab is active. It is divided into two main sections: 'Vertical' and 'Horizontal'. Each section contains a 'Scale' input field, a 'Position' input field, and an 'Autoscale' button. The 'Vertical' section shows a Scale of 22.8 ° and a Position of -24.7 m°. The 'Horizontal' section shows a Scale of 1.840 ms and a Position of 160.000 us.

Setting	Description
Vertical	
Scale	Changes the range shown between the top and bottom of the graph.
Position	Adjusts the phase shown at the center of the graph.
Autoscale	Resets the Position so that the entire trace in the graph.
Horizontal	
Scale	Changes the range shown between the left and right sides of the graph.
Position	Adjusts the phase shown at the left edge of the graph.
Autoscale	Resets the Scale and Position settings to show the entire trace within the graph.

Prefs Tab

The Prefs tab enables you to change appearance characteristics of the PM display.

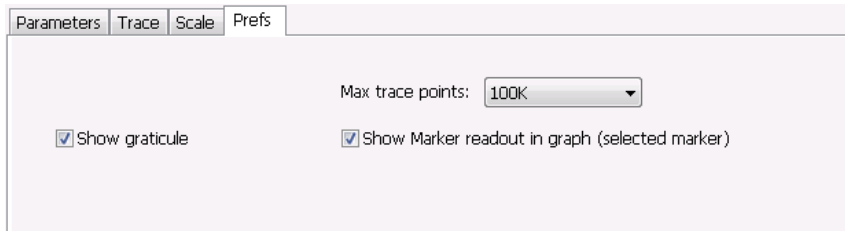

Setting	Description
Show graticule	Shows or hides the graticule.
Show Marker readout in graph (selected marker)	Shows or hides the readout for the selected marker in the graph area.
Max trace points	The trace in the PM display can be set to a maximum of 100,000 points (however, the actual number of trace points can extend up to 500,000 points if Max trace points is set to Never Decimate). If the Analysis Length includes more than the selected Max trace points value, the trace is decimated (using the method specified with the Detection control) to be equal to or less than the Max trace points setting (except when Max trace points is set to Never Decimate). This decimated (or undecimated) trace is what is used for marker measurements and for results export.

Overview

The displays in the RF Measurements folder (Displays > Folders > RF Measurements) are:

- CCDF
- Channel Power and ACPR
- MCPR
- Occupied Bandwidth
- Phase Noise (Option 11)
- SEM (Spectrum Emission Mask)
- Spurious

The RF Measurements power measurements and signal statistics help you characterize components and systems. With Option 11, the RF Measurements also includes Phase Noise and Jitter Measurements.

Power Measurements

Measurement	Description
Channel Power	The total RF power in the selected channel (located in the ACPR display).
Adjacent Channel Power Ratio	Measure of the signal power leaking from the main channel into adjacent channels.
Multi-Carrier Power Ratio	The ratio of the signal power in the reference channel or group of channels to the power in adjacent channels.
Peak/Avg Ratio	Ratio of the peak power in the transmitted signal to the average power in the transmitted signal (located in the CCDF display).
CCDF	The <i>Complementary Cumulative Distribution Function</i> (CCDF). CCDF shows how much time a signal spends at or above a given power level relative to the average power of a measured signal.

Channel Power and Strength Display

Use the **Chan Power & Strength** display to measure channel power, field strength, signal strength or adjacent channel leakage ratio with one main channel.

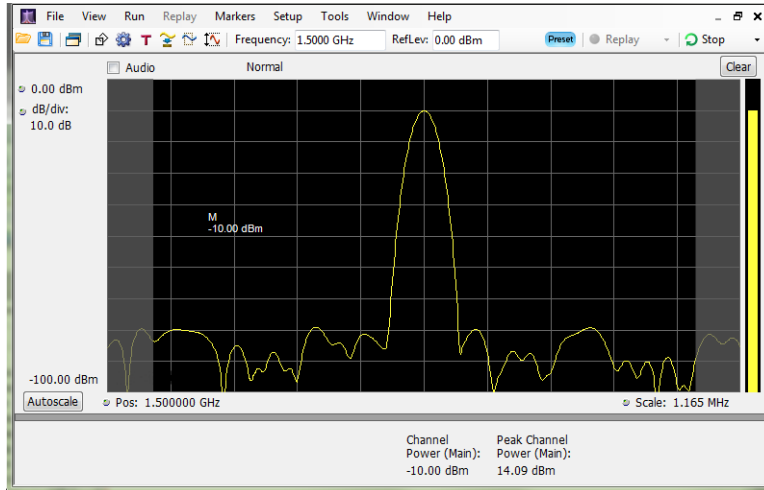

Measuring Channel Power and Field Strength

1. Select the **Displays** button.
2. Select **RF Measurements** from the **Folders** box.
3. Double-click **Chan Power & Strength** in the Available displays box. Click **OK** to complete your selection.
4. Press the front-panel **Freq** button and use the front panel keypad or knob to adjust the frequency to that of your main channel.
5. Press the **Run** button to take the measurements.
6. If you are measuring a signal with a directional antenna, select the **Audio** checkbox above the graph, on the left side.

When Audio is checked, the analyzer sounds a tone that varies in frequency with the signal strength. If you change the direction of the antenna and the signal strength drops, the frequency of the audio tone will also drop. If the signal strength increases, the audio tone frequency will also increase.

As signal strength changes, the signal strength indicator at the right side of the graph will rise and fall with the signal level.

Measuring Adjacent Channel Power Ratio

1. Select the **Displays** button.
2. Select **RF Measurements** from the **Folders** box.
3. Double-click **Chan Power & Strength** in the Available displays box. Click **OK** to complete your selection.
4. Press the front-panel **Freq** button and use the front panel keypad or knob to adjust the frequency to that of your main channel.

5. Press the **Settings** button. This displays the control panel for Chan Power and Strength (the tab displayed will be the tab displayed the last time the Settings panel was opened).

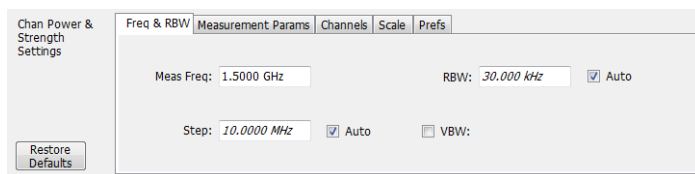

6. To set the number of adjacent channels, select the **Channels** tab. Enter the number of channels in the **Number of adjacent pairs** value box. If zero is entered for the number of adjacent pairs (the default value), the resultant measurement will be channel power only.

NOTE. As you add adjacent channels, the span of the display is adjusted so that all the channels can be seen. Use the horizontal scale and offset to zoom the display in on any portion of the trace.

7. To set the spacing between channel centers, enter the required value in the **Channel Spacing** value box.
8. To set the channel bandwidth, enter the required value in the **Channel Bandwidth** value box.
9. After you have configured the channel settings, click the close button () in the Settings panel or press the **Settings** button again to remove the settings panel.
10. Press the **Run** button to take the measurements.

Viewing Results

Measurement results are displayed below the graph and within the graph itself (which can be enabled/disabled in the Settings > Prefs tab). If you are measuring adjacent channel power ratio, to see all measurements, you might need to scroll the table. The size of the results table can be changed by dragging the horizontal divider bar between the graph and table areas.

Channel Power (Main):	Peak Channel Power (Main):
-10.00 dBm	14.09 dBm

Results for Channel Power and Strength

Heading	Description
Channel Power (Main)	The power measured for the Main channel. The channel power is displayed in dBm.
Peak Channel Power (Main)	The peak power measured for the Main channel. The channel power is displayed in dBm.

Channel Power (Main): -1.94 dBm	Ch	Offset	Lower	Upper
	A1	2.000 MHz	-65.69 dB	-64.82 dB

Results display for Adjacent Channel Power

Heading	Description
Channel	Identifies the displayed channels. A1 means the first adjacent channel. A2 means second adjacent channel. Adjacent channels are numbered according to their offset from the Main channel. The closest channel is numbered 1. The next closest channel is numbered 2; and so forth.
Lower	The power measured for the lower adjacent channel. Adjacent channel power measurements are displayed in dB relative to the Main channel.
Upper	The power measured for the upper adjacent channel. Adjacent channels power measurements are displayed in dB relative to the Main channel.
Channel Power (Main)	The power measured for the Main channel. The detection type used for measuring channel power and adjacent channel powers is Average. This means that the average of the linear (pre-log) samples is used to determine the power. The Main channel power is displayed in dBm.

[Setting Channel Power and ACPR Settings Parameters \(see page 153\)](#)

RF Channel Power Measurement

The RF channel power gives an indication of the total average (and other measures) RF power in a given channel.

For some communications systems, there is an “out-of-service” total power measurement defined in the specifications that calls for a specified constant modulation. In this case, the output power should be relatively constant. For many measurements, this may not be the case, and the Power Measurement results will vary as the signal varies.

Average power is the square root of the sum of the squares of the voltage samples over the measurement time.

The defined “channel” width for the Power Measurement defines the bandwidth and shape of the filter used to remove any RF power on frequencies outside of the channel bandwidth.

Channel Power

The total RF power in the selected frequency band. The detection type used for measuring channel power is Average. This means that the average of the linear (pre-log) samples is used to determine the channel power. To measure channel power, use the ACLR measurement, and set the number of adjacent channels to zero. This results in only the channel power being measured.

Average Channel Power

The total RF power in the selected channel (located in the ACPR display).

Adjacent Channel Leakage Power Ratio

Adjacent Channel Leakage power Ratio (ACLR) is the ratio of the mean power centered on the assigned channel frequency to the mean power centered on an adjacent channel frequency. In the 3GPP specification, both the main channel and adjacent channels are required to be filtered with RRC (Root Raised Cosine) filters.

Adjacent Channel Power

Measure of the signal power leaking into nearby channels.

Channel Power & Strength Settings

Menu Bar: Setup > Settings

Front Panel: Settings

Application Toolbar: 

The settings for the Channel Power & Strength display are shown in the following table.

Meas Freq	RBW	Step	VBW
1.50000 GHz	30.000 kHz <input checked="" type="checkbox"/> Auto	2.0000 MHz <input checked="" type="checkbox"/> Auto	<input type="checkbox"/> VBW:

Settings tab	Description
Freq & RBW (see page 160)	Specify the frequency and resolution bandwidth used for the Channel Power and ACPR measurements.
Measurement Params (see page 161)	Specify several parameters that control the measurement, such as channel filter, chip rate, averaging, and correcting for noise floor.
Channels (ACPR) (see page 154)	This tab specifies the BW and offset parameters of the Channels for the Channel Power and ACPR measurements.
Scale (see page 224)	Specifies the vertical and horizontal scale settings.
Prefs (see page 225)	Specifies whether certain display elements are visible.

Restore defaults. Sets parameters for a 1-channel WCDMA measurement.

Channels Tab

The Channels tab is where you specify parameters for the channels measured in the Chan Power display.

The screenshot shows a software interface with five tabs: 'Freq & RBW', 'Measurement Params', 'Channels', 'Scale', and 'Prefs'. The 'Channels' tab is active. It contains three settings:

- Number of adjacent pairs: 1
- Channel Bandwidth: 1.000 MHz
- Channel Spacing: 2.000 MHz

Setting	Description
Number of adjacent pairs	Specifies the number of adjacent channel pairs. The default value is 0. This setting is used to measure power and strength for a single channel. Range: 0- 50; Resolution 1.
Channel Bandwidth	Specifies the frequency width of each channel (all channels share the same value).
Channel Spacing	Specifies the difference in frequency between the centers of each channel.

The following figure illustrates the settings controlled from the Channels tab.

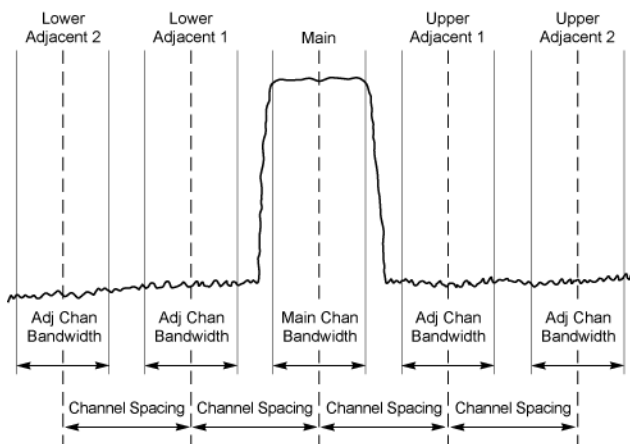

Changing the Number of Adjacent Pairs

1. Select **Number of adjacent pairs** number entry box.
2. Enter a value for the number of adjacent pairs using the knob or the keypad.

NOTE. As you change the value for the number of adjacent pairs, the analyzer will update the spectrum display to identify the adjacent channels.

3. Select the Close box when you have finished making changes.

Changing the Channel Bandwidth

1. Select the **Channel Bandwidth** number entry box.
2. Enter a value for the number of adjacent pairs using the knob or the keypad.

NOTE. As you change the value for the number of adjacent pairs, the analyzer will update the display to indicate the channel bandwidth

3. Select the Close box when you have finished making changes.

Channel Spacing

1. Select **Channel Spacing** number entry box.
2. Enter a value for the difference in center frequency between channels using the knob or the keypad.

NOTE. As you change the value for the number of adjacent pairs, the analyzer will update the display to indicate the channel bandwidth

3. Select **Close** when you have finished making changes.

MCPR (Multiple Carrier Power Ratio) Display

Use the MCPR measurement to measure adjacent channel power ratio for multiple main channels or when adjacent channel pairs have different offsets and/or bandwidths. The MCPR display show the Reference Power and the ratio of each adjacent channel to the Reference Power. You can select whether the Reference Power is the total of all active channels or a single channel.

Measuring Multiple Carrier Power Ratio

1. Press the front-panel **Displays** button.
2. From the **Select Displays** window, select **RF Measurements** from the Folders box.
3. Double-click the **MCPR** icon in the **Available displays** box. Click **OK** to complete your selection.
4. Press the front-panel **Freq** button and use the front panel keypad or knob to adjust the frequency to that of the main channel. Select **Meas. Freq** to set the measurement frequency. Use the front panel knob to adjust the frequency.
5. Press the **Settings** button. This displays the control panel for MCPR (the tab displayed will be the tab displayed the last time the Settings panel was opened).

The screenshot shows the MCPR Settings panel with the following configuration:

- Main Channels:**
 - Number: 4
 - BW: 3.840 MHz
 - Spacing: 5.000 MHz
 - Inactive: M1, M2, M3, M4 (all unchecked)
- Adj Chans:**
 - Buttons: Add..., Edit..., Delete...
 - Table:

Chan	BW	Offset
M1	3.840 MHz	-7.500 MHz
M2	3.840 MHz	-2.500 MHz
M3	3.840 MHz	2.500 MHz
M4	3.840 MHz	7.500 MHz
A1	3.840 MHz	+/-12.500 MHz
A2	3.840 MHz	+/-17.500 MHz

6. Click on the **Channels** tab. To set the number of Main channels, enter the number of Main channels in the **Number** text entry box under **Main Channels**.

NOTE. As you add channels, the span of the display will be adjusted so that all the channels can be seen.

7. To set the bandwidth of all main channels, enter a value in the **BW** value box.
8. To set the spacing between the main channels, enter a value in the **Spacing** value box.
9. To prevent a main channel power level from being included in the Power Reference (Total) calculation, select the channel to be excluded in the **Inactive** box.

10. To add adjacent channels, click the **Add** button under **Adj Chans**.

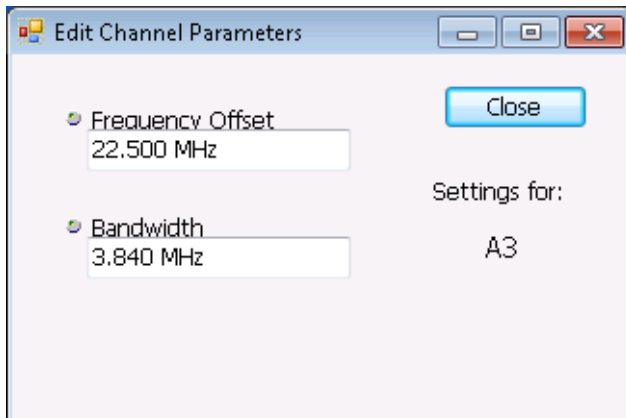

11. To edit Frequency Offset or Bandwidth, click within the value box and use the front-panel knob or your keyboard to set the value. Click **Close** to save your changes.

NOTE. *Frequency Offset is the difference between the center frequency of the selected channel and the Measurement Frequency. All channels (Main or Adjacent) are specified by their offset from the Measurement Frequency.*

12. After you have configured the Main and Adjacent channels, click the close button () in the Settings panel or the **Settings** button to remove the settings panel.

13. Click the Run button () to take the measurements.

Viewing Results

MCPR measurement results are displayed both in the spectrum graph and in a table below the spectrum display. Individual Main channel power measurements appear in the graph under their channel identifiers. Individual adjacent channel power ratios also appear in the graph under the adjacent channel identifier.

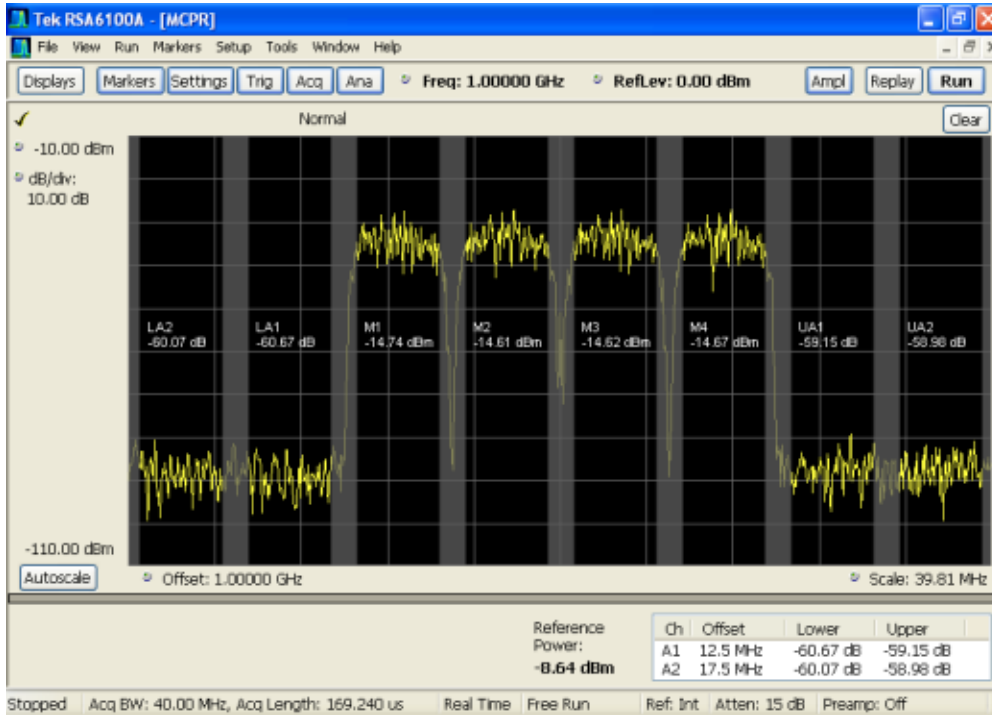

The following table details the entries in the results table.

Heading	Description
Ch	Identifies the adjacent channels. Adjacent channels are numbered according to their offset from the Main channel. The closest channel is numbered 1. The next closest channel is numbered 2; and so forth. The prefix "L" means lower; "U" means upper.
Offset	The offset is the difference in frequency between the Measurement Frequency and the center frequency of the channel.
Lower	Displays the ratio of the lower adjacent channel power to the Power Reference.
Upper	Displays the ratio of the upper adjacent channel power to the Power Reference.
Power Reference	Depending on the selected Power Ref, this readout displays either the power of the selected main channel or the total power in the active main channels.

Depending on the number of adjacent channels, to see all the measurements, you might need to drag the divider bar between the main display and the results table at the bottom of the window to change the height of the results table.

[Setting MCPR Measurement Parameters \(see page 161\)](#)

Multiple Carrier Power Ratio

The ratio of the signal power in an adjacent channel to the power in one or more main channels.

MCPR Settings

Menu Bar: Setup > Settings

Front Panel / Application Toolbar: Settings

The Setup control panel tabs for MCPR (Multiple Carrier Power Ratio) are:

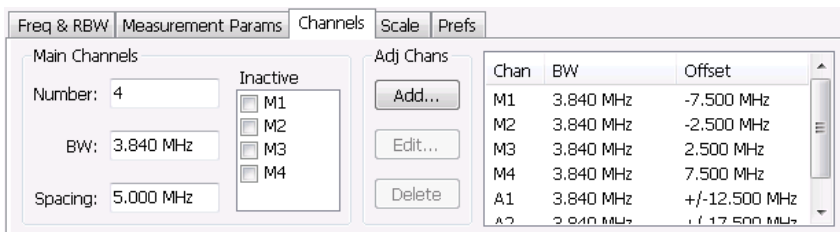

Settings tab	Description
Freq & RBW (see page 160)	Specify the frequency and resolution bandwidth used for the MCPR measurements.
Measurement Params (see page 161)	Specifies parameters controlling how the MCPR measurement is made.
Channels (see page 163)	Specifies the parameters of the channels to be measured.
Scale (see page 224)	Specifies the vertical and horizontal scale and offset values.
Prefs (see page 225)	Specifies whether or not certain display elements are shown.

Restore defaults. Sets parameters for a 4-carrier WCDMA measurement.

Freq & RBW Tab for ACPR and MCPR Displays

The Freq & RBW tab specifies frequency parameters for the Channel Power & ACPR measurements and MCPR measurement.

Setting	Description
Center Freq	Specifies the center/measurement frequency.
Step	The Step control sets the increment/decrement size for the knob adjustment of the center frequency. Arrow key adjustment of frequency is also affected (it is 10x the knob adjustment). If Auto is enabled, the signal analyzer will adjust the Step size as required.
RBW	Select Auto or Manual. Adjusts the RBW for the entire measurement. This setting is Independent of the Spectrum view's RBW setting.
VBW	Adjusts the VBW (Video Bandwidth) value. VBW Maximum = current RBW value. VBW Minimum = 1/10,000 RBW setting.

NOTE. While the center frequency and step settings on this control tab are shared between ACPR, MCPR and Occupied Bandwidth, the RBW setting is not shared. The RBW setting is unique for each measurement.

VBW

The VBW setting enables/disables the Video Bandwidth filter. VBW is used in traditional swept analyzers to reduce the effect of noise on the displayed signal. The VBW algorithm in the analyzer emulates the VBW filters of traditional swept analyzers.

The maximum VBW value is the current RBW setting. The minimum VBW value is 1/10,000 of the RBW setting.

NOTE. If you are following a procedure that says to “set VBW to three times the RBW value or greater”, it means that the test should be conducted with no VBW effects. In the RSA6100B Series instruments, this condition is met by disabling the VBW function.

Measurement Params for ACPR and MCPR Displays

The Measurement Params tab is where you set parameters that control the ACPR and MCPR measurements.

Freq & RBW Measurement Params Channels Scale Prefs

Requires triggered synchronous signal

Average: Time Domain Number: 10 Channel Filter: Root-raised Cosine

Correct for Noise Floor

Power Reference: Total (active channels) Filter Parameter: 0.22

Chip Rate: 3.84 MHz

Freq & RBW Measurement Params Channels Scale Prefs

Average: Frequency Domain Number: 10 Channel Filter: Root-raised Cosine

Correct for Noise Floor

Filter Parameter: 0.35

Chip Rate: 1 MHz

Parameter	Description
Average	Enables/disables measurement averaging. Averaging can be enabled in either the Frequency Domain or Time Domain.
Frequency-domain	This setting takes the average linear value of the traces (so that rms values are preserved). The number of averages is user-defined. Frequency domain averaging is available in spans larger (or smaller) than the maximum real time bandwidth. This is the mode to use unless you need to extract maximum dynamic range from an ACPR measurement.
Time-domain	This setting takes the average linear value of the traces. It is useful if you need to extract maximum dynamic range from an ACPR measurement. The number of traces is user defined. But, the signals must be triggered and repeating. That is, the signal needs to be exactly the same for each acquisition. When this condition is met, each waveform contains the same signal, but the random noise changes from acquisition to acquisition and the average value of the random noise is lowered, while the signal value remains constant. Time domain averaging is not available in spans wider than the maximum real-time bandwidth.
Number	Specifies the number of acquisitions to be averaged when Averaging is set to Frequency Domain. Specifies the number of successive capture records that are averaged when Averaging is set to Time Domain.
Correct for Noise Floor	Enables/disables the Noise Floor Correction function.
Power Reference	Specifies power against which the results are compared. Choices available are each of the existing main channels and "Total (active channels)". Only present when MCPR is the selected display.
Channel Filter	Specify the channel filter used. Select between None (default) and Root-raised Cosine.
Filter Parameter	Value entry box for the Root-raised Cosine filter Adjacent Channel Filter. Present only when the Channel Filter is set to Root-raised Cosine.
Chip Rate	Value entry box for the Root-raised Cosine chip rate. Present only when the Channel Filter is set to Root-raised Cosine.

Correct for Noise Floor

When this setting is enabled, the instrument applies a correction to the ACPR or MCPR measurement to reduce the effect of instrument noise on the results. It generates this correction by taking a preliminary acquisition to measure the instrument noise floor. Once this is done, the measurement proceeds, applying the correction to each result. When any relevant settings (reference level, attenuator, frequency, or span) are changed, the instrument performs a new noise measurement and correction.

The noise correction signal is created by switching off the input to the RTSA and performing acquisitions of the instrument internal noise. 100 acquisitions are averaged to create the noise reference signal. A single value of noise is measured for each channel defined by the measurement. The noise reference from each channel is subtracted from the incoming signal power for each channel to create the corrected result. All calculations are performed in Watts, and then converted to the desired units.

The amount of noise correction is limited to 12 dB to avoid the possibility of a negative power measurement. This is a rare condition that could occur if the subtraction of the reference power from the channel power results in a negative value (or 'infinite' dBm).

The measured values differ from the displayed trace in two ways. First, any filtering applied to the channels is not displayed on the trace. Second, the single value of measured noise for a channel is subtracted from each trace point in the channel, rather than offsetting the entire channel by a single amount. This produces a smooth trace with no discontinuities at the channel edges.

Channels Tab for MCPR

Path: Setup > Settings > Channels

Application Toolbar / Front Panel: Settings

The Channels tab is where you specify the parameters for the channels measured in the MCPR display.

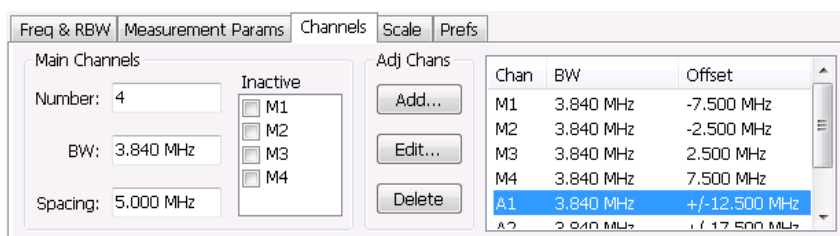

Setting	Description
Main Channels	
Number	Sets the number of Main channels.
BW	Sets the bandwidth of the Main channels.
Spacing	Sets the frequency difference between the centers of the Main channels.
Inactive	Selected channels are ignored by the measurement routine.
Adj Chans	
Add	Opens the Edit Channel Parameters dialog, which you use to specify the parameters of a new pair of adjacent channels. You can add up to 50 adjacent channel pairs.
Edit	Opens the Edit Channel Parameters dialog box. (You must first select a channel to enable the Edit button.)
Delete	Deletes the selected main channel or adjacent channel pair.
Add Adj.	Add a new pair of adjacent channels at the bottom. Their parameters are copied from the channels just above them.
Channel Definition table	A table of the parameters for every channel. Offset is the frequency difference between the Center Frequency and center of the selected channel. Nothing in the table is editable directly.

The following figure illustrates the settings controlled from the Channels tab.

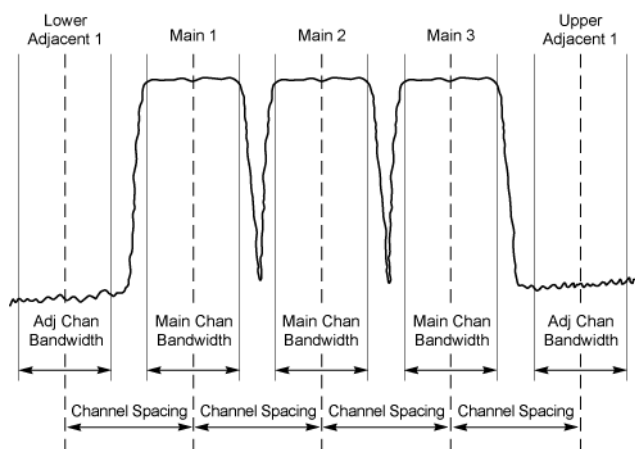

Editing Channel Parameters

To edit the offset or bandwidth of a Main channel:

1. Select the value in the **BW** or **Spacing** number entry boxes.
2. Adjust the value as required. All the Main channels share the same BW and Spacing.
3. Select the appropriate check box to make a channel Inactive, as appropriate.
4. Select the Close box when you have finished making changes.

To edit the offset or bandwidth of an Adjacent channel:

1. Select the channel to be edited in the channel definition table.
2. Select **Edit**. This displays the **Edit Channel Parameters** dialog box.
3. Adjust the values for the **Frequency Offset** or **Bandwidth** as required.
4. Select the Close box when you have finished making changes.

Adding Channels

To add a main channel:

1. Select the **Number** entry box.
2. Use the knob to enter a value for the desired number of Main channels.
3. Select the Close box when you have finished making changes.

To add an adjacent channel pair:

1. Select **Add**. This displays the **Edit Channel Parameters** dialog box.
2. Use the knob to enter values for the **Frequency Offset** and **Bandwidth** as required. The Frequency Offset is measured from the Center frequency of the Main channels.
3. Select the Close box when you have finished making changes.

Deleting Channels

To delete a main channel:

1. Select the **Number** entry box.
2. Use the knob to reduce the number of channels or enter a new value using the front-panel keypad.
3. Select the Close box when you have finished making changes.

To delete an adjacent channel:

1. Select the channel to be deleted in the channel definition table.
2. Select **Delete**. This removes the selected channel from the channel table.
3. Select the Close box when you have finished making changes.

Occupied BW & x dB BW Display

The Occupied BW display shows the bandwidth within which 99% (a user-defined value, the default is 99%) of the power transmitted within the measurement bandwidth falls.

To show the Occupied BW display:

1. Press the **Displays** button or select **Setup > Displays**.
2. In the **Select Displays** dialog, select **RF Measurements** in the **Folders** box.
3. In the **Available displays** box, double-click the **Occupied Bandwidth** icon or select the icon and click **Add**. The Occupied Bandwidth icon will appear in the **Selected displays** box and will no longer appear under Available displays.
4. Click **OK** to display the Occupied Bandwidth.

Elements of the Display

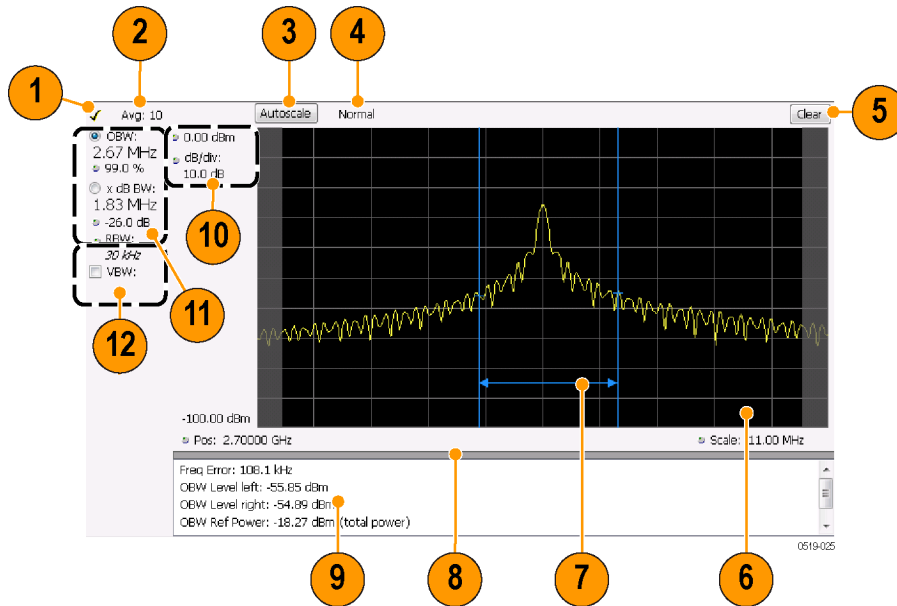

Item	Display element	Description
1	Check mark indicator	The check mark indicator denotes the display for which the acquisition hardware is optimized. This indicator appears only when the display is the selected display.
2	Averaging readout	Appears when averaging is enabled (Settings > Parameters tab > Average results). Displays "Avg: n of m" while averaging the results and "Avg: m" once the requested number of results have been averaged.
3	Autoscale	Adjusts the vertical and horizontal settings so that the entire trace fits in the graph.
4	Trace function readout	Displays either Normal or MaxHold to indicate trace function.
5	Clear	Resets count for Average and MaxHold functions. Enabled only when Averaging or MaxHold is enabled. Pressing Clear will clear the trace and, if acquisition is running, restart the averaging or hold process.
6	Graph	Displays the input signal. Shaded areas indicate the measurement bandwidth (Settings > Parameters tab > Measurement BW).
7	Blue lines	The blue lines indicate where the selected results (selected in the Main results area) are being measured on the trace.
8	Grid divider	Determines the portion of the display allocated to the graph and detailed results area. You can move the grid divider all the way to the top or bottom and any position in between.
9	Detailed results area	Displays additional measurements results.
10	Position and dB/div	Position sets the top of graph value. The dB/div setting is the vertical scale value.
11	Main results area	Displays results for Occupied Bandwidth (OBW) and x dB bandwidth. Use the two radio buttons to select which of the two results are illustrated in the graph with the blue lines and arrows. There are also controls for adjusting OBW % Power, x dB BW, and RBW.
12	VBW	Enables the VBW (Video Bandwidth) filter. Displays current VBW filter setting. See Setup > Settings > Freq & RBW tab (see page 160) .

Detailed Results Readouts

Measurement	Description
Freq Error	The frequency difference between the measured carrier frequency of the signal and the user-selected center frequency of the analyzer.
OBW Level left	The signal level at the left edge of the occupied bandwidth.
OBW Level right	The signal level at the right edge of the occupied bandwidth.
OBW Ref Power	The total power measured within the measurement bandwidth.
x dB BW Ref Power	The peak power measured within the measurement bandwidth.

[Changing the Occupied Bandwidth Settings \(see page 168\)](#)

Occupied Bandwidth

Bandwidth within which some defined percentage of the power transmitted on a single channel lies.

Occupied BW & x dB BW Settings

Menu Bar: Setup > Settings

Front Panel / Application Toolbar: Settings

The control panel tabs for the Occupied Bandwidth display are shown in the following table.

Settings tab	Description
Freq & RBW (see page 219)	Allows you to specify the Center Frequency, Step size and RBW.
Parameters (see page 169)	Allows you to specify the Occupied BW % Power, x dB level, Measurement BW, enable averaging and the Max Hold function.
Scale (see page 224)	Allows you to set the vertical and horizontal scale parameters.
Prefs (see page 225)	The Prefs tab enables you to set characteristics of the measurement display.

Parameters Tab

The Parameters tab enables you to specify parameters that control the Occupied BW measurement.

Setting	Description
Occupied BW % Power	Specifies the proportion of power within the occupied bandwidth (referenced against the total power in the measurement bandwidth).
x dB level	x dB level defines the x dB BW level search threshold.
Measurement BW	Specifies the frequency range used by the measurement.
Max Hold spectral data	Enables the Max Hold function.
Average results	Enables/disables results averaging. Note that this is not an averaging of the trace, but an averaging of the results.
Count	Specifies the number of results averaged to calculate the Occupied BW. Range: 2 to 10,000.

x dB Level

The x dB level determines the x dB BW. The instrument analyzes the spectrum trace to locate the frequencies at which the level is x dB down from the peak level calculated over the measurement bandwidth. The frequency difference between the upper and lower crossing thresholds is the x dB BW.

Range: -80.0 to -1.0 dB; Resolution: 0.1%; Inc/dec small: 0.1%, large: 1%; Default: -26 dB

Max Hold Spectral Data

Max Hold displays the maximum value in the acquisition record for each display point. Each new trace display point is compared to the previous maximum value and the greater value is retained for display and subsequent comparisons.

Spurious Display

To show the Spurious display:

1. Click the **Displays** button or select **Setup > Displays**.
2. From the Folders box, select **RF Measurements**.

- Double-click the **Spurious** icon in the **Available displays** box. This adds the Spurious icon to the **Selected displays** box (and removes it from the Available displays box). Alternatively, you can click the Spurious icon and then click the Add button to select Spectrum for display.
- Click the **OK** button.







Elements of the Spurious Display

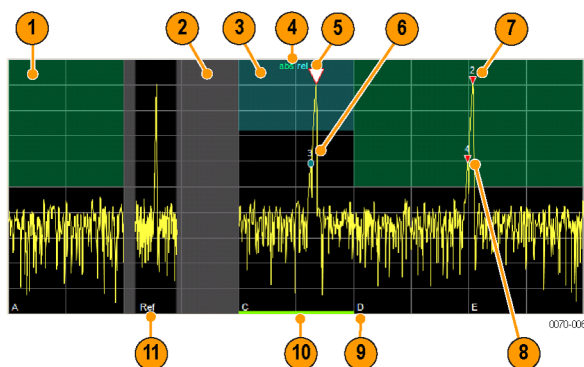

Item	Display element	Description
1	dB/ div	Sets the vertical scale value. The maximum value is 20.00 dB/division.
2	Vert Position	Sets the top of graph value. This is only a visual control for panning the graph. The Reference Level is adjusted in the Toolbar and the Ampl control panel. By default, Vert Position = Ref Level.
3	Check Mark Indicator	Indicates the display for which the acquisition hardware is optimized.
4	Pass / Fail readout	Indicates whether one or more spurs have exceeded a limit specified on the Settings > Limits tab.
5	Ref:	If enabled, displays the power reference level.
6	Trace function	Indicates the trace processing method. If Average or Max Hold is selected, this readout displays the number of traces being processed (averaged or compared for the Max Hold value).
7	Clear	Restarts multi-trace functions (Average, Max Hold).
8	Stop	Adjusts the graph stop frequency. This setting affects only visual scaling, not measurement parameters.
9	Green bar	Indicates the range that is selected on the Settings > Ranges and Settings > Limits tabs.
10	Spur table	Displays spur measurements. See the following table for details.
11	Start	Adjusts the graph start frequency. This setting affects only visual scaling, not measurement parameters.
12	Autoscale	Adjusts the Vertical and Horizontal scaling to display the entire trace on screen. Selects Multi-range display mode.
13	Bottom-of-graph readout	Indicates the amplitude at the bottom of the graph. This value changes with the dB/div and Vertical Position settings.

Elements of the Spurious Graph Display



Item	Display element	Description
1		The green line or shading indicates an Abs (absolute) limit. The absolute limit is enabled when the mask is set to Abs, Abs & Rel, or Abs OR Rel. Note that absolute and relative amplitude masks can overlap.
2		The gray-shaded area indicates a portion of the spectrum where no measurements are being taken.
3		The cyan line or shading indicates a Relative limit. The relative limit is enabled when the mask is set to Rel, Abs & Rel, or Abs OR Rel. Note that absolute and relative amplitude masks can overlap.
4	abs rel	Reminder that green-shaded areas highlight absolute limits and cyan-shaded areas highlight relative limits.
5		This indicates the selected spur, when it is in violation of the limits. In Run mode, this is the peak spur violation. The selected marker is highlighted in the Spur table below the graph with a blue background.
6		A spur marker. Indicates a spur that does not exceed the mask settings. See the Settings > Ranges and Limits tab (see page 176) .
7		A violation marker. Indicates a spur that exceeds the mask settings. See the Settings > Ranges and Limits tab (see page 176) .
--		Indicates the selected spur when it is not in violation of the limits. The selected marker is highlighted in the Spur table below the graph with a blue background.
8	1, 2, 3...	A Spur number. The number indicates the row in the spur table that corresponds to the spur. The instrument can display up to 999 spurs.
9	A, B, C, D...	Identifies the enabled ranges.
10	Green bar	Indicates the range selected on the Settings > Ranges and Limits (see page 176) tab.
11	Ref	Indicates the location of the power reference. See Settings > Reference (see page 174) .

Elements of the Spur Table

Spur	Range	Freq Abs	Freq Rel	Ampl Abs	Ampl Rel	Limit Abs	Limit Rel
1	B	1.751145 GHz	- Hz	-5.91 dBm	4.09 dB	-15.00 dBm	-15.00 dB
2	E	2.053875 GHz	- Hz	-8.99 dBm	1.01 dB	-15.00 dBm	-10.00 dB
3	D	1.903950 GHz	- Hz	-10.48 dBm	-0.48 dB	-50.00 dBm	-57.00 dB
4	A	1.748826 GHz	- Hz	-39.57 dBm	-29.57 dB	-57.00 dBm	-30.00 dB
5	D	1.899062 GHz	- Hz	-40.31 dBm	-30.31 dB	-50.00 dBm	-57.00 dB

Column	Description
Spur	A number that identifies a spur in the graph area. The instrument can display a maximum of 999 spurs.
Range	The letter representing the frequency range where the spur is located.
Freq Abs	The absolute frequency at which the spur occurs.
Freq Rel	The relative frequency at which the spur occurs. The relative frequency is the difference between the absolute frequency (absolute) and the carrier frequency.
Ampl Abs	The absolute amplitude of the spur.
Ampl Rel	The relative amplitude at which the spur occurs. The relative amplitude is the difference between the absolute amplitude and the carrier amplitude. See the Settings > Limits tab.
Lim Abs	The value of the absolute amplitude limit at the spur frequency. This value can vary even with small spur frequency changes if the start and stop limit values are different. See the Settings > Ranges and Limits tab (see page 176) .
Lim Rel	The relative amplitude limit at which the spur occurs. This value can vary even with small spur frequency changes if the start and stop relative amplitude limit values are different. See the Settings > Ranges and Limits tab (see page 176) .
Blue background	The cell in the Spur column with a blue background identifies the selected spur.
Red background	Cells in the Spur column with a red background identify violations. Cells in the results area with a red background identify the measurement that exceeded a limit.

Rearranging the Columns in the Spur Table

You can rearrange the order of the columns in the Spur Table. To move a column, click on the column heading and drag it to the desired position.

Sorting the Rows in the Spur Table

You can sort the rows in the Spur table by clicking on the column heading. For example, if you click on the Freq Abs heading, the results in the Spur table will be sorted by frequency. If you click on Range, the rows will be sorted by range. Clicking a second time on the same heading reverses the order.

[Changing the Spurious Display Settings \(see page 173\)](#)

Spurious Display Settings

Menu Bar: Setup > Settings

Front Panel: Settings

Application Toolbar: 

The control panel tabs for the Spurious display are shown in the following table.

Settings tab	Description
Parameters (see page 174)	Specifies whether the graph displays one range or multiple ranges. Specifies whether all spurs are shown or only spurs over specified limits.
Reference (see page 174)	Specifies the Power Reference level.
Ranges (see page 176)	Specifies start and stop frequencies of ranges and which ranges to take measurements in. Sets parameters that define a spur. Review, save and load the Range table from this tab.
Limits (see page 176)	Specifies Pass/Fail limit parameters.
Trace (see page 220)	Specifies the trace Function.
Scale (see page 224)	Specifies the vertical and horizontal scale settings.
Prefs (see page 225)	Specifies the appearance features of the graph area.

Restore defaults. Sets the Spurious parameters to their default values.

Parameters Tab

The Parameters tab enables you to specify settings that control the Spurious measurement.

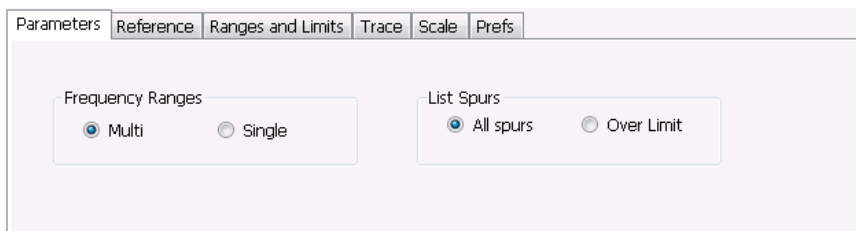

Setting	Description
Frequency Ranges	
Multi	Enables the instrument to display all enabled ranges in the graph.
Single	Limits the graph to the display of only one range. The displayed range is set to the range that contains the selected spur.
List Spurs	
All spurs	Displays any spur that exceeds the Threshold and Excursion values set on the Ranges tab.
Over Limit	Displays only spurs that exceed both the Threshold and Excursion values set on the Ranges tab and the limits specified on the Limits tab.

Reference Tab

The Reference tab enables you to specify the Power Reference parameter. The Power reference parameter is used to calculate relative values in the Spur table and to calculate relative amplitude limits.

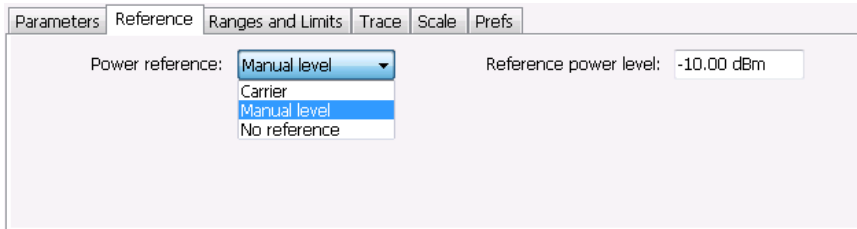

Setting	Description
Power Reference	Specifies the power reference level used for relative values and limits.
No reference	Power level readings are calculated only for absolute values, no relative values are calculated.
Manual level	The reference level for relative measurements is specified by the Reference power level setting.
Carrier	The reference level for relative measurements is based on the power level calculated at the specified carrier frequency.

Setting the Power Reference Level to No Reference

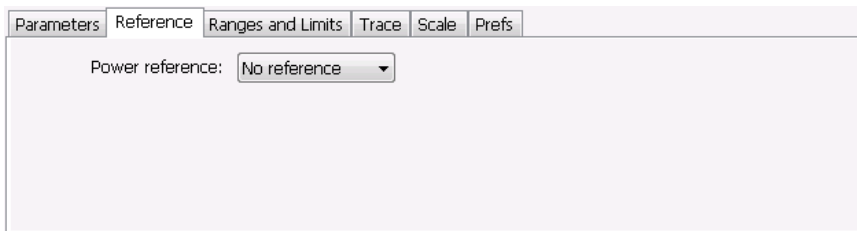

To set the power reference to No Reference:

- Select **No reference** from the **Power reference** drop-down list.

Setting the Power Reference Level to Manual Level

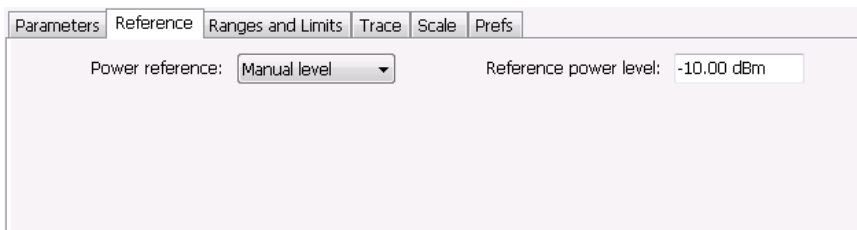

To set the power reference to manual level:

1. Select **Manual level** from the **Power reference** drop-down list. This displays the **Reference power level** entry box.
2. Specify the desired power level in the **Reference power level** entry box.

Setting the Power Reference Level to Carrier

Parameters	Reference	Ranges and Limits	Trace	Scale	Prefs
Power reference:	Carrier				
Frequency:	1.466000 GHz	Res BW:	85 kHz	<input checked="" type="checkbox"/> Auto	Detection:
Channel width:	8.500 MHz				+Peak
Threshold:	-10.00 dBm	Integration BW:	2 MHz		

To set the power reference to Carrier:

1. Select **Carrier** from the **Power reference** drop-down list.
2. To set the Carrier frequency, specify the necessary values in the **Frequency** and **Channel width** entry boxes .
3. Specify the **Threshold** level.
4. Specify the **Integration BW**. The Integration BW is the bandwidth over which the carrier is measured.
5. If necessary, specify the Resolution Bandwidth by changing the value in the **Res BW** entry box. Auto is the recommended setting.
6. Set the **Detection** method. Select **+Peak**, **Avg (VRMS)**, or **Avg (of logs)**.

NOTE. *If the power level measured over the Integration BW about the carrier frequency is below the threshold level, the instrument concludes that no carrier is present and no relative measurements will be taken. Absolute measurements will still be taken.*

Ranges and Limits Tab

Use the Ranges and Limits tab to specify the parameters that control the Spurious measurement. From the Ranges and Limits tab, you specify the start and stop frequencies for ranges, whether or not a range is enabled, the parameters that specify what constitutes a spur, measurement filter shape and bandwidth, and the detection method used for processing signals, as well as the pass/fail parameters for Limit Testing.

	On	Start (Hz)	Stop (Hz)	Filter Shape	BW (Hz)	Auto	Detector	VBW (Hz)	VBW On
A	X	1.492500G	1.507500G	RBW	100.000k	X	+Peak	100k	
B	X	1.512500G	1.537500G	RBW	200.000k	X	+Peak	200k	
C		0.000000	0.000000	RBW	1.000M	X	+Peak	1M	
D		0.000000	0.000000	RBW	1.000M	X	+Peak	1M	
E		0.000000	0.000000	RBW	1.000M	X	+Peak	1M	

Setting	Description
Expand	Displays the Ranges and Limits Table in a new, resizable window.
Reset layout	You can reorder columns in the Ranges and Limits Table by dragging the columns to a new position. Clicking Reset Layout returns the column order to the factory default order.
Load	Click to load a saved Ranges and Limits table from a file.
Save	Click to save the current Ranges and Limits table to a file.

To specify the ranges and limits for the Spurious measurement:

- Edit the values in the Ranges and Limits table.

You can edit the Ranges and Limits table in two ways:

- Edit values directly from the Ranges and Limits tab. You will need to scroll the table to access all settings.
- Click the **Expand** button. This displays the Ranges and Limits Table in a new window that can be sized to the fullscreen.

	On	Start (Hz)	Stop (Hz)	Filter Shape	BW (Hz)	Auto	Detector	VBW (Hz)	VBW On
A	X	1.492500G	1.507500G	RBW	100.000k	X	+Peak	100k	
B	X	1.512500G	1.537500G	RBW	200.000k	X	+Peak	200k	
C		0.000000	0.000000	RBW	1.000M	X	+Peak	1M	
D		0.000000	0.000000	RBW	1.000M	X	+Peak	1M	
E		0.000000	0.000000	RBW	1.000M	X	+Peak	1M	
F		0.000000	0.000000	RBW	1.000M	X	+Peak	1M	
G		0.000000	0.000000	RBW	1.000M	X	+Peak	1M	
H		0.000000	0.000000	RBW	1.000M	X	+Peak	1M	
I		0.000000	0.000000	RBW	1.000M	X	+Peak	1M	
J		0.000000	0.000000	RBW	1.000M	X	+Peak	1M	
K		0.000000	0.000000	RBW	1.000M	X	+Peak	1M	
L		0.000000	0.000000	RBW	1.000M	X	+Peak	1M	
M		0.000000	0.000000	RBW	1.000M	X	+Peak	1M	
N		0.000000	0.000000	RBW	1.000M	X	+Peak	1M	
O		0.000000	0.000000	RBW	1.000M	X	+Peak	1M	
P		0.000000	0.000000	RBW	1.000M	X	+Peak	1M	
Q		0.000000	0.000000	RBW	1.000M	X	+Peak	1M	
R		0.000000	0.000000	RBW	1.000M	X	+Peak	1M	
S		0.000000	0.000000	RBW	1.000M	X	+Peak	1M	
T		0.000000	0.000000	RBW	1.000M	X	+Peak	1M	

The following table describes the parameters that are set in the Ranges and Limits Table.

Ranges and Limits Table Settings

Setting	Description
On	Specifies whether or not measurements are taken in the specified range.
Start (Hz)	Readout of the start frequency for the selected range.
Stop (Hz)	Readout of the stop frequency for the selected range.
Filter shape	Specifies the filter shape used for the Spurious measurement.
BW (Hz)	Specifies the bandwidth used for the selected filter shape.
Auto	Sets the BW automatically. If CISPR is selected for Filter shape, this control is disabled.
Detector	Sets the processing method used for compressing excess intermediate data into the desired number of trace points.
VBW (Hz)	Adjusts the VBW (Video Bandwidth) value. VBW Maximum: RBW current value; VBW Minimum: 1/10,000 RBW setting. Disabled when Filter shape is set to CISPR.
VBW On	Specifies whether the VBW filter is applied.
Thrshld (dBm)	Threshold specifies the level that must be exceeded for a signal peak to be recognized as a spur. A signal peak must also exceed the Excursion setting to be considered a spur.
Excursn (dB)	Excursion specifies the peak to peak magnitude that must be exceeded for a signal peak to be recognized as a spur. A signal transition must also exceed the Threshold setting to be considered a spur.
Mask	Selects the type of limits used for Pass/Fail testing. Spurs that exceed the mask settings are considered violations. The available choices are shown below.
Abs	Spurs that exceed the Absolute limits settings are identified as violations.
Rel	Spurs that exceed the Relative limits settings are identified as violations.
Abs & Rel	Spurs that exceed both the Absolute and Relative limits settings are identified as violations.
Abs OR Rel	Spurs that exceed either the Absolute or Relative limits settings are identified as violations.
Off	Turns off limit testing for the selecting range. Measurements are still taken in the range, but violations are not flagged. Signal peaks that exceed the Threshold and Excursions values will still be identified as spurs.
(Abs Start and Abs Stop)	Absolute amplitude limits are not based on the measured carrier amplitude or manual reference. Start and stop values can be different.
Abs Start (dBm)	Abs Start specifies the limit at the start frequency of the range.
Abs Stop (dBm)	Abs Stop specifies the limit at the stop frequency of the range.
Abs Same	Sets the limit at the start and stop frequencies to the value set for the start frequency.
(Rel Start and Rel Stop)	Relative amplitude limits are calculated from the Power Reference. If the Power Reference is set to the Carrier level, the relative amplitude limits will change with the carrier level. Start and stop values can be different.
Rel Start (dB)	Specifies the limit at the start frequency of the range.
Rel Stop (dB)	Specifies the limit at the stop frequency of the range.
Rel Same	Sets the limit at the stop frequency to the value set for the start frequency.
Save As	Click to save the current Ranges and Limits table to a file.
Load	Click to load a saved Ranges and Limits table from a file.
Done	Save changes and close the Ranges and Limits Table window.

Changing the Range Start and Stop Frequencies

To change the range start and stop frequencies, edit the Start and Stop frequencies in the Ranges and Limits Table:

1. Click the **Expand** button on the **Settings > Range and Limits** tab. This displays the Ranges and Limits Table.
2. Click the **On** box for a range to take measurements in the range.
3. Click on the Start or Stop frequency setting to change it. Type in a number for the frequency and a letter as a multiplier. You can use k, m, or g to set the frequency multiplier.
4. Click **Done** to save your changes.

Specifying Spur Requirements

A spur is a signal peak that exceeds both the Threshold and Excursion settings in the Ranges and Limits table. The Threshold and Excursion settings are absolute values; they are not calculated relative to a reference. The Threshold and Excursion settings are specific to the selected range. If you want to use different settings for spurs in different ranges, you have to set the values separately for each range. The Excursion control is used to avoid interpreting a single spur as multiple narrower spurs by requiring the amplitude to drop by the Excursion amount between spurs. Raising the Threshold value means that fewer, larger signals will be identified as spurs.

To specify the spur requirements for a range:

1. Click the **Expand** button on the **Range and Limits** tab. This displays the Ranges and Limits Table.
2. Select the **Range** (A–T) for which you want to specify the spur requirements.
3. Set the **Thrshld** value.
4. Set the **Excrsn** value.

Setting Limits

Use the Limits settings in the Ranges and Limits Table to specify the pass/fail parameters for the Spurious measurement. When the Mask setting is set to any value except off, the instrument identifies any signal peak that exceeds the specified limits as a violation and displays Fail on the screen. If no signal peak exceeds the limits, the instrument displays Pass on the screen.

Performing Pass/Fail Limit Testing

To set limits:

1. Click the **Expand** button on the **Range and Limits** tab. This displays the Ranges and Limits Table.
2. Adjust the Start and Stop frequencies as required for each range you want to test.
3. For ranges that you wish to test, verify that the **On** box is checked.

4. For each range you wish to test, select the desired **Mask** type from the drop-down list.
5. Set the limits as desired in the **Abs Start**, **Abs Stop**, **Rel Start**, and **Rel Stop** boxes. The values you can edit depend on the mask type you select.
6. Verify that the **Thrshld** and **Excrsn** values are set as required. These are the values that define a spur.
7. Click **Done** to save your changes and close the Range and Limits Table window.
8. Click **Run** to begin testing.

CCDF Display

The CCDF (Complementary Cumulative Distribution Function) is a statistical characterization that plots power level on the x-axis and probability on the y-axis of a graph. Each point on the CCDF curve shows what percentage of time a signal spends at or above a given power level. The power level is expressed in dB relative to the average signal power level. The CCDF Display also shows the Average power level and the Peak/Average ratio.

To show the CCDF display:

1. Press the **Displays** button or select **Setup > Displays**. This shows the **Select Displays** dialog box.
2. From the **Folders** box, select **RF Measurements**.
3. Double-click the **CCDF** icon in the **Available Displays** box. This adds the CCDF icon to the **Selected displays** box.
4. Click the **OK** button.

Elements of the CCDF Display

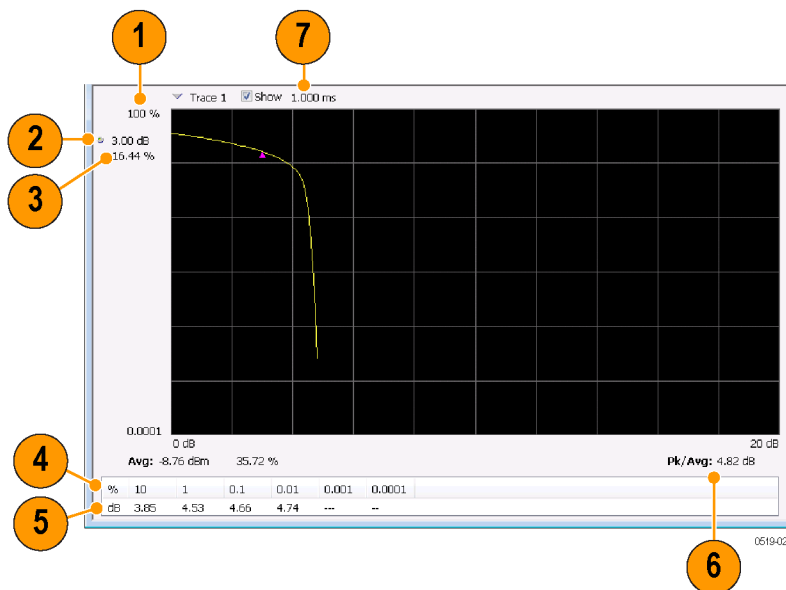

Item	Display element	Description
1	100%	The top of the graph represents the 100% probability that the signal will be at or above the average signal level.
2	Power level select	Adjust to display the value of the CCDF curve at a specific power level. The selected power level is indicated by a small triangle on the CCDF curve.
3	CCDF value	Readout of the value of the CCDF curve at the selected power level.
4	Avg	Readout of the Average power level and the CCDF value at the Average power level.
5	Readout Table	Readout of the CCDF curve at six points.
6	Pk / Avg	Readout of the Peak to Average power ratio.
7	Measurement time	Readout of the length of time used for the measurement. Displays --- s when the Measurement time is set to continuous.

[Changing the CCDF Display Settings \(see page 181\)](#)

CCDF Settings

Menu Bar: Setup > Settings

Front Panel: Settings

Application Toolbar: 

The control panel tabs for the CCDF Display are shown in the following table.

Settings tab	Description
Parameters (see page 182)	Specifies the time to be measured.
Traces (see page 220)	Select the trace to be measured and select reference trace for display.
Prefs (see page 225)	Specifies whether on not certain display elements are shown.

Restore defaults. Sets the CCDF parameters to their default values.

Parameters Tab

The Parameters tab enables you to specify several parameters that control signal acquisition for the CCDF Display.

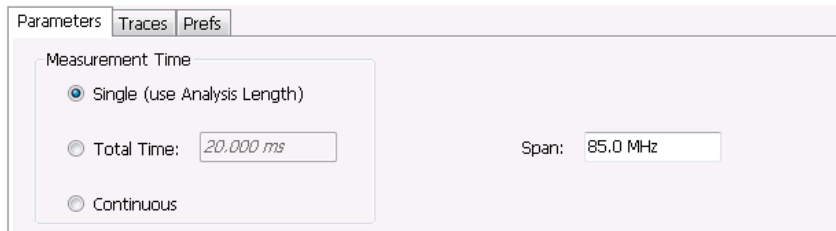

Setting	Description
Single	When Single is selected, the CCDF measurement is based on the Analysis Time parameters set on Analysis control panel (Setup > Analysis > Analysis Time), shared by all displays. In Single, CCDF is time-correlated with the other open displays.
Total Time	When Total Time is selected, you can adjust its value. The value set here does not affect the Analysis Length value set in the Analysis control panel. If the Total Time value is longer than the Analysis Length, CCDF uses multiple acquisitions to collect signal data.
Continuous	When Continuous is selected, the CCDF measurement combines each new record (Actual Analysis Length) into the existing result. It does not erase and start over until user presses STOP or CLEAR.
Span	Specifies the range of frequencies used for analysis.

Single

To have statistically meaningful results, CCDF works best when calculated on at least 1 ms of data. Depending on the Analysis Time setting, the CCDF display may present error messages:

- If the Actual Analysis Time is greater than 1 ms, the CCDF Display will calculate the trace without any problems.
- If the Actual Analysis time is less than 1 ms, the CCDF Display will measure the data as best it can, but if it receives fewer than 20 samples, the CCDF display will clear the trace and report "Not enough samples".

Phase Noise Display

Phase Noise measures and graphs the power in a 1 Hz bandwidth referenced to the carrier power. This is repeated for many frequency points across a user-adjustable span.

To show the Phase Noise display:

1. Click the **Displays** button or select **Setup > Displays**.
2. From the Folders box, select **RF Measurements**.
3. Double-click the **Phase Noise** icon in the **Available displays** box. This adds the Phase Noise icon to the **Selected displays** box (and removes it from the Available displays box). Alternatively, you can click the Phase Noise icon and then click the **Add** button to select Phase Noise for display, or drag the Phase Noise icon to the Selected Displays box.
4. Click the **OK** button.

Elements of the Phase Noise Display

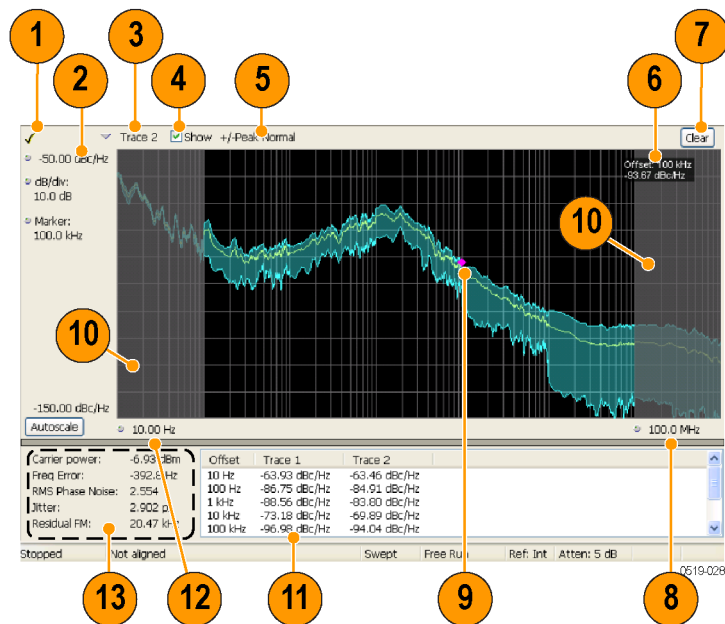

Item	Display element	Description
1	Check Mark Indicator	Indicates the display for which the acquisition hardware is optimized.
2	Vert Position (dBc/Hz)	Sets the top of graph value. This is only a visual control for panning the graph.
3	Trace selector	Selects a trace.
4	Show check box	Shows/hides the selected trace.
5	Detection method / Average count	Displays the Detector method used for the trace. If Average detection is enabled, the number of averaged traces appears here.
6	Measurement Marker readout	Readout of the value of the phase noise at the selected offset. The Phase Noise measurement marker does not affect the results reported in the readouts or table below the graph, nor is it associated with markers in any other display.
7	Clear	Restarts multi-trace function (Average).
8	Horizontal stop	Readout of the Right Horizontal frequency value. This setting affects only visual scale, not measurement bandwidth. (See Settings > Scale (see page 139))
9	Measurement marker	Indicates the position of the measurement point.
10	Integration frequency range indicators	The gray-shaded areas denote the frequencies outside the integration frequency range. (See Settings > Frequency (see page 351))
11	Phase Noise Table	Displays the phase noise values at different offsets.
12	Horizontal start	Readout of the Left Horizontal frequency value. Affects only visual scaling, not measurement bandwidth. (See Settings > Scale (see page 139))
13	Measurement results readouts	Display of the different measured values.

Elements of the Measurement Results Readout / Phase Noise Table

Carrier power:	-6.93 dBm	Offset	Trace 1	Trace 2
Freq Error:	-392.8 Hz	10 Hz	-63.93 dBc/Hz	-63.46 dBc/Hz
RMS Phase Noise:	2.554 °	100 Hz	-86.75 dBc/Hz	-84.91 dBc/Hz
Jitter:	2.902 ps	1 kHz	-88.56 dBc/Hz	-83.80 dBc/Hz
Residual FM:	20.47 kHz	10 kHz	-73.18 dBc/Hz	-69.89 dBc/Hz
		100 kHz	-96.98 dBc/Hz	-94.04 dBc/Hz

Readout	Description
Carrier power	The power level at the carrier frequency.
Freq Error	The measured carrier frequency error.
RMS Phase Noise	The RMS value of the phase noise, measured over the Integration BW.
Jitter	The jitter in seconds, measured over the Integration BW. Includes the effects of random and coherent jitter.
Residual FM	The residual frequency modulation, measured over the Integration BW.
Trace 1	The phase noise on trace 1 at different frequency offset values. Note that if Trace 1 is set to +/- Peak detection, the value displayed in the table is the +Peak value.
Trace 2	The phase noise on trace 2 at different frequency offset values. Note that if Trace 2 is set to +/- Peak detection, the value displayed in the table is the +Peak value.

[Changing the Phase Noise Settings \(see page 186\)](#)

How Phase Noise Is Measured

If carrier tracking is on, the instrument measures phase noise relative to the highest-amplitude signal within about 20 MHz of the user-entered frequency. The difference between center frequency and the frequency of the measured carrier is reported as frequency error. If carrier tracking is not on, the instrument measures phase noise relative to the amplitude at the user-entered frequency.

The unit will tune to a number of offsets from the carrier frequency, and calculate the spectrum for the frequency range about each offset using a resolution bandwidth appropriate for the offset frequency. This is done to optimize speed while maintaining acceptable frequency resolution. A table of the values used for measurement frequency offset, resolution bandwidths, hardware IF filter bandwidths and RF attenuations is shown below.

Measurement frequency offset range	Measured span	RBW use for spectrum calculation	Hardware IF filter	RF Attenuation
10 Hz to 100 Hz	312.5 kHz	1 Hz	40 MHz	Auto from ref level
100 Hz to 1 kHz	312.5 kHz	2 Hz	40 MHz	Auto from ref level
1 kHz to 10 kHz	312.5 kHz	20 Hz	40 MHz	Auto from ref level
10 kHz to 100 kHz	3 MHz	200 Hz	40 MHz	Auto from ref level
100 kHz to 1 MHz	3 MHz	1 kHz	40 MHz	Auto from ref level
1.0 MHz to 1.9 MHz	300 kHz	1 kHz	1 MHz	Auto from ref level (-5 dB) ¹
1.9 MHz to 20.0 MHz	300 kHz	1 kHz	1 MHz	Auto from ref level (-20 dB) ¹
20 MHz to 100 MHz	20 MHz	10 kHz	40 MHz	Auto from ref level (-5 dB) ¹
100 MHz to 1000 MHz	20 MHz	100 kHz	40 MHz	Auto from ref level (-5 dB) ¹

¹ Attenuator adjustment when 'optimize dynamic range' is selected

After acquisition and calculation, the spectrum is corrected to display power in a 1 Hz bandwidth referenced to the carrier power (dBc/Hz). The correction algorithm does not discriminate between noise signals and coherent signals in making the dBc/Hz correction. Since all measured signals are corrected as

if they were noise, coherent signal measurement results can contain errors in level. This is a key difference between an SA-based measurement and a dedicated phase noise tester.

The largest difference between operation of a swept spectrum analyzer and a real-time signal analyzer when measuring phase noise is a result of the wide acquisition bandwidths found in the real-time signal analyzer. The real-time signal analyzer can select between 1 MHz, 40 MHz and 110 MHz IF filters when performing acquisitions. By contrast, a traditional spectrum analyzer uses an IF bandwidth that can range from a few kHz wide up to 10 MHz wide, depending upon the selected resolution bandwidth. When the IF bandwidth is small it is able to reject out-of-band carriers so they don't overload the final IF and digitizers in the instrument. This allows the signal analyzer to begin to reduce attenuation as the phase noise measurement tunes farther away from the carrier, improving dynamic range. The same thing is done in the real-time signal analyzer, but the 1 MHz final IF section in the real-time signal analyzer can't reject signal within about 1 MHz whereas a conventional spectrum analyzer can reject signals within a few kHz of the desired carrier. This is the reason for the shape of the phase noise plot seen in the following illustration.

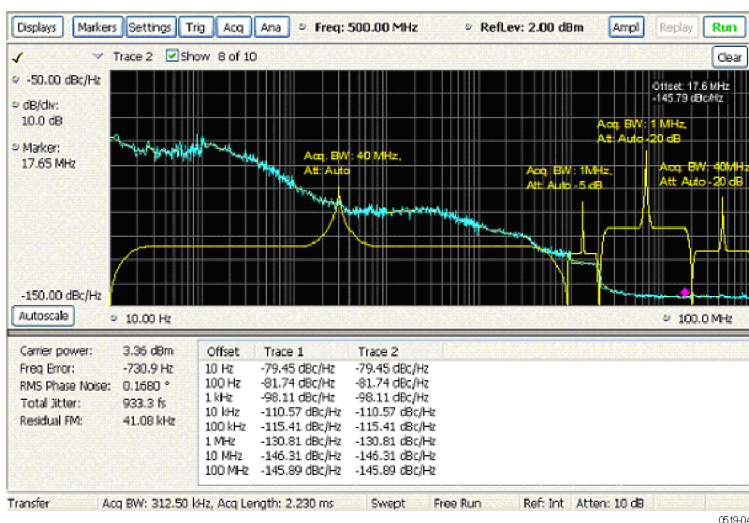

In the previous illustration, the effect of choosing 'optimize dynamic range' is seen. In the offsets between 10 Hz and 1 MHz, the 40 MHz acquisition bandwidth is used, and the RF attenuator is set based on the reference level of the instrument to prevent overload of the RF/IF signal path.

At an offset of >1 MHz, a 1 MHz IF bandwidth is applied, 5 dB of RF attenuation is removed from the signal path and the noise 'floor' of the measurement is reduced. At 2 MHz offset from carrier, 20 dB of attenuation is removed with a resultant increase in dynamic range. Finally, at 20 MHz offsets, the 40 MHz filter is used again with 20 dB attenuation removed. In order to be able to use the 40 MHz BW filter at a 20 MHz offset, the measurement frequency is moved so that the carrier is 30 MHz from the measurement point, and well down the filter rejection skirt.

Phase Noise Settings

Menu Bar: Setup > Settings

Front Panel: Settings**Application Toolbar:** 

The control panel tabs for the Phase Noise display are shown in the following table.

Settings tab	Description
Frequency (see page 351)	Specify Measurement BW and Integration BW. Enable carrier frequency tracking and specify the Carrier threshold level.
Parameters (see page 189)	Specifies the Optimization method.
Traces (see page 220)	Specifies trace parameters such as detection method and whether smoothing is enabled. Traces can also be saved and loaded for reference from this tab.
Scale (see page 224)	Specify vertical and horizontal scale settings.
Prefs (see page 225)	Specify appearance features of the graph area.

Restore defaults. Sets the Phase Noise parameters to their default values.

Frequency Tab

Use the Frequency tab to specify parameters used for taking the Phase Noise measurement.

Frequency	Parameters	Traces	Scale	Prefs
	Start Offset	Stop Offset	<input checked="" type="checkbox"/> Track carrier frequency	
Measurement BW:	100.0 Hz	100.0 MHz		
Integration BW:	100.0 Hz	100.0 MHz	Carrier threshold:	-20.00 dBm

Setting	Description
Measurement BW	This sets the frequency range for the phase noise measurement range. The instrument's Frequency control is used to set the "carrier frequency of interest". The widest available start/stop range is from 10 Hz greater than the carrier frequency ("Stop Offset") to 1 GHz above the carrier ("Stop Offset"). Very small start offsets will take significant time to measure as very narrow resolution bandwidths are used in to achieve small-offset measurements. Large-offset stop frequencies cause small effects on measurement time, but will increase the displayed scale of the phase noise plot.
Start Offset	Sets the starting point for the Phase Noise plot. Offset is from the carrier frequency. The minimum start offset is 10 Hz. The maximum start offset is 100 MHz. The setting is limited to powers of ten (1, 10, 100...).
Stop Offset	Sets the stopping point for the Phase Noise plot. Offset is from the carrier frequency. The minimum stop offset is 100 Hz. The maximum stop offset is 1 GHz. The Stop offset value must be at least 10X the Start offset value. The setting is limited to powers of ten (1, 10, 100...).
Integration BW	Integration bandwidth sets the frequency range over which integrated results for phase noise (labeled "RMS Phase Noise") and jitter are calculated. Integration start and stop cannot exceed the measurement bandwidth. If you set the integration bandwidth greater than the measurement, the error message 'Setup error: Integration BW exceeds Measurement BW' will appear.
Start Offset	Specifies the Integration BW's start offset from the carrier frequency.
Stop Offset	Specifies the Integration BW's stop offset from the carrier frequency.
Track carrier frequency	The instrument finds the carrier signal and measures its frequency at least once each time the Phase Noise measurement is taken and reports the error between the Freq setting and the measured frequency of the carrier. When Track carrier frequency is enabled, the measurement adjusts its tuning to counteract the carrier error or drift. When carrier tracking is disabled, the measurement is made using the Freq setting specified by the user.
Carrier threshold	The minimum power level required for the signal to be recognized as a carrier. If no signal is found above this level within 20 MHz of the Freq setting, the Phase Noise measurement will fail.

Parameters Tab

The Parameters tab enables you to specify acquisition settings that control the Phase Noise measurement.

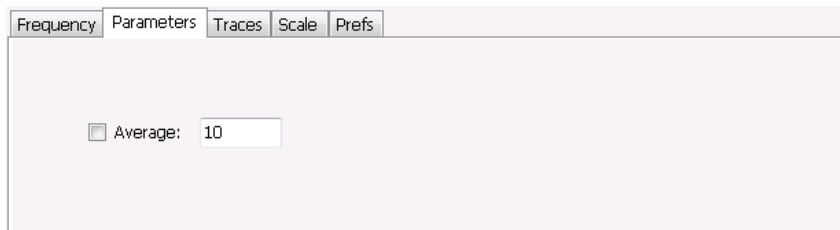

Average. Specifies whether averaging is used or not. This setting affects integrated numeric results and the trace display. The range for this setting is 2 to 100. The default setting is disabled.

Settling Time Measurement Overview

The Settling Time measurement (Option 12) is used to measure frequency and phase settling time of frequency-agile oscillators and subsystems. Automated measurements can reduce user-to-user measurement variations, improve repeatability and measurement confidence, and save time in gathering results.

Measurement Definitions

Settling time. The time measured from a reference point to when the signal of interest settles to within user-defined tolerance.

Settled frequency. The final reference frequency, determined automatically or manually. The tolerance band is centered about this settled frequency.

Settled phase. The final reference phase, determined automatically or manually. The tolerance band is centered about this settled phase.

Mask Testing

Mask testing is a tool to automatically determine the pass/fail state of the Device-Under-Test. The mask is defined over three or fewer user-defined time zones, with an independent limit band for each time zone. If the mask is violated, the area of violation is highlighted in red on screen, and a Fail message is displayed. The pass/fail status of the mask test can be queried over GPIB for rapid results. To configure Mask testing, see the [Mask tab \(see page 204\)](#).

The instrument's Search function can watch the Settling Time measurement for either pass or fail results, and perform actions such as stopping or saving data when the defined condition occurs. See [Search \(Limits Testing\) Settings \(see page 343\)](#) for details on configuring Search.

Frequency Settling Time Theory of Operation

The following paragraphs describe how a frequency and phase settling measurement is made.

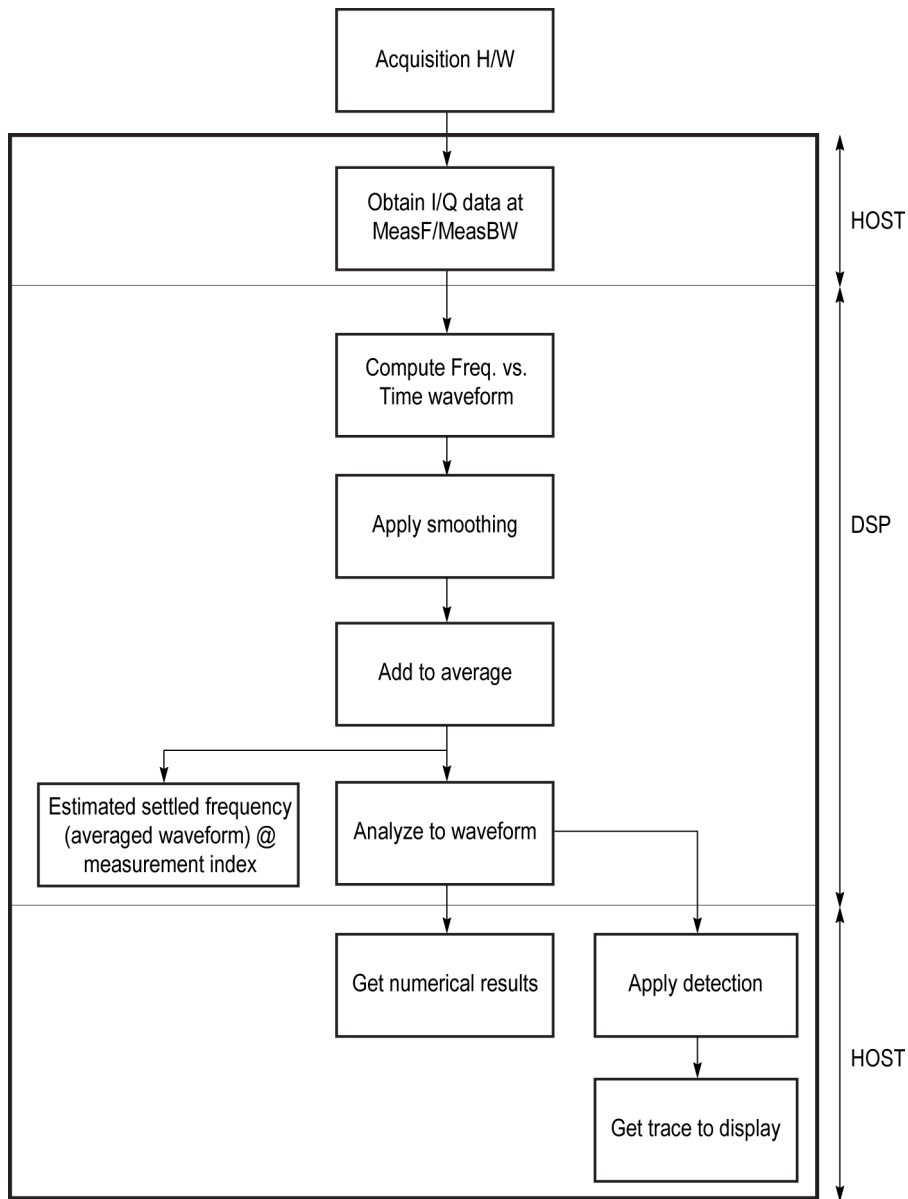

Frequency settling time flow diagram

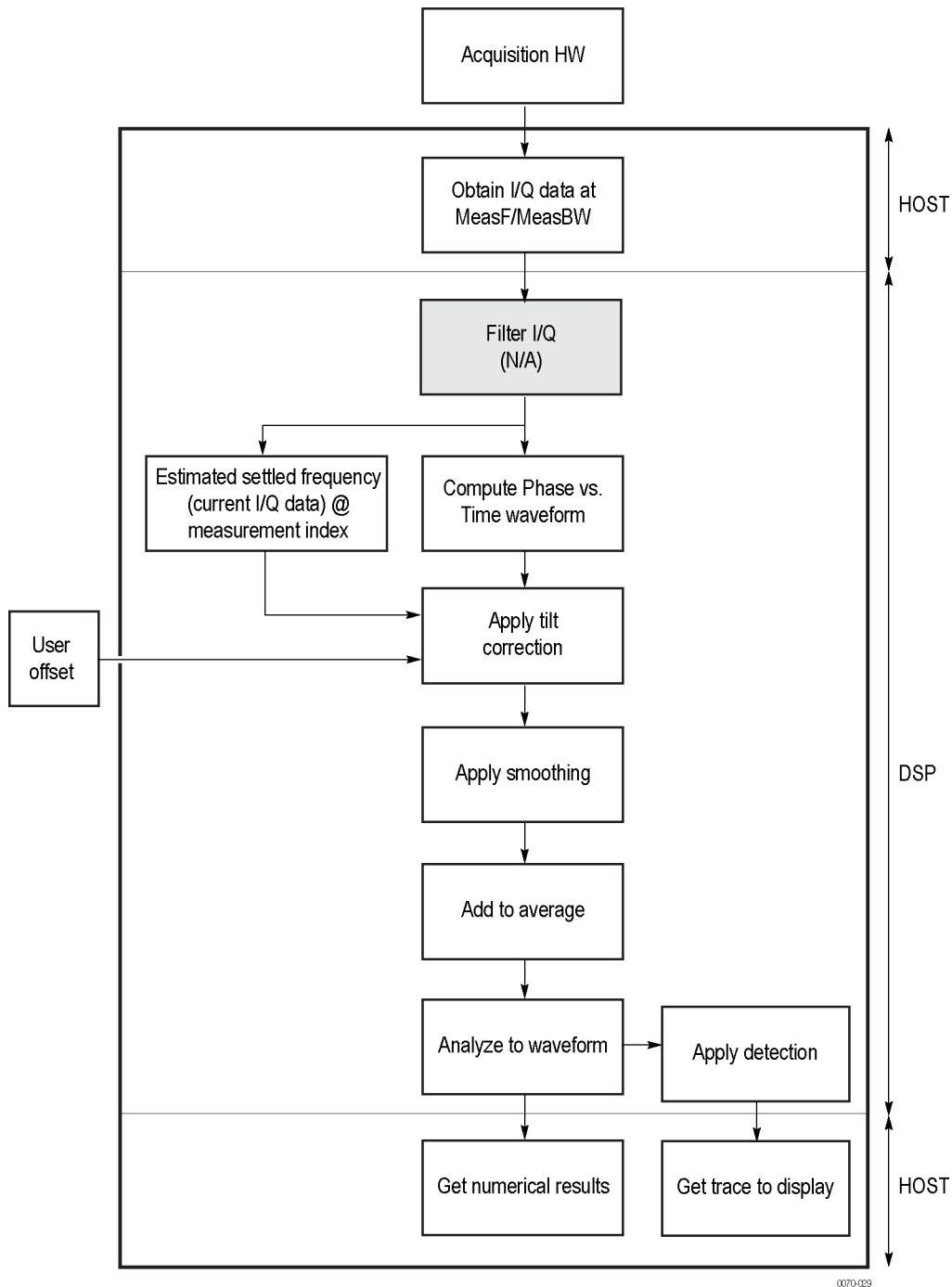

Phase settling time flow diagram

Acquisition hardware collects I and Q samples at the measurement frequency. Sample Rate is based on the measurement bandwidth setting.

The instantaneous phase is computed as:

$$Ph_{(n)} = \text{atan} \left(\frac{Q_{(n)}}{I_{(n)}} \right)$$

The instantaneous frequency is the derivative of the phase:

$$Fr_{(n)} = (Ph_{(n-1)} - Ph_{(n+1)}) \times \left(\frac{F_{\text{sampling}}}{(2 \times 2\pi I)} \right)$$

Data smoothing is applied (if selected by the user). This filtering method uses $\pm n$ adjacent samples to produce an average value that is used to replace the values of the original $2n$ samples. An example is shown below.

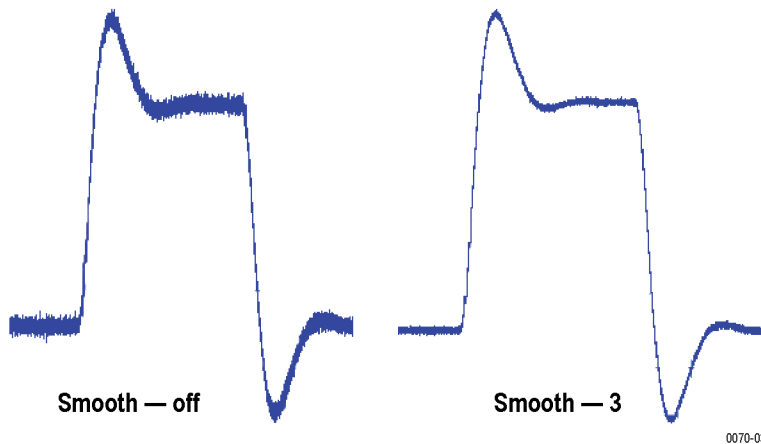

If averaging is turned on, the smoothed data array is averaged with data arrays of previous acquisitions on a point-by-point basis. Smoothing has the advantage of reducing noise-like variations in the measurement, but carries the risk of masking real measurement data. The amount of smoothing applied must be determined by evaluating the waveform you see for artifacts that result from the process.

Next, Settled Frequency is calculated. Settled frequency is the average frequency determined by looking back in time from the point set by the Measurement Length control over a minimum of 256 samples. This value is used to determine the frequency level about which to center the Tolerance range. The measurement then searches backward through the data until it finds the first point that exceeds the tolerance range. A maximum of 20 million acquisition data samples can be processed by the measurement.

Settling Time is measured as the time from the start reference to the point where the frequency remains within the tolerance band. The start reference can be any of three points:

- The trigger point
- The beginning of the analysis period. This result can only be computed when the instrument can find a previous settled state within the measurement period
- The point at the end of the previous frequency hop where the frequency first leaves the tolerance band. This result can only be computed when the instrument can find a previous settled state within the measurement period.

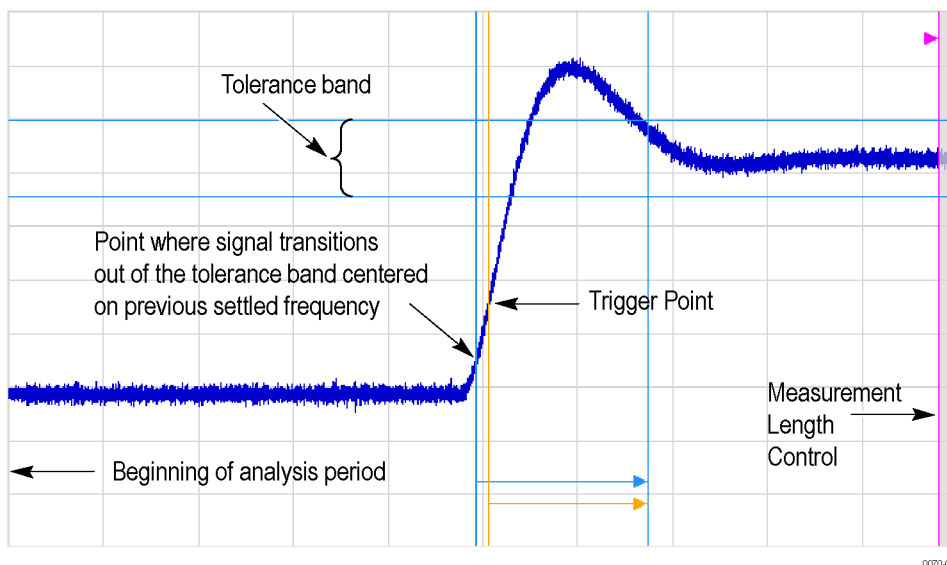

Settling time start reference points

All measurements are now complete and the numeric settling time values can be sent to the display. However, no result traces have been produced yet. Detection is used to reduce the measured points (which can number up to 10 million) to a number more easily processed by the display processor. +/- Peak detection is always used, preserving the maximum positive and negative excursions for display. Reducing the number of points in the result reduces the time resolution of the markers. If averaging is on, the measurement results are computed on the average of the undecimated results.

Phase Settling Time Overview

Phase settling time is determined, as described previously, with the addition of tilt correction.

The instrument estimates tilt (or slope of the phase) using linear least square fitting over (at least) 256 samples of the phase vs. time waveform, looking backwards from the point set by the Measurement Length. The instrument adjusts the phase waveform so that its phase is of zero value at the point set by the Measurement Length.

Settling Time Displays

The Frequency Settling Time measurement is used to measure the frequency settling time of frequency-agile oscillators and subsystems. The Phase Settling Time measurement is used to measure the phase settling time of phase-agile oscillators and subsystems. Automated measurements can reduce user-to-user measurement variations, improving repeatability and measurement confidence and saving time in gathering results. To measure phase settling, a phase reference is required. This means that the measurement tool must be frequency-referenced to the device under test, or must act as the frequency reference to the device under test. To lock the reference to an external source, go to Setup > Configure In/Out > Frequency Reference and choose **External**. Values from 1 MHz to 25 MHz in 1 MHz steps can be used as an external reference.

To show a Settling Time display:

1. Click the **Displays** button or select **Setup > Displays**.
2. From the Folders box, select **RF Measurements**.
3. Double-click the **Freq Settling** icon or the **Phase Settling** icon in the **Available displays** box. This adds the selected display to the **Selected displays** box (and removes it from the Available displays box).
4. Click the **OK** button.

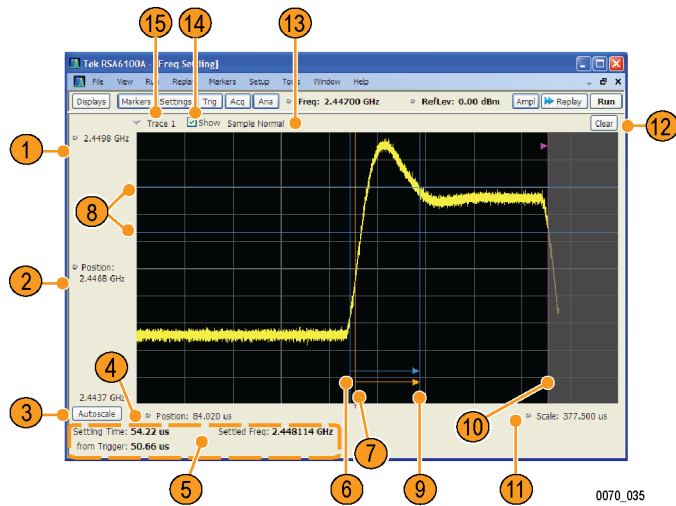

Frequency settling time display

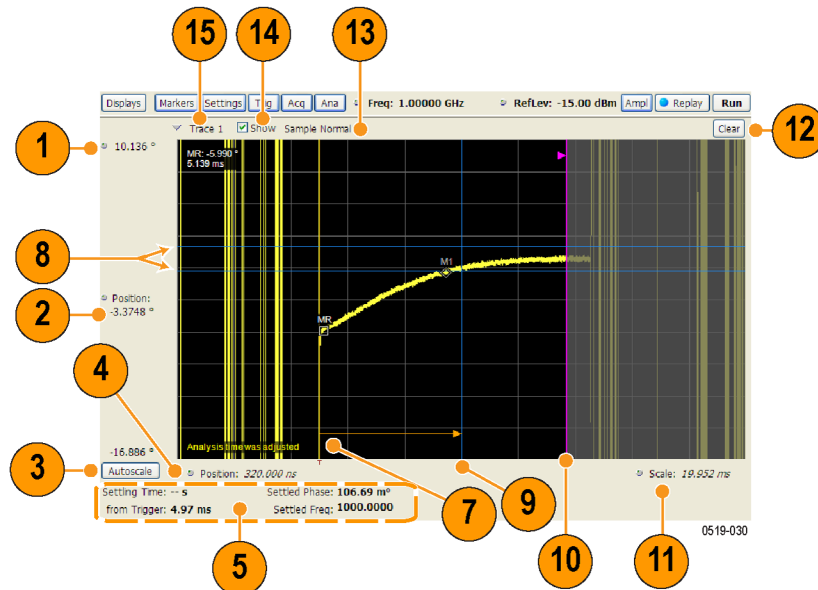

Phase settling time display

Elements of the Display

Item	Display element	Description
1	Top of graph	Sets the frequency/phase that appears at the top of the graph. However, note that the top of graph setting, vertical scale setting (Settings > Scale tab), and Vertical Position settings interact. Adjusting this value changes the frequency/phase at the top of the graph by adjusting the scale setting. Phase Settling Time: Sets
2	Vertical Position	Sets the frequency/phase value at the vertical center of the graph.
3	Autoscale	Adjusts the Vertical and Horizontal scaling to display the entire trace on screen.
4	Horizontal Position	Sets the horizontal position of the trace on the graph.
5	Measurement readouts	Displays measurement results. See <i>Measurement Readout Text Color</i> below.
6	Signal transition start indicator	A blue vertical line that indicates the starting point of the Settling Time measurement that is based on the signal transition away from the previous settled state, if a previous settled state is found within the measurement period.
7	Trigger point indicator	An orange line and "T" (which appears below the graph) that indicates the location of the trigger point in time.
8	+/- Tolerance indicators	A pair of blue horizontal lines that show the tolerance range.
9	Settled time indicator	A blue vertical bar that shows the point on the trace at which the measurement has determined the signal frequency or phase to be settled.
10	Measurement length indicator	A magenta vertical line that specifies the end of the allowed measurement period. This is a control, not a result.
11	Scale	Adjusts the horizontal (time) scale of the graph.
12	Clear	Restarts multi-trace functions (Avg, Hold) and erases the trace.
13	Function	Displays the Detection and Function selections for the selected trace. (Detection is always +/-Peak for Settling Time measurements.)
14	Show	Controls whether the selected Trace is visible or not. When trace is Off, the box is not checked.
15	Trace	Selects a trace. Touching here displays a menu that shows the available traces and whether they are enabled or not. If you select a trace that is not currently enabled, it will be enabled.

Measurement Readout Text Color

The measurement readouts can appear in either black text or red text. Measurement results that appear in black text indicate:

- the signal is settled AND
- the signal is settled longer than the minimum settled duration AND
- the settling time is valid OR the settling time from trigger is valid

If any of the conditions listed are not met, the measurement results text is red.

Elements of the Frequency Settling Time Graph

The following illustration shows the various indicators that appear in the Frequency Settling Time graph.

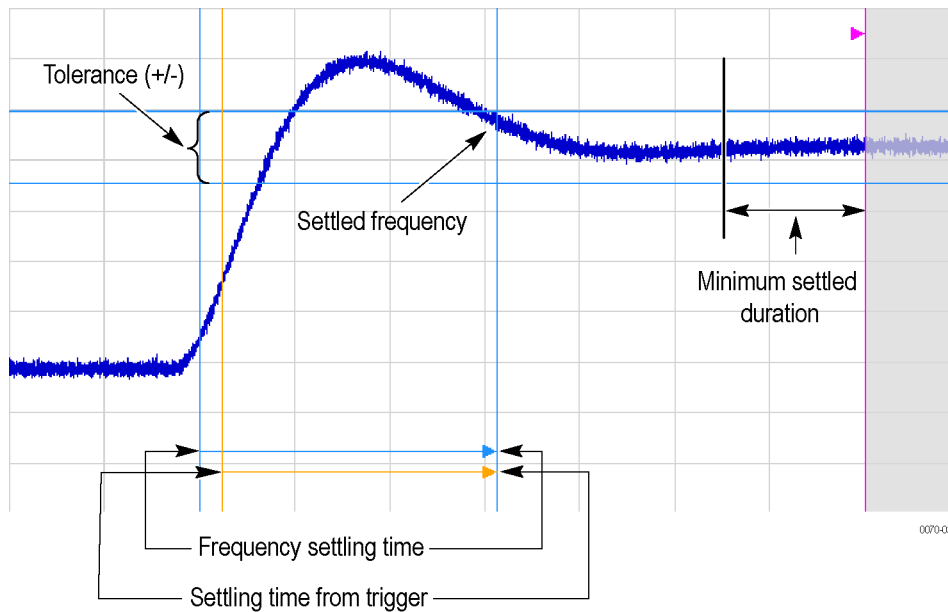

NOTE. The blue vertical bar that indicates the end of the previous settled state may not always appear. For frequency settling time, this can happen because the starting frequency is outside the measurement bandwidth.

Elements of the Phase Settling Time Graph

The following illustration shows the various indicators that appear in the Phase Settling Time graph. For most phase settling time measurements, there is not a previous settled state within the measurement period, making it impossible to measure the settling time from the previous settled value. However, the settling time from trigger is typically available.

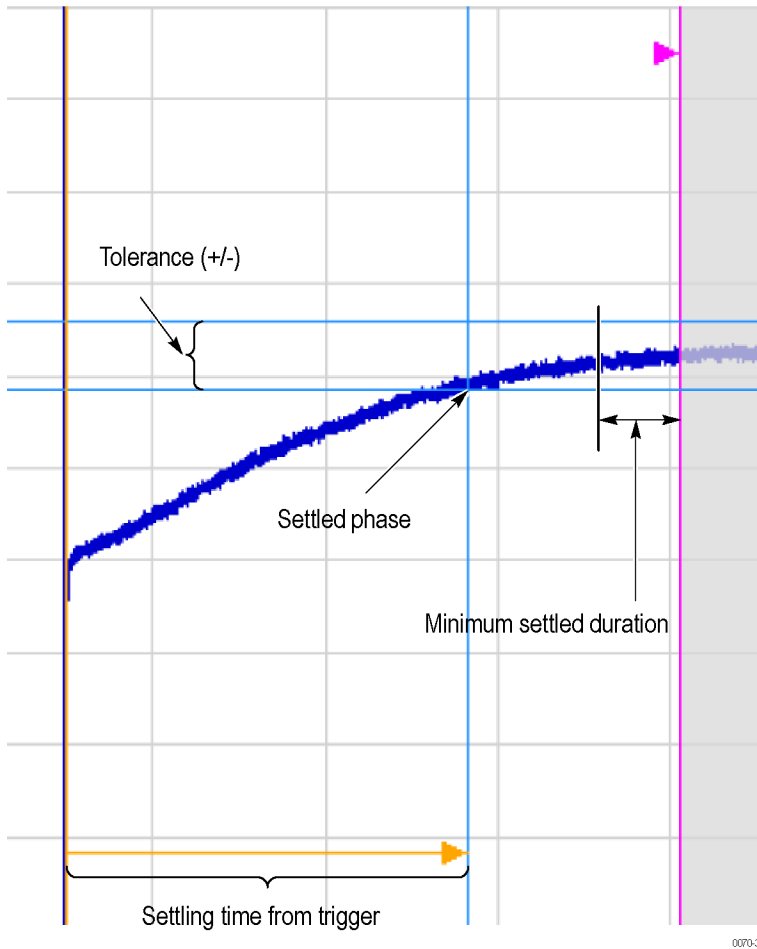

NOTE. The blue vertical bar indicating the measurement start time may not appear. Zero phase is referenced to the measured hop, as the phase will not typically have a settled value during the previous hop.

Measuring Settling Time

1. Select the **Displays** button.
2. Select **RF Measurements** from the **Folders** box.
3. Double-click the **Freq Settling** icon or **Phase Settling** icon in the Available displays box. Click **OK** to complete your selection.
4. Select **General Signal Viewing** from the **Folders** box.
5. Double-click the **Time Overview** icon in the Available displays box. Click **OK** to complete your selection.
6. Press the front-panel **Freq** button and use the front-panel keypad or knob to adjust the frequency to that of the signal you want to measure.

7. Select the Trig button.
8. In the Trigger control panel, select Triggered. Configure the trigger settings as needed to achieve a triggered signal.

For the next step in measuring settling time, you must set the starting point of the measurement. To do this, you will use the Time Overview display.

9. Select the Time Overview display.
10. At the left edge of the graph, drag across the graph to adjust the analysis offset. Adjust the Analysis Offset to locate the start of the settling time measurement just ahead of the signal transition where you want to measure the settling time. Any portion of the signal in the gray area will be excluded from the settling time measurement.

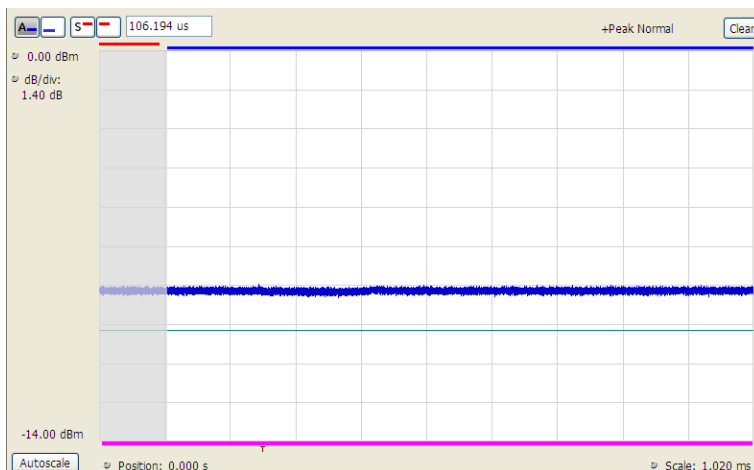

Setting the starting point of the settling time measurement

Even if the signal transition is difficult to see on the Time Overview display, you can set the starting point based on the location of the Trigger indicator below the graph. Or open the Frequency vs. Time graph to see the frequency transition.

11. Click in the Settling Time display to select it.
12. Select the **Settings** button to display the **Settling Time Settings** control panel.
13. On the **Define** tab, adjust the [Meas BW \(see page 202\)](#) to improve the signal-to-noise ratio as appropriate. Make sure the bandwidth covers the settled frequency, particularly when the instrument Measurement Frequency is not locked to the spectrum Center Frequency (Analysis control panel > Frequency tab).
14. Set the [Target reference \(see page 202\)](#) to Auto or Meas freq as appropriate. If you select Meas freq, also set Offset to fine-tune the measurement frequency if necessary.
15. Set the [Tolerance \(see page 202\)](#) as required for your measurement.

If your signal must be settled for a period of time before it is considered settled, you can specify a minimum settled duration for the settling time measurement.

16. Select the Time Params tab. Adjust the [Min settled duration](#) (see page 203) as required.

To get the measurement made in the correct location on the signal, you must adjust the measurement length. You do this by dragging the magenta line in the Settling Time graph.

17. Drag the measurement length indicator (magenta line) to the correct location on the signal. Choose a point at which the signal appears to be well settled. The measurement will then find the exact time at which the signal actually settled to within the specified tolerance.

Note the difference in the settling time in the two illustrations that follow. In both examples, the Target reference is set to Auto. The only difference is the measurement length, as shown by the magenta line.

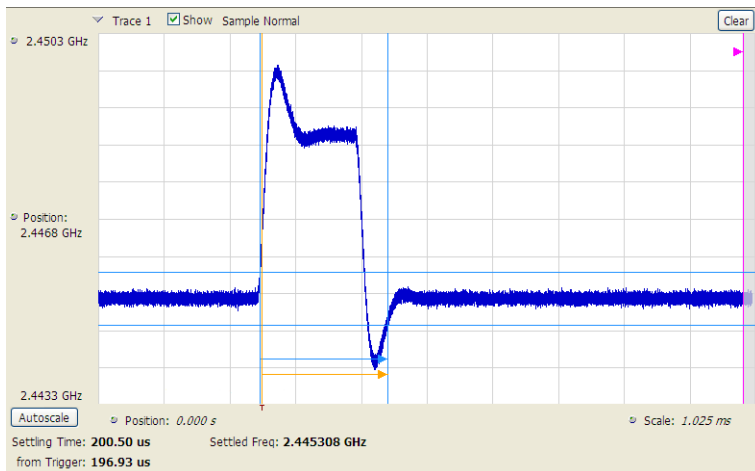

Frequency settling time display before setting the measurement length

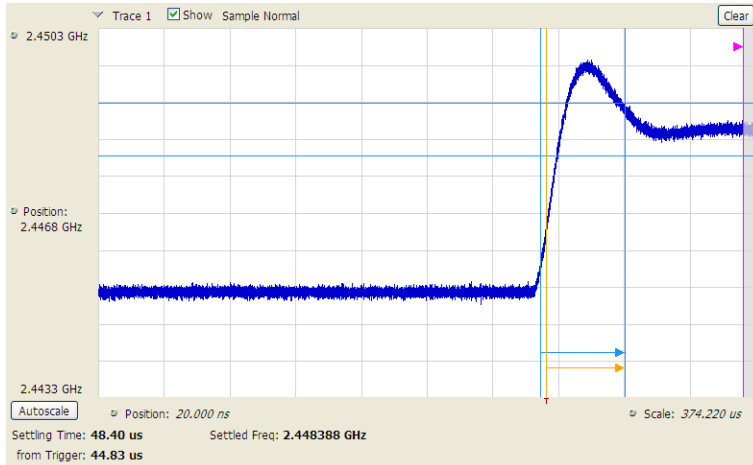

Frequency settling time display after setting the measurement length

Settling Time Settings

Menu Bar: Setup > Settings

Front Panel: Settings

Application Toolbar: 

The control panel tabs for the Phase Noise display are shown in the following table.

The settings for the Frequency and Phase Settling Time displays are shown in the following table.

Settings tab	Description
Define (see page 201)	Sets the measurement parameters that characterize the settling time measurement.
Time Params (see page 203)	Sets measurement end-time and minimum settled duration parameters.
Mask (see page 204)	Enable or disables mask testing and sets the parameters that specify the three zones used for mask testing.
Trace (see page 204)	Specifies trace display characteristics and which traces are displayed.
Scale (see page 224)	Sets vertical and horizontal scale and position parameters.
Prefs (see page 225)	Specifies whether or not to show certain display elements, the maximum number of points in the exported trace, and the displayed precision of the settling time measurement.

Settling Time Displays Shared Measurement Settings

The control panel tabs in this section are shared by the Frequency and Phase Settling Time displays. These control panel tabs are not shared with other RF Measurement displays. With few exceptions, each display shares values for each of the controls on these tabs. For example, Vertical Scale values are independent for each of the displays (degrees for Phase Settling Time and Hertz for Frequency Settling Time).

Common controls for settling time measurement displays

Settings tab	Description
Define (see page 201)	Specifies the parameters that characterize the settling time measurement.
Time Params (see page 203)	Specifies the Measurement length and minimum settled duration for the settling time measurement.
Mask (see page 204)	Specifies the parameters used for Mask testing.
Trace (see page 204)	Specify which traces to show and how they are computed.
Scale (see page 207)	Specifies the vertical and horizontal scale settings.
Prefs (see page 208)	Specifies display parameters of the Settling Time displays.

Define Tab for Settling Time Displays

The Define tab for the Frequency Settling Time measurement controls several parameters that affect how the measurement is made.

The screenshot shows the 'Define' tab selected. The controls are as follows:

- Meas Freq: 2.44700 GHz
- Target reference: Auto
- Offset: 0.0000 Hz
- Meas BW: 40.00 MHz (actual: 40.00 MHz)
- Tolerance (+/-): 500.0 kHz

Meas Freq

Select the frequency of the signal to be measured. Measurement Frequency can be selected as the target frequency (see *Target Reference*).

NOTE. *If Lock Center Frequency of Spectrum Display to Measurement Frequency is unchecked, then Measurement Frequency is independent of Center Frequency) Range: Entire input frequency of the instrument*

Meas BW

Target Reference

The target reference is a calculated or user-specified value of final settled frequency within the measurement period. When set to **Auto**, the instrument determines this value by averaging at least the last 256 samples at the end of the measurement period. When set to **Meas freq**, the Target Reference is set to the Measurement Frequency of the instrument. You can enter a manual offset from the target frequency to fine-tune the Target Reference when **Meas freq** is selected.

Tolerance(+/-)

The Tolerance is the frequency or phase range within which the signal must remain to be considered settled. This is set as a \pm value by the user. In the frequency settling time measurement, the tolerance band is centered about the target value. In the phase settling time measurement, the tolerance band is centered about the settled phase value.

The target frequency depends on the Target reference value setting:

- If Target Reference is set to **AUTO**, then the target value is the settled value (the frequency at which the signal is considered settled).
- If Target Reference is set to **MeasFreq**, then the Target value = **Meas Frequency** + **Offset**.

Offset

Offset is used for fine-tuning the Target Reference when **Meas freq** is selected. The value for Offset is entered manually.

Time Params Tab for Settling Time Displays

The Time Params tab is used to set the Measurement length and minimum settled duration parameters.

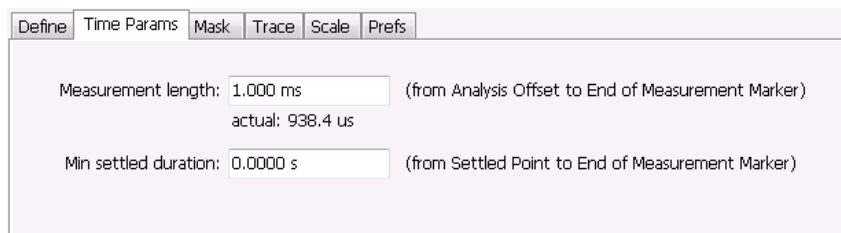

The screenshot shows a software interface with several tabs: Define, Time Params, Mask, Trace, Scale, and Prefs. The 'Time Params' tab is active. It contains two input fields. The first is labeled 'Measurement length:' with a value of '1.000 ms' and a description '(from Analysis Offset to End of Measurement Marker)'. Below this field, the text 'actual: 938.4 us' is displayed. The second input field is labeled 'Min settled duration:' with a value of '0.0000 s' and a description '(from Settled Point to End of Measurement Marker)'.

Measurement Length

Measurement length locates the end of the measurement period for settling time. This value is set independently of the analysis period for other measurements in the analyzer. This allows other measurements to display multiple frequency hops during an analysis, while focusing the settling time analysis on a single hop. You can set the measurement length either by entering a value in the entry box, or by dragging the magenta bar to the desired location in the graph. Traces and the display to the right of the measurement time are shown in grey to indicate that this section of the waveform is not being used in the measurement. If your signal does not settle to within your tolerance band, make sure that the measurement time ends during the settled portion of the waveform. The beginning of the settling time measurement is set with the analysis offset control, the same as other measurements in the instrument. Use analysis offset to exclude earlier hops from the measurement. See [Analysis Time \(see page 349\)](#) for setting the analysis offset control.

If there is more than one phase or frequency hop in the signal to be analyzed, use the Measurement Length control to instruct the analyzer which hop to measure. First, adjust the main Analysis Offset control to a point in time slightly earlier than the transition you wish to measure. Do this in the Time Overview display or the Analysis Settings control panel. Then adjust the Measurement Length so the end of the Settling Time measurement falls within the apparent settled period after the signal transition. The reason it is important for the user to set this control is that the Settling Time measurements start at this point and look backwards in time (towards the signal transition) to find the latest trace point that is not inside the tolerance band.

NOTE. *If your signal does not settle to within your tolerance bands, make sure that the measurement time ends during the settled portion of the waveform.*

Min Settled Duration

The minimum settled duration is the amount of time the signal must remain within the tolerance band to be considered settled. Some user specifications require that the signal be settled for a minimum period. If this is not required in your application, set this value to the default of 0 seconds.

Mask Tab for Settling Time Displays

The Mask tab is used to specify the parameters used for Mask testing.

Enable Mask Test

Enables or disables mask testing.

Start 1, 2, 3

Sets the starting point for the time zone of interest. If you don't want to use all three zones, set the Start Time for the unneeded zones to a time after the end of the Measurement Length.

Stop

Sets the end point for the final time zone of interest.

Limit (+/-)

Sets the mask violation limits for each time zone.

Mask Time Reference

When mask testing is enabled, the Mask time reference selection specifies the starting point of the mask. You can choose to start the mask test at the trigger point or at the point on the trace where the signal began its transition from its previous settled frequency or phase level to the level you intend to measure.

This capability is useful because some applications do not have a trigger signal available. For those situations where a trigger signal is available, the specification for the device-under-test may require that measurements be referenced to that signal.

Trace Tab for Settling Time Displays

The Traces Tab allows you to set the display characteristics of displayed traces.

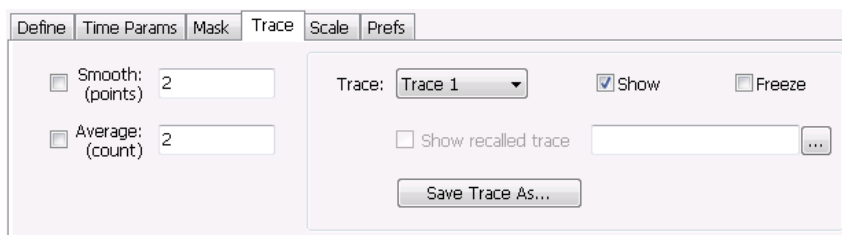

Smooth

Smooth is a low-pass filter function that uses n points in the trace to determine the smoothed value. For example, in the case of $n=3$, 3 consecutive points are averaged to determine the result of the smoothed output. This is very useful for single-shot signals that contain significant noise where multiple trace averages cannot be used. However, smoothing does have limits, and the user should visually determine whether smoothing is removing noise from the measurement, or if it is affecting the signal. The following illustration shows the effect smoothing has on the displayed trace.

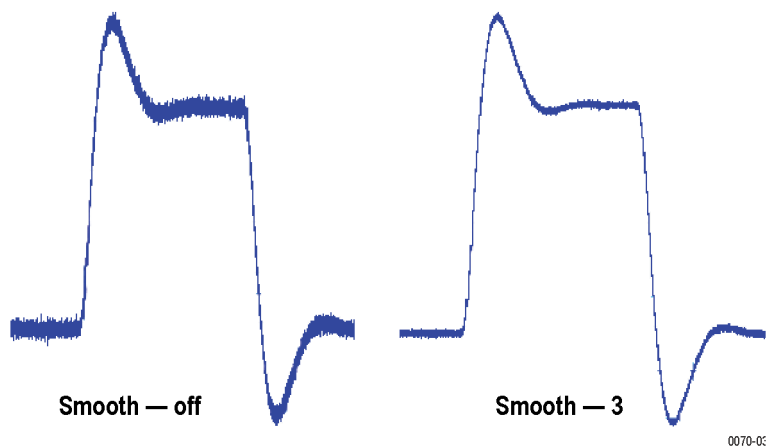

The range for the Smooth function is 2–1000. The setting resolution is 1. The knob increments this value by 1, and the arrow keys increment it in steps of 1, 2, 5, 10. When smoothing is enabled, it applies to both traces. Smooth is turned off by default.

Average

This sets the number of acquisitions to be averaged together to produce the result. Averaging reduces random variations but maintains the correct waveshape for repeating signal aberrations. To use averaging, the signal must be repetitive. For example, the tuning direction must always be same for each measurement

to be averaged. Signals that vary in tuning direction will tend to average positive-going effects with negative-going effects and the settling time characteristics will cancel out.

The range for the Average function is 2–1000. The resolution is 1. When averaging is enabled, it applies to both traces. Average is turned off by default.

Trace

Selects a trace for display. Choices are Trace 1 and 2. Either trace can be a recalled trace.

Saving Traces

To save a trace for later analysis:

1. Select the **Save Trace As** button. This displays the Save As dialog box.

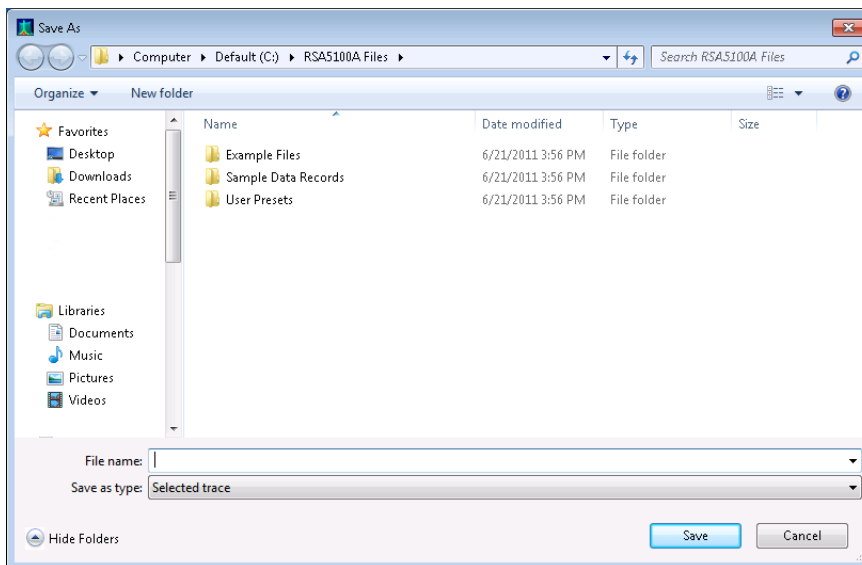

2. Navigate to the desired folder or use the default.
3. Type a name for the saved trace and click **Save**.

Recalling Traces

You can recall a previously saved trace for analysis or comparison to a live trace.

To select a trace for recall:

1. Select the trace into which the recalled trace will be loaded, from the Trace drop-down list.
2. Check the **Show** check box.
3. Click the ... button to display the Open dialog box.

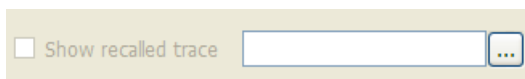

4. Navigate to the desired file and click **Open**.
5. Check the **Show Recalled Trace** check box.
6. Verify that the trace's **Show** check box is selected (either on this tab or next to the drop-down list located at the top-left corner of the graph).

Scale Tab for Settling Time Displays

The Scale tab allows you to change the vertical and horizontal scale settings. Changing the scale settings changes how the trace appears on the display but does not change control settings such as Measurement Frequency. In effect, these controls operate like pan and zoom controls.

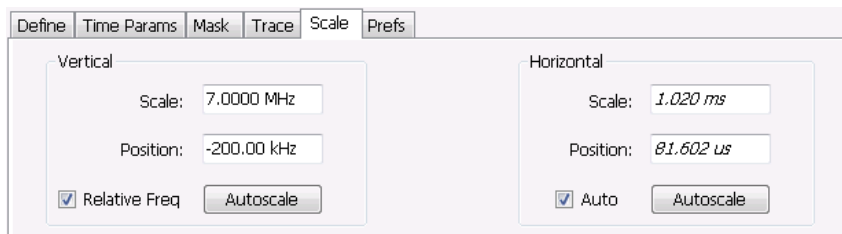

Setting	Description
Vertical	
Scale	Changes the vertical scale or span of the graph.
Position	Sets the frequency (or phase) at the vertical center of the graph.
Relative Freq	Sets the vertical (position) display readouts to show frequency values relative to the center frequency or as absolute values.
Autoscale	Resets the Scale and Position to center the trace in the graph.
Horizontal	
Scale	Sets the range of time shown in the graph.
Position	Allows you to pan the graph left and right.
Autoscale	Resets Scale and Position to the automatically determined settings.

Prefs Tab for Settling Time Displays

The Prefs tab allows you to change display parameters of the Settling Time displays.

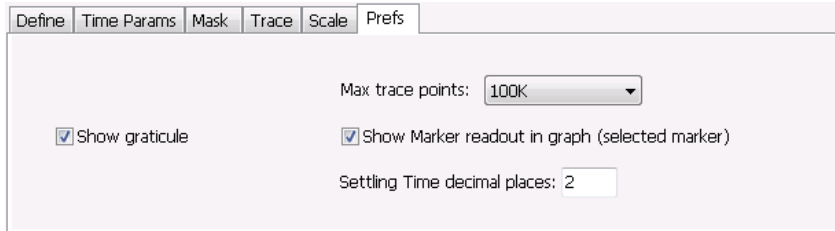

The following table explains the controls that can appear on the Prefs tab.

Setting	Description
Max trace points	Sets the number of trace points used for marker measurements and for results export.
Show graticule	Select to display or hide the graticule.
Show Marker readout in graph (selected marker)	Shows or hides the readout for the selected marker in the graph area.
Settling Time decimal places	Specifies the precision of the settling time measurement readout that appears below the graph. This setting does not affect the precision of internal calculations.

SEM Display

The SEM (Spectrum Emission Mask) display measures out-of-band emissions immediately outside the channel bandwidth that result from the modulation process and non-linearity in the transmitter. The Spectrum Emission Mask display allows you to define up to six pair of masks, or offsets, that specify the limits for out-of-band emissions and performs a pass/fail tests of the signal against the defined offsets and limits.

To show the Spectrum Emission Mask display:

1. Press the **Displays** button or select **Setup > Displays**.
2. In the **Select Displays** dialog, select **RF Measurements** in the **Folders** box.
3. In the Available displays box, double-click the **SEM** icon or select the icon and click **Add**. The SEM icon will appear in the **Selected displays** box and will no longer appear under Available displays.
4. Click **OK** to show the Spectrum Emission Mask display.



Elements of the Display

Item	Display element	Description
1	Check Mark Indicator	Indicates the display for which the acquisition hardware is optimized.
2	Top of graph setting	Sets the level that appears at the top of the graph.
3	dB/div	Sets the vertical scale value. The maximum value is 20.00 dB/division.
4	Bottom-of-graph readout	Indicates the amplitude at the bottom of the graph. This value changes with the dB/div and Vertical Position settings.
5	Autoscale	Adjusts the Vertical and Horizontal scaling to display the entire trace on screen
6	CF / Pos	Default function is CF - center frequency (equivalent to the Measurement Freq setting). If Horizontal scaling has been manually adjusted in Setup > Settings > Scale, then Pos replaces CF as the setting at the bottom-left corner of the screen. Adjusting Pos shifts the trace left or right in the graph, but does not change the measurement frequency.
7	Span / Scale	Default function is Span - frequency difference between the left edge of the display and the right edge. If Horizontal scaling has been manually adjusted in Settings > Scale, then Scale will replace Span as the setting at the bottom-right corner of the screen.
8	Clear	Erases the current results from the display.
9	Function readout	Readout of the Function selection for the Reference channel (Setup > Processing > Function).
10	Detection readout	Readout of the Detection selection for the Reference channel (Setup > Processing > Detection).
11	Pass / Fail readout	Readout indicating whether any part of the trace has exceeded the any of the limits defined in the Offsets & Limits table (Setup > Settings > Offsets & Limits Table).

Pass / Fail Readout

This readout displays either **Pass** or **Fail XX%**. When the signal exceeds the mask in any offset, it is considered a mask violation, and results in **Fail XX%** being displayed. If there are no mask violations, **Pass** is displayed.

How the fail percentage is determined. Each offset has two sides, one lower and one upper. For example, Offset A has two sides: AL (lower side) and AU (upper side). In the SEM display, there is a maximum of six offsets (A-F) and each offset can have a maximum of two sides (if Both is selected for Side in the Offsets & Limits table). This results in a total of six offsets multiplied by two sides per offset, which results in 12 offsets. Mask violations can occur in any of these offsets. The failure percentage is calculated as follows:

$$\text{Fail percentage} = \text{Number of offsets with mask violations} \times 100 / \text{Total number of enabled offsets}$$

For example: Assume there are three enabled offsets: A, B, C, and all these offsets have both lower and upper sides. Thus, the total number of enabled offsets is equal to six. Suppose there are mask violations in the offsets AL and CU, then the number of offsets having mask violations is equal to 2. Therefore, Fail percentage = 2 * 100 / 6 = 33%.

Results Display

The Results Display shows the measurement results for the SEM display.

Ref: Total Power	Row	Offset	Start Freq	Stop Freq	Peak Abs (dBm)	Margin Abs (dB)	Peak Rel (dBc)	Margin Rel (dB)	@Freq	Integ Abs (dBm)
-16.93 dBm	1	EL	-12.500 MHz	-8.000 MHz	-73.83	-62.33	-91.81	--	-8.010000 MHz	-68.44
	2	DL	-8.000 MHz	-4.000 MHz	-73.17	-61.67	-91.16	--	-7.460000 MHz	-67.61
	3	CL	-4.000 MHz	-3.515 MHz	-67.63	-63.13	-105.62	--	-3.965444 MHz	-77.11
	4	BL	-3.515 MHz	-2.715 MHz	-67.77	-75.17	-105.76	--	-2.722000 MHz	-75.14
	5	AL	-2.715 MHz	-2.515 MHz	-70.18	-57.68	-88.16	--	-2.515000 MHz	-70.74
	6	AU	2.515 MHz	2.715 MHz	-70.73	-58.23	-87.67	--	2.515000 MHz	-70.54
	7	BU	2.715 MHz	3.515 MHz	-67.66	-67.24	-104.59	--	3.243000 MHz	-74.72
	8	CU	3.515 MHz	4.000 MHz	-68.01	-63.51	-106	--	3.976356 MHz	-77.04

Readout

Description

Ref:	A two-part readout to the left of the table that displays information about the Reference Channel. The first part of the readout displays the Measurement Type selected on the Parameters tab. The second part of the readout displays the measurement result for the Reference channel.
Row	A sequence number for ordering the offsets. Click to organize by row number, resort rows from high to low or low to high.
Offset	The Offset name. A combination of the offset (A-F) and the location (U for upper and L for Lower).
Start Freq	The start frequency of the offset (relative to the Measurement Freq).
Stop Freq	The stop frequency of the offset (relative to the Measurement Freq).
Peak Abs	Absolute power peak power at worst case margin of the offset
Margin Abs	The worst case difference between the trace and the absolute limit line. Note that an offset can have different start and stop levels, thus, the margin can vary if the offset start and stop levels are different.
Peak Rel	Relative peak power of worst case margin of the offset. Relative with respect to the reference power level.
Margin Rel	The worst-case difference between the trace and the relative limit line. Because an offset can have different start and stop levels, the margin can vary if the offset start and stop levels are different.
@Freq	The frequency at which the worst margin occurs.
Integ Abs	The absolute integrated power of the offset.
Integ Rel	The relative integrated power of the offset (with respect to the reference power).

Reordering results in the results table. You can sort the results in the Results table by clicking the column heading containing the values you want to sort on. You can sort results for the following columns: Row, Offset, Start Frequency, Stop Frequency, Peak Abs, and Peak Rel.

Rearranging columns in the results table. You can rearrange the order of the columns and their size. To rearrange columns, select the column heading you want to move and drag it to the new position; the new location is indicated by a dark blue bar that appears between column headings.

You can resize the columns by selecting the divider between columns and dragging it to a new position.

Spectrum Emission Mask Settings

Front Panel: Settings

Application Toolbar:

The settings for the Spectrum Emission Mask display are visible when SEM is the selected display. To display the SEM Settings, select **Setup > Settings**.

Settings tab	Description
Parameters Tab (see page 212)	Specifies several characteristics that control how the measurement is made.
Processing Tab (see page 213)	Specifies settings for detection on the Reference channel and the offsets. Specifies the function setting.
Ref Channel Tab (see page 214)	Specifies how the measurements on the reference channel are performed.
Offsets & Limits Table (see page 214)	Specifies characteristics of offsets and mask limits.
Scale Tab (see page 217)	Specifies the vertical and horizontal scale settings.
Prefs Tab (see page 218)	Specifies the appearance features of the graph area and the maximum trace points.
Standard settings	Displays Select Standard dialog window to enable you to load settings for three standards: 3GPP Downlink, WLAN 802.11g, and WiMax 802.16 (ETSI).

Standard Settings

Selecting one of the standard settings loads factory-defined settings appropriate to the selected standard. In each case, one specific SEM definition is used. There may be many SEM definitions in any given standard. Check the SEM definition for your test against the standards-based reference documents. The following table describes the standards on which the standard settings are based.

Setting	Description
3GPP Downlink	3GPP 25.141 (Release 9), BS Maximum output power $P \geq 43$ dBm
WLAN 802.11g	IEEE Std 802.11 - 2007, 20 MHz Channel spacing
WiMax 802.16 (ETSI)	ETSI EN 301-021, 10 MHz Channel spacing, System Type G

Parameters Tab – SEM

The Parameters tab specifies several characteristics that control how the Spectrum Emission Mask measurements are made.

The screenshot shows the 'Parameters' tab with the following settings:

- Meas Freq: 1.500000 GHz
- Step: 1.000000 MHz
- Auto:
- Measurement Type: Total Power
- Offset definition: Ref Edge to OS center
- Filter shape: Gaussian

Setting	Description
Meas Freq	Specify the frequency of the signal to be measured.
Step	Sets the increment size when changing the Frequency using the knob or mouse wheel.
Auto	When Auto is enabled, the step size is adjusted automatically based on the span setting.
Measurement Type	Specifies the type of measurement for the reference channel; used as a reference for the offsets.
Total Power	Sets the reference to the integrated power of the reference channel within the reference's integration bandwidth.
PSD	Sets the reference to the mean of the power spectral density (dBm/Hz) of the reference channel. The trace and the absolute and relative limits line are also in dBm/Hz
Peak	Sets the reference to the Peak power of the reference channel.
Offset definition	Defines the relative position of the start/stop frequency of an offset. Choose the offset definition based on the standard.
Ref center to OS center	Specifies that the start/stop frequencies are defined from the center frequency of the reference channel to the center of the filter BW.
Ref center to OS edge	Specifies that the start/stop frequencies are defined from the center frequency of the reference channel to the center of the (inner) edge of the filter BW of the offset.
Ref Edge to OS center	Specifies that the start/stop frequencies are defined from the edge of the reference channel to the center of the filter BW of the offset.
Ref Edge to OS edge	Specifies that the start/stop frequencies are defined from the edge of the reference channel to the (inner) edge of the filter BW of the offset.
Filter Shape	Specifies the shape of the filter determined by the window that is applied to the data record, in the spectrum analysis, to reduce spectral leakage. 3GPP specifies a Gaussian window shape be applied to the reference channel measurements.
Gaussian	This filter shape provides optimal localization in the frequency domain.
Rectangular	This filter shape provides the best frequency, worst magnitude resolution. This is essentially the same as no window.

Processing Tab – SEM

The Processing tab controls the Detection settings for the Reference Channel and Offsets, as well as selecting the Function.

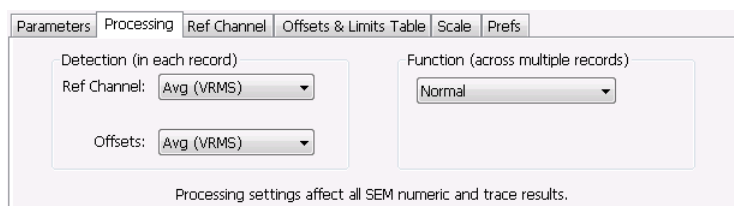

Settings tab	Description
Detection (in each sweep)	
Ref Channel	Specifies the Detection method used for the Reference Channel. Detection is used to produce the desired measurement result (peak or average) and to reduce the results of a measurement to the desired number of trace points.
Avg (VRMS)	For each sweep, each point of the trace is the result of determining the RMS voltage value for the last 'n counts' of the collected traces for the same point. When 'n count' has not been reached, partial averaging results are displayed.
+Peak	Selects the +Peak detection method. With this method, the highest value is selected from the results to be compressed into a trace point.
Offsets	Specifies the detection method used for the offsets.
Avg (VRMS)	Selects the Average Vrms detection method. With this method, each point on the trace in each offset is the result of determining the RMS Voltage value for all of the results values it includes.
+Peak	Selects the +Peak detection method. With this method, the highest value in each offset is selected from the results to be compressed into a trace point.
Function (across multiple sweeps)	
Function	Selects the trace processing method. Available settings are: Normal, Avg (VRMS), and Hold.
Normal	When a new trace has been computed, it replaces the previous trace.
Max Hold	With each sweep, each trace point in the new trace is compared to the point's value in the old trace and the greater value is retained for display and subsequent comparisons.
Avg (VRMS)	For each sweep, each point on the trace is the result of determining the RMS Voltage value for all of the collected traces' values for the same point.

Ref Channel Tab

The Ref Channel tab controls how the measurement of the Reference channel is performed.

Parameters	Processing	Ref Channel	Offsets & Limits Table	Scale	Prefs
Power Reference:	-10.02 dBm	<input checked="" type="checkbox"/> Auto	Channel width:	8.500 MHz	Channel Filter:
RBW:	100.000 kHz		Integration BW:	2.125 MHz	Filter param:
<input checked="" type="checkbox"/> VBW:	30.000 kHz				Chip rate:
					0.220
					3.84 MHz

Settings tab

Description

Power Reference	The value used to calculate relative measurements.
Auto	When Auto is unchecked, you can enter a value for the reference power, and the measured reference power is not used or displayed
RBW	Sets the RBW for the Reference Channel.
VBW	Enables/disables the Video Bandwidth filter. VBW is used in traditional swept analyzers to reduce the effect of noise on the displayed signal. The VBW algorithm in the analyzer emulates the VBW filters of traditional swept analyzers. When the checkbox next to VBW is not checked, the VBW filter is not applied. SEM standards specify what value of VBW should be applied, if any.
Channel width	Specifies the width of the reference channel.
Integration BW	Specifies the integration bandwidth used to compute the total power in the reference channel.
Channel Filter	Specifies the measurement filter used in the Reference Channel. Choices are None and Root-raised Cosine.
Filter param	Specifies the alpha value (or roll-off factor) of the Root-raised cosine filter. Present only when Channel Filter is set to Root-raised Cosine.
Chip rate	Specifies the chip rate used for the Root-raised Cosine filter. Present only when Channel Filter is set to Root-raised Cosine.

Offsets & Limits Table Tab – SEM

The Offsets & Limits Table tab is used to specify parameters that define Offsets and masks.

	On	Start (Hz)	Stop (Hz)	Side	RBW (Hz)	n (RBWs)	Filter BW (n x RBW)	VBW (Hz)	VBW On	Mask
▶ A	<input checked="" type="checkbox"/>	9.000000M	11.000000M	Both	100.000k	1	100.000k	30.000k	<input checked="" type="checkbox"/>	Rel
B	<input checked="" type="checkbox"/>	11.000000M	20.000000M	Both	100.000k	1	100.000k	30.000k	<input checked="" type="checkbox"/>	Rel
C	<input checked="" type="checkbox"/>	20.000000M	30.000000M	Both	100.000k	1	100.000k	30.000k	<input checked="" type="checkbox"/>	Rel
D	<input checked="" type="checkbox"/>	30.000000M	50.000000M	Both	100.000k	1	100.000k	30.000k	<input checked="" type="checkbox"/>	Rel
E	<input checked="" type="checkbox"/>	50.000000M	100.000000M	Both	100.000k	1	100.000k	30.000k	<input checked="" type="checkbox"/>	Rel
F	<input checked="" type="checkbox"/>	100.000000M	150.000000M	Both	100.000k	1	100.000k	30.000k	<input checked="" type="checkbox"/>	Rel

Expanded display of Offsets & Limits Table

Setting	Description
Buttons	
Expand	Displays the Offsets & Limits Table in a new, resizable window.
Reset Layout	You can reorder columns in the Offsets & Limits Table by dragging the columns to a new position. Clicking Reset Layout returns the column order to the factory default order.
Load	Click to load a saved Offsets & Limits table from a file.
Save As	Click to save the current Offsets & Limits table to a file.
Done	When the table is expanded, click Done when you have finished editing the table to save your changes and close the expanded table display.
Table columns	
On	Specifies whether or not measurements are taken in the specified offset.
Start (Hz)	Start Frequency of the selected offset.
Stop (Hz)	Stop Frequency of the selected offset.
Side	Specifies whether the specified range appears on both side of the carrier frequency or just one side (left or right).
RBW (Hz)	Specifies the RBW for the selected range.
n (RBWS)	An integer value that specifies how many times to multiply the RBW to set the Filter bandwidth.
Filter BW (n x RBW)	Displays the Filter BW. Filter BW is the equivalent BW of each point in the offset. When $n > 1$, an integration technique is used to achieve the Filter BW using narrower RBWs. For most SEM measurements, this value is set to 1. The 3GPP standard suggests n greater than 1.
VBW (Hz)	Adjusts the VBW (Video Bandwidth) value. VBW Maximum: RBW current value; VBW Minimum: 1/10,000 RBW setting.
VBW On	Specifies whether the VBW filter is applied.
Mask	Select the type of limits used for Pass/Fail testing. Signal excursions that exceed the mask settings are considered violations. The available choices are shown below.
Abs Start (dBm)	Specifies the mask level at the inner edge of the selected offset.
Abs Stop (dBm)	Specifies the mask level at the outer edge of the selected offset.
Abs Same	Specifies whether the value for the inner and outer edges of the offset must be the same value. When enabled, the Abs Stop cell is grayed-out and set to the value of the Abs Start cell.
Rel Start (dBm)	Specifies the mask level for the Relative mask at the inner edge of the selected offset.
Rel Stop (dBm)	Specifies the mask level for the Relative mask at the outer edge of the selected offset.
Rel Same	Specifies whether the inner and outer edges of the offset must be the same value. When enabled, the Rel Stop cell is grayed-out and its value is set to the value of the Rel Start cell.

Scale Tab – SEM

Use the Scale tab to change the vertical and horizontal scale settings. Changing the scale settings changes how the trace appears on the display. In effect, these controls operate like pan and zoom controls.

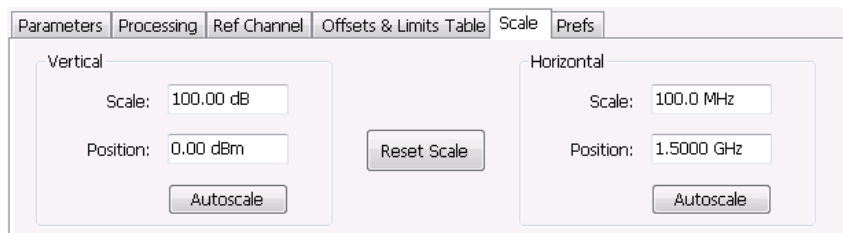

Setting	Description
Vertical	Controls the vertical position and scale of the trace display.
Scale	Changes the vertical scale units.
Position	Adjusts the reference level away from top of the graph.
Autoscale	Resets the scale of the vertical axis to contain the complete trace.
Horizontal	Controls the span of the trace display and position of the trace.
Scale	Specifies the frequency range displayed in the graph
Position	Specifies the frequency shown at the center of the graph.
Autoscale	Resets the scale of the horizontal axis to optimize the display of the trace.
Reset Scale	Resets all settings to their default values.

Prefs Tab – SEM

The Prefs tab enables you to change parameters of the measurement display. The parameters available on the Prefs tab vary depending on the selected display, but include such items as enabling/disabling Marker Readout, switching the Graticule display on/off, and Marker Noise mode. Some parameters appear with most displays while others appear with only one display.

The screenshot shows the 'Prefs' tab interface with the following settings:

- Max Trace points: 801 (per range)
- Show graticule
- Show Marker readout in graph (selected marker)
- Show limits: Line only

Setting	Description
Show graticule	Controls the vertical position and scale of the trace display.
Max Trace points (per range)	When the spectrum analysis produces more than the selected maximum number of points, the method specified in Detection control is used to decimate the result. This setting applies to both the Reference channel and offsets.
Show Marker readout in graph	Adjusts the reference level away from top of the graph.
Show limits	Controls the appearance of mask limits in the graph.
Shaded	Shows limits using a shaded area. Green shading is used to identify Absolute limits. Blue shading is used to indicate Relative limits.
Line only	Shows limits using only a line. A green line is used to identify Absolute limits. A blue line is used to indicate Relative limits.
None	No lines or shading are used to indicate limits in the graph. Violations of the mask are still identified by red shading.

RF Measurements Shared Measurement Settings

The control panel tabs in this section are shared by multiple displays in the RF Measurement folder (Setup > Displays). With few exceptions, each display maintains separate values for each of the controls on these tabs. For example, Scale values are independent for each of the displays.

Common controls for RF measurement displays

Settings tab	Description
Freq & RBW (see page 219)	Allows you to specify the Center Frequency, Step size and RBW.
Traces (see page 220)	Specifies trace parameters such as detection method and whether smoothing is enabled. Traces can also be saved and loaded for reference from this tab.
Scale (see page 224)	Specify vertical and horizontal scale settings.
Prefs (see page 225)	Specify appearance features of the graph area.

Freq & RBW Tab

The Freq & RBW tab specifies frequency parameters for some of the RF Measurements displays.

The screenshot shows the 'Freq & RBW' tab interface. It includes the following controls:

- Meas Freq:** 1.00000 GHz
- RBW:** 30.000 kHz
- Auto:**
- Step:** 2.0000 MHz
- Auto:**
- VBW:**

Setting	Description
Meas Freq	Specifies the measurement frequency.
Step	The Step control sets the increment/decrement size for the knob adjustment of the center frequency. Arrow key adjustment of frequency is also affected (it is 10x the knob adjustment). If Auto is enabled, the analyzer will adjust the Step size as required.
RBW	Select Auto or Manual. Adjusts the RBW for the entire measurement. This setting is Independent of the Spectrum view's RBW setting.
VBW	Adjusts the VBW (Video Bandwidth) value.

NOTE. While the measurement frequency and step settings on this control tab are shared between ACPR, MCPR and Occupied Bandwidth, the RBW setting is not shared. The RBW setting is unique for each measurement.

VBW

The VBW setting enables/disables the Video Bandwidth filter. VBW is used in traditional swept analyzers to reduce the effect of noise on the displayed signal. The VBW algorithm in the analyzer emulates the VBW filters of traditional swept analyzers.

The maximum VBW value is the current RBW setting. The minimum VBW value is 1/10,000 of the RBW setting.

Traces Tab

The Traces tab enables you to select traces for display. You can choose to display live traces and/or recalled traces. The [Trace tab \(see page 204\)](#) for Settling Time displays is described in the Settling Time controls section.

NOTE. *Not all RF Measurements support multiple traces and/or save and recall of traces.*



Setting	Description
Trace	Selects a trace for display. Choices are Trace 1, 2, and Gaussian (CCDF display only). Trace 1 and 2 can be recalled traces.
Show	Shows / hides the selected trace.
Freeze	Halts updates to the selected trace.
Save Trace As	Saves the selected trace to a file for later recall and analysis.
Show recalled trace	Used to select a saved trace for display.
Detection (Phase Noise only)	Sets the Detector used for the trace. Only +/- Peak and Avg (VRMS) are available for the Phase Noise display. This setting is not available for saved traces. +/-Peak detection results in a trace with two Y values for each X location, with shading between.
Function	Selects the trace processing method (Spurious display only). Possible settings are: Normal, Average (VRMS), Avg (of logs), and Max Hold.
Smoothing (Phase Noise only)	When enabled, diminishes point-to-point trace variations. Smoothing +/- Peak traces treats + and - lines independently. The smoothing value adjusts how many points are in each filter set. Range: 1 - 20; Default: 5.

Detection

Trace Detection occurs when the trace is being decimated by the measurement. For example, if the maximum number of trace points is 100,000, and the selected analysis region is 200,000 samples, the measurement must decimate the 200,000 resulting trace points by 2 to prevent exceeding the 100,000 trace point limit. Since only one value can be selected for each trace point, an algorithm must be used to select (detect) the appropriate value to use.

The IQ samples in a data acquisition can be detected in a variety of ways. The number of IQ samples available to each trace point varies with both analysis length and trace length. For example, with Spectrum Length set to 'Auto' in the Analysis menu, the instrument analyzes just enough samples to produce one

IQ sample pair per trace point. In this case, the detection method chosen has very little effect, as the +Peak, -Peak, Avg (VRMS) and Sample values are all equal. Changing the Spectrum Length causes the available detection methods to differ in value because they have a larger set of samples for the various detection methods to process.

The available detection methods (depending on the display) are:

- **+/-Peak** – Selects the highest and lowest values of all the samples contained in an acquisition interval.
- **Avg (VRMS)** [Average V_{RMS}] – Each point on the trace is the result of determining the RMS Voltage value for all of the IQ samples available to the trace point. When displayed in either linear (Volts, Watts) or Log (dB, dBm), the correct RMS value results. When the averaging function is applied to a trace, the averaging is performed on the linear (Voltage) values, resulting in the correct average for RMS values.

Trace Processing

The trace can be processed to display in different ways. The Function setting controls trace processing.

- **Max Hold** - Displays the maximum value in the trace record for each display point. Each new trace display point is compared to the previous maximum value and the greater value is retained for display and subsequent comparisons.
- **Normal** - Displays the trace record for each display point without additional processing.
- **Avg (VRMS)** [Average V_{RMS}] – Each point on the trace is the result of determining the RMS Voltage value for all of the IQ samples available to the trace point. When displayed in either linear (Volts, Watts) or Log (dB, dBm), the correct RMS value results. When the averaging function is applied to a trace, the averaging is performed on the linear (Voltage) values, resulting in the correct average for RMS values.
- **Avg (of logs)** – This is a trace function used to emulate legacy spectrum analyzer results and for the specification of displayed average noise level. In older swept analyzers, a voltage envelope detector is used in the process of measuring signal level, and the result is then converted to Watts and then to dBm. Averaging is then applied to the resultant traces.

For CW signals, this method results in an accurate power measurement. However, with random noise and digitally modulated carriers, errors result from this 'average of logs' method. For random noise, the average of logs methods results in power levels -2.51 dB lower than that measured with a power meter, or with a spectrum analyzer that measures the rms value of a signal, and performs averaging on the calculated power in Watts and not dBm or other log-power units.

This detector should be used when following a measurement procedure that specifies it, or when checking the Displayed Averaged Noise Level (DANL) of the instrument. The 'average of logs' detection and trace function is used for DANL specification to provide similar results to other spectrum/signal analyzers for comparison purposes. Use of the Average of Logs method of measurement is not recommended for digitally modulated carriers, as power measurement errors will occur.

NOTE. *The Detection setting does not affect the trace until the spectrum length is longer than the Auto setting.*

Saving Traces

To save a trace for later analysis:

1. Select the **Save Trace As** button. This displays the Save As dialog box.

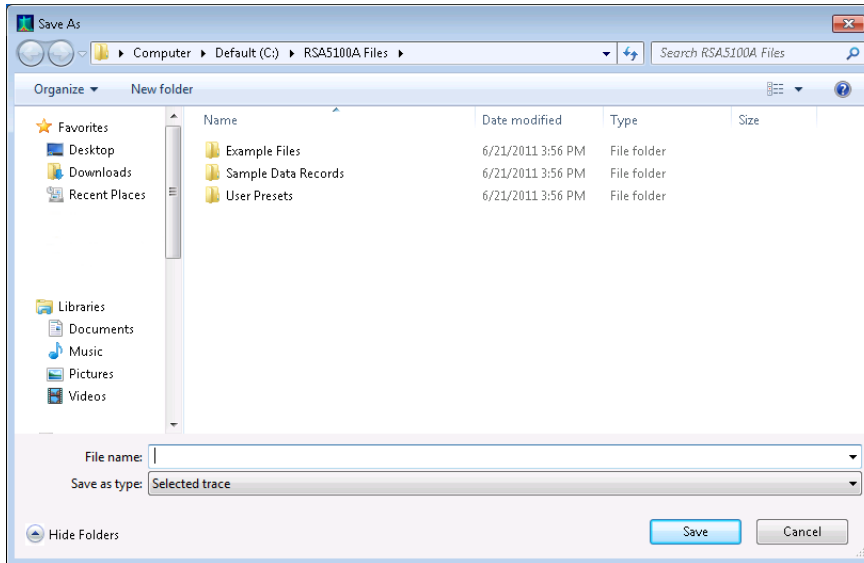

2. Navigate to the desired folder or use the default.
3. Type a name for the saved trace and click **Save**.

Recalling Traces

You can recall a previously saved trace for analysis or comparison to a live trace.

To select a trace for recall:

1. Select the trace into which the recalled trace will be loaded, from the Trace drop-down list.
2. Check the **Show** check box.
3. Click the ... button to display the Open dialog box.

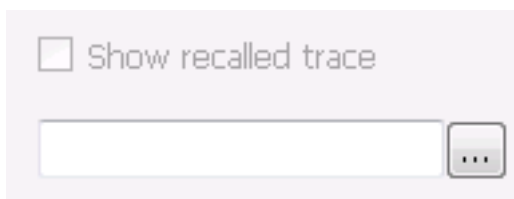

1. Navigate to the desired file and click **Open**.
2. Check the **Show Recalled Trace** check box.
3. Verify that the trace's **Show** check box is selected (either on this tab or next to the drop-down list located at the top-left corner of the graph).

Gaussian Trace

The Gaussian trace is a reference trace that you can compare your trace against. Because the Gaussian trace is for reference, there are no settings for the trace other than whether or not it is shown.

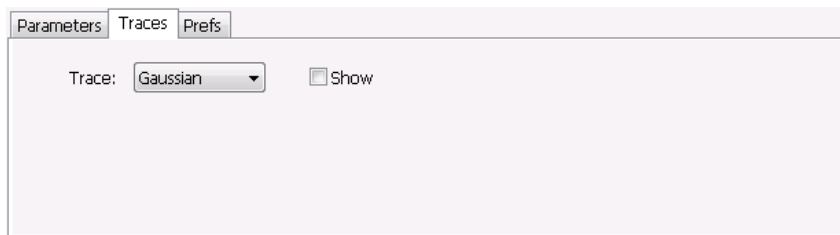

Scale Tab

The Scale tab allows you to change the vertical and horizontal scale settings. Changing the scale settings changes how the trace appears on the display but does not change control settings such as Center Frequency.

The screenshot shows the 'Scale' tab in a software interface. It has a tabbed menu at the top with 'Scale' selected. The interface is divided into two main sections: 'Vertical' and 'Horizontal'.
 In the 'Vertical' section, there is a 'Scale' input field set to '100.00 dB', a 'Position' input field set to '0.00 dBm', and an 'Autoscale' button. A 'Reset Scale' button is located between the two sections.
 In the 'Horizontal' section, there is a 'Scale' input field set to '39.00 MHz', a 'Position' input field set to '1.50000 GHz', and an 'Autoscale' button.

Setting	Description
Vertical	Controls the vertical position and scale of the trace display.
Scale	Changes the vertical scale units. This is only accessible when the vertical units are set to dBm.
Offset	Adjusts the Reference Level away from the top of the trace display.
Autoscale	Resets the scale of the vertical axis to contain the complete trace.
Horizontal	Controls the span of the trace display and position of the trace.
Scale	Allows you to, in effect, change the span.
Offset	Allows you to pan a zoomed trace without changing the Measurement Frequency. Offset is only enabled when the span, as specified by Freq / div, is less than the acquisition bandwidth.
Autoscale	Resets the scale of the horizontal axis to contain the complete trace.
Log (Spurious only)	Resets the display to show the frequency axis in a logarithmic scale.

Prefs Tab

The Prefs tab enables you to change parameters of the measurement display. The parameters available on the Prefs tab vary depending on the selected display, but include such items as enabling/disabling Marker Readout, switching the Graticule display on/off, and Marker Noise mode. Some parameters appear with most displays while others appear with only one display.

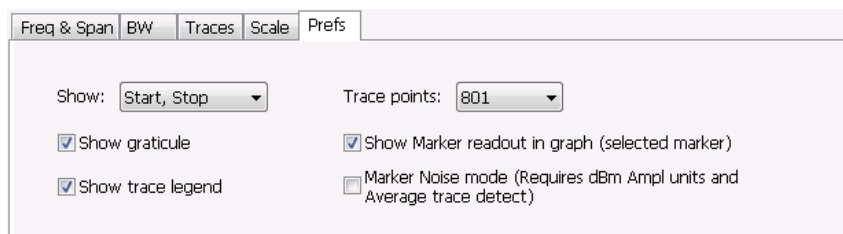

Setting	Description
Show graticule	Shows or hides the graticule.
Show Marker readout in graph (selected marker)	Shows or hides the readout for the selected marker in the graph area.
Show power levels in graph	Shows or hides the Channel Power readout in the graph.
Max trace points	In general, time-domain traces can include up to 100K points and frequency-domain traces can include up to 10K points. When the analysis produces a results array longer than the selected trace length, the trace is decimated (using the method specified with the Detection control) to be equal to or less than the Max trace points setting (except when Max trace points is set to Never Decimate). This decimated (or undecimated) trace is what is used for marker measurements and for results export.
Settling Time decimal places (Frequency and Phase Settling Time displays only)	Specifies the number of decimal places shown in the results readout below the graph. This setting does not affect the precision of internal calculations.
Show trace legend (Phase Noise display only)	Displays or hides the trace legend.

Overview

The OFDM Analysis option provides measurements for OFDM signals specified by 802.11a/g/j (Wifi) and 802.16 (ETSI) (commonly known as Fixed WiMAX) standards. User controls allow you to modify signal parameters for analysis of non-standard signals. The analysis results give multiple views of OFDM signal characteristics to allow diagnosing signal imperfections and impairments quickly and easily. Display controls provide the ability to selectively display the analysis results to help locate trouble-spots in the signal.

The displays in the OFDM Measurements folder (Displays > Folders > OFDM Measurements) are:

- OFDM Channel Response
- OFDM Constellation
- OFDM EVM
- OFDM Mag Error
- OFDM Phase Error
- OFDM Power
- OFDM Summary
- OFDM Symbol Table

OFDM Channel Response Display

The OFDM Channel Response display plots the channel response (magnitude or phase) versus the subcarrier or frequency.

To show the OFDM Channel Response display:

1. Press the **Displays** button or select **Setup > Displays**.
2. In the **Select Displays** dialog, select **OFDM Analysis** in the **Folders** box.
3. In the Available displays box, double-click the **OFDM Chan Response** icon or select the icon and click **Add**. The OFDM Chan Response icon will appear in the **Selected displays** box and will no longer appear under Available displays.
4. Click **OK** to show the OFDM Chan Response display.
5. Set the Frequency appropriate for the signal.
6. Select **Setup > Settings** to display the control panel.
7. Select the Modulation Params tab. Set the Standard, Guard Interval and Spacing and Bandwidth controls as appropriate for the input signal.

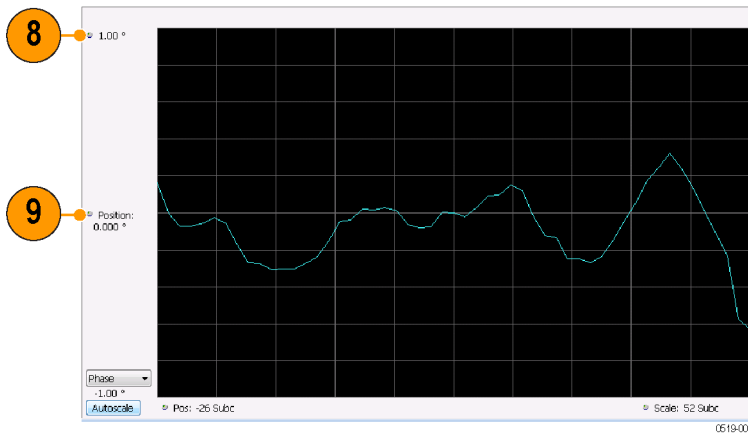
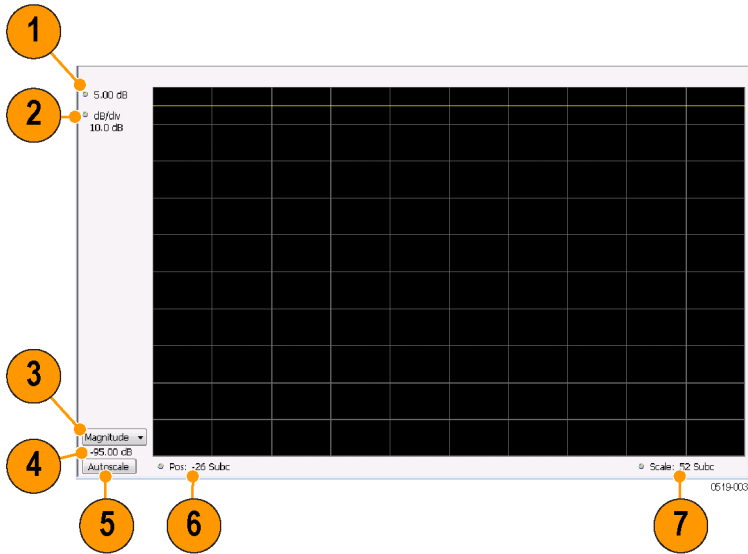

Elements of the Display

Item	Display element	Description
1	Top-of-graph (magnitude)	Sets the level that appears at the top of the magnitude graph. This is only a visual control for panning the graph. The Reference Level is adjusted in the Toolbar and the Ampl control panel. By default, Vert Position = Ref Level.
2	dB/div (magnitude)	Sets the vertical scale value. The maximum value is 20.00 dB/division.
3	Display selector	Selects the display type. Channel Response Magnitude or Phase can be displayed as a Magnitude or Phase graph.
4	Bottom-of-graph readout (magnitude)	Indicates the amplitude at the bottom of the graph. This value changes with the dB/div and Vertical Position settings.
5	Autoscale	Adjusts the Vertical and Horizontal scaling to display the optimize the trace display on screen.
6	Pos	Shifts the trace left or right in the graph. The readout indicates the subcarrier or frequency shown at the left edge of the display.
7	Scale	Specifies the number of subcarriers shown in the graph.
8	Top-of-graph (phase)	Sets the phase value indicated at the top of the graph. Since the Position value at the vertical center of this graph remains constant as the Top of Graph value is adjusted, the Vertical Scale increases as the Top of Graph value increases, which also affects the bottom of graph readout.
9	Position (phase)	Specifies the phase shown at the center of the graph display. Changing this value moves the trace up and down in the graph, which affects the Top of Graph and Bottom of Graph values as well.
10	Bottom-of-graph (phase)	Indicates the phase at the bottom of the graph. This value changes with the Position setting.

OFDM Channel Response Settings

The OFDM Channel Response Settings control panel provides access to settings that control parameters of the Channel Response Display.

Settings tab	Description
Modulation Params (see page 244)	Specifies the input signal standard and additional user-settable signal parameters.
Advanced Params (see page 245)	Specifies parameters used by the instrument to analyze the input signal.
Data Range Tab (see page 246)	Specifies which symbols and subcarriers of the signal to display.
Analysis Time Tab (see page 246)	Specifies parameters that define the portion of the acquisition record that is used for analysis. Also allows you to specify the time units (Symbols or Seconds) for OFDM Analysis displays.
Prefs Tab (see page 250)	Specifies the units of the display and whether elements of the graphs are displayed.

OFDM Constellation Display

Display shows the OFDM signal subcarriers' amplitude and phase in IQ constellation form.

To show the OFDM Constellation display:

1. Press the **Displays** button or select **Setup > Displays**.
2. In the **Select Displays** dialog, select **OFDM Constellation** in the **Folders** box.
3. In the Available displays box, double-click the **OFDM Constellation** icon or select the icon and click **Add**. The OFDM Constellation icon will appear in the **Selected displays** box and will no longer appear under Available displays.
4. Click **OK** to show the OFDM Constellation display.
5. Set the **Frequency** appropriate for the signal.
6. Select **Setup > Settings** to display the control panel.
7. Select the **Modulation Params** tab. Set the Standard, Guard Interval and Spacing and Bandwidth controls as appropriate for the input signal.

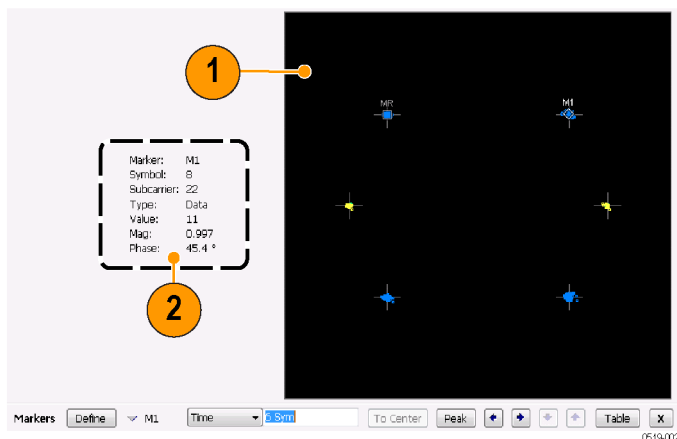

Elements of the Display

Item	Display element	Description
1	Plot	Constellation graph.
2	Marker Readout	If markers are enabled, the marker readout shows the selected Marker, Symbol, Subcarrier, Type, Value, Magnitude, and Phase for the symbol at the marker location. Located to the left of the constellation plot or below it, depending on the size of the window.

OFDM Constellation Settings

Front Panel: Settings

Application Toolbar:

The OFDM Constellation Settings control panel provides access to settings that control parameters of the Constellation Display.

Settings tab	Description
Modulation Params (see page 244)	Specifies the input signal standard and additional user-settable signal parameters.
Advanced Params (see page 245)	Specifies parameters used by the instrument to analyze the input signal.
Data Range (see page 246)	Specifies which symbols and subcarriers of the signal to display.
Analysis Time Tab (see page 246)	Specifies parameters that define the portion of the acquisition record that is used for analysis. Also allows you to specify the Units (Symbols or Seconds) for OFDM Analysis displays.
Trace (see page 248)	Enables you to freeze the display or hide the measurement or average trace.
Scale Tab (see page 248)	Specifies the Zoom scale, and vertical and horizontal positions of the display.
Prefs Tab (see page 250)	Specifies the units of the display and whether elements of the graphs are displayed.

OFDM EVM Display

The OFDM EVM display shows the data symbols' individual subcarrier Error Vector Magnitude values versus symbol interval (time) and subcarrier (frequency).

To show the OFDM EVM display:

1. Press the **Displays** button or select **Setup > Displays**.
2. In the **Select Displays** dialog, select **OFDM EVM** in the **Folders** box.
3. In the Available displays box, double-click the **OFDM EVM** icon or select the icon and click **Add**. The OFDM EVM icon will appear in the **Selected displays** box and will no longer appear under Available displays.

4. Click **OK** to show the OFDM EVM display.
5. Set the **Frequency** appropriate for the signal.
6. Select **Setup > Settings** to display the control panel.
7. Select the **Modulation Params** tab. Set the Standard as appropriate. Set the Standard, Guard Interval and Spacing and Bandwidth controls as appropriate for the input signal.

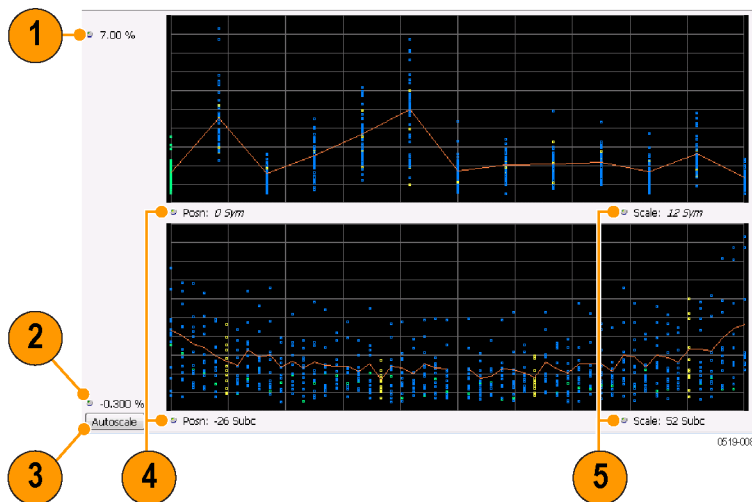

Elements of the Display

Item	Display element	Description
1	Top of graph	Sets the EVM value that appears at the top of the graph. This is only a visual control for panning the graph.
2	Bottom of graph	Sets the EVM value that appears at the bottom of the graph. This is only a visual control for panning the graph.
3	Autoscale	Adjusts the vertical and horizontal settings to provide the best display.
4	Pos	Specifies the horizontal position of the trace on the graph display.
5	Scale	Adjusts the horizontal range of the graph. By decreasing the scale, the graph essentially becomes a window that you can move over the analysis results by adjusting the position.

OFDM EVM Settings

Front Panel: Settings

Application Toolbar:

The settings for the OFDM EVM display are shown in the following table.

Settings tab	Description
Modulation Params (see page 244)	Specifies the type of modulation used for the input signal and other parameters.
Advanced Params (see page 245)	Specifies parameters used by the instrument to analyze the input signal.
Data Range (see page 246)	Specifies which symbols and subcarriers of the signal to display.
Analysis Time (see page 246)	Specifies parameters that define the portion of the acquisition record that is used for analysis. Also allows you to specify the Units (Symbols or Seconds) for OFDM Analysis displays.
Trace (see page 248)	Enables you to freeze the display or hide the measurement or average trace.
Scale (see page 248)	Specifies the vertical, subcarrier, and symbols scale and position settings.
Prefs (see page 250)	Specifies the units of the display and whether elements of the graphs are displayed.

OFDM Magnitude Error Display

The OFDM Mag Error display shows the data symbols' individual subcarrier Magnitude Error values versus symbol interval (time) and subcarrier (frequency).

To show the OFDM Magnitude Error display:

1. Press the **Displays** button or select **Setup > Displays**.
2. In the **Select Displays** dialog, select **OFDM Analysis** in the **Folders** box.
3. In the Available displays box, double-click the **OFDM Mag Error** icon or select the icon and click **Add**. The OFDM Mag Error icon will appear in the **Selected displays** box and will no longer appear under Available displays.
4. Click **OK** to show the OFDM Mag Error display.
5. Set the **Frequency** appropriate for the signal.
6. Select **Setup > Settings** to display the control panel.
7. Select the **Modulation Params** tab. Set the Standard, Guard Interval and Spacing and Bandwidth controls as appropriate for the input signal.

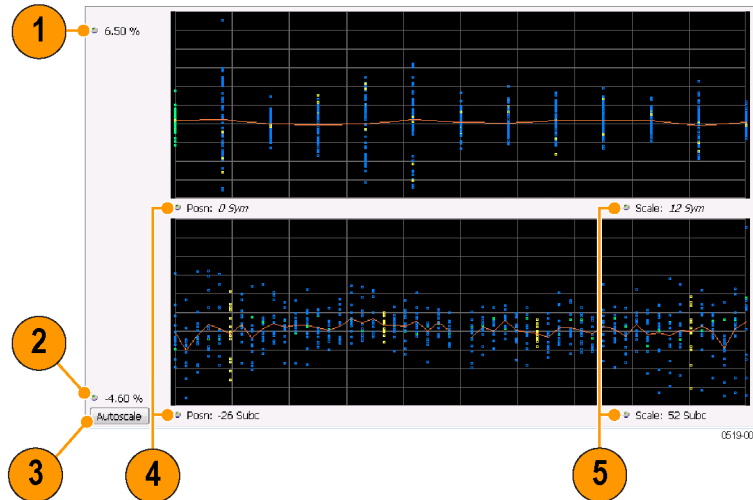

Elements of the Display

Item	Display element	Description
1	Top of graph	Sets the Magnitude Error value that appears at the top of the graph. This is only a visual control for panning the graph.
2	Bottom of graph	Sets the Magnitude Error value that appears at the bottom of the graph. This is only a visual control for panning the graph.
3	Autoscale	Adjusts the vertical and horizontal settings to provide the best display.
4	Pos	Specifies the horizontal position of the trace on the graph display.
5	Scale	Adjusts the horizontal range of the graph. By decreasing the scale, the graph essentially becomes a window that you can move over the analysis results by adjusting the position.

OFDM Magnitude Error Settings

Front Panel: Settings

Application Toolbar:

The settings for the OFDM Mag Error display are shown in the following table.

Settings tab	Description
Modulation Params (see page 244)	Specifies the type of modulation used for the input signal and other parameters.
Advanced Params (see page 245)	Specifies parameters used by the instrument to analyze the input signal.
Data Range (see page 246)	Specifies which symbols and subcarriers of the signal to display.
Analysis Time Tab (see page 246)	Specifies parameters that define the portion of the acquisition record that is used for analysis. Also allows you to specify the Units (Symbols or Seconds) for OFDM Analysis displays.
Trace (see page 248)	Enables you to display or hide the measurement or average trace.
Scale Tab (see page 248)	Specifies the vertical, subcarrier, and symbols scale and position settings.
Prefs Tab (see page 250)	Specifies the units of the display and whether elements of the graphs are displayed.

OFDM Phase Error Display

The OFDM Phase Error display shows the data symbols' individual subcarrier Phase Error values versus symbol interval (time) and subcarrier (frequency).

To show the OFDM Phase Error display:

1. Press the **Displays** button or select **Setup > Displays**.
2. In the **Select Displays** dialog, select **OFDM Analysis** in the **Folders** box.
3. In the Available displays box, double-click the **OFDM Phase Error** icon or select the icon and click **Add**. The OFDM Phase Error icon will appear in the **Selected displays** box and will no longer appear under Available displays.
4. Click **OK** to show the OFDM Phase Error display.
5. Set the **Frequency** appropriate for the signal.
6. Select **Setup > Settings** to display the control panel.
7. Select the **Modulation Params** tab. Set the Standard, Guard Interval and Spacing and Bandwidth controls as appropriate for the input signal.

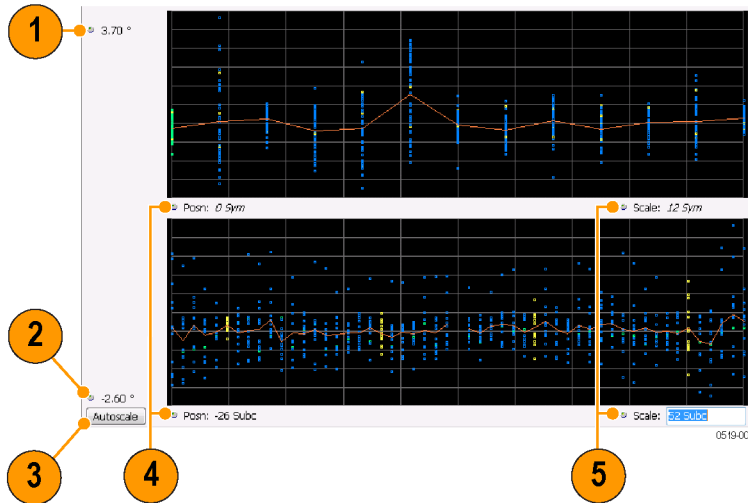

Elements of the Display

Item	Display element	Description
1	Top of graph	Sets the Phase Error value that appears at the top of the graph. This is only a visual control for panning the graph.
2	Bottom of graph	Sets the Phase Error value that appears at the bottom of the graph. This is only a visual control for panning the graph.
3	Autoscale	Adjusts the vertical and horizontal settings to provide the best display.
4	Pos	Specifies the horizontal position of the trace on the graph display.
5	Scale	Adjusts the horizontal range of the graph. By decreasing the scale, the graph essentially becomes a window that you can move over the analysis results by adjusting the position.

OFDM Phase Error Settings

Front Panel: Settings

Application Toolbar:

The settings for the OFDM Phase Error display are shown in the following table.

Settings tab	Description
Modulation Params (see page 244)	Specifies the type of modulation used for the input signal and other parameters.
Advanced Params (see page 245)	Specifies parameters used by the instrument to analyze the input signal.
Data Range (see page 246)	Specifies which symbols and subcarriers of the signal to display.
Analysis Time Tab (see page 246)	Specifies parameters that define the portion of the acquisition record that is used for analysis. Also allows you to specify the Units (Symbols or Seconds) for OFDM Analysis displays.
Trace (see page 248)	Enables you to display or hide the measurement or average trace.
Scale Tab (see page 248)	Specifies the vertical, subcarrier, and symbols scale and position settings.
Prefs Tab (see page 250)	Specifies the units of the display and whether elements of the graphs are displayed.

OFDM Power Display

The OFDM Power display shows the data symbols' individual subcarrier Power values versus symbol interval (time) and subcarrier (frequency).

To show the OFDM Power display:

1. Press the **Displays** button or select **Setup > Displays**.
2. In the **Select Displays** dialog, select **OFDM Analysis** in the **Folders** box.
3. In the Available displays box, double-click the **OFDM Power** icon or select the icon and click **Add**. The OFDM Power icon will appear in the **Selected displays** box and will no longer appear under Available displays.
4. Click **OK** to show the OFDM Power display.
5. Set the **Frequency** appropriate for the signal.
6. Select **Setup > Settings** to display the control panel.
7. Select the **Modulation Params** tab. Set the Standard, Guard Interval and Spacing and Bandwidth controls as appropriate for the input signal.

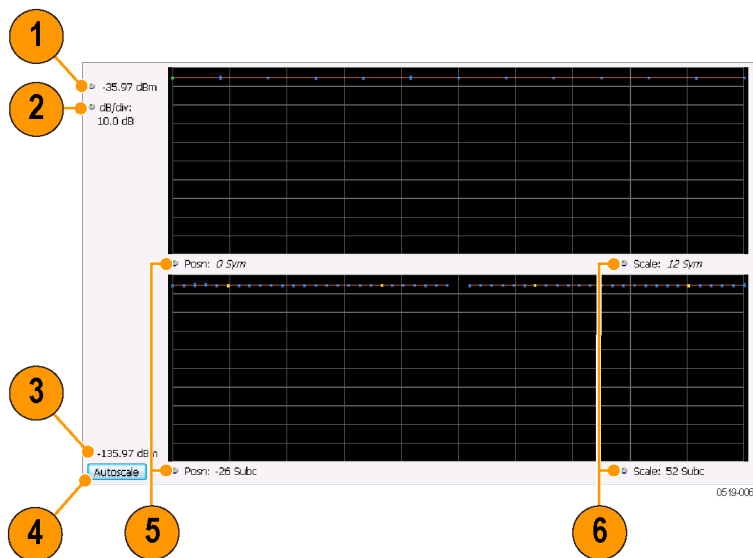

Elements of the Display

Item	Display element	Description
1	Vertical Position	Sets the top of graph value. This is only a visual control for panning the graph. The Reference Level is adjusted in the Toolbar and the Ampl control panel. By default, Vert Position = Ref Level.
2	dB/div	Sets the vertical scale value. The maximum value is 20.00 dB/division.
2	Bottom of graph readout	Indicates the amplitude at the bottom of the graph. This value changes with the dB/div and Vertical Position settings.
3	Autoscale	Adjusts the vertical and horizontal settings to provide the best display.
4	Pos	Specifies the horizontal position of the trace on the graph display.
5	Scale	Adjusts the horizontal range of the graph. By decreasing the scale, the graph essentially becomes a window that you can move over the analysis results by adjusting the position.

OFDM Power Settings

Front Panel: Settings

Application Toolbar:

The settings for the OFDM Power display are shown in the following table.

Settings tab	Description
Modulation Params (see page 244)	Specifies the type of modulation used for the input signal and other parameters.
Advanced Params (see page 245)	Specifies parameters used by the instrument to analyze the input signal.
Data Range (see page 246)	Specifies which symbols and subcarriers of the signal to display.
Analysis Time (see page 246)	Specifies parameters that define the portion of the acquisition record that is used for analysis. Also allows you to specify the Units (Symbols or Seconds) for OFDM Analysis displays.
Trace (see page 248)	Enables you to display or hide the measurement or average trace.
Scale (see page 248)	Specifies the vertical, subcarrier, and symbols scale and position settings.
Prefs (see page 250)	Specifies the units of the display and whether elements of the graphs are displayed.

OFDM Summary Display

The OFDM Summary display shows several measurements of OFDM signal quality.

To show the OFDM Summary display:

1. Press the **Displays** button or select **Setup > Displays**.
2. In the **Select Displays** dialog, select **OFDM Analysis** in the **Folders** box.
3. In the Available displays box, double-click the **OFDM Summary** icon or select the icon and click **Add**. The OFDM Summary icon will appear in the **Selected displays** box and will no longer appear under Available displays.
4. Click **OK** to show the OFDM Summary display.
5. Set the **Frequency** appropriate for the signal.
6. Select **Setup > Settings** to display the control panel.
7. Select the **Modulation Params** tab. Set the Standard, Guard Interval and Spacing and Bandwidth controls as appropriate for the input signal.

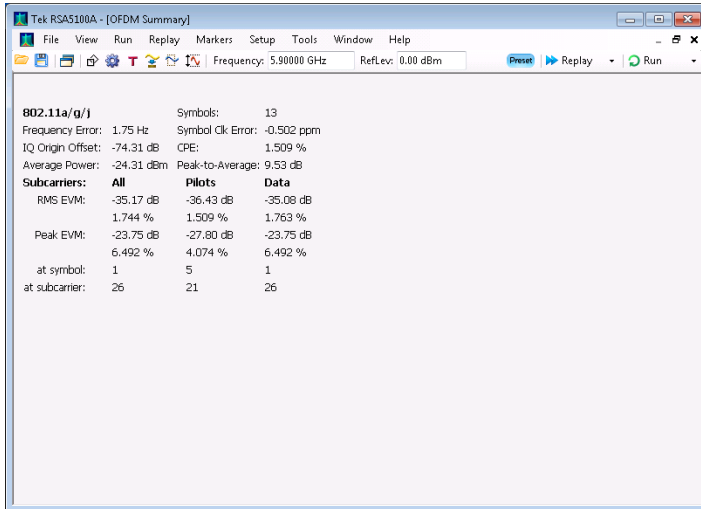

Elements of the Display

Measurement	Description
Standard	Display of the standard selected on the Setup > Settings > Modulation Params tab.
Frequency Error	The frequency difference between the measured carrier frequency of the signal and the measurement frequency setting.
IQ Origin Offset	The average magnitude of the DC subcarrier level relative to total signal power. It indicates the level of carrier feedthrough detected at the center (DC) subcarrier.
Average Power	The average power of all symbols in the analysis. Calculated over only the data symbols in the packet.
Symbols	How many symbols were analyzed.
Symbol Clk Error	The symbol clock error in parts per million.
CPE	CPE, Common Pilot Error, is the RMS magnitude error of the pilots over all analyzed symbols.
Peak-to-Average	The ratio of the highest instantaneous signal power level to the average signal power. Calculated over only the data symbols in the packet.
EVM	The RMS and Peak values of the normalized subcarrier Error Vector Magnitude values. The normalized subcarrier EVM values are calculated as the difference between the detected received signal subcarrier constellation points and ideal reference points estimated by the instrument from the received signal. Values are reported in units of percent and dB. Peak values include the symbol and subcarrier location. RMS and Peak values are displayed for groupings of all subcarriers, Pilots only and Data only. Results are calculated over the entire signal packet analyzed, covering the number of Symbols indicated in the Summary display.

OFDM Summary Settings

Front Panel: Settings

Application Toolbar:

The settings for the OFDM Summary display are shown in the following table.

Settings tab	Description
Modulation Params (see page 244)	Specifies the type of modulation used for the input signal and other parameters.
Advanced Params (see page 245)	Specifies parameters used by the instrument to analyze the input signal.
Data Range (see page 246)	Specifies which symbols and subcarriers of the signal to display.
Analysis Time (see page 246)	Specifies parameters that define the portion of the acquisition record that is used for analysis. Also allows you to specify the Units (Symbols or Seconds) for OFDM Analysis displays.
Prefs (see page 250)	Specifies the units of the display and whether elements of the graphs are displayed.

OFDM Symbol Table Display

The OFDM Symbol Table display shows decoded data bits for each subcarrier in each symbol in the analyzed signal packet. Results are presented with subcarrier (frequency) indices in the horizontal dimension and symbol (time) intervals in the vertical dimension.

To show the OFDM Symbol Table display:

1. Press the **Displays** button or select **Setup > Displays**.
2. In the **Select Displays** dialog, select **OFDM Analysis** in the **Folders** box.
3. In the Available displays box, double-click the **OFDM Symb Table** icon or select the icon and click **Add**. The OFDM Symbol icon will appear in the **Selected displays** box and will no longer appear under Available displays.
4. Click **OK** to show the OFDM Symbol Table display.
5. Set the **Frequency** appropriate for the signal.
6. Select **Setup > Settings** to display the control panel.
7. Select the **Modulation Params** tab. Set the Standard, Guard Interval and Spacing and Bandwidth controls as appropriate for the input signal.

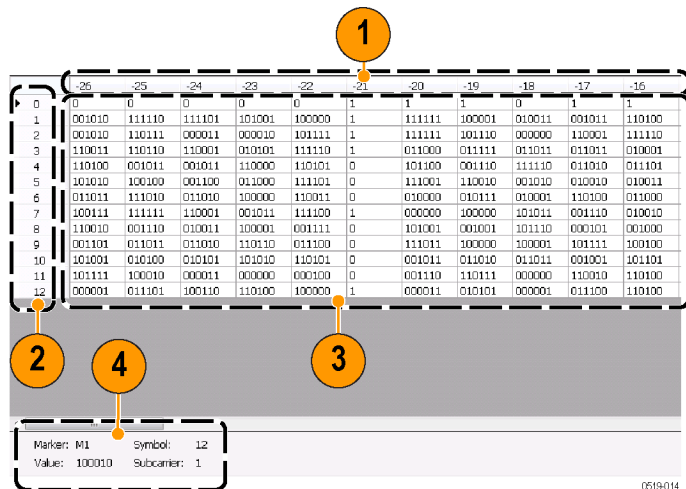

Item	Description
1	Subcarrier identifiers.
2	Symbol identifiers.

(cont.)

Item	Description
3	Subcarrier data values.
4	Marker readout when markers are enabled.

OFDM Symbol Table Settings

Front Panel: Settings

Application Toolbar:

The settings for the OFDM Symbol Table display are shown in the following table.

Settings tab	Description
Modulation Params (see page 244)	Specifies the type of modulation used for the input signal and other parameters.
Advanced Params (see page 245)	Specifies parameters used by the instrument to analyze the input signal.
Data Range (see page 246)	Specifies which symbols and subcarriers of the signal to display.
Analysis Time (see page 246)	Specifies parameters that define the portion of the acquisition record that is used for analysis. Also allows you to specify the Units (Symbols or Seconds) for OFDM Analysis displays.
Prefs (see page 250)	Specifies the units of the display and whether elements of the graphs are displayed.

OFDM Analysis Shared Measurement Settings

Front Panel: Settings

Application Toolbar:

The control panel tabs in this section are shared between the displays in the OFDM Analysis folder (Setup > Displays). Some tabs are shared by all the displays, some tabs are shared by only a couple of displays. The settings available on some tabs change depending on the selected display.

Common controls for OFDM analysis displays

Settings tab	Description
Modulation Params (see page 244)	Specifies the type of modulation used for the input signal and other parameters.
Advanced Params (see page 245)	Specifies parameters used by the instrument to analyze the input signal.
Data Range (see page 246)	Specifies which symbols and subcarriers of the signal to display.
Analysis Time (see page 246)	Specifies parameters that define the portion of the acquisition record that is used for analysis. Also allows you to specify the Units (Symbols or Seconds) for OFDM Analysis displays.
Trace (see page 248)	Enables you to display or hide the measurement or average trace.
Scale (see page 248)	Specifies the vertical, subcarrier, and symbols scale and position settings.
Prefs (see page 250)	Specifies the units of the display and whether elements of the graphs are displayed.

Modulation Params Tab – OFDM

The Modulation Params tab specifies the type of modulation used by the input signal and other parameters that control the demodulation of the input signal.

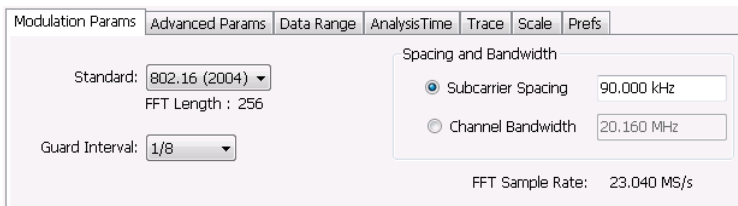

Settings	Description
Standard	Specifies the standard used for the input signal. Choices are 802.11a/g/j and 802.16 (ETSI).
Guard Interval	Specifies the guard interval used in the input signal. Choices are 1/4, 1/8, 1/16, 1/32, and User. When you select User, you can enter a percentage value to specify the size of the guard interval as a percentage of the useful symbol interval. The Guard Interval range is 0–100%.
Spacing and Bandwidth	Specifies the spacing between subcarriers and the nominal channel bandwidth. Only one of these settings can be set at a time, the other setting is automatically calculated.
Sample Rate	Indicates the FFT sample rate, based on the bandwidth or subcarrier setting.

Advanced Params Tab – OFDM

The Advanced Params tab contains parameters that control the analysis of the input signal.

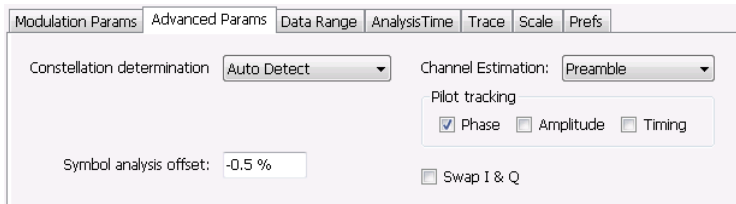

Settings	Description
Constellation determination	Specifies the method used to detect the constellation. Automatic analyzes the signal to determine the appropriate constellation, Manual allows you to specify the constellation type. Manual choices are: BPSK, QPSK, 16QAM, and 64QAM.
Symbol analysis offset	Specifies the analysis offset in the symbol interval. This value is a percentage of the Guard Interval. The allowable range is -100% to 0%. -100% positions the FFT to start at the beginning of the Guard Interval, 0% positions it to start at the end of the Guard Interval. Default value is -50% which usually gives the best measurement results.
Channel Estimation	Specifies the method used to estimate channel frequency response and equalization. This control can be used to diagnose changes in frequency response over the signal packet.
Preamble	When you select Preamble, the instrument uses only the Preamble to estimate channel frequency response. This response is then used to equalize the entire signal packet.
Preamble + Data	When you select Preamble + Data, the instrument makes an initial channel frequency response estimate from the Preamble. Then estimates the channel response for each data symbol using the decoded data content to derive equalization for each symbol individually. This allows compensation for time-varying channel response over the packet.
Pilot tracking	Specifies if pilot subcarriers should be used to correct amplitude, phase, and symbol timing variations over the packet. The choices available are Phase, Amplitude, and Timing. The default setting is Phase.
Swap I & Q	Select the checkbox to swap the I and Q components of a signal. This compensates the input signal for spectral inversion.

Data Range Tab – OFDM

The Data Range tab enables you to control how much signal is analyzed, as well as specify the range of results that are displayed in the Constellation, EVM, Magnitude Error, Phase Error, Power and Symbol Table graphs.

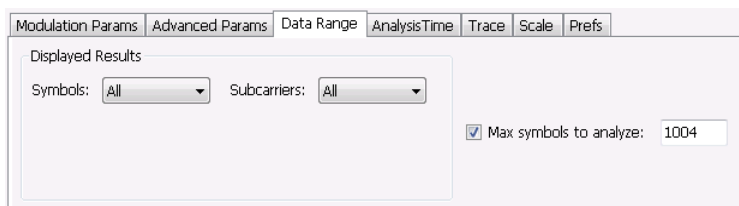

Settings	Description
Symbols	Specifies which symbols are displayed in the graphs.
All	Select All to display all symbols.
Range	Select Range to specify a subset of symbols for display.
Start	Specifies the first symbol to include in the display.
Number	Specifies how many symbols to display in the graphs.
Single	Select Single to display a single symbol.
Index	Use Index to specify the symbol you want to display.
Subcarriers	Specifies which subcarriers are displayed.
All	Select All to display all subcarriers in the signal.
Pilots Only	Select Pilot to display only pilot subcarriers.
Data Only	Select Data to display only data subcarriers.
Single	Specifies a specific subcarrier for display.
Index	Specifies the specific subcarrier to be displayed.
Range	Specifies a range to subcarriers to be displayed.
Start	Specifies the start value of the range to be displayed.
Stop	Specifies the ending value of the range to be displayed.
Max symbols to analyze	Specifies how many symbols are analyzed. You can use this setting to speed analysis by limiting the number of symbols being analyzed.

Analysis Time Tab – OFDM

The Analysis Time tab contains parameters that define how the signal is analyzed in the OFDM Analysis displays.

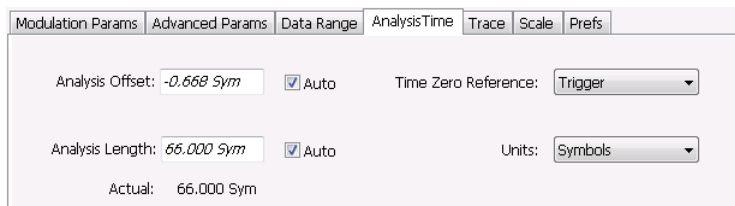

Settings	Description
Analysis Offset	Specifies the location of the first time sample to use in measurements.
Auto	When enabled, causes the instrument to set the Analysis Offset value based on the requirements of the selected display.
Analysis Length	Specifies the length of the analysis period to use in measurements. Length is specified in either symbols or seconds, depending on the Units setting.
Auto	When enabled, causes the instrument to set the Analysis Length value based on the requirements of the selected display.
Actual	This is a displayed value, not a setting. It is the Analysis Length (time or symbols) being used by the analyzer, this value may not match the Analysis Length requested (in manual mode).
Time Zero Reference	Specifies the zero point for the analysis time.
Units	Specifies the units of the Analysis Length to either Symbols or Seconds.

Analysis Offset

Use analysis offset to specify where measurements begin. Be aware that you cannot set the Analysis Offset outside the range of time covered by the current acquisition data. (all time values are relative to the Time Zero Reference).

You can set the Analysis Length so that the requested analysis period falls partly or entirely outside the current range of acquisition data settings. When the next acquisition is taken, its Acquisition Length will be increased to cover the new Analysis Length, as long as the Sampling controls are set to Auto. If the Sampling parameters are set to manual, or if the instrument is analyzing saved data, the actual analysis length will be constrained by the available data length, but in most cases, measurements are able to be made anyway. The instrument will display a notification when measurement results are computed from less data than requested. Range: 0 to [(end of acquisition) - Analysis Length]. Resolution: 1 effective sample (or symbol).

Analysis Length

Use the analysis length to specify how long a period of time is analyzed. As you adjust this value, the actual amount of time for Analysis Length, in Symbol or Seconds units, is shown below the control in the "Actual" readout. This setting is not available when Auto is checked. Range: minimum value depends on modulation type. Resolution: 1 symbol.

Time Zero Reference

All time values are measured from this point (such as marker position or horizontal position (in Y vs Time displays). Choices are: Acquisition Start or Trigger.

Parameter	Description
Acquisition Start	Offset is measured from the point at which acquisition begins.
Trigger	Offset is measured from the trigger point.

Trace Tab – OFDM

The Trace tab allows you to set the trace display characteristics of the selected display. This tab is not available for all OFDM displays.



Settings	Description
Trace	Use this drop-down list to select whether or not the Average trace or the measurement trace is displayed. The measurement trace depends on the selected display.
Show	Select or deselect this checkbox to show or hide the trace selected in the Trace drop-down list.
Freeze	Selecting Freeze halts updates to the trace.

Scale Tab – OFDM

The Scale tab allows you to change the scale settings that control how the trace appears on the display but does not change control settings such as Measurement Frequency. There are two versions of the Scale tab for OFDM displays. One version is used only for the Constellation display and the other version is used for the OFDM EVM, OFDM Magnitude Error, OFDM Phase Error, and OFDM Power displays.

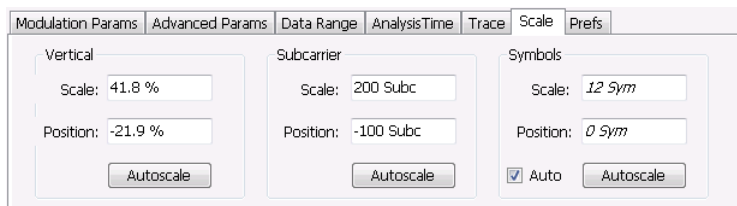

Scale tab for OFDM EVM, OFDM Mag Error, OFDM Phase Error, and OFDM Power displays

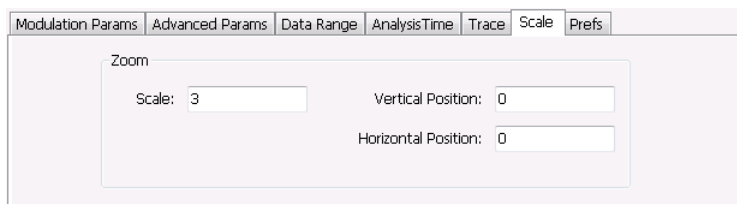

Scale tab for OFDM Constellation display

Settings	Description
Vertical	Controls the vertical position and scale of the trace display.
Scale	Changes the vertical scale of the graph.
Position	Adjusts the reference level away from top of the graph.
Autoscale	Resets the scale of the vertical axis to contain the complete trace.
Subcarrier	Controls the scale of the subcarrier graph and position of the trace.
Scale	Specifies how many subcarriers are displayed horizontally.
Position	Specifies the subcarrier that appears at the left edge of the subcarrier graph.
Autoscale	Resets the scale of the horizontal axis to contain the complete trace.
Symbols	Controls the scale of the Symbols graph.
Scale	Specifies the number of symbols that appear in the symbols graph.
Position	Specifies the symbol that appears at the left edge of the Symbols graph.
Autoscale	Resets the scale and position settings to optimize the display.
Auto	When Auto is checked, the scale and position values for the Symbols graph are automatically adjusted to maintain the optimal display.
Zoom	Sets the Constellation display size and position.
Scale	Sets the magnification value for the Constellation display.
Vertical Position	Sets the vertical location of the Constellation display within the graph. Range is -3.7 to +3.7.
Horizontal Position	Sets the horizontal location of the Constellation display within the graph. Range is -3.7 to +3.7.

Prefs Tab – OFDM

The Prefs tab enables you to change appearance characteristics of the OFDM Analysis displays. Not all settings on the Prefs tab shown below appear for every OFDM display.

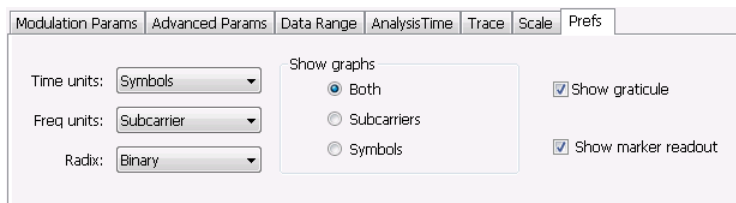

Settings	Description
Time units	Specifies whether the displayed time units are seconds or symbols.
Freq units	Specifies whether the displayed frequency units are frequency (Hz) or subcarrier channel.
Radix	Specifies whether symbol values are displayed in binary or hex format (for example, in the Symbol Table or markers readouts).
Show graphs	Specifies which graph types are displayed.
Both	Displays both the Subcarrier and Symbol graphs.
Subcarriers	Displays only the subcarrier graph.
Symbols	Displays only the symbol graph.
Show graticule	Displays or hides the graticule in the graphs.
Show marker readout	Displays or hides the marker readouts in the graphs.

Overview

The displays in the Pulsed RF folder (Displays > Folders > Pulsed RF) are:

- Pulse Statistics
- Pulse Table
- Pulse Trace

The Pulse measurements provide deep insight into pulse train behavior.

Pulse Measurements

The analyzer takes the following pulse measurements: Average ON Power, Peak Power, Average Transmitted Power, Pulse Width, Rise Time, Fall Time, Repetition Interval (Sec), Repetition Rate (Hz), Duty Factor (%), Duty Factor (Ratio), Ripple, Droop, Pulse-Pulse Phase Difference, Pulse-Pulse Frequency Difference, RMS Frequency Error, Maximum Frequency Error, RMS Phase Error, Maximum Phase Error, Frequency Deviation, Phase Deviation, and Time. See [Available Measurements \(see page 33\)](#) for definitions.

Pulse Table Display

The Pulse Table lists selected measurements in a spreadsheet format, showing the pulse numbers and all the results for each measurement on all the detected pulses. Pulses are numbered from one.

	Avg ON	Peak	Avg Tx	Width	Rise	Fall	Rep Int	Rep Rate	Ri
1	-2.3542 dBm	-2.2729 dBm	-18.732 dBm	5.1147485 us	70.286255 ns	69.794922 ns	220.95078 us	4.525895 kHz	0.1
2	-2.3518 dBm	-2.2345 dBm	-18.187 dBm	7.2183543 us	70.688479 ns	70.083004 ns	275.67105 us	3.627512 kHz	0.1
3	-2.3510 dBm	-2.2595 dBm	-18.619 dBm	5.2991536 us	71.052249 ns	69.774167 ns	223.23629 us	4.479559 kHz	0.1
4	-2.3513 dBm	-2.2816 dBm	-18.731 dBm	5.1165252 us	70.684202 ns	70.438233 ns	220.96363 us	4.525632 kHz	0.1
5	-2.3513 dBm	-2.2713 dBm	-18.192 dBm	7.2066669 us	71.347657 ns	70.579837 ns	275.49471 us	3.629834 kHz	0.1
6	-2.3531 dBm	-2.2518 dBm	-18.587 dBm	5.4644311 us	70.315551 ns	70.734863 ns	228.46991 us	4.376944 kHz	0.1
7	-2.3537 dBm	-2.2510 dBm	-18.727 dBm	5.1185839 us	71.486205 ns	70.560304 ns	220.90306 us	4.526873 kHz	0.1
8	-2.3530 dBm	-2.3067 dBm	-18.157 dBm	7.2754278 us	70.033572 ns	69.621585 ns	275.90856 us	3.624389 kHz	0.1
9	-2.3547 dBm	-2.2646 dBm	-18.667 dBm	5.1216639 us	70.291136 ns	69.699709 ns	218.00389 us	4.587074 kHz	0.1
10	-2.3505 dBm	-2.2762 dBm	-18.735 dBm	5.1066654 us	69.887697 ns	70.510254 ns	220.97585 us	4.525381 kHz	0.1
11	-2.3541 dBm	-2.2895 dBm	-18.198 dBm	7.1933723 us	70.523072 ns	70.412597 ns	275.21345 us	3.633543 kHz	0.1
12	-2.3528 dBm	-2.2509 dBm	-18.556 dBm	5.7297557 us	70.941773 ns	69.781493 ns	237.95580 us	4.202461 kHz	0.1
13	-2.3561 dBm	-2.2638 dBm	-18.444 dBm	6.0395946 us	71.277462 ns	70.528564 ns	244.25826 us	4.094027 kHz	0.1
14	-2.3530 dBm	-2.3083 dBm	-18.730 dBm	5.1135430 us	70.236204 ns	69.981688 ns	220.97836 us	4.525330 kHz	0.1
15	-2.3500 dBm	-2.3191 dBm	-18.193 dBm	7.2002217 us	71.079711 ns	71.169431 ns	275.33952 us	3.631880 kHz	0.1
16	-2.3559 dBm	-2.2768 dBm	-18.572 dBm	5.6117051 us	69.582519 ns	70.191653 ns	233.68913 us	4.279189 kHz	0.1
17	-2.3563 dBm	-2.3134 dBm	-18.668 dBm	5.1218622 us	70.316162 ns	69.885253 ns	218.00520 us	4.587046 kHz	0.1
18	-2.3558 dBm	-2.2804 dBm	-18.740 dBm	5.1066395 us	70.247189 ns	69.825440 ns	220.96526 us	4.525598 kHz	0.1
19	-2.3564 dBm	-2.2648 dBm	-18.195 dBm	7.2042967 us	71.071774 ns	70.909422 ns	275.35643 us	3.631656 kHz	0.1
20	-2.3509 dBm	-2.2886 dBm	-18.573 dBm	5.6055314 us	70.825806 ns	70.736085 ns	233.68525 us	4.279260 kHz	0.1
21	-2.3566 dBm	-2.2565 dBm	-18.669 dBm	5.1220964 us	71.097411 ns	70.708005 ns	218.00013 us	4.587153 kHz	0.1
22	-2.3541 dBm	-2.2646 dBm	-18.735 dBm	5.1116199 us	71.083370 ns	69.742434 ns	220.97304 us	4.525439 kHz	0.1

Displaying the Pulse Table

1. Press the **Displays** button or select **Setup > Displays**.
2. Select **PulsedRF** in the Folders box.
3. **Double-click Pulse Table** in the **Available displays** box to add the display to the Selected displays box.
4. Click **OK**.

Selecting the Measurements to Show

1. With the Pulse Table selected, press the **Settings** button.
2. In the Pulse Table Settings control panel, select the **Measurements** tab.

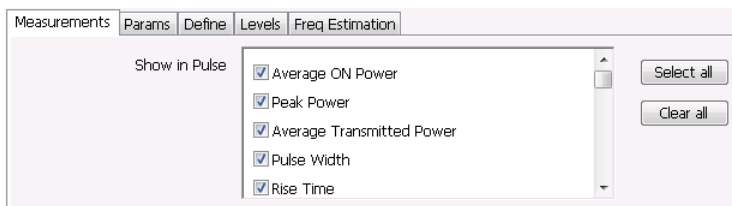

3. Select the measurements you wish to take from the list of measurements or click **Select all** to choose all measurements.
4. Click the close box () to remove the Settings control panel.

[Changing the Pulse Table Display Settings \(see page 252\)](#)

Pulse Table Settings

Menu Bar: Setup > Settings

Front Panel: Settings

Application Toolbar: 

The Settings control panel tabs for the Pulse Table Display are shown in the following table.

Settings tab	Description
Measurements (see page 253)	Selects the measurements to be show in the Pulse Table.
Params (see page 257)	Specifies several parameters that control how pulses are counted and defined.
Define (see page 259)	Specifies parameters that control where measurements are taken on a pulse.
Levels (see page 264)	Specifies parameters that control the method and levels used to calculate some pulse values.
Freq Estimation (see page 264)	Specifies the reference used for computing frequency errors.

Restore defaults. Sets the Pulse Table parameters to their default values.

Measurements Tab

The Measurements tab is used to specify the measurements that appear in the Pulse Table.

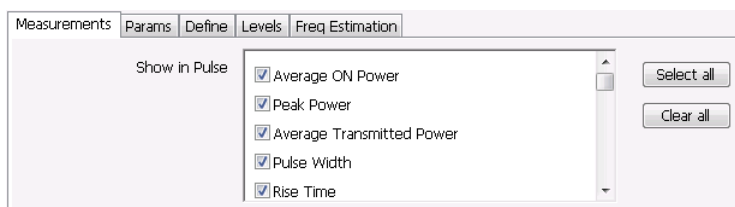

Show in Pulse

Checked measurements appear in the Pulse Table.

Select all

Click **Select all** to choose all measurements for display in the Pulse Table.

Clear all

Click **Clear all** to remove all measurements from the Pulse Table display.

Pulse Trace Display

The Pulse Trace display shows one measurement result and a trace graph illustrating that measurement for a selected pulse number. You can also choose to display arrows and lines in the graph that illustrate where on the pulse the measurement is being taken.

Elements of the Pulse Trace Display

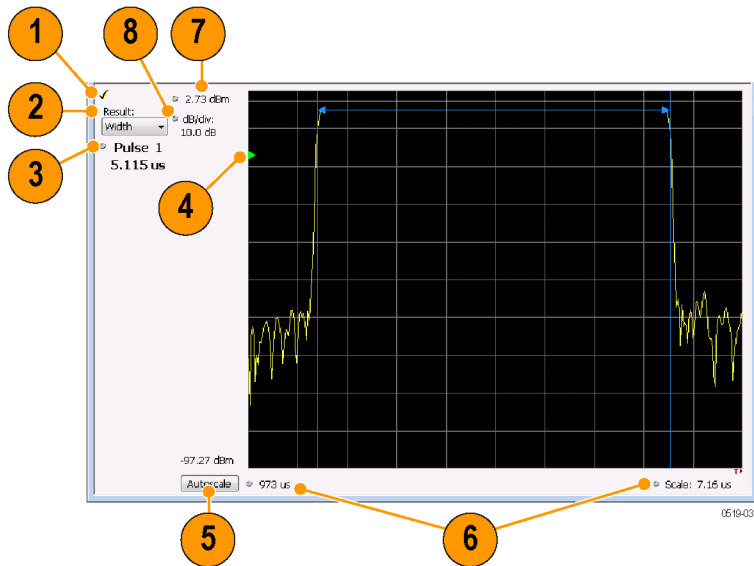

Item	Display element	Description
1	Optimized indicator	The check mark indicator in the upper, left-hand corner of the display shows when the Pulse Trace display is the optimized display.
2	Result	Use this list to select the measurement to show. The measurement chosen here selects the same result to be displayed in the Statistics view and highlighted in the Table view. Selecting a result in any of these views causes the same result to be selected in all of them.
3	Pulse	Selects which pulse result is shown. Like the Result, this selection is shared with the Statistics and Table views. The maximum number of pulses that can be measured is limited to 10000.
4	Pulse threshold indicator	This green triangle indicates the power threshold used to detect pulses. See Settings > Params > Power threshold to detect pulses.
5	Autoscale	Set the axes to values that show all trace points.
6	Horizontal offset and scale	Located along the bottom edge of the trace display, these controls specify the offset and scale on the horizontal axis.
7	Top of graph adjustment	Sets the power level shown at the top of the graph. If the number is greater than the Ref Level, a white line will appear in the graph to indicate the Ref Level.
8	Vertical scale	Sets the vertical scale value.

[Changing the Pulse Trace Display Settings \(see page 255\)](#)

Pulse Trace Settings

Menu Bar: Setup > Settings

Front Panel: Settings

Application Toolbar: 

The Setup settings for the Pulse Trace display are shown in the following table.

Settings tab	Description
Params (see page 257)	Specifies several parameters that control how pulses are counted and defined.
Define (see page 259)	Specifies parameters that control where measurements are taken on a pulse.
Levels (see page 264)	Specifies parameters that control the method and levels used to calculate some pulse values.
Freq Estimation (see page 264)	Specifies the reference used for computing frequency error.
Scale (see page 266)	Specifies the vertical and horizontal scale settings.
Prefs (see page 267)	Specifies whether or not certain display elements are shown.

Pulse Statistics Display

The Pulse Statistics view displays a plot of a pulse measurement's values for every pulse in the analysis period. For example, the Pulse Statistics display will show the rise time measurement for each of 30 pulses, with rise time on the Y axis and pulse number on the X axis. Alternatively, the Statistics Display can show an FFT trace for the values of a measurement over all the pulses analyzed. Numeric readouts of Max, Min, and Average in this display summarize results for the selected pulse measurement.

Elements of the Pulse Statistics Display

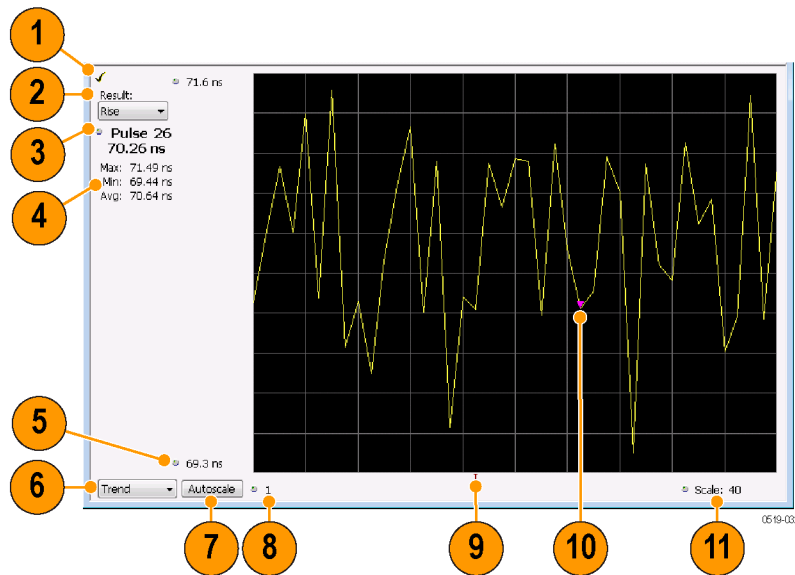

Item	Display element	Description
1	Optimized indicator	The check mark indicator in the upper, left-hand corner of the display shows when the Pulse Statistics display is the optimized display.
2	Result	Use this list to select which measurement statistics to display. The measurement chosen here selects the same result to be displayed in the Pulse Trace display and the Pulse Table display. Selecting a result in any of these views causes the same result to be selected in all of them.
3	Pulse	Selects which pulse's result is shown. Like the Result, this selection is shared with the Statistics and Table views.
4	Statistics summary	Display of measurement statistics for the selected Result.
5	Vertical range	Located at the top of the left graph edge and at the bottom of the left graph edge, use these controls to adjust the values at the top of the graph and the bottom of the graph.
6	Plot	Selects from Trend, Time Trend, FFT, and Histogram for the graph.
7	Autoscale	Set the axes to values that show all trace points.
8	Horizontal offset	Adjusting this value moves the graph right or left.
9	Trigger indicator	Indicates the trigger point on the pulse train if the trigger occurred during the time frame of the pulse measurements.
10	Pulse indicator	For Trend and Time Trend plot types, this indicates the pulse selected by the Pulse setting. For the FFT plot type, this indicator marks the trace point at the selected frequency. For Histogram plot types, this indicator marks the selected results bin.
11	Scale	Adjusts the horizontal scale.

[Changing the Pulse Statistics Display Settings \(see page 257\)](#)

Pulse Statistics Settings

Menu Bar: Setup > Settings

Front Panel: Settings

Application Toolbar: 

The settings for the Pulse Statistics Display are shown in the following table.

Settings tab	Description
Params (see page 257)	Specifies several parameters that control how pulses are counted and defined.
Define (see page 259)	Specifies parameters that control where measurements are taken on a pulse.
Levels (see page 264)	Specifies parameters that control the method and levels used to calculate some pulse values.
Freq Estimation (see page 264)	Specifies the reference used for computing frequency errors.
Scale (see page 266)	Specifies the vertical and horizontal scale settings.
Prefs (see page 267)	Specifies whether or not certain elements of the display are shown.

Pulsed RF Shared Measurement Settings

The control panel tabs in this section are shared by the displays in the Pulsed RF folder (Setup > Displays). Changing a setting on one tab changes that setting for all the Pulsed RF displays.

Common controls for pulsed RF displays

Settings tab	Description
Params (see page 257)	Specifies several parameters that control how pulses are counted and defined.
Define (see page 259)	Specifies parameters that control where measurements are taken on a pulse.
Levels (see page 264)	Specifies parameters that control the method and levels used to calculate some pulse values.
Freq Estimation (see page 264)	Specifies the reference used for computing frequency errors.
Scale (see page 266)	Specifies the vertical and horizontal scale settings.
Prefs (see page 267)	Specifies whether or not certain elements of the display are shown.

Params Tab

The Params tab enables you to adjust several measurement parameters for Pulsed RF displays.

Params	Define	Levels	Freq Estimation	Scale	Prefs
Measurement Filter:	Gaussian	Power threshold to detect pulses:	-12 dBc		
Bandwidth:	10 MHz	Minimum OFF time between pulses:	0.000 s		
		<input type="checkbox"/> Max number of pulses:	100		

Setting	Description
Measurement Filter	Specify whether a filter is used to limit the bandwidth of the input signal.
Bandwidth	Sets the bandwidth of the measurement filter.
Power threshold to detect pulses	Specifies the level used for locating pulses in the data.
Minimum OFF time between pulses	Specifies the time the signal must fall below the power threshold for two pulses to be considered separate pulses.
Max number of pulses	Specifies the number of pulses to measure within the analysis time.

Measurement Filter

Three choices are available for the measurement filter:

- **No Filter - Max BW:** The widest acquisition bandwidth available is used. The **Bandwidth** setting is disabled, but shows the value in use.
- **No Filter:** - This is the default. The Bandwidth control is enabled for you to specify an acquisition bandwidth.
- **Gaussian** - The Bandwidth control is enabled for you to specify a value. The instrument uses an acquisition bandwidth two times wider than the entered value.

Power Threshold to Detect Pulses

Specifies the minimum power level the trace must exceed to be detected as a pulse. The range for this setting is: -3 to -70 dBc. The setting resolution is 1 dB. The default value is -10 dB.

Max Number of Pulses

If the Analysis Time contains fewer pulses than specified, the analyzer will measure all the pulse within the analysis time. If there are more pulses in the Analysis Time, than the specified number, the analyzer measures the specified number of pulses and ignores the rest. The range for this setting is: 1 - 10000. The setting resolution is: 1. If this setting is not checked, the analyzer will measure all pulses within the Analysis Time, up to a maximum of 10000 pulses.

To determine the maximum number of pulses that can be analyzed, use the following equation:

$$\text{Max number of pulses that can analyzed} = \text{Pulse Rate} \times \text{capacity}$$

where:

- Pulse rate is the number of pulses per second (frequency).
- Capacity is a length of time which is displayed on the **Acquire > Sampling Parameters** tab.

Note that the maximum number of pulses is affected by several parameters. For example, measurement bandwidth affects the sample rate. The measurement algorithm also can reduce the maximum number of pulses that can be analyzed (by increasing the sample rate) based on the characteristics of the signal.

Additionally, when FastFrame is enabled, determining the maximum number of pulses is even more challenging. In FastFrame mode, the signal analyzer samples the signal around events of interest and ignores the signal between events of interest. Thus, if the instrument is only looking at pulses and ignoring the signal between pulses, the number of pulses that can be analyzed depends strongly on the characteristics of the pulse itself (for example, fewer wide pulses can be analyzed than narrow pulses, all other things being equal).

Define Tab

The Define tab enables you to specify parameters that control where measurements are made on a pulse. The settings available depend on the measurement selected.

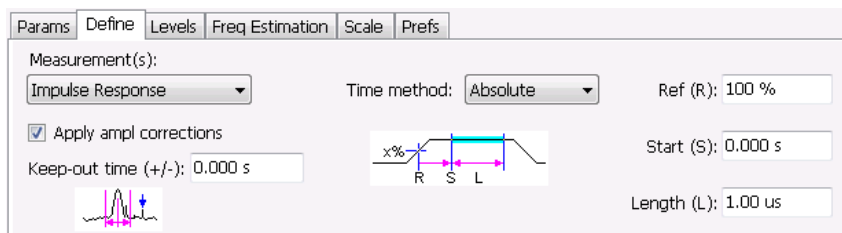

The following paragraphs describe the settings that appear on the Define tab according to the Measurement(s) selection.

Freq-Domain Linearity

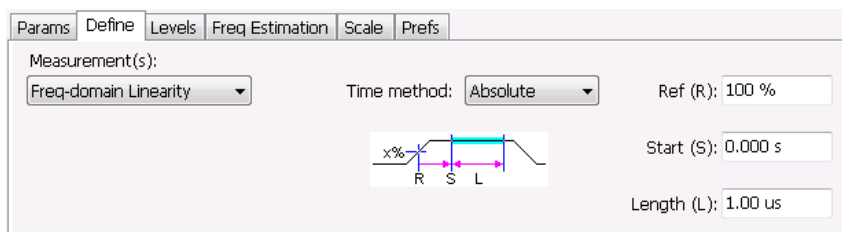

Setting	Description
Time method	Specifies how the measurement's duration is determined. The choices are Absolute and Relative.
Absolute time method	
Ref (R)	Ref specifies the level along the pulse rising edge that is defined as the point from which Start time is counted. Choices: 50%, 60%, 70%, 80%, 90% 100%; Default: 100%
Start (S)	Start specifies the time the instrument waits after the rising-edge reference before starting to measure the pulse. The Start time is measured from the point along the pulse rising edge specified by the Ref setting. Start Range: ± 100 ms; Resolution: 3 digits; inc/dec small: 1 ns, large: 1,2,5,10...; Default: 0
Length (L)	Length specifies the period of time that is used for pulse measurements The measurement time begins at the Start point and continues for the amount of time specified by Length.
Relative time method	
Length	In the Relative time method, Length specifies the percentage of the top of the pulse that is used for measurements. The instrument automatically determines the pulse top. The measurement length is centered within the pulse ON time.

Impulse Response

Params
Define
Levels
Freq Estimation
Scale
Prefs

Measurement(s):

Apply ampl corrections

Keep-out time (+/-):



Time method:

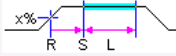

Ref (R):

Start (S):

Length (L):

Setting	Description
Apply ampl corrections	Enable/disable corrections that remove errors due to the window function and to the time offset of the side lobe.
Keep-out time (+/-)	The Keep-out time specifies a region that is ignored when the trace is analyzed for side lobes. The setting defines a region to the left and to the right of the center of the main lobe. Lobes that fall within this time region are not eligible to be the "highest side lobe".
Time method	Specifies how measurement parameters are determined. The choices are Absolute and Relative.
Absolute time method	
Ref (R)	Ref specifies the level along the pulse rising edge that is defined as the point from which Start time is counted. Choices: 50%, 60%, 70%, 80%, 90% 100%; Default: 100%
Start (S)	Start specifies the time the instrument waits after the rising-edge reference before starting to measure the pulse. The Start time is measured from the point along the pulse rising edge specified by the Ref setting. Start Range: ± 100 ms; Resolution: 3 digits; inc/dec small: 1 ns, large: 1,2,5,10...; Default: 0
Length (L)	Amount of time that should be included in the measurement. The measurement time begins at the Start point and continues for the amount of time specified by Length.
Relative time method	
Length	In the Relative time method, Length specifies the percentage of the top of the pulse that is used for measurements. The instrument automatically determines the pulse top. The measurement length is centered within the pulse ON time.

Freq Diff, Phase Diff

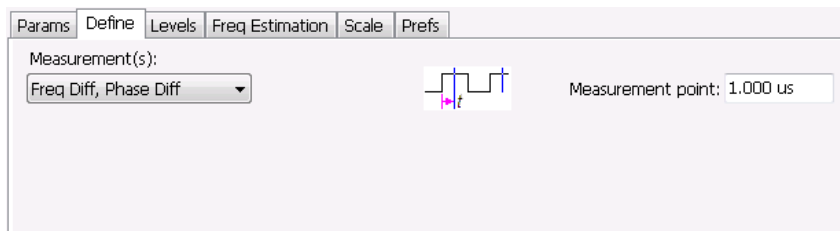

Setting	Description
Measure point	Specifies the period in time after the 50% rising edge at which frequency and phase difference measurements are made.

Ripple

Params Define Levels Freq Estimation Scale Prefs

Measurement(s):
 Ripple Time method: Relative Ref (R): 100 %

Start (S): 0.000 s
 Length (L): 50.0 %

Setting

Description

Length

Length specifies the percentage of the top of the pulse that is used for measurements. The instrument automatically determines the pulse top. The measurement length is centered within the pulse ON time. Only the Relative Time method is available for Ripple.

Overshoot

Params Define Levels Freq Estimation Scale Prefs

Measurement(s):
 Overshoot Time method: Relative Ref (R): 100 %

Start (S): 0.000 s
 Length (L): 25.0 %

Setting	Description
Time method	Specifies how measurement parameters are determined. The choices are Absolute and Relative.
Absolute time method	
Ref (R)	Ref specifies the level along the pulse rising edge that is defined as the point from which Start time is counted. Choices: 50%, 60%, 70%, 80%, 90% 100%; Default: 100%
Start (S)	Start specifies the time the instrument waits after the rising-edge reference before starting to measure the pulse. The Start time is measured from the point along the pulse rising edge specified by the Ref setting. Start Range: ± 100 ms; Resolution: 3 digits; inc/dec small: 1 ns, large: 1,2,5,10...; Default: 0
Length (L)	Amount of time that should be included in the measurement. The measurement time begins at the Start point and continues for the amount of time specified by Length.
Relative time method	
Ref	Ref specifies the level along the pulse rising edge that is defined as the point from which Start time is counted. Choices: 50%, 60%, 70%, 80%, 90% 100%; Default: 100%
Start	Start specifies the time the instrument waits after the rising-edge reference before starting to measure the pulse. The Start time is measured from the point along the pulse rising edge specified by the Ref setting. Start Range: ± 100 ms; Resolution: 3 digits; inc/dec small: 1 ns, large: 1,2,5,10...; Default: 0
Length	In the Relative time method, Length specifies the percentage of the top of the pulse that is used for measurements. The instrument automatically determines the pulse top. The measurement length is centered within the pulse ON time.

Levels Tab

Use the Levels tab to set parameters that control the method and levels used to calculate some pulse values.

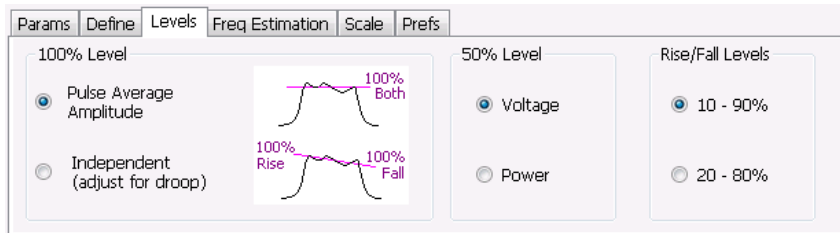

Setting	Description
100% Level	Specifies the method used to determine the 100% level(s).
50% Level	Specifies the method used to determine the 50% level on the pulse.
Rise/Fall Levels	Select whether to use the 10% to 90% or 20% to 80% points (based on voltage level) to define the rise and fall times.

100% Level

Use the 100% Level settings to select the method used to determine the 100% level(s) used for calculating pulse parameters, for example, Rise, Fall, and Width.

The Pulse Average Amplitude defines the pulse top as the average of the values of all the points along the pulse top. This average is used as the 100% level, from which the 10, 20, 50, 80 and 90% levels are calculated. Pulse measurements are referenced against these various levels. For example, Rise is the time between the 10 and 90% (or 20 and 80%) levels on the rising edge of the pulse. When the Pulse Average Amplitude method is selected, the same 100% level is used for both rising and falling edges.

Because some RF pulse types have droop (a height difference between the beginning and ending points of the pulse top), the 100% percent level on the rising edge may not be equal to the 100% level on the falling edge. The Independent method of pulse point location is designed for pulses with different 100% levels at their rising and falling edges. The Independent method calculates the 100% level for the rising edge separately from the 100% level of the falling edge. As a result, the 10, 20, 50, 80 and 90% levels are also different for the rising and falling edges, allowing for more accurate measurements on pulses with droop.

50% Level

Select Voltage to use -6 dB as the 50% point. Select Power to use -3 dB as the 50% level.

Freq Estimation Tab

Use the Freq Estimation tab to specify parameters used for determining frequency offset.

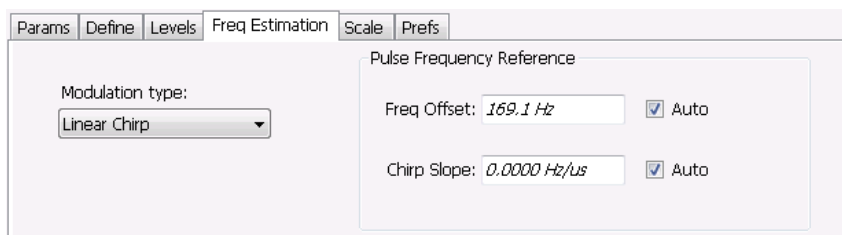

Setting	Description
Modulation type	Specifies which algorithm to use for estimating frequency error.
Pulse Frequency Reference	Specifies the method used to determine the pulse frequency error and if applicable, the chirp slope.
Auto	Selecting Auto causes the instrument to calculate the frequency offset and if applicable, the chirp slope.
Freq Offset	If Auto is not enabled, specify the value for frequency offset here. If Auto is enabled, the offset is set to zero and this readout displays the calculated frequency error.
Chirp BW	If Auto is not enabled, specify the value for Chirp Slope here. If Auto is enabled, this readout displays the calculated Chirp slope. This setting is used only when the modulation type is set to Linear Chirp.

Modulation Type

Frequency estimation is performed by the instrument using selectable methods, depending on signal type. The selections for modulation type are CW (constant phase), CW (changing phase), Linear Chirp and Other. Select the method of frequency method based upon a best match to your signal based on the following descriptions:

- CW (constant phase): The signal is not designed to change in either frequency or phase during the measured pulse train.
- CW (changing phase): The signal does not change the carrier phase within each pulse, although it could change the phase from one pulse to another pulse. The signal is not designed to make frequency changes.
- Linear Chirp: The signal changes frequency in a linear manner during each pulse. The signal has the same carrier phase at the same time offset from the rising edge of the pulse.
- Other: The signal is not one of the listed types. You must manually enter the Frequency Offset value.

The following table maps the appropriate signal type selection with the signal characteristics.

Signature	Phase offset from one pulse to another	
	Zero	Any (unknown)
CW	CW Constant Phase	CW Changing Phase
LFM	Linear Chirp	N/A

Scale Tab

The Scale tab allows you to change the vertical and horizontal scale settings. Changing the scale settings changes how the trace appears on the display but does not change control settings such as Measurement Frequency. In effect, these controls operate like pan and zoom controls.

The screenshot shows the Scale Tab interface with the following settings:

- Vertical:**
 - Scale: 100.00 dB
 - Position: 2.73 dBm
 - Autoscale button
- Horizontal:**
 - Scale: 348 ns
 - Position: 6.99 ms
 - Autoscale button
 - Full scale:
 - Selected
 - Max pulse

A central "Reset Scale" button is also visible.

Setting	Description
Vertical	Controls the vertical position and scale of the trace display.
Scale	Changes the vertical scale. The units for this setting depend on the statistic selected from the Result drop-down list in the Pulse Statistics display.
Position	Adjusts the Reference Level away from the top of the trace display. The units for this setting depend on the statistic selected from the Result drop-down list in the Pulse Statistics display.
Autoscale	Resets the scale of the vertical axis to contain the complete trace.
Horizontal	Controls the span of the trace display and position of the trace.
Scale	Allows you to change the span.
Position	Allows you to pan a zoomed trace.
Full Scale (Pulse Trace display only)	Specifies the Horizontal scale default.
Selected	Sets the horizontal scale default to be based on the result value for the currently-select pulse.
Max Pulse	Sets the horizontal scale default to be based on the largest value for the selected pulse measurement.
Autoscale	Resets the scale of the horizontal axis to contain the complete trace.
Plot (Pulse Statistics display only)	Specifies the FFT, Trend, Time Trend, or Histogram plot.
Reset Scale	Restores all settings to their default values.

Prefs Tab

The Prefs tab enables you to change parameters of the measurement display. The parameters available on the Prefs tab vary depending on the selected display.

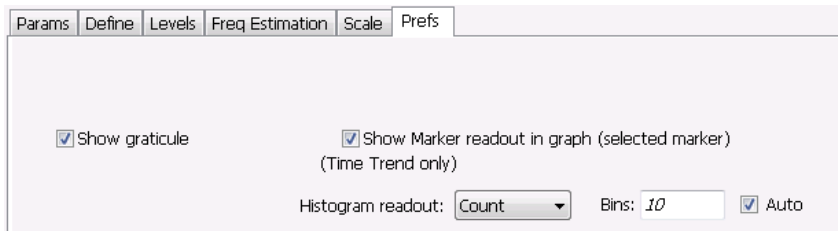

Params Define Levels Freq Estimation Scale Prefs

Show graticule

Show Marker readout in graph (selected marker)
(Time Trend only)

Histogram readout: Bins: Auto

Settings on the Pulsed RF Displays Prefs Tab

The following table describes the settings that appear on the Prefs tab of the Pulsed RF displays: Pulse Statistics and Pulse Trace. There is no Prefs tab for the Pulse Table display.

Setting	Description
Show graticule	Displays or hides the graticule in the trace display.
Show Marker readout in graph	When a marker is enabled, this setting displays or hides the maker readout, but not the maker itself, on Time Trend plots.
Histogram readout (present only when Histogram is the selected plot type)	Controls the parameters Histogram readout and Bins. Histogram readout can be set to either Count or %. Count indicates the number of hits that fell into each bin. % indicates percentage of the total count (for the acquisition) that fell into each bin.
Bins	Specifies how many "bins" or histogram bars the results are distributed into.

Overview

Audio Analysis measures basic time- and frequency-domain parameters of analog audio signals modulated on a carrier (AM, FM and PM modulation) or unmodulated (non-carrier) audio signals (Direct).

For modulated signals, the measurement analysis first demodulates the signal to provide the *Audio signal* waveform. Direct input signals bypass the demodulation step. For FM and PM demodulation, the carrier frequency error is estimated during demodulation.

The Audio signal waveform excursions are then measured to determine the Peak and RMS waveform parameters. Next, the analysis detects the highest-amplitude frequency component within the audio bandwidth, and makes a high-accuracy frequency measurement of the frequency component. This value is called the *Audio Frequency*.

A spectral analysis of the Audio signal waveform is performed to determine the presence and level of harmonically- and/or non-harmonically-related narrowband spurs and wideband noise. The Audio signal, harmonic and non-harmonic spurs, and noise level data are combined to produce signal summary parameters including SINAD, Modulation Distortion, Signal-to-Noise, Total Harmonic Distortion, and Total Non-Harmonic Distortion.

Controls are provided to allow the user to select audio filters of Low Pass, High Pass, FM De-emphasis, or Standard-defined response, as well as completely user-definable filter response. Filtering can be applied as needed to modify the audio spectrum result before measurement to remove unwanted spurs or noise.

Flexible control parameters are provided to allow setting the Audio Bandwidth for analysis, the Resolution Bandwidth (RBW) and RBW filter type of the spectral analysis, and number and level qualifications for Harmonic and Non-harmonic spur detection. Multiple-spectrum averaging can be enabled to provide a smoothed spectrum for results with less variability than single-spectrum results.

The Audio Spectrum display shows the frequency spectrum waveform with detected harmonic and non-harmonic components identified by markers, and a corresponding table of frequency and level values for the spur components. The markers and table provide easy visualization of the significant spurs and their relation to the fundamental Audio frequency signal.

Audio Spectrum Display

The Audio Spectrum display shows audio modulation characteristics. You can choose to show just the spectrum of the audio signal or show the audio spectrum of the signal and the results of distortion measurements. The Audio Spectrum display can show a table listing the frequency of a Harmonic Distortion (HD) and Non-Harmonic Distortion (NHD) and its level. The Spectrum graph indicates these harmonics and non-harmonics with special markers.

To display the Audio Spectrum display:

1. Press the **Displays** button or select **Setup > Displays**. This shows the **Select Displays** dialog box.
2. From the **Folders** box, select **Audio Analysis**.

3. Double-click the **Audio Spectrum** icon in the **Available Displays** box. This adds the Audio Spectrum icon to the **Selected displays** box.
4. Click the **OK** button. This shows the Audio Spectrum display.

Elements of the Audio Spectrum Display

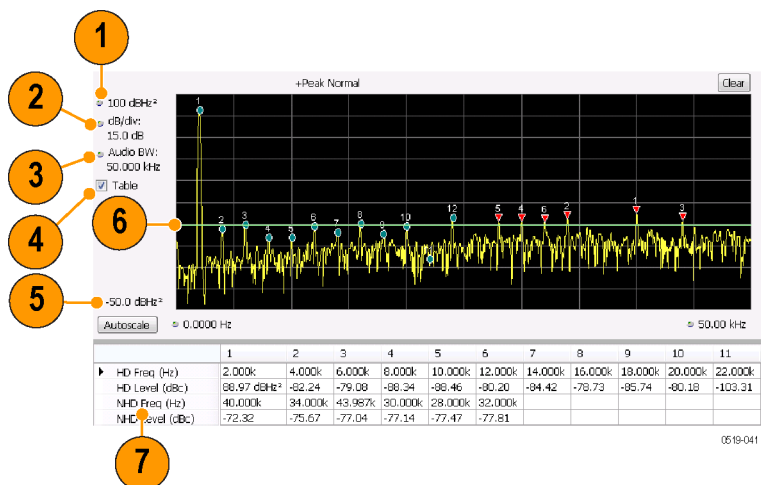

Item	Display element	Description
1	Vertical position	Sets the top of graph value.
2	dB/div	Sets the vertical scale value. The maximum value is 20.00 dB/division.
3	Audio BW	Specifies the measurement bandwidth of the Audio Spectrum display, which in turn can influence the acquisition bandwidth.
4	Table	Displays a table that shows the distortion measurement results and displays indicators on the graph that highlight the location of the harmonics on the trace.
5	Bottom of graph readout	Displays the bottom of graph value.
6	Non-harmonic threshold indicator	Displays the threshold for detecting non-harmonic components.
7	Analysis results	Display of the audio analysis results.

Audio Spectrum Settings

Menu Bar: Setup > Settings

Front Panel : Settings

Application Toolbar: 

The measurement settings for the Audio Spectrum display are shown in the following table.

Settings tab	Description
Params1 Tab (see page 273)	Specifies signal type, Audio Bandwidth, RBW, RBW filter, and Ref Audio Frequency.
Params2 Tab (see page 275)	Specifies Harmonics and Non-Harmonics measurement parameters.
Audio Filters Tab (see page 276)	Specifies the audio filter characteristics.
Scale Tab (see page 278)	Sets vertical and horizontal scale and position parameters.
Prefs Tab (see page 281)	Specifies vertical units, and whether on not some features are displayed in the graph.

Audio Summary Display

To display the Audio Summary display:

1. Press the **Displays** button or select **Setup > Displays**. This shows the **Select Displays** dialog box.
2. From the **Folders** box, select **Audio Analysis**.
3. Double-click the **Audio Summary** icon in the **Available Displays** box. This adds the Audio Summary icon to the **Selected displays** box.
4. Click the **OK** button. This shows the Audio Summary display.

The Audio Summary Display

Item	Display element	Description
1	Measurement results	Measurement results are displayed in this area. The displayed measurements vary with signal type.
2	Hum & Noise results	Hum & Noise analysis readout. Hum & Noise appears only when enabled on the Hum & Noise tab

Audio Summary Displayed Measurements

Table 5: Audio Summary Measurements

Signal type	Item	Description
AM, FM, PM	Carrier Power	Average power of the carrier signal with modulation removed.
Direct	Signal Power	Average power of the input signal
FM, PM	Carr Freq Err	Carrier frequency error
AM, FM, PM, Direct	Audio Freq	Fundamental audio frequency
	+Peak	+Peak modulation excursion (where the modulation excursion readout depends on the signal type) ¹
	-Peak	-Peak modulation excursion (where the modulation excursion readout depends on the signal type) ¹

Table 5: Audio Summary Measurements (cont.)

Signal type	Item	Description
	Peak-Peak/2	Half peak-peak modulation excursion (where the modulation excursion readout depends on the signal type) ¹
	RMS	RMS modulation excursion (where the modulation excursion readout depends on the signal type) ¹
	SINAD	Signal to noise and distortion
	Mod Distor	Modulation distortion
	S/N	An estimate of the Signal level to Noise (only level, with the HD and NHD components removed)
	THD	Total harmonic distortion
	TNHD	Total non-harmonic distortion
	Ref	Ref is the RMS modulation value stored when the Capture Reference button is pressed. (Displayed only when Hum & Noise is enabled.)
	Diff	Diff is the difference between the current RMS mod value and the Ref value captured previously. (Displayed only when Hum & Noise is enabled.)

¹ For AM signal types, modulation excursion is "% Modulation Depth". For FM signal types, modulation excursion is "Frequency Deviation". For PM signal types, modulation excursion is "Phase Deviation". For Direct, there is no modulation excursion, it is actually "signal excursion".

Audio Summary Settings

Front Panel: Settings

Application Toolbar:

The measurement settings for the Audio Summary display are shown in the following table.

Settings tab	Description
Params1 Tab (see page 273)	Specifies signal type, Audio Bandwidth, RBW, RBW filter, and Ref Audio Frequency.
Params2 Tab (see page 275)	Specifies Harmonics and Non-Harmonics measurement parameters.
Audio Filters Tab (see page 276)	Specifies the audio filter characteristics.
Hum Noise Tab (see page 280)	Specifies whether or not Hum & Noise is measured and enables the capture of a signal to be used as a reference of the Hum & Noise measurement.

Audio Analysis Measurement Settings

The control panel tabs in this section are shared by the displays in the Audio Analysis folder (Setup > Displays).

Common controls for Audio Analysis displays

Settings tab	Description
Params1 Tab (see page 273)	Specifies characteristics about the audio signal and how measurements are made.
Params2 Tab (see page 275)	Specifies parameters that control how measurements are made on harmonics.
Audio Filters Tab (see page 276)	Specifies characteristics of filters applied to the signal before measurements are taken.
Scale Tab (see page 278)	Sets vertical and horizontal scale and position parameters.
Prefs Tab for Audio Analysis (see page 281)	The Prefs tab enables you to change appearance characteristics of the Audio Analysis displays.

Params1 Tab

The Params1 tab is used to specify characteristics of the audio signal to be measured and how the signal will be measured.

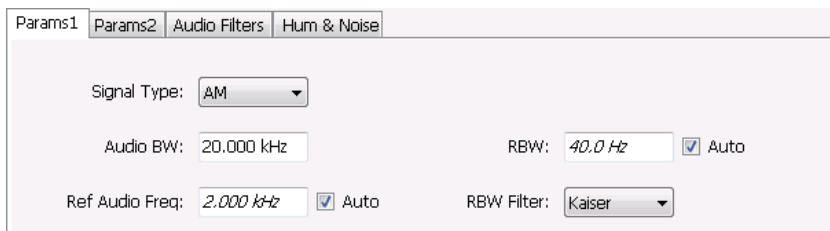

Params1 tab for AM signal types

Setting	Description
Signal Type	Specifies the type of signal to be analyzed. The available choices are AM, FM, PM, and Direct.
Audio BW	Specifies the bandwidth used for audio analysis.
Ref Audio Freq	A measured value when Auto is selected. If you want to specify the reference audio frequency, uncheck Auto and enter a value manually. If Ref Audio Freq is set manually, be aware that the automated detection is still performed, but it is limited to a frequency range of $\pm 1\%$ of the Audio BW centered around the manually specified value.
Carrier Freq Error / Carrier Freq Offset	(FM and PM only) A measured value, when Auto is selected. If Auto is unchecked, you can specify the Carrier Frequency Offset.
RBW	Displays the Resolution Bandwidth for Audio measurements. This value is automatically set by default to 1/500 of the measurement bandwidth. To manually specify the RBW, uncheck Auto. The minimum RBW value is limited to the larger of 1 Hz or AudioBW/10000. The maximum is limited to AudioBW/100.
RBW Filter	Specifies the windowing method used for the transform.

Setting Frequency for Direct Signal Types

Direct (unmodulated) signal analysis is only possible with the instrument Frequency control set to 0 Hz. You will receive a warning to set Frequency to 0 Hz when Direct signal type is selected, if you haven't already done so. Modulated signal types may be selected with Frequency set to 0 Hz, but results are not meaningful in that case. For modulated signals, Frequency should always be set to a value \geq Audio Bandwidth to avoid self-interference of the signal due to spectral folding.

Setting Audio Bandwidth

For AM, FM and PM, the Audio Bandwidth control sets not only the demodulated signal bandwidth, but also determines the pre-demodulation bandwidth. Set it to a value at least half the pre-demodulation signal bandwidth, as in this equation:

$$\text{Audio BW} \geq \text{Signal Bandwidth} / 2$$

NOTE. When performing audio analysis, you should allow the Audio BW control to automatically set the acquisition bandwidth, rather than manually adjusting the Acq BW control on the Sampling Parameters tab of the Acquire control panel. The audio measurement will cause the Acq BW setting to be \geq Audio BW (Direct) or $\geq 2 \times$ Audio BW (AM, FM, PM).

For Direct signals, set Audio Bandwidth large enough to include any significant harmonics/non-harmonics or other signal component of interest. For example, to measure up to the 10th harmonic of a signal with a 5 kHz fundamental component, set Audio Bandwidth to $10 \times 5 \text{ kHz} = 50 \text{ kHz}$.

For modulated signals, Audio Bandwidth must be set wide enough to include all significant signal modulation components in addition to the desired audio analysis bandwidth. For AM this is similar to Direct. For example, to measure up to the 10th harmonic of an AM signal with 3 kHz fundamental component, set Audio Bandwidth to $10 \times 3 \text{ kHz} = 30 \text{ kHz}$. This ensures that the bandwidth of the data provided by the system to the measurement will be at least of 60 kHz ($2 \times 30 \text{ kHz}$) which is sufficient for this signal and analysis requirement.

FM and PM are more complex. For FM, the analysis bandwidth needs to be at least twice as wide as the the sum of peak Frequency Deviation and the Fundamental Frequency (Carsons rule). This is a parallel condition along with setting Audio Bandwidth large enough for the maximum audio bandwidth to analyze. Therefore, for FM, Audio Bandwidth should be:

$$\text{AudioBW (FM)} = \text{MAX}(\text{MaxAudioAnalysisFreq}, \text{FreqDeviation} + \text{FundamentalFreq})$$

where MaxAudioAnalysisFreq is the highest audio frequency desired in the analysis. For example, for an FM signal with fundamental signal of 5 kHz and peak frequency deviation (one-sided) of 10 kHz, Acquisition Bandwidth should be at least $(2 \times (10\text{k} + 5\text{k})) = 30 \text{ kHz}$, or an Audio Bandwidth of 15 kHz. Also if the analysis should extend to the 8th harmonic, then the Audio Bandwidth needs to be at least $8 \times 5 \text{ kHz} = 40 \text{ kHz}$. So Audio Bandwidth should be set to 40 kHz. Using the equation:

$$\text{AudioBW(FM)} = \text{MAX}(8 \times 5 \text{ kHz}, (10 + 5) \text{ kHz}) = \text{MAX}(40 \text{ kHz}, 15 \text{ kHz}) = 40 \text{ kHz}$$

The formula for PM is:

$$\text{AudioBW (PM)} = \text{MAX}(\text{MaxAudioAnalysisFreq}, \text{PMFreqDeviation} + \text{FundamentalFreq})$$

where

$$PMFreqDeviation = PMPhaseDeviationInRadians \times FundamentalFreq$$

RBW Filter Shape

Select Kaiser in most cases for best measurement performance. Select Flattop only if you want to use standard markers to measure signal amplitude with highest accuracy.

Params2 Tab

The Params2 tab is used to specify how the signal harmonics are measured and to control spectrum averaging.

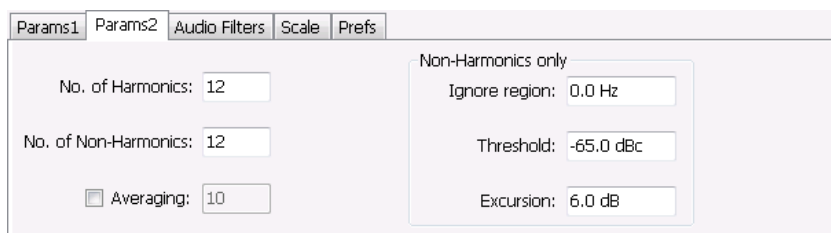

Setting	Description
No. of Harmonics	Specifies the number of harmonics to detect. The detected harmonics are tagged with a number on the spectrum trace. The available range is 1–20.
No. of Non-Harmonics	Specifies the number of non-harmonics to detect. The detected non-harmonics are tagged with a number on the spectrum trace. The available range is 0–20.
Averaging	Specifies the number of averages used to compute the results. Range: 2–100.
Ignore region	Specifies the region about the signal frequency where the instrument will ignore non-harmonics.
Non-Harmonic Threshold	Specifies the level which a spectrum peak must exceed to be declared a non-harmonic signal component.
Non-Harmonic Excursion	Specifies the difference in level between a spectrum peak and the average noise level that must be exceeded for the peak to be declared a non-harmonic signal component.

About Averaging In Audio Analysis Displays

Analysis averaging is implemented using a “block” method. This means that the entire record required for multiple spectrum computations is acquired and analyzed within one analysis cycle. The result of each analysis update is a complete, independent result from a set of N spectrums averaged together, where N is the Averaging control value.. Since each update is a fully averaged result, no partially averaged results are output before a final result is available, so each output is fully valid. However, with large Averaging values, acquisition record sizes and measurement times may become large, so care should be taken to select the minimum amount of averaging needed.

Audio Filters Tab

The Audio Filters tab is used to specify filters to be applied to the acquired audio signal before measurements are taken. You can select from pre-defined filters or use a filter you define in a text file. You can also specify the de-emphasis time constant applied to the audio signal and the telecom weighting filters used to measure noise.

The screenshot shows the 'Audio Filters' tab in a software interface. It has five sub-tabs: 'Params1', 'Params2', 'Audio Filters' (selected), 'Scale', and 'Prefs'. Under 'Audio Filters', there are two radio buttons: 'Pre-defined Filters' (selected) and 'File'. The 'Pre-defined Filters' section includes four checkboxes: 'LPF' (checked), 'HPF' (unchecked), 'De-emphasis' (unchecked), and 'Standard' (unchecked). Each checked checkbox has a corresponding drop-down menu: 'LPF' is set to '300 Hz', 'HPF' is set to '50 Hz', 'De-emphasis' is set to '25 µsec', and 'Standard' is set to 'CCITT'. The 'File' radio button has an empty text input field and a browse button (three dots).

Pre-defined Filters

You can specify low-pass filter (LPF) and high-pass filter (HPF) settings, a de-emphasis time constant and/or a telecom weighting filter to match the response of your receiver. Alternatively, you can create a text file to specify the frequency response points.

To use pre-defined filters:

1. Select the **Pre-defined Filters** option button.
2. Select the LPF, HPF, De-emphasis and Standard check boxes as appropriate.
3. Select the desired filter parameter from the drop-down list for each of the enabled filters or select User from the list if you wish to use a custom value. For LPF and HPF, the listed frequencies represent the 3dB cutoff point of the filter.
4. If you select **User** from the drop-down list, enter a value in the text entry box that appears.

To disable all filtering:

1. Select the **Pre-defined Filters** option button.
2. Deselect all four filter check boxes.

Table 6: Predefined audio filters

Filter type	Available settings
LPF (Low Pass Filter) (5th-order Butterworth response)	300 Hz
	3 kHz
	15 kHz
	30 kHz
	80 kHz
	300 kHz
	User ¹
HPF (High Pass Filter) (5th-order Butterworth response)	20 Hz
	50 Hz
	300 Hz
	400 Hz
	User ¹
De-emphasis (FM only)	25 µs
	50 µs
	75 µs
	750 µs
	User. Range: 25 µs to 10 ms
Standard	CCITT
	C-message

¹ User-entered values are restricted to maximum of 0.9 * Audio BW, and will automatically adjust downward to meet this limit (if required) when AudioBW is decreased.

Standard. Use this setting to specify the telecom weighting filter. The characteristics of these filters are described in ITU-T Recommendation O.41, Psophometer for Use on Telephone-type Circuits.

Using Custom Audio Filters

If you want to use audio filters that have a different response shape than the pre-defined filters, you can create a custom audio filter using a text or CSV file to specify the desired filter frequency response.

To use a custom audio filter:

1. Verify that Audio Spectrum or Audio Summary is the selected display.
2. Click the Settings icon or select **Setup > Settings**.
3. Select the **Audio Filters** tab.
4. Click the **File** button.
5. Click the **...** button and navigate to the location of the custom audio filter file you wish to use. Select the file you want to use and click Open.
6. Acquire a new trace or replay a saved file to see the effect of the custom filter.

Creating a Custom Audio Filter. A custom audio filter file is either a plain text file or a CSV format file. The file contains frequency (in Hz) and amplitude (in dB) value pairs which specify the filter frequency response shape. Each pair must be on a separate line. The filter response between the points is interpolated using a cubic spline fit.

The following table shows the first few lines of a custom audio filter text file.

0,	-100
16.66,	-85
50,	-63
100,	-41
200,	-21
300,	-10.6
400,	-6.3
500,	-3.6
600,	-2
700,	-0.9
800,	0
...	...

Format and rule-checking on custom audio filter files is performed as follows:

- The maximum number of frequency and amplitude pairs is 1000.
- Column 1 (frequency values in Hertz).
 - Non-negative values only (zero is allowed).
 - Strictly increasing order of frequencies (frequency value on each line > frequency value on previous line).
 - There is no upper limit on the frequency value.
- Column 2 (amplitude values in dB units, where gain is a positive value and attenuation is a negative value).
 - Values are restricted to the range -200 to +20 dB.

Scale Tab

The Scale tab allows you to change the vertical and horizontal scale settings. Changing the scale settings changes how the trace appears on the display but does not change acquisition control settings. In effect, these controls operate like pan and zoom controls.



Setting	Description
Vertical	
Scale	Changes the range shown between the top and bottom of the graph.
Position	Adjusts the level shown at the top of the graph for linear units or the top of the graph for log units (for example, dBm).
Autoscale	Resets the Position so that the highest trace points are in the graph. For linear units (Volts, Watts), the Autoscale also adjusts Scale.
Horizontal	
Left	Changes the frequency shown at the left side of the graph.
Right	Changes the frequency shown at the right side of the graph.
Autoscale	Resets the Left and Right settings to show the entire trace.
Log	Sets the graph horizontal axis to a logarithmic scale.
Reset Scale	Resets the Vertical and Horizontal settings to their default values.

Hum & Noise Tab

Hum & Noise (available only when the Audio Summary display is the active display) is useful for comparing residual power or modulation if the Ref value is captured when the Signal is On (Direct) or modulated (AM/FM/PM). When the signal is turned off (Direct) or modulation turned off (AM/FM/PM), Diff indicates how much residual Hum and Noise are still present in the measurement value.

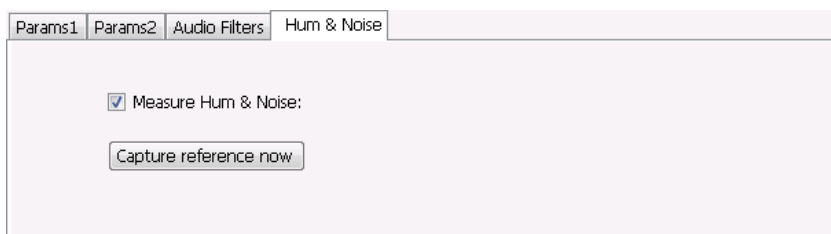

To display Hum & Noise measurement:

1. Select **Setup > Displays**.
2. In the Select Displays window, select the **Audio Analysis** folder.
3. Double-click the **Audio Summary** icon so that it appears in the **Selected displays** box.
4. Click **OK**
5. With the Audio Summary display selected, select **Setup > Settings**.
6. Select the **Hum & Noise** tab. Click on the **Measure Hum & Noise** checkbox so that it is checked.
The Hum & Noise values appear at the bottom list of measurements in the Audio Summary display.
7. Acquire an appropriate signal.
8. While the analyzer is analyzing a signal you want to use as a reference, click the **Capture reference now** button to save a reference value.

The Hum & Noise measurement compares the value of a specific signal quantity captured by the **Capture reference now** button with the current measured value of that quantity. For Direct signal types (set on the Params1 tab), the Signal Level is captured and compared. The Diff measurement is:

$$\text{SignalLevel}(\text{current}) - \text{SignalLevel}(\text{Ref})$$

in dB.

For AM, FM, and PM signal types, the RMS modulation value (related to Modulation Depth, Frequency Deviation or Phase Deviation) is captured and compared. The Diff measurement is:

$$20 \times \log_{10} (\text{RMS}(\text{current})/\text{RMS}(\text{Ref}))$$

in dB.

Prefs Tab

The Prefs tab enables you to change appearance characteristics of the Audio Spectrum display.

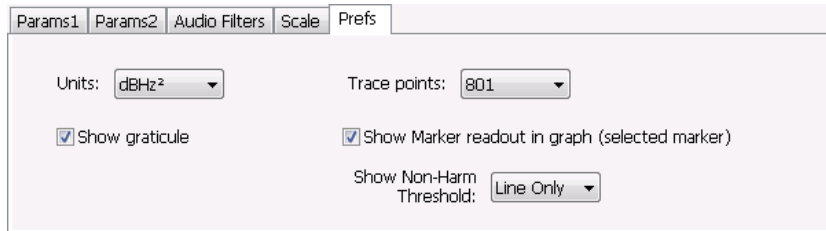

Setting	Description
Units:	Specifies the vertical scale units. The units available depend on the signal type selected.
Show graticule	Select to display or hide the graticule.
Trace points	Sets the number of trace points used for marker measurements and for results export.
Show Marker readout in graph (selected marker)	Shows or hides the readout for the selected marker in the graph area.
Show Non-Harm Threshold	Shows or hides the non-harmonic threshold line.

Overview

The displays in the General Purpose (GP) Digital Modulation folder (Displays > Folders > GP Digital Modulation) are:

- Constellation
- Demod I & Q vs Time
- EVM vs Time
- Eye Diagram
- Frequency Deviation vs Time
- Magnitude Error vs Time
- Phase Error vs Time
- Signal Quality
- Symbol Table
- Trellis Diagram

The General Purpose Digital Modulation Analysis (Option 21) provides vector signal analyzer functionality. A wide variety of modulation types are supported, allowing you to view your signals in Constellation, Eye and Trellis diagrams, measure the quality of the modulation, display time-domain waveforms for demodulated I & Q signals, EVM, Phase Error, Magnitude Error, and more.

Modulation Measurements

NOTE. *A maximum of approximately 80,000 samples can be analyzed by the General Purpose Digital Modulation measurements (the actual value varies with modulation type).*

Measurement	Description
EVM	The normalized RMS value of the error vector between the measured signal and the ideal reference signal over the analysis length. The EVM is generally measured on symbol or chip instants and can be reported in units of percent or dB. EVM is usually measured after best-fit estimates of the frequency error and a fixed phase offset have been removed.
Phase Error	The RMS phase difference between the measured signal and the ideal reference signal.
Magnitude Error	The RMS magnitude difference between the measured signal and the ideal reference signal.
IQ Origin Offset	The magnitude of the DC offset of the signal measured at the symbol times. It indicates the magnitude of the carrier feed-through signal.
Gain Imbalance	The gain difference between the I and Q channels in the signal generation path. Constellations with gain imbalance show a pattern with a width that is different from height.
Rho ρ	The normalized correlated power of the measured signal and the ideal reference signal. Like EVM, Rho is a measure of modulation quality. The value of Rho is less than 1 in all practical cases and is equal to 1 for a perfect signal measured in a perfect receiver.
Frequency Error	The frequency difference between the measured carrier frequency of the signal and the user-selected center frequency of the analyzer.
Quadrature Error	The orthogonal error between the I and Q channels. The error shows the phase difference between I and Q channels away from the ideal 90 degrees expected from the perfect I/Q modulation. Constellations with quadrature error will show some leakage of I into Q and vice versa.

Constellation Display

The Constellation Display shows a digitally-modulated signal in constellation form.

To show the Constellation Display:

1. Select the **Displays** button or select **Setup > Displays**. This shows the **Select Displays** dialog box.
2. From the **Folders** box, select **GP Digital Modulation**.
3. Double-click the **Constellation** icon in the **Available Displays** box. This adds the Constellation icon to the **Selected displays** box.
4. Click the **OK** button. This shows the Constellation display.

Elements of the Constellation Display

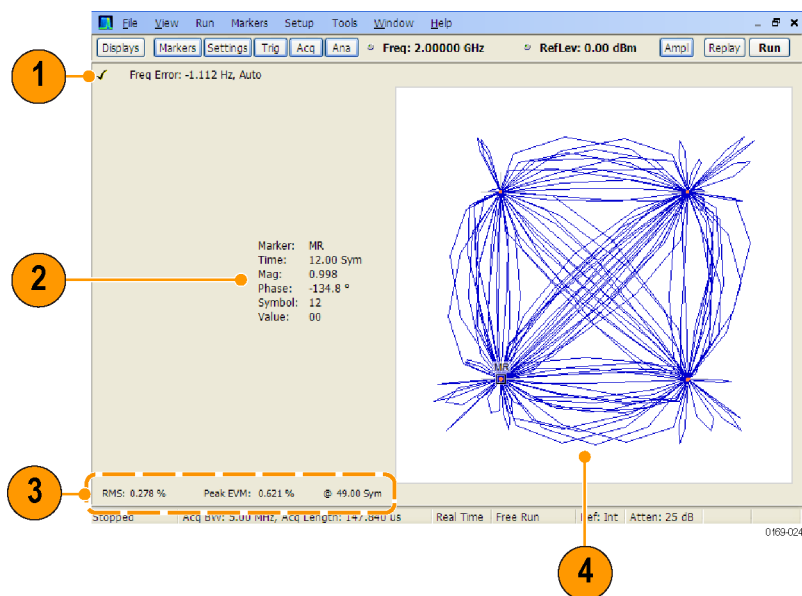

Item	Display element	Description
1	Check mark indicator	The check mark indicator in the upper, left-hand corner of the display shows when the Constellation display is the optimized display.
2	Marker Readout	Located to the left of the constellation plot or below it, depending on the size of the window. If markers are enabled, the marker readout shows the time, mag, phase, symbol marker and symbol value of the point with the selected marker.
3	EVM Readouts	The EVM readouts are located below the Constellation plot. The readout shows EVM Peak (%) and location, RMS (%).
4	Plot	Constellation graph.

[Changing Constellation Settings \(see page 285\)](#)

Constellation Settings

Menu Bar: Setup > Settings

Front Panel: Settings

Application Toolbar: 

The settings for the Constellation view are shown in the following table.

NOTE. You might be able to save time configuring the Constellation display by pressing the Standard Settings button from the Settings control panel. This allows you to select a preset optimized for a standard from the Select Standard dialog box. See [Standard Settings Button.](#) (see page 308)

Settings tab	Description
Modulation Params (see page 309)	Specifies the type of modulation, symbol rate, and filters to be used in demodulating the input signal.
Freq & BW (see page 313)	Sets values for frequency error/offset, measurement bandwidth, and frequency deviation (not every control is present for every modulation type).
Equalizer Tab (see page 314)	Enable the Equalizer and adjust its parameters.
Advanced Params (see page 316)	Specifies additional parameters that are less frequently used.
Find (see page 319)	Used to set parameters for finding a burst within the data record and for entering a Synch word.
Analysis Time (see page 319)	Contains parameters that define the portion of the acquisition record that is used for analysis. Also allows you to specify the Units (Seconds or Symbols) for the GP Digital Modulation displays.
Trace (see page 321)	Allows you to set the trace display characteristics.
Prefs (see page 323)	Enables you to set characteristics of the measurement display.

Demod I & Q vs Time Display

The Demod I & Q vs Time displays demodulated I and Q vs. Time. You can choose to display I only, Q only, or both.

Elements of the Display

To show the Demod I & Q vs Time display:

1. Select the **Displays** button or select **Setup > Displays**. This shows the **Select Displays** dialog box.
2. From the **Folders** box, select **GP Digital Modulation**.
3. Double-click the **Demod I&Q vs Time** icon in the **Available Displays** box. This adds the Demod I&Q vs Time icon to the **Selected displays** box.
4. Click the **OK** button. This shows the Demod I&Q vs Time display.

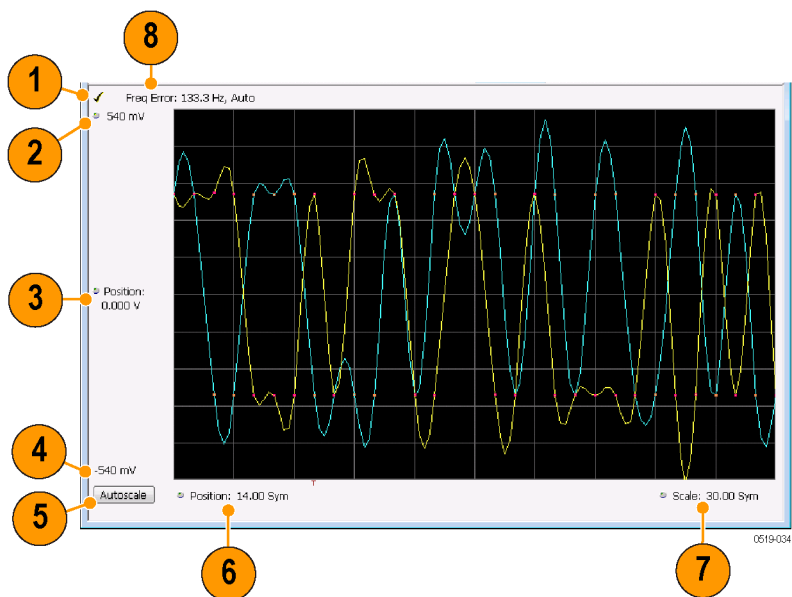

Item	Element	Description
1	Check mark indicator	The check mark indicator in the upper, left-hand corner of the display shows when the Demod I & Q vs Time display is the optimized display.
2	Top of Graph	Sets the I and Q amplitude value indicated at the top of the graph. Changing the top value affects the bottom of graph readout. Also, note that the top of graph setting interacts with the internal vertical scale setting (which is not user settable) such that the range between the top and bottom of the graph increases or decreases automatically.
3	Position	Specifies the I and Q amplitude value shown at the center of the graph display.
4	Bottom Readout	Displays the I and Q amplitude value shown at the bottom of graph.
5	Autoscale	Adjusts the vertical and horizontal settings to provide the best display.
6	Position	Specifies the horizontal position of the trace on the graph display.
7	Scale	Adjusts the span of the graph. By decreasing the scale (time per division), the graph essentially becomes a window that you can move over the acquisition record by adjusting the offset.
8	Freq Error	This readout can show Freq Error or Freq Offset. When it displays Freq Error, it shows the difference between the instrument Frequency setting and the measured value of the signal's carrier frequency. When it displays Freq Offset, it shows the frequency offset specified on the Settings > Freq & BW (see page 313) tab. If Freq Error is displayed, it also indicates that the Carrier frequency detection setting is Auto. If Freq Offset is displayed, it indicates that the Carrier frequency detection setting is manual.

[Changing Demod I&Q Settings. \(see page 288\)](#)

Demod I & Q vs Time Settings

Menu Bar: Setup > Settings

Front Panel: Settings

Application Toolbar: 

The settings for the Demod I & Q vs Time display are shown in the following table.

NOTE. You might be able to save time configuring the Demod I & Q display by pressing the Standard Settings button from the Settings control panel. This allows you to select a preset optimized for a standard from the Select Standard dialog box. See [Standard Settings Button. \(see page 308\)](#)

Settings tab	Description
Modulation Params (see page 309)	Specifies the type of modulation used for the input signal and other parameters.
Freq & BW (see page 313)	Specifies settings for frequency error, measurement BW and Frequency Deviation. Each of these settings is set internally when set to Auto. Alternatively, you can specify values appropriate for specific measurement needs.
Equalizer Tab (see page 314)	Enable the Equalizer and adjust its parameters.
Advanced Params (see page 316)	Specifies additional parameters.
Find (see page 319)	Used to set parameters for finding a burst within the data record and for entering a Synch word.
Analysis Time (see page 319)	Contains parameters that define the portion of the acquisition record that is used for analysis. Also allows you to specify the Units (Seconds or Symbols) for the GP Digital Modulation displays.
Trace (see page 321)	Allows you to set the trace display characteristics.
Scale (see page 323)	Specifies the horizontal and vertical scale settings.
Prefs (see page 323)	Enables you to set characteristics of the measurement display.

EVM vs Time Display

The EVM vs. Time Display shows the Error Vector Magnitude plotted over Time.

NOTE. A maximum of approximately 80,000 samples can be analyzed by the General Purpose Digital Modulation measurements (the actual value varies with modulation type).

To show an EVM vs. Time display:

1. Press the **Displays** button or select **Setup > Displays**. This shows the **Select Displays** dialog box.
2. From the **Folders** box, select **GP Digital Modulation**.
3. Double-click the **EVM vs. Time** icon in the **Available Displays** box. This adds the EVM vs. Time icon to the **Selected displays** box.
4. Click the **OK** button. This displays the EVM vs. Time view.

Elements of the EVM vs Time Display

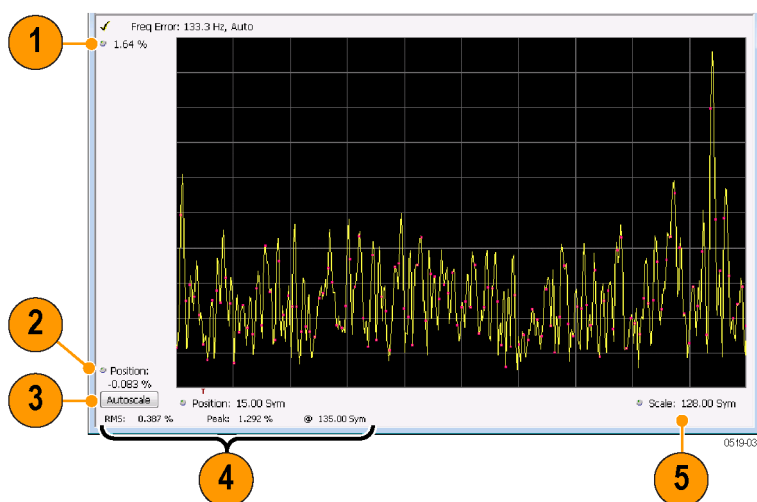

Item	Display element	Description
1	Top of graph adjustment	Use the knob to adjust the vertical scale.
2	Position	Adjusts the vertical position.
3	Autoscale	Adjusts the Horizontal and Vertical scale to show the entire trace.
4	Peak and RMS value readout	Shows the maximum result, the time it occurred, and the RMS of the result over the entire analysis length.
5	Scale	Sets the length of time shown in the graph.

[Changing the EVM vs Time Display Settings \(see page 289\)](#)

EVM vs Time Settings

Menu Bar: Setup > Settings

Front Panel: Settings

Application Toolbar: 

The settings for the EVM vs. Time display are shown in the following table.

NOTE. You might be able to save time configuring the EVM vs. Time display by pressing the *Standard Settings* button from the *Settings* control panel. This allows you to select a preset optimized for a standard from the *Select Standard* dialog box. See [Standard Settings Button. \(see page 308\)](#)

Settings tab	Description
Modulation Params (see page 309)	Specifies the type of modulation used in the input signal and other parameters that controls the demodulation of the input signal.
Freq & BW (see page 313)	Specifies settings for frequency error, measurement BW and Frequency Deviation. Each of these settings is set internally when set to Auto. Alternatively, you can specify values appropriate for specific measurement needs.
Equalizer Tab (see page 314)	Enable the Equalizer and adjust its parameters.
Advanced Params (see page 316)	Specifies Freq Offset, Magnitude normalization parameters, and enables swapping I and Q.
Find (see page 319)	The Find tab is used to set parameters for finding bursts within the data record.
Analysis Time (see page 319)	The Analysis Time tab contains parameters that define how the signal is analyzed in the general purpose digital modulation displays.
Trace (see page 321)	Specifies the display characteristics of the displayed trace.
Scale (see page 323)	Specifies the horizontal and vertical scale settings.
Prefs (see page 323)	Specifies whether certain display elements are visible.

Eye Diagram Display

The Eye Diagram Display shows a digitally modulated signal overlapped on itself to reveal variations in the signal.

To show an Eye Diagram display:

1. Press the **Displays** button or select **Setup > Displays**. This shows the **Select Displays** dialog box.
2. From the **Folders** box, select **GP Digital Modulation**.
3. Double-click the **Eye Diagram** icon in the **Available Displays** box. This adds the Eye Diagram icon to the **Selected displays** box.
4. Click the **OK** button. This displays the Eye Diagram view.

Elements of the Display

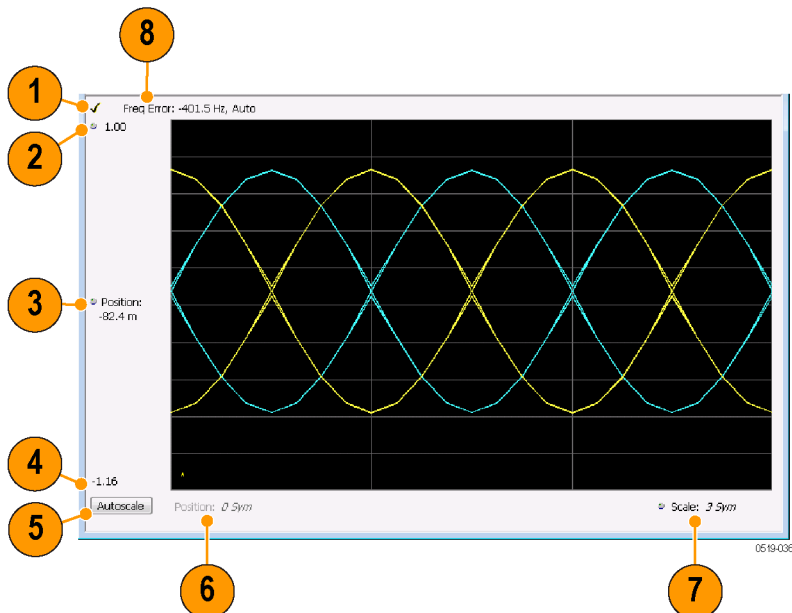

Item	Element	Description
1	Check mark indicator	The check mark indicator in the upper, left-hand corner of the display shows when the Frequency Deviation vs Time display is the optimized display.
2	Top of Graph	The vertical scale is normalized with no units (except for nFSK and C4FM modulation types where the vertical units are Hz).
3	Position	Specifies the value shown at the center of the graph display.
4	Bottom Readout	Displays the value indicated by the bottom of graph.
5	Autoscale	Adjusts the vertical and horizontal settings to provide the best display.
6	Position	Displays the horizontal position of the trace on the graph display.
7	Scale	Adjusts the span of the graph in symbols.
8	Freq Error	Displays the difference between the maximum and minimum measured values of the signal frequency during the Measurement Time. The displayed frequency error is followed by either Auto or Manual . This indicates the selected carrier frequency detection method (see Settings > Freq & BW).

[Changing Eye Diagram Settings \(see page 291\)](#)

Eye Diagram Settings

Menu Bar: Setup > Settings

Front Panel: Settings

Application Toolbar: 

The settings for the Eye Diagram display are shown in the following table.

NOTE. You might be able to save time configuring the Eye Diagram display by pressing the *Standard Settings* button from the *Settings* control panel. This allows you to select a preset optimized for a standard from the *Select Standard* dialog box. See [Standard Settings Button](#). (see page 308)

Settings tab	Description
Modulation Params (see page 309)	Specifies the type of modulation used for the input signal and other parameters.
Freq & BW (see page 313)	Specifies settings for frequency error, measurement BW and Frequency Deviation. Each of these settings is set internally when set to Auto. Alternatively, you can specify values appropriate for specific measurement needs.
Advanced Params (see page 316)	Specifies additional parameters.
Find (see page 319)	Used to set parameters for finding a burst within the data record and for entering a Synch word.
Analysis Time (see page 319)	Contains parameters that define the portion of the acquisition record that is used for analysis. Also allows you to specify the Units (Seconds or Symbols) for the GP Digital Modulation displays.
Trace (see page 321)	Allows you to set the trace display characteristics.
Scale (see page 323)	Specifies the horizontal and vertical scale settings.
Prefs (see page 323)	Enables you to set characteristics of the measurement display.

Frequency Deviation vs Time Display

To show a Frequency Deviation vs Time display:

1. Press the **Displays** button or select **Setup > Displays**. This shows the **Select Displays** dialog box.
2. From the **Folders** box, select **Frequency Deviation vs Time**.
3. Double-click the **Frequency Deviation vs Time** icon in the **Available Displays** box. This adds the Frequency Deviation vs Time icon to the **Selected displays** box.
4. Click the **OK** button. This displays the Frequency Deviation vs Time view.

Elements of the Display



Item	Element	Description
1	Check mark indicator	The check mark indicator in the upper, left-hand corner of the display shows when the Frequency Deviation vs Time display is the optimized display.
2	Top of Graph	Sets the frequency deviation value indicated at the top of the graph. Changing the top value affects the bottom of graph readout. Also, note that the top of graph setting interacts with the internal vertical scale setting (which is not user settable) such that the range between the top and bottom of the graph increases or decreases automatically.
3	Position	Specifies the frequency deviation value shown at the center of the graph display.
4	Bottom Readout	Displays the value of the frequency deviation value shown at the bottom of graph.
5	Autoscale	Adjusts the vertical and horizontal settings to provide the best display.
6	Position	Specifies the horizontal position of the trace on the graph display.
7	Scale	Adjusts the span of the graph. By decreasing the scale (time per division), the graph essentially becomes a window that you can move over the acquisition record by adjusting the offset.
8	Freq Error	Displays the difference between the maximum and minimum measured values of the signal frequency during the Measurement Time. The displayed frequency error is followed by either Auto or Manual . This indicates the selected carrier frequency detection method (see Settings > Freq & BW).

[Changing Frequency Deviation vs Time Settings \(see page 294\)](#)

Frequency Deviation vs Time Settings

Menu Bar: Setup > Settings

Front Panel: Settings

Application Toolbar: 

The Setup settings for Frequency Deviation vs. Time are shown in the following table.

NOTE. You might be able to save time configuring the Frequency vs. Time display by pressing the Standard Settings button from the Settings control panel. This allows you to select a preset optimized for a standard from the Select Standard dialog box. See [Standard Settings Button. \(see page 308\)](#)

Settings tab	Description
Modulation Params (see page 309)	Specifies the type of modulation used for the input signal and other parameters.
Freq & BW (see page 313)	Specifies settings for frequency error, measurement BW and Frequency Deviation. Each of these settings is set internally when set to Auto. Alternatively, you can specify values appropriate for specific measurement needs.
Equalizer Tab (see page 314)	Enable the Equalizer and adjust its parameters.
Advanced Params (see page 316)	Specifies additional parameters.
Find (see page 319)	Used to set parameters for finding a burst within the data record and for entering a Synch word.
Analysis Time (see page 319)	Contains parameters that define the portion of the acquisition record that is used for analysis. Also allows you to specify the Units (Seconds or Symbols) for the GP Digital Modulation displays.
Trace (see page 321)	Allows you to set the trace display characteristics.
Scale (see page 323)	Specifies the horizontal and vertical scale settings.
Prefs (see page 323)	Enables you to set characteristics of the measurement display.

Magnitude Error vs Time Display

The Magnitude Error displays the magnitude of the symbol error. The amplitude appears on the vertical axis while time is plotted along the horizontal axis.

NOTE. A maximum of approximately 80,000 samples can be analyzed by the General Purpose Digital Modulation measurements (the actual value varies with modulation type).

To display Magnitude Error vs. Time:

1. Select the **Displays** button or **Setup > Displays**. This displays the Select Displays dialog box.
2. Select **GP Digital Modulation** in the **Folders** box.
3. Double-click the **Mag Error vs. Time** icon or select the icon and click **Add**. The icon will appear in the **Selected displays** box and will no longer appear under Available displays.
4. Click **OK**.

Elements of the Display

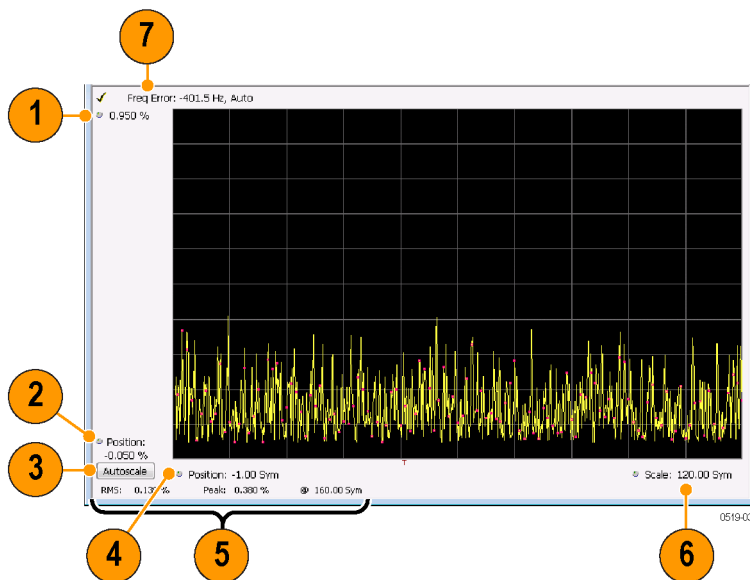

Item	Display element	Description
1	Top of graph adjustment	Use the knob to adjust the value of the vertical scale.
2	Position	Adjusts the level shown at the bottom of the display.
3	Autoscale button	Adjusts the vertical and horizontal settings to provide the best display.
4	Horizontal Position	Adjusts the horizontal position of the signal. Units can be either Symbols or Seconds (Settings > Analysis Time tab > Units).
5	Peak and RMS value readout	Displays the Peak value of the magnitude error, the RMS value of the magnitude error, and the time at which it occurs within the acquisition. Units can be either Symbols or Seconds (Settings > Analysis Time tab > Units).
6	Horizontal Scale	Sets the time spanned by the graph. Units can be either Symbols or Seconds (Settings > Analysis Time tab > Units).
7	Freq Error	Freq Error is the difference between the Center Frequency and the measured frequency of the signal being tested. This readout will be Freq Offset if the Freq Offset parameter on the Settings > Advanced Params (see page 316) tab is set to Manual.

[Changing Magnitude Error vs Time Display Settings \(see page 296\)](#)

Magnitude Error vs Time Settings

Menu Bar: Setup > Settings

Front Panel: Settings

Application Toolbar: 

The Setup settings for Magnitude Errors vs. Time are shown in the following table.

NOTE. You might be able to save time configuring the Magnitude vs. Time display by pressing the Standard Settings button from the Settings control panel. This allows you to select a preset optimized for a standard from the Select Standard dialog box. See [Standard Settings Button. \(see page 308\)](#)

Settings tab	Description
Modulation Params (see page 309)	Specifies the type of modulation used for the input signal and other parameters.
Freq & BW (see page 313)	Specifies settings for frequency error, measurement BW and Frequency Deviation. Each of these settings is set internally when set to Auto. Alternatively, you can specify values appropriate for specific measurement needs.
Equalizer Tab (see page 314)	Enable the Equalizer and adjust its parameters.
Advanced Params (see page 316)	Specifies additional parameters.
Find (see page 319)	Used to set parameters for finding a burst within the data record and for entering a Synch word.
Analysis Time (see page 319)	Contains parameters that define the portion of the acquisition record that is used for analysis. Also allows you to specify the Units (Seconds or Symbols) for the GP Digital Modulation displays.
Trace (see page 321)	Allows you to set the trace display characteristics.
Scale (see page 323)	Specifies the horizontal and vertical scale settings.
Prefs (see page 323)	Enables you to set characteristics of the measurement display.

Phase Error vs Time Display

The Phase Error vs. Time display shows the phase angle of the symbol error over time. The phase is plotted along the vertical axis while time is plotted along the horizontal axis.

NOTE. A maximum of approximately 80,000 samples can be analyzed by the General Purpose Digital Modulation measurements (the actual value varies with modulation type).

To show the Phase Error display:

1. Press the **Displays** button or select **Setup > Displays**.
2. In the **Select Displays** dialog, select **GP Digital Modulation** in the **Folders** box.
3. In the **Available displays** box, double-click the **Phase Error** icon or select the icon and click **Add**. The Phase Error icon will appear in the **Selected displays** box and will no longer appear under Available displays.
4. Click **OK** to display the Phase Error.

Elements of the Phase Error vs Time Display

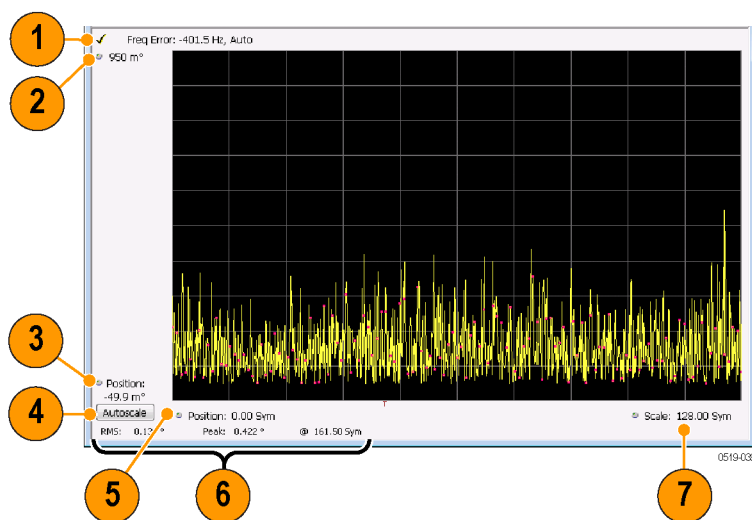

Item	Display element	Description
1	Freq Error	Freq Error is the difference between the Center Frequency and the measured frequency of the signal being tested. This readout will be Freq Offset if the Freq Offset parameter on the Settings > Advanced Params (see page 316) tab is set to Manual.
2	Top of graph adjustment	Adjusts the phase angle shown at the top of the graph.
3	Position	Adjusts the vertical offset.
4	Autoscale	Adjusts the vertical and horizontal settings so that the entire trace fits in the graph.
5	Offset	Adjusts the horizontal offset.
6	Peak and RMS readouts	Displays the Peak value of the phase error and the time at which it occurred. Also displays the RMS value over the analysis length.
7	Scale	Sets the time spanned by the graph.

[Changing the Phase Error vs Time Display Settings \(see page 298\)](#)

Phase Error vs. Time Settings

Menu Bar: Setup > Settings

Front Panel: Settings

Application Toolbar: 

The settings for the Phase Error vs. Time display are shown in the following table.

NOTE. You might be able to save time configuring the Phase Error vs. Time display by pressing the Standard Settings button from the Settings control panel. This allows you to select a preset optimized for a standard from the Select Standard dialog box. See [Standard Settings Button. \(see page 308\)](#)

Settings tab	Description
Modulation Params (see page 309)	Specifies the type of modulation used for the input signal and other parameters.
Freq & BW (see page 313)	Specifies settings for frequency error, measurement BW and Frequency Deviation. Each of these settings is set internally when set to Auto. Alternatively, you can specify values appropriate for specific measurement needs.
Equalizer Tab (see page 314)	Enable the Equalizer and adjust its parameters.
Advanced Params (see page 316)	Specifies additional parameters.
Find (see page 319)	Used to set parameters for finding a burst within the data record and for entering a Synch word.
Analysis Time (see page 319)	Contains parameters that define the portion of the acquisition record that is used for analysis. Also allows you to specify the Units (Seconds or Symbols) for the GP Digital Modulation displays.
Trace (see page 321)	Allows you to set the trace display characteristics.
Scale (see page 323)	Specifies the horizontal and vertical scale settings.
Prefs (see page 323)	Enables you to set characteristics of the measurement display.

Signal Quality Display

The Signal Quality display shows several measurements of signal quality. The measurements displayed depend on the modulation type. There is a set of measurements displayed for all modulation types except nFSK and C4FM. There is a second set of measurements displayed for nFSK and C4FM modulation types.

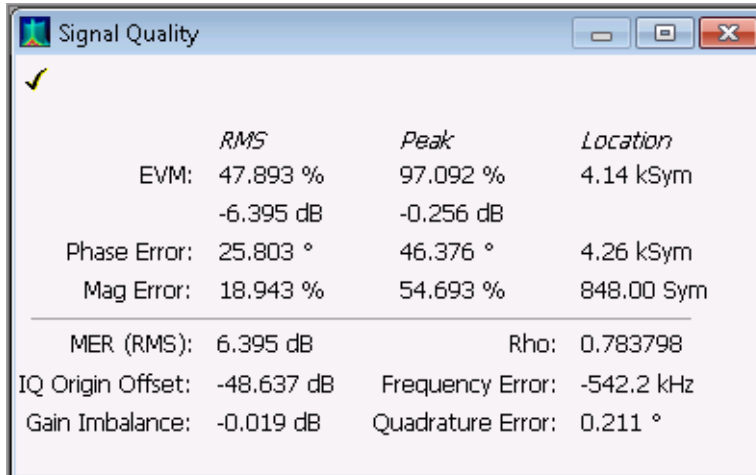

Signal Quality

	<i>RMS</i>	<i>Peak</i>	<i>Location</i>
EVM:	47.893 %	97.092 %	4.14 kSym
	-6.395 dB	-0.256 dB	
Phase Error:	25.803 °	46.376 °	4.26 kSym
Mag Error:	18.943 %	54.693 %	848.00 Sym
<hr/>			
MER (RMS):	6.395 dB	Rho:	0.783798
IQ Origin Offset:	-48.637 dB	Frequency Error:	-542.2 kHz
Gain Imbalance:	-0.019 dB	Quadrature Error:	0.211 °

Signal Quality display for all modulation types except nFSK, C4FM, OQPSK, and SOQPSK

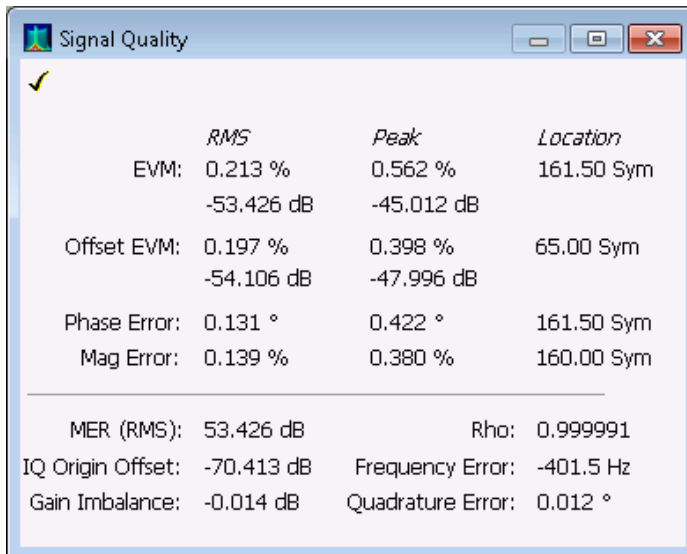

Signal Quality

	<i>RMS</i>	<i>Peak</i>	<i>Location</i>
EVM:	0.213 %	0.562 %	161.50 Sym
	-53.426 dB	-45.012 dB	
Offset EVM:	0.197 %	0.398 %	65.00 Sym
	-54.106 dB	-47.996 dB	
Phase Error:	0.131 °	0.422 °	161.50 Sym
Mag Error:	0.139 %	0.380 %	160.00 Sym
<hr/>			
MER (RMS):	53.426 dB	Rho:	0.999991
IQ Origin Offset:	-70.413 dB	Frequency Error:	-401.5 Hz
Gain Imbalance:	-0.014 dB	Quadrature Error:	0.012 °

Signal Quality display for OQPSK and SOQPSK modulation types

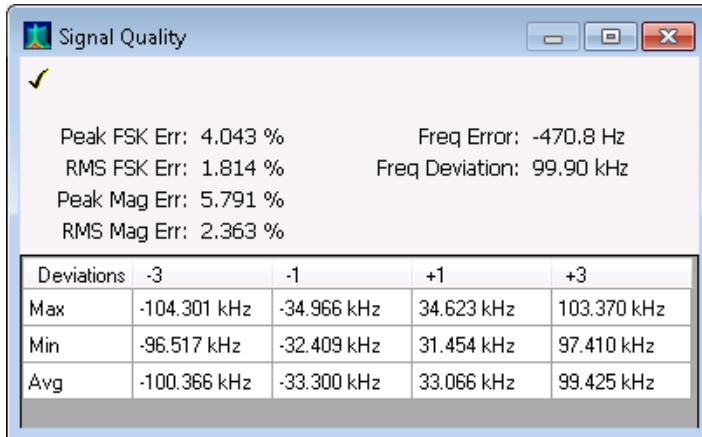

Signal Quality

✓

Peak FSK Err: 4.043 % Freq Error: -470.8 Hz
 RMS FSK Err: 1.814 % Freq Deviation: 99.90 kHz
 Peak Mag Err: 5.791 %
 RMS Mag Err: 2.363 %

Deviations	-3	-1	+1	+3
Max	-104.301 kHz	-34.966 kHz	34.623 kHz	103.370 kHz
Min	-96.517 kHz	-32.409 kHz	31.454 kHz	97.410 kHz
Avg	-100.366 kHz	-33.300 kHz	33.066 kHz	99.425 kHz

Signal Quality display for nFSK modulation type

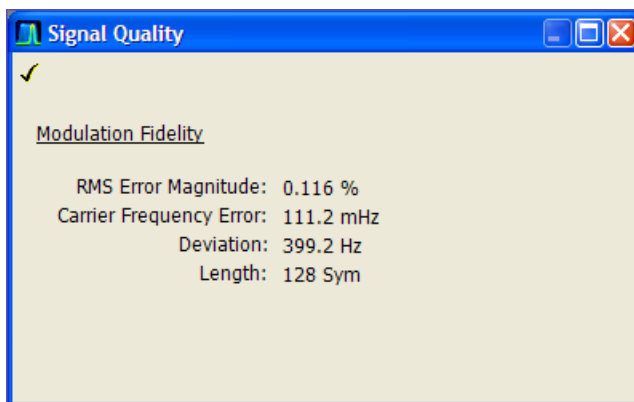

Signal Quality

✓

Modulation Fidelity

RMS Error Magnitude: 0.116 %
 Carrier Frequency Error: 111.2 mHz
 Deviation: 399.2 Hz
 Length: 128 Sym

Signal Quality display for C4FM modulation type

Elements of the Display

Measurements for all modulation types except nFSK, C4FM, OQPSK and SOQPSK

Measurement	Description
EVM	The normalized RMS value of the error vector between the measured signal and the ideal reference signal over the analysis length. The EVM is generally measured on symbol or chip instants and is reported in units of percent and dB. EVM is usually measured after best-fit estimates of the frequency error and a fixed phase offset have been removed. These estimates are made over the analysis length. Displays RMS and Peak values with location of Peak value.
Phase Error	The RMS phase difference between the measured signal and the ideal reference signal. Displays RMS and Peak values with location of Peak value.
Mag Error	The RMS magnitude difference between the measured signal and the reference signal magnitude. Displays RMS and Peak values with location of Peak value.
MER (RMS)	The MER is defined as the ratio of I/Q signal power to I/Q noise power; the result is indicated in dB.
IQ Origin Offset	The magnitude of the DC offset of the signal measured at the symbol times. It indicates the magnitude of the carrier feed-through signal.
Frequency Error	The frequency difference between the measured carrier frequency of the signal and the user-selected center frequency of the instrument.
Gain Imbalance	The gain difference between the I and Q channels in the signal generation path. Constellations with gain imbalance show a pattern with a width that is different from height.
Quadrature Error	The orthogonal error between the I and Q channels. The error shows the phase difference between I and Q channels away from the ideal 90 degrees expected from the perfect I/Q modulation. Not valid for BPSK modulation type.
Rho	The normalized correlated power of the measured signal and the ideal reference signal. Like EVM, Rho is a measure of modulation quality. The value of Rho is less than 1 in all practical cases and is equal to 1 for a perfect signal measured in a perfect receiver.

Measurements for QPSK and SQPSK modulation types

Measurement	Description
EVM	The normalized RMS value of the error vector between the measured signal and the ideal reference signal over the analysis length. The EVM is generally measured on symbol or chip instants and is reported in units of percent and dB. EVM is usually measured after best-fit estimates of the frequency error and a fixed phase offset have been removed. These estimates are made over the analysis length. Displays RMS and Peak values with location of Peak value.
Offset EVM	Offset EVM is like EVM except for a difference in the time alignment of the I and Q samples. For EVM, I and Q samples are collected at the same time, for every symbol decision point (twice the symbol rate for offset modulations). For Offset EVM, the I and Q symbol decision points are time-aligned before collecting the I and Q samples. In this case, one I and one Q sample is collected for each symbol (half as many samples as the same number of symbols for (non-offset) EVM).
Phase Error	The RMS phase difference between the measured signal and the ideal reference signal. Displays RMS and Peak values with location of Peak value.
Mag Error	The RMS magnitude difference between the measured signal and the reference signal magnitude. Displays RMS and Peak values with location of Peak value.
MER (RMS)	The MER is defined as the ratio of I/Q signal power to I/Q noise power; the result is indicated in dB.
IQ Origin Offset	The magnitude of the DC offset of the signal measured at the symbol times. It indicates the magnitude of the carrier feed-through signal.
Frequency Error	The frequency difference between the measured carrier frequency of the signal and the user-selected center frequency of the instrument.
Gain Imbalance	The gain difference between the I and Q channels in the signal generation path. Constellations with gain imbalance show a pattern with a width that is different from height.
Quadrature Error	The orthogonal error between the I and Q channels. The error shows the phase difference between I and Q channels away from the ideal 90 degrees expected from the perfect I/Q modulation. Not valid for BPSK modulation type.
Rho	The normalized correlated power of the measured signal and the ideal reference signal. Like EVM, Rho is a measure of modulation quality. The value of Rho is less than 1 in all practical cases and is equal to 1 for a perfect signal measured in a perfect receiver.

Measurements for nFSK modulation types

Measurement	Description
Peak FSK err	Peak value of the frequency deviation error at the symbol point.
RMS FSK Err	RMS value of the frequency deviation error at the symbol point.
Peak Mag Err	The Peak magnitude difference between the measured signal and the reference signal magnitude.
RMS Mag Err	The RMS magnitude difference between the measured signal and the reference signal magnitude.
Freq Error	The frequency difference between the measured carrier frequency of the signal and the user-selected center frequency of the instrument.
Freq Deviation	Frequency distance from the center frequency at the symbol point.
Symbol Rate Error	This compares the user-entered symbol rate to the instrument calculated symbol rate of the analyzed signal.
Symbol Rate	When in Auto-symbol rate, the instrument calculates the symbol rate of the signal and the instrument calculates the error between the user entered value and the instrument calculated value.

Measurements for C4FM modulation type

Measurement	Description
RMS Error Magnitude	RMS value of the frequency deviation error at the symbol point.
Carrier Frequency Error	Frequency difference between averaged signal frequency and the center frequency.
Deviation	Frequency distance from the center frequency at the symbol point.
Length	Number of symbols in the analysis area.

[Changing the Signal Quality Display Settings \(see page 303\)](#)

Signal Quality Settings

Menu Bar: Setup > Settings

Front Panel: Settings

Application Toolbar: 

The Setup settings for Signal Quality are accessible only when the Signal Quality display is selected.

NOTE. You might be able to save time configuring the Signal Quality display by pressing the Standard Settings button from the Settings control panel. This allows you to select a preset optimized for a standard from the Select Standard dialog box. See [Standard Settings Button. \(see page 308\)](#)

Settings tab	Description
Modulation Params (see page 309)	The Modulation tab specifies the type of modulation used for the input signal and other parameters.
Freq & BW (see page 313)	Specifies settings for frequency error, measurement BW and Frequency Deviation. Each of these settings is set internally when set to Auto. Alternatively, you can specify values appropriate for specific measurement needs.
Equalizer Tab (see page 314)	Enable the Equalizer and adjust its parameters.
Advanced Params (see page 316)	The Advanced Params tab specifies frequency offset, magnitude normalization method and allows you to swap the I and Q signals.
Find (see page 319)	Find tab is used to set parameters for finding bursts within the data record.
Analysis Time (see page 319)	The Analysis Time tab contains parameters that define the portion of the acquisition record that is used for analysis.
Prefs (see page 323)	The Prefs tab enables you to set characteristics of the measurement display.

Symbol Table Display

The Symbol Table Display is like the Constellation Display except that a text table is used to display data bits at a symbol rather than a graph. The Synch Word characters, if used, are in bold font.

To display the Symbol Table:

1. Select the **Displays** button or select **Setup > Displays**. This displays the **Select Displays** dialog box.
2. From the **Folders** box, select **GP Digital Modulation**.
3. Double-click the **Symbol Table** icon in the **Available Displays** box. This adds the Symbol Table icon to the **Selected displays** box.
4. Click the **OK** button. This displays the Symbol Table view.

0	10	01	11	10	00	10	01	10	11	00	00	11	01	11	01	11
16	01	10	00	01	10	11	10	00	01	10	10	00	00	01	10	11
32	10	00	01	11	01	10	10	00	11	00	00	10	00	11	10	01
48	11	10	01	01	11	11	11	01	01	00	11	00	00	11	01	11
64	01	01	11	11	10	11	10	10	01	10	10	10	00	10	01	11
80	10	10	00	11	11	01	01	01	00	00	00	10	10	10	01	
96	10	11	11	01	11	01	11	10	01	00	00	00	00	11	00	01
112	01	01	10	00	11	01	01	01	10	11	01	01	10	11	11	01
128	01	00	11	00	11	10	00	01	01	01	01	10	01	11	01	10
144	01	10	00	10	11	10	00	01	10	11	10	10	01	01	00	10
160	11	10	10	11	00	00	11	10	00	00	11	00	10	10	01	11
176	10	01	10	11	11	00	10	10	11	10	11	01	01	00	00	10
192	00	11	11	00	00	00	11	00	00	10	10	00	11	00	10	00
208	11	10	01	11	10	10	01	11	11	00	01	10	11	11	10	11
224	10	00	10	10	00	10	10	10	11	01	10	10	10	11	00	01
240	11	00	11	00	01	01	01	11	11	10	10	10	10	01	00	10

Marker: M1 Symbol: 0
Time: 0.00 Sym Value: 10

Using Markers

Markers are indicators in the display that you can position on a trace to measure values such as frequency, power, and time. A Marker always displays its position and, if the Delta readout is enabled, will display the difference between its position and that of the Marker Reference. Within the Symbol Table, colored cells indicate the location of markers. The selected Marker is highlighted with a light green background. All other markers are highlighted with a light gray background. In the Symbol Table, the marker readout below the table shows the marker location in time, symbol numbers and symbol value.

[Changing the Symbol Table Display Settings \(see page 305\)](#)

Symbol Table Settings

Menu Bar: Setup > Settings

Front Panel: Settings

Application Toolbar: 

The Setup settings for the Symbol Table view are shown in the following table.

NOTE. You might be able to save time configuring the Symbol Table display by pressing the Standard Settings button from the Settings control panel. This allows you to select a preset optimized for a standard from the Select Standard dialog box. See [Standard Settings Button. \(see page 308\)](#)

Settings tab	Description
Modulation Params (see page 309)	The Modulation tab specifies the type of modulation used for the input signal and other parameters.
Freq & BW (see page 313)	Specifies settings for frequency error, measurement BW and Frequency Deviation. Each of these settings is set internally when set to Auto. Alternatively, you can specify values appropriate for specific measurement needs.
Equalizer Tab (see page 314)	Enable the Equalizer and adjust its parameters.
Advanced Params (see page 316)	The Advanced Params tab specifies additional parameters.
Find (see page 319)	Find tab is used to set parameters for finding bursts within the data record.
Analysis Time (see page 319)	The Analysis Time tab contains parameters that define the portion of the acquisition record that is used for analysis.
Prefs (see page 323)	The Prefs tab enables you to set characteristics of the measurement display.

Trellis Diagram Display

To show an Trellis Diagram display:

1. Press the **Displays** button or select **Setup > Displays**. This shows the **Select Displays** dialog box.
2. From the **Folders** box, select **GP Digital Modulation**.
3. Double-click the **Trellis Diagram** icon in the **Available Displays** box. This adds the Trellis Diagram icon to the **Selected displays** box.
4. Click the **OK** button. This displays the Trellis Diagram view.

Elements of the Display

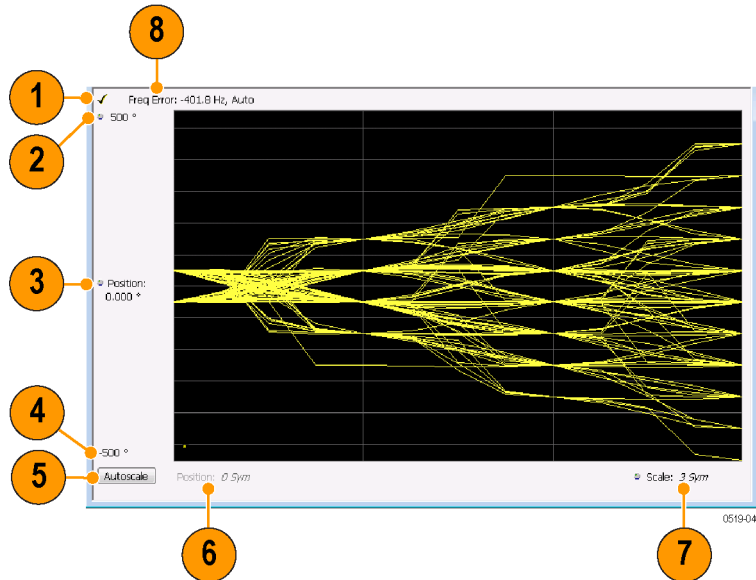

Item	Element	Description
1	Check mark indicator	The check mark indicator in the upper, left-hand corner of the display shows when the Frequency Deviation vs Time display is the optimized display.
2	Top of Graph	Sets the phase value indicated at the top of the graph. Changing the top value affects the bottom of graph readout. Also, note that the top of graph setting interacts with the internal vertical scale setting (which is not user settable) such that the range between the top and bottom of the graph increases or decreases automatically.
3	Position	Specifies the phase value shown at the center of the graph display.
4	Bottom Readout	Displays the value of the phase value shown at the bottom of graph.
5	Autoscale	Adjusts the vertical and horizontal settings to provide the best display.
6	Position	Displays the horizontal position of the trace on the graph display.
7	Scale	Adjusts the span of the graph in symbols.
8	Freq Error	Displays the difference between the maximum and minimum measured values of the signal frequency during the Measurement Time. The displayed frequency error is followed by either Auto or Manual . This indicates the selected carrier frequency detection method (see Settings > Freq & BW).

[Changing the Trellis Diagram Settings \(see page 307\)](#)

Trellis Diagram Settings

Menu Bar: Setup > Settings

Front Panel: Settings

Application Toolbar: 

The settings for the Trellis Diagram display are shown in the following table.

NOTE. You might be able to save time configuring the Trellis Diagram display by pressing the Standard Settings button from the Settings control panel. This allows you to select a preset optimized for a standard from the Select Standard dialog box. See [Standard Settings Button. \(see page 308\)](#)

Settings tab	Description
Modulation Params (see page 309)	Specifies the type of modulation used for the input signal and other parameters.
Freq & BW (see page 313)	Specifies settings for frequency error, measurement BW and Frequency Deviation. Each of these settings is set internally when set to Auto. Alternatively, you can specify values appropriate for specific measurement needs.
Equalizer Tab (see page 314)	Enable the Equalizer and adjust its parameters.
Advanced Params (see page 316)	Specifies additional parameters.
Find (see page 319)	Used to set parameters for finding a burst within the data record and for entering a Synch word.
Analysis Time (see page 319)	Contains parameters that define the portion of the acquisition record that is used for analysis. Also allows you to specify the Units (Seconds or Symbols) for the GP Digital Modulation displays.
Trace (see page 321)	Allows you to set the trace display characteristics.
Scale (see page 323)	Specifies the horizontal and vertical scale settings.
Prefs (see page 323)	Enables you to set characteristics of the measurement display.

GP Digital Modulation Shared Measurement Settings

The displays in the GP Digital Modulation folder (Setup > Displays) are each a different format for presenting the results of a single underlying analysis. For this reason, all controls that affect the analysis parameters are shared by all the displays in the GP Digital Modulation folder.

Changing a setting on one tab changes that setting for all the GP Digital Modulation displays. For example, if you change the Modulation Type for the Constellation Display, it also changes the Modulation

type setting for the Signal Quality display. There are some controls that affect only the way an individual display presents its results, such as graph scaling.

Common controls for GP digital modulation displays

Settings tab	Description
Modulation Params (see page 309)	Specifies the type of modulation, symbol rate, and filters to be used in demodulating the input signal.
Freq & BW (see page 313)	Sets values for frequency error/offset, measurement bandwidth, and frequency deviation (not every control is present for every modulation type).
Equalizer Tab (see page 314)	Enable the Equalizer and adjust its parameters.
Advanced Params (see page 316)	Specifies additional parameters that are less frequently used.
Find (see page 319)	Used to set parameters for finding a burst within the data record and for entering a Synch word.
Analysis Time (see page 319)	Contains parameters that define the portion of the acquisition record that is used for analysis. Also allows you to specify the Units (Seconds or Symbols) for the GP Digital Modulation displays.
Trace (see page 321)	Allows you to set the trace display characteristics.
Prefs (see page 323)	Enables you to set characteristics of the measurement display.

Standard Settings Button

On every GP Digital Modulation control panel there is a button labeled **Standard Settings**. This button is used to recall settings optimized for analyzing the selected standard. See the following table for a list of the standards for which standard settings are available. Choosing a standard from the dialog box changes only settings for GP Digital Modulation displays.

All of the presets in the Standard Settings Dialog make the following settings:

- Analysis Length: Auto
- Points per Symbol: 4
- Data Differential: No
- Burst Mode: Off
- Burst Detection Threshold: -10 dBc

Parameter values set by presets in the standard settings dialog

Standard	Modulation	Symbol Rate	Meas. Filter	Reference Filter	Filter Parameter	Other
802.15.4	OQPSK	1e6	None	Half sine	NA	
SBPSK-MIL	SBPSK	2.4e3	None	SBPSK-MIL	NA	
SOQPSK-MIL	SOQPSK	2.4e3	None	SOQPSK-MIL	NA	1
CPM-MIL	CPM	19.2e3	None	None	NA	
SOQPSK-ARTM Tier 1	SOQPSK	2.5e6	None	SOQPSK-ARTM	NA	1
Project25 Phase 1	C4FM	4.8e3	C4FM-P25	RC	0.2	
CDMA2000–Base	QPSK	1.2288e6	IS-95 TXE-Q_MEA	IS-95 REF	NA	
W-CDMA	QPSK	3.84e6	RRC	RC	0.22	

1 Center Symbol Position, Half Shift Removed

Modulation Params Tab

Menu bar: Setup > Settings > Modulation Params

The Modulation Params tab specifies the type of modulation on the input signal and other parameters that control the demodulation of the input signal.

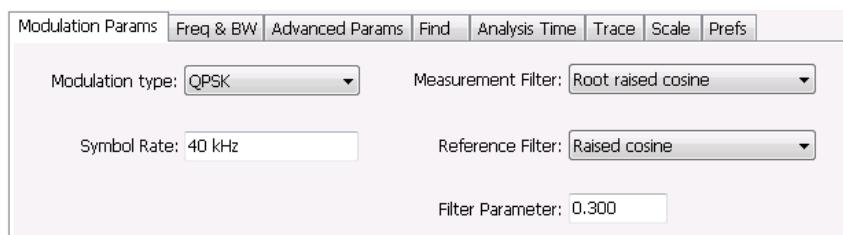

Parameter	Description
Modulation type	Specifies the type of modulation on the input signal.
Symbol Rate	Specifies the symbol rate in Hertz.
Measurement Filter	Specifies the filter used for measurements.
Reference Filter	Specifies the filter used as a reference.
Filter Parameter	Enter a value used for defining the Reference Filter. (Not present for some filter types)
Modulation index	(Present only for CPM modulation type)

Modulation Type

The modulation types that can be demodulated and analyzed are:

Modulation type	Description
QPSK	Quadrature Phase Shift Keying
8PSK	8-Phase Shift Keying
D8PSK	Differential Eight Phase Shift Keying
D16PSK	Differential Sixteen Phase Shift Keying
PI/2DBPSK	Pi/2 Differential Binary Phase Shift Keying
DQPSK	Differential Quadrature Phase Shift Keying
PI/4DQPSK	Pi/4 Differential Quadrature Phase Shift Keying
BPSK	Binary Phase Shift Keying
OQPSK	Offset Quadrature Phase Shift Keying
16QAM	16-state Quadrature Amplitude Modulation
32QAM	32-state Quadrature Amplitude Modulation
64QAM	64-state Quadrature Amplitude Modulation
128QAM	128-state Quadrature Amplitude Modulation
256QAM	256-state Quadrature Amplitude Modulation
MSK	Minimum Shift Keying
2FSK	2-Frequency Shift Keying
4FSK	4-Frequency Shift Keying
8FSK	8-Frequency Shift Keying
16FSK	16-Frequency Shift Keying
CPM	Continuous Phase Modulation
SOQPSK	Shaped Offset Quadrature Phase Shift Keying
SBPSK	Shaped Binary Phase Shift Keying
C4FM	Constant Envelope 4-Level Frequency Modulation

Symbol Rate

Specifies the symbol rate for demodulating digitally modulated signals. The symbol rate and the bit rate are related as follows:

$$(\text{Symbol rate}) = (\text{Bit rate}) / (\text{Number of bits per symbol})$$

For example, the number of bits per symbol is 3 for 8PSK.

Measurement and Reference Filters

The available measurement and reference filters depend on the selected modulation type. If a particular filter is not practical for a selected modulation type, it is not presented as an available filter. To determine which filters are available, make certain that your desired modulation type is selected. See the following table.

Modulation type	Measurement filters	Reference filters
BPSK	None	None
PI/2DBPSK	RootRaisedCosine	RaisedCosine
8PSK	RaisedCosine	Gaussian
D8PSK	Gaussian	User
DQPSK	User	Rectangular (freq)
PI/4DQPSK	Rectangular (freq)	IS-95REF
16QAM	IS-95TX_MEA	
32QAM	IS-95TXEQ_MEA	
64QAM		
128QAM		
256QAM		
QPSK		
MSK	None	None
	Root Raised Cosine	Gaussian
	RaisedCosine	User
	Gaussian	
	User	
	Rectangular (freq)	
OQPSK	None	None
	RootRaisedCosine	Half sine
	User	RaisedCosine
	IS-95TX_MEA	User
	IS-95TXEQ_MEA	IS-95REF
SOQPSK	None	SOQPSK-MIL
	User	SOQPSK-ARTM
		User
CPM	None	None
	User	User
2FSK	None	None
4FSK	Gaussian	Gaussian
8FSK	RootRaisedCosine	RaisedCosine
16FSK	RaisedCosine	User
	Rectangular (freq)	
	User	
C4FM	C4FM-P25	RaisedCosine
		User
SBPSK	None	SBPSK-MIL
	User	User

The measurement filter is applied before the demodulation bit is detected and the ideal reference is calculated.

The reference filter is applied to the internally generated ideal reference signal before the EVM is calculated.

How to Select Filters

In a signal transmitter/receiver system, the baseband signal might be filtered for bandwidth limiting or for another kind of necessary shaping that needs to be applied. Normally, a filter in the transmitter (F_t) and a filter in the receiver (F_r) are applied.

The Measurement Filter setting in the analyzer corresponds to the baseband filter in the receiver (F_r): This setting tells the analyzer what filter your receiver uses. When the analyzer is set to the same filter used by the receiver, the analyzer sees the signal as your receiver would. The Measurement Filter setting should be the same as the filter used in the receiver under normal operation (as opposed to testing).

The Reference Filter setting in the analyzer corresponds to the baseband filter in the transmitter-receiver combination ($F_r * F_t$). The baseband filter for the transmitter-receiver combination is often referred to as the *System Filter*. This filter is called the reference filter because it is used to recreate a reference signal that is compared to the received signal. This recreated reference signal is the *ideal signal* with $F_r * F_t$ applied; differences between this *ideal signal* and the received signal enables the determination of signal quality, such as EVM measurements.

The following is an example of a hypothetical signal that is transmitted into a vector signal analyzer for analysis:

Assume that a signal is transmitted using a baseband filter (F_t). It then travels through a transmission medium (air/cable/etc) where it may be affected by the communication channel (F_c). The signal is received and filtered by the receiver's filter (F_r). At this point, the signal has passed through F_t and F_r , and in addition, the communication channel might have affected it (so: $F_t * F_r * F_c$). This double-filtered signal is demodulated as it was received to determine the symbols/bits in it. The obtained bits are used to regenerate a baseband ideal signal that can be compared against the received signal to determine signal quality. However, to determine the effect of the environment on the signal quality, the ideal signal must be filtered by the REFERENCE FILTER ($F_t * F_r$), so that the ideal signal and the filtered signal differ only by the effect of the environment. So, the received signal is the ideal signal filtered by $F_t * F_r * F_c$ and the reference signal is the ideal signal filtered by $F_t * F_r$, since they only differ by the effect of F_c , the comparison will show the effect of the communication channel on the signal. The communication channel can also include the hardware path the signal follows after (Tx) or before (Rx) digitizing; this would account for Tx/Rx hardware linear and non-linear distortion.

Common examples of how these filters are used are shown below:

- For Transmit Filter = Root Raised Cosine (RRC), Measurement Filter = RRC, the Reference Filter = RRC^2 = Raised Cosine
- For Transmit Filter = Raised Cosine (RC), Measurement Filter = None, the Reference Filter = Raised Cosine (When the Measurement Filter = None, the Reference Filter = Transmit Filter)
- For Transmit Filter = Gaussian, Measurement Filter = None, the Reference Filter = Gaussian

Filter Parameter

The filter parameter specifies the alpha for the Root Raised Cosine or Raised Cosine filter, or the bandwidth-time product (BT) for the Gaussian filter, when selected as the Reference filter. Some filter types have a fixed parameter value that is specified by industry standard, while other filter types by definition have no filter parameter. For filter types with no filter parameter, there is no filter parameter control present in the control panel.

Freq & BW Tab

The Freq & BW tab specifies a group of settings that affect how measurements are made.

The screenshot shows the 'Freq & BW' tab selected in a software interface. The tab bar includes 'Modulation Params', 'Freq & BW', 'Advanced Params', 'Find', 'Analysis Time', 'Trace', 'Scale', and 'Prefs'. The main panel contains three rows of controls:

- Frequency Error: Auto
- Measurement BW: ▾
- Frequency Deviation: Auto

Freq & BW tab with nFSK or C4FM modulation type selected and Frequency Error readout enabled (Auto selected)

The screenshot shows the 'Freq & BW' tab selected in a software interface. The tab bar includes 'Modulation Params', 'Freq & BW', 'Advanced Params', 'Find', 'Analysis Time', 'Trace', 'Scale', and 'Prefs'. The main panel contains two rows of controls:

- Frequency Error: Auto
- Measurement BW: ▾

Freq & BW tab with SOQPSK modulation type selected and Frequency Offset enabled (Auto deselected)

Setting	Description
Frequency Error / Frequency Offset	When Auto is enabled, this readout displays frequency error and the measurement is made at the calculated frequency. When Auto is disabled, this setting changes to Frequency Offset. When set to Frequency Offset, this setting is used to demodulate a signal that is not at the center frequency. The measurement is made at the user-entered offset. The Measurement Filter (if any, specified on the Modulation Params tab) is applied about the offset frequency whether set automatically or manually.
Measurement BW	This setting allows you to override the automatic bandwidth calculation and directly enter a bandwidth value. If you enter a value for the measurement bandwidth, be aware that the actual bandwidth of data provided to the measurement will be at least as wide as the value you request and may be as much as two times wider than requested. This override of the selected measurement bandwidth is done so that the instrument uses sufficient bandwidth relative to the chosen symbol rate to ensure good signal quality measurements.
Frequency Deviation	For nFSK modulation types, this setting specifies the frequency deviation. Select Auto to make the instrument do this automatically. Deselect Auto to enter a value manually. This setting is present for only nFSK and C4FM modulation types.

Equalizer Tab

The Equalizer tab enables you to apply an adaptive equalizer to a digitally modulated signal to compensate for linear distortions in the signal. The Equalizer is available only for displays in the GP Digital Modulation folder (Select Displays window). The analyzer implements a decision directed, feed-forward FIR filter to correct linear distortion in the input signal.

Parameter	Description
Enable Equalization	This setting turns the Equalizer on and off.
Reset Equalization	Initializes the equalizer filter for training.
Mode	Specifies whether the equalizer is in learning (Train) mode or analysis (Hold) mode.
Convergence	Specifies the update rate. Maximum value: 0.002. Default value: 0.0005
Taps/Symbol	The number of filter coefficients per symbol used by the filter. Available choices are 1, 2, 4, and 8.
Taps	The number of filter coefficients. Range: 3 to 100 (you can set a higher number, but 100 is the practical limit).
Length	Specifies the number of symbols analyzed (or filter length).

Selecting the Mode

When enabled, the Equalizer is in either Train mode or Hold mode. When the equalizer is in Train mode, it will update internal filter parameters whenever you adjust the Convergence, Taps/Symbol, Taps, or Length values. When it is in Hold mode, the Equalizer uses the parameter values (both internal and the values accessible on the Equalizer tab) in effect when it was placed into Hold mode.

NOTE. *The Equalizer does not need to be retrained if the modulation type is changed. You can train the Equalizer by using a simpler modulation type (such as QPSK), place the Equalizer into Hold mode and can then measure more complex modulation types such as QAM.*

Training the Equalizer

To obtain the desired results using the Equalizer, you must first train the Equalizer. This is an iterative process where you adjust some filter parameters (and the analyzer adjusts internal parameters) to achieve the lowest error possible on the acquired signal.

To configure the Equalizer:

1. Press the **Displays** button or select **Setup > Displays**.
2. In the **Select Displays** window, select **GP Digital Modulation** from **Folders**.
3. Add **Signal Quality** to the **Selected Displays** and select **OK**.
4. With the Signal Quality display selected, select **Setup > Settings**.
5. Select the **Modulation Params** tab set the parameters as necessary for the signal.
6. Select the **Equalizer** tab.
7. Set the **Convergence** value to 0.0005.
8. Set **Taps/Symbol** to 2.
9. Click the **Reset Equalization** button to reset the equalizer.
10. Set the **Mode** to **Train**.
11. Click **Enable Equalization** so it is checked.
12. On the Signal Quality display, examine the value for EVM.
13. Change the Convergence, Taps/Symbol, and Taps values iteratively to achieve a minimum EVM value.

NOTE. *Changing the Taps/symbol or Taps values resets the equalizer.*

Using the Equalizer

To use the equalizer:

1. Select and configure a **GP Digital Modulation** display.
2. Select **Setup > Settings**.

3. Select the **Equalizer** tab.
4. Select **Enable Equalization** so it is checked.
5. Verify that Mode is set to **Hold** if you have previously trained the Equalizer. If you have not previously trained the Equalizer, [train the Equalizer \(see page 315\)](#) and then set the Mode to Hold.

Advanced Params Tab

The Advanced Params tab specifies additional parameters that control the demodulation of the signal.

Modulation Params | Freq & BW | **Advanced Params** | Find | Analysis Time | Trace | Scale | Prefs

Mag Normalize: RMS Symbol Magnitude Swap I and Q

User Symbol Map (per Modulation Type):

Advanced Params tab for all modulation types except nFSK and C4FM

Modulation Params | Freq & BW | **Advanced Params** | Find | Analysis Time | Trace | Scale | Prefs

Swap I and Q

Symbol rate search

User Symbol Map (per Modulation Type):

Advanced Params tab for modulation type nFSK

Modulation Params | Freq & BW | **Advanced Params** | Find | Analysis Time | Trace | Scale | Prefs

Swap I and Q

User Symbol Map (per Modulation Type):

Advanced Params tab for modulation type C4FM

Parameter	Description
Mag Normalize (not present for nFSK or C4FM modulation types)	Select RMS Symbol Magnitude or Max Symbol Magnitude. This setting applies to Mag Error and EVM.
Swap I and Q	When enabled, the I and Q data are exchanged before demodulating.
Symbol rate search (Present only for nFSK modulation types)	Determines whether to automatically detect or manually set the symbol rate. When selected, automatically detects the symbol rate to perform analysis. The calculated symbol rate is displayed in the Signal Quality display. The Symbol Rate Error is also calculated and displayed when Symbol rate search is enabled.
User Symbol Map (per Modulation Type)	Enables the use of custom symbol maps. This enables you to specify the location of symbols in the display. This control can be set independently for each of the modulation types.

Mag Normalize

Specifies whether Magnitude Normalization uses the RMS Symbol Magnitude or the Maximum Symbol Magnitude as the basis for normalization. Use RMS Symbol Magnitude on QPSK modulations (equal magnitude symbol locations), and use Maximum Symbol Magnitude for signals that have a large difference in magnitude among the symbol locations (such as 128QAM). It prevents the instrument from using the very low magnitude center symbols when normalizing the constellation. The outer symbols are a better normalization reference than the center in this case.

Swap I and Q

Use the Swap I and Q control to correct a signal sourced by a downconverter that inverts the frequency of the signal under test.

User Symbol Map

A User Symbol Map is a text file that specifies the location of symbols in the display. The symbol map is unique for each modulation type. The easiest way to create a custom symbol map is to start with the default symbol map and modify it. The default symbol map file is located at C:\RSA6100B Files. The default symbol map file is named **DefaultSymbolMaps.txt**. See [Symbol Maps \(see page 324\)](#) for illustrations of the default symbol mapping.

To specify a user symbol map:

1. Click the ... button.
2. Navigate to the directory containing the user symbol text file you want to use.
3. Select the desired file in the Open window and click **Open**.
4. Select **User Symbol Map** to enable the user symbol map.

Editing the User Symbol Map. The symbol map is a plain text file and can be edited with any plain text editor.



CAUTION. Whenever you reinstall the program software, the existing *DefaultSymbolMaps.txt* file will be overwritten. To create a custom symbol map, you should make a copy of the default symbol map file, edit the copy to suit your needs, and save it with a new name. Guidance on how to edit the symbol map file is contained within the default symbol map file.

The following excerpt from the default symbol map file explains the structure of the file and how to edit it.

```
## Symbol Mapping Definitions
## Version 1.2

## This file defines the mapping of modulation states to symbol values.
##
## File Format :
## -----
## 1. Comments begin with '##' and may appear after the last field in a line
## 2. A symbol map begins and ends with a line containing the name of the
## modulation type. These names must exactly match the name of one of the
## modulation types in the RSA software
## 3. Empty cells may be included to preserve the constellation shape.
## 4. Blank lines are ignored.
## 5. A modulation type which does not match the name of an existing
## type will be ignored.
##
## Usage :
## -----
## 1. The file is intended to be edited with Notepad or similar text editor
```

The following text is an example of a symbol map.

```
## Symbol Map for 32 QAM
## (Resembles the shape of the constellation)
      32QAM
00011 00010 00001 00000
01001 01000 00111 00110 00101 00100
01111 01110 01101 01100 01011 01010
10101 10100 10011 10010 10001 10000
11011 11010 11001 11000 10111 10110
      11111 11110 11101 11100
      32QAM
```

Find Tab

The Find tab is used to set parameters for finding bursts within the data record. This is a post-acquisition operation. Synch Word search controls are also on this tab.

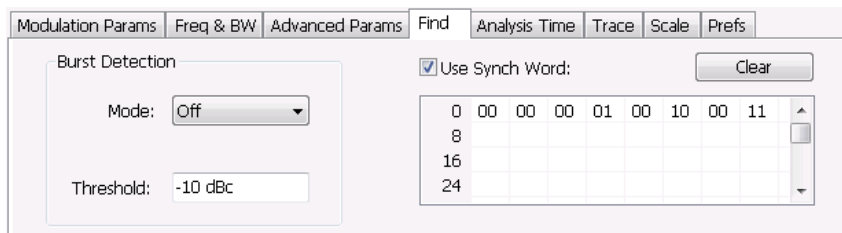

Setting	Description
Burst Detection: Mode	Select whether to analyze bursts - Auto: If a burst is found, analyze just that burst period. If a burst is not found, analyze the whole analysis length. - On: If a burst is found, analyze just that burst period. If a burst is not found, display an error message. - Off: Analyze the whole analysis length. If the signal isn't adequate for demodulation, an error message is shown.
Burst Detection: Threshold	Sets the level required for the signal to qualify as a burst. Enter a value in dBc down from top of the signal.
Use Synch Word	When enabled, specifies the string of symbols to look for. Enter the search string with external keyboard or the on-screen keyboard.
Clear	Blanks the search string field.

Analysis Time Tab

The Analysis Time tab contains parameters that define how the signal is analyzed in the general purpose digital modulation displays.

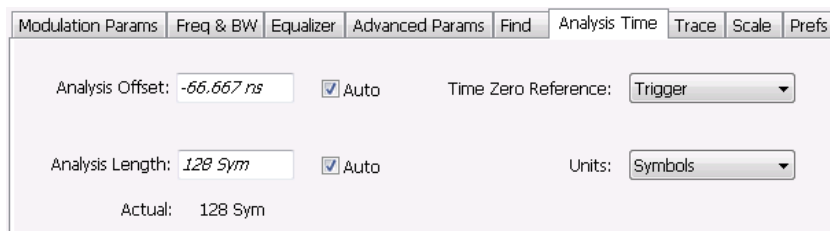

The settings values on this tab are the same as those on the main Analysis control panel for the instrument with the only difference being that Analysis Length can be set in either Seconds or Symbols in this location.

Setting	Description
Analysis Offset	Specifies the location of the first time sample to use in measurements.
Auto	When enabled, causes the instrument to set the Analysis Offset value based on the requirements of the selected display.
Analysis Length	Specifies the length of the analysis period to use in measurements. Length is specified in either seconds or symbols, depending on the Units setting. For most modulation types, the Analysis Length set when Auto is enabled is 128 symbols. For some modulation types, a longer length is used.
Auto	When enabled, causes the instrument to set the Analysis Length value based on the requirements of the selected display.
Time Zero Reference	Specifies the zero point for the analysis time.
Actual	This is a displayed value, not a setting. It is the Analysis Length (time or symbols) being used by the analyzer; this value may not match the Analysis Length requested (in manual mode).
Units	Sets the units of the Analysis Length to either Symbols or Seconds.

Analysis Offset

Use analysis offset to specify where measurements begin. Be aware that you cannot set the Analysis Offset outside the range of time covered by the current acquisition data. (all time values are relative to the Time Zero Reference).

You can set the Analysis Length so that the requested analysis period falls partly or entirely outside the current range of acquisition data settings. When the next acquisition is taken, its Acquisition Length will be increased to cover the new Analysis Length, as long as the Sampling controls are set to Auto. If the Sampling parameters are set to manual, or if the instrument is analyzing saved data, the actual analysis length will be constrained by the available data length, but in most cases, measurements are able to be made anyway. The instrument will display a notification when measurement results are computed from less data than requested. Range: 0 to [(end of acquisition) - Analysis Length]. Resolution: 1 effective sample (or symbol).

Analysis Length

Use the analysis length to specify how long a period of time is analyzed by a measurement. As you adjust this value, the actual amount of time for Analysis Length, in Symbol or Seconds units, is shown below the control in the "Actual" readout. This setting is not available when Auto is checked. Range: minimum value depends on modulation type. Resolution: 1 symbol. A maximum of approximately 80,000 samples can be analyzed (the actual value varies with modulation type).

Time Zero Reference

All time values are measured from this point (such as marker position or horizontal position (in Y vs Time displays). Choices are: Acquisition Start or Trigger.

Parameter	Description
Acquisition Start	Offset is measured from the point at which acquisition begins.
Trigger	Offset is measured from the trigger point.

Trace Tab

Menu Bar: Setup > Settings > Trace

The Trace tab allows you to set the trace display characteristics of the selected display.

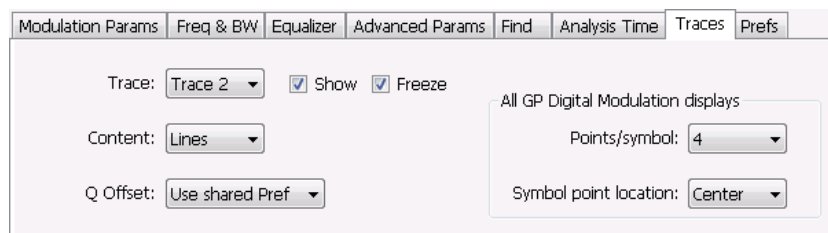

Example traces tab for constellation display set to SOQPSK modulation type

Note that some settings are not present for all modulation types and some settings are not present for all displays.

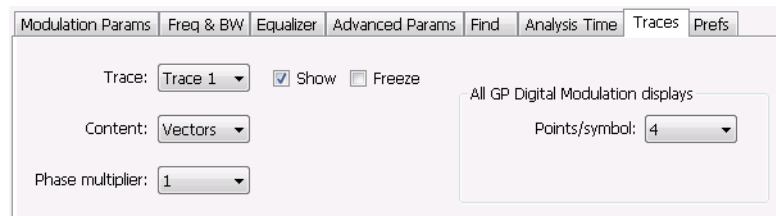

Example trace tab for constellation display set to CPM modulation type

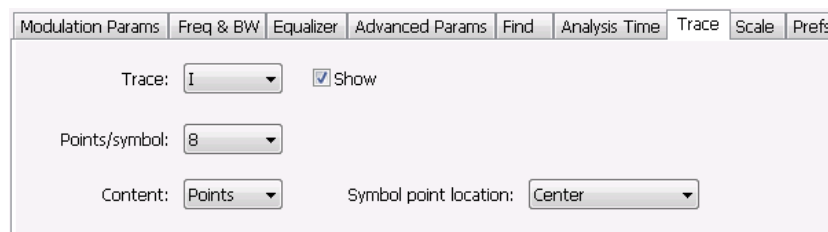

Example trace tab for Demod I&Q display

Setting	Description
Trace	Selects the trace that is hidden or displayed based on whether or not Show is selected.
Show	Specifies whether the trace selected by Trace is displayed or hidden.
Freeze	Halts updates to the trace selected by the Trace setting. Present for the Constellation display only.
Content	Selects whether to display the trace as vectors (points connected by lines), points (symbols only without lines), or lines (lines drawn between symbols, but no symbols are displayed). The choices available depend on the display.
Q Offset	For traces with offset modulation (OQPSK and SOQPSK), this setting enables the trace to be displayed with Q offset or without Q offset. Choices available are Remove Q offset , Include Q Offset , and Use Shared Pref . Selecting Use Shared Pref causes the analyzer to add or remove Q offset according to the Remove Q Offset setting located on the Prefs tab. Setting the Q Offset on the Traces tab changes the Q offset only for the Constellation display. If other GP Digital Modulation displays are shown, they will use the use the Remove Q Offset setting on the Prefs tab regardless of the Q Offset setting on the traces tab for the Constellation display. The Q Offset setting is available only when the modulation type is set to OQPSK or SOQPSK.
Points/symbol	Select how many points to use between symbols when connecting the dots. Values: 1, 2, 4, 8.
Symbol point location	Selects whether to evaluate the symbol value at the center or the end of the eye opening. This control is only present for some of the supported modulation types.
Phase Multiplier	Sets the multiplication constant for the phase multiplication display: $\times 1$ (default), $\times 2$, $\times 4$, $\times 8$, $\times 16$, or $\times 32$. The phase multiplication display facilitates observation of noisy CPM signals by multiplying measurement signal phase by the constant to reduce the number of phase states and expand the phase difference between adjacent symbols.

Comparing Two Traces in the Constellation Display

When the Constellation display is the selected display, you can use the Traces tab to enable the display of a second trace. The second trace is a version of the current acquisition. You can choose to freeze a trace in order to display the current live trace to an earlier version of itself, you can display the trace as a second trace with or without Q Offset, or you can choose to display both traces frozen in order to compare the trace to itself at different times.

To display a second trace in the Constellation display:

1. If more than one display is present, select the Constellation display to ensure it is the selected display.
2. Click the settings icon or select **Setup > Settings** from the menu bar.
3. Select the **Traces** tab.
4. Select **Trace 2** from the **Trace** drop-down list.
5. Click the **Show** checkbox so that it is checked.
6. Specify the **Content** as desired. Trace 2 lines appear in blue to aid in distinguishing Trace 2 from Trace 1.

Scale Tab

The Scale tab allows you to change the vertical and horizontal scale settings. Changing the scale settings changes how the trace appears on the display but does not change control settings such as Measurement Frequency.

The screenshot shows the Scale Tab interface with the following settings:

- Vertical:**
 - Scale: 200 mV
 - Position: 0.000 V
 - Autoscale button
- Horizontal:**
 - Scale: 128.00 Sym
 - Position: -1.00 Sym
 - Auto checkbox (checked)
 - Autoscale button

Setting	Description
Vertical	Controls the vertical position and scale of the trace display.
Scale	Changes the vertical scale units.
Position	Position adjusts the reference level away from top of the graph.
Autoscale	Resets the scale of the vertical axis to contain the complete trace.
Horizontal	Controls the span of the trace display and position of the trace.
Scale	Allows you to, in effect, change the span.
Position	Allows you to pan a zoomed trace without changing the Measurement Frequency. Position is only enabled when the span, as specified by Freq/div, is less than the acquisition bandwidth.
Autoscale	Resets the scale of the horizontal axis to contain the complete trace.
Auto	

A Note About Units

The Units used for the horizontal scale can be either Seconds or Symbols. To set the units for the horizontal scale, display the **Analysis Time** tab. On the tab, select the appropriate units from the **Units** drop-down list.

Prefs Tab

The Prefs tab enables you to change appearance characteristics of the GP Digital Modulation displays.

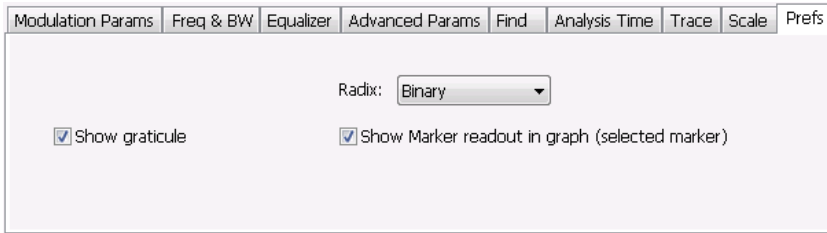

Setting	Description
Show graticule	Shows or hides the graticule.
Show Marker readout in graph (selected marker)	Shows or hides the readout for the selected marker in the graph area.
Radix	Specifies how symbols are displayed in the Symbol Table display and in the Marker readout in the Constellation display.
Remove Q offset	The I and Q data traces are displayed with an offset of half a symbol when the modulation type is set to SOQPSK or OQPSK. You can remove this offset by selecting Remove Q offset . (Which is only present when the modulation type is set to OQPSK or SOQPSK.)
Show EVM and Offset EVM results	Adds EVM results in the display when enabled (Offset EVM is always displayed). Present only in Signal Quality display and with SOQPSK and OQPSK modulation types only

Symbol Maps

This topic shows the symbol mapping for each digital modulation technique.

1	3
0	2

01	11
00	10

01	11
00	10

0169-018

8PSK				
Left				Right
		3		
	2		1	
6				0
	7		4	
		5		

0169-009

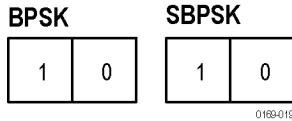
**D8PSK**

Phase shift (radians)	Symbol value (binary)
0	000
$\pi/4$	001
$\pi/2$	011
$3\pi/4$	010
π	110
$5\pi/4$	111
$3\pi/2$	101
$7\pi/4$	100

Pi/2 DBPSK

Phase shift (radians)	Symbol value (binary)
$+\pi/2$	0
$-\pi/2$	1

DQPSK

Phase shift (radians)	Symbol value (binary)
0	00
$\pi/2$	01
π	11
$3\pi/2$	10

Pi/4 DQPSK

Phase shift (radians)	Symbol value (binary)
$+\pi/4$	00
$+3\pi/4$	01
$-\pi/4$	10
$-3\pi/4$	11

MSK

Phase shift direction	Symbol value (binary)
-	0
+	1

16QAM

Left		Right	
3	2	1	0
7	6	5	4
B	A	9	8
F	E	D	C

0169-010

32QAM

Left			Right		
	3	2	1	0	
9	8	7	6	5	4
F	E	D	C	B	A
15	14	13	12	11	10
1B	1A	19	18	17	16
	1F	1E	1D	1C	

0169-011

64QAM

Left				Right			
7	6	5	4	3	2	1	0
F	E	D	C	B	A	9	8
17	16	15	14	13	12	11	10
1F	1E	1D	1C	1B	1A	19	18
27	26	25	24	23	22	21	20
2F	2E	2D	2C	2B	2A	29	28
37	36	35	34	33	32	31	30
3F	3E	3D	3C	3B	3A	39	38

0169-012

128QAM

		5D	5F	4F	4D	1A	1B	0B	0A		
		5C	5E	4E	4C	18	19	09	08		
4A	48	54	56	46	44	10	11	15	14	1C	1D
4B	49	55	57	47	45	12	13	17	16	1E	1F
5B	59	51	53	43	41	02	03	07	06	0E	0F
5A	58	50	52	42	40	00	01	05	04	0C	0D
6D	6C	64	65	61	60	20	22	32	30	38	3A
6F	6E	66	67	63	62	21	23	33	31	39	3B
7F	7E	76	77	73	72	25	27	37	35	29	2B
7D	7C	74	75	71	70	24	26	36	34	28	2A
		68	69	79	78	2C	2E	3E	3C		
		6A	6B	7B	7A	2D	2F	3F	3D		

0169-017

256QAM

Left

Right

EF	FD	EB	F9	E7	F5	E3	F1	0F	3F	4F	7F	8F	BF	CF	FF
CE	DC	CA	D8	C6	D4	C2	D0	0C	3C	4C	7C	8C	BC	CC	FC
AF	BD	AB	B9	A7	B5	A3	B1	0B	3B	4B	7B	8B	BB	CB	FB
8E	9C	8A	98	86	94	82	90	08	38	48	78	88	B8	C8	F8
6F	7D	6B	79	67	75	63	71	07	37	47	77	87	B7	C7	F7
4E	5C	4A	58	46	54	42	50	04	34	44	74	84	B4	C4	F4
2F	3D	2B	39	27	35	23	31	03	33	43	73	83	B3	C3	F3
0E	1C	0A	18	06	14	02	10	00	30	40	70	80	B0	C0	F0
E1	D1	A1	91	61	51	21	11	01	13	05	17	09	1B	0D	1F
E2	D2	A2	92	62	52	22	12	20	32	24	36	28	3A	2C	3E
E5	D5	A5	95	65	55	25	15	41	53	45	57	49	5B	4D	5F
E6	D6	A6	96	66	56	26	16	60	72	64	76	68	7A	6C	7E
E9	D9	A9	99	69	59	29	19	81	93	85	97	89	9B	8D	9F
EA	DA	AA	9A	6A	5A	2A	1A	A0	B2	A4	B6	A8	BA	AC	BE
ED	DD	AD	9D	6D	5D	2D	1D	C1	D3	C5	D7	C9	DB	CD	DF
EE	DE	AE	9E	6E	5E	2E	1E	E0	F2	E4	F6	E8	FA	EC	FE

0169-013

2FSK

Left Right

0	1
---	---

4FSK

Left Right

0	1	3	2
---	---	---	---

0169-014

8FSK

Left Right

0	1	2	3	7	6	5	4
---	---	---	---	---	---	---	---

0169-015

16FSK

Left														Right	
0	1	2	3	4	5	6	7	15	14	13	12	11	10	9	8

0109-016

C4FM

Left			Right
11	10	00	01

0109-020

CPM

Phase shift (h = modulation index)	Symbol value (binary)
-3h	11
-h	10
+h	01
+3h	00

Overview: User Defined Measurement and Reference Filters

The Modulation Parameters control tab for GP Digital Modulation displays enables you to load custom measurement and reference filters. If the existing filters do not meet your requirements, you can create your own filters for use in the measurement and reference settings. This section describes the structure of user filters and provides two examples of customized filters. See [User Filter File Format \(see page 330\)](#).

Loading a User Measurement Filter

To load a your own measurement filter:

1. From the Modulation Params control tab (Settings > Modulation Params), click on the drop-down list for **Measurement Filter**.
2. Select one of the filter names that starts with **User**. This displays the **Manage user filters** window.
3. Enter a name for the filter in one of the **Name (editable)** boxes. This name will appear in the drop-down list on the Modulation Params tab, prefaced with **User**. The maximum number of characters for the filter name is 20.

4. Click the **Browse** button and navigate to the directory containing the filter you want to load. Select the filter and click **Open**. If you wish to use a filter that is not in the list, select **User other** and locate and open the file you wish to use.
5. Click **OK** to load the filter and return to the Modulation Params page.

User Filter File Format

The filter file is selected on the Modulation Params control panel tab used by the GP Digital Modulation displays (Option 21 only). It stores the user-defined measurement or reference filter coefficient data in CSV format. The following figure shows the file structure.

```
# Rate
10
# FilterI,FilterQ
0.97321,0.01947
0.89559,0.04051
0.77497,0.05942
0.62333,0.07202
0.45524,0.07438
0.28614,0.06354
...
0.13045,0.01947
```

0169-023

User filter file structure

A filter file is a plain text file, in comma-separated-variable format. The file extension must be CSV.

The filter file contains the following variables:

Rate. Specifies the oversampling rate (the number of samples per symbol). The filter coefficient data will be interpolated by the specified rate.

FilterI,FilterQ. Specifies IQ pairs (1 to 1024) of the filter coefficient in time domain.

Rules for Creating a Filter File

- A line beginning with “#” is a comment line.
- Enter a positive value for the oversampling rate.
- A decimal number can be expressed by fixed point or floating point. For example, 0.01 and 1.0E-2 are both valid.
- “0” (zero) and “,0” (comma zero) can be omitted. For example, “1.5,0”, “1.5,”, and “1.5” are equivalent.
- Lines with only a comma and blank lines are skipped.

Example filters. For your reference, two example filters, Raised Cosine and Gaussian, are shown here. Both filters contain 65 data points with an oversampling rate of 8.

Raised Cosine ($\alpha = 0.3$)

(Row 1 to 18)	(Row 19 to 36)	(Row 37 to 54)	(Row 55 to 68)
# Rate	0.0383599,0	0.973215,0	0.0743803,0
8	0,0	0.895591,0	0.0720253,0
# FilterI,FilterQ	-0.047715,0	0.774975,0	0.0594205,0
0,0	-0.0984502,0	0.623332,0	0.0405144,0
-0.0062255,0	-0.143898,0	0.455249,0	0.0194761,0
-0.0136498,0	-0.174718,0	0.286147,0	0,0
-0.0209294,0	-0.181776,0	0.130455,0	-0.0151973,0
-0.0263419,0	-0.157502,0	0,0	-0.0246357,0
-0.0280807,0	-0.0971877,0	-0.0971877,0	-0.0280807,0
-0.0246357,0	0,0	-0.157502,0	-0.0263419,0
-0.0151973,0	0.130455,0	-0.181776,0	-0.0209294,0
0,0	0.286147,0	-0.174718,0	-0.0136498,0
0.0194761,0	0.455249,0	-0.143898,0	-0.0062255,0
0.0405144,0	0.623332,0	-0.0984502,0	0,0
0.0594205,0	0.774975,0	-0.047715,0	
0.0720253,0	0.895591,0	0,0	
0.0743803,0	0.973215,0	0.0383599,0	
0.063548,0	1,0	0.063548,0	

Gaussian (BT = 0.5)

(Row 1 to 18)	(Row 19 to 36)	(Row 37 to 54)	(Row 55 to 68)
# Rate	0.00191127,0	0.978572,0	0.000401796,0
8	0.00390625,0	0.917004,0	0.000172633,0
# FilterI,FilterQ	0.00764509,0	0.822878,0	7.10E--05,0
2.33E-10,0	0.0143282,0	0.707107,0	2.80E-05,0
9.11E-10,0	0.0257149,0	0.581862,0	1.06E-05,0
3.42E-09,0	0.0441942,0	0.458502,0	3.81E-06,0
1.23E- 08,0	0.0727328,0	0.345977,0	1.32E-06,0
4.21E-08,0	0.114626,0	0.25,0	4.37E-07,0
1.39E-07,0	0.172989,0	0.172989,0	1.39E-07,0
4.37E-07,0	0.25,0	0.114626,0	4.21E-08,0
1.32E-06,0	0.345977,0	0.0727328,0	1.23E-08,0
3.81E-06,0	0.458502,0	0.0441942,0	3.42E-09,0
1.06E-05,0	0.581862,0	0.0257149,0	9.11E-10,0
2.80E-05,0	0.707107,0	0.0143282,0	2.33E-10,0
7.10E-05,0	0.822878,0	0.00764509,0	
0.000172633,0	0.917004,0	0.00390625,0	
0.000401796,0	0.978572,0	0.00191127,0	
0.000895512,0	1,0	0.000895512,0	

Using Markers

Markers are indicators in the display that you can position on a trace to measure values for the X and Y axes, such as frequency, power, and time. A Marker always displays its position and, if enabled, will display the difference between its position and that of the Marker Reference (MR).

You can display up to five markers including the marker reference. Markers can all be placed on the same trace or they can be placed on different traces. There are two types of Markers: Reference and Delta Markers. The Marker Reference (labeled MR in the graph) makes absolute measurements and is also used for calculating differences when Delta readouts are enabled. The Delta Markers (labeled M1 to M4 in the graph) are used to measure other points on the trace or the difference between the Marker Reference and the Delta marker.

The following table shows the appearance of the four types of marker readouts.

Marker Reference Readout	Absolute Marker Readout	Delta Marker Readout	DPX Bitmap Marker Readout
<p>Reference Marker label</p>	<p>Absolute Marker label</p>	<p>Delta Marker label</p>	<p>Number of times pixel has been hit. May increase or decrease over time if persistence is used.</p>

The following table shows the appearance of the marker indicators as they appear on the trace.

Marker Reference	Absolute Marker	Delta Marker

Controlling Markers with the Touchscreen Actions Menu

In addition to controlling the marker actions from the front panel or screen menu items, you can use the touch screen actions menu to move markers or add and delete markers.

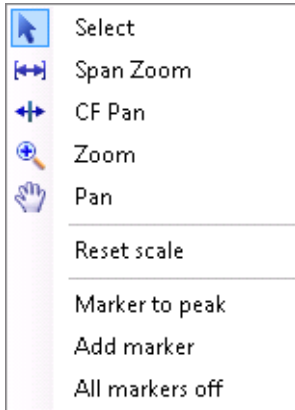

To use the Touchscreen Actions menu, touch the display and hold for one second, then remove your finger. You can also use a mouse to display the Touchscreen Action menu by clicking the right mouse button.

Menu item	Description
Marker to peak	Moves the selected marker to the highest peak. If no marker is turned on, this control automatically adds a marker.
Next Peak	Moves the selected marker to the next peak. Choices are Next left, Next right, Next lower (absolute), and Next higher (absolute).
Add marker	Defines a new marker located at the horizontal center of the graph.
Delete marker	Removes the last added marker.
All markers off	Removes all markers.

Measuring Signal Density, Frequency and Power on a DPX Bitmap Trace

To measure the signal density, frequency and power at a point on a DPX Bitmap trace:

1. Select **Markers > Define Markers**.
2. Select the **Marker Properties** tab.
3. Click **Add**. This displays a drop-down list under **MR** (Marker Reference), found inside the **Reference** box. The first marker defined is always designated the Marker Reference. Subsequently defined markers are designated as Delta Markers (you can also select and adjust markers by clicking on an existing marker on a trace).
4. From the drop-down list, select **Bitmap**.
5. Click the close control panel button () to remove the Define Markers control panel.
6. Touch or click on the MR marker on the trace to activate the marker.
7. Drag the marker to the desired location on the bitmap.

NOTE. Markers on the DPX Bitmap trace can be placed on any point in the display, unlike markers in other displays that can be placed only on a trace. This enables you to measure the signal density, frequency, and power level at any point on the graph.

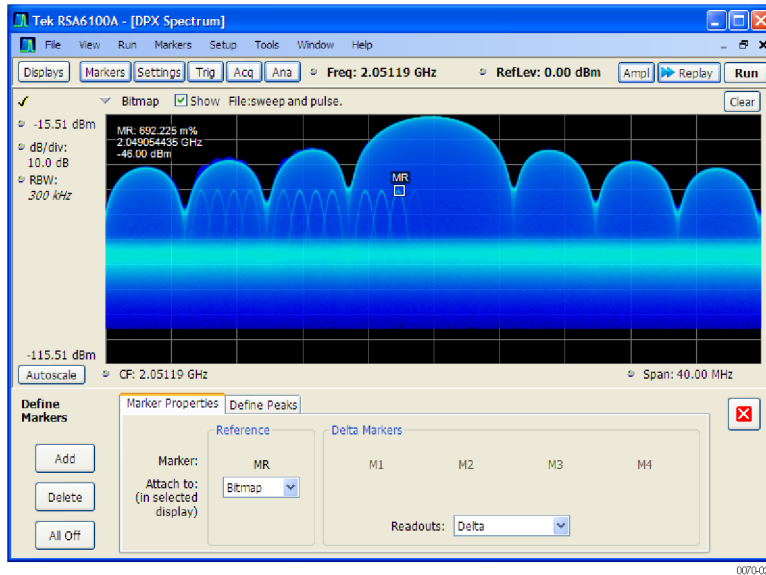

Searching for peaks on the DPX bitmap trace. To locate peaks on the DPX Bitmap trace, use the arrow buttons on the Marker toolbar. The left / right arrows move the selected marker to the next peak lower or higher in frequency. The up and down arrows search for peaks at the same frequency. The peaks on the DPX Bitmap trace are defined by the settings for the DPX Signal Density on the Markers > Define Markers > [Define Peaks \(see page 338\)](#) tab.

Measuring Frequency and Power in the Spectrum Display

To measure the frequency and power at a point on a Spectrum trace:

1. Select **Markers > Define Markers**.
2. Select the **Marker Properties** tab.
3. Click **Add**. This displays a drop-down list under **MR** (Marker Reference), found inside the **Reference** box. The first marker defined is always designated the Marker Reference. Subsequently defined markers are designated as Delta Markers (you can also select and adjust markers by clicking on an existing marker on a trace).
4. From the drop-down list, select the trace to which you want to assign the marker.

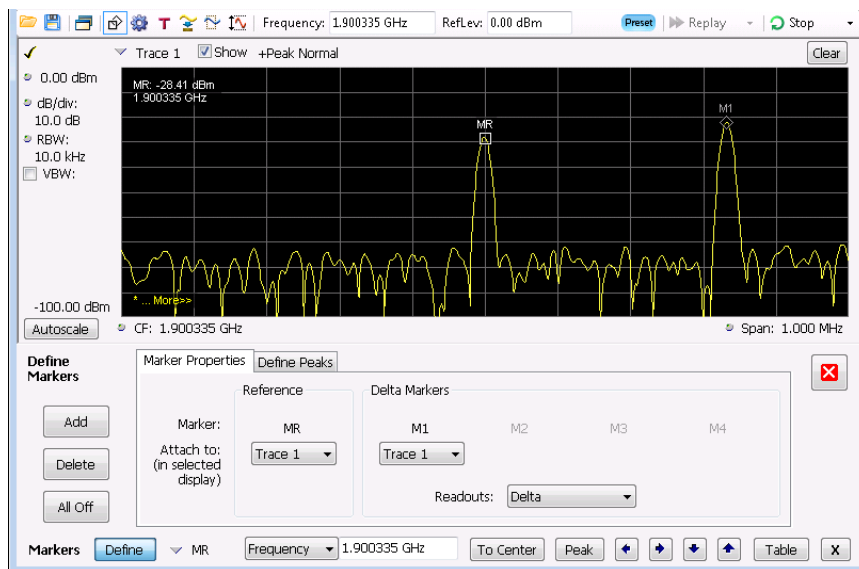

5. Click the close control panel button to remove the Define Markers control panel.
6. Click on the marker on the trace to activate that marker.
7. Use the knob or the arrow keys on the front panel to move the marker to the desired location on the trace. You can also click on the marker location text box in the Markers toolbar at the bottom of the screen and adjust it with your mouse wheel. The Peak button in the Markers toolbar and the arrow buttons to the right of it control marker peak searching on the trace.
8. Read the frequency and power level of the marker position on the display.
9. Read the signal density, frequency and power level of the marker position on the display.

Marker Action Controls

Controls for enabling and moving markers and for initiating marker peak searches are found in several locations. There are buttons for a few of the most common marker activities on the front panel of the instrument, used along with the knob for adjusting marker positions. The Markers menu contains selections for peak searches and the Marker toolbar also has buttons for peak searches. All graphs that support the markers offer a pop-up menu for marker actions.

Peak

Selecting **Peak** from the Markers menu moves the selected marker to the highest level peak within the acquisition record.

Next Peak

Selecting Next Peak displays a submenu that enables you to move the selected marker to the next peak.

Setting	Description
Next Left	Moves the selected marker to the next peak to the left of the current marker position.
Next Right	Moves the selected marker to the next peak to the right of the current marker position.
Next Lower (absolute)	Moves the selected marker to the lower level peak (in absolute terms) on the trace.
Next Higher (absolute)	Moves the selected marker to the higher level peak (in absolute terms) on the trace.

Marker to Center Frequency

Changes the center frequency to match the frequency of the selected marker.

Enabling Markers and Setting Marker Properties

The Define Markers Control Panel is used to enable markers and set their properties. You can set up to five markers including the marker reference. Markers are shown in most displays.

Markers have two types of on-screen readouts: Absolute and Delta. When **Readouts** is set to **Absolute**, each readout displays only the marker's position on the trace. In Frequency displays, this means the marker readout shows the frequency and power of the trace at the marker position. When **Readouts** is set to **Delta**, each delta marker (M1-M4) readout displays both the marker's position on the trace and the difference between its position and the position of the Reference Marker (MR).

Defining Markers



1. Select **Markers > Define Markers** to display the Define Markers control panel.
2. Select **Add** to turn on the next marker. A drop-down list under the marker label allows you to assign the marker to a trace.

NOTE. *The first marker defined will always be MR. The MR marker is the reference for delta marker readouts.*

3. Select the trace to which the marker should be attached from the drop-down list.
4. Click **Add** to add additional markers.
5. Click the close button to remove the Define Markers control panel.

Defining Peaks

You can specify two amplitude values that define peaks. For the DPX display, you can also define peaks based on signal density characteristics.

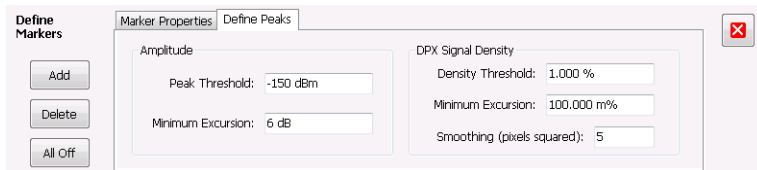

NOTE. *The settings shown in the DPX Signal Density section of the Define Peaks tab are not used by SignalVu-PC.*

Amplitude

Peak Threshold	Peak Threshold specifies the level that the signal must exceed to be considered a peak.
Minimum Excursion	Minimum Excursion specifies how much the signal must decrease and then increase before another peak can be declared.

DPX Signal Density

Density Threshold	Density Threshold specifies the signal density (number of hits per displayed pixel) that the DPX bitmap must exceed to be considered a trigger event.
Minimum Excursion	Minimum Excursion specifies how much the signal density must decrease and increase again before another peak can be declared.
Smoothing (pixels squared)	Smoothing specifies the number of pixels around the marker that are averaged together to reduce "noise" in the readout of signal density. The value of this control is the number of pixels on each side of the square area used for averaging. With Smoothing = 1, no averaging is done and the marker z-axis readout is the hit count (density) of a single pixel. Use this control to characterize how wide or narrow a range of pixels should be averaged to determine the signal density.

1. Select **Markers > Define Markers** to display the Define Markers control panel.
2. Select the **Define Peaks** tab.
3. To define the level for Peak Threshold, enter a value in the Peak Threshold number entry box.
4. To define the amount the trace must dip, enter a value in the Peak Excursion number entry box.
5. Click the close button to remove the Define Markers control panel.







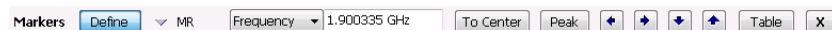

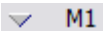

Using the Markers Toolbar

Front Panel: Markers**Application toolbar:****Menu bar: View > Marker Toolbar**

Select **Marker Toolbar** to display or hide the Marker Toolbar in the application window. The Marker Toolbar enables you to operate existing markers or define new markers.



Enabling a marker or adjusting the position of a marker automatically opens the Markers toolbar.

Icon / Readout	Description
	Opens the Define Markers control panel.
	Selected marker readout. This readout shows which marker is selected. The pop-up menu allows you to choose the selected marker, add markers, and turn all markers off.
	Marker position controls. For frequency displays, this readout shows the marker position in Hertz. For time displays, this readout shows the marker position in seconds. The position of the selected marker can be changed by selecting the numeric readout and using the knob to adjust the value.
	Changes the analyzer's Center Frequency to the frequency of the selected marker. Not selectable for time markers.
	Moves the marker to the highest peak on the signal. On displays that scale about zero on the vertical axis (for example, Magnitude Error, EVM, and Frequency vs. Time), the highest peak selected by the Peak button is an "absolute value", therefore, negative peaks are included in the search for the highest peak.
	Moves the selected marker to the next peak to the left of the current position.
	Moves the selected marker to the next peak to the right of the current position.
	Moves the selected marker to the next lower peak value. The peak value here refers to the numeric value of the peak amplitude. Thus, when repeatedly moving the marker, it can move to the right or left depending on the location of the next lower value.
	Moves the selected marker to the next higher peak value. The peak value here refers to the numeric value of the peak amplitude. Thus, when repeatedly moving the marker, it can move to the right or left depending on the location of the next higher value.
	Displays/hides the marker table from the display.
	Removes the Marker Toolbar from the display.

Using Noise Markers in the Spectrum Display

In the Spectrum display, you can set Markers to Noise Mode to measure noise on the trace. Markers in Noise Mode operate just as they do in normal mode, but the readouts for the markers are in dBm/Hz and dBc/Hz.

dBm/Hz is the power in milliwatts referenced to a 1 Hz bandwidth. To make this measurement, the analyzer assumes that the measured signal is random noise. It then converts the measured power (made at any RBW) to the power that would be measured had a 1 Hz filter been applied for the measurement.

dBc/Hz represents dBm/Hz referenced to a carrier. Here, it is assumed that the carrier is a CW signal, and its signal level does not change when the RBW is changed, so the Reference Marker measurement on the carrier is unchanged from any other marker measurement. However, the delta marker values are converted to dBm/Hz, and then a difference value, in dBc/Hz, is calculated between each delta measurement and the reference.

Measuring Noise

To measure noise on a Spectrum trace:

1. Select **Markers > Define** to display the Markers control panel.
2. Click **Add**. The first marker defined is always designated the Marker Reference. Subsequently defined markers are designated as Delta Markers (you can also select and adjust markers by clicking on an existing marker in the display).
3. Click **Add** again so that there are at least two markers defined.
4. Check that **Readouts** is set to Delta.
5. If you have more than one trace defined, use the drop-down list for each marker to set it to the trace on which you want to measure noise.
6. Select the **Settings** button to display the Spectrum settings control panel.
7. Click the **Prefs** tab.
8. Click the **Marker Noise Mode** check box so it is checked.
9. Click the **Traces** tab.
10. Verify that Detection is set to **Average** for the trace you are using for this measurement.
11. Click the (Analysis) icon.
12. Select the **Units** tab.
13. Select **dBm** for the Amplitude units.
14. Click the Close button to remove the control panel.
15. Move the markers to the desired locations on the trace.
16. Read the frequency and power level for the selected marker in the upper corners of the display. To display the delta measurement in dBc/Hz, select the delta marker (M1, M2, M3 or M4) by clicking on it or pressing the front-panel Select button until it is selected.

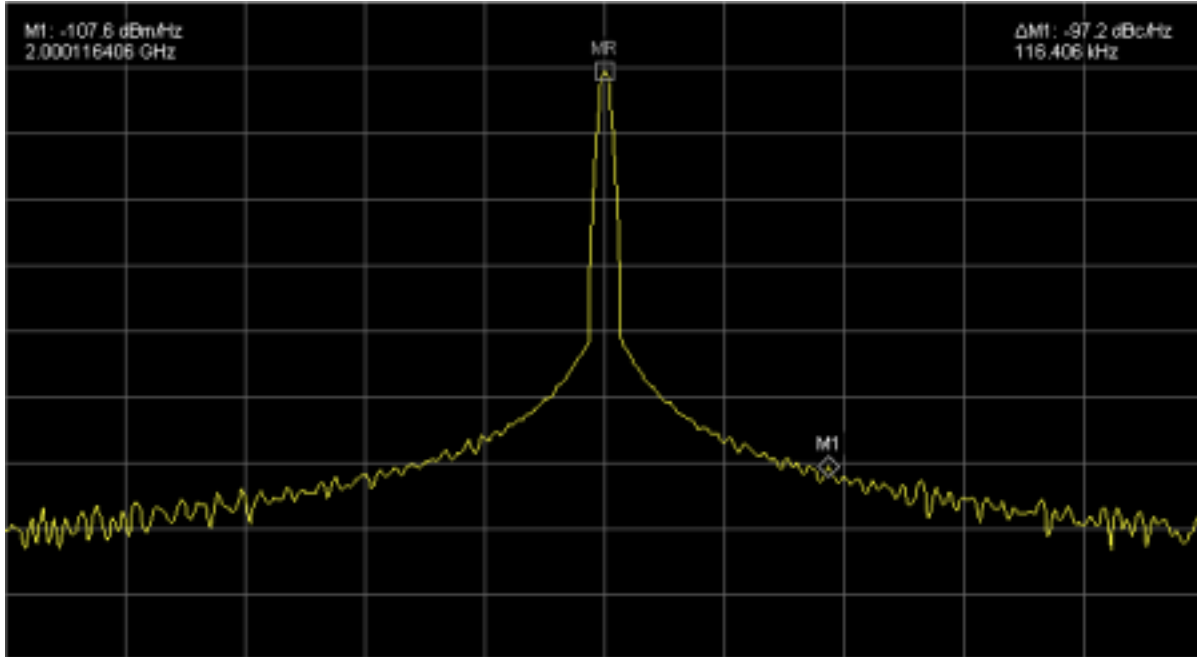

The Search Tool (Limits Testing)

You can specify pass/fail conditions for the Spectrum, Spurious, Frequency Settling Time and Phase Settling Time displays. When these conditions are met, the instrument can perform actions such as stopping acquisitions or saving data.

Search (Limits Testing) Settings

Menu Bar: Tools > Search

Selecting **Search** displays the Search control panel. These settings define search parameters and specify actions to be performed when the search condition is met.

The screenshot shows the 'Search' dialog box with the 'Define' tab selected. On the left, there is a checkbox labeled 'Enable Search' which is checked. The main area contains two dropdown menus: 'Search in:' is set to 'Spectrum: Trace 1' and 'Search for:' is set to 'is greater than'. To the right of the second dropdown is a text input field containing '-20.00 dBm'. A close button (red X) is located in the top right corner of the dialog.

Setting	Description
Enable Search	Select to perform a search.
Define (see page 343)	Specifies which result to search and what to search for.
Actions (see page 347)	Specifies the action to take when the search condition is met.

Define Tab (Search)

The Define tab sets the parameters for a search. From this tab, you specify which trace to search and what kind of violation to search for.

This screenshot is identical to the one above, showing the 'Define' tab of the 'Search' dialog. It highlights the configuration for the search parameters: 'Spectrum: Trace 1' for the search location and 'is greater than' with a threshold of '-20.00 dBm'.

Setting	Description
Search in	Specifies which result to search.
Search for	Specifies what to search for. You can specify a search based on a signal level or a mask.

Search In

The choices for **Search in** are: Phase Settling: Mask Test, Freq Settling: Mask Test, Spectrum Trace 1, Spectrum Trace 2, Spectrum Trace 3, Spectrum Math Trace, Spectrogram Trace, and Spurious. The available choices include only results from displays that are currently open.

NOTE. *If you select a trace result that is not the selected trace in the target display, you will not see the results of the Search until you select the trace in the target measurement display that is the "Search in" trace.*

Search For

The **Search for** setting has selections that vary based on which display's results you are testing.

Pass/Fail Searches for Spurious and Settling Time

The Frequency Settling Time, Phase Settling Time measurements, and Spurious measurements each include their own mask test functions that provide pass/fail results. Controls for defining and enabling these mask tests are found in the displays' own control panels. Search can be configured to look for either a Pass result or a Fail result in one of these measurements and then perform your specified Search actions when that result occurs.

Greater Than/Less Than Searches for Spectrum

If you select a greater than/less than search, you also specify the level that defines a violation. When you select either **is greater than** or **is less than**, a text entry box appears to the right of the drop-down list.

Use the text entry box to specify the signal level you wish to search for. While not as flexible as mask testing, this type of search is quicker to set up.

Mask-Based Searches for Spectrum

If you specify a mask-based search for the Spectrum display, then you need to edit the mask to specify the levels that define a violation. When you select **is outside mask** or **is inside mask**, an Edit limits button is displayed. Select the Edit limits button to display the Mask Editor.

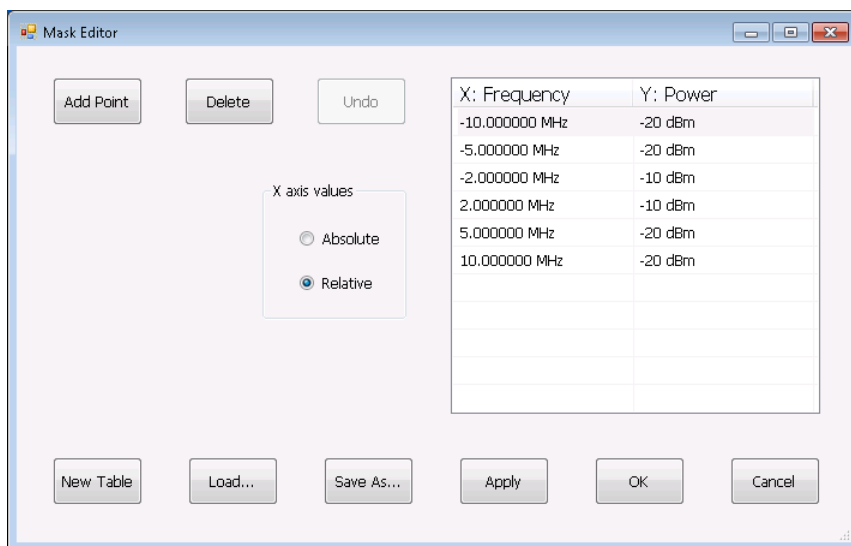

To edit a search mask for a Spectrum display search:

1. Click **Edit limits** to display the Mask Editor.
2. Click **New Table** to create a table. This clears the existing points and loads the default table.
3. Select the **X axis values** setting:
 - a. Select **Absolute** to specify mask point locations based on signal frequency.
 - b. Select **Relative** to specify mask point locations as offsets from the center frequency.
4. To edit values in the table:
 - a. To edit an existing value, double-click on the cell you want to edit.
 - b. To add a new point to the table, click on **Add Point**. Edit the values as required and click **Apply** when you are finished with your changes.

To specify a frequency multiplier, you can type K, M, or G. For the power level, you only need to specify a numeric value. The unit is set to the current Units setting (Setup > Analysis > Units).

1. To delete a point from the table, select the point to be removed, and click **Delete**.
2. To close the Mask Editor without saving your changes, click **Cancel** (if you have already clicked **Apply**, this only cancels changes since the last time **Apply** was clicked).

3. If Search mode is already enabled and the instrument is in Run mode, you can run a Search using your changed points without closing the Mask Editor, by clicking **Apply**.
4. To save changes and close the Mask Editor, click **OK**.
5. To save the mask to a file for later recall, click **Save As**.
6. From the Save As dialog, name the file and save it in the desired location.

Masks are saved only in CSV (Comma Separated Value) format.

Performing a Mask-Based Search

To perform a Search using a mask:

1. Select **Tools > Search**.
2. Click the **Enable Search** check box.
3. Select the trace that you wish to search from the **Searching** drop-down list.
4. Verify that the trace you selected to search is the selected trace in the display.
5. Select either **is outside mask** or **is inside mask** from the **Search for** drop-down list.
6. Click the **Edit limits** button.
7. Edit the table as necessary or click **Load** to use a previously saved mask.
8. If you load a saved a mask, use the Open dialog box to locate and open the mask file.
9. Click **OK**.

The following figure shows the results of an **is outside mask** Search. The vertical red bar highlights results that match the Search definition.

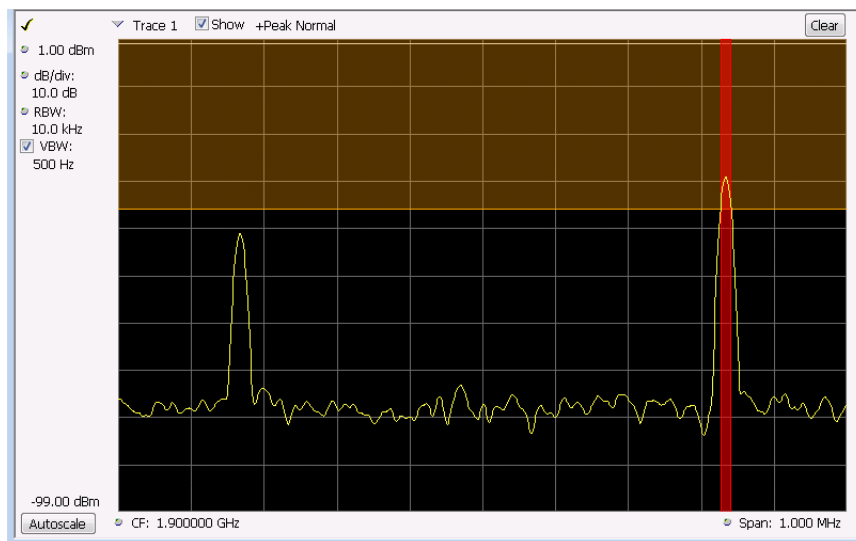

Actions Tab

The Actions tab is used to specify an action to be taken when the search condition is met.

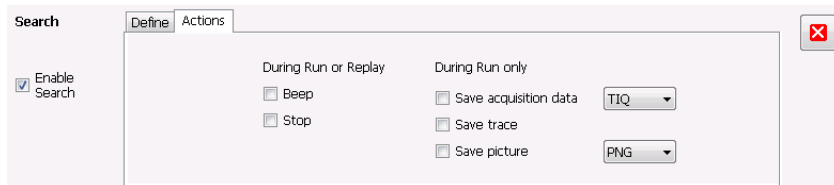

Setting	Description
During Run or Replay	Actions specified here will occur in either Run mode or Replay mode.
Stop	The analyzer stops when the search condition is met.
During Run Only	Actions specified here are taken only during Run mode (while acquiring live data).
Save acquisition data	Saves acquisition data to a file when the search condition is met. Use the drop-down list to specify the format of the saved data. The available file formats are: TIQ , CSV , and MAT (see page 379).
Save trace	Saves Trace data to a file when the search condition is met.
Save picture	Saves a screen capture to a file when the search condition is met. Use the drop-down list to specify the format of the saved picture. The available file formats are: PNG , JPG , and BMP (see page 379). Note that no trace will be saved if the searched trace isn't a saveable trace type. For example, a Spurious trace is not saveable.

AutoSave File Naming

When one of the AutoSave actions is enabled, the name of the saved file is automatically incremented even if the **Automatically generate filenames** option (Tools > Options > Save and Export) is not enabled. When the file is saved, it will be saved to the last location a file was saved. You can check this location by selecting **File > Save As**. The Save dialog will show you the current save location. If you want to save the file in a different location, save a file (any type) in the desired location. This resets the save destination to the new location.

Analysis Settings

Menu Bar: Setup > Analysis

Application Toolbar:

The Analysis control panel provides access to settings that are used by all displays. These settings affect only post processing and they do not control hardware settings.

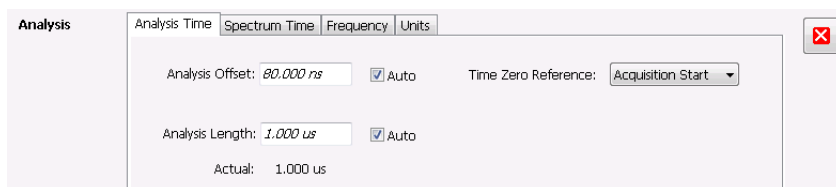

Setting	Description
Analysis Time (see page 349)	Specifies the length of time to use in measurements.
Spectrum Time (see page 351)	Specifies whether the Spectrum Analysis display uses the same Analysis Time parameters as all the other displays or if it uses a different Offset and Length.
Frequency (see page 351)	Specifies the measurement frequency (center frequency).
Units (see page 355)	Specifies the Power units for all displays.

Analysis Time Tab

The Analysis Time tab contains parameters that define the portion of the acquisition record that is used for analysis.

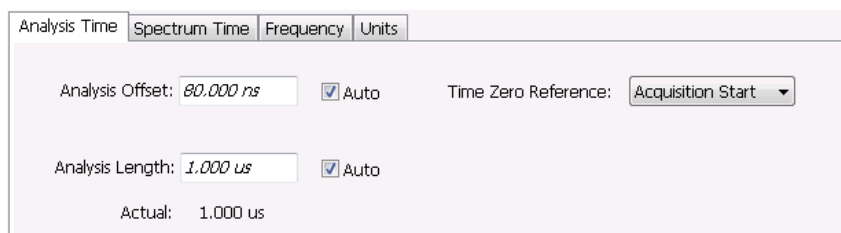

Setting	Description
Analysis Offset	Specifies the location of the first time sample to use in measurements.
Auto	When enabled, causes the instrument to set the Analysis Offset value based on the requirements of the selected display.
Analysis Length	Specifies the length of time to use in measurements.
Auto	When enabled, causes the instrument to set the Analysis Length value based on the requirements of the selected display.
Time Zero Reference	Specifies the zero point for the analysis time.
Actual	This is a displayed value, not a setting. It is the Analysis Length (time) being used by the analyzer; this value may not match the Analysis Length requested (in manual mode).

Analysis Offset

Use analysis offset to specify where measurements begin. Range: 0 to [(end of acquisition) - Analysis Length)]. Resolution: 1 effective sample (or symbol).

Analysis Length

Use the analysis length to specify how long a period of time is analyzed by a measurement. After you enter a value, this box changes to show the actual value in use, which is constrained by Acquisition Time. This setting is not available when Auto is checked. Range: minimum value depends on modulation type to Acquisition Length. Resolution: 1 effective sample (or symbol).

Time Zero Reference

The analysis offset is measured from this point. Choices are: Acquisition Start or Trigger Point.

Parameter	Description
Acquisition Start	Offset is measured from the point at which acquisition begins.
Trigger Point	Offset is measured from the trigger point.

Spectrum Time Tab

This tab controls whether the Spectrum display uses the same Analysis Time parameters as all the other views or uses a different Offset and Length. These settings do not apply to the DPX display because it has no acquisition record or analysis time.

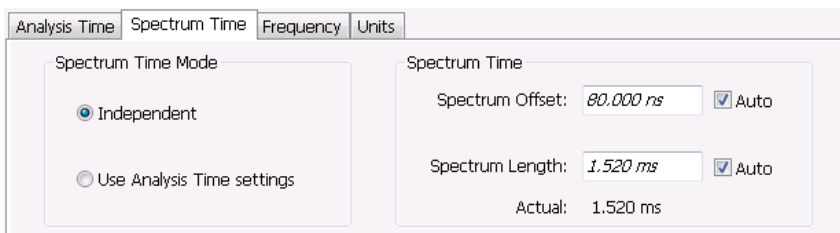

Settings	Description
Spectrum Time Mode	
Independent	Causes the spectrum analysis views to use the settings unique to those displays.
Use Analysis Time settings	Causes the spectrum analysis views to use the settings on the Analysis Time tab.
Spectrum Time (only available when <i>Independent</i> is selected)	
Spectrum Offset	Sets the beginning of Spectrum Time with respect to the selected time reference point (selectable in the Analysis Time tab as either Acquisition Start or Trigger).
Spectrum Length	The amount of data, in terms of time, from which spectrum traces are computed.
Auto	When enabled, causes the instrument to set the Spectrum Length value based on the RBW setting.
Actual	This is a displayed value, not a setting. It is the Spectrum Length (time) being used by the analyzer; this value may not match the Spectrum Length requested (in manual mode). The actual spectrum length is always an integer multiple of the time needed to support the RBW value.

Frequency Tab

The Frequency tab specifies two frequency values: the Measurement Frequency and the Spectrum Center Frequency. The Measurement Frequency is the frequency at which most displays take measurements. The Spectrum Center Frequency is the center frequency used by the Spectrum, DPX Spectrum, Spectrogram and Time Overview displays.

Analysis Time	Spectrum Time	Frequency	Units
Measurement Frequency: 1.500000 GHz			
<input checked="" type="checkbox"/> Lock Center Frequency of Spectrum displays to Measurement Frequency			
Spectrum Center Frequency: 1.500000 GHz			

The following screen capture shows a display with both the Measurement Frequency and the Spectrum Center Frequency locked together.

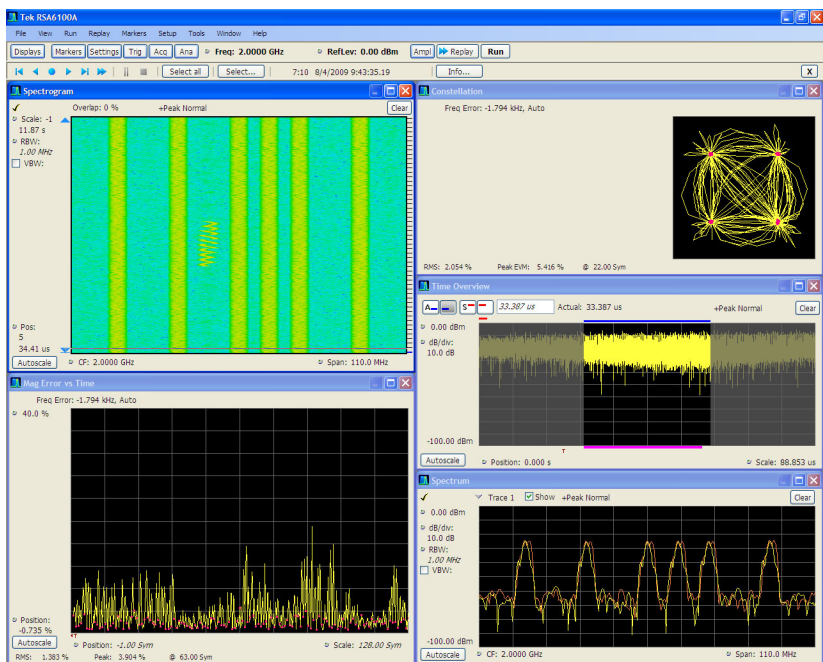

Normally, the Measurement Frequency and the Spectrum Center Frequency are locked together so that both have the same setting. But in some situations, for example, where a signal contains a set of channels, it is useful to unlock the Measurement Frequency from the Spectrum Center Frequency. When the Spectrum Center Frequency is unlocked from the Measurement Frequency, you can adjust the Measurement Frequency so that measurements can be taken at different frequencies without resetting the center frequency. The following screen capture shows the magenta-colored measurement frequency indicator still located at the center frequency.

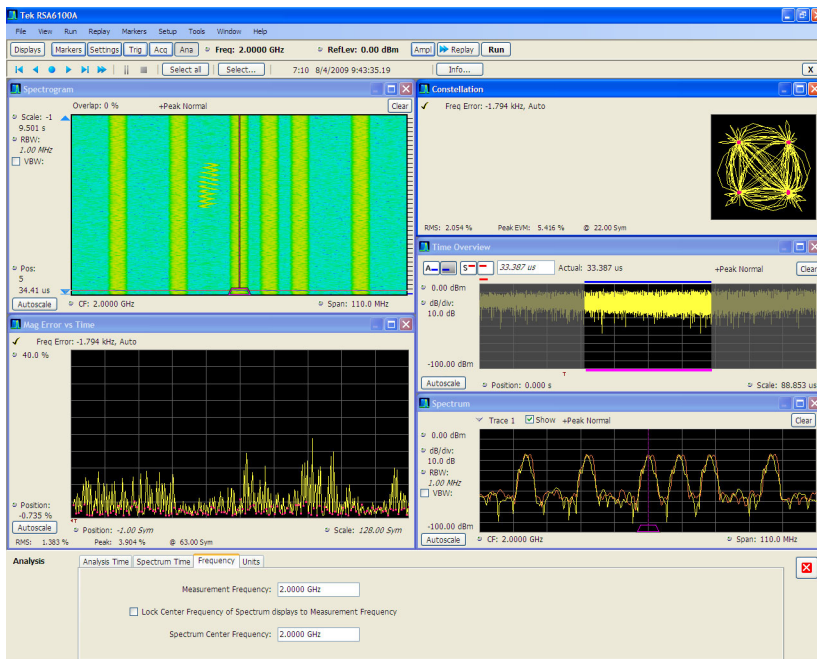

The following screen capture shows the measurement frequency indicator located at 2.0402 GHz while the Spectrum Center Frequency is still located at 2.0000 GHz.

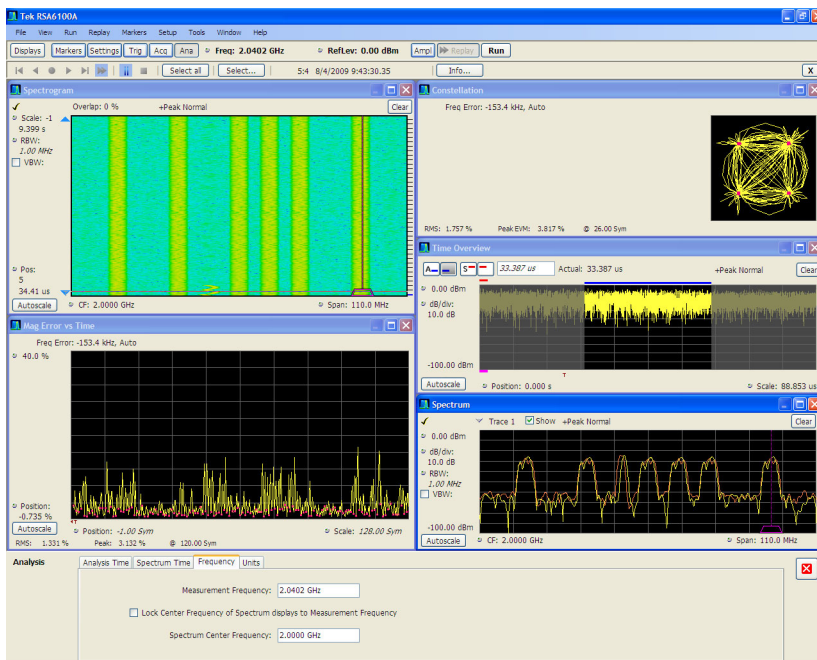

You can drag the Measurement Frequency indicator on the screen to set the measurement frequency. Note the base of the Measurement Frequency indicator. The width of the box indicates the widest measurement bandwidth in use among the open displays. You can see how the width of this box changes with the

measurement bandwidth by, in this example, adjusting the Measurement BW setting for the Constellation display (Settings > Freq & BW tab). As you adjust the setting, you will see how the width of the box at the base of the Measurement Frequency Indicator changes.

The Measurement Frequency indicator is useful for interpreting system behavior when MeasFreq is unlocked. If a measurement has a wide bandwidth relative to the spectrum span, and the Measurement Frequency is far from spectrum center, the measurement is likely to fail because its required frequency range exceeds the frequency range of the available data. In such a case, the navigation control will show that the measurement bandwidth extends outside the Spectrum's span.

There are interactions between frequency unlocking and RF & IF Optimization (see the [Amplitude control panel \(see page 363\)](#)). When **Best for multiple displays** is the selected optimization, the instrument is allowed to use its full bandwidth to meet the needs of all open displays. This is the most user-friendly optimization because it decreases the number of **Acq BW too small** errors, but it can increase noise and slightly decrease measurement accuracies. For all other optimization types, the instrument optimizes the acquisition bandwidth for the selected display, improving measurement quality somewhat, but reducing concurrent measurement capability.

There are also interactions with trigger settings. When the Spectrum Center Frequency is unlocked from Measurement Frequency, the RF triggers (Trigger Source = RF Input) can tune to either Spectrum Center Frequency or Measurement Frequency. When a spectrum display is selected, the trigger frequency is the same as the Spectrum Center Frequency. When one of the other displays that uses Measurement Frequency is selected, the trigger is tuned to the Measurement Frequency also. This allows you to trigger on the signal you are measuring. But, there is an exception: when the selected RF & IF Optimization is **Best for multiple displays**, the trigger is always tuned to the Spectrum Center Frequency.

The reason the trigger frequency is affected by Measurement Frequency and RF & IF Optimization, is that these functions control how the acquisition is tuned. The optimization **Best for multiple displays** keeps the acquisition centered about the Spectrum Center Frequency at all times. To accommodate off-center Measurement Frequencies, it just widens the acquisition bandwidth. Other optimizations tune the acquisition frequency to match that of whichever display is currently selected. The RF trigger module receives the same acquisition data as all the measurements, tuned to the center of the current acquisition bandwidth.

Units Tab

The Units tab specifies the global Amplitude units for all the views in the analysis window.

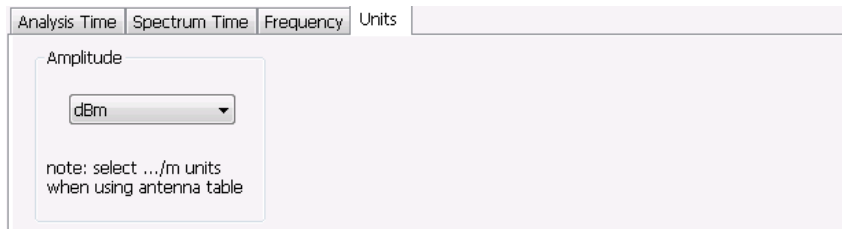

NOTE. If you are using an External Loss Table for antenna corrections (*Ampl > External Gain/Loss Correction*), be sure to set the Amplitude units to *dBuA/m, dBuV/m, V/m or W/m²*.

Replay Overview

The Replay function enables you to reanalyze data with different settings and even different measurements. You can replay all the acquisitions in memory, a single acquisition, a single frame within an acquisition (if Fast Frame is enabled), or any contiguous set of data records from acquisition history. You can replay the DPX Spectra that make up a DPXogram display.

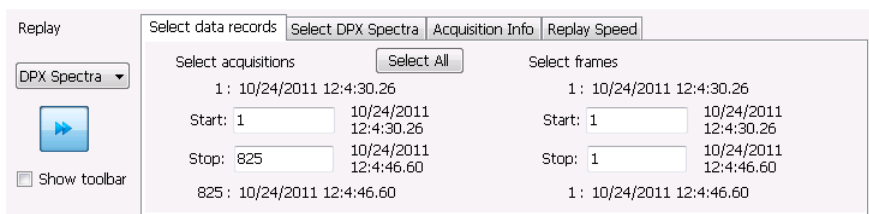

Displaying the Replay Control Panel

To display the Replay control panel:

- From the menu bar, select **Replay > Select data records from history**.

Selecting the Data Type to Replay

You can choose to replay either acquisition data or DPX spectra. Choose **Acq Data** to replay any acquisitions except DPXogram acquisitions. Choose **DPX Spectra** to replay a DPXogram acquisition.

Select Data Records Tab

The Select data records tab is used to select which data records to replay. A data record is the smallest unit that can be replayed. Note that what constitutes a data record can vary. If FastFrame is not enabled, a data record consists of a single acquisition. If FastFrame is enabled, each acquisition can contain multiple frames, and a data record consists of a single frame.

Select data records	Acquisition Info	Replay Speed
Select acquisitions <input type="button" value="Select All"/>		
1 : 7/25/2011 17:39:29.72		
Start: 1	7/25/2011	17:39:29.72
Stop: 304	7/25/2011	17:39:33.79
304 : 7/25/2011 17:39:33.79		

Without FastFrame enabled

Select data records	Acquisition Info	Replay Speed
Select acquisitions <input type="button" value="Select All"/>		
1 : 3/10/2010 4:47:40.22		
Start: 1	3/10/2010	4:47:40.22
Stop: 1	3/10/2010	4:47:40.22
1 : 3/10/2010 4:47:40.22		
Select frames		
1 : 3/10/2010 4:47:40.22		
Start: 1	3/10/2010	4:47:40.22
Stop: 10	3/10/2010	4:47:51.74
10 : 3/10/2010 4:47:51.74		

With FastFrame enabled

Date and Time Stamps. The line that appears above each Start box (one for acquisitions and one for frames when FastFrame is enabled) is a date stamp that displays the date and time the first record in the current acquisition was acquired. The line that appears below each Stop box is a date stamp that displays the date and time the last record in the current acquisition was acquired.

The line that appears to the right of each Start box displays the date and time the selected acquisition or frame was acquired. The line that appears to the right of each Stop box displays the date and time the selected record or frame in the current acquisition was acquired.

Select All button. Selecting Select All resets the Start and Stop values. The Start value is reset to the first acquisition or frame of the current acquisition. The Stop value is reset to the last acquisition or frame in the current acquisition.

Select DPX Spectra Tab

The Select DPX Spectra tab is used to select which DPXogram spectra to replay. A spectra is the smallest DPXogram unit that can be replayed. It is equivalent to one line in the DPXogram display.



Date and Time Stamps. The line that appears above the Start box is a date stamp that displays the date and time the first DPX spectra in the current acquisition was acquired. The line that appears below the Stop box is a date stamp that displays the date and time the last DPX Spectra in the current acquisition was acquired.

The line that appears to the right of each Start box displays the date and time the selected DPX Spectra was acquired. The line that appears to the right of each Stop box displays the date and time the selected DPX Spectra in the current acquisition was acquired.

Select All button. Selecting Select All resets the Start and Stop values. The Start value is reset to the first DPX Spectra of the current acquisition. The Stop value is reset to the last DPX Spectra in the current acquisition.

Acquisition Info Tab

Displays information about acquisition settings and sets the number of decimal places used for displaying the time stamp.

Replay Speed Tab

Sets the speed at which data records are replayed.



Replay Menu

The Replay menu provides controls that let you choose how to replay acquisitions. The replay function enables you to, in effect, “rerun” an analysis while applying different measurements to the same set of acquisition data.

Menu item	Description
Acq Data	Select Acq Data to replay acquisitions.
DPX Spectra	Select DPX Spectra to replay a DPXogram display.
Replay all selected records	Replays the sequence of records specified by Start and Stop on the Select data records tab.
Loop overall selected records	Replays the sequence of records specified by Start and Stop on the Select data records tab continuously.
Replay current record	Replays the currently selected acquisition (or frame).
Replay from selected	Displays a submenu that you use to specify which records are to be replayed.
First record	Replays the first record within the selected set.
Previous	Replays the previous record within the selected set.
Next	Replays the next record within the selected set.
Last record	Replays the last record within the selected set.
Pause	Suspends replay of the data records as soon as the current record's replay action is completed. Press Pause again to begin replay with the next record in the sequence.
Stop	Halts the replay of acquisitions. If replay is started after Stop has been selected, replay starts from the first acquisition.
Select all	Selects all acquisitions for replay.
Select records from history	Displays the Select data records tab of the Replay control panel. Use the Select data records tab to specify which acquisitions and frames you would like to replay.
Replay toolbar	Displays or hides the Replay toolbar.

Acq Data

Selecting **Acq Data** selects acquisition data as the source for replay. Selecting Acq Data does not start replay, it only selects the type of acquisition data that will be replayed.

DPX Spectra

Selecting **DPX Spectra** selects DPX spectra as the source for replay. Selecting DPX Spectra does not start replay, it only selects the type of acquisition data that will be replayed.

Replay All Selected Records

Selecting **Replay all selected records** replays all the selected data records. The set of selected records may comprise a single record, all records in acquisition history, or a subset of the records in history.

Replay Current Record

Selecting **Replay current record** replays the current data record. You can identify the current acquisition record by looking at the Replay toolbar. The first number to the right of the Select button identifies the current data record. For example, if the number is 2:10, it means the current record is the tenth frame of the second acquisition in history.

Replay from Selected

Select **Replay from selected** to replay records as selected from the submenu. The records replayed can be from the acquisition memory (history) or from a saved acquisition data file that has already been recalled as the current acquisition data.

Pause

Select Pause to suspend playback. Selecting Pause again restarts the replay at the point it was paused.

Stop

Select **Stop** to halt the replay of data. Selecting any Replay action restarts replay of records from the beginning.

Select All

Select **Select all** to select all data records for replay.

Select Records from History









Selecting **Select records from history** displays the **Select data records** tab of the **Replay** control panel. The Select data records tab allows you to specify which records in the acquisition history will be used when the Replay button is selected.

Replay Toolbar

Displays or hides the Replay toolbar that appears below the main tool bar.



Replay toolbar

Item	Description
Replay	Selects data type to be replayed.
	Replays the first record in the selected set.
	Replays the previous record in the selected set.
	Replays the current record in the selected set.
	Replays the next record in the selected set.
	Replays the last record in the selected set.
	Replays all records in the selected set.
	Replays all records in the selected set continuously until stopped.
	Pauses replay. Pressing pause suspends replay with the current record. Selecting pause again starts Replay with the next record.
	Stops replay. Starting any replay action after pressing stop starts a new Replay action rather than continuing from the record at which the previous replay action was stopped.
Select All	Pressing Select all selects all records in history for replay. Selecting Select all resets the Start and Stop values on the Select data records tab of the Replay control panel.
Select...	Pressing Select displays the Select data records tab of the Replay control panel. The Select data records tab allows you to select records from acquisition history for replay.

Item	Description
1:10 3/10/2010 4:47:51.74	This readout shows information about the data record being replayed. The information displayed shows the acquisition and frame number and time stamp for the current data record.
	The Info button displays the Acquisition Info tab of the Replay control panel. The Acquisition Info tab displays information about the acquisition data such as acquisition bandwidth, sampling rate and acquisition length. All data records in the acquisition history were acquired with identical parameters. When any of these parameters are changed, all records in history are deleted as soon as the first record acquired under the new parameter values is received.

Amplitude Settings

Menu Bar: Setup > Amplitude

Application Toolbar:

The Amplitude control panel provides access to power-related settings that are used by all displays within the analyzer application.

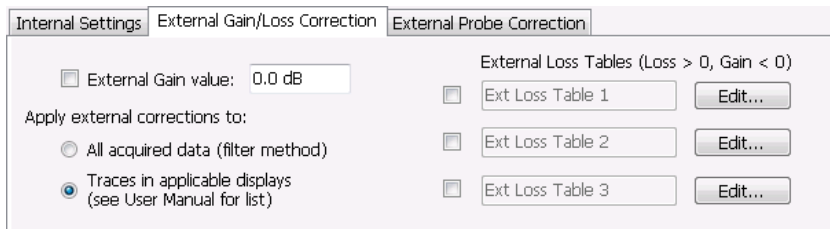

Setting	Description
Internal Settings (see page 363)	Sets the parameters that control the acquisition of the signal.
External Gain/Loss Correction (see page 366)	Specifies whether a correction is applied to the signal to compensate for the use of external equipment.
External Probe Correction (see page 370)	Specifies whether a correction is applied to the signal if the analyzer detects a probe is connected to the instrument. (Probes are connected to the analyzer through the RTPA2A Real-Time Spectrum Analyzer TekConnect Probe Adapter.)

Internal Settings Tab

On the Internal Settings tab, you can specify the Reference Level for the signal analyzer's RF front end, the settings for the internal attenuator, enable/disable the optional internal preamp, and specify the RF & IF Optimization.

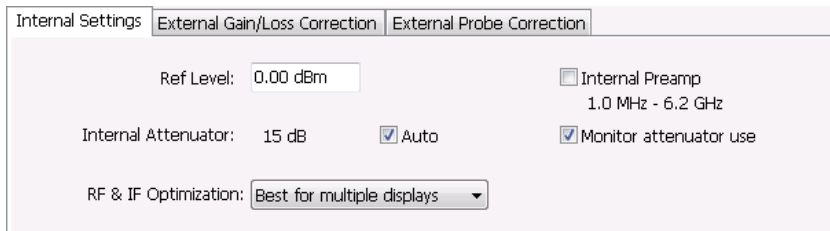

Internal Attenuator

The Internal Attenuator setting can be set to Auto or manual. When Auto mode is enabled, the attenuation setting is displayed but is not adjustable. When Auto is disabled, the attenuator operates in manual mode, allowing you to set the internal attenuation. The internal attenuation setting range is 0 - 75 dB.

Internal Preamp

If your instrument has the optional internal preamp installed, use this setting to switch the preamp on or off.

NOTE. *To ensure the best accuracy, turn on the Internal Preamp and allow it to run for 20 minutes to thermally stabilize before taking critical measurements.*

Monitor Attenuator Use

The input attenuator relays are rated for several million cycles. Some measurement settings result in high rates of attenuator switching and could prematurely age the relays. Enabling this function causes the instrument to monitor the attenuator switching rate. When a high rate of switching is maintained for more than an hour, the instrument will halt acquisitions and display a message about the condition. To restart acquisitions, press Run. If the check box is not selected, the monitoring function is disabled.

NOTE. *This feature is provided to prevent accidental long-term high-rate attenuator switching (thus extending attenuator life). If you need to run the instrument for extended period, such as overnight or over a weekend, disable the setting to prevent the halting of acquisitions.*

RF & IF Optimization

Specifies how the gain and bandwidth should be optimized (in the RF and IF stages of the front end). The available settings are: Best for multiple displays, Auto, Minimize Sweep Time, Maximize Dynamic Range (Spectrum/Spectrogram only) and Minimize Noise.

You can select RF & IF optimizations to achieve the best dynamic range, fastest sweep speed, or minimum displayed noise. These choices affect the RF and IF attenuation levels, the selection of the acquisition bandwidth, digitizer and the resolution of the mathematical operation performed on the acquisitions used in varying conditions of span, reference level and resolution bandwidth. The following paragraphs describe the effects of choosing each of the available choices.

Best for multiple displays (Default). This setting is the instrument default and is set as part of the Preset function. When this is selected, the instrument considers all the open displays and chooses an Acquisition Bandwidth wide enough to satisfy as many measurements as possible. Instead of optimizing the measurement performance of the selected display, this setting decreases the incidence of non-selected displays being unable to run because the acquisition bandwidth is set too small by the selected display.

Auto. The Auto setting is an optimized trade-off of the competing performance choices.

Minimize sweep time. Selecting Minimize Sweep Time causes the instrument to use the widest available acquisition bandwidth when sweeping across spans greater than the maximum available real-time span.

RSA6100B Series: For instruments without Option 110 (110 MHz acquisition BW), this control has no effect. For instruments with Option 110, the swept update rate is improved by approximately 3X compared to all other RF/IF optimization choices. RSA5100A Series: For instruments with Option 40/85, swept update rate is significantly faster than Auto. This setting has no effect in instruments without Option 40/85

Maximize dynamic range. Selecting Maximize Dynamic Range has several effects:

- Sets RF attenuation to allow higher drive levels at the RF mixer.
- Sets IF gain levels to optimize the IF for the higher signal levels that result from allowing higher drive levels at the mixer.
- Selects the acquisition path used in the instrument taking into account the user-specified Resolution Bandwidth (RBW). When an RBW of less than 30 kHz (RSA6100B) or 20 kHz (RSA5100A) is selected, the instrument uses a narrow-band (312.5 kHz) acquisition path, regardless of the selected span or measurement bandwidth. This results in the best rejection of out-of-band signals in the IF stage of the analyzer, but comes at the cost of slower update rates for all signal analyzer spans and measurement bandwidths greater than 312.5 kHz.
- Increases the resolution of the mathematics used in calculations of all signal results from 16 bits to 28 bits whenever span or measurement bandwidth is set to ≤ 312.5 kHz. This is made possible by the high levels of decimation applied to signals processed in these narrow bandwidths.

Minimize noise. This mode increases the system gain at points past the RF mixer. This has the effect of reducing the displayed average noise level.

The table below summarizes the conditions.

Settings	RF auto attenuation (min 10 dB, max 55 dB)	Selected Acquisition Bandwidth	IF Gain/Loss settings	Notes and Trade-offs
Best for Multiple Displays	Ref Level +15 dB	Acquisition Bandwidth is set to the value required to service as many of the open displays as possible.	Neutral	Swept Speed, Dynamic Range, Noise Floor
Auto	Ref Level +15 dB	Driven by the measurement bandwidth of the selected display. If span is greater than the available acquisition BW, unit sweeps using 25 MHz (SPECMON3) or 85 MHz (SPECMON6) acquisitions	Neutral	Swept Speed, Dynamic Range, Noise Floor may not be optimal

Settings	RF auto attenuation (min 10 dB, max 55 dB)	Selected Acquisition Bandwidth	IF Gain/Loss settings	Notes and Trade-offs
Minimize Sweep Time	Ref Level +15 dB	Unit uses widest available acquisition BW for spans greater than maximum acquisition BW.	Neutral	RSA6100B Series: For units equipped with Option 110 (RSA6100B), swept update rate is approximately 3 times faster than Auto. No effect in units without Option 110. RSA5100A Series: For units with Option 40/85, swept update rate is significantly faster than Auto. No effect in units without Option 40/85
Maximize Dynamic Range	Ref Level +20 dB	Driven by span and user-selected RBW when a spectrum-type display is selected, or by measurement bandwidth and filter bandwidth when other display types are selected. For RBW < 20 kHz, the high dynamic range 312.5 kHz path is used regardless of selected span or measurement bandwidth. Sweeps are made in 85 MHz (SPECMON6) or 25 MHz (SPECMON3) acquisitions.	IF attenuation increased to improve dynamic range. This causes higher noise level.	Might result in very slow sweep speeds in wide spans when RBW < 20 kHz.
Minimize Noise	Ref Level +15 dB	Same as Auto	Set to minimize noise level.	Might result in earlier IF overload under some signal conditions.

External Gain/Loss Correction Tab

The External Gain/Loss Correction tab allows you to apply a correction to a signal to compensate for the use of external equipment, such as an amplifier or attenuator. You can specify whether the corrections on this tab apply to all acquired data or only to a set group of displays.

External Gain Value

Use the External Gain Value setting to apply a flat gain/loss correction to the signal. Positive values represent a gain and negative values represent a loss. The range is -50 to $+30$ dB. Resolution is 0.1 dB.

NOTE. *Selecting Preset clears the check box, but it does not change the value.*

Apply External Corrections To

Use the two selections to specify whether the enabled external loss tables are applied to all acquired *data* or only to *traces* in the Spectrum, Spectrogram, Spurious, and Amplitude vs Time displays.

When choosing whether to correct sample data or traces, keep the following in mind:

- If sample data is acquired while data correction is enabled, that data record is permanently corrected. If the acquisition is saved and recalled, the recalled acquisition includes corrections. Corrections are not saved separately from the raw data; they are used during the acquisition process to adjust the data values.
- Trace corrections can be applied at any time, as they are part of the measurement's computations. Using Replay will apply trace corrections to a trace if this control is enabled (and an external loss table is specified and enabled).
- Be aware that if you recall acquisition data that was saved with data corrections and you use Replay with trace corrections selected and an external loss table enabled, the trace will be calculated using corrected data and also corrected with trace corrections. This probably creates incorrect traces.
- When only Traces are being corrected, triggering operates on uncorrected acquisition data. Frequency masks and trigger level lines in the displays are also not corrected, so there is a visual discrepancy between data traces and trigger indicators in the graphs under this condition.
- When only Traces are being corrected, triggering operates on uncorrected acquisition data. Frequency masks and trigger level lines in the displays are also not corrected, so there is a visual discrepancy between data traces and trigger indicators in the graphs under this condition.

Trace Corrections Versus Data Corrections

Because of the real-time nature of the instrument and desire to frequently reanalyze stored acquisitions, it is possible to apply amplitude corrections in real time. Applying real-time corrections to the incoming data means that, the correction factors present during the acquisition are already part of the data when the data is stored and then reanalyzed. This also allows the DPX display to maintain its update rate while presenting an amplitude-corrected display.

Real-time gain/loss factors are applied by creating a correction filter that is applied by the same digital signal processing hardware used to correct for calibration and alignment factors in the instrument. This process does have limitations. In creating a digital filter to represent the gain/loss table, a limited number of filter taps are be used in order for the filter to be practically realizable. If your amplitude corrections contain discontinuities or extremely sharp transitions, the filter used will contains errors and ringing.

If the above is the case, we recommended that you use trace corrections. These are very similar to a conventional spectrum analyzer, and may be applied to the spectrum, spectrogram, spurious search and amplitude vs. time displays. These traces may contain transitions of any type within the maximum and minimum correction values allowed in the tables.

External Loss Tables

Use an External Loss Table to apply a frequency dependent gain/loss correction to the signal. When an External Loss Table is selected, the analyzer adjusts the signal according to the values in the table. An external loss table allows you to compensate the signal level for variations in cable loss, antenna frequency response or preamp frequency response.

You can create external loss tables from the analyzer application and save them as files. External loss tables are saved as plain text files in CSV (Comma Separated Value) format. The tables have a CSV file extension.

You can change the title for each table. However, note that the title is only a label. It is not tied to the file name of any table you may have loaded or saved.

NOTE. *If you are using an External Loss Table for antenna corrections, be sure to set the Amplitude units (Setup > Analysis > Units) to dBuA/m, dBuV/m, V/m or W/m².*

Creating an External Loss Table

You can create an external loss table with the analyzer application. No external application is required.

To create an external loss table:

1. Click **Edit.** to display the Table Editor.

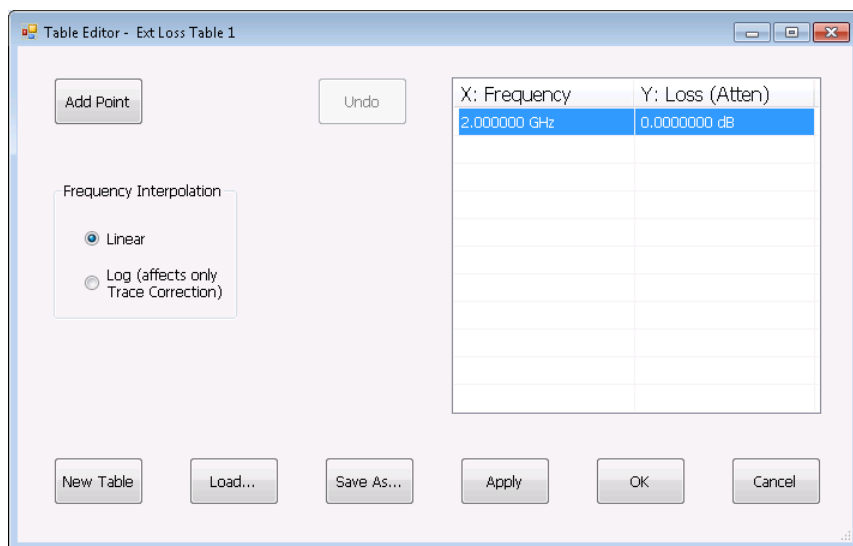

2. Click **New Table** to create a table. This clears all entries in the existing table and loads the default table.

3. To edit values in the table:
 - a. To edit an existing value, double-click on the cell you want to edit.
 - b. To add a new point to the table, click on **Add Point**. Edit the values as required.
 - c. Click **Apply** if you want to test your table without closing the editor (the table must be enabled with the check box in the control panel and measurements must already be running).
To specify a frequency multiplier, you can type K, M, or G.
4. To delete a point from the table, select the point to be removed, and click **Delete**.
5. Select the Frequency Interpolation method:
 - Select Linear when the frequency scale of the spectrum or spurious measurements are linear.
 - Select Log when the frequency scale of the spectrum is logarithmic.
6. When you have entered all the necessary values, click **Save As** (to save the table in a file) or click **OK**.
7. From the Save As dialog, name the file and save it in the desired location.
External loss tables are saved in CSV (Comma Separated Value) format.

Loading an External Loss Table

To load an external loss table file:

1. Click **Edit** to display the Table Editor.
2. Click **Load** to display the Open dialog box.
3. Navigate to the location of the desired file, select it and click Open.
4. Click **OK**.

External Probe Correction Tab

The External Probe Correction tab is used to specify whether a correction factor is applied to the signal when a Tektronix P7000 Series probe is connected to the analyzer through the Tektronix RTPA2A Real-Time Spectrum Analyzer TekConnect Probe Adapter.

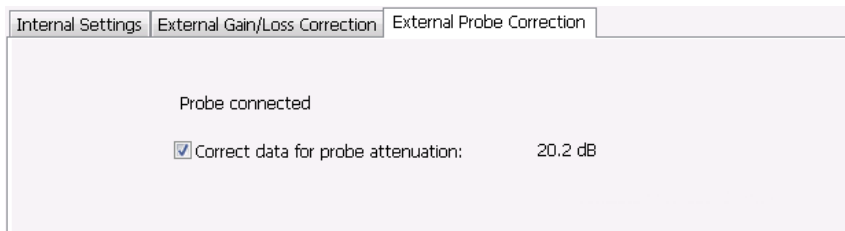

The analyzer can detect when an RTPA2A TekConnect probe adapter is connected to the instrument. The only setting available on the tab specifies whether a correction is applied to the signal or not. The amount of correction is specific to the probe and is communicated to the signal analyzer through the RTPA2A TekConnect probe adapter.

If the signal analyzer does not detect a probe adapter, the setting to correct for a probe is dimmed and **No probe detected** is displayed on the tab.

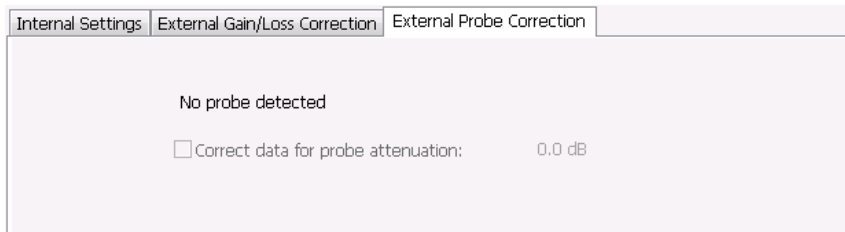

Continuous Versus Single Sequence

Menu Bar: **Run > Single Sequence / Continuous**

Selecting Single Sequence sets the acquisition mode so that when you press Run, a single acquisition sequence is performed and the instrument stops once the acquisition sequence is completed. Selecting **Continuous** sets the acquisition mode so that an acquisition sequence is started as soon as you select Continuous and as one acquisition sequence completes, another begins.

Note that an acquisition sequence can require more than one acquisition. For example, in a spectrum view, the trace function might be set to Average 100 acquisitions. Thus, a complete acquisition sequence would consist of 100 acquisitions that are averaged together to create the trace that is displayed.

Run

Menu Bar: **Run > Run**

Application Bar / Front Panel: **Run**

Selecting **Run** begins a new acquisition/measurement cycle.

Resume

Menu Bar: **Run > Resume**

Restarts data acquisition, but does not reset accumulated results, such as Average or MaxHold. This allows you to stop acquisitions temporarily, then continue. If the accumulation is already complete, for example, 10 acquisitions or 10 averages have already been completed, each subsequent Resume command will cause one more acquisition to be taken, and its results added to the accumulation. Not available if instrument settings have been changed.

Abort

Menu Bar: **Run > Abort**

Selecting **Abort** immediately halts the current acquisition/measurement cycle. In-process measurements and acquisitions are not allowed to complete. Visibility and accuracy of results is unspecified after an abort.

The Acquire Control Panel

Menu Bar: Setup > Acquire

Application Toolbar:

Selecting **Acquire** displays the Acquire control panel. These settings control the hardware acquisition parameters for the signal analyzer. Normally, these parameters are automatically adjusted for selected measurements. You can use Acquire to change these parameters manually if necessary.

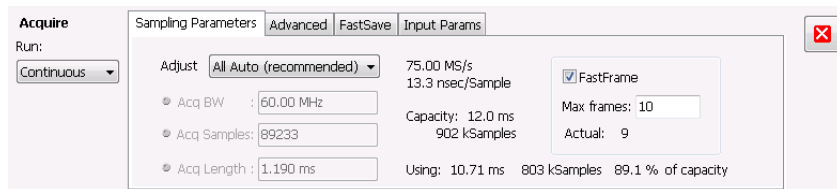

Tab	Description
Sampling Parameters (see page 372)	Sets the parameters that control the acquisition of the signal.
Advanced (see page 374)	Sets the Dither parameters.
FastSave (see page 377)	Sets the FastSave parameters. Initiates FastSave acquisitions.

Run

Run mode specifies whether the analyzer will stop acquiring data after it completes a measurement sequence.

- **Continuous** - In Continuous mode, once the analyzer completes a measurement sequence, it begins another.
- **Single** - In Single mode, once the analyzer completes a measurement sequence, it stops.

NOTE. A measurement sequence can require more than one acquisition. If the analyzer is configured to average 100 traces together, the measurement sequence will not be completed until 100 traces have been acquired and averaged.

Sampling Parameters Tab

The Sampling Parameters tab enables you to set the controls for data acquisition. There are two settings on the Sampling Parameters Tab, the Adjust setting and FastFrame. Depending on the setting chosen for Adjust, two additional parameters can be set. Normally, the best results are achieved by leaving the Adjust control set to All Auto. Manually overriding the automatic settings affects both real-time and swept acquisitions.

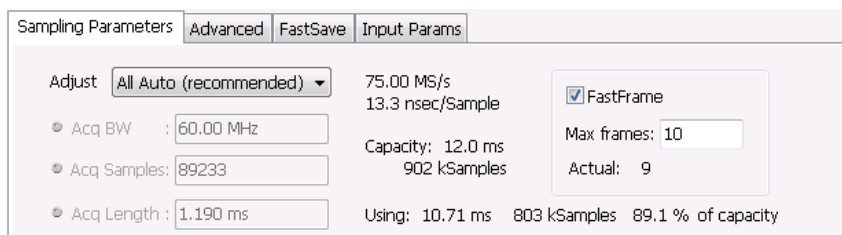

Sampling Control

There are three sampling parameters that interact with each other: Acquisition Bandwidth, Acquisition Length, and Acquisition Samples. Acquisition Bandwidth is the frequency range of the acquisition. Acquisition Length refers to the time over which the acquisition occurs. Acquisition Samples is the number of samples acquired over the acquisition time. The parameters available for Adjust and how the parameters are determined are shown in the following table.

Adjust	User sets	Analyzer calculates
All Auto	N /A	N /A
Acq BW / Acq Samples	Acq BW	Acq Samples
Acq BW / Acq Length	Acq BW	Acq Length

Acquisition Memory Usage

The center portion of the tab shows how the acquisition memory is used.

Readout	Description
Samples/s, sec/Sample	Readout of the acquisition sample rate and sample period.
Capacity	The maximum period of time and number of samples that could be acquired with the current sampling parameters.
Using	The total amount of acquisition memory that will be used based on the current settings.

FastFrame

FastFrame is a feature that allows you to segment the acquisition record into a series of frames, or data records. A typical use of FastFrame is to record data samples around signal events of interest, while not wasting memory on irrelevant data between these events. FastFrame is only valid for real-time acquisitions. If any measurement is configured for swept acquisitions, an error message is displayed: Disabled: *FastFrame doesn't support swept settings.*

Setting	Description
FastFrame	Enables FastFrame acquisition mode.
Max Frames	Specifies the maximum number of frames to record in a single acquisition process.

The Actual readout shows the actual number of frames that will be acquired into the acquisition memory. This number changes based on the Acq BW, Acq Samples, and Acq Length values. This number will never be greater than the value set by Max Frames.

Advanced Tab (Acquire)

Provides access to Advanced Acquire settings.

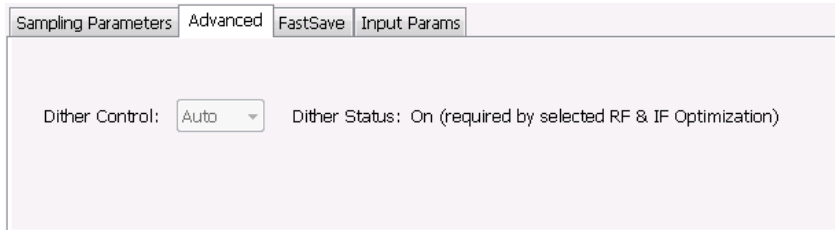

Setting	Description
Dither	Can be set to Auto or Manual. In Auto mode, each measurement sets Dither as appropriate for the measurement. In Manual mode, the user setting overrides the measurement preference.

Dither

Dither is the process of adding noise to the analog signal prior to the analog-to-digital conversion. The purpose of adding noise is to randomize the quantizing process of the ADC (analog-to-digital converter) so it does not appear as discrete components in locations where the distortion components of the ADC would fall. All ADCs produce quantizing errors that appear as noise (quantizing noise) or as discrete components which are less desirable. Without dither and in the presence of tones that are close to sub-multiples of the sample rate or correlated to the sample rate, all the quantizing energy can fall in the same locations as discrete distortion components. This can increase what appears as spurious tones but they are not related to the normal spurious mechanisms or true distortion. Adding noise can randomize the quantization process so those tones aren't produced.

In general, you should leave the Dither setting on Auto. In the Auto mode, individual measurements will select the best guess dither setting (on or off). In Manual mode, the user setting overrides individual measurements' dither settings enabling the user to determine the best use for the best measurement.

NOTE. *If the [RF & IF Optimization \(see page 364\)](#) is set to Best for multiple displays, you cannot change the Dither setting.*

Dither is not always necessary. The signal itself can be used to randomize quantizing errors. Since the input signal is not under control of the instrument, the use of dither is signal dependent and its use must be determined by the user. Typically, pure tones create the most problems with quantizing errors. Dither should be used for those input types. Many digital modulation types are noise-like, so dither is usually not

needed for modulation types such as CDMA, GSM and many others. Dither also uses up a bit of headroom in the ADC, typically 2-3 dB. If the largest dynamic range to the noise floor is needed, that is Signal to Noise Ratio, the dither can probably be turned off. The measurements for Channel Power/ACLR and MCPDR automatically turn dither off for just that reason. Signals in the range of -6 dB to -40 dB below the reference level usually show the greatest benefit from having dither present. The user can find the best use by observing the results for the particular input signals while setting dither on or off. There are cases where dither can make things worse. If dither makes an improvement in the measurement, it should be left on. It is doing its job to improve dynamic range. If it makes it worse, dither should be left off.

FastSave

FastSave (also known as Fast Save) is a way to automatically save acquisitions to a file. It is a way to collect data, not to analyze the data. Analyzing the data require recalling the saved acquisition data file.

When making acquisitions and performing analysis, the instrument creates a cache file with a copy of the acquisition that it uses as the source for analysis and displays. To Save a waveform as a .TIQ or .MAT file, the instrument pulls data from the cache, formats the data for the chosen file type, and writes again to the disk with a .TIQ or .MAT extension. Normal operation requires creation of the cache file and reading of a cache file prior to analysis or save functions. These hard-drive read and write cycles can be time consuming for large files. If you need only to save data for later analysis, a mode named FastSave is available.

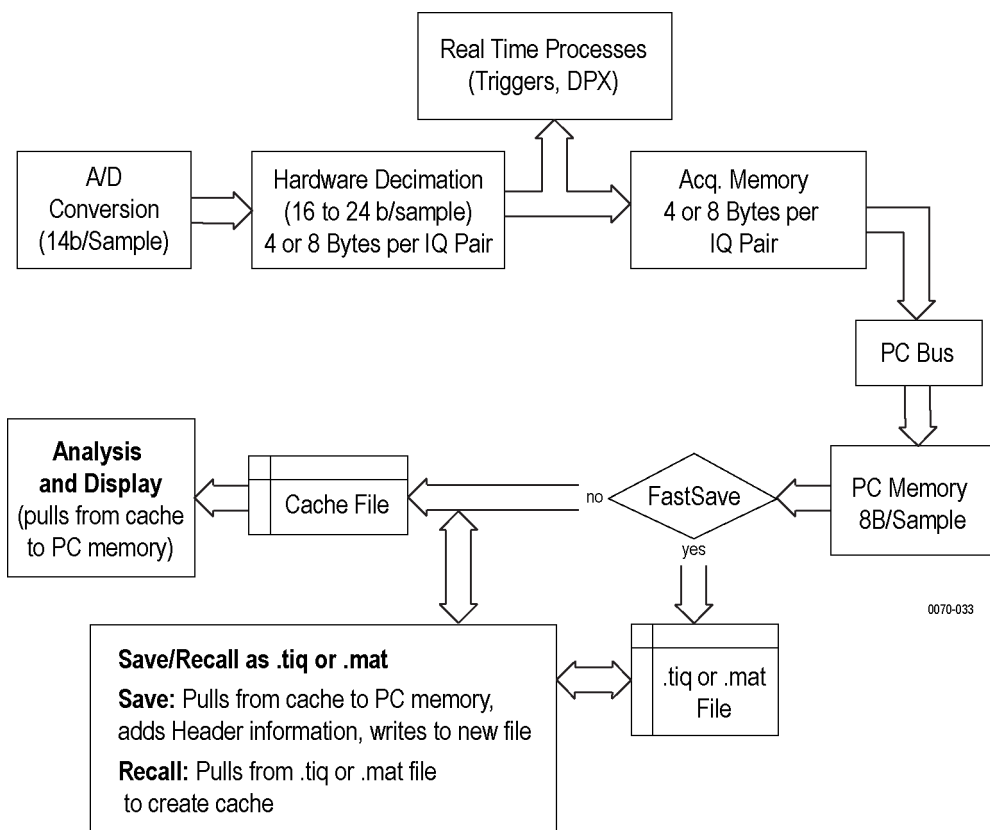

FastSave mode bypasses cache file creation and writes directly to a file. This eliminates two of three disk read or write operations. Depending on the file size, FastSave reduces the time required for data acquisition up to 65%. Using FastSave means that *only* real-time processes will be used. The instrument triggers and DPX display are not affected. All other measurements are suspended, and an information message (Disabled - FastSave is selected) is displayed in the graph area of each display.

Preparing for a FastSave Acquisition

1. Configure the instrument as necessary to capture the signal event you are interested in.
2. On the **Setup > Acquire > FastSave** tab, specify the **Base file name**.
3. Click the ... button to specify the location where the acquisition files will be saved.
4. Set the number of files to save by entering a number in the **Max files saved per Run** box.
5. Specify the file format (TIQ or Matlab).

Starting a FastSave Acquisition

To start a FastSave acquisition:

1. Select the **Acq** button to display the Acquire control panel.
2. Select the **FastSave** tab.
3. Select the **FastSave acquisition data** checkbox to enable FastSave acquisition.
4. Start a FastSave acquisition:
 - a. If the instrument is running when you enable FastSave, FastSave acquisitions begin immediately.
 - b. If the instrument is paused when you select FastSave, select **Run** to begin FastSave acquisitions.

NOTE. *When using FastSave in Single Sequence, it is possible for more than one acquisition to be saved under the following conditions.*

- *The DPX display is open*
- *Acquisition length is less than about 50 ms*

*FastSave can store more than one short acquisition in the time it takes DPX to acquire, process and display one set of DPX spectrums (about 50 milliseconds). Thus, you may find that FastSave creates more than one file under these conditions. To limit FastSave to a single acquisition per process, set **Max files saved per run** to 1 in the FastSave tab (Setup > Acquire > FastSave).*

FastSave Status Messages

Once the FastSave acquisition begins, a status message appears in the graph area. The message that appears depends on whether the instrument was running or paused when FastSave acquisition data was clicked.

- **Disabled - FastSave is selected:** This appears when acquisition is paused. It means that the display update is disabled until FastSave is disabled. FastSave acquisition will not begin until you select **Run**.
- **Saving X of XX** - FastSave is active and saving files. This appears only while FastSave is active.
- **Done saving - restart with Stop, then Run .. More** - Displayed when the specified number of files have been saved. FastSave can be restarted by selecting Run to begin a new set of acquisitions.

FastSave Tab

Use FastSave tab is used to configure and initiate [FastSave \(see page 375\)](#) acquisitions.

Setting	Description
FastSave acquisition data	Enables/disables FastSave acquisitions. If acquisitions are running, selecting the FastSave acquisition data checkbox immediately begins saving acquisition data to files. If the instrument is paused, FastSave acquisitions will not begin until you select Run .
Format	Specifies the file format of the FastSave acquisition data files. Files can be saved in TIQ or MAT format.
Base file name	Specifies the base name for acquisition data filenames. When acquisition data files are saved, a 24-character timestamp is appended to the base file name. The maximum base file name length cannot exceed 232 characters.
Location	Specifies the directory location where files will be saved. Files can be saved on the local hard drive, a network location or even a USB- connected drive. However, due to the time required to transfer files across a network or by USB, the local hard drive is the only recommended location.
Max files saved per Run	Specifies the number of files to be saved each time a FastSave acquisition is started. The number of files that can be saved is limited only by the storage space available. Each saved acquisition file uses about 3.3 MB of space.

Saving and Recalling Data, Settings, and Pictures

You can save different types of data for later recall and analysis.

Data type	Description	Save as type
Setup files	Saves all of the setup information for all displays, except those settings that are not part of Preset.	Setup (.Setup)
Picture of Selected Display (PNG/JPG/BMP)	Saves a capture of the screen in the specified format. This option is useful for including the graphic in reports or other applications. Marker readouts and other information are included.	Picture (.BMP, .PNG, .JPG)
Results Export files	Saves the trace and numeric data for the selected display. The trace and numeric data are saved as CSV files.	Results export (various)
Measurement Settings	Saves a list of settings relevant to the selected measurement to a text file. This option is useful for including the measurement settings in reports.	Measurement settings export (TXT)
Trace	Saves a trace for later recall into the display from which it was saved.	Selected trace (various)
Data	Saves data for reanalysis by RSA6100B Series Real-Time Spectrum Analyzers, RSA5100A Series Real-Time Signal Analyzers, SPECMON Series Real-Time Spectrum Analyzers, or as data to use with external software (either CSV (comma-separated value) or MAT (MATLAB format)). For fastest capture of data files in TIQ or MAT format, use FastSave. This function disables caching and analysis of incoming data, greatly decreasing the time required to save files to local or network storage.	Acquisition data with setup (TIQ); or Acquisition data export (CSV or MAT)

Saving Files

Saving files follows the same procedure regardless of the type of data being saved. To save setups (including application presets), pictures, results, or acquisition data:

1. If you are going to save DPX Spectra (DPXogram) acquisition data, stop acquisitions.
Saving while running is allowed by the analyzer, but data files saved while running will not contain any DPX spectral data.
2. Select **Save As** from the **File** menu to open the **Save As** dialog box.

3. Navigate to the folder where you want to save the setups, or use the default location.
 - To save setups so that they appear in the User Presets list, save your setup in the folder **C:\SPECMON Files\User Presets**. The saved setup will appear in the User Presets window with the name you give the file.
5. Enter a file name.
6. Select the type of file to save from the **Save as type** drop-down list.
7. Click **Save**.
8. If you save acquisition data (Acq data with setup (TIQ), Acq data export (CSV), and Acq data export (MAT)), the File Contents window appears. In the File Contents window, you need to specify the data type, data records, and data length to save the acquisition data.

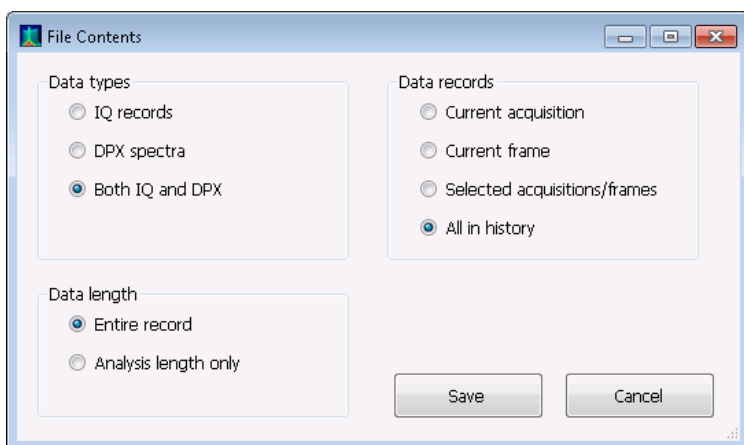

- a. Select the data type: Choose IQ data, DPX Spectra, or both. DPX spectral data only exists while either the DPXogram or Split DPX display is open, and acquisitions are stopped. IQ data is not available when FastSave is turned on. In cases where the selected data type is not available, the file will be saved without that data.
- b. Select the data records you want saved. Frames can be saved only when FastFrame was enabled during acquisition.
- c. Select the desired data length. The data length controls are enabled only when IQ data is being saved.
- d. Click Save to save the acquisition data file.

Saving Data with FastSave

To save data using FastSave, use the procedure [Preparing for a FastSave Acquisition \(see page 376\)](#).

Recalling Files

You can recall three types of files: Setup files, Selected Trace, and Acquisition data with setup. Recalling data follows the same procedure regardless of the type of data being recalled.

1. Select **Recall** from the **File** menu to open the **Open** dialog box.
2. Navigate to the folder containing the file you want to recall.
3. Select the type of file to recall from the **Files of type** drop-down list. This selection determines the files that appear in the Open dialog box.
4. Select the file to recall.
5. Click **Open**.

To open an .iqt file:

Setup Files

You can set up the instrument as desired and then save the settings in a setup file. This enables you to quickly setup the instrument by recalling previously saved setups.

Exporting Results

Save for further analysis of results in other programs, such as MATLAB or Excel.

Pictures of the Selected Display

You can save pictures of the instrument display for documentation purposes. When saving pictures of the display, you can select from three file types: BMP, JPG, or PNG.

Measurement Settings

You can save a list of settings relevant to the selected display to a file for documentation purposes. The exported file uses tab characters to separate values. The settings included in the file depend on the selected display. The contents of the file are the same as a Results export except it does not include the results.

Saving Acquisition Data with Setup

Save for later analysis with the analyzer. The setup is saved as part of the acquisition data file so you can choose when recalling data whether or not to also recall the associated acquisition and analysis parameters.

Saving Acquisition Data Export in CSV Format

Save for examining results in other programs, such as MATLAB or Excel.

Data, Settings, and Picture File Formats

You can save different types of data for later recall and analysis.

Saved File Types

File type	File extension	Description
Setup files	.setup	Setup files enable you to save instrument settings for later recall. Using these files saves setup time and ensures consistent measurements.
Picture	.png/.jpg/.bmp	Screen capture of analyzer application window. They are useful for documenting results in test reports.
Results Export	.csv	Results files contain the trace points and numeric values that were produced by the selected measurement. The header of a Results file includes key acquisition and analysis settings to aid in the interpretation of the data. The file is saved as a plain text file, but the contents are formatted as CSV (comma-separated values). Results files can be opened from applications such as Microsoft Excel and MATLAB.
Measurement Settings	.txt	Measurement settings files contain a list of settings that describe how the instrument is set up for the selected measurement. The list contains measurement settings (for example, Span), trace settings (for example, whether or not a trace is selected) and global settings (for example, Frequency and Reference Level). The list of settings contained in the file varies depending on which display is selected.
Selected Trace	varies with display	Trace files contain the trace results data in binary format. These files are only readable by the analyzer application. Several of the instrument's measurements allow you to recall a Trace file for visually comparing a saved trace to a live trace.
Acquisition Data with Setup	.tiq	These files contain the acquisition data record and complete instrument setup (in binary format). Use these files to save data for later recall and analysis. When you save an Acquisition Data file, the current Setup is always saved with the file. At the time of recall, you will be asked whether you want to restore only the acquisition data or both data and setup. If the instrument is already set up for a specific measurement, you will probably want to recall only the acquisition data. Recalling both data and setup returns the instrument to the same state it was in at the time you saved the file.
Acquisition Data	.csv	These files contain IQ sample data before it has been processed by a measurement. The acquisition data points are saved as IQ pairs. Use this format to import the acquisition data into Microsoft Excel for further analysis.
Acquisition Data	.mat	These files contain IQ sample data before it has been processed by a measurement. The acquisition data points are saved as IQ pairs. Use this format to import the acquisition data into MATLAB for further analysis.
Range file	.csv	These files contain a list of settings that describe how the instrument is set up for the Spurious measurement. The file contains the number of ranges enabled, the start and stop frequencies for each enabled range, the limits for each enabled range, the mask type and more.

Results Export File Format

The Results Export format contains trace points and/or scalar results produced by the measurement. The file contains general information about the measurement settings at the top of the file and the results data in the second part of the file. Groups of settings or results are headed with [text], as described below.

At the top of the file is the measurement name and the date and time data was acquired.

The first group of settings is [Global Parameters]. These settings include the Measurement Frequency, Acquisition Data, Reference Level and others.

The second group of settings is [Parameters]. These settings are specific parameters which vary depending on the measurement.

The next group is [Trace Parameters], which may not be present, depending on the measurement. Within this group, there are parameters specific to a trace. There will be a Trace Parameters group for each trace shown on the display.

The next group is [Results]. These are scalar results for the measurement.

Next is [Traces]. The Traces group consists of one or more [Trace] groups. There is one Trace group for each trace. Each [Trace] group contains background information about the trace (units, number of points, x scaling, and others depending on the measurement) at the top of the group, followed by the trace points.

Acquisition Data with Setup File (.tiq) Format

The file consists of two parts - the header that is in XML and the data that is in binary format.

Header. The header consists entirely of the DataFile element. This element is broken down into sub-elements.

1. DataSetsCollection
2. Setup

DataSetsCollection. The DataSetsCollection contains a DataDescription element, a DataSet element, and a ProductSpecific element.

Binary data. Binary data is a sequence of Int32 values, which are IQ pairs (I,Q,I,Q, ...) in binary Little Endian format.

To convert these values to volts, multiply the individual values by the Scaling value in the DataDescription.

The binary data starts at an offset into the file == the "offset" attribute in the DataFile element. This offset number will always start at the 19th character into the file (starting with 1), and will always be 9 characters long.

NOTE. *You should not casually modify the XML header, because this will change the offset to the start of the binary data.*

Acquisition Data Files (.csv)

The acquisition data files have two sections. At the top of the file is the following information:

- SamplingFrequency - The sampling frequency in Hertz.
- NumberSamples - The number of IQ samples in the file.
- DateTime - When the data was acquired.
- Frequency - The center frequency in Hertz.
- AcquisitionBandwidth - The acquisition bandwidth Hz.

Following the AcquisitionBandwidth are the data. The data are IQ pairs, in volts.

Groups of settings or results are headed with [some text].

The first thing in the file is the measurement name and the date/time when the acquisition was taken.

The first group [Parameters] are global parameters. Measurement Bandwidth in this group is the measurement bandwidth used by the General Signal Viewing measurements (Spectrum, Amplitude vs. Time, etc). It also includes some source settings, like Acq BW, Dither, Preamp, and RF Attenuation.

The second group [Parameters] are measurement-specific parameters.

Another group which can occur is [Trace Parameters]. Within this group, there will be a set of parameters, one for each trace that is currently shown.

Another group is [Results]. These are scalar results for the measurement.

Another group is [Traces]. It has [Trace] groups under it, one for each trace. Each [Trace] group has some background information about the trace (units, number of points, x scaling, etc), and the trace points themselves.

Acquisition Data Files (.mat)

The acquisition data files saved in MATLAB format contain the following MATLAB variables:

- InputCenter - The center frequency in Hertz.
- XDelta - The sample period in seconds.
- Y - A complex array containing IQ pairs.
- InputZoom - The acquisition bandwidth in Hertz.

The MATLAB format used to save acquisition data has the following properties and limitations:

- Files are stored in MATLAB Level 5 format.
- MATLAB Level 5 file size is limited to 2 GB.

- The instrument acquisition memory limit is 1 GB (1.024 Gigabytes). Because of the way acquisition data is processed, 1 GB of acquisition memory requires 2 GB of memory to store. When header information (instrument settings) is added to the acquisition data, the resulting file size is >2 GB.
- If acquisition memory is filled (1 GB), exporting the data to MATLAB format will result in a file that exceeds 2 GB in Matlab level 5 format. A PC with sufficient memory is required to open the file. If memory is not sufficient, Matlab will warn the user. To check how much acquisition memory is filled, select Setup > Acquire > Sampling Parameters. When the instrument is stopped, or you are analyzing a recalled data file, you can find the acquisition length under File > Acquisition Data Info.

Printing Screen Shots

You can screen print shots (screen captures) two ways: use File > Print or save a picture file and print the file using a separate graphics program. Printing a screen capture is the same as printing with any windows program. For details on the available file formats for saving a screen capture, refer to [Data, Settings, and Picture File Formats \(see page 381\)](#). For details on saving a picture to a file, see [Saving and Recalling Data, Settings, and Pictures \(see page 379\)](#).

To print a screen shot:

1. Select **File > Print**.
2. Select **File > Print Preview** if you wish to review the screen shot before sending it to the printer.
3. Select **File > Print** to print the file to a printer.

Online Help

Menu Bar: Help > User Manual

This menu item displays this help. The help is a standard Windows help system. The Online Help menu item is the only method available to display the help; there are no other links to the help within the software.

About the Tektronix RTSA

This window displays information about the software and hardware versions for the analyzer.

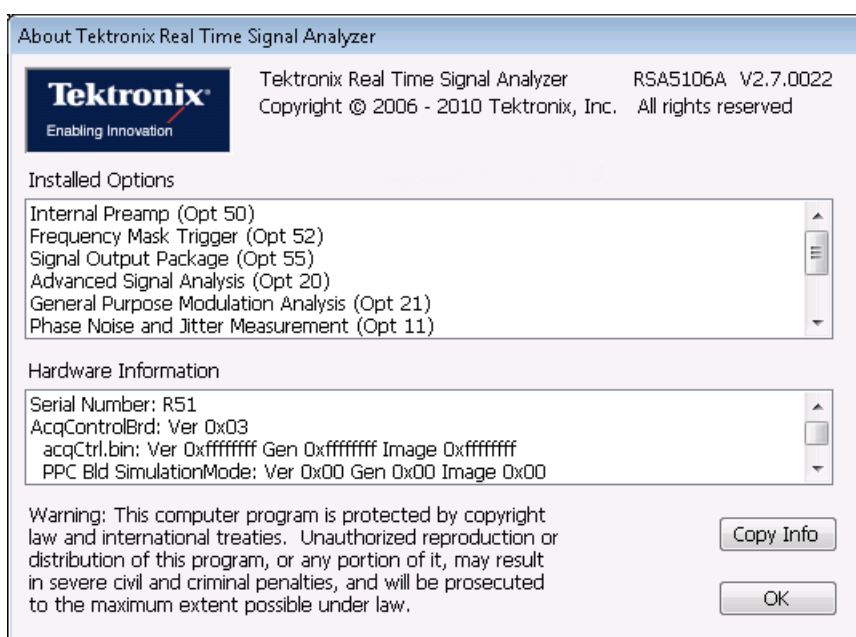

Version

At the top of the window is a line that displays the version of the analyzer application software.

Installed Options

This text box lists the instrument options installed on the analyzer. This window does not list every option installed on the instrument, just those that can be detected by the software.

Hardware Information

This text box lists information about the instrument hardware versions.

Copy Info

The Copy Info button copies information about the instrument to the Windows clipboard. This information may be useful if you need to have your instrument serviced.

Configure In/Out Settings

Menu bar: Setup > Configure In/Out.

The Configure In/Out control panel enables you to configure the analyzer inputs and outputs. The settings in this control panel are shared by all application windows.

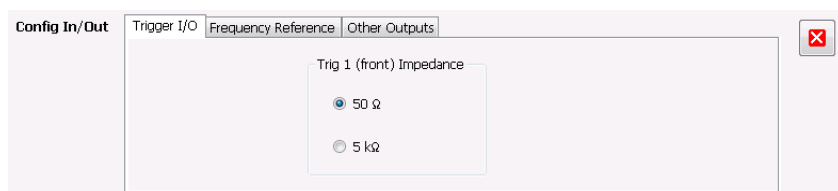

Settings tab	Description
Trigger I/O	Specifies the impedance for the Trig 1 input.
Frequency Reference	Specifies the source of the Frequency Reference. You can select between an Internal (10 MHz) source and an external source.
Other Outputs (see page 392)	Specifies whether the 28 VDC, Analog IF and IQ outputs are on or off. Additional settings are available for IF and IQ outputs.

Connecting an RF Signal

The analyzer has a single RF signal input located on the front panel. The input impedance is 50 Ω. The input frequency range for each analyzer model is listed in the following table. The maximum measurable continuous input power for all models is 1 W.

Model	Input frequency range
SPECMON3	1 Hz to 3 GHz
SPECMON6	1 Hz to 6.2 GHz

About RF Input Protection

The following paragraphs describe how the analyzer behaves to protect the RF input during power-off, power-on, power-on self test (POST), and attenuator switching:

- When switched off (or when power is removed), the RF input is electronically disconnected from the input connector. The analyzer always has a minimum 10 dB attenuation applied during power-up and power-on-self-test. This is accomplished by always switching the attenuation control to Auto during

these states. The minimum Auto attenuation value is 10 dB and is applied prior to the pre-amplifier (Option 50/51) in the signal path.

- When switching attenuator values, the action is performed in a 'make before break' sequence, such that the attenuation never switches to zero during an attenuator switching sequence. For example, consider switching from 20 dB to 15 dB attenuation. This change requires the instrument to switch from using one 20 dB attenuator to using one 10 dB and one 5 dB attenuator. This attenuator switching is done such that the 10 dB and 5 dB attenuators are switched in prior to switching out the 20 dB attenuator.

To connect an RF signal:

1. If the source signal is greater than 1 Watt (+30 dBm), connect the source signal to an attenuator. Connect the attenuator output to the RF Input connector.



CAUTION. To prevent damage to the analyzer, do not connect signals greater than +30 dBm (1 Watt).



CAUTION. To prevent damage to the analyzer, do not turn the equipment under test on or off with a LISN (Line Impedance Stabilization Network) RF cable connected to the analyzer. The power cycling of the equipment under test causes surge currents that can damage the sensitive input of the analyzer.

2. Connect the signal to the RF INPUT connector.

The maximum limits for the input signal are as follows:

SPECMON series maximum input signal limits

Characteristic	Description
Maximum DC Voltage	± 5 V (RF input)
Maximum Measurable Input Power	+ 30 dBm (RF input, RF ATT Auto) 50 Watts peak (RF Band, RF ≥ 30 dB (<10 ms pulse width, 1% Duty Cycle repetitive pulses))

Connecting a Signal Using a TekConnect Probe

You can connect a signal to the analyzer using a TekConnect Probe by using an RTPA2A Real-Time Spectrum Analyzer TekConnect Probe Adapter. The RTPA2A enables you to use Tektronix P7000 Series active and differential probes to connect to signals. See the RTPA2A Instruction Manual for instructions on how to connect the probe adapter and a probe to the analyzer.

Installing the RTPA2A Probe Adapter Device Driver

When the RTPA2A probe adapter is connected to the instrument's USB port for the first time, the Windows Add Hardware wizard may automatically start. If the wizard does start, use the procedure below to install the device driver for the new hardware. (If the wizard does not start, the probe adapter device driver is already installed.)

To properly install the probe adapter device driver:

1. Select the option for Windows to install from a specific location (then select **Next**).
2. Only search for the driver in the following location depending on your instrument:
 - **C:\Program Files\Tektronix\SPECMON\RSA\ProbeAdapter**
3. If Windows warns about Windows Logo testing, select **Continue Anyway**.
4. Select **Finish** after the Found New Hardware wizard completes.

Connecting External Trigger Signals

External trigger signals are connected to the analyzer using the **Trig In** connector on the front panel. There is also an additional trigger input on the rear panel, the Trig 2 In.

To connect a trigger signal to the analyzer, connect the signal to the **Trig In** connector on the front panel, or the **Trig 2 In** connector on the rear panel.

Table 7: External trigger signal input requirements

Input	Level	Impedance
Trig In	-2.5 V to +2.5 V	50 Ω or 5,000 Ω
Trig 2 In	+5 V (TTL)	10,000 Ω

Enabling External Trigger

To use an external trigger signal, select either **Trig In (front)** or **Trig 2 In (rear)** in the **Source** control on the Trigger control panel's [Event tab](#).

Digital I/Q Output

The Real-time Digital I/Q Output is a means for the you to obtain the analyzer digital baseband I/Q signals in a real-time data stream. This output enables you to use the analyzer as a down-converter and then pass the down-converted baseband I/Q signals to external equipment for either additional processing or storage.

IQ Outputs

Connect to the IQ output signals on the rear panel of the signal analyzer. The rear panel connectors are LVDS connectors. For full details on the connectors, see the *SPECMON3 Real-Time Spectrum Analyzer and SPECMON6 Series Real-Time Spectrum Analyzer Specifications and Performance Verification Technical Reference* (Tektronix part number 077-0742-XX). A PDF file of the manual is located on the Documents CD that shipped with your instrument. If you do not have access to the Documents CD, a PDF of the manual can be downloaded from the Tektronix Web site, www.tektronix.com/manuals.

NOTE. *The IQ and IF outputs are disabled when an alignment is running.*

Other Outputs

The Other Outputs tab is accessed from the Configure In/Out control panel (Setup > Configure In/Out). The IQ output settings appear only when Option 55 is installed.

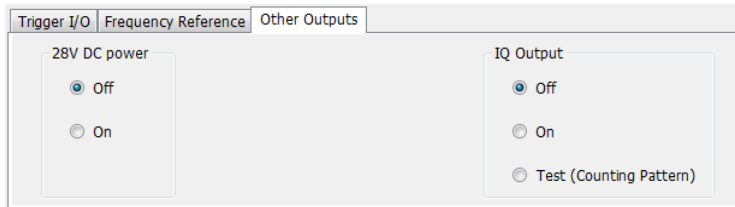

IQ Output

The Digital IQ Output transmits the digitized analyzer data for capture and storage by external equipment. The I/Q data is provided in 16-bit, two's complement format, along with clock and data-valid signals.

There are three selections available for the IQ Output: Off, On, and Test. When in the “Off” position, the IQ Output is disabled, and all lines are static. When in the “On” position, the data is output as described in the *SPECMON3 Real-Time Spectrum Analyzer and SPECMON6 Series Real-Time Spectrum Analyzer Specifications and Performance Verification Technical Reference* (Tektronix part number 077-0742-XX).

Use the “Test” position to verify operation when setting up your equipment. When in the “Test (Counting Pattern)” position, the I channel data will be counting up and the Q channel data will be counting down. The EXT_IQ_CLK and EXT_IQ_DAV signals will operate at a rate consistent with the instrument SPAN setting.

Mapping Measurements

The SPECMON3 and SPECMON6 can record measurements on a map using the included RSA Map software. The RSA Map software lets you record measurements on a geo-referenced map or a bitmap map for documentation purposes. If an external GPS receiver is connected to the analyzer, measurements can be mapped at the GPS coordinates where the measurement was taken. Using an external GPS receiver, RSA Map can perform repeat measurements using either time or distance to initiate measurements. RSA Map software can also save results for future reference or analysis.

To map measurements:

- Select **Tools > RSA Map**. This launches the RSA Map software in a separate window.

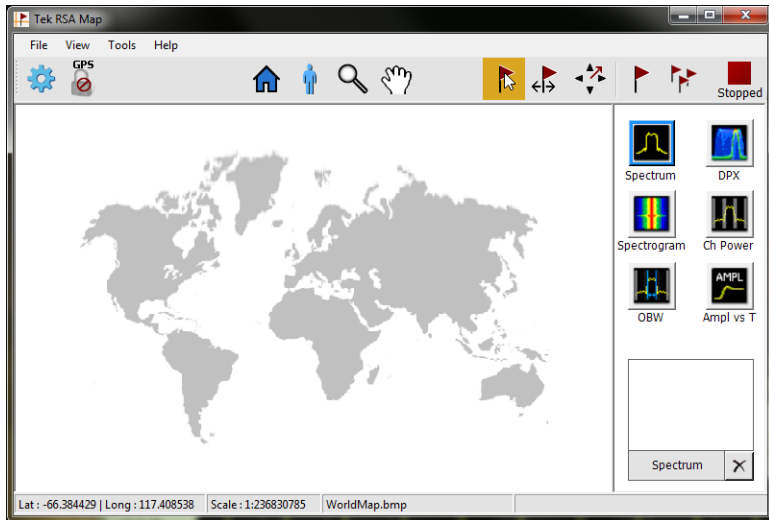

Full documentation on how to use RSA Map is provided in the RSA Map Help. In RSA Map, select **Help > User Manual**.

Menu Overview

The main menus are:

Menu	Description
File (see page 394)	Select measurements, open and save files, print documents, and preset.
View (see page 398)	Change display size, display the Marker toolbar and Status bar.
Run (see page 400)	Start, stop and abort acquisitions, select single or continuous acquisition mode.
Replay (see page 357)	Replay measurements; select which record(s) to play, Replay/Stop/Pause, or enable continuous loop.
Markers (see page 401)	Define markers and search for signal peaks.
Setup (see page 401)	Change settings for acquisition, trigger, analysis, measurements, amplitude, alignments, and configure in/out settings.
Tools (see page 402)	Perform searches, access diagnostics, install upgrades and configure user preferences.
Window (see page 404)	Controls the size and layout of displays within the analyzer application.
Help (see page 405)	Access the help, display information about the instrument hardware and software.

File Menu

Command	Description
Recall (see page 394)	The Recall dialog enables you to recall saved data, setups and traces.
Save (see page 395)	Saves a file without asking for a file parameters (based on most recent settings).
Save As (see page 395)	Displays the Save dialog enabling you to specify the parameters of the save operation.
Acquisition save options (see page 29)	Displays the Save and Export tab of the Options control panel which allows you to specify how much data is saved in acquisition files.
FastSave Acquisitions (see page 377)	Displays the FastSave tab of the Acquire control panel which allows you to configure FastSave acquisitions.
Acquisition data info (see page 357)	Displays the Acquisition Info tab (see page 357) of the Replay control panel. The info on this tab describes such acquisition parameters as acquisition bandwidth, sampling rate, RF attenuation, and acquisition length.
Measurement Data Info (see page 397)	Displays the characteristics of the most recently analyzed record in the display.
Print (see page 397)	Prints the selected display.
Print Preview (see page 397)	Displays a preview of the print output.
Preset (Main) (see page 398)	Preset resets the instrument to factory defaults. Acquisition data and settings that have not been saved will be lost.
More presets (see page 398)	Displays a control panel where you can configure options for Presets.

Recall

Menu Bar: File > Recall

Front Panel: Recall

Application Toolbar:

Use the Recall command to load previously saved acquisition data, setups or trace data.

To Recall Data or Setups

1. Select **File > Recall**. This displays the **Open** dialog box.

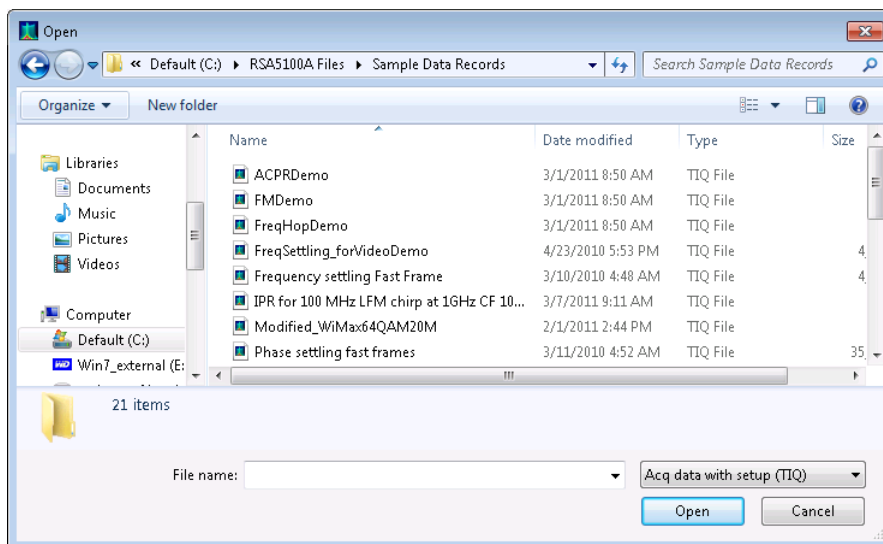

2. Select the file type to be recalled and click **Open**.

Save / Save As

Menu Bar: File > Save / Save As

Use Save / Save As to store acquisition data, setups, and traces. Save is also used to export traces, results and pictures of the display for use in other programs.

Difference Between Save and Save As

Use Save As to specify what kind of data you want to save and where the data should be saved. Use Save to quickly save the same data as you saved the last time you executed a Save, without having to specify the data type and location.

For example, suppose you want to save a picture of a spectrum trace each time you adjust a circuit to document how the adjustments affect the output of the circuit. The first time you want to save a picture of the display, you will need to select Save As. From the Save As dialog box, you specify the type of data you want to save (Picture of Selected Display) and specify the location of the saved file. As long as the [Save and Export option \(see page 27\)](#) is set to automatically name saved files, the next time you want to save a picture of the display, you can just press Save on the front panel and a picture of the selected display will be saved without requiring you to type a file name or the location of the file to be saved.

What Data Types Can Be Saved

Data type	Description
Acquisition Data	Data collected during acquisition that can be recalled for later analysis. Data is saved in a format readable only by RSA6100B/RSA5100A/SPECMON Series instruments or oscilloscopes running SignalVu software. You can save acquisition data as IQ records only, DPX spectra (DPXogram data) only, or both IQ records and DPX Spectra.
Setup	Configuration information detailing instrument settings. Data can be saved in a format readable only by SignalVu-PC, oscilloscopes running SignalVu software, or RSA6100B/RSA5100A Series instruments.
Selected Trace	Saves the selected trace for later analysis by the analyzer. Data is saved in a format readable only by SignalVu-PC, oscilloscopes running SignalVu software, or RSA6100B/RSA5100A Series instruments.
Exported Traces and Numeric Results	Save traces and results in a file format that can be used by other programs.
Pictures of the Display	Save screen images in graphic image file formats that can be used in other programs.
Exported Acquisition Data	Save acquisition data records in a file format that can be used by other programs. Acquisition data can be saved in either comma-separated-variable format or MATLAB format.

[Data, Settings, and Picture File Formats \(see page 381\).](#)

Options for Saving Pictures of the Display

Option	Setting	Description
Image Format	PNG	Saves exported screen captures in Portable Network Graphics format.
	JPG	Saves exported screen captures in Joint Photographic Experts Group (JPEG) format.
	BMP	Saves exported screen captures in Windows bitmap format.

Measurement Data Info

The Measurement Data Info command in the File menu displays a listing of acquisition-related information about the last data analyzed by the selected measurement. The last data can be from the current acquisition or it could be from a recalled data file.

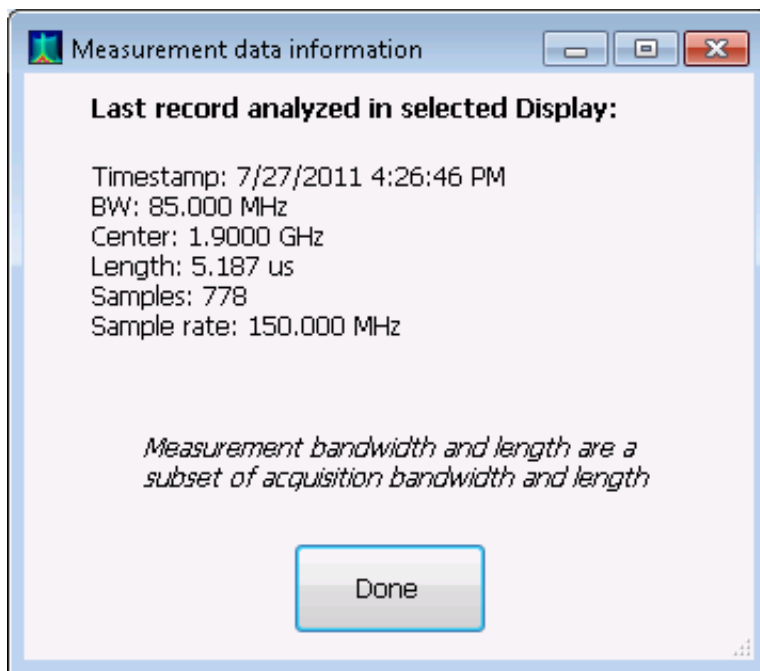

Print

Menu Bar: File > Print

Front Panel: Print

Print displays the Windows Print dialog box for printing a screen capture of the display. To save ink when printing, use the Colors tab to set the color scheme. See [Options Settings \(see page 27\)](#).

Print Preview

Menu Bar: File > Print Preview

Print Preview shows how a print out will appear when it is printed.

Preset (Main)

Menu Bar: File > Preset

Preset resets settings and clears all acquisition data. Settings and acquisition data that have not been saved will be lost. Settings in the [Config In/Out \(see page 388\)](#) control panel are not reset by Preset.

After Preset resets the analyzer settings, it displays the Spectrum view.

Preset does not affect time or date settings; the Windows operating system settings, or Tools > Alignments or Tools Options menu items.

More Presets

The analyzer includes a set of configuration files that are tailored to specific applications or displays. These configuration files open selected displays and load settings that are optimized to address specific application requirements. You can add to the default presets by creating your own User presets. For detailed information about these presets, see [Application Presets](#). See [Creating Application Presets](#).

View Menu

The View menu enables you to control the display of items in the application window.

Command	Description
Full Screen (see page 398)	Toggles all views between full-screen size and user-selected size.
Replay Toolbar (see page 360)	Shows or hides the Replay toolbar.
Marker Toolbar (see page 339)	Shows or hides the Marker toolbar. Enables you to define Markers and perform Peak searches.
Status Bar (see page 399)	Shows or hides the Status bar.

Full Screen

Menu Bar: View > Full Screen

When unchecked, clicking **Full Screen** resizes the application window to fill the screen. Full Screen mode maximizes the application window, and turns off the application title bar.

When checked, clicking **Full Screen** restores the application window to its previous size. The application title bar is restored.

Status Bar

The Status Bar displays information on specific instrument settings. It contains only status information; it does not display any error information. The Status bar has no controls. It can be hidden.

Elements of the Status Bar

Area within Bar	Description
Run Status	Displays the running state. For example, some run states are Arm, Ready, Triggered, Analyzing, or Stopped.
Status message area	Displays status messages (for example, ADC Overage). When there no status messages to report, displays current acquisition parameters (for example, Acq Length: 22.320 us).
Acquisition mode	Displays either Real Time or Swept. Indicates how the next acquisition will be acquired.
Trigger Settings	Displays Trigger settings. For example, you will see Free Run, Power, Trig In (front), Frequency Mask and others.
Frequency Reference Setting	Indicates whether the internal or external reference source is selected. Displays Ref: Int or Ref: Ext.
Internal Attenuator setting	Displays the setting of the internal attenuator.
Preamp Setting	If the optional preamp is installed, this indicates whether the preamp is on or off. If the preamp is on, displays Preamp: ON, 3 GHz max. as a reminder that the input frequency range is restricted when using the preamp.

Run Status Indicators

Indicator	Description
Acquiring	The analyzer is capturing the signal.
Analyzing	The analyzer has captured the signal and is processing the signal record.
Arm	The trigger circuitry is filling the pretrigger portion of the signal record.
File Data	The analyzer is analyzing recalled acquisition records.
Replaying	The analyzer is analyzing recalled waveform or acquisition records.
Stopped	If Stopped is displayed, Signal acquisition has been halted. This can occur because the Run button has been pressed or because a trigger event has occurred, signal acquisition has occurred and Run mode was set to Single.
Triggered	If Triggered is displayed, the analyzer has recognized a valid trigger and is filling the posttrigger portion of the signal record.

Showing or Hiding the Status Bar

- Select **View > Status Bar** to toggle the display of the Status bar.

Run Menu

The Run menu provides access to commands that control the signal acquisition.

Command	Description
Run (see page 371)	If acquisition mode is Stopped, selecting Run begins a new measurement/acquisition cycle. If acquisition mode is Run, pressing Run halts the current measurement/acquisition cycle after it completes.
Resume	Restarts data acquisition, but does not reset accumulated results, such as Average or MaxHold. This allows you to stop acquisitions temporarily, then continue. If the accumulation is already complete, for example, 10 acquisitions or 10 averages have already been completed, each subsequent Resume command will cause one more acquisition to be taken, and its results added to the accumulation. Resume is not available if instrument settings have been changed.
Abort (see page 371)	Immediately halts the current measurement/acquisition cycle.
Single Sequence (see page 400)	Selects the single-sequence acquisition mode. This is only a mode selector; it does not initiate an acquisition.
Continuous (see page 401)	Selects the continuous acquisition mode. Selecting Continuous does initiate acquisitions.

Single Sequence Acquisition Mode

Menu Bar: Run > Single

Selecting **Single** sets the Run mode to Single. In Single mode, as soon as one acquisition sequence completes, acquisition stops.

Note that a single acquisition sequence can require more than one acquisition. For example, in a spectrum view, the trace function might be set to Average 100 acquisitions. Thus, a complete acquisition sequence would consist of 100 acquisitions to produce 100 intermediate traces that are averaged together to create the final trace that is displayed. Once the 100 acquisitions have been completed, acquisition stops.

This is only a mode selector, it does not initiate an acquisition.

Continuous Acquisition Mode

Menu bar: Run > Continuous

Selecting **Continuous** places the analyzer in the Continuous acquisition mode. In Continuous mode, the analyzer acquires and displays acquisitions repeatedly. The Continuous and Single Sequence acquisition modes are mutually exclusive.

Selecting Continuous restarts acquisitions.

Replay Menu

The [Replay Menu \(see page 357\)](#) allows you to rerun measurements using the data in acquisition memory or a recalled TIQ file. You can use this to compute new results for old data after you change settings or measurements.

Markers Menu

The Markers menu provides to settings that define and control the location of markers.

Setting	Description
Peak (see page 337)	Moves the selected marker to the highest peak on the trace.
Next Peak >	Moves the selected marker to next peak depending on the setting chosen.
Marker to Center Frequency	Sets center frequency to the frequency of the selected marker.
Define Markers (see page 337)	Displays the Define Marker control panel.

Setup Menu

The Setup menu provides access to control panels that specify parameters for numerous signal analyzer functions.

Command	Description
Displays (see page 31)	Displays the Displays control panel.
Settings (see page 414)	Displays the Settings control panel for the selected display.
Trigger	Displays the Trigger control panel.
Acquire (see page 372)	Displays the Acquire control panel.
Analysis (see page 349)	Displays the Analysis control panel.
Amplitude (see page 363)	Displays the Amplitude control panel.
Configure In/Out (see page 388)	Displays the Configure In/Out panel.
Preset (Main) (see page 402)	Initiates the factory Preset.
More presets (see page 398)	Recalls Application, DPX, or User Presets, or displays the Presets tab of the Options control panel (Setup > Options).

Preset (Main)

Menu Bar: Setup > Preset (Main)

After Preset (Main) resets the analyzer settings, it displays the Spectrum display.

Preset does not affect time or date settings, the Windows operating system settings, or Tools > Alignments or Tools Options menu items.

Tools Menu

Provides access to several utilities for controlling instrument functions.

Command	Description
Search (see page 343)	Enables you to locate and highlight specified signal levels in Spectrum displays.
Alignments (see page 21)	Displays the Alignments dialog box.
Diagnostics (see page 404)	Displays the Diagnostics dialog box.
Install Upgrades (see page 404)	Used to activate upgrades you have purchased.
Options (see page 27)	Displays the Options control panel.
RSA Map (see page 392)	Launches the RSA Map application for mapping measurement results.

Alignments Dialog

Menu Bar: Tools > Alignments

The analyzer can adjust itself, optimizing the internal signal path used to acquire the signal you measure. Alignment optimizes the analyzer to take more accurate measurements based on the ambient temperature. The Alignments dialog enables you to specify when alignments occur, either automatically or only when manually initiated.

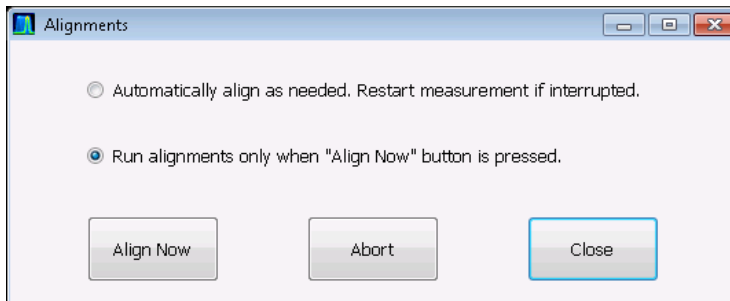

Elements of the Alignments Dialog

Setting	Description
Automatically align as needed	Specifies that alignments run as ambient conditions require.
Run alignments only when "Align Now" button is pressed.	Specifies that alignments will never run unless manually initiated.
Align Now	Use to manually initiate an alignment.
Abort	Stops the alignment process.
Close	Closes the Alignments dialog box.

Diagnostics

Menu Bar: Tools > Diagnostics

The Diagnostics menu item displays the Diagnostics Tests window, which enables you to run variety of tests to verify the operation of the signal analyzer. For detailed information on running diagnostics, refer to the *SPECMON3 Real-Time Spectrum Analyzer and SPECMON6 Real-Time Signal Analyzer Service Manual*, Tektronix part number 077-0755-XX.

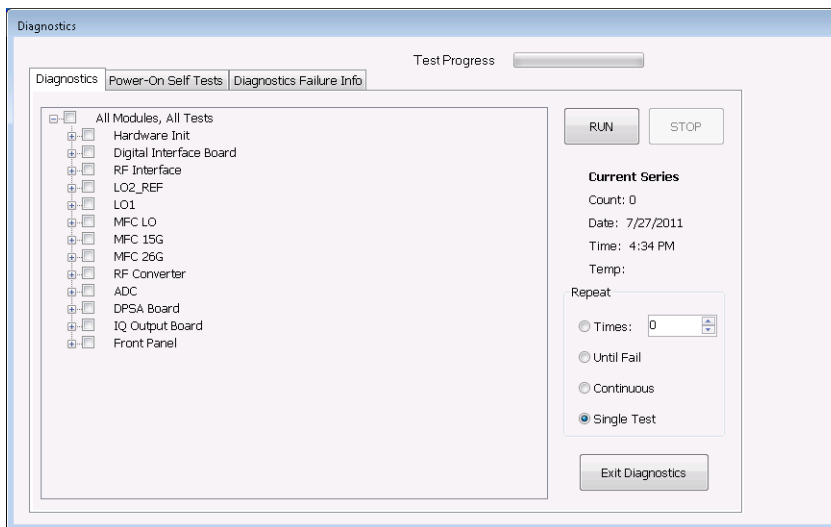

Install Upgrades

You can install upgrades on your analyzer as your needs change. To install upgrades, you will need an Option Installation Key. For information about available options or to make a purchase in North America, call 1-800-833-9200. Worldwide, visit www.tektronix.com to find contacts in your area.

Full instructions on how to install your upgrade and activate the option with the Option Installation Key are provided in the upgrade kit instructions.

Arranging Displays

Use the Window menu to arrange how windows are displayed. Displays can be set to appear full screen (one display at a time) or with all (selected) displays visible at once. When all displays are visible at once, you can rearrange the displays by dragging the title bar of a window (deselect Window > Lock Windows to move displays around).

Command	Description
Close View	Closes the selected view.
Cascade	Positions windows in a cascade view (not available when Lock Windows is selected).
Tile Horizontally	Positions widows in a horizontal orientation (top to bottom).
Tile Vertically	Positions widows in a vertical orientation (side by side).
Lock Windows	Locks the windows into their current position, preventing them from being moved. If the windows are locked, the Cascade arrangement is not selectable.
(List of windows)	A numbered list of open windows.

Help Menu

The Help menu provides access to the help and version information about the analyzer hardware and software.

Command	Description
User Manual On-line	Displays the help.
User Manual (PDF)	Displays a PDF version of the help.
Application Reference (PDF)	Displays a PDF version of the analyzer Applications Manual.
Quick Start Manual (PDF)	Displays a PDF version of the analyzer Quick Start User Manual.
	Displays information about the analyzer model and installed options.

Error and Information Messages

The following list describes some of the common error and information messages that might appear during instrument operation. Messages that apply specifically to one or more measurements appear in the displays. Messages that pertain globally, such as those about hardware status, are shown in the Status Bar at the bottom of the analyzer application window.

Acq BW too small for current setup

The display needs a wider acquisition bandwidth than what the current data record contains. This can be due to any of the following reasons:

- The sampling parameters are being manually controlled.

In the Acquire control panel > Sampling Parameters tab, set the Adjust control to All Auto to allow the software to pick the sample rate and record length that it needs.

- A display other than the one you intended has been selected. The selected display has requested a smaller acquisition bandwidth to achieve a better accuracy or dynamic range for its particular measurement.

Select the display that contains the message. Click Run if the instrument is not already acquiring data.

- Acquisitions are not running and the measurement now requests a wider bandwidth than the last acquisition.

Click Run to perform a new acquisition with a wider bandwidth.

- The data is from a recalled TIQ file.

There is no way to increase the acquisition bandwidth for saved IQ data. You must adjust the measurement settings so that less bandwidth is required.

Analysis failure: <description of error>

The instrument is unable to complete a measurement due to difficulty in characterizing the signal. For example, due to either the signal or settings, the instrument may not be able to recognize a pulse so it can compute the pulse measurements.

- Try changing settings to improve analysis. For example, when Pulse Trace is displayed, try changing the settings on the Settings > Params.

Analysis failure: Carrier detection failed

The instrument was unable to locate a carrier signal. Try adjusting the Carrier Threshold or Integration BW values, if the measurement has these controls.

Analysis Length was limited

This message appears if the "Results Length", the time over which the measurement computed its results, is less than the Actual Analysis Length reported in the Analysis Time control panel tab and the Time Overview display. The Results Length is indicated by the magenta line below the Time Overview graph. This can occur because the acquisition contained more data samples than a measurement can process (for example, digital demodulation is limited to 80,000 samples) or the measurement had to use some of the first and last samples for pre-measurement processes.

Analysis length too small for current setup

Increase the Analysis Length or decrease the RBW (Spectrum, ACPR, MCPR).

Avg Tx not available in Volts units

The Average Transmitted Power measurement is not defined for Volts.

Can't get acquisition data record

No acquisition record currently exists in memory (run an acquisition or recall a file), or an error has occurred. Repeat the acquisition.

Can't replay data from swept acq

The measurement could not produce results because it is a real-time only measurement but was asked to reanalyze (Replay) an acquisition taken in swept mode.

Can't replay. Live data needed for swept settings

The measurement could not produce results because it was asked to reanalyze (Replay) the acquisition but it is in Swept acquisition mode. Swept-mode measurements cannot analyze recalled data.

CISPR accuracy limited by acq memory. Adjust RBW or freq range

The CISPR function was applied, but the available data did not represent a long enough time to satisfy CISPR requirements. Increasing RBW reduces the amount of time needed for analysis. Reducing frequency range (for example, by reducing Span), decreases sample rate, allowing the available memory to cover a longer time period.

If this data is from a saved file, the error cannot be cleared.

If this data is from a saved file, this error cannot be cleared.

This data was acquired when the input signal contained peaks greater than 6 dB above the Reference Level setting.

If the data is from a file, this error cannot be cleared.

Data from unaligned instrument

The acquisition data was captured when the instrument was not aligned. This message refers to the acquisition data currently being analyzed, but not necessarily to the current status of the instrument. Measurements made on this data might not be accurate.

Data from uncalibrated instrument

Disabled: data is from swept acquisition

The display needs to run in real-time mode. The display associated with this message cannot run now because it is not the selected display, and the selected display is performing multiple acquisitions (it is in swept mode).

- Change the settings of the selected display so it is performing real-time acquisitions.
- Select the associated display to make it the selected display. When it is selected, it will force the acquisition parameters to change to meet its own needs.

Frequency exceeds preamp range

This is a warning that signals below the minimum preamp operating frequency are likely to be severely attenuated (this is 100 kHz for option 51, 1 MHz for option 50).

Needs swept acq or larger AcqBW - Acquire data while display is selected

The display is not running because it needs to perform multiple acquisitions (it must be in swept mode) but it is not the selected display. Only the selected display can perform multiple acquisitions.

- Select the display showing this message to give it control of acquisitions parameters.

Sometimes, only one display can work and the others will be blank and show errors. This happens when different displays have conflicting demands on the acquisition data record.

Export failure: file not saved

An error occurred while exporting Results. The file was not created.

- Export the results again.

Export failure: unable to open results file for export. File not saved.

The Export Results file could not be opened for writing, so the export of results was not completed.

- Verify that there is sufficient free space on hard disk.

Insufficient data for CISPR. Acquire while display is selected

This message appears when a measurement is not the selected measurement and CISPR filters are selected. Set the measurement to be the selected measurement and reacquire the signal.

IQ Processing Error: 8012

This message occurs in GP Digital Modulation displays. The most likely cause for this message is that there are not enough symbols to analyze. This can happen if:

- The Analysis Length is set too short. Increase the Analysis Length on the Analysis Time tab.
- The Analysis Offset has pushed the Analysis Time so far out that the actual Analysis Length is too short, even though the user-requested Analysis Length would have been long enough without the excessive offset. Decrease the Analysis Offset on the Analysis Time tab.
- The input signal is bursted, and the burst does not contain enough symbols.

Needs swept acq or larger Acq BW - Acquire data while display is selected

The display has one of two problems: It is not the selected display, which prevents it from controlling the hardware acquisition parameters, and setting the acquisition mode to Swept; or its settings require a wider data bandwidth.

- Select the display that you are interested in and it will change the acquisition to meet its own needs.
- Increase the acquisition bandwidth manually or by changing the selected display's settings to cause the wider bandwidth.

No Math trace: unmatched trace lengths

A math trace could not be produced because the traces selected to generate the math trace do not have the same number of points. This can easily happen if both traces are recalled, but were saved under different "Points" settings. This can also occur if one of the selected traces is a live trace and the other trace is a recalled trace.

- In a Spectrum display, as long as one trace is live, you can change the "Points" setting (Setup > Settings > Freq & Span tab) to match the recalled trace.
- If you are using two recalled traces to generate the Math trace. You must recreate at least one of the traces.

No burst detected

The [Burst Detection Mode \(see page 319\)](#) is On, but no burst was detected in the signal.

- Check that the Threshold setting is properly set.

Not enough samples for current setup

The measurement was not able to run because the combination of analysis length, offset, and measurement bandwidth relative to acquisition bandwidth, were such that not enough samples were available for the measurement to analyze. This can occur when two or more displays are shown and one display requires a wide acquisition bandwidth and another display requires a much narrower bandwidth. The display requiring the much narrower bandwidth must decimate and filter the acquisition record which can result in too few samples left for the measurement.

- Increase the Analysis Length to provide more samples.
- Close any displays you don't currently need.

Not enough samples – try increasing MeasBW

The measurement was not able to run because there are not enough samples available for the measurement to analyze. The Settling Time measurement requires at least 256 samples. This can occur when two or more displays are shown and one display requires a wide acquisition bandwidth and another display requires a much narrower bandwidth. The display requiring the much narrower bandwidth must decimate and filter the acquisition record which can result in too few samples left for the measurement.

- Increase the Analysis Length to provide more samples.
- Close any displays you don't currently need.

No FFT (not all pulses have results)

If a pulse cannot be measured (because its shape is too indistinct or it does not meet the [parameters that define a pulse \(see page 257\)](#)), its results will be “- -” for every measurement on that pulse. The instrument cannot compute an FFT.

No pulses found

The instrument was unable to find any complete pulses in the signal.

- Make sure the [analysis length \(see page 349\)](#) includes at least one complete pulse cycle, from before one rising edge until after the next rising edge.

Pulse Detection Error

The instrument was unable to detect a pulse.

- The pulse [Measurement Filter \(see page 257\)](#) needs to be smaller. Try reducing the bandwidth and/or selecting the Gaussian filter.
- Detection threshold is not set to the proper level for the signal. Adjust the [Power threshold to detect pulses \(see page 257\)](#).
- The pulse interval is too long for the current settings. Try decreasing the [filter bandwidth \(see page 257\)](#), as this may reduce the number of data points to a manageable quantity.

RBW conflict. Increase Span or Analysis Length

The measurement is not running because the actual RBW used by the measurement is too large for the current acquisition span. Typically, the analysis length is too short as well.

- Either increase the span or increase the Analysis Length.

RBW decreased

The current span or acquisition bandwidth is too small to allow a wider RBW filter.

- Increase the span or acquisition bandwidth if the decreased RBW is not acceptable.

RBW increased

The current Spectrum Length (or Analysis Length if Spectrum Length is not Independent) is too small to allow the requested RBW.

- Increase the Spectrum Length (or Analysis Length) if the increased RBW is not acceptable.

RBW limited by AcqBW to: XX Hz

The requested RBW is too close to the acquisition BW. Increase the frequency range of the measurement (for example, Span).

RBW too small/large for current Acq BW

If the RBW is set manually, it is possible for the acquisition bandwidth to be incompatible with the RBW setting.

- Change the RBW setting.
- Adjust the Acq BW setting, either directly (Setup > Acquire > Sampling Params: select on of the manual modes) or by adjusting the measurement bandwidth of the selected display (Setup > Acquire > Sampling Params: All Auto).

Recall error: Setup not completely restored

An error occurred while recalling a Setup file. Thus, the current setup may be a combination of settings from the Setup file and the previous Setup.

- Recall the setup again.

Recall failure: problem with file or file contents

An error occurred while recalling a Setup, Trace or Data file. This can occur because of a problem opening the file (operating system error) or because of a problem with the contents of the file.

- Recall the file again.

Restoring acquisition data

This is a status message displayed while data is being restored from a file.

Save failure: file not saved

An error occurred while saving a Setup or Data file.

- Save the file again.

Saving acquisition data

This is a status message displayed while data is being saved to a file.

Selected VBW does not use full Spectrum Length

This message can occur when the Spectrum Length is greater than required for the VBW filter. If you look at the Time Overview display, the Magenta line for Results Length indicates the part of the Spectrum Length that was actually used. The measurement results are correct, but don't include some of the data in the selected Spectrum Length. To clear this message, you can set the Spectrum Length to Auto.

Setup error: <description of error>

When this message appears, it includes text that explains the problem. For example, the ACPR display might show: “Setup error: channels can’t overlap”. Setup errors are the result of conflicts in instrument settings. These types of errors occur when a user makes manual changes to settings. In the example above, the channel settings in the Channel Power and ACPR display have been set so that the channels overlap in frequency.

- Adjust the instrument settings, or change a setting back to Auto, to eliminate the error.

Setup error: Integration BW exceeds Measurement BW

When this message appears, it includes text that explains the problem. Setup errors are the result of conflicts in instrument settings. These types of errors occur when a user makes manual changes to settings.

- Adjust the instrument settings, or change a setting back to Auto, to eliminate the error.

Setup error: Measurement time for Freq & Phase results

The [Measurement time for Freq & Phase results \(see page 259\)](#) specifies how far across the pulse top the instrument should wait before measuring the Phase Difference and Frequency Difference for each pulse. If this value is set too large for any of the pulses in the signal, the measurement point ends up on the falling edge or during the pulse off time.

- Decrease the Measurement time for Freq & Phase results setting (Settings > Define tab).

Unexpected software error. Please cycle power and try again. If the problem persists, contact your Tektronix Service Center.

An unrecoverable error has occurred, and the instrument application software will shut down.

VBW not applied - Acq BW too small

Increase VBW or measurement bandwidth. Make sure Sampling Parameters are set to Auto.

VBW not applied - Spectrum Length too short

This message occurs when the requested VBW can't be produced because the Spectrum Length is too short.

To clear this problem, set the Spectrum Length to Auto or manually increase the Spectrum Length (see Setup > Analysis > Spectrum Time tab). If Spectrum Length is coupled to Analysis Length, set Analysis Length to Auto or manually increase it (see Setup > Analysis > Analysis Time tab).

Displaying the Windows Event Viewer

When the analyzer generates an error message, information about the error is logged to the Windows Event Viewer.

To display the Windows Event Viewer:

1. Select **Start > Control Panel**.
2. Select **Administrative Tools**. (If your instrument displays control panels in Category View, select System and Security. and then select Administrative Tools.)
3. Double-click **Event Viewer**.

- From the Event Viewer window, select **Windows Logs**, then select **Application**. This displays a list of all errors that have been reported to the operating system from applications.

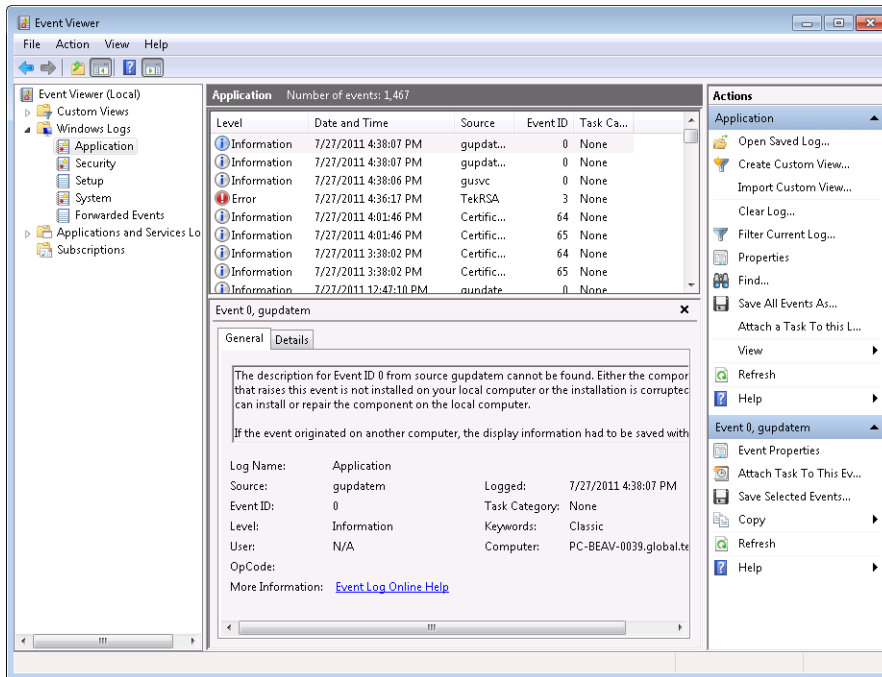

Errors reported to the Event Viewer from the analyzer application appear under Source as TekRSA.

- Double-click the last error reported for TekRSA to see details on the most recently reported error. Please note that many items reported as “errors” are simply informational and do not mean that your instrument is impaired. Contact the Tektronix Customer Support Center or Service Center if you are concerned about an error shown in the Event Viewer. Do not send an instrument out for repair based solely on these event reports.

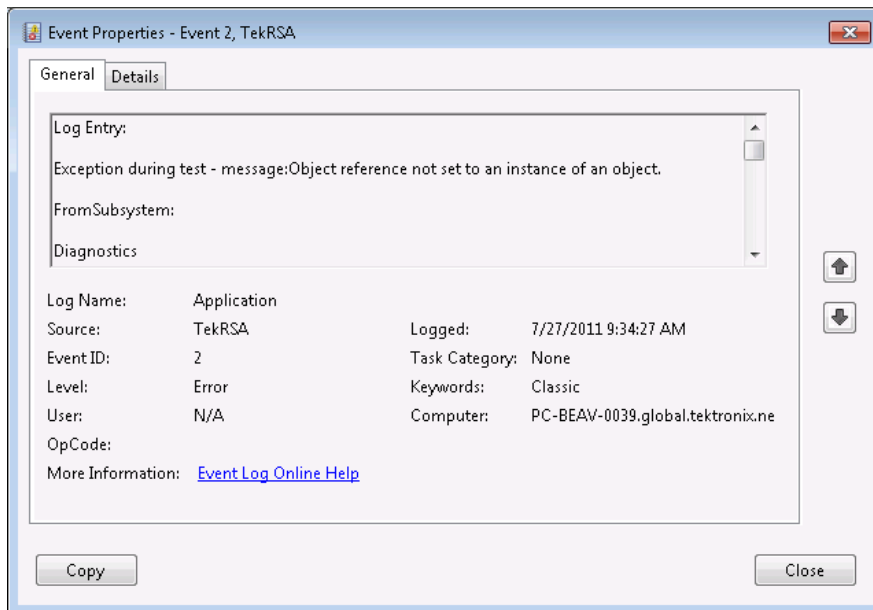

Dealing with Sluggish Instrument Operation

Over time you might notice that acquisitions seem to be occurring sluggishly. This can occur if the disk is too full or if someone has accidentally deleted the instrument cache file. While the instrument automatically recreates a missing 4 GB cache file, if the disk is too full when the replacement cache file is created, the cache file can be fragmented and result in sluggish performance.

If your instrument appears to be performing acquisitions slowly, do the following:

- Delete unnecessary files to create free space. After deleting unnecessary files, run a commercial disk defragmentation program.
- If removing unnecessary files and defragging the hard drive does not improve instrument performance, reinstall the operating system and application software. To do this, back up all your data and files, and then reinstall the instrument operating system. After reinstalling the operating system, reinstall the application software.

On/Standby Switch

Use this button to power the instrument on or to shut down (set the instrument to standby).

Before shutting down, you should first exit the instrument application and any other active Windows applications to avoid error messages on shutdown or the next power up.

How to Find Out If Instrument Software Upgrades Are Available

Software upgrades might be available from Tektronix. They can either be downloaded from the Tektronix Web site or they can be ordered from your local Tektronix representative. To see if a software upgrade is available for your instrument, use your browser to go to www.tektronix.com/software. Search by the instrument model number.

To add additional software options or features, you will need an option key from Tektronix. When you receive the software from Tektronix, install it on your instrument. When prompted, enter the option key, and then follow the online instructions to complete the upgrade.

Settings

Menu Bar: Setup > Settings

Front Panel / Application Toolbar: Settings

The Settings menu item enables access to control panels that allow you to change settings for the selected display. The control panel that appears when you select **Settings** depends on the selected display. The Settings control panel for the Spectrum display is shown in the following figure.

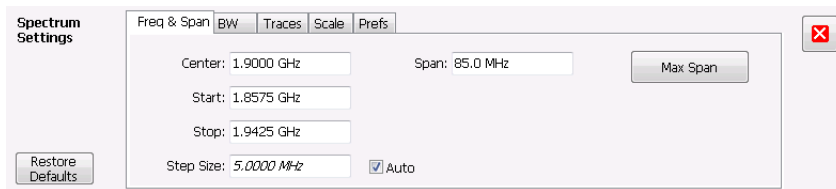

The control panel for the CCDF display is shown in the following figure.

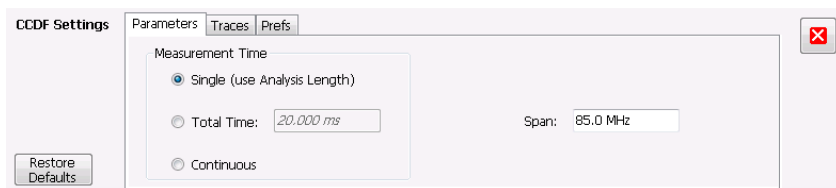

Settings Control Panels

[Acquire \(see page 372\)](#)

[AM Settings \(see page 126\)](#)

[Amplitude Settings \(see page 363\)](#)

[Amplitude vs Time Settings \(see page 104\)](#)

[Analysis Settings \(see page 349\)](#)

[Audio Spectrum Settings \(see page 270\)](#)

[Audio Summary Settings \(see page 272\)](#)

[CCDF Settings \(see page 181\)](#)

[Channel Power and Strength Settings \(see page 153\)](#)

[Configure In/Out Settings \(see page 388\)](#)

[Constellation Settings \(see page 285\)](#)

[DPX Spectrum Settings \(see page 70\)](#)

[EVM vs Time Settings \(see page 289\)](#)

[Eye Diagram Settings \(see page 291\)](#)

[FM Settings \(see page 134\)](#)

[Frequency Deviation vs Time Settings \(see page 294\)](#)

[Frequency vs Time Settings \(see page 106\)](#)

[Magnitude Error Settings \(see page 296\)](#)

[MCPR Settings \(see page 159\)](#)

[Occupied Bandwidth Settings \(see page 168\)](#)

[OFDM Channel Response Settings \(see page 229\)](#)

[OFDM Constellation Settings \(see page 231\)](#)

[OFDM EVM Settings \(see page 232\)](#)

[OFDM Magnitude Error Settings \(see page 234\)](#)

[OFDM Phase Error Settings \(see page 236\)](#)

[OFDM Power Settings \(see page 238\)](#)

[OFDM Summary Settings \(see page 241\)](#)

[OFDM Symbol Table Settings \(see page 243\)](#)

[Phase Error vs Time Settings \(see page 298\)](#)

[Phase Noise Settings \(see page 186\)](#)

[Phase vs Time Settings \(see page 108\)](#)

[PM Settings \(see page 142\)](#)

[Pulse Statistics Settings \(see page 257\)](#)

- [Pulse Table Settings \(see page 252\)](#)
- [Pulse Trace Settings \(see page 255\)](#)
- [RF I Q vs Time Settings \(see page 110\)](#)
- [Search \(Limits Testing\) Settings \(see page 343\)](#)
- [Spectral Emissions Mask Settings \(see page 211\)](#)
- [Settling Time Settings \(see page 201\)](#)
- [Signal Quality Settings \(see page 303\)](#)
- [Spectrogram Settings \(see page 99 \)](#)
- [Spectrum Settings \(see page 95\)](#)
- [Spurious Settings \(see page 173\)](#)
- [Symbol Table Settings \(see page 305\)](#)
- [Time Overview Settings \(see page 90\)](#)
- [Trellis Diagram Settings \(see page 307\)](#)

Accuracy

The closeness of the indicated value to the true value.

ACLR

Adjacent Channel Leakage power Ratio is the ratio of the RRC (Root Raised Cosine) filtered mean power centered on the assigned channel frequency to the RRC filtered mean power centered on an adjacent frequency (defined in 3GPP).

ACPR Measurement

Adjacent Channel Power Ratio (ACPR) is the ratio of the mean power centered on the assigned channel frequency to the mean power centered on an adjacent channel frequency. In the 3GPP specification, it is called ACLR (Adjacent Channel Level Ratio) and both the main channel and adjacent channels are required to be filtered with RRC (Root Raised Cosine) filters.

Acquisition

A series of time-contiguous frames. This is also called a Block.

Analysis Length

The length of time in the Analysis Time.

Analysis Time

The portion of the acquisition record over which one or more measurements are calculated.

ASK

Acronym for Amplitude Shift Keying. The process, or result of a process, in which the amplitude of the carrier is varied in accordance with the state of a digital input signal.

Block

An integer number of time-contiguous frames. See also: Acquisition.

Calibrator

A signal generator producing a specified output used for calibration purposes.

Carrier

The RF signal upon which modulation resides.

Carrier Frequency

The frequency of the CW component of the carrier signal.

Carrier Signal

The electrical signal, typically a sine wave, upon which modulation is impressed.

Carrier-to-Noise Ratio (C/N)

The ratio of carrier signal power to average noise power in a given bandwidth surrounding the carrier; usually expressed in decibels.

CCDF - Complimentary Cumulative Distribution Function

The Complementary Cumulative Distribution Function (CCDF) represents the probability that the peak power above average power of a measured signal exceeds a threshold.

CCDF is a plot of the percent of time that a signal's power value exceeds its average value versus the amount by which it exceeds the average. The CCDF plot has a log of probability on the Y-axis (100% at the top) and dB above average amplitude on the X-axis (0 at the left).

CDMA

Acronym for Code Division Multiple Access.

Center Frequency

The frequency corresponding to the center of a frequency span of the analyzer display.

Check Mark Indicator

The check mark indicator in the upper-left corner of the display indicates the display for which the acquisition hardware is optimized. When you have more than one display open, the display with the check mark indicator has control over the acquisition hardware. To give a display priority over any others, click its title bar.

CISPR

International special committee on radio interference. (Comité international spécial des perturbations radioélectriques)

CW

Acronym for Continuous Wave.

CW Signal

Continuous wave signal - a sine wave.

DANL

Acronym for Displayed Average Noise Level. See [Sensitivity \(see page 430\)](#).

dBfs

A unit to express power level in decibels referenced to full scale. Depending on the context, this is either the full scale of the display screen or the full scale of the analog-to-digital converter (ADC).

dBm

A unit of expressed power level in decibels referenced to 1 milliwatt.

dBmV

A unit to express voltage levels in decibels referenced to 1 millivolt.

dBuV

A unit to express voltage levels in decibels referenced to 1 microvolt.

Decibel

Ten times the logarithm of the ratio of one electrical power to another.

Detection

The process by which a long waveform is decimated (reduced) down to the desired number of trace points, by dividing the waveform into intervals and choosing a single value to represent each interval in the trace.

Display Reference Level

A designated vertical position representing a specified input level. The level may be expressed in dBm, volts, or any other units.

Distortion

Degradation of a signal, often a result of nonlinear operations, resulting in unwanted signal components. Harmonic and intermodulation distortion are common types.

Dynamic Range

The maximum ratio of the levels of two signals simultaneously present at the input which can be measured to a specified accuracy.

EVM

Acronym for Error Vector Magnitude.

Export

Save data to a file in a format other than application-native.

FastFrame

FastFrame segments the acquisition record into a series of frames and then captures acquisitions as single frames. You can then view and measure each frame individually.

Field Strength

Field Strength measures the absolute electromagnetic power at the antenna for a specified frequency and bandwidth.

FFT

Fast Fourier Transform - a mathematical process to calculate the frequency spectrum of a discrete number of time domain sample points.

Filter

A circuit that separates electrical signals or signal components based on their frequencies.

FM

Acronym for Frequency Modulation.

Frame

A series of time-contiguous samples, long enough in duration and at a sufficient sample rate to produce a spectrum view of a specified span and RBW.

Frequency

A series of time-contiguous samples, long enough in duration and at a sufficient sample rate to produce a spectrum view of a specified span and RBW.

Frequency Band

The continuous range of frequencies extending between two limiting frequencies, expressed in hertz.

Frequency Domain View

The representation of the power of the spectral components of a signal as a function frequency; the spectrum of the signal.

Frequency Drift

Gradual shift or change in displayed frequency over the specified time due to internal changes in the analyzer, where other conditions remain constant. Expressed in hertz per second.

Frequency Range

The range of frequencies over which the performance of the instrument is specified.

Frequency Span

A continuous range of frequencies extending between two frequency limits.

Frequency Settling Time

The time measured from a reference point to when the signal of interest settles to within user-defined tolerance.

GPIB

Acronym for General Purpose Interface Bus, the common name for the communications interface system defined in IEEE Std. 488.

Graticule

The calibrated grid overlaying the display screen of analyzers, oscilloscopes, and other test instruments.

Grayed Out

An on-screen control is “Grayed Out” if it is not adjustable.

I/Q

Acronym for In-phase / Quadrature.

IF

Acronym for Intermediate Frequency.

Import

Bring data into the application from a file of some format other than application-native.

Impulse Response

The Impulse Response trace display shows normalized power on the vertical axis and time on the horizontal axis.

Input Impedance

The impedance at the desired input terminal. Usually expressed in terms of VSWR, return loss, or other related terms for low impedance devices and resistance-capacitance parameters for high impedance devices.

LISN

Acronym for Line Impedance Stabilization Network.

Local Oscillator (LO)

An oscillator which produces the internal signal that is mixed with an incoming signal to produce the IF signal.

Marker

A visually identifiable point on a waveform trace, used to extract a readout of domain and range values represented by that point.

Max Hold

Digitally stored display mode which, at each frequency address, compares the incoming signal level to the stored level and retains the greater level. In this mode, the display indicates the peak level at each frequency after several successive acquisitions.

MCPR (Multiple Carrier Power Ratio)

The ratio of the signal power in the reference channel or group of channel to the power in adjacent channels.

Min Hold

Digitally stored display mode which, at each frequency address, compares the incoming signal level to the stored level and retains the lower level. In this mode, the display indicates the minimum level at each frequency after several successive sweeps.

Modulate

To regulate or vary a characteristic of a signal, typically in order to transmit information.

Modulating Signal

The signal which modulates a carrier. The signal which varies or regulates some characteristic of another signal.

Modulation

The process of varying some characteristic of a signal with a second signal.

Noise

Unwanted random disturbances superimposed on a signal which tend to obscure it.

Noise Bandwidth (NBW)

The exact bandwidth of a filter that is used to calculate the absolute power in dBm/Hz.

Noise Floor

The noise intrinsic to a system that represents the minimum limit at which input signals can be observed; ultimately limited by thermal noise (kTB). The analyzer noise floor appears as a “grassy” baseline in the display, even when no signal is present.

Open (Recall)

Bring data into the application from a file of application-native format.

OQPSK

Acronym for Offset QPSK (Quadrature Phase Shift Keying).

Phase Settling Time

The time measured from a reference point to when the signal of interest settles to within user-defined tolerance.

PM

Acronym for Phase Modulation.

Primary Marker

The marker displayed in the Single Marker mode whose frequency and/or position is changed when tuning with the general purpose knob.

PSK

Acronym for Phase Shift Keying. The process, or result of a process, in which the carrier phase is varied discretely in accordance with a digital code.

QAM

Acronym for Quadrature Amplitude Modulation. The process, or result of a process, in which the amplitude and phase of the carrier are varied concurrently by synthesizing two orthogonal ASK waves (see ASK).

Real-Time Analysis

Measurement technique based on triggering on an RF signal, seamlessly capturing it into memory, and analyzing it in the frequency, time, and modulation domains.

Real-Time Bandwidth

The frequency span over which real-time seamless capture can be performed, which is a function of the digitizer and the IF bandwidth of a Real-Time Signal Analyzer.

Real-Time Seamless Capture

The ability to acquire and store an uninterrupted series of time domain samples that represent the behavior of an RF signal over a long period of time.

Reference Level

The signal level represented by the uppermost graticule line of the analyzer display.

Residual FM (Incidental FM)

Short term displayed frequency instability or jitter due to instability in the analyzer local oscillators. Given in terms of peak-to-peak frequency deviation and expressed in hertz or percent of the displayed frequency.

Residual Response

A spurious response in the absence of an input signal. (Noise and zero pip are excluded.)

RBW

The RBW determines how well the analyzer can resolve or separate two or more closely spaced signal components.

Ripple

The Ripple measurement result is displayed in either Watts or Volts. The amplitude units selected on the Setup > Analysis > Units tab determine whether the measurement is presented in Watts or Volts. Volts are shown for linear units (for example, volts or amps); Watts are shown for non-linear units (for example, watts or dBm).

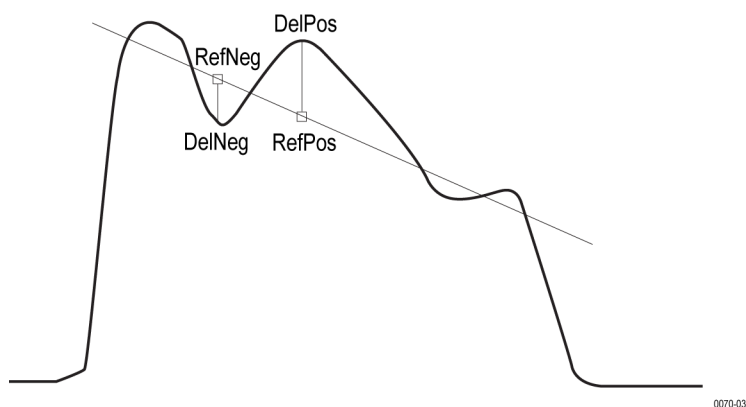

The Ripple measurement, in Watts, is calculated as follows:

$$\%Ripple (Watts) = 100 \times (RatioPos + RatioNeg)$$

Where:

$$RatioNeg = \left(\left(\left(\frac{DelNeg}{RefNeg} \right) + 1 \right)^2 \right) - 1$$

$$RatioPos = \left(\left(\left(\frac{DelPos}{RefPos} \right) + 1 \right)^2 \right) - 1$$

- DelPos = Delta Positive in Volts
- RefPos = Reference Positive in Volts
- DelNeg = Delta Negative in Volts (this is a positive value)
- RefNeg = Reference Negative in Volts

The Ripple measurement, in Volts, is calculated as follows:

$$\%Ripple (Volts) = 100 \times (RatioPosV + RatioNegV)$$

Where:

- RatioPosV = DelPos/RefPos
- RatioNegV = DelNeg/RefNeg

Secondary Marker

The “second” marker displayed only in the Delta Marker mode.

Sensitivity

Measure of a analyzer’s ability to display minimum level signals, usually expressed as displayed average noise level ([DANL \(see page 420\)](#)).

Shape Factor (Skirt Selectivity)

The ratio of the frequency separation of the two (60 dB/3 dB) down points on the response curve to the static resolution bandwidth.

Signal

As used in this help, the signal refers to the input signal before it is processed. The signal is an input.

Signal Strength

Signal Strength locates the direction of a signal using a directional antenna and an audio tone and a visual display.

Span

Span is the range of frequencies displayed in a spectrum window. Span, start frequency and stop frequency are related by the following equation: $\text{Span} = (\text{stop frequency}) - (\text{start frequency})$. The settings for center, start and stop frequencies are related to the setting for span; when one parameter is changed, the others are changed automatically.

Span Per Division (Span/Div)

Frequency difference represented by each major horizontal division of the graticule.

Spectrogram

Frequency vs. time vs. amplitude display where the frequency is represented on the x-axis and time on the y-axis. The power level is indicated by variations in color.

Spectrum

The frequency domain representation of a signal showing the power distribution of its spectral component versus frequency.

Spectrum Analysis

The technique or process of determining the frequency content of an RF signal.

Spectrum Analyzer

A device for determining the frequency components of a signal.

Spectrum Time

Analysis Time for spectrum analysis views. Spectrum time can be the same as Analysis Time, but it can be different.

Spur

A spur is a signal peak that exceeds a user-definable threshold (See Spurious > Settings > Ranges) and excursion setting. A spur that also exceeds a limit (either Absolute or Relative) specified on the Settings > Limits tab is considered a violation.

Spurious Response

A response to a analyzer wherein the displayed frequency is not related to the input frequency.

Time Measurement

This is the time in seconds relative to the time reference point in the first acquisition record in the data set.

Time Reference

The point in time during the acquisition record used as the zero point for counting time. The time reference can be set to either the start of the acquisition record or the trigger point.

Trace

As used in this help, trace refers to the displayed signal. The displayed signal can be a processed version of the input signal (for example, it may be averaged.) The trace is a result or output.

Vector Signal Analyzer

Like a spectrum analyzer, a device for determining the frequency components of a signal. However, unlike a standard spectrum analyzer, the vector signal analyzer is optimized for analyzing digitally modulated RF signals.

Vertical Scale Factor, Vertical Display Factor

The number of dB, volts, etc., represented by one vertical division of a spectrum analyzer display screen.

Violation

A violation is a spur that exceeds either an Absolute or Relative limit (depending on the selected mask) specified on the Settings > Limits tab. A spur is a signal peak that exceeds a user-definable threshold (See Spurious > Settings > Ranges) and excursion setting.

Index

Symbols and Numbers

- 6dB RBW (MIL) Filter shape
 - Spectrum display BW
 - tab, 118
- 3-D Spectrogram display, 97
- 3-D Waterfall
 - Spectrogram/DPXogram, 101
 - Spectrogram/DPXogram display, 80

A

- Abort acquisition, 371
- About the RTSA, 387
- Abs
 - Ranges and Limits table, 178
- Abs & Rel
 - Ranges and Limits table, 178
- Abs OR Rel
 - Ranges and Limits table, 178
- Abs Same
 - Ranges and Limits table, 178
- Abs Start (dBm)
 - Ranges and Limits table, 178
- Abs Stop (dBm)
 - Ranges and Limits table, 178
- Accessories, 6
- accuracy, 417
- ACLR, 417
- ACLR measurement, 153
- ACPR measurement, 417
- Acq Data
 - Replay menu, 358
- Acq Data/DPX Spectra, 355
- Acquire control panel, 372
- acquisition, 417
- acquisition data
 - saving, 379
- Acquisition data files, 29
- Acquisition Info tab, 357
- acquisition memory usage, 373
- Actions tab
 - Search, 347
- Actual BW
 - Freq & BW tab, 72
- adaptive equalizer, 314
- adjacent channel leakage ratio, 149
- Adjacent Channel Power measurement, 153
- Adjacent Channel Power Ratio, 33
- Advanced Params tab
 - OFDM Analysis displays, 245
- Advanced Params Tab
 - GP Digital Modulation displays, 316
- Advanced tab (Acquire), 374
- Alignments, 402
 - Align Now, 21
 - Auto button, 21
 - Off button, 21
- +AM, 36
 - AM display, 36
- AM
 - AM display, 36
- AM display, 125
- AM measurements, 36
- Ampl Scale tab
 - DPXogram display, 80
- Amplitude control panel, 363
- Amplitude vs. Time display, 103
- Amplitude vs. Time display Settings, 104
- Analysis control panel, 349
- analysis length, 417
- analysis time, 417
- Analysis Time tab
 - GP Digital Modulation displays, 319
 - OFDM Analysis displays, 246
 - Options control panel, 27
- Analysis Time tab (Analysis control panel), 349
- application presets
 - saving, 379
- Application presets, 22
- Apply ampl corrections, 260
- arranging windows, 404
- ASK, 418
- attenuator settings, 363
- Audio BW, 273
 - setting, 274
- Audio checkbox
 - Chan Power & Strength display, 150
- Audio Demod tab, 86
- audio filters
 - custom, 277
- Audio Filters tab
 - Audio Analysis displays, 276
- Audio Freq
 - Audio Summary display, 271
- Audio Spectrum display, 269
- Audio Spectrum settings, 270
- Audio Summary settings, 272
- Auto
 - Ranges and Limits table, 178
- Auto button (Alignments dialog), 21
- automatically generate filenames, 27
- Automatically increment filename/number, 29
- Average Channel Power measurement, 153
- Average ON Power, 37
- Average Transmitted Power, 37
- Averaging
 - Audio Analysis displays, 275
 - Params2 tab, 275

B

- Base file name
 - FastSave tab, 377
- BER, 83
 - See also* Tx BER

- black text
 - settling time
 - measurements, 195
 - Blackman-Harris 4B Filter Shape
 - Spectrum display BW
 - tab, 118
 - Blizzard color scheme, 29
 - block, 418
 - Blue background (cells), 169
 - Burst detect threshold, 136
 - BW (Hz)
 - Ranges and Limits table, 178
 - BW Tab
 - Amplitude vs. Time display, 105
 - DPXogram display, 118
 - Spectrum display, 118
- C**
- C4FM modulation type
 - measurements, 36
 - C4FM signal quality
 - measurements, 303
 - calibration, 22
 - See also* Alignments
 - calibrator, 418
 - Carr Freq Err
 - Audio Summary display, 271
 - carrier, 418
 - carrier frequency, 418
 - Carrier frequency detection, 143
 - Carrier Frequency Error, 36
 - Carrier Power
 - Audio Summary display, 271
 - carrier signal, 418
 - carrier-to-noise ratio (C/N), 418
 - CCDF, 33
 - CCDF - Complimentary
 - Cumulative Distribution Function, 419
 - CCDF display, 180
 - CDMA, 419
 - center frequency, 419
 - Center Frequency
 - Freq & BW tab, 72
 - Chan Power and Strength
 - display, 149
 - changing the input connector, 389
 - channel power, 149
 - Channel Power, 33
 - Channel Power (Main), 151
 - Channel Power and ACPR
 - Settings control panel, 153
 - Channel Power measurement, 152
 - Channels tab
 - Channel Power & Strength display, 154
 - Channels tab (MCPR), 163
 - check mark indicator, 15
 - CISPR, 419
 - CISPR Filter shape
 - Spectrum display BW tab, 118
 - Classic color scheme, 29
 - Color (DPXogram)
 - DPXogram display, 80
 - Configure In/Out control
 - panel, 388
 - connecting signals, 388
 - connecting trigger signals, 390
 - Constellation display, 284
 - displaying a second trace, 322
 - Constellation display
 - settings, 285
 - Continuous Acquisition
 - Mode, 401
 - Convergence
 - Equalizer tab, 314
 - correction tables, 366
 - creating presets, 22
 - CW, 419
 - CW signal, 420
- D**
- DANL, 420
 - Data file formats, 381
 - Data length
 - File Contents window, 380
 - Data properties
 - File menu, 397
 - Data Range tab
 - OFDM Analysis displays, 246
 - Data records
 - File Contents window, 380
 - Data types
 - File Contents window, 380
 - dBfs, 420
 - dBm, 420
 - dBmV, 420
 - dBuV, 420
 - De-emphasis
 - Audio Filters tab, 277
 - decibel, 420
 - default settings, restore, 21
 - Define Markers, 337
 - Define Peaks tab, 338
 - Define tab, 343
 - Pulsed RF displays, 259
 - Settling Time displays, 201
 - Delta Markers, 337
 - Demod I&Q vs Time display
 - settings, 288
 - Density tab, 82
 - detect
 - AM display, 129
 - FM display, 137
 - General Signal Viewing displays, 114
 - PM display, 145
 - Time Overview, 91
 - detection, 421
 - AM display, 129
 - FM display, 137
 - General Signal Viewing displays, 114
 - PM display, 145
 - Time Overview, 91
 - Detection
 - DPX display, 75
 - detector
 - AM display, 129
 - FM display, 137
 - General Signal Viewing displays, 114
 - PM display, 145
 - Time Overview, 91
 - Detector
 - Ranges and Limits table, 178
 - Deviation, 36
 - Diagnostics, 404
 - Diff
 - Audio Summary display, 272

- Digital I/Q output, 391
- Digital Phosphor Spectrum, 62
- Disabled - FastSave is
 - selected, 377
- display reference level, 421
- Displays
 - arranging, 31
 - Frequency Settling Time, 193
 - interactions between, 31
 - OFDM Channel
 - Response, 227
 - OFDM Constellation, 230
 - OFDM EVM, 231
 - OFDM Mag Error, 233
 - OFDM Phase Error, 236
 - OFDM Power, 237
 - OFDM Summary, 239
 - OFDM Symbol Table, 242
 - Phase Settling Time, 193
 - selecting, 31
 - SEM (Spectrum Emission Mask), 208
- distortion, 421
- Dither Control, 374
- documentation, 7
- Done
 - Ranges and Limits table, 178
- Done saving - restart with Stop, then Run, 377
- Dot Persistence, 72
- DPX
 - Bitmap settings, 72
 - DPXogram Settings, 72
- DPX Density, 82
- DPX display
 - DPXogram, 62
 - Frequency, 62
 - Phase, 62
 - Spectrum, 62
 - Zero Span, 62
- DPX presets, 22
- DPX Spectra
 - Replay menu, 358
- DPX Spectra/Acq Data, 355
- DPX Spectrum settings, 70
- DPXogram
 - DPX display, 62
- Droop, 37
- Droop dB, 37
- Duty Factor (%) measurement, 37
- Duty Factor (Ratio)
 - measurement, 37
- dynamic range, 421
- E**
- Elements of the display, 15
- Enable Equalization
 - Equalizer tab, 314
- Equalizer tab
 - GP Digital Modulation displays, 314
- error message
 - Windows Event Viewer, 411
- Error messages, 405
- Event Viewer, 411
- EVM, 35
- EVM vs. Time display, 288
- EVM vs. Time Settings, 289
- Excrrsn (dB)
 - Ranges and Limits table, 178
- Expand
 - Ranges and Limits Tab, 177
- export, 421
- External Gain value, 366
- External Gain/Loss Correction
 - tab, 366
- External Loss Tables, 366
- External Probe Correction
 - tab, 370
- external trigger
 - enabling, 390
- external trigger signals
 - connecting, 390
- Eye Diagram display settings, 291
- F**
- Fall Time, 37
- Fast Save, 375
 - See also* FastSave
- FastFrame, 421
- FastSave
 - configuring, 376
 - overview, 375
 - starting, 376
 - status messages, 376
- FastSave acquisition data
 - FastSave tab, 377
- FastSave tab, 377
- FFT, 422
- field strength, 422
- File Contents window, 380
- File formats, 381
- File Menu, 394
- filter, 422
- Filter Parameter
 - GP Digital Modulation displays, 309
- Filter Shape
 - Ranges and Limits table, 178
 - Spectrum display BW tab, 118
- Find tab
 - GP Digital Modulation displays, 319
- finding bursts in data
 - GP Digital Modulation displays, 319
- FlatTop (CW ampl) Filter Shape
 - Spectrum display BW tab, 118
- FM, 422
- FM display, 132
- FM measurements, 36
- Format
 - FastSave tab, 377
- frame, 422
- Freq & BW tab
 - DPX display, 72
 - RF I & Q vs Time display, 112
- Freq & BW Tab
 - GP Digital Modulation displays, 313
- Freq & Span tab
 - General Signal Viewing displays, 113
- Freq Deviation, 38
- Freq Diff, Phase Diff setting, 261
- Freq Error, 36
- Freq Estimation tab
 - Pulsed RF displays, 264

Freq, Span & RBW tab
 Channel Power & ACPR
 display, MCPR
 display, 160
 RF Measurements
 displays, 219
Freq-domain Linearity
 setting, 259
frequency, 422
Frequency
 DPX display, 62
 frequency band, 422
 Frequency Deviation vs. Time
 settings, 294
 frequency domain view, 423
 frequency drift, 423
 Frequency Error, 35
 GP Digital Modulation
 displays, 313
 Frequency Offset
 GP Digital Modulation
 displays, 313
 frequency range, 423
 frequency settling time, 423
 measuring, 197
 Frequency Settling Time
 display, 193
 Frequency Settling Time
 settings, 200
 frequency span, 423
 Frequency tab, 351
 Frequency tab (Phase Noise), 188
 Frequency vs. Time display, 105
 Frequency vs. Time Settings, 106
 Front panel connectors, 9
 Front panel controls, 9
 Full Screen, 398

G

Gain Imbalance, 301
GPIB, 423
GPIB tab, 27
graticule, 423
Graticule On/Off
 RF Measurements
 displays, 225
grayed out, 424

H

Hanning Filter Shape
 Spectrum display BW
 tab, 118
Help Menu, 405
Hide sensitive readouts, 27
Hide Sensitive readouts, 28
Histogram readout
 Pulsed RF displays, 267
HPF
 Audio Filters tab, 276
Hum & Noise
 Audio Summary display, 280

I

I/Q, 424
IF, 424
Ignore Region
 Params2 tab, 275
import, 424
Impulse Response Amplitude, 38
Impulse Response setting, 260
Impulse Response Time, 38
Information messages, 405
input impedance, 424
input protection, 388
Installed options, 7
Internal Attenuator
 Internal Settings tab, 363
Internal attenuator (Internal
 Settings tab), 363
Internal Preamp
 Internal Settings tab, 364
Internal Settings tab, 363
IQ Origin Offset, 35
IQ output signals, 391
IQ vs. time view, 109
is greater than (search), 344
is inside mask, 343
is inside mask (search), 345
is less than (search), 344
is outside mask, 343
is outside mask (search), 345

K

Kaiser (RBW) Filter Shape
 Spectrum display BW
 tab, 118
Keep-out time, 260

L

Length, 36
 Equalizer tab, 314
Levels tab
 Pulsed RF displays, 264
Limit lines, 343
Limits
 Spurious display, 179
Link to Span, 112
LISN, 424
Load
 Ranges and Limits Tab, 177
 Ranges and Limits table, 178
local oscillator (LO), 425
Location
 FastSave tab, 377
Lock Center Frequency of
 Spectrum displays, 351
Lock Center Frequency of
 Spectrum displays to
 Measurement Frequency
 Frequency tab, 352
Log
 Audio Spectrum display, 279
Log (Horizontal)
 Spectrum display, 96
Loop over all selected records
 Replay menu, 358
LPF
 Audio Filters tab, 276

M

Mag Error, 35
Magnitude Error vs. Time
 display, 294
Magnitude Error vs. Time
 settings, 296
manuals, 4
mapping measurements, 392
marker, 425
Marker Noise mode, 340

- Marker Properties tab, 337
 - Marker to Center Frequency, 337
 - Markers, 339
 - Marker Toolbar, 339
 - Using Markers, 333
 - Using Markers in Noise Mode, 340
 - Markers menu, 401
 - Markers snap to peaks when dragged, 29
 - Mask
 - Ranges and Limits table, 178
 - Mask Editor, 343
 - Mask tab
 - Settling Time displays, 204
 - mask testing
 - settling time
 - measurement, 189
 - MATLAB file format, 381
 - Max files saved per Run
 - FastSave tab, 377
 - Max Freq Error, 38
 - max hold, 425
 - Max number of pulses
 - Pulse Table display, 257
 - Max Number of Pulses
 - Params tab, 258
 - Max Phase Error, 38
 - Max trace points, 103
 - Settling Time displays, 208
 - MCPR (multiple carrier power ratio), 425
 - MCPR display, 156
 - MCPR settings, 159
 - Meas BW
 - Frequency Settling Time, 202
 - Meas Frequency
 - Frequency Settling Time, 201
 - Measurement BW, no filter, 112
 - Freq & BW tab, 72
 - Measurement Filter
 - GP Digital Modulation displays, 309
 - Params tab, 258
 - Measurement Frequency, 351
 - Frequency tab, 352
 - Measurement Length
 - Time Params tab, 203
 - Measurement Params tab
 - Channel Power & ACPR display, MCPR display, 161
 - Measurement point, 261
 - Measurement settings export, 379
 - Measurements, 33
 - Measurements tab, 253
 - measuring settling time, 197
 - measuring Tx BER, 83
 - Menus, 393
 - MER (RMS), 302
 - min hold, 425
 - Min Settled Duration
 - Time Params tab, 203
 - Mod Distor
 - Audio Summary display, 272
 - Mode
 - Equalizer tab, 314
 - modulate, 425
 - modulating signal, 426
 - modulation, 426
 - modulation measurements, 34
 - Modulation Params tab
 - GP Digital Modulation displays, 309
 - OFDM Analysis displays, 244
 - modulation types supported, 309
 - Monitor attenuator use, 363
 - Monitor Attenuator Use
 - Internal Settings tab, 364
 - moving windows, 404
 - Multi-Carrier Power Ratio, 33
 - Multiple Carrier Power Ratio, 158
- N**
- Network Connections, 19
 - nFSK modulation type
 - measurements, 36
 - nFSK signal quality
 - measurements, 302
 - No. of Harmonics
 - Params2 tab, 275
 - No. of Non-Harmonics
 - Params2 tab, 275
 - noise, 426
 - noise bandwidth (NBW), 426
 - noise floor, 426
 - Noise markers, 340
 - Non-Harmonic Excursion
 - Params2 tab, 275
 - Non-Harmonic Threshold
 - Params2 tab, 275
 - None
 - trace motion, 71
 - Normal
 - trace motion, 71
- O**
- OBW Level Left/Right, 165
 - OBW Ref Power, 165
 - Occupied Bandwidth, 168
 - Occupied Bandwidth
 - settings, 168
 - Occupied BW display, 165
 - OFDM Channel Response
 - display, 227
 - settings, 227
 - OFDM Constellation
 - display, 230
 - settings, 231
 - OFDM EVM
 - display, 231
 - settings, 232
 - OFDM Mag Error
 - display, 233
 - settings, 234
 - OFDM Phase Error
 - display, 236
 - OFDM Power
 - display, 237
 - settings, 238
 - OFDM Summary
 - display, 239
 - settings, 241
 - OFDM Symbol Table
 - display, 242
 - settings, 243
 - Off
 - Ranges and Limits table, 178
 - Off button (Alignments dialog), 21
 - Offset & Limits Table tab
 - SEM display, 214
 - Offset EVM, 35

- On
 - Ranges and Limits table, 178
 - On/Standby switch, 413
 - online help, 387
 - Open (Recall), 426
 - Optimization
 - Channel Power & ACPR
 - display, MCPR
 - display, 161
 - Options
 - installed, 7
 - Options control panel, 27
 - OQPSK, 426
 - OQPSK and SOQPSK modulation
 - type measurements, 35
 - Other Outputs tab, 392
 - Overlap, 99
 - Overshoot, 37
 - Overshoot dB, 37
 - Overshoot settings, 262
- P**
- Parameters tab
 - AM display, 127
 - CCDF display, 182
 - FM display, 136
 - Occupied BW display, 169
 - Phase Noise display, 189
 - PM display, 143
 - SEM display, 212
 - Spurious display, 174
 - Params tab
 - DPX display, 71
 - Pulsed RF displays, 257
 - Params1 tab
 - Audio Analysis displays, 273
 - Params2 tab
 - Audio Analysis displays, 275
 - Pass /Fail readout
 - SEM display, 209
 - Pass/Fail Limit Testing
 - Spurious display, 179
 - Pass/Fail searches, 344
 - Pause
 - Replay menu, 358
 - +Peak
 - Audio Summary display, 271
 - Peak
 - Audio Summary display, 271
 - Peak Channel Power (Main), 151
 - Peak Excursion, 337
 - Peak FSK err, 36
 - Peak Mag Err, 36
 - Peak Power, 37
 - Peak Threshold, 337
 - Peak/Avg Ratio, 33
 - Peak-Peak/2
 - Audio Summary display, 272
 - Phase
 - DPX display, 62
 - Phase Deviation, 38
 - Phase Error, 302
 - Phase Error vs. Time display, 296
 - Phase Error vs. Time settings, 298
 - Phase Noise display, 182
 - Phase Noise settings, 186
 - phase settling time, 427
 - measuring, 197
 - Phase Settling Time display, 193
 - Phase Settling Time settings, 196
 - Phase vs. Time display, 107
 - Phase vs. Time settings, 108
 - pictures
 - saving, 379
 - +Pk
 - FM display, 36
 - PM display, 37
 - Pk
 - FM display, 36
 - PM display, 37
 - Pk-Pk
 - FM display, 36
 - PM display, 37
 - Pk-Pk/2
 - FM display, 36
 - Planar Crown input
 - connector, 389
 - PM, 427
 - PM measurements, 37
 - power measurements, 149
 - Power Threshold to Detect Pulses
 - Params tab, 258
 - Pre-defined Filters
 - Audio Filters tab, 276
 - Prefs tab
 - AM display, 132
 - FM display, 140
 - General Signal Viewing
 - Displays, 120
 - GP Digital Modulation
 - displays, 323
 - OFDM Analysis
 - displays, 250
 - Options control panel, 27
 - PM display, 148
 - Pulsed RF displays, 267
 - RF Measurements
 - displays, 225
 - Settling Time displays, 208
 - Preset (File menu), 398
 - Preset (Settings menu), 402
 - presets, 22
 - Presets
 - recalling, 26
 - Presets tab
 - Options control panel, 28
 - primary marker, 427
 - Print, 397
 - Print Preview, 397
 - Probes, 390
 - Processing tab
 - SEM display, 213
 - PSK, 427
 - pulse measurements, 251
 - Pulse Statistics display, 255
 - Pulse Statistics display
 - settings, 257
 - Pulse Table display, 251
 - Pulse Table settings, 252
 - Pulse Trace display, 253
 - Pulse Trace display settings, 255
 - Pulse Width, 37
 - Pulse-Pulse Freq Difference, 38
 - Pulse-Pulse Phase Difference, 37
 - pulses
 - how many can be
 - analyzed, 258
- Q**
- QAM, 427
 - Quadrature Error, 34

R

- Range file, 381
 - Ranges and Limits Tab
 - Spurious display, 176
 - RBW, 428
 - RBW (Time-domain BW) filter
 - Freq & BW tab, 72
 - real-time analysis, 427
 - real-time bandwidth, 428
 - real-time seamless capture, 428
 - rear panel connectors, 19
 - recalling Presets, 26
 - Red background (cells), 169
 - red text
 - settling time
 - measurements, 195
 - Ref
 - Audio Summary display, 272
 - Ref Channel tab
 - SEM display, 214
 - Ref level (Internal Settings tab), 363
 - Reference Filter
 - GP Digital Modulation displays, 309
 - Reference Level, 428
 - Reference tab
 - Spurious display, 174
 - Rel
 - Ranges and Limits table, 178
 - Rel Same
 - Ranges and Limits table, 178
 - Rel Start (dB)
 - Ranges and Limits table, 178
 - Rel Stop (dB)
 - Ranges and Limits table, 178
 - Repeat, 371
 - Repetition Interval, 37
 - Repetition Rate, 37
 - Replay all selected records
 - Replay menu, 358
 - Replay control panel, 355
 - Replay current record
 - Replay menu, 358
 - Replay from selected
 - Replay menu, 358
 - Replay menu, 357
 - Replay Speed tab, 357
 - Replay toolbar, 360
 - Replay menu, 358
 - Reset Equalization
 - Equalizer tab, 314
 - Reset layout
 - Ranges and Limits Tab, 177
 - residual FM (incidental FM), 428
 - residual response, 428
 - results
 - saving, 379
 - Resume, 371
 - RF & IF Optimization
 - Internal Settings tab, 364
 - RF Channel Power
 - measurement, 152
 - RF I & Q vs. Time display, 109
 - RF I & Q vs. Time settings, 110
 - RF input connector, 389
 - RF input protection, 388
 - Rho, 35
 - Ripple, 37
 - Ripple dB, 37
 - Ripple measurement
 - calculation, 429
 - Ripple settings, 262
 - Rise Time, 37
 - RMS
 - Audio Summary display, 272
 - FM display, 36
 - PM display, 37
 - RMS Error Magnitude, 36
 - RMS FSK Err, 36
 - RMS Mag Err, 36
 - RMS Phase Error, 38
 - Roll
 - trace motion, 71
 - RSA Map, 392
 - RTPA2A, 390
 - Run, 371
 - Run menu, 400
- S**
- S/N
 - Audio Summary display, 272
 - Sampling Parameters Tab, 372
 - Save
 - Ranges and Limits Tab, 177
 - Save and Export tab, 27
 - Options control panel, 29
 - Save As
 - Ranges and Limits table, 178
 - saved file types, 379
 - saving
 - acquisition data, 379
 - pictures, 379
 - presets, 22
 - results, 379
 - setups, 379
 - Saving and Recalling Data, 379
 - Saving X of XX, 377
 - Scale tab
 - AM display, 131
 - Audio Analysis displays, 278
 - DPX Spectrum display, 78
 - FM display, 139
 - General Signal Viewing displays, 120
 - GP Digital Modulation displays, 323
 - OFDM Analysis displays, 248
 - Phase Noise display, 147
 - Pulsed RF displays, 266
 - RF Measurements displays, 224
 - SEM display, 217
 - Settling Time displays, 207
 - Spectrogram display, 101
 - Spectrum display, 96
 - Search, 343
 - Search control panel, 347
 - Search For, 344
 - Search In, 344
 - search using a mask, 345
 - secondary marker, 430
 - Security tab, 27
 - Options control panel, 28
 - Select all
 - Replay menu, 358
 - Select data records tab, 355
 - Select records from history
 - Replay menu, 358
 - SEM display, 208
 - sensitivity, 430
 - Set to max BW, 112

- Settings, 414
 - AM display, 126
 - Audio Spectrum display, 270
 - Audio Summary display, 272
 - CCDF display, 181
 - Constellation display, 285
 - Demod I&Q vs Time display, 288
 - DPX Spectrum, 70
 - EVM vs. Time display, 289
 - Eye Diagram display, 291
 - FM display, 134
 - Frequency Deviation vs. Time, 294
 - Frequency Settling Time, 200
 - Frequency vs. Time, 106
 - Magnitude Error vs. Time, 296
 - MCPR, 159
 - Occupied Bandwidth, 168
 - OFDM Channel
 - Response, 227
 - OFDM Constellation, 231
 - OFDM EVM, 232
 - OFDM Mag Error, 234
 - OFDM Phase Error, 236
 - OFDM Power, 238
 - OFDM Summary, 241
 - OFDM Symbol Table, 243
 - Options control panel, 27
 - Phase Error vs. Time, 298
 - Phase Noise, 186
 - Phase Settling Time, 196
 - Phase vs. Time, 108
 - Pulse Statistics display, 257
 - Pulse Table display, 252
 - Pulse Trace display, 255
 - restoring defaults, 21
 - RF I & Q vs. Time, 110
 - Signal Quality, 303
 - Spectrogram display, 99
 - Spectrum display, 95
 - Spectrum Emission Mask, 211
 - Spurious display, 173
 - Symbol Table display, 305
 - Time Overview display, 90
 - Trellis Diagram display, 307
- Settled Frequency
 - definition, 189
- Settled Phase
 - definition, 189
- settling time
 - measuring, 197
- Settling Time, 189
 - definition, 189
- Settling Time decimal places
 - Settling Time displays, 208
- settling time measurement
 - text color, 195
- Setup Menu, 401
- setups
 - saving, 379
- shape factor (skirt selectivity), 430
- Show graticule
 - General Signal Viewing Displays, 120
 - Pulsed RF displays, 267
 - Settling Time displays, 208
- Show Marker Readout in Graph
 - General Signal Viewing Displays, 120
 - Pulsed RF displays, 267
 - RF Measurements displays, 225
 - Settling Time displays, 208
- Show recalled trace, 114
 - AM display, 128
 - FM display, 137
 - PM display, 144
 - Time Overview display, 91
- signal, 430
- Signal Power
 - Audio Summary display, 271
- Signal Quality display, 298
- Signal quality measurements, 301
- Signal Quality settings, 303
- signal strength, 149
- SINAD
 - Audio Summary display, 272
- Single, 400
- sluggish operation, 413
- span, 430
- span per division, 431
- Span/RBW Ratio
 - Spectrum display BW tab, 118
 - spectrogram, 431
- Spectrogram display, 97
- Spectrogram display settings, 99
- spectrum, 431
- Spectrum
 - DPX display, 62
 - spectrum analysis, 431
 - spectrum analyzer, 431
 - Spectrum Center Frequency, 351
 - Frequency tab, 352
 - Spectrum display, 94
 - Spectrum display settings, 95
 - Spectrum Emission Mask display, 208
 - settings, 211
 - Spectrum Monitor
 - Spectrogram, 102
 - spectrum time, 431
 - Spectrum Time tab, 351
 - Spectrums/line, 99
- Split
 - DPX display, 62
- spur, 431
- Spur
 - defining, 179
- Spurious, 169
- Spurious display settings, 173
- spurious response, 432
- Standard
 - Audio Filters tab, 276
- Standard settings button
 - SEM display, 211
- Standard Settings button, 308
- Start (Hz)
 - Ranges and Limits table, 178
- Status Bar, 399
- Step size
 - Freq & BW tab, 72
- Stop
 - Replay menu, 358
- Stop (Hz)
 - Ranges and Limits table, 178
- Sweep time, 71
- symbol maps, 324
- Symbol Rate, 36

- Symbol Rate Error, 36
- Symbol Table display, 304
- Symbol Table display
 - settings, 305
- T**
- Taps
 - Equalizer tab, 314
- Taps/Symbol
 - Equalizer tab, 314
- Target Reference
 - Frequency Settling Time, 202
- THD
 - Audio Summary display, 272
- Threshld (dBm)
 - Ranges and Limits table, 178
- Thunderstorm color scheme, 29
- Time, 38
- Time & Freq Scale tab
 - Spectrogram display, 101
- Time measurement, 432
- Time Overview, 88
- Time Overview display
 - settings, 90
- Time Params tab
 - Settling Time displays, 203
- time reference, 432
- time scale status readout, 99
- TIQ acquisition data files, 29
- TIQ acquisition data files
 - parameters, 28
- TNHD
 - Audio Summary display, 272
- Tolerance (+/-)
 - Frequency Settling Time, 202
- Tools Menu, 402
- Total AM
 - AM display, 36
- Touch Screen, 13
- Touch Screen Off, 9
- Touch-screen Actions, 13
- trace, 432
- Trace 2
 - Constellation display, 322
- Trace motion for Sweep
 - ≥ 1 sec, 71
- Trace tab
 - AM display, 128
 - FM display, 137
 - GP Digital Modulation
 - displays, 321
 - OFDM Analysis
 - displays, 248
 - PM display, 144
 - Settling Time displays, 204
 - Time Overview display, 91
- Traces tab
 - DPX Bitmap, 72
 - DPX display, 75
 - DPXOgram view, 72
 - General Signal Viewing
 - displays, 114
 - RF Measurements
 - display, 220
 - Spectrogram display, 100
- Traces tab – Math Trace
 - General Signal Viewing
 - displays, 117
- Transform Window
 - Spectrum display BW
 - tab, 118
- Trellis Diagram display
 - settings, 307
- trigger signals
 - connecting, 390
- troubleshooting, 404
- Tx BER
 - measuring, 83
 - overview, 68
 - tab, 83
 - user pattern file format, 84
- U**
- Uniform (None) Filter Shape
 - Spectrum display BW
 - tab, 118
- Units tab, 355
- Upgrades, 404
- User Filters
 - file format, 330
 - loading, 329
 - user pattern file format
 - Tx BER, 84
 - User presets, 22
 - User Symbol Map, 317
- V**
- VBW, 97
 - Channel Power & ACPR
 - display, MCPR
 - display, 160
 - RF Measurements
 - displays, 219
 - Spectrum display BW
 - tab, 118
 - VBW (Hz)
 - Ranges and Limits table, 178
 - VBW On
 - Ranges and Limits table, 178
 - vector signal analyzer, 432
 - vertical scale factor, vertical
 - display factor, 432
 - View Menu, 398
 - violation, 433
- W**
- Waterfall
 - Spectrogram/DPXo-
 - gram, 101
 - Spectrogram/DPXogram
 - display, 80
- Window menu, 404
- Windows Event Viewer, 411
- X**
- x dB BW Ref Power, 165
- x dB Level, 169
- Z**
- Zero Span
 - DPX display, 62