

TCA-1MEG High Impedance Buffer Amplifier Instruction Manual



Rev. A



071-1010-03

Tektronix

TCA-1MEG

High Impedance Buffer Amplifier

Instruction Manual

Warning

The servicing instructions are for use by qualified personnel only. To avoid personal injury, do not perform any servicing unless you are qualified to do so. Refer to all safety summaries prior to performing service.

www.tektronix.com
071-1010-03

Tektronix

Copyright © Tektronix. All rights reserved. Licensed software products are owned by Tektronix or its subsidiaries or suppliers, and are protected by national copyright laws and international treaty provisions.

Tektronix products are covered by U.S. and foreign patents, issued and pending. Information in this publication supersedes that in all previously published material. Specifications and price change privileges reserved.

TEKTRONIX and TEK are registered trademarks of Tektronix, Inc.

Contacting Tektronix

Tektronix, Inc.
14150 SW Karl Braun Drive
P.O. Box 500
Beaverton, OR 97077
USA

For product information, sales, service, and technical support:

- In North America, call 1-800-833-9200.
- Worldwide, visit www.tektronix.com to find contacts in your area.

Warranty

Tektronix warrants that this product will be free from defects in materials and workmanship for a period of one (1) year from the date of shipment. If any such product proves defective during this warranty period, Tektronix, at its option, either will repair the defective product without charge for parts and labor, or will provide a replacement in exchange for the defective product. Parts, modules and replacement products used by Tektronix for warranty work may be new or reconditioned to like new performance. All replaced parts, modules and products become the property of Tektronix.

In order to obtain service under this warranty, Customer must notify Tektronix of the defect before the expiration of the warranty period and make suitable arrangements for the performance of service. Customer shall be responsible for packaging and shipping the defective product to the service center designated by Tektronix, with shipping charges prepaid. Tektronix shall pay for the return of the product to Customer if the shipment is to a location within the country in which the Tektronix service center is located. Customer shall be responsible for paying all shipping charges, duties, taxes, and any other charges for products returned to any other locations.

This warranty shall not apply to any defect, failure or damage caused by improper use or improper or inadequate maintenance and care. Tektronix shall not be obligated to furnish service under this warranty a) to repair damage resulting from attempts by personnel other than Tektronix representatives to install, repair or service the product; b) to repair damage resulting from improper use or connection to incompatible equipment; c) to repair any damage or malfunction caused by the use of non-Tektronix supplies; or d) to service a product that has been modified or integrated with other products when the effect of such modification or integration increases the time or difficulty of servicing the product.

THIS WARRANTY IS GIVEN BY TEKTRONIX WITH RESPECT TO THE PRODUCT IN LIEU OF ANY OTHER WARRANTIES, EXPRESS OR IMPLIED. TEKTRONIX AND ITS VENDORS DISCLAIM ANY IMPLIED WARRANTIES OF MERCHANTABILITY OR FITNESS FOR A PARTICULAR PURPOSE. TEKTRONIX' RESPONSIBILITY TO REPAIR OR REPLACE DEFECTIVE PRODUCTS IS THE SOLE AND EXCLUSIVE REMEDY PROVIDED TO THE CUSTOMER FOR BREACH OF THIS WARRANTY. TEKTRONIX AND ITS VENDORS WILL NOT BE LIABLE FOR ANY INDIRECT, SPECIAL, INCIDENTAL, OR CONSEQUENTIAL DAMAGES IRRESPECTIVE OF WHETHER TEKTRONIX OR THE VENDOR HAS ADVANCE NOTICE OF THE POSSIBILITY OF SUCH DAMAGES.

[W2 – 15AUG04]

Table of Contents

Important safety information	v
General safety summary	v
Service safety summary.....	vii
Terms in this manual	viii
Symbols and terms on the product.....	viii
Compliance information	x
Safety compliance.....	x
Environmental considerations.....	xiii
Preface.....	xv
Getting Started	1
Product Description	1
Accessories	3
Input Voltage Derating.....	4
Probe Calibration for High Accuracy.....	4
Functionality Not Supported	5
Installation	5
Connecting the TCA-1MEG to the Host Instrument	7
Connecting a Probe to the TCA-1MEG	8
Attaching and Grounding a TCA-1MEG System.....	9
Functional Overview	10
Cleaning.....	11
Functional Checks.....	13
Prerequisites	13
Required Equipment	14
Run the SPC (Signal Path Compensation) on the Host Instrument	16
Calibrate the TCA-1MEG to the Host Instrument.....	16
Calibrate the P6139B Passive Voltage Probe to the TCA-1MEG and Host Instrument.....	18
LF Probe Compensation	20
Check Vertical Input Coupling	22
Check Bandwidth Limit	26

Table of Contents

Specifications	31
Performance Verification	37
TCA-1MEG System Bandwidth	38
Replaceable Parts	43

List of Figures

Figure 1: TCA-1MEG High Impedance Buffer Amplifier	1
Figure 2: Connecting and disconnecting the TCA-1MEG	7
Figure 3: Calibration data message	8
Figure 4: TekConnect and TEKPROBE Interface features	10
Figure 5: Simplified block diagram	11
Figure 6: Probe Compensation Output of the TDS6604	15
Figure 7: Setup with the P6139B attached to the TCA-1MEG	20
Figure 8: Probe compensation waveforms	21
Figure 9: Test equipment hookup for the Vertical Input Coupling and Bandwidth Limit checks	22
Figure 10: Typical waveform at GND	23
Figure 11: Typical waveform at AC Coupling	24
Figure 12: Typical waveform at DC Coupling	25
Figure 13: Typical waveform at Full (500 MHz) bandwidth	27
Figure 14: Typical waveform at 100 MHz bandwidth	28
Figure 15: Typical waveform at 20 MHz bandwidth	29
Figure 16: Typical Input Impedance and Phase versus Frequency	33
Figure 17: Voltage Derating versus Frequency	34
Figure 18: TCA-1MEG dimensions	35
Figure 19: TCA-1MEG System Bandwidth equipment hookup	39
Figure 20: TCA-1MEG replaceable parts	44

List of Tables

Table 1: Compatible devices that require high impedance input	2
Table 2: Required equipment.....	14
Table 3: Warranted electrical specifications.....	31
Table 4: Typical electrical characteristics	32
Table 5: Physical characteristics	35
Table 6: Environmental characteristics	35
Table 7: Equipment required for performance verification	37
Table 8: TCA-1MEG test record.....	42
Table 9: TCA-1MEG replaceable parts.....	44

Important safety information

This manual contains information and warnings that must be followed by the user for safe operation and to keep the product in a safe condition.

To safely perform service on this product, additional information is provided at the end of this section. (See page vii, *Service safety summary*.)

General safety summary

Use the product only as specified. Review the following safety precautions to avoid injury and prevent damage to this product or any products connected to it. Carefully read all instructions. Retain these instructions for future reference.

Comply with local and national safety codes.

For correct and safe operation of the product, it is essential that you follow generally accepted safety procedures in addition to the safety precautions specified in this manual.

The product is designed to be used by trained personnel only.

Only qualified personnel who are aware of the hazards involved should remove the cover for repair, maintenance, or adjustment.

Before use, always check the product with a known source to be sure it is operating correctly.

This product is not intended for detection of hazardous voltages.

Use personal protective equipment to prevent shock and arc blast injury where hazardous live conductors are exposed.

While using this product, you may need to access other parts of a larger system. Read the safety sections of the other component manuals for warnings and cautions related to operating the system.

When incorporating this equipment into a system, the safety of that system is the responsibility of the assembler of the system.

To avoid fire or personal injury

Ground the product. This product is indirectly grounded through the grounding conductor of the mainframe power cord. To avoid electric shock, the grounding conductor must be connected to earth ground. Before making connections to the input or output terminals of the product, make sure that the product is properly grounded.

Do not disable the power cord grounding connection.

Connect and disconnect properly. Do not connect or disconnect probes or test leads while they are connected to a voltage source.

Use only insulated voltage probes, test leads, and adapters supplied with the product, or indicated by Tektronix to be suitable for the product.

Observe all terminal ratings. To avoid fire or shock hazard, observe all ratings and markings on the product. Consult the product manual for further ratings information before making connections to the product. Do not exceed the Measurement Category (CAT) rating and voltage or current rating of the lowest rated individual component of a product, probe, or accessory. Use caution when using 1:1 test leads because the probe tip voltage is directly transmitted to the product.

Do not apply a potential to any terminal, including the common terminal, that exceeds the maximum rating of that terminal.

Do not float the common terminal above the rated voltage for that terminal.

The measuring terminals on this product are not rated for connection to mains Category III or IV circuits, or to mains Category II circuits greater than 100 V.

When connected to circuits other than mains, the maximum transient overvoltage rating is 400 V peak.

Do not operate without covers. Do not operate this product with covers or panels removed, or with the case open. Hazardous voltage exposure is possible.

Avoid exposed circuitry. Do not touch exposed connections and components when power is present.

Do not operate with suspected failures. If you suspect that there is damage to this product, have it inspected by qualified service personnel.

Disable the product if it is damaged. Do not use the product if it is damaged or operates incorrectly. If in doubt about safety of the product, turn it off and disconnect the power cord. Clearly mark the product to prevent its further operation.

Before use, inspect voltage probes, test leads, and accessories for mechanical damage and replace when damaged. Do not use probes or test leads if they are damaged, if there is exposed metal, or if a wear indicator shows.

Examine the exterior of the product before you use it. Look for cracks or missing pieces.

Do not operate in wet/damp conditions. Be aware that condensation may occur if a unit is moved from a cold to a warm environment.

Do not operate in an explosive atmosphere.

Keep product surfaces clean and dry. Remove the input signals before you clean the product.

Service safety summary

The *Service safety summary* section contains additional information required to safely perform service on the product. Only qualified personnel should perform service procedures. Read this *Service safety summary* and the *General safety summary* before performing any service procedures.

To avoid electric shock. Do not touch exposed connections.

Do not service alone. Do not perform internal service or adjustments of this product unless another person capable of rendering first aid and resuscitation is present.

Use care when servicing with power on. Dangerous voltages or currents may exist in this product. Disconnect power, remove battery (if

applicable), and disconnect test leads before removing protective panels, soldering, or replacing components.

Verify safety after repair. Always recheck ground continuity after performing a repair.

Terms in this manual

These terms may appear in this manual:



WARNING. *Warning statements identify conditions or practices that could result in injury or loss of life.*



CAUTION. *Caution statements identify conditions or practices that could result in damage to this product or other property.*

Symbols and terms on the product

These terms may appear on the product:

- **DANGER** indicates an injury hazard immediately accessible as you read the marking.
- **WARNING** indicates an injury hazard not immediately accessible as you read the marking.
- **CAUTION** indicates a hazard to property including the product.



When this symbol is marked on the product, be sure to consult the manual to find out the nature of the potential hazards and any actions which have to be taken to avoid them. (This symbol may also be used to refer the user to ratings in the manual.)

The following symbol(s) may appear on the product:



CAUTION
Refer to Manual

Compliance information

This section lists the safety and environmental standards with which the instrument complies.

Safety compliance

This section lists the safety standards with which the product complies and other safety compliance information.

EU declaration of conformity – low voltage

Compliance was demonstrated to the following specification as listed in the Official Journal of the European Union:

Low Voltage Directive 2006/95/EC.

- EN 61010-1. Safety Requirements for Electrical Equipment for Measurement, Control, and Laboratory Use – Part 1: General Requirements.
- EN 61010-2-030. Safety Requirements for Electrical Equipment for Measurement, Control, and Laboratory Use – Part 2-030: Particular requirements for testing and measuring circuits.

U.S. nationally recognized testing laboratory listing

- UL 61010-1. Safety Requirements for Electrical Equipment for Measurement, Control, and Laboratory Use – Part 1: General Requirements.
- UL 61010-2-030. Safety Requirements for Electrical Equipment for Measurement, Control, and Laboratory Use – Part 2-030: Particular requirements for testing and measuring circuits.

Canadian certification

- CAN/CSA-C22.2 No. 61010-1. Safety Requirements for Electrical Equipment for Measurement, Control, and Laboratory Use – Part 1: General Requirements.
- CAN/CSA-C22.2 No. 61010-2-030. Safety Requirements for Electrical Equipment for Measurement, Control, and Laboratory

Use – Part 2-030: Particular requirements for testing and measuring circuits.

Additional compliances

- IEC 61010-1. Safety Requirements for Electrical Equipment for Measurement, Control, and Laboratory Use – Part 1: General Requirements.
- IEC 61010-2-030. Safety Requirements for Electrical Equipment for Measurement, Control, and Laboratory Use – Part 2-030: Particular requirements for testing and measuring circuits.

Equipment type

Test and measuring equipment.

Safety class

Class 1 – grounded product.

Pollution degree descriptions

A measure of the contaminants that could occur in the environment around and within a product. Typically the internal environment inside a product is considered to be the same as the external. Products should be used only in the environment for which they are rated.

- Pollution degree 1. No pollution or only dry, nonconductive pollution occurs. Products in this category are generally encapsulated, hermetically sealed, or located in clean rooms.
- Pollution degree 2. Normally only dry, nonconductive pollution occurs. Occasionally a temporary conductivity that is caused by condensation must be expected. This location is a typical office/home environment. Temporary condensation occurs only when the product is out of service.
- Pollution degree 3. Conductive pollution, or dry, nonconductive pollution that becomes conductive due to condensation. These are sheltered locations where neither temperature nor humidity is controlled. The area is protected from direct sunshine, rain, or direct wind.
- Pollution degree 4. Pollution that generates persistent conductivity through conductive dust, rain, or snow. Typical outdoor locations.

Pollution degree rating

Pollution degree 2 (as defined in IEC 61010-1). Rated for indoor, dry location use only.

IP rating

IP20 (as defined in IEC 60529).

Measurement and overvoltage category descriptions

Measurement terminals on this product may be rated for measuring mains voltages from one or more of the following categories (see specific ratings marked on the product and in the manual).

- Category II. Circuits directly connected to the building wiring at utilization points (socket outlets and similar points).
- Category III. In the building wiring and distribution system.
- Category IV. At the source of the electrical supply to the building.

NOTE. *Only mains power supply circuits have an overvoltage category rating. Only measurement circuits have a measurement category rating. Other circuits within the product do not have either rating.*

Environmental considerations

This section provides information about the environmental impact of the product.

Product end-of-life handling

Observe the following guidelines when recycling an instrument or component:

Equipment recycling. Production of this equipment required the extraction and use of natural resources. The equipment may contain substances that could be harmful to the environment or human health if improperly handled at the product's end of life. To avoid release of such substances into the environment and to reduce the use of natural resources, we encourage you to recycle this product in an appropriate system that will ensure that most of the materials are reused or recycled appropriately.



This symbol indicates that this product complies with the applicable European Union requirements according to Directives 2002/96/EC and 2006/66/EC on waste electrical and electronic equipment (WEEE) and batteries. For information about recycling options, check the Support/Service section of the Tektronix Web site (www.tektronix.com).

Restriction of hazardous substances

This product is classified as an industrial monitoring and control instrument accessory, and is not required to comply with the substance restrictions of the recast RoHS Directive 2011/65/EU until July 22, 2017.

Preface

This is the Instruction manual for the TCA-1MEG High Impedance Buffer Amplifier. Read this preface to learn how this manual is structured and what conventions it uses. Before using this manual or the TCA-1MEG amplifier, read the *General Safety Summary* and *Service Safety Summary* sections at the beginning of this manual for safety and other important background information.

Manual Structure

This manual is divided into sections, which are made of related topics:

- *Getting Started* includes a product description, list of accessories, and instructions for installation.
- *Functional Checks* includes procedures for verifying that the TCA-1MEG functions properly with a host instrument.
- *Specifications* includes warranted electrical specifications, typical electrical characteristics, and graphs for typical input impedance, and typical bandwidth.
- *Performance Verification* includes a procedure for verifying warranted electrical specifications.

NOTE. *Service software for this instrument is included on the TDS Applications CD ROM (Tektronix part number 063-3376-XX) for your host instrument, and is also available for download from the Tektronix Web site.*

Be sure to read the introductory text for each procedure, which provide important information needed to use the TCA-1MEG High Impedance Buffer Amplifier correctly, safely, and efficiently.

Manual Conventions

The following conventions are used in this manual:

Safety

Symbols and terms related to safety appear in the *Service Safety Summary* found at the beginning of this manual.

Getting Started

Product Description

The TCA-1MEG is a High Impedance Buffer Amplifier system that broadens the functionality of a TekConnect host instrument. Features include:

- Input impedance — 1 M Ω , 10 pF
- Bandwidth — 500 MHz
- Bandwidth limit (selectable) — Full (500 MHz), 100 MHz, and 20 MHz
- Input coupling (selectable) — AC, DC, and GND
- Input Connection — 1 M Ω TEKPROBE BNC

The TCA-1MEG amplifier, or other Tektronix TekConnect probes and adapters, enable you to easily configure each channel of your host instrument for the input characteristics you require.

To achieve a 1 M Ω system when you need it, use this amplifier to connect a Tektronix 1 M Ω TEKPROBE BNC probe or other standard 1 M Ω BNC accessory to your 50 Ω TekConnect host instrument. To regain your high-speed, 50 Ω signal path, simply replace the TCA-1MEG with a high performance TekConnect probe or adapter.

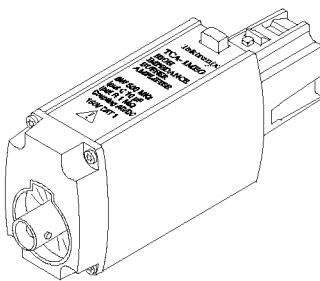

Figure 1: TCA-1MEG High Impedance Buffer Amplifier

The table below lists Tektronix high-voltage passive probes, high-voltage active probes, current probes, and other measurement analysis tools that require high impedance input. Use these devices with the TCA-1MEG to extend the use of your TekConnect host instrument.

Table 1: Compatible devices that require high impedance input

Device type	Model	Description
Passive voltage probes	P6101B	15 MHz, 1X, passive
	P6139B	500 MHz, 10X, passive
High voltage probes	P6015A	20 kV, 1000X, 75 MHz, passive
	P5100A	2.5 kV, 100X, 500 MHz, passive
	P5205A	1.3 kV, 200 MHz, active differential
	P5210A	4.4 kV, 100 MHz, active differential
Micro-volt differential probe	ADA400A	100X / 10X / 1X / 0.1X preamplifier
Current probes	P6021A	AC, 15 A _{p-p} , 60 MHz
	P6022	AC, 6 A _{p-p} , 120 MHz
	AM503S	AC/DC current amplifier measurement system
Others	012-0057-01	50 Ω BNC-to-BNC coaxial cable
	011-0049-02	50 Ω feed through termination
	012-0482-00	50 Ω BNC-to-BNC coaxial cable, male to male

¹ Nine-digit part numbers (xxx-xxxx-xx) are Tektronix part numbers.

Accessories

The TCA-1MEG amplifier package has a set of standard accessories.

Standard Accessories for the TCA-1MEG

- P6139B 10X Passive Probe with standard accessories and Instructions
- Certificate of Traceable Calibration
- *TCA-1MEG High Impedance Buffer Amplifier Instruction Manual* (Tektronix part number 071-1010-XX)
- TDS6000 Series Product Software (Tektronix part number 063-3541-XX), also available on the Tektronix Web site
- TDS7000 Series Product Software (Tektronix part number 063-3461-XX), also available on the Tektronix Web site

Optional Accessories for the TCA-1MEG

Service software for the TCA-1MEG is included on the TDS Applications Software CD for your host instrument. The CD is also available as an optional accessory for the TCA-1MEG (Tektronix part number 063-3376-XX). The software is also available for download from the Tektronix Web site. The Tektronix Web site provides up-to-date firmware and software upgrades.

Input Voltage Derating

The TCA-1MEG is designed to be used in a high voltage environment. However, voltage input rating decreases as the frequency of the applied signal increases. Refer to *Specifications* for input voltage rating and voltage versus frequency derating information. (See page 31, *Specifications*.)

Probe Calibration for High Accuracy

To ensure high accuracy, you should run a probe calibration routine on the TCA-1MEG:

- When the ambient temperature changes by more than 5 °C (9 °F) from the temperature of the previous calibration
- When you install the TCA-1MEG on a host instrument channel where it has not been calibrated previously

Refer to *Functional Checks* for the probe calibration procedure. (See page 13, *Functional Checks*.)

Probes or adapters with the following characteristics will not calibrate using the internal calibration signal of the TekConnect host instrument:

- Probes or adapters without TEKPROBE readout capabilities
- Probes with attenuation levels greater than 20X, due to the low signal level at the output of the internal calibration generator

Functionality Not Supported

50 Ω Termination at BNC input:

The TCA-1MEG amplifier does not provide a 50 Ω termination at its BNC input. If you require 50 Ω termination for your applications, use a Tektronix TekConnect 50 Ω adapter (TCA-BNC, TCA-SMA, or TCA-N) in place of the TCA-1MEG. When the host instrument detects an incompatible device connected to the TCA-1MEG, it displays a message that an incompatible combination of accessories has been installed. The host instrument, however, will not detect all incompatible devices.

Readout and Power Connection Pins

The BNC connector of the TCA-1MEG is not compatible for use with nonTektronix probes, cables, and adapters that have readout or power connection pins.



CAUTION. To avoid damage to your equipment, do not use the TCA-1MEG with nonTektronix probes, cables, and adapters that have readout or power connection pins.

Installation

The TCA-1MEG connects directly to the TekConnect interface on the TekConnect host instrument.

Firmware Requirements

To ensure compatibility of your TekConnect host instrument with the TCA-1MEG, your host instrument (for example, TDS6000, TDS7000, or CSA7000 series) must have the firmware upgrade V2.1.0 or higher.



CAUTION. To avoid instrument malfunctions, do not overwrite V2.1.0 or higher firmware with an earlier version of firmware. Doing so would require reinstallation of up-to-date firmware on the host instrument.

Firmware upgrade instructions are available on the CD ROMs included with the TCA-1MEG. The upgrades are also available on the Tektronix Web site at www.tektronix.com. Select the *Software & Drivers* link on the home page of the Web site. The Tektronix Web site provides up-to-date software and firmware upgrades.

Connecting the TCA-1MEG to the Host Instrument

The TekConnect Interface features a spring-loaded latch that provides audible and tactile confirmation that a reliable connection has been made to the TekConnect host instrument. Slide the TCA-1MEG into the TekConnect receptacle on the host instrument. The unit snaps into the host instrument when fully engaged. (See Figure 2.)

To release the TCA-1MEG from the host instrument, grasp the unit, depress the latch button, and pull it out of the TekConnect receptacle.

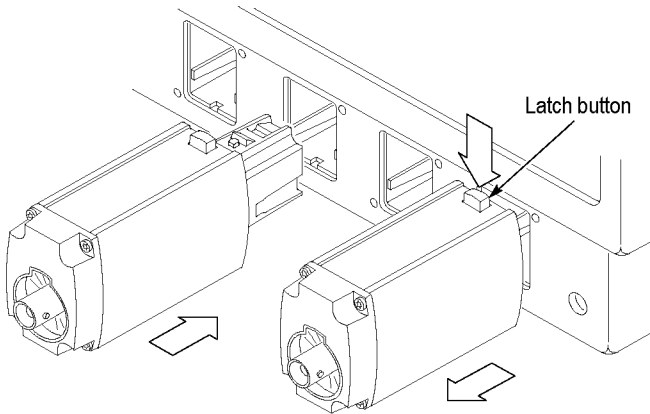

Figure 2: Connecting and disconnecting the TCA-1MEG

NOTE. If you connect the TCA-1MEG to a channel where it has already been probe calibrated, a message may appear on the display screen. (See Figure 3 on page 8.) Follow the instructions on the message.

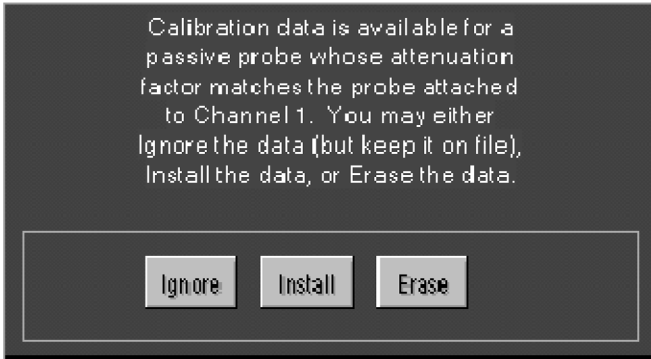

Figure 3: Calibration data message

Connecting a Probe to the TCA-1MEG



WARNING. *To avoid fire or personal injury, connect the TCA-1MEG amplifier to the host instrument, then connect the probe or other input device to the TCA-1MEG. Connect the probe or other input device to the device-under-test.*

Before disconnecting the TCA-1MEG from the host instrument, disconnect the probe or other input device, and the probe ground, from the device-under-test, and then disconnect the probe or other input device from the TCA-1MEG amplifier.

Before you connect a probe or other device, ensure that the device is compatible with the TCA-1MEG. Refer to *Functionality Not Supported*. (See page 1, *Getting Started*.)

Follow the instructions in your probe manual for connecting your probe or other device to a TEKPROBE BNC connector.

NOTE. *The maximum V/division setting with a 1X probe, or with no probe, is 10 V/division. The Volts/division of the host instrument may change when you connect probes with different attenuation factors.*

Before connecting a probe or other device to the TCA-1MEG, always refer to the list of compatible devices. (See Table 1 on page 2.)

Attaching and Grounding a TCA-1MEG System

Always use these procedures for safely connecting and disconnecting the TCA-1MEG and probe to the circuit under test.



WARNING. *To avoid fire or personal injury, connect the TCA-1MEG and probe output to the measurement instrument before connecting the probe or other input device to the circuit under test. Disconnect the probe input and probe ground from the circuit under test before disconnecting the probe or the TCA-1MEG from the measurement instrument.*

After connecting the TCA-1MEG to the host instrument and connecting a probe to TCA-1MEG, connect the ground lead of the probe to the ground of the circuit under test before taking any measurements.

Be careful that no part of the ground lead or probe grounding ring contacts voltage in the circuit under test. Except for the probe tip and BNC center conductor, all accessible metal (including the ground clip) is connected to the BNC outer shell and is considered earth ground.

Functional Overview

The TekConnect-to-TEKPROBE Interface

The TCA-1MEG is powered through the Tektronix TekConnect Interface. The TekConnect Interface provides a communication path through contact pins on the host instrument. Power, signal, offset, and probe characteristic data transfer through the interface to the host instrument. (See Figure 4.) Also, refer to your oscilloscope or probe documentation for more detailed specifications.

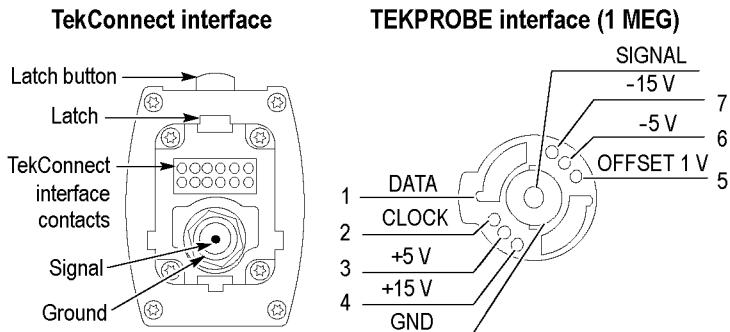

Figure 4: TekConnect and TEKPROBE Interface features

When the TCA-1MEG is connected to the host instrument, the input of the host instrument is set to 1 M Ω . If the TCA-1MEG was previously connected to the host instrument channel, the input coupling and bandwidth limit are set to the settings previously used. If the TCA-1MEG has never been connected to the host instrument channel, the input coupling and bandwidth limit are set to the default TCA-1MEG settings (DC coupling and Full bandwidth).

When a probe is connected to the TCA-1MEG, the host instrument reads its attenuation factor and displays readouts adjusted for the attenuation factor of the probe. The host instrument controls offset if the connected probe requires it.

Operating Characteristics

Although the TCA-1MEG amplifier has no replaceable parts, this functional overview is intended to help you isolate failures to either the probe or the host instrument. Refer to the simplified block diagram of the amplifier. (See Figure 5.)

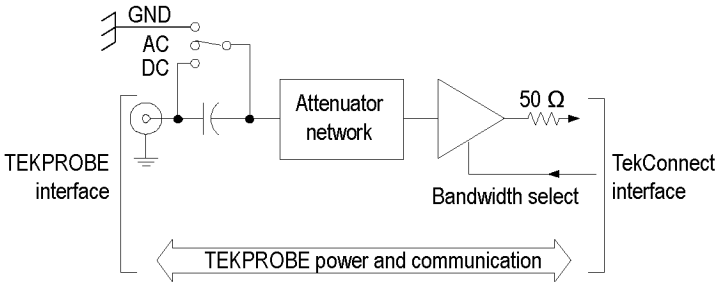

Figure 5: Simplified block diagram

Cleaning

Follow these guidelines for cleaning the TCA-1MEG amplifier.

General Care. Do not use chemical cleaning agents. Avoid using chemicals that contain acetone, benzene, toluene, xylene, or similar solvents because they may damage the plastic.

Clean the exterior surfaces with a dry, lint-free cloth or a soft-bristle brush. If dirt remains, use a cloth or swab dampened with a 75% isopropyl alcohol solution. A swab is useful for cleaning in narrow spaces around the TekConnect release button and connectors. Do not use abrasive compounds on any part of the instrument.



CAUTION. To avoid permanent damage to the TCA-1MEG while cleaning, use only enough solution to dampen the cloth or swab. The TCA-1MEG is not waterproof.

Functional Checks

The purpose of these procedures is to confirm that the TCA-1MEG High Impedance Buffer Amplifier functions properly with the host instrument.

The following functions are checked:

- Probe LF Compensation
- Vertical Input Coupling
- Bandwidth Limit

NOTE. *To perform these procedures, you should be familiar with the basic operation, control, and setup of the TekConnect host instrument. Refer to the host instrument manual and online help for detailed operating information.*

Prerequisites

The conditions listed below must be met in the following order before you perform the functional checks:

1. The host instrument, TCA-1MEG, and probe must have been operating for a warm-up period of at least 20 minutes.
2. The host instrument SPC (Signal Path Compensation) must be run at an ambient temperature between +20 °C and +30 °C. (Disconnect the TCA-1MEG and probe when you run the SPC.)
3. The TCA-1MEG calibration procedure must be performed. Refer to *Calibrate the TCA-1MEG to the Host Instrument*. (See page 16.)

Required Equipment

Table 2: Required equipment

Description	Performance requirement	Recommended example
Oscilloscope	TekConnect interface	TDS6000, TDS7000, CSA7000 ¹
Cable	50 Ω coaxial, male-to-male	Tektronix part number 103-0226-XX
Probe tip adapter	BNC, nonterminated	Tektronix part number 013-0367-XX

¹ See Required Oscilloscope Firmware Version below

Required Oscilloscope Firmware Version

To ensure compatibility of your TekConnect host instrument with the TCA-1MEG, your host instrument (for example, TDS6000, TDS7000, or CSA7000 series) must have firmware version V2.1.0 or higher. Upgrade instructions are available on the included CD ROM, or visit our website at www.tek.com and select the *Software and Drivers* link. The Tektronix Web site provides up-to-date firmware and software upgrades.

TCA-1MEG Readings on the Host Instrument

The TCA-1MEG readings on the host instrument display screen may vary from instrument to instrument.

The output amplitude and frequency shown for the TCA-1MEG is dependent on the probe compensation output of the TekConnect host instrument. The output amplitude, frequency, and voltage offset of the host instrument is shown next to the Probe Compensation output connector. (See Figure 6.)

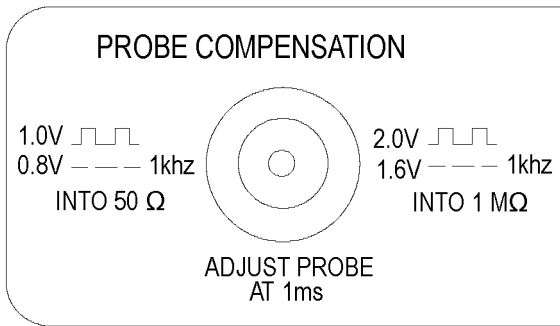
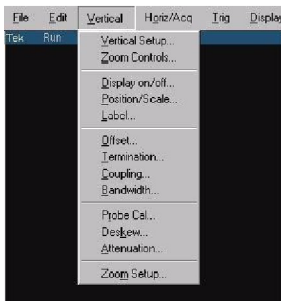

Figure 6: Probe Compensation Output of the TDS6604

NOTE. Unless specifically directed, do not terminate the probe compensation output of the host instrument or the TCA-IMEG input with a 50 Ω feedthrough terminator.

Reference Commands on the Host Instrument

The following test procedures use some of the commands available on a TDS6604 Oscilloscope. These commands are similar to the commands that other TekConnect host instruments use. Refer to the host instrument user manual and online help for more information.



To set up your host instrument to enable quick- setting changes while testing:

1. On the display screen, choose Buttons display.
2. On the front panel, activate Touch Screen.
3. On the Vertical menu, select Vertical Setup. A tabbed panel of Vertical options displays across the bottom of the screen.

Run the SPC (Signal Path Compensation) on the Host Instrument

You must run the SPC on the host instrument before you calibrate the TCA-1MEG to your host instrument. Do the following:

1. Warm up the instrument for 20 minutes.
2. From the Utilities menu, select Instrument Calibration.
3. In the Calibration box, check that the Status field is **Pass**. If it is not, disconnect all probes and signal sources from the instrument.
4. In the Calibration box, click the Calibrate button.
5. When the Status field is **Pass**, proceed to the *Calibrate the TCA-1MEG to the Host Instrument* procedure.

Calibrate the TCA-1MEG to the Host Instrument

You must perform a calibration of the TCA-1MEG to your host instrument before you perform the functional checks. A BNC-to-BNC 50 Ω coaxial cable (or suitable equivalent) is required for this procedure.

Perform the TCA-1MEG calibration routine:

- The first time that you connect the TCA-1MEG and/or probe to the host instrument (allow a 20 minute warm-up period).
- If you move the TCA-1MEG and/or probe to a new channel or host instrument.
- If the host instrument, TCA-1MEG or probe have had an SPC, repair, or calibration.

This procedure only calibrates the TCA-1MEG to the TekConnect host instrument. If you intend to use a probe with the TCA-1MEG, you must also perform the *Calibrate the P6139A Passive Voltage Probe to the TCA-1MEG and Host Instrument* procedure. (See page 18.)

Test Equipment Hookup.

1. Connect the TCA-1MEG to the channel that you intend to use on your host instrument.
2. Connect a BNC-to-BNC 50 Ω coaxial cable to the BNC input of the TCA-1MEG. Do not terminate the cable with a 50 Ω terminator.
3. Connect the other end of the BNC-to-BNC 50 Ω coaxial cable to the PROBE COMPENSATION connector of the host instrument.

Test Procedure.

1. On the Vertical menu, select Probe Cal. A probe calibration panel appears along the right side of the screen.
2. Select the signal channel that the TCA-1MEG is connected to.
3. Choose Calibrate Probe. This operation may take several minutes. Do not remove the TCA-1MEG or cable during this operation.
4. When probe calibration is complete, the Probe Status field should read **Pass**. If the field reads **Fail**, contact your Tektronix Service representative.

NOTE. For Volts/division settings ≥ 10 mV/division, the typical Displayed System Input Offset is ± 0.2 divisions or less, when used within ± 5 °C of the calibrated temperature.

5. Close the probe calibration panel.

The TCA-1MEG is now calibrated to the host instrument for the specified channel only. If you move the TCA-1MEG to another channel or to another host instrument, you must repeat this procedure.

6. Proceed to the functional checks.

If you attach a probe to the TCA-1MEG, you must perform the *Calibrate the P6139B Passive Voltage Probe to the TCA-1MEG and Host Instrument* procedure that follows.

Calibrate the P6139B Passive Voltage Probe to the TCA-1MEG and Host Instrument

A P6139B probe and an instrument calibration connection (or suitable equivalent) are required for this procedure.

NOTE. *Variations in the characteristics of the TCA-1MEG and/or probe require you to adjust the low-frequency compensation of the probe that is connected to the TCA-1MEG. Consider this whenever you connect a different probe to a TCA-1MEG, or when you move a probe from one TCA-1MEG to another.*

If a 1 kHz calibrated square wave displayed at 1 ms/division shows significant amplitude differences between the leading and trailing edges, perform the LF Probe Compensation procedure to optimize low-frequency compensation. (See page 20.)

Test Equipment Hookup.

1. Connect the TCA-1MEG to a channel on your host instrument.
2. Connect the probe to the TEKPROBE input of the TCA-1MEG.
3. Using a nonterminated probe tip-to-BNC adapter, connect the probe to the probe calibration signal on the front panel of the host instrument.
4. Check for proper LF compensation: If a 1 kHz calibrated square wave displayed at 1 ms/division shows significant amplitude differences between the leading and trailing edges, perform the *LF Probe Compensation* procedure to optimize low-frequency compensation. (See page 20.)

Test Procedure.

Do the following after a warm up period of at least 20 minutes:

1. On the Vertical menu, select Probe Cal. A probe calibration panel appears along the right side of the screen.
2. Select the signal channel that the TCA-1MEG and/or probe are connected to.
3. Choose Calibrate Probe. This operation may take several minutes. Do not remove the TCA-1MEG or probe during this operation.

4. When probe calibration is complete, the Probe Status field should read **Pass**. If the field reads **Fail**, contact your Tektronix Service representative.

NOTE. For Volts/division settings ≥ 10 mV/division, the typical Displayed System Input Offset is ± 0.2 divisions or less, when used within ± 5 °C of the calibrated temperature.

5. Close the probe calibration panel.

The TCA-1MEG and probe are now calibrated to the host instrument for the specified channel only. If you move the TCA-1MEG and probe to another channel or to another host instrument, you must repeat the TCA-1MEG and probe calibration procedures.

LF Probe Compensation

Variations in the TCA-1MEG input characteristics may require you to adjust the low-frequency compensation of the probe that is connected to the TCA-1MEG. Consider this whenever you connect a different probe to a TCA-1MEG, or when you move a probe from one TCA-1MEG to another.

If a 1 kHz calibrated square wave displayed at 1 ms/division shows significant differences between the leading and trailing edges, perform these steps to optimize low-frequency compensation:

1. Connect the TCA-1MEG to any channel on the host instrument.
2. Connect the probe to the TEKPROBE input of the TCA-1MEG.
3. Using a nonterminated probe tip adapter, connect the probe to the probe calibration signal on the front panel of the oscilloscope.

NOTE. After connecting the TCA-1MEG to the host instrument, allow them to warm up for at least twenty minutes before performing the functional checks.

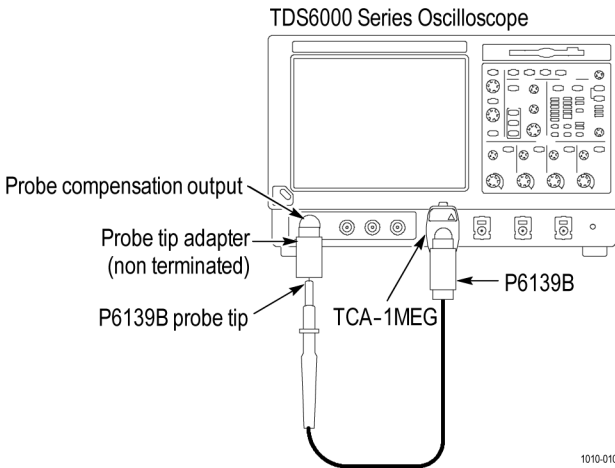

Figure 7: Setup with the P6139B attached to the TCA-1MEG

4. Press AUTOSET or otherwise adjust your host instrument to display a meaningful waveform.

5. On the Vertical menu, select Vertical Setup, and then choose the tab of the channel that the TCA-1MEG is connected to.
 - a. Set coupling to DC. Set trigger level to 50%.
 - b. Set bandwidth to Full.
 - c. Set vertical scale to 100 mV/division.
 - d. Set offset to 1.6.
 - e. Adjust vertical position of the waveform to display on center screen.
 - f. Close the panel.
6. Set horizontal scale to 1.0 ms.
7. On the Horiz/Acq menu, select Horizontal/Acquisition Setup, and then choose the Acquisition tab.
 - a. Set acquisition mode to High Resolution.
 - b. Close the panel.
8. Adjust the trimmer in the probe (accessible through the compensation box) until you see a square wave with a perfectly flat top on the display. (See Figure 8.)



CAUTION. To avoid damaging the trimmer, use the adjustment tool supplied with your probe. Adjustment tools from some probe models may not be compatible with your probe.

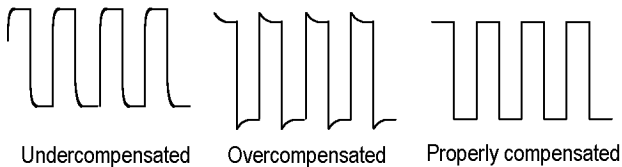

Figure 8: Probe compensation waveforms

Check Vertical Input Coupling

Verify the AC, DC, and GND coupling of the TCA-1MEG.

Test Equipment Hookup.

TDS6000 TekConnect oscilloscope

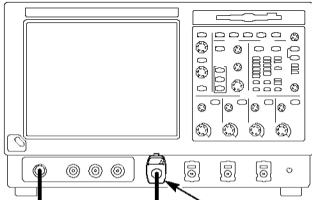

TCA-1MEG

BNC cable from TCA-1MEG input to PROBE COMPENSATION output. Do not use a 50 Ω terminator.

Figure 9: Test equipment hookup for the Vertical Input Coupling and Bandwidth Limit checks

Test Procedure.

1. On the front panel of the host instrument, press the button corresponding to the channel that the TCA-1MEG is connected to.
2. Push the AUTOSET button to display a waveform on the screen.
3. If autoset does not set the host instrument to 500 mV/division, manually change vertical V/division to 500 mV.
4. Using the Vertical Position control knob, position the waveform to two divisions above center screen.
5. On the Vertical menu, select Vertical Setup, and then choose the tab of the channel that the TCA-1MEG is connected to.
6. Set coupling to GND.

The resulting waveform should appear as shown. (See Figure 10 on page 23.)

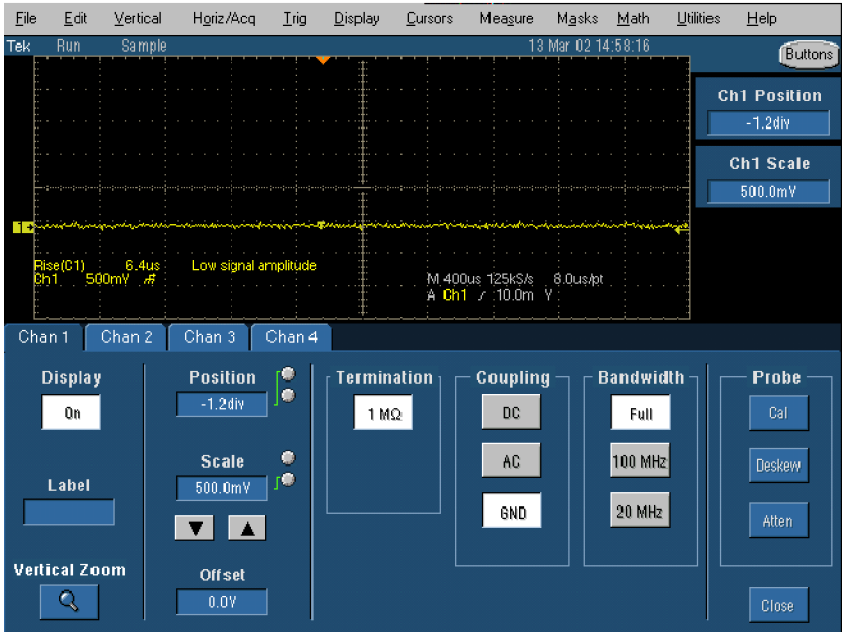

Figure 10: Typical waveform at GND

- Set Coupling to AC, and set trigger level to 50%. The resulting waveform should appear as shown. (See Figure 11.)

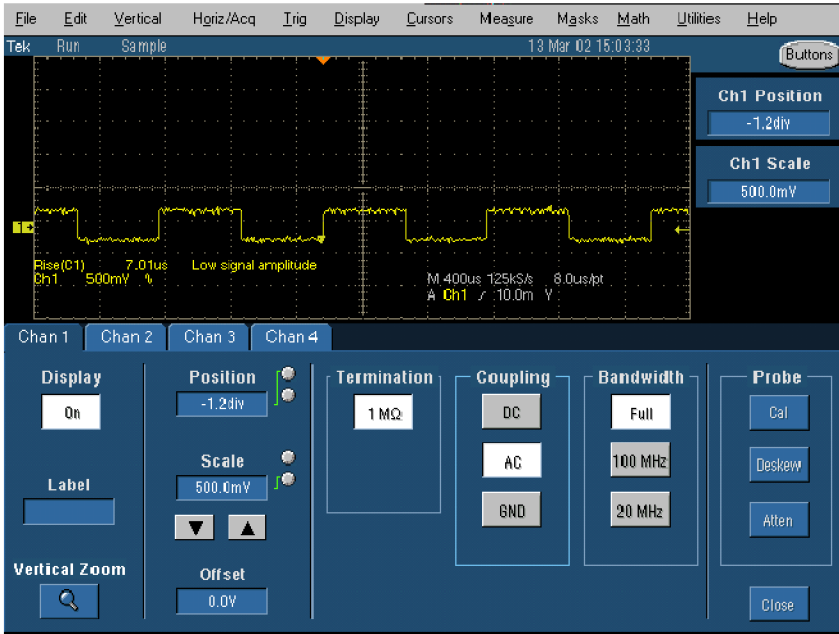

Figure 11: Typical waveform at AC Coupling

- Set Coupling to DC, and set trigger level to 50%. The resulting waveform should appear as shown. (See Figure 12.)

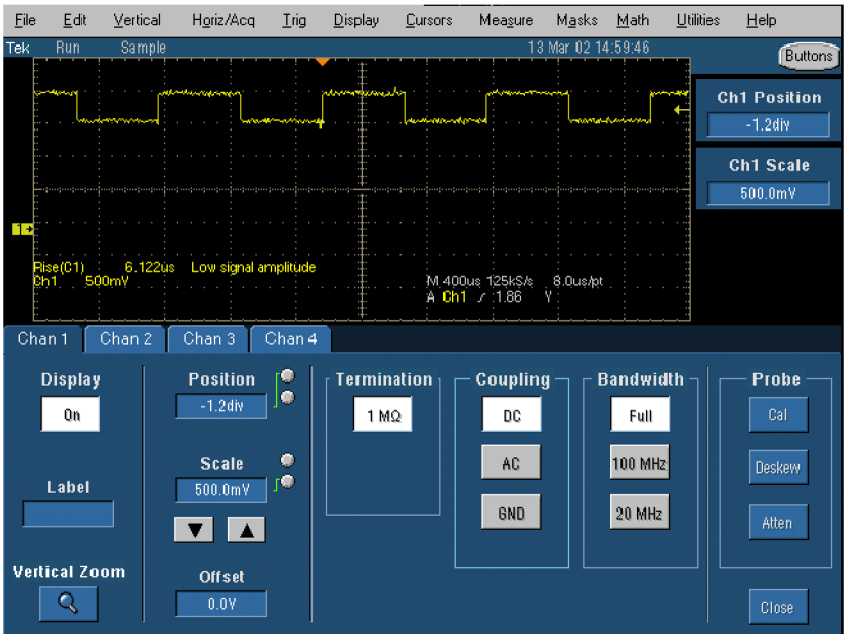

Figure 12: Typical waveform at DC Coupling

- Leave the Coupling set to DC.
- Close the panel.

Check Bandwidth Limit

Verify bandwidth limits at full, 100 MHz, and 20 MHz.

Test Equipment Hookup. Use the same hardware configuration as the Vertical Input Coupling check. (See Figure 9 on page 22.)

Test Procedure. Do the following:

1. On the front panel of the host instrument, select the channel that the TCA-1MEG is connected to.
2. Set the vertical scale to 200 mV/division.
3. Set the horizontal scale to 40 ns/division.
4. On the Vertical menu, select Vertical Setup, and then choose the tab of the channel that the TCA-1MEG is connected to.
 - a. Set coupling to AC.
 - b. Set bandwidth to Full (500 MHz).
5. Set to trigger at 50%.
6. Set the horizontal position of the leading edge to the left of center screen.

NOTE. *When full bandwidth is set, overshoot and ringing on the signal is normal and does not indicate problems with the TCA-1MEG.*

The resulting waveform should appear as shown. (See Figure 13.)

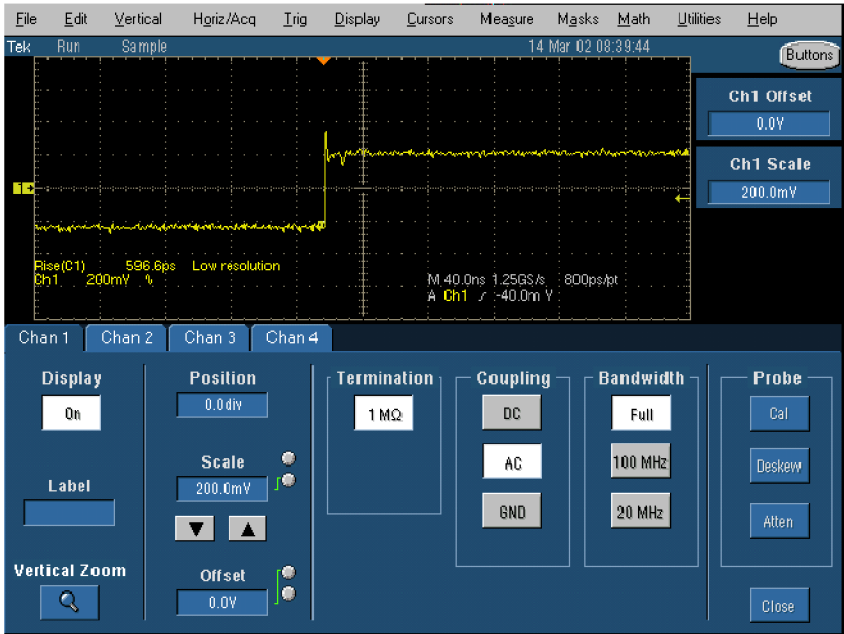

Figure 13: Typical waveform at Full (500 MHz) bandwidth

- Set bandwidth to 100 MHz.

NOTE. When 100 MHz bandwidth is set, the signal risetime increases and overshoot and ringing decreases.

The resulting waveform should appear as shown. (See Figure 14.)

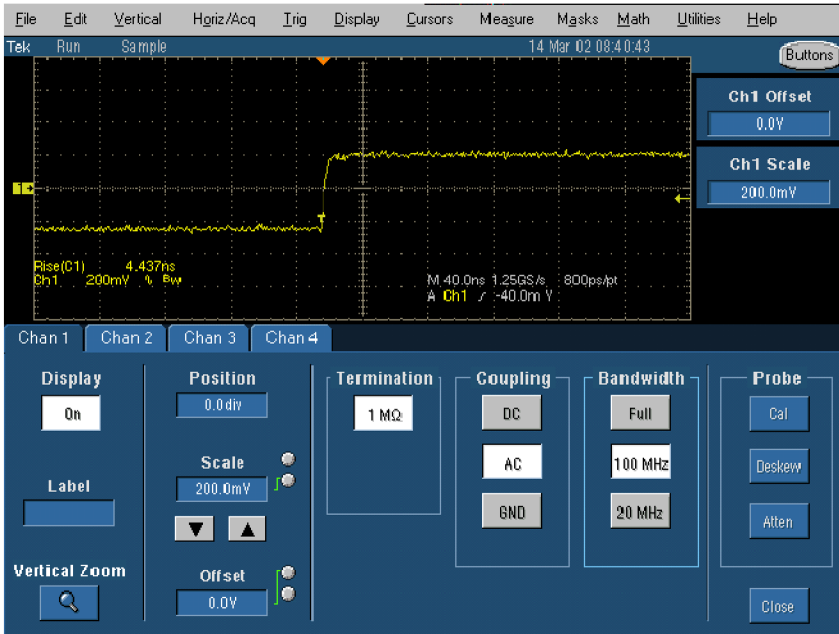

Figure 14: Typical waveform at 100 MHz bandwidth

8. Set bandwidth to 20 MHz.

NOTE. When the 20 MHz bandwidth limit is set, signal risetime is near 15 ns.

The resulting waveform should appear as shown. (See Figure 15.)

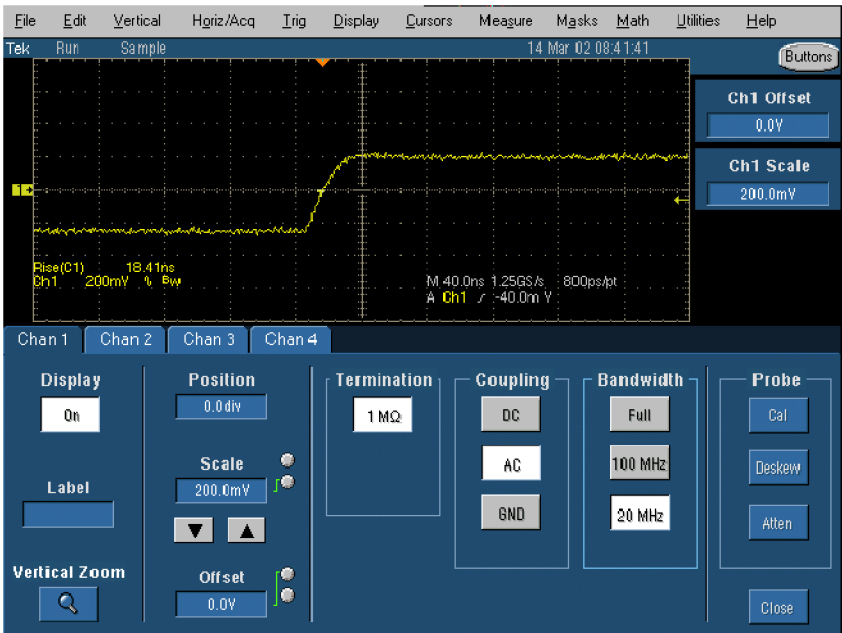

Figure 15: Typical waveform at 20 MHz bandwidth

9. After completing the bandwidth limit checks, do the following:
 - a. Set bandwidth to Full.
 - b. Set coupling to DC.
 - c. Press AUTOSET.
 - d. Close the panel.

Specifications

These specifications apply to the TCA-1MEG High Impedance Buffer Amplifier when used with Tektronix TekConnect host instruments.

Specifications for the TCA-1MEG fall into three categories: warranted, typical, and nominal characteristics. Performance Verification procedures are provided in the *Performance Verification* section for warranted specifications marked with the ✓ symbol.

Specifications



CAUTION. To prevent damage to the TCA-1MEG, do not apply voltages that are beyond the input voltage rating specified for the TCA-1MEG. (See Table 3.)

Table 3: Warranted electrical specifications

Characteristic	Description
✓ Bandwidth (TCA-1MEG only), at -3dB, 100 mV/division with 50 Ω termination	≥500 MHz when used with a Tektronix host instrument that has ≥1.5 GHz bandwidth. 100 MHz bandwidth limit ±25% 20 MHz bandwidth limit ±25%
Attenuation	Maximum sensitivity to 10 V/division in 1-2-5 sequence on a Tektronix host instrument
Input Capacitance	10 pF ±2 pF
Input Resistance, DC Coupled	1 MΩ ±1% at DC 1 MΩ ±10% at $ V_{in} > 50$ V
P6139B Probe tip Bandwidth with TCA-1MEG, at 100 mV/division	≥500 MHz with TCA-1MEG connected to a Tektronix 50 Ω host instrument that has ≥1.5 GHz bandwidth.

Table 3: Warranted electrical specifications (cont.)

Input Voltage Rating ¹ (with TCA-1MEG or a 1X probe)	150 V 100 V, CAT II
---	------------------------

¹ RMS voltage limited to ≤ 150 V for arbitrary wave shapes including DC. For pulse widths less than 50 μ s, 400 Vpk, <30% Duty Factor. RMS = Root Mean Square = rms = the square root of the average of the sum of the squares of the instantaneous voltage in one cycle = $\sqrt{\sum (fx_i)^2/n}$

Table 4: Typical electrical characteristics

Characteristic	Description
Linear dynamic range	The lesser of ± 5 divisions or the dynamic range of the TekConnect host instrument.
Bandwidth (TCA-1MEG only)	≥ 500 MHz when used with a TekConnect host instrument that has ≥ 1.5 GHz bandwidth 100 MHz $\pm 25\%$ 20 MHz $\pm 25\%$
Linearity	$\pm 0.2\%$
Full-bandwidth small-signal rise time (TCA-1MEG only)	800 ps calculated from $0.40 / \text{measured bandwidth}$
AC Coupling (LF 3 dB cutoff frequency)	≤ 10 Hz with TCA-1MEG ≤ 1 Hz with P6139A probe attached
DC Offset Drift	600 μ V/ $^{\circ}$ C or less at output of TCA-1MEG
Displayed system input offset	± 0.2 divisions or less, when used within ± 5 $^{\circ}$ C of calibrated temperature for V/division settings ≥ 10 mV/division
Propagation Delay	≤ 2 ns

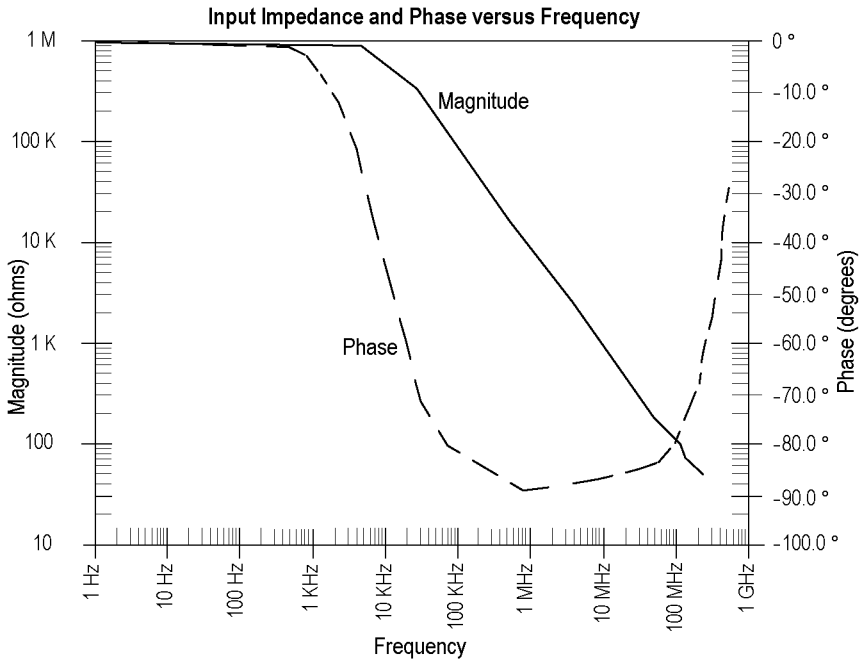

Figure 16: Typical Input Impedance and Phase versus Frequency

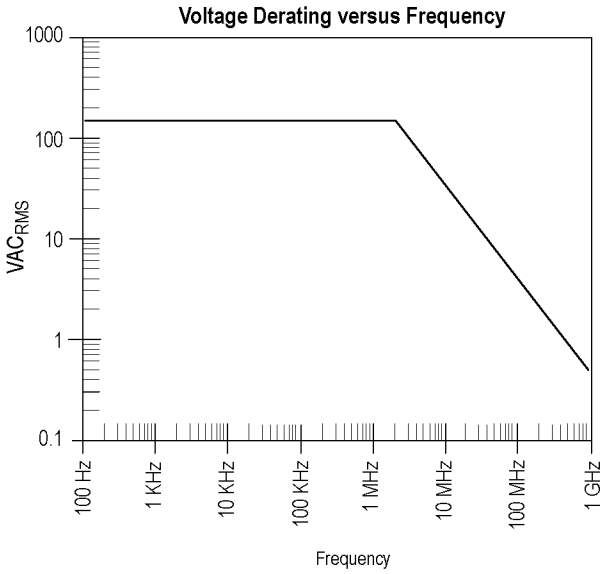

Figure 17: Voltage Derating versus Frequency

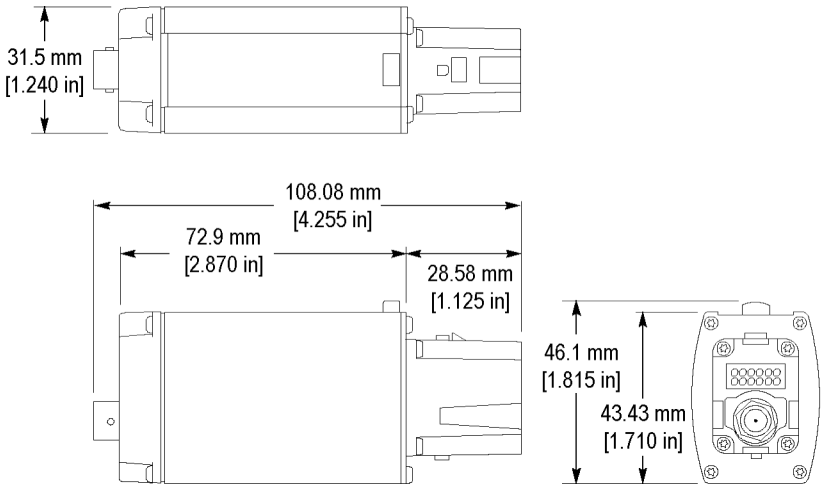

Figure 18: TCA-1MEG dimensions

Table 5: Physical characteristics

Characteristic	Description
Unit weight (TCA-1MEG)	5.5 oz (155 g) net

Table 6: Environmental characteristics

Characteristic	Description
Operating Temperature	+ 32 ° F to + 122 ° F (0 °C to + 50 °C)
Humidity	≤80% relative humidity through the entire operating range
Altitude	Operating: 9,842 ft (3,000 m) Nonoperating: 50,000 ft (15,240 m)

Performance Verification

Use the following procedure to verify that the TCA-1MEG High Impedance Buffer Amplifier meets the warranted specifications marked with a ✓ in the *Specifications* section. (See Table 3 on page 31.)

Perform a probe calibration (a TCA-1MEG calibration) procedure before performing this test. Refer to *Functional Checks* for the probe calibration procedure. (See page 13.)

Verify this specification:

- TCA-1MEG System Bandwidth

Before beginning this procedure, photocopy the test record and use it to record the performance test results. (See Table 8 on page 42.)

The equipment listed, or a suitable substitute, is required for testing the TCA-1MEG.

Table 7: Equipment required for performance verification

Description	Minimum requirements	Examples
Oscilloscope	TCA-1MEG in a Tektronix TekConnect Oscilloscope with a bandwidth ≥ 1.5 GHz	TDS6000, TDS7000, or CSA7000 TekConnect instruments
50 Ω coaxial cable	Connects BNC input of the TCA-1MEG to the PROBE COMPENSATION connection on the front panel of the host instrument.	Tektronix part number 012-0057-XX

Table 7: Equipment required for performance verification (cont.)

Leveled sine wave generator	50 kHz to 500 MHz $\pm 3\%$ amplitude accuracy	Wavetek 9500 ¹
50 Ω feedthrough termination	BNC connectors	Tektronix part number 011-0049-XX

¹ Wavetek 9500 Oscilloscope Calibrator with two 9510 Output Modules.

Required Software

To ensure compatibility of your TekConnect host instrument with the TCA-1MEG, your host instrument (for example, TDS6000, TDS7000, or CSA7000 series) must have the firmware upgrade V2.1.0 or higher. Upgrade instructions are available on the included CD ROM, or visit our Web site at www.tek.com and select the *Software and Drivers* link.

NOTE. *The test procedure references commands available on a TDS6604 Oscilloscope. These commands are similar to commands that other TekConnect host instruments use. If needed, refer to the user manual and online help supplied with your instrument.*

TCA-1MEG System Bandwidth

This test verifies the system bandwidth.

Test Equipment Hookup. Connect the TCA-1MEG to a channel of the host instrument. Use a 50 Ω coaxial cable and 50 Ω BNC feedthrough termination to connect the output of the leveled sine wave generator to the input of the TCA-1MEG. (See Figure 19.)

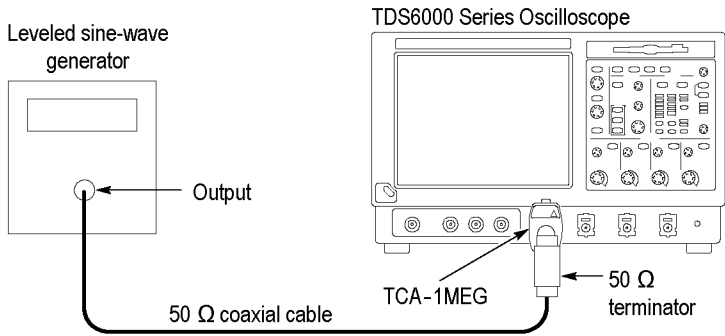

Figure 19: TCA-1MEG System Bandwidth equipment hookup

System Bandwidth Test Procedure. Use these instructions for testing the TCA-1MEG system bandwidth.

1. Set the signal generator to a reference frequency of 50 kHz, setting the initial output level to display a waveform.
2. Push AUTOSET to display a waveform on the host instrument screen.
3. On the Horiz/Acq menu, select Horizontal/Acquisition Setup, and then select the Acquisition tab.
 - a. Set acquisition to Average.
 - b. Adjust the number of averages to 16.
 - c. Close the panel.
4. Use the Trigger area of the front panel to:
 - a. Set trigger source to the channel where the TCA-1MEG is connected.
 - b. Set trigger coupling to DC.
 - c. Set trigger slope to Positive.
 - d. Set trigger mode to Auto.
5. On the Measure menu, select Measurement Setup, select Amplitude, and then select Peak to Peak.
6. On the Vertical menu, select Vertical Setup, choose the tab for the channel where the TCA-1MEG is connected, and then set vertical coupling to DC.
7. Use the vertical scale knob to set the channel to 100 mV/division.
8. Perform steps 9 through 13 for each of these vertical bandwidth settings of the host instrument:
 - a. Full
 - b. 100 MHz
 - c. 20 MHz
9. On the Vertical Setup panel, set the vertical bandwidth that you are testing (refer to step 8, above).

10. Set the horizontal scale to 10 μ s/division.
11. On the leveled sine wave generator, do the following:
 - a. Set the output frequency to 50 kHz.
 - b. Adjust the output amplitude until the peak-to-peak measurement displaying on the oscilloscope screen is between 599 mV and 601 mV.
12. On the leveled sine wave generator, set the output frequency according to the bandwidth limit you are testing:
 - a. For bandwidth limit set to Full, set the sine wave generator to 500 MHz. Set the horizontal scale of the oscilloscope to 5 ns/division. Record the measured value.
 - b. For bandwidth limit set to 100 MHz, set the sine wave generator to 75 MHz. Set the horizontal scale of the oscilloscope to 10 ns/division. Record the measured value. Set the sine wave generator to 125 MHz. Record the measured value.
 - c. For bandwidth limit set to 20 MHz, set the sine wave generator to 15 MHz. Set the horizontal scale of the oscilloscope to 20 ns/division. Record the measured value. Set the sine wave generator to 25 MHz. Record the measured value.
13. Verify that the peak-to-peak measurement of the oscilloscope meets the specification listed on the TCA-IMEG Test Record - System bandwidth verification.

NOTE. *If the results of these tests do not meet the specifications listed on the TCA-IMEG test record, contact your Tektronix Service representative.*

Use this test record to record the test results of the TCA-1MEG System Bandwidth tests.

Table 8: TCA-1MEG test record

Instrument serial number:		Certificate number:
Temperature:		RH %:
Date of calibration:		Technician:
Input amplitude (600 mV):		
System bandwidth verification		
Input voltage	Specification¹	Measured as
Full (500 MHz)	$\geq 425 \text{ mV}_{p-p}$	
100 MHz limit		
min. 75 MHz	$\geq 425 \text{ mV}_{p-p}$	
max. 125 MHz	$\leq 425 \text{ mV}_{p-p}$	
20 MHz limit		
min. 15 MHz	$\geq 425 \text{ mV}_{p-p}$	
max. 25 MHz	$\leq 425 \text{ mV}_{p-p}$	

¹ The 425 mV specification limit is based on a 600 mV input level. -3 dB voltage level = input voltage x 70.7%, calculated as $425 \text{ mV} = 600 \text{ mV} \times 0.707$

Replaceable Parts

This section contains a list of replaceable parts for the TCA-1MEG High Impedance Buffer Amplifier. Use this list to identify and order replacement parts.

Parts Ordering Information

Replacement parts are available from or through your local Tektronix, Inc. service center or representative.

Changes to Tektronix instruments are sometimes made to accommodate improved components as they become available and to give you the benefit of the latest circuit improvements. Therefore, when ordering parts, it is important to include the following information in your order:

- Part number
- Instrument type or model number
- Instrument serial number
- Instrument modification number, if applicable

If a part you order has been replaced with a different or improved part, your local Tektronix service center or representative will contact you concerning any change in the part number.

Using the Replaceable Parts List

The tabular information in the Replaceable Parts List is arranged for quick retrieval. Understanding the structure and features of the list will help you find the information you need for ordering replacement parts.

Item Names

In the Replaceable Parts List, an Item Name is separated from the description by a colon (:). Because of space limitations, an Item Name may sometimes appear as incomplete. For further Item Name identification, U.S. Federal Cataloging Handbook H6-1 can be used where possible.

Abbreviations

Abbreviations conform to American National Standards Institute (ANSI) standard Y1.1

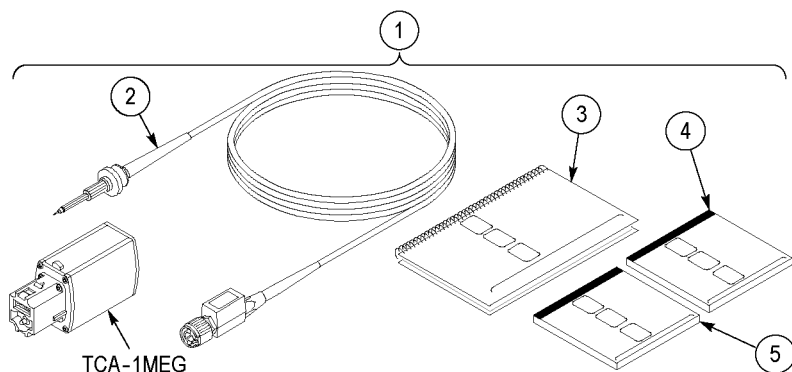

Figure 20: TCA-1MEG replaceable parts

Table 9: TCA-1MEG replaceable parts

Fig. & index no.	Tektronix part number	Name & description
20-1	TCA-1MEG	TCA-1MEG AMPLIFIER, HIGH IMPEDANCE BUFFER, 1 MEGOHM / 10 PF, TEKPROBE BNC-TO-TEKCONNECT, with P6139B
20-2	P6139B	P6139B 10X PASSIVE PROBE; STANDARD ACCESSORIES
20-3	071-1010-XX	MANUAL, TECH:INSTRUCTION, TCA-1MEG
20-4	063-3541-XX	SOFTWARE PKG; PRODUCT SOFTWARE, CD, V2.1.0; TDS6000 SERIES
20-5	063-3461-XX	SOFTWARE PKG; PRODUCT SOFTWARE, CD, V2.1.0; TDS7000 SERIES
Optional Accessories		
—	063-3376-XX	TDS7000 SERIES APPLICATIONS SOFTWARE PKG, PRODUCT CD