

5 Series MSO Low Profile

MSO58LP Datasheet

More system visibility in less rack space.



Standard rack mount configuration



Optional bench conversion configuration

Strength in numbers

Input channels

- 8 FlexChannel® inputs
- Each FlexChannel provides:
 - One analog signal that can be displayed as a waveform view, a spectral view, or both simultaneously
 - Eight digital logic inputs with TLP058 logic probe

Bandwidth (all analog channels)

- 1 GHz

Sample rate (all analog / digital channels)

- Real-time: 6.25 GS/s
- Interpolated: 500 GS/s

Record length (all analog / digital channels)

- 125 Mpoints

Waveform capture rate

- >500,000 waveforms/s

Vertical resolution

- 12-bit ADC
- Up to 16-bits in High Res mode
- 7.6 ENOB at 1 GHz

Standard trigger types

- Edge, Pulse Width, Runt, Timeout, Window, Logic, Setup & Hold, Rise/Fall Time, Parallel Bus, Sequence, Visual Trigger
- Auxiliary Trigger $\leq 5 V_{RMS}$, 50 Ω , 200 MHz (Edge Trigger only)

Standard analysis

- Measurements: 36
- Spectrum View: Frequency-domain analysis with independent controls for frequency and time domains. RF vs. time traces (magnitude, frequency, phase)
- FastFrame™: Segmented memory acquisition mode with maximum trigger rate >5,000,000 waveforms per second
- Plots: Time Trend, Histogram and Spectrum
- Math: Basic waveform arithmetic, FFT, and advanced equation editor
- Search: Search on any trigger criteria
- Jitter: TIE and Phase Noise

Optional analysis

- Advanced Jitter and Eye Diagram Analysis
- Digital Power Management
- Mask Testing
- Advanced Power Measurements and Analysis

Optional serial bus trigger, decode and analysis

- I²C, SPI, I3C, RS-232/422/485/UART, SPMI, CAN, CAN FD, LIN, FlexRay, SENT, Automotive Ethernet, USB 2.0, Ethernet, I²S, LJ, RJ, TDM, MIL-STD-1553, ARINC 429, Spacewire, 8B/10B, NRZ

Arbitrary/Function Generator ¹

- 50 MHz waveform generation

Digital voltmeter ²

- 4-digit AC RMS, DC, and DC+AC RMS voltage measurements

Trigger frequency counter ²

- 8-digit

Video display output

- High Definition (1,920 x 1,080) resolution video output

Connectivity

- USB Host (6 ports), USB 3.0 Device (1 port), LAN (10/100/1000 Base-T Ethernet), Display Port, DVI-D, VGA

e*Scope®

- Remotely view and control the oscilloscope over a network connection through a standard web browser

Operating system

- Closed Embedded OS

Warranty

- 3 years standard

Dimensions

- 2U Rack Mount Kit included
- 3.44 in (87.3 mm) H x 17.01 in (432 mm) W x 24.74 in (621.5 mm) D
- Weight: 28 lbs. (12.7 kg)

With a remarkable 8 input channels in a 2U high package and a 12-bit ADC, the 5 Series MSO Low Profile sets a new standard for performance in applications where extreme analog, spectrum, or digital channel density is required.

¹ Optional and upgradable.

² Free with product registration.

Based on the highly successful 5 Series MSO

The 5 Series MSO Low Profile is based on the 5 Series MSO benchtop platform. The benchtop 5 Series MSO has a remarkably innovative pinch-swipe-zoom touchscreen user interface, the industry's largest high-definition display, and 4, 6, or 8 FlexChannel® inputs that let you measure a single analog channel waveform, a spectral view of the analog input, simultaneous analog and spectral views with independent acquisition controls for each domain, or eight digital logic inputs (with TLP058 logic probe). The 5 Series MSO is ready for today's toughest challenges, and tomorrow's too. It sets a new standard for performance, analysis, and overall user experience.

Like the benchtop 5 Series MSO, the low profile instrument offers FlexChannel inputs, an optional arbitrary/function generator output, and a built-in digital voltmeter and trigger frequency counter. And, if you plug in an external touch-capable monitor you can experience the same revolutionary pinch-swipe-zoom user experience as if you were in front of the benchtop 5 Series MSO.

For more information on the capabilities of the benchtop 5 Series MSO, including the revolutionary user experience and the various analysis software options, please see the 5 Series MSO datasheet at www.tek.com/5SeriesMSO.



The 5 Series MSO Low Profile is based on the 5 Series MSO benchtop platform.

Low-profile, high-density package saves space

The 5 Series MSO Low Profile has 8 FlexChannel inputs plus an auxiliary trigger input in a space-saving 2U high package designed to fit into 19-inch wide racks. The instrument has side air vents so that instruments can be mounted in a rack directly on top of one another, saving even more space.

The 5 Series MSO Low Profile comes standard with rack mount brackets installed, ready for mounting into a rack right out of the box.

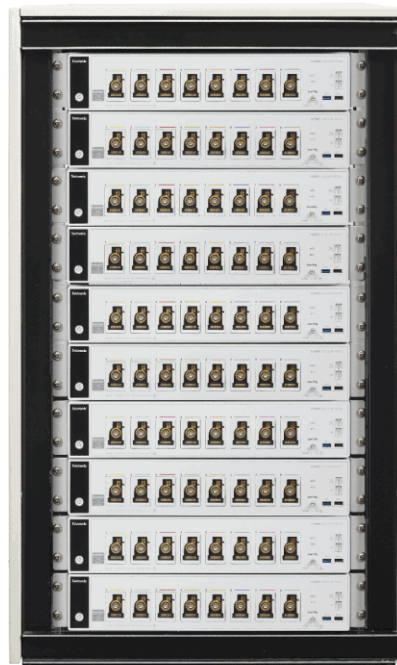

Multiple MSO58LP instruments installed in a rack, making efficient use of available space.

An optional bench conversion kit includes four feet and a strap handle for use in a lab environment on a bench surface.



The MSO58LP with the optional bench conversion kit installed, optimizing the instrument for use on a benchtop.

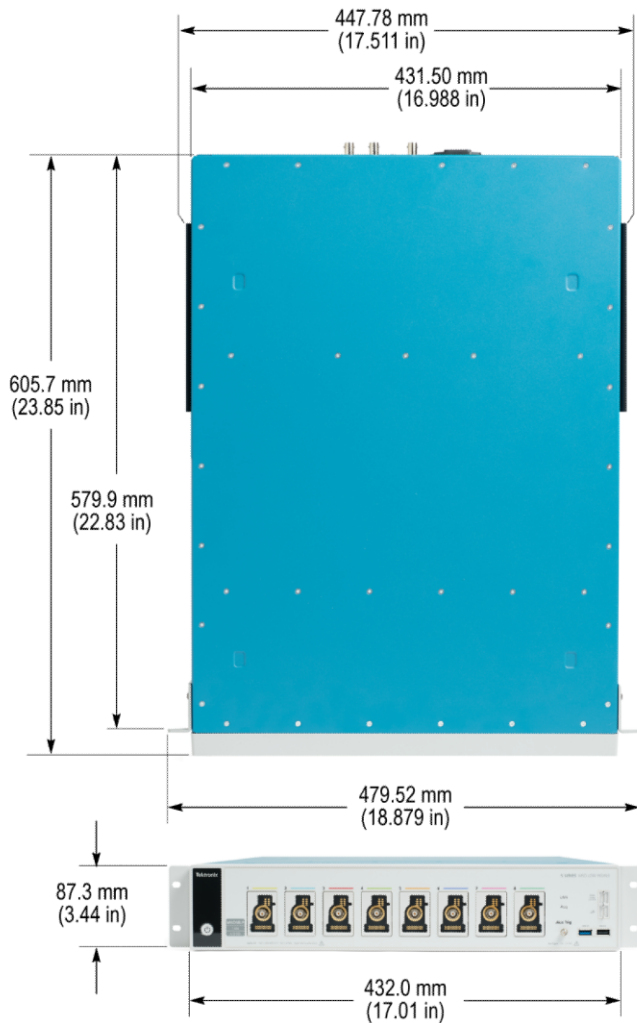

The 5 Series MSO Low Profile saves valuable rack space.

Experience the performance difference

With 1 GHz analog bandwidth, 6.25 GS/s sample rate, 125 Mpts record length, and 12-bit analog to digital converters (ADCs), the 5 Series MSO Low Profile has the performance you need to capture accurate waveform data with the best possible signal integrity and vertical resolution for seeing small waveform details.

The 5 Series MSO Low Profile has up to 6.25 GS/s sample rate on all channels, providing more than 5x oversampling, enabling better noise performance and fine timing resolution.

The standard 125 Mpts record length provides 20 ms of acquisition time at the highest sample rate (6.25 GS/s), enabling long time captures while maintaining high timing resolution for more accurate measurements.

³ 6.25 GS/s not available as real-time sample rate when High Res is on.

Industry leading vertical resolution

The 5 Series MSO Low Profile provides the performance to capture the signals of interest while minimizing the effects of unwanted noise when you need to capture high-amplitude signals while seeing smaller signal details. At the heart of the 5 Series MSO Low Profile are 12-bit analog-to-digital converters (ADCs) that provide 16 times the vertical resolution of traditional 8-bit ADCs.

A new High Res mode applies a hardware-based unique Finite Impulse Response (FIR) filter based on the selected sample rate. The FIR filter maintains the maximum bandwidth possible for that sample rate while preventing aliasing and removing noise from the oscilloscope amplifiers and ADC above the usable bandwidth for the selected sample rate.

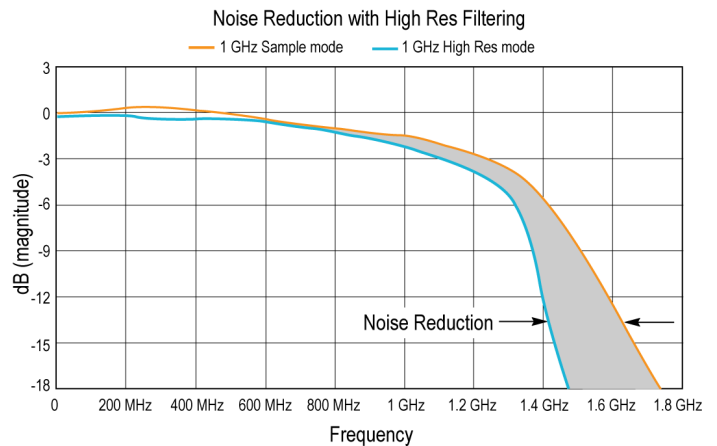

1 GHz frequency plot with High Res filter overlaid shows the reduction in noise when High Res mode is enabled

High Res mode always provides at least 12 bits of vertical resolution and extends all the way to 16 bits of vertical resolution at ≤ 125 MS/s sample rates. The following table shows the number of bits of vertical resolution for each sample rate setting when in High Res.

Sample rate	Number of bits of vertical resolution
6.25 GS/s ³	8
3.125 GS/s	12
1.25 GS/s	13
625 MS/s	14
312.5 MS/s	15
≤125 MS/s	16

Typical 8-bit ADC oscilloscopes have an Effective Number of Bits (ENOB) of between 4 and 6, depending on bandwidth and vertical scale selected. The 12-bit ADC in the 5 Series MSO Low Profile, coupled with a new low-noise front-end amplifier, provides an ENOB of between 7 and 9 bits, enabling better viewing of fine signal detail in the presence of large amplitude signals.

The following table shows the typical ENOB values for the 5 Series MSO Low Profile measured with High Res mode, 50 Ω , 10 MHz input with 90% full screen.

Bandwidth	ENOB
1 GHz	7.6
500 MHz	7.9
350 MHz	8.2
250 MHz	8.1
20 MHz	8.9

Spectrum View

It is often easier to debug an issue by viewing one or more signals in the frequency domain. Oscilloscopes have included math-based FFTs for decades in an attempt to address this need. However, FFTs are notoriously difficult to use as they are driven by the same acquisition system that's delivering the analog time-domain view. When you optimize acquisition settings for the analog view, your frequency-domain view isn't what you want. When you get the frequency-domain view you want, your analog view is not what you want. With math-based FFTs, it is virtually impossible to get optimized views in both domains.

Spectrum View changes all of this. Tektronix' patented technology provides both a decimator for the time-domain and a digital downconverter for the frequency-domain behind each FlexChannel. The two different acquisition paths let you simultaneously observe both time- and frequency-domain views of the input signal with independent acquisition settings for each domain. Other manufacturers offer various 'spectral analysis' packages that claim ease-of-use, but they all exhibit the limitations described above. Only Spectrum View provides both exceptional ease-of-use and the ability to achieve optimal views in both domains simultaneously.

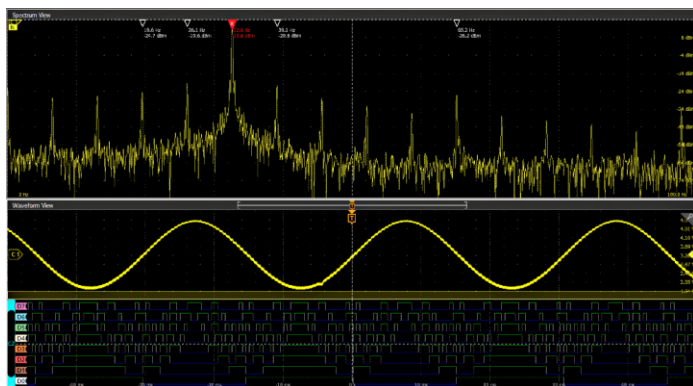

Intuitive spectrum analyzer controls like center frequency, span and resolution bandwidth (RBW), independent from time domain controls, provide easy setup for frequency domain analysis. A spectrum view is available for each FlexChannel analog input, enabling multi-channel mixed domain analysis.

TekVPI Probe Interface

The TekVPI[®] probe interface sets the standard for ease of use in probing. In addition to the secure, reliable connection that the interface provides, many TekVPI probes feature status indicators and controls, as well as a probe menu button right on the probe compensation box. The TekVPI interface enables direct attachment of current probes without requiring a separate power supply. TekVPI probes can be controlled remotely through USB or LAN, enabling more versatile solutions in ATE environments. The 5 Series MSO Low Profile provides up to 80 W of power to the front panel connectors, sufficient to power all connected TekVPI probes without the need for an additional probe power supply.

The TekVPI probe interface is key to enabling the high bandwidth and low attenuation versions of the optional TPP Series of passive voltage probes. The TPP Series probes offer all the benefits of general-purpose probes -- high dynamic range, flexible connection options, and robust mechanical design, while providing the performance of active probes. At 1 GHz bandwidth, the optional TPP1000 probes enable you to see high frequency components in your signals, and extremely low 3.9 pF capacitive loading minimizes adverse effects on your circuits. The optional low-attenuation (2x) TPP0502 has 500 MHz bandwidth and is exceptional at measuring low voltages.



MSO58LP with TekVPI probes and touch monitor attached for use in a lab environment.

Designed with your needs in mind

Remote operation to speed automated test

IVI-COM⁴, IVI-C⁵, and LabVIEW⁴ instrument drivers are available for free and enable easy communication with the oscilloscope using LAN or USBTMC connections from an external PC. A full set of programmatic commands to setup and control the instrument remotely enable easy test automation.

Remote operation to improve collaboration

The embedded e*Scope[®] capability enables fast control of the oscilloscope over a network connection through a standard web browser. Simply enter the IP address or network name of the oscilloscope and a web page will be served to the browser. Control the oscilloscope remotely in the exact same ways you do in-person, whether you are across the lab or across the globe. e*Scope enables multiple sites to connect to an instrument providing data acquisition results in real-time.

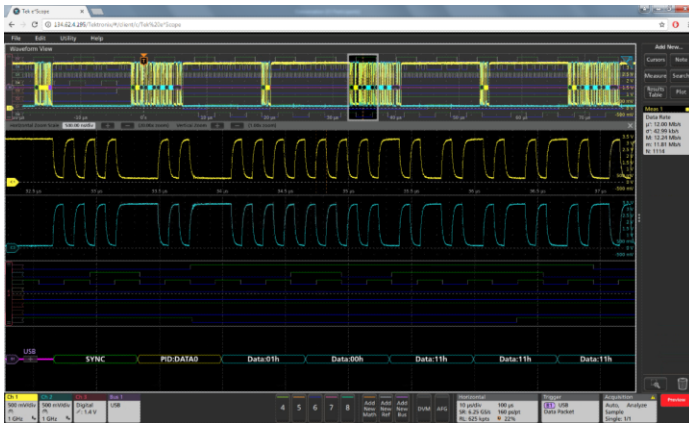

e*Scope provides easy remote viewing and control using modern web browsers.

Enhanced security option

The 5-SEC enhanced security option enables password-protected enabling/disabling of all USB communication ports and firmware upgrades. In addition, option 5-SEC provides the highest level of security by ensuring that internal memory is clear of all setup and waveform data in compliance with National Industrial Security Program Operating Manual (NISPOM) DoD 5220.22-M, Chapter 8 requirements as well as Defense Security Service Manual for the Certification and Accreditation of Classified Systems under the NISPOM. This ensures you can confidently move the instrument out of a secure area.

To permanently store data, you can save it to an external flash memory device or programmatically to USBTMC ports in keeping with your lab security protocols.

⁴ Drivers are available from www.tek.com/downloads.

⁵ Drivers are available from www.ni.com.

Quickly transition from the lab to manufacturing

The 5 Series MSO Low Profile is based on the successful 5 Series MSO platform. This means you can use the benchtop 5 Series MSO with its beautiful 15.6-in touch display and its full measurement analysis capabilities during the development process. Then, when you are ready to transition your product to manufacturing, you can use the same software and test routines developed during R&D in your manufacturing test application, saving time and rack space.

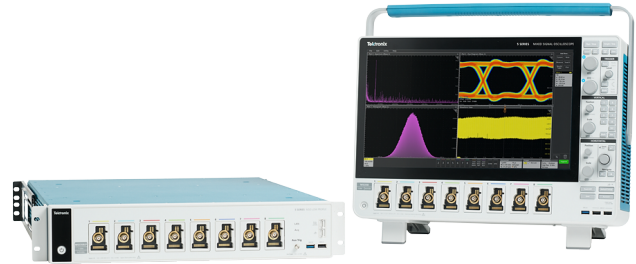

Use the benchtop 5 Series MSO during R&D, then seamlessly transition to the low profile version for manufacturing test.

The Low Profile family

The 6 Series Low Profile Digitizer expands the performance of the 5 Series MSO Low Profile by adding twice the number of Tektronix TEK049 ASICS in the same 2U footprint. Now with 25 GS/s and up to 8 GHz on all channels. Low Profile users now have the choice of extreme high channel count or extreme performance in the same rack form factor.

For more information on the capabilities of the 6 Series Low Profile Digitizer, please see the datasheet at <https://www.tek.com/high-speed-digitizer/>



Two 6 Series Low Profile Digitizers (left) and two 5 Series MSO Low Profile oscilloscopes (right)

Quick Comparison	6 Series Low Profile Digitizer	5 Series MSO Low Profile
Sample Rate	25 GS/s	6.25 GS/s
Analog Bandwidth	Up to 8 GHz	1 GHz
RF (DDC) Span Bandwidth	2 GHz	500 MHz
ENOB @ 1 GHz	8.2 bits	7.6 bits
LXI compliance version	1.5	-
Rack Dimensions	2U	2U

5 Series MSO Low Profile - The highest channel density and greatest performance in its class

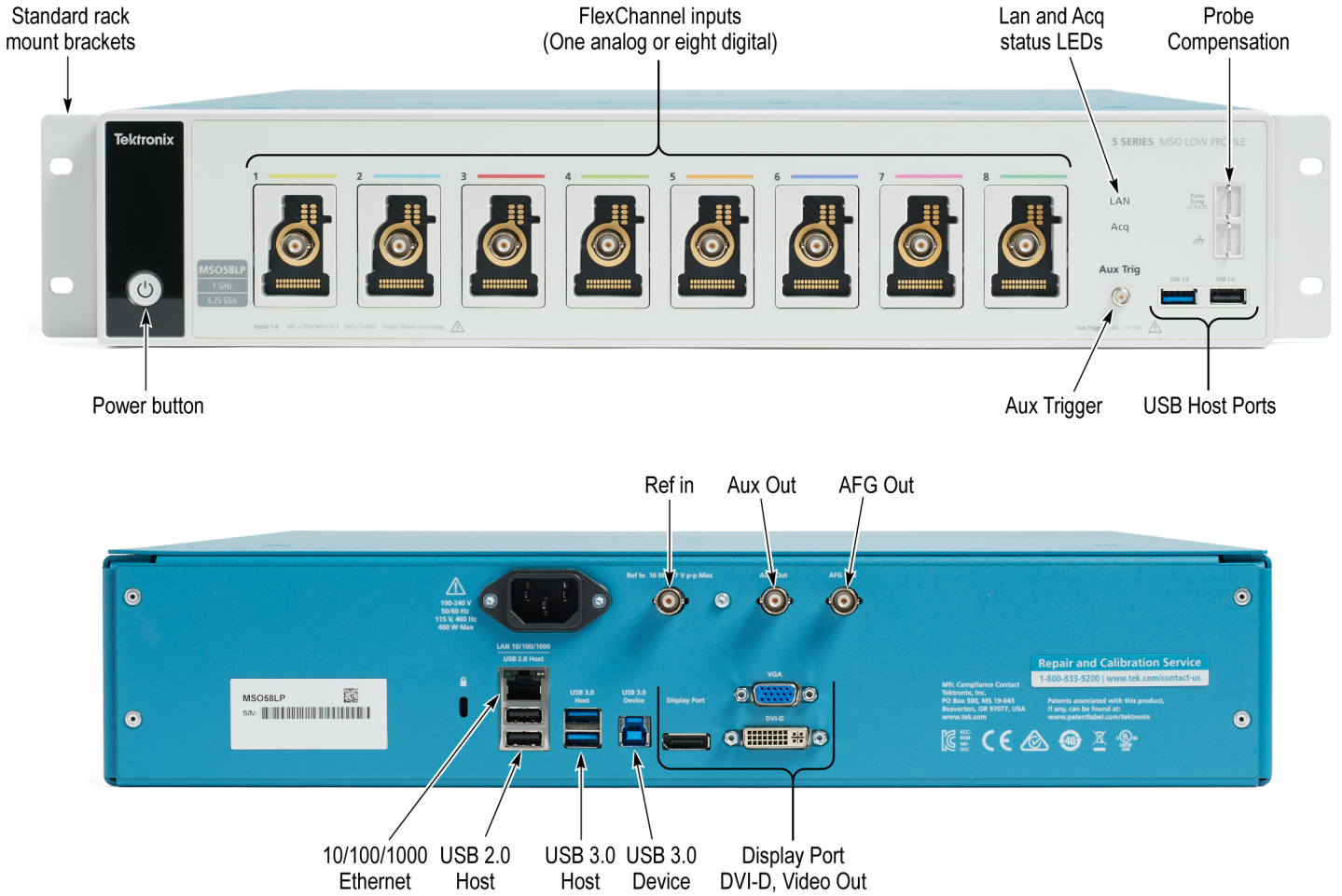

Specifications

All specifications are guaranteed unless noted otherwise. All specifications apply to all models unless noted otherwise.

Model overview

Oscilloscope

	MSO58LP, MSO58LPGSA
FlexChannel inputs	8
Maximum analog channels	8
Maximum digital channels (with optional logic probes)	64
Bandwidth (calculated rise time)	1 GHz (400 ps)
DC Gain Accuracy	50 Ω : $\pm 1.0\%$, ($\pm 2.0\%$ at ≤ 1 mV/div), $\pm 0.5\%$ of full scale, ($\pm 1.0\%$ of full scale at 1 mV/Div and 500 μ V/Div Settings) 1 M Ω : $\pm 1.0\%$, ($\pm 2.0\%$ at ≤ 1 mV/div), $\pm 0.5\%$ of full scale, ($\pm 1.0\%$ of full scale at 1 mV/Div and 500 μ V/Div Settings)
ADC Resolution	12 bits
Vertical Resolution	8 bits @ 6.25 GS/s 12 bits @ 3.125 GS/s 13 bits @ 1.25 GS/s (High Res) 14 bits @ 625 MS/s (High Res) 15 bits @ 312.5 MS/s (High Res) 16 bits @ ≤ 125 MS/s (High Res)
Sample Rate	6.25 GS/s on all analog / digital channels (160 ps resolution)
Record Length	125 Mpoints on all analog / digital channels
Waveform Capture Rate	>500,000 wfms/s
Arbitrary/Function Generator (opt.)	13 predefined waveform types with up to 50 MHz output
DVM	4-digit DVM (free with product registration)
Trigger Frequency Counter	8-digit frequency counter (free with product registration)

Vertical system - analog channels

Bandwidth selections 20 MHz, 250 MHz, and 1 GHz

Input coupling DC, AC

Input impedance 50 $\Omega \pm 1\%$
1 M $\Omega \pm 1\%$ with 13.0 pF ± 1.5 pF

Input sensitivity range

1 M Ω 500 μ V/div to 10 V/div in a 1-2-5 sequence

50 Ω 500 μ V/div to 1 V/div in a 1-2-5 sequence

Note: 500 μ V/div is a 2X digital zoom of 1 mV/div

Maximum input voltage 50 Ω : 5 V_{RMS}, with peaks $\leq \pm 20$ V (DF $\leq 6.25\%$)

1 M Ω : 300 V_{RMS}, CAT II

For 1 M Ω , derate at 20 dB/decade from 4.5 MHz to 45 MHz;

Derate at 14 dB/decade from 45 MHz to 450 MHz; > 450 MHz, 5.5 V_{RMS}

Vertical system - analog channels

Effective bits (ENOB), typical

< 1 GHz models, High Res mode, 50 Ω, 10 MHz input with 90% full screen

Bandwidth	ENOB
1 GHz	7.6
500 MHz	7.9
350 MHz	8.2
250 MHz	8.1
20 MHz	8.9

Random noise, RMS, typical

1 GHz, High Res mode (RMS)

V/div	50 Ω					1 MΩ			
	1 GHz	500 MHz	350 MHz	250 MHz	20 MHz	500 MHz	350 MHz	250 MHz	20 MHz
1 mV/div ⁶	254 μV	198 μV	141 μV	118 μV	70.0 μV	189 μV	143 μV	118 μV	64.8 μV
2 mV/div	255 μV	198 μV	143 μV	121 μV	70.4 μV	194 μV	145 μV	121 μV	66.0 μV
5 mV/div	262 μV	202 μV	150 μV	133 μV	72.8 μV	196 μV	152 μV	130 μV	69.6 μV
10 mV/div	283 μV	218 μV	169 μV	158 μV	79.8 μV	212 μV	167 μV	154 μV	78.2 μV
20 mV/div	357 μV	273 μV	222 μV	223 μV	102 μV	269 μV	214 μV	223 μV	104 μV
50 mV/div	677 μV	516 μV	436 μV	460 μV	196 μV	490 μV	410 μV	480 μV	207 μV
100 mV/div	1.61 mV	1.23 mV	1.02 mV	1.04 mV	464 μV	1.16 mV	964 μV	1.05 mV	475 μV
1 V/div	13.0 mV	9.88 mV	8.41 mV	8.94 mV	3.77 mV	13.6 mV	10.6 mV	11.1 mV	5.47 mV

Position range ±5 divisions

Offset ranges, maximum

Volts/div Setting	Maximum offset range	
	50 Ω Input	1 MΩ Input
500 μV/div - 63 mV/div	±1 V	±1 V
64 mV/div - 999 mV/div	±10 V	±10 V
1 V/div - 10 V/div	±10 V	±100 V

Offset accuracy ±(0.005 X | offset - position | +)

Crosstalk (channel isolation), typical ≥ 200:1 up to the rated bandwidth for any two channels having equal Volts/div settings

DC balance

- 0.1 div with DC-50 Ω oscilloscope input impedance (50 Ω BNC terminated)
- 0.2 div at 1 mV/div with DC-50 Ω oscilloscope input impedance (50 Ω BNC terminated)
- 0.4 div at 500 μV/div with DC-50 Ω oscilloscope input impedance (50 Ω BNC terminated)
- 0.2 div with DC-1 MΩ oscilloscope input impedance (50 Ω BNC terminated)
- 0.4 div at 500 μV/div with DC-1 MΩ scope input impedance (50 Ω BNC terminated)

⁶ Bandwidth at 500 μV/div is limited to 250 MHz in 50 Ω.

Vertical system - digital channels

Number of channels	8 digital inputs (D7-D0) per installed TLP058 (traded off for one analog channel)
Vertical resolution	1 bit
Maximum input toggle rate	500 MHz
Minimum detectable pulse width, typical	1 ns
Thresholds	One threshold per digital channel
Threshold range	± 40 V
Threshold resolution	10 mV
Threshold accuracy	$\pm [100 \text{ mV} + 3\% \text{ of threshold setting after calibration}]$
Input hysteresis, typical	100 mV at the probe tip
Input dynamic range, typical	$30 V_{pp}$ for $F_{in} \leq 200 \text{ MHz}$, $10 V_{pp}$ for $F_{in} > 200 \text{ MHz}$
Absolute maximum input voltage, typical	± 42 V peak
Minimum voltage swing, typical	400 mV peak-to-peak
Input impedance, typical	100 k Ω
Probe loading, typical	2 pF

Horizontal system

Time base range	200 ps/div to 1,000 s/div
Sample rate range	1.5625 S/s to 6.25 GS/s (real time) 12.5 GS/s to 500 GS/s (interpolated)
Record length range	
Standard	1 kpoints to 125 Mpoints in single sample increments
Maximum duration at highest sample rate	20 ms
Time base delay time range	-10 divisions to 5,000 s
Deskew range	-125 ns to +125 ns with a resolution of 40 ps

Horizontal system

Timebase accuracy $\pm 2.5 \times 10^{-6}$ over any ≥ 1 ms time interval

Description	Specification
Factory Tolerance	$\pm 5.0 \times 10^{-7}$ At calibration, 23 °C ambient, over any ≥ 1 ms interval
Temperature stability	$\pm 5.0 \times 10^{-7}$ Tested at operating temperatures
Crystal aging	$\pm 1.5 \times 10^{-6}$. Frequency tolerance change at 25 °C over a period of 1 year

Delta-time measurement accuracy, nominal

$$DTA_{pp}(\text{typical}) = 10 \times \sqrt{\left(\frac{N}{SR_1}\right)^2 + \left(\frac{N}{SR_2}\right)^2 + \left(0.450 \text{ ps} + \left(1 \times 10^{-11} \times t_p\right)\right)^2} + TBA \times t_p$$

$$DTA_{RMS} = \sqrt{\left(\frac{N}{SR_1}\right)^2 + \left(\frac{N}{SR_2}\right)^2 + \left(0.450 \text{ ps} + \left(1 \times 10^{-11} \times t_p\right)\right)^2} + TBA \times t_p$$

(assume edge shape that results from Gaussian filter response)

The formula to calculate delta-time measurement accuracy (DTA) for a given instrument setting and input signal assumes insignificant signal content above Nyquist frequency, where:

SR_1 = Slew Rate (1st Edge) around 1st point in measurement

SR_2 = Slew Rate (2nd Edge) around 2nd point in measurement

N = input-referred guaranteed noise limit (V_{RMS})

TBA = timebase accuracy or Reference Frequency Error

t_p = delta-time measurement duration (sec)

Aperture uncertainty $\leq 0.450 \text{ ps} + (1 \times 10^{-11} \times \text{Measurement Duration})_{RMS}$, for measurements having duration ≤ 100 ms

Delay between analog channels, full bandwidth, typical ≤ 100 ps for any two channels with input impedance set to 50 Ω , DC coupling with equal Volts/div or above 10 mV/div

Delay between analog and digital FlexChannels, typical < 1 ns when using a TLP058 and a passive probe matching the bandwidth of the scope, with no bandwidth limits applied

Delay between any two digital FlexChannels, typical 320 ps

Delay between any two bits of a digital FlexChannel, typical 160 ps

Trigger system

Trigger modes Auto, Normal, and Single

Trigger coupling DC, HF Reject (attenuates > 50 kHz), LF Reject (attenuates < 50 kHz), noise reject (reduces sensitivity)

Trigger holdoff range 0 ns to 10 seconds

Trigger system

Trigger jitter, typical	$\leq 5 \text{ ps}_{\text{RMS}}$ for sample mode and edge-type trigger $\leq 7 \text{ ps}_{\text{RMS}}$ for edge-type trigger and FastAcq mode $\leq 40 \text{ ps}_{\text{RMS}}$ for non edge-type trigger modes $\leq 200 \text{ ps}_{\text{RMS}}$ for AUX trigger in, Sample acquisition mode, edge trigger $\leq 220 \text{ ps}_{\text{RMS}}$ for AUX trigger in, FastAcq acquisition mode, edge trigger
-------------------------	---

AUX In trigger skew between instruments, typical	$\pm 100 \text{ ps}$ jitter on each instrument with 150 ps skew; $\leq 350 \text{ ps}$ total between instruments. With manual deskewing of individual channels, total instrument skew can reach 200 ps between different instrument channels. Skew improves for sinusoidal input voltages $\geq 500 \text{ mV}$
--	--

Edge-type trigger sensitivity, DC coupled, typical

Path	Range	Specification
1 M Ω path (all models)	0.5 mV/div to 0.99 mV/div	4.5 div from DC to instrument bandwidth
	$\geq 1 \text{ mV/div}$	The greater of 5 mV or 0.7 div from DC to lesser of 500 MHz or instrument BW, & 6 mV or 0.8 div from > 500 MHz to instrument bandwidth
50 Ω path		The greater of 5.6 mV or 0.7 div from DC to the lesser of 500 MHz or instrument BW, & 7 mV or 0.8 div from > 500 MHz to instrument bandwidth
Line		Fixed
AUX Trigger in		200 mV _{pp} , DC to 250 MHz

Trigger level ranges

Source	Range
Any Channel	± 5 divs from center of screen
Aux In Trigger	$\pm 5 \text{ V}$
Line	Fixed at about 50% of line voltage

This specification applies to logic and pulse thresholds.

Trigger frequency counter	8-digits (free with product registration)
---------------------------	---

Trigger types

Edge:	Positive, negative, or either slope on any channel. Coupling includes DC, AC, noise reject, HF reject, and LF reject
Pulse Width:	Trigger on width of positive or negative pulses. Event can be time- or logic-qualified
Timeout:	Trigger on an event which remains high, low, or either, for a specified time period. Event can be logic-qualified
Runt:	Trigger on a pulse that crosses one threshold but fails to cross a second threshold before crossing the first again. Event can be time- or logic-qualified
Window:	Trigger on an event that enters, exits, stays inside or stays outside of a window defined by two user-adjustable thresholds. Event can be time- or logic-qualified
Logic:	Trigger when logic pattern goes true, goes false, or occurs coincident with a clock edge. Pattern (AND, OR, NAND, NOR) specified for all input channels defined as high, low, or don't care. Logic pattern going true can be time-qualified
Setup & Hold:	Trigger on violations of both setup time and hold time between clock and data present on any input channels
Rise / Fall Time:	Trigger on pulse edge rates that are faster or slower than specified. Slope may be positive, negative, or either. Event can be logic-qualified
Sequence:	Trigger on B event X time or N events after A trigger with a reset on C event. In general, A and B trigger events can be set to any trigger type with a few exceptions: logic qualification is not supported, if A event or B event is set to Setup & Hold, then the other must be set to Edge, and Ethernet and High Speed USB (480 Mbps) are not supported
Visual trigger	Qualifies standard triggers by scanning all waveform acquisitions and comparing them to on-screen areas (geometric shapes). An unlimited number of areas can be defined with In, Out, or Don't Care as the qualifier for each area. A boolean expression can be defined using any combination of visual trigger areas to further qualify the events that get stored into acquisition memory. Shapes include rectangle, triangle, trapezoid, hexagon and user-defined.

Trigger system

Parallel Bus:	Trigger on a parallel bus data value. Parallel bus can be from 1 to 64 bits (from the digital and analog channels) in size. Supports Binary and Hex radices
I²C Bus (option 5-SREMBD):	Trigger on Start, Repeated Start, Stop, Missing ACK, Address (7 or 10 bit), Data, or Address and Data on I ² C buses up to 10 Mb/s
SPI Bus (option 5-SREMBD):	Trigger on Slave Select, Idle Time, or Data (1-16 words) on SPI buses up to 20 Mb/s
RS-232/422/485/UART Bus (option 5-SRCOMP):	Trigger on Start Bit, End of Packet, Data, and Parity Error up to 15 Mb/s
CAN Bus (option 5-SRAUTO):	Trigger on Start of Frame, Type of Frame (Data, Remote, Error, or Overload), Identifier, Data, Identifier and Data, End Of Frame, Missing Ack, and Bit Stuff Error on CAN buses up to 1 Mb/s
CAN FD Bus (option 5-SRAUTO):	Trigger on Start of Frame, Type of Frame (Data, Remote, Error, or Overload), Identifier (Standard or Extended), Data (1-8 bytes), Identifier and Data, End Of Frame, Error (Missing Ack, Bit Stuffing Error, FD Form Error, Any Error) on CAN FD buses up to 16 Mb/s
LIN Bus (option 5-SRAUTO):	Trigger on Sync, Identifier, Data, Identifier and Data, Wakeup Frame, Sleep Frame, and Error on LIN buses up to 1 Mb/s
FlexRay Bus (option 5-SRAUTO):	Trigger on Start of Frame, Indicator Bits (Normal, Payload, Null, Sync, Startup), Frame ID, Cycle Count, Header Fields (Indicator Bits, Identifier, Payload Length, Header CRC, and Cycle Count), Identifier, Data, Identifier and Data, End Of Frame, and Errors on FlexRay buses up to 10 Mb/s
SENT Bus (option 5-SRAUTOSEN)	Trigger on Start of Packet, Fast Channel Status and Data, Slow Channel Message ID and Data, and CRC Errors
SPMI Bus (option 5-SRPM):	Trigger on Sequence Start Condition, Reset, Sleep, Shutdown, Wakeup, Authenticate, Master Read, Master Write, Register Read, Register Write, Extended Register Read, Extended Register Write, Extended Register Read Long, Extended Register Write Long, Device Descriptor Block Master Read, Device Descriptor Block Slave Read, Register 0 Write, Transfer Bus Ownership, and Parity Error
USB 2.0 LS/FS/HS Bus (option 5-SRUSB2):	Trigger on Sync, Reset, Suspend, Resume, End of Packet, Token (Address) Packet, Data Packet, Handshake Packet, Special Packet, Error on USB buses up to 480 Mb/s
Ethernet Bus (option 5-SRENET):	Trigger on Start of Frame, MAC Addresses, MAC Q-tag, MAC Length/Type, MAC Data, IP Header, TCP Header, TCP/IPV4 Data, End of Packet, and FCS (CRC) Error on 10BASE-T and 100BASE-TX buses
Audio (I²S, LJ, RJ, TDM) Bus (option 5-SRAUDIO):	Trigger on Word Select, Frame Sync, or Data. Maximum data rate for I ² S/LJ/RJ is 12.5 Mb/s. Maximum data rate for TDM is 25 Mb/s
MIL-STD-1553 Bus (option 5-SRAERO):	Trigger on Sync, Command (Transmit/Receive Bit, Parity, Subaddress / Mode, Word Count / Mode Count, RT Address), Status (Parity, Message Error, Instrumentation, Service Request, Broadcast Command Received, Busy, Subsystem Flag, Dynamic Bus Control Acceptance, Terminal Flag), Data, Time (RT/IMG), and Error (Parity Error, Sync Error, Manchester Error, Non-contiguous Data) on MIL-STD-1553 buses
ARINC 429 Bus (option 5-SRAERO):	Trigger on Word Start, Label, Data, Label and Data, Word End, and Error (Any Error, Parity Error, Word Error, Gap Error) on ARINC 429 buses up to 1 Mb/s

Acquisition system

Sample	Acquires sampled values
Peak Detect	Captures glitches as narrow as 640 ps at all sweep speeds
Averaging	From 2 to 10,240 waveforms
Envelope	Min-max envelope reflecting Peak Detect data over multiple acquisitions
High Res	Applies a unique Finite Impulse Response (FIR) filter for each sample rate that maintains the maximum bandwidth possible for that sample rate while preventing aliasing and removing noise from the oscilloscope amplifiers and ADC above the usable bandwidth for the selected sample rate. High Res mode always provides at least 12 bits of vertical resolution and extends all the way to 16 bits of vertical resolution at ≤ 125 MS/s sample rates.
FastAcq[®]	FastAcq optimizes the instrument for analysis of dynamic signals and capture of infrequent events by capturing >500,000 wfms/s (one channel active; >100K wfms/s with all channels active).

Acquisition system

Roll mode	Scrolls sequential waveform points across the display in a right-to-left rolling motion, at timebase speeds of 40 ms/div and slower, when in Auto trigger mode.
FastFrame™	Acquisition memory divided into segments. Maximum trigger rate >5,000,000 waveforms per second Minimum frame size = 50 points Maximum Number of Frames: For frame size ≥ 1,000 points, maximum number of frames = record length / frame size. For 50 point frames, maximum number of frames = 950,000

Waveform measurements

Cursor types Waveform, V Bars, H Bars, V&H Bars, and Polar (XY/XYZ plots only)

DC voltage measurement accuracy, Average acquisition mode	Measurement Type	DC Accuracy (In Volts)
	Average of ≥ 16 waveforms	$\pm((\text{DC Gain Accuracy}) * \text{reading} - (\text{offset} - \text{position}) + \text{Offset Accuracy} + 0.1 * \text{V/div setting})$
Delta volts between any two averages of ≥ 16 waveforms acquired with the same oscilloscope setup and ambient conditions	$\pm(\text{DC Gain Accuracy} * \text{reading} + 0.05 \text{ div})$	

Automatic measurements 36, of which an unlimited number can be displayed as either individual measurement badges or collectively in a measurement results table

Amplitude measurements Amplitude, Maximum, Minimum, Peak-to-Peak, Positive Overshoot, Negative Overshoot, Mean, RMS, AC RMS, Top, Base, and Area

Timing measurements Period, Frequency, Unit Interval, Data Rate, Positive Pulse Width, Negative Pulse Width, Skew, Delay, Rise Time, Fall Time, Phase, Rising Slew Rate, Falling Slew Rate, Burst Width, Positive Duty Cycle, Negative Duty Cycle, Time Outside Level, Setup Time, Hold Time, Duration N-Periods, High Time, and Low Time

Jitter measurements (standard) TIE and Phase Noise

Measurement statistics Mean, Standard Deviation, Maximum, Minimum, and Population. Statistics are available on both the current acquisition and all acquisitions

Reference levels User-definable reference levels for automatic measurements can be specified in either percent or units. Reference levels can be set to global for all measurements, per source channel or signal, or unique for each measurement

Gating Screen, Cursors, Logic, Search, or Time. Specifies the region of an acquisition in which to take measurements. Gating can be set to Global (affects all measurements set to Global) or Local (all measurements can have a unique Time gate setting; only one Local gate is available for Screen, Cursors, Logic, and Search actions).

Measurement plots Time Trend, Histogram, and Spectrum plots are available for all standard measurements

Measurement limits Pass/fail testing for user-definable limits on measurement values. Act on event for measurement value failures include Save Screen Capture, Save Waveform, and Stop Acquisitions

Jitter analysis (option 5-DJA) adds the following:

Measurements	Jitter Summary, TJ@BER, RJ- $\delta\delta$, DJ- $\delta\delta$, PJ, RJ, DJ, DDJ, DCD, SRJ, J2, J9, NPJ, F/2, F/4, F/8, Eye Height, Eye Height@BER, Eye Width, Eye Width@BER, Eye High, Eye Low, Q-Factor, Bit High, Bit Low, Bit Amplitude, DC Common Mode, AC Common Mode (Pk-Pk), Differential Crossover, T/nT Ratio, SSC Freq Dev, SSC Modulation Rate
Measurement plots	Eye Diagram and Jitter Bathtub

Waveform measurements

	Fast eye rendering: Shows the Unit Intervals (UIs) that define the boundaries of the eye along with a user specified number of surrounding UIs for added visual context
	Complete eye rendering: Shows all valid Unit Intervals (UIs)
Measurement limits	Pass/fail testing for user-definable limits on measurement values. Act on event for measurement value failures include Save Screen Capture, Save Waveform, and Stop Acquisitions
Eye diagram mask testing	Automated mask pass/fail testing
<hr/>	
Power analysis (option 5-PWR) adds the following:	
Measurements	Input Analysis (Frequency, V_{RMS} , I_{RMS} , voltage and current Crest Factors, True Power, Apparent Power, Reactive Power, Power Factor, Phase Angle, Harmonics, Inrush Current, Input Capacitance)
	Amplitude Analysis (Cycle Amplitude, Cycle Top, Cycle Base, Cycle Maximum, Cycle Minimum, Cycle Peak-to-Peak)
	Timing Analysis (Period, Frequency, Negative Duty Cycle, Positive Duty Cycle, Negative Pulse Width, Positive Pulse Width)
	Switching Analysis (Switching Loss, dv/dt, di/dt, Safe Operating Area, R_{DSON})
	Magnetic Analysis (Inductance, I vs. Intg(V), Magnetic Loss, Magnetic Property)
	Output Analysis (Line Ripple, Switching Ripple, Efficiency, Turn-on Time, Turn-off Time)
	Frequency Response Analysis (Control Loop Response Bode Plot, Power Supply Rejection Ratio, Impedance)
Measurement Plots	Harmonics Bar Graph, Switching Loss Trajectory Plot, and Safe Operating Area
<hr/>	
Digital power management (option 5-DPM) adds the following:	
Measurements	Ripple Analysis (Ripple)
	Transient Analysis (Overshoot, Undershoot, Turn On Overshoot, DC Rail Voltage)
	Power Sequence Analysis (Turn-on, Turn-off)
	Jitter Analysis (TIE, PJ, RJ, DJ, Eye Height, Eye Width, Eye High, Eye Low)
<hr/>	
Digital Power Management Basic (option 5-DPMBAS) adds the following:	
Measurements	Ripple Analysis (Ripple)
	Transient Analysis (Overshoot, Undershoot)
	Power Sequence Analysis (Turn-on, Turn-off)
<hr/>	
LVDS debug and analysis option (option 5-DBLVDS) adds the following:	
Data Lane Measurements	Generic Test (Unit Interval, Rise Time, Fall Time, Data Width, Data Intra Skew (PN), Data Inter Skew (Lane-to-Lane), Data Peak-to-Peak)
	Jitter Test (AC Timing, Clock Data Setup Time, Clock Data Hold Time, Eye Diagram (TIE), TJ@BER, DJ Delta, RJ Delta, DDJ, De-Emphasis Level)
Clock Lane Measurements	Generic Test (Frequency, Period, Duty Cycle, Rise Time, Fall Time, Clock Intra Skew (PN), Clock Peak-to-Peak)
	Jitter Test (TIE, DJ, RJ)
	SSC On (Mod Rate, Frequency Deviation Mean)
<hr/>	

Waveform math

Number of math waveforms	Unlimited
Arithmetic	Add, subtract, multiply, and divide waveforms and scalars
Algebraic expressions	Define extensive algebraic expressions including waveforms, scalars, user-adjustable variables, and results of parametric measurements. Perform math on math using complex equations. For example (Integral (CH1 - Mean(CH1)) X 1.414 X VAR1)
Math functions	Invert, Integrate, Differentiate, Square Root, Exponential, Log 10, Log e, Abs, Ceiling, Floor, Min, Max, Degrees, Radians, Sin, Cos, Tan, ASin, ACos, and ATan
Relational	Boolean result of comparison >, <, ≥, ≤, =, and ≠
Logic	AND, OR, NAND, NOR, XOR, and EQV
Filtering function	User-definable filters. Users specify a file containing the coefficients of the filter
FFT functions	Spectral Magnitude and Phase, and Real and Imaginary Spectra
FFT vertical units	Magnitude: Linear and Log (dBm) Phase: Degrees, Radians, and Group Delay
FFT window functions	Hanning, Rectangular, Hamming, Blackman-Harris, Flattop2, Gaussian, Kaiser-Bessel, and TekExp

Spectrum View

Center Frequency	Limited by instrument analog bandwidth														
Span	18.6 Hz to 312.5 MHz 18.6 Hz to 500 MHz (with option 5-SV-BW-1) Coarse adjustment in a 1-2-5 sequence														
RF vs. Time Traces	Magnitude vs. time, Frequency vs. time, Phase vs. time														
Resolution Bandwidth (RBW)	93 μHz to 62.5 MHz 93 μHz to 100 MHz (with option 5-SV-BW-1)														
Window types and factors	<table border="1"> <thead> <tr> <th>Window type</th> <th>Factor</th> </tr> </thead> <tbody> <tr> <td>Blackman-Harris</td> <td>1.90</td> </tr> <tr> <td>Flat-Top 2</td> <td>3.77</td> </tr> <tr> <td>Hamming</td> <td>1.30</td> </tr> <tr> <td>Hanning</td> <td>1.44</td> </tr> <tr> <td>Kaiser-Bessel</td> <td>2.23</td> </tr> <tr> <td>Rectangular</td> <td>0.89</td> </tr> </tbody> </table>	Window type	Factor	Blackman-Harris	1.90	Flat-Top 2	3.77	Hamming	1.30	Hanning	1.44	Kaiser-Bessel	2.23	Rectangular	0.89
Window type	Factor														
Blackman-Harris	1.90														
Flat-Top 2	3.77														
Hamming	1.30														
Hanning	1.44														
Kaiser-Bessel	2.23														
Rectangular	0.89														
Spectrum Time	FFT Window Factor / RBW														
Reference level	Reference level is automatically set by the analog channel Volts/div setting Setting range: -42 dBm to +44 dBm														

Spectrum View

Vertical Position	-100 divs to +100 divs
Vertical units	dBm, dB μ W, dBmV, dB μ V, dBmA, dB μ A

Search

Number of searches	Unlimited
Search types	Search through long records to find all occurrences of user specified criteria including edges, pulse widths, timeouts, runt pulses, window violations, logic patterns, setup & hold violations, rise/fall times, and bus protocol events. Search results can be viewed in the Waveform View or in the Results table.

Save

Waveform Type	Tektronix Waveform Data (.wfm), Comma Separated Values (.csv), MATLAB (.mat)
Waveform Gating	Cursors, Screen, Resample (save every nth sample)
Screen Capture Type	Portable Network Graphic (*.png), 24-bit Bitmap (*.bmp), JPEG (*.jpg)
Setup Type	Tektronix Setup (.set)
Report Type	Adobe Portable Documents (.pdf), Single File web Pages (.mht)
Session Type	Tektronix Session Setup (.tss)

Display (available only through the video out ports or e*Scope)

	1,920 horizontal \times 1,080 vertical pixels
Display modes	Overlay: traditional oscilloscope display where traces overlay each other Stacked: display mode where each waveform is placed in its own slice and can take advantage of the full ADC range while still being visually separated from other waveforms. Groups of channels can also be overlaid within a slice to simplify visual comparison of signals.
Zoom	Horizontal and vertical zooming is supported in all waveform and plot views.
Interpolation	Sin(x)/x and Linear
Waveform styles	Vectors, dots, variable persistence, and infinite persistence
Graticules	Movable and fixed graticules, selectable between Grid, Time, Full, and None
Color palettes	Normal and inverted for screen captures Individual waveform colors are user-selectable
Format	YT, XY, and XYZ
Local Language User Interface	English, Japanese, Simplified Chinese, Traditional Chinese, French, German, Italian, Spanish, Portuguese, Russian, Korean
Local Language Help	English, Japanese, Simplified Chinese

Arbitrary/Function Generator (optional)

Function types Arbitrary, sine, square, pulse, ramp, triangle, DC level, Gaussian, Lorentz, exponential rise/fall, sin(x)/x, random noise, Haversine, Cardiac

Sine waveform

Frequency range 0.1 Hz to 50 MHz
Frequency setting resolution 0.1 Hz
Frequency accuracy 130 ppm (frequency \leq 10 kHz), 50 ppm (frequency $>$ 10 kHz)
 This is for Sine, Ramp, Square and Pulse waveforms only.
Amplitude range 20 mV_{pp} to 5 V_{pp} into Hi-Z; 10 mV_{pp} to 2.5 V_{pp} into 50 Ω
Amplitude flatness, typical \pm 0.5 dB at 1 kHz
 \pm 1.5 dB at 1 kHz for $<$ 20 mV_{pp} amplitudes
Total harmonic distortion, typical 1% for amplitude \geq 200 mV_{pp} into 50 Ω load
 2.5% for amplitude $>$ 50 mV AND $<$ 200 mV_{pp} into 50 Ω load
 This is for Sine wave only.
Spurious free dynamic range, typical 40 dB ($V_{pp} \geq 0.1$ V); 30 dB ($V_{pp} \geq 0.02$ V), 50 Ω load

Square and pulse waveform

Frequency range 0.1 Hz to 25 MHz
Frequency setting resolution 0.1 Hz
Frequency accuracy 130 ppm (frequency \leq 10 kHz), 50 ppm (frequency $>$ 10 kHz)
Amplitude range 20 mV_{pp} to 5 V_{pp} into Hi-Z; 10 mV_{pp} to 2.5 V_{pp} into 50 Ω
Duty cycle range 10% - 90% or 10 ns minimum pulse, whichever is larger
 Minimum pulse time applies to both on and off time, so maximum duty cycle will reduce at higher frequencies to maintain 10 ns off time
Duty cycle resolution 0.1%
Minimum pulse width, typical 10 ns. This is the minimum time for either on or off duration.
Rise/Fall time, typical 5 ns, 10% - 90%
Pulse width resolution 100 ps
Overshoot, typical $<$ 6% for signal steps greater than 100 mV_{pp}
 This applies to overshoot of the positive-going transition (+overshoot) and of the negative-going (-overshoot) transition
Asymmetry, typical \pm 1% \pm 5 ns, at 50% duty cycle
Jitter, typical $<$ 60 ps TIE_{RMS}, \geq 100 mV_{pp} amplitude, 40%-60% duty cycle

Ramp and triangle waveform

Frequency range 0.1 Hz to 500 kHz
Frequency setting resolution 0.1 Hz
Frequency accuracy 130 ppm (frequency \leq 10 kHz), 50 ppm (frequency $>$ 10 kHz)
Amplitude range 20 mV_{pp} to 5 V_{pp} into Hi-Z; 10 mV_{pp} to 2.5 V_{pp} into 50 Ω
Variable symmetry 0% - 100%
Symmetry resolution 0.1%

DC level range \pm 2.5 V into Hi-Z
 \pm 1.25 V into 50 Ω

Random noise amplitude range 20 mV_{pp} to 5 V_{pp} into Hi-Z
 10 mV_{pp} to 2.5 V_{pp} into 50 Ω

Arbitrary/Function Generator (optional)

Sin(x)/x	
Maximum frequency	2 MHz
Gaussian pulse, Haversine, and Lorentz pulse	
Maximum frequency	5 MHz
Lorentz pulse	
Frequency range	0.1 Hz to 5 MHz
Amplitude range	20 mV _{pp} to 2.4 V _{pp} into Hi-Z 10 mV _{pp} to 1.2 V _{pp} into 50 Ω
Cardiac	
Frequency range	0.1 Hz to 500 kHz
Amplitude range	20 mV _{pp} to 5 V _{pp} into Hi-Z 10 mV _{pp} to 2.5 V _{pp} into 50 Ω
Arbitrary	
Memory depth	1 to 128 k
Amplitude range	20 mV _{pp} to 5 V _{pp} into Hi-Z 10 mV _{pp} to 2.5 V _{pp} into 50 Ω
Repetition rate	0.1 Hz to 25 MHz
Sample rate	250 MS/s
Signal amplitude accuracy	±[(1.5% of peak-to-peak amplitude setting) + (1.5% of absolute DC offset setting) + 1 mV] (frequency = 1 kHz)
Signal amplitude resolution	1 mV (Hi-Z) 500 μV (50 Ω)
Sine and ramp frequency accuracy	(frequency ≤10 kHz) (frequency >10 kHz)
DC offset range	±2.5 V into Hi-Z ±1.25 V into 50 Ω
DC offset resolution	1 mV (Hi-Z) 500 μV (50 Ω)
DC offset accuracy	±[(1.5% of absolute offset voltage setting) + 1 mV] Add 3 mV of uncertainty per 10 °C change from 25 °C ambient

Digital volt meter (DVM)

Measurement types	DC, AC _{RMS} +DC, AC _{RMS}
Voltage resolution	4 digits
Voltage accuracy	
DC:	$\pm((1.5\% * \text{reading} - \text{offset} - \text{position}) + (0.5\% * (\text{offset} - \text{position}))) + (0.1 * \text{Volts/div})$ De-rated at 0.100%/°C of reading - offset - position above 30 °C Signal ± 5 divisions from screen center
AC:	$\pm 2\%$ (40 Hz to 1 kHz) with no harmonic content outside 40 Hz to 1 kHz AC, typical: $\pm 2\%$ (20 Hz to 10 kHz) For AC measurements, the input channel vertical settings must allow the V_{pp} input signal to cover between 4 and 10 divisions and must be fully visible on the screen

Trigger frequency counter

Accuracy	$\pm(1 \text{ count} + \text{time base accuracy} * \text{input frequency})$ The signal must be at least 8 mV _{pp} or 2 div, whichever is greater.
Maximum input frequency	10 Hz to maximum bandwidth of the analog channel The signal must be at least 8 mV _{pp} or 2 div, whichever is greater.
Resolution	8-digits

Processor system

Host processor	Intel i5-4400E, 2.7 GHz, 64-bit, dual core processor
Operating system	Default instrument: Closed Embedded OS
Internal storage	≥ 80 GB. Form factor is an 80 mm m.2 card with a SATA-3 interface

Input-Output ports

DisplayPort connector	A 20-pin DisplayPort connector; connect to show the oscilloscope display on an external monitor or projector
DVI connector	A 29-pin DVI-D connector; connect to show the oscilloscope display on an external monitor or projector
VGA	DB-15 female connector; connect to show the oscilloscope display on an external monitor or projector
Probe compensator signal, typical	
Connection:	Connectors are located on the lower right front panel of the instrument
Amplitude:	0 to 2.5 V
Frequency:	1 kHz
Source impedance:	1 k Ω
External reference input	The time-base system can phase lock to an external 10 MHz reference signal (± 4 ppm).

Input-Output ports

USB interface (Host, Device ports) Front panel USB Host ports: One USB 2.0 Hi-Speed port, one USB 3.0 SuperSpeed port
 Rear panel USB Host ports: Two USB 2.0 Hi-Speed ports
 Rear panel USB Device port: One Device port providing USBTMC support

Ethernet interface 10/100/1000 Mb/s

Auxiliary output Rear-panel BNC connector. Output can be configured to provide a positive or negative pulse out when the oscilloscope triggers, the internal oscilloscope reference clock out, or an AFG sync pulse

Characteristic	Limits
Vout (HI)	≥ 2.5 V open circuit; ≥ 1.0 V into a 50 Ω load to ground
Vout (LO)	≤ 0.7 V into a load of ≤ 4 mA; ≤0.25 V into a 50 Ω load to ground

Aux Trigger In

Connection Front-panel SMA connector
Input impedance 50 Ω
Maximum input ≤5 V_{RMS}

Kensington-style lock Rear-panel security slot connects to standard Kensington-style lock

Power source

Power

Power consumption 400 Watts maximum
Source voltage 100 - 240 V ±10% at 50 Hz to 60 Hz
 115 V ±10% at 400 Hz ±10%

Physical characteristics

Dimensions Height: 3.44 in (87.3 mm)
 Width: 17.01 in (432 mm)
 Depth: 23.85 in (605.7 mm)
 Fits rack depths from 24 inches to 32 inches

Weight 25.5 lbs (11.6 kg)

Cooling The clearance requirement for adequate cooling is 2.0 in (50.8 mm) on the left and right sides of the instrument (when viewed from the front). Air flows through the instrument from left to right

Rackmount configuration 2U (rack mounts and screws come standard)

Environmental specifications

Temperature

Operating	+0 °C to +50 °C (32 °F to 122 °F)
Non-operating	-20 °C to +60 °C (-4 °F to 140 °F)

Humidity

Operating	5% to 90% relative humidity (% RH) at up to +40 °C
	5% to 55% RH above +40 °C up to +50 °C, noncondensing, and as limited by a maximum wet-bulb temperature of +39 °C
Non-operating	5% to 90% relative humidity (% RH) at up to +40 °C
	5% to 39% RH above +40 °C up to +50 °C, noncondensing, and as limited by a maximum wet-bulb temperature of +39 °C

Altitude

Operating	Up to 3,000 meters (9,843 feet)
Non-operating	Up to 12,000 meters (39,370 feet)

Random vibration

Operating	0.31 GRMS, 5-500 Hz, 10 minutes per axis, 3 axes (30 minutes total)
Non-operating	2.46 GRMS, 5-500 Hz, 10 minutes per axis, 3 axes (30 minutes total)

EMC, Environment, and Safety

Regulatory	CE marked for the European Union and UL approved for the USA and Canada RoHS compliant
-------------------	---

Software

Software

IVI driver	Provides a standard instrument programming interface for common applications such as LabVIEW, LabWindows/CVI, Microsoft .NET, and MATLAB. Compatible with Python, C/C++/C# and many other languages through VISA.
e*Scope®	Enables control of the oscilloscope over a network connection through a standard web browser. Simply enter the IP address or network name of the oscilloscope and a web page will be served to the browser. Transfer and save settings, waveforms, measurements, and screen images or make live control changes to settings on the oscilloscope directly from the web browser.
LXI Web interface	Connect to the oscilloscope through a standard Web browser by simply entering the oscilloscope's IP address or network name in the address bar of the browser. The Web interface enables viewing of instrument status and configuration, status and modification of network settings, and instrument control through the e*Scope web-based remote control.
Programming Examples	Programming with the 5 & 6 Series platforms has never been easier. With a programmers manual and a GitHub site you have many commands and examples to help you get started remotely automating your instrument. See https://github.com/tektronix/Programmatic-Control-Examples .

Ordering information

Use the following information to select the appropriate instrument and options for your measurement needs.

Step 1

Start by selecting the 5 Series MSO Low Profile model that you need.

Model	Description
M5058LP	Low Profile Mixed Signal Oscilloscope; 1 GHz bandwidth, (8) FlexChannels with 125 M record length
M5058LPGSA	Low Profile Mixed Signal Oscilloscope; 1 GHz bandwidth, (8) FlexChannels with 125 M record length; Trade Agreements Act (TAA) compliant

Each model includes
Rackmount attachments installed
Installation and safety manual (translated in English, Japanese, Simplified Chinese)
Embedded Help
Power cord
Calibration certificate documenting traceability to National Metrology Institute(s) and ISO9001/ISO17025 quality system registration
Three-year warranty covering all parts and labor on the instrument.

Step 2

Add instrument functionality

Instrument functionality can be ordered with the instrument or later as an upgrade kit.

Instrument Option	Built-in Functionality
5-AFG	Add Arbitrary / Function Generator
5-SEC ⁷	Add enhanced security for instrument declassification and password-protected enabling and disabling of all USB ports and firmware upgrade.

⁷ This option must be purchased at the same time as the instrument. Not available as an upgrade.

Step 3

Add optional serial bus triggering, decode, and search capabilities

Choose the serial support you need today by choosing from these serial analysis options. You can upgrade later by purchasing an upgrade kit.

Instrument Option	Serial Buses Supported
5-SRAERO	Aerospace (MIL-STD-1553, ARINC 429)
5-SRAUDIO	Audio (I ² S, LJ, RJ, TDM)
5-SRAUTO	Automotive (CAN, CAN FD, LIN, FlexRay, and CAN symbolic decoding)
5-SRAUTOEN1	100BASE-T1 Automotive Ethernet serial analysis
5-SRAUTOSEN	Automotive sensor (SENT)
5-SRCOMP	Computer (RS-232/422/485/UART)
5-SREMBD	Embedded (I ² C, SPI)
5-SRENET	Ethernet (10BASE-T, 100BASE-TX)
5-SR8B10B	8B/10B
5-SRI3C	MIPI I3C (I3C decode and search only)
5-SRNRZ	NRZ
5-SRPM	Power Management (SPMI)
5-SRSPACEWIRE	Spacewire serial analysis
5-SRUSB2	USB (USB2.0 LS, FS, HS)

Differential serial bus? Be sure to check *Add analog probes and adapters* for differential probes.

Step 4

Add optional analysis capabilities

Instrument Option	Advanced Analysis
5-DJA	Advanced Jitter and Eye Analysis
5-DPM	Digital Power Management
5-DPMBAS	Basic Digital Power Management
5-MTM	Mask testing
5-PS2 ^{8 9}	Power Solution Bundle (5-PWR, THDP0200, TCP0030A, 067-1686-xx deskew fixture)
5-PS2FRA ^{8 9}	Power Solution Bundle (5-PWR, THDP0200, TCP0030A, two TPP0502, 067-1686-xx deskew fixture)
5-PWR ¹⁰	Power Measurement and Analysis
5-SV-BW-1	Increase Spectrum View Capture Bandwidth to 500 MHz
5-SV-RFVT	Spectrum View RF versus Time Analysis and remote IQ data transferring

⁸ This option is not compatible with option 5-PWR.

⁹ This option must be purchased at the same time as the instrument. Not available as an upgrade.

¹⁰ This option is not compatible with option 5-PS2 or 5-PS2FRA.

Step 5

Add analog probes and adapters

Add additional recommended probes and adapters

Recommended Probe / Adapter	Description
TAP1500	1.5 GHz TekVPI® active single-ended voltage probe, ±8 V input voltage
TAP2500	2.5 GHz TekVPI® active single-ended voltage probe, ±4 V input voltage
TCP0030A	30 A AC/DC TekVPI® current probe, 120 MHz BW
TCP0020	20 A AC/DC TekVPI® current probe, 50 MHz BW
TCP0150	150 A AC/DC TekVPI® current probe, 20 MHz BW
TRCP0300	30 MHz AC current probe, 250 mA to 300 A
TRCP0600	30 MHz AC current probe, 500 mA to 600 A
TRCP3000	16 MHz AC current probe, 500 mA to 3000 A
TDP0500	500 MHz TekVPI® differential voltage probe, ±42 V differential input voltage
TDP1000	1 GHz TekVPI® differential voltage probe, ±42 V differential input voltage
TDP1500	1.5 GHz TekVPI® differential voltage probe, ±8.5 V differential input voltage
TDP7704	4 GHz TriMode™ voltage probe
THDP0100	±6 kV, 100 MHz TekVPI® high-voltage differential probe
THDP0200	±1.5 kV, 200 MHz TekVPI® high-voltage differential probe
TMDP0200	±750 V, 200 MHz TekVPI® high-voltage differential probe
TPR1000	1 GHz, Single-Ended TekVPI® Power-Rail Probe; includes one TPR4KIT accessory kit
TIVH02	Isolated Probe; 200 MHz, ±2500 V, TekVPI, 3 Meter Cable
TIVH02L	Isolated Probe; 200 MHz, ±2500 V, TekVPI, 10 Meter Cable
TIVH05	Isolated Probe; 500 MHz, ±2500 V, TekVPI, 3 Meter Cable
TIVH05L	Isolated Probe; 500 MHz, ±2500 V, TekVPI, 10 Meter Cable
TIVH08	Isolated Probe; 800 MHz, ±2500 V, TekVPI, 3 Meter Cable
TIVH08L	Isolated Probe; 800 MHz, ±2500 V, TekVPI, 10 Meter Cable
TIVM1	Isolated Probe; 1 GHz, ±50 V, TekVPI, 3 Meter Cable
TIVM1L	Isolated Probe; 1 GHz, ±50 V, TekVPI, 10 Meter Cable
TPP0500B	500 MHz, 10X TekVPI® passive voltage probe, 1.3 Meter Cable
TPP0502	500 MHz, 2X TekVPI® passive voltage probe, 12.7 pF input capacitance
TPP0850	2.5 kV, 800 MHz, 50X TekVPI® passive high-voltage probe
TPP1000	1 GHz, 10X TekVPI® passive voltage probe, 1.3 Meter cable, 3.9 pF input capacitance
P6015A	20 kV, 75 MHz high-voltage passive probe
TPA-BNC ¹¹	TekVPI® to TekProbe™ BNC adapter
TEK-DPG	TekVPI deskew pulse generator signal source
067-1686-xx	Power measurement deskew and calibration fixture

Looking for other probes? Check out the probe selector tool at www.tek.com/probes.

¹¹ Recommended for connecting your existing TekProbe probes to the MSO58LP Low Profile.

Step 6

Add digital probes

Each FlexChannel input can be configured as eight digital channels simply by connecting a TLP058 logic probe. TLP058 probes are ordered separately.

For this instrument	Order	To add
MSO58LP, MSO58LPGSA	1 to 8 TLP058 Probes	8 to 64 digital channels

Add accessories

Optional Accessory	Description
020-3180-xx	Benchtop conversion kit including four (4) instrument feet and a strap handle
016-2139-xx	Hard transit case with handles and wheels for easy transportation
GPIB to Ethernet adapter	Order model 4865B (GPIB to Ethernet to Instrument Interface) directly from ICS Electronics www.icselect.com/gpib_instrument_intf.html

Select power cord option

Power Cord Option	Description
A0	North America power plug (115 V, 60 Hz) Includes mechanism that retains power cord to instrument
A1	Universal Euro power plug (220 V, 50 Hz)
A2	United Kingdom power plug (240 V, 50 Hz)
A3	Australia power plug (240 V, 50 Hz)
A5	Switzerland power plug (220 V, 50 Hz)
A6	Japan power plug (100 V, 50/60 Hz)
A10	China power plug (50 Hz)
A11	India power plug (50 Hz)
A12	Brazil power plug (60 Hz)
A99	No power cord

Step 9

Add extended service and calibration options

Service Option	Description
T3	Three Year Total Protection Plan, includes repair or replacement coverage from wear and tear, accidental damage, ESD or EOS.
T5	Five Year Total Protection Plan, includes repair or replacement coverage from wear and tear, accidental damage, ESD or EOS.
R5	Standard Warranty Extended to 5 Years. Covers parts, labor and 2-day shipping within country. Guarantees faster repair time than without coverage. All repairs include calibration and updates. Hassle free - a single call starts the process.
C3	Calibration service 3 Years. Includes traceable calibration or functional verification where applicable, for recommended calibrations. Coverage includes the initial calibration plus 2 years calibration coverage.
C5	Calibration service 5 Years. Includes traceable calibration or functional verification where applicable, for recommended calibrations. Coverage includes the initial calibration plus 4 years calibration coverage.
D1	Calibration Data Report
D3	Calibration Data Report 3 Years (with Option C3)
D5	Calibration Data Report 5 Years (with Option C5)

Feature upgrades after purchase

Add feature upgrades in the future You can easily add functionality after the initial purchase. Node-locked licenses permanently enable optional features on a single product. Floating licenses allow license-enabled options to be easily moved between compatible instruments.

Upgrade feature	Node-locked license upgrade	Floating license upgrade	Description
Add instrument functions	SUP5-AFG	SUP5-AFG-FL	Add arbitrary function generator
Add protocol analysis	SUP5-SR8B10B	SUP5-SR8B10B-FL	8b/10b serial decoding and analysis
	SUP5-SRAERO	SUP5-SRAERO-FL	Aerospace serial triggering and analysis (MIL-STD-1553, ARINC 429)
	SUP5-SRAUDIO	SUP5-SRAUDIO-FL	Audio serial triggering and analysis (I ² S, LJ, RJ, TDM)
	SUP5-SRAUTO	SUP5-SRAUTO-FL	Automotive serial triggering and analysis (CAN, CAN FD, LIN, FlexRay, and CAN symbolic decoding)
	SUP5-SRAUTOEN1	SUP5-SRAUTOEN1-FL	100Base-T1 Automotive Ethernet serial analysis
	SUP5-SRAUTOSEN	SUP5-SRAUTOSEN-FL	Automotive sensor serial triggering and analysis (SENT)
	SUP5-SRCOMP	SUP5-SRCOMP-FL	Computer serial triggering and analysis (RS-232/422/485/UART)
	SUP5-SREMBD	SUP5-SREMBD-FL	Embedded serial triggering and analysis (I ² C, SPI)
	SUP5-SRENET	SUP5-SRENET-FL	Ethernet serial triggering and analysis (10Base-T, 100Base-TX)
	SUP5-SRI3C	SUP5-SRI3C-FL	MIPI I3C serial analysis
	SUP5-SRNRZ	SUP5-SRNRZ-FL	NRZ serial decoding and analysis
	SUP5-SRPM	SUP5-SRPM-FL	Power Management serial triggering and analysis (SPMI)
	SUP5-SRSPACEWIRE	SUP5-SRSPACEWIRE-FL	Spacewire serial analysis
	SUP5-SRUSB2	SUP5-SRUSB2-FL	USB 2.0 serial bus triggering and analysis (LS, FS, and HS)
Add advanced analysis	SUP5-DJA	SUP5-DJA-FL	Advanced jitter and eye analysis
	SUP5-DPM	SUP5-DPM-FL	Digital Power Management
	SUP5-DPMBAS	SUP5-DPMBAS-FL	Basic digital power management
	SUP5-PWR	SUP5-PWR-FL	Advanced power measurements and analysis
	SUP5-SV-RFVT	SUP5-SV-RFVT-FL	Spectrum View RF versus Time Analysis
	SUP5-SV-BW-1	SUP5-SV-BW-1-FL	Increase Spectrum View Capture Bandwidth to 500 MHz
Add digital voltmeter	SUP5-DVM	N/A	Add digital voltmeter / trigger frequency counter (Free with product registration at www.tek.com/register5mso)



Tektronix is registered to ISO 9001 and ISO 14001 by SRI Quality System Registrar.



Product(s) complies with IEEE Standard 488.1-1987, RS-232-C, and with Tektronix Standard Codes and Formats.



Product Area Assessed: The planning, design/development and manufacture of electronic Test and Measurement instruments.

ASEAN / Australasia (65) 6356 3900
Belgium 00800 2255 4835*
Central East Europe and the Baltics +41 52 675 3777
Finland +41 52 675 3777
Hong Kong 400 820 5835
Japan 81 (3) 6714 3086
Middle East, Asia, and North Africa +41 52 675 3777
People's Republic of China 400 820 5835
Republic of Korea +822 6917 5084, 822 6917 5080
Spain 00800 2255 4835*
Taiwan 886 (2) 2656 6688

Austria 00800 2255 4835*
Brazil +55 (11) 3759 7627
Central Europe & Greece +41 52 675 3777
France 00800 2255 4835*
India 000 800 650 1835
Luxembourg +41 52 675 3777
The Netherlands 00800 2255 4835*
Poland +41 52 675 3777
Russia & CIS +7 (495) 6647564
Sweden 00800 2255 4835*
United Kingdom & Ireland 00800 2255 4835*

Balkans, Israel, South Africa and other ISE Countries +41 52 675 3777
Canada 1 800 833 9200
Denmark +45 80 88 1401
Germany 00800 2255 4835*
Italy 00800 2255 4835*
Mexico, Central/South America & Caribbean 52 (55) 56 04 50 90
Norway 800 16098
Portugal 80 08 12370
South Africa +41 52 675 3777
Switzerland 00800 2255 4835*
USA 1 800 833 9200

* European toll-free number. If not accessible, call: +41 52 675 3777

For Further Information. Tektronix maintains a comprehensive, constantly expanding collection of application notes, technical briefs and other resources to help engineers working on the cutting edge of technology. Please visit www.tek.com.

Copyright © Tektronix, Inc. All rights reserved. Tektronix products are covered by U.S. and foreign patents, issued and pending. Information in this publication supersedes that in all previously published material. Specification and price change privileges reserved. TEKTRONIX and TEK are registered trademarks of Tektronix, Inc. All other trade names referenced are the service marks, trademarks, or registered trademarks of their respective companies.

