

Automotive Ethernet Test Application

Multigigabit Ethernet (Opt. 6-CMAUTOEN10G), 1000/100BASE-T1 (Opt. 6-CMAUTOEN/5-CMAUTOEN), 10BASE-T1S (Opt. 6-CMAUTOEN10, 5-CMAUTON10) Datasheet

Get more visibility into your Automotive Ethernet designs

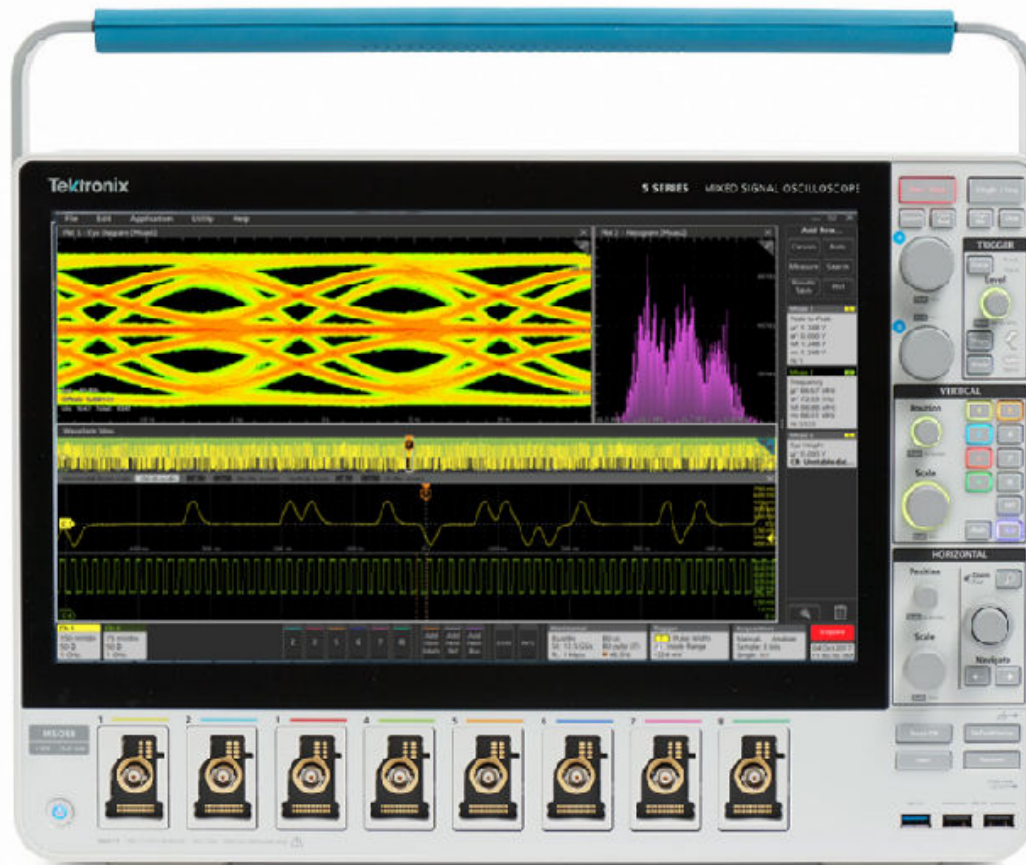

Tektronix options CMAUTOEN10G (MultiGBASE-T1), CMAUTOEN (100BASE-T1/1000BASE-T1) and CMAUTOEN10 (10BASE-T1S) comprise the most comprehensive solution for Automotive Ethernet transmitter compliance testing, as well as debug and validation of Automotive Ethernet devices and ECU's, against the IEEE and Open Alliance specifications. The test suite runs on the 5 Series and 6 Series B MSO's, letting you take full advantage of validation and debug capabilities in the oscilloscope, in addition to compliance testing. The integration of Automotive Ethernet is placing greater demands on technology and is placing even greater demands on comprehensive design validation to ensure interoperability between multiple ECU's and reliability in demanding environments. A complete testing solution enables passing strict compliance tests and provides greater confidence in design margins under real-world conditions.

The Tektronix Automotive Ethernet application allows you to select the reference specification, and the test plan depending on the selected specification and currently supports the following data rates and standards:

- 10BASE-T1S as per IEEE 802.3cg and OPEN Alliance TC14.
- 100BASE-T1 as per IEEE 802.3bw and OPEN Alliance TC1.
- 1000BASE-T1 as per IEEE 802.3bp and OPEN Alliance TC12.
- 2.5/5/10GBASE-T1 as per IEEE 802.3ch and OPEN Alliance TC15¹

Features and benefits

Test coverage: Tektronix Automotive Ethernet application covers transmitter compliance tests for 100BASE-T1 (IEEE 802.3bw), 1000BASE-T1 (IEEE 802.3bp), MultiGBASE-T1 (IEEE 802.3ch), and 10BASE-T1S (IEEE 802.3cg) standards through a single Automotive Ethernet compliance application. The application uses the TekExpress automation framework and tests as per IEEE and Open Alliance specification for Tektronix 5 Series and 6 Series B MSO's.

Test time: Fully automated with setup wizard, configures all required test parameters to perform compliance testing as per Automotive Ethernet standards. Highly optimized and intuitive user interface for quick test configuration and validation of electrical signals.

Accuracy: The 5 Series and 6 Series B MSO's provide accurate and repeatable results with a 12-bit vertical resolution at sampling rates of 3.125 Gs/s (5 Series MSO) and 50 Gs/s (6B Series MSO).

Pattern matching: Verifies that the correct set of compliance patterns are sent by the transmitter before acquiring signals for compliance analysis.

Reporting: Compiles all test results into a customizable report with pass/fail results for easy analysis and record keeping, as well as margin testing.

Compliance and debug: Provides a toolkit of DPOJET based setups to quickly switch into debug and validation mode when a DUT fails compliance.

Analysis and debug tools: Supporting tools, such as TekExpress user defined Mode, advanced DPOJET jitter analysis (Opt. DJA), PAM3 Eye Diagram Analysis (Opt. PAM3), and Tektronix patented software based on non-intrusive signal separation tools (Opt. AUTOEN-SS) help to catch problems before compliance testing, or root-cause the problem in the event of a failure.

Performance verification: The Automotive Ethernet application allows you to run a test multiple times and save or stop acquisitions in the event of an out-of-limit condition. The report shows statistics with pass/fail results for each run to show device performance over multiple runs.

PHY level protocol decode: Opt. SR-AUTOETH1 decodes and displays 100BASE-T1 data in a protocol-aware view. A time-correlated event table view with waveforms allow you to quickly search through decoded data for events of interest.

Comprehensive programmatic interface: Enables automation programs and scripts to call Automotive Ethernet test functions.

Automated Automotive Ethernet compliance application

Physical layer compliance tests have been defined to ensure the interoperability between different designs and hardware vendors. Tektronix Automotive Ethernet compliance testing application provides the most comprehensive solution to serve the need of engineers designing Automotive Ethernet silicon or electronic control units (ECU's), as well as those validating physical layer compliance of Automotive Ethernet as per IEEE or Open Alliance specifications.

	10BASE-T1S	100BASE-T1	1000BASE-T1S	MultiGBASE-T1
IEEE Specification	802.3cg	802.3bw	802.3bp	802.3ch
Data rate	10 Mbps	100 Mbps	1 Gbps	2.5/5/10 Gbps
Symbol rate	12.5 MHz	66.66 MHz	750 MHz	1.4/2.8/5.6 GHz
Line coding	4B/5B, DME	PAM3	PAM3	PAM4
Voltage	1 Vpp	2.2 Vpp	1.3 Vpp	1.3 Vpp
Communication	Half Duplex	Full Duplex	Full Duplex	Full Duplex

¹ Refer Ordering information section to know more about bandwidth requirements.

Test Name	10BASE-T1S IEEE 802.3cg and TC14	100BASE-T1 IEEE 802.3bw and Open Alliance TC1	ECU TC8 100/1000 BASE-T1	1000BASE-T1 IEEE 802.3bp and TC12	Multigigabit IEEE 802.3ch and TC15
Transmitter Output Droop	147.5.4.2	96.5.4.1	OABR_P MA_TX_0 1	97.5.3.1	149.5.2.1
Transmitter Distortion	NA	96.5.4.2	OABR_P MA_TX_0 8	97.5.3.2	NA
Transmitter Linearity	NA	NA	NA	NA	149.5.2.2
Transmitter Timing Jitter in Master/ Slave Mode	147.5.4.3	96.5.4.3	OABR_P MA_TX_0 2	97.5.3.3	149.5.2.3
Transmitter MDI Jitter	NA	NA	NA	97.5.3.3	NA
Tx MDI Random Jitter (Master)	NA	NA	NA	NA	149.5.2.3.1
Tx MDI Deterministic Jitter (Master)	NA	NA	NA	NA	149.5.2.3.2
Transmitter Power Spectral Density (PSD)	147.5.4.4	96.5.4.4	OABR_P MA_TX_0 4	97.5.3.4	149.5.2.4
Transmit Clock Frequency	NA	96.5.6	OABR_P MA_TX_0 3	97.5.3.6	149.5.2.6
Transmitter Peak Differential Output	147.5.4.1	96.5.4.5	NA	97.5.3.5	149.5.2.5
MDI Return Loss	146.8.3	96.8.2.1	OABR_P MA_TX_0 5	97.7.2.1	149.8.2.1
MDI Mode Conversion	NA	NA	OABR_P MA_TX_0 6	NA	NA

Table continued...

Test Name	10BASE-T1S IEEE 802.3cg and TC14	100BASE-T1 IEEE 802.3bw and Open Alliance TC1	ECU TC8 100/1000 BASE-T1	1000BASE-T1 IEEE 802.3bp and TC12	Multigigabit IEEE 802.3ch and TC15
Common Mode Emission	NA	NA	Only 100BASE-T1	NA	NA

Compliance testing for Physical Media Attach (PMA) transmitters

The IEEE and Open Alliance provide compliance tests for an Automotive Ethernet PHY or ECU. As per the IEEE and Open Alliance, we have the following compliance requirements for Automotive Ethernet PHY or ECU.

Compliance testing requires a complex sequence of setting specific test modes, configuring instruments, acquiring data and analyzing it per the test procedure. Manually capturing the required waveforms and analyzing them is tedious, time consuming, and prone to error.

The TekExpress Automotive Ethernet compliance application allows you to automatically execute physical layer electrical tests for transmitter compliance using IEEE and/or Open Alliance (OABR) specifications. The Tektronix Opt. CMAUTOEN10, Opt. CMAUTOEN and Opt. CMAUTOEN10G applications provide automated testing for 10BASE-T1S, 100BASE-T1, 1000BASE-T1 and Multigigabit Ethernet, respectively. All of these standards can be combined and tested from within a common TekExpress test automation platform. The TekExpress Automotive Ethernet application allows you to choose complete or selective testing of any of the transmitter electrical specifications. Tests are configured by following a step-by-step process. The application sets up the oscilloscope and automates testing, guiding you to accurate and repeatable results.

Multigigabit Ethernet PMA transmitter compliance measurements

The IEEE 802.3ch standard defines a physical layer specification for a 10 Gb/s Ethernet full duplex local area network over a single balanced pair of conductors. The physical layer can operate at 2.5 Gb/s, 5 Gb/s or 10 Gb/s with four level Pulse Amplitude Modulation (PAM4). The standard specifies the following test requirements. Each test is performed with a specific test mode pattern.

Table 1: MultiGBASE-T1 PMA transmitter measurements

Test specification	Test mode	Pattern type	Instrument
Tx Output Droop	6	NRZ	Oscilloscope
Tx Linearity	4	PAM4	Oscilloscope

Table continued...

Test specification	Test mode	Pattern type	Instrument
Tx Timing Jitter (Master and Slave)	1	Clock	Oscilloscope
Tx MDI Random Jitter (Master Mode)	2	Square	Oscilloscope
Tx MDI Deterministic Jitter (Master Mode)	2	JP03A	Oscilloscope
Even odd Jitter (EOJ)	2	JP03B	Oscilloscope
Tx Power Spectral Density and Power level	5	PAM4	Oscilloscope
Tx Clock Frequency	1	Clock	Oscilloscope
Tx Peak Differential Output	5	PAM4	Oscilloscope
MDI Return Loss	Slave		VNA

Table 2: 100BASE-T1 PMA Transmitter measurements

Test specification	Test mode	Pattern type	Instrument
Tx Output Droop	6	NRZ	Oscilloscope
Tx Distortion	4	PAM3	Oscilloscope
Tx Timing Jitter (Master and Slave)	1	Clock	Oscilloscope
Tx MDI Jitter	2	Clock	Oscilloscope
Tx Power Spectral Density and Power level	5	PAM3	Oscilloscope
Tx Clock Frequency	1	Clock	Oscilloscope
Tx Peak Differential Output	5	PAM3	Oscilloscope
MDI Return Loss	Slave		VNA

Table 3: 100BASE-T1 PMA Transmitter measurements

Test specification	Test mode	Pattern type	Instrument
Tx Output Droop	1	NRZ	Oscilloscope
Tx Distortion	4	PAM3	Oscilloscope
Tx Timing Jitter (Master and Slave)	1	Clock	Oscilloscope
Tx Power Spectral Density and Power level	5	PAM3	Oscilloscope
Tx Clock Frequency	2	Clock	Oscilloscope
Tx Peak Differential Output	5	PAM3	Oscilloscope
MDI Return Loss	Slave		Oscilloscope + AFG
MDI Mode conversion	Slave		VNA
MDI Common mode emission	5	PAM3	Oscilloscope

Table 4: 10BASE-T1S PMA Transmitter measurements

Test specification	Test mode	Instrument
Tx Output Droop	2	Oscilloscope
Tx Timing Jitter	1	Oscilloscope
Tx Power Spectral Density and Power level	3	Oscilloscope
Tx Peak Differential Output	1	Oscilloscope
MDI Return Loss	Slave	Oscilloscope + AFG

The TekExpress Automotive Ethernet automated testing application

The Tektronix TekExpress Automotive Ethernet application reduces test time by using TekExpress automation platform. The navigation in the application follows a logical workflow for quick, easy test setups, changes and review of test results. Valid testing requires proper cabling, probes, and connections between fixtures, instruments, and the device under test (DUT). The application provides setup instructions for each test, with images and reference illustrations showing correct configurations. It generates a comprehensive, date-stamped test report with pass/fail results, waveforms, and data plots.

The TekExpress automation platform is an easy to navigate tool with 5 easy steps to perform compliance testing.

Step 1: Selection of test suite

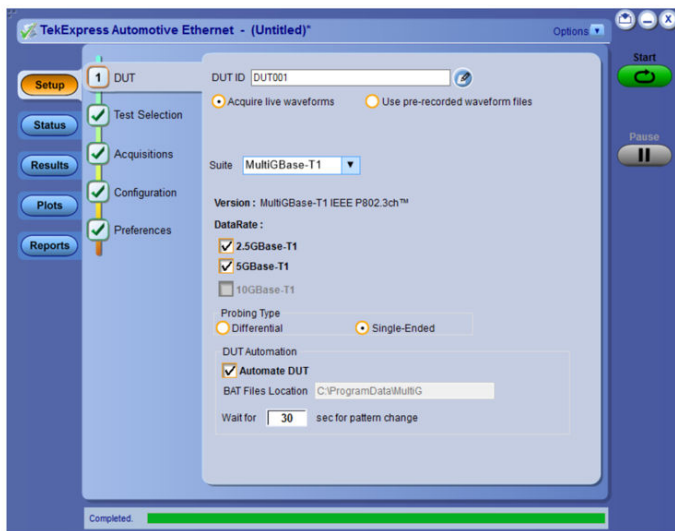
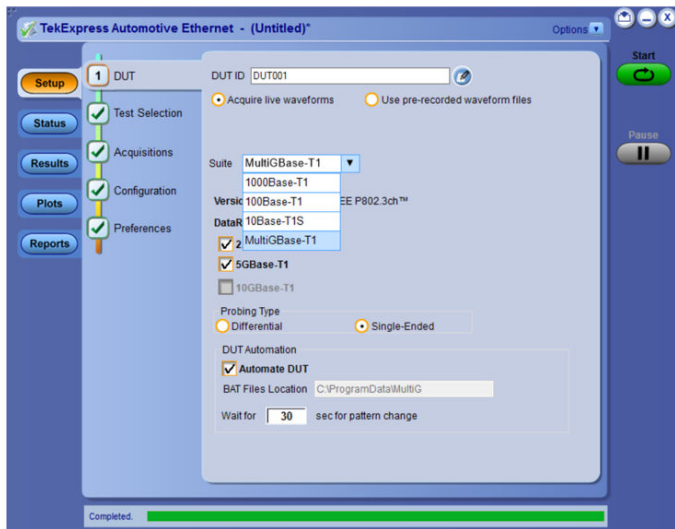

Selection of test suite in the DUT panel

Test selections includes 10BASE-T1S, 100BASE-T1, 1000BASE-T1, and Multigigabit Ethernet. You can select different speed gears for MultiGBASE-T1. The test selection, test limits, and configuration will be selected based on the test suite chosen. You can test using live oscilloscope waveforms or previously recorded waveforms or sessions.

Step 2: Test selection

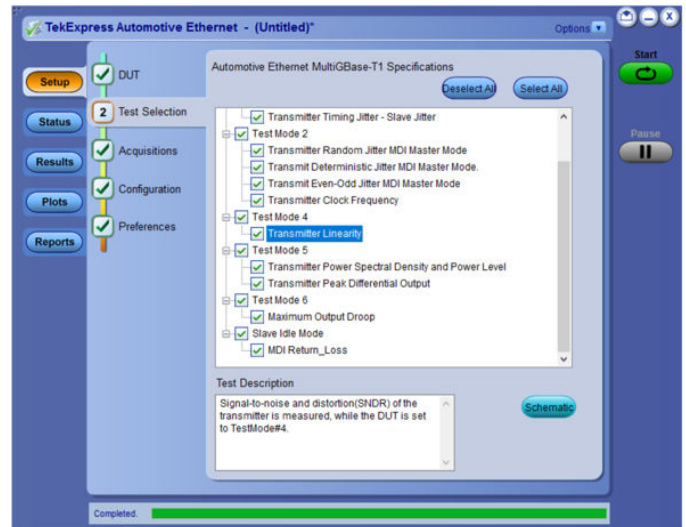

Multigigabit Ethernet Test Selection

Based on test suite selected in the DUT panel, the TekExpress Automotive Ethernet application allows you to select the tests. You can select single or multiple tests to perform.

A schematic view and description show the proper connections along with other relevant information and "golden waveform". If you select multiple tests, the application will prompt you to change the DUT test mode or/and any connections during the text execution.

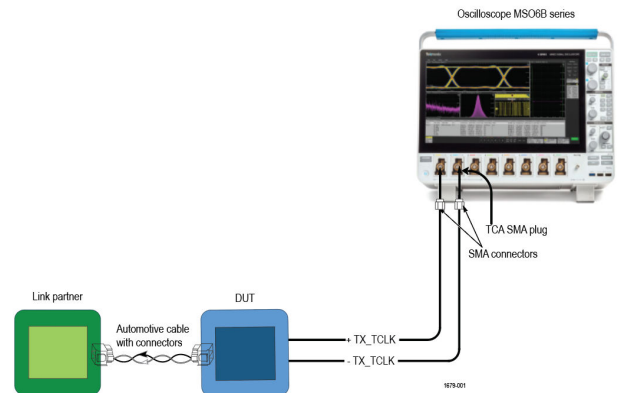

Automotive Ethernet connection diagram

Step 3: Signal validation

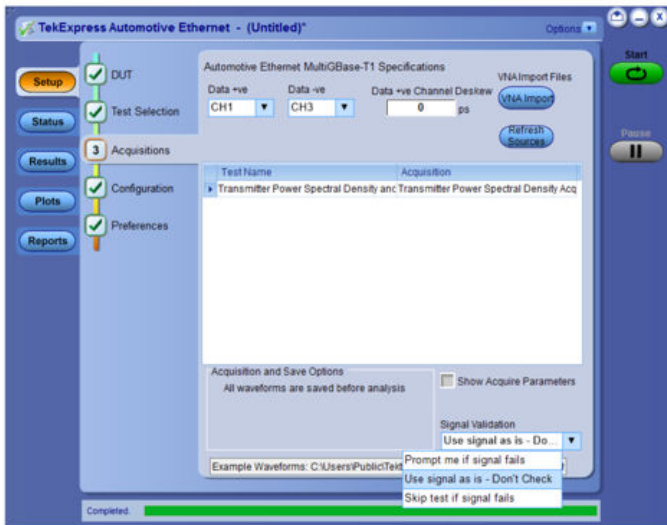

Signal acquisition and validation

It is important to validate the signal parameters before performing a test. The TekExpress application includes intelligence to identify the test mode waveform before running the test. This ensures that the DUT is sending the correct test pattern and if the connection is correct before the test begins.

Step 4: Configuration of User defined and Compliance Mode

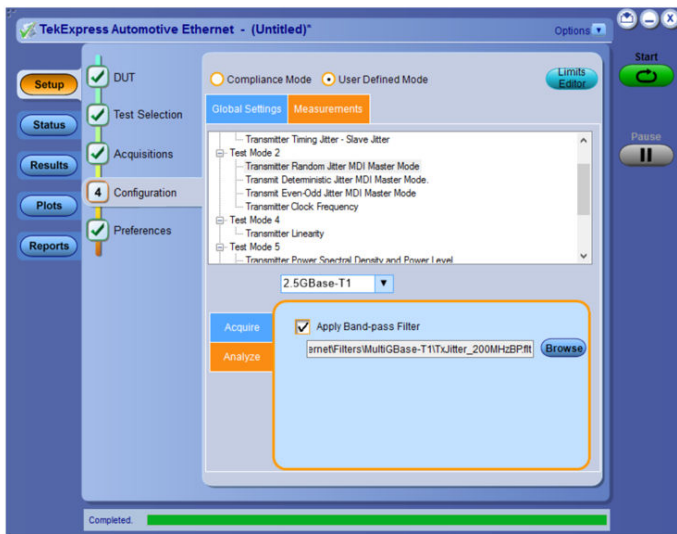

User defined configuration for PSD test

The TekExpress Automotive Ethernet application allows you to configure the test in compliance mode or user defined mode. In compliance mode, the application configures all the parameters of oscilloscope as defined in the specification test procedure. It will test the DUT against the limit defined in specification.

In user defined mode, you can change test parameters as well as test limits. User defined mode allows you to test your device beyond compliance test.

Step 5: Preference for multi-run analysis

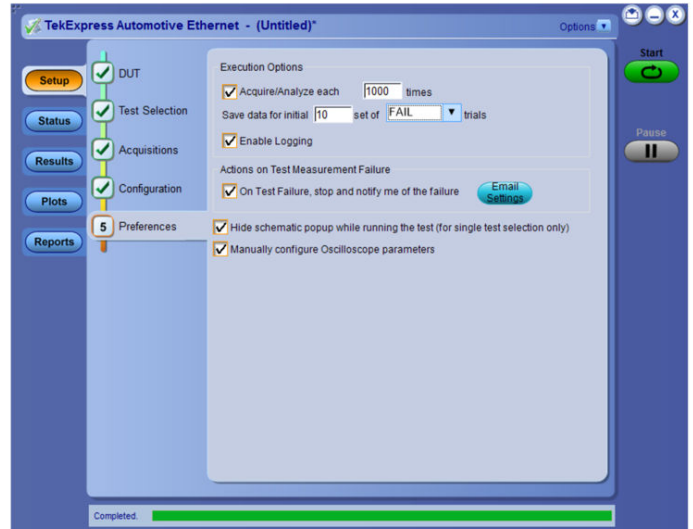

Multi-run configuration for statistical analysis

The TekExpress application allows you to perform multiple runs (loops) of one or more tests for statistical analysis. The application allows you to save failing waveforms for debugging.

Test results:

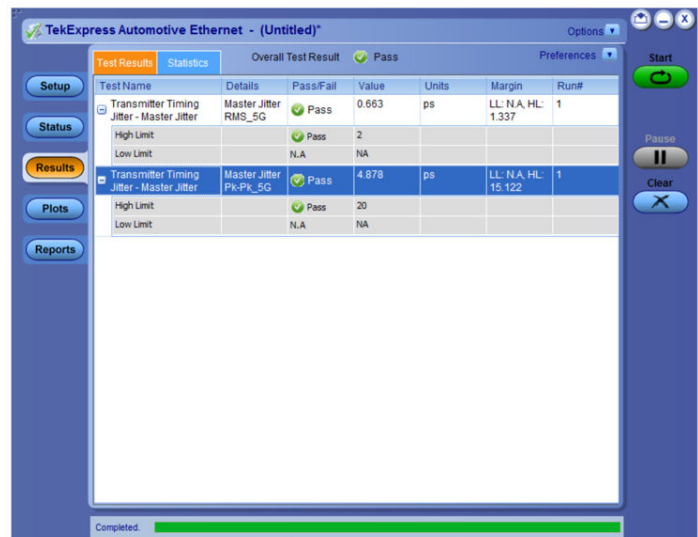

Results tab displaying the summary of test results

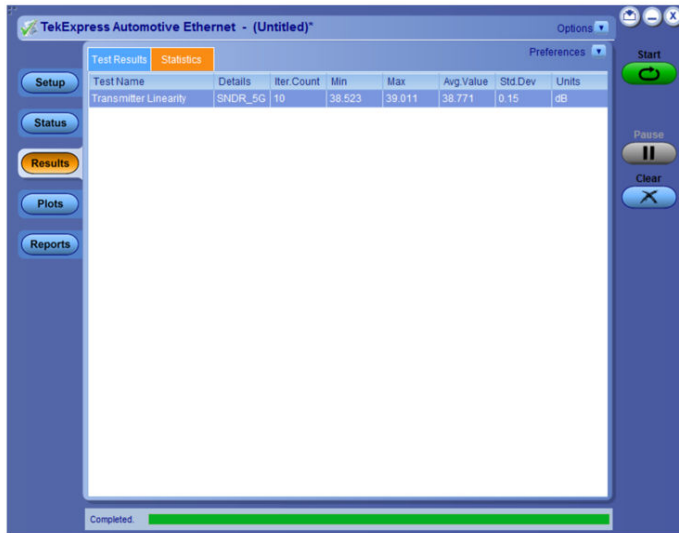

Results tab displaying the test statistics for multi-run analysis

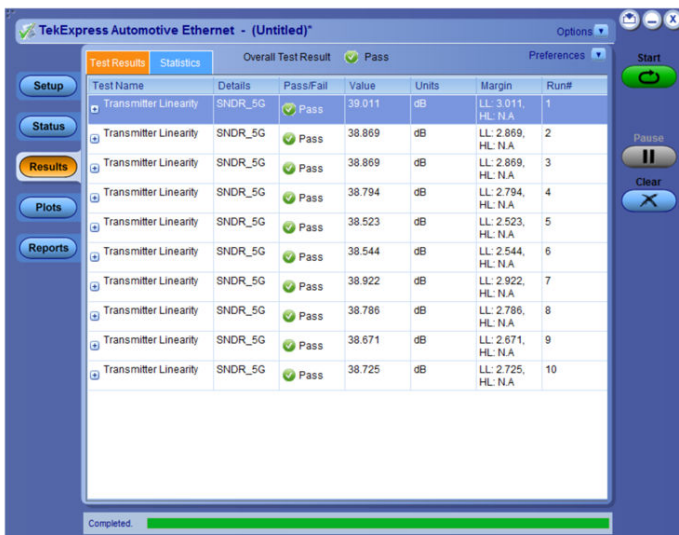

Test results of MultiGBASE-T1: Analyzing test result variation



Detailed test report showing PSD mask test plot

Creating compliance test documentation is quick and easy in the TekExpress application with a summary report in MHL or PDF formats. The application generates a report after the test execution is complete, and includes pass/fail status to quickly analyze the test results. The report also includes test configuration details, waveform plots, oscilloscope displays, margin analysis, and statistical analysis to provide insights into your design.

Single instrument for Time Domain and Frequency Domain measurements

Automotive Ethernet compliance testing includes time domain measurements such as jitter, droop, peak differential output and clock frequency, as well as frequency domain measurements like power spectral density and return loss. Traditionally, dedicated frequency domain instruments such as spectrum analyzers and vector network analyzers have been required to perform these measurements. Tektronix' patented algorithms allow you to perform power spectral density and return loss measurements using the 5 or 6 Series MSO.

Return loss measurement

The MDI return loss measurement determines the impedance mismatch from the differential impedance specification of 100 Ω , which will affect hardware interoperability. The Tektronix Automotive Ethernet solution can perform this test with an oscilloscope and function generator using a patented measurement approach. Return loss using this method is available for 10BASE-T1S, 100BASE-T1, and 1000BASE-T1.

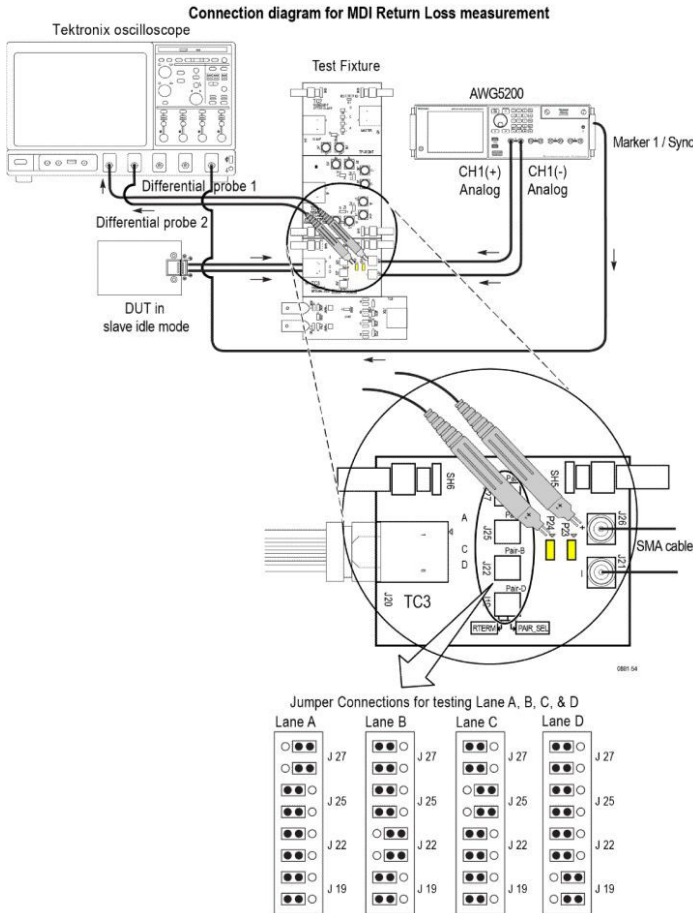

Note: For best result, connect the oscilloscope, DUT, and test fixture to a common ground.

Tektronix patented return loss measurement using oscilloscope and AWG for 100/1000BASE-T1



Return loss plot generated using oscilloscope and AWG method

Power spectral density

The power spectral density of a test signal (as per the appropriate test modes for Multigigabit Ethernet/ 1000BASE-T1/100BASE-T1/10BASE-

T1S), is computed using built-in MATH functions. Post processing is done on the signal to arrive at the PSD. The computed PSD is then compared with the specification by using lower and upper masks to arrive at the final result.

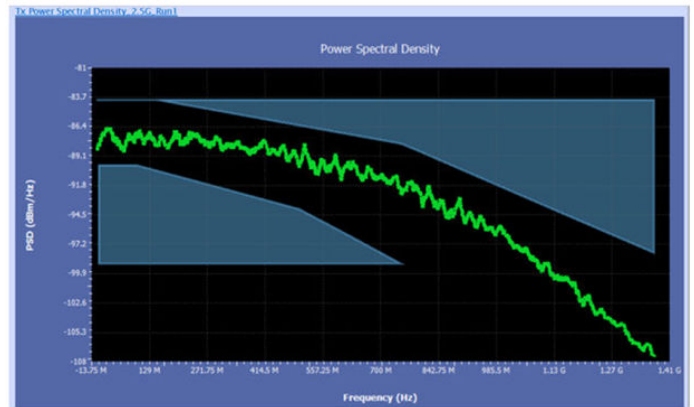

Power spectral density plot

Debug and validation

Validation and debugging can easily be accomplished early in the design process and ahead of final compliance testing by using the 5 Series and 6 Series B MSO's. The oscilloscope's standard measurement set, along with Opt. 5-DJA/6-DJA Advanced Jitter and Timing Analysis software, supports several of the key compliance tests including:

- Clock frequency and transmitter amplitude with histogram and trend analysis.
- Positive and negative droop measurements.
- Full characterization of jitter performance including TIE and histogram profiles.
- Deterministic and random jitter performance using TIE method.
- Eye diagram analysis of PAM3 signals.

This type of early testing increases the likelihood of passing compliance tests, while allowing more complete characterization and determination of design margins. Master and slave jitter measurements can be particularly challenging given the tight compliance limits and the need to eliminate any possible sources of random or deterministic jitter.

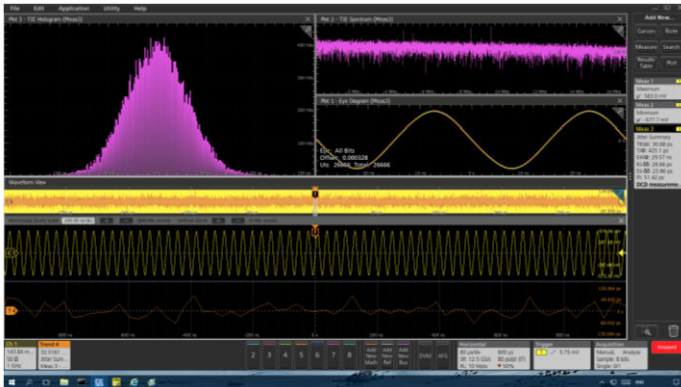

Jitter Measurement using DPOJET

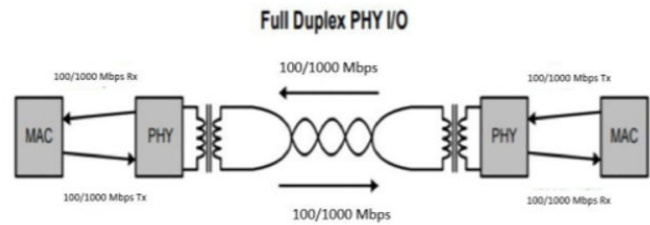

Automotive Ethernet operates as a full-duplex communication link over a twisted pair cable. The full-duplex communication along with PAM3 signal adds complexity in validating the ECU's in the real-world conditions. To perform signal analysis over the link and to decode the protocol in a real system environment, designers need to look at each link separately which requires them to separate the signals before performing analysis.

Tektronix award winning signal separation solution separates the full-duplex signal using advanced software. The signal separation solution accesses the voltage and current signals from either the Master or Slave test point, or from both sides simultaneously using the Tektronix proprietary Signal Separation algorithm. This method displays true ECU signals (Master and Slave) without impacting the ECU's. Please refer to the datasheet <https://download.tek.com/datasheet/PAM3-Datasheet.pdf> for more information.

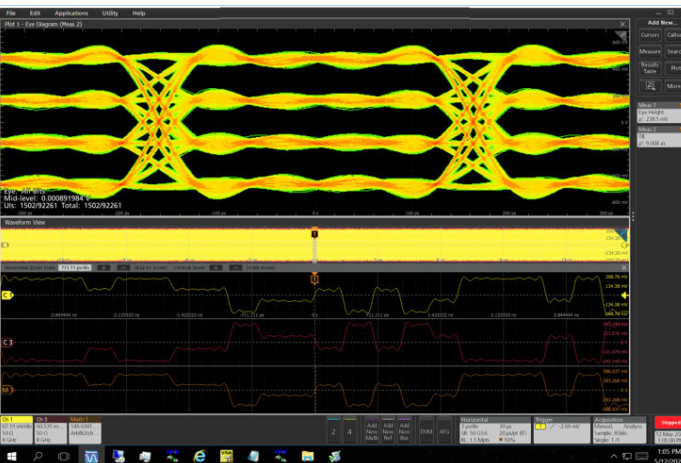

Eye diagram using DPOJET

Jitter tests quantify the timing variations of the edges of the signal, using specified test patterns. These jitter measurements include the contributions from duty cycle distortion and the baseline wander. Jitter is determined by accumulating waveforms, measuring the width of the accumulated points at the eye crossing. The peak-to-peak is inferred from minimum and maximum values in the tails of the histogram.

The new jitter measurements introduced with Multigigabit Ethernet provides separate limits for Deterministic Jitter (DJ), Even Odd Jitter (EOJ) and Random Jitter (Rj). The DPOJET analysis (Opt. DJA) tool provides additional analysis capabilities like crosstalk or power noise separation which helps to find root cause of the failure.

See the true automotive ethernet signal at system the level (Opt. AUTOEN-SS and Opt. PAM3)

The integration of Automotive Ethernet technology is placing greater demands on comprehensive design validation to ensure interoperability and reliability between multiple ECU's and devices that will perform reliably in demanding environments. To meet strict compliance tests and have greater confidence in design margins operating under real world conditions, a complete testing solution is a necessity.

Automotive Ethernet and full duplex communication

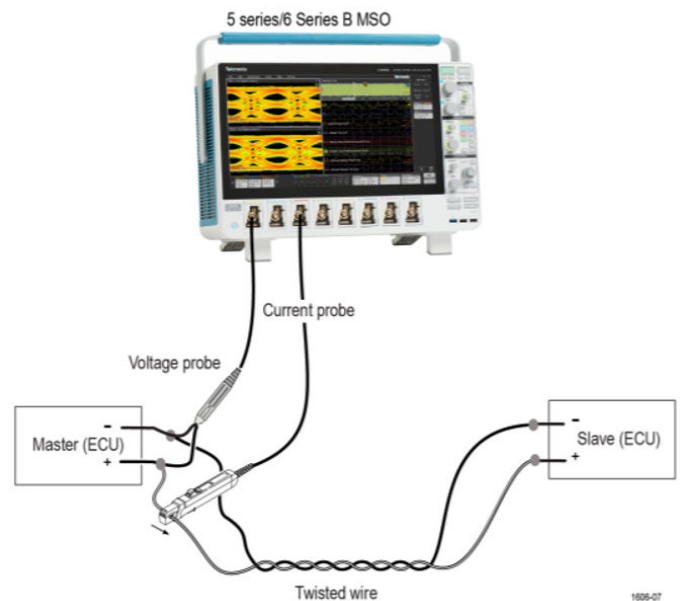

Software based signal separation configuration

Automotive Ethernet decoder for 100BASE-T1 (Opt. SRAUTOEN1)



100BASE-T1 Protocol decode solution

The Tektronix protocol decode solution can work with the signal separation technique outlined above, or with a directional coupler. Decoded traffic is displayed in a protocol-aware view with the characters and names that are familiar from the standards such as the ordered sets: SOF, Electrical Idle, and EOF.

Opt. SRAUTOEN1 protocol decode software can easily decode PAM3 encoded 100BASE-T1 signals. This enables the engineers to quickly understand the protocol activity between the Master and Slave ECU. The event tables show decoded traffic with time stamps and are synchronized with waveforms, allowing you to scan through the packets to correlate any errors and signal anomalies.

Key features

- Decodes PAM3 encoded 100BASE-T1 signals.
- Decodes Send_N mode packets without any training sequence.
- Validate FCS and reports error packets in red.
- Display the time stamp, packet type, IP source and destination address, decoding of the payload.
- Detail view correlates the decoded packets with waveform using a bus diagram.
- Separately displays Master and Slave packets.

Ordering information

Standard	Compliance test	Instrument	Model number
MultiGBASE-T1	Droop, Linearity, Dj and Rj Jitter, Power Spectral Density, Clock frequency, Peak Differential output	Oscilloscope with bandwidth <ul style="list-style-type: none"> • ≥ 4 GHz for 2.5GBASE-T1 • ≥ 6 GHz for 5GBASE-T1 • ≥ 13 GHz for 10GBASE-T1 	MSO6B and <i>DPO70000 SX/DX</i> Series
	MDI Return Loss	Vector Network Analyzer with bandwidth ≥ 4 GHz	8.5 GHz ShockLine MS46522B 2-port VNA
1000BASE-T1	Droop, Jitter, Power Spectral Density, Clock frequency, Peak Differential output	Oscilloscope with bandwidth ≥ 2 GHz	MSO5/6B or DPO70000 C/SX/DX Series
	Distortion Test	2 channel Arbitrary Function Generators with bandwidth ≥ 125 MHz	AFG31000 or AWG5200 Series
	MDI Return Loss	Vector Network Analyzer with bandwidth ≥ 1 GHz	8.5 GHz ShockLine MS46522B 2-port VNA
	MDI Mode conversion	Vector Network Analyzer with bandwidth ≥ 1 GHz	8.5 GHz ShockLine MS46522B 2-port VNA
100BASE-T1	Droop, Jitter, Power Spectral Density, Clock frequency, Peak Differential output, Common mode emission	Oscilloscope with bandwidth ≥ 1 GHz	MSO5/6B or DPO70000 C/SX/DX Series
	Distortion Test	2 channel Arbitrary Function Generators with bandwidth ≥ 25 MHz	AFG31000 Series
	MDI Return loss	Vector Network Analyzer with bandwidth ≥ 1 GHz	8.5 GHz ShockLine MS46522B 2-port VNA
	MDI Mode conversion	Vector Network Analyzer with bandwidth ≥ 1 GHz	8.5 GHz ShockLine MS46522B 2-port VNA
10BASE-T1S	Droop, Jitter, Power Spectral Density, Clock frequency, Peak Differential output	Oscilloscope with bandwidth ≥ 350 MHz	MSO5/6B Series
	MDI Return loss	Arbitrary Function Generators	AFG31000 Series

Software option

Standard	Product	Option	Description
MultiGBASE-T1 Compliance	New Instrument order option	Opt. 6-CMAUTOEN10G	TekExpress Automotive Ethernet - MultiGBASE-T1 Compliance Solution (Requires Opt. DJA)
	Product upgrade option	Opt. SUP6-CMAUTOEN10G	TekExpress Automotive Ethernet - MultiGBASE-T1 Compliance Solution (Requires Opt. DJA); Upgrade
	Floating license	Opt. SUP6-AUTOEN10G-FL	TekExpress Automotive Ethernet - MultiGBASE-T1 Compliance Solution (Requires Opt. DJA); Floating
1000/100BASE-T1 Compliance	New Instrument order option	Opt. 5-CMAUTOEN Opt. 6-CMAUTOEN	TekExpress Automotive Ethernet Compliance
	Product upgrade option	Opt. SUP5-CMAUTOEN Opt. SUP6-CMAUTOEN	TekExpress Automotive Ethernet Compliance; Upgrade
	Floating license	Opt. SUP5-CMAUTOEN-FL Opt. SUP6-CMAUTOEN-FL	TekExpress Automotive Ethernet Compliance; Floating
10BASE-T1S Compliance	New Instrument order option	Opt. 5-CMAUTOEN10 Opt. 6-CMAUTOEN10	TekExpress Automotive Ethernet 10BASE-T1S compliance
	Product upgrade option	Opt. SUP5-CMAUTOEN10 Opt. SUP6-CMAUTOEN10	TekExpress Automotive Ethernet 10BASE-T1S compliance; upgrade
	Floating license	Opt. SUP5-CMAUTOEN10-FL Opt. SUP6-CMAUTOEN10-FL	TekExpress Automotive Ethernet 10BASE-T1S compliance; floating

Required software

Standard	Compliance test	Option	Description
MultiGBASE-T1	DPOJET Analysis	Opt. DJA	Advance Jitter Analysis (Order preinstalled on a new oscilloscope)

Software bundles

Bundle options	Description	Includes
5-PRO-AUTO-1Y	1 Year License Pro Auto Bundle for 5 Series MSO	<ul style="list-style-type: none"> • 10BASE-T1S, 100BASE-T1, 1000BASE-T1, Multigigabit Ethernet Compliance • MIPI D-PHY Compliance • Automotive Ethernet Signal Separation • PAM3 Analysis • Jitter Analysis • Inverter & Motor Drive Analysis • 100BASE-T1, CAN, CAN-FD, LIN, FlexRay, SENT, PSIS, CXPI, I3C Protocol decode
5-PRO-AUTO-PER	Perpetual License Pro Auto Bundle for 5 Series MSO	
6-PRO-AUTO-1Y	1 Year License Pro Auto Bundle for 6B Series MSO	
6-PRO-AUTO-PER	Perpetual License Pro Auto Bundle for 6B Series MSO	

Probes

Standard	Compliance test	Description
MultiGBASE-T1	TDP3500	Only for clock measurement
1000BASE-T1	TDP3500	All measurements
100BASE-T1	TDP1500	All measurements
10BASE-T1S	TDP1500	All measurements

MDI Return loss with AWG/AFG method

Standard	Model Number	Description
1000BASE-T1	AWG5202 with Opt. 250, 2 HV	Tektronix AWG5200 with high amplitude DC coupled with output option
	TDP3500 (2 nos)	3.5 GHz Differential Probe with TekVPI™ Probe Interfaces (requires TCA-VPI50 adapter)
100BASE-T1	AFG31152	1 µHz to 150 MHz sine wave, 2-channel arbitrary function generator
	TDP1500 (2 nos)	1.5 GHz Differential Probe with TekVPI™ Probe Interfaces (requires TCA-VPI50 adapter)
10BASE-T1S	AFG31152	1 µHz to 150 MHz sine wave, 2-channel arbitrary function generator
	TDP1500 (2 nos)	1.5 GHz Differential Probe with TekVPI™ Probe Interfaces (requires TCA-VPI50 adapter)

Accessory

Accessory	Part number	Use case
Multigigabit Ethernet Fixture	PCB S3401 SB 396373 ²	Compliance measurement

Table continued...

² 3rd Party items

Accessory	Part number	Use case
100/1000BASE-T1 Fixture	TF-XGBT	Compliance measurement
	02K3E6 K00S3 387390 ²	Mode conversion and Return loss fixture with Rosenberger connector type
	02K3E6 S00S3 387391 ²	
	02S3E6 S00S3 387392 ²	
02S3E6 K00S3 387393 ²		
100BASE-T1 Protocol decode fixture	DCDP for H-MTD	Protocol decode directional coupler
Clock divider unit	TF-BRR-CFD	Distortion test
Cable ²	SMA(f) to SMA(m) phase stable cables and N(m) to SMA(m) adapters (2 nos)	Return Loss and MDI Mode conversion
Cal kit for Anritsu ²	TOSLKF50A-20 calibration kit	MDI Return and Mode conversion loss
Power splitter ²	Mini circuit Z99SC-621	Common mode emission test



Tektronix is registered to ISO 9001 and ISO 14001 by SRI Quality System Registrar.



Product(s) complies with IEEE Standard 488.1-1987, RS-232-C, and with Tektronix Standard Codes and Formats.



Product Area Assessed: The planning, design/development and manufacture of electronic Test and Measurement instruments.

ASEAN / Australasia (65) 6356 3900
 Belgium 00800 2255 4835*
 Central East Europe and the Baltics +41 52 675 3777
 Finland +41 52 675 3777
 Hong Kong 400 820 5835
 Japan 81 (120) 441 046
 Middle East, Asia, and North Africa +41 52 675 3777
 People's Republic of China 400 820 5835
 Republic of Korea +822 6917 5084, 822 6917 5080
 Spain 00800 2255 4835*
 Taiwan 886 (2) 2656 6688

Austria 00800 2255 4835*
 Brazil +55 (11) 3759 7627
 Central Europe & Greece +41 52 675 3777
 France 00800 2255 4835*
 India 000 800 650 1835
 Luxembourg +41 52 675 3777
 The Netherlands 00800 2255 4835*
 Poland +41 52 675 3777
 Russia & CIS +7 (495) 6647564
 Sweden 00800 2255 4835*
 United Kingdom & Ireland 00800 2255 4835*

Balkans, Israel, South Africa and other ISE Countries +41 52 675 3777
 Canada 1 800 833 9200
 Denmark +45 80 88 1401
 Germany 00800 2255 4835*
 Italy 00800 2255 4835*
 Mexico, Central/South America & Caribbean 52 (55) 56 04 50 90
 Norway 800 16098
 Portugal 80 08 12370
 South Africa +41 52 675 3777
 Switzerland 00800 2255 4835*
 USA 1 800 833 9200

* European toll-free number. If not accessible, call: +41 52 675 3777

For Further Information. Tektronix maintains a comprehensive, constantly expanding collection of application notes, technical briefs and other resources to help engineers working on the cutting edge of technology. Please visit www.tek.com.

Copyright © Tektronix, Inc. All rights reserved. Tektronix products are covered by U.S. and foreign patents, issued and pending. Information in this publication supersedes that in all previously published material. Specification and price change privileges reserved. TEKTRONIX and TEK are registered trademarks of Tektronix, Inc. All other trade names referenced are the service marks, trademarks, or registered trademarks of their respective companies.

21 Jun 2021 61W-73783-1
www.tek.com

Tektronix[®]