

CEI-VSR

Compliance and Debug Solution

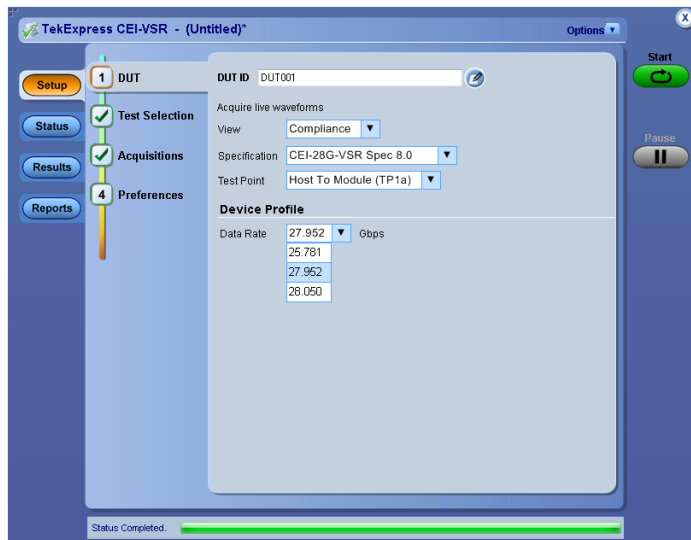

TekExpress® CEI-VSR user interface for PHY measurements

CEI-VSR Compliance and Debug Solution

The new CEI-VSR solution helps customers to easily select measurements for CEI-28G-VSR testing. Simple and easy-to-use measurement setup helps customers perform all measurements with a single button click. Automation options help customers meet their compliance needs and generate detailed reports. User-defined mode lets customers make changes to the test limits and perform margin testing beyond compliance.

- With an industry-leading intrinsic jitter of less than 100 femtoseconds for extremely accurate device characterization, the DSA8300 Series provides comprehensive support for Electrical and Optical Communications Standards.

Key features

- Option CEI-VSR enables both an automation solution (for compliance) and 80SJNB Option (for debug)
- Option CEI-VSR works on Tektronix DSA8300 Series oscilloscopes; it allows you to automate setup and quickly generate reports
- Meets compliance needs of CEI-28G-VSR Host-To-Module (H2M) and Module-To-Host (M2H)
- Supports PRBS9 pattern for all measurements, and in addition, supports 8180 pattern for transition time measurement.
- VEC (Vertical Eye Closure) measurement is provided as an informative test under the H2M section
- Option CEI-VSR determines the optimal value of CTLE peaking, which is required by the CEI 28G Very Short Reach for the H2M interface.

The best CTLE filter is chosen from the given set of filters and used for performing the measurement.

- Peaking Value and Loop BW are configurable and help to achieve better measurement accuracy
- Under user defined mode, users can configure BER and rely on the feature available to perform this complex measurement
- Detailed test reports with margin and statistical information aid analysis
- User-defined mode enables flexible parameter control for characterization and margin analysis
- Complete programmatic interface available; users can call CEI-VSR functions using their automation scripts
- Design engineers can utilize many built-in reporting features, such as Appending the Report, Auto-incrementing the Report, including user comments and more to tailor their reporting requirements.
- CEI-VSR Compliance Solution performs Automatic Signal Validation before performing tests and throws an error if the signal does not meet acceptable limits.

Applications

CEI-VSR transmitter testing for:

- Device silicon validation
- Product developers (Product Design, Validation, Debug and Compliance)
- System compliance and debug
- Manufacturing test

Technology overview

Electrical interconnect (chip-to-chip, chip-to-module, board-to-board in the box), electrical backplane and short (<15 m) Infiniband-grade passive cables must support systems fronted with optical 100 Gb/s signaling in standards such as 100GbE Optical (802.3ba) and OTN. Original system designs accomplished this by using 10x10G electrical signaling which has been developed previously to support 10 Gb/s optical links (802.3ae, for example).

Optical Internetworking Forum - Common Electrical Interface - 28G-VSR (CEI-28G-VSR)

This clause details the requirements for the CEI-28G-VSR very short reach high speed chip-module electrical I/O of nominal baud rates of 19.60 Gsym/s to 28.05 Gsym/s. A compliant device must meet all of the requirements listed below. The electrical I/O is based on high speed, low voltage logic, and connections are point-to-point balanced differential pairs. The electrical IA is based on channel loss and jitter budgets. It defines the characteristics required to communicate between CEI-28G-VSR drivers and CEI-28G-VSR receivers using copper signal traces on a printed circuit board, a mated connector pair and copper signal traces inside an optical module. These characteristics are normative for the devices and informative for the channel. A 'length' is effectively defined in terms of its attenuation and phase response rather than its physical length. CEI-28G-VSR devices from different manufacturers shall be interoperable.

Increasing worldwide demand for video and data transfer is placing new requirements for network expansion. Designers are creating innovative network elements that allow up to 100 Gb/s, which will be delivered using four lanes of 25-28 Gb/s. The Implementation Agreement for Optical Internetworking Forum Common Electrical Interface (OIF CEI) 3.0 specifies the tests and limits for these devices.

The use of pluggable optical transceivers is a common practice in equipment developed for the communications market. Developing interoperable pluggable IO (input/output) solutions that keeps up with the demanding bandwidth needs of industry is critical to enabling next generation equipment that supports the communications service providers. The 28G-VSR channel consists of 100 Ω differential PCB traces, vias, one connector and AC coupling capacitors. The 28G-VSR IA is intended to be used for Very Short Reach channels with up to 10 dB loss at Nyquist rate and is being initially targeted for the next generation of optical modules having retimed interfaces operating at 25 - 28 Gb/s.

Simplified instrument setup

Setup and test execution is simple with the CEI-VSR software. The oscilloscope acquisition and analysis are all controlled through the CEI-VSR automation solution. The Graphical User Interface (GUI) provides an intuitive workflow for setup and testing.

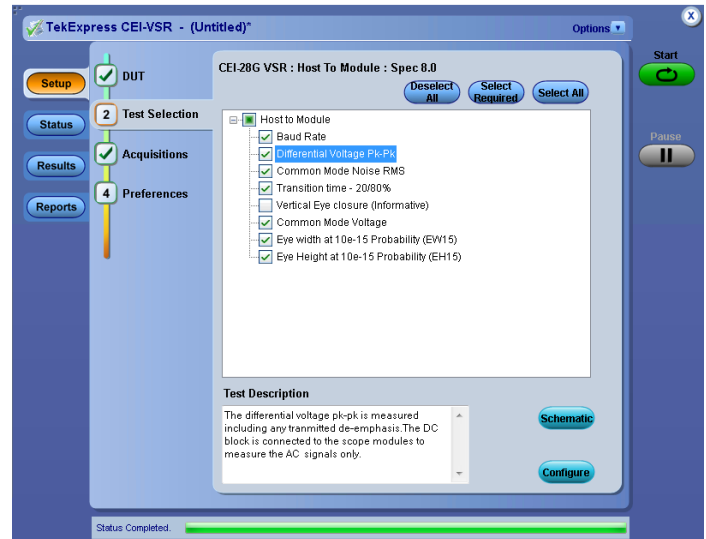

TekExpress® CEI-VSR measurement setup

Test configurations

Design characterization is supported beyond CEI-28G-VSR compliance requirements for all measurements. Qualify PHY with flexible control over test configurations such as analysis windows and other parameters. User-defined mode lets customers make changes to the test limits and perform marginal testing beyond compliance.



Margin testing

User-defined mode

Under user-defined mode, users can configure BER and rely on off-the-shelf products to perform this complex measurement rather than developing custom lab setup, reducing testing time and complexity.

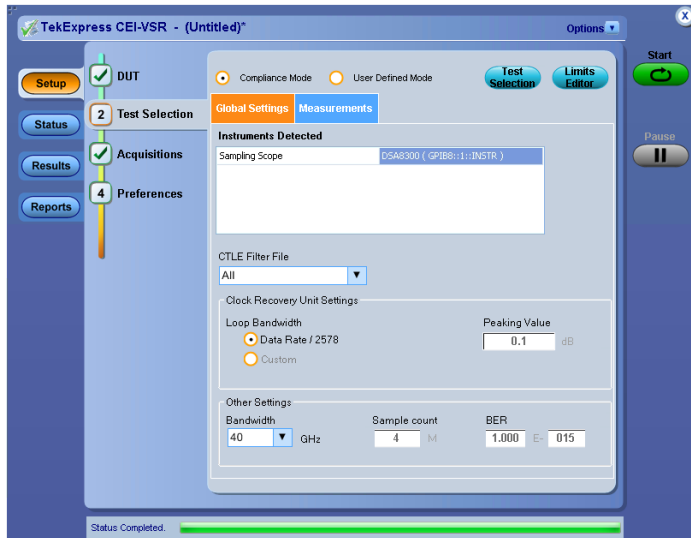

User configurable BER

Automatic selection of CTLE filter

Option CEI-VSR determines the optimal value of CTLE peaking, which is required by the CEI 28G Very Short Reach for the Host-to-Module interface. The best CTLE filter is chosen from the given set of filters and used for performing the measurement. Peaking Value and Loop BW are configurable and helps in better measurement accuracy.

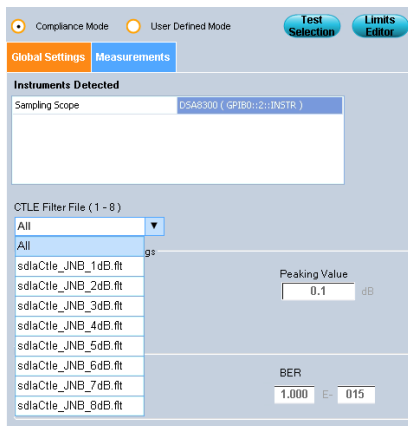

Parameters	CEI-28G-VSR H2M	CEI-28G-VSR M2H
Baud rate	1.1	1.1
Rise times / fall times	13.2	13.3
Differential output voltage	13.2	13.3
Output Common mode voltage	13.2	13.3
TX Common Mode Noise RMS	13.2	13.3
UUGJ-Uncorrelated Unbounded Gaussian Jitter		
UBHPJ-Uncorrelated Bounded High Probability Jitter		
Eye width (EW15)	13.2	13.3
Eye height (EH15)	13.2	13.3
Vertical eye closure		13.3

CEI-28G-VSR measurements covered in Tektronix CEI-VSR solution

Calibration parameter

Design engineers working on their next generation 28G products are given access to various calibration parameters like Deskew, External Attenuation, etc., to make sure results are as accurate as possible.

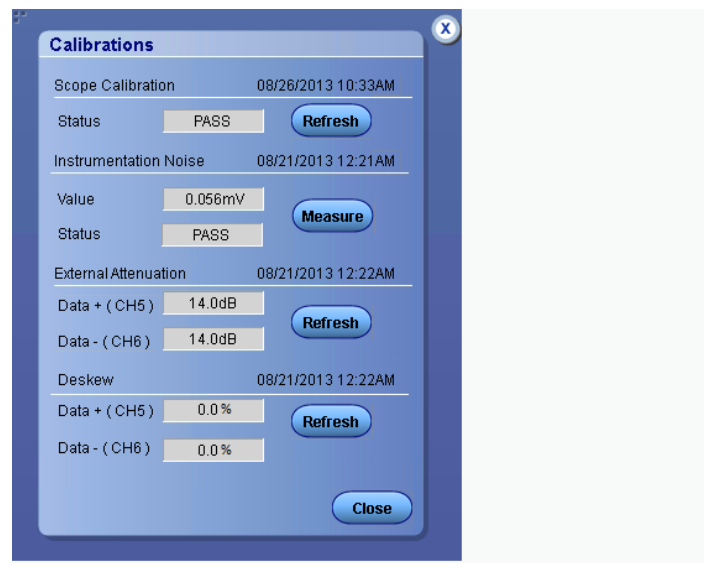

Calibration dialog

Setup diagram

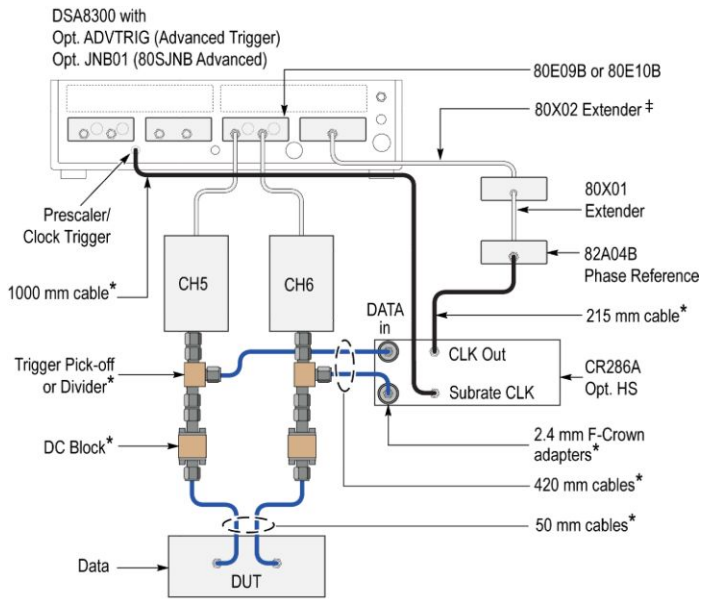

* See application note 071-3207-XX for information about the cables and interconnect accessories required for this setup.

† Or 80N01 Extender

For more information, refer to the Application Note *Practices for Measurements on 25 Gb/s Signaling* on the Tektronix Web site at www.tektronix.com.

Summary report

A summary report in .MHT (MHTML) or PDF format with Pass/Fail status is automatically generated after tests complete. The report includes test configuration details, waveform plots, and margin analysis to provide more insight into your design.

TekExpress CEI-VSR

TekExpress CEI-VSR Host To Module Test Report

Setup Information			
DUT ID	DUT001	Scope Model	DSA8300
Date/Time	2013-10-28 15:14:45	Scope Serial Number	C040103
TekExpress Version	CEI-VSR:1.0.0.65 Framework:3.0.0.21	Scope F/W Version	6.3.1.3
Execution Mode	Live	Data+ connected to	CH3 "80E10"
Overall Compliance Mode	Yes	Data- connected to	CH4 "80E10"
Overall Execution Time	0:06:26	Phase Reference connected to	CH1 CH2 "82A04B"
Overall Test Result	Pass	Data Rate	25.781Gbps
DUT COMMENT:		General Comment - CEI-VSR	

Test Name Summary Table	
Baud Rate	Informative
Differential Voltage Pk-Pk	Pass
Common Mode Noise RMS	Pass
Transition time - 20/80%	Pass
Common Mode Voltage	Pass
Eye width at 10e-15 Probability (EW15)	Pass
Eye Height at 10e-15 Probability (EH15)	Pass

Pass/Fail report

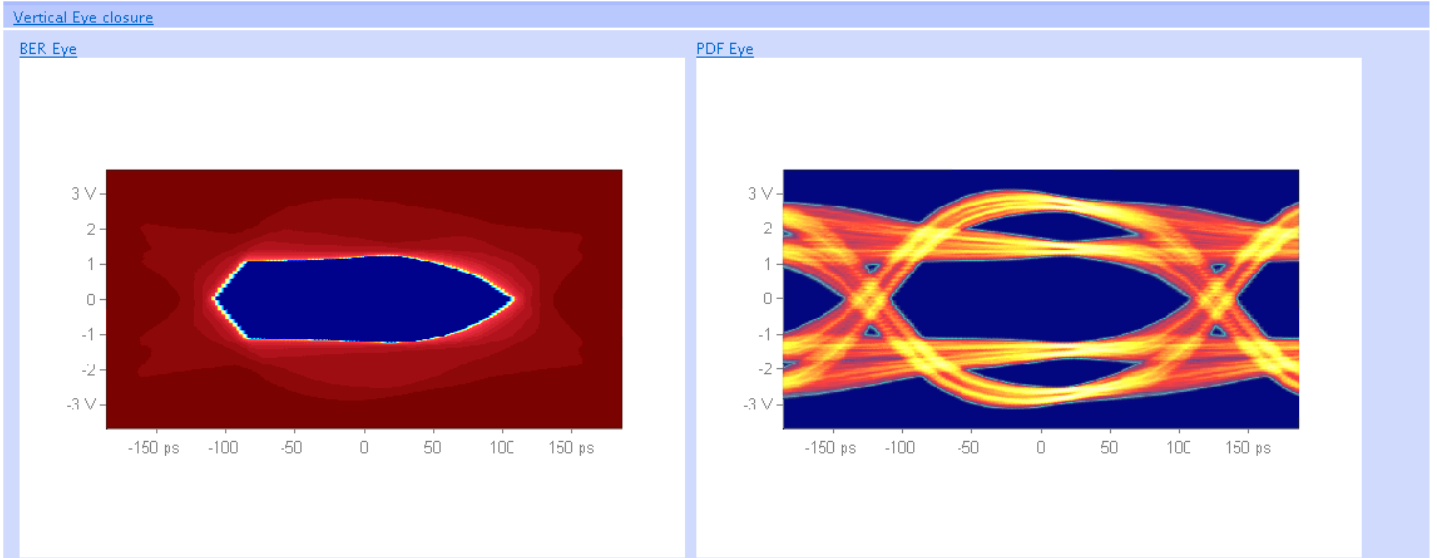

Ordering information

CEI-VSR - OIF CEI 3.0 Compliance Solution for DSA8300

To order with oscilloscope	Oscilloscope Option DSA8300 Order CEI-VSR
To upgrade an oscilloscope	Oscilloscope Option DSA8300 DSA83UP CEI-VSR

Software options

Option CEI-VSR	OIF CEI 3.0 Compliance Solution for DSA8300
Option JNB01	80SJNB Advanced
Option ADVTRIG	Advanced triggers with pattern sync

Recommended accessories

DC block	4 kHz-65 GHz, 2.4 mm connectors, male/female (available from Picosecond Pulse Labs, P/N 5509-205-224)
Pick-off T	2.4 mm, female/male/female (available from Picosecond Pulse Labs, P/N 5361-237-14DB)
Cables:	50 GHz, 2.4 mm, male connectors 65 GHz, 1.85 mm, male connectors
Adapters:	1.85 mm male, to 2.92 mm female 2.4 mm male, to 2.92 mm female

Recommended products

BERTScope clock recovery	CR286A
Remote sampling oscilloscope module	80E10B - 8000 Series, dual-channel, 50 GHz remote electrical sampling module w/TDR, or 80E09B - 8000 Series, dual-channel, 60 GHz remote electrical sampling module
Phase reference module	82A04B - 8000 Series, phase reference module
Module extender cables	80X01 & 80X02 (1 each) - 8000 Series, electrical module extender cable (Please contact Product Marketing for availability and status)

CE Marking Not Applicable.



Tektronix is registered to ISO 9001 and ISO 14001 by SRI Quality System Registrar.



Product(s) complies with IEEE Standard 488.1-1987, RS-232-C, and with Tektronix Standard Codes and Formats.

ASEAN / Australasia (65) 6356 3900
Belgium 00800 2255 4835*
Central East Europe and the Baltics +41 52 675 3777
Finland +41 52 675 3777
Hong Kong 400 820 5835
Japan 81 (3) 6714 3010
Middle East, Asia, and North Africa +41 52 675 3777
People's Republic of China 400 820 5835
Republic of Korea 001 800 8255 2835
Spain 00800 2255 4835*
Taiwan 886 (2) 2722 9622

Austria 00800 2255 4835*
Brazil +55 (11) 3759 7627
Central Europe & Greece +41 52 675 3777
France 00800 2255 4835*
India 000 800 650 1835
Luxembourg +41 52 675 3777
The Netherlands 00800 2255 4835*
Poland +41 52 675 3777
Russia & CIS +7 (495) 6647564
Sweden 00800 2255 4835*
United Kingdom & Ireland 00800 2255 4835*

Balkans, Israel, South Africa and other ISE Countries +41 52 675 3777
Canada 1 800 833 9200
Denmark +45 80 88 1401
Germany 00800 2255 4835*
Italy 00800 2255 4835*
Mexico, Central/South America & Caribbean 52 (55) 56 04 50 90
Norway 800 16098
Portugal 80 08 12370
South Africa +41 52 675 3777
Switzerland 00800 2255 4835*
USA 1 800 833 9200

* European toll-free number. If not accessible, call: +41 52 675 3777

Updated 10 April 2013

For Further Information. Tektronix maintains a comprehensive, constantly expanding collection of application notes, technical briefs and other resources to help engineers working on the cutting edge of technology. Please visit www.tektronix.com.

Copyright © Tektronix, Inc. All rights reserved. Tektronix products are covered by U.S. and foreign patents, issued and pending. Information in this publication supersedes that in all previously published material. Specification and price change privileges reserved. TEKTRONIX and TEK are registered trademarks of Tektronix, Inc. All other trade names referenced are the service marks, trademarks, or registered trademarks of their respective companies.



14 Nov 2013

61W-29487-1

www.tektronix.com

Tektronix[®]

