

## 3-Phase Inverter Motor Drive Analysis

5 Series/5 Series B/6 Series B MSO Option 5-IMDA/6-IMDA Application Datasheet

*Get more visibility into your inverters, motors, and drive systems*

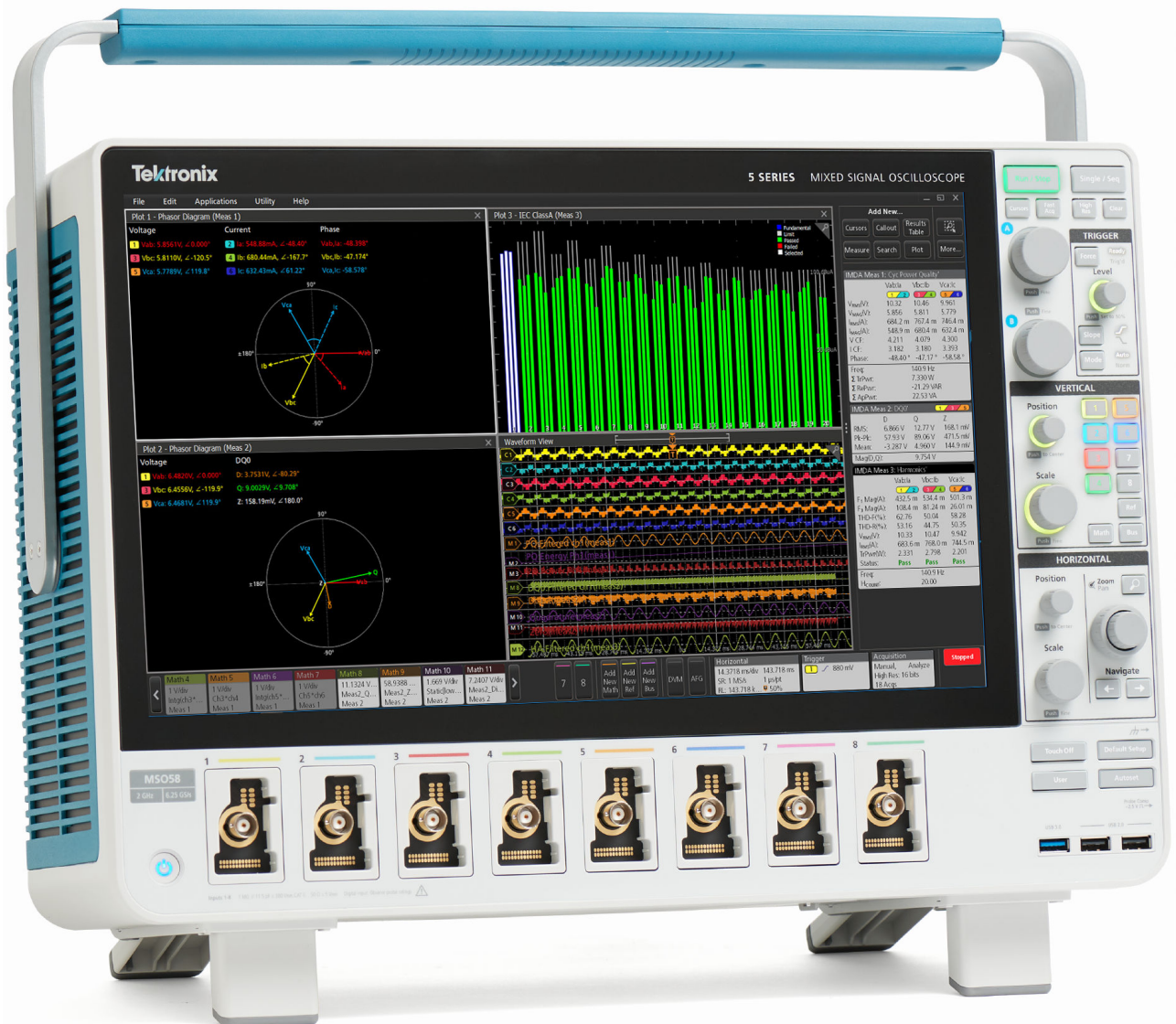

Measurements and analysis on three-phase power systems are inherently more complex than on single-phase systems. Although oscilloscopes can capture voltage and current waveforms with high sample rates, further calculations are required to produce key power measurements from the data. The oscilloscope based three-phase solution allows to capture three-phase voltage and current waveforms with higher sample rates, longer record lengths using the HiRes acquisition mode that goes up to 16-bits and with the support of automated measurements produce key power test results. The Power converters based on Pulse Width Modulation (PWM), such as variable-frequency motor drives can complicate measurements since it is very important to extract precise zero crossings for the PWM signals, thus making an oscilloscope a recommended test tool for validation and troubleshooting for motor designers. Special software, designed to automate power analysis on inverters, motors, and drives, greatly simplifies important three-phase power measurements on PWM systems and can help engineers get faster insights into their designs. The Inverter Motor Drive Analysis (IMDA) solution from Tektronix helps engineers design better and more efficient three-phase motor drive systems, taking full advantage of the advanced user interface, six or eight analog input channels, and 'High Res' mode (16 bits) on the 5 Series/5 Series B/6 Series B MSO. The IMDA solution provides fast, accurate, and repeatable results for electrical measurements on industrial motors and drive systems for AC induction motors, permanent magnet synchronous motors (PMSM), and brushless DC (BLDC) motors. It can be configured to measure DC to three-phase AC converters, such as those used in the electric vehicles.

### Key features and specifications

- Accurately analyze three-phase PWM signals used to drive AC induction, BLDC, and PMSM motors.
- Unique oscilloscope based phasor diagrams indicate  $V_{RMS}$ ,  $I_{RMS}$ ,  $V_{MAG}$ ,  $I_{MAG}$ , and phase relationships at a glance for the configured wiring pairs.
- Debug motor drive designs by viewing the drive input/output voltage and current signals in the time domain simultaneously with the phasor diagram.
- Three-phase Autoset feature configures the oscilloscope for optimal horizontal, vertical, trigger, and acquisition parameters for acquiring three-phase signals.
- Measures three-phase harmonics per the IEC-61000-3-2, IEEE-519, or custom limits.
- Measures the system efficiency based on the selected wiring configurations.
- Quickly add and configure measurements through the intuitive drag and drop interface on the 5 Series/5 Series B/ 6 Series B MSO.
- Analyze Inverter and Automotive three-phase designs for DC input and AC output wiring configuration.
- Displays the PWM filtered edge qualifier waveform during analysis.
- Displays the test results per Record, or per Cycle mode during analysis for specific measurements.

- Supports Time trend and Acquisition trend plots for specific measurements.
- Supports mathematical conversion of Line-Line to Line-Neutral for specific wiring.
- Supports DQ0 measurements with the phasor plot and DQ0 resultant vector.
- Supports mechanical measurements using Hall sensors and QEI (Quadrature Encoder Interface) signals with and without the Index pulse.
- Supports Torque measurement.
- Supports harmonic gating of all measurements by fundamental frequency and full spectrum.

### Measurement overview

Three-phase power converters such as variable frequency drives require a range of measurements during the design process. The Inverters, Motors, and Drives Analysis package for the 5 Series/5 Series B/6 Series B MSO automates key electrical measurements which are grouped into the Electrical Analysis group. The measurements can be configured to measure the Input or Output wiring configuration.

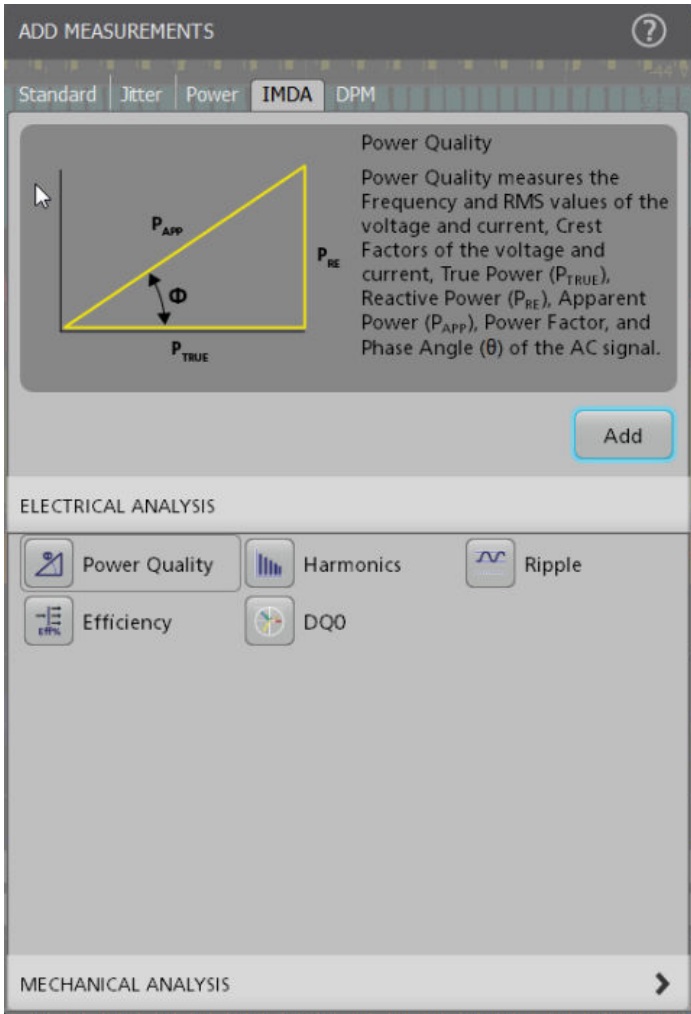

IMDA measurements under Electrical Analysis group

The measurements can be set to measure 1V1I (1-Phase-2-Wire), 2V2I (1-Phase-3-Wire), 2V2I (3-Phase-3-Wire), 1V1I (1-Phase 2-Wire DC) or 3V3I (3-Phase-3-Wire), and 3P4W (3-Phase-4-Wire) to support various supply and motor configurations. Measurements can be performed line-to-line or line-to-neutral, to support delta and wye or star configurations.



Configuring the measurement for Input wiring configuration

## Harmonics

Power waveforms are rarely textbook sinusoids. Harmonics measurements break down non-sinusoidal voltage or current waveforms into their sinusoidal components, indicating the frequency and amplitude for each component.

Harmonics analysis can be performed up to 200<sup>th</sup> harmonic order. The maximum harmonic order can be set to suit your needs by specifying the range in the measurement configuration. THD-F, THD-R and fundamental values are measured for each phase. Measurements can be evaluated against the IEEE-519 or IEC 61000-3-2 standard, or custom limits. Test results can be recorded in a detailed report indicating pass/fail status.

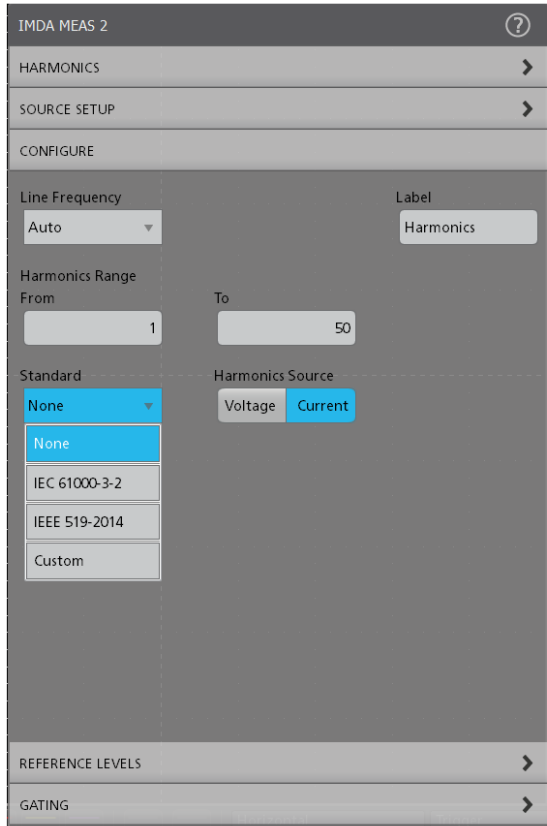

Compare harmonics measurements against industry standards or custom limits

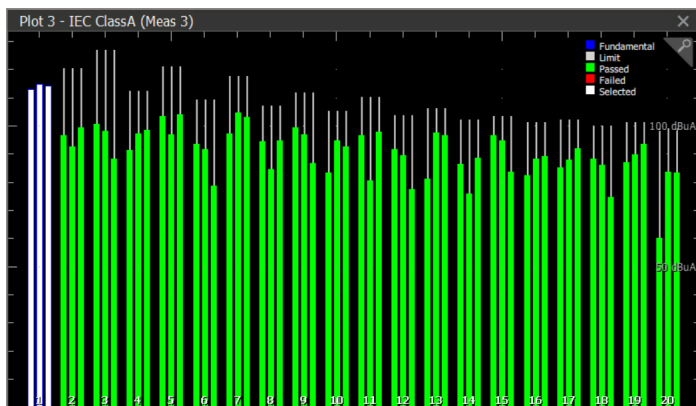

A sample harmonics plot indicates passing harmonics test results. Each set of bars contains results for Phase A, B, and C for easy correlation.

The Harmonics plot shows the test results for all three phases grouped together so user can correlate the test results between the phases. The plot also shows the test results visually. The harmonics bars are highlighted in green color during a pass condition, and highlight to red color when it exceeds the test limits. This gives a quick insight when debugging for harmonics design.

### Power quality

This measurement provides critical three-phase power sub-measurements including: frequency and RMS magnitudes of voltage and current, crest factors of voltage and current, PWM frequency, and phase angle for each phase. It also displays the sum of true power, sum of reactive power, sum of apparent power components.

Additionally, in the Line-Neutral configuration, this measurement displays True Power, Reactive Power, and Apparent Power components of all the three-phases.

Voltage and current vectors can be displayed on a phasor diagram so you can quickly judge phase shift for each phase and the balance among phases. Each vector is represented by an RMS value and phase is computed using the Discrete Fourier Transform (DFT) method.

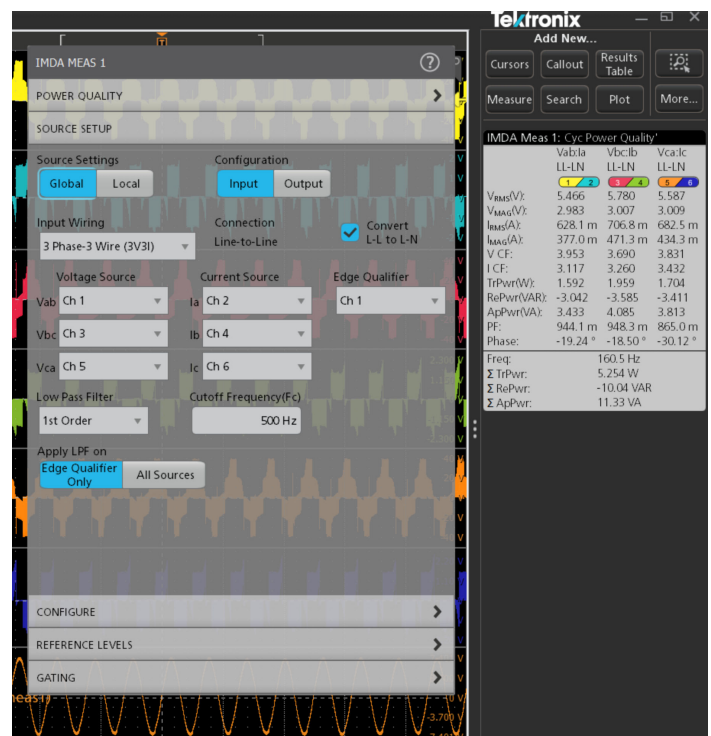

Easily configure the settings to get insight into the power quality

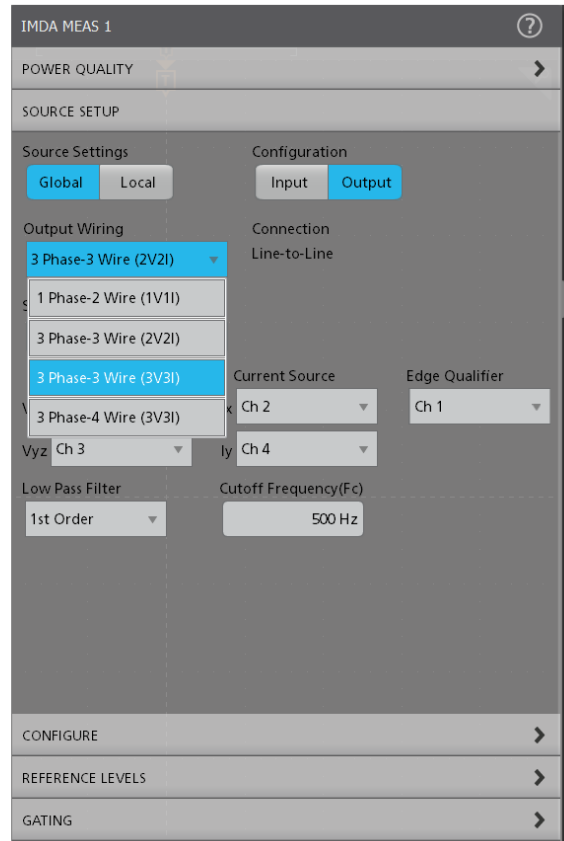
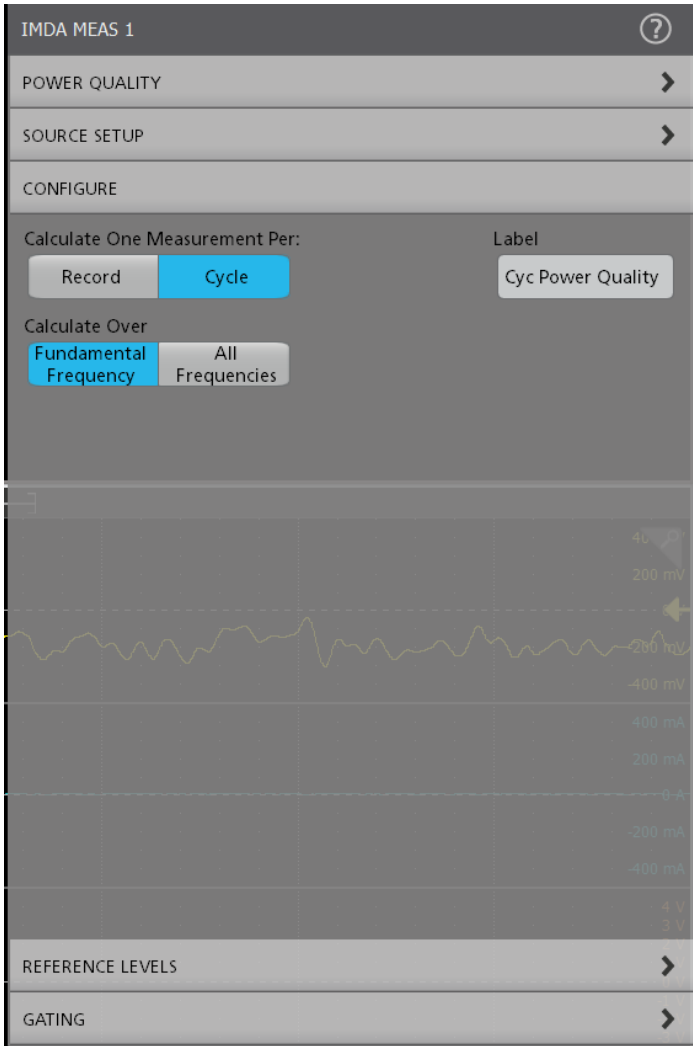

Easily configure the voltage and current inputs on the Power Quality measurement to display phasor diagrams

*Method to compute power quality*

The Power quality measurement can be configured to provide critical three-phase power measurements on the output side, including: frequency and RMS magnitudes of voltage and current, crest factors of voltage and current, PWM frequency, true power, reactive power, apparent power, power factor, and phase angle for each phase.

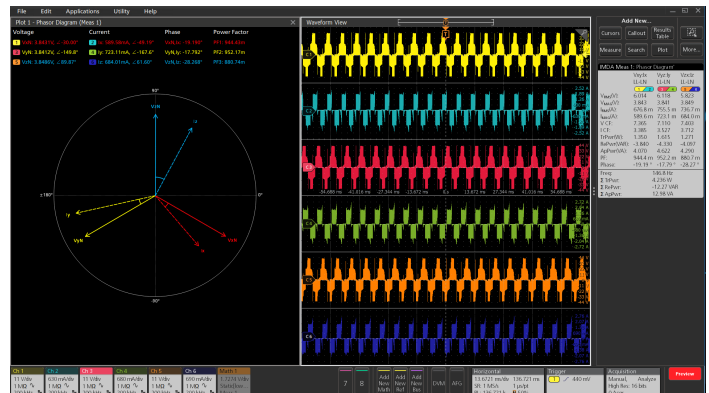

Unique oscilloscope based phasor diagram feature provides the relation between the voltage and current vectors





## Ripple analysis

Ripple is defined as the residual or unwanted AC voltage on a constant DC component. It is typically measured on the DC bus. This measurement helps to understand how efficiently the signal is getting converted from AC-DC on the input side, and the impact of unwanted components on the PWM signal on the output side.

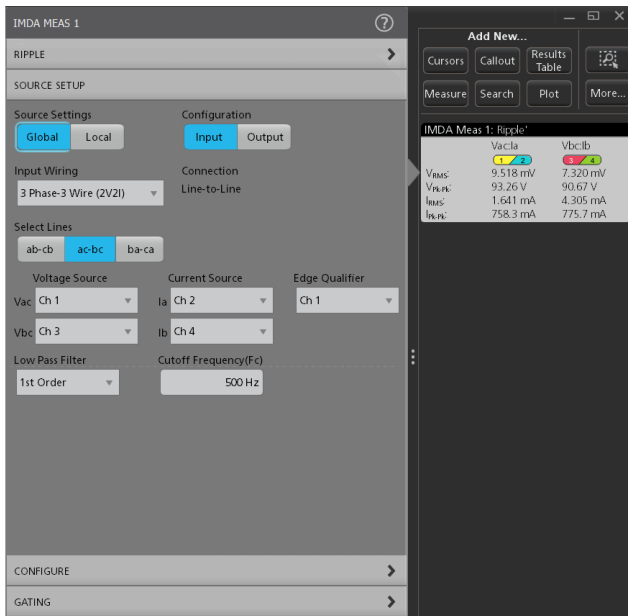

Ripple analysis configuration can be set to look into line and switching ripple



Ripple measurement being carried out on the DC-input signals when testing an Inverter

## Direct Quadrature Zero (DQ0) analysis

The behavior of three-phase AC machines can be described by rotating voltage and current equations as below.

$$V_A = Vg \times \cos ( w(t) )$$

$$V_B = Vg \times \cos \left( \frac{w(t)-2\pi i}{3} \right)$$

$$V_C = Vg \times \cos \left( \frac{w(t)-4\pi i}{3} \right)$$

Where,

A, B, and C are three phase AC signals.

'Vg' is the corresponding gain.

'w(t)' is the  $2\pi i \times t$ .

The voltages (V) and currents (I) at the AC interface are usually separated, typically 120 degrees out of phase. These V and I components are time-varying, which means there is no representation of a steady-state operation point.

Generally, AC signals are real-world signals, but converting them to DC helps get an abstract representation of the direct quadrature transform. The DQ0 assists in emulating the controller. This information helps to understand more about what the controller is doing and allows to tune the controller design.

The DQ0 transformations typically rotate the reference frames of AC waveforms to convert them to DC signals. This allows simplified calculations on the DC signals before performing the inverse transform to recover the actual three-phase AC results.

To measure and monitor the control system's output, the designers depend on FPGA's and ASIC-based hardware to handle sensor data to get the DQ0 information and then check the control information through multiple iterations. This solution involves a complex and time taking process.

It is practically challenging to measure or probe the D-Q-0 signals. A typical solution provides an external stimulus to the controller to replicate the controller input signals and the Analog-Digital Controller (ADC) outputs as the DQ0 signals.

To address this challenge, users depend on the software application DQ0 solution to understand the complex dynamic phenomena in power control systems.

The IMDA solution features DQ0 transformation, which rotates the reference frames of the three phase waveforms, so they become DC signals. Calculations can be simplified on these DC quantities before inverting them and getting to the actual three-phase AC results. A basic control scheme is shown in the following figure.

systems. Without this information, it would be difficult to understand the performance of the motor control systems.

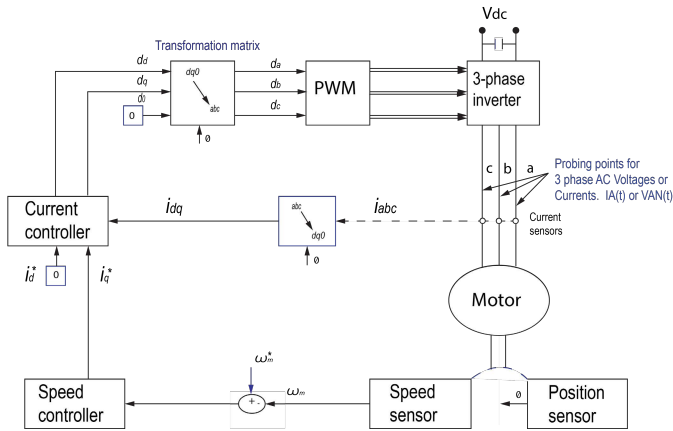

A basic control scheme for a permanent magnet synchronous motor

Typical connection setup and probing points for doing DQ0 measurements

Tektronix offers a patented on-scope measurement called DQ0 under the electrical analysis measurement category as an added option using Clarke's and Park's transformation matrix. The DQ0 feature is available as an option 5-IMDA-DQ0/6-IMDA-DQ0 on the 5 Series, 5 Series B, and 6 Series B MSO.

The DQ0 method calculates the angle ( $\theta$ ) as  $2\pi \cdot f \cdot t$  and extrapolates the reference frame based on where we expect time-varying signals to be. The DQ0 frame (phasor diagram) rotates with the right speed and frequency and not necessarily in phase with the rotor, which helps to understand the instantaneous state of the motor.

This measurement is supported in the 3V3I configuration, takes the three-phase voltage or current signals from the motor as inputs, and converts them into D-Q-0 coefficients acting as a powerful debugging tool for the motor designers to tune their PWM controller circuit designs.

The measurement computes real-time DQ0 transformation by converting the 3-phase drive output voltage or current waveforms. The transform matrix converts time-varying AC signals into time-invariant DC components. This helps to reproduce the control system's understanding of instantaneous motor torque and speed. The use of the DQ0 transformation allows motor designers to correlate the performance of the 3Phase power section to control system of the hardware algorithms and design. The overlapped DQ0 and 3-phase ABC vectors act as a good debug feature for designers to observe simultaneously both vector axis on the same plot.

There are different outputs of this measurement such as scalar values with the magnitude of D and Q, RMS values with statistics, derived math waveforms, and a phasor diagram. Math waveform provides the DC transformed waveform. This provides the different views of the control system outputs in a single view.

By observing the DQ0 results, some important inferences can be drawn, such as variations indicating to RMS ripple, peak to peak values, and higher-order harmonics. These parameters directly relate to understanding the operation of the algorithms in the control

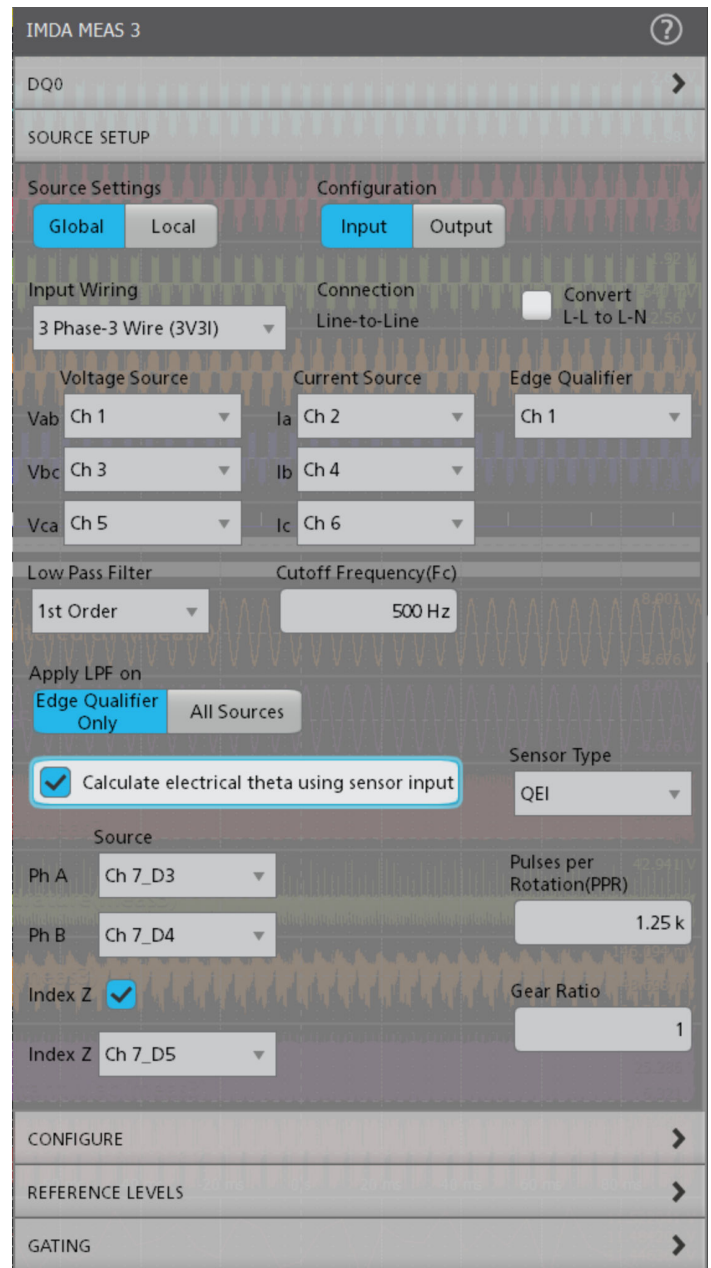

DQ0 with QEI configuration



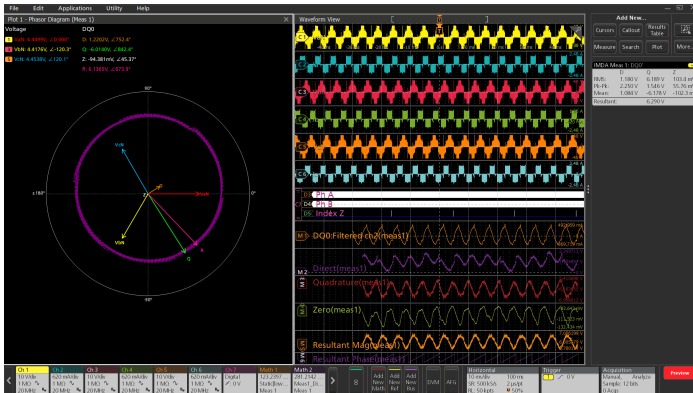

DQ0 measurement running on the 5 Series MSO. They are represented on the phasor diagram as Q (green), D (orange), and Z (white) vectors and their scalar values are available in the results badge on the right. The DQ0 waveforms are shown as Math M1, Direct (purple), Quadrature (red), and Zero (green).

The enhanced DQ0 algorithm computes the resultant vector from the D and Q components and displays a resultant vector as an overlapped motor rotations, and integrated with instantaneous motor angle (theta).

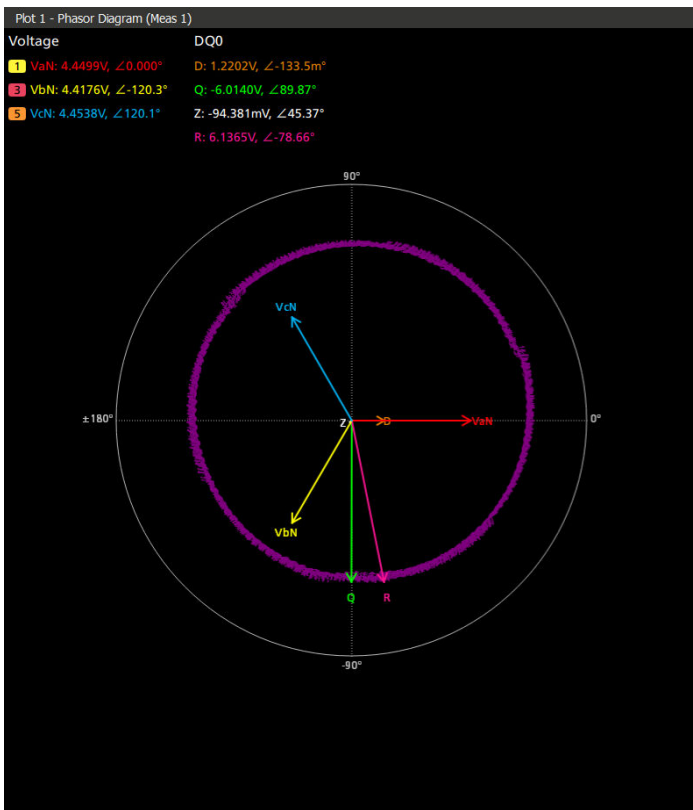

The DQ0 plot displays the resultant as rotating persistence plot.

### Dynamic measurements using trend analysis

A common requirement in motor drive analysis is an ability to look at the motor response over longer test times, records, and an extended number of acquisitions to monitor the DUT behavior over varying load conditions. This dynamic measurement helps to understand

optimal designs and interdependency between different parameters like voltage, current, power, frequency, and their variance based on the load conditions. You can manually zoom and get the specific region of interest to look at test results at the particular region of the waveform.

IMDA solution offers two unique trend plots on the power quality measurement to support such requirements:

- Time trend plot
- Acq trend plot

Each plot has its advantages and can be used to plot the supported sub-measurements under power quality measurement. The time trend plot shows the measured value per cycle, or for an acquired waveform (a record), while the acq trend plot shows a mean of the measured value per record, over each of the acquisitions. The acquisition count can be set during the test configuration. This allows you to capture long records of data to perform deep record analysis and understand the dynamic behaviors of the motor response. The plots can be saved as a CSV file for post-processing.

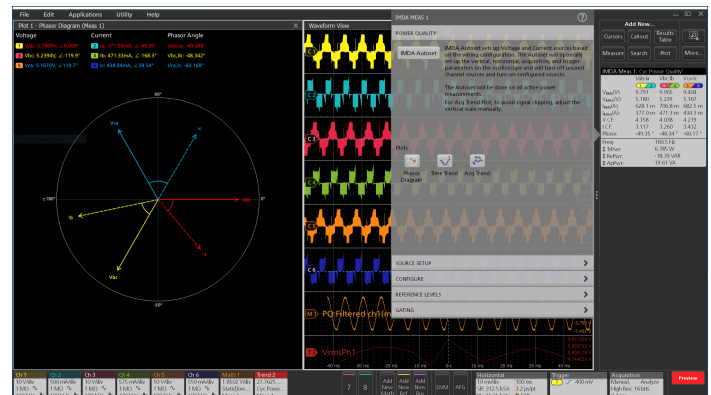

Time trends enable you to graphically analyze power measurements within one acquisition record. Acquisition trends can plot power measurements over many acquisitions for longer-term testing.

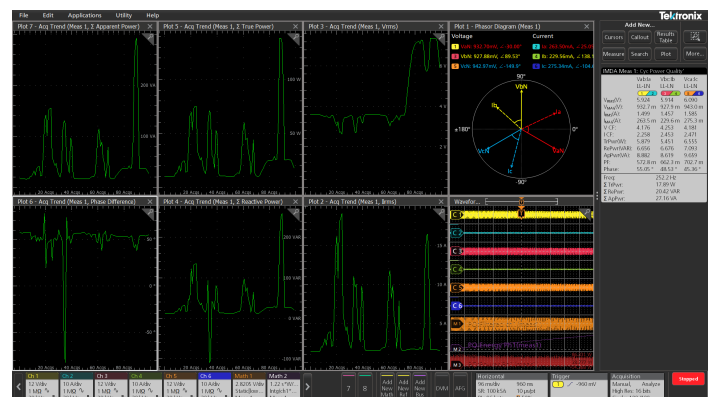

This example shows acquisition trend plots of mean power measurements for 100 acquisitions, including - Vrms, Irms, phase difference, sum of true power, apparent power, and reactive power.



### Speed measurement

Hall sensor signal transition as shown in the following figure.

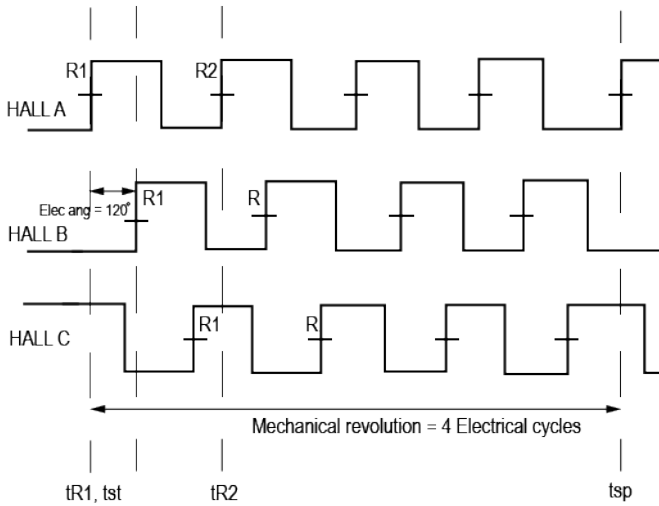

Speed measurement computation using three hall sensor transitions

Speed is defined by the following equation,

$$Speed \text{ in RPM} = \left( \left( \frac{1}{T_{SP} - T_{ST}} \right) * 60 \right) * G$$

Where,

Difference between  $T_{SP}$  and  $T_{ST}$  is defined by the number of pole pairs.

$T_{ST}$  is the start if the electrical pulse

$T_{SP}$  is the stop if the electrical pulse

60 is the RPM (revolutions per minute)

G is the gear ratio.

### Acceleration

Acceleration is rate of change of speed per unit time. It is defined as

$$Accr = \frac{Speed(t_{n+1}) - Speed(t_n)}{((t_{n+1}) - t_n)}$$

Speed and direction support following plots:

- Histogram
- Time Trend
- ACQ Trend

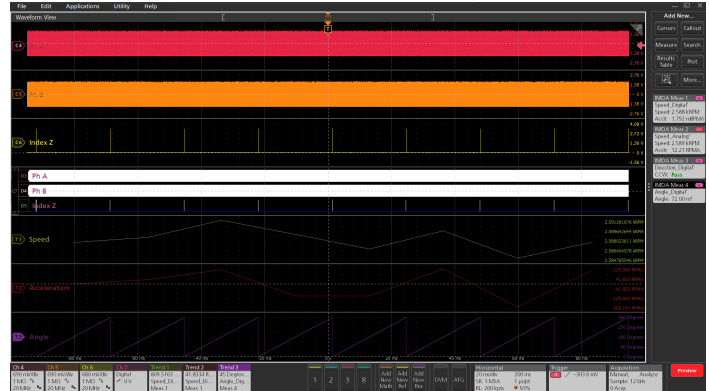

Measuring motor speed and direction using QEI method. The QEI signals (Phase A, B, and Z index) are shown for reference by connecting both Analog (TPP1000) and Digital (TLP058) probes.

### Importance of speed ACQ trend plots

The ACQ trend along with the histogram plot shows jitter on motor speed, which otherwise requires dedicated instrument like a flutter meter to measure. This jitter information (variations in edge timing) measures the motor-speed consistency.

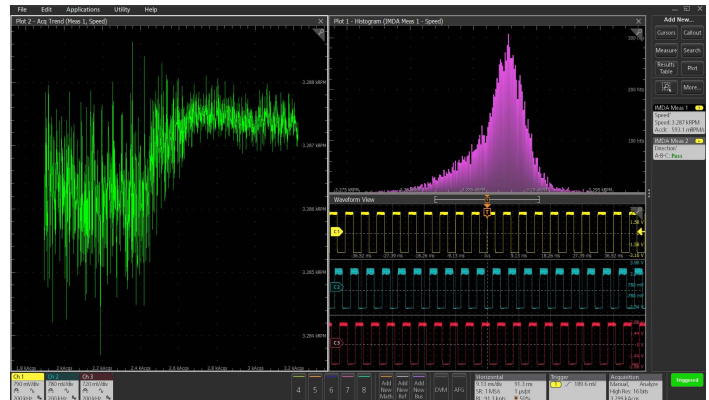

ACQ trend plot displaying Jitter on the motor speed (left) along with a histogram plot (right) that indicates the speed distribution

### Motor start-up profile

Motor designers are interested to investigate the motor startup profile during the design stage. The time trend gives the instantaneous speed information of a motor which otherwise is hard to measure.

In the following *Time trend plot showing startup sequence of a motor image*, where the start-up time taken by the motor is 2.3s from OFF to a ON state. Similarly, one can perform ON to OFF state and gain insights into the de-acceleration process as shown in the figure *Time trend plot showing deceleration of a motor into a stop state image*.

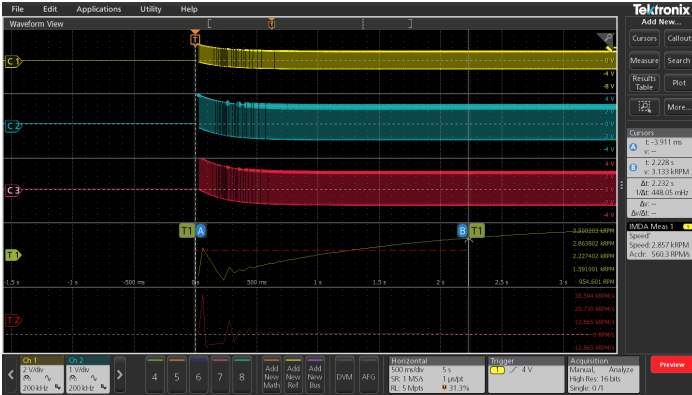

Time trend plot displaying startup sequence of a motor



Time trend plot displaying deceleration of a motor into a stop state

### Direction

Some applications like drills, washing machines, and electric pumps require motor to operate and change directions rapidly. The direction measurement helps with this analysis. The order of rising edges or falling edges of hall sensor output determines the direction of rotation. The direction measurement needs all three hall signals. They are available as configurable parameters for the direction measurement and are validated during the motor operation. Generally, a A-B-C sequence is interpreted as clockwise (CW) and a A-C-B sequence is interpreted as counter-clockwise (CCW).

For example, if the first rising edge is from HALL A and a rising edge of HALL B exists at 120 degrees, then the rotor rotation sequence is A-B-C. Else, if the second rising edge of HALL C occurs at 120 degrees, then the sequence is A-C-B.

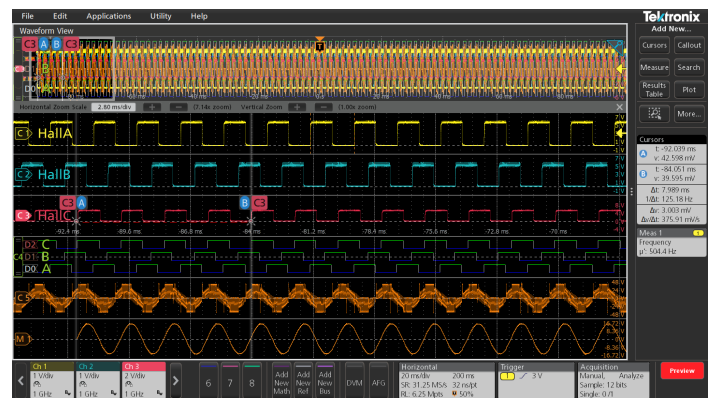
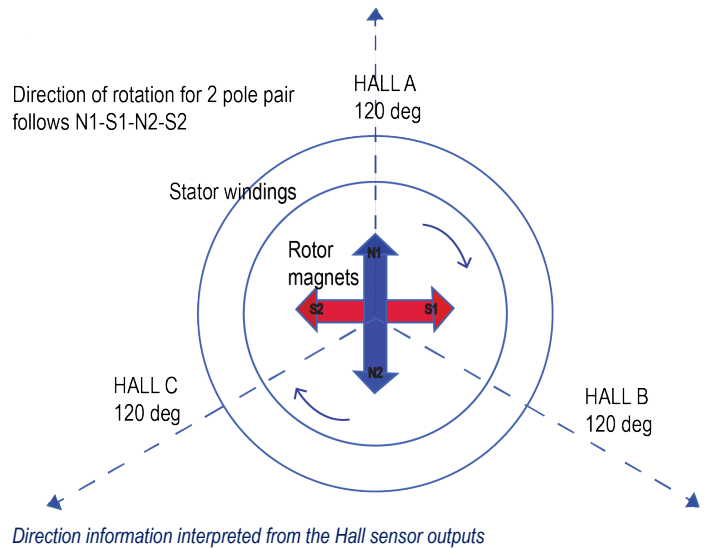

Direction information captured on the scope shows a HALL A,B,C rising edge sequence (clockwise rotation)

Here is the formula used to compute the direction information.

$$\text{Order (Clockwise)} = (A-B-C)$$

$$\text{Order (Counter-clockwise)} = (A-C-B)$$

Where *Order* function checks for the sequence of rising edges on all three hall sensor signals.

Direction can be displayed as an ACQ trend plot to give a visual indication on an exact timestamp when the motor reversed the direction helping during the debug. This is shown as a sample plot in the following figure.

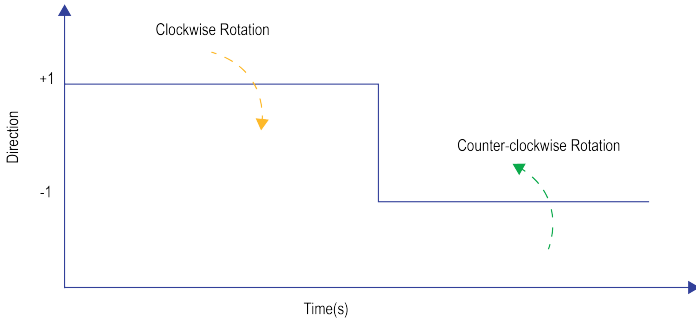

The ACQ trend plot shows +1 and -1 based on CW and CCW motor rotation.

**Torque Measurement**

The torque of a motor is the rotary force produced on its output shaft, it is a twisting force that is measured in Newton-meters (Nm).

IMDA supports two methods for torque measurements:

**1. Sensor method:**

This is the most common torque measurement that uses the torque sensor or the Load cell output. Measuring the torque generated by motors can be done by coupling a rotary torque sensor in line with the motor shaft. Users can capture Torque waveform using a passive voltage probe. The voltage waveform is proportional to a measured torque value.

The user must configure high and low values of the Torque sensor and corresponding high and low values of the output voltage. The measurement rescales the acquired voltage waveform to the Torque values.

The Load cell provides the Force. The Torque value is computed as a product of force and the arm length (distance).

$$Torque\ Output = Voltage\ Input \times \frac{High\ Torque - Low\ Torque}{High\ Voltage - Low\ Voltage}$$

**2. Current method:**

Many motors have data specifications by which torque can be inferred as proportional to applied RMS current by using the Torque constant. This is an estimation of the torque value.

Generally, the torque developed in any dc motor is proportional to the torque constant times the armature current. In a series motor, the field current is proportional to the armature current.

The torque produced by the rotor is estimated to be directly proportional to the armature current. The user must configure the Torque constant of the motor.

$$Torque = Torque\ constant \times I_{rms}$$

The torque measurement supports the following plots:

- Histogram

- Time Trend
- ACQ trend.

Following torque units are part of the configuration:

- Newton Meters (N·m)
- Foot pounds (ft·lb)
- Inch ounces (in·oz)
- Inch pounds (in·lb).

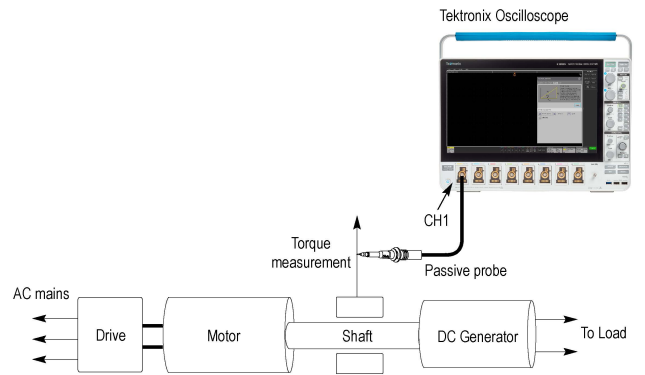

Torque measurement setup using the torque sensor method

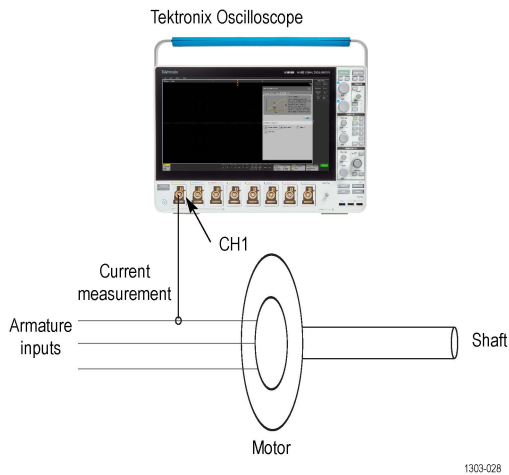

Torque measurement setup using the armature current method



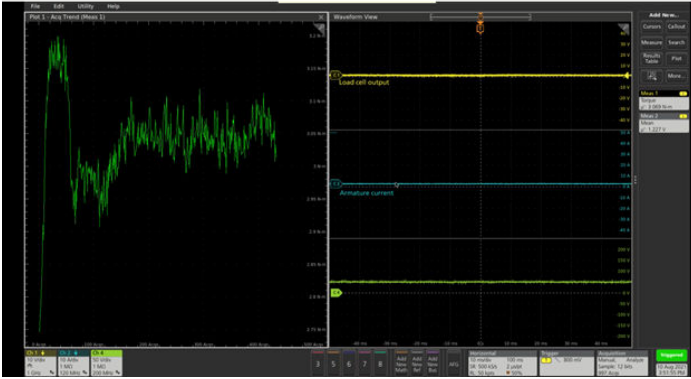

The image shows torque results as an ACQ trend plot using a Load cell output.

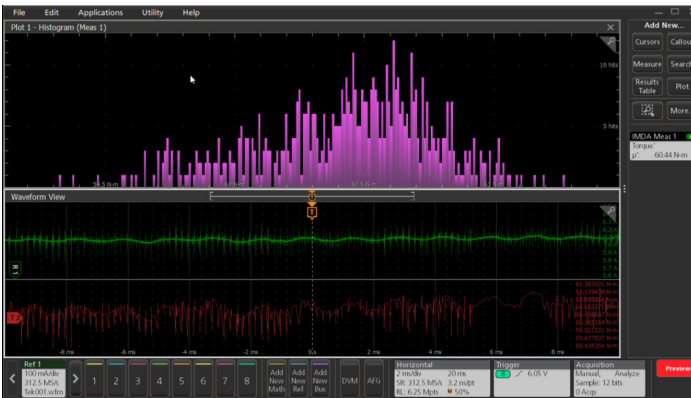

The image shows torque results as a histogram plot using a torque constant and armature current output

## Report generation

The IMDA software simplifies data collection, archiving, documentation of your design, and development process. It supports the report generation in MHT or PDF formats with pass/fail results for easy analysis.

## Measurement Report

Teltronix

Monday February 3 2020 10:54:56

### Setup Configuration

Scope Details	Scope Serial Number	TekScope Version	Scope Calibration Status
MSOS8	Q100118	1.24.6	Pass

### IMDA High Level Configuration

Measurement Type	Wiring	Connection	L-L to L-N
Industrial	3 Phase-3 Wire (3V3)	Line-to-Line	False

Name	Measurement Set(s)	Mean	Min	Max	Pk-Pk	Std Dev	Population	Accum Mean	Accum Min	Accum Max	Accum Pk-Pk	Accum Std Dev	Accum Pop
IMDA Meas 1 - Power Quality	Ch 1, Ch 2 Phase 1 (Vab, Ia)	375.12 V	375.12 V	375.12 V	0.0000 V	0.0000 V	1	375.12 V	375.12 V	375.12 V	0.0000 V	0.0000 V	1
	IRMS	330.21 mA	330.21 mA	330.21 mA	0.0000 A	0.0000 A	1	330.21 mA	330.21 mA	330.21 mA	0.0000 A	0.0000 A	1
	Voltage	1.7386	1.7386	1.7386	0.0000	0.0000	1	1.7386	1.7386	1.7386	0.0000	0.0000	1
	Crest Factor	3.0543	3.0543	3.0543	0.0000	0.0000	1	3.0543	3.0543	3.0543	0.0000	0.0000	1
	Current	83.258 W	83.258 W	83.258 W	0.0000 W	0.0000 W	1	83.258 W	83.258 W	83.258 W	0.0000 W	0.0000 W	1
	True Power	-91.713 VAR	-91.713 VAR	-91.713 VAR	0.0000 VAR	0.0000 VAR	1	-91.713 VAR	-91.713 VAR	-91.713 VAR	0.0000 VAR	0.0000 VAR	1
	Reactive Power	123.87 VA	123.87 VA	123.87 VA	0.0000 VA	0.0000 VA	1	123.87 VA	123.87 VA	123.87 VA	0.0000 VA	0.0000 VA	1
	Apparent Power	980.75 m	980.75 m	980.75 m	0.0000 m	0.0000 m	1	980.75 m	980.75 m	980.75 m	0.0000 m	0.0000 m	1
	Power Factor	-11.260	-11.260	-11.260	0.0000	0.0000	1	-11.260	-11.260	-11.260	0.0000	0.0000	1
	Phase Angle	Degrees	Degrees	Degrees	Degrees	Degrees	Degrees	Degrees	Degrees	Degrees	Degrees	Degrees	Degrees
	V Phase	0.0000	0.0000	0.0000	0.0000	0.0000	1	0.0000	0.0000	0.0000	0.0000	0.0000	1
	I Phase	-11.260	-11.260	-11.260	0.0000	0.0000	1	-11.260	-11.260	-11.260	0.0000	0.0000	1
	I Phase	Degrees	Degrees	Degrees	Degrees	Degrees	Degrees	Degrees	Degrees	Degrees	Degrees	Degrees	Degrees

### Views

#### Time Domain View

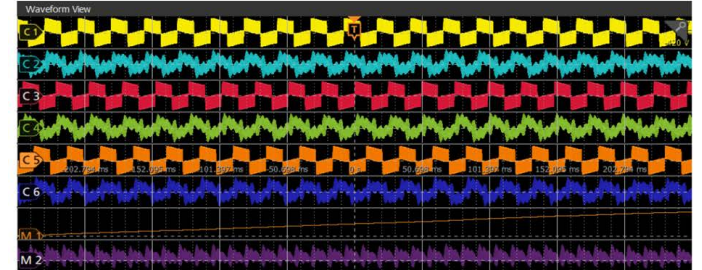

### Global Configuration

Logging	Jitter Separation Model	Dual Dirac Model	Display Unit Type	Standard Reference Levels	Jitter Reference Levels	Lock RJ
None	SpectralOnly	PCIExpress	Seconds	Every Acquisition	First Acquisition	false

### Reference Levels Configuration

Ref Levels	Ch1, Ch2, Ch3, Ch4, Ch5, Ch6
Ref Level Type	Global
Base Top Method	MinMax
RiseHigh	90%
RiseMid	50%
RiseLow	10%
FallHigh	90%
FallMid	50%
FallLow	10%
Hysteresis	10%

A sample IMDA test report file with summary, details, and corresponding images

## Specifications

<b>Wiring configuration</b>	1V1I (1-Phase-2Wire), 2V2I (1 Phase-3-Wire), 2V2I (3-Phase-3-Wire), 2V2I (DC In-AC Out), 3V3I (DC In-AC Out) or 3V3I (3-Phase-3Wire), and 3P4W (3-Phase-4Wire)
<b>L-L to L-N conversion</b>	Applicable for 3 Phase-3 Wire (3V3I) <sup>1</sup>
<b>Electrical analysis</b>	Power quality, Harmonics <sup>2</sup> , Ripple, DQ0 <sup>3</sup> , Efficiency <sup>4</sup>
<b>Sensors supported</b>	Hall sensors and QEI (Quadrature Encoder Interface)
<b>Mechanical analysis</b>	Speed, Acceleration, Angle (QEI method), Direction, and Torque
<b>Harmonic gating</b>	Fundamental and full spectrum
<b>Three-phase autose</b>	For all measurements
<b>Plots</b>	Time Trend plot, ACQ trend plot, Phasor diagram, harmonics bar graph <sup>5</sup> , DQ0 plot, and Histogram plot (speed distribution)
<b>Report</b>	MHT and PDF format, Data export to CSV format
<b>Degauss/Deskew (static)</b>	Automatic detection of probes, Auto Zero. User can deskew voltage and current probes, degauss the current probe from the menus for each channel
<b>Source support</b>	Live analog signals, reference waveforms, and math waveforms

<sup>1</sup> For 3 Phase-4 Wire (3V3I) the connection is always Line to Neutral and for 3 Phase-3 Wire (2V2I), it is Line to Line.

<sup>2</sup> Supports custom limits.

<sup>3</sup> Applicable for 3V3I wiring only.

<sup>4</sup> For 2V2I wiring only.

<sup>5</sup> Range filter as part of measurement configuration.

## Ordering information

### Models

Product	Options <sup>6</sup>	Supported instruments	Bandwidth available
New instrument order option	5-IMDA	5 Series/5 Series B MSO (MSO56, MSO58, MSO56B, MSO58B)	<ul style="list-style-type: none"> <li>• 350 MHz</li> <li>• 500 MHz</li> <li>• 1 GHz</li> <li>• 2 GHz</li> </ul>
Product upgrade option	SUP5-IMDA		
Floating license	SUP5-IMDA-FL		
New instrument order option	5-IMDA-DQ0		
Product upgrade option	SUP5-IMDA-DQ0		
Floating license	SUP5-IMDA-DQ0-FL		
New instrument order option	5-IMDA-MECH		
Product upgrade option	SUP5-IMDA-MECH		
Floating license	SUP5-IMDA-MECH-FL		
New instrument order option	6-IMDA	6 Series B MSO (MSO66B, MSO68B)	<ul style="list-style-type: none"> <li>• 1 GHz</li> <li>• 2.5 GHz</li> <li>• 4 GHz</li> <li>• 6 GHz</li> <li>• 8 GHz</li> <li>• 10 GHz</li> </ul>
Product upgrade option	SUP6B-IMDA		
Floating license	SUP6B-IMDA-FL		
New instrument order option	6-IMDA-DQ0		
Product upgrade option	SUP6B-IMDA-DQ0		
Floating license	SUP6B-IMDA-DQ0-FL		
New instrument order option	6-IMDA-MECH		
Product upgrade option	SUP6B-IMDA-MECH		
Floating license	SUP6B-IMDA-MECH-FL		

<sup>6</sup> Options IMDA-DQ0 and IMDA-MECH requires Option IMDA as a pre-requisite

## Software bundles

Supported instruments	Bundle options	Description
5 Series/5 Series B MSO	5-PRO-POWER-1Y	1 Year License Pro Power Bundle
	5-PRO-POWER-PER	Perpetual License Pro Power Bundle
	5-ULTIMATE-1Y	1 Year License Ultimate Bundle
	5-ULTIMATE-PER	Perpetual License Ultimate Bundle
	5-PRO-AUTO-1Y	1 Year License Pro Automotive Bundle
	5-PRO-AUTO-PER	Perpetual License Pro Automotive Bundle
6 Series B MSO	6-PRO-POWER-1Y	1 Year License Pro Power Bundle
	6-PRO-POWER-PER	Perpetual License Pro Power Bundle
	6-ULTIMATE-1Y	1 Year License Ultimate Bundle
	6-ULTIMATE-PER	Perpetual License Ultimate Bundle
	6-PRO-AUTO-1Y	1 Year License Pro Automotive Bundle
	6-PRO-AUTO-PER	Perpetual License Pro Automotive Bundle

## Recommended probes

Probe model	Description	Quantity
TCP0030A or TCP0150	Current Probes	3 for 3V3I wiring <sup>7</sup>
THDP0200 or TMDP0200	High Voltage Differential Probes	3 for 3V3I wiring <sup>7</sup>



Tektronix is registered to ISO 9001 and ISO 14001 by SRI Quality System Registrar.



Product(s) complies with IEEE Standard 488.1-1987, RS-232-C, and with Tektronix Standard Codes and Formats.



Product Area Assessed: The planning, design/development and manufacture of electronic Test and Measurement instruments.

<sup>7</sup> For performing efficiency measurement, four quantities are required.

ASEAN / Australasia (65) 6356 3900  
Belgium 00800 2255 4835\*  
Central East Europe and the Baltics +41 52 675 3777  
Finland +41 52 675 3777  
Hong Kong 400 820 5835  
Japan 81 (120) 441 046  
Middle East, Asia, and North Africa +41 52 675 3777  
People's Republic of China 400 820 5835  
Republic of Korea +822 6917 5084, 822 6917 5080  
Spain 00800 2255 4835\*  
Taiwan 886 (2) 2656 6688

Austria 00800 2255 4835\*  
Brazil +55 (11) 3759 7627  
Central Europe & Greece +41 52 675 3777  
France 00800 2255 4835\*  
India 000 800 650 1835  
Luxembourg +41 52 675 3777  
The Netherlands 00800 2255 4835\*  
Poland +41 52 675 3777  
Russia & CIS +7 (495) 6647564  
Sweden 00800 2255 4835\*  
United Kingdom & Ireland 00800 2255 4835\*

Balkans, Israel, South Africa and other ISE Countries +41 52 675 3777  
Canada 1 800 833 9200  
Denmark +45 80 88 1401  
Germany 00800 2255 4835\*  
Italy 00800 2255 4835\*  
Mexico, Central/South America & Caribbean 52 (55) 56 04 50 90  
Norway 800 16098  
Portugal 80 08 12370  
South Africa +41 52 675 3777  
Switzerland 00800 2255 4835\*  
USA 1 800 833 9200

\* European toll-free number. If not accessible, call: +41 52 675 3777

**For Further Information.** Tektronix maintains a comprehensive, constantly expanding collection of application notes, technical briefs and other resources to help engineers working on the cutting edge of technology. Please visit [www.tek.com](http://www.tek.com).

Copyright © Tektronix, Inc. All rights reserved. Tektronix products are covered by U.S. and foreign patents, issued and pending. Information in this publication supersedes that in all previously published material. Specification and price change privileges reserved. TEKTRONIX and TEK are registered trademarks of Tektronix, Inc. All other trade names referenced are the service marks, trademarks, or registered trademarks of their respective companies.

11 Jan 2022 48W-61649-4  
[www.tek.com](http://www.tek.com)