

## PSPL5500 Series DC Blocks

PSPL5500A, PSPL5501A, PSPL5508 Datasheet



The PSPL5500 Series of DC Blocks is composed of extremely broadband, coaxial blocking capacitors. Due to the coaxial construction, excellent microwave and very fast rise time responses are achieved. The PSPL5508 has a -3 dB bandwidth in excess of 26 GHz and a rise time faster than 8 ps. Large capacitance values up to 2.2  $\mu\text{F}$  are available that give -3 dB low frequency cutoffs as low as 0.7 kHz.

### Key performance specifications

- 0.7 kHz to > 26 GHz
- 8 ps Risetime

Typical performance

**Insertion Loss**  
0.25 dB/div,  
40 MHz to 25GHz,  
2.5 GHz/div

**Group Delay**  
5 ps/div,  
40 MHz to 25GHz,  
2.5 GHz/div

**Return Loss**  
5 dB/div,  
40 MHz to 25GHz,  
2.5 GHz/div

**10 ps Step Response**  
Top: In  
Bottom: Out  
20 ps/div

PSPL5500A

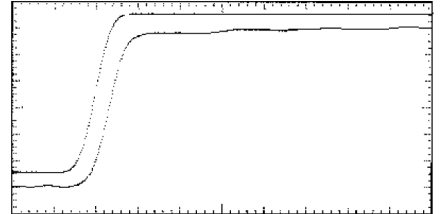
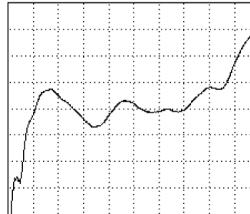
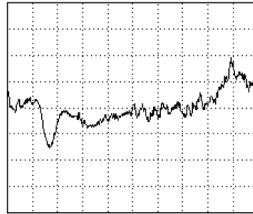
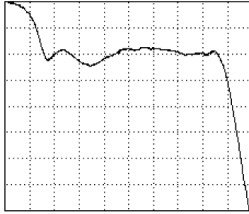

PSPL5501A

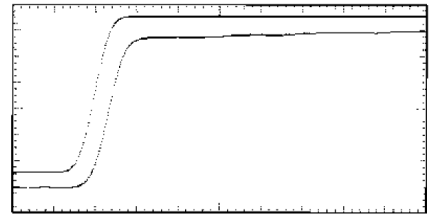
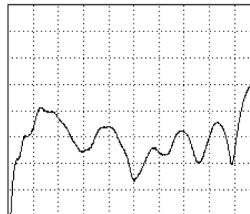
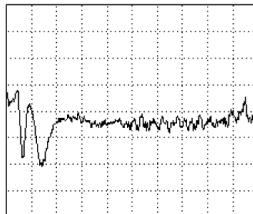
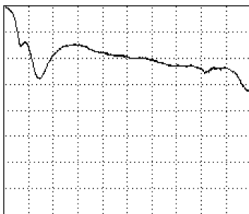

PSPL5508

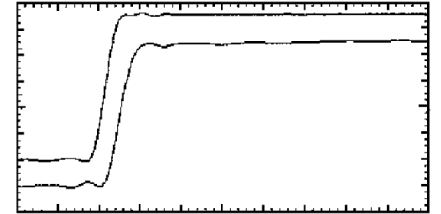
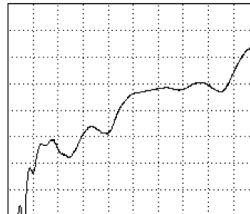
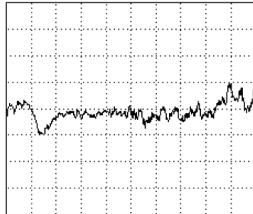
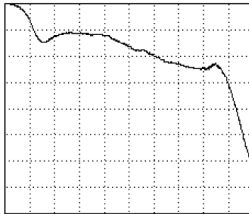

# Specifications

All specifications apply to all models unless noted otherwise.

Parameter <sup>1</sup>	PSPL5500A	PSPL5501A	PSPL5508
Capacitance	0.02 $\mu$ F	0.22 $\mu$ F	2.2 $\mu$ F
Tolerance	20 %	-50, +80%	-50, +80%
DC Voltage	50 V max.	50 V max.	16 V max.
Type	inner	inner	inner
BW (-3 dB) guaranteed	> 26 GHz 20 GHz min.	> 26 GHz 20 GHz min.	> 26 GHz 20 GHz min.
Low Freq -3 dB	80 kHz	7 kHz	0.7 kHz
Risetime	10 ps	10 ps	< 8 ps
Insertion Loss	See S <sub>21</sub> plots < 0.5 dB max. 100 MHz to 2 GHz is guaranteed		
Delay	155 ps, see S <sub>21</sub> group delay plots for typical responses		
Impedance	50 $\Omega$		
Return Loss	See S <sub>11</sub> plots for typical responses		
Temp. Range	-55 C to +125 C, operating and storage		
Dimensions	37.1 mm x 12.7 mm x 12.7mm sq. (1.46" x 0.5" x 0.5") including connectors		
Connectors	SMA jack (f) & plug (m)		
Warranty	One Year		

## Mechanical dimensions

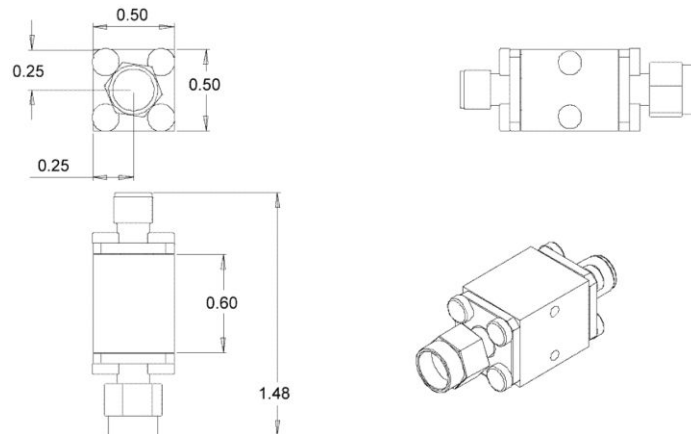

<sup>1</sup> Parameters listed are typical values. Max/min limits for capacitance, bandwidth and insertion loss are guaranteed.

## Ordering information

### Models

PSPL5500A	50 V DC block, 80 kHz
PSPL5501A	50 V DC block, 7 kHz
PSPL5508	16 V DC block

**ASEAN / Australasia** (65) 6356 3900  
**Belgium** 00800 2255 4835\*  
**Central East Europe and the Baltics** +41 52 675 3777  
**Finland** +41 52 675 3777  
**Hong Kong** 400 820 5835  
**Japan** 81 (3) 6714 3086  
**Middle East, Asia, and North Africa** +41 52 675 3777  
**People's Republic of China** 400 820 5835  
**Republic of Korea** +822 6917 5084, 822 6917 5080  
**Spain** 00800 2255 4835\*  
**Taiwan** 886 (2) 2656 6688

**Austria** 00800 2255 4835\*  
**Brazil** +55 (11) 3759 7627  
**Central Europe & Greece** +41 52 675 3777  
**France** 00800 2255 4835\*  
**India** 000 800 650 1835  
**Luxembourg** +41 52 675 3777  
**The Netherlands** 00800 2255 4835\*  
**Poland** +41 52 675 3777  
**Russia & CIS** +7 (495) 6647564  
**Sweden** 00800 2255 4835\*  
**United Kingdom & Ireland** 00800 2255 4835\*

**Balkans, Israel, South Africa and other ISE Countries** +41 52 675 3777  
**Canada** 1 800 833 9200  
**Denmark** +45 80 88 1401  
**Germany** 00800 2255 4835\*  
**Italy** 00800 2255 4835\*  
**Mexico, Central/South America & Caribbean** 52 (55) 56 04 50 90  
**Norway** 800 16098  
**Portugal** 80 08 12370  
**South Africa** +41 52 675 3777  
**Switzerland** 00800 2255 4835\*  
**USA** 1 800 833 9200

\* European toll-free number. If not accessible, call: +41 52 675 3777

**For Further Information.** Tektronix maintains a comprehensive, constantly expanding collection of application notes, technical briefs and other resources to help engineers working on the cutting edge of technology. Please visit [www.tek.com](http://www.tek.com).

Copyright © Tektronix, Inc. All rights reserved. Tektronix products are covered by U.S. and foreign patents, issued and pending. Information in this publication supersedes that in all previously published material. Specification and price change privileges reserved. TEKTRONIX and TEK are registered trademarks of Tektronix, Inc. All other trade names referenced are the service marks, trademarks, or registered trademarks of their respective companies.



20 Jun 2017 1PW-30585-0

