

Wide Bandgap – Double Pulse Test Analysis

4/5B/6B Series MSO Option 4-WBG-DPT/5-WBG-DPT/6-WBG-DPT Application Datasheet

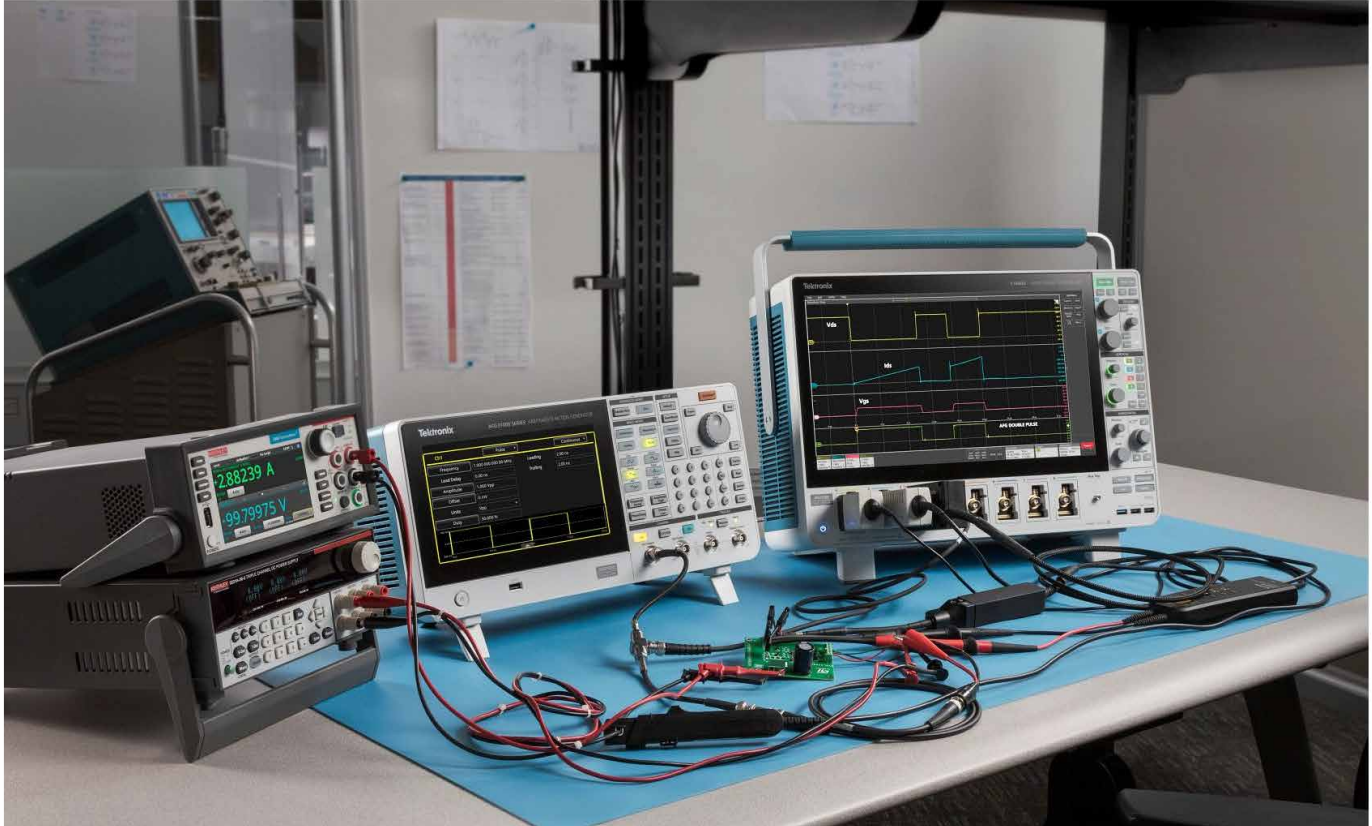

Semiconductor materials used in power electronics are transitioning from Silicon to Wide Bandgap (WBG) semiconductors such as Silicon Carbide (SiC) and Gallium Nitride (GaN) due to their superior performance at higher power levels in automotive and industrial applications. Due to its high operating voltage levels, SiC technology is finding applications in EV power trains, whereas GaN is primarily used in fast chargers for laptops, mobile devices, and other consumer devices.

Double Pulse Test (DPT) is an industry standard technique for measuring a range of important parameters during turn on, turn off, and reverse recovery.

In DPT, the DUT can either be the power device or a diode. The power device can be a Si, SiC, or GaN MOSFET or IGBTs.

The Wide Bandgap Double Pulse Test application (Opt. WBG-DPT) on the 4/5B/6B Series MSO offers precise Wide Bandgap measurements that make device and system validation easier. The application is compatible with all Tektronix VPI probes and, when used with the Tektronix IsoVu™ probes it helps uncover all the hidden artifacts of SiC or GaN devices at the circuit level.

The application offers automated measurements as per JEDEC and IEC standards. It offers unique features such as per-cycle analysis with annotation, flexibility with custom reference level settings, configurable integration points, and power preset that can be set based on the DUT designs.

The WBG-DPT application saves the designers time and cost. It's quick to set up and measure, allowing design and test engineers to focus on debugging and improving target designs.

Key features and specifications

- 16+ key measurements as per JEDEC and IEC standards
- Ability to test SiC or GaN devices as well as Si MOSFET and IGBTs
- Specify pulse regions such as the first, second, or multiple pulses of interest and correlate with the scalar results in the badge
- Annotations on waveforms to show the regions of interest
- Easily navigate the pulse region of interest for multi-pulse use case
- Unique edge refinement algorithm to analyze noisy waveforms
- Programmatic interface to all measurements and configurations enable the complete automation in test system applications
- Support of Auto and Custom reference levels helps to precisely identify Start and Stop regions effectively
- Hysteresis level configuration on the gate source helps to avoid false edges
- Quickly add and configure measurements through the intuitive drag and drop interface on the 4/5B/6B Series MSO
- Overlapped plot for Reverse Recovery (trr) measurement
- Added search directions (forward, backward) for effective debugging of pulse regions

- Support for gate driver (AFG31000 Series) control for double pulse signal generation
- Deskew feature for switching analysis

The application is designed based on the following standard references:

- Double Pulse Test (DPT)
 - IEC 60747-9
 - JEP182
 - IEC 60747-8
- Diode Reverse Recovery
 - JESD24-10
 - IEC 60747-9

Following measurements are performed:

- Low side switching parameters and High side diode reverse recovery measurements
- Low side and High side switching parameters

Test setup

The following schematic shows the measurement setup of the Double Pulse Test. This is an example of a half-bridge gate driver for a power MOSFET with both low and high side switching. On the high side, the source to gate pin is shorted to measure the diode reverse recovery current parameters.

The 4/5B/6B Series MSO are ideally suited for double pulse testing. Four channels are sufficient to test the high or low side switching separately, but if you would like to monitor the gate voltage as a source and diode reverse recovery parameters, then you may need more than four channels, in which case a scope with six or eight channels are ideal.

For DPT switching parameters, user needs to acquire V_{ds} , I_d , and V_{gs} on the low side. Similarly, the user needs to check for V_{gs} on the high side when testing both high-side and low-side MOSFETs (refer [Double Pulse test on the low and high side setup](#) below). The diode reverse recovery is generally measured on High side, which needs I_{rr} and V_{rr} . Tektronix recommends gate voltage as a qualifier source to avoid false detection of edges.

To accurately make the measurements on the high-side V_{gs} measurement, we need a measurement system that combines high bandwidth, high common mode voltage, and high common mode rejection. Along with its complete galvanic isolation, the Tektronix IsoVu system offers 1 GHz bandwidth, 2000 V common mode voltage, and 1 million to 1 (120 dB) common mode rejection ratio. It is a combination of these specifications that makes these kind of difficult measurements possible.

The IsoVu measurement system shows the details of what is occurring in the design and makes stable and repeatable measurements. The coupling due to parasitics between the switch node and the high and

low-side MOSFETs are apparent, and the IsoVu measurement system has enough bandwidth to measure this dead time correctly.

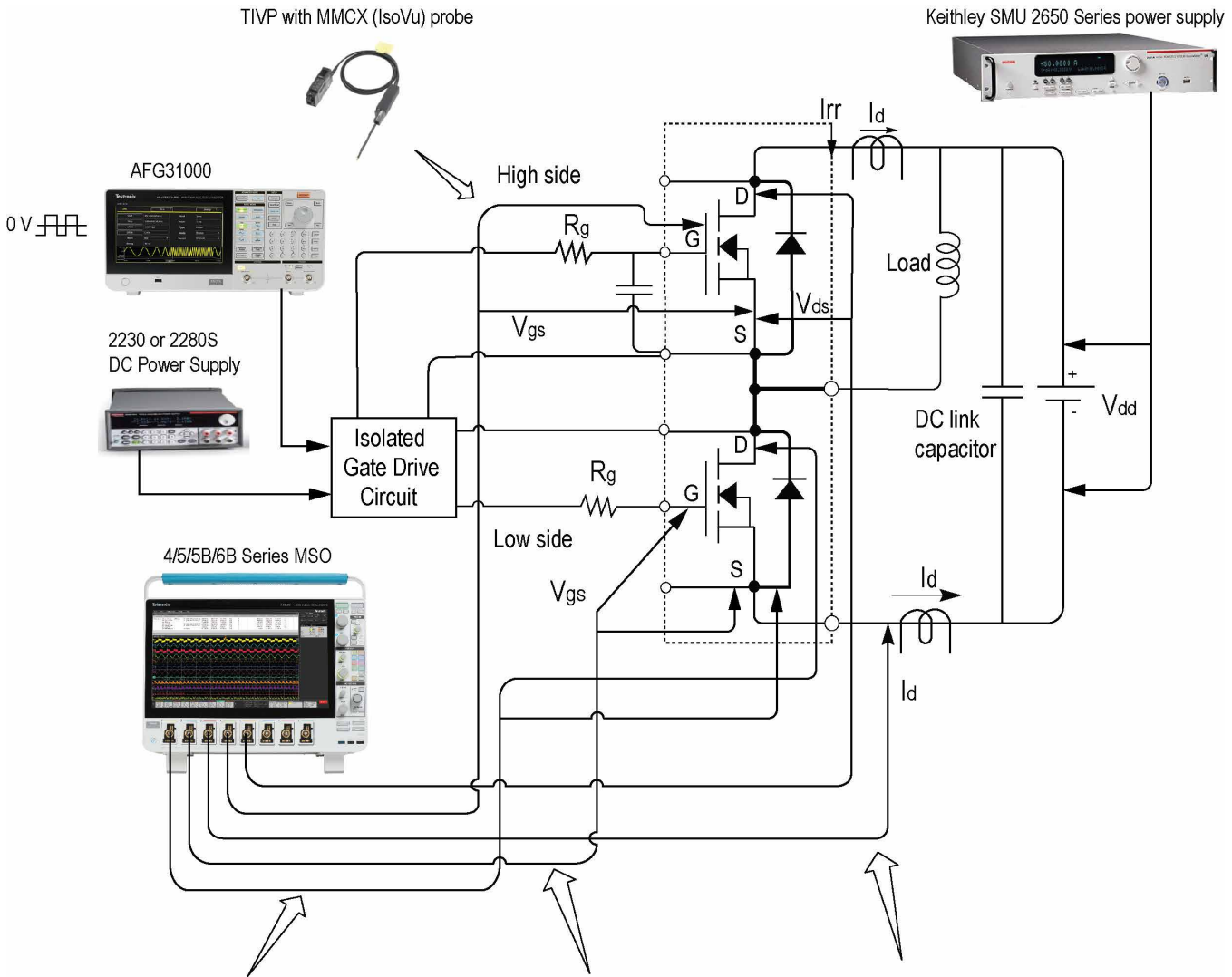

TPP0850 or TPP1000 or THDP0100/200

TPP1000 and Square to MMCX adapter tip

TRCP Series Rogowski or TCP0030A

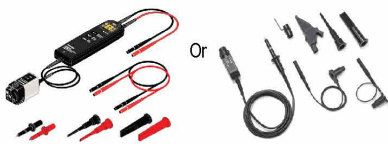

Low side:
 CH1: Vds-TPP0850 or TPP1000 or THDP0200
 CH2: Vgs-TPP1000 and Square to MMCX adapter tip
 CH3: Id-TCP

High Side:
 Ch4: Vgs-TIVP with MMCX
 Ch5: Vds-THDP

Note:
 TPP1000 - Use this probe if voltage is less than 400 V.
 TPP0850 - It should only be used when properly grounded and with an isolated power supply.

1303-029

Double Pulse test on the low and high side setup

Keithley SMU 2650 Series HV power supply

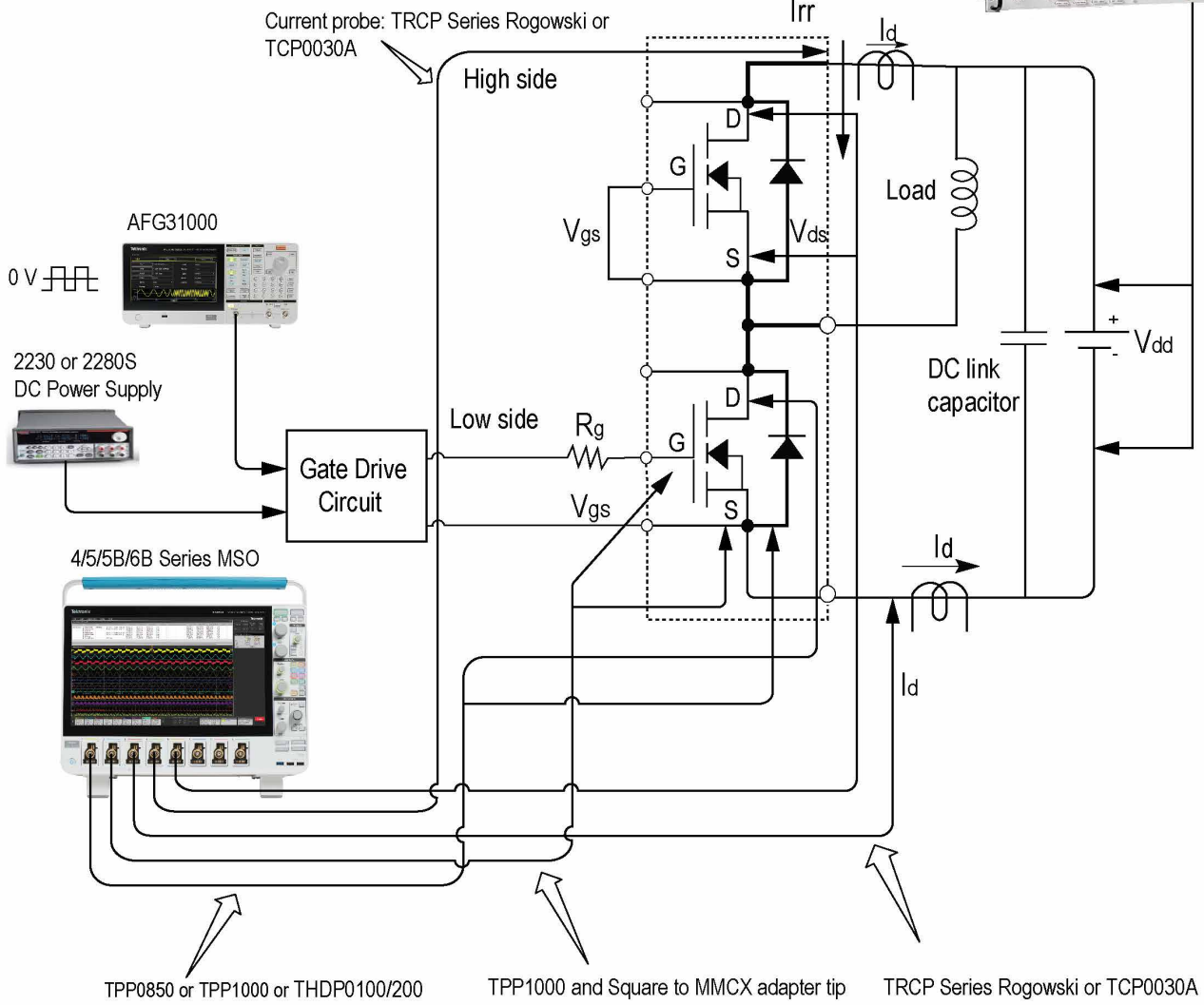

Low side:

- CH1: Vds-TPP0850 or TPP1000 or THDP0200
- CH2: Vgs-TPP1000 and Square to MMCX adapter tip
- CH3: Id-TCP

High Side:

- Ch4: Irr-TCP
- Ch5: Vds-THDP

Note:

- TPP1000 - Use this probe if voltage is less than 400 V.
- TPP0850 - It should only be used when properly grounded and with an isolated power supply.

1303-035

Double Pulse test on the low side and Diode reverse recovery on the high side

AFG31000 as a gate driver

The Tektronix AFG31000 Series is a high-performance AFG with built-in arbitrary waveform generation, real-time waveform monitoring, and a large touchscreen. Providing advanced waveform generation and programming capabilities, waveform verification, and a modern touchscreen interface, the AFG31000 is an ideal choice of equipment that acts as a gate driver device. The AFG31000 includes the Double Pulse Test application, a downloadable plugin software application that enables double pulse applications for the power and semiconductor markets. The Double Pulse Test user interface provides touch-and-swipe or point-and-click control for generating at least two varying pulse widths. These pulses can be output to an isolated gate driver to trigger power devices such as MOSFETs or IGBTs and start conduction of current. The Double Pulse Test on the AFG31000 offers the design and test engineers the ability to generate voltage pulses with varying pulse widths on their DUTs. The design and test engineers are able to perform the Double Pulse Test in less than one minute, saving hours when compared to using a PC software or a microcontroller to perform the test with varying configurations.

The application also allows users to specify pulse regions of interest such as First pulse, Second pulse, and Multiple pulses. This input is used to validate and analyze the acquired waveforms on the oscilloscope and perform the WBG measurements.

Refer [Application note on the AFG31000](#) for more details.

The user can configure the AFG 31000 Series from the WBG-DPT application to generate a double pulse signal of required amplitude and pulse widths. The AFG output stimulus should be given to the gate driver of the power device to measure switching, timing, capacitance, and reverse recovery parameters of the device.

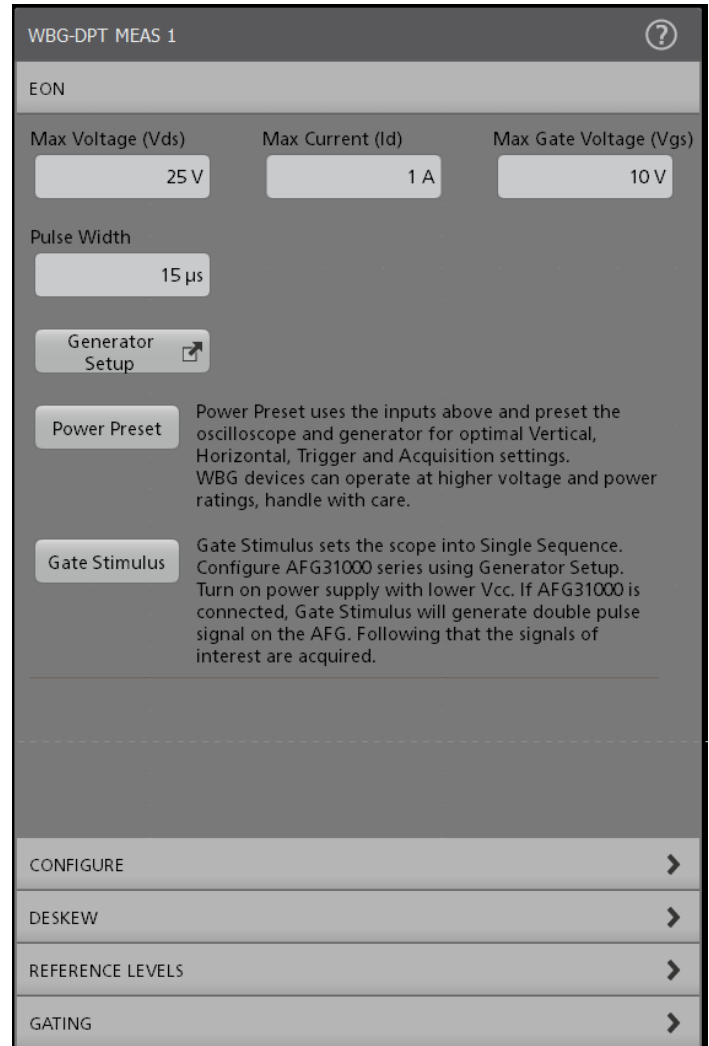

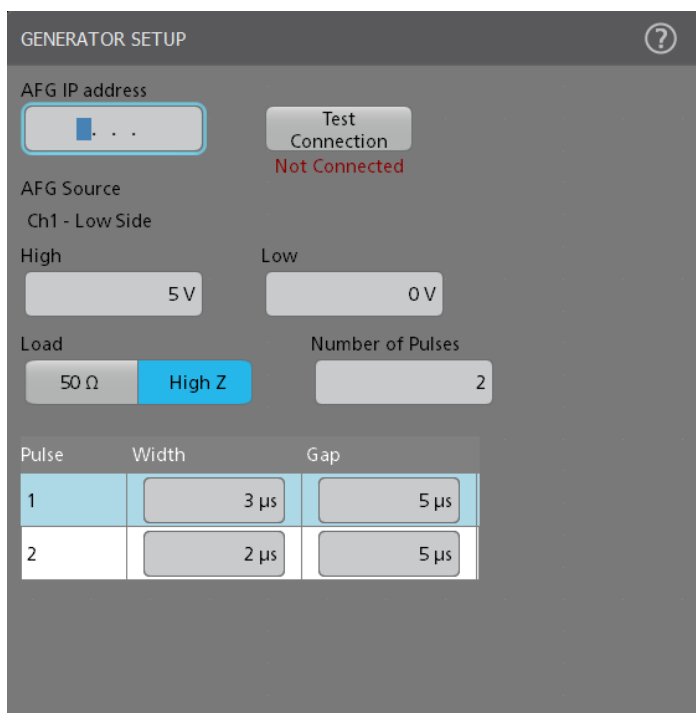

Power supplies

Based on the DUT requirements, a proper power supply must be chosen to power on the DUT. Designers can either use a DC power supply or a Source Measure Unit (SMU). The SMU is an instrument that can precisely source voltage or current and simultaneously measure voltage and/or current. It varies from a typical DC power supply in providing greater speed and precision, a wider operating range and better resolution, and built-in sweep capabilities.

Here are some of the recommended options for Tektronix power supplies that could be used for the Double Pulse Test.

- High voltage power supply:
 - 2657 A High voltage Source Meter Unit (SMU)
 - 2260B-800-2, programmable DC power supply
- Power supply to gate drive circuit:
 - 2230 or 2280S Series DC power supply

Probing and Accessories

When an engineer consider switching the designs from legacy silicon to WBG devices, some of the questions that arise are:

- Is my test equipment capable of accurately measuring the fast switching dynamics exhibited by SiC devices?
- How can I accurately optimize gate drive performance and deadtime?
- Will common-mode transients affect the accuracy of measurements?
- Is the observed ringing real or a result of probe response?

The traditional method for making a gate voltage measurement is by using a standard differential probe with MMCX connectors. This is important for gate voltage measurements on the high side. Measuring the gate voltage of a SiC power device is challenging since it is a low voltage signal (~20 Vpp) that is referenced to a node that may have a high DC offset and high dv/dt relative to the oscilloscope ground.

The Tektronix Isolated probes play a crucial role in making these floating gate measurements in a precise manner. The probe helps uncover the fast and floating signals that non-isolated probes are hiding. IsoVu™ Probe Technology virtually eliminates common mode interference using optical isolation. This delivers accurate differential measurements on reference voltages slewing ± 60 kV at 100 V/ns or faster. With the IsoVu Generation 2 design, designers get all the benefits of IsoVu technology at 1/5 of the size.

The probes also offer versatile MMCX connectors and an unmatched combination of bandwidth, dynamic range, and common mode rejection to meet all the DPT test needs.

The best performance from the IsoVu measurement system is achieved when an industry standard MMCX connectors are inserted close to the test points. These connectors offer high signal fidelity and are recommended for precise and repeatable results. On the low side, use TPP with square pin to MMC adapter for Vgs probing, while on the high side, use TIVP with MMCX accessory.

Current probes

- Current probes are required in the WBG setup to accurately make Id measurements. Tektronix offers a range of current probes to choose from.
- TCP0030A is a high-performance, easy-to-use AC/DC current probe designed for use with and direct connection to oscilloscopes with the TekVPI™ probe interface. This AC/DC current measurement probe provides greater than 120 MHz of bandwidth with selectable 5 A and 30 A measurement ranges. It also provides exceptional low current measurement capability and accuracy to current levels as low as 1 mA, which is important for meeting the challenging current measurement needs.
- For higher current needs, it's recommended to test with TCP0150 probes. In addition to the TCP family of probes, Tektronix offers the TRCP Series Rogowski current probes that are equipped with a

BNC connector and work with any instrument supporting the BNC interface. Rogowski probes allow you to easily connect to large connection points such as bus bars or connect to small IC legs on a MOSFET or IGBT.

Here are the recommended probing details for DPT on Low side and diode reverse recovery setup on the High side:

- Low side probing
 - Ch1: Vds - TPP or THDP Series voltage probe
 - Ch2: Vgs - TPP Series with MMCX adapter tips
 - Ch3: Id - TCP Series current probe
- High side probing
 - Ch4: Irr - TCP - Series current probe
 - Ch5: Vds - THDP Series voltage probe

Here are the recommended probing details for DPT on Low side and High side:

- Low side probing
 - Ch1: Vds - TPP or THDP Series voltage probe
 - Ch2: Vgs - TPP Series with MMCX adapter tips
 - Ch3: Id - TCP Series current probe
- High Side Probing
 - Ch4: Vgs - TIVP Isolated probes with MMCX adapter tips
 - Ch5: Vds - THDP Series voltage probe

Measurements

Measurements offered by option WBG-DPT can be used to test power devices like MOSFET and IGBT as shown in the image below.

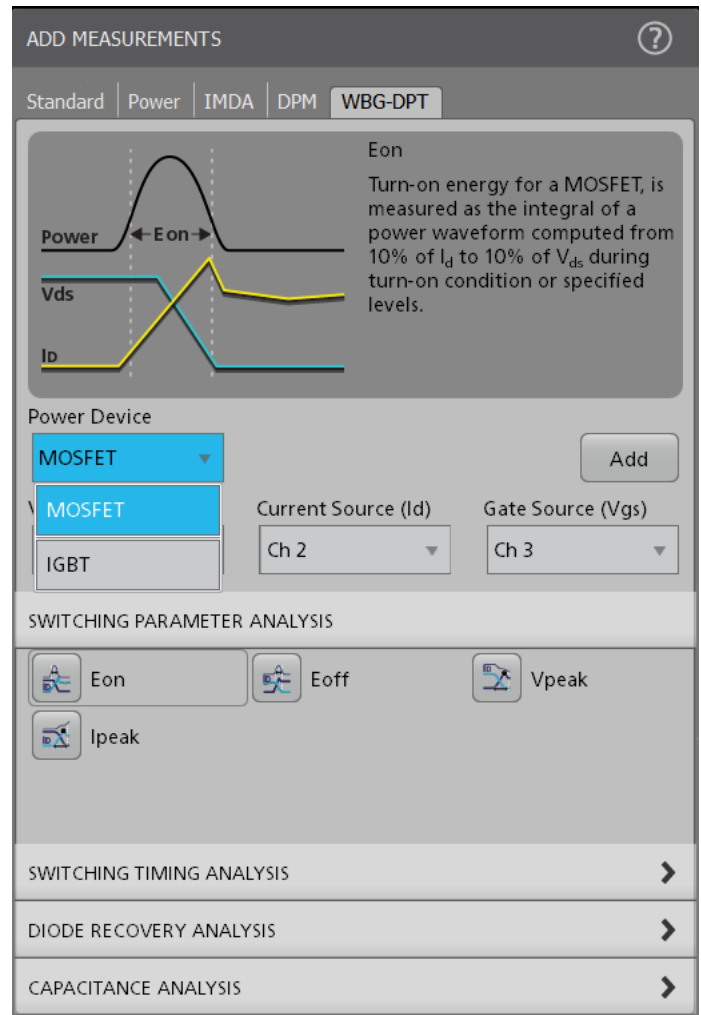

Power preset

The preset setting is useful to setup the oscilloscope for an optimal vertical scale, horizontal time base, sample rate, trigger source and level, and number of pulses for a specified Vds and Vgs levels.

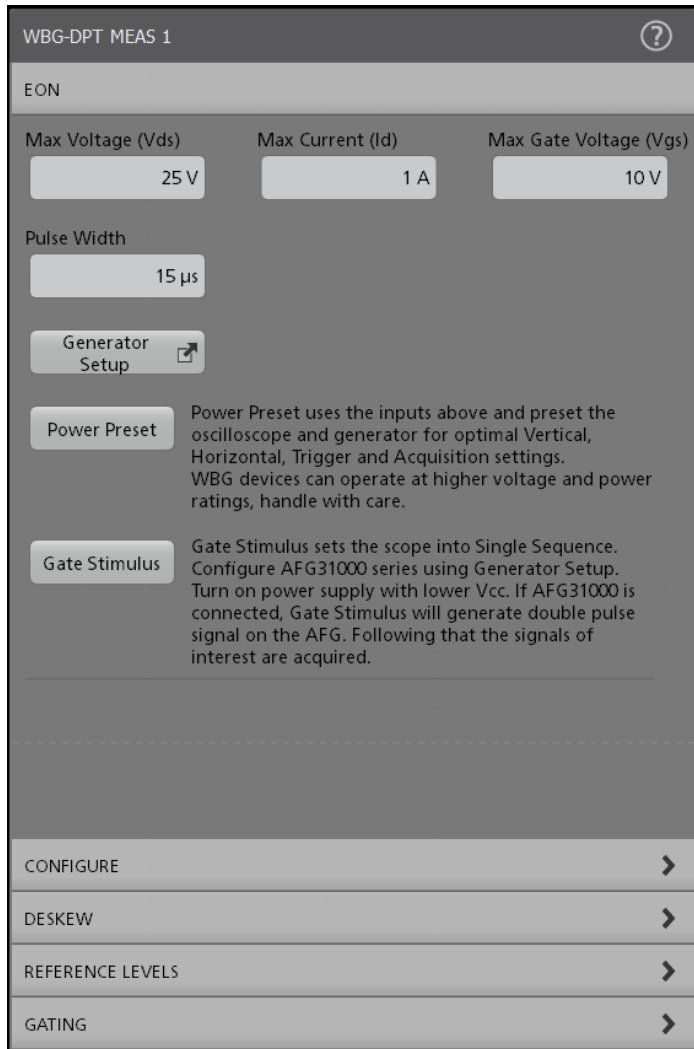

Auto levels indicates the Start and Stop levels of the pulse regions as per JEDEC/IEC standards.

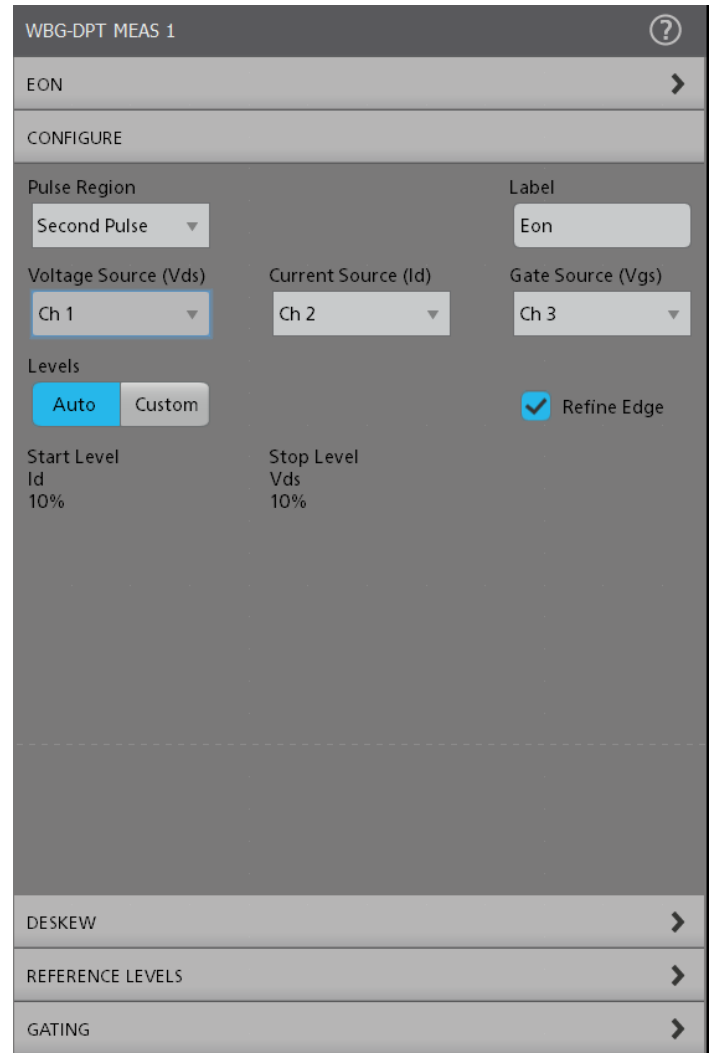

By default, the pulse region is defined as per the standard. For example, Eon in DPT is measured on the second pulse and Eoff is measured on the first pulse. However, you can configure the pulses as per your custom requirements. You can also choose the multiple pulse configuration to test more than two pulses. This offers greater flexibility based on the designs.

Generally, designers test with multiple pulses at different levels of drain current rather than making double pulse test. When switching the devices multiple times in continuous operation, this can stress the power devices and check for switching reliability.

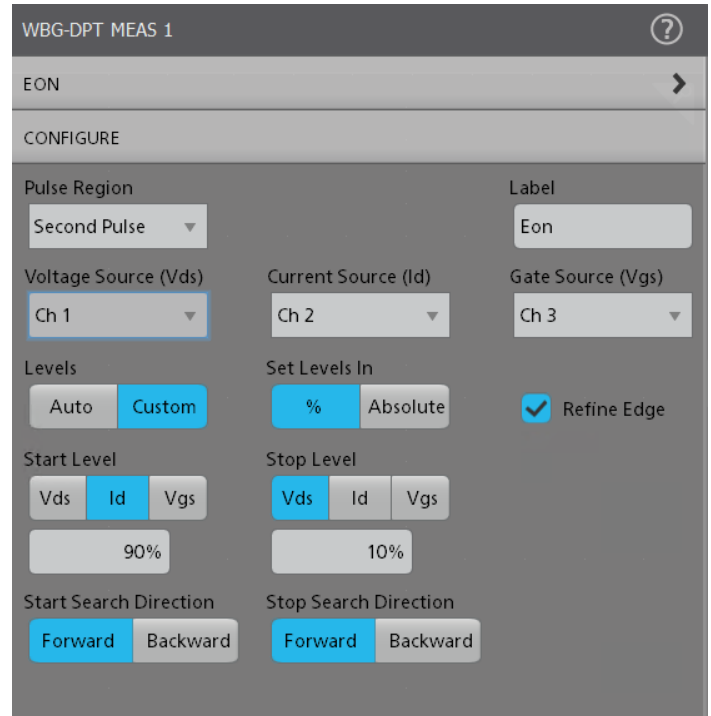
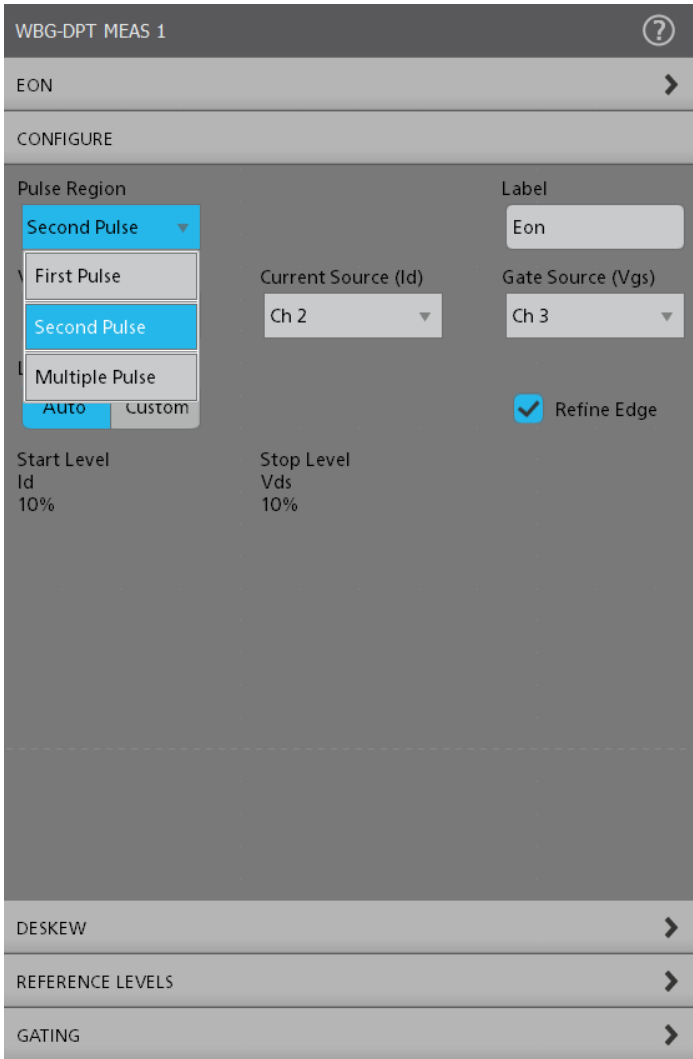

During this operation, it is important to measure the turn on and turn off switching parameters of multiple edges. Multiple pulses are supported as part of the measurement configuration.

Since real world WBG waveforms are non-ideal and noisy in nature, user can define the sources by specifying custom start and stop levels in percentage units. This helps ease debug especially when Vds and Id are noisy and contain oscillations.

WBG Deskew

WBG-DPT MEAS 1

EON

CONFIGURE

DESKEW

Probe Resistance: 100 mohm

Effective Inductance: 50 µH

Bias Voltage: 260 V

Differential Order: 3

WBG Deskew

WBG Deskew uses above circuit parameters and calculates the skew between Vds and Id. We recommend to keep the DUT ON and perform Preset before running WBG Deskew. Circuit parameters should be set iteratively to match the mathematical model.

Ch 1's deskew value is 0 s

REFERENCE LEVELS

GATING

WBG Deskew calculates the skew between the Drain to Source Voltage (Vds) and Drain Current (Id) or Collector to Emitter Voltage (Vce) and Collector Current (Ic) when Power Device is MOSFET or IGBT respectively. The skew value is then applied on to the source to which Vds or Vce signal is configured on the oscilloscope.

WBG Deskew differs from the conventional scope-based Deskew operation. Conventionally, skew between probes is computed before starting any measurement on the test setup. In WBG-DPT, the skew of the measurement system is performed as a post-acquisition operation.

The Tektronix method of performing WBG deskew does not require any connection modification on the device. The deskew method models the Vds based on the acquired Id, Vgs, and circuit parameters (probe resistance, effective inductance). The mathematical modeled Vds is created and shown as Math. The acquired Vds signal and modeled Vds are overlapped to compute the skew and this skew is applied on the acquired Vds signal. This deskew procedure is simpler compared to conventional method.

Switching Parameter Analysis

Switching parameter analysis measurements

ADD MEASUREMENTS

Standard | Power | IMDA | DPM | WBG-DPT

Eon

Turn-on energy for a MOSFET, is measured as the integral of a power waveform computed from 10% of Id to 10% of Vds during turn-on condition or specified levels.

Power Device: MOSFET

Voltage Source (Vds): Ch 1

Current Source (Id): Ch 2

Gate Source (Vgs): Ch 3

SWITCHING PARAMETER ANALYSIS

Eon | Eoff | Vpeak | Ipeak

SWITCHING TIMING ANALYSIS

DIODE RECOVERY ANALYSIS

CAPACITANCE ANALYSIS

Eon

Turn on energy for a MOSFET is measured as the integral of a power waveform computed from 10% of Id to 10% of Vds during turn on condition or specified levels.

Turn on energy for an IGBT is measured as the integral of a power waveform computed from 10% of Vge to 2% of Vce during turn on condition or specified levels.

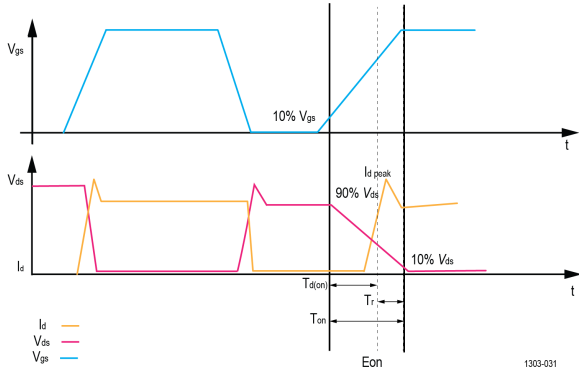

Waveform during turn on time

WBG-DPT MEAS 1 ?

EON ➤

CONFIGURE

Pulse Region Second Pulse ▼	Label Eon
Voltage Source (Vds) Ch 1 ▼	Current Source (Id) Ch 2 ▼
Gate Source (Vgs) Ch 3 ▼	

Levels

Auto Custom Refine Edge

Start Level Id 10%	Stop Level Vds 10%
--------------------------	--------------------------

DESKEW ➤

REFERENCE LEVELS ➤

GATING ➤

Eoff

Turn off energy for a MOSFET is measured as the integral of power waveform computed between 10% of V_{ds} and 10% of I_d during turn off condition or specified levels.

Turn off energy for an IGBT is measured as the integral of a power waveform computed from 90% of V_{ge} to 2% of I_c during turn off condition or specified levels.

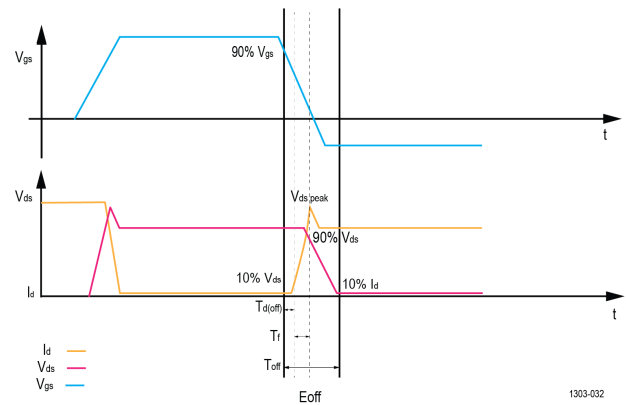

Waveform during turn off time

WBG-DPT MEAS 2 ?

EOFF ➤

CONFIGURE

Pulse Region First Pulse ▼	Label Eoff
Voltage Source (Vds) Ch 1 ▼	Current Source (Id) Ch 2 ▼
Gate Source (Vgs) Ch 3 ▼	

Levels

Auto Custom Refine Edge

Start Level Vds 10%	Stop Level Id 10%
---------------------------	-------------------------

DESKEW ➤

REFERENCE LEVELS ➤

GATING ➤

Vpeak

Voltage peak is the maximum voltage peak value in the power device during turn off condition of collector current or drain current pulse. Usually, the voltage peak is measured in Eoff region.

Ipeak

Current peak is the maximum current peak value in the power device during turn on condition of a collector current or drain current pulse. Usually, the current peak is measured in Eon region.

Switching Timing Analysis

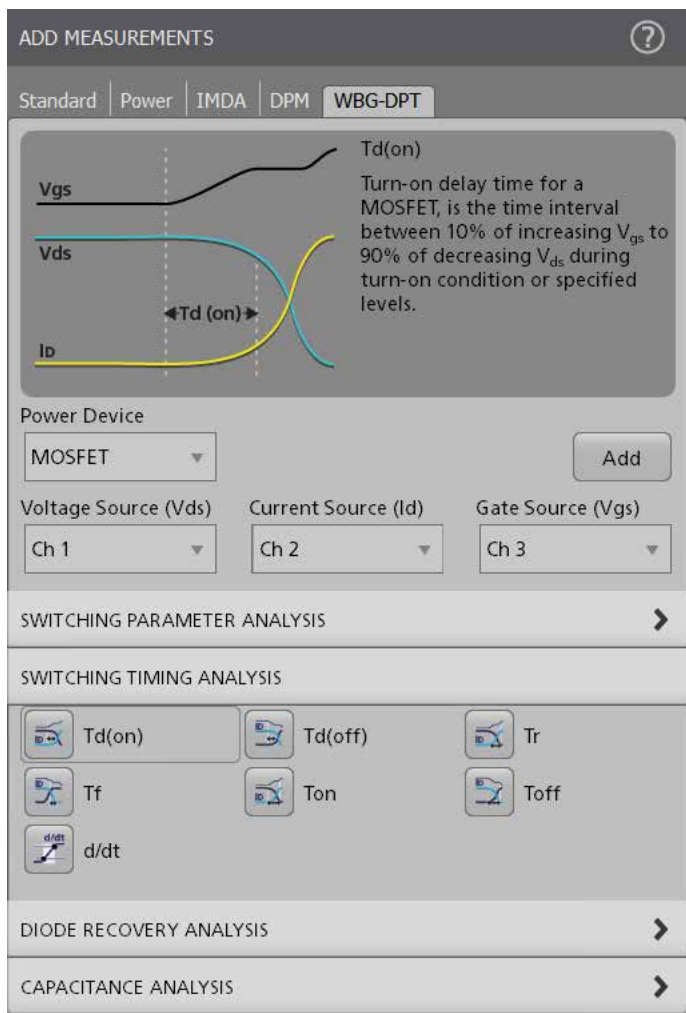

Td(on)

Turn on delay time for a MOSFET is the time interval between 10% of increasing Vgs to 90% of decreasing Vds during turn on condition or specified levels.

Turn on delay time for an IGBT is the time interval between 10% of increasing Vge to 10% of increasing Ic during turn on condition or specified levels.

Td(off)

Turn off delay time for a MOSFET is the time interval between 90% of the decreasing Vgs to 90% of increasing Vds during turn off condition or specified levels.

Turn off delay time for an IGBT is the time interval between 90% of the decreasing Vge to 90% of decreasing Ic during turn off condition or specified levels.

Tr

Rise time for a MOSFET is the time interval between 90% and 10% of the Vds during turn on condition or specified levels.

Rise time for an IGBT is the time interval between 10% and 90% of the Ic during turn on condition or specified levels.

Tf

Fall time for a MOSFET is the time interval between 10% and 90% of the Vds during turn off condition or specified levels.

Fall time for an IGBT is the time interval between 90% and 10% of the Ic during turn off condition or specified levels.

Ton

Turn on time is the sum of the turn on delay time and the rise time. It is the time interval between the rising of a voltage pulse across the input terminals which switches the power device from off-state to on-state.

Toff

Turn off time is the sum of the turn off delay time and the fall time. It is the time interval between the fall of a voltage pulse across the input terminals which switches the power device from on-state to off-state.

d/dt

Switching d/dt measures the rate of change of the voltage or current (slew rate), as it rises from the base reference level to the top reference level or as it falls from the top reference level to the base reference level.

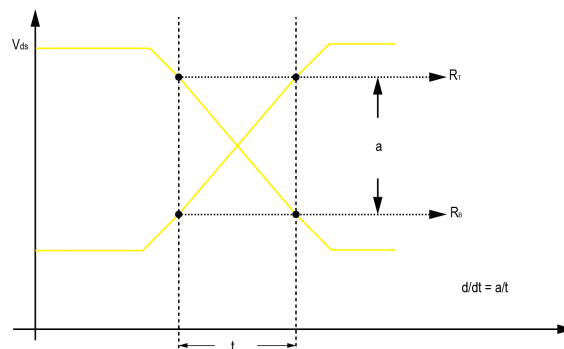

1303-038

Reverse Recovery Analysis

ADD MEASUREMENTS

Standard | Power | IMDA | DPM | **WBG-DPT**

Id

Reverse recovery time is time interval between the instant when the current passes through zero when changing from the forward direction to the reverse direction and the instant when extrapolated reverse current between A and B points reaches zero.

Power Device: MOSFET

Current Source (Id): Ch 1

Gate Source (Vgs): Ch 2

SWITCHING PARAMETER ANALYSIS

SWITCHING TIMING ANALYSIS

DIODE RECOVERY ANALYSIS

Trr, Qrr, Err, Irrm, Diode d/dt

CAPACITANCE ANALYSIS

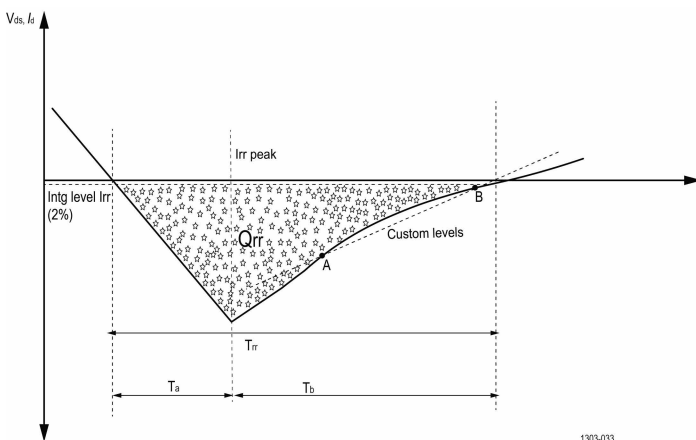

Diode reverse recovery area of a current

Trr

Reverse recovery time (Trr) is the time interval between the instant when the current passes through zero when changing from the forward

direction to the reverse direction and the instant when extrapolated reverse current between A and B points reaches zero.

The Trr is comprised of two time intervals T_a and T_b when rectifiers respond with their own peak reverse recovery current I_{rr} as shown in [above figure](#). The T_a begins at the moment forward current has been ramped down and intersects the zero-current axis, and concludes at the rectifier I_{rr} peak response point.

Reverse recovery current rise time (Ta)

Ta is defined as time taken by reverse recovery current to reach its maximum reverse peak value I_{RM} .

Reverse recovery current fall time (Tb)

Tb is defined as time taken by reverse recovery current (or extrapolated current) to recovery back to zero from its reverse peak value. Hence, $T_{rr} = T_a + T_b$.

Recovery Softness Factor (RSF)

RSF is defined as ratio of reverse recovery current fall time (Tb) to the reverse recovery current rise time (Ta).

Qrr

Reverse recovery charge (Qrr) is the total charge recovered from the power device during a specified integration time of a single collector current or drain current pulse, when the power device is switched from a specified forward current condition to a specified reverse voltage condition with forward biased gate condition.

The recovered charge is measured as:

$$Q_{rr} = \int_{t_0}^{t_0+t_i} I_{rr} \times dt$$

Where:

t_0 is the instant when the current passes through zero.

t_i is the specified integration time, preferably when the current has reached 2% of I_{rr} .

Err

The Reverse recovery energy (Err) is the energy dissipated within the power device during a specified integration time of a single collector current or drain current pulse, when the power device is switched from a specified forward current condition to a specified reverse voltage condition with forward biased gate condition.

The switching energy is the result of the integration of the product from the device voltage and current during the integration time t_i .

$$Err = \int_{t_0}^{t_0+t_i} V_R \times I_{rr} \times dt$$

Diode d/dt

Diode d/dt measures the rate of change of voltage or current (slew rate) during the specified start and stop integration levels. Diode d/dt can be measured during rising or falling edge.

I_{rrm}

Reverse recovery current (I_{rrm}) is the maximum reverse current that occurs during the reverse recovery time interval.

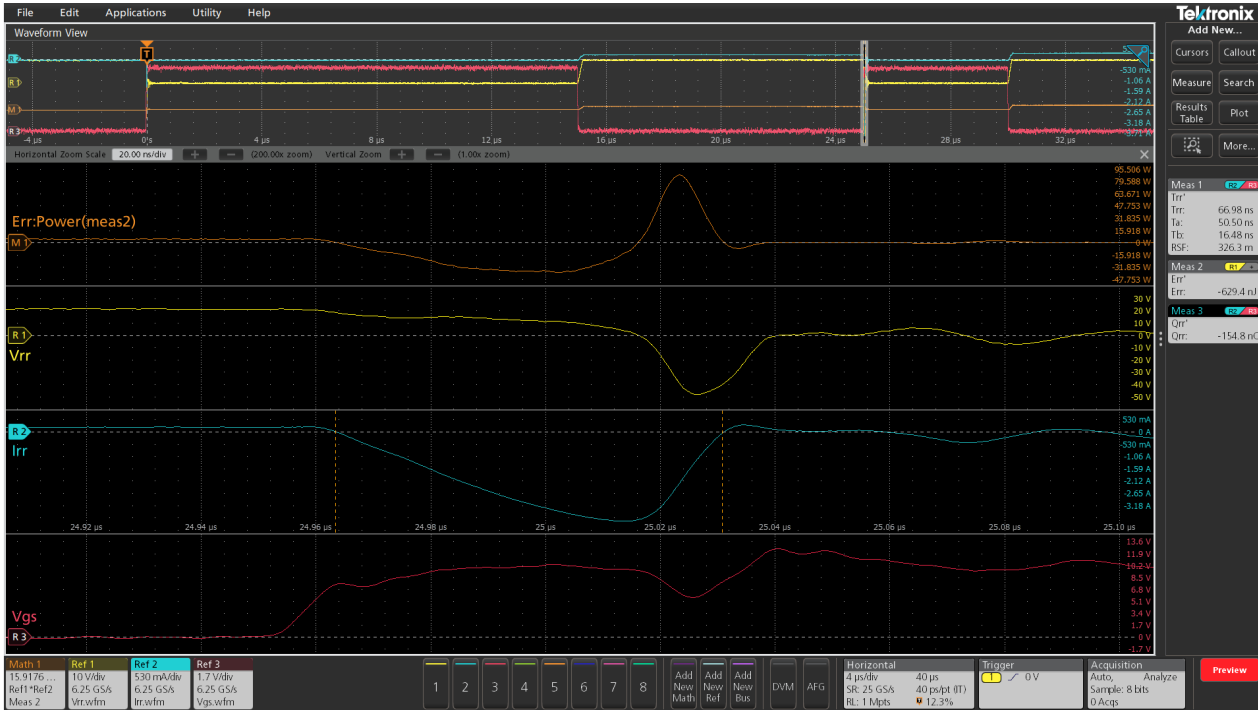

The image shows diode reverse recovery measurements with reverse recovery current and voltage captured on the high side

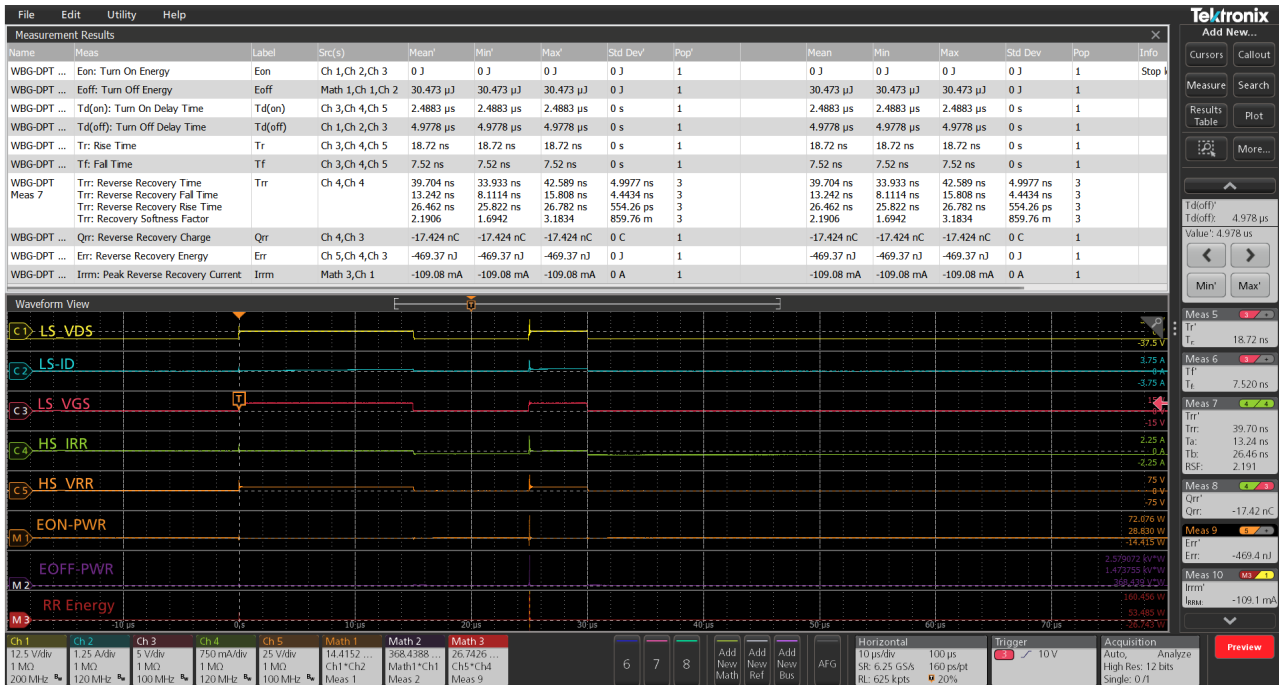

All measurements together, showing switching analysis, and timing parameters on the low side and diode reverse recovery measurements on the high side

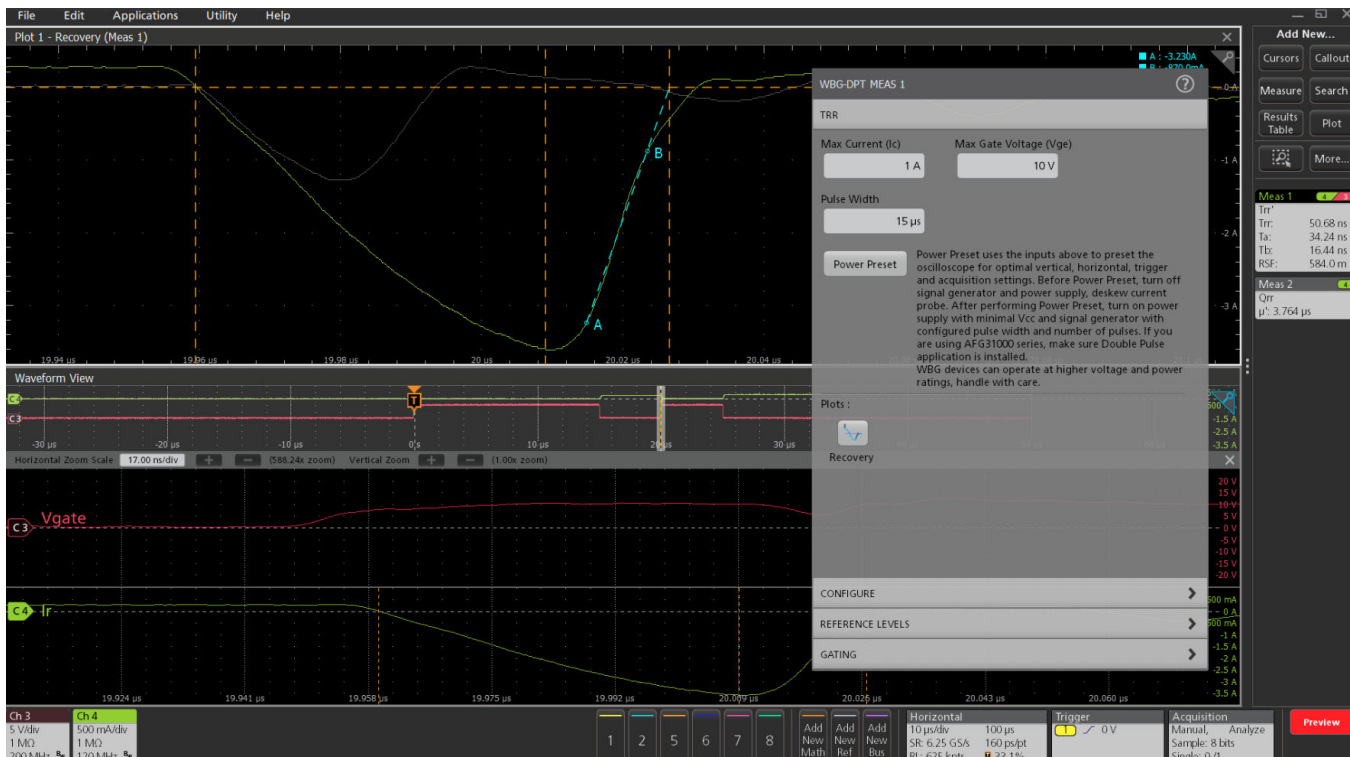

The image shows overlapped plot on the Timing Reverse Recovery (Trr) measurement. The plot can be added from the measurement configuration.

Capacitance analysis

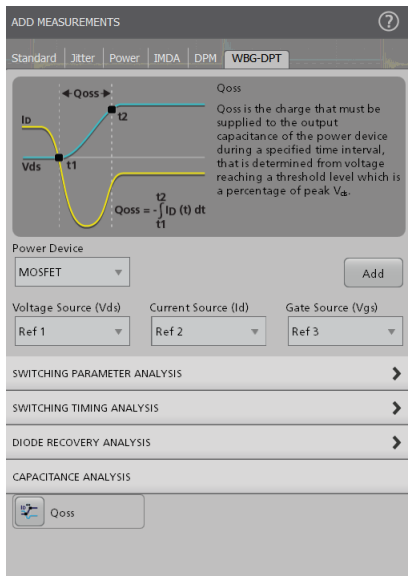

as it directly affects switching speeds of a WBG device and capacitive property of SiC MOSFET body diode during turn on.

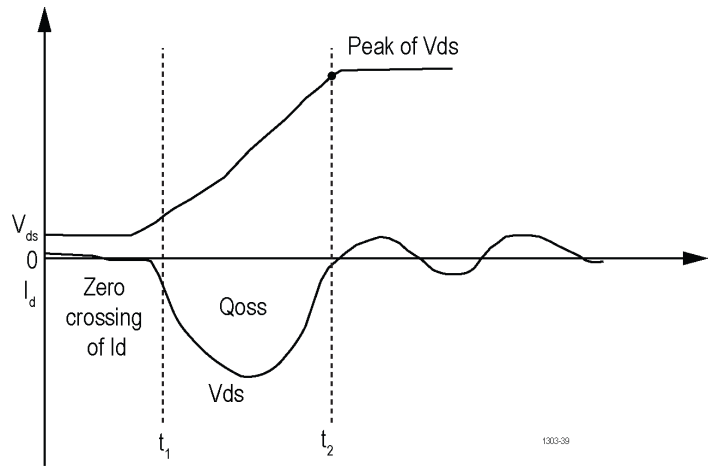

$$Q_{oss} = - \int_{t_1}^{t_2} i_r(t) dt$$

Qoss

Qoss measurement of a WBG-DPT application is the charge that must be supplied to the parasitic output capacitances of the power device during each switching cycle. This represents the output charge. The accurate measurement of output charge is of paramount importance

where,

t1 is the instance when the current passes through zero.

t2 is the specified time interval, preferably when Vds has reached 90% of the peak voltage.

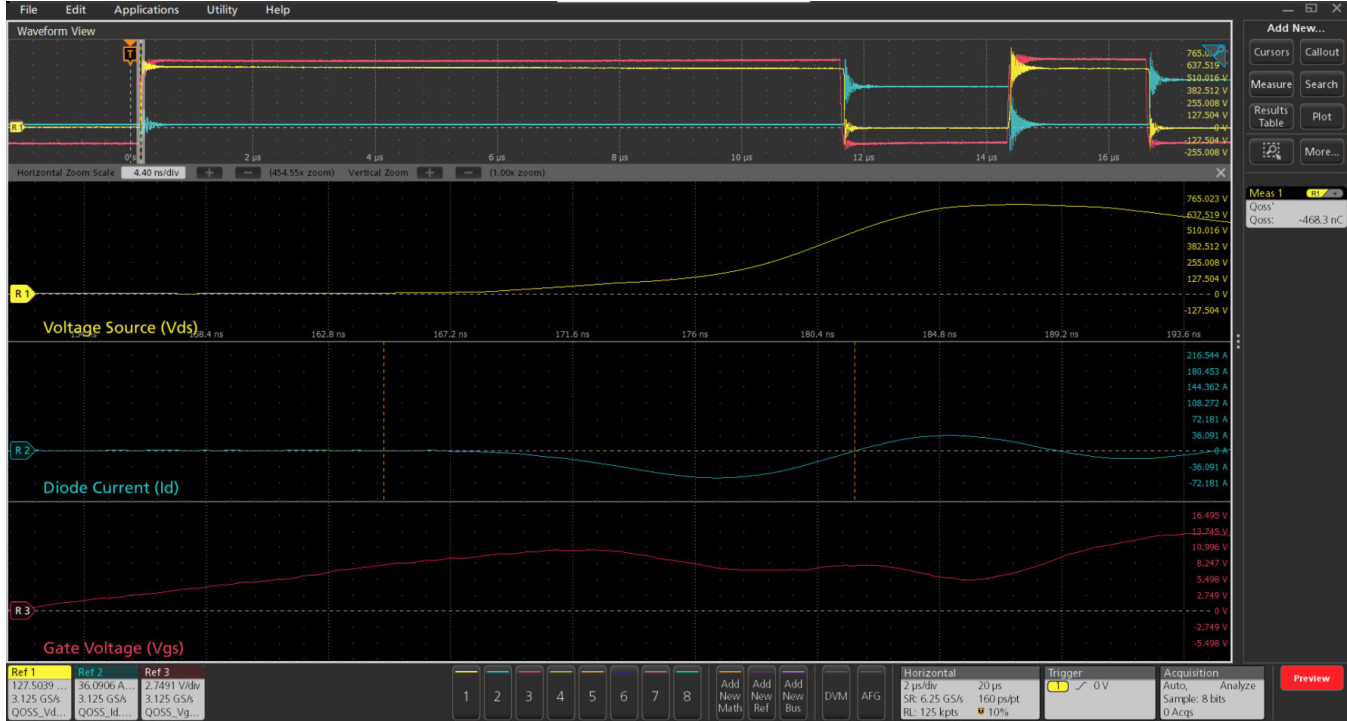

Qoss measured on the diode current with annotations

Specification

Switching Parameter Analysis measurements panel

Measurement	Description
Eon	Measures the energy dissipated in the power device during turn on region using the configured levels.
Eoff	Measures the energy dissipated in the power device during turn off region using the configured levels.
Vpeak	Measures the peak voltage of the power device in the turn off region.
Ipeak	Measures the peak current of the power device in the turn on region.

Switching Timing Analysis measurements panel

Measurement	Description
Td(on)	Measures the turn on delay time of the power device in the turn on region using the configured levels.
Td(off)	Measures the turn off delay time of the power device in the turn off region using the configured levels.
Tr	Measures the rise time of the power device in the turn on region using the configured levels.
Tf	Measures the fall time of the power device in the turn off region using the configured levels.
Ton	Measures the turn on time of the power device. It is the sum of the turn on delay time and the rise time.
Toff	Measures the turn off time of the power device. It is the sum of the turn off delay time and the fall time.
d/dt	Measures the rate of change of Drain to Source Voltage, or Drain Current between the specified levels.

Diode Recovery Analysis measurements panel

Measurement	Description
Trr ¹	Measures the reverse recovery time of the power device using the configured levels.
Qrr	Measures the reverse recovery charge in the power device using the configured levels.
Err	Measures the reverse recovery energy dissipated in the power device using the configured levels.
Irrm	Measures the reverse recovery current statistics.
Diode d/dt	Measures the rate of change of reverse recovery voltage or current between the specified levels.

Capacitance Analysis measurements panel

Measurement	Description
Qoss	Measures the charge that must be supplied to the parasitic output capacitances of a power device during each switching cycle.

Plots Waveform view with annotation, Recovery plot for Trr measurement.

Report MHT and PDF formats, Data export to CSV format

Degauss/Deskew (static) User can deskew voltage and current probes, degauss the current probes from the menus for each channel

¹ Ta, Tb, and RSF are reported as part of this measurement.

WBG Deskew Perform deskew between Vds and Id on the switching device²

Source support Live analog signals, reference waveforms, and math waveforms

² Refer [4/5/6 Series MSO Help](#) for more details.

Ordering information

Models and software licenses

Product	Options	Supported instruments	Bandwidth available
New instrument purchase option	4-WBG-DPT	4 Series MSO (MSO44 and MSO46)	<ul style="list-style-type: none"> • 200 MHz • 350 MHz • 500 MHz • 1 GHz • 1.5 GHz
Product upgrade option	SUP4-WBG-DPT		
Floating license	SUP4-WBG-DPT-FL		
New instrument purchase option	5-WBG-DPT	5 Series B MSO (MSO54B, MSO56B, and MSO58B)	<ul style="list-style-type: none"> • 350 MHz • 500 MHz • 1 GHz • 2 GHz
Product upgrade option	SUP5-WBG-DPT		
Floating license	SUP5-WBG-DPT-FL		
New instrument purchase option	6-WBG-DPT	6 Series B MSO (MSO64B, MSO66B, and MSO68B)	<ul style="list-style-type: none"> • 1 GHz • 2.5 GHz • 4 GHz • 6 GHz • 8 GHz • 10 GHz
Product upgrade option	SUP6-WBG-DPT		
Floating license	SUP6-WBG-DPT-FL		

Software bundles

Supported instruments	Bundle options	Description
4 Series MSO	4-PRO-POWER-1Y	1 Year License Pro Power Bundle
	4-PRO-POWER-PER	Perpetual License Pro Power Bundle
	4-ULTIMATE-1Y	1 Year License Ultimate Bundle
	4-ULTIMATE-PER	Perpetual License Ultimate Bundle
5 Series B MSO	5-PRO-POWER-1Y	1 Year License Pro Power Bundle
	5-PRO-POWER-PER	Perpetual License Pro Power Bundle
	5-ULTIMATE-1Y	1 Year License Ultimate Bundle
	5-ULTIMATE-PER	Perpetual License Ultimate Bundle
	5-PRO-AUTO-1Y	1 Year License Pro Automotive Bundle
	5-PRO-AUTO-PER	Perpetual License Pro Automotive Bundle

Table continued...

Supported instruments	Bundle options	Description
6 Series B MSO	6-PRO-POWER-1Y	1 Year License Pro Power Bundle
	6-PRO-POWER-PER	Perpetual License Pro Power Bundle
	6-ULTIMATE-1Y	1 Year License Ultimate Bundle
	6-ULTIMATE-PER	Perpetual License Ultimate Bundle
	6-PRO-AUTO-1Y	1 Year License Pro Automotive Bundle
	6-PRO-AUTO-PER	Perpetual License Pro Automotive Bundle

Recommended probes

Probe model	Description	Quantity
TCP0030A, TCP0150, or TRCP Series	Current probe for making Ids measurement	1
TIVP02, TIVP05, or TIVP1	Voltage probe for making High-side Vgs measurement	1
TPP0100, TPP0200, TPP0500B, or TPP1000	Voltage probe for making Low-side Vgs measurement	1
THDP0100, THDP0200, TMDP0200, TPP0850 ³ , or TPP1000 ³	Voltage probe for making Low-side Vds measurement	1

Recommended function generators and power supply

Recommended function generators, gate driver source

Model	Analog channels	Frequency range	Plug-in
AFG31000 Arbitrary Function Generator	2 ⁴	25 MHz, 50 MHz, 100 MHz, 150 MHz, 250 MHz	Double Pulse Test Plug-In Application on the AFG31000

Recommended power supplies

Model	Rated voltage ranges	Rated current	Rated output power
2470 SMU	Max 1000 V	Up to 1 A	20 W
2260B-800-2	0 - 800 V	0 – 2.88 A	720 W
2657A	Max 3000 V	Max 120 mA	180 W



Tektronix is ISO 14001:2015 and ISO 9001:2015 certified by DEKRA.

³ If grounded solidly with isolated power supply.

⁴ The double pulse test application on the AFG31000 does not have two channel functionality, so a low/high side double pulse test requires a manual test setup.

ASEAN / Australasia (65) 6356 3900
Belgium 00800 2255 4835*
Central East Europe and the Baltics +41 52 675 3777
Finland +41 52 675 3777
Hong Kong 400 820 5835
Japan 81 (120) 441 046
Middle East, Asia, and North Africa +41 52 675 3777
People's Republic of China 400 820 5835
Republic of Korea +82 2 565 1455
Spain 00800 2255 4835*
Taiwan 886 (2) 2656 6688

Austria 00800 2255 4835*
Brazil +55 (11) 3759 7627
Central Europe & Greece +41 52 675 3777
France 00800 2255 4835*
India 000 800 650 1835
Luxembourg +41 52 675 3777
The Netherlands 00800 2255 4835*
Poland +41 52 675 3777
Russia & CIS +7 (495) 6647564
Sweden 00800 2255 4835*
United Kingdom & Ireland 00800 2255 4835*

Balkans, Israel, South Africa and other ISE Countries +41 52 675 3777
Canada 1 800 833 9200
Denmark +45 80 88 1401
Germany 00800 2255 4835*
Italy 00800 2255 4835*
Mexico, Central/South America & Caribbean 52 (55) 56 04 50 90
Norway 800 16098
Portugal 80 08 12370
South Africa +41 52 675 3777
Switzerland 00800 2255 4835*
USA 1 800 833 9200

* European toll-free number. If not accessible, call: +41 52 675 3777

For Further Information. Tektronix maintains a comprehensive, constantly expanding collection of application notes, technical briefs and other resources to help engineers working on the cutting edge of technology. Please visit www.tek.com.

Copyright © Tektronix, Inc. All rights reserved. Tektronix products are covered by U.S. and foreign patents, issued and pending. Information in this publication supersedes that in all previously published material. Specification and price change privileges reserved. TEKTRONIX and TEK are registered trademarks of Tektronix, Inc. All other trade names referenced are the service marks, trademarks, or registered trademarks of their respective companies.

15 Sep 2023 61W-73888-03
tek.com

Tektronix[®]