

The Fundamentals of Three-Phase Power Measurements

Application Note

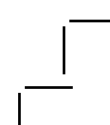

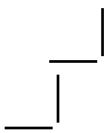

Application Note

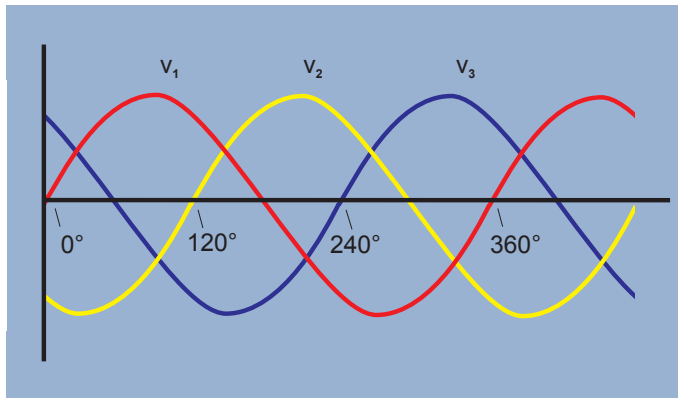

Figure 1. Three-phase voltage waveform.

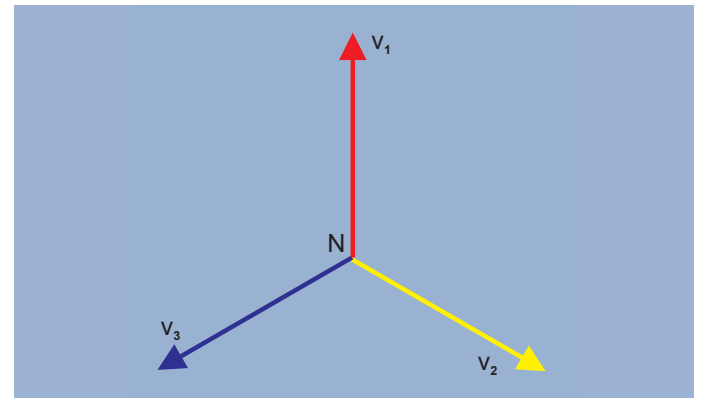

Figure 2. Three-phase voltage vectors.

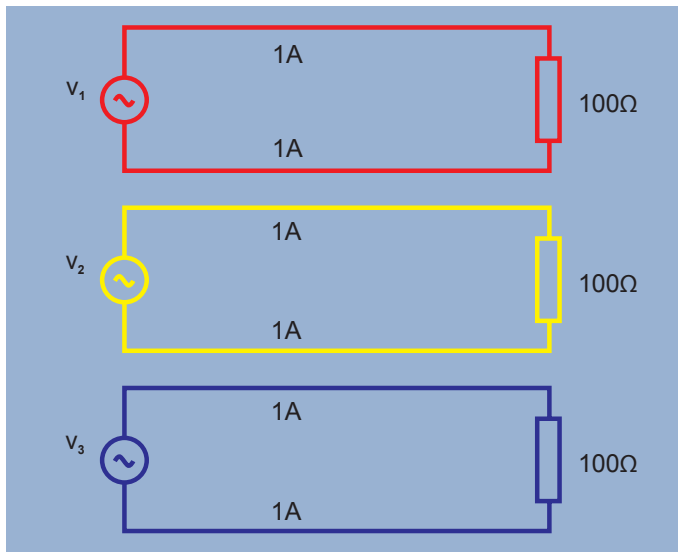

Figure 3. Three single-phase supplies - six units of loss.

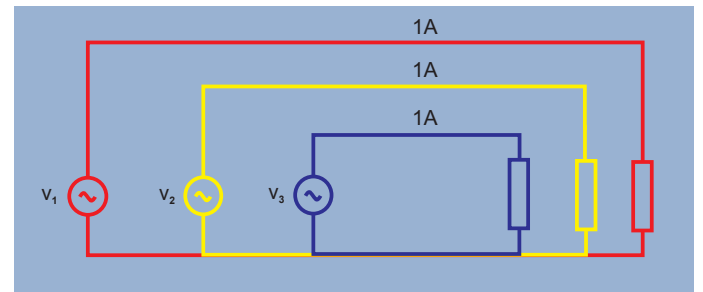

Figure 4. Three-phase supply, balanced load - 3 units of loss.

Introduction

Although single-phase electricity is used to supply common domestic and office electrical appliances, three-phase alternating current (a.c.) systems are almost universally used to distribute electrical power and to supply electricity directly to higher power equipment.

This technical note describes the basic principles of three-phase systems and the difference between the different measurement connections that are possible.

Three-phase systems

Three-phase electricity consists of three ac voltages of identical frequency and similar amplitude. Each ac voltage 'phase' is separated by 120° from the other (Figure 1). This can be represented diagrammatically by both waveforms and a vector diagram (Figure 2).

Three phase systems are used for two reasons:

1. The three vector-spaced voltages can be used to create a rotating field in a motor. Motors can thus be started without the need for additional windings.
2. A three-phase system can be connected to a load such that the amount of copper connections required (and thus the transmission losses) are one half of what they would otherwise be.

Consider three single-phase systems each supplying 100W to a load (Figure 3). The total load is $3 \times 100\text{W} = 300\text{W}$. To supply the power, 1 amp flows through 6 wires and there are thus 6 units of loss. Alternatively, the three supplies can be connected to a common return, as shown in Figure 4. When the load current in each phase is the same the load is said to be balanced. With the load balanced, and the three currents phase shifted by 120° from each other, the sum of the current at any instant is zero and there is no current in the return line.

In a three-phase 120° system, only 3 wires are required to transmit the power that would otherwise require 6 wires. One half of the copper is required and the wire transmission losses will be halved.

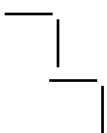

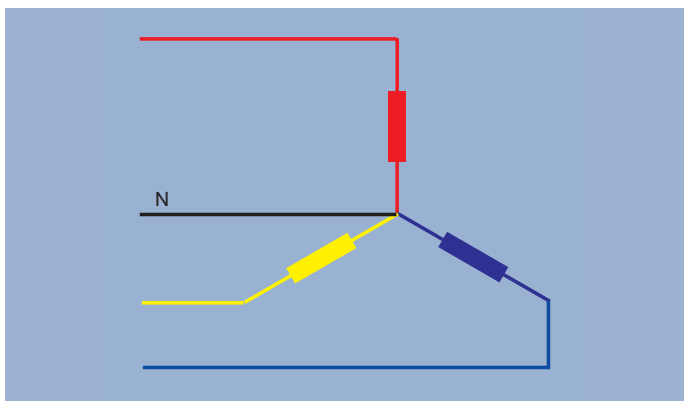

Figure 5. Wye or star connection - three- phase, four wires.

Wye or Star Connection

A three-phase system with a common connection is normally drawn as shown in Figure 5 and is known as a 'wye' or 'star' connection.

The common point is called the neutral point. This point is often grounded at the supply for safety reasons. In practice, loads are not perfectly balanced and a fourth 'neutral' wire is used to carry the resultant current. The neutral conductor may be considerably smaller than the three main conductors, if allowed by local codes and standards.

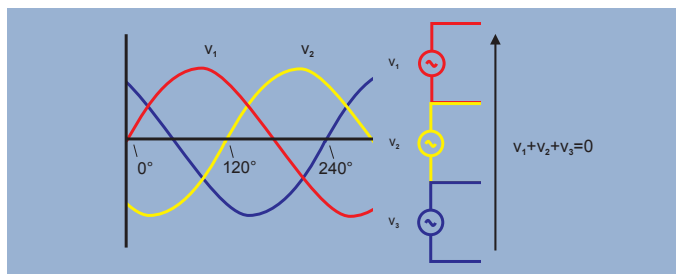

Figure 6. The sum of the instantaneous voltage at any time is zero.

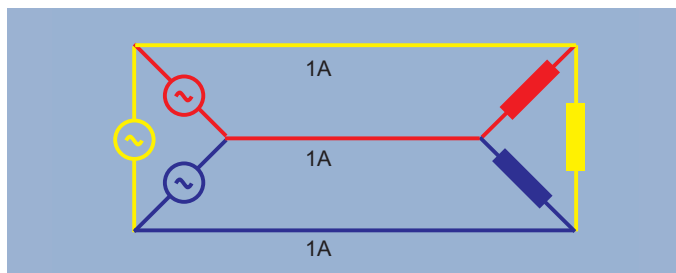
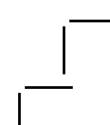
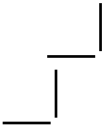

Figure 7. Delta connection - three-phase, three wires.

Delta Connection

The three single-phase supplies discussed earlier could also be connected in series. The sum of the three 120° phase shifted voltages at any instant is zero. If the sum is zero, then both end points are at the same potential and may be joined together. The connection is usually drawn as shown in Figure 7 and is known a delta connection after the shape of the Greek letter delta, Δ.





Application Note

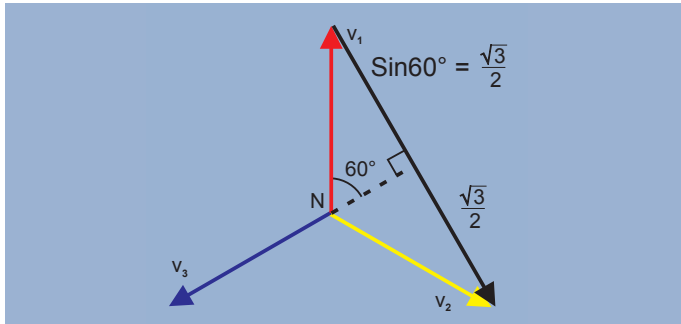

Figure 8. $V_{\text{phase-phase}} = \sqrt{3} \times V_{\text{phase-neutral}}$

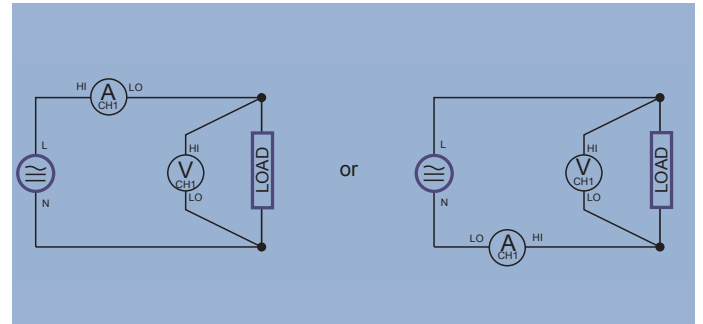

Figure 10. Single-phase, two-wire and DC measurements.

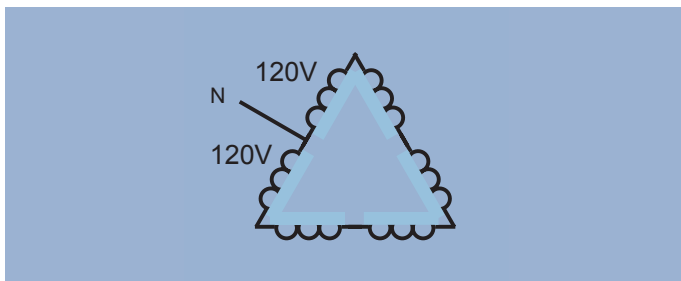

Figure 9. Delta configuration with a "split-phase" or "center-tapped" winding.

Wye and Delta Comparison

The Wye configuration is used to distribute power to everyday single-phase appliances found in the home and office. Single-phase loads are connected to one leg of the wye between line and neutral. The total load on each phase is shared out as much as possible to present a balanced load to the primary three phase supply.

The wye configuration can also supply single or three-phase power to higher power loads at a higher voltage. The single-phase voltages are phase to neutral voltages. A higher phase to phase voltage is also available as shown by the black vector in Figure 8.

The delta configuration is most often used to supply higher power three-phase industrial loads. Different voltage combinations can be obtained from one three-phase delta supply however, by making connections or 'taps' along the windings of the supply transformers. In the US, for example, a 240V delta system may have a split-phase or center-tapped winding to provide two 120V supplies (Figure 9). The center-tap may be grounded at the transformer for safety reasons. 208V is also available between the center tap and the third 'high leg' of the delta connection.

Power Measurements

Power is measured in ac systems using wattmeters. A modern digital sampling wattmeter, such as any of the Tektronix power analyzers, multiplies instantaneous samples of voltage and current together to calculate instantaneous watts and then takes an average of the instantaneous watts over one cycle to display the true power. A wattmeter will provide accurate measurements of true power, apparent power, volt-amperes reactive, power factor, harmonics and many others over a broad range of wave shapes, frequencies and power factor. In order for the power analyzer to give good results, you must be able to correctly identify the wiring configuration and connect the analyzer's wattmeters correctly.

Single-Phase Wattmeter Connection

Only one wattmeter is required, as shown in Figure 10. The system connection to the voltage and current terminals of the wattmeter is straightforward. The voltage terminals of the wattmeter are connected in parallel across the load and the current is passed through the current terminals which are in series with the load.

Single-Phase Three-Wire Connection

In this system, shown in Figure 11, the voltages are produced from one center-tapped transformer winding and all voltages are in phase. This is common in North American residential applications, where one 240 V and two 120V supplies are available and may have different loads on each leg. To measure the total power and other quantities, connect two wattmeters as shown in Figure 11.

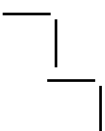

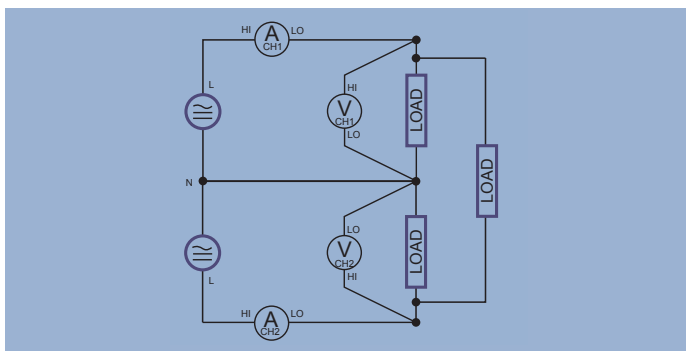

Figure 11. Single-phase, three-wire.

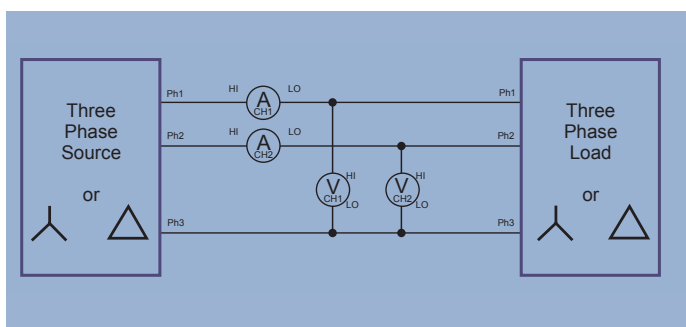

Figure 13. Three-phase, three-wire, 2 wattmeter method.

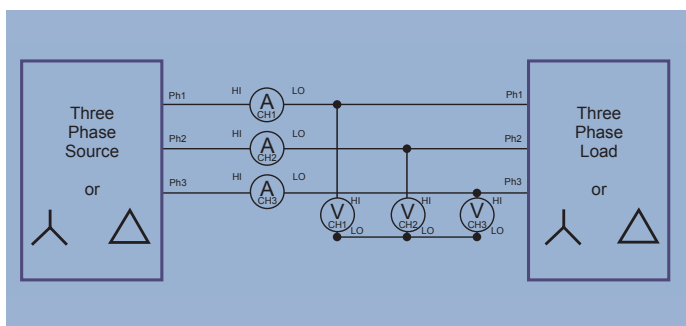

Figure 14. Three-phase, three-wire (three wattmeter method - set analyzer to three-phase, four-wire mode).

Three-Phase Three-Wire Connection - Two Wattmeter Method

Where three wires are present, two wattmeters are required to measure total power. Connect the wattmeters as shown in Figure 11. The voltage terminals of the wattmeters are connected phase to phase.

Three-Phase Three-Wire Connection - Three Wattmeter Method

Although only two wattmeters are required to measure total power in a three-wire system as shown earlier, it is sometimes

Blondel's Theorem: Number of Wattmeters Required

In a single-phase system there are just two wires. Power is measured using a single wattmeter. In a three-wire system, two wattmeters are required as shown in Figure 12.

In general, the Number of Wattmeters Required = the Number of Wires - 1

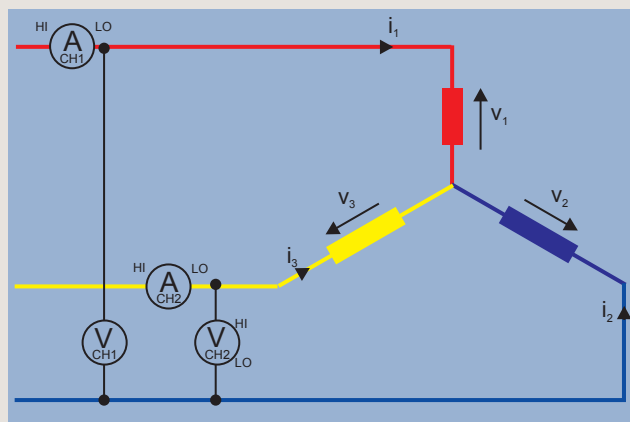

Figure 12. Three-wire wye system.

Proof for a three-wire wye system

The instantaneous power measured by a wattmeter is the product of the instantaneous voltage and current samples.

$$\text{Wattmeter 1 reading} = i_1 (v_1 - v_3)$$

$$\text{Wattmeter 2 reading} = i_2 (v_2 - v_3)$$

$$\begin{aligned} \text{Sum of readings } W_1 + W_2 &= i_1 v_1 - i_1 v_3 + i_2 v_2 - i_2 v_3 \\ &= i_1 v_1 + i_2 v_2 - (i_1 + i_2) v_3 \end{aligned}$$

(From Kirchoff's law, $i_1 + i_2 + i_3 = 0$, so $i_1 + i_2 = -i_3$)

$$\mathbf{2 \text{ readings } W_1 + W_2 = i_1 v_1 + i_2 v_2 + i_3 v_3 = \text{total instantaneous watts.}}$$

convenient to use three wattmeters. In the connection shown in Figure 14 a false neutral has been created by connecting the voltage low terminals of all three wattmeters together.

The three-wire, three-wattmeter connection has the advantages of indicating the power in each individual phase (not possible in the two-wattmeter connection) and phase to neutral voltages.

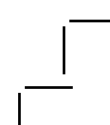

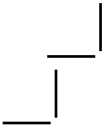

Application Note

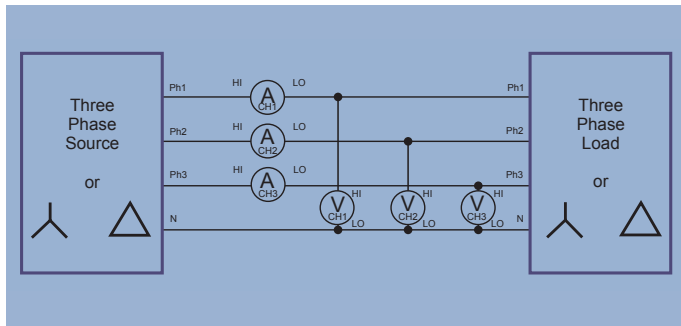

Figure 15. Three-phase, four-wire (three wattmeter method).

Three-Phase, Four-Wire Connection

Three wattmeters are required to measure total watts in a four-wire system. The voltages measured are the true phase to neutral voltages. The phase to phase voltages can be accurately calculated from the phase to neutral voltages' amplitude and phase using vector mathematics. A modern power analyzer will also use Kirchoff's law to calculate the current flowing in the neutral line.

Configuring Measurement Equipment

As shown in the sidebar, for a given number of wires, N, N-1 wattmeters are required to measure total quantities such as power. You must make sure you have sufficient number of channels, and connect them properly.

Modern multi-channel power analyzers will calculate total or sum quantities such as watts, volts, amps, volt-amperes and power factor directly using appropriate built-in formulas. The formulas are selected based on the wiring configuration, so setting the wiring is critical to get good total power measurements. A power analyzer with vector mathematics capability will also convert phase to neutral (or wye) quantities to phase to phase (or delta) quantities. The factor $\sqrt{3}$ can only be used to convert between systems or scale the measurements of only one wattmeter on balanced, linear systems.

Understanding wiring configurations and making proper connections is critical to performing power measurements. Being familiar with common wiring systems, and remembering Blondel's Theorem will help you get the connections right and results you can rely upon.

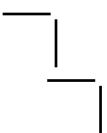

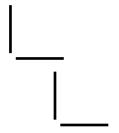

The Fundamentals of Three-Phase Power Measurements

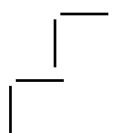

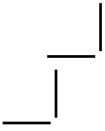

Contact Tektronix:

- ASEAN / Australia (65) 6356 3900
- Austria* 00800 2255 4835
- Balkans, Israel, South Africa and other ISE Countries +41 52 675 3777
- Belgium* 00800 2255 4835
- Brazil +55 (11) 3759 7627
- Canada 1 (800) 833-9200
- Central East Europe and the Baltics +41 52 675 3777
- Central Europe & Greece +41 52 675 3777
- Denmark +45 80 88 1401
- Finland +41 52 675 3777
- France* 00800 2255 4835
- Germany* 00800 2255 4835
- Hong Kong 400-820-5835
- Ireland* 00800 2255 4835
- India +91-80-30792600
- Italy* 00800 2255 4835
- Japan 0120-441-046
- Luxembourg +41 52 675 3777
- Macau 400-820-5835
- Mongolia 400-820-5835
- Mexico, Central/South America & Caribbean 52 (55) 56 04 50 90
- Middle East, Asia and North Africa +41 52 675 3777
- The Netherlands* 00800 2255 4835
- Norway 800 16098
- People's Republic of China 400-820-5835
- Poland +41 52 675 3777
- Portugal 80 08 12370
- Puerto Rico 1 (800) 833-9200
- Republic of Korea +822-6917-5000
- Russia +7 (495) 7484900
- Singapore +65 6356-3900
- South Africa +27 11 206 8360
- Spain* 00800 2255 4835
- Sweden* 00800 2255 4835
- Switzerland* 00800 2255 4835
- Taiwan 886-2-2656-6688
- United Kingdom* 00800 2255 4835
- USA 1 (800) 833-9200

* If the European phone number above is not accessible,
please call +41 52 675 3777

Contact List Updated March 2013

For Further Information

Tektronix maintains a comprehensive, constantly expanding collection of application notes, technical briefs and other resources to help engineers working on the cutting edge of technology. Please visit www.tektronix.com



Copyright © 2013, Tektronix. All rights reserved. Tektronix products are covered by U.S. and foreign patents, issued and pending. Information in this publication supersedes that in all previously published material. Specification and price change privileges reserved. TEKTRONIX and TEK are registered trademarks of Tektronix, Inc. All other trade names referenced are the service marks, trademarks or registered trademarks of their respective companies.

