

## **Instructions**

**Tektronix**

**P6562A  
350 MHz SMD Probe**

**070-8768-01**

Copyright© Tektronix, Inc., 1993. All rights reserved.

Tektronix products are covered by U.S. and foreign patents, issued and pending. Information in this publication supercedes that in all previously published material. Specifications and price change priviledges reserved.

Printed in the U.S.A.

Tektronix, Inc., P.O. Box 1000, Wilsonville, OR 97070

TEKTRONIX,TEK, KlipChip, and SureFoot are registered trademarks of Tektronix, Inc.

## WARRANTY

Tektronix warrants that this product will be free from defects in materials and workmanship for a period of one (1) year from the date of shipment. If any such product proves defective during this warranty period, Tektronix, at its option, either will repair the defective product without charge for parts and labor, or will provide a replacement in exchange for the defective product.

In order to obtain service under this warranty, Customer must notify Tektronix of the defect before the expiration of the warranty period and make suitable arrangements for the performance of service. Customer shall be responsible for packaging and shipping the defective product to the service center designated by Tektronix, with shipping charges prepaid. Tektronix shall pay for the return of the product to Customer if the shipment is to a location within the country in which the Tektronix service center is located. Customer shall be responsible for paying all shipping charges, duties, taxes, and any other charges for products returned to any other locations.

This warranty shall not apply to any defect, failure or damage caused by improper use or improper or inadequate maintenance and care. Tektronix shall not be obligated to furnish service under this warranty a) to repair damage resulting from attempts by personnel other than Tektronix representatives to install, repair or service the product; b) to repair damage resulting from improper use or connection to incompatible equipment; or c) to service a product that has been modified or integrated with other products when the effect of such modification or integration increases the time or difficulty of servicing the product.

**THIS WARRANTY IS GIVEN BY TEKTRONIX WITH RESPECT TO THIS PRODUCT IN LIEU OF ANY OTHER WARRANTIES, EXPRESSED OR IMPLIED. TEKTRONIX AND ITS VENDORS DISCLAIM ANY IMPLIED WARRANTIES OF MERCHANTABILITY OR FITNESS FOR A PARTICULAR PURPOSE. TEKTRONIX' RESPONSIBILITY TO REPAIR OR REPLACE DEFECTIVE PRODUCTS IS THE SOLE AND EXCLUSIVE REMEDY PROVIDED TO THE CUSTOMER FOR BREACH OF THIS WARRANTY. TEKTRONIX AND ITS VENDORS WILL NOT BE LIABLE FOR ANY INDIRECT, SPECIAL, INCIDENTAL, OR CONSEQUENTIAL DAMAGES IRRESPECTIVE OF WHETHER TEKTRONIX OR THE VENDOR HAS ADVANCE NOTICE OF THE POSSIBILITY OF SUCH DAMAGES.**

## Getting Started

The P6562A is a miniature, 350 MHz, 10X-attenuating passive probe that is compatible with the TDS 460. It may also be used with general purpose oscilloscopes having a 1 M $\Omega$  input impedance with an input capacitance of 15 pF.

The P6562A is provided with several accessories designed to make probing and measurement a simpler task. Please take a moment to familiarize yourself with these accessories and their uses.

Figure 1 shows the probe and identifies various parts that are referred to in these instructions.

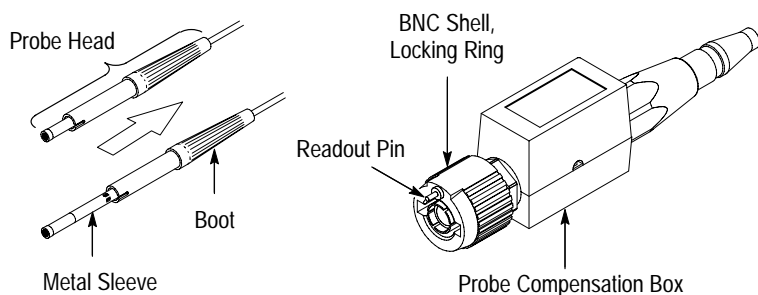

Figure 1: The P6562A Probe

## General Safety Summary

### Observe Maximum Working Voltage

Do not use the P6562A above 42 VDC.

### Do Not Operate in an Explosive Atmosphere

To avoid personal injury or fire hazard, do not operate this product in an explosive atmosphere.

### Do Not Immerse in Liquids

Clean the probe using a damp cloth. Refer to the cleaning instructions on page 8.

---

## Accessories and Operation

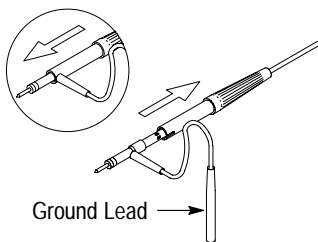

**Ground lead with socket** — Use the ground lead to set a ground reference for your measurements. The ground lead socket (0.025 inch) can be connected to the KlipChip® test clip, directly to a square-pin ground on a circuit board, or to the right-angle square pin adapter.

To attach the ground lead with socket to the probe, gently slide the probe boot back to expose the metal sleeve. Then, slide the ground lead's metal ring over the probe tip onto the probe's metal sleeve. Push the boot back over the metal sleeve and the metal ring. Align the boot slot to fit over the contact of the ground lead.

---

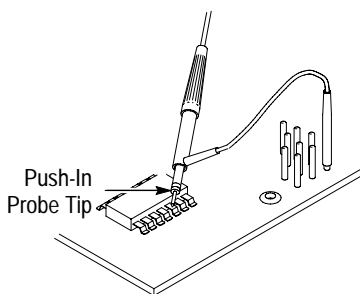

**Push-in probe tip** — Use the push-in probe tip when you are probing circuits by hand. The tip presses into the socket in the probe head.

To attach the push-in probe tip, seat the tip into the probe head and push the tip in until it is seated; *do not force the tip*. To remove the tip, *gently* grab the tip with small pliers and pull the tip out.

---

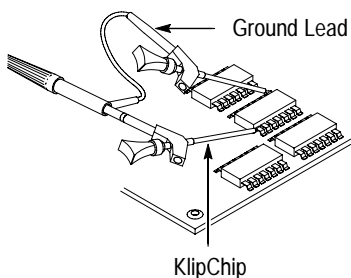

**KlipChip** — Use a KlipChip test clip to access fragile, dense circuitry. To connect a KlipChip, insert the probe socket into its body.

You can connect a second KlipChip to the ground lead with socket. To attach the ground lead, insert the ground lead socket into the KlipChip body.

The KlipChip body freely turns, allowing better probe orientation. To reduce stress and provide a lower profile on components being tested, the flexible sleeve of the KlipChip bends up to a 35 degree angle.

---

## Accessories and Operation

---

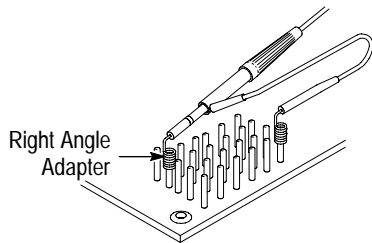

**Right-angle adapter** — Use the right-angle adapter to probe boards with 0.025-inch diameter square pins; for example, on micro-computer and communications backplanes.

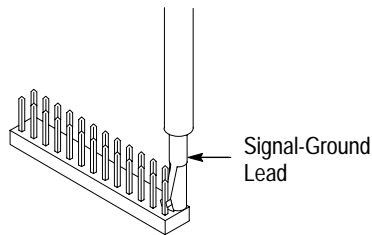

**Signal-Ground lead** — Use the signal-ground lead to substantially reduce ground lead inductance. Because the ground lead simply touches the ground reference (instead of clipping onto it), you can easily move the probe to different points on the device under test.

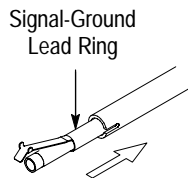

To attach the signal-ground lead, gently slide the boot back to expose the probe's metal sleeve. Slide the metal ring of the signal-ground lead over the probe tip onto the probe's metal sleeve. Push the boot back up to cover both the metal sleeve and metal ring.

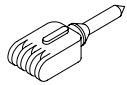

**SureFoot®** — The SureFoot tip is an integral probe tip and miniature guide that enables fault-free probing of fine-pitch SMD packages. The .025 SureFoot tip is designed to be compatible with JEDEC 25 mil packages.

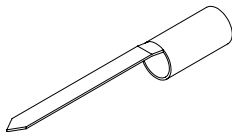

**Short Ground blade** — Use the short ground blade with the SureFoot tip for probing ease and improved signal fidelity. To use it, form a ground plane of copper clad on the top of the IC to be probed. Attach short jumper wires from the device ground to the copper clad. With the SureFoot tip installed, rest the short ground blade on the ground plane while probing the IC.

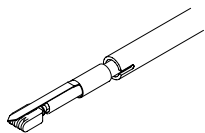

**Installing SureFoot** — Install the short ground blade using the same method as the signal-ground lead. The SureFoot tip is pressed into the probe head in place of the standard push-in tip.

---

## Accessories and Operation

---

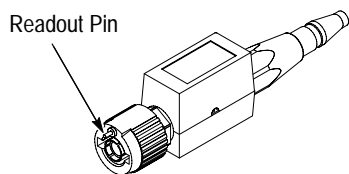

**Readout Pin** — The BNC connector on the probe compensation box includes a spring-loaded pin that connects to a mating contact ring on certain oscilloscopes. These oscilloscopes recognize the attenuation factor of the probe and automatically correct the oscilloscope indication of scale factor.

You can see if your oscilloscope supports this feature by watching the oscilloscope vertical scale factor readout when attaching the probe. If the displayed scale changes by a factor of 10—for instance, from 10 mV to 100 mV—your oscilloscope supports this feature.

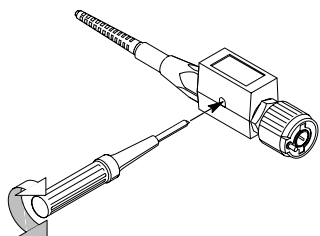

**Adjustment tool** — Use the insulated adjustment tool to adjust the low- and high-frequency adjustments in the probe compensation box.

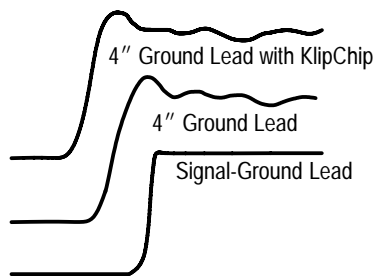

**Ground Lead Length** — To maintain the best signal quality, use the shortest possible ground lead and signal input path.

## Maintenance

### Low-Frequency Probe Compensation

Probe low-frequency (LF) compensation may need adjustment after moving the probe from one oscilloscope to another. Check the low-frequency compensation before making critical rise time or amplitude measurements.

1. Connect the P6562A to the oscilloscope.
2. Remove all accessories from the P6562A probe and attach the push-in probe tip. Make sure the boot covers the probe's metal sleeve.
3. Connect the probe tip to a calibration signal. Most oscilloscopes have a front-panel test point for this purpose; if yours does not, use a signal generator that produces a well-formed square wave at approximately 1 kHz.
4. Adjust the oscilloscope so that it displays two to five cycles.
5. Using the adjustment tool, adjust **LF** in the probe until you see a flat-top square wave on the display. See figure 2.

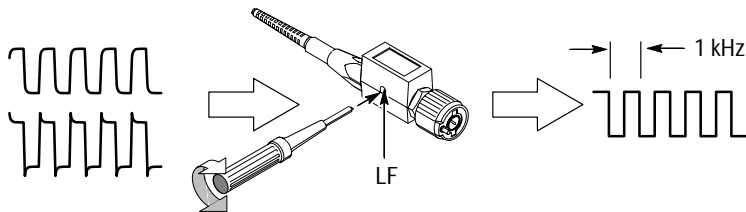

Figure 2: P6562A Low-Frequency Adjustment



## High-Frequency Probe Compensation

The probe high-frequency compensation should seldom require adjustment; however, your probe may require high-frequency adjustment if any of the following are true:

- the probe has high-frequency aberrations
- the probe doesn't perform at the rated bandwidth
- the oscilloscope input capacitance is near the limits of the probe compensation range in Table 1 on page 10.

To perform the high-frequency compensation adjustment you will need a signal source that has all of the following characteristics (see figure 3):

- a square-wave output at 1 MHz
- a fast rise output with rise time less than 1 ns

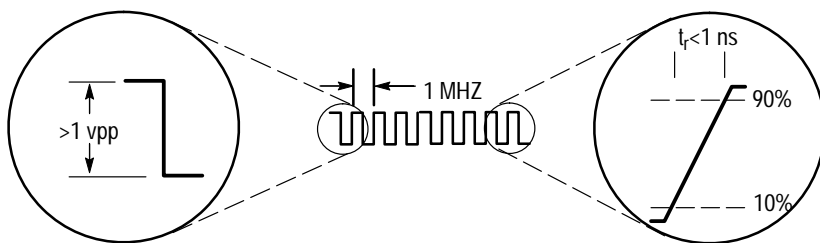
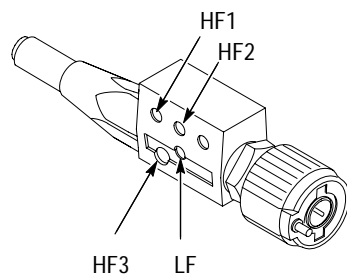

Figure 3: High-Frequency Compensation Signal

The Tektronix PG506A Calibration Generator meets these requirements when properly terminated.

1. Remove the top plastic cover from the compensation box. (To remove the cover, gently insert a tool, such as a small flat-blade screwdriver, under one side of the cover and carefully pry up and out.)
2. Connect the P6562A to the oscilloscope.
3. On the calibration generator, change the pulse period to 1  $\mu$ s (1 MHz).
4. Connect the probe tip to the calibration signal. If you are using a PG 506A, first connect a feed-through termination to the fast-rise output, then connect the probe tip to the feed-through termination. The signal-ground clip can be used for the ground connection.
5. Adjust the oscilloscope to view the first 40 ns of the waveform. See figure 4.
6. Alternately adjust **HF1** and **HF2** for overall flatness. (These adjustments interact.)
7. Adjust **HF3** for the squarest waveform.



(b) Location of Adjustments

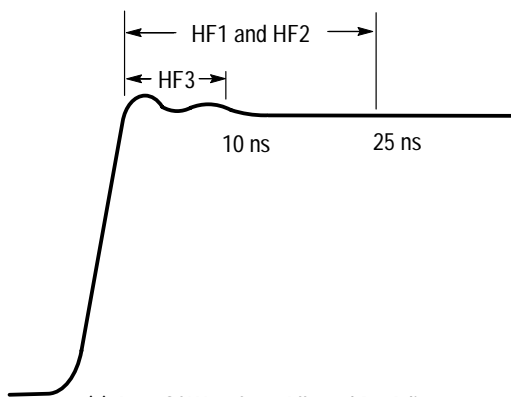

(a) Area Of Waveform Affected By Adjustments

Figure 4: P6562A High-Frequency Compensation

## Cleaning

To prevent damage to probe materials, avoid using chemicals that contain benzene, toluene, xylene, acetone, or similar solvents.

Remove loose dust from the probe exterior using a soft cloth or small brush. Remaining dirt may be removed with a soft cloth dampened with a mild detergent and water solution or isopropyl alcohol. Do not immerse the probe in liquids or use abrasive cleaners.

## Replacing the Probe Cable

Use the following procedure to disassemble the probe to replace the cable assembly. Refer to Figure 5.

1. Using a small flat-blade screwdriver, remove the top and bottom plastic covers on the compensation box. (To remove a cover, insert the tool into the side of the box, under the cover edge; pry gently upward and outward.)
2. Using an adjustable or 1/2" (13 mm) wrench, loosen the compensation box cable retaining nut and slide it back.
3. Lightly grasp the cable strain relief and pull the cable out of the compensation box.
4. Slide the cable retaining nut off of the old cable and onto the new one.
5. Push the new cable connector into the compensation box and press it into place.
6. Using the wrench, gently tighten the cable retaining nut into place until it is snug.

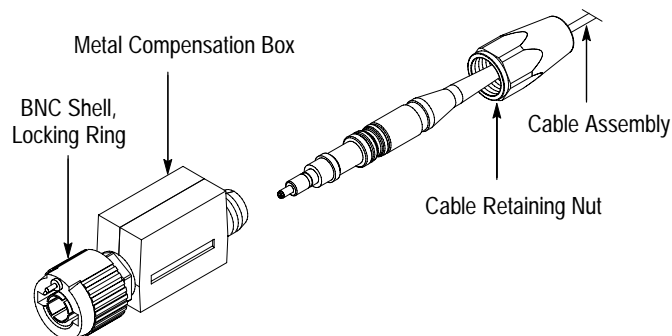

Figure 5: Probe Disassembly

## Specifications

**Table 1: Electrical Characteristics**

System bandwidth (-3 dB)	350 MHz
Attenuation (system)	10X
Rise time (system)	1.1 ns (typical)
Input resistance (system)	10 M $\Omega$ at DC (See Figure 6)
Input capacitance	11.0 pF (typical)
Compensation range	12 pF to 35 pF (typical)
Maximum nondestructive input voltage	42 V (See Figure 7)
Uniform Signal Delay	$\pm$ 125 ps

**Table 2: Mechanical and Environmental Characteristics**

Net Weight (including accessories)	<113 g (4.0 oz)
Probe Cable Length	1.3 m (approximately 4.27 ft.)
Temperature Range	
Operating	0°C to +50°C (+32°F to +122°F)
Nonoperating	-55°C to +75°C (-67°F to +167°F)
Humidity	90% relative humidity
Operating	<50° C
Nonoperating	<60° C

## Specifications

---

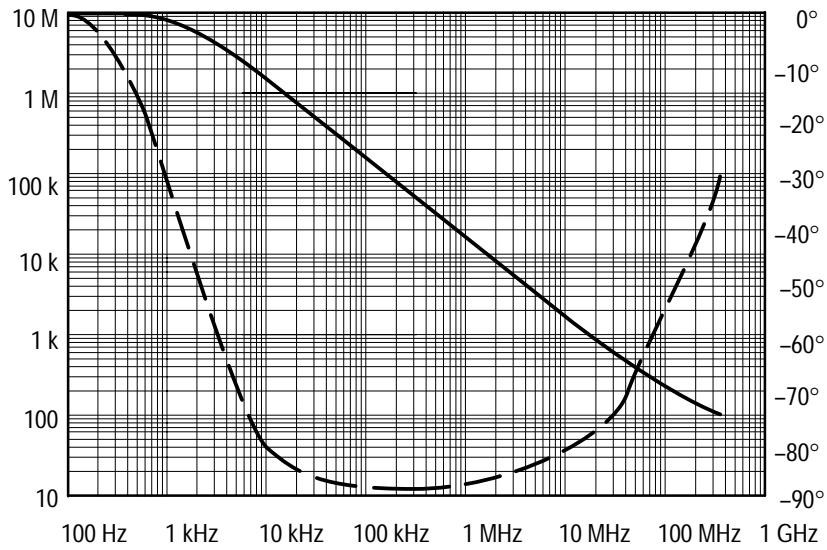

Figure 6: Typical Input Impedance / Phase

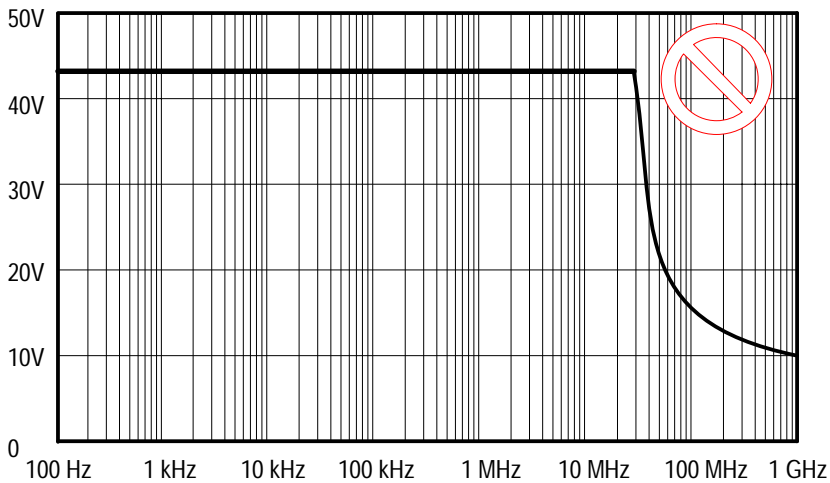

Figure 7: Derating Curve for Determining Maximum Input Voltage (DC + Peak AC)

# Replaceable Parts

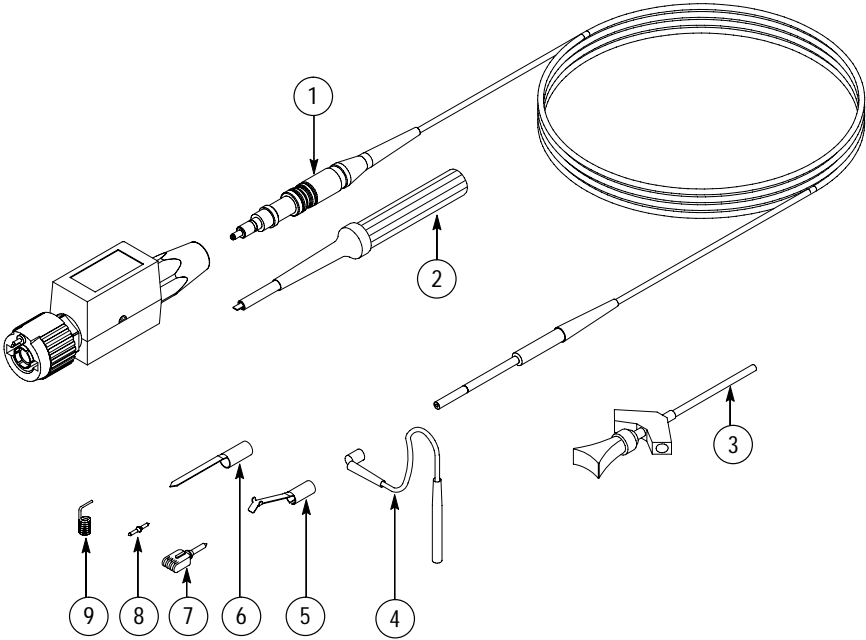

Figure 8: P6562A Replaceable Parts

Replaceable Parts

Fig. & Index No.	Tektronix Part No.	Serial No. Effective	Discont	Qty	12345 Name & Description	Mfr. Code	Mfr. Part No.
8-				1	P6562A,SMD PROBE;350 MHZ 10X		
-1	206-0417-10			1	PROBE HEAD ASSY:WITH CABLE;1.3M	80009	206041710
					<b>STANDARD ACCESSORIES</b>		
-2	020-1993-00			1	ACCESSORY KIT:	80009	020199300
				1	.SCREWDRIVER:ADJUSTMENT TOOL,METAL TIP		
-3				2	.TIP,PROBE:MICROCKT TEST,0.05 CTR		
-4				1	.LEAD,ELECTRICAL:28 AWG,4.0 L		
-5				1	.CONTACT,ELEC:SIGNAL-GROUND LEAD:FEMALE,STR,0.095 ID X 215 L		
-6		9349		1	.CONN,CONTACT:SLDR,SIGNAL-GND LEAD		
-7				1	.ADAPTER,PROBE:0.025 HOUSING		
-8				2	.PROBE,TIP:0.260 L,DUAL TIP,0.120 L		
-9				2	.SPRING,ADAPTER:RIGHT ANGLE,0.025 SQ PIN		
	070-8768-01			1	MANUAL,TECH:INSTRUCTIONS,P6562A	80009	070876801