

Technical Reference

Tektronix

**TDS 500C, TDS 600B & TDS 700C
Digitizing Oscilloscopes
Performance Verification and Specifications**

070-9874-02

CE

Copyright © Tektronix, Inc. All rights reserved.

Tektronix products are covered by U.S. and foreign patents, issued and pending. Information in this publication supercedes that in all previously published material. Specifications and price change privileges reserved.

Printed in the U.S.A.

Tektronix, Inc., P.O. Box 1000, Wilsonville, OR 97070-1000

TEKTRONIX and TEK are registered trademarks of Tektronix, Inc.

WARRANTY

Tektronix warrants that this product will be free from defects in materials and workmanship for a period of three (3) years from the date of shipment. If any such product proves defective during this warranty period, Tektronix, at its option, either will repair the defective product without charge for parts and labor, or will provide a replacement in exchange for the defective product.

In order to obtain service under this warranty, Customer must notify Tektronix of the defect before the expiration of the warranty period and make suitable arrangements for the performance of service. Customer shall be responsible for packaging and shipping the defective product to the service center designated by Tektronix, with shipping charges prepaid. Tektronix shall pay for the return of the product to Customer if the shipment is to a location within the country in which the Tektronix service center is located. Customer shall be responsible for paying all shipping charges, duties, taxes, and any other charges for products returned to any other locations.

This warranty shall not apply to any defect, failure or damage caused by improper use or improper or inadequate maintenance and care. Tektronix shall not be obligated to furnish service under this warranty a) to repair damage resulting from attempts by personnel other than Tektronix representatives to install, repair or service the product; b) to repair damage resulting from improper use or connection to incompatible equipment; or c) to service a product that has been modified or integrated with other products when the effect of such modification or integration increases the time or difficulty of servicing the product.

THIS WARRANTY IS GIVEN BY TEKTRONIX WITH RESPECT TO THIS PRODUCT IN LIEU OF ANY OTHER WARRANTIES, EXPRESSED OR IMPLIED. TEKTRONIX AND ITS VENDORS DISCLAIM ANY IMPLIED WARRANTIES OF MERCHANTABILITY OR FITNESS FOR A PARTICULAR PURPOSE. TEKTRONIX' RESPONSIBILITY TO REPAIR OR REPLACE DEFECTIVE PRODUCTS IS THE SOLE AND EXCLUSIVE REMEDY PROVIDED TO THE CUSTOMER FOR BREACH OF THIS WARRANTY. TEKTRONIX AND ITS VENDORS WILL NOT BE LIABLE FOR ANY INDIRECT, SPECIAL, INCIDENTAL, OR CONSEQUENTIAL DAMAGES IRRESPECTIVE OF WHETHER TEKTRONIX OR THE VENDOR HAS ADVANCE NOTICE OF THE POSSIBILITY OF SUCH DAMAGES.

Table of Contents

General Safety Summary	v
Preface	ix
Contacting Tektronix	x

Performance Verification Procedures

Performance Verification Procedures	1-1
Input Channels vs. Model	1-2
Conventions	1-2
Brief Procedures	1-5
Self Tests	1-5
Functional Tests	1-7
Performance Tests	1-15
Prerequisites	1-15
Equipment Required	1-16
TDS 600B Test Record	1-19
TDS 500C/700C Test Record	1-23
Signal Acquisition System Checks	1-27
Time Base System Checks	1-43
Trigger System Checks	1-45
Output Signal Checks	1-58
Option 05 Video Trigger Checks	1-67
Sine Wave Generator Leveling Procedure	1-84
Optical Filters Checks (TDS 500C/TDS 700C Only)	1-87

Specifications

Specifications	2-1
Product Description	2-1
User Interface	2-2
Signal Acquisition System	2-3
Horizontal System	2-3
Trigger System	2-5
Acquisition Control	2-5
On-Board User Assistance	2-6
Measurement Assistance	2-6
Storage	2-7
I/O	2-7
Display	2-8
Nominal Traits	2-9
Warranted Characteristics	2-17
Typical Characteristics	2-25

List of Figures

Figure 1–1: Map of display functions	1–3
Figure 1–2: Verifying adjustments and signal-path compensation ..	1–6
Figure 1–3: Universal test hookup for functional tests – TDS 600B shown	1–8
Figure 1–4: Measurement of DC offset accuracy at zero setting	1–29
Figure 1–5: Initial test hookup	1–30
Figure 1–6: Measurement of DC accuracy at maximum offset and position	1–32
Figure 1–7: Initial test hookup	1–34
Figure 1–8: Optional initial test hookup	1–34
Figure 1–9: Measurement of analog bandwidth	1–37
Figure 1–10: Initial test hookup	1–39
Figure 1–11: Measurement of channel delay – TDS 684B shown	1–41
Figure 1–12: Initial test hookup	1–43
Figure 1–13: Measurement of accuracy — Long-term and delay time	1–45
Figure 1–14: Initial test hookup	1–46
Figure 1–15: Measurement of time accuracy for pulse and glitch triggering	1–48
Figure 1–16: Initial test hookup	1–49
Figure 1–17: Measurement of trigger-level accuracy	1–51
Figure 1–18: Initial test hookup	1–54
Figure 1–19: Measurement of trigger sensitivity — 50 MHz results shown on a TDS 684B screen	1–55
Figure 1–20: Initial test hookup	1–58
Figure 1–21: Measurement of main trigger out limits	1–60
Figure 1–22: Initial test hookup	1–62
Figure 1–23: Measurement of probe compensator frequency	1–64
Figure 1–24: Subsequent test hookup	1–65
Figure 1–25: Measurement of probe compensator amplitude	1–66
Figure 1–26: Jitter test hookup	1–68
Figure 1–27: Jitter test displayed waveform – TDS 684B shown	1–69
Figure 1–28: Jitter test when completed – TDS 684B shown	1–70
Figure 1–29: Triggered signal range test – 300 mV	1–72
Figure 1–30: Triggered signal range test – 75 mV	1–73
Figure 1–31: 60 Hz Rejection test hookup	1–74
Figure 1–32: 60 Hz Rejection test setup signal	1–74

Figure 1–33: Subsequent 60 Hz Rejection test hookup	1–75
Figure 1–34: 60 Hz Rejection test result – TDS 684B shown	1–76
Figure 1–35: Line count accuracy test hookup	1–77
Figure 1–36: Line count accuracy test setup waveform – TDS 684B shown	1–78
Figure 1–37: Line count accuracy correct result waveform	1–79
Figure 1–38: Setup for sync duty cycle test	1–81
Figure 1–39: Sync duty cycle test: one-div neg pulse waveform	1–82
Figure 1–40: Sync duty cycle test: critically adjusted pulse	1–83
Figure 1–41: Sine wave generator leveling equipment setup	1–85
Figure 1–42: Equipment setup for maximum amplitude	1–86
Figure 1–43: Reference-receiver performance-verification set up ...	1–89
Figure 1–44: Optical impulse of Ch1 input from OA5022 Optical Attenuator (OIG501 / OIG502 fed into optical attenuator in Step 1)	1–91
Figure 1–45: Optical impulse response for OC–12 SONET Reference Receiver	1–94
Figure 1–46: Optical impulse response for OC–12 SONET Reference Receiver	1–95

List of Tables

Table 1–1: Test equipment	1–16
Table 1–2: DC offset accuracy (zero setting)	1–28
Table 1–3: DC Voltage measurement accuracy	1–31
Table 1–4: Analog bandwidth	1–35
Table 1–5: Delay between channels worksheet	1–42
Table 1–6: Available Filters	1–87
Table 1–7: Reference Receiver Filter Options:	1–88
Table 1–8: Option 3C and 4C Specifications	1–88
Table 1–9: Available receivers	1–88
Table 1–10: Bessel Thompson frequency response and reference receiver limits	1–96
Table 2–1: Key features of the TDS 500C, 600B and 700C oscilloscopes	2–1
Table 2–2: Record length and divisions per record vs. TDS model ..	2–4
Table 2–3: Nominal traits — Signal acquisition system	2–9
Table 2–4: Nominal traits — Time base system	2–10
Table 2–5: Nominal traits — Triggering system	2–11
Table 2–6: Nominal traits — Display system	2–13
Table 2–7: Nominal traits — GPIB interface, output ports, and power fuse	2–14
Table 2–8: Nominal traits — Data handling and reliability	2–14
Table 2–9: Nominal traits — Mechanical	2–15
Table 2–10: Warranted characteristics — Signal acquisition system	2–18
Table 2–11: Warranted characteristics — Time base system	2–19
Table 2–12: Warranted characteristics — Triggering system	2–20
Table 2–13: Warranted characteristics — Output ports, probe compensator, and power requirements	2–20
Table 2–14: Warranted characteristics — Environmental	2–22
Table 2–15: Certifications and compliances	2–24
Table 2–16: Typical characteristics — Signal acquisition system ...	2–25
Table 2–17: Typical characteristics — Triggering system	2–28

General Safety Summary

Review the following safety precautions to avoid injury and prevent damage to this product or any products connected to it. To avoid potential hazards, use the product only as specified.

Only qualified personnel should perform service procedures.

While using this product, you may need to access other parts of the system. Read the *General Safety Summary* in other system manuals for warnings and cautions related to operating the system.

Injury Precautions

Use Proper Power Cord	To avoid fire hazard, use only the power cord specified for this product.
Avoid Electric Overload	To avoid electric shock or fire hazard, do not apply a voltage to a terminal that is outside the range specified for that terminal.
Ground the Product	This product is grounded through the grounding conductor of the power cord. To avoid electric shock, the grounding conductor must be connected to earth ground. Before making connections to the input or output terminals of the product, ensure that the product is properly grounded.
Do Not Operate Without Covers	To avoid electric shock or fire hazard, do not operate this product with covers or panels removed.
Use Proper Fuse	To avoid fire hazard, use only the fuse type and rating specified for this product.
Do Not Operate in Wet/Damp Conditions	To avoid electric shock, do not operate this product in wet or damp conditions.
Do Not Operate in Explosive Atmosphere	To avoid injury or fire hazard, do not operate this product in an explosive atmosphere.

Product Damage Precautions

- Use Proper Power Source** Do not operate this product from a power source that applies more than the voltage specified.
- Provide Proper Ventilation** To prevent product overheating, provide proper ventilation.
- Do Not Operate With Suspected Failures** If you suspect there is damage to this product, have it inspected by qualified service personnel.
- Do Not Immerse in Liquids** Clean the probe using only a damp cloth. Refer to cleaning instructions.

Safety Terms and Symbols

Terms in This Manual These terms may appear in this manual:



WARNING. *Warning statements identify conditions or practices that could result in injury or loss of life.*



CAUTION. *Caution statements identify conditions or practices that could result in damage to this product or other property.*

Terms on the Product These terms may appear on the product:

DANGER indicates an injury hazard immediately accessible as you read the marking.

WARNING indicates an injury hazard not immediately accessible as you read the marking.

CAUTION indicates a hazard to property including the product.

Symbols on the Product The following symbols may appear on the product:



DANGER
High Voltage



Protective Ground
(Earth) Terminal



ATTENTION
Refer to
Manual



Double
Insulated

Certifications and Compliances

CSA Certified Power Cords

CSA Certification includes the products and power cords appropriate for use in the North America power network. All other power cords supplied are approved for the country of use.

Preface

This is the Performance Verification and Specifications for the TDS 500C, TDS 600B, and TDS 700C Oscilloscopes. It contains procedures suitable for determining if each instrument functions, was adjusted properly, and meets the performance characteristics as warranted. The following models are covered:

TDS 500C:	TDS 520C and TDS 540C
TDS 600B:	TDS 620B, TDS 644B, TDS 680B, and TDS 684B
TDS 700C:	TDS 724C, TDS 754C, and TDS 784C

This document also contains the technical specifications for these oscilloscopes.

Related Manuals

The following documents are related to the use or service of this digitizing oscilloscope:

- The *TDS 500C, TDS 600B & 700C User Manual* describes how to use this digitizing oscilloscope.
- The *TDS Family Programmer Manual* describes using a computer to control the digitizing oscilloscope through the GPIB interface.
- The *TDS 500C, TDS 600B & 700C Reference* describes a quick overview of how to operate your digitizing oscilloscope.
- The *TDS 500C, TDS 600B & 700C Service Manual* describes information for maintaining and servicing the digitizing oscilloscope to the module level.

Contacting Tektronix

Product Support	<p>For application-oriented questions about a Tektronix measurement product, call toll free in North America: 1-800-TEK-WIDE (1-800-835-9433 ext. 2400) 6:00 a.m. – 5:00 p.m. Pacific time</p> <p>Or, contact us by e-mail: tm_app_supp@tek.com</p> <p>For product support outside of North America, contact your local Tektronix distributor or sales office.</p>
Service Support	<p>Contact your local Tektronix distributor or sales office. Or, visit our web site for a listing of worldwide service locations.</p> <p>http://www.tek.com</p>
For other information	<p>In North America: 1-800-TEK-WIDE (1-800-835-9433) An operator will direct your call.</p>
To write us	<p>Tektronix, Inc. P.O. Box 1000 Wilsonville, OR 97070-1000</p>



Performance Verification Procedures

Performance Verification Procedures

Two types of Performance Verification procedures can be performed on this product: *Brief Procedures* and *Performance Tests*. You may not need to perform all of these procedures, depending on what you want to accomplish.

- To rapidly confirm that the oscilloscope functions and was adjusted properly, just do the brief procedures under *Self Tests*, which begin on page 1–5.

Advantages: These procedures are quick to do, require no external equipment or signal sources, and perform extensive functional and accuracy testing to provide high confidence that the oscilloscope will perform properly. They can be used as a quick check before making a series of important measurements.

- To further check functionality, first do the *Self Tests* just mentioned; then do the brief procedures under *Functional Tests* that begin on page 1–7.

Advantages: These procedures require minimal additional time to perform, require no additional equipment other than a standard-accessory probe, and more completely test the internal hardware of the oscilloscope. They can be used to quickly determine if the oscilloscope is suitable for putting into service, such as when it is first received.

- If more extensive confirmation of performance is desired, do the *Performance Tests*, beginning on page 1–15, after doing the *Functional* and *Self Tests* just referenced.

Advantages: These procedures add direct checking of warranted specifications. They require more time to perform and suitable test equipment is required. (See *Equipment Required* beginning on page 1–16).

If you are not familiar with operating this oscilloscope, read the *TDS 500C, TDS 600B & TDS 700C Reference* (070-9861-XX) or the *TDS 500C, TDS 600B & TDS 700C User Manual* (070-9869-XX). These contain instructions that will acquaint you with the use of the front-panel controls and the menu system.

Input Channels vs. Model

When performing the procedures in this section, be aware that some TDS models refer to input channels Ch 3 and Ch 4 as Aux 1 and Aux 2 respectively. Where appropriate, both names will appear in the procedure, for example, Ch 3 (Aux 1). The channel names for the various TDS models are shown below.

TDS Model	Channel Names
TDS 540C, 644B, 684B, 754C, and 784C	Ch 1, Ch 2, Ch 3, and Ch 4
TDS 520C, 620B, 680B, and 724C	Ch 1, Ch 2, Aux 1, and Aux 2

Conventions

Throughout these procedures the following conventions apply:

- Each test procedure uses the following general format:
 - Title of Test
 - Equipment Required
 - Prerequisites
 - Procedure
- Each procedure consists of as many steps, substeps, and subparts as required to do the test. Steps, substeps, and subparts are sequenced as follows:
 1. First Step
 - a. First Substep
 - First Subpart
 - Second Subpart
 - b. Second Substep
 2. Second Step
- In steps and substeps, the lead-in statement in italics instructs you what to do, while the instructions that follow tell you how to do it, as in the example step below, “*Initialize the oscilloscope*” by doing “Press save/recall **SETUP**. Now, press the main-menu button...”.

Initialize the oscilloscope: Press save/recall **SETUP**. Now, press the main-menu button **Recall Factory Setup**; then the side-menu button **OK Confirm Factory Init**.

- Where instructed to use a front-panel button or knob, or select from a main or side menu, or verify a readout or status message, the name of the button or knob appears in boldface type: “press **SHIFT**; then **UTILITY**, press the main-menu button **System** until **Cal** is highlighted in the pop-up menu. Verify that the status message is **Pass** in the main menu under the **Voltage Reference** label.”

STOP. The symbol at the left is accompanied by information you must read to do the procedure properly.

- Refer to Figure 1–1: “Main menu” refers to the menu that labels the seven menu buttons under the display; “side menu” refers to the menu that labels the five buttons to the right of the display. “Pop-up menu” refers to a menu that pops up when a main-menu button is pressed.

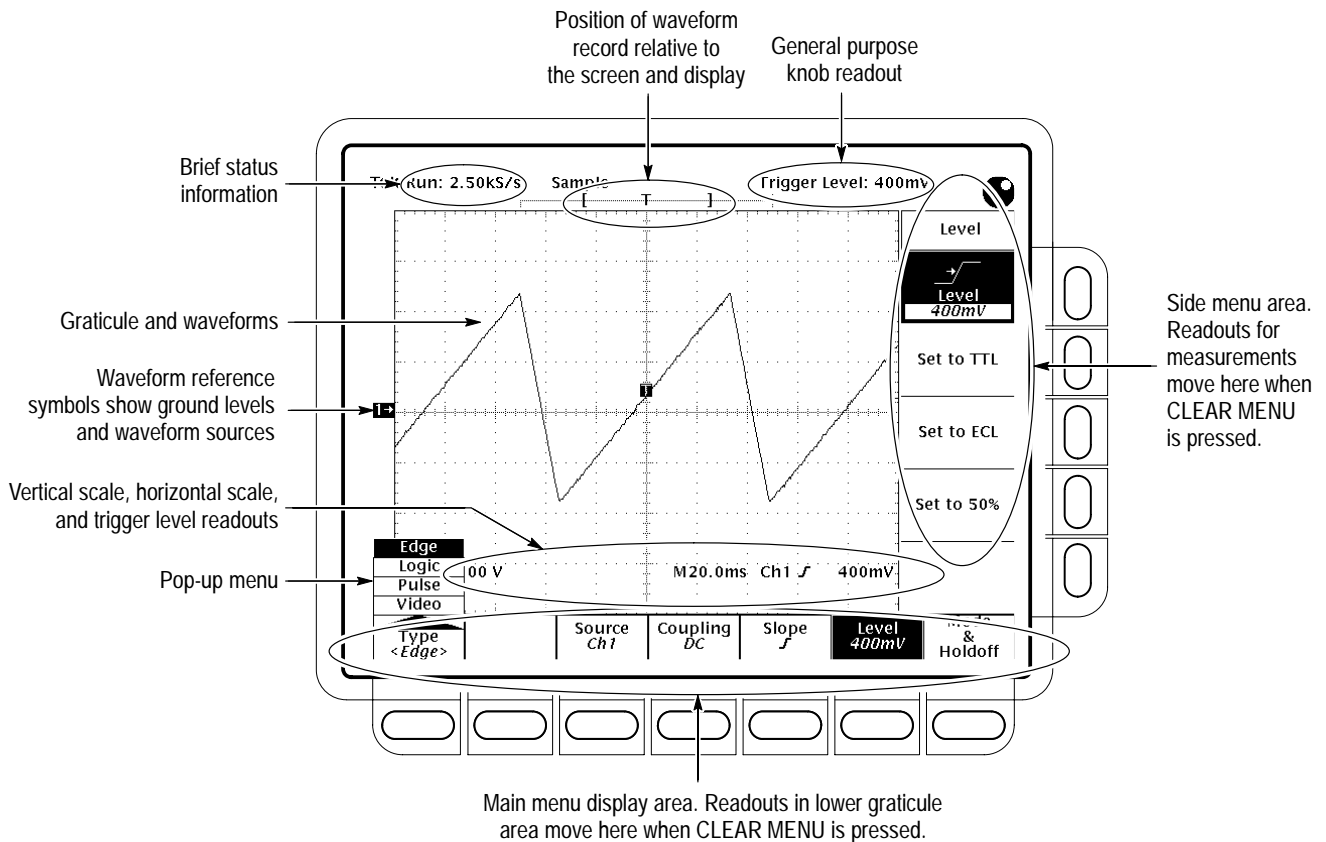

Figure 1–1: Map of display functions

Brief Procedures

The *Self Tests* use internal routines to confirm basic functionality and proper adjustment. No test equipment is required to do these test procedures.

The *Functional Tests* utilize the probe-compensation output at the front panel as a test-signal source for further verifying that the oscilloscope functions properly. A probe is required to do these test procedures.

Self Tests

This procedure uses internal routines to verify that the oscilloscope functions and was adjusted properly. No test equipment or hookups are required.

Verify Internal Adjustment, Self Compensation, and Diagnostics

Equipment required	None
Prerequisites	Power on the digitizing oscilloscope and allow a 20 minute warm-up before doing this procedure.

1. *Verify that internal diagnostics pass:* Do the following substeps to verify passing of internal diagnostics.
 - a. *Display the System diagnostics menu:*
 - Press **SHIFT**; then press **UTILITY**.
 - Repeatedly press the main-menu button **System** until **Diag/Err** is highlighted in the pop-up menu.
 - b. *Run the System Diagnostics:*
 - First disconnect any input signals from all four channels.
 - Press the main-menu button **Execute**; then press the side-menu button **OK Confirm Run Test**.
 - c. *Wait:* The internal diagnostics do an exhaustive verification of proper oscilloscope function. This verification will take up to three and a half minutes on some models. When the verification is finished, the resulting status will appear on the screen.
 - d. *Confirm no failures are found:* Verify that no failures are found and reported on-screen.
 - e. *Confirm the three adjustment sections have passed status:*

- Press **SHIFT**; then press **UTILITY**.
 - Highlight **Cal** in the pop-up menu by repeatedly pressing the main-menu button **System**. See Figure 1–2.
 - Verify that the word **Pass** appears in the main menu under the following menu labels: **Voltage Reference**, **Frequency Response**, and **Pulse Trigger**. See Figure 1–2.
- f. *Run the signal-path compensation:* Press the main-menu button **Signal Path**; then press the side-menu button **OK Compensate Signal Paths**.
- g. *Wait:* Signal-path compensation may take five minutes on the TDS 500C/700C and fifteen minutes on the 600B to run. While it progresses, a “clock” icon (shown at left) is displayed on-screen. When compensation completes, the status message will be updated to **Pass** or **Fail** in the main menu. See step h.
- h. *Confirm signal-path compensation returns passed status:* Verify that the word **Pass** appears under **Signal Path** in the main menu. See Figure 1–2.

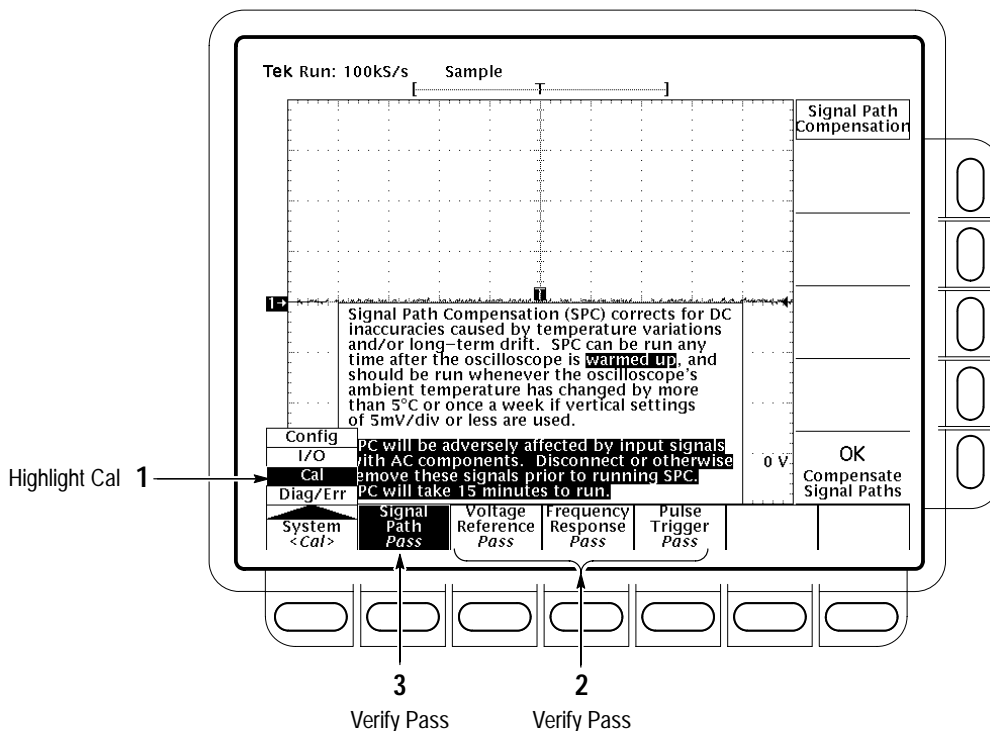

Figure 1–2: Verifying adjustments and signal-path compensation

2. *Return to regular service:* Press **CLEAR MENU** to exit the system menus.

Functional Tests

The purpose of these procedures is to confirm that the oscilloscope functions properly. The only equipment required is one of the standard-accessory probes and, to check the file system, a 3.5 inch, 720 K or 1.44 Mbyte floppy disk.



CAUTION. The P6243 and P6245 probes that can be used with this oscilloscope provide an extremely low loading capacitance (<1 pF) to ensure the best possible signal reproduction. These probes should not be used to measure signals exceeding ± 8 volts, or errors in signal measurement will be observed. Above 40 volts, damage to the probe may result. To make measurements beyond ± 10 volts, use either the P6139A probe (good to 500 volts peak), or refer to the catalog for a recommended probe.

STOP. These procedures verify functions; that is, they verify that the oscilloscope features operate. They do not verify that they operate within limits.

Therefore, when the instructions in the functional tests that follow call for you to verify that a signal appears on-screen “that is about five divisions in amplitude” or “has a period of about six horizontal divisions,” etc., do NOT interpret the quantities given as limits. Operation within limits is checked in Performance Tests, which begin on page 1–15.

STOP. DO NOT make changes to the front-panel settings that are not called out in the procedures. Each verification procedure will require you to set the oscilloscope to certain default settings before verifying functions. If you make changes to these settings, other than those called out in the procedure, you may obtain invalid results. In this case, just redo the procedure from step 1.

When you are instructed to press a menu button, the button may already be selected (its label will be highlighted). If this is the case, it is not necessary to press the button.

Verify All Input Channels

Equipment required	One probe such as the P6243, P6245 or P6139A
Prerequisites	None

1. Install the test hookup and preset the oscilloscope controls:
 - a. Hook up the signal source: Install the probe on **CH 1**. Connect the probe tip to **PROBE COMPENSATION SIGNAL** on the front panel;

connect the probe ground (typically black) to **PROBE COMPENSATION GND**. If using a P6243 or P6245 probe, you may want to attach a Y-lead connector and two SMD KlipChips as shown in Figure 1–3.

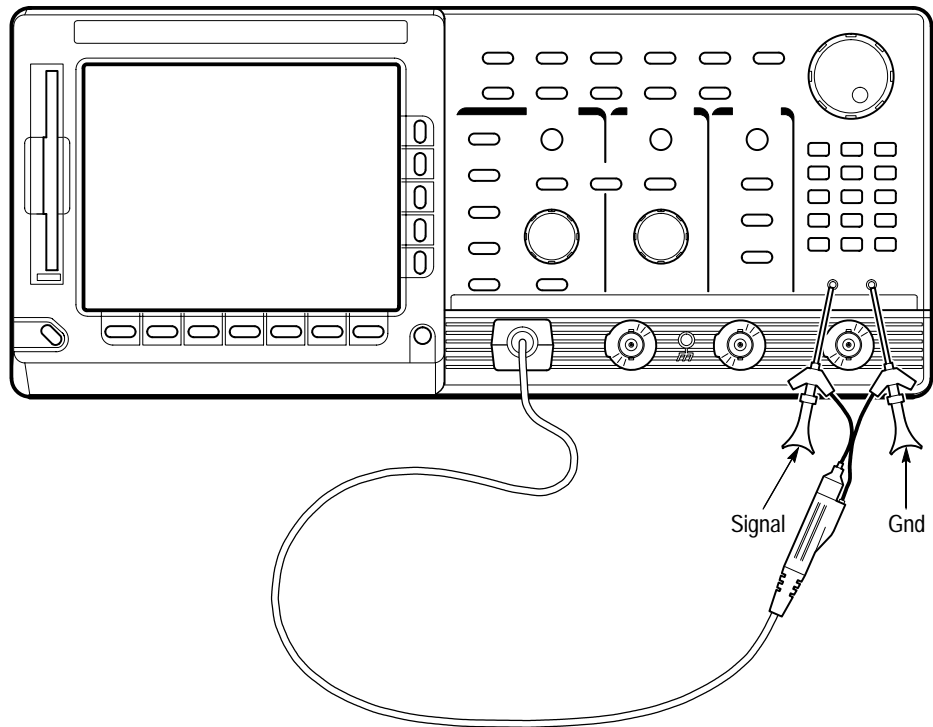





Figure 1–3: Universal test hookup for functional tests – TDS 600B shown

- b. *Initialize the oscilloscope:*
 - Press save/recall **SETUP**.
 - Press the main-menu button **Recall Factory Setup**.
 - Press the side-menu button **OK Confirm Factory Init**.
 2. *Verify that all channels operate:* Do the following substeps — test CH 1 first, *skipping substep a and b since CH 1 is already set up for verification and as the trigger source from step 1.*
 - a. *Select an unverified channel:*
 - Press **WAVEFORM OFF** to remove the channel just verified from display.
 - Press the front-panel button that corresponds to the channel you are to verify.

- Move the probe to the channel you selected.
- b. *Match the trigger source to the channel selected:*
 - Press **TRIGGER MENU**.
 - Press the main-menu button **Source**.
 - Press the side-menu button that corresponds to the channel selected, **Ch2**, **Ch3**, or **Ch4**. (Some TDS models use **Ax1** and **Ax2** instead of **Ch3** and **Ch4**).
- c. *Set up the selected channel:*
 - Set the vertical **SCALE** to 200 mV.
 - Set the horizontal **SCALE** to 200 μ s. Press **CLEAR MENU** to remove any menu that may be on the screen.
 - Press **SET LEVEL TO 50%**.
- d. *Verify that the channel is operational:* Confirm that the following statements are true.
 - The vertical scale readout for the channel under test shows a setting of 200 mV, and a square-wave probe-compensation signal about 2.5 divisions in amplitude is on-screen. See Figure 1–1 on page 1–3 to locate the readout.
 - The vertical **POSITION** knob moves the signal up and down the screen when rotated.
 - Turning the vertical **SCALE** knob counterclockwise decreases the amplitude of the waveform on-screen, turning the knob clockwise increases the amplitude, and returning the knob to 200 mV returns the amplitude to about 2.5 divisions.
- e. *Verify that the channel acquires in all acquisition modes:* Press **SHIFT**; then press **ACQUIRE MENU**. Use the side menu to select, in turn, each of the three hardware acquire modes and confirm that the following statements are true. Refer to the icons at the left of each statement as you confirm those statements.
 - 
 - Sample mode displays an actively acquiring waveform on-screen. (Note that there is noise present on the peaks of the square wave).
 - 
 - Peak Detect mode displays an actively acquiring waveform on-screen with the noise present in Sample mode “peak detected.”
 - 
 - Hi Res mode (TDS 500C and 700C only) displays an actively acquiring waveform on-screen with the noise that was present in Sample mode reduced.



- Envelope mode displays an actively acquiring waveform on-screen with the noise displayed.
 - Average mode displays an actively acquiring waveform on-screen with the noise reduced.
- f. *Test all channels:* Repeat substeps a through e until all four input channels are verified.
3. *Remove the test hookup:* Disconnect the probe from the channel input and the probe-compensation terminals.

Verify the Time Base

Equipment required	One probe such as the P6243, P6245 or P6139A
Prerequisites	None

1. *Install the test hookup and preset the oscilloscope controls:*
- a. *Hook up the signal source:* Install the probe on **CH 1**. Connect the probe tip to **PROBE COMPENSATION SIGNAL** on the front panel; connect the probe ground to **PROBE COMPENSATION GND**. See Figure 1–3 on page 1–8.
 - b. *Initialize the oscilloscope:*
 - Press save/recall **SETUP**.
 - Press the main-menu button **Recall Factory Setup**; then press the side-menu button **OK Confirm Factory Init**.
 - c. *Modify default settings:*
 - Set the vertical **SCALE** to 200 mV.
 - Set the horizontal **SCALE** to 200 μ s.
 - Press **SET LEVEL TO 50%**.
 - Press **CLEAR MENU** to remove the menus from the screen.
2. *Verify that the time base operates:* Confirm the following statements.
- a. One period of the square-wave probe-compensation signal is about five horizontal divisions on-screen for the 200 μ s horizontal scale setting (set in step 1c).
 - b. Rotating the horizontal **SCALE** knob clockwise expands the waveform on-screen (more horizontal divisions per waveform period), counter-clockwise rotation contracts it, and returning the horizontal scale to 200 μ s returns the period to about five divisions.

- c. The horizontal **POSITION** knob positions the signal left and right on-screen when rotated.
3. *Remove the test hookup:* Disconnect the probe from the channel input and the probe-compensation terminals.

Verify the Main and Delayed Trigger Systems

Equipment required	One probe such as the P6243, P6245, or P6139A
Prerequisites	None

1. *Install the test hookup and preset the oscilloscope controls:*
 - a. *Hook up the signal source:* Install the probe on **CH 1**. Connect the probe tip to **PROBE COMPENSATION SIGNAL** on the front panel; connect the probe ground to **PROBE COMPENSATION GND**. See Figure 1–3 on page 1–8.
 - b. *Initialize the oscilloscope:*
 - Press save/recall **SETUP**.
 - Press the main-menu button **Recall Factory Setup**.
 - Press the side-menu button **OK Confirm Factory Init**.
 - c. *Modify default settings:*
 - Set the vertical **SCALE** to 200 mV.
 - Set the horizontal **SCALE** for the **M** (main) time base to 200 μ s.
 - Press **SET LEVEL TO 50%**.
 - Press **TRIGGER MENU**.
 - Press the main-menu button **Mode & Holdoff**.
 - Press the side-menu button **Normal**.
 - Press **CLEAR MENU** to remove the menus from the screen.
2. *Verify that the main trigger system operates:* Confirm that the following statements are true.
 - The trigger level readout for the main trigger system changes with the trigger-**LEVEL** knob.
 - The trigger-**LEVEL** knob can trigger and untrigger the square-wave signal as you rotate it. (Leave the signal *untriggered*, which is indicated by the display not updating).

- Pressing **SET LEVEL TO 50%** triggers the signal that you just left untriggered. (Leave the signal triggered).
3. *Verify that the delayed trigger system operates:*
- a. *Select the delayed time base:*
 - Press **HORIZONTAL MENU**.
 - Press the main-menu button **Time Base**.
 - Press the side-menu button **Delayed Triggerable**; then press the side-menu button **Delayed Only**.
 - Set the horizontal **SCALE** for the **D** (delayed) time base to 200 μ s.
 - b. *Select the delayed trigger level menu:*
 - Press **SHIFT**; then press **DELAYED TRIG**.
 - Press the main-menu button **Level**; then press the side-menu button **Level**.
 - c. *Confirm that the following statements are true:*
 - The trigger-level readout for the delayed trigger system changes as you turn the general purpose knob.
 - As you rotate the general purpose knob, the square-wave probe-compensation signal can become triggered and untriggered. (Leave the signal *untriggered*, which is indicated by the display not updating).
 - Pressing the side-menu button **Set to 50%** triggers the probe-compensation signal that you just left untriggered. (Leave the signal triggered).
 - d. *Verify the delayed trigger counter:*
 - Press the main-menu button **Delay by Time**.
 - Use the keypad to enter a delay time of 1 second. Press **1**, then press **ENTER**.
 - Verify that the trigger **READY** indicator on the front panel flashes about once every second as the waveform is updated on-screen.
4. *Remove the test hookup:* Disconnect the probe from the channel input and the probe-compensation terminals.

Verify the File System

Equipment required	One probe such as the P6243, P6245 or P6139A One 720 K or 1.44 Mbyte, 3.5 inch DOS-compatible disk. You can use a disk of your own or you can use the Programming Examples Software 3.5 inch disk (Tektronix part number 063-1134-XX) contained in the TDS Family Programmer Manual (Tektronix part number 070-9556-XX).
Prerequisites	None

1. *Install the test hookup and preset the oscilloscope controls:*
 - a. *Hook up the signal source:* Install the probe on **CH 1**. Connect the probe tip to **PROBE COMPENSATION SIGNAL** on the front panel; connect the probe ground to **PROBE COMPENSATION GND**. See Figure 1–3 on page 1–8.
 - b. *Insert the test disk:* Insert the floppy disk in the floppy disk drive to the left of the monitor.
 - Position the disk so the metal shutter faces the drive.
 - Position the disk so the stamped arrow is on the top right side. In other words, place the angled corner in the front bottom location.
 - Push the disk into the drive until it goes all the way in and clicks into place.
 - c. *Initialize the oscilloscope:*
 - Press save/recall **SETUP**.
 - Press the main-menu button **Recall Factory Setup**.
 - Press the side-menu button **OK Confirm Factory Init**.
 - d. *Modify default settings:*
 - Set the vertical **SCALE** to 200 mV.
 - Set the horizontal **SCALE** for the **M** (main) time base to 200 μ s. Notice the waveform on the display now shows two cycles instead of five.
 - Press **SET LEVEL TO 50%**.
 - Press **CLEAR MENU** to remove the menus from the screen.
 - e. *Save the settings:*
 - Press **SETUP**.
 - Press the main-menu button **Save Current Setup**; then press the side-menu button **To File**.

- Turn the general purpose knob to select the file to save. Choose TEK?????.SET (or **fd0:**, the floppy disk drive, or **hd0:**, the optional hard disk drive). With this choice, you will save a file starting with TEK, then containing 5-numbers, and a .SET extension. For example, the first time you run this on a blank, formatted disk or on the Example Programs Disk, the oscilloscope will assign the name TEK00000.SET to your file. If you ran the procedure again, the oscilloscope would increment the name and call the file TEK00001.SET.
 - f. To test the optional hard disk drive, use the general purpose knob to select the file to save. Then choose the hard disk drive (**hd0:**). Save the file as in step e.
 - Press the side-menu button **Save To Selected File**.
2. *Verify the file system works:*
- Press the main-menu button **Recall Factory Setup** and the side-menu button **OK Confirm Factory Init** to restore the 500 μ s time base and the five cycle waveform.
 - Press the main-menu button **Recall Saved Setup**; then press the side-menu button **From File**.
 - Turn the general purpose knob to select the file to recall. For example, if you followed the instructions previously and saved the file to either the floppy disk drive (**fd0:**), or the optional hard disk drive (**hd0:**), you had the oscilloscope assign the name TEK00000.SET to your file.
 - Press the side-menu button **Recall From Selected File**.
 - Verify that digitizing oscilloscope retrieved the saved setup from the disk. Do this by noticing the horizontal **SCALE** for the **M** (main) time base is again 200 μ s and the waveform shows only two cycles just as it was when you saved the setup.
3. *Remove the test hookup:*
- Disconnect the probe from the channel input and the probe-compensation terminals.
 - Remove the floppy disk from the floppy disk drive.

Performance Tests

This section contains a collection of procedures for checking that the TDS 500C, TDS 600B, and TDS 700C Digitizing Oscilloscopes perform as warranted.

The procedures are arranged in four logical groupings: *Signal Acquisition System Checks*, *Time Base System Checks*, *Triggering System Checks*, and *Output Ports Checks*. They check all the characteristics that are designated as checked in *Specifications*. (The characteristics that are checked appear in **boldface** type under *Warranted Characteristics* in *Specifications*).

STOP. *These procedures extend the confidence level provided by the basic procedures described on page 1–5. The basic procedures should be done first, then these procedures performed if desired.*

Prerequisites

The tests in this section comprise an extensive, valid confirmation of performance and functionality when the following requirements are met:

- The cabinet must be installed on the digitizing oscilloscope.
- You must have performed and passed the procedures under *Self Tests*, found on page 1–5, and those under *Functional Tests*, found on page 1–7.
- A signal-path compensation must have been done within the recommended calibration interval and at a temperature within $\pm 5^{\circ}$ C of the present operating temperature. (If at the time you did the prerequisite *Self Tests*, the temperature was within the limits just stated, consider this prerequisite met).
- The digitizing oscilloscope must have been last adjusted at an ambient temperature between $+20^{\circ}$ C and $+30^{\circ}$ C, must have been operating for a warm-up period of at least 20 minutes, and must be operating at an ambient temperature between $+4^{\circ}$ C and either $+45^{\circ}$ C for the TDS 600B or $+50^{\circ}$ C for the TDS 500C and 700C. (The warm-up requirement is usually met in the course of meeting the Self Tests and Functional Tests prerequisites listed above).

Equipment Required

These procedures use external, traceable signal sources to directly check warranted characteristics. The required equipment list follows this introduction.

Table 1–1: Test equipment

Item number and description	Minimum requirements	Example	Purpose
1. Attenuator, 10X (two required)	Ratio: 10X; impedance 50 Ω ; connectors: female BNC input, male BNC output	Tektronix part number 011-0059-02	Signal Attenuation
2. Attenuator, 5X	Ratio: 5X; impedance 50 Ω ; connectors: female BNC input, male BNC output	Tektronix part number 011-0060-02	Signal Attenuation
3. Adapter, BNC female to Clip Leads	BNC female to Clip Leads	Tektronix part number 013-0076-00	Signal Coupling for Probe Compensator Output Check
4. Terminator, 50 Ω	Impedance 50 Ω ; connectors: female BNC input, male BNC output	Tektronix part number 011-0049-01	Signal Termination for Channel Delay Test
5. Cable, Precision 50 Ω Coaxial (two required)	50 Ω , 36 in, male to male BNC connectors	Tektronix part number 012-0482-00	Signal Interconnection
6. Connector, Dual-Banana (two required)	Female BNC to dual banana	Tektronix part number 103-0090-00	Various Accuracy Tests
7. Connector, BNC "T"	Male BNC to dual female BNC	Tektronix part number 103-0030-00	Checking Trigger Sensitivity
8. Coupler, Dual-Input	Female BNC to dual male BNC	Tektronix part number 067-0525-02	Checking Delay Between Channels
9. Generator, DC Calibration	Variable amplitude to ± 104 V; accuracy to 0.1%	Data Precision 8200	Checking DC Offset, Gain, and Measurement Accuracy
10. Generator, Calibration	500 mV square wave calibrator amplitude; accuracy to 0.25%	Wavetek 9100 with options 100 and 250 (or, optionally, Tektronix PG 506A Calibration Generator ¹)	To check accuracy of CH 3 Signal Out
11. Generator, Time Mark	Variable marker frequency from 10 ms to 10 ns; accuracy within 2 ppm	Wavetek 9100 with options 100 and 250 (or, optionally, Tektronix TG 501A Time Mark Generator ¹)	Checking Sample-Rate and Delay-time Accuracy
12. Probe, 10X	A P6139A, P6243, or P6245 probe ²	Tektronix part number P6139A or P6245	Signal Interconnection
13. 3.5 inch, 720 K or 1.44 Mbyte, DOS-compatible floppy disk		Programming Examples Software Disk (Tektronix part number 063-1134-XX) that comes with the TDS Family Programmer Manual (Tektronix part number 070-9556-XX)	Checking File System Basic Functionality

Table 1–1: Test equipment (cont.)

Item number and description	Minimum requirements	Example	Purpose
14. Generator, Video Signal	Provides PAL compatible outputs	Tektronix TSG 121	Used to Test Video Option 05 Equipped Instruments Only
15. Oscillator, Leveled Sine wave Generator	60 Hz Sine wave	Wavetek 9100 with options 100 and 250 (or, optionally, Tektronix SG 502)	Used to Test Video Option 05 Equipped Instruments Only
16. Pulse Generator		Tektronix CFG280 (or, optionally, PG 502)	Used to Test Video Option 05 Equipped Instruments Only
17. Cable, Coaxial (two required)	75 Ω , 36 in, male to male BNC connectors	Tektronix part number 012-1338-00	Used to Test Video Option 05 Equipped Instruments Only
18. Terminator, 75 Ω (two required)	Impedance 75 Ω ; connectors: female BNC input, male BNC output	Tektronix part number 011-0102-01	Used to Test Video Option 05 Equipped Instruments Only
19. Generator, Sine Wave	100 kHz to at least 400 MHz. Variable amplitude from 12 mV to 2 V _{p-p} . Frequency accuracy >2.0%	Rohde & Schwarz SMY ³	Checking Analog Bandwidth, Trigger Sensitivity, Sample-rate, External Clock, and Delay-Time Accuracy
20. Meter, Level and Power Sensor	Frequency range: 10 MHz to 400MHz. Amplitude range: 6 mV _{p-p} to 2 V _{p-p}	Rohde & Schwarz URV 35, with NRV-Z8 power sensor ³	Checking Analog Bandwidth and Trigger Sensitivity
21. Splitter, Power	Frequency range: DC to 1 GHz. Tracking: >2.0%	Rohde & Schwarz RVZ ³	Checking Analog Bandwidth
22. Generator, Function	Frequency range 5 MHz to 10 MHz. Square wave transition time \leq 25 ns. Amplitude range: 0 to 10 V _{p-p} into 50 Ω	Tektronix CFG280	Checking External Clock
23. Adapter (four required)	Male N to female BNC	Tektronix 103-0045-00	Checking Analog Bandwidth
24. Adapter	Female N to male BNC	Tektronix 103-0058-00	Checking Analog Bandwidth
25. Generator, Leveled Sine Wave, Medium-Frequency (optional)	200 kHz to 250 MHz; Variable amplitude from 5 mV to 4 V _{p-p} into 50 Ω	Tegam/Tektronix SG 503 Leveled Sine Wave Generator ^{1, 3}	Checking Trigger Sensitivity at low frequencies
26. Generator, Leveled Sine Wave, High-Frequency (optional)	250 MHz to 1 GHz; Variable amplitude from 5 mV to 4 V _{p-p} into 50 Ω ; 6 MHz reference	Tegam/Tektronix SG 504 Leveled Sine Wave Generator ¹ with SG 504 Output Head ³	Checking Analog Bandwidth and Trigger Sensitivity at high frequencies

Table 1-1: Test equipment (cont.)

Item number and description	Minimum requirements	Example	Purpose
27. Generator, Optical Impulse	850 nm optical impulse	Tektronix OIG501 Optical Impulse Generator ¹	Checking Option 3C
28. Generator, Optical Impulse	1300 nm optical impulse	Tektronix OIG502 Optical Impulse Generator ¹	Checking Option 4C
29. Attenuator, Optical	62.5 micron optical attenuator	Tektronix OA5022 Optical Attenuator ¹	Checking Option 3C and 4C
30. Cable, Fibre Optic	FC-FC fiber cable	174-2322-00	Checking Option 3C and 4C
31. Optical-to-Electrical Converter	P6701B (used with Option 3C) or P6703B (used with Option 4C) optical-to-electrical converter	Tektronix part number P6701B or P6703B	Checking Option 3C and 4C

¹ Requires a TM 500 or TM 5000 Series Power Module Mainframe.

² Warning: The P6243 and P6245 probes that may be used with this oscilloscope provide an extremely low loading capacitance (<1 pF) to ensure the best possible signal reproduction. These probes should not be used to measure signals exceeding ± 8 V, or errors in signal measurement will be observed. Above 40 V, damage to the probe may result. To make measurements beyond ± 8 V, use either the P6139A probe (good to 500 V), or refer to the catalog for a recommended probe.

³ You can replace items 19, 20, or 21 with a Tegan/Tektronix SG503 (item 25) or SG504 (item 26) – if available.

TDS 600B Test Record

Photocopy this and the next three pages and use them to record the performance test results for your TDS 600B.

TDS 600B Test Record

Instrument Serial Number: _____ Certificate Number: _____
 Temperature: _____ RH %: _____
 Date of Calibration: _____ Technician: _____

TDS 600B Performance Test		Minimum	Incoming	Outgoing	Maximum
Offset Accuracy					
CH1 Offset	+1 mV	- 2.1 mV	_____	_____	+ 2.1 mV
	+101 mV	- 75.6 mV	_____	_____	+ 75.6 mV
	+1.01 V	- 756 mV	_____	_____	+ 756 mV
CH2 Offset	+1 mV	- 2.1 mV	_____	_____	+ 2.1 mV
	+101 mV	- 75.6 mV	_____	_____	+ 75.6 mV
	+1.01 V	- 756 mV	_____	_____	+ 756 mV
CH3 or AX1 Offset	+1 mV	- 2.1 mV	_____	_____	+ 2.1 mV
	+101 mV	- 75.6 mV	_____	_____	+ 75.6 mV
	+1.01 V	- 756 mV	_____	_____	+ 756 mV
CH4 or AX2 Offset	+1 mV	- 2.1 mV	_____	_____	+ 2.1 mV
	+101 mV	- 75.6 mV	_____	_____	+ 75.6 mV
	+1.01 V	- 756 mV	_____	_____	+ 756 mV
DC Voltage Measurement Accuracy (Averaged)					
CH1	5 mV Vert scale setting, -5 Div position setting, +1 V offset	+ 1.0329 V	_____	_____	+ 1.0471 V
CH1	5 mV Vert scale setting, +5 Div position setting, -1 V offset	- 1.0471 V	_____	_____	- 1.0329 V
CH1	200 mV Vert scale setting, -5 Div position setting, +10 V offset	+ 11.4165 V	_____	_____	+ 11.7835 V
CH1	200 mV Vert scale setting, +5 Div position setting, -10 V offset	- 11.7835 V	_____	_____	- 11.4165 V
CH1	1 V Vert scale setting, -5 Div position setting, +10 V offset	+ 17.2425 V	_____	_____	+ 18.7575 V
CH1	1 V Vert scale setting, +5 Div position setting, -10 V offset	- 18.7575 V	_____	_____	- 17.2425 V
CH2	5 mV Vert scale setting, -5 Div position setting, +1 V offset	+ 1.0329 V	_____	_____	+ 1.0471 V
CH2	5 mV Vert scale setting, +5 Div position setting, -1 V offset	- 1.0471 V	_____	_____	- 1.0329 V
CH2	200 mV Vert scale setting, -5 Div position setting, +10 V offset	+ 11.4165 V	_____	_____	+ 11.7835 V

Performance Tests

TDS 600B Test Record (Cont.)

Instrument Serial Number: _____ Certificate Number: _____
 Temperature: _____ RH %: _____
 Date of Calibration: _____ Technician: _____

TDS 600B Performance Test		Minimum	Incoming	Outgoing	Maximum
CH2	200 mV Vert scale setting, +5 Div position setting, -10 V offset	- 11.7835 V	_____	_____	- 11.4165 V
CH2	1 V Vert scale setting, -5 Div position setting, +10 V offset	+ 17.2425 V	_____	_____	+ 18.7575 V
CH2	1 V Vert scale setting, +5 Div position setting, -10 V offset	- 18.7575 V	_____	_____	- 17.2425 V
CH3 or AX1	5 mV Vert scale setting, -5 Div position setting, +1 V offset	+ 1.0329 V	_____	_____	+ 1.0471 V
CH3 or AX1	5 mV Vert scale setting, +5 Div position setting, -1 V offset	- 1.0471 V	_____	_____	- 1.0329 V
CH3 or AX1	200 mV Vert scale setting, -5 Div position setting, +10 V offset	+ 11.4165 V	_____	_____	+ 11.7835 V
CH3 or AX1	200 mV Vert scale setting, +5 Div position setting, -10 V offset	- 11.7835 V	_____	_____	- 11.4165 V
CH3 or AX1	1 V Vert scale setting, -5 Div position setting, +10 V offset	+ 17.2425 V	_____	_____	+ 18.7575 V
CH3 or AX1	1 V Vert scale setting, +5 Div position setting, -10 V offset	- 18.7575 V	_____	_____	- 17.2425 V
CH4 or AX2	5 mV Vert scale setting, -5 Div position setting, +1 V offset	+ 1.0329 V	_____	_____	+ 1.0471 V
CH4 or AX2	5 mV Vert scale setting, +5 Div position setting, -1 V offset	- 1.0471 V	_____	_____	- 1.0329 V
CH4 or AX2	200 mV Vert scale setting, -5 Div position setting, +10 V offset	+ 11.4165 V	_____	_____	+ 11.7835 V
CH4 or AX2	200 mV Vert scale setting, +5 Div position setting, -10 V offset	- 11.7835 V	_____	_____	- 11.4165 V
CH4 or AX2	1 V Vert scale setting, -5 Div position setting, +10 V offset	+ 17.2425 V	_____	_____	+ 18.7575 V
CH4 or AX2	1 V Vert scale setting, +5 Div position setting, -10 V offset	- 18.7575 V	_____	_____	- 17.2425 V
Analog Bandwidth					
CH1	100 mV	424 mV	_____	_____	N/A
CH2	100 mV	424 mV	_____	_____	N/A
CH3 or AX1	100 mV	424 mV	_____	_____	N/A
CH4 or AX2	100 mV	424 mV	_____	_____	N/A

TDS 600B Test Record (Cont.)

Instrument Serial Number: _____ Certificate Number: _____
 Temperature: _____ RH %: _____
 Date of Calibration: _____ Technician: _____

TDS 600B Performance Test	Minimum	Incoming	Outgoing	Maximum
Delay Between Channels				
Delay Between Channels	N/A	_____	_____	100 ps
Time Base System				
Long Term Sample Rate/ Delay Time @ 500 ns/10 ms	-2.0 Div	_____	_____	+2.0 Div
Trigger System Accuracy				
Pulse-Glitch or Pulse-Width, Hor. scale $\leq 1 \mu\text{s}$				
Lower Limit	3.5 ns	_____	_____	6.5 ns
Upper Limit	3.5 ns	_____	_____	6.5 ns
Pulse-Glitch or Pulse-Width, Hor. scale $> 1 \mu\text{s}$				
Lower Limit	1.9 μs	_____	_____	2.1 μs
Upper Limit	1.9 μs	_____	_____	2.1 μs
Main Trigger, DC Coupled, Positive Slope	9.863 V	_____	_____	10.137 V
Main Trigger, DC Coupled, Negative Slope	9.863 V	_____	_____	10.137 V
Delayed Trigger, DC Coupled, Positive Slope	9.863 V	_____	_____	10.137 V
Delayed Trigger, DC Coupled, Negative Slope	9.863 V	_____	_____	10.137 V
CH1 Sensitivity, 50 MHz, Main	Pass/Fail	_____	_____	Pass/Fail
CH1 Sensitivity, 50 MHz, Delayed	Pass/Fail	_____	_____	Pass/Fail
CH1 AUX Trigger Input	Pass/Fail	_____	_____	Pass/Fail
CH1 Sensitivity, 1 GHz, Main	Pass/Fail	_____	_____	Pass/Fail
CH1 Sensitivity, 1 GHz, Delayed	Pass/Fail	_____	_____	Pass/Fail
Output Signal Checks				
MAIN TRIGGER OUTPUT, 1 M Ω				
High	High $\geq 2.5 \text{ V}$	_____	_____	Low $\leq 0.7 \text{ V}$
Low		_____	_____	
MAIN TRIGGER OUTPUT, 50 Ω				
High	High $\geq 1.0 \text{ V}$	_____	_____	Low $\leq 0.25 \text{ V}$
Low		_____	_____	
DELAYED TRIGGER OUTPUT, 50 Ω				
High	High $\geq 1.0 \text{ V}$	_____	_____	Low $\leq 0.25 \text{ V}$
Low		_____	_____	
DELAYED TRIGGER OUTPUT, 1 M Ω				
High	High $\geq 2.5 \text{ V}$	_____	_____	Low $\leq 0.7 \text{ V}$
Low		_____	_____	

Performance Tests

TDS 600B Test Record (Cont.)

Instrument Serial Number: _____ Certificate Number: _____
 Temperature: _____ RH %: _____
 Date of Calibration: _____ Technician: _____

TDS 600B Performance Test	Minimum	Incoming	Outgoing	Maximum
CH 3 or AX1 SIGNAL OUTPUT, 1 MΩ	Pk-Pk ≥ 80 mV	_____	_____	Pk-Pk ≤ 120 mV
CH 3 or AX1 SIGNAL OUTPUT, 50 Ω	Pk-Pk ≥ 40 mV	_____	_____	Pk-Pk ≤ 60 mV
Probe Compensator Output Signal				
Frequency (CH1 Freq).	950 Hz	_____	_____	1.050 kHz
Voltage (difference)	495 mV	_____	_____	505 mV

TDS 500C/700C Test Record

Photocopy this and the next three pages and use them to record the performance test results for your TDS 500C/700C.

TDS 500C/700C Test Record

Instrument Serial Number: _____ Certificate Number: _____
 Temperature: _____ RH %: _____
 Date of Calibration: _____ Technician: _____

TDS 500C/700C Performance Test		Minimum	Incoming	Outgoing	Maximum
Offset Accuracy					
CH1 Offset	+1 mV	- 1.6 mV	_____	_____	+ 1.6 mV
	+101 mV	- 25.1 mV	_____	_____	+ 25.1 mV
	+1.01 V	- 251 mV	_____	_____	+ 251 mV
CH2 Offset	+1 mV	- 1.6 mV	_____	_____	+ 1.6 mV
	+101 mV	- 25.1 mV	_____	_____	+ 25.1 mV
	+1.01 V	- 251 mV	_____	_____	+ 251 mV
CH3 or AX1 Offset	+1 mV	- 1.6 mV	_____	_____	+ 1.6 mV
	+101 mV	- 25.1 mV	_____	_____	+ 25.1 mV
	+1.01 V	- 251 mV	_____	_____	+ 251 mV
CH4 or AX2 Offset	+1 mV	- 1.6 mV	_____	_____	+ 1.6 mV
	+101 mV	- 25.1 mV	_____	_____	+ 25.1 mV
	+1.01 V	- 251 mV	_____	_____	+ 251 mV
DC Voltage Measurement Accuracy (Averaged)					
CH1	5 mV Vert scale setting, -5 Div position setting, +1 V offset	+ 1.0355 V	_____	_____	+ 1.0445 V
CH1	5 mV Vert scale setting, +5 Div position setting, -1 V offset	- 1.0445 V	_____	_____	- 1.0355 V
CH1	200 mV Vert scale setting, -5 Div position setting, +10 V offset	+ 11.5195 V	_____	_____	+ 11.6805 V
CH1	200 mV Vert scale setting, +5 Div position setting, -10 V offset	- 11.6805 V	_____	_____	- 11.5195 V
CH1	1 V Vert scale setting, -5 Div position setting, +10 V offset	+ 17.7575 V	_____	_____	+ 18.2425 V
CH1	1 V Vert scale setting, +5 Div position setting, -10 V offset	- 18.2425 V	_____	_____	- 17.7575 V
CH2	5 mV Vert scale setting, -5 Div position setting, +1 V offset	+ 1.0355 V	_____	_____	+ 1.0445 V
CH2	5 mV Vert scale setting, +5 Div position setting, -1 V offset	- 1.0445 V	_____	_____	- 1.0355 V
CH2	200 mV Vert scale setting, -5 Div position setting, +10 V offset	+ 11.5195 V	_____	_____	+ 11.6805 V

Performance Tests

TDS 500C/700C Test Record (Cont.)

Instrument Serial Number: _____ Certificate Number: _____
 Temperature: _____ RH %: _____
 Date of Calibration: _____ Technician: _____

TDS 500C/700C Performance Test		Minimum	Incoming	Outgoing	Maximum
CH2	200 mV Vert scale setting, +5 Div position setting, -10 V offset	- 11.6805 V	_____	_____	- 11.5195 V
CH2	1 V Vert scale setting, -5 Div position setting, +10 V offset	+ 17.7575 V	_____	_____	+ 18.2425 V
CH2	1 V Vert scale setting, +5 Div position setting, -10 V offset	- 18.2425 V	_____	_____	- 17.7575 V
CH3 or AX1	5 mV Vert scale setting, -5 Div position setting, +1 V offset	+ 1.0355 V	_____	_____	+ 1.0445 V
CH3 or AX1	5 mV Vert scale setting, +5 Div position setting, -1 V offset	- 1.0445 V	_____	_____	- 1.0355 V
CH3 or AX1	200 mV Vert scale setting, -5 Div position setting, +10 V offset	+ 11.5195 V	_____	_____	+ 11.6805 V
CH3 or AX1	200 mV Vert scale setting, +5 Div position setting, -10 V offset	- 11.6805 V	_____	_____	- 11.5195 V
CH3 or AX1	1 V Vert scale setting, -5 Div position setting, +10 V offset	+ 17.7575 V	_____	_____	+ 18.2425 V
CH3 or AX1	1 V Vert scale setting, +5 Div position setting, -10 V offset	- 18.2425 V	_____	_____	- 17.7575 V
CH4 or AX2	5 mV Vert scale setting, -5 Div position setting, +1 V offset	+ 1.0355 V	_____	_____	+ 1.0445 V
CH4 or AX2	5 mV Vert scale setting, +5 Div position setting, -1 V offset	- 1.0445 V	_____	_____	- 1.0355 V
CH4 or AX2	200 mV Vert scale setting, -5 Div position setting, +10 V offset	+ 11.5195 V	_____	_____	+ 11.6805 V
CH4 or AX2	200 mV Vert scale setting, +5 Div position setting, -10 V offset	- 11.6805 V	_____	_____	- 11.5195 V
CH4 or AX2	1 V Vert scale setting, -5 Div position setting, +10 V offset	+ 17.7575 V	_____	_____	+ 18.2425 V
CH4 or AX2	1 V Vert scale setting, +5 Div position setting, -10 V offset	- 18.2425 V	_____	_____	- 17.7575 V
Analog Bandwidth					
CH1	100 mV	424 mV	_____	_____	N/A
CH2	100 mV	424 mV	_____	_____	N/A
CH3 or AX1	100 mV	424 mV	_____	_____	N/A
CH4 or AX2	100 mV	424 mV	_____	_____	N/A

TDS 500C/700C Test Record (Cont.)

Instrument Serial Number: _____ Certificate Number: _____
 Temperature: _____ RH %: _____
 Date of Calibration: _____ Technician: _____

TDS 500C/700C Performance Test	Minimum	Incoming	Outgoing	Maximum
Delay Between Channels				
Delay Between Channels	N/A	_____	_____	50 ps
Time Base System				
Long Term Sample Rate/ Delay Time @ 100 ns/10.0 ms	-2.5 Div	_____	_____	+2.5 Div
Trigger System Accuracy				
Pulse-Glitch or Pulse-Width, Hor. scale $\leq 1 \mu\text{s}$				
Lower Limit	3.5 ns	_____	_____	6.5 ns
Upper Limit	3.5 ns	_____	_____	6.5 ns
Pulse-Glitch or Pulse-Width, Hor. scale $> 1 \mu\text{s}$				
Lower Limit	1.9 μs	_____	_____	2.1 μs
Upper Limit	1.9 μs	_____	_____	2.1 μs
Main Trigger, DC Coupled, Positive Slope	9.9393 V	_____	_____	10.1147 V
Main Trigger, DC Coupled, Negative Slope	9.9393 V	_____	_____	10.1147 V
Delayed Trigger, DC Coupled, Positive Slope	9.9393 V	_____	_____	10.1147 V
Delayed Trigger, DC Coupled, Negative Slope	9.9393 V	_____	_____	10.1147 V
CH1 Sensitivity, 50 MHz, Main	Pass/Fail	_____	_____	Pass/Fail
CH1 Sensitivity, 50 MHz, Delayed	Pass/Fail	_____	_____	Pass/Fail
CH1 AUX Trigger Input	Pass/Fail	_____	_____	Pass/Fail
CH1 Sensitivity, full bandwidth, Main	Pass/Fail	_____	_____	Pass/Fail
CH1 Sensitivity, full bandwidth, Delayed	Pass/Fail	_____	_____	Pass/Fail
Output Signal Checks				
MAIN TRIGGER OUTPUT, 1 M Ω				
High	High $\geq 2.5 \text{ V}$	_____	_____	Low $\leq 0.7 \text{ V}$
Low		_____	_____	
MAIN TRIGGER OUTPUT, 50 Ω				
High	High $\geq 1.0 \text{ V}$	_____	_____	Low $\leq 0.25 \text{ V}$
Low		_____	_____	
DELAYED TRIGGER OUTPUT, 50 Ω				
High	High $\geq 1.0 \text{ V}$	_____	_____	Low $\leq 0.25 \text{ V}$
Low		_____	_____	
DELAYED TRIGGER OUTPUT, 1 M Ω				
High	High $\geq 2.5 \text{ V}$	_____	_____	Low $\leq 0.7 \text{ V}$
Low		_____	_____	

Performance Tests

TDS 500C/700C Test Record (Cont.)

Instrument Serial Number: _____ Certificate Number: _____
 Temperature: _____ RH %: _____
 Date of Calibration: _____ Technician: _____

TDS 500C/700C Performance Test	Minimum	Incoming	Outgoing	Maximum
CH 3 or AX 1 SIGNAL OUTPUT, 1 M Ω	Pk-Pk \geq 88 mV	_____	_____	Pk-Pk \leq 132 mV
CH 3 or AX 1 SIGNAL OUTPUT, 50 Ω	Pk-Pk \geq 44 mV	_____	_____	Pk-Pk \leq 66 mV
Probe Compensator Output Signal				
Frequency (CH1 Freq).	950 Hz	_____	_____	1.050 kHz
Voltage (difference)	495 mV	_____	_____	505 mV

Signal Acquisition System Checks

These procedures check those characteristics that relate to the signal-acquisition system and are listed as checked under *Warranted Characteristics* in *Specifications*.

Check Offset Accuracy (Zero Setting)

Equipment required	None
Prerequisites	The oscilloscope must meet the prerequisites listed on page 1–15. See <i>Input Channels vs. Model</i> on page 1–2.

1. *Preset the instrument controls:*
 - a. *Initialize the oscilloscope:*
 - Press save/recall **SETUP**.
 - Press the main-menu button **Recall Factory Setup**.
 - Press the side-menu button **OK Confirm Factory Init**.
 - Press **CLEAR MENU** to remove the menus from the screen.
 - b. *Modify the default settings:*
 - Press **SHIFT**; then press **ACQUIRE MENU**.
 - On the TDS 600B, press the main-menu button **Mode**; then press the side-menu button **Average 16**.
 - On the TDS 500C and 700C, press the main-menu button **Mode**; then press the side-menu button **Hi Res**.
 - Press **CURSOR**.
 - Press the main-menu button **Function**; then press the side-menu button **H Bars**.
 - Press **CLEAR MENU**.
 - Be sure to disconnect any input signals from all four channels.
2. *Confirm input channels are within limits for offset accuracy at zero offset:*
Do the following substeps — test CH 1 first, *skipping substep a since CH 1 is already set up to be checked from step 1*.
 - a. *Select an unchecked channel:* Press **WAVEFORM OFF** to remove the channel just confirmed from the display. Then, press the front-panel button that corresponds to the channel you are to confirm.

- b. *Set the vertical scale:* Set the vertical **SCALE** to one of the settings listed in Table 1–2 that is not yet checked. (Start with the first setting listed).
 - Press **VERTICAL MENU**. Press the main-menu button **Fine Scale**.
 - Use the keypad to enter the vertical scale. For the 1 mV setting, press **1**, **SHIFT**, **m**, then **ENTER**. For the 101 mV setting, press **101**, **SHIFT**, **m**, then **ENTER**. For the 1.01 V setting, press **1.01**, then **ENTER**.
 - Press **CLEAR MENU**.

Table 1–2: DC offset accuracy (zero setting)

Vertical scale setting	Vertical position and offset setting ¹	TDS 600B offset accuracy limits	TDS 500C/700C offset accuracy limits
1 mV	0	±2.1 mV	±1.6 mV
101 mV	0	±75.6 mV	±25.1 mV
1.01 V	0	±756 mV	±251 mV

¹ Vertical position is set to 0 divisions and vertical offset to 0 V when the oscilloscope is initialized in step 1.

- c. *Display the test signal:* The waveform position and offset were initialized for all channels in step 1 and are displayed as you select each channel and its vertical scale.
- d. *Measure the test signal:* Align the active cursor over the waveform by rotating the general purpose knob. Ignore the other cursor. See Figure 1–4.
- e. Read the measurement results at the absolute (@:) cursor readout, not the delta (Δ:) readout on screen. That is, read the offset relative to the ground reference. See Figure 1–4.
- f. *Check against limits:* Do the following subparts in the order listed.
 - CHECK that the measurement results are within the limits listed for the current vertical scale setting.
 - Enter voltage on test record.
 - Repeat substeps b through f until all vertical scale settings listed in Table 1–2, are checked for the channel under test.

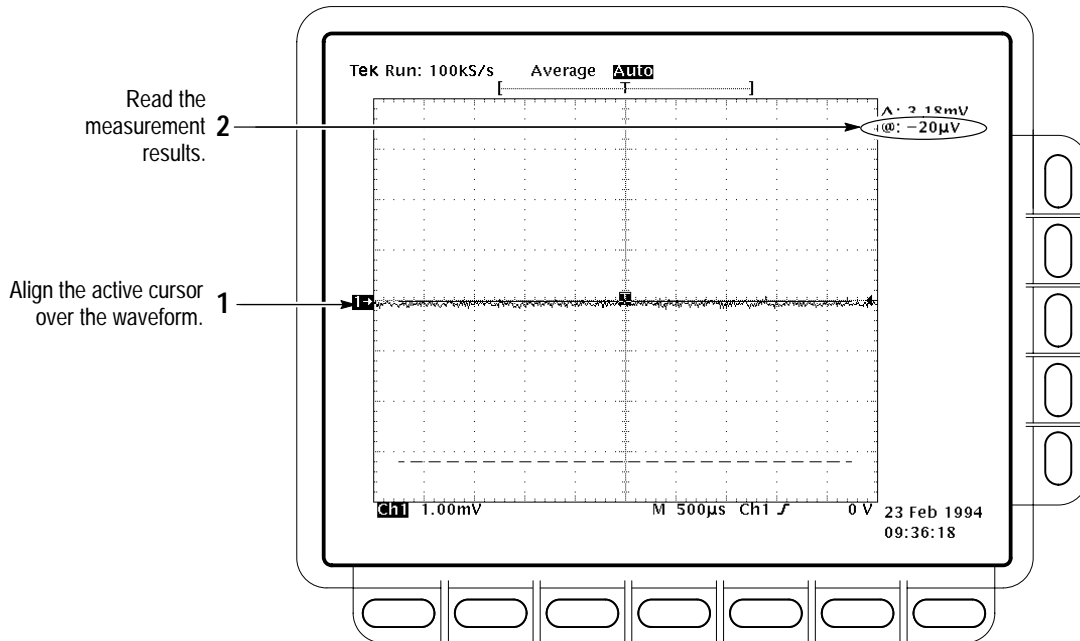

Figure 1-4: Measurement of DC offset accuracy at zero setting

- g. *Test all channels:* Repeat substeps a through f for all input channels.
- 3. *Disconnect the hookup:* No hookup was required.

Check DC Voltage Measurement Accuracy



WARNING. The generator is capable of outputting dangerous voltages. Be sure to set the DC calibration generator to 0 volts before connecting, disconnecting, and/or moving the test hookup during the performance of this procedure.

Equipment required	Two dual-banana connectors (Item 6) One BNC T connector (Item 7) One DC calibration generator (Item 9) Two precision 50 Ω coaxial cables (Item 5)
Prerequisites	The oscilloscope must meet the prerequisites listed on page 1-15 See <i>Input Channels vs. Model</i> on page 1-2.

1. *Install the test hookup and preset the instrument controls:*

a. *Hook up the test-signal source:*

- Set the output of a DC calibration generator to 0 volts.
- Connect the output of a DC calibration generator through a dual-banana connector followed by a 50 Ω precision coaxial cable to one side of a BNC T connector. See Figure 1–5.
- Connect the Sense output of the generator through a second dual-banana connector followed by a 50 Ω precision coaxial cable to the other side of the BNC T connector. Now connect the BNC T connector to **CH 1**. See Figure 1–5.

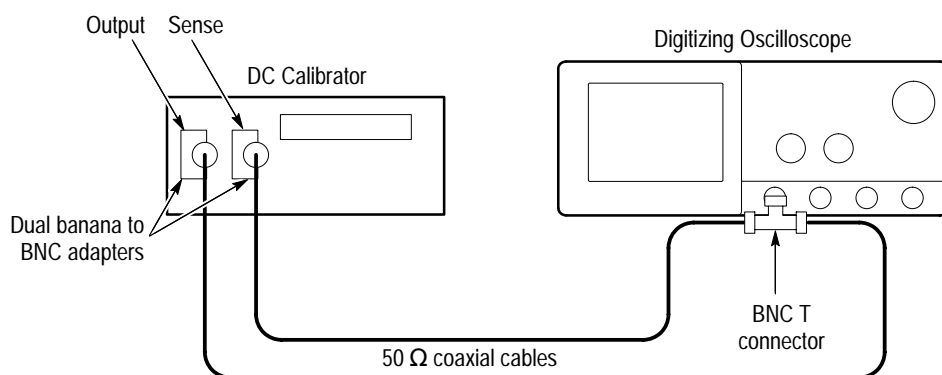

Figure 1–5: Initial test hookup

b. *Initialize the oscilloscope:*

- Press save/recall **SETUP**.
- Press the main-menu button **Recall Factory Setup**.
- Press the side-menu button **OK Confirm Factory Init**.

c. *Modify the default settings:*

- Press **SHIFT**; then press **ACQUIRE MENU**.
- Press the main-menu button **Mode**; then press the side-menu button **Average 16**.

2. *Confirm input channels are within limits for DC accuracy at maximum offset and position: Do the following substeps — test CH 1 first, skipping substep 2a since CH 1 is already selected from step 1.*

- a. *Select an unchecked channel:*
- Press **WAVEFORM OFF** to remove the channel just confirmed from the display.
 - Press the front-panel button that corresponds to the channel you are to confirm.
 - *Set the generator output to 0 V.*
 - Move the test hookup to the channel you selected.
- b. *Turn on the measurement Mean for the channel:*
- Press **MEASURE**, then press the main-menu button **Select Measrmnt for CHx**.
 - Press the side-menu button **more** until the menu label **Mean** appears in the side menu (its icon is shown at the left). Press the side-menu button **Mean**.
 - Press **CLEAR MENU**.
- c. *Set the vertical scale:* Set the vertical **SCALE** to one of the settings listed in Table 1–3 that is not yet checked. (Start with the first setting listed).



Table 1–3: DC Voltage measurement accuracy

Scale setting	Position setting (Divs)	Offset setting	Generator setting	TDS 600B Accuracy limits	TDS 500C/700C Accuracy limits
5 mV	-5 V	+1 V	+1.040 V	+1.0329 V to +1.0471 V	+1.0355 V to +1.0445 V
	+5 V	-1 V	-1.040 V	-1.0471 V to -1.0329 V	-1.0445 V to -1.0355 V
200 mV	-5 V	+10 V	+11.6 V	+11.4165 V to +11.7835 V	+11.5195 V to +11.6805 V
	+5 V	-10 V	-11.6 V	-11.7835 V to -11.4165 V	-11.6805 V to -11.5195 V
1 V	-5 V	+10 V	+18V	+17.2425 V to +18.7575 V	+17.7575 V to +18.2425 V
	+5 V	-10 V	-18 V	-18.7575 V to -17.2425 V	-18.2425 V to -17.7575 V

- d. *Display the test signal:*
- Press **VERTICAL MENU**. Press the main-menu button **Position**.
 - Use the keypad to set vertical position to -5 divisions (press **-5**, then **ENTER**, on the keypad). The baseline level will move off screen.
 - Press the main-menu button **Offset**.

- Use the keypad to set vertical offset to the positive-polarity setting listed in the table for the current vertical scale setting. The baseline level will remain off screen.
 - Set the generator to the level and polarity indicated in the table for the vertical scale, position, and offset settings you have made. The DC test level should appear on screen. (If it doesn't return, the DC accuracy check is failed for the current vertical scale setting of the current channel).
- e. *Measure the test signal:* Press **CLEAR MENU**. Read the measurement results at the **Mean** measurement readout. See Figure 1–6.

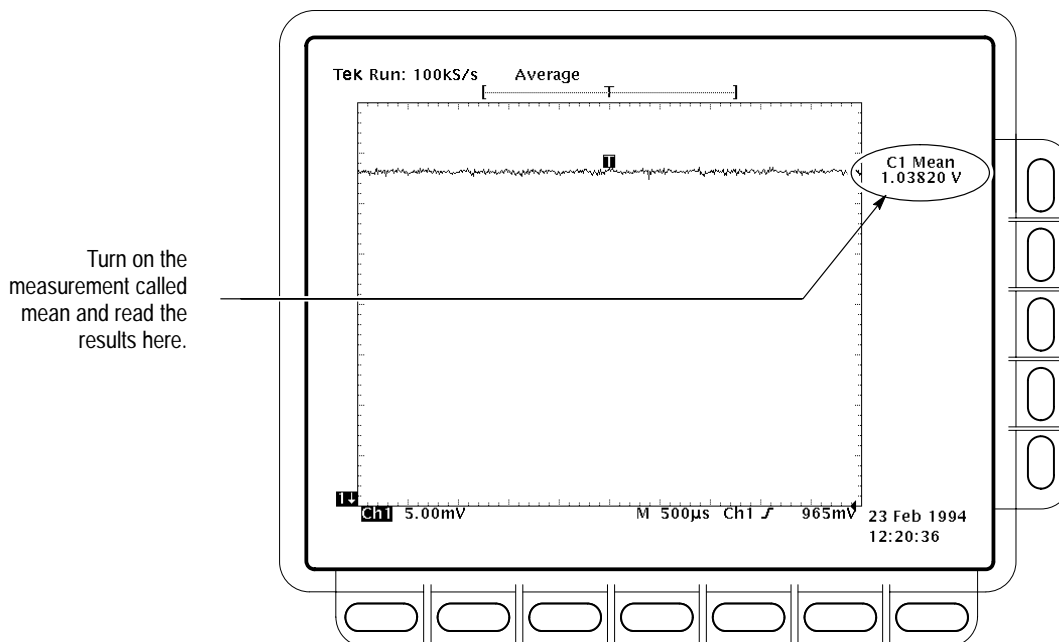

Figure 1–6: Measurement of DC accuracy at maximum offset and position

- f. *Check against limits:*
- CHECK that the readout for the measurement **Mean** readout on screen is within the limits listed for the current vertical scale and position/offset/generator settings. Enter value on test record.
 - Repeat substep d, reversing the polarity of the position, offset, and generator settings as is listed in the table.
 - CHECK that the **Mean** measurement readout on screen is within the limits listed for the current vertical scale setting and position/offset/generator settings. Enter value on test record.

- Repeat substeps c through f until all vertical scale settings, listed in Table 1–3, are checked for the channel under test.
 - g. *Test all channels:* Repeat substeps a through f for all four channels.
- 3. *Disconnect the hookup:*
 - a. *Set the generator output to 0 V.*
 - b. Disconnect the cable from the generator output at the input connector of the channel last tested.

Check Analog Bandwidth

Equipment required	One sine wave generator (Item 19) One level meter and power sensor (Item 20) One power splitter (Item 21) One female N to male BNC adapter (Item 24) Four male N to female BNC adapters (Item 23) Two 50 Ω precision cables (Item 5) Attenuators (Items 1 and 2) Optional: One high-frequency leveled sine wave generator and its leveling head (Item 26) – replaces items 19, 20, 21, 23, 24, and 5
Prerequisites	See page 1–15

1. *Install the test hookup and preset the instrument controls:*
 - a. *Initialize the oscilloscope:*
 - Press save/recall **SETUP**. Press the main-menu button **Recall Factory Setup**; then press the side-menu button **OK Confirm Factory Init**.
 - b. *Modify the default settings:*
 - Press **TRIGGER MENU**.
 - Press the main-menu button **Coupling**. Then press the side menu button **Noise Rej**.
 - Turn the horizontal **SCALE** knob to 50 ns. Press **SHIFT**; then press **ACQUIRE MENU**.
 - Press the main-menu button **Mode**; then press the side-menu button **Average 16**.
 - Press **MEASURE**. Press the main-menu button **Level Setup**; then press the side-menu button **Min-Max**.

NOTE. Refer to the Sine Wave Generator Leveling Procedure on page 1–84 if your sine wave generator does not have automatic output amplitude leveling.

- c. *Hook up the test-signal source:* Connect the sine wave output of a leveled sine wave generator to **CH 1**. Set the output of the generator to a reference frequency of 10 MHz or less. See Figure 1–7. For the optional setup using a leveled sine wave generator with a leveling head (item 26) see Figure 1–8 and, if using this optional setup with the example Tektronix SG 504, set the generator output to 6 MHz.

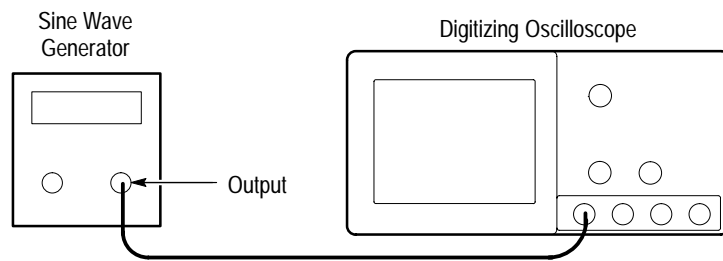

Figure 1–7: Initial test hookup

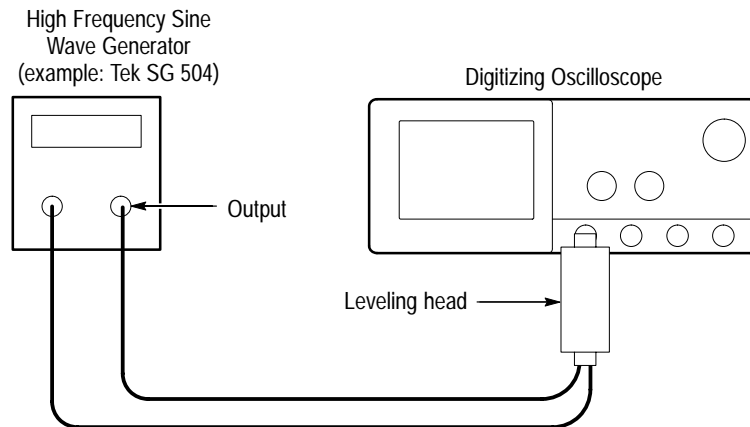

Figure 1–8: Optional initial test hookup

- 2. *Confirm the input channels are within limits for analog bandwidth:* Do the following substeps — test CH 1 first, *skipping substeps a and b since CH 1 is already set up for testing from step 1.*
 - a. *Select an unchecked channel:*
 - Press **WAVEFORM OFF** to remove the channel just confirmed from display.

- Press the front-panel button that corresponds to the channel you are to confirm.
 - Move the leveling output of the sine wave generator to the channel you selected.
- b. *Match the trigger source to the channel selected:*
- Press **TRIGGER MENU**. Press the main-menu button **Source**; then press the side-menu button that corresponds to the channel selected.
- c. *Set its input impedance:*
- Press **VERTICAL MENU**; then press the main-menu button **Coupling**.
 - Press the side-menu **Ω** button to toggle it to the **50 Ω** setting.
- d. *Set the vertical scale:* Set the vertical **SCALE** to one of the settings listed in Table 1–4 not yet checked. (Start with the 100 mV setting).

Table 1–4: Analog bandwidth

Vertical scale	Reference amplitude	Horizontal scale	Test frequency			Limits
			TDS 680B TDS 684B TDS 784C	TDS 620B TDS 644B	TDS 520C TDS 540C TDS 724C TDS 754C	
100 mV	600 mV (6 divisions)	1 ns	1 GHz	500 MHz	500 MHz	≥ 424 mV
1 V	5 V (5 divisions)	1 ns	1 GHz	500 MHz	500 MHz	≥ 3.535 V
500 mV	3 V (6 divisions)	1 ns	1 GHz	500 MHz	500 MHz	≥ 2.121 V
200 mV	1.2 V (6 divisions)	1 ns	1 GHz	500 MHz	500 MHz	≥ 848 mV
50 mV	300 mV (6 divisions)	1 ns	1 GHz	500 MHz	500 MHz	≥ 212 mV
20 mV	120 mV (6 divisions)	1 ns	1 GHz	500 MHz	500 MHz	≥ 84.8 mV
10 mV	60 mV (6 divisions)	1 ns	1 GHz	500 MHz	500 MHz	≥ 42.4 mV
5 mV	30 mV (6 divisions)	1 ns	750 MHz	450 MHz	500 MHz	≥ 21.2 mV
2 mV	12 mV (6 divisions)	1 ns	600 MHz	300 MHz	500 MHz	≥ 8.48 mV
1 mV	6 mV (6 divisions)	1 ns	500 MHz	250 MHz	450 MHz	≥ 4.24 mV

- e. *Display the test signal:* Do the following subparts to first display the reference signal and then the test signal.
- Press **MEASURE**; then press the main-menu button **Select Measrmt for CHx**.



- Press the side-menu button **more**, if needed, until the menu label **Frequency** appears in the side menu (its icon is shown at the left). Press the side-menu button **Frequency**.



- Press the side-menu button **more** until the menu label **Pk-Pk** appears in the side menu (its icon is shown at the left). Press the side-menu button **Pk-Pk**.
- Press **CLEAR MENU**.
- Set the generator output so the CHx Pk-Pk readout equals the reference amplitude in Table 1–4 that corresponds to the vertical scale set in substep d.
- Press the front-panel button **SET LEVEL TO 50%** as necessary to trigger a stable display. At full bandwidth, you may also want to make small, manual adjustments to the trigger level. You can use the **TRIGGER LEVEL** knob to do this. (Full bandwidth varies with TDS model as is shown in Table 1–4).

f. *Measure the test signal:*

- Set the frequency of the generator, as shown on screen, to the test frequency in Table 1–4 that corresponds to the vertical scale set in substep d. See Figure 1–9.
- Set the horizontal **SCALE** to the horizontal scale setting in Table 1–4 that corresponds to the vertical scale set in substep d. Press **SET LEVEL TO 50%** as necessary to trigger the signal.
- Read the results at the CHx Pk-Pk readout, which will automatically measure the amplitude of the test signal. See Figure 1–9.

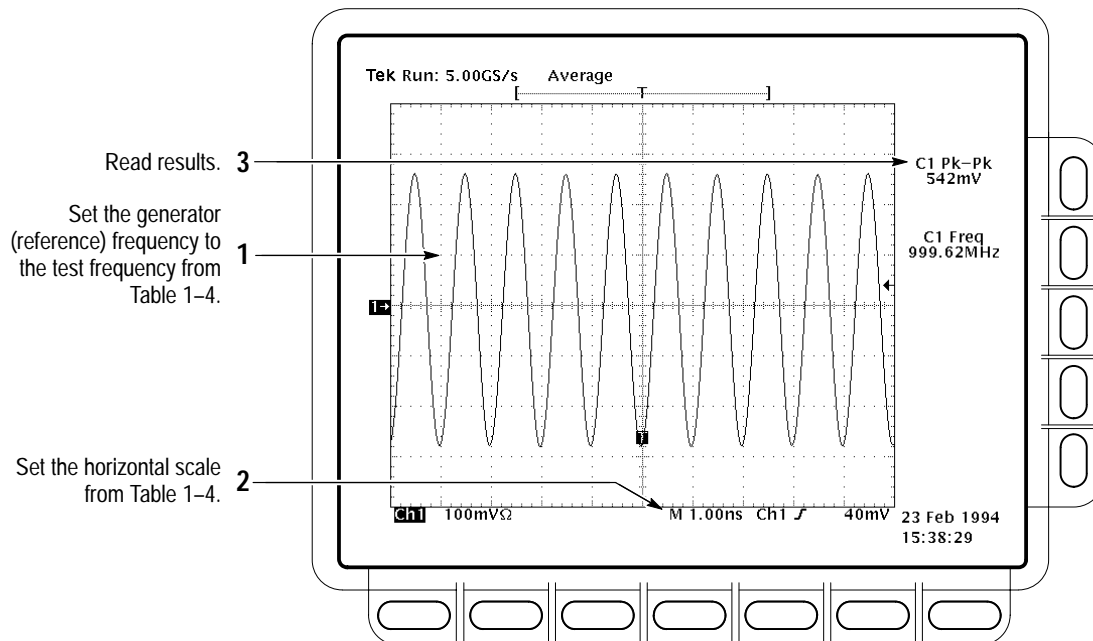

Figure 1-9: Measurement of analog bandwidth

g. *Check against limits:*

- CHECK that the **Pk-Pk** readout on screen is within the limits listed in Table 1-4 for the current vertical scale setting.
- Enter voltage on test record.
- When finished checking, set the horizontal **SCALE** back to the 50 ns setting.

STOP. *Checking each channel's bandwidth at all vertical scale settings is time consuming and unnecessary. You may skip checking the remaining vertical scale settings in Table 1-4 (that is, skip the following substep, h) if this digitizing oscilloscope has performed as follows:*

- Passed the 100 mV vertical scale setting just checked in this procedure.
- Passed the *Verify Internal Adjustment, Self Compensation, and Diagnostics* procedure found under *Self Tests*, on page 1-5.

NOTE. *Passing the signal path compensation confirms the signal path for all vertical scale settings for all channels. Passing the internal diagnostics ensures that the factory-set adjustment constants that control the bandwidth for each vertical scale setting have not changed.*

- h. *Check remaining vertical scale settings against limits (optional):*
 - If desired, finish checking the remaining vertical scale settings for the channel under test by repeating substeps d through g for each of the remaining scale settings listed in Table 1–4 for the channel under test.
 - When doing substep e, skip the subparts that turn on the CHx Pk-Pk measurement until you check a new channel.
 - Install/remove attenuators between the generator leveling head and the channel input as needed to obtain the six division reference signals listed in the table.
 - i. *Test all channels:* Repeat substeps a through g for all four channels.
- 3. *Disconnect the hookup:* Disconnect the test hook up from the input connector of the channel last tested.

Check Delay Between Channels

Equipment required	One sine wave generator (Item 19, or optionally, item 25) One precision 50 Ω coaxial cable (Item 5) One 50 Ω terminator (Item 4) One dual-input coupler (Item 8)
Prerequisites	See page 1–15 See <i>Input Channels vs. Model</i> on page 1–2.

STOP. DO NOT use the vertical position knob to reposition any channel while doing this check. To do so invalidates the test.

- 1. *Install the test hookup and preset the instrument controls:*
 - a. *Initialize the front panel:*
 - Press save/recall **SETUP**.
 - Press the main-menu button **Recall Factory Setup**.
 - Press the side-menu button **OK Confirm Factory Init**.

b. *Modify the initialized front-panel control settings:*

- Do *not* adjust the vertical position of any channel during this procedure.
- Set the horizontal **SCALE** to 500 ps.
- Press **SHIFT**; then press **ACQUIRE MENU**.
- Press the main-menu button **Mode**, and then press the side-menu button **Average 16**.

c. *Hook up the test-signal source:*

- Connect the sine wave output of a sine wave generator (item 19 or, optionally, 25) to a 50 Ω precision coaxial cable followed by a 50 Ω termination, and a dual-input coupler. See Figure 1–10.
- Connect the coupler to both **CH 1** and **CH 2**. See Figure 1–10.

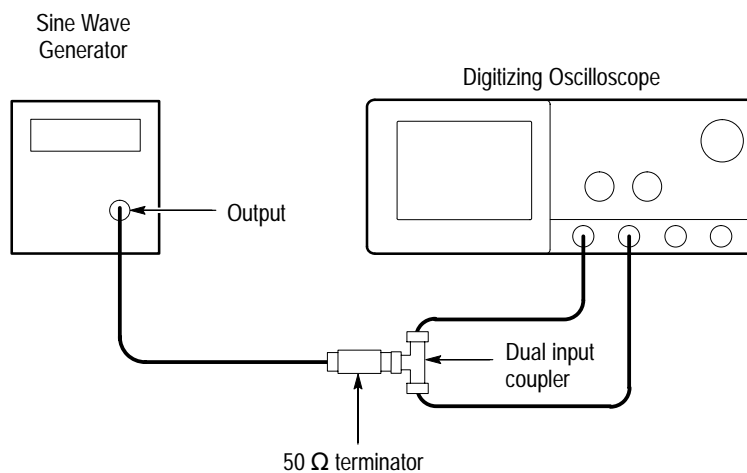

Figure 1–10: Initial test hookup

2. *Confirm all four channels are within limits for channel delay:*

- a. *Set up the generator:* Set the generator frequency to 250 MHz and the amplitude for about six divisions in CH 1.

Hint: As you are adjusting the generator amplitude, push **SET LEVEL TO 50%** frequently to speed up the updating of the waveform amplitude on screen.

- b. The horizontal **SCALE** should already be set to 500 ps. On the TDS 784C, and 600B, now set it to 200 ps. On the TDS 520C, 540C, 724C, and 754C, push the front-panel **ZOOM** button, press the side-menu **On** button, set the horizontal **SCALE** to 250 ps, and be sure the vertical scale factor is kept at 1.0X and the horizontal scale factor is 2.0X.
- c. *Save a CH 2 waveform:* Press **CH 2**. Be sure the vertical scale factor is kept at 1.0X. Then press save/recall **WAVEFORM**. Now, press the main-menu button **Save Wfm**; then press the side-menu button **To Ref 2**.
- d. *Save CH 3 (AX1 on some TDS models) waveform:*
 - Move the coupler from **CH 2** to **CH 3** (AX1 on some TDS models), so that **CH 1** and **CH 3** are driven. Press **WAVEFORM OFF**. Press **CH 3**. Be sure the vertical scale factor is kept at 1.0X. Then press the side-menu button **To Ref 3**.
- e. *Display all test signals:*
 - Press **WAVEFORM OFF** to remove CH 3 (AX1 on some TDS models) from the display.
 - Display the live waveform. Move the coupler from **CH 3** to **CH 4**, so that CH 1 and CH 4 are driven. (Use AX1 and AX2 instead of CH3 and CH4 if your TDS model is so equipped). Press **CH 4** to display. Be sure the vertical scale factor is kept at 1.0X. See Figure 1–11 on page 1–41.
 - Display the reference waveforms. To do this, press the front-panel button **MORE**. Press the main-menu buttons **Ref 2** and **Ref 3**. You may notice their overlapping ground reference indicators. See Figure 1–11 on page 1–41.
- f. *Measure the test signal:*
 - Locate the time reference points for these waveforms. Do this by first identifying the point where the rising edge of the left-most waveform crosses the center horizontal graticule line. Next, note the corresponding *time reference point* for the right-most waveform. See Figure 1–11 on page 1–41.
 - Press **CURSOR**.
 - Press the main-menu button **Function**; then press the side-menu button **V Bars**.
 - Press **CLEAR MENU**.

- Align one V bar cursor to the *time reference point* of the left-most waveform edge and the other cursor to the *time reference point* of the right-most waveform edge by rotating the General Purpose knob. (Press **SELECT** to switch between the two cursors). See Figure 1–11 on page 1–41.
- Read the measurement results at the Δ : cursor readout, not the @: readout on screen.

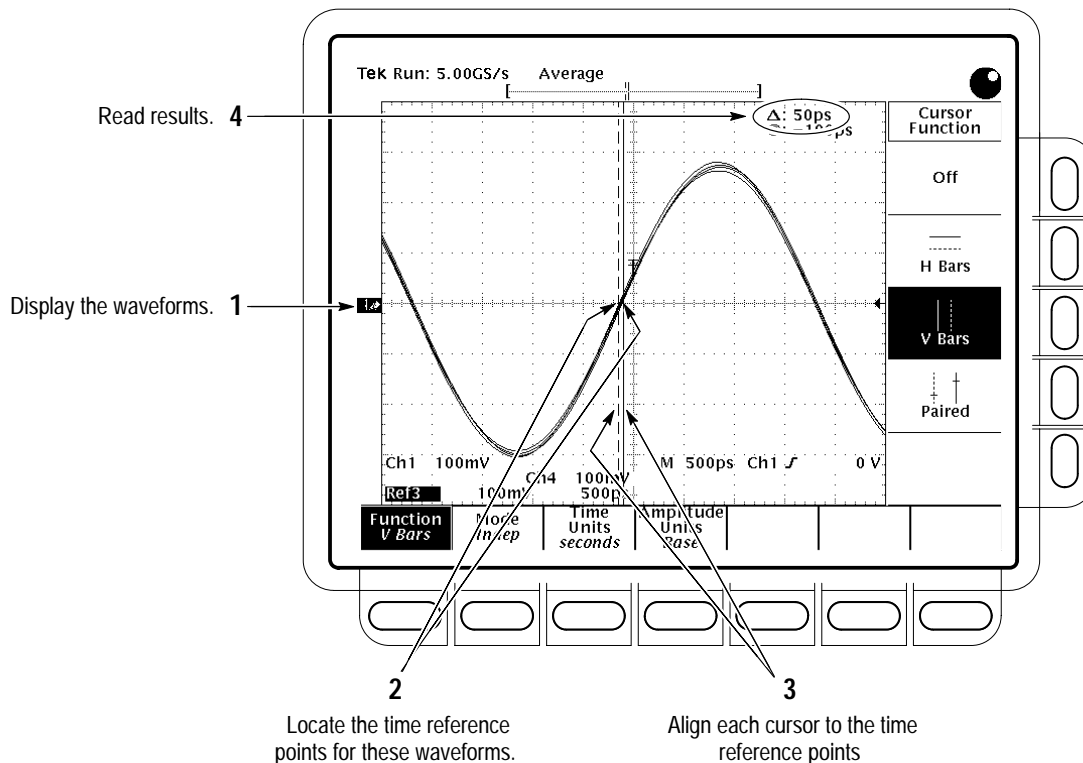

Figure 1–11: Measurement of channel delay – TDS 684B shown

- Check against limits: CHECK that the cursor readout on screen is ≤ 100 ps for the TDS 600B or ≤ 50 ps for the TDS 500C/700C.
- If the channel skew is within the limits, enter time on the test record and proceed to step 3. Otherwise, proceed with steps **i** through **p**.
- Use the cursors to measure the skew from CH1 to CH2, CH1 to CH3, and CH1 to CH4 (use AX1 and AX2 instead of CH3 and CH4 if your TDS model is so equipped). Write down these three numbers in the first measurement column of Table 1–5. Note that these numbers may be either positive or negative.

- j.** Repeat the procedure from step 1.c through 2.e.
- k.** Again use the cursors to measure the skew from CH1 to CH2, CH1 to CH3, and CH1 to CH4. Write down these numbers in the second measurement column of Table 1–5. Note that these numbers may be either positive or negative.
- l.** Add the first CH1 to CH2 skew measurement to the second CH1 to CH2 skew measurement and divide the result by 2. Use Table 1–5.
- m.** Add the first CH1 to CH3 (AX1 on some TDS models) skew measurement to the second CH1 to CH3 skew measurement and divide the result by 2. Use Table 1–5.
- n.** Add the first CH1 to CH4 (AX2 on some TDS models) skew measurement to the second CH1 to CH4 skew measurement and divide the result by 2. Use Table 1–5.
- o.** Check against limits: CHECK that the largest of the three results from steps l, m, and n is between –100 ps and + 100 ps for the TDS 600B or between –50 ps and + 50 ps for the TDS 500C/700C.
- p.** Enter time on the test record.

Table 1–5: Delay between channels worksheet

Coupling	First measurement	Second measurement	Add first and second measurements	Divide sum by 2
CH1 to CH2 skew				
CH1 to CH3 skew				
CH1 to CH4 skew				

- 3.** *Disconnect the hookup:* Disconnect the cable from the generator output at the input connectors of the channels.

Time Base System Checks

These procedures check those characteristics that relate to the Main and Delayed time base system and are listed as checked under *Warranted Characteristics in Specifications*.

Check Accuracy for Long-Term Sample Rate, Delay Time, and Delta Time Measurements

Equipment required	One time-mark generator (Item 11) One 50 Ω , precision coaxial cable (Item 5)
Prerequisites	See page 1–15

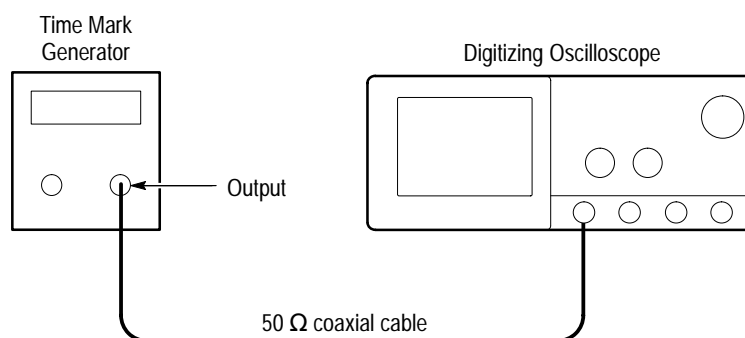

Figure 1–12: Initial test hookup

1. *Install the test hookup and preset the instrument controls:*
 - a. *Hook up the test-signal source:* Connect, through a 50 Ω precision coaxial cable, the time-mark output of a time-mark generator to **CH 1**. Set the output of the generator for 10 ms markers.
 - b. *Initialize the oscilloscope:*
 - Press save/recall **SETUP**. Press the main-menu button **Recall Factory Setup**. Press the side-menu button **OK Confirm Factory Init**.
 - c. *Modify the initialized front-panel control settings:*
 - Set the vertical **SCALE** to 200 mV (or 500 mV with the optional Tektronix TG 501A Time Mark Generator).
 - Press **VERTICAL MENU**; then press the main-menu button **Coupling**. Press the side-menu button **Ω** to toggle it to the **50 Ω** setting.
 - Press **SET LEVEL TO 50%**.

- Use the vertical **POSITION** knob to center the test signal on screen.
 - Set the horizontal **SCALE** of the Main time base to 1 ms.
 - Press **TRIGGER MENU**; then press the main-menu button **Mode & Holdoff**. Press the side-menu button **Normal**.
2. *Confirm Main and Delayed time bases are within limits for accuracies:*
- a. *Display the test signal:*
 - Align the trigger **T** to the center vertical graticule line by adjusting the horizontal **POSITION**. See Figure 1–13 on page 1–45.
 - Press **HORIZONTAL MENU**.
 - Set horizontal modes. To do this, press the main-menu button **Time Base**. Press the side-menu buttons **Delayed Only** and **Delayed Runs After Main**. See Figure 1–13.
 - b. *Measure the test signal:*
 - Set the horizontal **SCALE** of the **D** (delayed) time base to 500 ns for the TDS 600B or to 100 ns for the TDS 500C/700C.
 - Set delayed time to 10 ms. Do this on the keypad by pressing **10**, then **SHIFT**, then **m** followed by **ENTER**).
 - c. *Check long-term sample rate and delay time accuracies against limits:*
 - **CHECK** that the rising edge of the marker crosses the center horizontal graticule line at a point within either ± 2.0 divisions, for the TDS 600B, or ± 2.5 divisions, for the TDS 500C/700C, of center graticule. See Figure 1–13.
 - Enter number of divisions on test record.

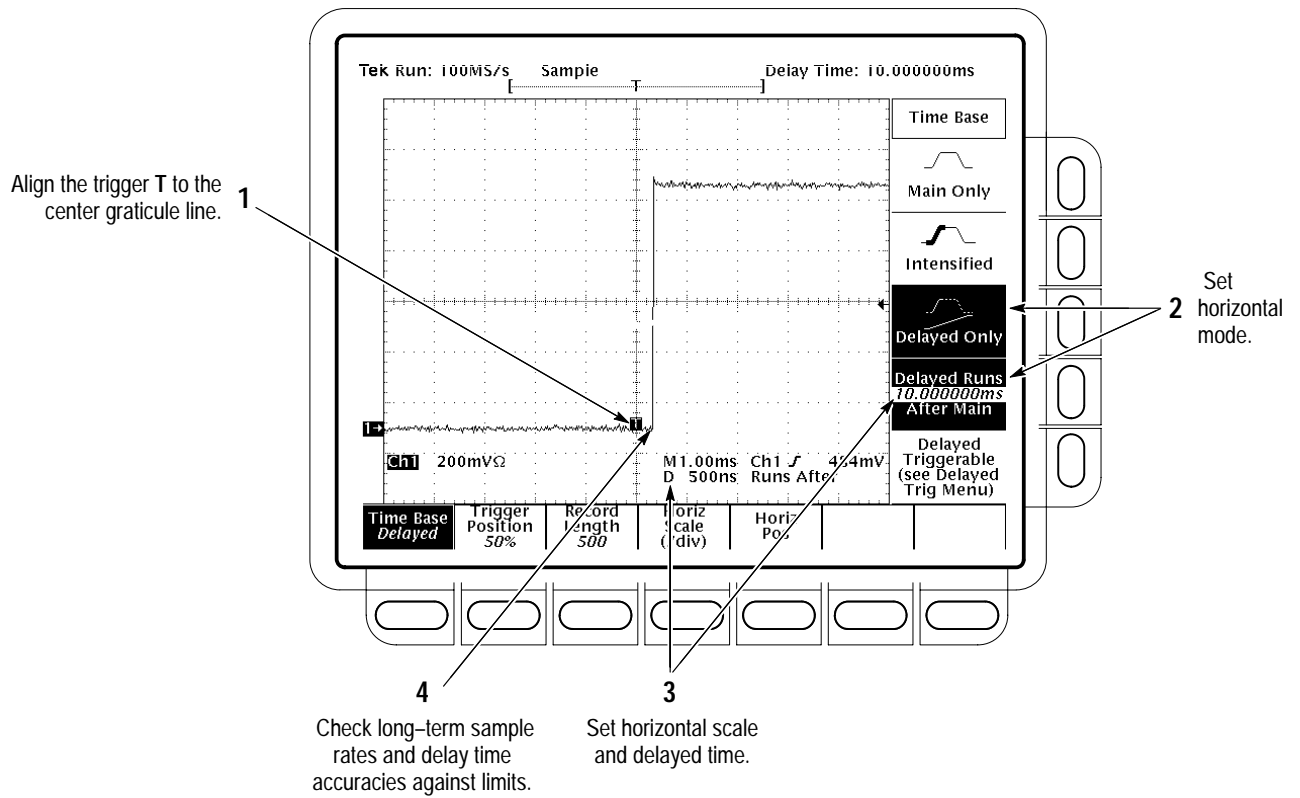

Figure 1-13: Measurement of accuracy — Long-term and delay time

3. *Disconnect the hookup:* Disconnect the cable from the generator output at the input connector of CH 1.

Trigger System Checks

These procedures check those characteristics that relate to the Main and Delayed trigger systems and are listed as checked in *Specifications*.

Check Accuracy (Time) for Pulse-Glitch or Pulse-Width Triggering

Equipment required	One medium-frequency sine wave generator (Item 19 or, optionally, item 25) One 10X attenuator (Item 1) One 50 Ω, precision coaxial cable (Item 5)
Prerequisites	See page 1-15

1. *Install the test hookup and preset the instrument controls:*
 - a. *Initialize the instrument:*
 - Press save/recall **SETUP**.
 - Press the main-menu button **Recall Factory Setup**.
 - Press the side-menu button **OK Confirm Factory Init**.
 - b. *Modify the default setup:*
 - Press **VERTICAL MENU**.
 - Press the main-menu button **Coupling**; then press the side-menu **Ω** button to select **50 Ω** coupling.
 - Set the horizontal **SCALE** to 10 ns on the TDS 600B and 12.5 ns on the TDS 500C/700C.
 - c. *Hook up the test-signal source:* Connect the output of a medium-frequency leveled sine wave generator (Item 25) to CH 1. Do this through a 50 Ω precision coaxial cable, followed by a 10X attenuator. See Figure 1–14.

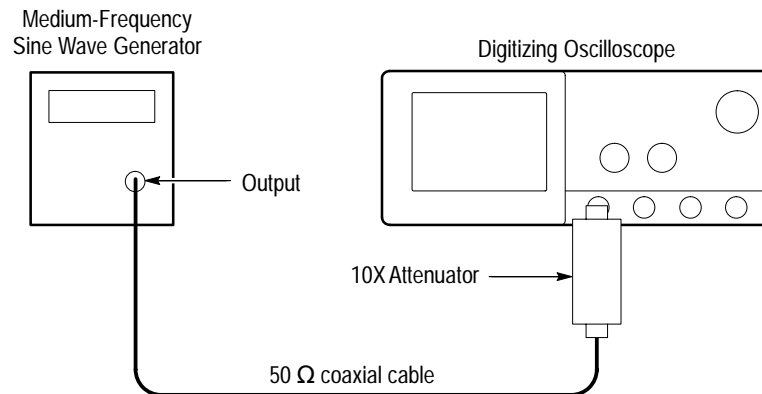

Figure 1–14: Initial test hookup

2. *Confirm the trigger system is within time-accuracy limits for pulse-glitch or pulse-width triggering (Horizontal Scale $\leq 1 \mu\text{s}$):*
 - a. *Display the test signal:* Set the output of the sine wave generator for a 100 MHz, five-division sine wave on screen. Press **SET LEVEL TO 50%**.

-
- b. *Set the trigger mode:* Press **TRIGGER MENU**. Now press the main-menu button **Mode & Holdoff**; then press the side-menu button **Normal**.
- c. *Set upper and lower limits that ensure triggering:* See Figure 1–15.
- Press the main-menu button **Type**; then repeatedly press the same button until **Pulse** is highlighted in the menu that pops up.
 - Press the main-menu button **Class**; then repeatedly press the same button until **Width** is highlighted in the menu that pops up.
 - Press the main-menu button **Trig When**; then press the side-menu button **Within Limits**.
 - Press the side-menu button **Upper Limit**. Use the keyboard to set the upper limit to 10 ns: press **10**, then **SHIFT**, then **n**, and **ENTER**.
 - Press the side-menu button **Lower Limit**. Use the keypad to set the lower limit to 2 ns.
- d. *Change limits until triggering stops:*
- Press **SET LEVEL TO 50%**.
 - While doing the following subparts, monitor the display (it will stop acquiring) and the front-panel light **TRIG** (it will extinguish) to determine when triggering is lost.
 - Press the side-menu button **Lower Limit**.
 - Use the general purpose knob to *increase* the **Lower Limit** readout until triggering is lost.
 - CHECK that the **Lower Limit** readout, after the oscilloscope loses triggering, is within 3.5 ns to 6.5 ns, inclusive.
 - Enter time on test record.
 - Use the keypad to return the **Lower Limit** to 2 ns and reestablish triggering.
 - Press the side-menu button **Upper Limit**; then use the general purpose knob to slowly *decrease* the **Upper Limit** readout until triggering is lost.
 - CHECK that the **Upper Limit** readout, after the oscilloscope loses triggering, is within 3.5 ns to 6.5 ns, inclusive.
 - Enter time on test record.

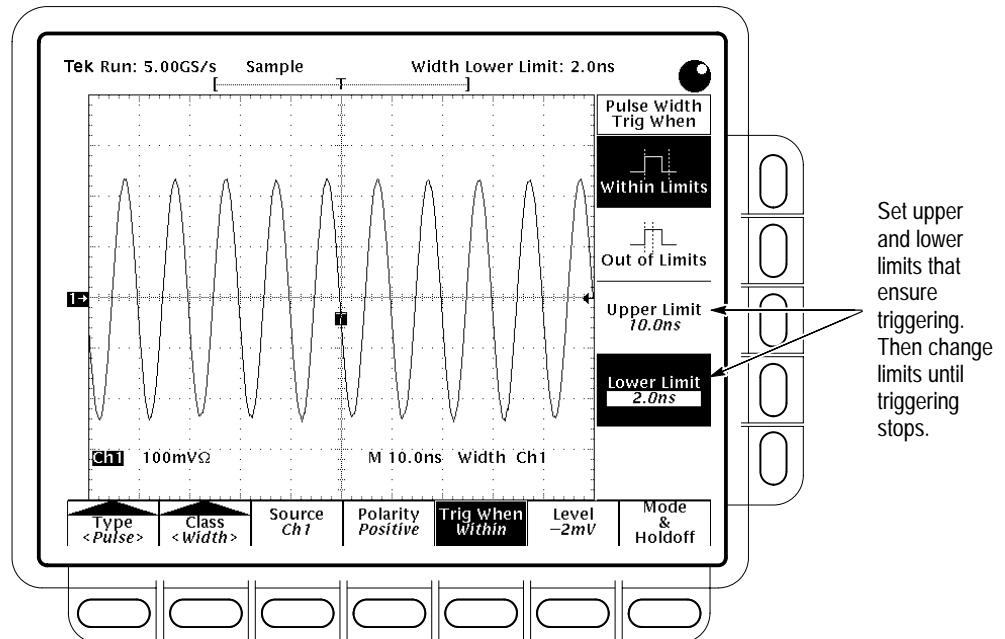

Figure 1-15: Measurement of time accuracy for pulse and glitch triggering

3. *Confirm the trigger system is within time-accuracy limits for pulse-glitch or pulse-width triggering (horizontal scale $>1 \mu\text{s}$):*
 - a. *Set upper and lower limits that ensure triggering at 250 kHz:*
 - Press the side-menu button **Upper Limit**. Use the keyboard to set the upper limit to $4 \mu\text{s}$.
 - Press the side-menu button **Lower Limit**. Use the keypad to set the lower limit to 500 ns .
 - b. *Display the test signal:*
 - Set the horizontal **SCALE** to $5 \mu\text{s}$.
 - Set the output of the sine wave generator for a 250 kHz, five-division sine wave on screen. Set the vertical **SCALE** to 20 mV (the waveform will overdrive the display).
 - Press **SET LEVEL TO 50%**.
 - c. *Check against limits:* Do the following subparts in the order listed.
 - Press the side-menu button **Lower Limit**.
 - Use the general purpose knob to *increase* **Lower Limit** readout until triggering is lost.

- CHECK that the **Lower Limit** readout, after the oscilloscope stops triggering, is within 1.9 μ s to 2.1 μ s, inclusive.
- Enter time on test record.
- Use the keypad to return the **Lower Limit** to 500 ns and reestablish triggering.
- Press the side-menu button **Upper Limit**; then use the general purpose knob to slowly *decrease* the **Upper Limit** readout until triggering stops.
- CHECK that the **Upper Limit** readout, after the oscilloscope loses triggering, is within 1.9 μ s to 2.1 μ s, inclusive.
- Enter time on test record.

4. *Disconnect the hookup:* Disconnect the cable from the generator output at the input connector of **CH 1**.

Check Accuracy, Trigger-Level or Threshold, DC Coupled

Equipment required	One DC calibration generator (Item 9) One BNC T connector (Item 7) Two 50 Ω , precision coaxial cables (Item 5)
Prerequisites	See page 1–15.

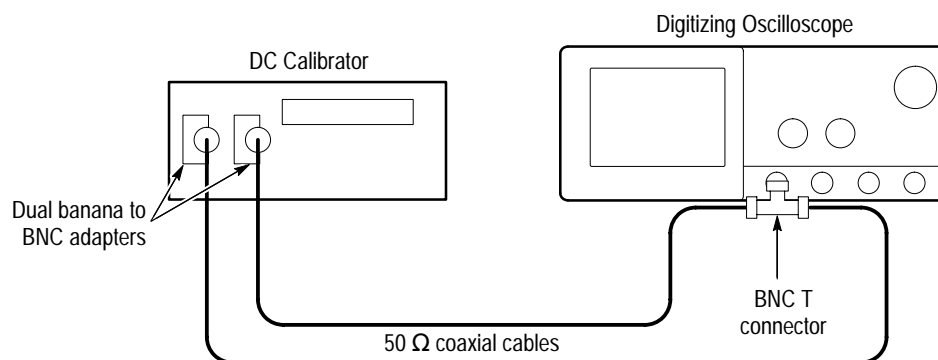

Figure 1–16: Initial test hookup

1. *Install the test hookup and preset the instrument controls:*
 - a. *Hook up the test-signal source:*
 - Set the output of the DC calibration generator to 0 volts.

- Connect the output of the DC calibration generator, through a dual-banana connector followed by a 50 Ω precision coaxial cable, to one side of a BNC T connector.
 - Connect the Sense output of the generator, through a second dual-banana connector followed by a 50 Ω precision coaxial cable, to other side of the BNC T connector. Now connect the BNC T connector to **CH 1**.
- b.** *Initialize the oscilloscope:*
- Press save/recall **Setup**.
 - Press the main-menu button **Recall Factory Setup**.
 - Press the side-menu button **OK Confirm Factory Init**.
- 2.** *Confirm Main trigger system is within limits for Trigger-level/Threshold accuracy:*
- a.** *Display the test signal:*
- Set the vertical **SCALE** to 200 mV.
 - Press **VERTICAL MENU**, then press the main-menu button **Position**.
 - Set vertical position to –3 divisions (press **–3**, then **ENTER**, on the keypad). The baseline level will move down three divisions. See Figure 1–17 on page 1–51.
 - Press the main-menu button **Offset**.
 - Set vertical offset to +10 volts with the keypad. The baseline level will move off screen.
 - Set the standard output of the DC calibration generator equal to the offset (+10 volts). The DC test level will appear on screen. See Figure 1–17.
- b.** *Measure the test signal:*
- Press **SET LEVEL TO 50%**.
 - Press **TRIGGER MENU**.
 - Read the measurement results from the readout below the label **Level** in the main menu, not the trigger readout in the graticule area.

c. *Read results (Check against limits):* See Figure 1–17.

- CHECK that the **Level** readout in the main menu is within 9.863 V to 10.137 V, inclusive, for the TDS 600B or is within 9.9393 V to 10.1147 V, inclusive, for the TDS 500C/700C.
- Enter voltage on test record.
- Press the main-menu button **Slope**; then press the side-menu button for negative slope. See icon at left. Repeat substep b.
- CHECK that the **Level** readout in the main menu is within 9.863 V to 10.137 V, inclusive, for the TDS 600B or is within 9.9393 V to 10.1147 V, inclusive, for the TDS 500C/700C.
- Enter voltage on test record.

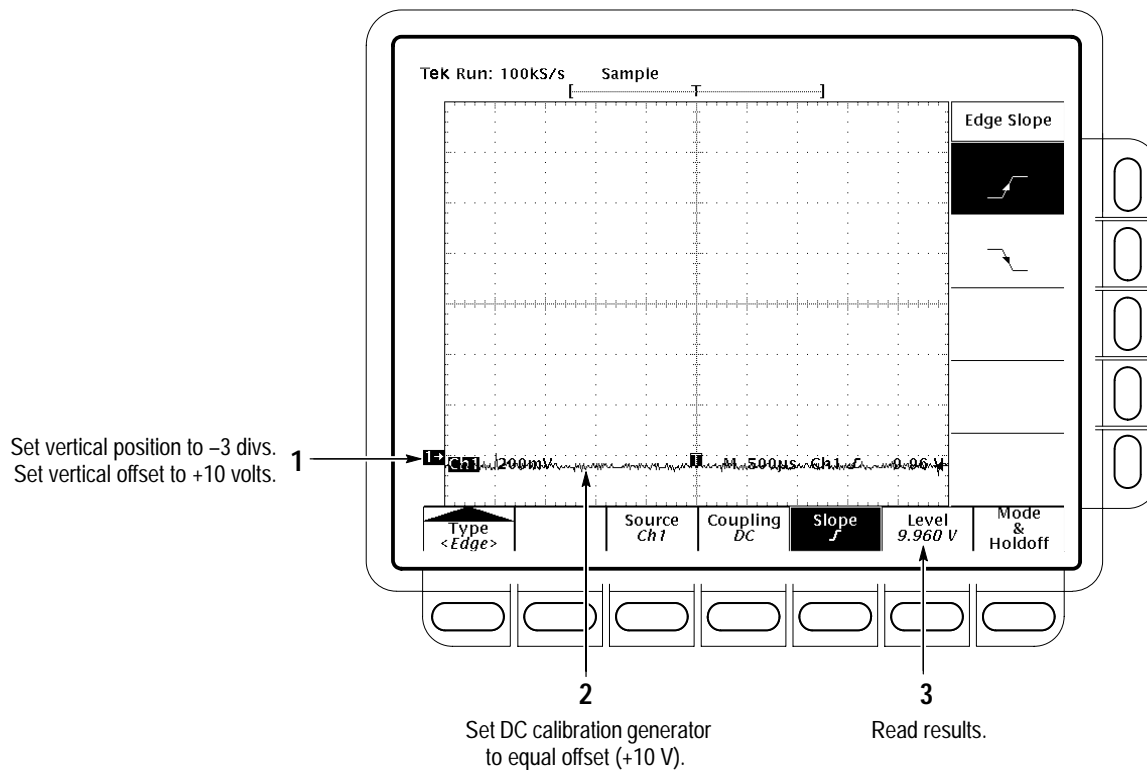

Figure 1–17: Measurement of trigger-level accuracy

3. *Confirm Delayed trigger system is within limits for Trigger-level/Threshold accuracy:*
 - a. *Select the Delayed time base:*

- Press **HORIZONTAL MENU**.
 - Press the main-menu button **Time Base**.
 - Press the side-menu buttons **Delayed Only** and **Delayed Triggerable**.
 - Set **D** (delayed) horizontal **SCALE** to 500 μ s.
- b. *Select the Delayed trigger system:*
- Press **SHIFT**; then press the front-panel **DELAYED TRIG** button.
 - Press the main-menu button **Level**.
- c. *Measure the test signal:* Press the side-menu button **SET TO 50%**. Read the measurement results in the side (or main) menu below the label **Level**.
- d. *Check against limits:* Do the following subparts in the order listed.
- CHECK that the **Level** readout in the side menu is within 9.863 V to 10.137 V, inclusive, for the TDS 600B or is within 9.9393 V to 10.1147 V, inclusive, for the TDS 500C/700C.
 - Enter voltage on test record.
 - Press the main-menu button **Slope**; then press the side-menu button for negative slope. See icon at left. Press the main-menu button **Level**. Repeat substep c.
 - CHECK that the **Level** readout in the side menu is within 9.863 V to 10.137 V, inclusive, for the TDS 600B or is within 9.9393 V to 10.1147 V, inclusive, for the TDS 500C/700C.
 - Enter voltage on test record.
4. *Disconnect the hookup:*
- a. First set the output of the DC calibration generator to 0 volts.
 - b. Disconnect the cable from the generator output at the input connector of **CH 1**.



Sensitivity, Edge Trigger,
DC Coupled

Equipment required	One sine wave generator (Item 19 or, optionally, items 25 and 26) Two precision 50 Ω coaxial cables (Item 5) One 10X attenuator (Item 1) One BNC T connector (Item 7) One 5X attenuator (Item 2)
Prerequisites	See page 1–15.

1. *Install the test hookup and preset the instrument controls:*a. *Initialize the oscilloscope:*

- Press save/recall **SETUP**.
- Press the main-menu button **Recall Factory Setup**.
- Press the side-menu button **OK Confirm Factory Init**.

b. *Modify the initialized front-panel control settings:*

- Set the horizontal **SCALE** for the **M** (main) time base to 20 ns on the TDS 600B or 25 ns on the TDS 500C/700C.
- Press **HORIZONTAL MENU**; then press the main-menu button **Time Base**.
- Press the side-menu button **Delayed Only**; then press the side-menu button **Delayed Triggerable**.
- Set the horizontal **SCALE** for the **D** (delayed) time base to 20 ns on the TDS 600B or 25 ns on the TDS 500C/700C; then press the side-menu button **Main Only**.
- Press **TRIGGER MENU**; then press the main-menu button **Mode & Holdoff**. Press the side-menu button **Normal**.
- Press **VERTICAL MENU**; then press the main-menu button **Coupling**. Press the side-menu button Ω to select the 50 Ω setting.
- Press **SHIFT**; then press **ACQUIRE MENU**. Press the main-menu button **Mode**; then press the side-menu button **Average 16**.

c. *Hook up the test-signal source:*

- Connect the signal output of a medium-frequency sine wave generator (item 19 or, optionally, item 25) to a BNC T connector. Connect one output of the T connector to **CH 1** through a 50 Ω precision coaxial cable. Connect the other output of the T connector to the **AUX TRIG INPUT** at the rear panel. See Figure 1–18.

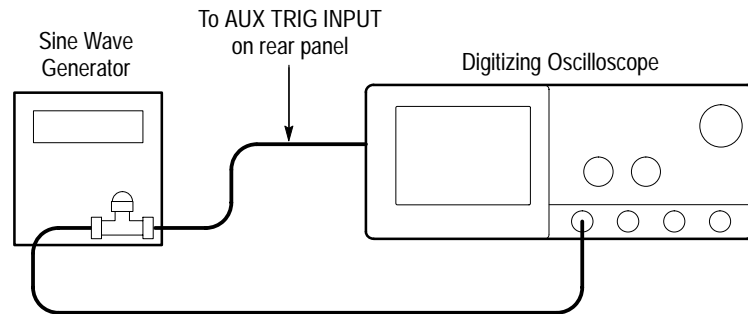

Figure 1-18: Initial test hookup

2. *Confirm Main and Delayed trigger systems are within sensitivity limits (50 MHz):*

a. *Display the test signal:*

- Set the generator frequency to 50 MHz.
- Press **MEASURE**.
- Press the main-menu button **Level Setup**; then press the side-menu button **Min-Max**.
- Press the main-menu button **Select Measrmt for Ch1**.
- Press the side-menu button **–more–** until **Amplitude** appears in the side menu (its icon is shown at the left). Press the side-menu button **Amplitude**.
- Press **SET LEVEL TO 50%**.
- Press **CLEAR MENU**.
- Set the test signal amplitude for about three and a half divisions on screen. Now fine adjust the generator output until the **CH 1 Amplitude** readout indicates the amplitude is 350 mV. Readout may fluctuate around 350 mV.
- Disconnect the 50 Ω precision coaxial cable at **CH 1** and reconnect it to **CH 1** through a 10X attenuator.



b. *Check the Main trigger system for stable triggering at limits:*

- Read the following definition: A stable trigger is one that is consistent; that is, one that results in a uniform, regular display triggered on the selected slope (positive or negative). This display should *not* have its trigger point switching between opposite slopes, nor should it roll across the screen. At horizontal scale settings of

2 ms/division and faster, **TRIG'D** will remain constantly lighted. It will flash for slower settings.

- Press **TRIGGER MENU**; then press the main-menu button **Slope**.
- Press **SET LEVEL TO 50%**. Adjust the **TRIGGER LEVEL** knob so that the **TRIG'D** light is on. Set the level to near the middle of the range where the **TRIG'D** light is on. **CHECK** that the trigger is stable for the test waveform on both the positive and negative slopes. Use the side menu to switch between trigger slopes.
- Enter pass/fail result for main trigger on the test record.
- Leave the Main trigger system triggered on the positive slope of the waveform before continuing to the next step.

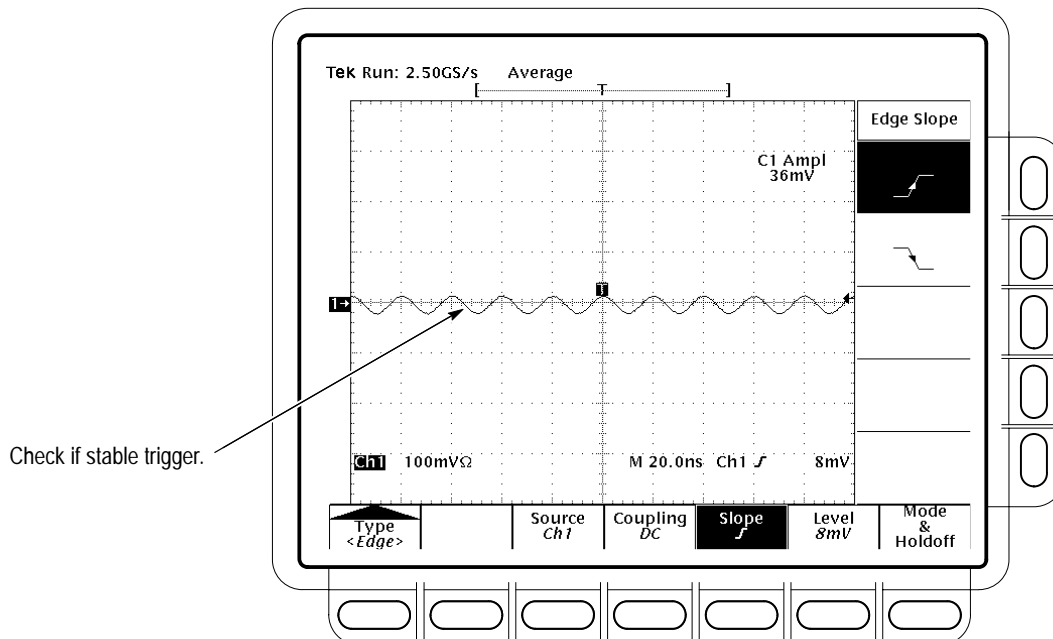

Figure 1-19: Measurement of trigger sensitivity — 50 MHz results shown on a TDS 684B screen

- c. *Check Delayed trigger system for stable triggering at limits: Do the following subparts in the order listed.*
 - Press **HORIZONTAL MENU**; then press the main-menu button **Time Base**. Press the side-menu button **Delayed Only**; then press **Delayed Triggerable** in the same menu.

- Press **SHIFT**; then press **DELAYED TRIG**. Press the main-menu button **Level**.
- Press the side-menu button **SET TO 50%**.

CHECK that a stable trigger is obtained for the test waveform for both the positive and negative slopes of the waveform. Use the **TRIGGER LEVEL** knob to stabilize the Main trigger. Use the general purpose knob to stabilize the Delayed trigger. Press the main-menu button **Slope**; then use the side menu to switch between trigger slopes. See Figure 1–19.

- Enter pass/fail result for delayed trigger on the test record.
- Leave the Delayed trigger system triggered on the positive slope of the waveform before continuing to the next step. Also, return to the main time base: Press **HORIZONTAL MENU**; then press the main-menu button **Time Base**. Press the side-menu button **Main Only**.
- Press **CLEAR MENU**.

3. *Confirm the AUX Trigger input:*

a. *Display the test signal:*

- Remove the 10X attenuator and reconnect the cable to **CH 1**.
- Set the test signal amplitude for about 2.5 divisions on screen.
- Now fine adjust the generator output until the **CH 1 Amplitude** readout indicates the amplitude is 250 mV. (Readout may fluctuate around 250 mV).

b. *Check the AUX trigger source for stable triggering at limits: Do the following in the order listed.*

- Use the definition for stable trigger from step 2.
- Press **TRIGGER MENU**; then press the main-menu button **Source**.
- Press the side-menu button **–more–** until the side-menu label **DC Aux** appears; then press **DC Aux**.
- Press **SET LEVEL TO 50%**. CHECK that a stable trigger is obtained for the test waveform on both the positive and negative slopes. Press the main-menu button **Slope**; then use the side menu to switch between trigger slopes. Use the **TRIGGER LEVEL** knob to stabilize the trigger if required.
- Enter the pass/fail result on the test record.

- Leave the Main trigger system triggered on the positive slope of the waveform before proceeding to the next check.
 - Press the main-menu button **Source**; then press the side-menu button **–more–** until **CH 1** appears. Press **CH 1**.
4. *Confirm that the Main and Delayed trigger systems are within sensitivity limits (full bandwidth):*
- a. *Hook up the test-signal source:* Disconnect the hookup installed in step 1. Connect the signal output of a high-frequency sine wave generator (item 19 or, optionally, item 26) to **CH 1**.
 - b. *Set the Main and Delayed Horizontal Scales:*
 - Set the horizontal **SCALE** to 500 ps for the **M** (Main) time base.
 - Press **HORIZONTAL MENU**. Now press the main-menu button **Time base**; then press the side-menu button **Delayed Triggerable**.
 - Press the side-menu button **Delayed Only**.
 - Set the horizontal **SCALE** to 500 ps for the **D** (Delayed) time base. Press the side-menu button **Main Only**.
 - c. *Display the test signal:*
 - Set the generator frequency to full bandwidth as follows:

TDS 680B, 684B, & 784C:	1 GHz
TDS 520C, 540C, 620B, 644B, 724C, & 754C:	500 MHz
 - Set the test signal amplitude for about five divisions on screen. Now fine adjust the generator output until the **CH 1 Amplitude** readout indicates the amplitude is 500 mV. (Readout may fluctuate around 500 mV).
 - Disconnect the leveling head at **CH 1** and reconnect it to **CH 1** through a 5X attenuator.
 - d. Repeat step 2, substeps **b** and **c** only, since only the full bandwidth is to be checked here.

***NOTE.** You just checked the trigger sensitivity. If desired, you may repeat steps 1 through 4 for the other channels (CH2, CH3, and CH4).*

5. *Disconnect the hookup:* Disconnect the cable from the channel last tested.

Output Signal Checks

The procedure that follows checks those characteristics of the output signals that are listed as checked under *Warranted Characteristics* in *Specifications*. The oscilloscope outputs these signals at its front and rear panels.

Check Outputs — CH 3 (AX1 on some models) Main and Delayed Trigger

Equipment required	Two 50 Ω precision cables (Item 5) One calibration generator (Item 10)
Prerequisites	See page 1–15. Also, the digitizing oscilloscope must have passed <i>Check DC Voltage Measurement Accuracy</i> on page 1–29. See <i>Input Channels vs. Model</i> on page 1–2.

1. Install the test hookup and preset the instrument controls:

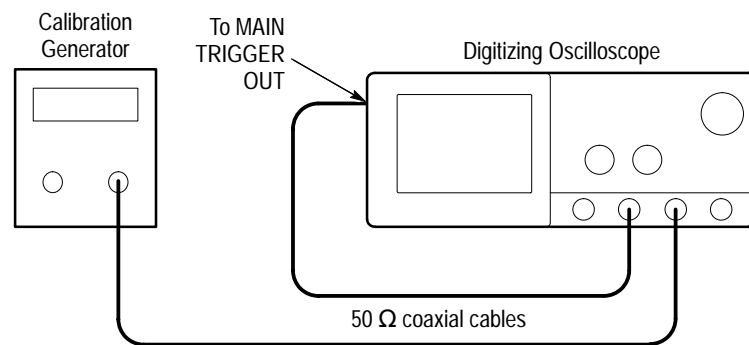

Figure 1–20: Initial test hookup

- a. *Hook up test-signal source 1:*
 - Connect the standard amplitude output of a calibration generator through a 50 Ω precision coaxial cable to **CH 3 (AX1)** on some TDS models).
 - Set the output of the calibration generator to 0.500 V.
- b. *Hook up test-signal source 2:* Connect the **Main Trigger Out** at the rear panel to **CH 2** through a 50 Ω precision cable.
- c. *Initialize the oscilloscope:*
 - Press save/recall **SETUP**.
 - Press the main-menu button **Recall Factory Setup**.
 - Press the side-menu button **OK Confirm Factory Init**.

d. *Modify the initialized front-panel control settings:*

- Set the horizontal **SCALE** to 200 μ s.
- Press **SHIFT**; then press **ACQUIRE MENU**.
- Press the main-menu button **Mode**; then press the side-menu button **Average**.
- Select **64** averages. Do this with the keypad or the general purpose knob

2. *Confirm Main and Delayed Trigger outputs are within limits for logic levels:*

a. *Display the test signal:*

- Press **WAVEFORM OFF** to turn off CH 1.
- Press **CH 2** to display that channel.
- Set the vertical **SCALE** to 1 V.
- Use the vertical **POSITION** knob to center the display on screen.

b. *Measure logic levels:*

- Press **MEASURE**; then press the main-menu button **Select Measurement for Ch2**.
- Select high and low measurements. To do this, repeatedly press the side-menu button **–more–** until **High** and **Low** appear in the side menu (their icons are shown at the left). Press both side-menu buttons **High** and **Low**.



c. *Check Main Trigger output against limits:*

- CHECK that the **Ch2 High** readout is ≥ 2.5 volts and that the **Ch2 Low** readout is ≤ 0.7 volts. See Figure 1–21.
- Enter high and low voltages on test record.
- Press **VERTICAL MENU**; then press the main-menu button **Coupling**. Now press the side-menu button **Ω** to toggle it to the 50 Ω setting.
- CHECK that the **Ch2 High** readout is ≥ 1.0 volt and that the **Ch2 Low** readout ≤ 0.25 volts.
- Enter high and low voltages on test record.

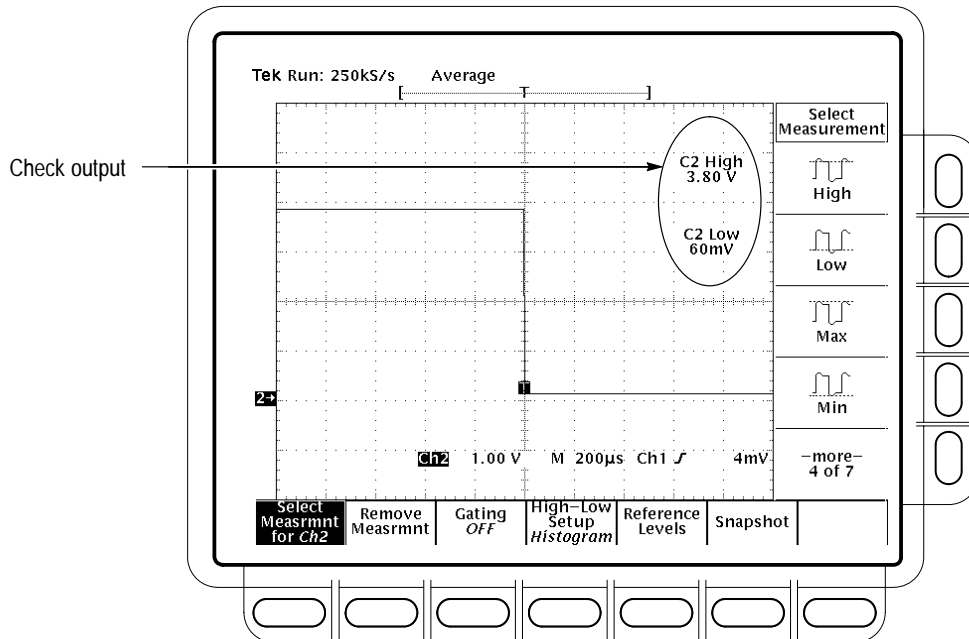

Figure 1-21: Measurement of main trigger out limits

d. *Check Delayed Trigger output against limits:* See Figure 1-21.

- Move the precision 50 Ω cable from the rear-panel **Main Trigger Output** BNC to the rear-panel **Delayed Trigger Output** BNC.
- CHECK that the **Ch2 High** readout is ≥ 1.0 volt and that the **Ch2 Low** readout ≤ 0.25 volts.
- Enter high and low voltages on test record.
- Press the side-menu button **Ω** to select the 1 MΩ setting.
- Press **CLEAR MENU**.
- CHECK that the **Ch2 High** readout is ≥ 2.5 volts and that the **Ch2 Low** readout is ≤ 0.7 volts.
- Enter high and low voltages on test record.

3. *Confirm CH 3 (Ax1 on some TDS models) output is within limits for gain:*

a. *Measure gain:*

- Move the precision 50 Ω cable from the rear-panel **DELAYED TRIGGER OUTPUT** BNC to the rear-panel **SIGNAL OUT** BNC.
- Push **TRIGGER MENU**.



- Press the main-menu button **Source**.
 - Press the side-menu button **Ch3**.
(**Ax1** on some TDS models)
 - Set vertical **SCALE** to 100 mV.
 - Press **SET LEVEL TO 50%**.
 - Press **MEASURE**; then press the main-menu button **Select Measrmt for Ch2**.
 - Repeatedly press the side-menu button **–more–** until **Pk-Pk** appears in the side menu (its icon is shown at the left). Press the side-menu button **Pk-Pk**.
 - Press **CLEAR MENU**.
- b. Check against limits:**
- CHECK that the readout **Ch2 Pk-Pk** is between 80 mV and 120 mV, inclusive, for the TDS 600B or is between 88 mV and 132 mV, inclusive, for the TDS 500C/700C.
 - Enter voltage on test record.
 - Press **VERTICAL MENU**; then press the side-menu button **Ω** to toggle to the 50 Ω setting.
 - Press **CLEAR MENU**.
 - CHECK that the readout **Ch2 Pk-Pk** is between 40 mV and 60 mV, inclusive, for the TDS 600B or is between 44 mV and 66 mV, inclusive, for the TDS 500C/700C.
 - Enter voltage on test record.
- 4. Disconnect the hookup:** Disconnect the cables from the channel inputs and the rear panel outputs.

**Check Probe
Compensator Output**

Equipment required	One female BNC to clip adapter (Item 3) Two dual-banana connectors (Item 6) One BNC T connector (Item 7) Two 50 Ω precision cables (Item 5) One DC calibration generator (Item 9)
Prerequisites	See page 1–15. Also, the digitizing oscilloscope must have passed <i>Check Accuracy For Long-Term Sample Rate, Delay Time, and Delta Time Measurements</i> on page 1–43.

1. Install the test hookup and preset the instrument controls:

a. Hook up test-signal:

- Connect one of the 50 Ω cables to **CH 1**. See Figure 1–22.
- Connect the other end of the cable just installed to the female BNC-to-clips adapter. See Figure 1–22.
- Connect the red clip on the adapter just installed to the **PROBE COMPENSATION SIGNAL** on the front panel; connect the black clip to **PROBE COMPENSATION GND**. See Figure 1–22.

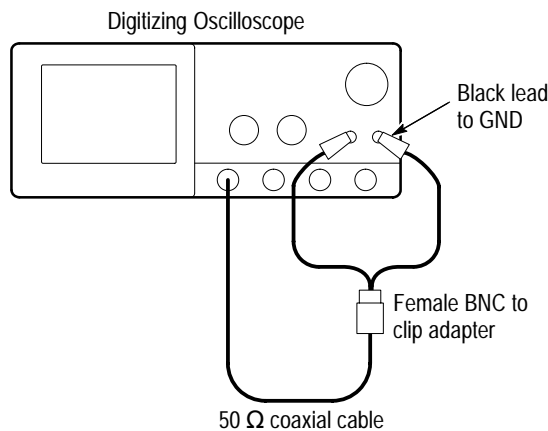

Figure 1–22: Initial test hookup

b. Initialize the oscilloscope:

- Press save/recall **SETUP**.
- Press the main-menu button **Recall Factory Setup**.
- Press the side-menu button **OK Confirm Factory Init**.

- c. *Modify the initialized front-panel control settings:*
 - Set the horizontal **SCALE** to 200 μ s.
 - Press **SET LEVEL TO 50%**.
 - Use the vertical **POSITION** knob to center the display on screen.
 - Press **SHIFT**; then press **ACQUIRE MENU**.
 - Press the main-menu button **Mode**; then press the side-menu button **Average**.
 - Select **128** averages with the keypad or the general purpose knob.
2. *Confirm that the Probe Compensator signal is within limits for frequency:*
 - a. *Measure the frequency of the probe compensation signal:*
 - Press **MEASURE**; then press the main-menu button **Select Measrmt for Ch1**.
 - Repeatedly press the side-menu button **–more–** until **Frequency** appears in the side menu (its icon is shown at the left). Press the side-menu button **Frequency**.
 - b. *Check against limits:*
 - CHECK that the **CH 1 Freq** readout is within 950 Hz to 1.050 kHz, inclusive. See Figure 1–23.
 - Enter frequency on test record.
 - Press **MEASURE**; then press the main-menu button **Remove Measrmt**. Press the side-menu **Measurement 1**.



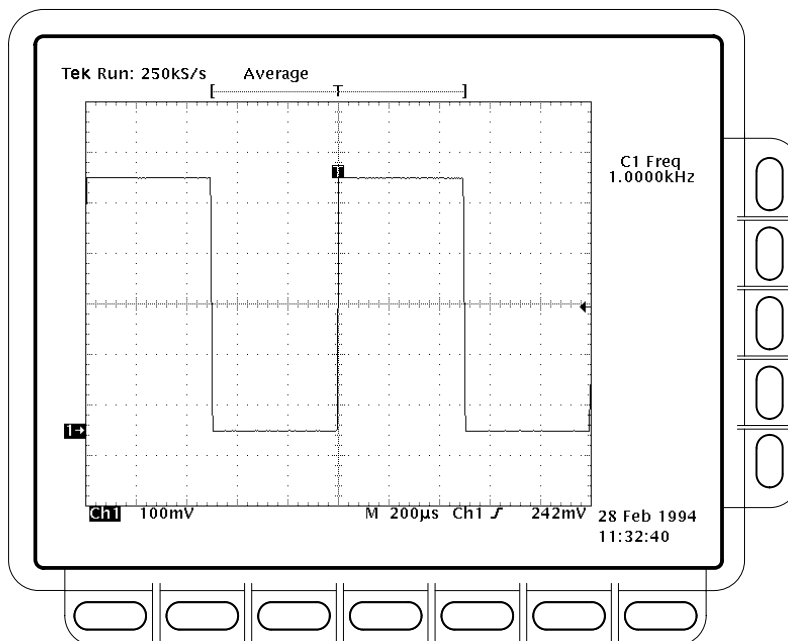

Figure 1-23: Measurement of probe compensator frequency

c. *Save the probe compensation signal in reference memory:*

- Press **SAVE/RECALL WAVEFORM**; then press the main-menu button **Save Wfm Ch 1**.
- Press the side-menu button **To Ref 1** to save the probe compensation signal in reference 1.
- Disconnect the cable from **CH 1** and the clips from the probe compensation terminals.
- Press **MORE**; then press the main-menu button **Ref 1** to displayed the stored signal.
- Press **CH 1**.

d. *Hook up the DC standard source:*

- Set the output of a DC calibration generator to 0 volts.
- Connect the output of a DC calibration generator through a dual-banana connector followed by a 50 Ω precision coaxial cable to one side of a BNC T connector. See Figure 1-24.

- Connect the Sense output of the generator through a second dual-banana connector followed by a 50 Ω precision coaxial cable to the other side of the BNC T connector. Now connect the BNC T connector to **CH 1**. See Figure 1–24.

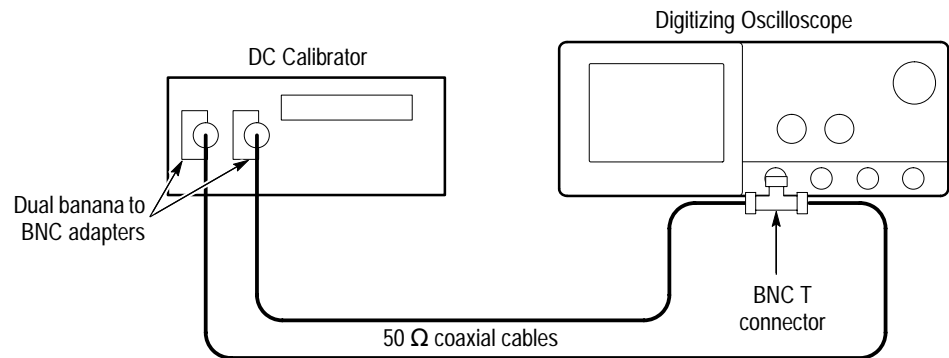

Figure 1–24: Subsequent test hookup

- Measure amplitude of the probe compensation signal:*
 - Press **SHIFT**; then press **ACQUIRE MENU**. Press the side-menu button **AVERAGE** then enter 16 using the keypad or the general purpose knob.
 - Adjust the output of the DC calibration generator until it precisely overlaps the top (upper) level of the stored probe compensation signal. (This value will be near 500 mV).
 - Record the setting of the DC generator.
 - Adjust the output of the DC calibration generator until it precisely overlaps the base (lower) level of the stored probe compensation signal. (This value will be near zero volts).
 - Record the setting of the DC generator.
- f. Press **CLEAR MENU** to remove the menus from the display. See Figure 1–25.

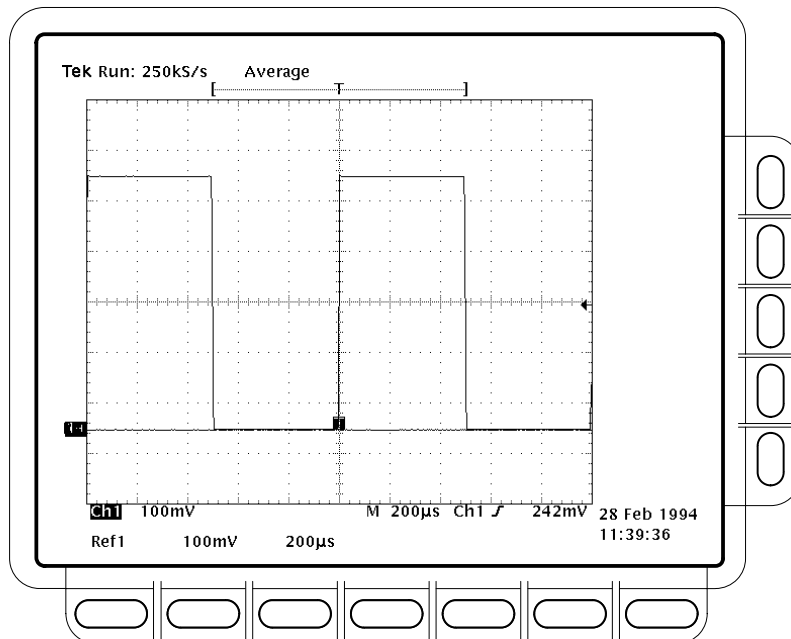

Figure 1-25: Measurement of probe compensator amplitude

g. *Check against limits:*

- Subtract the value just obtained (base level) from that obtained previously (top level).
- CHECK that the difference obtained is within 495 mV to 505 mV, inclusive.
- Enter voltage difference on test record.

3. *Disconnect the hookup:* Disconnect the cable from **CH 1**.

Option 05 Video Trigger Checks

Check Video Trigger	Equipment required	PAL signal source (Item 14) 60 Hz. sine wave generator (Item 15) Pulse generator (Item 16) Two 75 Ω cables (Item 17) Two 75 Ω terminators (Item 18) One BNC T connector (Item 7) 50 Ω cable (Item 5) 50 Ω terminator (Item 4)
	Prerequisites	See page 1–15. These prerequisites include running the signal path compensation routine.

1. *Set up digitizing oscilloscope to factory defaults by completing the following steps:*
 - a. Press save/recall **SETUP**.
 - b. Press the main-menu **Recall Factory Setup**.
 - c. Press the side-menu **OK Confirm Factory Init**.
 - d. Wait for the Clock Icon to leave the screen.
 - e. CONFIRM the digitizing oscilloscope is setup as shown below.
Channel: CH1
Volt/div: 100 mV
Horizontal scale: 500 μ s/div
2. *Set up digitizing oscilloscope for TV triggers by completing the following steps:*
 - a. Press **TRIGGER MENU**.
 - b. Press the main-menu **Type** pop-up until you select **Video**.
 - c. Press the main-menu **Standard** pop-up until you select **625/PAL**.
 - d. Press the main-menu **Line**.
 - e. Use the keypad to set the line number to 7 (press **7**, then **ENTER**).
 - f. Press **VERTICAL MENU**.

- g. Press the main-menu **Bandwidth**.
- h. Select **250 MHz** from the side menu.
- i. Press the main-menu **Fine Scale**.
- j. Use the keypad to set the fine scale to 282mV (press **282**, **SHIFT**, **m**, then **ENTER**).
- k. Press **HORIZONTAL MENU**.
- l. Press the main-menu **Horiz Scale**.
- m. Use the keypad to set the horizontal scale to 200 ns (press **200**, **SHIFT**, **n**, then **ENTER**).

3. *Check Jitter vs. Signal Amplitude*

- a. Set up equipment for Jitter Test. See Figure 1–26.
 - Connect one of the rear panel composite outputs marked **COMPST** on the TSG121 through a 75 Ω cable and a 75 Ω terminator to the CH1 input of the TDS.
 - Press the **100% FIELD** control (the fourth TSG121 front-panel button from the left) of the PAL signal source.

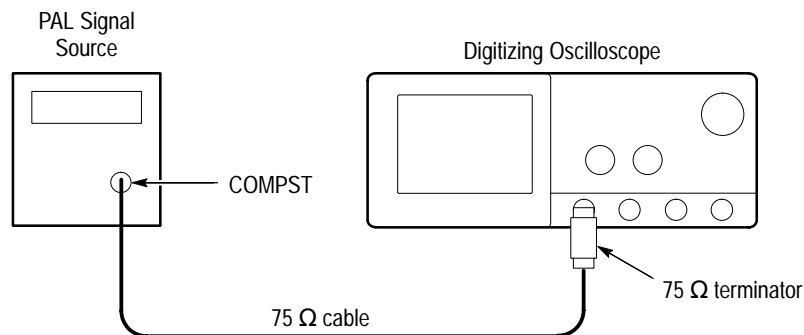

Figure 1–26: Jitter test hookup

- b. CHECK that the oscilloscope lights up its front panel **TRIG'D** LED and it displays the waveform on screen. See Figure 1–27.

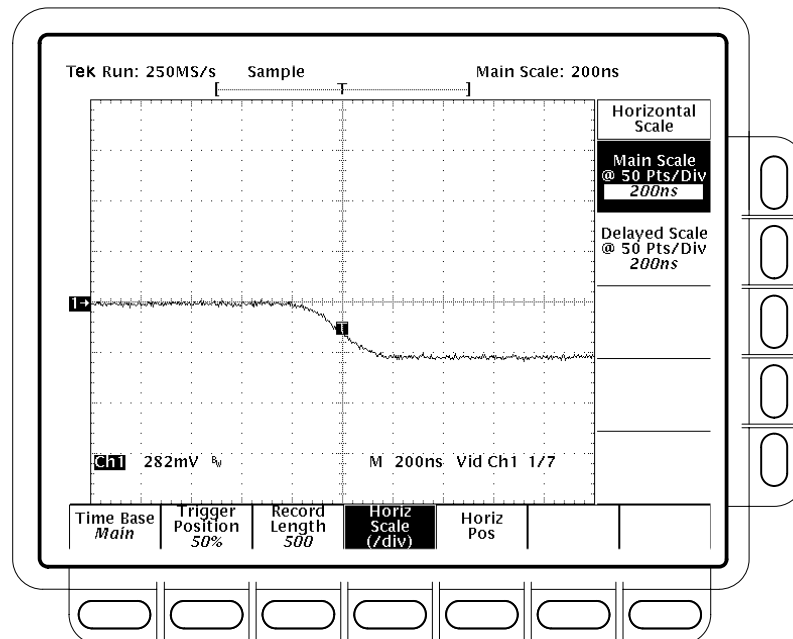

Figure 1-27: Jitter test displayed waveform – TDS 684B shown

- c. Press **SHIFT**; then press **ACQUIRE MENU**.
- d. Press the main-menu **Mode**.
- e. Select the side-menu **Average**. It should be already set to 16.
- f. Press the main-menu **Create Limit Test Template**.
- g. Press the side-menu **V Limit**.
- h. Use the keypad to set V Limit to 180 mdiv (press **180**, **SHIFT**, **m**, then **ENTER**).
- i. Press the side-menu **OK Store Template**.
- j. Press **MORE**.
- k. Press the main-menu **Ref1**.
- l. Press **CH1**.
- m. Press **SHIFT**; then press **ACQUIRE MENU**.
- n. Press the main-menu **Limit Test Setup**.
- o. Toggle the side-menu **Limit Test** to **ON**.
- p. Toggle the side-menu **Ring Bell if Condition Met** to **ON**.

- q. Press the main-menu **Mode**.
- r. Press the side-menu **Envelope**.
- s. Use the keypad to set envelope to use 100 acquisitions (press **100**, then **ENTER**).
- t. Press the main-menu **Stop After** button.
- u. Press the side-menu **Single Acquisition Sequence**.
- v. Confirm that the oscilloscope successfully makes 100 acquisitions. If not successful, the oscilloscope bell will ring. When the word **Run** in the top left corner of the display changes to **STOP**, the test is complete. See Figure 1–28.

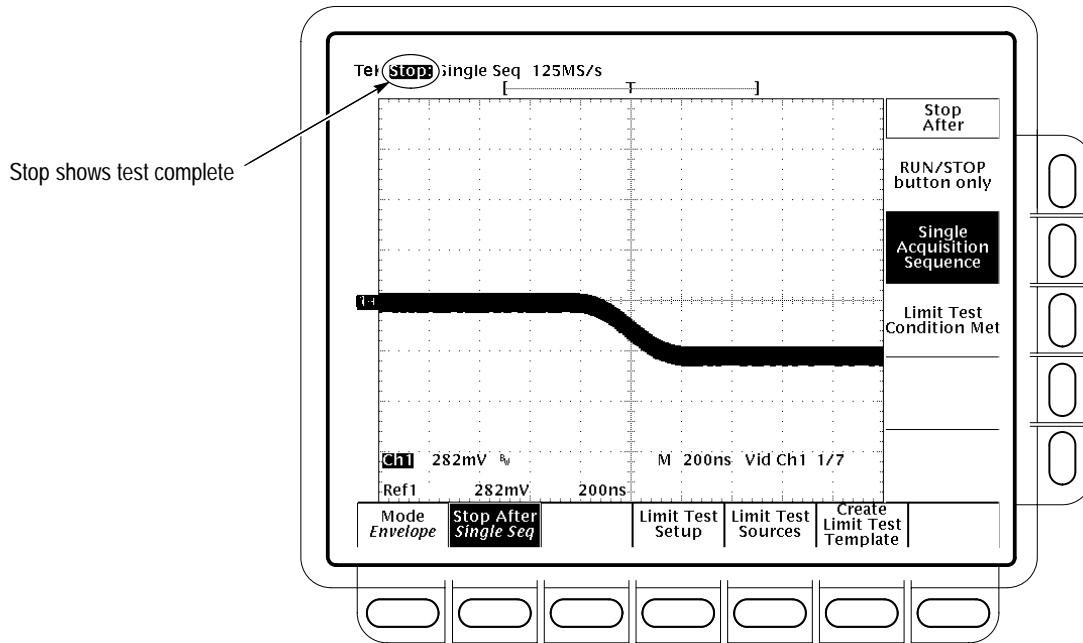

Figure 1–28: Jitter test when completed – TDS 684B shown

- w. Press the main-menu **Limit Test Setup**.
 - x. Toggle the side-menu **Ring Bell if Condition Met** to **OFF**.
 - y. Toggle the side-menu **Limit Test** to **OFF**.
4. *Check Triggered Signal Range.*

Set up oscilloscope for Triggered Signal Test.

- a. Press **MORE**.

- b. Press **WAVEFORM OFF**.
- c. Press **HORIZONTAL MENU**.
- d. Use the keypad to set horizontal scale (/div) to 50 μ s (press **50**, **SHIFT**, **μ** , then **ENTER**).
- e. Press **SHIFT**; then press **ACQUIRE MENU**.
- f. Press the main-menu **Stop After**.
- g. Press the side-menu **RUN/STOP button only**.
- h. Press the main-menu **Mode**.
- i. Press the side-menu **Sample**.
- j. Press **RUN/STOP**.
- k. Press **VERTICAL MENU**.
- l. Use the keypad to set fine scale to 300 mV (press **300**, **SHIFT**, **m**, then **ENTER**).
- m. CONFIRM that the **TRIG'D** LED stays lighted and that the waveform on screen is stable. That is, it does not move horizontally or vertically. Also, CONFIRM that the waveform on the screen has one positive pulse and a number of negative pulses. See Figure 1–29.

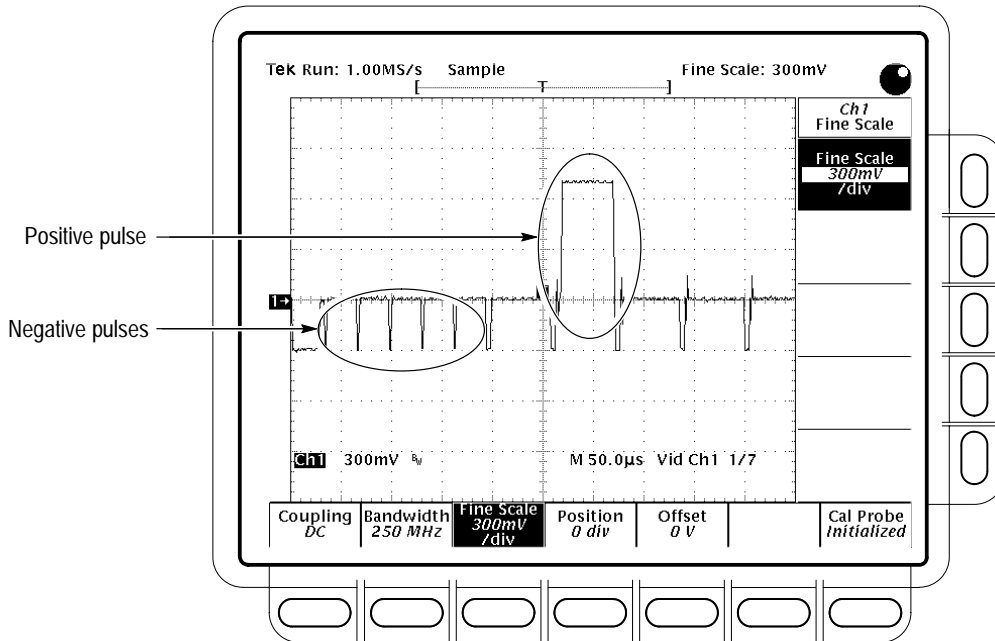

Figure 1–29: Triggered signal range test – 300 mV

- n. Use the keypad to set the fine scale to 75 mV (press **75**, **SHIFT**, **m**, then **ENTER**).
- o. CONFIRM that the **TRIG'D** LED stays lighted and that the waveform on screen is stable. That is, it does not move horizontally or vertically. Also, CONFIRM that the waveform on the screen has one positive pulse and a number of negative pulses. See Figure 1–30.

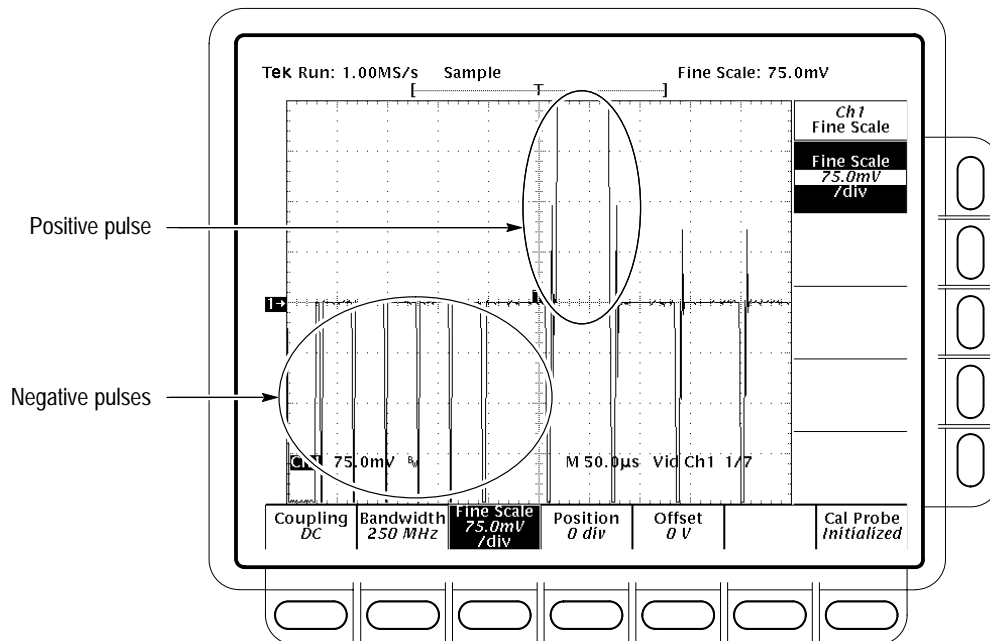

Figure 1-30: Triggered signal range test – 75 mV

- p. Disconnect all test equipment (TSG121) from the digitizing oscilloscope.
5. *Check 60 Hz Rejection.*
 - a. *Set up oscilloscope for 60 Hz Rejection Test:*
 - Use the keypad to set the Ch1 Fine Scale to 282 mV (press **282**, **SHIFT m**, then **ENTER**).
 - Press **WAVEFORM OFF**.
 - Press **CH2**.
 - Press **VERTICAL MENU**.
 - Use the keypad set the fine scale to 2 V (press **2**, then **ENTER**).
 - Press **HORIZONTAL MENU**.
 - Use the keypad to set the horizontal scale (/div) to 5 ms (press **5**, **SHIFT, m**, then **ENTER**).
 - b. *Set up 60 Hz signal generator:*
 - Connect the output of the signal generator to the CH2 input through a 50 Ω cable. See Figure 1-31.

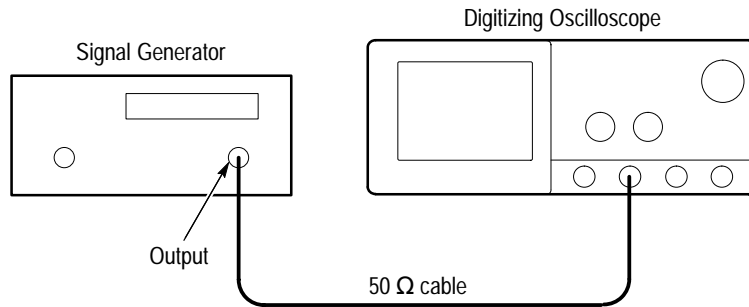

Figure 1-31: 60 Hz Rejection test hookup

- Adjust the signal generator for three vertical divisions of 60 Hz signal. See Figure 1-32. The signal will not be triggered. That is, it will run free.

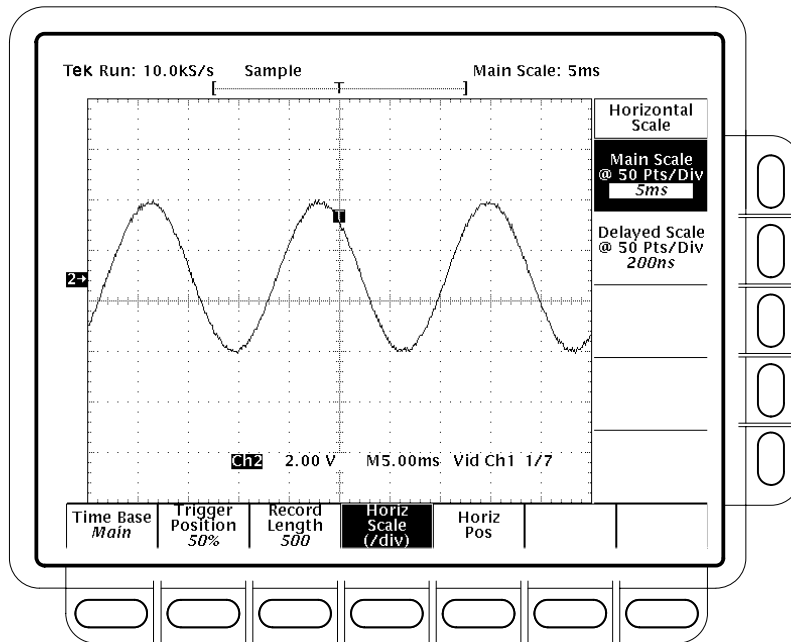

Figure 1-32: 60 Hz Rejection test setup signal

c. Check 60 Hz rejection:

- Use the keypad to set the horizontal scale (/div) to 50 μ s (press **50**, **SHIFT**, **μ** , then **ENTER**).

- Reconnect the output of the signal generator. Connect the composite signal connector of the PAL signal source (labeled **COMPST** on the TSG 121) to a 75 Ω cable and a 75 Ω terminator. Connect both signals to the CH1 input through a BNC T. See Figure 1–33.
- Press **VERTICAL MENU**.
- If needed, press the main-menu **Fine Scale**.
- Use the keypad to set fine scale to 500 mV (press **500**, **SHIFT**, **m**, then **ENTER**).
- Connect another composite signal connector of the PAL signal source (labeled **COMPST** on the TSG 121) through a 75 Ω cable and a 75 Ω terminator to the CH2 input. See Figure 1–33.

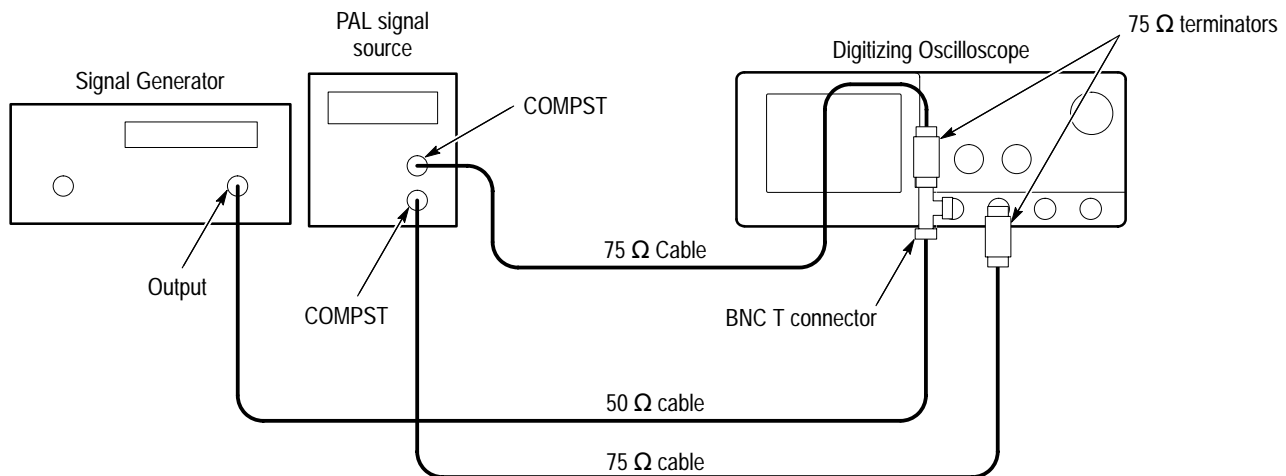

Figure 1–33: Subsequent 60 Hz Rejection test hookup

- CONFIRM that the **TRIG'D** LED stays lighted and that the waveform on screen is stable. In other words, be sure the waveform does not move horizontally or vertically. Also, confirm that the waveform on the screen has one positive pulse and a number of negative pulses. See Figure 1–34.
- Disconnect all test equipment from the digitizing oscilloscope.

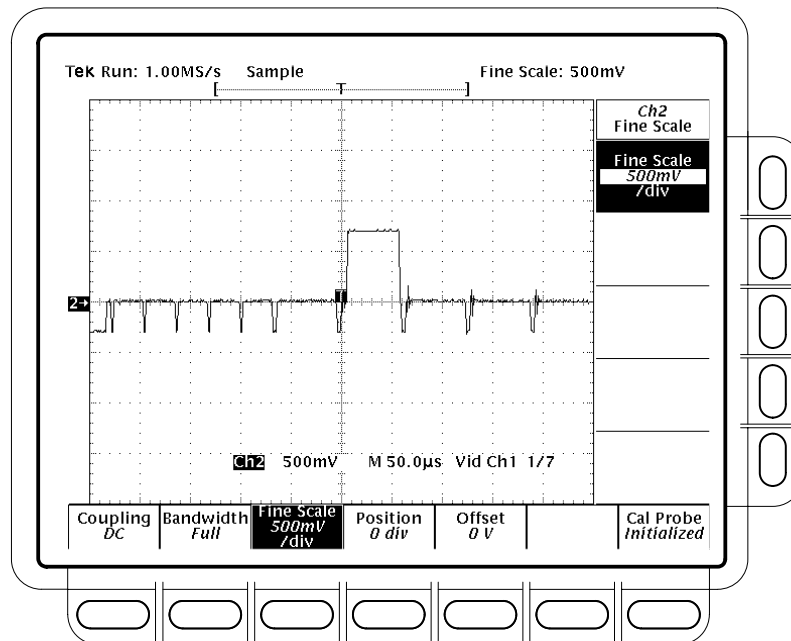

Figure 1-34: 60 Hz Rejection test result – TDS 684B shown

6. *Check Line Count Accuracy.*

a. *Set up oscilloscope for Line Count Accuracy Test:*

- Press **WAVEFORM OFF**.
- Press **CH1**.
- Press **HORIZONTAL MENU**.
- Press the main-menu **Record Length**.
- Press the side-menu **–more–** until you see the appropriate menu.
- Press the side-menu **5000 points in 100divs**.
- Press the main-menu **Horiz Scale (/div)**.
- Use the keypad to set the horizontal scale to 200 ns (press **200**, **SHIFT**, **n**, then **ENTER**).

b. *Check Line Count Accuracy:*

- Connect a composite output signal from the rear of the PAL signal source (labeled **COMPST** on the TSG 121) to the CH1 input through a 75 Ω cable and a 75 Ω terminator. See Figure 1–35.

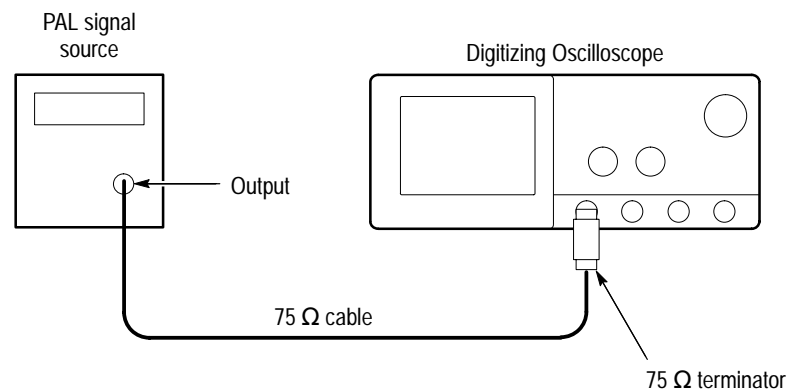

Figure 1–35: Line count accuracy test hookup

- Press the main-menu **Trigger Position**.
- Press the side-menu to **Set to 50%**.
- Press the main-menu to **Horiz Pos**.
- Press the side-menu to **Set to 50%**.
- Use the **HORIZONTAL POSITION** knob to move the falling edge of the sync pulse to two divisions to the left of center screen. See Figure 1–36.

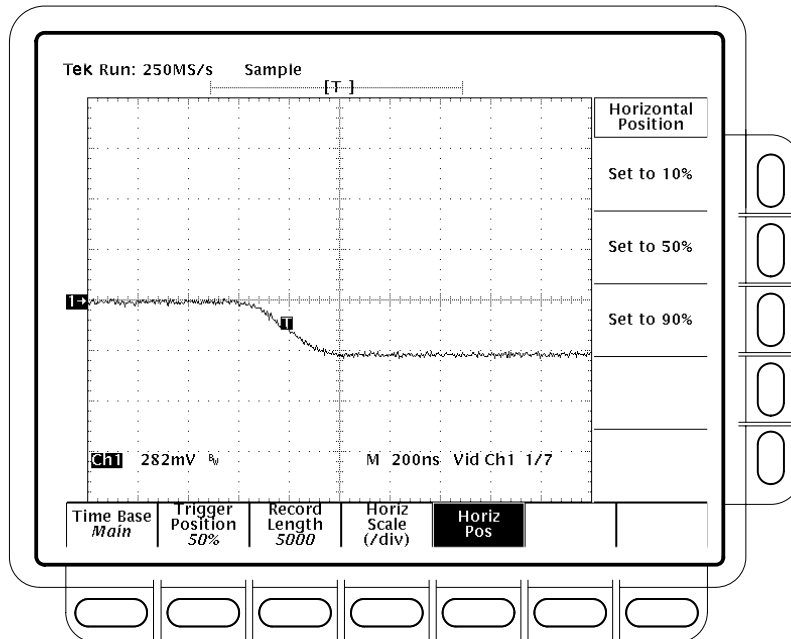

Figure 1-36: Line count accuracy test setup waveform – TDS 684B shown

- Press **CURS**.
- Press the main-menu **Function**.
- Press the side-menu **V Bars**.
- Using the General Purpose knob, place the left cursor directly over the trigger 'T' icon.
- Press **SELECT**.
- Turn the General Purpose knob to adjust the right cursor for a cursor delta reading of **6.780us**.
- Use the **HORIZONTAL POSITION** knob to position the right cursor to center screen.
- Verify that the cursor is positioned on a positive slope of the burst signal. See Figure 1-37.

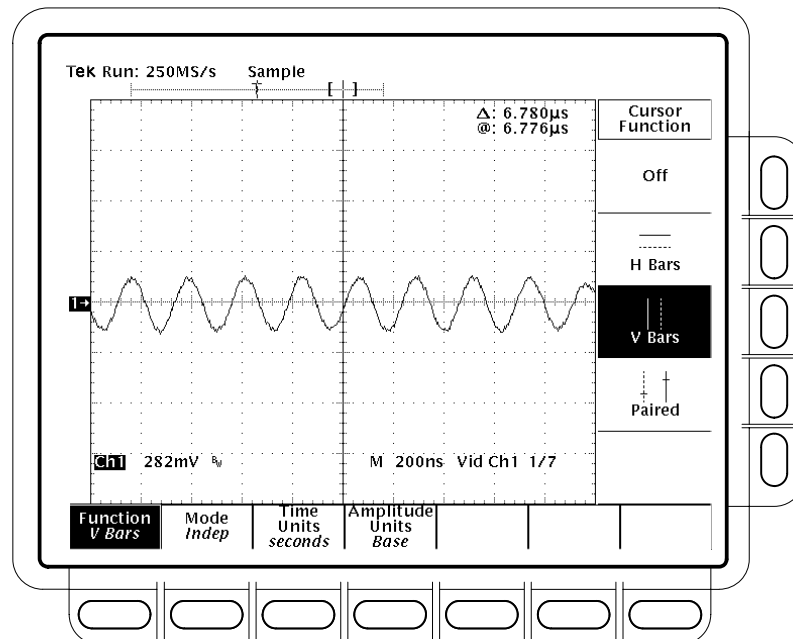

Figure 1-37: Line count accuracy correct result waveform

- Disconnect all test equipment (TSG 121) from the digitizing oscilloscope.
 - Turn off cursors by pressing **CURSOR**, then the main-menu **Function** button, and, finally, **Off** from the side menu.
7. *Check the Sync Duty Cycle.*
- a. *Set up digitizing oscilloscope for Sync Duty Cycle Test:*
 - Press **TRIGGER MENU**.
 - Press the **Standard** pop-up to select **FlexFmt**. Trigger **Type** should already be set to **Video**.
 - Press the main-menu **Setup**.
 - Press the side-menu **Field Rate**.
 - Use the keypad to set the field rate to 60.05 Hz (press **60.05**, then **ENTER**).
 - Press the side-menu **Lines**.
 - Use the keypad to set the field rate to 793 lines (press **793**, then **ENTER**).

- Press the side-menu **Fields**.
 - Use the keypad to set the number of fields to 1 (press **1**, then **ENTER**).
 - Press the side-menu **Sync Width**.
 - Use the keypad to set the width to 400 ns (press **400**, **SHIFT**, **n**, then **ENTER**).
 - Press the side-menu **–more– 1 of 2**. Then press **V1 Start Time**.
 - Use the keypad to set V1 start time to 10.10 μ s (press **10.10**, **SHIFT**, **μ** , then **ENTER**).
 - Press the side-menu **V1 Stop Time**.
 - Use the keypad to set V1 stop time to 10.50 μ s (press **10.50**, **SHIFT**, **μ** , then **ENTER**).
 - Press the main-menu **Type** pop-up to select **Edge**.
 - Press **HORIZONTAL MENU**.
 - Press the main-menu **Record Length**.
 - Select the side-menu **1000 points in 20div**. If needed, first press the side-menu **–more–** until you see the appropriate side-menu item.
 - Turn the **HORIZONTAL POSITION** knob to position the trigger ‘T’ two divisions to the left of the center screen.
 - Press **MEASURE**.
 - If needed, press the main-menu **Select Measrmt**.
 - Press the side-menu **Negative Width**.
 - Press the side-menu **Period**.
- b.** *Set up the pulse generator for Sync Duty Cycle Test:*
- Set **PULSE DURATION** to 50 ns.
 - Set **PERIOD** to 10 μ s.
 - Set **OUTPUT (VOLTS)** to **–1** for **LOW LEVEL** and **+1** for **HIGH LEVEL**.
 - Depress the **COMPLEMENT** button.
 - Be sure **BACK TERM** is depressed (in).

c. *Check Sync Duty Cycle:*

- Connect the pulse generator through a 50 Ω cable and a 50 Ω terminator to the oscilloscope CH1 input. See Figure 1–38.

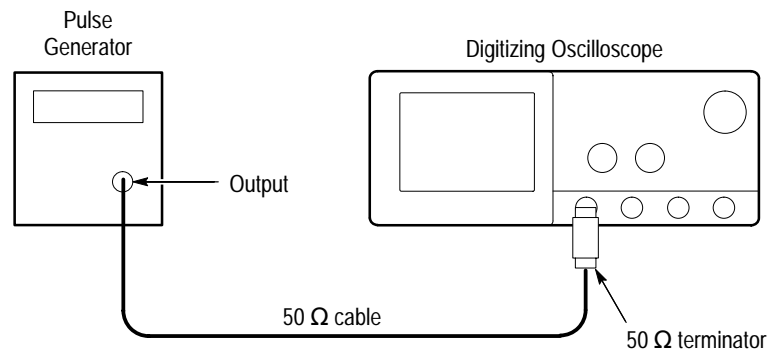

Figure 1–38: Setup for sync duty cycle test

- Turn the pulse generator **OUTPUT (VOLTS)** control until the signal on the oscilloscope shows a one division negative going pulse. See Figure 1–39.

NOTE. You may need to adjust the trigger level control to obtain a stable trigger.

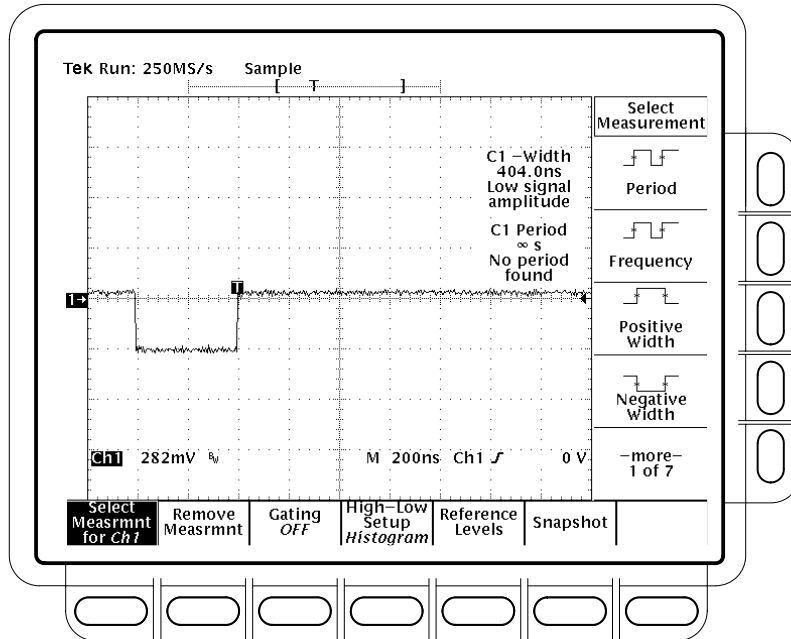

Figure 1-39: Sync duty cycle test: one-div neg pulse waveform

- Turn the pulse generator **PULSE DURATION** variable control to adjust the negative pulse so the oscilloscope’s **CH1 – Width** measurement displays **400ns +/-10 ns**.
- Turn the **HORIZONTAL SCALE** knob to set the oscilloscope time base to **5µs/div**.
- Turn the pulse generator **PERIOD** variable control to adjust the period until the oscilloscope **CH1 Period** measurement reads **21.000µs -25/+50 ns**. See Figure 1-40. Read note shown below.

NOTE. The pulse duration and period adjustments are critical in making this measurement. If the pulse duration and/or the duty cycle are not stable, the **FLEXFMT** function may not function. You must take care when making these adjustments.

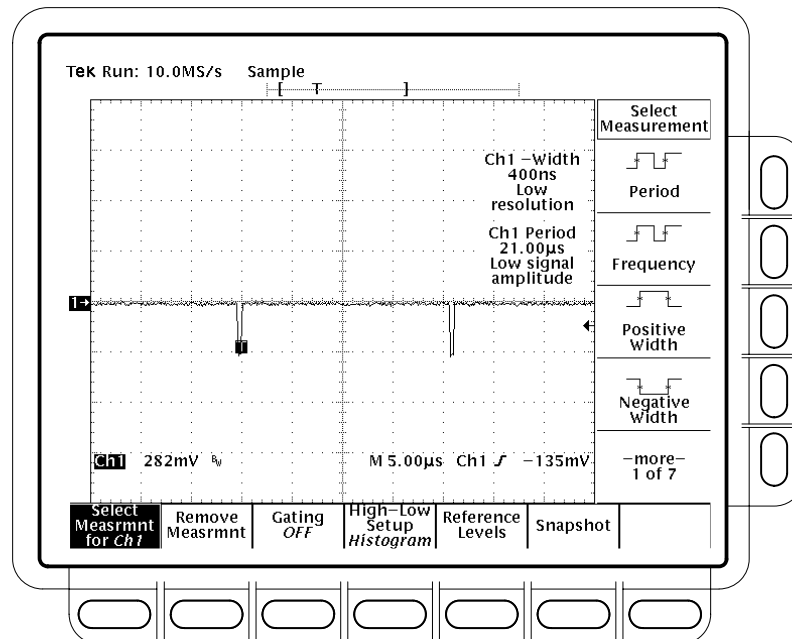

Figure 1-40: Sync duty cycle test: critically adjusted pulse

- Press **TRIGGER MENU**.
- Press the main-menu **Type** pop-up until you select **Video**.
If the **TRIG'D** LED is not lighted, check that the **CH1 – Width** and **CH1 Period** measurements are adjusted correctly. See note above. CONFIRM that the setup is correct and the oscilloscope will trigger.
- CONFIRM that the **TRIG'D** LED is lighted and the waveform is stable.
- Disconnect the signal source from CH1, wait a few seconds, then reconnect the signal.
- CONFIRM that the **TRIG'D** LED is lighted and the waveform is stable.
- Press **Sync Polarity**.
- Press **Pos Sync**.
- Push the pulse generator **COMPLEMENT** button out.
- CONFIRM that the **TRIG'D** LED is lighted and the waveform is stable.

- Disconnect the signal source from CH1, wait a few seconds, then reconnect the signal.
- CONFIRM that the **TRIG'D** LED is lighted and the waveform is stable.
- Disconnect all test equipment from the digitizing oscilloscope.
- Press save/recall **SETUP**, the main-menu button **Recall Factory Setup**, and the side-menu **OK Confirm Factory Init**.

Sine Wave Generator Leveling Procedure

Some procedures in this manual require a sine wave generator to produce the necessary test signals. If you do not have a leveled sine wave generator, use one of the following procedures to level the output amplitude of your sine wave generator.

Equipment required	Sine wave generator (Item 19) Level meter and power sensor (Item 20) Power splitter (Item 21) Two male N to female BNC adapters (Item 23) One precision coaxial cable (Item 5)
Prerequisites	See page 1-15

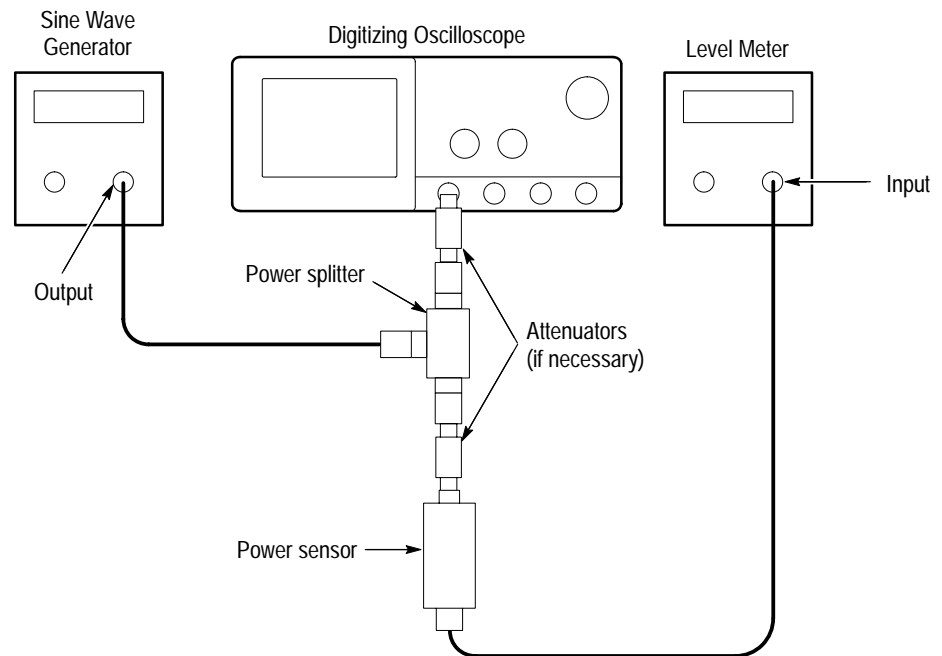

Figure 1-41: Sine wave generator leveling equipment setup

1. *Install the test hookup:* Connect the equipment as shown in Figure 1-41.
2. *Set the Generator:*
 - Set the sine wave generator to a reference frequency of 10 MHz.
 - Adjust the sine wave generator amplitude to the required number of divisions as measured by the digitizing oscilloscope.
3. *Record the reference level:* Note the reading on the level meter.
4. *Set the generator to the new frequency and reference level:*
 - Change the sine wave generator to the desired new frequency.
 - Input the correction factor for the new frequency into the level meter.
 - Adjust the sine wave generator amplitude until the level meter again reads the value noted in step 3. The signal amplitude is now correctly set for the new frequency.

Equipment required	Sine wave generator (Item 19) Level meter and power sensor (Item 20) Two male N to female BNC adapters (Item 23) Two precision coaxial cables (Item 5)
Prerequisites	See page 1–15

1. *Install the test hookup:* Connect the equipment as shown in Figure 1–42 (start with the sine wave generator connected to the digitizing oscilloscope).

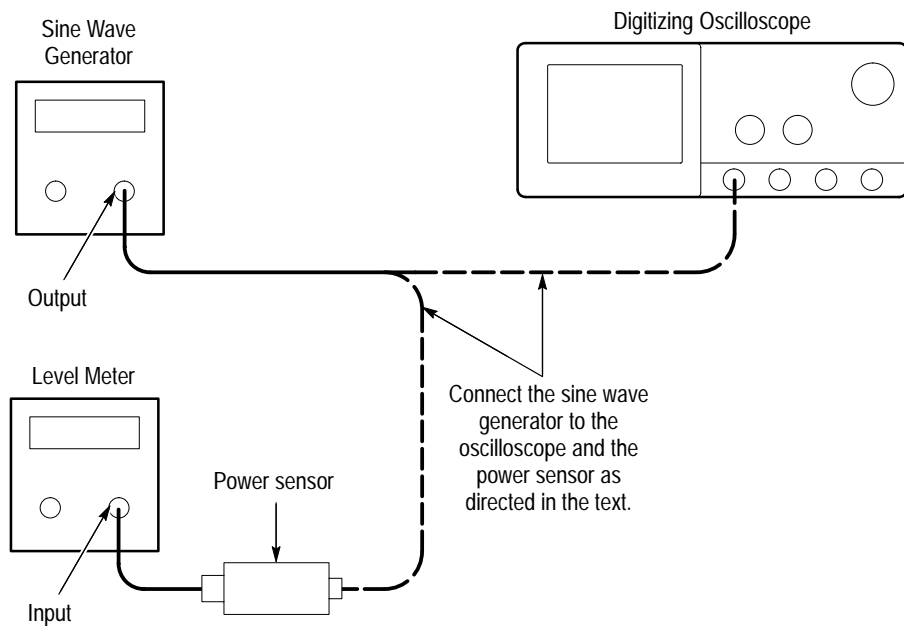

Figure 1–42: Equipment setup for maximum amplitude

2. *Set the Generator:*
 - Set the sine wave generator to a reference frequency of 10 MHz.
 - Adjust the sine wave generator amplitude to the required number of divisions as measured by the digitizing oscilloscope.
3. *Record the reference level:*
 - Disconnect the sine wave generator from the digitizing oscilloscope.
 - Connect the sine wave generator to the power sensor.
 - Note the level meter reading.

4. *Set the generator to the new frequency and reference level:*
 - Change the sine wave generator to the desired new frequency.
 - Input the correction factor for the new frequency into the level meter.
 - Adjust the sine wave generator amplitude until the level meter again reads the value noted in step 3. The signal amplitude is now correctly set for the new frequency.
 - Disconnect the sine wave generator from the power sensor.
 - Connect the sine wave generator to the digitizing oscilloscope.

Optical Filters Checks (TDS 500C/TDS 700C Only)

The procedure that follows verifies that the frequency response of the combined P670xB and TDS500C/700C oscilloscope system is a Fourth Order Bessel Thompson Filter which is within limits.

Filter Availability

Nominal Filters are available with Option 2C. Reference Receiver Filters are available with Options 3C and 4C (3C and 4C are not available without 2C). Table 1–6 lists the available vertical scale factors for each option. Tables 1–7, 1–8, and 1–9 list the available filters and their specifications.

Table 1–6: Available Filters

Nominal Filters (Option 2C)	Reference Receivers Filters (Options 3C, 4C)
1 μ W per division	
2 μ W per division	
5 μ W per division	
10 μ W per division	10 μ W per division
20 μ W per division	20 μ W per division
50 μ W per division	50 μ W per division
100 μ W per division	
200 μ W per division	
500 μ W per division	
1 mW per division	

Table 1-7: Reference Receiver Filter Options:

Option 4C – SONET (P6703B 1300nm)	Option 3C – Fibre Channel (P6701B 850nm)
52Mbit OC1	FC133Mbit
	FC266Mbit
	FC531Mbit
155Mbit OC3	155Mbit OC3
622Mbit OC12	622Mbit OC12
FC1063 (TDS784C Only)	FC1063 (TDS784C Only)

Table 1-8: Option 3C and 4C Specifications

Name	Description
Calibration Range, Reference Receiver	10 μ W per division
	20 μ W per division
	50 μ W per division
Temperature Range, Warranted Filter	23° C, \pm 5° C
Calibration Range, Controlled	Up to 2X the data rate for all filters except FC1063 filter
	Up to 1.5X the data rate for FC1063 filter

Table 1-9: Available receivers

	Option 4C ¹				Option 3C ²					
	OC1 ⁴	OC3	OC12	FC1063 ³	FC133	FC266	FC531	FC1063 ³	OC3	OC12
TDS 520C	✓	✓			✓				✓	
TDS 540C	✓	✓	✓		✓	✓	✓		✓	✓
TDS 724C	✓	✓			✓				✓	
TDS 754C	✓	✓	✓		✓	✓	✓		✓	✓
TDS 784C	✓	✓	✓	✓	✓	✓	✓	✓	✓	✓

¹ Requires Tektronix P6703B, 1300 nm Optical to Electrical Converter.

² Requires Tektronix P6701B, 850 nm Optical to Electrical Converter.

³ Reference receivers are warranted to 2.0 times the bit rate except for FC1063 which is warranted to 1.5 times the bit rate.

⁴ OC1 is type tested

Reference Receiver
Verification

Equipment required	OIG501 (use with P6701B) (Item 27) OIG502 (use with P6703B) (Item 28) Optical Attenuator OA5022 (Item 29) Fibre Optic Cable (Item 30) Optical-to-Electrical Converter (item 31)
Prerequisites	See page 1–15. Also, the probe and the oscilloscope channel it is attached to must have been calibrated as a reference receiver.

1. Install the test hookup and preset the instrument controls:

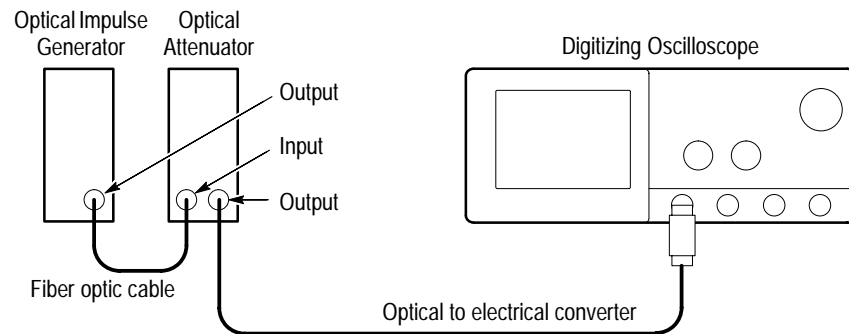

Figure 1–43: Reference-receiver performance-verification set up

- a. *Initialize the oscilloscope:*
 - Press **SAVE/RECALL SETUP**.
 - Press the main-menu button **Recall Factory Setup**.
 - Press the side-menu button **OK Confirm Factory Init**.
- b. *Connect the probe, oscilloscope, optical impulse generator (OIG), and the optical attenuator:*
 - Connect the optical probe to CH 1 of the oscilloscope under test (see Figure 1–43).
 - See Table 1–9. If using a P6701B probe, connect the OIG501 (Item 27) **OPTICAL OUTPUT** to the optical attenuator (Item 29) **OPTICAL INPUT** using a fiber-optic cable (Item 30). If using a P6703B probe, connect the OIG502 (Item 28) **OPTICAL OUTPUT** to the optical attenuator (Item 29) **OPTICAL INPUT** using a fiber-optic cable (Item 30).

- Connect the optical probe on CH 1 of the oscilloscope to the OPTICAL OUTPUT of the optical attenuator using the fiber-optic cable of the probe. Set an optical impulse level that does not clip the vertical channel of the oscilloscope.
- c. Set up the OIG to run with LOW impulse energy.
 - Keep the impulse below 100 μW peak level because high-energy impulses into the P670x probe will cause major changes in the frequency response of the probe.
 - Set the OIG for 1 Mhz internal trigger.
 - Set the OIG for the wavelength shown in Table 1–9 that is required for the standard and option you are verifying.
- d. Enable the laser.
- e. Set the VERTICAL SCALE of the oscilloscope to either 10 μW , 20 μW or 50 μW /division.

NOTE. These are the only scale settings for which the reference receivers have calibrated filters.

- f. *Set the trigger type to edge:*
 - Press **TRIGGER MENU**; then select **Edge** from the Type pop-up menu.
 - Press **SET LEVEL TO 50%**.
- g. Set the HORIZONTAL SCALE to 500 ps.
- h. Set the Optical Attenuator for several divisions of display on the oscilloscope.
- i. *Set the horizontal controls:*
 - If Fit To Screen is not OFF, press **HORIZONTAL MENU**; then press **Record Length**. Then press **Fit to Screen** to toggle it to the **OFF** setting. Fit to Screen needs to be OFF so that the FFT waveform horizontal scale can be adjusted to obtain the desired display of the frequency response.
 - To obtain a 10000 point FFT in step 3, press **HORIZONTAL MENU**; then press **Record Length**. Then repeatedly press the side-menu button **–more–** until **15000** appears in the side menu. Press the side-menu button **15000**.

- Press **HORIZONTAL MENU**; then press the main-menu button **Trigger Position**. Set the Trigger Position to **20%** using the general purpose knob or keypad.

NOTE. Press **SHIFT** to change the horizontal position speed. The position moves faster when **SHIFT** is lighted.

- Adjust the **HORIZONTAL POSITION** to move the 20% trigger point onto the display (see Figure 1–44).

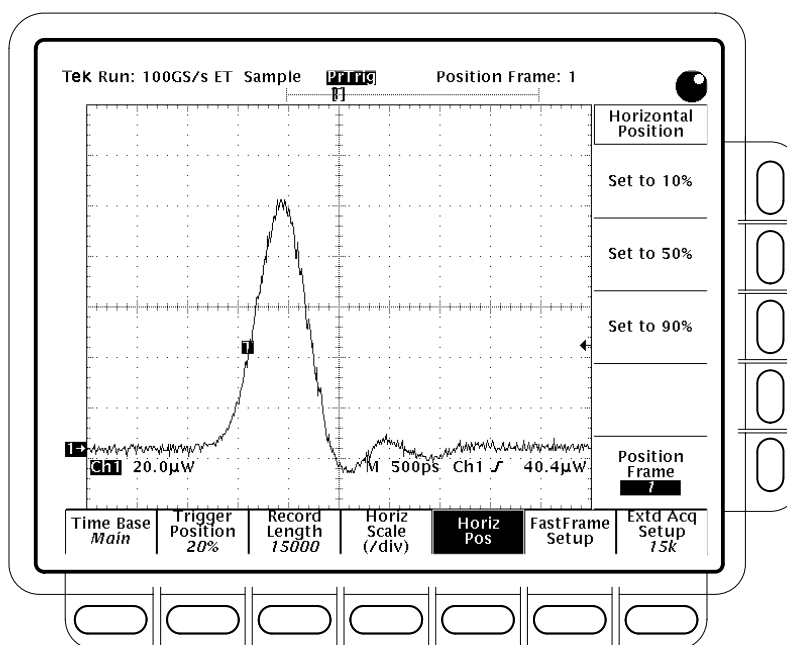

Figure 1–44: Optical impulse of Ch1 input from OA5022 Optical Attenuator (OIG501 / OIG502 fed into optical attenuator in Step 1)

- j. *Select linear interpolation:*
 - If SHIFT is lighted, press **SHIFT**.
 - Press **DISPLAY**; then press the main-menu button **Filter**.
 - Press the side-menu button **Linear Interpolation**.
2. *Select the desired Mask standard and turn it on:*
 - Press **MEASURE**; then select **Masks** from the Measure pop-up menu.

NOTE. <xxx> is the standard that you are verifying (such as OC1, OC3, OC12, FC1063; see Table 1–10).

- From the Mask Type pop-up menu, select the mask type (<xxx>) of your reference receiver.
- Press the **Standard Mask** main menu; then select your reference receiver mask (<xxx>) from the side menu.

NOTE. For the Bessel Thompson (BT) filter to be active, the VERTICAL MENU deskew must be set to zero on all four channels. Also, the ACQUIRE MENU Acquisition Mode must be Sample. If you did the Factory Setup specified in Step 1a, you selected these modes.

- If checking a reference receiver, verify that RR is displayed to the right of the vertical scale factor (see Figure 1–45).
 - Press **TRIGGER MENU**; then select **Edge** from the Type pop-up menu.
3. Turn on an FFT of the optical impulse [the Impulse Response (or Frequency Response) of the P670xB and oscilloscope system] (Refer to Figure 1–46):
- a. Press the front panel **MORE** button; then press the main-menu button **Math2**. This turns on a math waveform.
 - b. If the math waveform is not set to FFT, create an FFT waveform:
 - Press **Change Math waveform definition**; then press the main-menu button **FFT**.
 - Press the side-menu button **Set FFT source to Ch1**.

NOTE. Verify the FFT window is set to Rectangular. Also verify the FFT Vert Scale is set to dBV RMS. If you did the Factory Setup in Step 1a, you selected these modes.

- Press the side-menu button **OK Create Math Waveform**.
- Press the side menu button **Average**, then set the number of averages to **16** using the general purpose knob or keypad.

4. Move the beginning of the FFT data record onto the screen:

NOTE. Press **SHIFT** to change the horizontal position speed. The position moves faster when **SHIFT** is lighted.

- Adjust the **HORIZONTAL POSITION** control to move the beginning of the FFT data record onto the display.

NOTE. Expanding the horizontal scale of the FFT waveform gives greater resolution when making cursor measurements. Expand the FFT to display DC to the highest frequency listed in Table 1–10 for the standard being verified.

- Adjust the **HORIZONTAL SCALE** and **VERTICAL SCALE** to view the frequency response of the BT filter. The large spike around DC is due to DC offset in the signal and should be ignored.
5. Observe the desired response characteristics using the vertical paired cursors (see figures 1–45 and 1–46):
- a. Press **CURSOR**.
 - b. Press the main-menu button **Function**; then press the side-menu button **Paired**.
 - c. Press **CLEAR MENU**.

NOTE. Pressing **SHIFT** will change cursor speed. Use the select key to alternate between cursors.

- d. Position one cursor at the beginning of the FFT record.
- e. Position the other cursor at the bit rate (the frequency closest to the bit rate) of the mask that is turned on (see Table 1–10 and Figure 1–45).

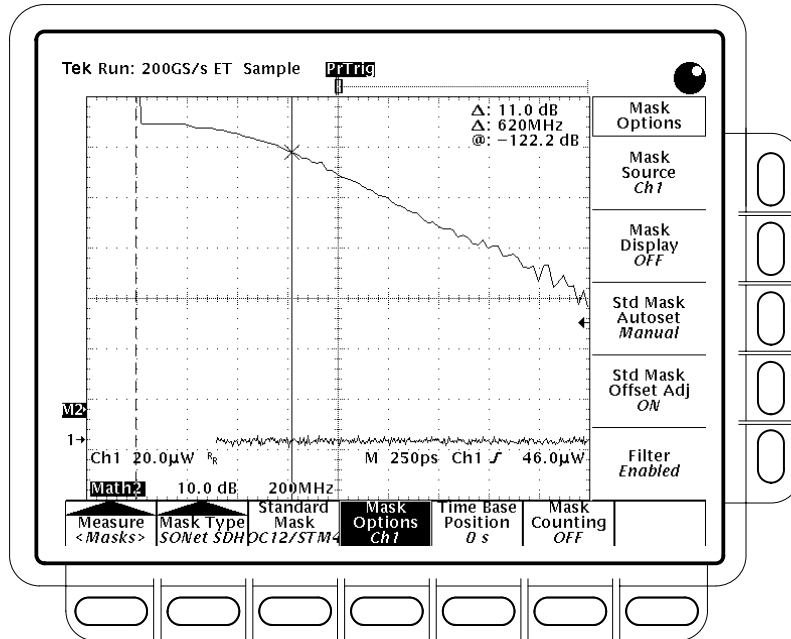

Figure 1-45: Optical impulse response for OC-12 SONET Reference Receiver

NOTE. In Figure 1-45, the left cursor is at the DC frequency. The right cursor is at the OC-12 data rate of $622 \text{ MHz} \pm 4 \text{ MHz}$. Also, note that the reference receiver, RR, designation is beside the $20 \mu\text{W}$ vertical scale factor.

- f. Next, move the cursor currently positioned at the beginning of the record until the cursor is just right of the DC spike in the response (see Figure 1-46). The unsigned $\Delta \text{ dB}$ readout should be at or between the upper and lower limits shown in Table 1-10 (note that the entries in the table are signed numbers, but the $\Delta \text{ dB}$ readout is not) for the mask that is turned on.

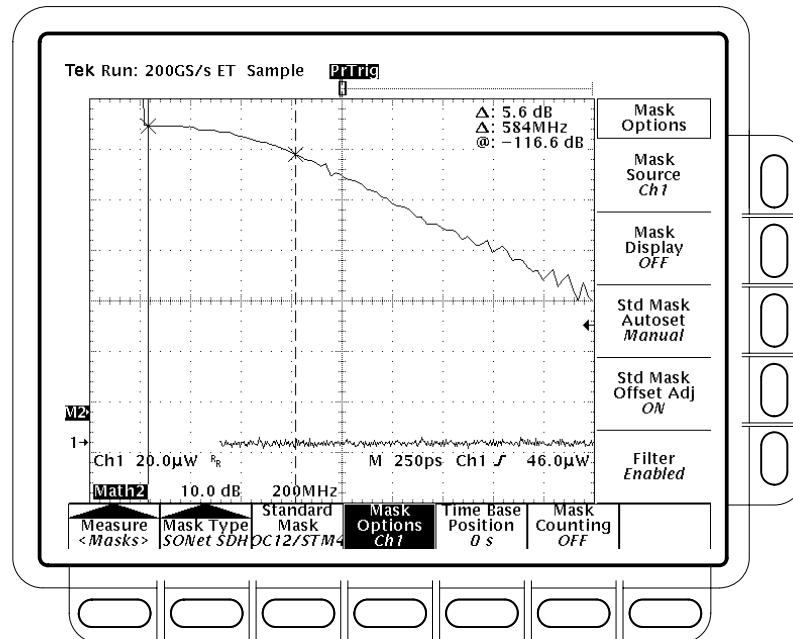

Figure 1-46: Optical impulse response for OC-12 SONET Reference Receiver

NOTE. In Figure 1-46 the left cursor has been moved to the zero dB level. The right cursor remains at the OC-12 data rate of 622 MHz \pm 4 MHz (the delta frequency is 584 MHz because the right cursor is no longer referenced to DC). The delta attenuation from the zero dB level to the 622 MHz Cursor is 5.6 dB.

6. Repeat steps 5d through 5f, starting on page 1-93, moving the second cursor to twice the bit rate (1.5 times the bit rate for the FC1063 standard).
7. For an exhaustive test of the reference receiver, repeat steps 5d through 5f for each frequency shown in Table 1-10 for the standard.
8. If verifying additional standards, repeat this procedure for each standard.

Table 1–10: Bessel Thompson frequency response and reference receiver limits

Standard	Frequency (MHz)	Lower Limit (dB)	Nominal (dB)	Upper Limit (dB)	Measured (delta dB)
OC–12 SONET or STM–4 SDH, Data Rate: 622.08 Mb/s					
	0.0	–0.3	0.0	0.3	
	93.31	–0.41	–0.11	0.19	
	186.6	–0.75	–0.45	–0.15	
	279.9	–1.32	–1.02	–0.72	
	373.2	–2.16	–1.86	–1.56	
	466.7	–3.31	–3.00	–2.71	
	5.60.0	–5.15	–4.51	–3.87	
	622.08	–6.58	–5.71	–4.84	
	653.2	–7.35	–6.37	–5.39	
	746.5	–9.86	–8.54	–7.22	
	839.8	–12.59	–10.93	–9.27	
	933.1	–15.41	–13.41	–11.41	
	1244.2	–24.58	–21.44	–18.31	
OC–3 SONET or STM–1 SDH, Data Rate: 155.52 Mb/s					
	0.0	–0.3	–0.0	0.3	
	23.327	–0.41	–0.11	0.19	
	46.65	–0.75	–0.45	–0.15	
	69.975	–1.32	–1.02	–0.72	
	93.3	–2.16	–1.86	–1.56	
	116.88	–3.31	–3.00	–2.71	
	139.97	–5.15	–4.51	–3.87	
	155.52	–6.58	–5.71	–4.84	
	163.3	–7.35	–6.37	–5.39	
	209.95	–9.86	–8.54	–7.22	
	209.95	–12.59	–10.93	–9.27	
	233.27	–15.41	–13.41	–11.41	
	311.04	–24.58	–21.44	–18.31	

Table 1–10: Bessel Thompson frequency response and reference receiver limits (Cont.)

Standard	Frequency (MHz)	Lower Limit (dB)	Nominal (dB)	Upper Limit (dB)	Measured (delta dB)
FC133 Fibre Channel, Data Rate: 132.8125 Mb/s					
	0.00	-0.5	0.0	0.5	
	19.922	-0.6	-0.1	0.4	
	38.440	-0.9	-0.4	-0.1	
	59.765	-1.5	-1.0	-0.5	
	79.690	-2.4	-1.9	-1.4	
	99.610	-3.5	-3.0	-2.5	
	119.53	-5.5	-4.5	-3.5	
	132.81	-7.03	-5.7	-4.37	
	139.45	-7.9	-6.4	-4.9	
	159.37	-10.5	-8.5	-6.5	
	179.29	-13.4	-10.9	-8.4	
	199.22	-16.4	-13.4	-10.4	
	265.62	-26.17	-21.5	-16.5	
FC266 Fibre Channel, Data Rate: 265.625 Mb/s					
	0.0	-0.5	0.0	0.5	
	39.844	-0.6	-0.1	0.4	
	79.688	-0.9	-0.4	-0.1	
	119.53	-1.5	-1.0	-0.5	
	159.38	-2.4	-1.9	-1.4	
	199.22	-3.5	-3.0	-2.5	
	239.06	-5.5	-4.5	-3.5	
	265.62	-7.03	-5.7	-4.37	
	278.91	-7.9	-6.4	-4.9	
	318.75	-10.5	-8.5	-6.5	
	358.59	-13.4	-10.9	-8.4	
	398.44	-16.4	-13.4	-10.4	
	531.25	-26.17	-21.5	-16.5	

Table 1–10: Bessel Thompson frequency response and reference receiver limits (Cont.)

Standard	Frequency (MHz)	Lower Limit (dB)	Nominal (dB)	Upper Limit (dB)	Measured (delta dB)
FC531 Fibre Channel, Data Rate: 531.25 Mb/s					
	0.0	-0.5	-0.0	0.5	
	79.688	-0.6	-0.1	0.4	
	159.38	-0.9	-0.4	-0.1	
	239.06	-1.5	-1.0	-0.5	
	318.76	-2.4	-1.9	-1.4	
	398.44	-3.5	-3.0	-2.5	
	478.12	-5.5	-4.5	-3.5	
	531.24	-7.03	-5.7	-4.37	
	557.82	-7.9	-6.4	-4.9	
	637.50	-10.5	-8.5	-6.5	
	717.18	-13.4	-10.9	-8.4	
	796.88	-16.4	-13.4	-10.4	
	1062.5	-26.17	-21.5	-16.3	
FC1063 Fibre Channel (Controlled to 1.5X Data Rate), Data Rate: 1062.5 Mb/s					
	0.0	-0.5	0.0	0.5	
	159.38	-0.6	-0.1	0.4	
	318.75	-0.9	-0.4	0.1	
	478.12	-1.5	-1.0	-0.5	
	637.50	-2.4	-1.9	-1.4	
	796.87	-3.5	-3.0	-2.5	
	956.25	-5.5	-4.5	-3.5	
	1062.5	-7.03	-5.7	-4.37	
	1115.63	-7.9	-6.4	-4.9	
	1275.0	-10.5	-8.5	-6.5	
	1434.37	-13.4	-10.9	-8.4	
	1593.75	-16.4	-13.4	-10.4	



Specifications

Specifications

This section begins with a general description of the traits of the TDS 500C, TDS 600B, and TDS 700C oscilloscopes. Three sections follow, one for each of three classes of traits: *nominal traits*, *warranted characteristics*, and *typical characteristics*.

Product Description

The TDS 500C, TDS 600B and TDS 700C Digitizing Oscilloscopes are portable, four-channel instruments suitable for use in a variety of test and measurement applications and systems. Table 2–1 lists key features.

Table 2–1: Key features of the TDS 500C, 600B and 700C oscilloscopes

Feature	TDS 600B	TDS 500C & TDS 700C
Digitizing rate, maximum	TDS 684B: 5 GS/s on ea. of 4 ch TDS 680B: 5 GS/s on ea. of 2 ch TDS 644B: 2.5 GS/s on ea. of 4 ch TDS 620B: 2.5 GS/s on ea. of 2 ch	TDS 784C: 4 GS/s TDS 540C, 754C: 2 GS/s TDS 520C, 724C: 1 GS/s
Analog bandwidth	TDS 680B, 684B, and 784C: 1 GHz TDS 520C, 540C, 620B, 644B, 724C and 754C: 500 MHz	
No. of Channels	TDS 644B & 684B: 4 TDS 620B & 680B: 2 + 2 ¹	TDS 540C, 754C & 784C: 4 TDS 520C & 724C: 2 + 2 ¹
Record lengths, maximum	15,000 samples	50,000 samples (500,000 with option 1M) (8,000,000 with option 2M)
Acquisition modes	Sample, envelope, peak detect and average	Sample, envelope, average, high-resolution, and peak-detect
Trigger modes	Modes include: Edge, logic, and pulse. Video trigger, with option 05, modes include: NTSC, SECAM, PAL, HDTV, and FlexFormat. Communications Trigger with option 2C (available on TDS 500C/700C), modes include: AMI, CMI, and NRZ	
Display	TDS 520C, 540C, 620B, 680B: Monochrome TDS 644B, 684B, 724C, 754C, 784C: Color	

Table 2–1: Key features of the TDS 500C, 600B and 700C oscilloscopes (cont.)

Feature	TDS 600B	TDS 500C & TDS 700C
Storage	Floppy disk drive: 1.44 Mbyte, 3.5 inch, DOS 3.3-or-later floppy disk drive Internal hard disk drive (option HD available on the TDS 500C and 700C) 170 MByte capacity Subject to change due to the fast-moving PC component environment. NVRAM storage for saving waveforms, hardcopies, and setups	
I/O	Full GPIB programmability. Hardcopy output using GPIB, RS-232, or Centronics ports	

¹ **Two plus Two channel operation allows up to two of the four channels to be displayed simultaneously. Channels not displayed can be used to couple a triggering signal to the oscilloscope.**

User Interface

Use a combination of front-panel buttons, knobs, and on-screen menus to control the many functions of the oscilloscope. The front-panel controls are grouped according to function: vertical, horizontal, trigger, and special. Set a function you adjust often, such as vertical positioning or the time base setting, directly by its own front-panel knob. Set a function you change less often, such as vertical coupling or horizontal mode, indirectly using a selected menu.

Menus Pressing one (sometimes two) front-panel button(s), such as vertical menu, displays a *main* menu of related functions, such as coupling and bandwidth, at the bottom of the screen. Pressing a main-menu button, such as coupling, displays a *side* menu of settings for that function, such as AC, DC, or GND (ground) coupling, at the right side of the screen. Pressing a side-menu button selects a setting such as DC.

Indicators On-screen readouts help you keep track of the settings for various functions, such as vertical and horizontal scale and trigger level. Some readouts use the cursors or the automatic parameter extraction feature (called measure) to display the results of measurements made or the status of the instrument.

General Purpose Knob Assign the general purpose knob to adjust a selected parameter function. More quickly change parameters by toggling the **SHIFT** button. Use the same method as for *selecting* a function, except the final side-menu selection assigns the

general purpose knob to *adjust* some function, such as the position of measurement cursors on screen, or the setting for a channel fine gain.

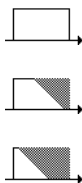

GUI The user interface also makes use of a GUI, or Graphical User Interface, to make setting functions and interpreting the display more intuitive. Some menus and status are displayed using iconic representations of function settings, such as those shown here for full, 250 MHz and 20 MHz bandwidth. Such icons allow you to more readily determine status or the available settings.

Signal Acquisition System

The signal acquisition system provides four, full-featured vertical channels with calibrated vertical scale factors from 1 mV to 10 V per division. All channels can be acquired simultaneously.

Each of the full-featured channels can be displayed, vertically positioned, and offset, can have their bandwidth limited (250 MHz or 20 MHz) and their vertical coupling specified. Fine gain can also be adjusted.

Besides these channels, up to three math waveforms and four reference waveforms are available for display. (A math waveform results when you specify dual waveform operations, such as add, on any two channels. A reference waveform results when you save a waveform in a reference memory).

Horizontal System

There are three horizontal display modes: main only, main intensified, and delayed only. You can select among various horizontal record length settings.

A feature called “Fit to Screen” allows you to view entire waveform records within the 10 division screen area. Waveforms are compressed to fit on the screen. See Table 2–2.

Both the delayed only display and the intensified zone on the main intensified display may be delayed by time with respect to the main trigger. Both can be set to display immediately after the delay (delayed runs after main mode). The delayed display can also be set to display at the first valid trigger after the delay (delayed-triggerable modes).

The delayed display (or the intensified zone) may also be delayed by a selected number of events. In this case, the events source is the delayed-trigger source. The delayed trigger can also be set to occur after a number of events plus an amount of time.

Table 2-2: Record length and divisions per record vs. TDS model

Standard Models	Record length	Divisions per record	
		FTS ¹ Off ²	FTS ¹ On ³
All TDS 500C, TDS600B & TDS 700C All channels ⁴	500	10 divs	10 divs
	1,000	20 divs	10 divs
	2,500	50 divs	10 divs
	5,000	100 divs	10 divs
	15,000	300 divs	10 divs
TDS 500C & TDS 700C, All channels	50,000	1,000 divs	10 divs
Models with Option 1M	Record length	Divisions per record	
		FTS ¹ Off ²	FTS ¹ On ³
TDS 500C & TDS 700C, All channels	75,000	1,500 divs	10 divs
TDS 500C & TDS 700C, All channels	100,000	2,000 divs	10 divs
TDS 500C & TDS 700C, All channels	130,000	2,600 divs	10 divs
	250,000	5,000 divs	10 divs
	500,000	10,000 divs	10 divs
Models with Option 2M	Record length	Divisions per record	
		FTS ¹ Off ²	FTS ¹ On ³
TDS 520C & TDS 724C One or two channels	2,000,000	40,000 divs	10 divs
TDS 540C, TDS 784C & TDS 754C Three or four channels			
TDS 520C & TDS 724C One channel only	4,000,000	80,000 divs	10 divs
TDS 540C, TDS 784C & TDS 754C Two channels			
TDS 540C, TDS 784C & TDS 754C One channel only	8,000,000	160,000 divs	10 divs

¹ Fit to Screen setting

² Fit to Screen off preserves 50 samples/division in a 1-2-5 sec/division sequence.

³ Fit to Screen on lets the samples/division and the sec/division sequence vary.

⁴ All channels means all that may be displayed at one time: four channels for some models, two for others. See Table 2-1 and its footnote on page 2-1.

Trigger System

The triggering system supports a varied set of features for triggering the signal-acquisition system. Trigger signals recognized include:

- Edge (main- and delayed-trigger systems): This familiar type of triggering is fully configurable for source, slope, coupling, mode (auto or normal), and holdoff.
- Logic (main-trigger system): This type of triggering can be based on pattern (asynchronous) or state (synchronous). In either case, logic triggering is configurable for sources, for Boolean operators to apply to those sources, for logic pattern or state on which to trigger, for mode (auto or normal), and for holdoff. Time qualification may be selected in pattern mode. Another class of logic trigger, setup/hold, triggers when data in one trigger source changes state within the setup and hold times that you specify relative to a clock in another trigger source.
- Pulse (main-trigger system): Pulse triggering is configurable for triggering on runt or glitch pulses, or on pulse widths or periods inside or outside limits that you specify. It can also trigger on a pulse edge that has a slew rate faster or slower than the rate you specify. The timeout trigger will act when events do *not* occur in a defined time period. The pulse trigger is also configurable for source, polarity, mode, and holdoff.
- Video (with option 05: Video Trigger): Video triggering is compatible with standard NTSC, PAL, SECAM, and HDTV formats. An additional feature called FlexFormat™ (flexible format) allows the user to define the video format on which to trigger.
- Comm (with option 2C): is provided for triggering on AMI, CMI, or NRZ communications signals.

You can choose where the trigger point is located within the acquired waveform record by selecting the amount of pretrigger data displayed. Presets of 10%, 50%, and 90% of pretrigger data can be selected in the horizontal menu, or the general purpose knob can be assigned to set pretrigger data to any value within the 0% to 100% limits.

Acquisition Control

You can specify a mode and manner to acquire and process signals that matches your measurement requirements.

- Select the mode for interpolation (linear or sin (x)/x). This can increase the apparent sample rate on the waveform when the maximum real-time rate is exceeded.

- Use sample, envelope, average and peak detect modes to acquire signals. With the TDS 500C/700C, also use high-resolution mode.
- Set the acquisition to stop after a single acquisition (or sequence of acquisitions if acquiring in average or envelope modes) or after a limit condition has been met.
- Select channel sources for compliance with limit tests. You can direct the TDS to signal you or generate hard copy output either to a printer or to a floppy-disk file based on the results. Also, you can create templates for use in limit tests.

On-Board User Assistance

Help and autoset can assist you in setting up the digitizing oscilloscope to make your measurements.

Help Help displays operational information about any front-panel control. When help mode is in effect, manipulating any front-panel control causes the digitizing oscilloscope to display information about that control. When help is first invoked, an introduction to help is displayed on screen.

Autoset Autoset automatically sets up the digitizing oscilloscope for a viewable display based on the input signal.

Measurement Assistance

Once you have set up to make your measurements, the cursor and measure features can help you quickly make those measurements.

Cursor Three types of cursors are provided for making parametric measurements on the displayed waveforms. Horizontal bar cursors (H Bar) measure vertical parameters (typically volts). Vertical bar cursors (V Bar) measure horizontal parameters (typically time or frequency). Paired cursors measure both amplitude and time simultaneously. These are delta measurements; that is, measurements based on the difference between two cursors.

Both H Bar and V Bar cursors can also be used to make absolute measurements. For the H Bars, either cursor can be selected to read out its voltage with respect to any channel's ground reference level. For the V Bars, the cursors measure time with respect to the trigger point (event) of the acquisition. The cursors can also control the portion of the waveform on which automatic measurements are made.

For time measurements, units can be either seconds or hertz (for 1/time).

With the video trigger option installed (Option 05), you can measure the video line number using the vertical cursors. You can measure IRE amplitude (NTSC) using the horizontal cursors with or without the video trigger option installed.

Measure

Measure can automatically extract parameters from the signal input to the digitizing oscilloscope. Any four out of the 25 parameters available can be displayed to the screen. The waveform parameters are measured continuously with the results updated on-screen as the digitizing oscilloscope continues to acquire waveforms.

Digital Signal Processing (DSP)

An important component of the multiprocessor architecture of this digitizing oscilloscope is Tektronix's proprietary digital signal processor, the DSP. This dedicated processor supports advanced analysis of your waveforms when doing such compute-intensive tasks as interpolation, waveform math, and signal averaging. It also teams with a custom display system to deliver specialized display modes (See *Display*, later in this description).

Storage

Acquired waveforms may be saved in any of four nonvolatile REF (reference) memories or on a 3.5 inch, DOS 3.3-or-later compatible disk. Any or all of the saved waveforms may be displayed for comparison with the waveforms being currently acquired.

The TDS 500C/700C instrument with option HD or option 2M can save waveforms to an internal hard disk drive. Any or all of the saved waveforms may be displayed for comparison with the waveforms being currently acquired.

The source and destination of waveforms to be saved may be chosen. You can save any of the four channels to any REF memory or move a stored reference from one REF memory to another. Reference waveforms may also be written into a REF memory location via the GPIB interface.

I/O

The oscilloscope is fully controllable and capable of sending and receiving waveforms over the GPIB interface (IEEE Std 488.1–1987/IEEE Std 488.2–1987 standard). This feature makes the instrument ideal for making automated measurements in a production or research and development environment that calls for repetitive data taking. Self-compensation and self-diagnostic features built into the digitizing oscilloscope to aid in fault detection and servicing are also accessible using commands sent from a GPIB controller.

The oscilloscope can also output copies of its display using the hardcopy feature. This feature allows you to output waveforms and other on-screen information to a variety of graphic printers and plotters from the TDS front panel, providing hard copies without requiring you to put the TDS into a system-controller environment.

You can make hardcopies in a variety of popular output formats, such as PCX, TIFF, BMP, RLE, EPS, Interleaf, and EPS mono or color. You can also save hardcopies in a disk file in any of the formats listed in the I/O section.

The hardcopies obtained are based on what is displayed on-screen at the time hardcopy is invoked. The hardcopies can be stamped with date and time and spooled to a queue for printing at a later time. You can output screen information via GPIB, RS-232C, or Centronics interfaces.

Display

The TDS 500C, TDS 600B and TDS 700C Digitizing Oscilloscopes offer flexible display options. You can customize the following attributes of your display:

- Color (TDS 644B, TDS 684B, and TDS 700C): Waveforms, readouts, graticule, and variable persistence with color coding
- Intensity: waveforms, readouts, and graticule
- Style of waveform display(s): vectors or dots, intensified or nonintensified samples, infinite persistence, and variable persistence
- Interpolation method: $\text{Sin}(x)/x$ or Linear
- Display format: xy or yt with various graticule selections including NTSC and PAL to be used with video trigger (option 05)

Zoom

This oscilloscope also provides an easy way to focus in on those waveform features you want to examine up close. By invoking zoom, you can magnify the waveform using the vertical and horizontal controls to expand (or contract) and position it for viewing.

Nominal Traits

This section contains a collection of tables that list the various *nominal traits* that describe the TDS 500C, TDS 600B, and TDS 700C oscilloscopes. Electrical and mechanical traits are included.

Nominal traits are described using simple statements of fact such as “Four, all identical” for the trait “Input Channels, Number of,” rather than in terms of limits that are performance requirements.

Table 2-3: Nominal traits — Signal acquisition system

Name	Description	
Bandwidth Selections	20 MHz, 250 MHz, and FULL	
Samplers, Number of	TDS 540C, 644B, 684B, 754C, and 784C: Four, simultaneous TDS 520C, 620B, 680B, and 724C: Two, simultaneous	
Digitized Bits, Number of	8 bits ¹	
Input Channels, Number of	Four	
Input Coupling	DC, AC, or GND	
Input Impedance Selections	1 M Ω or 50 Ω	
Ranges, Offset	Volts/Div setting	Offset range
	1 mV/div – 100 mV/div	± 1 V
	101 mV/div – 1 V/div	± 10 V
	1.01 V/div – 10 V/div	± 100 V
Range, Position	± 5 divisions	
Range, 1 M Ω Sensitivity	1 mV/div to 10 V/div ²	
Range, 50 Ω Sensitivity	1 mV/div to 1 V/div ⁵	

- ¹ Displayed vertically with 25 digitization levels (DLs) per division and 10.24 divisions dynamic range with zoom off. A DL is the smallest voltage level change of the oscilloscope input that can be resolved by the 8-bit A-D Converter. Expressed as a voltage, a DL is equal to 1/25 of a division times the volts/division setting.
- ² The sensitivity ranges from 1 mV/div to 10 V/div (for 1 M Ω) or to 1 V/div (for 50 Ω) in a 1–2–5 sequence of coarse settings with Fit-to-Screen off. Between coarse settings, the sensitivity can be finely adjusted with a resolution equal to 1% of the more sensitive coarse setting. For example, between 50 mV/div and 100 mV/div, the volts/division can be set with 0.5 mV resolution.

Table 2-4: Nominal traits — Time base system

Name	Description
Range, Sample-Rate ^{1,3}	<p>TDS 684B: 5 Samples/sec to 5 GSamples/sec on four channels simultaneously</p> <p>TDS 680B: 5 Samples/sec to 5 GSamples/sec on two channels simultaneously</p> <p>TDS 644B: 5 Samples/sec to 2.5 GSamples/sec on four channels simultaneously</p> <p>TDS 620B: 5 Samples/sec to 2.5 GSamples/sec on two channels simultaneously</p> <p>TDS 520C and 724C: 5 Samples/sec to 1 GSamples/sec when acquiring 1 channel, to 500 MSamples/sec when acquiring 2 channels</p> <p>TDS 540C: 5 Samples/sec to 2 GSamples/sec when acquiring 1 channel, to 1 GSample/sec when acquiring 2 channels, or to 500 MSamples/sec when acquiring 3 or 4 channels</p> <p>TDS 754C: 5 Samples/sec to 2 GSamples/sec when acquiring 1 or 2 channels, to 1 GSamples/sec when acquiring 3 or 4 channels</p> <p>TDS 784C: 5 Samples/sec to 4 GSamples/sec when acquiring 1 channel, to 2 GSample/sec when acquiring 2 channels, or to 1GSamples/sec when acquiring 3 or 4 channels</p>
Range, Interpolated Waveform Rate ^{2,3}	<p>TDS 600B: 10 GSamples/sec to 250 GSamples/sec</p> <p>TDS 520C, 540C, 724C, and 754C: 1 GSamples/sec to 100 GSamples/sec</p> <p>TDS 784C: 2 GSamples/sec to 250 GSamples/sec</p>
Range, Seconds/Division	<p>TDS 600B: 0.2 ns/div to 10 s/div</p> <p>TDS 500C, 724C, and 754C: 0.5 ns/div to 10 s/div</p> <p>TDS 784C: 0.2 ns/div to 10 s/div</p>

Table 2-4: Nominal traits — Time base system (cont.)

Name	Description
Record Length Selection	<p>TDS 500C & TDS 700C: 500, 1,000, 2,500, 5,000, 15,000 and 50,000 samples</p> <p>In addition to the record lengths previously listed, the following record lengths are available with the following options:</p> <p>TDS 520C & TDS 724 with option 1M: 1-channel: up to 250,000 samples 2-channels: up to 130,000 samples</p> <p>TDS 520C & TDS 724 with option 2M: 1-channel: up to 4,000,000 samples 2-channels: up to 2,000,000 samples</p> <p>TDS 540C, TDS 754C & TDS 784C with option 1M: 1-channel: up to 500,000 samples 2-channels: up to 250,000 samples 3 or 4-channels up to 130,000 samples</p> <p>TDS 540C, TDS 754C & TDS 784C with option 2M: 1-channel: up to 8,000,000 samples 2-channels: up to 4,000,000 samples 3 or 4-channels up to 2,000,000 samples</p>

- ¹ The range of real-time rates, expressed in samples/second, at which a digitizer samples signals at its inputs and stores the samples in memory to produce a record of time-sequential samples.
- ² The range of waveform rates for interpolated (or equivalent-time on the TDS 700C) waveform records.
- ³ The Waveform Rate (WR) is the equivalent sample rate of a waveform record. For a waveform record acquired by real-time sampling of a single acquisition, the waveform rate is the same as the real-time sample rate; for a waveform created by interpolation of real-time samples from a single acquisition or, on applicable products, the equivalent-time sampling of multiple acquisitions, the waveform rate created is faster than the real time sample rate. For all these cases, the waveform rate is $1/(\text{Waveform Interval})$ for the waveform record, where the waveform interval (WI) is the time between the samples in the waveform record.

Table 2-5: Nominal traits — Triggering system

Name	Description
Range, Delayed Trigger Time Delay	16 ns to 250 s
Range, Events Delay	TDS 600B; 2 to 10,000,000 TDS 500C/700C: 1 to 10,000,000
Range (Time) for Pulse-Glitch, Pulse-Width, Time-Qualified Runt, Timeout, or Slew Rate Trigger, Delta Time	1 ns to 1 s

Table 2-5: Nominal traits — Triggering system (cont.)

Name	Description	
Ranges, Setup and Hold for TimeSetup/Hold Violation Trigger	Feature	Min to max
	Setup Time	-100 ns to 100 ns
	Hold Time	-1 ns to 100 ns
	Setup + Hold Time	2 ns
Ranges, Trigger Level or Threshold	For Setup Time, positive numbers mean a data transition before the clock edge and negative means a transition after the clock edge.	
	For Hold Time, positive numbers mean a data transition after the clock edge and negative means a transition before the clock edge.	
	Setup + Hold Time is the algebraic sum of the Setup Time and the Hold Time programmed by the user.	
	Source	Range
	Any Channel	±12 divisions from center of screen
	Auxiliary	±8 V
	Line	±400 V
Video Trigger Modes of Operation (Option 05 Video Trigger)	<p>Supports the following video standards:</p> <ul style="list-style-type: none"> ■ NTSC (525/60) – 2 field mono or 4 field ■ PAL (625/50) – 2 field mono or SECAM, 8 field ■ HDTV – <ul style="list-style-type: none"> (787.5/60) (1050/60) (1125/60) (1250/60) ■ FlexFormat™ (user definable standards) <p>User can specify: field rate, number of lines, sync pulse width and polarity, line rate, and vertical interval timing.</p>	

Table 2-5: Nominal traits — Triggering system (cont.)

Name	Description		
Communication Trigger Modes of Operation (Option 2C Comm Trigger)	Standard Name	Code ¹	Bit Rate
	OC1/STM0	NRZ	51.84 Mb/s
	OC3/STM1	NRZ	155.52 Mb/s
	OC12/STM4	NRZ	622.08 Mb/s
	DS0 Sgl	Masks ²	64 kb/s
	DS0 Dbl	Masks ²	64 kb/s
	DS0 Data Contra	Masks ²	64 kb/s
	DS0 Timing	Masks ²	64 kb/s
	E1	AMI	2.048 Mb/s
	E2	AMI	8.44 Mb/s
	E3	AMI	34.368 Mb/s
	E4	CMI	139.26 Mb/s
	E5 (CEPT)	NRZ	565 Mb/s
	STM1E	CMI	155.52 Mb/s
	DS1	AMI	1.544 Mb/s
	DS1A	AMI	2.048 Mb/s
	DS1C	AMI	3.152 Mb/s
	DS2	AMI	6.312 Mb/s
	DS3	AMI	44.736 Mb/s
	DS4NA	CMI	139.26 Mb/s
	STS-1	AMI	51.84 Mb/s
	STS-3	CMI	155.52 Mb/s
	FC133	NRZ	132.8 Mb/s
	FC266	NRZ	265.6 Mb/s
	FC531	NRZ	531.2 Mb/s
	FC1063	NRZ	1.0625 Mb/s
	D2	NRZ	143.18 Mb/s
D1	NRZ	270 Mb/s	
FDDI	NRZ	125 Mb/s	

¹ AMI = Alternate Mark Inversion. CMI = Code Mark Inversion. NRZ = Non-return to Zero.

² These Telecom DS0 standards are automatically selected from the Mask Menu. The trigger uses Pulse/Width trigger.

Table 2-6: Nominal traits — Display system

Name	Description
Video Display	7 inch diagonal, with a display area of 5.04 inches horizontally by 3.78 inches vertically TDS 520C, 540C, 620B, and 680B: Monochrome display TDS 644B, 684B, 724C, 754C, and 784C: Color display
Video Display Resolution	640 pixels horizontally by 480 pixels vertically

Table 2-6: Nominal traits — Display system (cont.)

Name	Description
Waveform Display Graticule	Single Graticule: 401 × 501 pixels, 8 × 10 divisions, where divisions are 1 cm by 1 cm
Waveform Display Levels/Colors	TDS 520C, 540C, 620B, and 680B: Sixteen levels in infinite-persistence or variable persistence display TDS 644B, 684B, 724C, 754C, and 784C: Sixteen colors in infinite-persistence or variable persistence display

Table 2-7: Nominal traits — GPIB interface, output ports, and power fuse

Name	Description
Interface, GPIB	GPIB interface complies with IEEE Std 488-1987
Interface, RS-232	RS-232 interface complies with EIA/TIA 574 (talk only) Optional on the TDS 520C, 540C, 620B, and 680B
Interface, Centronics	Centronics interface complies with Centronics interface standard C332-44 Feb 1977, REV A Optional on the TDS 520C, 540C, 620B, and 680B
Interface, Video	VGA video output with levels that comply with EIA RS 343A standard. DB-15 connector
Logic Polarity for Main- and Delayed-Trigger Outputs	Negative TRUE. High to low transition indicates the trigger occurred.
Fuse Rating	Either of two fuses ¹ may be used: a 0.25" × 1.25" (UL 198.6, 3AG): 6 A FAST, 250 V or a 5 mm × 20 mm (IEC 127): 5 A (T), 250 V.

¹ Each fuse type requires its own fuse cap.

Table 2-8: Nominal traits — Data handling and reliability

Name	Description
Time, Data-Retention, Nonvolatile Memory ^{1, 2}	Battery life ≥ 5 years
Floppy disk drive	3.5 inch, 720 K or 1.44 Mbyte, DOS 3.3-or-later compatible
Internal hard disk drive (option HD and 2M available on the TDS 500C and 700C)	170 MByte capacity

¹ The times that reference waveforms, stored setups, and calibration constants are retained.

² Data is maintained by small lithium-thionyl-chloride batteries internal to the memory ICs. At the time of manufacture, no special disposal requirements were in effect for these batteries as the amount of hazardous material contained was below the regulated threshold. Consult your local waste disposal agency for proper disposal.

Table 2-9: Nominal traits — Mechanical

Name	Description
Cooling Method	Forced-air circulation with no air filter. Clearance is required. Refer to the <i>TDS 500C</i> , <i>TDS 600B</i> & <i>TDS 700C User Manual</i> for minimum clearance dimensions.
Construction Material	Chassis parts constructed of aluminum alloy; front panel constructed of plastic laminate; circuit boards constructed of glass laminate. Cabinet is aluminum and is clad in Tektronix Blue vinyl material.
Weight	<p>Standard Digitizing Oscilloscope</p> <p>14.1 kg (31 lbs), with front cover. 24.0 kg (53 lbs), when packaged for domestic shipment</p> <p>Rackmount Digitizing Oscilloscopes</p> <p>14.1 kg (31 lbs) plus weight of rackmount parts, for the rackmounted Digitizing Oscilloscopes (Option 1R).</p> <p>Rackmount conversion kit</p> <p>2.3 kg (5 lbs), parts only; 3.6 kg (8 lbs), parts plus package for domestic shipping</p>
Overall Dimensions	<p>Standard Digitizing Oscilloscope</p> <p>Height: 193 mm (7.6 in), with the feet installed Width: 445 mm (17.5 in), with the handle Depth: 434 mm (17.1 in), with the front cover installed</p> <p>Rackmount Digitizing Oscilloscope</p> <p>Height: 178 mm (7.0 in) Width: 483 mm (19.0 in) Depth: 558.8 mm (22.0 in)</p>

Warranted Characteristics

This section lists the various *warranted characteristics* that describe the TDS 500C, TDS 600B and TDS 700C oscilloscopes. Electrical and environmental characteristics are included.

Warranted characteristics are described in terms of quantifiable performance limits which are warranted.

NOTE. *In these tables, those warranted characteristics that are checked in the procedure Performance Verification appear in **boldface type** under the column Name.*

As stated above, this section lists only warranted characteristics. A list of *typical characteristics* starts on page 2–25.

Performance Conditions

The performance limits in this specification are valid with these conditions:

- The oscilloscope must have been calibrated/adjusted at an ambient temperature between +20° C and +30° C.
- The oscilloscope must be in an environment with temperature, altitude, humidity, and vibration within the operating limits described in these specifications.
- The oscilloscope must have had a warm-up period of at least 20 minutes.
- The oscilloscope must have had its signal-path-compensation routine last executed after at least a 20 minute warm-up period at an ambient temperature within $\pm 5^{\circ}$ C of the current ambient temperature.

Table 2-10: Warranted characteristics — Signal acquisition system

Name	Description		
Accuracy, DC Gain	TDS 600B: $\pm 1.5\%$ for all sensitivities from 2 mV/div to 10 V/div $\pm 2.0\%$ at 1 mV/div sensitivity TDS 500C, 700C: $\pm 1\%$ for all sensitivities from 1 mV/div to 10 V/div with offset from 0 V to $\pm 100\text{V}$		
Accuracy, DC Voltage Measurement, Averaged (using Average mode)	Measurement type	DC Accuracy	
	Average of ≥ 16 waveforms	TDS 600B: $\pm((1.5\% \times \text{reading} - \text{Net Offset}^1) + \text{Offset Accuracy}) + (0.06 \text{ div} \times \text{V/div})$ TDS 500C, 700C: $\pm((1.0\% \times \text{reading} - \text{Net Offset}^1) + \text{Offset Accuracy} + (0.06 \text{ div} \times \text{V/div}))$	
	Delta volts between any two averages of ≥ 16 waveforms acquired under the same setup and ambient conditions	TDS 600B: $\pm((1.5\% \times \text{reading}) + (0.1 \text{ div} \times \text{V/div}) + 0.3 \text{ mV})$ TDS 500C, 700C: $\pm((1.0\% \times \text{reading}) + (0.1 \text{ div} \times \text{V/div}) + 0.3 \text{ mV})$	
Accuracy, Offset	Volts/Div setting	TDS 600B Offset accuracy	TDS 500C/700C Offset accuracy
	1 mV/div – 100 mV/div	$\pm((0.2\% \times \text{Net Offset}^1) + 1.5 \text{ mV} + (0.6 \text{ div} \times \text{V/div}))$	$\pm((0.2\% \times \text{Net Offset}^1) + 1.5 \text{ mV} + (0.1 \text{ div} \times \text{V/div}))$
	101 mV/div – 1 V/div	$\pm((0.25\% \times \text{Net Offset}^1) + 15 \text{ mV} + (0.6 \text{ div} \times \text{V/div}))$	$\pm((0.25\% \times \text{Net Offset}^1) + 15 \text{ mV} + (0.1 \text{ div} \times \text{V/div}))$
	1.01 V/div – 10 V/div	$\pm((0.25\% \times \text{Net Offset}^1) + 150 \text{ mV} + (0.6 \text{ div} \times \text{V/div}))$	$\pm((0.25\% \times \text{Net Offset}^1) + 150 \text{ mV} + (0.1 \text{ div} \times \text{V/div}))$
Analog Bandwidth, DC-50 Ω Coupled and Bandwidth selection is FULL, TDS 600B	Volts/Div	TDS 620B & 644B Bandwidth²	TDS 680B & 684B Bandwidth²
	10 mV/div – 1 V/div	DC – 500 MHz	DC – 1 GHz
	5 mV/div – 9.95 mV/div	DC – 450 MHz	DC – 750 MHz
	2 mV/div – 4.98 mV/div	DC – 300 MHz	DC – 600 MHz
	1 mV/div – 1.99 mV/div	DC – 250 MHz	DC – 500 MHz
Analog Bandwidth, DC-50 Ω Coupled and Bandwidth selection is FULL, TDS 500C/700C	Volts/Div	TDS 520C, 540C, 724C & 754C Bandwidth²	TDS 784C Bandwidth²
	10 mV/div – 1 V/div	DC – 500 MHz	DC – 1 GHz
	5 mV/div – 9.95 mV/div	DC – 500 MHz	DC – 750 MHz
	2 mV/div – 4.98 mV/div	DC – 500 MHz	DC – 600 MHz
	1 mV/div – 1.99 mV/div	DC – 450 MHz	DC – 500 MHz
Crosstalk (Channel Isolation)	$\geq 100:1$ at 100 MHz and $\geq 30:1$ at the rated bandwidth for the channel's Volt/Div setting, for any two channels having equal Volts/Div settings		

Table 2-10: Warranted characteristics — Signal acquisition system (cont.)

Name	Description
Delay Between Channels, Full Bandwidth	TDS 600B: ≤ 100 ps for any two channels with equal Volts/Div and Coupling settings and both channels' deskew values set to 0 TDS 500C/700C: ≤ 50 ps for any two channels with equal Volts/Div and Coupling settings and both channel deskew values set to 0.0 μ s.
Input Impedance, DC-1 M Ω Coupled	1 M Ω $\pm 0.5\%$ in parallel with 10 pF ± 3 pF
Input Impedance, DC-50 Ω Coupled	50 Ω $\pm 1\%$ with VSWR $\leq 1.3:1$ from DC - 500 MHz, $\leq 1.5:1$ from 500 MHz - 1 GHz
Input Voltage, Maximum, DC-1 M Ω , AC-1 M Ω , or GND Coupled	TDS 600B: ± 300 V CAT II, 400 V peak; derate at 20 dB/decade above 1 MHz TDS 500C/700C: ± 300 V CAT II, 400 V peak; derate at 20 dB/decade above 1 MHz
Input Voltage, Maximum, DC-50 Ω or AC-50 Ω Coupled	5 V _{RMS} , with peaks $\leq \pm 30$ V
Lower Frequency Limit, AC Coupled	≤ 10 Hz when AC-1 M Ω Coupled; ≤ 200 kHz when AC-50 Ω Coupled ³

¹ Net Offset = Offset - (Position \times Volts/Div). Net Offset is the nominal voltage level at the oscilloscope input that corresponds to the center of the A-D converter's dynamic range. Offset Accuracy is the accuracy of this voltage level.

² The limits given are for the ambient temperature range of 0°C to +30°C. Reduce the upper bandwidth frequencies by 5 MHz for the TDS 600B or by 2.5 MHz for the TDS 500C/700C for each °C above +30°C.

³ The AC Coupled Lower Frequency Limits are reduced by a factor of 10 when 10X passive probes are used.

Table 2-11: Warranted characteristics — Time base system

Name	Description
Accuracy, Long Term Sample Rate and Delay Time	TDS 600B: ± 100 ppm over any ≥ 1 ms interval TDS 500C/700C: ± 25 ppm over any ≥ 1 ms interval

Table 2-12: Warranted characteristics — Triggering system

Name	Description	
Sensitivity, Edge-Type Trigger, Coupling set to "DC" ¹	Trigger source	Sensitivity
	Any Channel	TDS 620B & 644B: 0.35 division from DC to 50 MHz, increasing to 1 division at 500 MHz TDS 680B & 684B: 0.35 division from DC to 50 MHz, increasing to 1 division at 1 GHz MHz TDS 500C, 724C, & 754C: 0.35 division from DC to 50 MHz, increasing to 1 division at 500 MHz TDS 784C: 0.35 division from DC to 50 MHz, increasing to 1 division at 1 GHz
	Auxiliary	TDS 600B: 250 mV from DC to 50 MHz, increasing to 500 mV at 100 MHz TDS 500C, 724C, & 754C: 400 mV from DC to 50 MHz, increasing to 750 mV at 100 MHz TDS 784C: 250 mV from DC to 50 MHz, increasing to 500 mV at 100 MHz
Accuracy (Time) for Pulse-Glitch or Pulse-Width Triggering	Time range	Accuracy
	1 ns to 1 μ s	\pm (20% of setting + 0.5 ns)
	1.02 μ s to 1 s	\pm (100 ns + 0.01% of Setting)
Input Signal Sync Amplitude for Stable Triggering, NTSC and PAL modes (Option 05 Video Trigger)	Field selection "Odd", "Even", or "All": 0.6 division to 4 divisions	
	Field selection "Numeric": 1 division to 4 divisions (NTSC mode)	
Jitter (Option 05 Video Trigger)	60 ns _{p-p} on NTSC or PAL signal	

¹ The minimum sensitivity for obtaining a stable trigger. A stable trigger results in a uniform, regular display triggered on the selected slope. The trigger point must not switch between opposite slopes on the waveform, and the display must not "roll" across the screen on successive acquisitions. The TRIG'D LED stays constantly lighted when the SEC/DIV setting is 2 ms or faster but may flash when the SEC/DIV setting is 10 ms or slower.

Table 2-13: Warranted characteristics — Output ports, probe compensator, and power requirements

Name	Description	
Logic Levels, Main- and Delayed-Trigger Outputs	Characteristic	Limits
	Vout (HI)	\geq 2.5 V open circuit; \geq 1.0 V into a 50 Ω load to ground
	Vout (LO)	\leq 0.7 V into a load of \leq 4 mA; \leq 0.25 V into a 50 Ω load to ground

Table 2-13: Warranted characteristics — Output ports, probe compensator, and power requirements (cont.)

Name	Description	
Output Voltage and Frequency, Probe Compensator	Characteristic	Limits
	Output Voltage	0.5 V (base-top) $\pm 1\%$ into a $\geq 50 \Omega$ load
	Frequency	1 kHz $\pm 5\%$
Output Voltage, Signal Out (CH 3 ¹)	For TDS 600B: 20 mV/division $\pm 20\%$ into a 1 M Ω load; 10 mV/division $\pm 20\%$ into a 50 Ω load For TDS 500C/700C: 22 mV/division $\pm 20\%$ into a 1 M Ω load; 11 mV/division $\pm 20\%$ into a 50 Ω load	
Source Voltage	90 to 250 VAC _{RMS} , continuous range, CAT II	
Source Frequency	45 Hz to 440 Hz	
Power Consumption	≤ 300 W (450 VA)	

¹ CH 3 signal out is present at the rear panel if CH 3 (AUX 1 on the TDS 620B or 680B) is selected as the trigger source for the main and/or delayed trigger systems. It is not available when a channel other than CH3 (AUX 1 on the TDS 620B or 680B) is the source for the Video Trigger when Option 05 is installed.

Table 2-14: Warranted characteristics — Environmental

Name	Description
Atmospherics	<p>Temperature (no disk in floppy drive):</p> <p>TDS 600B: Operating: +4° C to +45° C</p> <p>Floppy disk drive: Operating: +10° C to +45° C</p> <p> Nonoperating: -22° C to +60° C</p> <p>TDS 500C/700C: Operating: +0° C to +50° C</p> <p>Floppy disk drive: Operating: +10° C to +50° C</p> <p> Nonoperating: -22° C to +60° C</p> <p>Relative humidity (no disk in floppy drive):</p> <p>Operating: 20% to 80%, at or below +32° C, upper limit derates to 30% relative humidity at +45° C</p> <p>Nonoperating: 5% to 90%, at or below +31° C, upper limit derates to 20% relative humidity at 60° C</p> <p>Altitude:</p> <p>To 4570 m (15,000 ft.), operating (excluding hard disk drive)</p> <p>To 3048 m (10,000 ft.), operating (including hard disk drive)</p> <p>To 12190 m (40,000 ft.), nonoperating</p>
Dynamics	<p>Random vibration (floppy disk not installed):</p> <p>0.31 g rms, from 5 to 500 Hz, 10 minutes each axis, operating</p> <p>3.07 g rms, from 5 to 500 Hz, 10 minutes each axis, nonoperating</p>
Emissions (TDS 500C/700C) ^{1, 2}	<p>Meets or exceeds the requirements of the following standards:</p> <p>FCC Code of Federal Regulations, 47 CFR, Part 15, Subpart B, Class A</p> <p>European Community Requirements</p> <p>EN 55011 Class A Radiated Emissions</p> <p>EN 55011 Class A Conducted Emissions</p> <p>EN 50081-1</p> <p>EN60555-2 Power Line Harmonic Emissions</p>
Emissions (TDS 600B) ^{1, 2}	<p>Meets or exceeds the requirements of the following standards:</p> <p>FCC Code of Federal Regulations, 47 CFR, Part 15, Subpart B, Class A</p> <p>EN 50081-1 European Community Requirements</p> <p>EN 55022 Radiated Emissions Class B</p> <p>EN 55022 Class B Conducted Emissions</p> <p>EN60555-2 Power Line Harmonic Emissions</p>

Table 2-14: Warranted characteristics — Environmental (cont.)

Name	Description										
Susceptibility ^{1, 2}	Meets or exceeds the EMC requirements of the following standards: <table border="0" data-bbox="662 449 1425 709"> <tr> <td data-bbox="662 449 841 478">EN 50082-1</td> <td data-bbox="857 449 1208 478">European Community Requirements</td> </tr> <tr> <td data-bbox="662 499 841 529">IEC 801-2</td> <td data-bbox="857 499 1305 529">Electrostatic Discharge Performance Criteria B</td> </tr> <tr> <td data-bbox="662 550 841 579">IEC 801-3</td> <td data-bbox="857 550 1425 604">Radiated Susceptibility 3 V/meter from 27 MHz to 500 MHz unmodulated</td> </tr> <tr> <td data-bbox="662 625 841 655">IEC 801-4</td> <td data-bbox="857 625 1230 655">Fast Transients Performance Criteria B</td> </tr> <tr> <td data-bbox="662 676 841 705">IEC 801-5</td> <td data-bbox="857 676 1175 705">AC Surge Performance Criteria B</td> </tr> </table>	EN 50082-1	European Community Requirements	IEC 801-2	Electrostatic Discharge Performance Criteria B	IEC 801-3	Radiated Susceptibility 3 V/meter from 27 MHz to 500 MHz unmodulated	IEC 801-4	Fast Transients Performance Criteria B	IEC 801-5	AC Surge Performance Criteria B
EN 50082-1	European Community Requirements										
IEC 801-2	Electrostatic Discharge Performance Criteria B										
IEC 801-3	Radiated Susceptibility 3 V/meter from 27 MHz to 500 MHz unmodulated										
IEC 801-4	Fast Transients Performance Criteria B										
IEC 801-5	AC Surge Performance Criteria B										
Approvals	Conforms to and is certified where appropriate to: <table border="0" data-bbox="662 764 1425 875"> <tr> <td data-bbox="662 764 1312 793">UL 3111-1³</td> <td data-bbox="662 764 1312 793">– Standard for electrical measuring and test equipment</td> </tr> <tr> <td data-bbox="662 814 1425 875">CAN/CSA C22.2 no. 1010.1³</td> <td data-bbox="662 814 1425 875">– Safety requirements for electrical equipment for measurement, control and laboratory use</td> </tr> </table>	UL 3111-1 ³	– Standard for electrical measuring and test equipment	CAN/CSA C22.2 no. 1010.1 ³	– Safety requirements for electrical equipment for measurement, control and laboratory use						
UL 3111-1 ³	– Standard for electrical measuring and test equipment										
CAN/CSA C22.2 no. 1010.1 ³	– Safety requirements for electrical equipment for measurement, control and laboratory use										

¹ **VGA output cable needs to be terminated, if connected at all, for the Instrument to meet these standards. The test will pass with LCOM part # CTL3VGAMM-5.**

² **The GPIB cable connected to the instrument for certain of the emissions tests must be “low EMI” having a high-quality outer shield connected through a low impedance to both connector housings. Acceptable cables are Tektronix part numbers 012-0991-00, -01, -02, and -03. In order to maintain the EMI performance conforming to the above regulations, the following cables, or their equivalent, should be used: a shielded Centronics cable, 3 meters in length, part number 012-1214-00, and a shielded RS-232 cable, 2.7 meters in length, CA part number 0294-9.**

³ **UL 3111, CSA 22.2 no.1010 Safety Certification Compliance:**
 Temperature (operating) 5 to +40 C
 Altitude (maximum operating): 2000 meters
 Equipment Type: Test and Measurement
 Safety Class: Class I (as defined in IEC 1010-1, Annex H) – grounded product
 Overvoltage Category: Overvoltage Category II (as defined in IEC 1010-1, Annex J)
 Pollution Degree: Pollution Degree 2 (as defined in IEC 1010-1)
 Note – Rated for indoor use only

Table 2–15: Certifications and compliances

<p>EC Declaration of Conformity (TDS 500C and TDS 700C)</p>	<p>Meets intent of Directive 89/336/EEC for Electromagnetic Compatibility. Compliance was demonstrated to the following specifications as listed in the Official Journal of the European Communities:</p> <p>EMC Directive 89/336/EEC: EN 55011 Class A Radiated and Conducted Emissions EN 50081-1 Emissions: EN 60555-2 AC Power Line Harmonic Emissions EN 50082-1 Immunity: IEC 801-2 Electrostatic Discharge Immunity IEC 801-3 RF Electromagnetic Field Immunity IEC 801-4 Electrical Fast Transient/Burst Immunity IEC 801-5 Power Line Surge Immunity</p>
<p>Australian Declaration of Conformity – EMC (TDS 500C and TDS 700C)</p>	<p>Conforms with the following standards in accordance with the Electromagnetic Compatibility Framework:</p> <p>AS/NZS 2064.1/2 Class A radiated and Conducted Emissions</p>
<p>EC Declaration of Conformity (TDS 600B)</p>	<p>Meets intent of Directive 89/336/EEC for Electromagnetic Compatibility. Compliance was demonstrated to the following specifications as listed in the Official Journal of the European Communities:</p> <p>EMC Directive 89/336/EEC: EN 50081-1 Emissions: EN 55022 Class B Radiated and Conducted Emissions EN 60555-2 AC Power Line Harmonic Emissions EN 50082-1 Immunity: IEC 801-2 Electrostatic Discharge Immunity IEC 801-3 RF Electromagnetic Field Immunity IEC 801-4 Electrical Fast Transient/Burst Immunity IEC 801-5 Power Line Surge Immunity</p>
<p>EC Declaration of Conformity – Low Voltage</p>	<p>Compliance was demonstrated to the following specification as listed in the Official Journal of the European Communities:</p> <p>Low Voltage Directive 73/23/EEC EN 61010-1:1993 Safety requirements for electrical equipment for measurement, control, and laboratory use</p>

Typical Characteristics

This subsection contains tables that list the various *typical characteristics* which describe the TDS 500C, TDS 600B and TDS 700C oscilloscopes.

Typical characteristics are described in terms of typical or average performance. Typical characteristics are not warranted.

Table 2-16: Typical characteristics — Signal acquisition system

Name	Description		
Analog Bandwidth, DC-50 Ω Coupled with P6243 or P6245 Probe and Bandwidth selection is FULL TDS 520C, 540C, 724C & 754C	Volts/Div as read out on screen	520C, 540C, 724C & 754C Bandwidth ¹	
	10 V/div – 100 V/div	Not Applicable	
	100 mV/div – 10 V/div	DC – 500 MHz	
	50 mV/div – 99.5 mV/div	DC – 500 MHz	
	20 mV/div – 49.8 mV/div	DC – 500 MHz	
	10 mV/div – 19.9 mV/div	DC – 450 MHz (P6243) DC – 500 MHz (P6245)	
Analog Bandwidth, DC-50 Ω Coupled with P6245 Probe and Bandwidth selection is FULL TDS 784C	Volts/Div as read out on screen	TDS 784C	
	10 V/div – 100 V/div	(Not Applicable)	
	100 mV/div – 10 V/div	DC – 1 GHz	
	50 mV/div – 99.5 mV/div	DC – 750 MHz	
	20 mV/div – 49.8 mV/div	DC – 600 MHz	
	10 mV/div – 19.9 mV/div	DC – 500 MHz	
Analog Bandwidth, DC-1M Ω Coupled with P6139A Probe and Bandwidth selection is FULL TDS 520C, 540C, 724C, 754C & 784C	Volts/Div as read out on screen	520C, 540C, 724C, 754C & 784C Bandwidth ¹	
	10 V/div – 100 V/div	500 MHz	
	100 mV/div – 10 V/div	500 MHz	
	50 mV/div – 99.5 mV/div	500 MHz	
	20 mV/div – 49.8 mV/div	500 MHz	
	10 mV/div – 19.9 mV/div	500 MHz	
Analog Bandwidth, DC-50 Ω Coupled with P6139A Probe (TDS 620B & 644B) or P6245 Probe (TDS 680B & 684B) and Bandwidth selection is FULL TDS 600B	Volts/Div as read out on screen	620B & 644B Bandwidth ¹	680B & 684B Bandwidth ¹
	10 V/div – 100 V/div	(Not Applicable)	(Not Applicable)
	100 mV/div – 10 V/div	DC – 500 MHz	DC – 1 GHz
	50 mV/div – 99.5 mV/div	DC – 450 MHz	DC – 750 MHz
	20 mV/div – 49.8 mV/div	DC – 300 MHz	DC – 600 MHz
	10 mV/div – 19.9 mV/div	DC – 250 MHz	DC – 500 MHz

Table 2-16: Typical characteristics — Signal acquisition system (cont.)

Name	Description		
<p>Accuracy, Delta Time Measurement</p> <p>Conditions for accuracy listed at right are: Single Shot or Sample mode (or HiRes mode on the TDS 500C/700C), with Full Bandwidth selected.</p> <p>Conditions for accuracy listed at right are: ≥ 100 Averages, will Full Bandwidth selected, and for TDS 500C/700C, repetitive mode.</p>	<p>The limits are given in the following table for signals having amplitude greater than 5 divisions, reference level = 50%, filter set to (sinX/X), acquired at 5 mV/div or greater. For the TDS 700C, pulse duration < 10 div. Channel skew not included.</p> <p>For the Single Shot condition, $1.4 \leq T_r/S_i \leq 4$, where S_i is the sample interval and T_r is the displayed rise time.</p> <p>TDS 600B: For the averaged condition, $1.4 \leq T_r/W_i \leq 40$, where W_i is the Waveform Interval, as described elsewhere in these specifications.</p> <p>TDS 600B: Extra error in the measurement will occur for two-channel measurements due to channel-to-channel skew. This is described elsewhere in these specifications.</p> <hr/> <p>Time measurement accuracy</p> <p>TDS 600B: $\pm((0.20 \times \text{sample interval}) + (100 \text{ ppm} \times \text{Reading}) + (0.05 \times W_i))$</p> <p>TDS 600B example: at 5 GS/s, 5 ns/div, measuring a 40 ns wide pulse, accuracy = $\pm(40 \text{ ps} + 4 \text{ ps} + 5 \text{ ps}) = \pm 49 \text{ ps}$.</p> <p>TDS 500C/700C: $\pm 0.15 \text{ sample interval} + (25 \text{ ppm} \times \text{Reading}) + t/\text{div}/1000$</p> <p>TDS 500C/700C example: at 4 Gs/s, accuracy = 37.5 ps</p> <hr/> <p>TDS 600B: $\pm(10 \text{ ps} + (100 \text{ ppm} \times \text{Reading}) + (0.25 \times W_i))$</p> <p>TDS 500C/700C: $20 \text{ ps} + (25 \text{ ppm} \times \text{Reading}) + t/\text{div}/1000$</p>		
<p>Calculated Rise Time, TDS 600B²</p>	<p>Volts/Div setting</p>	<p>620B & 644B Rise time</p>	<p>680B & 684B Rise time</p>
	<p>10 mV/div – 1 V/div</p>	<p>900 ps</p>	<p>450 ps</p>
	<p>5 mV/div – 9.95 mV/div</p>	<p>1 ns</p>	<p>600 ps</p>
	<p>2 mV/div – 4.98 mV/div</p>	<p>1.5 ns</p>	<p>750 ps</p>
	<p>1 mV/div – 1.99 mV/div</p>	<p>1.8 ns</p>	<p>900 ps</p>
<p>Calculated Rise Time, TDS 500C/700C²</p>	<p>Volts/Div setting</p>	<p>520C, 540C, 724C, & 754C Rise time</p>	<p>784C Rise time</p>
	<p>10 mV/div – 1 V/div</p>	<p>800 ps</p>	<p>400 ps</p>
	<p>5 mV/div – 9.95 mV/div</p>	<p>800 ps</p>	<p>530 ps</p>
	<p>2 mV/div – 4.98 mV/div</p>	<p>800 ps</p>	<p>600 ps</p>
	<p>1 mV/div – 1.99 mV/div</p>	<p>890 ps</p>	<p>800 ps</p>
<p>Effective Bits — TDS 600B</p> <p>The chart on the right gives the typical effective bits for a 9-division p-p sine-wave input, 50 mV/div, 10 ns/div (5 GS/s), with a record length of 1000 points</p>	<p>Input frequency</p>	<p>Effective bits</p>	
	<p>98 MHz</p>	<p>6.3 bits</p>	
	<p>245 MHz</p>	<p>6.0 bits</p>	
	<p>490 MHz</p>	<p>5.5 bits</p>	
	<p>990 MHz</p>	<p>5.2 bits (TDS 680B & 684B only)</p>	

Table 2-16: Typical characteristics — Signal acquisition system (cont.)

Name	Description				
Effective Bits — TDS 520C & 724C The chart on the right gives the typical effective bits for a sine wave adjusted to 9.2 divisions at 1 MHz, 50 mV/div @ 25° C.	Input frequency 1 MHz – 9.2 divs 490 MHz – 6.5 divs	Sample rate			
		1 GS/s	10 MS/s & HiRes		
	6.8 bits	9.7 bits	6.5 bits	N/A	
Effective Bits — TDS 540C & 754C The chart on the right gives the typical effective bits for a sine wave adjusted to 9.2 divisions at 1 MHz, 50 mV/div @ 25° C.	Input frequency 1 MHz – 9.2 divs 500 MHz	Sample rate			
		2 GS/s	10 MS/s & HiRes		
	6.8 bits	9.7 bits	6.8 bits	N/A	
Effective Bits — TDS 784C The chart on the right gives the typical effective bits for a sine wave adjusted to 9.2 divisions at 1 MHz, 50 mV/div @ 25° C.	Input frequency 1 MHz – 9.2 divs 1 GHz – 6.5 divs	Sample rate			
		4 GS/s	10 MS/s & HiRes		
	6.6 bits	9.7 bits	5.5 bits	N/A	
Frequency Limit, Upper, 250 MHz Bandwidth Limited	250 MHz				
Frequency Limit, Upper, 20 MHz Bandwidth Limited	20 MHz				
Step Response Settling Errors	Volts/Div setting	± Step amplitude	Settling error (%)³ at		
			20 ns	100 ns	20 ms
	1 mV/div – 100 mV/div	≤2 V	≤0.5%	≤0.2%	≤0.1%
	101 mV/div – 1 V/div	≤20 V	≤1.0%	≤0.5%	≤0.2%
1.01 V/div – 10 V/div	≤200 V	≤1.0%	≤0.5%	≤0.2%	

¹ The limits given are for the ambient temperature range of 0° C to +30° C. Reduce the upper bandwidth frequencies by 5 MHz for the TDS 600B or by 2.5 MHz for the TDS 500C/700C for each ° C above +30° C.

² The numbers given are valid 0° C to +30° C and will increase as the temperature increases due to the degradation in bandwidth. Rise time is calculated from the bandwidth. It is defined by the following formula:

$$TDS\ 600B\ Rise\ Time\ (ns) = \frac{450}{BW\ (MHz)} \qquad TDS\ 500C/700C\ Rise\ Time\ (ns) = \frac{400}{BW\ (MHz)}$$

Note that if you measure rise time, you must take into account the rise time of the test equipment (signal source, etc.) that you use to provide the test signal. That is, the measured rise time (RT_m) is determined by the instrument rise time (RT_i) and the rise time of the test signal source (RT_{gen}) according to the following formula:

$$RT_m^2 = RT_i^2 + RT_{gen}^2$$

³ The values given are the maximum absolute difference between the value at the end of a specified time interval after the midlevel crossing of the step and the value one second after the midlevel crossing of the step, expressed as a percentage of the step amplitude.

Table 2-17: Typical characteristics — Triggering system

Name	Description			
Accuracy, Trigger Level or Threshold, DC Coupled (for signals having rise and fall times ≥ 20 ns)	Trigger source		Accuracy	
	Any Channel		$\pm((2\% \times \text{Setting} - \text{Net Offset}) + (0.3 \text{ div} \times \text{Volts/div Setting}) + \text{Offset Accuracy})$	
	Auxiliary		Not calibrated or specified	
Input, Auxiliary Trigger	The input resistance is ≥ 1.5 k Ω ; the maximum safe input voltage is ± 20 V (DC + peak AC).			
Trigger Position Error, Edge Triggering	Acquisition mode		Trigger-position error ^{1,2}	
	Sample, Average		$\pm(1 \text{ Waveform Interval} + 1 \text{ ns})$	
	Envelope		$\pm(2 \text{ Waveform Intervals} + 1 \text{ ns})$	
Holdoff, Variable, Main Trigger	For all Time/Division ranges, the minimum holdoff is 250 ns and the maximum holdoff is 12 seconds. The minimum resolution is 8 ns for settings ≤ 1.2 μ s.			
Lowest Frequency for Successful Operation of "Set Level to 50%" Function	30 Hz			
Sensitivity, Edge Trigger, Not DC Coupled ³	Trigger source		Typical signal level for stable triggering	
	AC		Same as the DC-coupled limits for frequencies above 60 Hz. Attenuates signals below 60 Hz.	
	Noise Reject		Three times the DC-coupled limits.	
	High Frequency Reject		One and one-half times the DC-coupled limits from DC to 30 kHz. Attenuates signals above 30 kHz.	
	Low Frequency Reject		One and one-half times the DC-coupled limits for frequencies above 80 kHz. Attenuates signals below 80 kHz.	
Sensitivities, Logic Trigger and Events Delay, DC Coupled ⁴	1.0 division, from DC to 500 MHz, at vertical settings > 10 mV/div and ≤ 1 V/div at the BNC input			
Sensitivities, Pulse-Type Runt Trigger ⁵	1.0 division, from DC to 500 MHz, at vertical settings > 10 mV/div and ≤ 1 V/div at the BNC input			
Sensitivities, Pulse-Type Trigger Width and Glitch ⁶	1.0 division, at vertical settings > 10 mV/div and ≤ 1 V/div at the BNC input			
Width, Minimum Pulse and Rearm, for Logic Triggering or Events Delay	For vertical settings > 10 mV/div and ≤ 1 V/div at the BNC input			
	Triggering type	Minimum pulse width	Minimum re-arm width	Minimum time between channels ⁷
	Logic	Not Applicable	1 ns	1 ns
	Events Delay	1 ns (for either + or - pulse widths)	Not Applicable	2 ns

Table 2-17: Typical characteristics — Triggering system (cont.)

Name	Description		
Width, Minimum Pulse and Rearm, for Pulse Triggering The minimum pulse widths and rearm widths and transition times ⁸ required for Pulse-Type triggering.	For vertical settings > 10 mV/div. and 3 1 V/div at the BNC input		
	Pulse class	Minimum pulse width	Minimum re-arm width
	Glitch	1 ns	2 ns + 5% of Glitch Width Setting
	Runt	2 ns	2 ns
	Time-Qualified Runt	2 ns	TDS 600B: 7 ns + 5% of Width Setting TDS 700C: 8.5 ns + 5% of Width Setting
	Width	1 ns	2 ns + 5% of Width Upper Limit Setting
	Timeout	1 ns	2 ns + 5% of Width Upper Limit Setting
	Slew Rate	600 ps ⁸	TDS 600B: 7 ns + 5% of Delta Time Setting TDS 700C: 8.5 ns + 5% of Delta Time Setting
Setup/Hold Time Violation Trigger, Minimum Clock Pulse Widths	For vertical settings > 10 mV/div and ≤ 1 V/div at the BNC input, the minimum requirements are:		
	Minimum Pulsewidth, Clock High		Minimum Pulsewidth, Clock Low
	Users Hold Time + 2.5 ns ⁹		2 ns
Input Signal Sync Amplitude for Stable Triggering, HDTV and FLEXFMT modes (Option 05 Video Trigger)	All field selections: 0.6 division to 4 divisions		
Jitter for HDTV mode (Option 05 Video Trigger)	17 ns _{p-p}		
Sync Width Flex Format and HDTV modes (Option 05 Video Trigger)	min. 400 ns		
Sync Duty Cycle, Flex Format and HDTV modes (Option 05 Video Trigger)	min. 50 to 1		
Hum Rejection (Option 05 Video Trigger)	NTSC and PAL: -20 dB without any trigger spec deterioration. Triggering will continue down to 0 dB with some performance deterioration.		

- ¹ The trigger position errors are typically less than the values given here. These values are for triggering signals having a slew rate at the trigger point of ≥ 0.5 division/ns.
- ² The waveform interval (WI) is the time between the samples in the waveform record. Also, see the footnote for the characteristics *Sample Rate Range or Interpolated Waveform Rates* in Table 2-4, on page 2-10.
- ³ The minimum sensitivity for obtaining a stable trigger. A stable trigger results in a uniform, regular display triggered on the selected slope. The trigger point must not switch between opposite slopes on the waveform, and the display must not “roll” across the screen on successive acquisitions. The TRIG'D LED stays constantly lighted when the SEC/DIV setting is 2 ms or faster but may flash when the SEC/DIV setting is 10 ms or slower.
- ⁴ The minimum signal levels required for stable logic or pulse triggering of an acquisition, or for stable counting of a DC-coupled, events-delay signal. Also, see the footnote for *Sensitivity, Edge-Type Trigger, DC Coupled* in this table. (Stable counting of events is counting that misses no events and produces no extra, phantom events).

Table 2-17: Typical characteristics — Triggering system (cont.)

Name	Description
5	The minimum signal levels required for stable runt pulse triggering of an acquisition. Also, see the footnote for <i>Sensitivity, Edge-Type Trigger, DC Coupled</i> in this table. (Stable counting of events is counting that misses no events).
6	The minimum signal levels required for stable pulse width or glitch triggering of an acquisition. Also, see the footnote for <i>Sensitivity, Edge-Type Trigger, DC Coupled</i> in this table. (Stable counting of events is counting that misses no events).
7	For Logic, time between channels refers to the length of time a logic state derived from more than one channel must exist to be recognized. For Events, the time is the minimum time between a main and delayed event that will be recognized if more than one channel is used.
8	For Slew Rate Triggering, this is the minimum transition time, defined to be the time the user's signal spends between the two trigger threshold settings.
9	User Hold Time is the number selected by the user in the Hold Time Menu.

