

# User Manual



## **TDSCEM1 Communications Eye-Diagram Measurements Application**

**071-0606-00**

This document supports software version 1.0.0 and above.

### **Warning**

The servicing instructions are for use by qualified personnel only. To avoid personal injury, do not perform any servicing unless you are qualified to do so. Refer to all safety summaries prior to performing service.

Copyright © Tektronix, Inc. All rights reserved. Licensed software products are owned by Tektronix or its suppliers and are protected by United States copyright laws and international treaty provisions.

Use, duplication, or disclosure by the Government is subject to restrictions as set forth in subparagraph (c)(1)(ii) of the Rights in Technical Data and Computer Software clause at DFARS 252.227-7013, or subparagraphs (c)(1) and (2) of the Commercial Computer Software – Restricted Rights clause at FAR 52.227-19, as applicable.

Tektronix products are covered by U.S. and foreign patents, issued and pending. Information in this publication supercedes that in all previously published material. Specifications and price change privileges reserved.

Printed in the U.S.A.

Tektronix, Inc., P.O. Box 1000, Wilsonville, OR 97070–1000

TEKTRONIX and TEK are registered trademarks of Tektronix, Inc.

## WARRANTY

Tektronix warrants that the media on which this software product is furnished and the encoding of the programs on the media will be free from defects in materials and workmanship for a period of three (3) months from the date of shipment. If a medium or encoding proves defective during the warranty period, Tektronix will provide a replacement in exchange for the defective medium. Except as to the media on which this software product is furnished, this software product is provided "as is" without warranty of any kind, either express or implied. Tektronix does not warrant that the functions contained in this software product will meet Customer's requirements or that the operation of the programs will be uninterrupted or error-free.

In order to obtain service under this warranty, Customer must notify Tektronix of the defect before the expiration of the warranty period. If Tektronix is unable to provide a replacement that is free from defects in materials and workmanship within a reasonable time thereafter, Customer may terminate the license for this software product and return this software product and any associated materials for credit or refund.

**THIS WARRANTY IS GIVEN BY TEKTRONIX IN LIEU OF ANY OTHER WARRANTIES, EXPRESS OR IMPLIED. TEKTRONIX AND ITS VENDORS DISCLAIM ANY IMPLIED WARRANTIES OF MERCHANTABILITY OR FITNESS FOR A PARTICULAR PURPOSE. TEKTRONIX' RESPONSIBILITY TO REPLACE DEFECTIVE MEDIA OR REFUND CUSTOMER'S PAYMENT IS THE SOLE AND EXCLUSIVE REMEDY PROVIDED TO THE CUSTOMER FOR BREACH OF THIS WARRANTY. TEKTRONIX AND ITS VENDORS WILL NOT BE LIABLE FOR ANY INDIRECT, SPECIAL, INCIDENTAL, OR CONSEQUENTIAL DAMAGES IRRESPECTIVE OF WHETHER TEKTRONIX OR THE VENDOR HAS ADVANCE NOTICE OF THE POSSIBILITY OF SUCH DAMAGES.**



# Table of Contents

Related Documentation .....	vii
Conventions .....	vii
Contacting Tektronix .....	viii

## Getting Started

<b>Product Description .....</b>	<b>1</b>
Compatibility .....	1
Requirements and Restrictions .....	2
Updates Through a Web Browser .....	2
Accessories .....	2
<b>Installation .....</b>	<b>3</b>
Installing the Application .....	3
Connecting to a System Under Test .....	4

## Operating Basics

<b>Operating Basics .....</b>	<b>5</b>
Application Menu Structure .....	5
Main and Side Menus .....	5
Common Menu Items .....	6
Utility Menus .....	6
Using Basic Oscilloscope Functions .....	6
Using Local Help .....	6
Returning to the Application .....	7
Warning Messages .....	7
Configuring the Display .....	7
Setting Up the Application .....	8
Standard Menu .....	8
Measurement Setup .....	9
Measurement Options .....	10
Display Results Setup .....	11
Taking Measurements .....	11
Saving the Results to a Data Log File .....	12
Importing a Data Log File into a Personal Computer .....	12
Viewing Data .....	13
Saving and Recalling Setups .....	14
Saving a Setup .....	14
Recalling a Setup .....	15
Exiting the Application .....	15
<b>Tutorial .....</b>	<b>17</b>
Connecting to a Communications Signal .....	17
Setting Up the Oscilloscope .....	17
Starting the Application .....	18
Taking Measurements .....	19
Saving the Results to a Data Log File .....	24
Viewing the Results.csv File (Data Log) .....	26

Stopping the Tutorial .....	26
Returning to the Tutorial .....	26
<b>GPIB Program Example .....</b>	<b>27</b>

## Reference

<b>Menu Structure .....</b>	<b>33</b>
<b>Parameters Reference .....</b>	<b>35</b>
Standard Menu .....	35
Measure Menu .....	35
Measure Options Menu .....	36
Logging Menu .....	36
Control Menu .....	37
Utility Menu .....	37

## Appendices

<b>Appendix A: Measurement Algorithms .....</b>	<b>39</b>
Oscilloscope Setup Guidelines .....	39
Test Methodology .....	39
Measurements .....	39
<b>Appendix B: GPIB Command Syntax .....</b>	<b>43</b>
VARIABLE:VALUE TDS COMMAND .....	44
Description .....	44
Syntax .....	44
Arguments and Returns .....	44

## Index

# List of Figures

<b>Figure 1: TDSCEM1 Communication Eye-Diagram Measurements Application</b> .....	<b>1</b>
<b>Figure 2: Connecting to the SUT</b> .....	<b>4</b>
<b>Figure 3: Returning to the application</b> .....	<b>7</b>
<b>Figure 4: Example of a mask pattern with an eye-diagram, the Results readout and a .csv file (data log)</b> .....	<b>13</b>
<b>Figure 5: Starting the application</b> .....	<b>18</b>
<b>Figure 6: TDSCEM1 application initial display</b> .....	<b>19</b>
<b>Figure 7: OC1/STM0 standard mask pattern selected</b> .....	<b>20</b>
<b>Figure 8: An OC1/STM0 eye-diagram, and Results readout</b> .....	<b>21</b>
<b>Figure 9: Measure menu, page 1</b> .....	<b>21</b>
<b>Figure 10: Measure menu, page 2</b> .....	<b>22</b>
<b>Figure 11: Measure menu, page 3</b> .....	<b>22</b>
<b>Figure 12: Measure menu, page 4</b> .....	<b>23</b>
<b>Figure 13: Results readout for all measurements</b> .....	<b>23</b>
<b>Figure 14: Logging setup menu</b> .....	<b>24</b>
<b>Figure 15: Path to the RESULTS.CSV file</b> .....	<b>25</b>
<b>Figure 16: Copying the RESULTS.CSV file to a floppy disk</b> .....	<b>25</b>
<b>Figure 17: Data in a Results.csv file viewed in a spreadsheet program</b> .....	<b>26</b>
<b>Figure 18: Application-specific menu structure</b> .....	<b>33</b>
<b>Figure 19: Control and Utility menu structures</b> .....	<b>34</b>
<b>Figure 20: Eye-diagram and mask pattern values</b> .....	<b>40</b>

# List of Tables

<b>Table 1: Common menu items</b> .....	<b>6</b>
<b>Table 2: Utility menus</b> .....	<b>6</b>
<b>Table 3: Display options</b> .....	<b>7</b>
<b>Table 4: Mask pattern selections and communications standard documents</b> .....	<b>8</b>
<b>Table 5: Measurements</b> .....	<b>9</b>
<b>Table 6: Measurement Options</b> .....	<b>10</b>
<b>Table 7: Control menu items</b> .....	<b>11</b>
<b>Table 8: Logging menu selections</b> .....	<b>12</b>
<b>Table 9: Measure menu parameters</b> .....	<b>35</b>
<b>Table 10: Measure Options menu parameters</b> .....	<b>36</b>
<b>Table 11: Logging menu parameters</b> .....	<b>36</b>
<b>Table 12: Control menu parameters</b> .....	<b>37</b>
<b>Table 13: Utility menus and parameters</b> .....	<b>37</b>
<b>Table 14: Measurements and calculations</b> .....	<b>41</b>
<b>Table 15: VARIABLE:VALUE TDS COMMAND arguments and queries</b> .....	<b>44</b>
<b>Table 16: Measurement results queries</b> .....	<b>46</b>



# General Safety Summary

Review the following safety precautions to avoid injury and prevent damage to this product or any products connected to it. To avoid potential hazards, use this product only as specified.

*Only qualified personnel should perform service procedures.*

While using this product, you may need to access other parts of the system. Read the *General Safety Summary* in other system manuals for warnings and cautions related to operating the system.

**Connect and Disconnect Properly.** Connect the probe output to the measurement instrument before connecting the probe to the circuit under test. Disconnect the probe input and the probe ground from the circuit under test before disconnecting the probe from the measurement instrument.

Do not apply a potential to any terminal, including the common terminal, that exceeds the maximum rating of that terminal.

## Symbols and Terms

**Terms in this Manual.** This term may appear in this manual:



---

**WARNING.** Warning statements identify conditions or practices that could result in injury or loss of life.

---



# Preface

This manual contains operating information for the TDSCEM1 Communication Eye-Diagram Measurements Application. The manual consists of the following chapters:

- The chapter *Getting Started* briefly describes the TDSCEM1 Communication Eye-Diagram Measurements Application, lists oscilloscope compatibility, and provides installation instructions.
- The chapter *Operating Basics* covers basic operating principles of the application and includes a tutorial that teaches you how to set up the application to acquire a waveform, take measurements, and view the results.

To show you how to operate the application using GPIB commands, this chapter includes a simple GPIB program.

- The chapter *Reference* includes a diagram of the menu structure and descriptions of parameters.
- The appendix *Measurement Algorithms* contains information on measurement guidelines and on how the application takes the measurements.
- The appendix *GPIB Command Syntax* contains a list of arguments and values that you can use with the GPIB commands and their associated parameters.

## Related Documentation

The user manual for your oscilloscope provides general information on how to operate the oscilloscope.

## Conventions

This manual uses the following conventions:

- This manual refers to the TDSCEM1 Communication Eye-Diagram Measurements Application as the TDSCEM1 application or as the application.
- When steps require that you make a sequence of selections using front-panel controls and menu buttons, an arrow ( → ) marks each transition between a front panel button and a menu, or between menus. Names that are for a main menu or side menu item are clearly indicated: Press VERTICAL MENU → Coupling (main) → DC (side) → Bandwidth (main) → 250 MHz (side).

## Contacting Tektronix

Product Support	<p>For application-oriented questions about a Tektronix measurement product, call toll free in North America: 1-800-TEK-WIDE (1-800-835-9433 ext. 2400) 6:00 a.m. – 5:00 p.m. Pacific time</p> <p>Or contact us by e-mail: tm_app_supp@tek.com</p> <p>For product support outside of North America, contact your local Tektronix distributor or sales office.</p>
Service Support	<p>Contact your local Tektronix distributor or sales office. Or visit our web site for a listing of worldwide service locations.</p> <p><a href="http://www.tektronix.com">http://www.tektronix.com</a></p>
For other information	<p>In North America: 1-800-TEK-WIDE (1-800-835-9433) An operator will direct your call.</p>
To write us	<p>Tektronix, Inc. P.O. Box 1000 Wilsonville, OR 97070-1000</p>



# Getting Started



# Product Description

The TDSCEM1 Communication Eye-Diagram Measurements Application is a Java™-based application that enhances basic capabilities of TDS oscilloscopes.

The application displays a mask pattern behind the eye-diagram of the communication signal being acquired. This allows you to visually analyze the eye-diagram against the mask pattern. In addition, the application can display other measurements in a numeric format, as well as saving the information to a data log file to view on a personal computer.

Figure 1 shows an example of a standard mask pattern, the eye-diagram of an OC1/STM0 communications signal, and the Results readout.

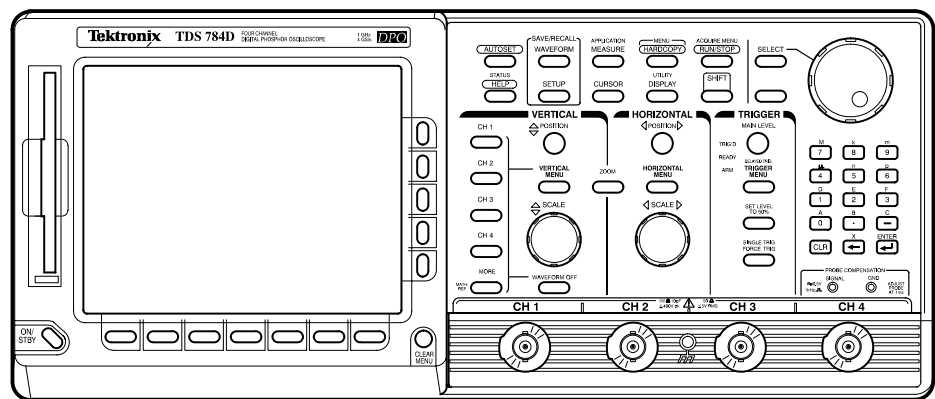

Figure 1: TDSCEM1 Communication Eye-Diagram Measurements Application

## Compatibility

The Communication Eye-Diagram Measurements Application is compatible with the following Tektronix oscilloscopes:

- All TDS 500D and 700D Digital Phosphor Oscilloscopes with Option 2C (Communications Signal Analyzer package) and Option HD (hard disk drive) or Option 2M (hard disk drive plus 8 MB record length); the TDS oscilloscope must also have firmware version 6.4e and up
- TDS 700C Color Digitizing Oscilloscopes with Option 2C (Communications Signal Analyzer package) and Option HD (hard disk drive) or Option 2M (hard disk drive plus 8 MB record length); the TDS oscilloscope must also be serial number B020100 and up, with firmware version 6.4e and up

You can also use this application with Tektronix TDS Option 3C (Short-wavelength Fibre Channel Optical Reference Receiver) or TDS Option 4C (Long-wavelength SONET/SDH Optical Reference Receiver).

For a current list of compatible oscilloscopes, check the Tektronix, Inc. web site, <http://www.tektronix.com/Measurement/scopes/index.html> in the Software and Drivers category.

## Requirements and Restrictions

The TDS Run-Time Environment V1.1.0 and above must be installed on the oscilloscope to operate the TDSCEM1 application.

The TDS Run-Time Environment V1.2.0 and above must be installed on the oscilloscope to use the GPIB commands.

## Updates Through a Web Browser

You can find information about this and other applications at the Tektronix, Inc. web site, <http://www.tektronix.com/Measurement/scopes/index.html> in the Software and Drivers category. Check this site for application updates that you can download and for free applications.

To install an application update, you will need to download it from the Tektronix ftp site to a hard disk, copy it to a blank DOS-formatted floppy disk, and then install it on your oscilloscope.

---

**NOTE.** *More information about changes to the application or installation is in a Readme.txt file on the ftp site. You should read it before you continue.*

---

To copy the application from a web browser, follow these steps:

1. Access the ftp site at <ftp://ftp.tek.com/mbd/support/00-index.html#1>.
2. Scroll through the files to the TDSCEM1 application, select the file, and download it to your hard disk drive. If necessary, unzip the file.
3. Copy the application from the hard disk to a blank, DOS-formatted floppy disk.
4. Follow the *Installing the Application* procedure on page 3.

## Accessories

There are no standard accessories for this product.



# Installation

The TDSCEM1 floppy disk contains the Communication Eye-Diagram Measurements Application. You can download updates, if any, from the Tektronix ftp site through a web browser.

---

**NOTE.** To operate the TDSCEM1 application, the TDS Run-Time Environment V1.1.0 or above must be installed on your oscilloscope. To use GPIB commands, the TDS Run-Time Environment V1.2.0 or above must be installed.

---

## Installing the Application

To install the application from the floppy disk to your oscilloscope, follow these steps:

1. Power off the oscilloscope.

---

**NOTE.** Additional information about the application or installation is located in a Readme.txt file on the floppy disk. You should insert the floppy disk into a DOS-based personal computer and read the Readme.txt file before you continue.

If you are updating the application, the Readme.txt file on the Tektronix ftp site supercedes the Readme.txt file on the TDSCEM1 floppy disk.

---

2. Insert the disk in the floppy disk drive and power on the oscilloscope.

---

**NOTE.** To verify that the TDS Run-Time Environment V1.1 or above is installed, watch for the name to appear at the top of the display when you power on the oscilloscope. If it does not appear, contact your local Tektronix sales office.

---

After performing the power-up selftest, the oscilloscope automatically begins the installation procedure.

As the application loads from the disk, the oscilloscope displays a clock icon to indicate that it is busy. Also, the floppy disk drive LED is on, indicating activity. If the clock icon continues to display after the floppy disk LED has gone out, a problem has occurred with the installation. Repeat the above procedure. If the problem persists, contact your Tektronix representative.

When the installation is complete, an Installation Complete message displays.

3. Remove the floppy disk and cycle the power to the oscilloscope.

## Connecting to a System Under Test

You can use a P6701B or P6703B optical receiver probe to connect between your System Under Test (SUT) and the oscilloscope.

To connect the probe between the SUT and oscilloscope, refer to Figure 2 and follow these steps:



**WARNING.** To avoid electric shock, you must ensure that power is removed from the SUT before attaching a probe to it. Do not touch exposed conductors except with the properly rated probe tips. Refer to the probe manual for proper use.

1. Power down the SUT.
2. Connect the optical receiver probe to CH 1 of the oscilloscope.
3. Press VERTICAL MENU → Probe Functions (main) → Cal Probe (side).

This removes the dark level (Pdark) from the signal which allows the cursors to read the true signal power levels.

4. Connect the optical receiver probe to a communication signal in the SUT.

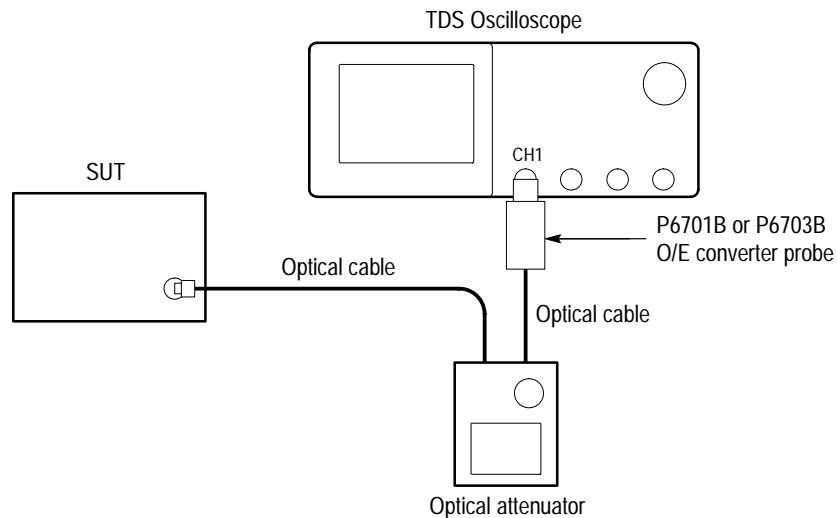

Figure 2: Connecting to the SUT



# Operating Basics



# Operating Basics

This section contains information on the following topics and tasks:

- Application menu structure
- Using basic oscilloscope functions
- Warning messages
- Configuring the display
- Setting up the application
- Taking measurements
- Storing the results to a data log file
- Importing the data log file into a personal computer
- Viewing the results
- Saving and recalling setups
- Exiting the application

## Application Menu Structure

There are two types of menus in the application menu structure: main menus and side menus. Some side menus contain common menu items as shown in Table 1.

### Main and Side Menus

The main menu names appear in the bottom of the display and the side menu names appear on the right side of the display. To see the complete application menu structure, refer to Figure 18 on page 33.

When you press the front-panel button associated with a main menu, the side menu changes. In many cases, when you press a side menu, new side menu items appear. As an example, the next figure shows you how to access the Help selections through the main Utility menu and the Help side menu.

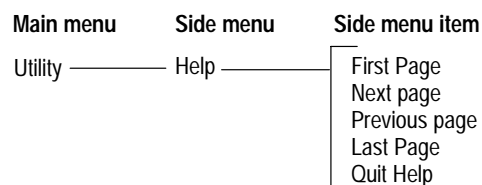

**Common Menu Items** Table 1 lists common side menu items.

**Table 1: Common menu items**

Menu item	Description
Cancel	Cancels the message being displayed
Done	Indicates that you are through making changes to that set of side menus. The application returns to the previous menu
OK	Confirms the action

**Utility Menus** Table 2 lists the Utility menus.

**Table 2: Utility menus**

Utility name	Description
Help	Accesses the online help information and views various pages
Exit	Exits the application
Save/Recall Setup	Accesses the save and the recall menus for application setups
Display Options	Accesses other menus where you can change display settings, such as the message box location on the display

## Using Basic Oscilloscope Functions

You can use the Utility menu to access help information about the application. You can also use other oscilloscope functions and easily return to the application.

**Using Local Help** The application includes local help information about the measurements modes, with some explanation of the individual controls.

To display the local help, follow these steps:

1. Press Utility (main) → Help (side).
2. Use the side menu buttons to navigate through the help.

### Returning to the Application

You can easily switch between the TDSCEM1 application and other oscilloscope functions.

To access other oscilloscope functions, press the desired front panel control. To return to the application, push the SHIFT and then the APPLICATION front-panel menu buttons as shown in Figure 3.

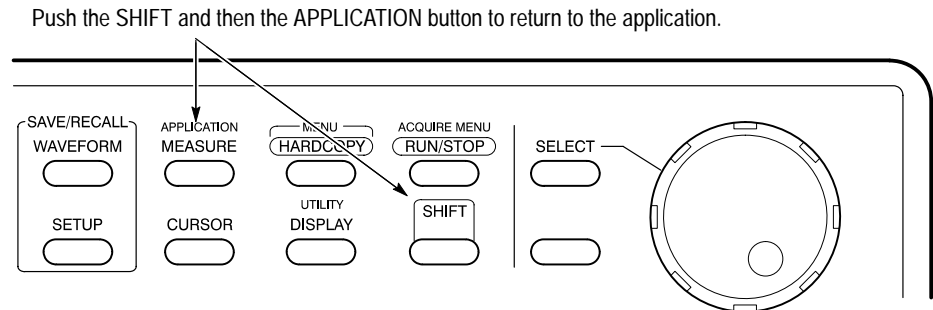

Figure 3: Returning to the application

### Warning Messages

All eye-diagram measurements provide a warning if the input conditions on channel 1 do not support accurate measurements. For example, the OC12 standard mask selection warns you if the signal is outside the expected rate.

### Configuring the Display

You can change how dialog boxes appear on your oscilloscope, as well as the color of waveforms. The next figure shows how to access the Display Options menu and Table 3 lists the options with a brief description of each.

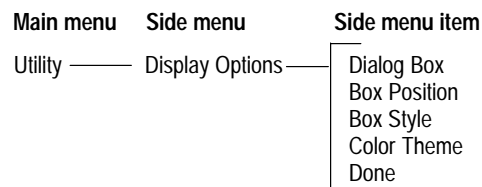

Table 3: Display options

Option	Description
Dialog box (visibility)	Select Show or Hide to make dialog boxes visible or invisible
Box position	Select where on the display to position dialog boxes: Left, Middle, or Right

**Table 3: Display options (Cont.)**

Option	Description
Box style	Select the style of dialog boxes to be Opaque or Transparent
Color Theme	Select a set of colors for waveforms and dialog boxes. The application offers seven color themes

## Setting Up the Application

You can set up the application to take eye-diagram measurements based on a standard mask pattern, and to display the results or save them to a data log file.

### Standard Menu

The next figure shows how to access the standard mask pattern selections.

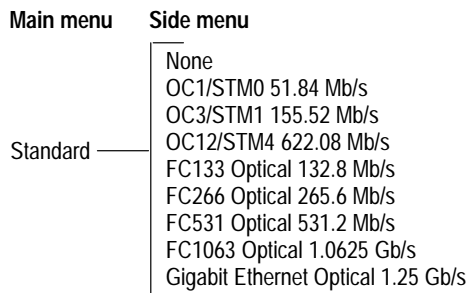

Table 4 lists the mask pattern selections and the corresponding communication standard document to which each measurement complies.

**Table 4: Mask pattern selections and communications standard documents**

Standard menu selection	Communication standard document
OC1/STM0 51.84 Mb/s OC3/STM1 155.52 Mb/s OC12/STM4 622.08 Mb/s	<i>GR-253-CORE ISSUE 1, December 1994, Synchronous Optical Network (SONET) Transport Systems: Common Generic Criteria, Bellcore</i>
FC133 Optical 132.8 Mb/s FC266 Optical 265.6 Mb/s FC531 Optical 531.2 Mb/s FC1063 Optical 1.0625 Gb/s	<i>ANSI X3.230-1994 Fibre Channel - Physical and Signaling Interface (FC-PH)</i>
Gigabit Ethernet Optical 1.25 Gb/s	<i>ANSI/IEEE 802.3 Fifth Edition 1996 – Information Technology – Telecommunications and Information Exchange Standard</i>



## Measurement Setup

The next figure shows how to access the measurement selections and Table 5 lists the TDSCEM1 measurements with a brief description of each.

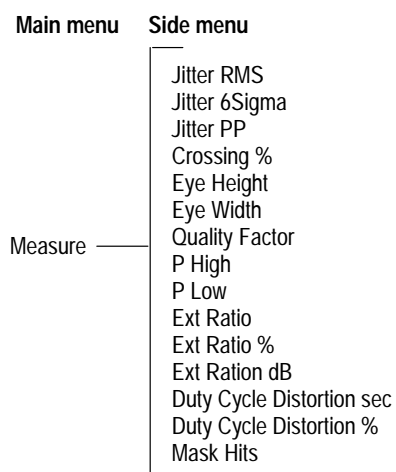

**Table 5: Measurements**

Measurement name	Description
Jitter RMS	The RMS value of the edge jitter of the communication signal in seconds
Jitter 6Sigma	The "6 sigma" value of the edge jitter of the communication signal in seconds
Jitter PP	The peak-to-peak value of the edge jitter of the communication signal in seconds
Crossing %	The crossing point of the communication signal as a percentage of the height of the eye-diagram
Eye Height	The height of the communication signal in watts
Eye Width	The height of the communication signal in seconds
Quality Factor	The ratio of the size of the communication signal to the "noise" on the signal
P High	The highest power level of the communication signal in watts
P Low	The lowest power level of the communication signal in watts
Ext Ratio	The ratio of the top of the communication signal to its base
Ext Ratio %	The ratio of the top of the communication signal to its base as a percentage
Ext Ratio dB	The ratio of the top of the communication signal to its base in dBs
Duty Cycle Distortion sec	Difference between the maximum and the minimum signal crossing times at 50% of the level

**Table 5: Measurements (Cont.)**

Measurement name	Description
Duty Cycle Distortion %	Difference between the maximum and the minimum signal crossing times as a percentage of the bit period
Mask Hits	The number of mask hits

### Measurement Options

The next figure shows how to access the Measurement Options menu and Table 6 lists the measurement options with a brief description of each.

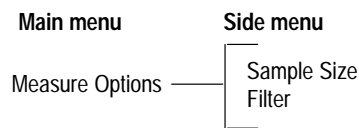

**Table 6: Measurement Options**

Option name	Description
Sample Size	The number of records needed in the eye-diagram to determine when the results are stable; results are more accurate with more samples
Filter	Enables or disables the Bessel Thompson filter and changes the settings of the oscilloscope accordingly

To enable the Bessel Thompson filter, press the AUTOSET front-panel button.

---

**NOTE.** *Once the Bessel-Thompson filter is enabled, changing some settings on the oscilloscope will disable it. However, the display will not update and the filter will appear to still be enabled, even though it is not.*

---

To use the Bessel Thompson filter, the TDS oscilloscope must use the following setups:

- Only use CH 1 to acquire the communications signal
- Set all other channels to Off
- In the VERTICAL MENU, set the Deskew to 0.0 on all channels
- In the ACQUIRE MENU, set the Acquisition mode to Sample
- In the MEASURE menu, enable the Filter through the Measure (main) → Masks (main) → Mask Options (main) menu.

- In the ZOOM menu, set the Zoom Mode to Off and then use the VERTICAL SCALE knob to set the Vert Attenuation to 20, 50, or 100  $\mu\text{W}$  per division or to a specific value between 20  $\mu\text{W}$  and 100  $\mu\text{W}$ .

### Display Results Setup

The measurement results (see Table 5 on page 9) display in a Results readout dialog box. To view the mask pattern, eye-diagram, and the results, change the configuration of the Results readout through the Display Options side menu.

## Taking Measurements

When the measurement parameters are set up, you can acquire data from the communications signal. To do so, follow these steps:

1. Press Control (main). Table 7 lists menu items in the Control menu.

**Table 7: Control menu items**

Menu item	Description
Mode	
Single	Performs measurements on a single acquisition and stops
Free Run	Repeatedly acquires the signal, and takes measurements
Start	The application starts to take measurements from the signal
Pause	The application stops taking measurements and waits for a Continue
Continue	When paused, the application continues taking measurements
Stop	The application stops taking measurements

2. Press Mode (side) to select Single or Free Run acquisition mode.
3. Press Start (side).

---

**NOTE.** Do not change oscilloscope settings while a measurement is being taken. Doing so can invalidate the measurement.

---

## Saving the Results to a Data Log File

You can save the measurement results in a data log file. The next figure shows the Logging setup menu and Table 8 lists the TDSCEM1 data log file selections with a brief description of each.

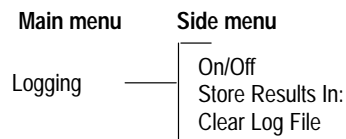

**Table 8: Logging menu selections**

Data log file	Description
On/Off	Stores the measurement results in a .csv file that you can view later on a personal computer
Store Results In:	Allows you to name the .csv file; the extension must be .csv
Clear Log File	Resets all result values to zero. You must disable the log file before you can clear its contents

## Importing a Data Log File into a Personal Computer

You can import the data log file (.csv file) into into a spreadsheet, database, or data analysis program on your personal computer for further analysis. To do so, follow these steps:

1. Insert a blank DOS-formatted floppy disk into the floppy disk drive of the oscilloscope.
2. Copy the .csv file from the hd0: to the fd0:. Refer to the Tutorial section.
3. Insert the floppy disk into the floppy disk drive on your personal computer.
4. Copy the .csv file.
5. Open the file using a spreadsheet, database, or data analysis program.

The rows represent successful measurements. The columns represent each type of measurement taken. Figure 4 on the next page shows an example of the .csv file viewed in a spreadsheet program on a personal computer.

## Viewing Data

The application displays the selected mask pattern with the eye-diagram of the communications signal for visual analysis, and can display the results from selected measurements as numeric values in a Results readout. (You can also log the data to a .csv file for viewing on a personal computer.)

Figure 4 shows an example of the various ways to view the measurement data.

Mask pattern with eye-diagram

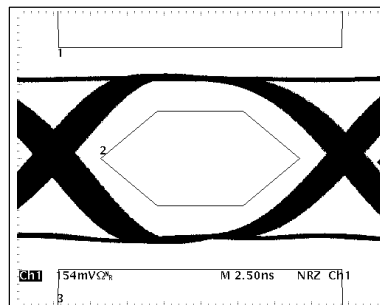

Results readout

Jitter 6Sig	=	1.2768ns
Jitter RMS	=	212.8ps
Jitter PP	=	1.0999ns
Crossing	=	48.473%
Ext ratio	=	24.818
Ext ratio	=	4.0293%
Ext ratio	=	13.947dB
Eye height	=	214.00uW
Eye width	=	18.051ns
Quality Fact	=	16.375
P high	=	273.00uW
P low	=	11.0uW
D cycle dist	=	1.0ns
D cycle dist	=	5.184%
Mask Fail%	=	0.0%

	Jitter RMS	Jitter 6Sig	Jitter PP	Crossing	Eye Height	Eye Width	Qual Fact	P High	P Low	Ext Ratio	Ext Ratio %	Ext Ratio dB	D Cycle Dist sec	D Cycle Dist %	Mask Hits
	A	B	C	D	E	F	G	H	I	J	K	L	M	N	O
1	1.95E-10	1.17E-09	1.05E-09	48.67925	2.23E-04	1.81E-08	18.92857	2.75E-04	1.00E-05	27.5	3.636364	14.3933	1.00E-09	5.184	0
2	2.12E-10	1.27E-09	1.10E-09	48.85496	2.23E-04	1.81E-08	20.15385	2.73E-04	1.10E-05	24.8182	4.029304	13.9476	1.10E-09	5.7024	0
3	2.04E-10	1.22E-09	1.15E-09	49.61538	2.24E-04	1.80E-08	21.66667	2.71E-04	1.10E-05	24.6364	4.059041	13.9157	1.05E-09	5.4432	0
4	1.95E-10	1.17E-09	1.05E-09	49.23664	2.23E-04	1.82E-08	20.15385	2.72E-04	1.00E-05	27.2	3.676471	14.3456	1.00E-09	5.184	0

A .csv file viewed in a spreadsheet program on a personal computer

Figure 4: Example of a mask pattern with an eye-diagram, the Results readout and a .csv file (data log)

To view parts of the mask pattern and eye-diagram that are obscured by the Results readout, push the CLEAR MENU button. To return to the application, push the SHIFT then the APPLICATION front-panel menu buttons.

**NOTE.** To view the mask pattern, eye-diagram, and the results, you can change the configuration of the display through Utility (main) → Display Options (side).

The next figure shows how to make the Results readout visible or invisible.

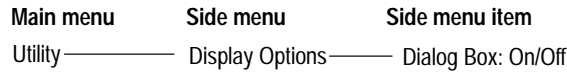

---

**NOTE.** The Results readout does not have to be visible to save measurements to a data log file. The application can save the measurement results to a data log file while the oscilloscope displays the mask pattern and eye-diagram, and takes measurements.

---

## Saving and Recalling Setups

You can use the Save/Recall Setup menu to save and recall application setups. The TDSCEM1 application Save/Recall function is totally independent of the primary oscilloscope Save/Recall function stored in nonvolatile RAM.

The next figure shows how to access the Save/Recall Setup menu.

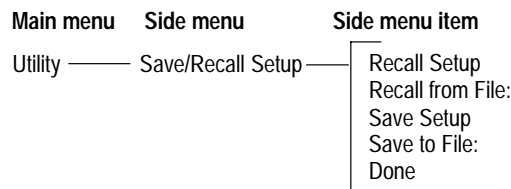

---

**NOTE.** Press Utility (main) → Save/Recall Setup (side) to access the menu items that you can use to save and to recall setup files.

---

### Saving a Setup

To save the application setup to the file displayed in the Save to File: menu item, press Save Setup (side).

To create a new file in which to save the application setup, follow these steps:

1. Press Save to File: (side).
2. Use the direction arrows and Delete Char (side) to clear the existing file name or part of the file name.
3. Use the General Purpose (GP) knob to select each character in the file name. Press Enter Char (side) after selecting each character.

The file name can be up to eight characters long.

4. Press OK Accept (side) to save the file name.
5. Press Save Setup (side) to store the application setup in the file just created.
6. Press Done (side).

Application setups are always saved in the APPS/TDSCEM1/TEMP directory (accessed through the File Utilities menu) on the oscilloscope. Once you have saved a setup, you must recall it to use it again.

### Recalling a Setup

To recall the application settings from the Default setup file or from a saved setup file, follow these steps:

1. Press Recall from File: (side) until Default or the desired setup file name displays.

---

**NOTE.** *The application always starts with the settings in the Default setup file.*

---

2. Press Recall Setup (side).
3. Press Done (side).

### Exiting the Application

To exit the application, press Utility (main) → Exit (side). To confirm, press OK (side).





# Tutorial

This tutorial teaches you how to setup and take measurements, and view the results on the display or from a log file. In addition, it teaches you how to exit the application and how to save and recall setups. Further operating information is located in the *Operating Basics* section.

Before you begin the tutorial, you need to do the following tasks:

- Connect to a communication signal
- Set up the oscilloscope
- Start the application

---

**NOTE.** *This tutorial uses a standard communication signal from the Tektronix Quick Start 7 board. Your results will match those shown in this section if you connect your TDS oscilloscope to the same signal.*

---

## Connecting to a Communications Signal

Connect an optical receiver probe between the OC1/STM0 communications signal on the Quick Start 7 board and CH 1 on your TDS oscilloscope as described in *Connecting to a System Under Test* on page 4.

Be sure to calibrate the probe and power up the Quick Start 7 board.

## Setting Up the Oscilloscope

To set up the oscilloscope, follow these steps:

1. Press SETUP → Recall Factory Setup (main) → OK Confirm Factory Init (side) to set the oscilloscope to the default factory settings.
2. Press the VERTICAL MENU → Ch 1 Coupling Impedance (main) → DC (side) →  $\Omega$  and select 50.
3. Press WAVEFORM OFF as often as necessary to remove all waveforms from the display.

## Starting the Application

To perform these lessons, the TDSCEM1 application must be installed on the oscilloscope. See *Installation* on page 3.

To start the application, follow these steps:

1. Press SETUP → Select Application (main).
2. Use the general purpose (GP) knob to select hd0:, and press SELECT. See Figure 5.

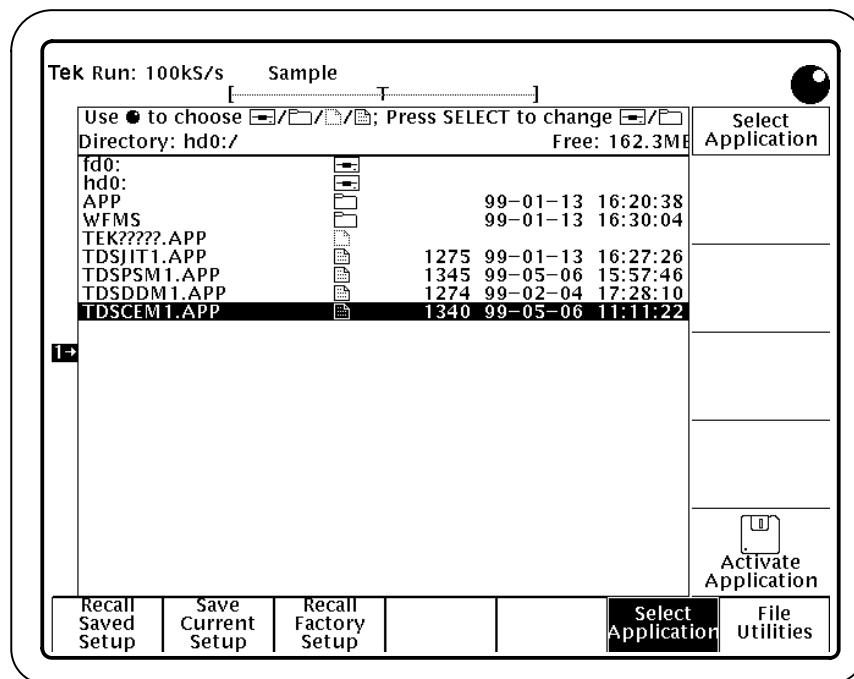

**Figure 5: Starting the application**

3. Use the GP knob to select the TDSCEM1.APP file and press Activate Application (side).

The application starts up and displays as shown in Figure 6.

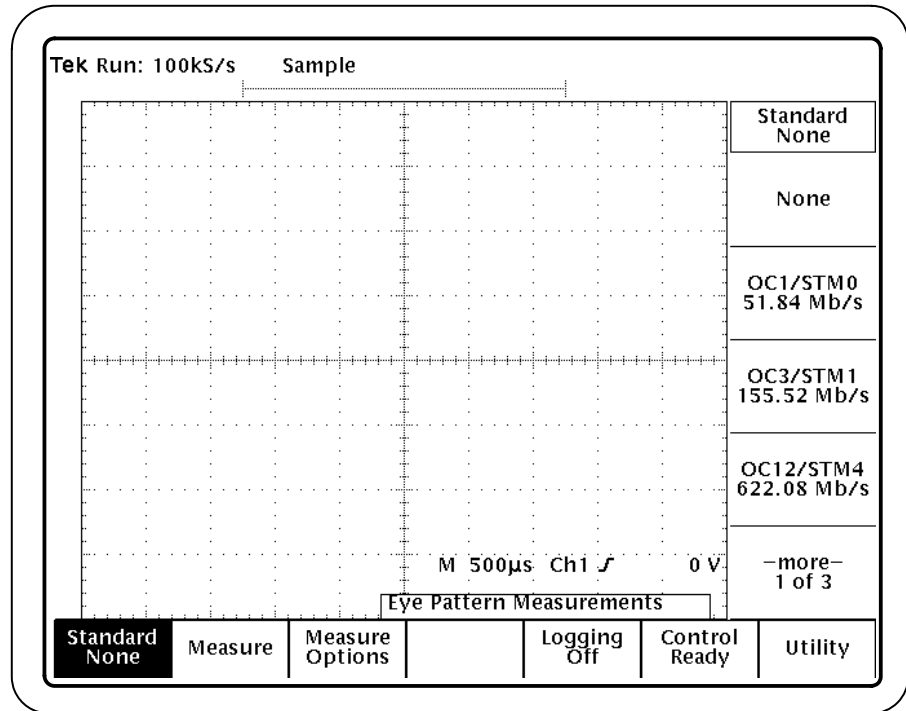

Figure 6: TDSCEM1 application initial display

## Taking Measurements

In this lesson, you will learn how to use the TDSCEM1 application to take measurements from an eye-diagram and its corresponding standard mask pattern.

To become familiar with communication eye-diagram measurements, follow these steps:

1. Press Standard (main) → OC1/STM0 51.84 Mb/s (side).

Figure 7 shows the Standard setup menu with the OC1/STM0 mask pattern selected.

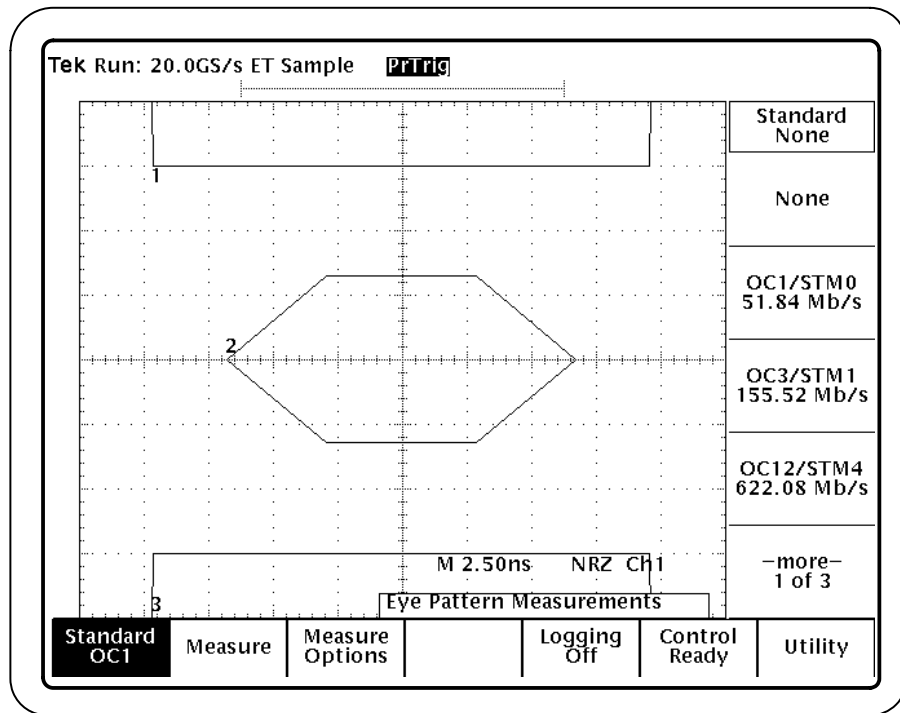

**Figure 7: OC1/STM0 standard mask pattern selected**

2. Press CH 1 to display the OC1/STM0 waveform.
3. To take the measurement, press Control (main) → Start (side).

The Control menu (main) displays Control Sequencing while the application is executing. When the Control menu displays Control Ready, the application has completed the calculations.

---

**NOTE.** The TDSCEM1 application properly aligns the eye-diagram of the communications signal over the selected mask pattern.

---

4. Wait for the calculations to complete. Figure 8 shows the mask pattern, the OC1/STM0 eye-diagram, and the measurement Results readout.

---

**NOTE.** By default, the Jitter 6 Sigma and Crossing measurements display.

---

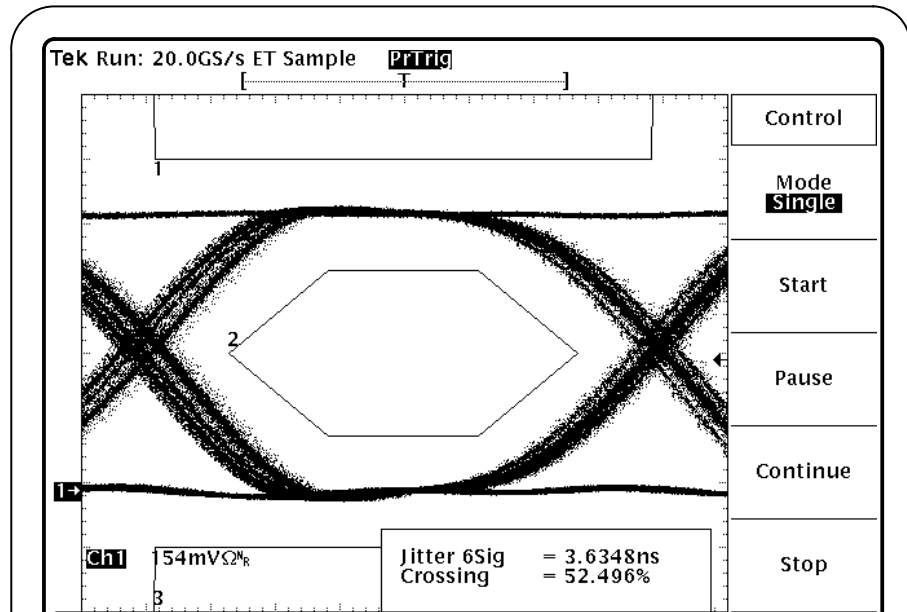

Figure 8: An OC1/STM0 eye-diagram, and Results readout

5. Press Measure (main) and set all the measurements to “On.” Figures 9, 10, 11, and 12 show all the measurements selected.

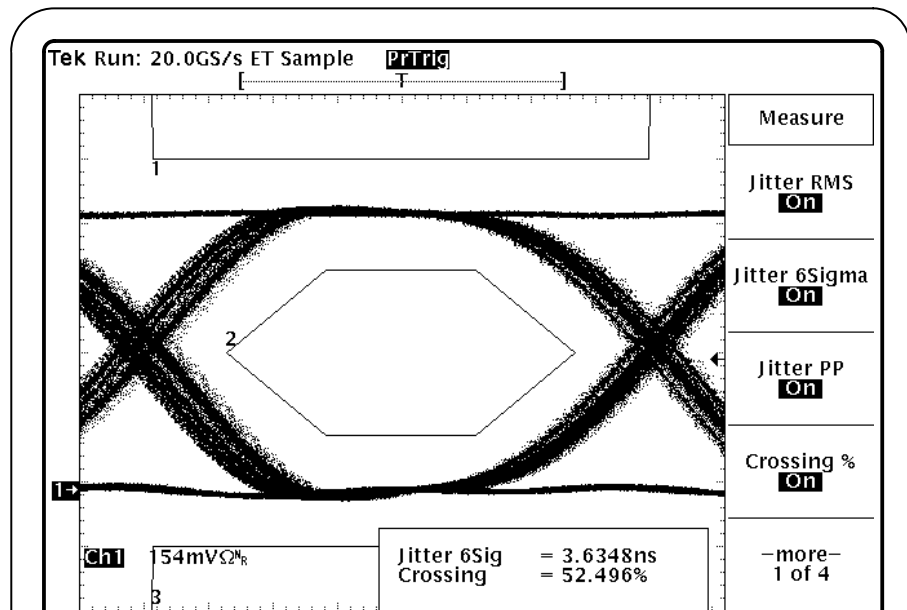

Figure 9: Measure menu, page 1

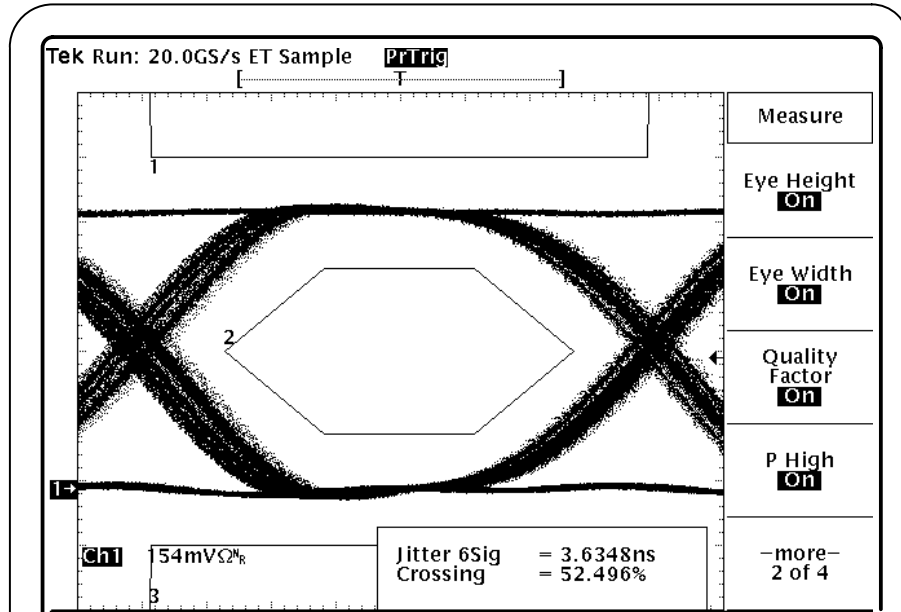

Figure 10: Measure menu, page 2

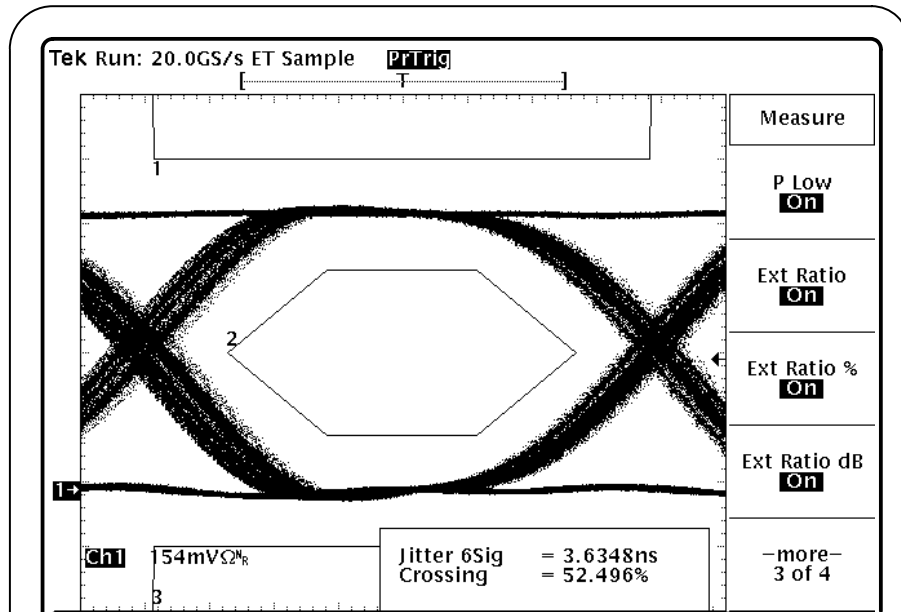

Figure 11: Measure menu, page 3

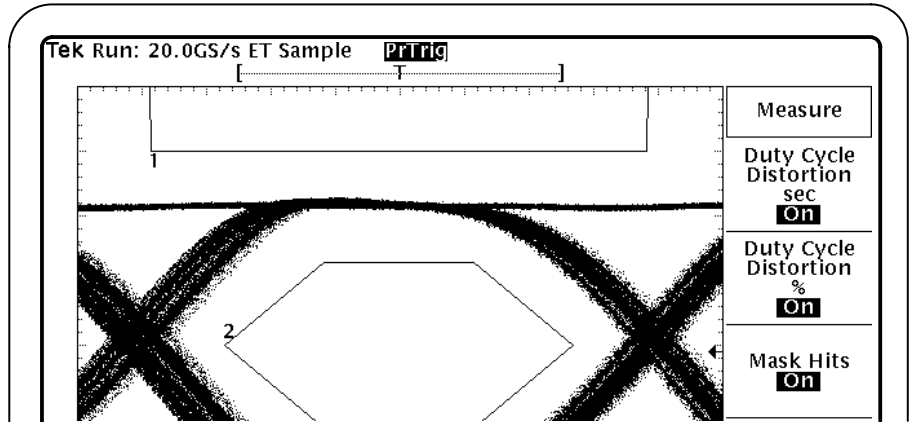

Figure 12: Measure menu, page 4

- To take the measurement, press Control (main) → Start (side). Figure 13 shows the Results readout for all the measurements.

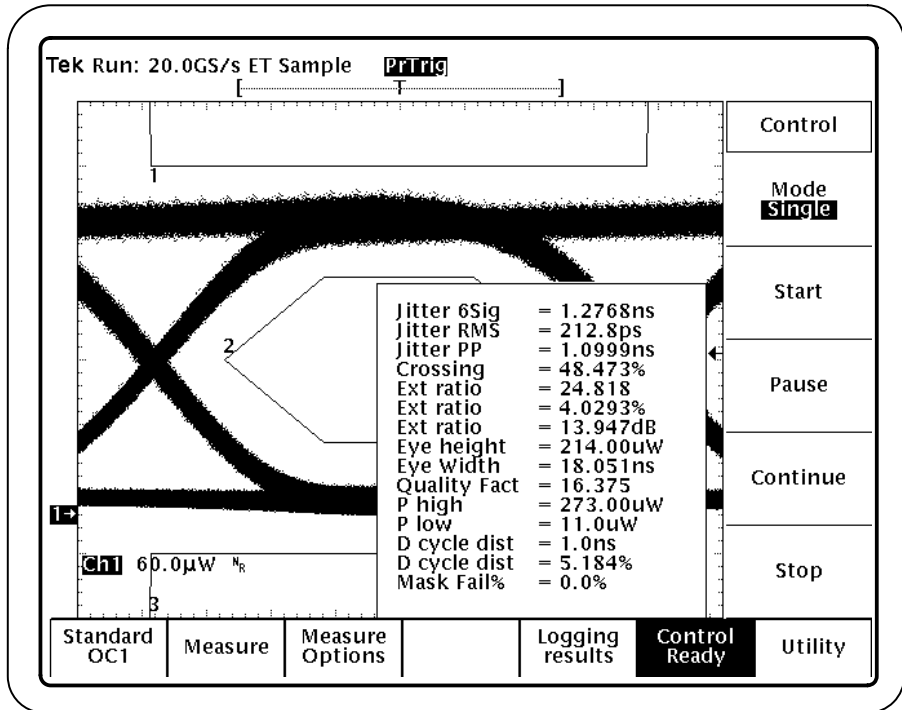

Figure 13: Results readout for all measurements

## Saving the Results to a Data Log File

To save the measurement results to a data log file, follow these steps:

1. Press Logging (main) → On (side). Figure 14 shows the Logging setup menu.

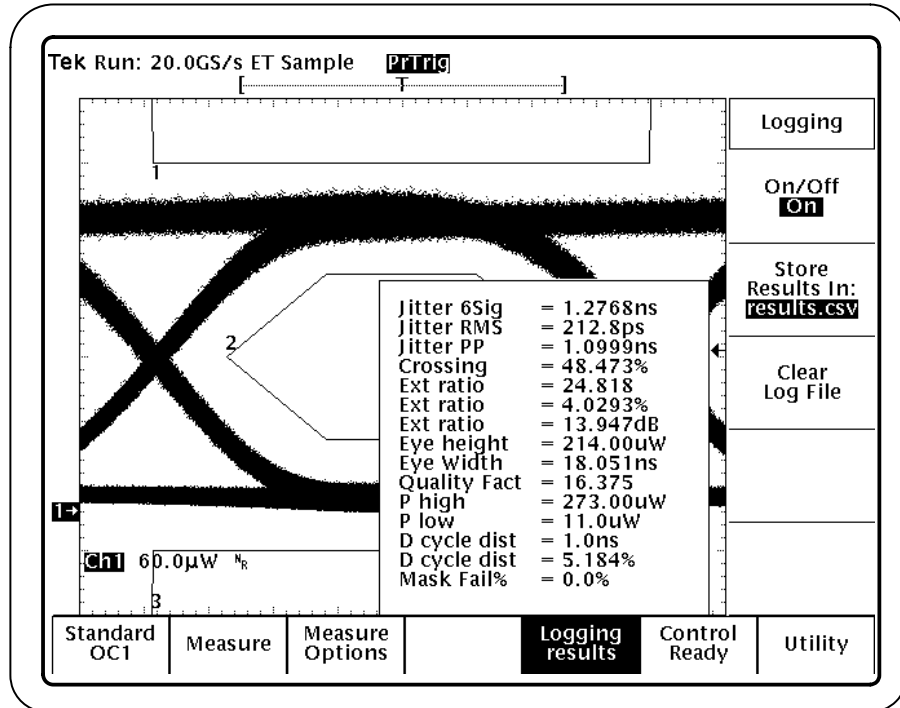

Figure 14: Logging setup menu

2. To log the results to a .csv file, press Control (main) → Start (side).

The “comma separated variable” file format (.csv) is compatible with many spreadsheet, database, or data analysis programs on a personal computer.

3. After the measurement completes, press Control (main) → Start (side) to log more data to the results.csv file. Repeat this step two more times. There are now four rows of data in the results.csv file.
4. To copy the results.csv file to a floppy disk to view on a personal computer, follow these steps:
  - a. Insert a blank DOS-formatted floppy disk into the floppy disk drive on the oscilloscope.
  - b. Press SAVE/RECALL SETUP → File Utilities (main).



- c. Use the GP knob to highlight APP and press SELECT.
- d. Use the GP knob to highlight TDSCEM1 and press SELECT.
- e. Use the GP knob to highlight TEMP and press SELECT.

Figure 15 shows the RESULTS.CSV file and the path to it.

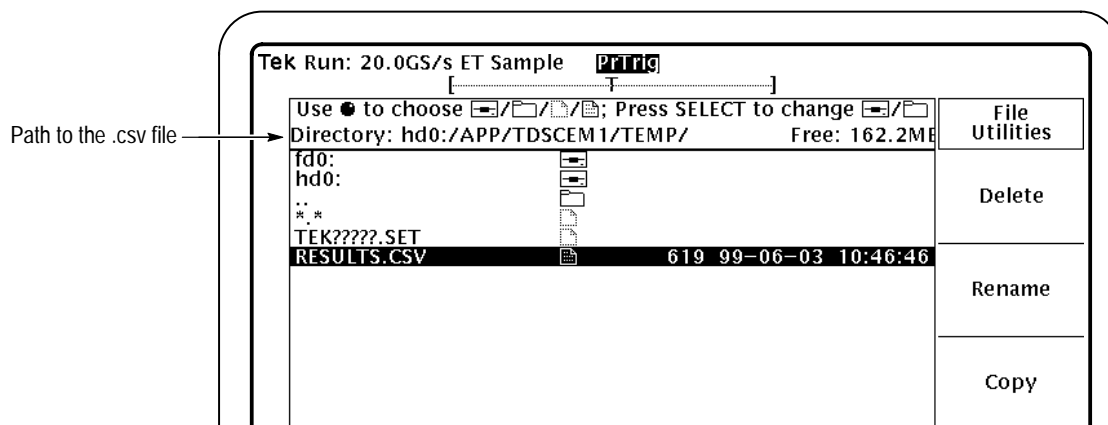

Figure 15: Path to the RESULTS.CSV file

- f. Use the GP knob to highlight RESULTS.CSV and press Copy (side).
- g. Use the GP knob to highlight fd0: and press Copy RESULTS.CSV to selected directory (side). Figure 16 shows this side menu item.

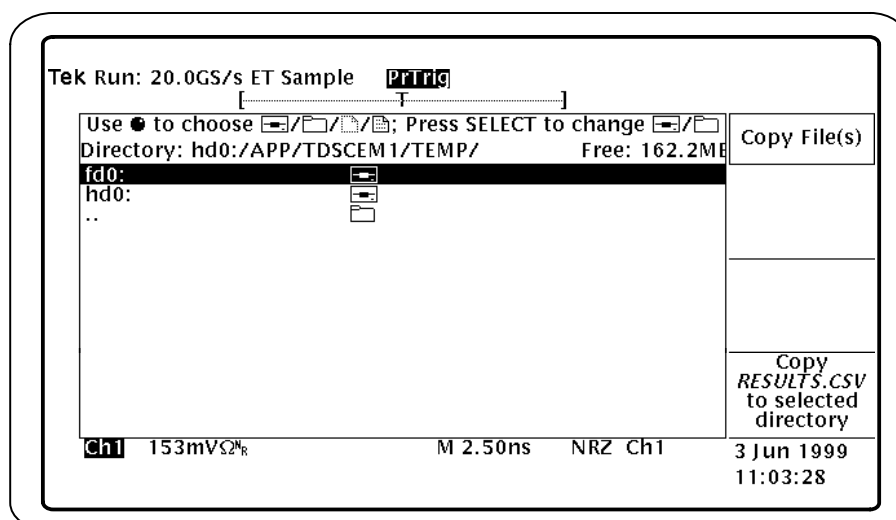

Figure 16: Copying the RESULTS.CSV file to a floppy disk

- Eject and remove the floppy disk from the floppy disk drive.

## Viewing the Results.csv File (Data Log)

You can import the RESULTS.CSV file to a DOS-based personal computer and then view the data log file with a spreadsheet, database, or data analysis program. Figure 17 shows an example of how the RESULTS.CSV file might look in a spreadsheet program on a personal computer.

	Jitter RMS	Jitter 6Sig	Jitter PP	Crossing	Eye Height	Eye Width	Qual Fact	P High	P Low	Ext Ratio	Ext Ratio %	Ext Ratio dB	D Cycle Dist sec	D Cycle Dist %	Mask Hits
	A	B	C	D	E	F	G	H	I	J	K	L	M	N	O
1	1.95E-10	1.17E-09	1.05E-09	48.67925	2.23E-04	1.81E-08	18.92857	2.75E-04	1.00E-05	27.5	3.636364	14.3933	1.00E-09	5.184	0
2	2.12E-10	1.27E-09	1.10E-09	48.85496	2.23E-04	1.81E-08	20.15385	2.73E-04	1.10E-05	24.8182	4.029304	13.9476	1.10E-09	5.7024	0
3	2.04E-10	1.22E-09	1.15E-09	49.61538	2.24E-04	1.80E-08	21.66667	2.71E-04	1.10E-05	24.6364	4.059041	13.9157	1.05E-09	5.4432	0
4	1.95E-10	1.17E-09	1.05E-09	49.23664	2.23E-04	1.82E-08	20.15385	2.72E-04	1.00E-05	27.2	3.676471	14.3456	1.00E-09	5.184	0

Figure 17: Data in a Results.csv file viewed in a spreadsheet program

## Stopping the Tutorial

If you need more than one session to complete the tutorial lessons, you can stop the tutorial and return to it another time. To do so, you will need to save the oscilloscope setup and then the application setup.

To save the oscilloscope setup, refer to the user manual for your oscilloscope. The procedure varies between models.

To save the application setup and stop your session, refer to *Saving a Setup* on page 14 and to *Exiting the Application* on page 15.

## Returning to the Tutorial

To return to the tutorial setup, you can recall the saved oscilloscope setup from the hard disk, and then restart the application.

To recall the oscilloscope setup, refer to the user manual for your oscilloscope. The procedure varies between models.

To recall the application setup, refer to *Recalling a Setup* on page 15.

# GPIB Program Example

This section contains an example of a GPIB program that can execute the TDSCEM1 application.

To execute the TDSCEM1 application with a GPIB program, the program should comply with the following guidelines:

- Turn on the GPIB response leaders with the “HEADER OFF” command; refer to the programmer manual for your TDS oscilloscope
- The application startup must complete before sending additional GPIB commands to the application (see example)
- The measurements cycle must complete before data is queried (see example)
- The error variable should be checked to ensure that an error has not occurred because of a measurement command problem

This example shows how a GPIB program might execute the application to do the following tasks:

- Start the application
- Select a mask pattern
- Enable a measurement
- Set the sample size
- Enable the logger
- Take a measurement
- Check for an error
- Exit the application

Refer to *Appendix B: GPIB Command Syntax* for a complete list of the GPIB command syntax with the arguments, variables and variable values.

```

/* C Example Program:    TDSCEM1 GPIB control                */
/* =====
 * This sample program is for the Tektronix Java-based TDSCEM1
 * Communication Eye-Diagram Measurements Application
 */

#include <string.h>
#include <stdio.h>
#include <sys/timeb.h>
#include <windows.h>
#include "C:\Program Files\NationalInstruments\GPIB\NI488\LangInt\C\decl-32.h"

int start_application(/* in */ int scope);
int do_single_measurement(/* in */ int scope);

void main (void)
{
    char  read_buffer      [100] = "";
    char  write_buffer     [100] = "";
    int   scope;
    int   status;
    /*
     * Open session with for IBIC
     */
    scope = ibfind ("DEV2");
    status = ibpad (scope, 1);
    status = ibtmo (scope, T10s);

    /*
     * Start Application
     */
    if (start_application(scope)){
        printf ("Application is started up!\n");

        /*
         * Select a mask standard
         */
        sprintf (write_buffer, "%s", "Variable:value \"maskStandard\", \"OC1\"");
        status = ibwrt (scope, write_buffer, strlen (write_buffer));

        /*
         * Turn on Jitter RMS measurement
         */
        sprintf (write_buffer, "%s", "Variable:value \"jitterRmsState\", \"On\"");
        status = ibwrt (scope, write_buffer, strlen (write_buffer));
    }
}

```

```
/*
 * Set sample size to 32
 */
sprintf (write_buffer, "%s", "Variable:value \"sampleSize\", \"32\"");
status = ibwrt (scope, write_buffer, strlen (write_buffer));

/*
 * Turn on the logger
 */
sprintf (write_buffer, "%s", "Variable:value \"loggerState\", \"On\"");
status = ibwrt (scope, write_buffer, strlen (write_buffer));
/*
 * Do a single measurement
 */
if (do_single_measurement(scope)){
    /*
     * Query measurement result
     */
    sprintf (write_buffer, "%s", "Variable:value? \"jitterRMS\"");
    status = ibwrt (scope, write_buffer, strlen (write_buffer));
    status = ibrd (scope, read_buffer, sizeof (read_buffer));
    if (ibcnt != 3) { /* It's not an empty string */
        read_buffer [ibcnt] = 0; /* Get rid of extra characters */
        printf ("jitterRMS? %s\n", read_buffer);
    }
    else{
        printf ("*** Computation Error ***\n");
    }
}
else{
    printf ("*** Measurement fails ***\n");
}
}
else{
    printf ("*** Fails to start Application ***\n");
    return;
}

/*
 * Exit application
 */
printf ("Exit application!\n");
sprintf (write_buffer, "%s", "Variable:value \"application\", \"exit\"");
status = ibwrt (scope, write_buffer, strlen (write_buffer));

/*
 * Program Ending
 */
printf ("Program Terminating Normally\n\n");
}
```

```

/*-----
 * Function: start_application
 * Argument: scope
 * Return: 1 if success, 0 otherwise
 *
 * This function starts the application and confirms the completion of startup
 */
int start_application(/* in */ int scope)
{
    char read_buffer [100];
    char write_buffer [100];
    char app_name[30] = "\"TDSCEM1\"\\n";
    int status;
    int timer = 0;
    int i = 0;

    /*
     * Start Application
     */
    sprintf (write_buffer, "%s", "Application:activate \\hd0:/tdscem1.app\\");
    status = ibwrt (scope, write_buffer, strlen (write_buffer));
    printf ("Starting application, please wait...\\n");
    do{
        /* Wait for application to completely start up */
        timer = timer + 2;
        if (timer > 30) { /* The application normally take 24 seconds to start up */
            printf ("***Application start up time out***\\n");
            return 0; /* Something is wrong if application does start up*/
        }
        sprintf (write_buffer, "%s", "Variable:value? \\application\\");
        status = ibwrt (scope, write_buffer, strlen (write_buffer));
        status = ibrd (scope, read_buffer, sizeof (read_buffer));
        read_buffer [ibcnt] = 0; /* Get rid of extra characters */
        Sleep(2000);
    }while (strcmp(app_name, read_buffer) != 0);
    /* Application start up! */

    return 1;
}

```

```

/*-----
 * Function: do_single_measurement
 * Argument: scope
 * Return: 1 if success, 0 otherwise
 *
 * This function does a single measurement and checks error status
 */
int do_single_measurement(/* in */ int scope)
{
    char read_buffer    [100];
    char write_buffer   [100];
    char state[10]      = "\"Ready\"\n";
    int status;
    int timer = 0;
    int i = 0;

    /*
     * Start measurement
     */
    printf ("Do a single measurement...\n");
    sprintf (write_buffer, "%s", "Variable:value\"sequencerState\", \"Sequencing\"");
    status = ibwrt (scope, write_buffer, strlen (write_buffer));
    do{
        timer = timer + 2;
        if (timer > 60) { /* Assumes single measurement is done in 60 seconds */
            printf ("***Measurement time out***\n");
            return 0; /* Something is wrong if sequencerState does not come back
                       * to Ready */
        }
        sprintf (write_buffer, "%s", "Variable:value? \"sequencerState\"");
        status = ibwrt (scope, write_buffer, strlen (write_buffer));
        status = ibrd (scope, read_buffer, sizeof (read_buffer));
        read_buffer [ibcnt] = 0; /* Get rid of extra characters */
        Sleep(2000);
    }while (strcmp(state, read_buffer) != 0);
    /*
     * Though sequencerState Back to Ready, need to check the error variable
     * to make no error occur during measurement
     */
    sprintf (write_buffer, "%s", "Variable:value? \"error\"");
    status = ibwrt (scope, write_buffer, strlen (write_buffer));
    status = ibrd (scope, read_buffer, sizeof (read_buffer));
    if (ibcnt != 3){ /* error string is not empty */
        read_buffer [ibcnt] = 0; /* Get rid of extra characters */
        printf ("*** Error: %s ***\n", read_buffer);
        return 0;
    }
    return 1;
}

```







# Reference



# Menu Structure

Figure 18 shows the relationship of the application-specific menus.

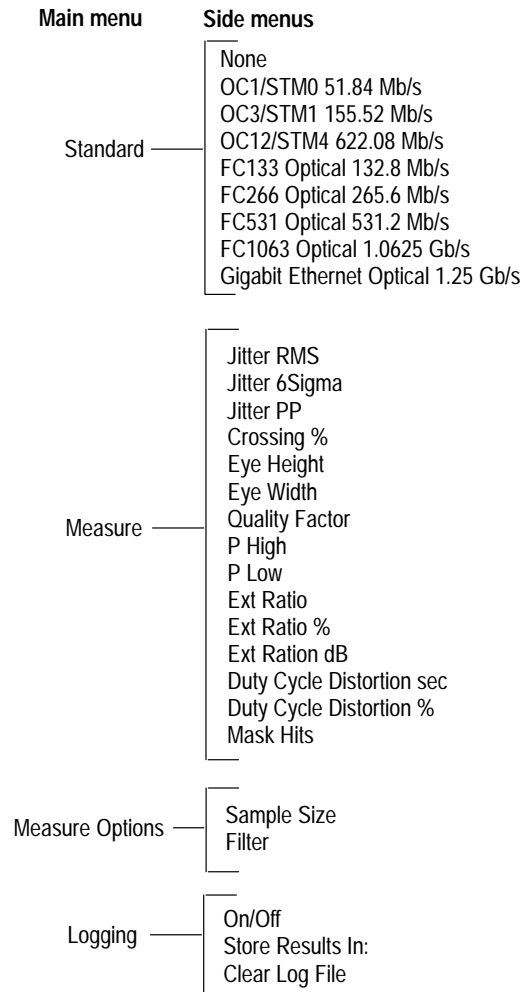

Figure 18: Application-specific menu structure

Figure 19 shows the structure of the Control and Utility menus.

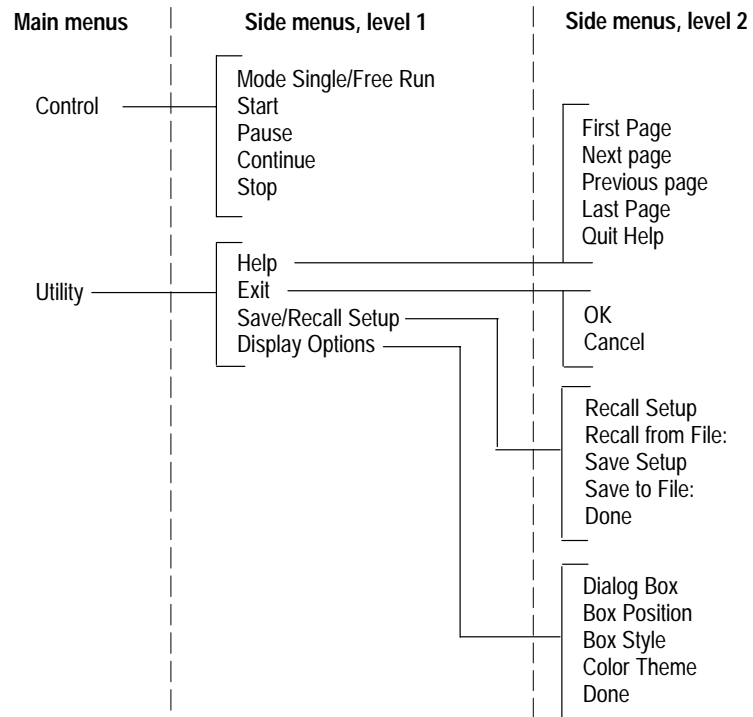

Figure 19: Control and Utility menu structures

# Parameters Reference

This section describes the TDSCEM1 application parameters. You should refer to the user manual for your oscilloscope for operating details associated with each front-panel menu button.

Refer to *Appendix B: GPIB Command Syntax* for a complete list of the GPIB command syntax with the arguments, variables and variable values that correspond to the TDSCEM1 parameters.

## Standard Menu

The selections for the Standard menu are as follows:

- None, the default selection
- OC1/STM0 51.84 Mb/s
- OC3/STM1 155.52 Mb/s
- OC12/STM4 622.08 Mb/s
- FC133 Optical 132.8 Mb/s
- FC266 Optical 265.6 Mb/s
- FC531 Optical 531.2 Mb/s
- FC1063 Optical 1.0625 Gb/s
- Gigabit Ethernet Optical 1.25 Gb/s

## Measure Menu

Table 9 lists the parameters for the Measure menu, the selections available, and the default settings.

**Table 9: Measure menu parameters**

Parameter	Selections	Default setting
Jitter RMS	On, Off	Off
Jitter 6Sigma	On, Off	On
Jitter PP	On, Off	Off
Crossing %	On, Off	On

**Table 9: Measure menu parameters (Cont.)**

Parameter	Selections	Default setting
Eye Height	On, Off	Off
Eye Width	On, Off	Off
Quality Factor	On, Off	Off
P high	On, Off	Off
P low	On, Off	Off
Ext Ratio	On, Off	Off
Ext Ratio %	On, Off	Off
Ext Ratio dB	On, Off	Off
Duty Cycle Distortion sec	On, Off	Off
Duty Cycle Distortion %	On, Off	Off
Mask Hits	On, Off	Off

## Measure Options Menu

Table 10 lists the parameters for the Measure Options menu, the selections available, and the default settings.

**Table 10: Measure Options menu parameters**

Parameter	Selections	Default setting
Sample Size	32 to 32767 in increments of 1	256
Filter	On, Off	On

## Logging Menu

Table 11 lists the parameters for the Logging menu, the selections available, and the default settings.

**Table 11: Logging menu parameters**

Parameter	Selections	Default setting
On/Off	On, Off	Off
Store Results In:	results.csv or new file name	results.csv
Clear Log File	None	

## Control Menu

Table 12 lists the parameters for the Control menu and the selections available.

**Table 12: Control menu parameters**

Parameters	Selections	Default setting
Mode	Single, Freerun	Single
Start	None	
Pause	None	
Continue	None	
Stop	None	

## Utility Menu

Table 13 lists each utility menu, the parameters, the selections available and default settings.

**Table 13: Utility menus and parameters**

Utility menu	Parameters	Selections	Default setting	Comments
Help	Refer to Figure 19 on page 34.	None		Help returns to the last page viewed
Exit	Refer to Figure 19 on page 34.	None		
Save/Recall Setup	Recall Setup	None	Default	Recalls the setup file displayed in the Recall from File: menu item
	Recall from File:	Saved setup files		Selects the setup file to recall
	Save Setup	None	setup1.ini	Saves the setup to the file displayed in the Save to File: menu item
	Save to File:	setup1.ini, or new file name		Selects or creates the setup file to save
Display Options	Dialog Box	On, Off	On	Colors affect dialog boxes and waveforms
	Box Position	Left, Middle, Right	Right	
	Box Style	Opaque, Transparent	Opaque	
	Color Theme	Based on the TDS oscilloscope choices.	TDS Default	







# Appendices



# Appendix A: Measurement Algorithms

The TDSCEM1 application displays a standard mask pattern behind the eye-diagram of the communications signal being acquired. The application can also take measurements from the eye-diagram of a communication signal.

## Oscilloscope Setup Guidelines

For all measurements, use the following guidelines to set up the oscilloscope:

1. Always connect the communication signal to CH 1.
2. The vertical scale for the communication signal must be set so that the eye-diagram does not exceed the vertical range of the TDS oscilloscope.
3. The input power level must be kept under 250  $\mu$ W.

## Test Methodology

The application performs the measurement according to the following algorithm:

1. Imports the eye-diagram.
2. Performs the measurement.
3. Uses the results in the Results readout, or saves the results to a data log file.

## Measurements

All eye-diagram measurements are based on the power level, the voltage level, or the time locations of edges within each acquisition. Mask patterns are defined in the Standard menu.

Figure 20 shows a mask pattern with an eye-diagram and the areas from which values are taken that are used to calculate measurements.

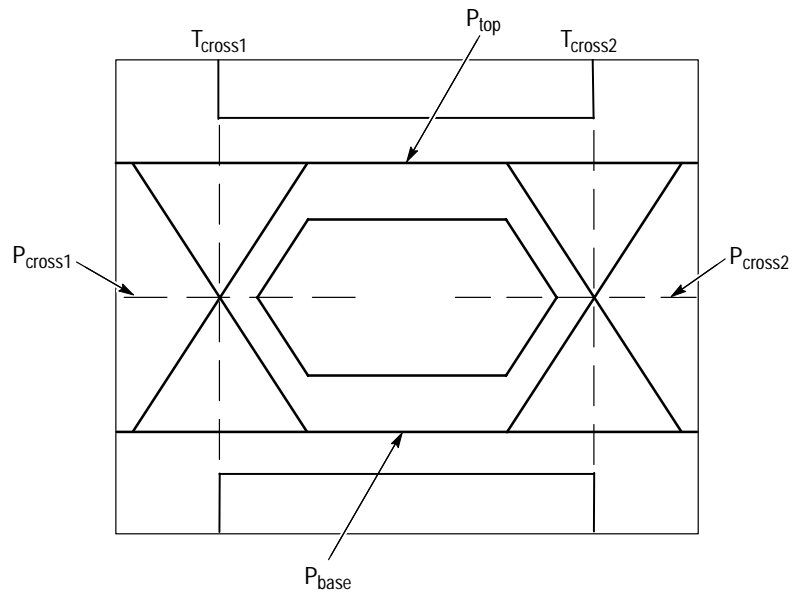

**Figure 20: Eye-diagram and mask pattern values**

**P Values** The P values include the mean and standard deviation of the vertical location of  $P_{top}$  and  $P_{base}$ . These areas are used with a specified sample size to statistically measure the following values:

- $p_{TopMean}$ , the mean value of  $P_{top}$
- $p_{TopSigma}$ , the standard deviation of  $P_{top}$
- $p_{BaseMean}$ , the mean value of  $P_{base}$
- $p_{BaseSigma}$ , the standard deviation of  $P_{base}$

**T1 Values** The T1 values are vertical and horizontal values associated with the leftmost crossing point. These areas are used to establish the following directions:

- $t_{Cross1Mean}$ , the horizontal mean of the left crossing point at  $T_{cross1}$
- $t_{Cross1Sigma}$ , the horizontal standard deviation of the left crossing point at  $T_{cross1}$
- $t_{Cross1PP}$ , the horizontal peak-to-peak deviation of the left crossing point at  $T_{cross1}$
- $p_{Cross1Mean}$ , the vertical mean of the left crossing point at  $P_{cross1}$

- T2 Values** The T2 values are vertical and horizontal values associated with the rightmost crossing point. These areas are used to establish the following directions:
- $t_{Cross2Mean}$ , the horizontal mean of the right crossing point at  $T_{cross2}$
  - $t_{Cross2Sigma}$ , the horizontal standard deviation of the right crossing point at  $T_{cross2}$
  - $t_{Cross2PP}$ , the horizontal peak-to-peak deviation of the right crossing point at  $T_{cross2}$

**DCD Values** The DCD values are horizontal values associated with the rightmost crossing point at 50% of the eye height. These areas are used to establish the  $dcdPP$ , the horizontal peak-to-peak deviation of the left crossing point at half the height of the eye.

**MaskHit Values** The MaskHit values are the number of hits in the mask.

Table 14 lists the measurements and how the application calculates them.

**Table 14: Measurements and calculations**

Measurement	Calculated using	Definition
Jitter RMS	$t_{Cross1Sigma}$	The RMS value of the edge jitter of the eye-diagram in seconds
Jitter 6Sigma	$6 * t_{Cross1Sigma}$	The "6 sigma" value of the edge jitter of the eye-diagram in seconds
Jitter PP	$t_{CrossPP}$	The peak-to-peak value of the edge jitter of the eye-diagram in seconds
Crossing %	$100 * [(p_{Cross1Mean} - p_{BaseMean}) / (p_{TopMean} - p_{BaseMean})]$	The crossing point of the eye-diagram as a percentage of the height of the eye diagram
Eye Height	$(p_{TopMean} - 3 * p_{TopSigma}) - (p_{BaseMean} + 3 * p_{BaseSigma})$	The height of the eye-diagram in watts
Eye Width	$(t_{Cross2Mean} - 3 * t_{Cross2Sigma}) - (t_{Cross1Mean} + 3 * t_{Cross1Sigma})$	The width of the eye-diagram in seconds
Quality Factor	$(p_{TopMean} - p_{TopBase}) / (p_{TopSigma} + p_{BaseSigma})$	The ratio of the size of the eye-diagram to the "noise" on the eye-diagram
P High	$p_{TopMean}$	The highest power level of the eye-diagram in watts
P Low	$p_{BaseMean}$	The lowest power level of the eye-diagram in watts

**Table 14: Measurements and calculations (Cont.)**

Measurement	Calculated using	Definition
Ext Ratio	$p_{TopMean}/p_{BaseMean}$	The ratio of the top of the eye-diagram to its base
Ext Ratio %	$100*(p_{BaseMean}/p_{TopMean})$	The ratio of the base of the eye-diagram to its top as a percentage
Ext Ratio dB	$10*\log(p_{TopMean}/p_{BaseMean})$	The ratio of the top of the eye-diagram to its base in dBs
Duty Cycle Distortion sec	dcdPP	Difference between the maximum and the minimum signal crossing times at 50% of the level
Duty Cycle Distortion %	$100*dcdPP/(Eye\ Width)$	Difference between the maximum and the minimum signal crossing times as a percentage of the bit period
Mask Hits	maskHits	The number of hits in the mask

## Appendix B: GPIB Command Syntax

This appendix describes the GPIB command syntax that you can use in your GPIB program to do the following tasks:

- Start the TDSCEM1 application
- Recognize an active application with GPIB protocol
- Program and read application setup parameters
- Sequence measurements
- Synchronously read measurement results

**Description.** Gives the function of the command, conditions of its use, and its interactions with other commands.

**Syntax.** Gives the valid select and query command forms. The required arguments are listed in their proper order.

For example, in the syntax definition

```
PATH= <Ad><Ars>
```

the arguments <Ad> and <Ars> are required in the order indicated.

**Arguments.** The arguments to a command are defined along with their range of values.

**Returns.** Defines the data returned in response to a command query.

Refer to the *GPIB Program Example* section for an example of a GPIB program that can execute the TDSCEM1 application.

---

**NOTE.** Refer to the *GPIB Program Example* section for guidelines to use while designing your GPIB program.

---

## VARIABLE:VALUE TDS COMMAND

**Description** VARIABLE:VALUE TDS COMMAND accepts string arguments for a control or data variable and a value to which to set the argument.

**Syntax** VARIABLE:VALUE

VARIABLE:VALUE "<variable name>","<variable value>"

the arguments <variable name> and <variable value> are required in the order indicated.

**Arguments and Returns** Table 15 lists the arguments, their function, and the query returns.

**Table 15: VARIABLE:VALUE TDS COMMAND arguments and queries**

Variable name	Variable value	Function	Query form
application	Exit	Terminates the active application	Returns a string that corresponds to the name of the active application
boxBackground	{Transparent, Opaque}	Sets the message box background	Returns the message box background
boxPosition	{Left, Middle, Right}	Sets the message box position	Returns the message box position
boxVisibility	{On, Off}	Sets box visible or invisible	Returns box visible or invisible
colorTheme	{TDSDefault, Black, Green, Mild, Purple, Steel, Tek Blue}	Sets the TDS oscilloscope color scheme	Returns the TDS oscilloscope color scheme
crossingState	{On, Off}	Sets the state of the crossing measurement	Returns the state of the crossing measurement
dcdState	{On, Off}	Sets the state of the dcd measurement	Returns the state of the dcd measurement
dcdPercentState	{On, Off}	Sets the state of the dcdPercent measurement	Returns the state of the dcdPercent measurement
extRatioState	{On, Off}	Sets the state of the extRatio measurement	Returns the state of the extRatio measurement
extRatioPState	{On, Off}	Sets the state of the extRatio % measurement	Returns the state of the extRatio % measurement
extRatioDState	{On, Off}	Sets the state of the extRatio dB measurement	Returns the state of the extRatio dB measurement
eyeHeightState	{On, Off}	Sets the state of the eye height measurement	Returns the state of the eye height measurement
eyeWidthState	{On, Off}	Sets the state of the eye width measurement	Returns the state of the eye width measurement



Table 15: VARIABLE:VALUE TDS COMMAND arguments and queries (Cont.)

Variable name	Variable value	Function	Query form
filterState	{On, Off}	Sets the state of the digital filter	Returns the state of the digital filter
jitter6SigmaState	{On, Off}	Sets the state of the jitter 6 Sigma measurement	Returns the state of the jitter 6 Sigma measurement
jitterPPState	{On, Off}	Sets the state of the jitter peak-to-peak measurement	Set the state of the jitter peak-to-peak measurement
jitterRmsState	{On, Off}	Sets the state of the jitter RMS measurement	Returns the state of the jitter RMS measurement
loggerDestination		Sets the data log file name	Returns the data log file name
loggerState	{On, Off}	Sets the state of the data log	Returns the state of the data log
maskStandard	{None, OC1, OC3, OC12, FC133, FC266, FC531, FC1063, ENET1250}	Sets the communications mask standard	Returns the communications mask standard
maskState	{On, Off}	Sets the state of the eye-diagram measurement	Returns the state of the eye-diagram measurement
pTopState	{On, Off}	Sets the state of the pTop measurement	Returns the state of the pTop measurement
pBaseState	{On, Off}	Sets the state of the pBase measurement	Returns the state of the pBase measurement
qualityFactorState	{On, Off}	Sets the state of the quality Factor measurement	Returns the state of the quality Factor measurement
recallName	Any string that uses one to eight characters from A to Z and/or zero to nine	Sets the recalled setup file name	Returns the saved setup file name
sampleSize	Any number from 32 to 32767	Sets the statistical sample size used to take measurements	Returns the statistical sample size used to take measurements
saveName	Any string from one to eight characters from A to Z and/or zero to nine	Sets setup file name	Returns the setup file name
setup	{Default, Recall, Save}	Sets the setup file name	Returns the setup file name
sequencerMode	{FreeRun, Single}	Sets the sequencer mode	Returns the sequencer mode
sequencerState	{Ready, Paused, Sequencing}	Sets the state of the sequencer	Returns the state of the sequencer

Table 16 lists the measurement results queries.

**Table 16: Measurement results queries**

Variable name	Function
crossing	Returns the crossing measurement
dcd	Returns the dcd measurement
dcdPercent	Returns the dcd % measurement
error	Returns an error message or returns "" if no error is detected
extRatio	Returns the extinction ratio measurement
extRatioP	Returns the extinction ratio % measurement
extRatioD	Returns the extinction ratio dB measurement
eyeHeight	Returns the eye height measurement
eyeWidth	Returns the eye width measurement
jitter6Sigma	Returns the jitter 6 Sigma measurement
jitterPP	Returns the jitter peak-to-peak measurement
jitterRMS	Returns the jitter RMS measurement
mask	Returns the mask measurement
pHigh	Returns the pHigh measurement
pLow	Returns the pLow measurement
qualityFactor	Returns the quality factor measurement



# Index



# Index

## Symbols

- .csv file
  - definition, 24
  - example of viewing, 13
  - importing, 12
  - saving, 12

## A

- accessories, 2
- ANSI documents, 8
- application
  - basic functions with an oscilloscope, 6
  - description, 1
  - exiting, 15
  - GPIB program example, 27
  - menu structure, 5, 33
  - returning, 7
  - setting up
    - standard eye-diagram masks, 8
    - to display results, 11
    - to save results to a data log file, 12
    - to take measurements, 9
  - starting, 18
  - test algorithms, 39
  - tutorial, 17
  - updates, 2

## C

- Cancel, 6
- CH 1 only channel used, 4
- changing settings during a measurement, 11
- CLEAR MENU button, 13
- command syntax, 43
- common menu items, 6
- communication standards documents, 8
- configuring the display, 7
- connection to CH 1, 4
- contacting Tektronix, viii
- Control menu, 11
  - parameters, 35, 36, 37
- conventions, vii

## D

- data log file
  - example of viewing, 13
  - importing, 12
  - saving, 12
  - saving the results tutorial lesson, 24
- Default Setup, 15
- dialog boxes, changing the appearance, 7
- Display Options, 7
- Done, 6

## E

- exiting the application, 15
- eye-diagram, 8
  - viewing obscured parts, 13

## F

- Free Run acquisition mode, 11

## G

- GPIB protocol
  - command syntax, 43
  - guidelines, 27
  - program example, 28

## H

- Help, online, 6

## I

- installation
  - application, 3
  - downloading updates, 2

## L

- leaving the application, 15

lessons. *See* tutorial lessons  
log file, example, 13  
Logging menu, 12

## M

main menus, 5  
Measure menu, 9  
Measure Options menu, 10  
measurements  
  algorithms, 41  
  application test method, 39  
  descriptions, 9  
  display results, 11  
  example of viewing the results, 13  
  GPIB program example, 27  
  oscilloscope changes, 11  
  parameters, 35  
  selections, 9  
  setting up, 8  
  turning off display, 14  
  tutorial lessons, 17  
menu  
  Control, 11  
  overview, 33  
menu structure  
  description, 5  
  detailed illustration, 33  
messages, Warning, 7

## O

Okay, 6  
online help, 6  
oscilloscope  
  basic functions with the application, 6  
  compatibility, 1  
  setup guidelines, 39

## P

parameters, reference section, 35  
product  
  compatibility, 1  
  description, 1  
  requirements and restrictions, 2  
  updates, 2

## Q

quitting the application, 15

## R

readout, turning off, 14  
Recall from File:, 15  
Recall Setup, 15  
recalling a setup, 14  
requirements and restrictions, 2  
Results readout, turning off, 14

## S

Save Setup, 14  
Save to File:, 14  
Save/Recall Setup menu, 14  
setup  
  default, 15  
  recalling, 15  
  saving, 14  
setup menus, descriptions, 10  
side menus, 5  
Single acquisition mode, 11  
SONET document, 8  
Standard menu, 8  
starting, application, 18

## T

technical support, viii  
Tektronix, contacting, viii  
terms, vii  
tutorial lessons, 17  
  saving the results to a data log file, 24  
  Statistics readout, 21  
  taking a measurement, 19

## U

Utility menu, parameters, 37  
Utility menus, 6

## V

viewing, obscured parts of an eye-diagram, 13

## W

Warning messages, 7  
waveforms, display color, 8  
web site, 2

