

User Manual



NetTek[®] YBT1E1
T1 & E1 Circuit Tester
071-1664-00

This document supports firmware version 2.100
and above.

www.tektronix.com

Copyright © Tektronix, Inc. All rights reserved.

Tektronix products are covered by U.S. and foreign patents, issued and pending. Information in this publication supercedes that in all previously published material. Specifications and price change privileges reserved.

Tektronix, Inc., P.O. Box 500, Beaverton, OR 97077

TEKTRONIX, TEK, and NetTek are registered trademarks of Tektronix, Inc.

WARRANTY

Tektronix warrants that the products that it manufactures and sells will be free from defects in materials and workmanship for a period of one (1) year from the date of purchase from an authorized Tektronix distributor. If any such product proves defective during this warranty period, Tektronix, at its option, either will repair the defective product without charge for parts and labor, or will provide a replacement in exchange for the defective product. Batteries are excluded from this warranty.

In order to obtain service under this warranty, Customer must notify Tektronix of the defect before the expiration of the warranty period and make suitable arrangements for the performance of service. Customer shall be responsible for packaging and shipping the defective product to the service center designated by Tektronix, shipping charges prepaid, and with a copy of customer proof of purchase. Tektronix shall pay for the return of the product to Customer if the shipment is to a location within the country in which the Tektronix service center is located. Customer shall be responsible for paying all shipping charges, duties, taxes, and any other charges for products returned to any other locations.

This warranty shall not apply to any defect, failure or damage caused by improper use or improper or inadequate maintenance and care. Tektronix shall not be obligated to furnish service under this warranty a) to repair damage resulting from attempts by personnel other than Tektronix representatives to install, repair or service the product; b) to repair damage resulting from improper use or connection to incompatible equipment; c) to repair any damage or malfunction caused by the use of non-Tektronix supplies; or d) to service a product that has been modified or integrated with other products when the effect of such modification or integration increases the time or difficulty of servicing the product.

THIS WARRANTY IS GIVEN BY TEKTRONIX WITH RESPECT TO THE LISTED PRODUCTS IN LIEU OF ANY OTHER WARRANTIES, EXPRESS OR IMPLIED. TEKTRONIX AND ITS VENDORS DISCLAIM ANY IMPLIED WARRANTIES OF MERCHANTABILITY OR FITNESS FOR A PARTICULAR PURPOSE. TEKTRONIX' RESPONSIBILITY TO REPAIR OR REPLACE DEFECTIVE PRODUCTS IS THE SOLE AND EXCLUSIVE REMEDY PROVIDED TO THE CUSTOMER FOR BREACH OF THIS WARRANTY. TEKTRONIX AND ITS VENDORS WILL NOT BE LIABLE FOR ANY INDIRECT, SPECIAL, INCIDENTAL, OR CONSEQUENTIAL DAMAGES IRRESPECTIVE OF WHETHER TEKTRONIX OR THE VENDOR HAS ADVANCE NOTICE OF THE POSSIBILITY OF SUCH DAMAGES.



Table of Contents

General Safety Summary	v
Preface	ix
About This Manual	ix
Online Help Information	ix
Conventions	x
Software Version	x
Contacting Tektronix	xi

Getting Started

The NetTek Analyzer Platform	1-1
YBT1E1 T1 & E1 Circuit Tester Product Description	1-3
Components and Accessories	1-5
Installing the YBT1E1 PC Card and Line Interface	1-6
Connecting External Power Supplies	1-9
Batteries	1-10
Installing or Removing a Battery	1-10
Charging a Battery	1-12
Maximizing Battery Operating Time	1-13
Transporting Lithium-Ion Batteries	1-13
Powering On the Instrument	1-14
Calibrating the Touch-Screen Display	1-14
Setting the stylus tap rate	1-14
Setting the stylus centering	1-14
Installing NetTek YBT1E1 Software	1-15
Starting the NetTek YBT1E1 Software	1-15
Setting the YBT1E1 Software to Automatically Run	1-16
Performing a Functional Check	1-18
Powering Off the Instrument	1-18
Suspend Mode	1-19
Shutdown Mode	1-19
Restart (Software Reset)	1-20
Power Switch Function Summary	1-20
Preventing Personal Injury from the Effects of Lightning	1-20

Operating Basics

Navigating the Desktop	2-1
Icons	2-2
Taskbar	2-2
Getting Help	2-3
Entering Text	2-3
Application User Interface Elements	2-4
Command Bar	2-6
Test Configuration	2-9
Status and Measurements Elements	2-11
The Measurement Results Windows	2-15
The Summary Window	2-15
The Alarms Window	2-17
Alarms Rolling Display	2-17
The Errors Window	2-18
Errors Rolling Display	2-18
The Alarms and Errors Rolling Display	2-19
History Indicator	2-20
Event Indicator	2-20
Current Indicator	2-21
Limit Alarm	2-21
Event Detail	2-21
Display Time Span	2-21
The History Window	2-22

Reference

Connecting to a Signal	3-1
Making a Monitor Connection	3-1
Making a Terminate Connection	3-3
Making a Loopback Connection	3-4
Making a Bridge Connection	3-5
Testing a Circuit	3-7
Verify Received Signal and Line Coding	3-7
Automatic Measurement Setup	3-7
Manual Measurement Setup	3-9
Performing Timed Tests	3-11
Limit Testing	3-11

Performing Automated BER Tests	3-12
The Create/Edit a Pattern Sequence Dialog	3-14
Creating Custom Pattern Sequence Tests	3-15
Editing an Existing Pattern	3-16
Pattern Sequence Results View	3-17
Loopback Testing (Option T1 only)	3-19
Setting up Loopback Codes	3-21
Using the DS0 View	3-21
Setting the DS0 Data Collection Update Time Interval ...	3-23
Monitoring Audio Data On a DS0 Channel	3-23

Appendices

Appendix A: Specifications	A-1
Appendix B: Installing NetTek YBT1E1 Software	B-1
PC Requirements	B-1
Installing Using an Archive File	B-1
Installing Using an RS-232 Serial Connection	B-3
Disabling the Windows CE Services Serial Connection ...	B-3
Disabling the Windows Active Sync Serial Connection ...	B-3
Installing the YBT1E1 Software	B-4
Installing Software Using a USB Connection (Y400 Only) ...	B-5
Uninstalling the YBT1E1 Software	B-5
Appendix C: Diagnostic Self Tests	C-1
Test Descriptions	C-3
Appendix D: Accessories	D-1
Standard Accessories	D-1
Components And Accessories	D-1

Index

Table of Contents

General Safety Summary

Review the following safety precautions to avoid injury and prevent damage to this product or any products connected to it. To avoid potential hazards, use this product only as specified.

Only qualified personnel should perform service procedures.

While using this product, you may need to access other parts of the system. Read the *General Safety Summary* in other system manuals for warnings and cautions related to operating the system.



WARNING. *To avoid injury, do not connect this product to any source which may be subject to the effects of lightning. See page 1-20 for complete information.*

To Avoid Fire or Personal Injury

Use Proper Power Cord. Use only the power cord specified for this product and certified for the country of use.

Observe All Terminal Ratings. To avoid fire or shock hazard, observe all ratings and markings on the product. Consult the product manual for further ratings information before making connections to the product.

Replace Batteries Properly. Replace batteries only with the proper type and rating specified.

Recharge Batteries Properly. Recharge batteries for the recommended charge cycle only.

Use Proper AC Adapter. Use only the AC adapter specified for this product.

Do Not Operate Without Covers. Do not operate this product with covers or panels removed.

Avoid Exposed Circuitry. Do not touch exposed connections and components when power is present.

Wear Eye Protection. Wear eye protection if exposure to high-intensity rays or laser radiation exists.

Do Not Operate With Suspected Failures. If you suspect there is damage to this product, have it inspected by qualified service personnel.

Do Not Operate in an Explosive Atmosphere.

Safety Terms and Symbols

Terms in This Manual. These terms may appear in this manual:



WARNING. *Warning statements identify conditions or practices that could result in injury or loss of life.*



CAUTION. *Caution statements identify conditions or practices that could result in damage to this product or other property.*

Terms on the Product. These terms may appear on the product:

DANGER indicates an injury hazard immediately accessible as you read the marking.

WARNING indicates an injury hazard not immediately accessible as you read the marking.

CAUTION indicates a hazard to property including the product.

Symbols on the Product. These symbols may appear on the product:



CAUTION
Refer to Manual

Battery Recycling

The NetTek Analyzer Platform uses rechargeable lithium-ion batteries. Please consult your local government regulations for the recycling or disposal of lithium-ion batteries.

Transporting Lithium-Ion Batteries

Each NetTek Analyzer Platform lithium-ion battery pack contains less than 8 grams of lithium, with individual cells each containing less than 1.5 grams of lithium, as measured by International Civil Aviation Organization (ICAO) standards.

Regulations regarding transportation of lithium-ion batteries on passenger aircraft may subject this product to special handling restrictions. Consult your air carrier for applicability and determination of any special lithium-ion battery transportation requirements.



Preface

This manual contains setup and operating instructions for the NetTek YBT1E1 T1 & E1 Circuit Tester.

About This Manual

This manual is divided into four sections: *Getting Started*, *Operating Basics*, *Reference*, and *Appendices*.

The *Getting Started* section explains how to install and start up your T1 & E1 Circuit Tester.

The *Operating Basics* section explains how to operate the tester.

The *Reference* section explains how to perform tests.

The *Appendices* contain reference information you might need occasionally, such as specifications or diagnostic procedures.

Online Help Information

The NetTek YBT1E1 online help provides detailed information on operating the tester. The online help is the first place you should look for information.

The NetTek YBT1E1 tester runs on the NetTek Analyzer Platform. You will find important information on configuring and operating this platform in the NetTek Analyzer Platform online help.

Conventions

This manual uses the following convention to document the commands you must use to operate the NetTek YBT1E1 T1 & E1 Circuit Tester..

The statement **Start > Help** is asking you to open the Start menu and select Help. To accomplish this, tap the **Start** button in the toolbar at the bottom of the desktop window; then tap **Help** in the resulting menu.

Software Version

This manual supports products running YBT1E1 T1 and E1 Circuit Tester, Option T1 and Option E1 software Version 2.100 and above.

To view your software version, do the following:

1. In the toolbar at the top of the startup screen, select **Tools**.
2. Select **Software Info** from the menu to display the software information, including version number.

Contacting Tektronix

Phone	1-800-833-9200*
Address	Tektronix, Inc. Department or name (if known) 14200 SW Karl Braun Drive P.O. Box 500 Beaverton, OR 97077 USA
Web site	www.tektronix.com
Sales support	1-800-833-9200, select option 1*
Service support	1-800-833-9200, select option 2*
Technical support	www.tektronix.com/support 1-800-833-9200, select option 3* 6:00 a.m. - 5:00 p.m. Pacific Standard Time

* This phone number is toll free in North America. After office hours, please leave a voice mail message. Outside North America, contact a Tektronix sales office or distributor; see the Tektronix web site for a list of offices.



Getting Started

Getting Started

This section provides the information you need to set up and operate the NetTek YBT1E1 T1 & E1 Circuit Tester.

The NetTek Analyzer Platform

The YBT1E1 Tester operates on the NetTek Analyzer Platform. Figure 1-1 shows the NetTek Analyzer Platform layout. Figure 1-2 on page 1-2 shows the front-panel controls and indicators.

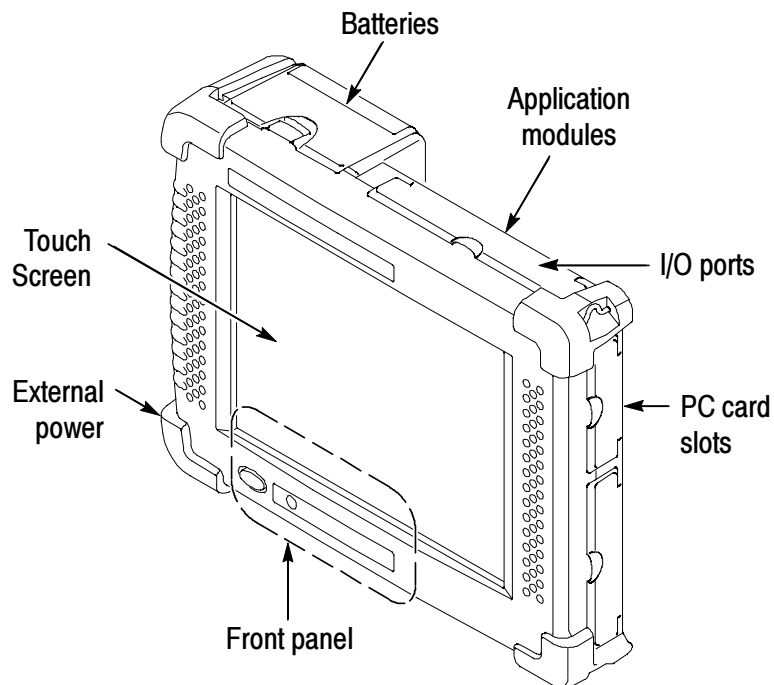

Figure 1-1: NetTek Analyzer Layout



CAUTION. Only use soft objects, such as plastic or your finger, to tap the touch-screen display. Do not use metal or other abrasive materials because they will damage the display surface.

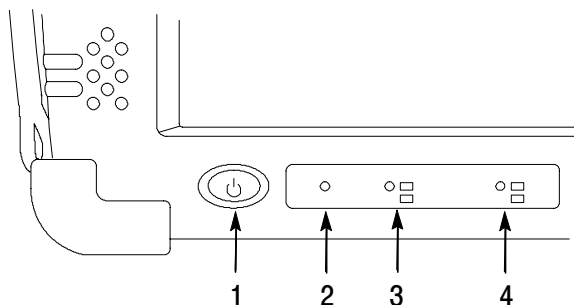

Figure 1-2: Front Panel Controls

- 1. Power/Suspend Switch.** Powers on or off the instrument. Push on; push off. See pages 1-14 and 1-18 for additional information.
- 2. Reset Switch.** Push to perform a hardware reset if a lock-up occurs. All programs and data loaded into volatile memory since startup are lost.
- 3. Status Indicator.** Green indicates that the instrument is powered on. Amber indicates that the instrument is powered on but the display is turned off (for power conservation).
- 4. Batteries Indicator.** Green indicates that the instrument is connected to an external power source (and charging any installed batteries). Red indicates a low battery.

YBT1E1 T1 & E1 Circuit Tester Product Description

The NetTek YBT1E1 T1 & E1 Circuit Tester is part of the NetTek BTS Field Tool family: a high-performance, portable, field-ready tester, optimized for rapid troubleshooting and base station performance verification.

The NetTek YBT1E1 compliments the functionality of the NetTek YBT250 Field Transmitter and Interference Tester and the NetTek YBA250 Antenna and Transmission Line Analyzer, which also operate on the NetTek Analyzer Platform.

Use the NetTek YBT1E1 to verify the proper operation of T1 and E1 data lines by verifying synchronization, line framing, bit errors, and other important characteristics. The NetTek YBT1E1 circuit tester can perform measurements on both in-service and out-of-service networks.

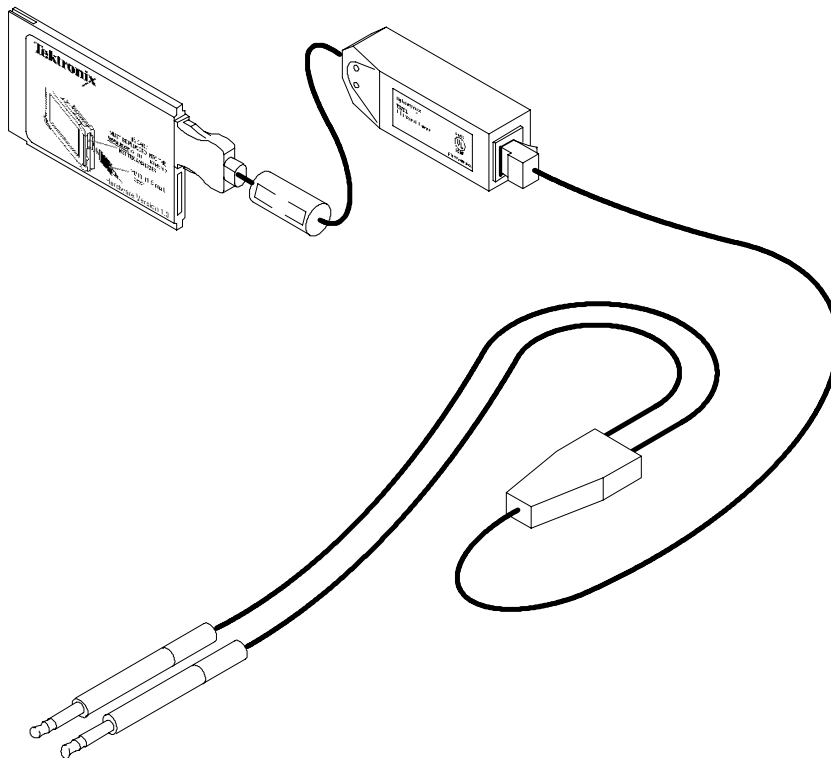

Figure 1-3: The NetTek YBT1E1 T1 & E1 Circuit Tester assembly

Table 1-1: YBT1E1 Tester features summary

Feature	Option T1	Option E1
Standards	T1.402, T1.403, G.703	G.703, G.704, G.706, G.826
Line coding and detection	AMI, B8ZS	AMI, HDB3
Frame formats	D4 Superframe, ESF	PCM30, PCM30-CRC, PCM31, PCM31-CRC,
Status indicators	T1 pulses, frame synchronization and type, pattern synchronization and type	E1 pulses, frame synchronization and type, pattern synchronization and type
Error detection and counters	Carrier Loss, Frame Loss, Frame Errors, AIS, RAI, Pattern Loss, Bit Error, BPV, CRC Error, Errored Seconds, 1's Density Fail	Carrier Loss, Frame Loss, Frame Errors, AIS, EB (error block), RAI, Pattern Loss, Bit Error, BPV, BBE (background block error), CRC Error, Errored Seconds, SES (severely errored seconds), UAS (unavailable seconds)
Alarm reporting	Carrier Loss, Frame Loss, Pattern Loss, AIS/Blue, RAI/Yellow, 1's Density Fail	Carrier Loss, Frame Loss, Pattern Loss, AIS/Blue, RAI/Yellow
Error insertion (single error)	Bit Errors, Frame Errors, CRC Errors, BPV	
Bit error rate test patterns	Same As Rx Signal, QRSS, All Ones, All Zeros, 1-in-8, 2-in-8, 3-in-24, T1-1 (Min/Max), T1-2 (Trip Test), T1-3 (54-Octet), T1-4 (120 Octet), T1-5 (53 Octet), T1-6 (55 Octet), T1-Daly, User Defined	Same As Rx Signal, PRBS 2 ¹⁵ -1, PRBS 2 ²⁰ -1, All Ones, All Zeros, Alternating One/Zero, DSO PCM31 Test, 3 in 24, User Defined

Table 1-1: YBT1E1 Tester features summary (Cont.)

Feature	Option T1	Option E1
DSO drop	Visual display of ones density and audio monitoring	
Loop code transmission	CSU, NUI, User	N/A
Automated testing	Limit tests, timed tests, BERT pattern sequence tests	
Receive signal measurement	Signal level in dBdsx and V_{p-p}	Signal level in dBdsx, and V_{p-p} for 75 Ω and 120 Ω impedances
Transmit levels (dBdsx)	0.0, -7.5, -15.0, -22.5	N/A
Transmit/receive clock	Internal, recovered	
Connection configurations	Single-port monitor, bridge, terminate, receive-to-transmit loopback	
Line impedance	monitoring (110 Ω) terminating (110 Ω) bridging (>1 k Ω)	

Components and Accessories

For a complete list of accessories, see *Appendix D, Accessories*.

Installing the YBT1E1 PC Card and Line Interface

See Figures 1-4 through 1-7 for how to assemble and install the YBT1E1 Tester components.

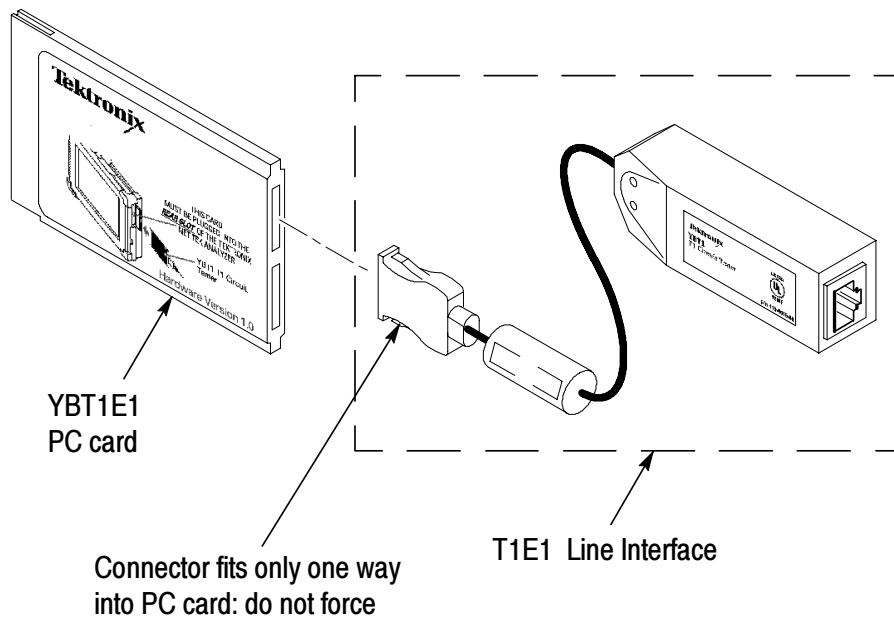

Figure 1-4: Connect the T1E1 Line Interface to the YBT1E1 Tester

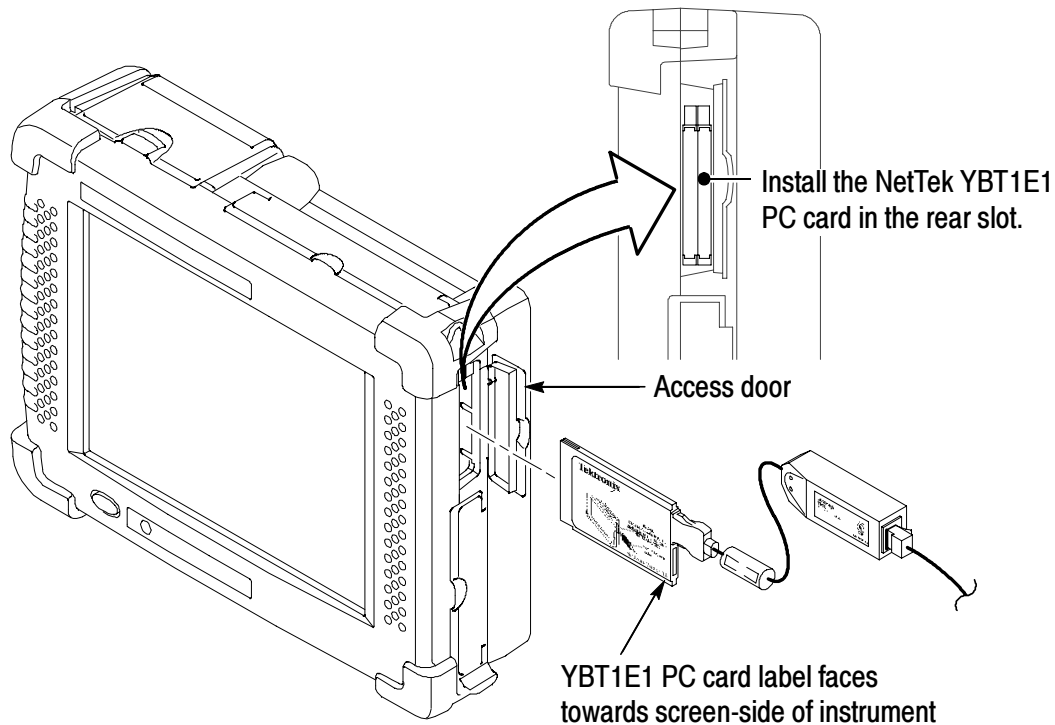

Figure 1-5: Installing the YBT1E1 PC card in the NetTek Analyzer



CAUTION. To meet the electromagnetic emissions standards specified for this product, install the NetTek YBT1E1 PC card in the rear slot of the NetTek Analyzer Platform. See Figure 1-5.

Do not install any other PC card while using the NetTek YBT1E1 card.

NOTE. To remove the YBT1E1 PC card, press in the button located at the top edge of the PC card slot, and then pull out the PC card.

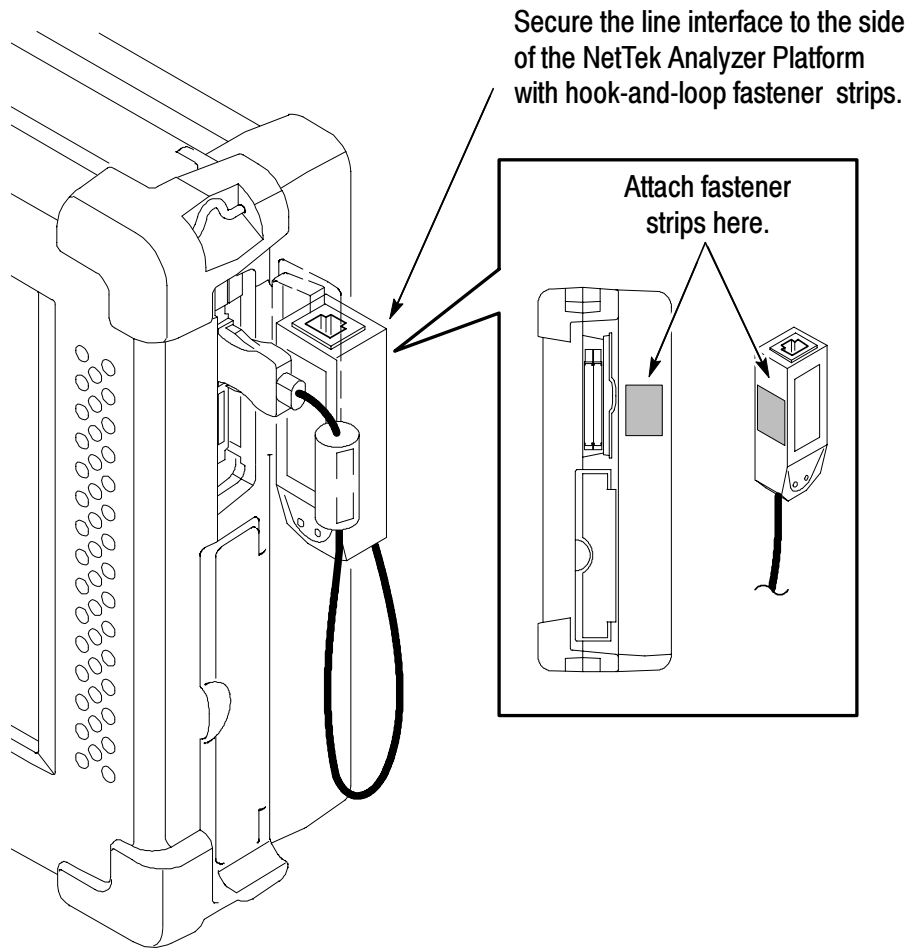

Figure 1-6: Attaching the line interface to the NetTek Analyzer Platform

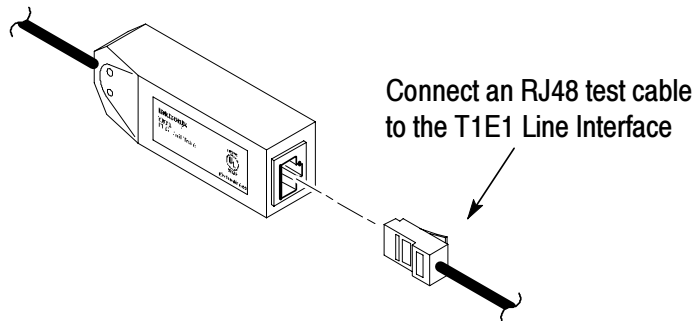

Figure 1-7: Connecting the NetTek YBT1E1 components

Connecting External Power Supplies

To power the NetTek Analyzer Platform from AC mains or DC vehicle voltage, or recharge installed batteries, connect the Desktop Power Supply or the In-Vehicle Adapter to the NetTek Analyzer Platform as shown in Figure 1-8. The Desktop Power Supply operates from 100 VAC to 240 VAC mains.

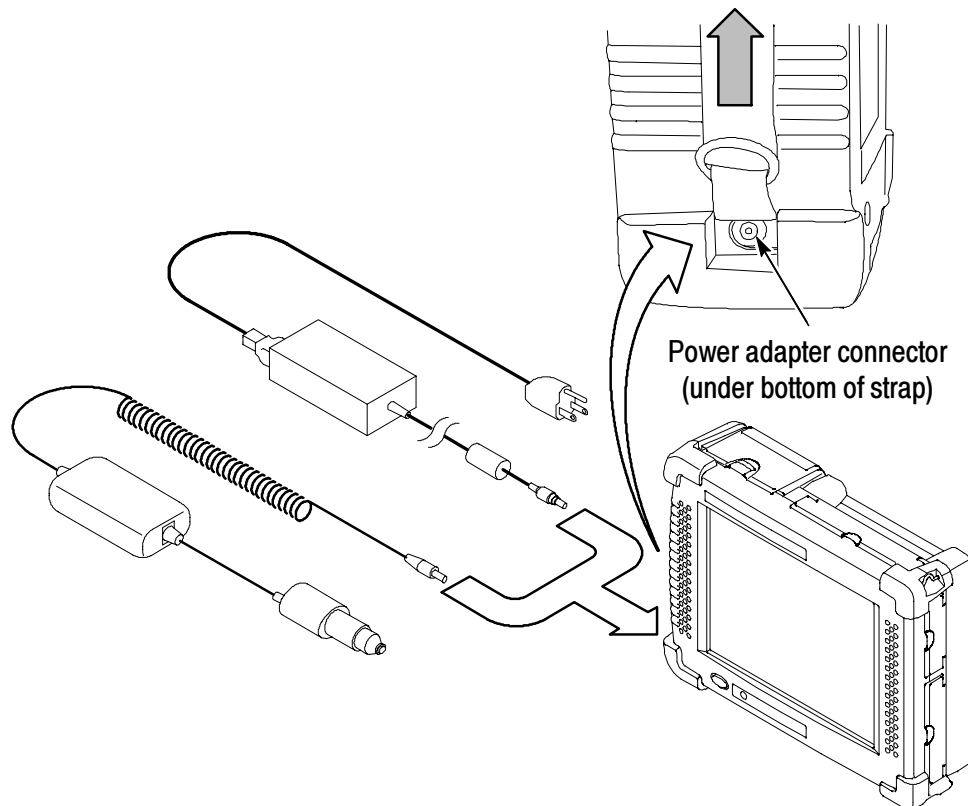

Figure 1-8: External power supplies

Batteries

Installing or Removing a Battery

The NetTek Analyzer Platform comes standard with a single battery, which is not installed when the instrument is shipped. The instrument can use two batteries. Refer to Figures 1-9 through 1-11 for battery installation or removal steps.

NOTE. *Disconnect the power supply cables from the NetTek Analyzer Platform before installing or removing batteries.*

New batteries, or batteries that have not been used for an extended period, must be charged before using them to power the instrument. Refer to Charging a Battery on page 1-12 for more information.

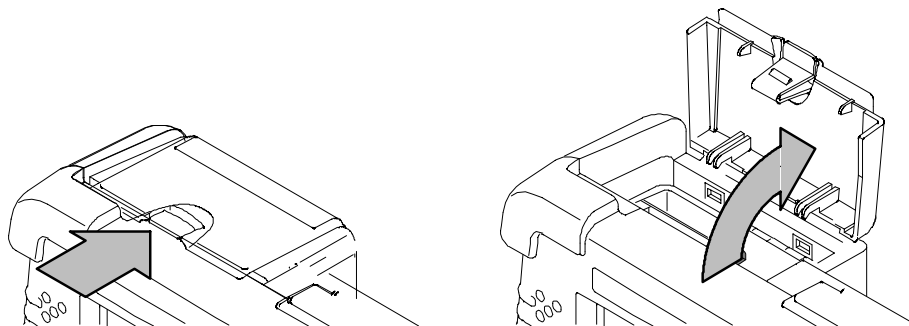

Figure 1-9: Opening the battery compartment

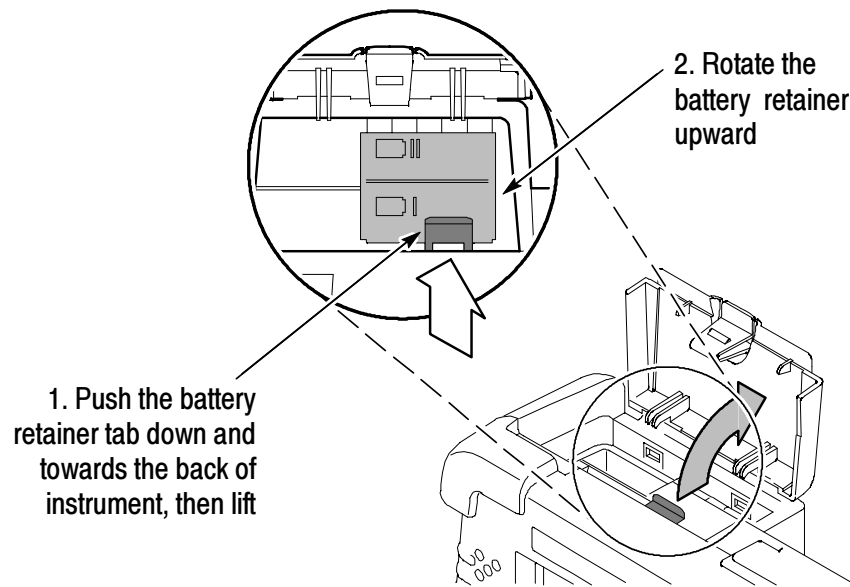

Figure 1-10: Opening the battery retainer

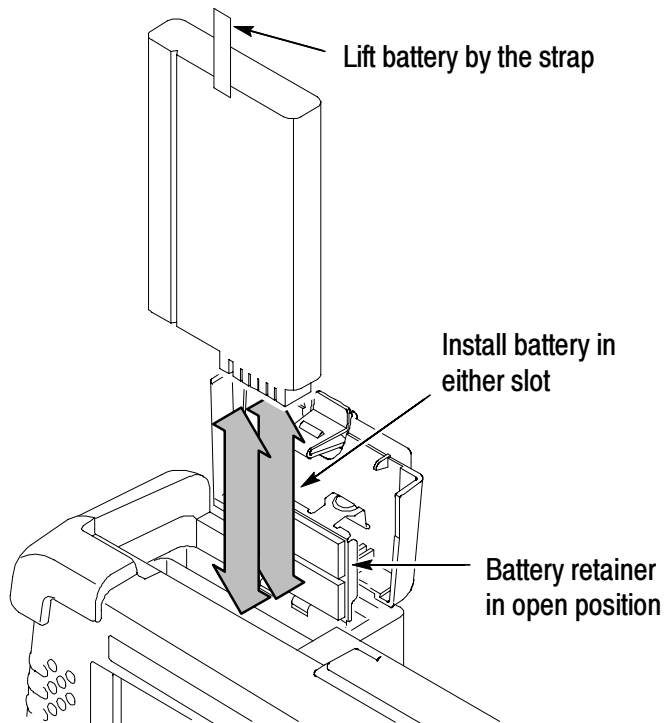

Figure 1-11: Installing/removing a battery

NOTE. *The battery electrical contacts, on the bottom of the battery, must face in the direction shown in Figure 1-11 on page 1-11.*

Close and latch the battery retainer and battery compartment door after installing or removing batteries.

You can add a second battery to increase the operating time. Replace a battery with the specified type only. To purchase a battery from Tektronix, please contact your Tektronix Service Center for the correct part number.

Charging a Battery

To charge batteries installed in the NetTek Analyzer Platform, connect the instrument to an external power supply (see Figure 1-8 on page 1-9) and let the battery or batteries recharge in the instrument. Table 1-2 lists the approximate charge times for fully-discharged batteries. You can also charge batteries in the optional external battery charger.

Table 1-2: Approximate battery charge times

Number of batteries in instrument	Instrument powered on	Instrument powered off
1	12 hours	4.5 hours
2	24 hours	9 hours

NOTE. *To achieve optimum performance from a new battery, fully charge the battery. Then fully discharge the battery by leaving the software running (see **Start > Help > Settings > Power Management** for information on disabling the power saver function), then fully charge the battery again.*

Batteries are partially charged and calibrated at the factory. A calibrated battery allows the NetTek Analyzer Platform to more accurately estimate how much longer the software can operate before the instrument automatically powers off. The software always warns you before it powers off, so that you can save important test results or settings.

To verify the status of your batteries at any time:

1. Select **Start > Settings > Control Panel**.
2. Double-tap the **Power Management** icon. The Batteries tab lists the status of each battery.

If the battery charge is low, connect the NetTek Analyzer Platform to an external power source and let the battery or batteries recharge in the instrument for eight hours. For more information, select **Start > Help > Settings > Power Management > Charging Batteries**.

Maximizing Battery Operating Time

For tips on how to maximize battery operating time, select **Start > Help > Settings > Power Management > Optimizing Battery Life**.

Transporting Lithium-Ion Batteries

Each NetTek Analyzer Platform lithium-ion battery pack contains less than 8 grams of lithium, with individual cells each containing less than 1.5 grams of lithium, as measured by International Civil Aviation Organization (ICAO) standards.

Regulations regarding transportation of lithium-ion batteries on passenger aircraft may subject this product to special handling restrictions. Consult your air carrier for applicability and determination of any special lithium-ion battery transportation requirements.

Powering On the Instrument

To power on the NetTek Analyzer Platform, press the large blue oval front-panel switch (in the front lower-left corner of the instrument). The green status indicator to the right of the switch lights and the system begins its power-on process. The touch-screen display and human interface are described in the *Operating Basics* section.

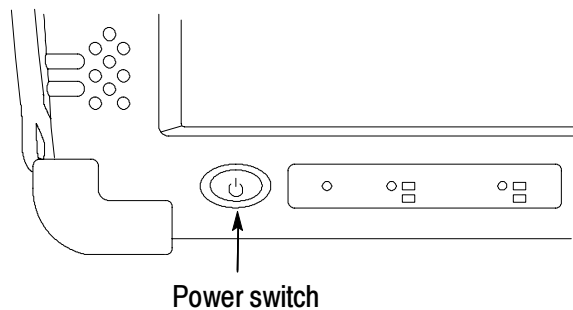

Figure 1-12: Power switch

Calibrating the Touch-Screen Display

For the touch-screen display to respond correctly to your taps, you must set the stylus centering and double-tap speed before installing and running the YBT1E1 software.

Setting the stylus tap rate

1. Select **Start > Settings > Control Panel**.
2. Open (double-tap) the Stylus icon.
3. In the **Double-Tap** tab, double-tap the checkerboard grid at a comfortable speed with your stylus or finger to set the tap rate.
4. Double-tap the checkerboard grid to verify your settings.

Setting the stylus centering

1. Select **Start > Settings > Control Panel**.
2. Open the Stylus icon.
3. In the **Calibration** tab, select **Recalibrate**.

4. Follow the on-screen instructions to set the location and amount of pressure needed for the touch-screen to respond to your taps. Apply pressure to the touch-screen for approximately 5 seconds at each position, until the target moves.
5. Select **OK** to close the dialog box and save your settings.

Installing NetTek YBT1E1 Software

Follow the procedures in Appendix D, *Installing NetTek YBT1E1 Software*, to install, upgrade, or reinstall the NetTek YBT1E1 Option T1 or Option E1 software on the NetTek Analyzer Platform.

Starting the NetTek YBT1E1 Software

Do one of the following to start up the NetTek YBT1E1 measurement software:

- Double-tap the **YBT1** or **YBE1** application icon on the NetTek Analyzer Platform desktop.
- Select **Start > Programs > NetTek > YBT1** (or **YBE1**) in the taskbar.
- Configure the NetTek YBT1E1 software to start up automatically at power on.

Figure 1-13 shows a typical power-on screen of the YBT1E1 Tester Option T1 software.

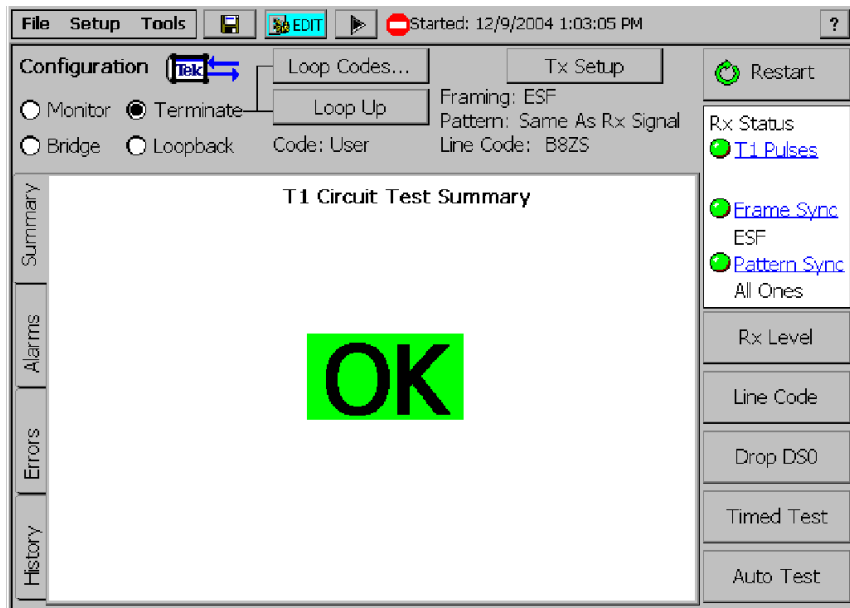

Figure 1-13: Typical YBT1E1 Option T1 power on screen

Setting the YBT1E1 Software to Automatically Run

If you installed your YBT1E1 software on a Y400 or Y350C NetTek Analyzer Platform that is running NetTek firmware version 1.12 or greater, use the following procedure to set the software to run automatically when you power on your NetTek Analyzer.

1. Select **Start > Programs > Tektronix Utilities > System Configuration**.
2. On the Software tab, select the StartUp checkbox for the YBT1 or YBE1 software.

NOTE. You can have both Option T1 and Option E1 software installed at the same time. However, you can only run one of these applications at a time. You cannot set both applications to start automatically when the instrument is powered on.

3. Close the System Configuration dialog.

The next time the NetTek Analyzer Platform is powered on, the YBT1E1 software will start up automatically.

If you installed your YBT1E1 Option T1 or Option E1 software on a Y350C NetTek Analyzer Platform that is running NetTek firmware version earlier than 1.12, use the following procedure to set the software to run automatically when you power on your NetTek Analyzer.

1. Select **Start > Programs > Windows Explorer**.
2. Navigate to the **Windows\Programs\NetTek** directory.
3. Select **YBT1** in the NetTek directory to start the Option T1 software, or Select **YBE1** in the NetTek directory to start the Option E1 software. You can select only one software option to start automatically.
4. In the menu bar, select **Edit > Copy**.
5. Navigate back to the \Windows directory by tapping the left arrow in the menu bar.
6. Open the Startup folder.
7. In the menu bar, select **Edit > Paste Shortcut**.

Performing a Functional Check

Following installation and start up of the NetTek YBT1E1 software, perform the following procedure to verify that the YBT1E1 T1 & E1 Circuit Tester is functioning properly.

1. Insert the RJ48 Loopback Plug into the YBT1E1 Line Interface as shown in Figure 1-14.

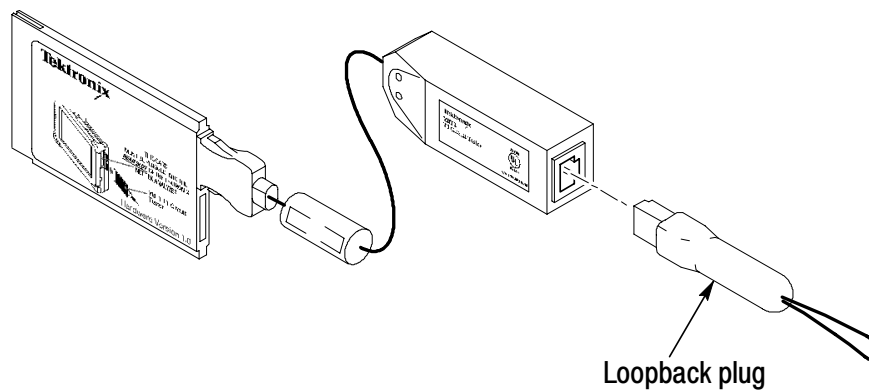

Figure 1-14: Inserting the Loopback Plug into the T1E1 Line Interface

2. Perform the diagnostic tests on page C-1.

Powering Off the Instrument

The NetTek Analyzer Platform has standby and power off functions. You access these functions in the Shut Down dialog.

To display the Shut Down dialog, do one of the following:

- For Y350C and Y400 NetTek Analyzer Platforms with software version 1.12 and greater, tap the **Shutdown** icon on the desktop.
- For all Y350C or Y400 NetTek Analyzer Platforms, select **Start > Programs > Shutdown**.

Suspend Mode

Use Suspend mode to place the NetTek Analyzer Platform in a suspended (standby or sleep) state. This is the typical power down mode that allows the software to remain in volatile memory. If the NetTek Analyzer Platform remains in Suspend mode for an extended time (approximately two hours), it automatically enters Shutdown mode.

To suspend analyzer operation, choose one of the following methods:

- Press the front-panel power switch.
- Select **Suspend** in the Shut Down dialog.

To cancel Suspend mode and wake up the NetTek Analyzer Platform, press the front-panel power switch. The instrument returns to the state that existed before suspend mode was invoked.

Shutdown Mode

To completely power down the NetTek Analyzer Platform, select **Shutdown** in the Shut Down dialog.

A shutdown clears volatile memory, including the application software if it is loaded in volatile memory, user setups, and measurement data not saved to nonvolatile memory.

For information on how to save these items to nonvolatile memory, do the following to view online help:

1. Select **Start > Help**.
2. In the Help window select **Tektronix Basics**.
3. Select **Store Data in Nonvolatile Memory**.

The next time you press the front-panel power switch, the NetTek Analyzer Platform cycles through the complete power up process, taking about 30 seconds to completely power up.

Restart (Software Reset)

If the NetTek Analyzer Platform or application stops responding correctly, try performing a restart to clear the problem.

To restart the software, select **Restart** in the Shut Down dialog. The display blanks for approximately five seconds. The software reloads and restarts. A restart does not empty volatile memory.

Power Switch Function Summary

Depending on the current state of the NetTek Analyzer Platform, pressing the front-panel power switch performs one of the following functions:

- If the NetTek Analyzer Platform is shut down: powers on the instrument.
- If the NetTek Analyzer Platform is operating: initiates Suspend mode.
- If the NetTek Analyzer Platform is in Suspend mode: cancels Suspend mode and activates the software.
- If the analyzer is in PowerSaver mode (touch-screen display off): activates the display.

Preventing Personal Injury from the Effects of Lightning



WARNING. *To prevent personal injury from the effects of lightning, exercise the following precautions when using this product.*

Before Connecting This Product to Any Source

- Be sure there is no lightning in your vicinity.
- Check your local weather forecast for the possibility of thunderstorms or lightning.
- If weather conditions could allow thunderstorms or lightning to develop, be sure to visually check the sky and weather conditions in your area frequently.

- If you hear thunder or see lightning, do not connect this product to any source that may be exposed to the effects of lightning.
- Use your own good judgement and common sense. You must protect yourself from the effects of lightning.
- You must assume that hazardous voltages will be present on exposed surfaces of this product if it is connected to a source exposed to lightning. The insulation of this product will not protect you from these hazardous voltages.

Do Not Connect this Product to Any Source that Might be Subject to the Effects of Lightning

If thunderstorms or lightning are in your vicinity:

- When weather conditions that could lead to lightning activity exist in your area, *you could be at risk of a lightning strike* before the cloud is close enough for you to hear thunder or see lightning.
- When lightning strikes a structure or facility, current travels through the rebar, concrete, pipes, cables, vent stacks, and electrical system.
- Lightning can induce electric and magnetic fields into structures and portions of wiring. The length of a conductor affected by the magnetic field of a lightning strike may exceed two miles.

Be Alert and Aware of the Effects of Lightning

- When lightning strikes a conductor, which in turn introduces current into an area some distance from the ground strike point, *equipment can be damaged and personnel injured* if they become an indirect path in the completion of the ground circuit.
- Conductors such as the braided shields of cables or unshielded wire, will have significant transient currents flowing in them in regions exposed to the electric field effect of lightning.
- Induced voltages can cause wiring insulation breakdown at connectors and in electrical components, or breakdown of air.



Operating Basics

Operating Basics

Navigating the Desktop

The NetTek Analyzer Platform desktop, shown in Figure 2-1, is your primary workspace. Use the desktop to configure hardware and software, adjust settings, establish communications, and access built-in applications.

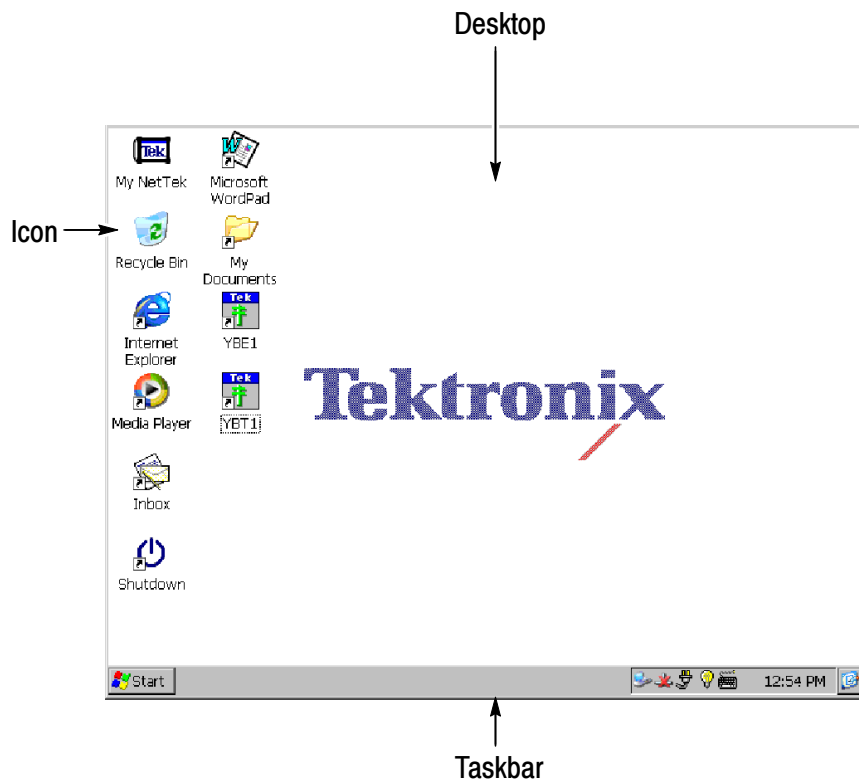

Figure 2-1: The NetTek Analyzer Platform desktop

Icons

Double-tap desktop icons to open folders or to start programs.

Taskbar

The Taskbar, shown in Figure 2-2, contains the Start menu, buttons to identify the programs you are running, a status area, and a desktop icon.

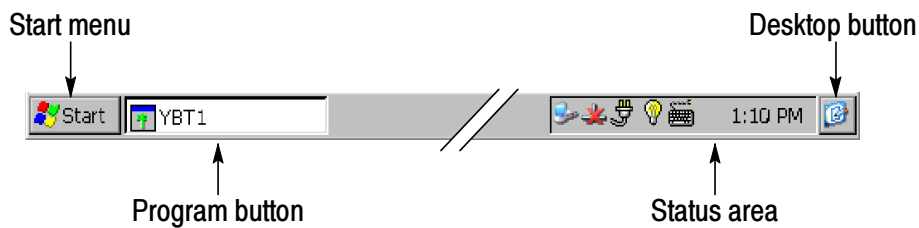

Figure 2-2: The Microsoft WindowsCE Taskbar

Start Menu. Use the Start menu, shown in Figure 2-3, to load and run other instrument modules and other programs, access settings, open documents, and obtain help. Select (tap) **Start** to open the menu; then select the entry you want.



Figure 2-3: The Microsoft WindowsCE Start menu

Program Buttons. To hide a program that is running, tap its taskbar button. To restore the program, tap the button again.

Status Area. Icons and buttons appearing in this area indicate status, activate features, or open settings windows. Double-tap the icons for further information.

For a complete list and explanation of all status area icons, refer to the online help:

1. Select **Start > Help**.
2. In the Help window select **Windows CE Basics**
3. Select **Understanding Taskbar Icons**.

Desktop. Tap this button to minimize all open applications and display the desktop.

Getting Help

To open the WindowsCE Help window and access the YBT1E1 topics, select **Start > Help**. Then select **YBE1** or **YBT1**.

There are three ways to display Help when you are running the YBT1E1 software:

- Tap the  icon in the upper-right corner of the application to display the top-level application help.
- Tap underlined text on the screen to display the Help topic for the item selected.
- Tap the **Help** button in the bottom-right corner of a dialog box.

Entering Text

The Input Panel soft keyboard lets you type characters into text boxes or address fields without using an external keyboard. To display and use the soft keyboard, tap the  icon in the toolbar status area. Figure 2-4 shows the default keyboard.

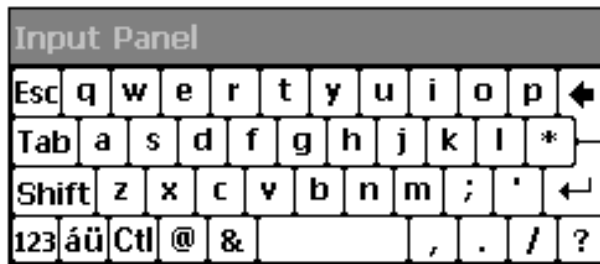

Small keyboard: Y350 and Y400



Large keyboard: Y400 only

Figure 2-4: The Soft Keyboards

To set soft keyboard properties, or switch between a large keyboard (default) and a smaller keyboard, do the following:

1. Select **Start > Settings > Control Panel**.
2. Double-tap the **Input Panel** icon to open the Input Panels Properties dialog.

Application User Interface Elements

Figure 2-5 on page 2-5 shows the YBT1E1 Option T1 application window. The Option E1 application window is the same except for minor differences. Differences between the Option T1 and Option E1 applications are called out in text.

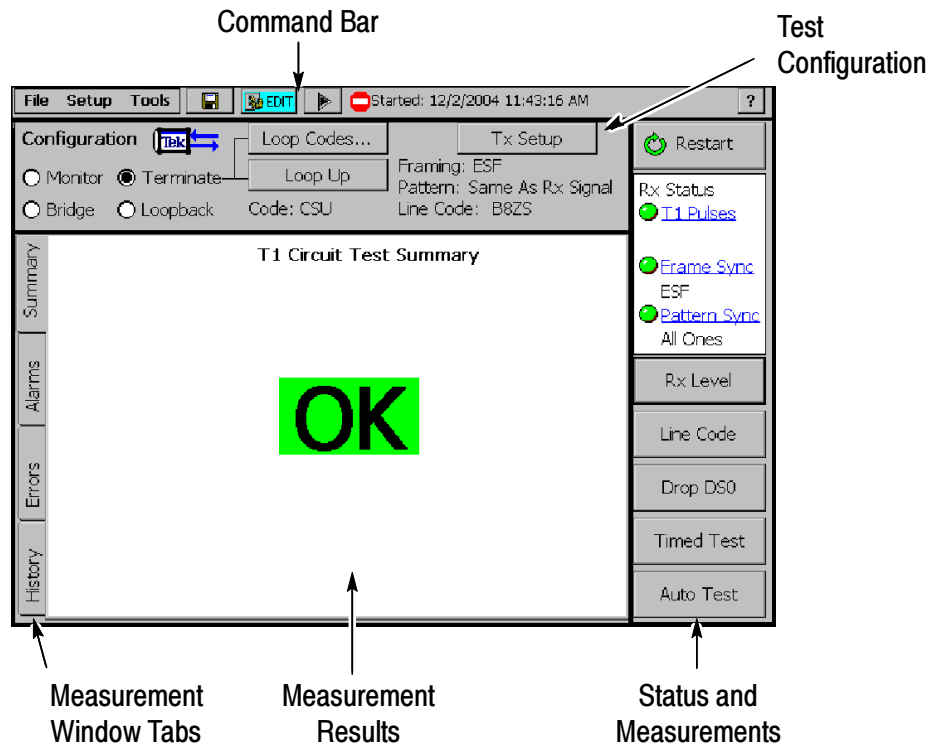

Figure 2-5: Option T1 application window elements

- **Command Bar:** The Command Bar provides common instrument controls such as running and stopping measurements, setting instrument test and operation parameters, and saving measurements and instrument settings. See Tables 2-1 and 2-2, starting on page 2-6, for a description of these elements.
- **Test Configuration:** The Test Configuration area sets the instrument test settings. See Table 2-3 on page 2-9 for a description of these elements.
- **Status and Measurements:** Displays receive signal status, enables receive signal level and line code measurement, and initiates timed and automatic test sequences. See Table 2-4 on page 2-11 for a description of these elements.
- **Measurement Results:** Shows details of measurement results. The appearance of this area changes depending on the selected measurement tab. See *The Measurement Results Windows*,

starting on page 2-15, for a description of the Measurement Results windows.

Command Bar

Table 2-1: Command bar elements







Button/Icon	Function
	Application drop-down menus. See Table 2-2 on page 2-7 for more information.
	Save button. Saves the latest measurement results to a file.
	Edit button. Displays the Setup window, which lets you edit the application setup parameters.
	Open button. Displays the Open dialog box, which lets you load a saved application setup. Replaces the Edit button when Hide Setup Controls is selected.
	Pause button. Pauses trace acquisition (stops measurements).
	Restart/Play button. Starts/Restarts trace acquisition.
	Acquisition active bar. Shows that the application is acquiring measurements. The number of vertical bars displayed cycles to indicate measurements are in progress.
	Stop icon. Shown when the measurements are paused.
	Recalled data icon. Shown when displaying recalled data.

Table 2-1: Command bar elements (Cont.)

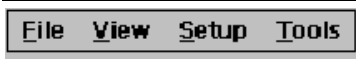
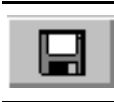

Button/Icon	Function
	Timestamp. Shows the time and date the displayed results were acquired (not present on live displays).
	Displays the Option T1 or option E1 Online Help.

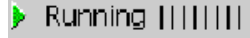
Table 2-2: Command bar menus

Menu	Function or description
File >	
Open	Invokes the <i>Open</i> dialog box to select and open a previously saved *.nr0 (Option T1) or *.nr1 (Option E1) results file.
Open Last Results	Recalls the results of the previous test, or data collected since the last Restart.
Save Results	Saves the results of the current test. Uses identical settings as the previous <i>Save Results As</i> and <i>Settings > Save and Export</i> dialog boxes.
Save Results As	Saves the current test results as specified by the <i>Save As</i> and <i>Settings > Save and Export</i> dialog boxes.
Export Results As	Invokes the <i>Save As</i> dialog box to save results as a tab-separated or comma-separated file for export by the NetTek Analyzer Platform.
Export Screen As	Invokes the <i>Save As</i> dialog box to save screens as PNG, JPEG, or Bitmap files for export by the NetTek Analyzer Platform.
Print	Invokes the <i>Print</i> dialog box to print the current screen.

Table 2-2: Command bar menus (Cont.)

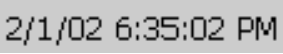
Menu	Function or description
Results Properties	Lists the <i>Settings > Save and Export</i> properties and user notes to be saved with the current results file.
Exit	Closes the application.
Setup >	
Edit	Invokes the <i>Settings</i> dialog box to change or configure instrument settings.
Open	Invokes the <i>Open</i> dialog box to execute *.sav files for changing instrument settings.
Save	Invokes the <i>Save As</i> dialog box to save current instrument settings as a *.sav file.
Preset	Returns the NetTek YBT1E1 to factory default settings.
Tools >	
Options	Opens the <i>Setup Menu</i> dialog box to show/hide and protect instrument settings.
Keyboard	Invokes the on-screen soft keyboard to enter alphanumeric characters into entry fields and dialog boxes.
Touchscreen Calibration	Invokes the <i>Stylus Properties</i> dialog box for calibrating the touch-screen display.
Upgrade Software	See Appendix B for software upgrade instructions.
Technical Support	Displays information on how to contact Tektronix.
Software Info	Displays the NetTek YBT1E1 software version and other properties.
Hardware Info	Displays NetTek YBT1E1 hardware properties.

Test Configuration

Table 2-3: Test Configuration elements





Button/Icon	Function
<input type="radio"/> Monitor 	<p>Sets the instrument for in-service monitoring of T1/E1 lines at DSX monitor ports that are resistor-isolated. The YBT1 transmitter is disabled in Monitor mode.</p> <p>T1 and E1: Provides a nominal 110 Ω input impedance and compensates for the 20 dB resistive loss of a DSX monitor port.</p>
<input type="radio"/> Bridge 	<p>Sets the instrument for in-service monitoring of terminated bridging T1/E1 lines at DSX monitor ports. The YBT1 transmitter is disabled in Bridge mode.</p> <p>T1 and E1: Provides a nominal 1 kΩ input impedance and compensates for up to 10 dB cable losses.</p>
<input type="radio"/> Terminate 	<p>Sets the instrument for out-of-service error insertion testing on terminated lines. The YBT1 transmitter is enabled in Terminate mode.</p> <p>T1 and E1: Provides a nominal 110 Ω input impedance and compensates for up to 10 dB cable losses.</p>
<input type="button" value="Loop Codes..."/>	<p>Option T1 only. Opens the Loop Codes tab (Setup > Edit > Loop Codes) to select a loop code. The YBT1E1 Tester only supports Line Loopback codes. Only available when Terminate is selected. See page 3-19 for more information.</p>
<input type="button" value="Loop Up"/>	<p>Option T1 only. Sets the instrument to send a loop code and loop up equipment at the far end.</p>

Table 2-3: Test Configuration elements (Cont.)

Button/Icon	Function
Loop Down	Option T1 only. Sets the instrument to remove the far end loop and return the instrument to Terminate configuration.
Code: CSU	Option T1 only. Displays the loopback code as set with the Loop Codes button.
<input type="radio"/> Loopback 	<p>Sets the instrument to take measurements on received data while looping the payload data from the receiver back to the transmitter. Loopback is useful when testing from the far end of a line. The YBT1E1 transmitter is enabled in Terminate mode. See page 3-19 for more information.</p> <p>T1 and E1: Provides a nominal 110 Ω input impedance and compensates for up to 10 dB cable losses.</p>
Tx Setup	<p>Sets the instrument transmitted signal line coding, framing, receive/transmit clock type, BER pattern, and (Option T1 only) transmitter power output level.</p> <p>Changing any of these parameters resets the alarm and error counters and restarts measurement acquisition.</p>
Framing: ESF Pattern: Same As Rx Signal Line Code: B8ZS	Displays the instrument transmit values as set with the Tx Setup button.

Status and Measurements Elements

Table 2-4: Status and Measurements elements



Button/Icon	Function
	<p>Resets all of the current measurement status and history, including error and alarm counts, and starts taking new measurements. If any instrument setting is configured for Same as Rx Signal, a Restart initiates the receiver detection algorithm for the selected setting(s).</p>
<p>Rx Status</p> 	<p>Indicates the status of received signal pulses.</p> <p>Green: pulses have been detected. White: searching for pulses.</p> <p>Displays <i>Receiving</i> when searching for pulses. Displays <i>Weak Signal</i> when pulse levels are too low to make accurate measurements, continues searching.</p>
	<p>The application compares the data framing detected at the Receive input to the criteria selected in the Setup > Edit > Instrument tab.</p> <p>Green: received framing matches the instrument settings. Red: received framing does not match the instrument settings. White: searching for framing synchronization.</p> <p>Displays the detected framing type.</p>

Table 2-4: Status and Measurements elements (Cont.)







Button/Icon	Function
	<p>The application compares the detected receive signal pattern to the criteria selected in the Setup > Edit > Instrument tab.</p> <p>Green: received pattern matches the instrument settings. Red: received pattern does not match the instrument settings. White: searching for pattern synchronization.</p> <p>Displays the detected framing pattern. If a known pattern is not detected for a period exceeding 10 seconds, the indicator displays <i>Unknown</i>. Unknown is also a likely pattern detected for live lines.</p>
	<p>Measures and displays the receive signal level, in dBdsx and Volts peak-to-peak. Select Done to return to the main application window.</p>
	<p>Detects and displays the detected receive signal line code. Select Done to return to the main application window.</p> <p>The History field displays the number of seconds the indicated line code has been received since the measurement began.</p>
	<p>Displays the DSO Activity Graph. This view shows the data activity for each of the T1 or E1 time slots. Each vertical time slot indicates the percentage of ones-density, represented as a unique color ranging from all zeros through all ones, in 10% increments. Each horizontal row represents a user-defined time period. The display builds up row-by-row with the newest row added to the bottom, and the oldest row removed from the top. See page 3-21 for more information. Select Close to return to the main application window.</p>

Table 2-4: Status and Measurements elements (Cont.)

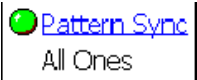
Button/Icon	Function
	Changes the Configuration Test area contents to allow setting a length of time to acquire measurements with the current instrument settings. See page 3-11 for additional information.
	Opens the Bert Pattern Selection dialog box to select and run predefined or custom BER test pattern sequences. See page 3-12 for additional information.

The Measurement Results Windows

The Summary Window

The Summary window displays a summary of the current measurement results, including any alarm or error events. To open the Summary window, tap the **Summary** tab on the left side of the display. This is the default test window when you open the application.

If no alarms or errors were detected during the test period or since the last Restart, then the Summary window displays **OK**, as shown in Figure 2-6.

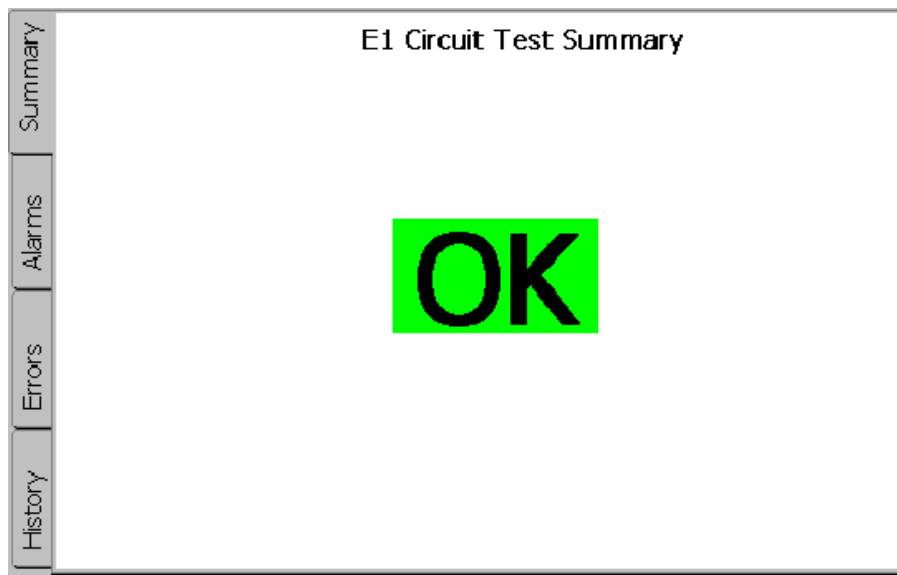
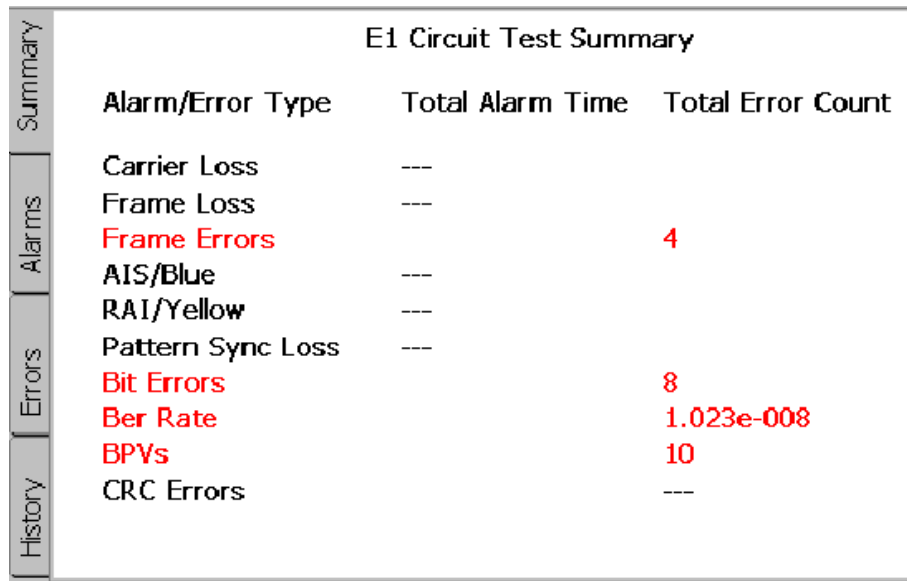

Figure 2-6: The Summary window with no errors

If any alarms or errors are detected during the test period or since the last Restart, then the Summary window displays a summary of the measurement errors, as shown in Figure 2-7.



E1 Circuit Test Summary			
	Alarm/Error Type	Total Alarm Time	Total Error Count
Summary	Carrier Loss	---	
	Frame Loss	---	
Alarms	Frame Errors		4
	AIS/Blue	---	
	RAI/Yellow	---	
Errors	Pattern Sync Loss	---	
	Bit Errors		8
	Ber Rate		1.023e-008
	BPVs		10
History	CRC Errors	---	

Figure 2-7: The Summary window with errors

Alarm /Error Type. Lists the type of alarm or error detected during the test period.

Total Alarm Time. Lists the time duration of the alarm or error.

Total Error Count. Lists error counts.

The Alarms Window

To open the Alarms window, tap the **Alarms** tab on the left side of the display. Figure 2-8 shows an example Alarms window for the Option T1 application. This window uses a rolling event display to show alarm events collected during the test period.

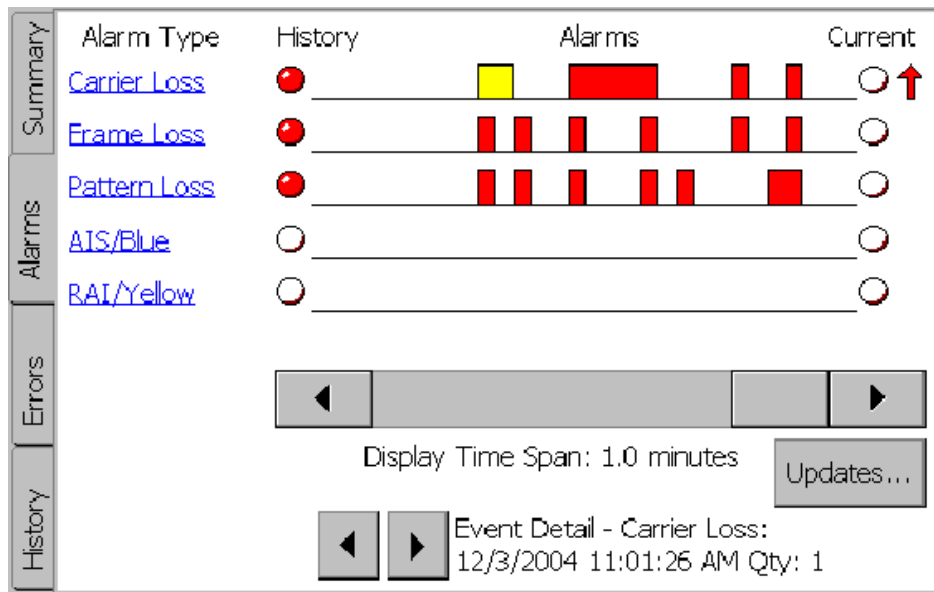

Figure 2-8: The Alarms window

Alarms Rolling Display

See page 2-20 for a description of the Rolling Display elements.

The Errors Window

To open the Errors window, tap the **Errors** tab on the left side of the display. Figure 2-9 shows an example Errors window for the Option E1 application.

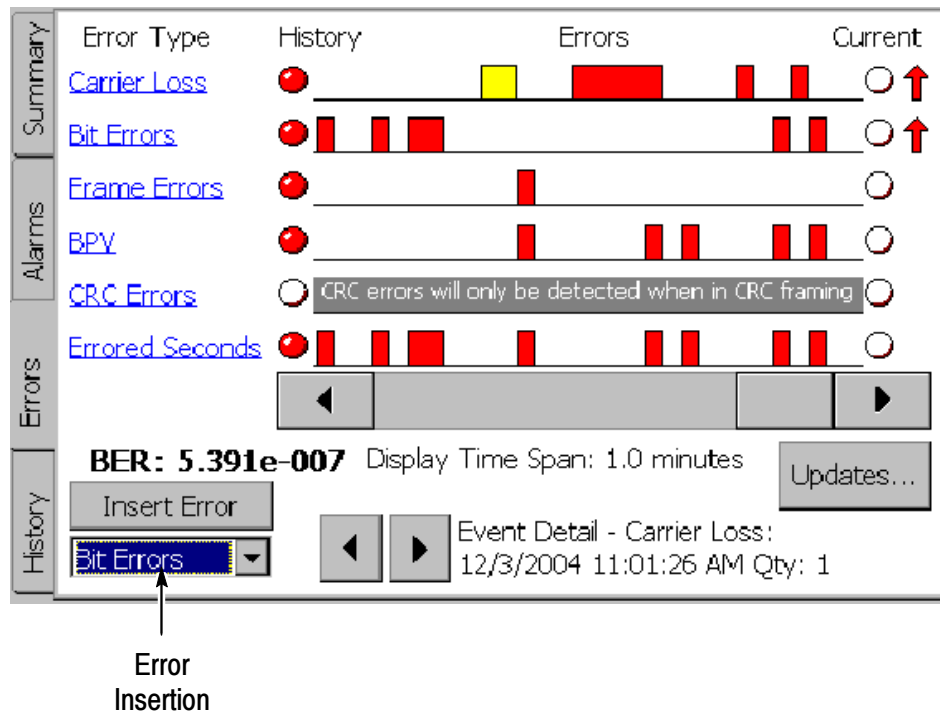

Figure 2-9: Errors window

Errors Rolling Display

The Errors Rolling Display operates the same as the Alarms Rolling Display; see page 2-20 for a description of the Rolling Display elements. The Errors Rolling Display also provides BER error rate measurement and error insertion functions, which are described in the following text.

BER Error Rate. The BER: indicator (bit error rate indicator) displays the cumulative bit error rate since the last time you began a test or selected the Restart button. The reported BER is calculated for the total number of bits received for a synchronized pattern session.

Insert Error button and Error Insertion List Box. The Insert Error button lets you insert a single error into the output data stream. To insert a single error, tap the **Insert Error** button. To change the error type, tap the error list directly below the Insert Error button and select an error type.

NOTE. *Configure the instrument for a Terminate connection before inserting errors. See page 3-3 for instructions.*

The NetTek YBT1E1 transmits a single error immediately. You must loop the far end connection to monitor errors at the Rx (Receive) input of the NetTek YBT1E1. See *Loopback Testing (Option T1 only)* on page 3-19 for information on loopback set up and testing.

The Alarms and Errors Rolling Display

The Rolling Display shows alarm events in relationship to time. New events are added at the right side of the display, and scroll to the left as the application continues to take measurements. Use the scroll bar below the Rolling Display to scroll through the events. Figure 2-10 shows the Rolling Display elements.

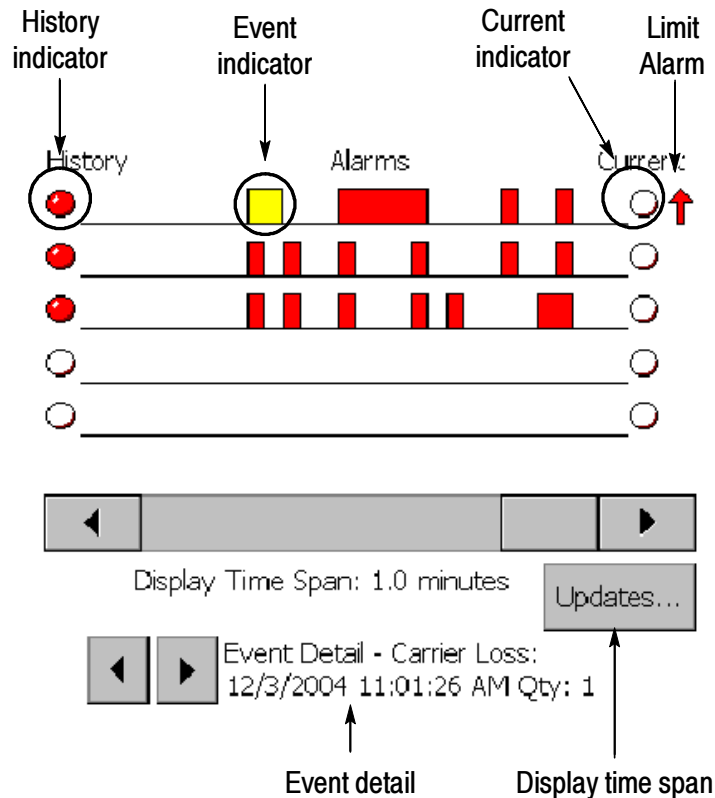

Figure 2-10: The Rolling Display elements

History Indicator

The History indicator color denotes whether any events have occurred during the current measurement acquisition period. Red indicates that an event has occurred; white indicates that no events have occurred. Once an event has occurred, the History indicator stays red until you change test parameters or restart the test.

Event Indicator

An event indicator marks the occurrence of an alarm event. Each indicator represents the time period specified by the data collection resolution.

To view details of an event, tap on an event indicator to select it. A selected event indicator changes color from red to yellow. Details of the event appear in the Event Detail field at the bottom of the display.

Current Indicator

The Current indicator color denotes whether an event is detected at the current measurement period. Red indicates that an event is detected; white indicates that no event is detected.

Limit Alarm

The Limit Alarm (red arrow) displays when the number of detected alarm events has exceeded the measurement error/alarm limits as defined in the **Setup > Edit > Limits** tab. The Limit Alarm indicator is displayed until you change test parameters or restart the test.

Event Detail

The Event Detail displays the time, date, and number of alarms of the selected event indicator. Tap the left and right arrows to scroll through the time record for information on each event of the currently-selected alarm type.

Display Time Span

The **Updates...** button sets the collection resolution and data collection time of the Rolling Display. To set the time span and data collection rate, do the following:

1. Tap the **Updates...** button (or select **Setup > Edit > Data Collection**).
2. Select a Time Interval (data collection time) from the drop-down list box.
3. Tap **OK**. Updated settings become the active settings. They will also be used as the default settings at the next power up.

NOTE. *Updating the time interval restarts the test. Data collected for the current test is deleted from memory.*

The 30 most recent time intervals comprise the default display time span of the rolling display. You can scroll beyond the 30 most recent events by tapping and dragging the scroll bar.

Select the History tab to review details of the last 150 time intervals or the number of errors detected since the beginning of the test.

This value specifies the data collection period represented by each event indicator in the rolling display. A maximum of 150 time intervals are allowed before the display memory allocation is exceeded and previously collected data is overwritten. The Data Collection Time = Time Interval x 150.

The Display Time Span of the rolling display is also defined by the data collection resolution, consisting of the most recent 30 time intervals.

You can scroll beyond the 30 most recent time intervals and access historical data by tapping and dragging the display scroll bar, which is located just above the Updates button.

To review the details of the last 150 time intervals (or the number of errors detected since the beginning of the test) in table format, select the History tab.

The History Window

To open the History window, tap the **History** tab on the left side of the display. Figure 2-11 shows an example History window for the Option T1 application.

Test History					
	Alarm/Error...	Count	Start Time	End Time	
Summary	BPV	1	7/24/02 3:34:00 PM		
	Bit Error	1	7/24/02 3:34:14 PM		
	Errored Seco...	1	7/24/02 3:34:14 PM		
Alarms	Frame Errors	1	7/24/02 3:34:24 PM		
	CRC Error	1	7/24/02 3:34:32 PM		
	Errored Seco...	1	7/24/02 3:34:32 PM		
Errors	BPV	1	7/24/02 3:34:41 PM		
	Errored Seco...	1	7/24/02 3:34:41 PM		
History	Totals				
	Carrier Loss	1	RAI	0	CRC Error 1
	Frame Loss	2	Pattern Loss	0	Errored Seconds 3
	Frame Errors	1	Bit Error	1	1's Density Fail 0
	AIS	0	BPV	2	

Figure 2-11: History window

The History window lists detailed information on the last 150 alarm and error events since you began a test or selected the Restart button. Information includes the alarm/error type, number of occurrences (count), and the start time (and stop time if relevant) of each event.

You can sort the information in this window by tapping the column header of the data you want to sort.

The Totals area at the bottom of the window lists a total errors count for each measurement. The list of measurements shown in this area is different for Option T1 and Option E1.



Reference

Connecting to a Signal

There are several ways to connect the NetTek YBT1E1 to a T1 or E1 circuit within the base station environment. Each type of connection allows you to test a different aspect of functionality.

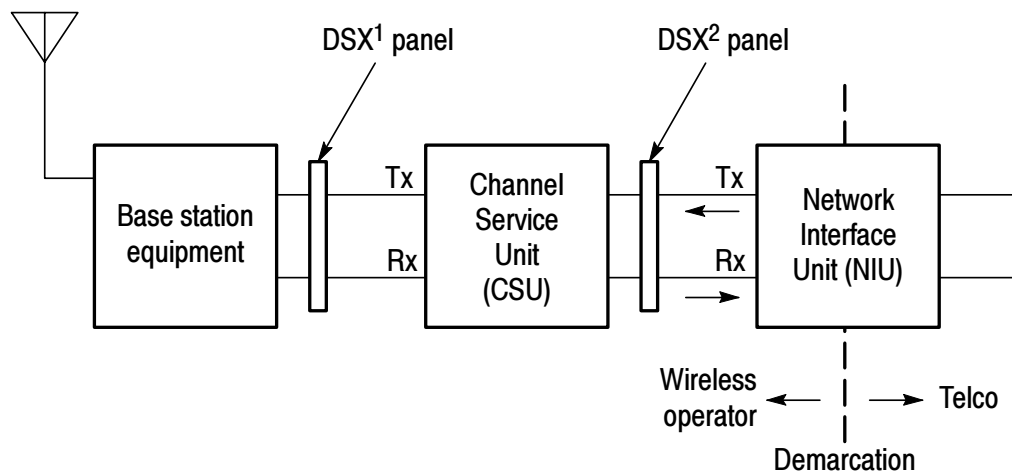

Figure 3-1: Typical base station showing network interfaces

Making a Monitor Connection

This is the most common type of connection to a DSX service panel. With this configuration, you can use the YBT1E1 to monitor either the network side or the customer side of the data stream, without removing the line from service. This configuration does not transmit data, therefore it does not block communications on either side.

Use this configuration to detect errors on the line, such as Bipolar Violations (BPV) and CRC (Cyclic Redundancy Check) errors, or to perform bit error-rate testing if a known test pattern is being received.

To monitor an outgoing signal at a DSX service panel, do the following:

1. Select the **Monitor** radio button.
2. Connect the RJ48-to-Bantam Y Cable to the YBT1E1 Line Interface.
3. Connect the Bantam **Receive** plug to the **MON** monitor jack on the DSX¹ service panel as shown in Figure 3-2.
4. Refer to *Testing a Circuit* on page 3-7 for how to configure the YBT1E1 Tester to take measurements.

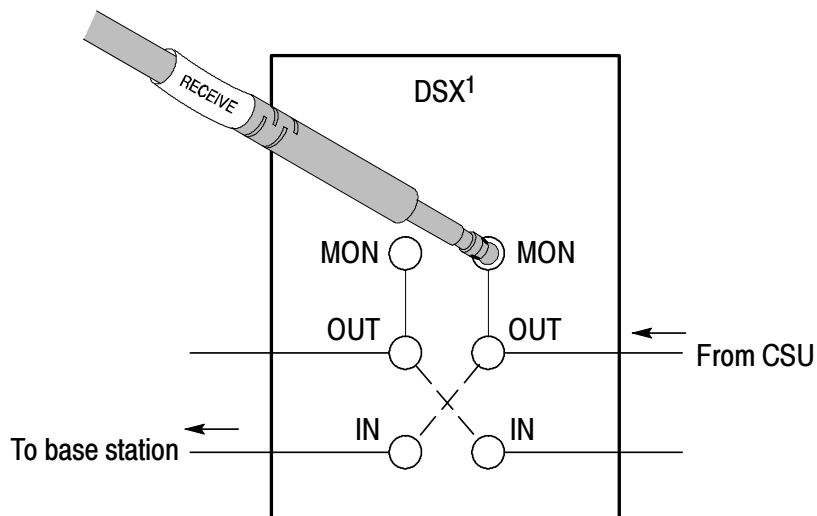

Figure 3-2: Typical connection for single-port monitoring

Making a Terminate Connection

Use this type of connection to place the NetTek YBT1E1 at the end of a service line when the line is out of service. With this configuration you can test base station equipment independent of the service line, or the service line independent of the base station.

To connect the NetTek YBT1E1 to test CSU equipment that is off line, do the following:

1. Select the **Terminate** radio button.
2. Connect the RJ48-to-Bantam Y to the YBT1E1 Line Interface.
3. Connect the **Transmit** Bantam plug to the **IN** side of the service access as shown in Figure 3-3.
4. Connect the **Receive** Bantam plug to the **OUT** side of the service access as shown in Figure 3-3.
5. Loop the DSX² service panel at the NIU.
6. Refer to *Testing a Circuit* on page 3-7 for how to configure the YBT1E1 Tester to take measurements.

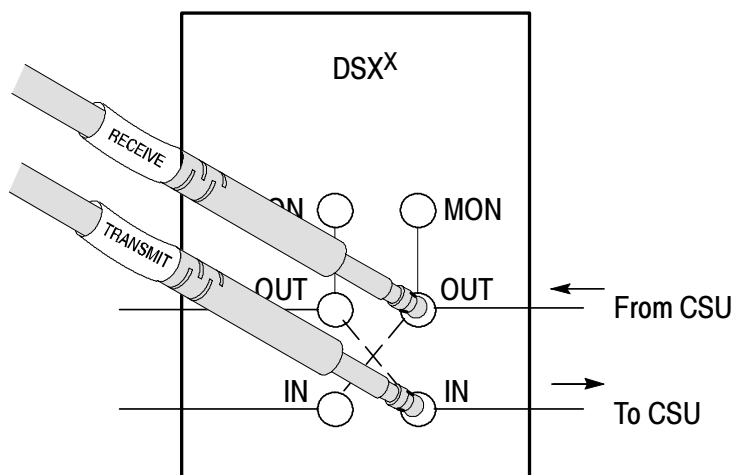

Figure 3-3: Typical connections for terminating a T1 circuit

Making a Loopback Connection

Use this type of connection to retransmit the incoming signal back to the point of origin through the NetTek YBT1E1. Looping back is virtually equivalent to hard wiring the receive side of the line to the transmit side of the line while allowing the NetTek YBT1E1 to make measurements on the received data.

To loopback a circuit through the NetTek YBT1E1, do the following:

1. Select the **Loopback** radio button.
2. Connect the RJ48-to-Bantam Y cable, RJ48-to-Alligator Clip Cable, or RJ45 to BNC cable to the YBT1E1 Line Interface.
3. Connect the **Transmit** Bantam plug, alligator clips, or BNC connector to the **IN** or **OUT** side of the service access, depending on the circuit you want to terminate. See Figure 3-4.
4. Connect the **Receive** Bantam plug, alligator clips, or BNC connector to the other side of the line for monitoring purposes.
5. Refer to *Testing a Circuit* on page 3-7 for how to configure the YBT1E1 Tester to take measurements.

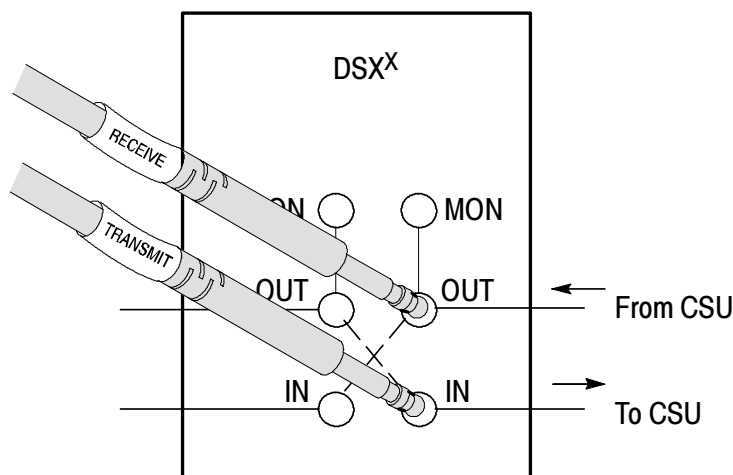

Figure 3-4: Typical connections for loopback mode

Making a Bridge Connection

Use this type of connection to perform nonintrusive testing on a circuit, without being limited to a designated monitoring port with the appropriate isolation.

Use this configuration to detect errors online, such as bipolar violations and CRC errors, or to perform bit error-rate testing if a known test pattern is being received.

To connect the NetTek YBT1E1 to a line without loading the circuit, do the following:

1. Select the **Bridge** radio button.
2. Connect the RJ48-to-Alligator Clip Cable to the YBT1E1 Line Interface.
3. Connect the Receive alligator clips to the appropriate points in the service access. See Figure 3-5.
4. Refer to *Testing a Circuit* on page 3-7 for how to configure the YBT1E1 Tester to take measurements.

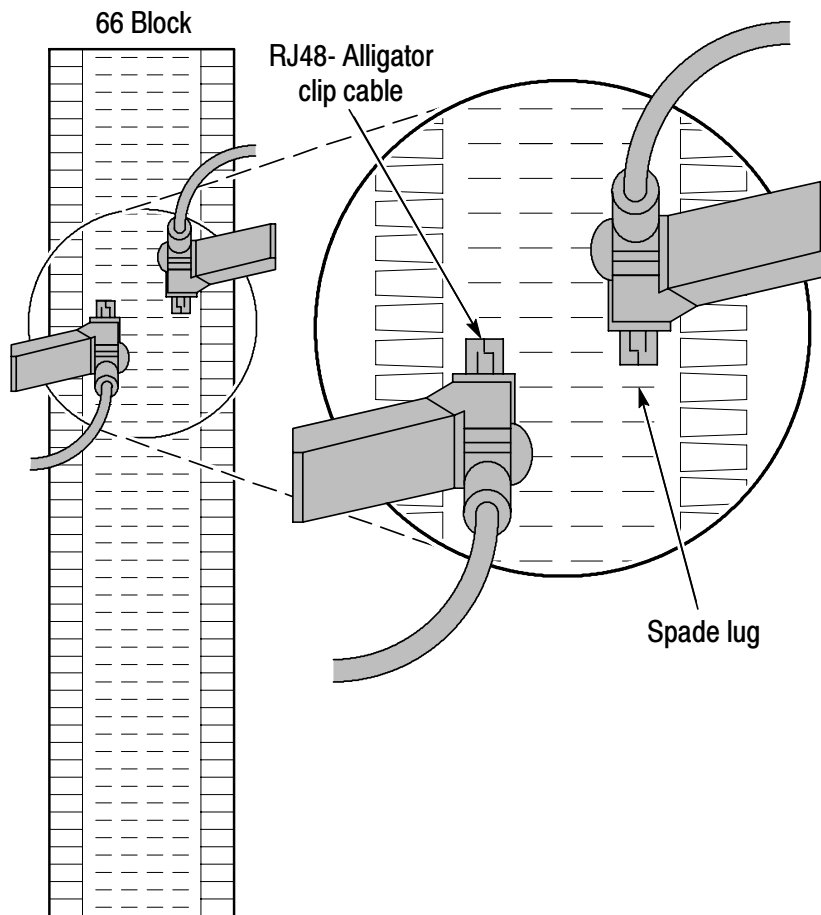

Figure 3-5: Typical connections for bridge monitoring

Testing a Circuit

Verify Received Signal and Line Coding

After you connect the NetTek YBT1E1 to a signal, you should verify that the YBT1E1 is receiving a sufficiently-strong signal and detects a line coding format. To verify signal strength and line format coding, do the following:

1. Select the **Rx Level** button. Verify that the signal level meets the minimum receiver sensitivity requirements listed in the Specifications section. See page A-1.
2. Select the **Line Code** button. Verify that the displayed line code is correct for the type of signal you are testing.

Automatic Measurement Setup

The NetTek YBT1E1 can automatically detect most of the parameters necessary to test a circuit. However, the instrument Line Coding setting must match the line code of the signal you are testing.

To set the instrument to automatically detect received signal parameters:

1. Tap the **Line Code** button to see which line code type the instrument is detecting.
2. Tap the **Done** button to close the Line Code Detect window.
3. Tap the **Edit** button (or select **Setup > Edit**).
4. Tap the Instrument tab if not already selected
5. Set the following parameters:
 - a. Line Coding: select the line code determined in step 1.
 - b. Framing: **Same as Rx Signal**.
 - c. Transmit Clock: **Recovered**.
 - d. Generated BER Pattern: **Same as Rx Signal**.

- Tap **OK** to apply the settings and close the Settings window. Tap **Apply** to apply the settings and remain in the Settings window.

The NetTek YBT1E1 automatically detects data formatting and analyzes the received signal. To view summarized test results, tap the **Summary** tab and check the Summary report. To view details of specific test results, select the **Alarms** or **Errors** tabs.

Typically, the first thing you see in the main window (Summary tab) is an indication that either the data stream contains no anomalies (the display reads “OK”), or that the NetTek YBT1E1 detected an alarm or error, in which case the Circuit Test Summary results are displayed. The Circuit Test Summary lists all of the alarms or errors detected since the last restart. See Figure 3-6.

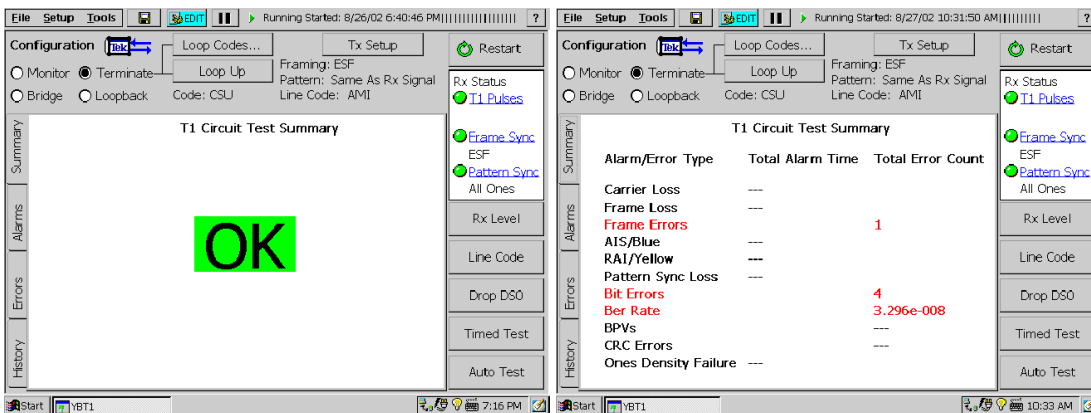

Figure 3-6: Summary window showing typical test results

If the NetTek YBT1E1 detected an alarm or error, select the **Alarms** or **Errors** tab to open an **Alarms** or **Errors** window to obtain additional information. These windows provide graphical presentations of the most recent test events, as well as indicators that show the current and past performance of the line under test. To view an itemized list of the alarm or error history since the last restart, open the **History** tab.

You can also view all of the DS0 time slots simultaneously on the Drop DS0 activity graph. To view the DS0 Activity Graph, select the

Drop DS0 button. See page 3-21 for information on using and configuring the Drop DSO display.

Measurement results accumulate as long as the NetTek YBT1E1 detects signal pulses. You can view test summary results at the end of a timed test or while a test is running by selecting the History tab.

NOTE. *To ensure accurate measurements, always press the **Restart** button after you connect the NetTek YBT1E1 Tester to a circuit.*

Manual Measurement Setup

The NetTek YBT1E1 automatically detects most of the parameters necessary to test a circuit. However, you can override any or all of the automated settings to speed up synchronization or to perform specialized tests. The Instrument Settings dialog allows you to configure the NetTek YBT1E1 for specialized testing.

NOTE. *The Line Coding setting in the Setup > Edit > Instrument tab must match the line code of the signal you are testing. Select the **Line Code** button on the right side of the main display to view the line code currently being detected. You may need to manually set the Line Coding in the Instrument tab before taking measurements.*

To manually set the NetTek YBT1E1 instrument settings, do the following:

1. Select **Setup > Edit** to open the Settings dialog.
2. Tap the **Instrument** tab if not already selected. Figure 3-7 shows the available instrument settings for Option T1.

3. Select the option buttons appropriate to the tests you want to make:
 - Option T1: Line Coding, Framing, Receive/transmit Clock, BER Pattern, and Transmit Level.
 - Option E1: Line Coding, Framing, Receive/transmit Clock, and BER Pattern.

NOTE. *The Transmit Level field and settings are only available in the Option T1 application.*

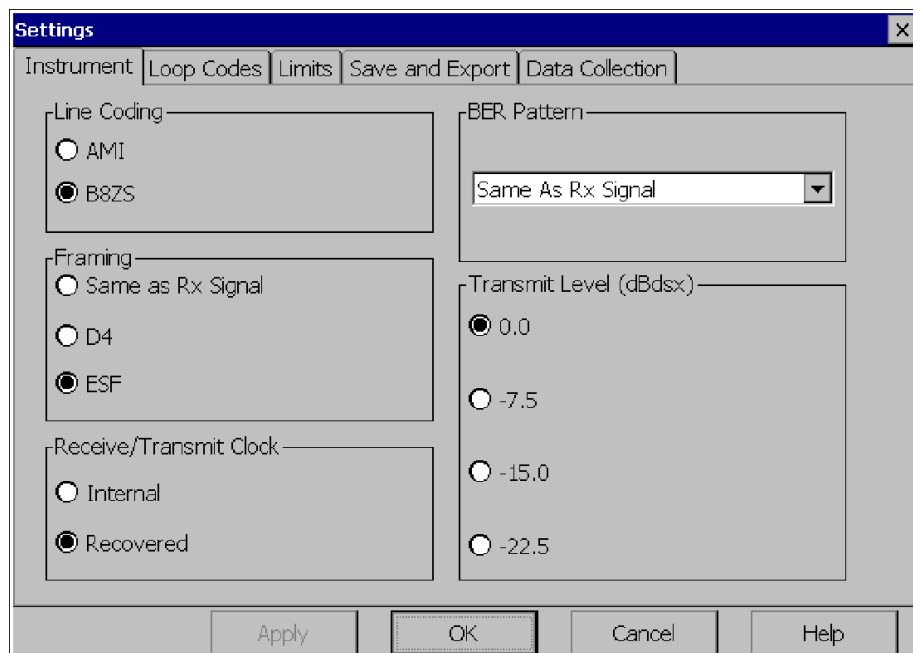

Figure 3-7: Option T1 Instrument settings dialog

Performing Timed Tests

A timed test acquires measurements for a specified time and current software settings and then stops acquisitions. Measurement results are displayed using the standard measurement results windows.

To perform a timed test, tap the **Timed Test** button. Tapping this button replaces the test configuration area contents with the contents shown in Figure 3-8.



Figure 3-8: Timed Test; configuration area elements

Use the keypad icon to enter a test time duration. The minimum time unit is one minute. Figure 3-8 shows a time setting of one hour and 30 minutes.

Tap the **Start Test** button to start the timed test. Tap **Pause** to pause the test or continue a paused test. Tap **Cancel** or **Close** to stop the timed test mode and return to the main application window.

Limit Testing

The YBT1E1 Circuit tester provides limit testing for all measurements. Measurements that exceed the set limits display a Limit Alarm arrow icon in the Alarms and Errors windows.

To set measurement alarm limits, do the following:

1. Tap the **Edit** button.
2. Select the **Limits** tab
3. In the Enable column, select the test for which you want to set error limits.

4. In the Limit column, tap the limit value you want to edit.
5. Tap the keypad icon and enter the error limit value.
6. Repeat steps 3 through 5 for all tests for which you want to set limits.
7. At the bottom of the display, set the actions that the instrument takes upon failing any limit test:
 - Emit a Beep
 - Pause the measurement acquisition
 - Export the screen image to a file (as set in the Setup > Edit > Save and Export tab)
 - Save the measurement results to a file (as set in the Setup > Edit > Save and Export tab)
8. Tap **OK** to close the Limits dialog.
9. To perform the limit testing, tap **Restart** to start a new measurement acquisition.

Performing Automated BER Tests

To run a series of preselected BER tests for specified periods of time, perform the following steps:

1. Select the **Auto Test** button to open the Bert Pattern Sequence dialog. See Figure 3-9.

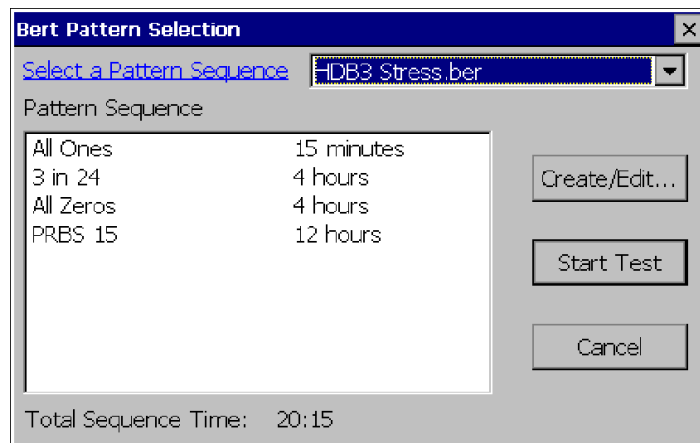

Figure 3-9: Auto Test BERT Pattern Selection dialog

2. Select a Pattern Sequence from the drop-down list box:
 - **Acceptance.ber.** Runs a standard sequence of BER patterns that you can use as an acceptance criteria for new circuits.
 - **AMI Stress.ber.** Runs a sequence of BER patterns designed to stress equipment configured for AMI line coding.
 - **B8ZS Stress.ber (Option T1 only).** Contains a sequence of BER patterns designed to stress equipment configured for B8ZS line coding.
 - **HDB3 Stress.ber (Option E1 only).** Contains a sequence of BER patterns designed to stress equipment configured for HDB3 line coding.
 - *filename.ber.* User-created BER pattern sequence files. See *Creating Custom Pattern Sequence Tests* on page 3-15 for information on how to use the editor.
3. The dialog displays the selected sequence information (pattern type and duration) in the Pattern Sequence window.
4. Select **Start Test**.

The selected sequences run for the specified number of minutes. The NetTek YBT1E1 pauses at the end of the test and opens a Pattern Sequence Results window, similar to the one shown in Figure 3-11 on page 3-18.

The Create/Edit a Pattern Sequence Dialog

The **Create/Edit...** button opens the Pattern Sequence dialog box that lets you create, edit, and save test patterns and test sequences. See Figure 3-10.

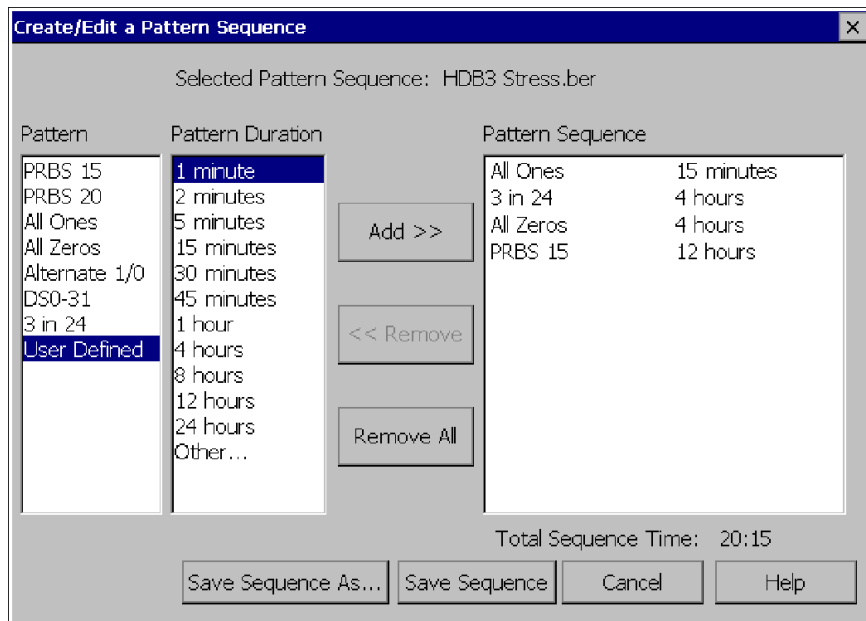

Figure 3-10: The Create/Edit Pattern Sequence dialog

Pattern Sequence. This field lists the pattern you selected in the drop-down list box of the Bert Pattern Selection dialog box (after you selected the Auto Test button).

Pattern. This field contains a list of the available test patterns. To select a pattern, tap on the pattern name you wish to select.

Pattern Duration. This field contains a list of the common pattern durations. Select a time duration by tapping the desired setting. To create a custom time duration, select **Other...** and enter the time in hh:mm (hours:minutes) on the pop-up keypad.

Pattern Sequence. This field lists the details of the pattern you selected or are editing.

Save Sequence. You can save the sequence you have just edited/created by selecting this button. Note that you may not save a Pattern Sequence under the same name as the predefined pattern sequences, but you may rename the sequence using the dialog window that appears.

Save Sequence As. You can save the sequence you have just edited/created by selecting this button and typing in your new sequence name.

Cancel. Select this button to cancel and close the Create/Edit a Pattern Sequence dialog box.

Creating Custom Pattern Sequence Tests

To create custom pattern sequences, do the following

1. Tap **Auto Test** to open the Bert Pattern Selection dialog box.
2. Tap **Create/Edit** to open the Create/Edit a Pattern Sequence dialog box.
3. Tap **Remove All** to clear the Pattern Sequence field.
4. Select a pattern and duration for your test.
5. Edit the Pattern Sequence list:
6. Tap the **Add >>** button to add the pattern and duration to the Pattern sequence field.
 - To delete a pattern from the list, select the pattern and tap the **<< Remove** button.
 - To insert a pattern at a particular line of the list, select the pattern sequence list item that is directly below where you want to insert the new pattern, then tap the **Add >>** button.

7. Repeat steps 4 through 6 until you have completed a pattern.
8. Tap the **Save Sequence As...** button.
9. Enter a name for your new pattern.
10. Tap the **OK** button to save the pattern sequence to a file. You can now select the new sequence file from the BERT pattern Selection dialog.

NOTE. *To start an automated test, you must return to the BERT Pattern Selection dialog box.*

Editing an Existing Pattern

To edit an existing BERT pattern sequence, do the following:

1. Select the **Auto Test** button to open the Bert Pattern Selection dialog box.
2. Select the BERT pattern you want to modify in the drop-down list box.
3. Select the **Create/Edit** button to open the Create/Edit a Pattern Sequence dialog box.
4. Select the pattern name to delete in the Pattern Sequence list.
5. Select the **Remove** button.
6. Select a pattern and time duration to replace the deleted pattern.
7. Select the pattern in the Pattern Sequence list box below which you want to insert the new pattern.
8. Select **Add** to insert the new pattern in the Pattern Sequence list.
9. Select **Save Sequence**.

You can create a custom pattern sequence by selecting **Remove All** and adding your own contents to the Pattern Sequence list:

1. Select the desired Pattern(s) and associated Pattern Duration in the list boxes.
2. Select **Add**.
3. Select **Save Sequence**.

NOTE. *To start an automated test, you must return to the BERT Pattern Selection dialog box.*

Pattern Sequence Results View

This window displays the results of the automated BER pattern sequence test; it automatically opens when the sequence is completed.

Results are displayed in table format, with each row representing one of the test patterns employed in the test. See Figure 3-11 on page 3-18.

- **Pattern.** The BER test pattern used in this section of the test.
- **Duration.** The programmed duration for the transmission of this test pattern. The format is hh:mm.
- **Pattern Availability.** The actual time duration in which the pattern was received. The format for this column is hh:mm:ss. If the NetTek YBT1E1 lost pattern synchronization or framing for any period during the programmed pattern duration, this number will be minus the Duration. The time required to obtain pattern synchronization with the incoming pattern may also cause the Pattern Availability to be less than the programmed duration.
- **Bit Errors.** The bit error count for this pattern.
- **Bit Error Rate.** The bit error count divided by the number of received bits during the Pattern Availability duration.
- **BPV.** The number of BiPolar Violations received during the pattern duration.

- **CRCs.** The number of CRC Errors received during the pattern duration.
- **Frame Errors.** The number of Frame Errors received during the pattern duration.

Select **Run Again** to repeat the test.

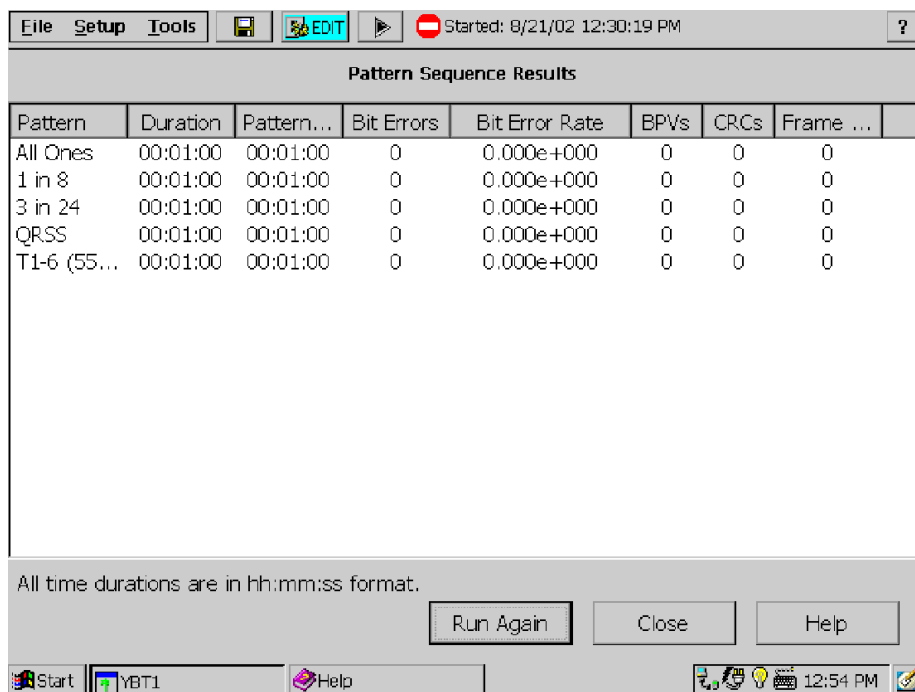

The screenshot shows a software window titled "Pattern Sequence Results". The window has a menu bar with "File", "Setup", and "Tools". Below the menu bar is a toolbar with icons for "EDIT", a play button, and a stop button. The main area contains a table with the following data:

Pattern	Duration	Pattern...	Bit Errors	Bit Error Rate	BPVs	CRCs	Frame ...
All Ones	00:01:00	00:01:00	0	0.000e+000	0	0	0
1 in 8	00:01:00	00:01:00	0	0.000e+000	0	0	0
3 in 24	00:01:00	00:01:00	0	0.000e+000	0	0	0
QRSS	00:01:00	00:01:00	0	0.000e+000	0	0	0
T1-6 (55...	00:01:00	00:01:00	0	0.000e+000	0	0	0

Below the table, there is a note: "All time durations are in hh:mm:ss format." At the bottom of the window, there are three buttons: "Run Again", "Close", and "Help". The taskbar at the bottom shows the Start button, a taskbar with "YBT1" and "Help", and a system tray with a clock showing 12:54 PM.

Figure 3-11: Pattern sequence results window

Loopback Testing (Option T1 only)

Loopback testing is creating a loopback at the far end of the span and using a single instrument to measure the round-trip performance of the T1 line. Because loopback testing only requires a single test instrument and operator, it is more convenient and more efficient than point-to-point testing.

The downside to loopback testing is that it can only analyze the combined performance of both transmit and receive paths at the same time, making it difficult to distinguish on which side the problem exists. However, loopback testing can offer enough information to determine a general fault location, such as in telephone company lines or the base transceiver station site.

There are several ways to set up a loopback on a T1 circuit:

- Inserting loop plugs at a patch panel
- Using the Channel Service Unit (CSU) or Network Interface Unit (NIU) front panel to force the equipment into loopback
- Logging into the network and setting the equipment to loop back the signal
- Sending T1-standard defined loopback codes to set the equipment into loopback mode

You can use the YBT1E1 with any of these methods; the YBT1E1 can send loopback codes to force remote equipment into a loopback mode.

NOTE. *You must set the NetTek YBT1E1 to Terminate configuration to use this feature.*

The ANSI T1 standard defines the following loop control formats:

- **In-Band Codes:** transmitted in place of payload data (but not framing bits). These codes are repeated continuously for a period of 5 seconds and are defined for use with either D4 (Superframe) or ESF framing formats.
- **Out-of-Band Codes:** defined for ESF framing only. An out-of-band communication link does not exist for D4 framing.

Additionally, there are two types of loop codes:

- **Line Loopback:** generates a full 1.5444 Mbps stream looping back from the receiver to the transmitter, including the framing bits.
- **Payload Loopback:** the equipment performing the loopback generates the framing, looping back 1.536 Mbps user channel data only.

The YBT1E1 only supports line loopback codes, in both in-band and out-of-band loop control formats, as shown in Table 3-1.

Table 3-1: Defined line loopback codes

Type	In-band/ out-of-band	Up	Down
CSU			
CSU In-Band	In-band	10000	100
ESF Line	Out-of-band	0000 1110 1111 1111	0011 1000 1111 1111
NUI			
NIU FAC2	In-band	1100	1110
NIU FAC1	In-band	11000	11100
ESF Net	Out-of-band	0001 0010 1111 1111	0010 0100 1111 1111
User	In-band	3- to 8-bit user-entered pattern	

Setting up Loopback Codes

1. Tap **Terminate** in the Configure area.
2. Tap **Loop Codes** to display the Loop Codes tab.
3. Select one of the following:
 - Select the **CSU** or **NUI** option button and the associated drop-down list to specify a pre-defined loop code.
 - Select **User**, then tap the keypad icon to open the numeric keypad and enter a binary code.
4. Tap **OK**. The current loop code type (CSU, NUI, or User) is displayed below the Loop Up / Loop Down button. This configuration is similar to the Terminate configuration except that a far end loop has been established.

Tap the **Loop Down** button to remove the loopback mode and return the NetTek YBT1E1 to a standard Terminate configuration.

NOTE. *The Loop Down button appears after you have selected the Loop Up button and successfully completed a loop up of the far end.*

Using the DSO View

The DSO view is a vertically-rolling display that shows the ones-density data activity of each signal time slot. The DSO view uses unique colors to represent the percentage of ones-density from all zeros through all ones, in 10% increments. New signal information starts at the bottom of the display and scrolls upward.

Select the **Drop DSO** button on the right side of display to open the DSO view. Figure 3-12 on page 3-22 shows the DSO view for the DSO PCM31 BER test pattern.

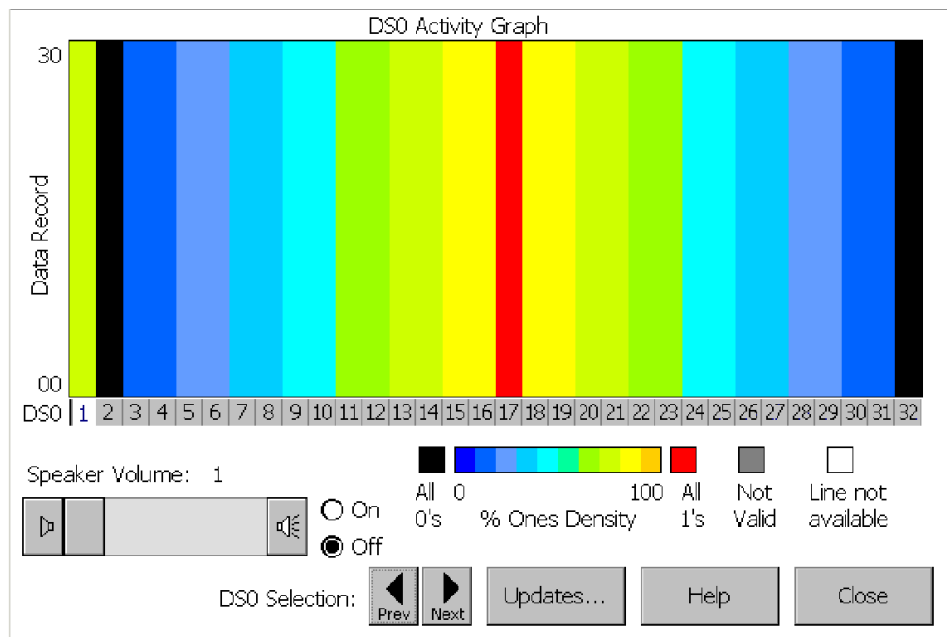

Figure 3-12: The Drop DSO view

Each row of the display represents a user-defined period of time. Over multiple time periods, the display builds up row by row, with the oldest row being removed from the top as the new row is added to the bottom.

The DSO display is useful in detecting:

- DSO muxing problems
- Identifying PRI control channels
- Identifying concatenated DSO data pipelines
- Aural identification of some signal problems
- Normally quiet channels disrupted by random noise
- Normally variable data channels that are locked into a continuous pattern
- Normal startup protocols, represented by identifiable fixed bars, not changing to a variable pattern

NOTE. *Errors and alarms data collection continues while viewing this screen. To view the Errors or Alarms count, select the **Close** button; then select the desired display tab.*

Setting the DS0 Data Collection Update Time Interval

To set the update interval of the DS0 Activity Graph data record, do the following:

1. Select **Setup > Edit > Data Collection**.
2. Select a Minutes, Hours, or Days option button.
3. Tap the corresponding left/right arrows to increment or decrement the Update Interval value. (You can also tap the keyboard icon in the taskbar or attach an external PS2 keyboard to enter a specific value.) The DS0 Activity Graph time span (data record full screen) is shown in the scroll box.
4. Tap **OK**.

NOTE. *The updated settings become the active settings. They will also be used as the default settings at the next power up.*

Updating the time interval restarts the test. Data collected for the current test is deleted from memory.

Monitoring Audio Data On a DS0 Channel

Use the following procedure to monitor audio data on a selected DS0 channel:

1. Tap a DS0 channel number at the bottom of the display; 1 through 24 (Option T1) or 1 through 32 (Option E1).
2. Set the the speaker option button to **On**.
3. Tap and drag the slider to control the speaker volume.



Appendices

Appendix A: Specifications

This section lists the electrical, environmental, and physical specifications of the NetTek YBT1E1 T1 & E1 Circuit Tester. All specifications are guaranteed unless labeled “typical.” Typical specifications are provided for your convenience and are not guaranteed.

The electrical characteristics listed in Table A-1 apply to the NetTek YBT1E1 operating within the environmental conditions listed in Table A-3 on page A-3.

Table A-1: Electrical characteristics

Characteristic	Description
Transmitter (Tx) Characteristics	
Pulse Shape	<p>T1: Compatible with ANSI T1.102, 1993 and DS1, DSX-1 specifications, section 6.2.5 to 6.2.8 and 6.2.10.</p> <p>E1: Compatible with ITU-T G.703</p>
Output Jitter	<p>T1: UI peak-to-peak: < 0.02% Compatible with PUB 62411.</p> <p>E1: UI peak-to-peak: < 0.11% Compatible with ITU-T I.431 and ETSI TBR 12.</p>
Data Format, nominal	<p>T1: AMI, B8ZS</p> <p>E1: AMI, HDB3</p>
Frequency accuracy, nominal	T1 and E1: ± 50 ppm
Loopback Codes	<p>T1: CSU, NIU, User-defined, In-band, Out-of-band</p> <p>E1: N/A</p>

Table A-1: Electrical characteristics (Cont.)

Characteristic	Description
Receiver (Rx) Characteristics	
Input Impedance, nominal	T1 and E1 : Bridge mode: > 1000 Ω Monitor, Loopback, and Terminate mode: 110 Ω \pm 10%
Sensitivity	T1 and E1 : Terminate mode: 0 to -12 dBdsx ^{1, 4} Bridge mode: 0 to -12 dBdsx ^{2, 4} Monitor mode: -20 to -30 dBdsx ^{3, 4}
Level Measurements	T1 and E1 : dBdsx ⁵ and V_{p-p}
Jitter Tolerance, nominal	T1 : 400 to 100,000 Hz: complies with ITU, AT&T, and Telcordia requirements for T1 applications (PUB 62411, TRNWT 000499 Cat II, CCITT G.823, ITU-T1.431) E1 : 400 to 100,000 Hz: complies with ITU-T I.431 for CEPT applications (CCITT G.823, ITU-T I.431)
Jitter Transfer Curve, nominal ⁶	T1 : Attenuator meets the requirements of PUB 62411, PUB 43802, TR-TSY 009, TR-TSY 253, TR-TSY 499, and ITU-T1.431 and G.703 E1 : Attenuator meets the requirements of ITU-T I.431 and G.736

¹ 110 Ω input impedance. Employs long-haul equalizer.

² >1 k Ω input impedance. Employs long-haul equalizer.

³ 110 Ω input impedance. Employs long-haul equalizer and 20 db amplification.

⁴ Rx Status Indicator (T1 pulses) reports *Weak Signal* when lower amplitude signals are detected.

⁵ \pm 3 dB

⁶ NetTek Y350 or NetTek Y400 reference clock.

Table A-2: Physical characteristics

Characteristic	Description
Dimensions ¹	Height: 25 cm (9.75 in) Width: 33 cm (13 in) Depth: 9 cm (3.5 in)
Weight ¹	One battery installed: 4.23 kg (9.32 lbs) Two batteries installed: 4.82 kg (10.63 lbs)

¹ NetTek Analyzer Platform with NetTek YBT1E1 PC card installed.

Table A-3: Environmental characteristics

Characteristic	Description
Temperature Range	
Operating	0 to +50 °C (+32 to +122 °F)
Nonoperating	-40 to +60 °C (-40 to +140 °F)
Humidity	
Operating	5% to 80% RH, noncondensing: 0 °C to +30 °C (32 °F to 86 °F) 5% to 30% RH, noncondensing: +30 °C to +50 °C (86 °F to 122 °F)
Nonoperating	5% to 80% RH, noncondensing: 0 °C to +30 °C (32 °F to 86 °F) 5% to 30% RH, noncondensing: +30 °C to +50 °C (86 °F to 122 °F)
Altitude	
Operating	4,600 m (15,100 ft)
Nonoperating	12,192 m (40,000 ft)

Table A-4: Certifications and compliances

Category	Standards or description
EC Declaration of Conformity - EMC	<p>Meets intent of Directive 89/336/EEC for Electromagnetic Compatibility. Compliance was demonstrated to the following specifications as listed in the Official Journal of the European Union:</p> <p>EN 61326 EMC requirements for Class A electrical equipment for measurement, control, and laboratory use.^{1,2,3}</p> <p>IEC 61000-4-2 Electrostatic discharge immunity (Performance criterion C).</p> <p>IEC 61000-4-3 RF electromagnetic field immunity (Performance criterion A).</p> <p>IEC 61000-4-4 Electrical fast transient / burst immunity (Performance criterion B).</p> <p>IEC 61000-4-5 Surge immunity (Performance criterion B).</p> <p>IEC 61000-4-6 Conducted RF immunity (Performance criterion A).</p> <p>IEC 61000-4-11 Voltage dips and interruptions immunity (Performance criterion B).</p> <p>EN 61000-3-2⁴ AC power line harmonic emissions.</p> <p>EN 61000-3-3 Voltage fluctuations and flicker.</p>
Australia/New Zealand Declaration of Conformity - EMC	<p>Complies with EMC provision of Radiocommunications Act per the following standard:</p> <p>AS/NZS 2064.1/2 Industrial, Scientific, and Medical Equipment:1992.</p>

Table A-4: Certifications and compliances (Cont.)

Category	Standards or description
U.S. Nationally Recognized Testing Laboratory Listing	UL 60950 3rd edition Safety of Information Technology Equipment.

- 1 Emissions that exceed the levels required by this standard may occur when this equipment is connected to a test object.
- 2 Compliance demonstrated using high-quality, shielded interface cables.
- 3 Compliance demonstrated with NetTek YBT1E1 PC card installed in the rear PCMCIA slot of the NetTek Analyzer Platform.
- 4 (A14)

Appendix B: Installing NetTek YBT1E1 Software

You can use the following methods to install, reinstall, or upgrade NetTek YBT1E1 software on the NetTek Analyzer Platform:

- Archive file method. Uses a PC memory card installed in the NetTek Analyzer Platform. This is the easiest method.
- Serial connection method. Uses a standard serial (RS-232) connection between a host PC and the NetTek Analyzer Platform.
- USB connection method (NetTek Y400 only). Uses a standard USB connection between a host PC and the NetTek Analyzer Platform.

PC Requirements

This installation requires a desktop PC with CD-ROM drive and Microsoft Windows 98, NT 4.0, 2000, or XP operating system.

Installing Using an Archive File

To install the NetTek YBT1E1 software using an archive file, do the following:

1. Use a desktop PC to copy the correct archive file from the CD-ROM to a PC memory card:

- To install Option E1 on a NetTek Y350C:

```
<CD>:\Upgrade\E1\Archive\Y350C\ybe1y_upgrade_vx-xxx.arq
```

- To install Option E1 on a NetTek Y400:

```
<CD>:\Upgrade\E1\Archive\Y400\ybe1k_upgrade_vx-xxx.arq
```

- To install Option T1 on a NetTek Y350C:

<CD>:\Upgrade\T1\Archive\Y350C\ybt1y_upgrade_vx-xxx.arq

- To install Option T1 on a NetTek Y400:

<CD>:\Upgrade\T1\Archive\Y400\ybt1k_upgrade_vx-xxx.arq

Where <CD> is the CD-ROM drive letter, and xxx is the software version information.

2. On the NetTek Analyzer Platform, select **Start > Shutdown**; then select **Shutdown**.
3. Remove the NetTek YBT1E1 PC card if installed.
4. Insert the PC memory card containing the *.arq file into the NetTek Analyzer Platform.
5. Power on the NetTek Analyzer Platform.
6. On the NetTek Analyzer Platform, select **Start > Programs > Tektronix Utilities > Module Upgrade**.
7. Follow the on-screen instructions to install the NetTek YBT1E1 Option T1 or Option E1 software.
8. When the YBT1E1 software install is complete, shut down the NetTek Analyzer Platform and remove the PC memory card.
9. Install the NetTek YBT1E1 PC card into the NetTek Analyzer Platform.
10. Start up the NetTek Analyzer Platform.

The NetTek YBT1E1 T1 & E1 Circuit Tester is now ready to use. To start the application, double-tap the YBT1 or YBE1 icon on the NetTek Analyzer Platform desktop or select **Start > Programs > NetTek > YBT1** (or **YBE1**).

Installing Using an RS-232 Serial Connection

1. Connect one end of an RS-232 cable to the serial (COM) port on the desktop PC.
2. Connect the other end of the cable to the NetTek Analyzer Platform serial port.

If the desktop PC serial interface has already been configured to use Windows CE Services or Active Sync, you must disable the serial connection as explained below.

Disabling the Windows CE Services Serial Connection

If Windows CE Services is installed, you must do the following to disable the serial connection:

1. Right-click on the Windows CE Services icon in the desktop PC status area; then select **Communications**.
2. In the Windows CE Services Properties dialog box, open the Communications tab.
3. In the Device Connections via Serial Port field, deselect **Enabled**. (Enable mobile device connection must already be selected to make this selection).
4. Select **OK**; then close the dialog box.

Disabling the Windows Active Sync Serial Connection

If Windows Active Sync is installed, you must do the following to disable the serial connection:

1. Right-click on the Active Sync icon in the desktop PC status area; then select **Connection Settings**.
2. In the Connection Settings dialog box, deselect the Allow serial cable or infrared connection to this COM port check box.
3. Select **OK** to close the dialog box.

Installing the YBT1E1 Software

To install the NetTek YBT1E1 software on the NetTek Analyzer Platform, do the following:

1. Shutdown the NetTek Analyzer Platform and remove the NetTek YBT1E1 PC card if installed.
2. Insert the NetTek YBT1E1 software installation CD-ROM into the desktop PC.
3. The disk should start up automatically. If it does not, run:
 - For Option T1:
 - **<CD>:\Upgrade\T1\Serial\ybt1setup_vx-xxx.exe.**
 - For Option E1:
 - **<CD>:\Upgrade\E1\Serial\ybe1setup_vx-xxx.exe.**where <CD> is the CD-ROM drive letter and xxx is the software version information.
4. Follow the on-screen instructions provided by the upgrade wizard.
5. When the module upgrade is complete, shut down the NetTek Analyzer Platform and install the NetTek YBT1E1 PC card.
6. Start up the NetTek Analyzer Platform.

The NetTek YBT1E1 T1 & E1 Circuit Tester is now ready to use. To start the application, double-tap the YBT1 or YBE1 icon on the NetTek Analyzer Platform desktop or select **Start > Programs > NetTek > YBT1 (or YBE1)**.

NOTE. *When you have completed the installation process, be sure to re-enable your Windows CE Services or Active Sync serial connection.*

Installing Software Using a USB Connection (Y400 Only)

You can use a USB connection to install product software onto the Y400 NetTek Analyzer. See the YBT1E1 CD-ROM for information on this procedure.

Uninstalling the YBT1E1 Software

You can uninstall the Option T1 or Option E1 software from all Y400 NetTek Analyzer Platforms, and from Y350C NetTek Analyzer Platforms running firmware version 1.120 or greater. You may need to uninstall the YBT1E1 software to free up flash memory space to run other NetTek products (such as the NetTek YBT250 Field Transmitter and Interference Tester or the NetTek YBA250 Antenna and Transmission Line Analyzer module).

To uninstall the YBT1E1 Option T1 or E1 software, do the following:

1. Exit the YBT1 or YBE1 software if it is running.
2. Select **Start > Programs > Tektronix Utilities > System Configuration**.
3. Tap the **Software** tab if not already selected.
4. Under **Application Name**, select the name of the software to uninstall (**YBT1** or **YBE1**).
5. Tap the **Unload** button. This displays the Delete Data dialog.
6. Tap the **Delete** button if you want to delete associated software setup and results files. Tap **Cancel** to retain the setup and results files in memory.
7. The selected software is unloaded.

Appendix C: Diagnostic Self Tests

To verify the NetTek YBT1E1 T1 & E1 Circuit Tester is functioning properly, run the diagnostic self tests.

NOTE. *The following verification procedure does not confirm that the YBT1E1 T1 & E1 Circuit Tester meets or exceeds the specifications listed in Appendix A-1.*

1. Install the RJ48 Loopback Plug into the YBT1E1 Line Interface as shown in Figure 1-14 on page 1-18.
2. Power on the NetTek Analyzer Platform.
3. Select **File > Exit** in the YBT1E1 application if the T1 & E1 Circuit Tester is running.
4. In the taskbar, select **Start > Programs > Tektronix Utilities > Diagnostics**.
5. Tap the + box next to **All Modules, All Tests** to expand the selection tree.
6. Tap the + box next to **Platform**.
7. Deselect all platform diagnostics (remove all checks).
8. Tap the + box next to **Platform** again to compress the menu tree.
9. Tap the + box next to **YBT1** or **YBE1** (as appropriate)
10. Verify that General Tests, Line Port Tests, Monitor Dongle Tests, and Pattern Tests are checked. See Figure C-1.

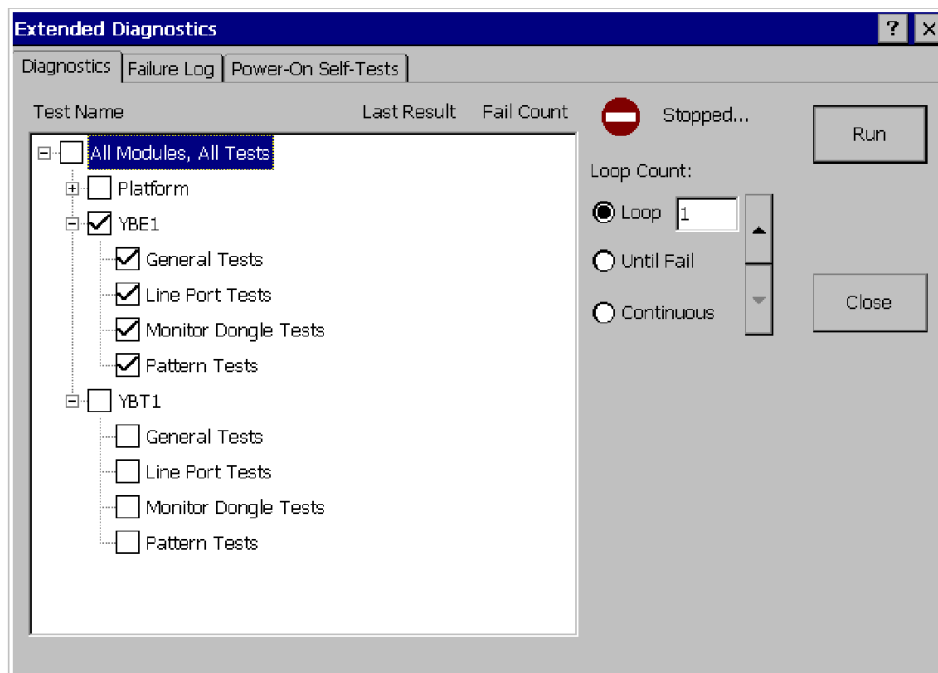

Figure C-1: YBT1E1 Option E1 diagnostic settings

11. Select the **LOOP** option button.
12. Set the loop count to **1** with the up/down arrow buttons.
13. Select **Run** to start the diagnostics.
14. Verify that each test executes and passes.
15. Select **Close** to exit the diagnostic system.

If you encounter any errors, open the **Failure Log** tab to obtain more information.

Test Descriptions

You must install the RJ48 Loopback Plug into the YBT1E1 Line Interface to run any of the following tests.

General Tests

Verifies that the NetTek YBT1E1 Option T1 or Option E1 software module loaded onto the NetTek Analyzer Platform is communicating with the YBT1E1 PC card.

Line Port Tests

Verifies that the Line port is functioning properly in both transmit and receive modes (through the loopback plug).

Monitor Dongle Tests

Verifies that the line interface amplifier is functioning properly.

Pattern Tests

A transmitted reference pattern is compared to the received data pattern for an exact match. This test also verifies that the internal PC card hardware is functioning properly.

Appendix D: Accessories

Standard Accessories

Table D-1: Option T1 and Option E1 standard accessories

Quantity	Part number	Description
1 ea	015-0719-XX	YBT1E1 PC Card
1 ea	119-7145-XX	YBT1E1 Line Interface
1 ea	020-2635-XX	Component kit: RJ48 loopback plug, single port RJ48-to-Bantam Y cable RJ48-to-RJ48 straight-wired cable
1 ea	020-2629-XX	NetTek YBT1E1 T1 & E1 Circuit Tester Documentation kit. Includes software installation CD-ROM and User manual.

Components And Accessories

Table D-2 contains general information on YBT1E1 T1 & E1 Circuit Tester components and accessories.

Table D-2: Components and accessories



	YBT1E1 PC Card. Acts as the product platform and provides T1 and E1 digital interfaces to the NetTek Analyzer Platform. Tektronix part number 015-0719-XX.
	YBT1E1 Line Interface. Adapts the PC card interface to RJ48 test cables. Tektronix part number 119-7145-XX.

Table D-2: Components and accessories (Cont.)

	RJ48-to-Bantam Y Cable. Provides an RJ48-compatible connection between the YBT1E1 Line Interface and a DSX patch panel. Tektronix part number 174-4631-XX.
	120Ω RJ45-to-75Ω-BNC Y Cable. Provides a BNC-compatible connection between the YBT1E1 Line Interface and BNC-equipped system equipment. Tektronix part number 012-1687-XX.
	RJ48-to-RJ48 Straight-Wired Cable. Provides a RJ48-compatible connection between the YBT1E1 Line Interface and base station equipment. Tektronix part number 174-4629-XX.
	RJ48-to-Alligator Clip Cable. Provides a connection between the YBT1E1 Line Interface and the internal wiring of base station equipment. Tektronix part number 174-4630-XX.
	RJ48 Loopback Plug. Connects the NetTek YBT1E1 receive input to the NetTek YBT1E1 transmit output when plugged into the YBT1E1 Line Interface. Required to run the diagnostic self tests. Tektronix part number 174-4628-XX.
	Installation Software CD-ROM. Installs NetTek YBT1E1 Option T1 or Option E1 software on the NetTek Analyzer Platform from a desktop computer. See page D-1 for replacement information.
	NetTek YBT1E1 T1 & E1 Circuit Tester User Manual. Provides setup and basic operating information. See page D-1 for replacement information.
	NetTek Analyzer Platform Lithium-Ion battery. Provides portable power for field test use. Contact your local Tektronix representative and order by part description.

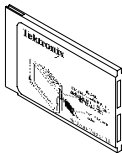
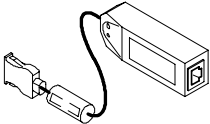
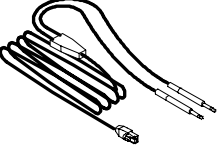
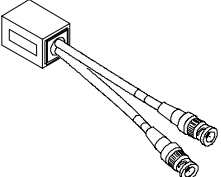
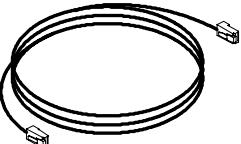
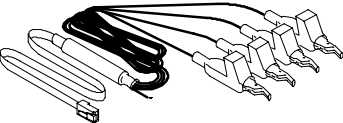
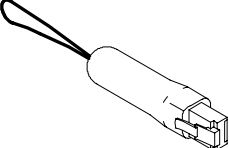

Index

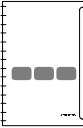
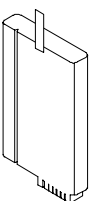
Index

A

- accessories, D-1
 - standard, D-1
- acquisition active, 2-6
- address, Tektronix, xi
- alarms
 - display, rolling, 2-19
 - window
 - open, 2-17
 - tab, 2-17
- alarm event detail, 2-21
- alarm/error count window, 2-22
- alarms summary, 2-16
- application
 - command bar, 2-5
 - measurement results, 2-5
 - status and measurements, 2-5
 - test configuration area, 2-5
 - user interface elements, 2-4
- assemble, line interface to test
 - cable, 1-8
- assemble product, 1-6
- assembly, diagram, 1-6
- audio, monitor DS0 channel, 3-23
- Auto Test button, 2-13
- automatic measurement, 3-7
- automatic testing, 3-12
- automatically start software, 1-17

B

- base transceiver station (BTS),
 - connecting to, 3-1
- BATTERIES indicator, 1-2

- battery
 - charging, 1-12
 - charging times, 1-12
 - installing and removing, 1-10
 - maximizing operation time, 1-13
 - ordering, D-2
 - recycling, vii
 - transporting Lithium-Ion batteries, vii, 1-13
- BER
 - counter, 2-18
 - testing, 3-12
- bridge, input configuration, connecting to a circuit, 3-5
- Bridge mode, 2-9
- buttons
 - Auto Test, 2-13
 - command bar area, 2-6, 2-11
 - Drop DSO, 2-12
 - Edit, 2-6
 - Insert Error, 2-19
 - Line Code, 2-12
 - Loop Codes, 2-9
 - Loop Down, 2-10
 - Loop Up, 2-9
 - Open, 2-6
 - pause, 2-6
 - play/restart, 2-6
 - program, 2-3
 - Restart, 2-11
 - restart/play, 2-6
 - Rx Level, 2-12
 - test configuration area, 2-9
 - Timed Test, 2-13
 - Tx Setup, 2-10

C

- cable
 - line interface adapter, D-1
 - test
 - RJ45-to-BNC Y, D-2
 - RJ48 loopback, D-2
 - RJ48-to-Alligator clip, D-2
 - RJ48-to-Bantam Y, D-2
 - RJ48-to-RJ48 straight-wired, D-2
- card, YBT1E1 PC, D-1
- CD-ROM, D-2
- certifications
 - EC, A-4
 - EMC, A-4
- channel service unit (CSU), 3-1
- charging batteries, 1-12
- codes, loopback, A-1
- command bar (application), 2-5
- components, NetTek YBT1E1, D-1
- connecting
 - line interface to platform, 1-8
 - power supplies, 1-9
 - test cable to line interface, 1-8
 - YBT1E1 card into platform, 1-7
- connecting the tester to a circuit, 3-1
- connections
 - alligator clip to 66 block, 3-5
 - bridge, 3-5
 - loopback, 3-4
 - monitor, 3-1
 - terminate, 3-3
 - to end of service line, 3-3
- connector, loopback, D-2
- contacting Tektronix, xi
- controls
 - front panel, 1-1
 - user interface, 2-4

- counter, BER, 2-18
- current indicator, 2-21
- custom pattern sequences, 3-15

D

- data
 - collection, set resolution, 2-21
 - retransmit, 3-4
- DC power adapter, 1-9
- defined loopback codes, 3-20
- description, product, 1-3
- desktop
 - icon, 2-2
 - overview, 2-1
 - program button, 2-3
 - Start menu, 2-2
 - status area, 2-3
 - taskbar, 2-2
- desktop AC power supply, 1-9
- diagnostic tests, C-1
 - test descriptions, C-3
- dimensions, external, A-3
- disable
 - Windows Active Sync, B-3
 - Windows CE services, B-3
- display, time span, 2-22
- display
 - alarms, 2-19
 - errors, 2-19
- dongle, D-1
- Drop DSO
 - overview, 3-21
 - set update interval, 3-23
 - uses, 3-22
- Drop DSO button, 2-12

DS0

- activity graph, 3-8

- view activity, 3-8

- DSX panel, connecting to, 3-1

E**E1**

- alarms, 1-4

- BERT patterns, 1-4

- detected errors, 1-4

- error insertion, 1-4

- frame formats, 1-4

- line coding standards, 1-4

- testing, 3-7

 - connecting to a circuit, 3-1

- Edit button, 2-6

- editing pattern sequences, 3-16

- ejecting the PC card, 1-7

- electrical specifications, A-1

- emissions

 - electromagnetic compliance, 1-7

 - PC card, 1-7

- environmental specifications, A-3,

 - A-4

- error

 - insertion, 2-19

 - rolling display, 2-19

 - event detail, 2-21

- errors summary, 2-16

- Errors window

 - open, 2-18

 - tab, 2-18

- event indicator, 2-20

- external power supplies, 1-9

F

- failure log, C-2

- far end loop, set up, 3-19

- features, product, 1-4

- features table, 1-4

- File menu, 2-7

- find information, start Help, 2-3

- floppy disk button, 2-6

- folder icon in command bar, 2-6

- frame formats, 1-4

- Frame Sync icon, 2-11

- front-panel controls, 1-1

- function verification, C-1

- functional check, 1-18

- functional verification, 1-18

G

- G.703, 1-4

- G.704, 1-4

- G.706, 1-4

H

- help

 - find information, 2-3

 - icon, 2-3

- help icon, 2-7

- hide program, 2-3

- history

 - alarms/errors count, 2-22

 - window

 - open, 2-22

 - sort data, 2-23

 - tab, 2-22

- History indicator, 2-20

I

icon

- current indicator, 2-21
- event indicator, 2-20
- history, 2-20
- limit alarm indicator, 2-21
- Windows status, 2-3
- YBE1 start up, 1-15
- YBT1 start up, 1-15

icons

- ?, 2-3
- command bar area, 2-6, 2-11
- desktop, 2-2
- Frame Sync, 2-11
- Pattern Sync, 2-12
- recalled data, 2-6
- Rx Status, 2-11
- stop, 2-6
- test configuration area, 2-9

impedance, input, A-2

in-vehicle DC adapter, 1-9

indicator, alarms/errors, 3-8

information

- getting help, 2-3
- measurement running, 2-6

injury, from lightning, 1-20

input, connections, 3-1

input impedance, A-2

input panel, enter keyboard characters, 2-3

install

- batteries, 1-10
- software, 1-15, B-1
 - from archive file, B-1
 - from serial cable, B-3
 - from USB cable (Y400 only), B-5

installing other PC cards, 1-7

instructions, operating, 2-1

instrument power

- shutdown mode, 1-19
- software reset, 1-20
- suspend mode, 1-19

instrument settings, 3-9

J

jitter, specification, A-1

K

keyboard, (soft) input panel, 2-3

L

lightning, avoiding personal injury, 1-20

limit alarm indicator, 2-21

limit testing, 3-11

line, interface adaptor, PCMCIA, D-1

Line Code button, 2-12

line coding, 1-4

line interface, attach to platform, 1-8

Lock-up, recovering from, 1-2

log, failure, C-2

loop, 3-19

Loop Codes button, 2-9

Loop Down button, 2-10

Loop Up button, 2-9

Loopback, codes, specifications, A-1

loopback, 3-19

- defined codes, 3-20

- input configuration, connecting to a circuit, 3-4
- plug, C-3, D-2
 - for performance check, 1-18
 - install, 1-18
 - setting up codes, 3-21
- Loopback mode, 2-10

M

- manual, user, D-1, D-2
- manual measurement, 3-9
- maximum battery operation time, 1-13
- measurement mode
 - Bridge, 2-9
 - Loopback, 2-10
 - Monitor, 2-9
 - Terminate, 2-9
- measurement results (application), 2-5
- measurement running indicator, 2-6
- menu
 - conventions, x
 - file, 2-7
 - online help, 2-3
 - setup, 2-8
 - tools, 2-8
 - Windows Start, 2-2
- monitor
 - audio data, 3-23
 - data path
 - customer side, 3-1
 - high-impedance connection, 3-5
 - network side, 3-1
 - E1 data, 3-1
 - input configuration, connecting to a circuit, 3-1

- input configuration, impedance, 2-10
- T1 data, 3-1
- Monitor mode, 2-9

N

- NetTek Analyzer Platform, ix
- NetTek controls, front panel, 1-1
- network interface unit (NIU), 3-1

O

- On-Off button, 1-2
- online help, ix, 2-3
- open
 - Alarms window, 2-17
 - Errors window, 2-18
 - History window, 2-22
 - Summary window, 2-15
- Open button, 2-6
- operating, instructions, 2-1
- ordering a battery, D-2

P

- pattern sequence editing, 3-14
- pattern sequence results window, 3-17
- pattern sequences, 3-14
- Pattern Sync icon, 2-12
- Pause button, 2-6
- PC card, D-1
 - emissions compliance, 1-7
 - product assembly, 1-6
 - remove, 1-7
- phone number, Tektronix, xi
- play button, 2-6
- power supplies, external, 1-9

- power switch, 1-2
- power switch functions, 1-20
- powering off the instrument, 1-18
- powering on the instrument, 1-14
- product
 - assembly, 1-6
 - features, 1-4
 - support, contact information, xi
- product description, 1-3
- program button, 2-3

Q

- question mark icon, 2-7

R

- recalled data icon, 2-6
- recharge battery time, 1-12
- recycle, battery, vii
- removing batteries, 1-10
- removing the PC card, 1-7
- reset
 - hardware, 1-2
 - software, 1-20
- reset switch, 1-2
- Restart button, 2-6, 2-11
- retransmit data, 3-4
- rolling display
 - alarms, 2-19
 - current indicator, 2-21
 - errors, 2-19
 - event indicator, alarms, 2-20
 - History indicator, alarms, 2-20
 - limit alarm indicator, 2-21
- Rx Level button, 2-12
- Rx Status icon, 2-11
- Rx status indicators, 1-4

S

- safety
 - lightning, v
 - summary, v
- save results button, 2-6
- sensitivity, receiver, A-2
- serial cable, for software upgrade,
 - B-3
- service,
 - panel, connecting to, 3-1
 - support, contact information, xi
- set up instrument, 3-9
- setting up loopback codes, 3-21
- settings
 - automatic measurement, 3-7
 - change, 3-9
 - manual measurement, 3-9
 - rolling display, collection resolution, 2-21
- Setup menu, 2-8
- shutdown mode, 1-19
- software
 - automatic start-up, 1-16
 - install, 1-15, B-1
 - install, CD-ROM, D-2
 - install from
 - PC memory card, B-1
 - serial cable, B-3
 - USB cable (Y400 only), B-5
 - start up, 1-15
 - uninstall, B-5
 - upgrade, 1-15
 - version, x
- software reset, 1-20
- specifications
 - altitude, A-3
 - electrical, A-1
 - environmental, A-3, A-4

- humidity, A-3
- temperature, A-3
- standards supported, 1-4
- start YBT1E1 software, 1-15
 - automatic start-up, 1-16
- status and measurements (application), 2-5
- Status indicator, 1-2
- Stop icon, 2-6
- Summary window
 - tab, 2-15
 - test results, 2-16
- suspend mode, 1-19

T

- T1
 - alarms, 1-4
 - BERT patterns, 1-4
 - detected errors, 1-4
 - error insertion, 1-4
 - frame formats, 1-4
 - line coding standards, 1-4
 - loop code support, 1-5
 - testing, 3-7
 - connecting to a circuit, 3-1
 - transmit signal levels, 1-5
- T1.402, 1-4
- T1.403, 1-4
- tab
 - Alarms window, 2-17
 - Errors window, 2-18
 - History window, 2-22
 - summary window, 2-15
- taskbar, Windows desktop, 2-2
- technical support, contact information, xi
- Tektronix, contacting, xi

- terminate, input configuration,
 - connecting to a circuit, 3-3
- Terminate mode, 2-9
- test
 - automated, 3-12
 - automatic measurement, 3-7
 - BER, 3-12
 - diagnostic, C-1
 - E1 data path, 3-1
 - limit testing, 3-11
 - manual measurement, 3-9
 - nonintrusive, 3-5
 - strategy, 3-7
 - summary window, 2-16
 - T1 data path, 3-1
 - timed, 3-11
- test configuration (application), 2-5
- test running indicator, 2-6
- time interval, 2-22
- time span, 2-22
- time to charge batteries, 1-12
- Timed Test button, 2-13
- timed tests, 3-11
- timestamp readout, 2-7
- Tools menu, 2-8
- touch-screen calibration, 1-14
- touch-screen keyboard, 2-3
- transporting batteries, vii, 1-13
- turning off the instrument, 1-18
- turning on the instrument, 1-14
- Tx Setup button, 2-10

U

- uninstalling software, B-5
- upgrade, software, 1-15, B-1
- URL, Tektronix, xi

USB cable, for software upgrade,
 B-5
user manual, D-2

V

verify
 line coding, 3-7
 receive signal level, 3-7
 test descriptions, C-3
 YBT1E1 operation, C-1
verify YBT1E1, 1-18
version, software/hardware, x
View DS0 activity, 3-8

W

web site address, Tektronix, xi
weight, A-3
window
 alarm/error count, 2-22
 Alarms, 2-17
 default start up, 2-15
 Errors, 2-18
 History, 2-22
 Summary, 2-15
Windows
 Start menu, 2-2
 status area, 2-3
 status icons, 2-3