

# User Manual



## **RSA3408A Option 40 3GPP Release 6 (HSUPA) Analysis Software**

**071-2060-00**

This document supports firmware version 3.30 and above.

[www.tektronix.com](http://www.tektronix.com)

Copyright © Tektronix. All rights reserved. Licensed software products are owned by Tektronix or its subsidiaries or suppliers, and are protected by national copyright laws and international treaty provisions.

Tektronix products are covered by U.S. and foreign patents, issued and pending. Information in this publication supercedes that in all previously published material. Specifications and price change privileges reserved.

TEKTRONIX and TEK are registered trademarks of Tektronix, Inc.

## **Contacting Tektronix**

Tektronix, Inc.  
14200 SW Karl Braun Drive  
P.O. Box 500  
Beaverton, OR 97077  
USA

For product information, sales, service, and technical support:

- In North America, call 1-800-833-9200.
- Worldwide, visit [www.tektronix.com](http://www.tektronix.com) to find contacts in your area.

## Warranty 2

Tektronix warrants that this product will be free from defects in materials and workmanship for a period of one (1) year from the date of shipment. If any such product proves defective during this warranty period, Tektronix, at its option, either will repair the defective product without charge for parts and labor, or will provide a replacement in exchange for the defective product. Parts, modules and replacement products used by Tektronix for warranty work may be new or reconditioned to like new performance. All replaced parts, modules and products become the property of Tektronix.

In order to obtain service under this warranty, Customer must notify Tektronix of the defect before the expiration of the warranty period and make suitable arrangements for the performance of service. Customer shall be responsible for packaging and shipping the defective product to the service center designated by Tektronix, with shipping charges prepaid. Tektronix shall pay for the return of the product to Customer if the shipment is to a location within the country in which the Tektronix service center is located. Customer shall be responsible for paying all shipping charges, duties, taxes, and any other charges for products returned to any other locations.

This warranty shall not apply to any defect, failure or damage caused by improper use or improper or inadequate maintenance and care. Tektronix shall not be obligated to furnish service under this warranty a) to repair damage resulting from attempts by personnel other than Tektronix representatives to install, repair or service the product; b) to repair damage resulting from improper use or connection to incompatible equipment; c) to repair any damage or malfunction caused by the use of non-Tektronix supplies; or d) to service a product that has been modified or integrated with other products when the effect of such modification or integration increases the time or difficulty of servicing the product.

THIS WARRANTY IS GIVEN BY TEKTRONIX WITH RESPECT TO THE PRODUCT IN LIEU OF ANY OTHER WARRANTIES, EXPRESS OR IMPLIED. TEKTRONIX AND ITS VENDORS DISCLAIM ANY IMPLIED WARRANTIES OF MERCHANTABILITY OR FITNESS FOR A PARTICULAR PURPOSE. TEKTRONIX' RESPONSIBILITY TO REPAIR OR REPLACE DEFECTIVE PRODUCTS IS THE SOLE AND EXCLUSIVE REMEDY PROVIDED TO THE CUSTOMER FOR BREACH OF THIS WARRANTY. TEKTRONIX AND ITS VENDORS WILL NOT BE LIABLE FOR ANY INDIRECT, SPECIAL, INCIDENTAL, OR CONSEQUENTIAL DAMAGES IRRESPECTIVE OF WHETHER TEKTRONIX OR THE VENDOR HAS ADVANCE NOTICE OF THE POSSIBILITY OF SUCH DAMAGES.



# Table of Contents

<b>Preface</b> .....	<b>v</b>
About This Manual .....	v
Related Manuals .....	v

## Getting Started

<b>Getting Started</b> .....	<b>1-1</b>
Analysis Definition .....	1-2
Measurement Menu .....	1-5

## Operating Basics

<b>Downlink Analysis</b> .....	<b>2-3</b>
Measurement Procedure .....	2-4
Measurement Setup Menu .....	2-7
Scale and Format of View .....	2-10
Code Domain Power .....	2-14
Power Codogram .....	2-16
Code Power versus Time Slot .....	2-18
Code Power versus Symbol .....	2-20
Symbol Constellation .....	2-22
Symbol EVM .....	2-23
Symbol Eye Diagram .....	2-25
Symbol Table .....	2-26
Modulation Accuracy .....	2-27
Modulation Accuracy versus Time Slot .....	2-28
<b>Uplink Analysis</b> .....	<b>2-31</b>
Measurement Procedure .....	2-32
Measurement Setup Menu .....	2-34
Display Method for HS-DPCCH .....	2-38
Scale and Format of View .....	2-41
Code Domain Power .....	2-46
Power Codogram .....	2-48
Code Power versus Time Slot .....	2-50
Code Power versus Symbol .....	2-52
Symbol Constellation .....	2-54
Symbol EVM .....	2-55
Symbol Eye Diagram .....	2-57
Symbol Table .....	2-58
Modulation Accuracy .....	2-59
Modulation Accuracy versus Time Slot .....	2-61
Gain Ratio .....	2-63

## Appendices

<b>Appendix A: Scale Setting Range</b> .....	<b>A-1</b>
<b>Appendix B: Saving Measurement Results</b> .....	<b>B-1</b>
Save Menu .....	B-1
Saved File Format .....	B-2

## Glossary and Index

# List of Figures

<b>Figure 1-1: Measurement menus for the 3GPP-R6 analysis</b> .....	<b>1-5</b>
<b>Figure 2-1: Downlink analysis measurement menu in the Demod mode</b> .....	<b>2-3</b>
<b>Figure 2-2: Code domain power measurement example</b> .....	<b>2-6</b>
<b>Figure 2-3: Time slot table (at the lower left of the screen)</b> .....	<b>2-13</b>
<b>Figure 2-4: Code domain power</b> .....	<b>2-14</b>
<b>Figure 2-5: Power codogram</b> .....	<b>2-16</b>
<b>Figure 2-6: Code power versus Time slot</b> .....	<b>2-18</b>
<b>Figure 2-7: Code domain power versus Symbol</b> .....	<b>2-20</b>
<b>Figure 2-8: Symbol constellation</b> .....	<b>2-22</b>
<b>Figure 2-9: Symbol EVM</b> .....	<b>2-23</b>
<b>Figure 2-10: Symbol eye diagram</b> .....	<b>2-25</b>
<b>Figure 2-11: Symbol table</b> .....	<b>2-26</b>
<b>Figure 2-12: Modulation accuracy</b> .....	<b>2-27</b>
<b>Figure 2-13: Modulation accuracy versus Time slot, EVM (rms)</b> .....	<b>2-28</b>
<b>Figure 2-14: Uplink analysis measurement menu in the Demod mode</b> .....	<b>2-31</b>
<b>Figure 2-15: Code domain power measurement example</b> .....	<b>2-33</b>
<b>Figure 2-16: Subframe offset</b> .....	<b>2-36</b>
<b>Figure 2-17: HS-DPCCH display method</b> .....	<b>2-38</b>
<b>Figure 2-18: HS-DPCCH display method</b> .....	<b>2-39</b>
<b>Figure 2-19: HS-DPCCH display method (symbol table)</b> .....	<b>2-40</b>
<b>Figure 2-20: View Format setting (code domain power)</b> .....	<b>2-44</b>
<b>Figure 2-21: Time slot table (at the lower left of the screen)</b> .....	<b>2-45</b>
<b>Figure 2-22: Code domain power</b> .....	<b>2-46</b>
<b>Figure 2-23: Power codogram</b> .....	<b>2-48</b>
<b>Figure 2-24: Code power versus Time slot</b> .....	<b>2-50</b>
<b>Figure 2-25: Code domain power versus Symbol</b> .....	<b>2-52</b>
<b>Figure 2-26: Symbol constellation</b> .....	<b>2-54</b>
<b>Figure 2-27: Symbol EVM</b> .....	<b>2-55</b>
<b>Figure 2-28: Symbol eye diagram</b> .....	<b>2-57</b>
<b>Figure 2-29: Symbol table</b> .....	<b>2-58</b>
<b>Figure 2-30: Modulation accuracy</b> .....	<b>2-59</b>
<b>Figure 2-31: Modulation accuracy versus Time slot, EVM (rms)</b> .....	<b>2-61</b>
<b>Figure 2-32: Gain ratio</b> .....	<b>2-63</b>
<b>Figure B-1: Setting the time slots to save</b> .....	<b>B-2</b>
<b>Figure B-2: CSV file example (code domain power measurement)</b> .....	<b>B-2</b>

## List of Tables

<b>Table 1-1: Additional functions in Option 40</b> .....	<b>1-1</b>
<b>Table 1-2: 3GPP-R6 downlink transmission parameters</b> .....	<b>1-2</b>
<b>Table 1-3: 3GPP-R6 uplink transmission parameters</b> .....	<b>1-3</b>
<b>Table 2-1: Column items</b> .....	<b>2-13</b>
<b>Table 2-2: Vertical scale setting range, Symbol EVM</b> .....	<b>2-24</b>
<b>Table 2-3: Vertical scale setting range, Modulation accuracy versus Time slot</b>	<b>2-29</b>
<b>Table 2-4: Channel number</b> .....	<b>2-44</b>
<b>Table 2-5: Time-slot table contents selection</b> .....	<b>2-45</b>
<b>Table 2-6: Vertical scale setting range, Symbol EVM</b> .....	<b>2-56</b>
<b>Table 2-7: Vertical scale setting range, Modulation accuracy versus Time slot</b>	<b>2-62</b>
<b>Table A-1: Display format and scale</b> .....	<b>A-1</b>



# Preface

This manual provides operating instructions for the RSA3408A Real-Time Spectrum Analyzer Option 40 3GPP Release 6 (HSUPA) analysis software.

## About This Manual

The manual consists of the following sections:

- *Getting Started* describes the overview of the 3GPP Release 6 analysis.
- *Operating Basics* explains the menu functions and measurement procedures.
- Appendices provide additional information about default settings and scale setting ranges.

The analyzer uses Microsoft Windows XP as the operating system. This manual does not describe common usage of Windows XP. Refer to your Windows manuals as necessary.

## Related Manuals

The following documents are also available for the analyzer.

- *RSA3408A User Manual*  
(Standard accessory; Tektronix part number 071-1617-XX)  
Describes how to install the analyzer and how to work with the menus, and details the standard functions. Also shows the specifications.
- *RSA3408A Programmer Manual*  
(Standard accessory; PDF, Tektronix part number 077-0003-XX)  
Contains an alphabetical listing of the programming commands and other information related to controlling the analyzer over the GPIB interface.

### PDF Manual

The programmer manual described above is a PDF document (the file size is about 3 MB). The file is stored in this directory on the analyzer hard disk:

C:\Program Files\Tektronix\wca200a\Manuals

Use the USB or LAN interface to copy the file onto your PC. Refer to the *RSA3408A User Manual* for information about using the interface.





# Getting Started



# Getting Started

The RSA3408A Option 40 3GPP Release 6 (HSUPA) analysis software enables modulation analysis of HSUPA (High Speed Uplink Packet Access) signals defined in 3GPP (3<sup>rd</sup> Generation Partnership Project) Release 6 (“3GPP-R6”). Measurements can be performed on downlink QPSK and 16QAM or uplink BPSK signals.

Table 1-1 summarizes the functions added in Option 40 by the measurement modes of the analyzer.

**Table 1-1: Additional functions in Option 40**

Measurement mode	Additional functions	Requirement
S/A (spectrum analysis)	None	-
Demod (modulation analysis)	3GPP-R6 downlink analysis <ul style="list-style-type: none"> <li>■ Code domain power</li> <li>■ Power codogram</li> <li>■ Code power versus Time slot</li> <li>■ Code power versus Symbol</li> <li>■ EVM versus Time slot</li> <li>■ Symbol constellation</li> <li>■ Symbol EVM (Error Vector Magnitude)</li> <li>■ Symbol eye diagram</li> <li>■ Symbol table</li> <li>■ Modulation accuracy</li> <li>■ Modulation accuracy versus Time slot</li> </ul>	Option 27 3GPP-R5 analysis software
	3GPP-R6 uplink analysis <ul style="list-style-type: none"> <li>■ Code domain power</li> <li>■ Power codogram</li> <li>■ Code power versus Time slot</li> <li>■ Code power versus Symbol</li> <li>■ EVM versus Time slot</li> <li>■ Symbol constellation</li> <li>■ Symbol EVM (Error Vector Magnitude)</li> <li>■ Symbol eye diagram</li> <li>■ Symbol table</li> <li>■ Modulation accuracy</li> <li>■ Modulation accuracy versus Time slot</li> <li>■ Gain ratio</li> </ul>	Option 23 W-CDMA uplink analysis software and Option 27 3GPP-R5 analysis software
Time (time analysis)	None	-

**NOTE.** Option 40 3GPP-R6 analysis software requires Option 23 W-CDMA uplink (for uplink analysis only) and Option 27 3GPP-R5 analysis software as shown in Table 1-1.

## Analysis Definition

The analyzer performs measurements according to 3GPP-R6 specifications.

### Downlink Analysis

Table 1-2 shows the 3GPP-R6 downlink transmission parameters for the analyzer.

**Table 1-2: 3GPP-R6 downlink transmission parameters**

Item	Description
Chip rate	3.84 Mcps
Symbol rate	7.5, 15, 30, 60, 120, 240, 480, and 960 ksps
Maximum number of channels	512
Frame structure	Time slot: 666.7 $\mu$ s
Scrambling code	Gold code using M series by generator polynomial 18 bits
Channelization code	Hierarchical orthogonal code series based on the combination of chip rate and symbol rate
Modulation method for each channel	QPSK or 16QAM
Baseband filter	Root-cosine with $\alpha = 0.22$ (default) Can be set in the range of $0.0001 \leq \alpha \leq 1$

**Measurement Functions.** The analyzer has the following measurement functions:

- *Code domain power:* Measures the power relative to the total power for each channel. Multi-rate is supported and up to 512 channels can be measured.
- *Code domain power versus Time:* Measures the relative power at symbol points for each channel in time series.
- *Power codogram:* Measures the code domain power and displays spectrogram for each slot.
- *Vector/Constellation:* Measures the vector loci and chip points for all signals as well as constellation at symbol points for each channel.
- *Modulation accuracy:* Measures EVM (Error Vector Magnitude), amplitude and phase errors, waveform quality, and origin offset for each channel. Measures PCDE (Peak Code Domain Error), amplitude, frequency, and phase errors; waveform quality; and origin offset for each time slot.

**Measurement Process.** The following steps show the internal process for the 3GPP-R6 downlink analysis:

1. Perform flatness correction and filtering.
2. Establish the synchronization with P-SCH.
3. Determine the range of scrambling code numbers with S-SCH.
4. Fix the scrambling code number and the phase.
5. Correct the frequency and the phase.
6. Perform high-speed Hadamard transformation.
7. Calculate the power for each symbol on all channels.

**Uplink Analysis** The analyzer supports the following types of 3GPP-R6 uplink signals:

- DPCCH (Dedicated Physical Control Channel)
- DPDCH (Dedicated Physical Data Channel)
- HS-DPCCH (Dedicated Physical Control Channel for HS-DSCH (High Speed Downlink Shared Channel))
- E-DPCCH (Enhanced Dedicated Physical Control Channel)
- E-DPDCH (Enhanced Dedicated Physical Data Channel)

The analyzer covers the 3GPP-R6 uplink transmission parameters listed in Table 1-3.

**Table 1-3: 3GPP-R6 uplink transmission parameters**

Item	DPCCH	DPDCH	HS-DPCCH	E-DPCCH	E-DPDCH
Chip rate	3.84 Mcps				
Symbol rate	15 ksps	15, 30, 60, 120, 240, 480, and 960 ksps	15 ksps	15 ksps	15, 30, 60, 120, 240, 480, 960, and 1920 ksps
Maximum number of channels	1	6	1	1	4
Frame structure	15 time-slots, 10 ms	15 time-slots, 10 ms	5 sub-frames, 10 ms	5 sub-frames, 10 ms	15 time-slots, 10 ms
Time slot	2560 chips, 667 $\mu$ s				
Scrambling code	Long or short. Number: 0 to 16,777,215				
Modulation method	BPSK				
Baseband filter	Root-cosine with $\alpha = 0.22$ (default). Can be set in the range of $0.0001 \leq \alpha \leq 1$				

**Measurement Functions.** The analyzer has the following measurement functions:

- *HS-DPCCH analysis:* Measures the HS-DPCCH to detect and display the ACK/NACK/PRE/POST indicator, DTX (Discontinuous Transmission), and CQI (Channel Quality Indicator).
- *E-DPCCH analysis:* Measures the E-DPCCH to detect and display the E-TFC (E-DCH Transport Format Combination) indicator, RSN (Retransmission Sequence Number), and Happy.
- *Code domain power:* Measures the power relative to the total power for each channel. Multi-rate is supported and up to 512 channels can be measured.
- *Power codogram:* Measures the code domain power continuously for up to 150 slots (0.1 sec) and displays spectrogram for each slot.

---

**NOTE.** *The code domain power and the power codogram can be displayed in the subview only.*

---

**Measurement Process.** The following steps show the internal process for the 3GPP-R6 uplink analysis:

1. Perform flatness correction and filtering.
2. Search for a synchronous point by de-spreading DPCCH.
3. Correct the frequency and phase.
4. Obtain symbols for each channel of DPDCH and DPCCH, and calculate power for each symbol.

---

**NOTE.** *The analyzer de-spreads DPCCH and the control part of an input signal, using the frequency and phase to establish synchronization. If the level of DPCCH or the control part is much lower than (about  $1/10^{\text{th}}$ ) the level of the other channels (DPDCH or the data part), the analysis may not be performed accurately.*

---



## Measurement Menu

Figure 1-1 shows the measurement menus related to the 3GPP-R6 analysis. The menu items boxed with solid lines indicate the functions included in Option 40.

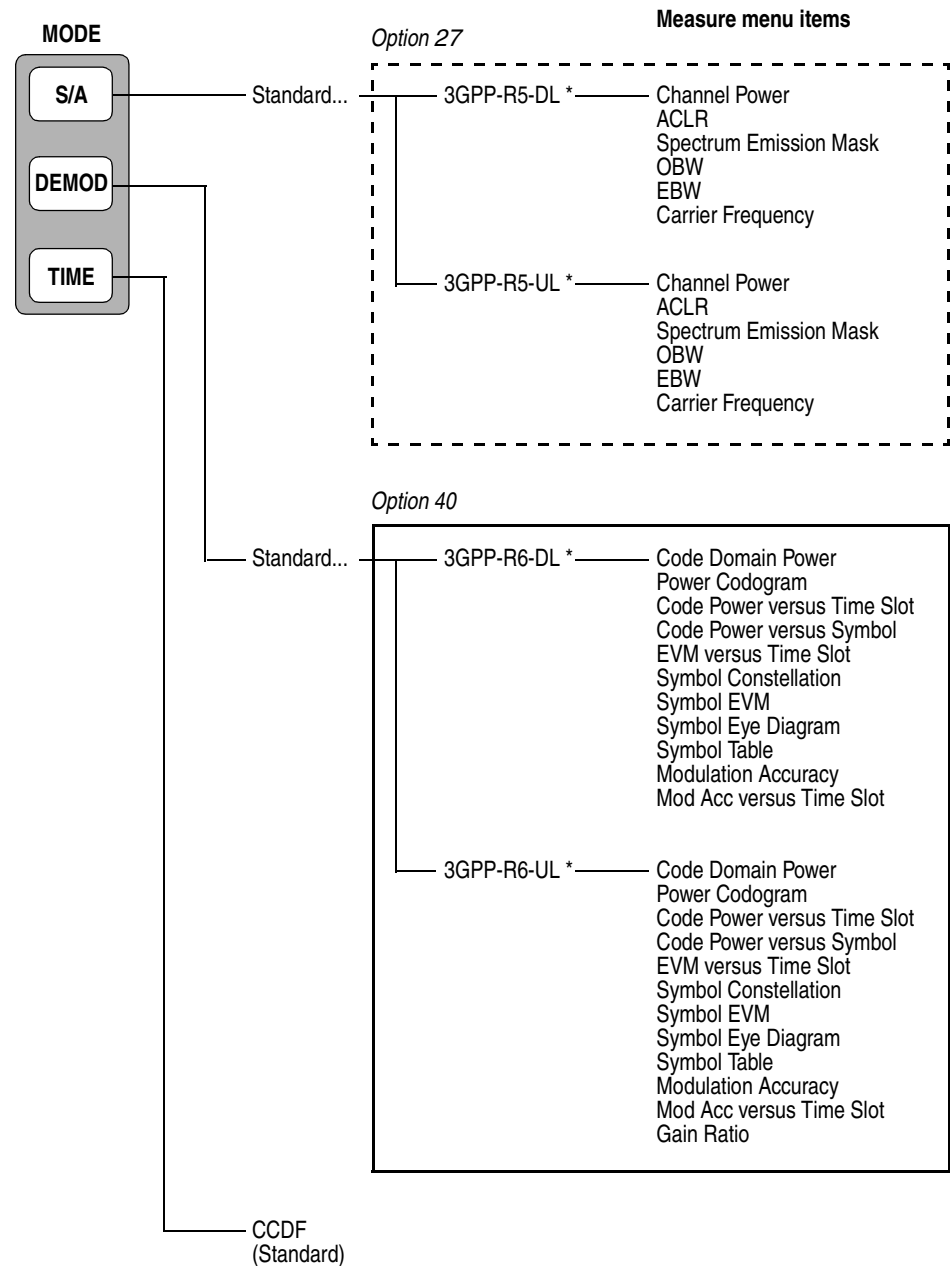

\* DL and UL represent downlink and uplink, respectively.

**Figure 1-1: Measurement menus for the 3GPP-R6 analysis**

---

**NOTE.** *Option 40 performs only modulation analysis in the Demod mode. For spectrum analysis in the S/A mode, use Option 27 (3GPP-R5 analysis software).*

---

The following sections detail the measurement functions included in Option 40 which are indicated in the two boxes in Figure 1-1. For details on the other measurements, refer to the following user manuals:

- For the 3GPP-R5 analysis in the S/A mode, refer to the *RSA3408A Option 27 3GPP Release 5 Downlink (HSDPA) Analysis Software User Manual* (Tektronix part number 071-1681-XX).
- For the CCDF (Complementary Cumulative Distribution Function) analysis in the Time mode, refer to the *RSA3408A User Manual* (Tektronix part number 071-1617-XX).

---

**NOTE.** *If you are not familiar with the operation of the RSA3408A, refer to the RSA3408A User Manual (Tektronix part number 071-1617-XX).*

---



# Operating Basics



# Downlink Analysis

This section describes the basic operation of the 3GPP-R6 downlink analysis in the Demod (Modulation Analysis) mode. You can access the measurement items by pressing **DEMOD** → **Standard...** → **3GPP-R6-DL** as shown in Figure 2-1.

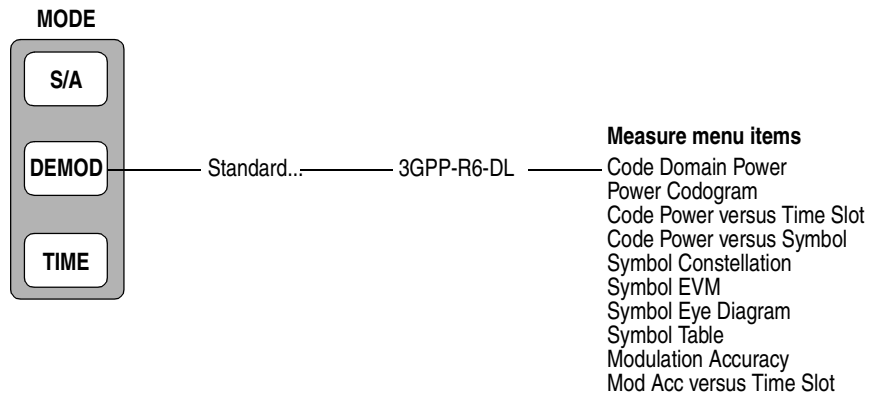

**Figure 2-1: Downlink analysis measurement menu in the Demod mode**

The measurement in the Demod mode is based on the digital modulation analysis function. For the digital modulation analysis, refer to the *RSA3408A User Manual*.

**Transmission Diversity.** This software performs analysis synchronizing with CPICH of the STTD antenna 1 or 2 automatically, but does not apply decode (symbol replacement and inversion).

## Measurement Procedure

The following procedure shows you how to acquire data of multiple slots in advance, measure continuous data, and obtain continuous code domain power:

---

**NOTE.** For details on setting frequency, span, and amplitude, refer to the *RSA3408A User Manual*.

---

1. Press the **DEMOD** key on the front panel.
2. Press the side key **Standard...** → **3GPP-R6-DL**.
3. Press the **FREQUENCY/CHANNEL** key on the front panel to set frequency.

If you use the channel table, do these steps:

- a. Press the **Channel Table...** side key and select **W-CDMA-DL**.
- b. Press the **Channel** side key and select a channel by rotating the general purpose knob.

The center frequency is set to the value corresponding to the channel.

4. Press the **SPAN** key on the front panel to set the span.
5. Press the **AMPLITUDE** key on the front panel to set the amplitude appropriately.

---

**NOTE.** If the input level is too high, *A/D OVERFLOW* displays in the red box at the center top of the screen. If this occurs, raise the reference level.

---

6. Press the **TIMING** key on the front panel and then the **Acquisition Length** side key to set the time length to acquire one block.

Suppose that one block contains M frames; the acquisition length is calculated with this equation:

$$(\text{One block acquisition length}) = M \times (\text{One frame acquisition length})$$

One frame acquisition length is determined by span and indicated on the **Spectrum Length** side key.

The number of frames M required for measuring N slots must meet the following condition:

$$M > K \times (N + 1.2) + 1$$

where

- K = 16.7 (for the span of 20 MHz and 15 MHz)
- 8.34 (for the span of 10 MHz)
- 4.17 (for the span of 5 MHz)

7. After acquiring measurement data, stop the data acquisition. If you are acquiring data in the continuous mode, press the **RUN/STOP** key.
8. Press the **MEASURE** key on the front panel and select measurement items. For example, press the **Power Codogram** side key to observe the code domain power spectrogram.
9. Press the **MEAS SETUP** key on the front panel and set the measurement parameters. Refer to page 2-7 for details of the Meas Setup menu.
10. Set the analysis range in the overview using the Timing menu. Refer to the *RSA3408A User Manual* for the details.
11. Press the **MEAS SETUP** key on the front panel and then the **Analyze** side key to start processing the frames in the analysis range. The results are displayed in the main view.

Change the scale and format of the view as needed. Refer to page 2-10 for setting views specific to the 3GPP-R6 downlink analysis.

12. If the level of input signals is low, the waveform may not be displayed correctly. In this case, perform the following procedure:

---

**NOTE.** *The 3GPP-R6 downlink signal analysis may not be performed correctly if the P-SCH, S-SCH, and PCPICH channels are too low to be detected. An error occurs when one of these channel levels is lower than several tenths the sum of other channel levels. In this case, set Scrambling Code Search to Off and specify the scrambling code with the Scrambling Code side key.*

---

- a. Press the **MEAS SETUP** key on the front panel.
- b. Press the **Modulation Parameters...** side key.
- c. Press the **Scrambling Code Search** side key to select **Off**.
- d. Press the **Scrambling Code** side key and enter the scrambling code.  
The analyzer performs measurement with the value set here in place of detecting the scrambling code.
- e. Press the **MEAS SETUP** key on the front panel.
- f. Press the **Analyze** side key to perform measurement for the frames in the analysis range.

Figure 2-2 shows an example of the code domain power measurement.



Figure 2-2: Code domain power measurement example

Change the scale and format of the view as needed. Refer to page 2-10 for setting views specific to the 3GPP-R6 downlink analysis.



## Measurement Setup Menu

Press the **MEAS SETUP** key on the front panel to set the measurement parameters. The Meas Setup menu for the 3GPP-R6 downlink modulation analysis contains the following controls:

**Analyze** Performs analysis for time slots in the analysis range.

---

**NOTE.** When you change the parameter setting(s) in the Meas Setup menu, press the **Analyze** side key to perform the measurement for the modified setting(s).

---

### Modulation Parameters...

Sets a measurement parameter to a non-standard value. The following controls are provided:

**Scrambling Code Search.** Selects whether to perform analysis by detecting a scrambling code from input signals.

- **On.** Detects a scrambling code automatically from the input signal to perform the measurement.
- **Off. Default.** Performs measurement using the scrambling code that has been set manually with **Scrambling Code** described below.

---

**NOTE.** The manual mode (*Scrambling Code Search Off*) should be used with the appropriate scrambling code for reliable detection when either multiple code channels are active or the sync channels have low power.

---

Also refer to *Note* on page 2-5.

**Scrambling Code.** Sets the scrambling code number when you select Off in Scrambling Code Search. The analyzer performs measurement using the set scrambling code. Range: 0 to 24575 (default: 0).

The 3GPP standard defines the scrambling code with the following formulas. Input the n value to set the code.

$$\begin{aligned} \text{Primary scrambling code: } n &= 16 * i && \text{where } i = 0 \text{ to } 511 \\ \text{Secondary scrambling code: } n &= 16 * i + k && \text{where } k = 1 \text{ to } 15 \end{aligned}$$

**Use Alternative Scramb. Code...** Selects the de-spread method to display the measurement results:

- **Not Used. Default.** Uses the primary scrambling code only (without the left and the right alternative scrambling codes) to de-spread the input signal.
- **Primary.** Uses the primary scrambling with the left and the right alternative scrambling codes to de-spread the input signal.

- **Left Alternative.** Uses the left alternative scrambling code to de-spread the input signal.
- **Right Alternative.** Uses the right alternative scrambling code to de-spread the input signal.

**Primary, Left Alternative and Right Alternative** use the proprietary algorithm to enhance the sensitivity by approximately 20 to 30 dB compared to **Not Used**. **Not Used** does not use the alternative scrambling codes for faster measurement.

**Use SCH Part.** Selects whether to include or exclude the SCH (Synchronization Channel) portion when calculating the code domain power.

- **On.** Calculates the code domain power by including the SCH portion.
- **Off. Default.** Calculates the code domain power by excluding the SCH portion.

**Composite.** Determines whether to perform the composite analysis (automatic detection of symbol rate).

- **On. Default.** Specifies that the composite analysis is performed.
- **Off.** Specifies that the composite analysis is not performed.

---

**NOTE.** *You should usually specify that composite analysis is performed. If a normal analysis does not result, select Off in this command and select a specific symbol rate with Symbol Rate in the View: Define menu.*

---

**16QAM Detection.** Selects whether to detect the QPSK or 16QAM code channel automatically.

- **On. Default.** Automatically detects whether the code channel is QPSK or 16QAM.
- **Off.** Assumes that all code channels are QPSK.

**Measurement Filter...** Selects a filter for demodulating digitally-modulated signals:

- None (no filter)
- RootRaisedCosine (default)

**Reference Filter...** Selects a filter for creating reference data:

- None (no filter)
- RaisedCosine (default)
- Gaussian

For the filters, refer to *Process Flow of Digitally-Modulated Signal* in the *RSA3408A User Manual*.

**Filter Parameter.** Sets the  $a/BT$  value for Measurement Filter and Reference Filter described above. Range: 0.0001 to 1 (default: 0.22).

**EVM IQ Origin Offset.** Determines whether to include the I/Q origin offset in the EVM (Error Vector Magnitude), Rho (waveform quality), and PCDE (Peak Code-Domain Error) calculation.

- **Include.** *Default.* Includes the I/Q origin offset in the calculation.
- **Exclude.** Excludes the I/Q origin offset from the calculation.

<b>E-AGCH Code</b>	Specifies the E-AGCH (E-DCH Absolute Grant Channel) code. Range: Channel 0 to 127 (default: 0).
<b>E-RGCH/E-HICH Code</b>	Specifies the E-RGCH (E-DCH Relative Grant Channel) or E-HICH (E-DCH HARQ Acknowledgement Indicator Channel) code. Range: Channel 0 to 127 (default: 0).
<b>E-RGCH Sequence Index</b>	Specifies the E-RGCH sequence index number. Range: 0 to 39 (default: 0).
<b>E-HICH Sequence Index</b>	Specifies the E-HICH sequence index number. Range: 0 to 39 (default: 0).
<b>Update Timeslot Table</b>	Re-analyzes the existing time slot data to update the table display after you change the subframe offset manually or abort the Analyze (top side key) operation.
<b>Auto Carrier</b>	Selects whether to detect the carrier automatically. <ul style="list-style-type: none"> <li>■ <b>On.</b> <i>Default.</i> Automatically detects the carrier for every frame. The error from the center frequency is shown on the <b>Freq Error</b> side key.</li> <li>■ <b>Off.</b> Sets the carrier frequency using <b>Frequency Offset</b> described below.</li> </ul>
<b>Frequency Offset</b>	Sets the carrier frequency when <b>Auto Carrier</b> is selected to Off. Input the carrier offset from the center frequency.

## Scale and Format of View

The following main views are specific to the measurement items of the 3GPP-R6 downlink analysis in the Demod mode:

- Code domain power
- Power codogram
- Code power versus Time slot
- Code power versus Symbol
- Symbol constellation
- Symbol EVM
- Symbol eye diagram
- Symbol table
- Modulation accuracy
- Modulation accuracy versus Time slot

The scale and format of view are controlled by the View menu. This section describes the View: Define menu and the View: Scale menu for each view.

**View: Define Menu**

The View: Define menu is common to all main views of the 3GPP-R6 downlink measurement items. It contains the following controls:

**Show Views.** Selects the view style:

- **Single.** Displays only the view selected by the VIEW: **SELECT** key.
- **Multi.** *Default.* Displays the overview, subview, and main view.

**Overview Content...** Selects a view to display in the overview:

- Waveform (power versus time)
- Spectrogram

**Subview Content...** Selects a view to display in the subview:

- Spectrum
- Code Domain Power
- Power Codogram
- CDP vs Time Slot (Code Domain Power versus Time Slot)
- CDP vs Symbol (Code Domain Power versus Symbol)
- EVM vs Time Slot
- Symbol Constellation
- Symbol EVM
- Symbol Eye Diagram
- Symbol Table
- Modulation Accuracy

**Time Slot.** Sets a time slot number to position the marker.

Range: 0 to [(the number of slots) – 1] (default: 0).

**Channelization Code.** Sets a channelization code number to position the marker.

Range: Channel 0 to 511 (default: 0).

**Multi Slot.** Selects whether to display single slot or multiple slots in the main view. This selection is effective only in the code domain power versus symbol view and the symbol EVM view. In the other views, it has no effect.

- **Off.** Displays a time-slot selected by the **Time Slot** side key.
- **On.** Displays up to 15 time-slots in the main view.

**Menu Off.** Turns off the side menu on screen to expand the waveform and measurement result display. Press the **MENU** side key when you return to the original display.

**Show SCH Part.** Determines whether to display SCH (Synchronization Channel) at the beginning of data.

- **Off.** Hides the SCH part.
- **On.** Shows the SCH part.

**Symbol Rate...** Sets the symbol rate for displaying symbol constellation:

- 960 k
- 480 k
- 240 k
- 120 k
- 60 k
- 30 k
- 15 k
- 7.5 k
- Composite

The default is Composite for multi-rate.

**Column Items to Display...** Turns on or off the following items in the time-slot table.

**Table 2-1: Column items**

Column title	Channel	Description	Value
SSCH	-	S-SCH	Channel number
SCG	-	Scrambling Code Group	Group number
SCN	-	Scrambling Code Number	Code number
AGS	E-AGCH	Absolute Grant Scope	0 or 1
AGV	E-AGCH	Absolute Grant Value	0 to 31
RG	E-RGCH	Relative Grant	UP, DOWN, or HOLD
ACK	E-HICH	ACK/NACK	ACK, NACK0 or NACK1 <sup>1</sup>

<sup>1</sup> **NACK0:** NACK for RLSs not containing the serving E-DCH cell. (RLS: Radio Link Set)  
**NACK1:** NACK for RLS containing the serving E-DCH cell.

The time slot table is displayed in the main view, as shown in Figure 2-3, with waveforms and measurement results.

	TS	SSCH	SCG	SCN	AGS	AGV	RG
-7	12	15	1	0			HOLD
-6	13	7	1	0			HOLD
-5	14	16	1	0	0	0	HOLD
-4	0	1	1	0			HOLD
-3	1	1	1	0			HOLD
-2	2	2	1	0	0	0	HOLD
-1	3	8	1	0			HOLD
0	4	9	1	0			HOLD

**Figure 2-3: Time slot table (at the lower left of the screen)**

**Scroll Timeslot Table.** Scrolls the time slot table to the right and left.

**Menu Off.** Turns off the side menu on screen to expand the waveform and measurement result display. Press the **MENU** side key when you return to the original display.

# Code Domain Power

When you select Code Domain Power in the Measure menu, the code domain power is displayed for each short code, as shown in Figure 2-4.

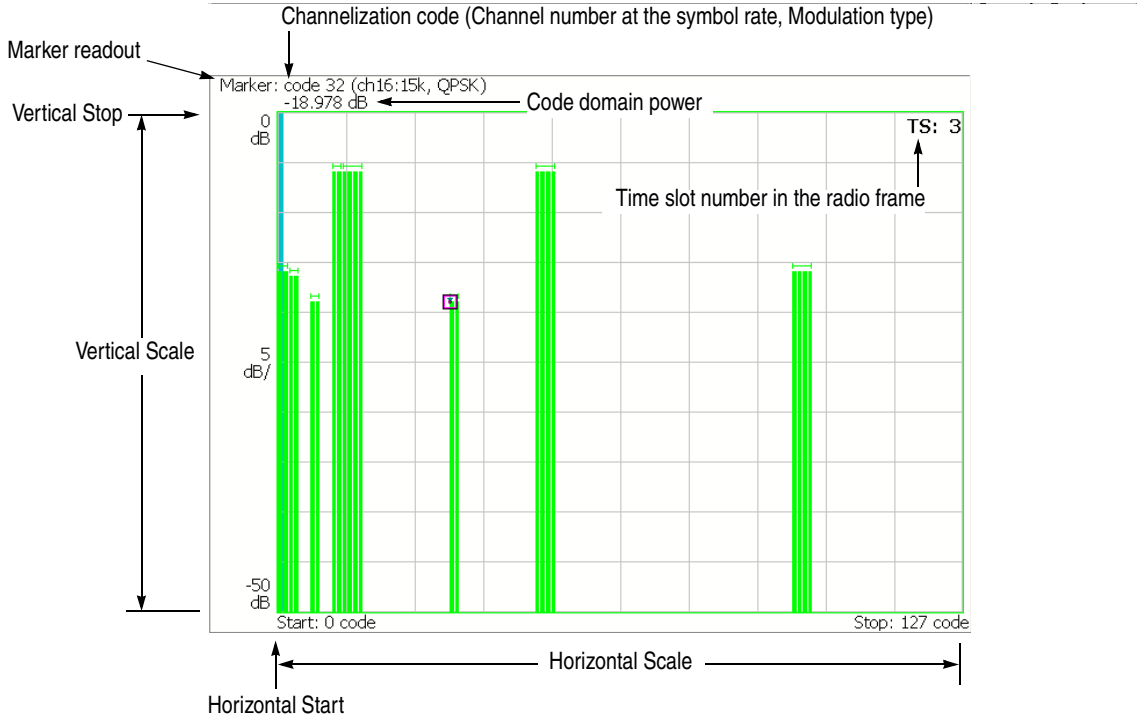

Figure 2-4: Code domain power



**View: Scale Menu** Use the following controls to scale the view:

**Auto Scale.** Sets the start value and the scale of the vertical axis automatically to fit the waveform to the screen.

**Horizontal Scale.** Sets the scale of the horizontal axis.  
Range: 16 to 512 channels.

**Horizontal Start.** Sets the start channel number of the horizontal axis.  
Range: 0 to [512 – (Horizontal Scale)].

**Vertical Scale.** Sets the scale of the vertical axis.  
Range: 50  $\mu$  to 50 dB.

**Vertical Stop.** Sets the maximum value (top edge) of the vertical axis.  
Range: –50 to Vertical Scale [dB].

**Full Scale.** Sets the scale of the vertical axis to the default full scale value.

**Y Axis.** Selects whether to represent the vertical axis (amplitude) with relative or absolute values.

- **Relative.** The vertical axis represents power relative to the total power of all channels.
- **Absolute.** The vertical axis represents absolute power of each channel.

## Power Codogram

When you select Power Codogram in the Measure menu, the code domain power is displayed in spectrogram, as shown in Figure 2-5.

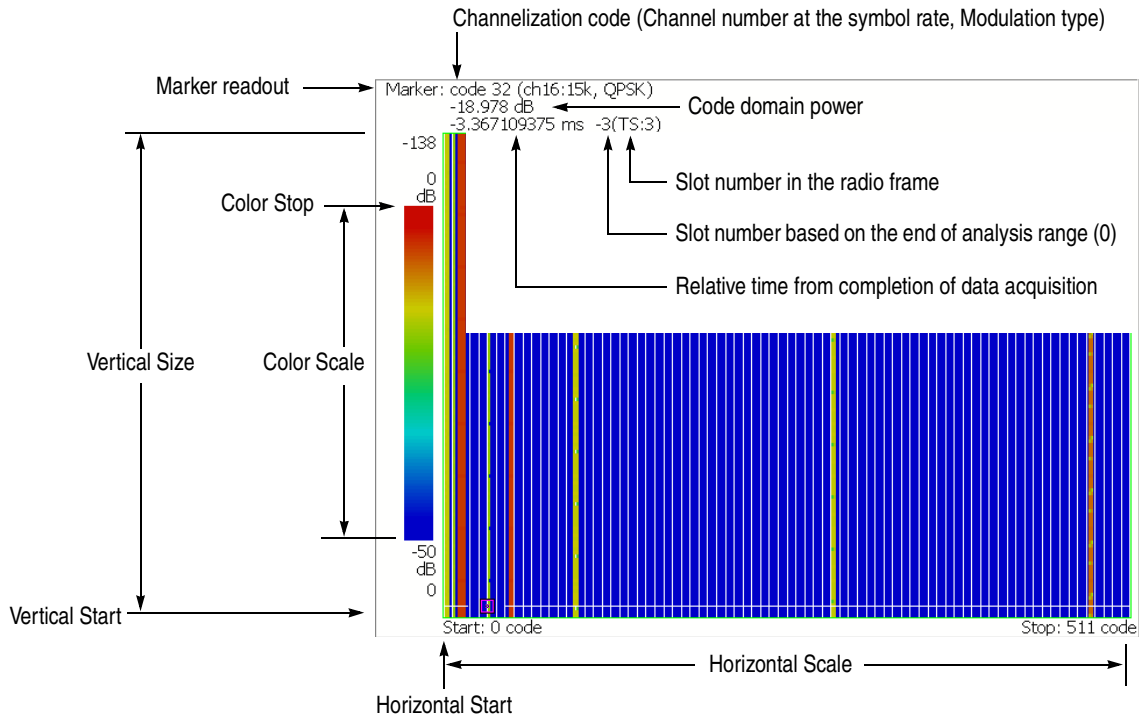

Figure 2-5: Power codogram

**View: Scale Menu** Use the following controls to scale the view:

**Auto Scale.** Sets the start value and the scale of the vertical axis automatically to fit the waveform to the screen.

**Horizontal Scale.** Sets the scale of the horizontal axis.  
Range: 16 to 512 channels.

**Horizontal Start.** Sets the start channel number of the horizontal axis.  
Range: 0 to [512 – (Horizontal Scale)].

**Vertical Size.** Sets the full scale of the vertical axis in frames.  
Range: 58 to 59392 frames.

**Vertical Start.** Sets the start frame number of the vertical axis.

**Color Scale.** Sets the range of the color axis:

- 5 dB
- 10 dB
- 20 dB
- 50 dB

The spectrogram is displayed in 100 steps (100 colors) from the minimum value (blue) to the maximum value (red) in the default state.

**Color Stop.** Sets the maximum value (top edge) of the color axis.  
Range: –50 to Color Scale [dB].

**Full Scale.** Sets Color Stop to 0 (zero) and Color Scale to 50 dB.

**Y Axis.** Selects whether to represent the Y (color) axis with relative or absolute values.

- **Relative.** The Y axis represents power relative to the total power of all channels.
- **Absolute.** The Y axis represents absolute power of each channel.

## Code Power versus Time Slot

When you select Code Power versus Time Slot in the Measure menu, the code domain power is displayed for each slot, as shown in Figure 2-6.

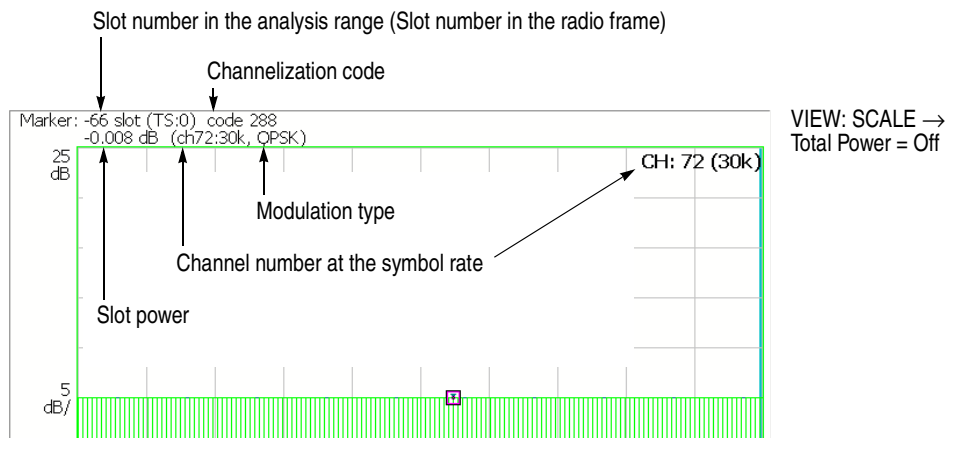
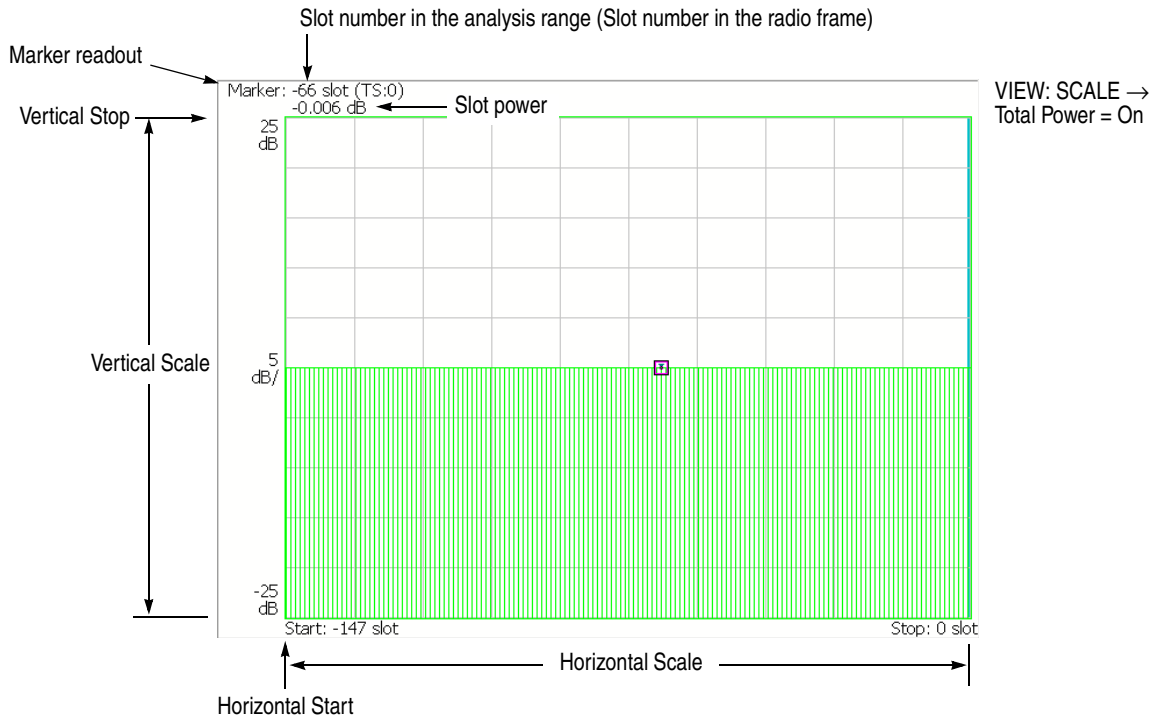

Figure 2-6: Code power versus Time slot

**View: Scale Menu**

Use the following controls to scale the view:

**Auto Scale.** Sets the start value and the scale of the vertical axis automatically to fit the waveform to the screen.

**Horizontal Scale.** Sets the scale of the horizontal axis (number of slots).  
Range:  $N/8$  to  $N$  slots ( $N$ : the number of slots in the analysis range.)

**Horizontal Start.** Sets the start slot number of the horizontal axis.  
Range:  $-(N - 1)$  to  $[1 - (\text{Horizontal Scale})]$ .

**Vertical Scale.** Sets the scale of the vertical axis.  
Range:  $50 \mu$  to  $50$  dB.

**Vertical Stop.** Sets the maximum value (top edge) of the vertical axis.  
Range:  $-25$  to  $[(\text{Vertical Scale}) + 25]$  dB.

**Full Scale.** Sets the scale of the vertical axis to the default full scale value.

**Y Axis.** Selects whether to represent the vertical (amplitude) axis with relative or absolute values.

- **Relative.** The vertical axis represents time-slot power relative to the power of the first time-slot in the analysis range.
- **Absolute.** The vertical axis represents absolute power of time slots.

**Select Power.** Selects the channel to show the power for each time slot.

- **Code.** Shows the power of all channels or the specified channel depending on the setting of Total Power described below.
- **PSCH.** Shows the power of the PSCH (Primary Synchronization Channel).
- **SSCH.** Shows the power of the SSCH (Secondary Synchronization Channel).

**Total Power.** Determines whether to display the total power for each time slot when the Select Power is set to Code.

- **On. Default.** Displays the total power of all channels for each time slot.
- **Off.** Displays power of the channel specified using Channelization Code in the View: Define menu (refer to page 2-11).

## Code Power versus Symbol

When you select Code Power versus Symbol in the Measure menu, the code domain power is displayed for each symbol, as shown in Figure 2-7.

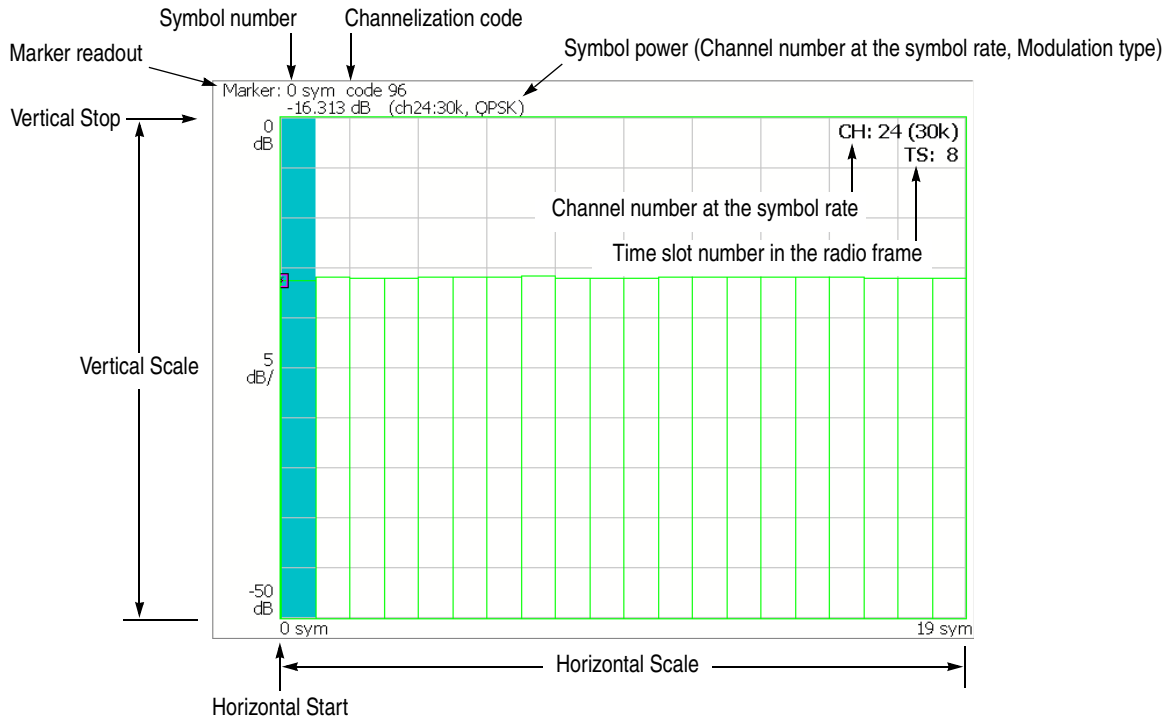

Figure 2-7: Code domain power versus Symbol

**View: Scale Menu** Use the following controls to scale the view:

**Auto Scale.** Sets the start value and the scale of the vertical axis automatically to fit the waveform to the screen.

**Horizontal Scale.** Sets the scale of the horizontal axis (number of symbols).  
Range: 0 to 640 symbols.

**Horizontal Start.** Sets the start symbol number of the horizontal axis.  
Range: 0 to [(initial value of Horizontal Scale) – (set value of Horizontal Scale)].

**Vertical Scale.** Sets the scale of the vertical axis.  
Range: 50  $\mu$  to 50 dB.

**Vertical Stop.** Sets the maximum value (top edge) of the vertical axis.  
Range: –50 to Vertical Scale [dB].

**Full Scale.** Sets the scale of the vertical axis to the default full-scale value.

**Y Axis.** Selects whether to represent the vertical (amplitude) axis with relative or absolute values.

- **Relative.** The vertical axis represents power relative to the total power of all channels.
- **Absolute.** The vertical axis represents absolute power of each channel.

## Symbol Constellation

The symbol constellation is displayed when you select Symbol Constellation in the Measure menu, as shown in Figure 2-8.

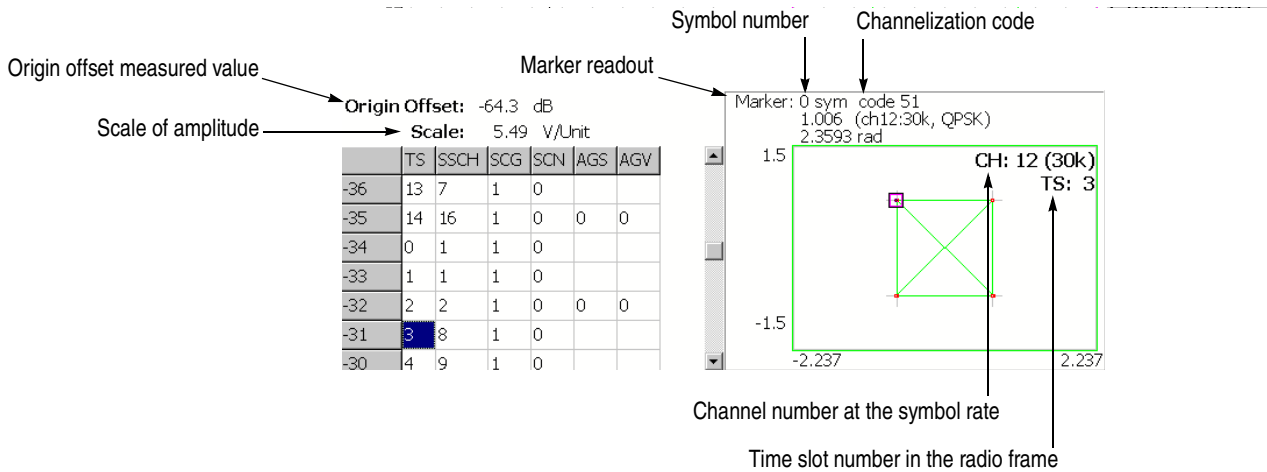

Figure 2-8: Symbol constellation

### View: Scale Menu

Use the following controls to set the scale:

**Measurement Content...** Selects vector or constellation display.

- **Vector.** Selects vector display. A signal represented by phase and amplitude is displayed in polar coordinate or IQ diagram. The red point indicates the symbol position of the measured signal, and the yellow trace indicates the locus of the signal between symbols.
- **Constellation.** Selects constellation display. It is the same as the vector display, except that only symbols of the measured signal are indicated in red, and the locus between symbols is not shown. The cross marks indicate the symbol positions of an ideal signal.

You can select degree or radian for the angular unit by pressing **SYSTEM** → **Instrument Setup...** → **Angular Units...**



## Symbol EVM

When you select Symbol EVM in the Measure menu, EVM (Error Vector Magnitude) is displayed for each symbol, as shown in Figure 2-9.

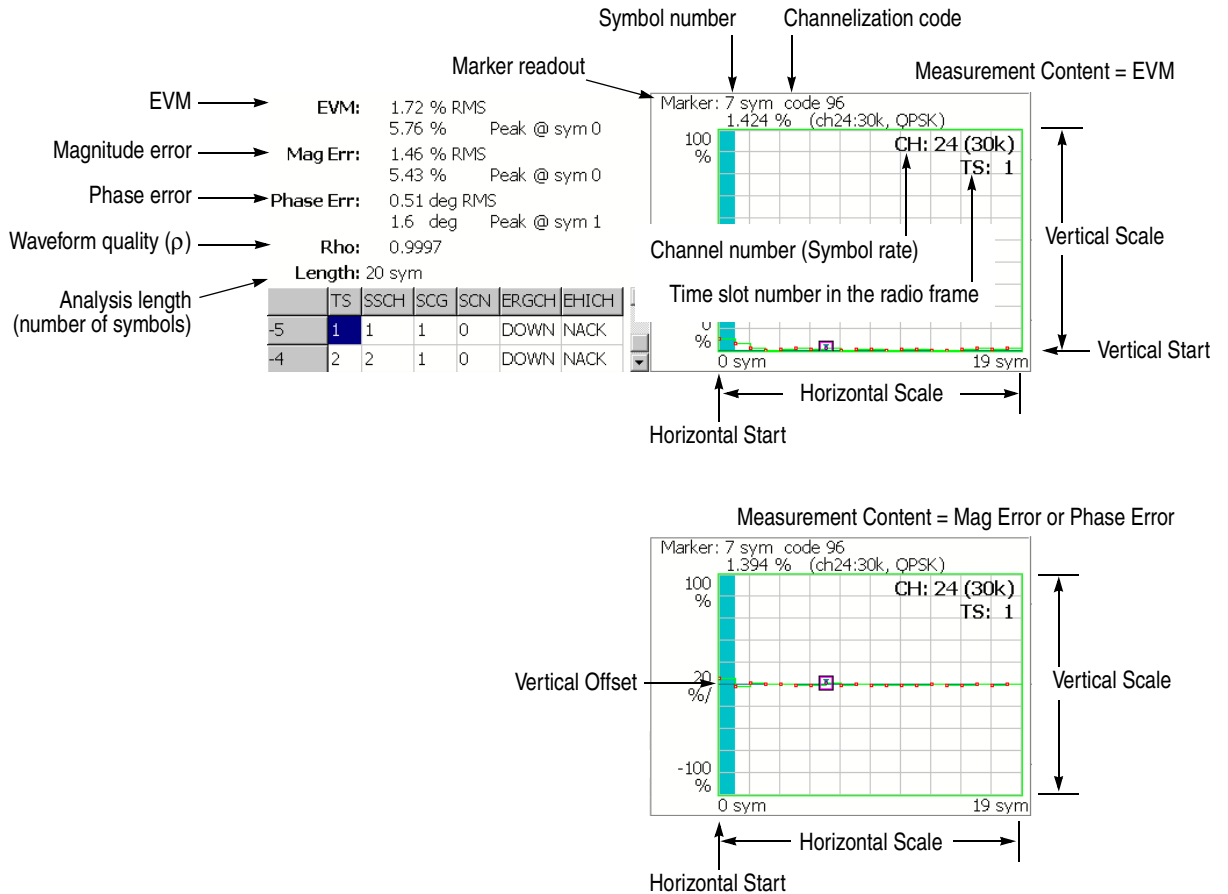

Figure 2-9: Symbol EVM

**NOTE.** For the symbol EVM, the measurement results of EVM, magnitude and phase error are calculated and displayed with EVM IQ Origin Offset (refer to page 2-9) set to Include even if you set it to Exclude.

**View: Scale Menu**

Use the following controls to scale the view:

**Auto Scale.** Sets the start value and the scale of the vertical axis automatically to fit the waveform to the screen.

**Horizontal Scale.** Sets the scale of the horizontal axis (number of symbols).  
Range: 0 to 640 symbols.

**Horizontal Start.** Sets the start symbol number of the horizontal axis.  
Range: 0 to [(initial value of Horizontal Scale) – (set value of Horizontal Scale)].

**Vertical Scale.** Sets the scale of the vertical axis.  
Refer to Table 2-2 for the setting range.

**Vertical Start.** Sets the minimum value (bottom edge) of the vertical axis when the measurement content is EVM. Refer to Table 2-2 for the setting range.

**Vertical Offset.** Sets the center value ((maximum + minimum) / 2) of the vertical axis when the measurement content is Mag Error or Phase Error.  
Refer to Table 2-2 for the setting range.

**Full Scale.** Sets the scale of vertical axis to the default full-scale value.

**Measurement Content...** Selects how to display the vertical axis (refer to Table 2-2).

- **EVM.** Represents the vertical axis with EVM.
- **Mag Error.** Represents the vertical axis with magnitude error.
- **Phase Error.** Represents the vertical axis with phase error.

**Table 2-2: Vertical scale setting range, Symbol EVM**

Measurement Content...	Vertical Scale	Vertical Start	Vertical Offset
EVM	100μ to 100%	-100 to 100%	-
Mag Error	200μ to 200%	-	-200 to 200%
Phase Error	450μ to 450°	-	-450 to 450°

You can select degree or radian for the angular unit by pressing **SYSTEM** → **Instrument Setup...** → **Angular Units...**

## Symbol Eye Diagram

The symbol eye diagram is displayed when you select Symbol Eye Diagram in the Measure menu, as shown in Figure 2-10.

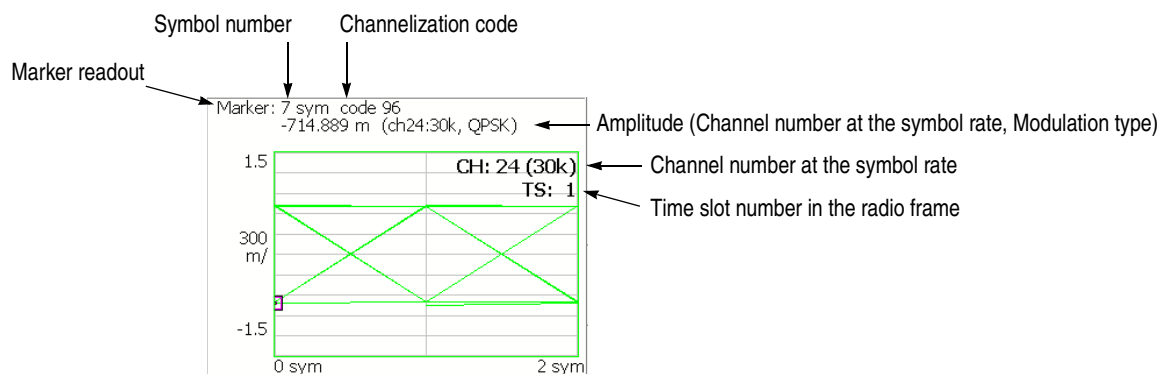

**Figure 2-10: Symbol eye diagram**

**View: Scale Menu** Use the following controls to scale the view.

**Measurement Content...** Selects the vertical axis of eye diagram.

- **I. Default.** Displays I data on the vertical axis.
- **Q.** Displays Q data on the vertical axis.
- **Trellis.** Displays phase on the vertical axis.

**Eye Length.** Enters the number of display symbols on the horizontal axis.  
Range: 1 to 16 (default: 2)

## Symbol Table

The symbol table is displayed when you select Symbol Table in the Measure menu, as shown in Figure 2-11.

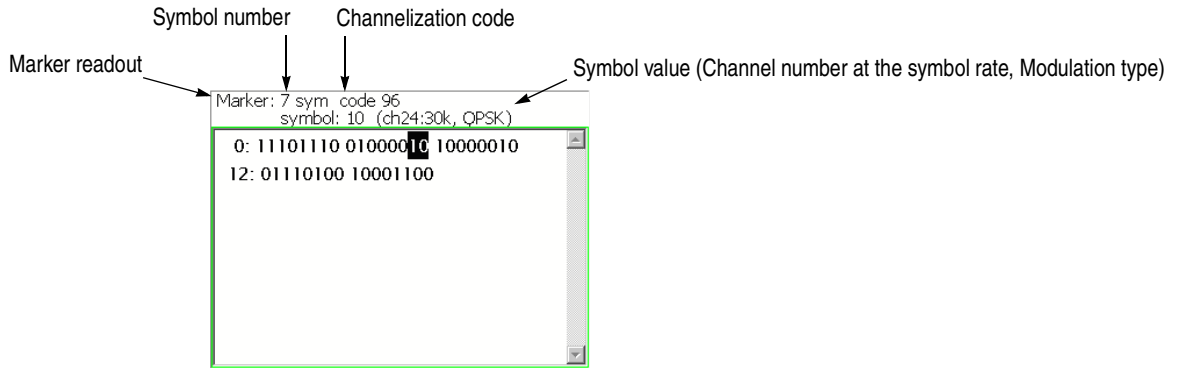

**Figure 2-11: Symbol table**

### View: Scale Menu

Use the following controls to scale the view:

**Radix.** Selects the radix for displaying the table:

- **Hex (packed).** Displays data in the hexadecimal form every 4 bits.
- **Hex.** Displays data in the hexadecimal form every modulation symbol.
- **Oct.** Displays data in the octal form every modulation symbol.
- **Bin.** *Default.* Displays data in the binary form.

Hex and Oct indicate values of binary data string in units of modulation symbol. When a signal contains one or two-bit data in a symbol, you can select Hex (packed) to represent multiple symbols as a hexadecimal digit every 4 bits. For example, the BPSK modulation signal contains one-bit data in a symbol, so the symbol table has the same values for Hex, Oct, and Bin. But Hex (packed) represents every 4 symbols as a hexadecimal digit.

**Rotate.** Sets the start position. Range: 0 to 3.

## Modulation Accuracy

The constellation of all channels before the de-spread is displayed when you select Modulation Accuracy in the Measure menu.

When you press the VIEW: **SELECT** key on the front panel to select the constellation view, the measurement results for the time slot are displayed instead of the overview, as shown in Figure 2-12.

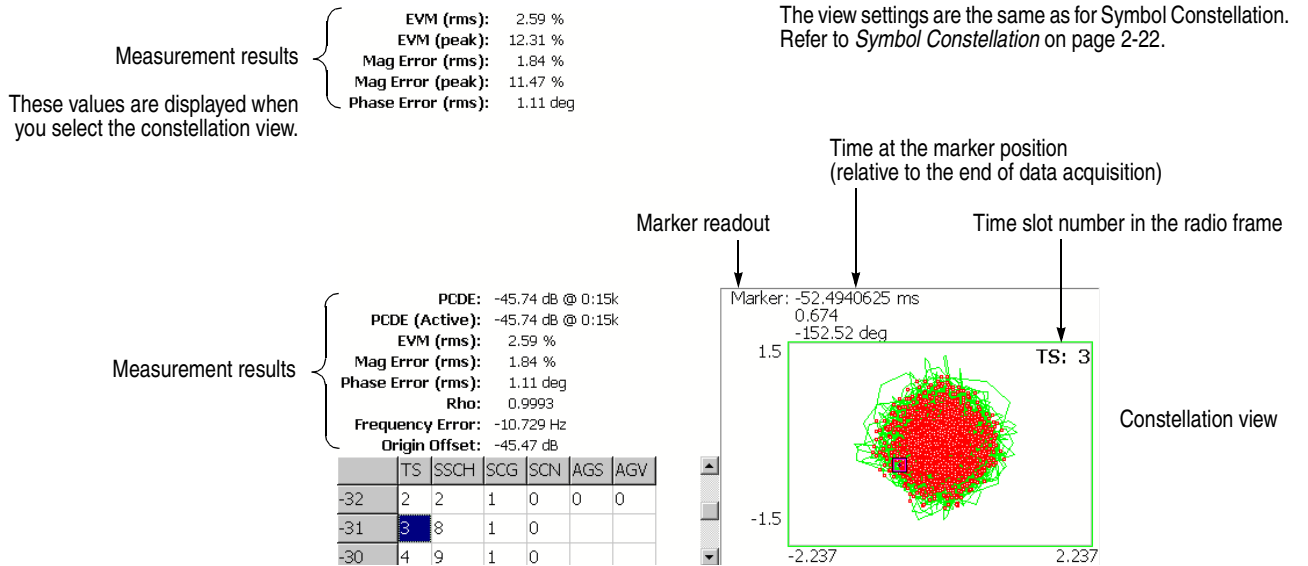

Figure 2-12: Modulation accuracy

The following table shows the measurement results readout.

Measurement results	Description
PCDE	PCDE [dB] @ channel: symbol rate (I/Q)
PCDE (Active)	PCDE [dB] for active channels only @ channel: symbol rate (I/Q)
EVM (rms) <sup>1</sup>	RMS value of EVM [%]
(Peak) <sup>1</sup>	Peak value of EVM [%]
Mag Error (rms) <sup>1</sup>	RMS value of magnitude error [%]
(Peak) <sup>1</sup>	Peak value of magnitude error [%]
Phase Error (rms) <sup>1</sup>	RMS value of phase error [degrees or radians]
(Peak)	Peak value of phase error [degrees or radians]
Rho	Waveform quality ( $\rho$ )
Frequency Error	Frequency error [Hz]
Origin Offset	Origin offset (IQ feedthrough) [dB]

<sup>1</sup> Displayed on the upper-left corner of the screen when you select the constellation view.

## Modulation Accuracy versus Time Slot

The Modulation accuracy versus Time slot measurement displays EVM, magnitude error, phase error, PCDE (Peak Code Domain Error), or Frequency error for each time slot in the main view. Figure 2-13 shows an example of EVM (rms).

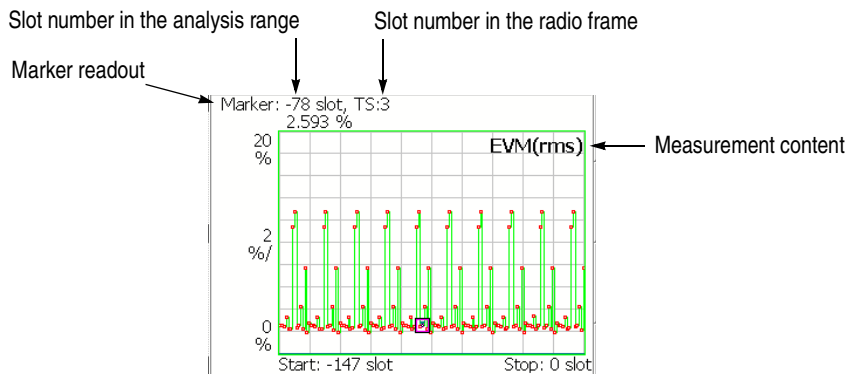

**Figure 2-13: Modulation accuracy versus Time slot, EVM (rms)**

### View: Scale Menu

Use the following controls to scale the view.

**Auto Scale.** Sets the start value and the scale of the vertical axis automatically to fit the waveform to the screen.

**Horizontal Scale.** Sets the scale of the horizontal axis (number of slots).  
Range:  $N/8$  to  $N$  slots ( $N$ : the number of slots in the analysis range.)

**Horizontal Start.** Sets the start slot number of the horizontal axis.  
Range:  $-(N - 1)$  to  $[1 - (\text{Horizontal Scale})]$ .

**Vertical Scale.** Sets the scale of the vertical axis.  
Refer to Table 2-3 for the setting range.

**Vertical Start.** Sets the minimum value (bottom edge) of the vertical axis when the measurement content is EVM. Refer to Table 2-3 for the setting range.

**Vertical Stop.** Sets the maximum value (top edge) of the vertical axis when the measurement content is PCDE. Refer to Table 2-3 for the setting range.

**Vertical Offset.** Sets the center value  $((\text{maximum} + \text{minimum}) / 2)$  of the vertical axis when the measurement content is Mag Error, Phase Error, or Frequency Error. Refer to Table 2-3 for the setting range.

**Full Scale.** Sets the scale of vertical axis to the default full-scale value.

**Measurement Content...** Selects the measurement content (refer to Table 2-3).

**Table 2-3: Vertical scale setting range, Modulation accuracy versus Time slot**

Measurement Content...	Vertical Scale	Vertical Start	Vertical Stop	Vertical Offset
EVM (rms)	100 $\mu$ to 100%	-100 to 100%	-	-
EVM (peak)	100 $\mu$ to 100%	-100 to 100%	-	-
Mag Error (rms)	200 $\mu$ to 200%	-	-	-200 to 200%
Mag Error (peak)	200 $\mu$ to 200%	-	-	-200 to 200%
Phase Error (rms)	450 $\mu$ to 450°	-	-	-450 to 450°
Phase Error (peak)	450 $\mu$ to 450°	-	-	-450 to 450°
PCDE (Peak Code Domain Error)	100 $\mu$ to 100 dB	-	-100 to 100 dB	-
Frequency Error	10 m to 10 kHz	-	-	-10 k to 10 kHz

You can select degree or radian for the angular unit by pressing **SYSTEM**  
 → **Instrument Setup...** → **Angular Units...**





# Uplink Analysis

This section describes the basic operation for the 3GPP-R6 uplink analysis in the Demod (modulation analysis) mode. You can access the measurement item by pressing **DEMOD** → **Standard...** → **3GPP-R6-UL** as shown in Figure 2-14.

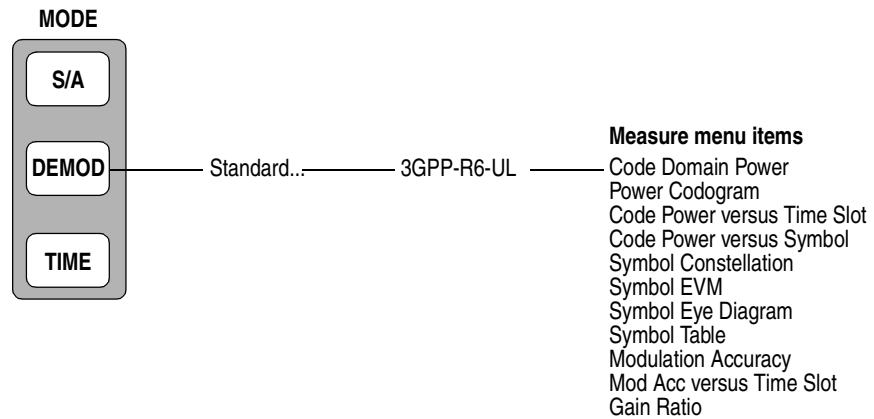

**Figure 2-14: Uplink analysis measurement menu in the Demod mode**

The measurement in the Demod mode is based on the digital modulation analysis function. For the digital modulation analysis, refer to the *RSA3408A User Manual*.

## Measurement Procedure

The following procedure shows you how to acquire data from multiple slots in advance, measure continuous data, and obtain continuous code domain power:

---

**NOTE.** For details on setting frequency, span, and amplitude, refer to the *RSA3408A User Manual*.

---

1. Press the **DEMOD** key on the front panel.
2. Press the side key **Standard...** → **3GPP-R6-UL**.
3. Press the **FREQUENCY/CHANNEL** key on the front panel to set frequency.

If you use the channel table, do these steps:

- Press the **Channel Table...** side key and select **W-CDMA-UL**.
- Press the **Channel** side key and select a channel by rotating the general purpose knob.

The center frequency is set to the value corresponding to the channel.

4. Press the **SPAN** key on the front panel to set the span.
5. Press the **AMPLITUDE** key on the front panel to set the amplitude appropriately.

---

**NOTE.** If the input level is too high, *A/D OVERFLOW* displays in the red box at the center top of the screen. If this occurs, raise the reference level.

---

6. Press the **TIMING** key on the front panel and then the **Acquisition Length** side key to set the time length to acquire one block.

Suppose that one block contains M frames; the acquisition length is calculated with this equation:

$$(\text{One block acquisition length}) = M \times (\text{One frame acquisition length})$$

One frame acquisition length is determined by span and indicated on the Spectrum Length side key.

The number of frames M required for measuring N slots must meet the following condition:

$$M > K \times (N + 1.2) + 1$$

where

K = 16.7 (for span 20 MHz and 15 MHz)

8.34 (for span 10 MHz)

4.17 (for span 5 MHz)

7. After acquiring measurement data, stop the data acquisition. If you are acquiring data in the continuous mode, press the **RUN/STOP** key.
8. Press the **MEASURE** key on the front panel to select measurement items. For example, press the **Power Codogram** side key to observe the code domain power spectrogram.
9. Press the **MEAS SETUP** key on the front panel and set the measurement parameters. Refer to page 2-34 for details of the Meas Setup menu.
10. Set the analysis range in the overview using the Timing menu. Refer to the *RSA3408A User Manual* for the details.
11. Press the **MEAS SETUP** key on the front panel and then the **Analyze** side key to start processing the frames in the analysis range. The results are displayed in the main view.

Change the scale and format of the view as needed. Refer to page 2-41 for setting views specific to the 3GPP-R6 uplink analysis.

Figure 2-15 shows an example of the code domain power measurement.

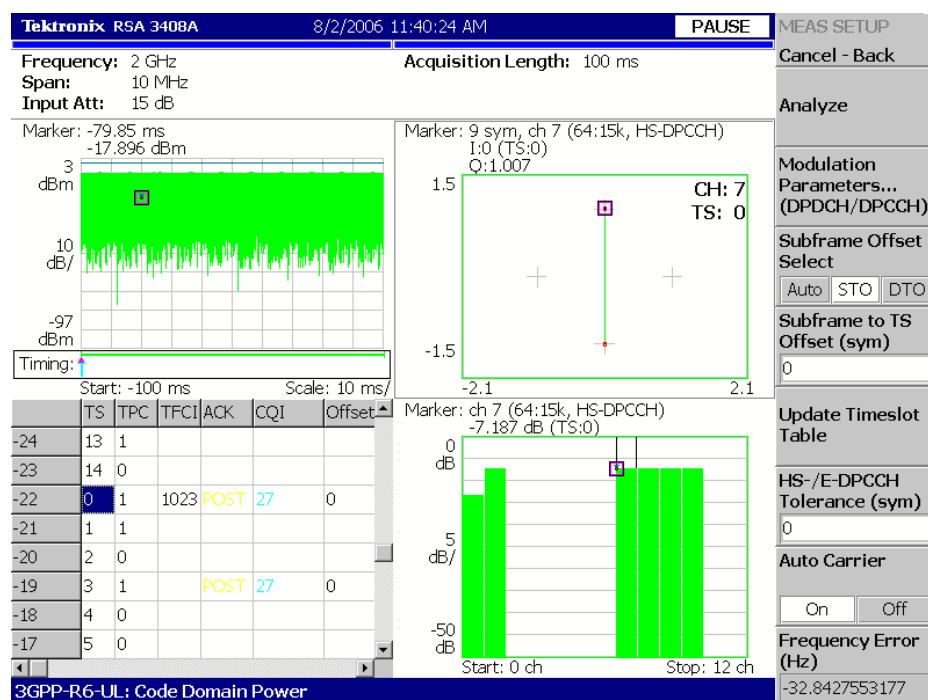

Figure 2-15: Code domain power measurement example

## Measurement Setup Menu

Press the **MEAS SETUP** key on the front panel to set the measurement parameters. The Meas Setup menu for the 3GPP-R6 uplink modulation analysis contains the following controls:

**Analyze** Performs analysis for time slots in the analysis range.

---

**NOTE.** When you change settings in the Meas Setup menu, press the **Analyze** side key to perform the measurement for the modified setting(s).

---

**Modulation Parameters...** Sets parameters to demodulate the input signal. The following setting items are provided:

**Measurement Mode.** Selects the type of uplink signal:

- DPDCH/DPCCH (default)
- PRACH
- PCPCH

**Scrambling Code Type.** Available for the DPDCH/DPCCH measurement mode. Selects the scrambling code type:

- Long (default)
- Short

**Scrambling Code.** Sets the scrambling code number. Range: 0 to 16777215 (default: 0).

**Configuration...** Available for the DPDCH/DPCCH measurement mode. Selects the channel configuration (defined in 3GPP-R6).

- **Auto.** *Default.* Detects the configuration automatically.
- **1.** Selects Configuration #1.
- **2.** Selects Configuration #2.
- **3.** Selects Configuration #3.

For details on the Configuration, refer to the 3GPP-R6 specifications.

**DPCCH Slot Format...** Available for the DPDCH/DPCCH measurement mode.  
Selects the DPCCH slot format to decode TFCI.

- **Auto. Default.** Detects the Slot Format automatically.
- **0.** Selects Slot Format #0 (including 0A and 0B).
- **1.** Selects Slot Format #1.
- **2.** Selects Slot Format #2 (including 2A and 2B).
- **3.** Selects Slot Format #3.

---

**NOTE.** When selecting Slot Format #1 or #3, the time-slot table does not show TFCI. (Refer to page 2-45 for the time-slot table.)

---

For details on the Slot Format, refer to the 3GPP-R6 specifications.

**HS-/E-DPCCH Tolerance.** Available for the DPDCH/DPCCH measurement mode.  
Sets the number of symbols which are allowed to be different from the 3GPP-R6 specifications for decoding HS-DPCCH and E-DPCCH.  
Range: 0 to 5 symbols (default: 0).

**DTX Detection Threshold.** Available for the DPDCH/DPCCH measurement mode.  
Sets the threshold level to detect the DTX state.  
Range: -20 to 0 dB relative to the DPCCH power (default: -11.8 dB).

**Threshold.** Sets the threshold level to detect a burst.  
Range: -100 to 10 dB relative to the reference level (default: -30 dB).

**Measurement Filter...** Selects a filter for demodulating digitally-modulated signals:

- None (no filter)
- RootRaisedCosine (default)

**Reference Filter...** Selects a filter for creating reference data:

- None (no filter)
- RaisedCosine (default)
- Gaussian

For the filters, refer to *Process Flow of Digitally-Modulated Signal* in the *RSA3408A User Manual*.

**Filter Parameter.** Sets an  $\alpha$ /BT value for Measurement Filter and Reference Filter described above. Range: 0.0001 to 1 (default: 0.22)

**EVM IQ Origin Offset.** Determines whether or not to include the I/Q origin offset in the EVM (Error Vector Magnitude), Rho (waveform quality), and PCDE (Peak Code Domain Error) calculation.

- **Include.** *Default.* Includes the I/Q origin offset in the calculation.
- **Exclude.** Excludes the I/Q origin offset from the calculation.

**EVM Transient Periods of 25 us.** Determines whether or not to include the transient periods (both 25 μs ends of the time slot) from the EVM and PCDE calculation.

- **Include.** Calculates EVM and PCDE using all chips of the slot.
- **Exclude.** *Default.* Excludes both 25 μs ends of the slot from the calculation.

**Subframe Offset Select** Selects how to specify the subframe offset.

- **Auto.** *Default.* The symbol table is displayed for any offset.
- **STO.** Sets the Subframe to Time-Slot Offset (STO) using the **Subframe to TS Offset** side key.
- **DTO.** Sets the Downlink Time Offset (DTO) using the **Downlink Time Offset** side key.

**Subframe to TS Offset** Specifies the subframe to time-slot offset when you select **STO** with the **Subframe Offset Select** side key. Range: 0 to 9 symbols (default: 0).

The subframe to time-slot offset is the time offset between the start of the DPDCH time slot and the start of the HS-DPCCH subframe (see Figure 2-16).

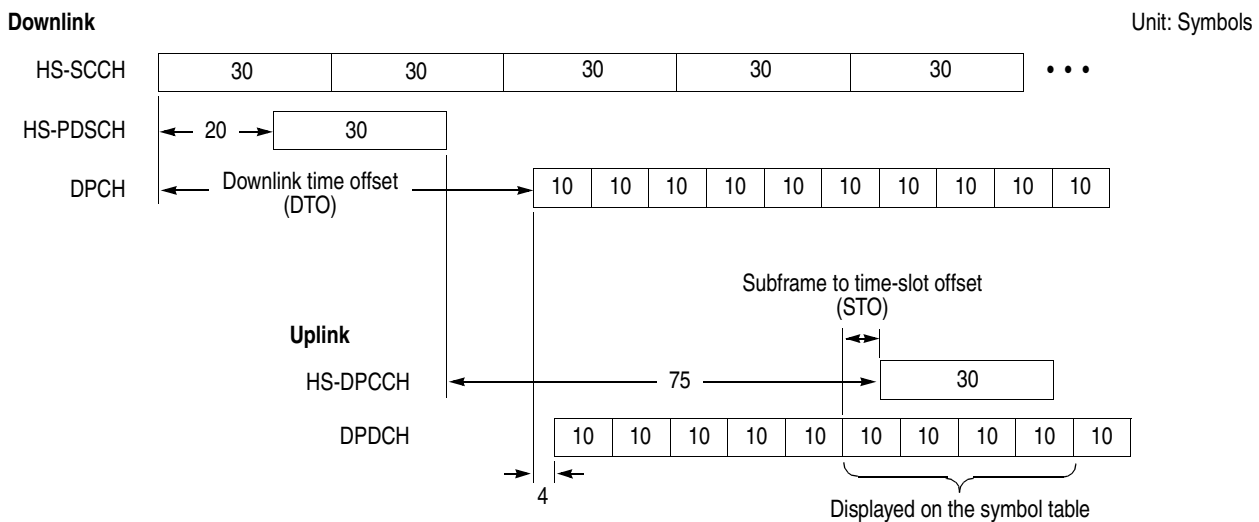

Figure 2-16: Subframe offset

- Downlink Time Offset** Specifies the downlink time offset when you select **DTO** with the **Subframe Offset Select** side key. Range: 0 to 149 symbols (default: 1).
- The downlink time offset is the time offset between the start of HS-SCCH and the start of DPCH (see Figure 2-16).
- Update Timeslot Table** Reanalyzes the existing time slot data to update the table display after you change the subframe offset manually or abort the Analyze (top side key) operation.
- Auto Carrier** Selects whether to detect the carrier automatically.
- **On. Default.** Automatically detects the carrier for every frame. The error from the center frequency is shown on the **Freq Error** side key.
  - **Off.** Sets the carrier frequency using **Frequency Offset**.
- Frequency Offset** Sets the frequency offset when **Auto Carrier** is set to Off. Input the carrier offset from the center frequency.

## Display Method for HS-DPCCH

The measurement results for each channel are normally displayed in the view for each time slot. But HS-DPCCH has the different display methods for the settings of Subframe Offset Select in the Meas Setup menu. This section describes how to display HS-DPCCH in each view.

### Code Domain Power, Power Codogram, and Code Power versus Time Slot

- *When Subframe Offset Select is set to AUTO*  
Each time slot is displayed without offset as the other channels (see the upper part of Figure 2-17).
- *When Subframe Offset Select is set to STO (Subframe to Time slot Offset)*  
Each time slot is displayed with offset specified by Subframe to TS Offset in the Meas Setup menu. Also in the total power calculation for the relative value display, only HS-DPCCH is offset in the same way. But the last time slot is displayed without offset (see the lower part of Figure 2-17).
- *When Subframe Offset Select is set to DTO (Downlink Time Offset)*  
Each time slot is displayed in the same manner as when Subframe Offset Select is set to STO. But the number of offset symbols is determined by this formula:  $[151 - (\text{Downlink Time Offset})] \bmod 10$  (see the lower part of Figure 2-17).

Subframe Offset Select = AUTO

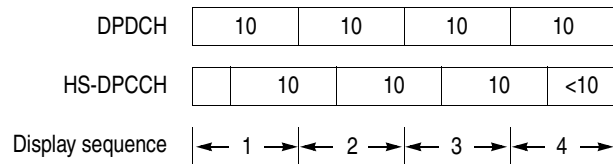

Subframe Offset Select = STO or DTO

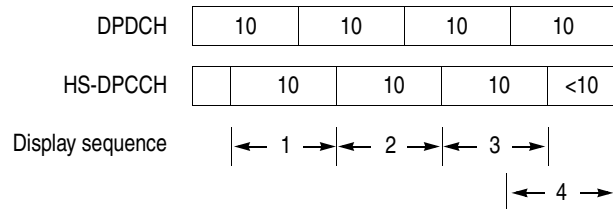

**NOTE.** "10" in the box represents the number of symbols in a time slot.

**Figure 2-17: HS-DPCCH display method**



### Code Power versus Symbol, Symbol Constellation, Symbol EVM, and Symbol Eye Diagram

- *When Subframe Offset Select is set to AUTO*  
10 symbols are displayed for each time slot without offset as the other channels (see the upper part of Figure 2-17 on page 2-38).
- *When Subframe Offset Select is set to STO (Subframe to Time slot Offset)*  
30 symbols are displayed for each time slot with offset specified by Subframe to TS Offset in the Meas Setup menu. Also in the total power calculation for the relative value display in the Code power versus Symbol view, only HS-DPCCH is offset in the same way (see the upper part of Figure 2-18). But when there are not enough symbols in the last part of the analysis range, 30, 20, and 10 symbols are displayed without offset as shown in the upper part of Figure 2-18, the display sequence 8, 9, and 10, respectively.
- *When Subframe Offset Select is set to DTO (Downlink Time Offset)*  
If the specified time slot is the first one in the subframe, symbols are displayed in the same manner as when Subframe Offset Select is set to STO. Otherwise symbols are displayed in the same manner as when Subframe Offset Select is set to AUTO (see the lower part of Figure 2-17).

Subframe Offset Select = STO

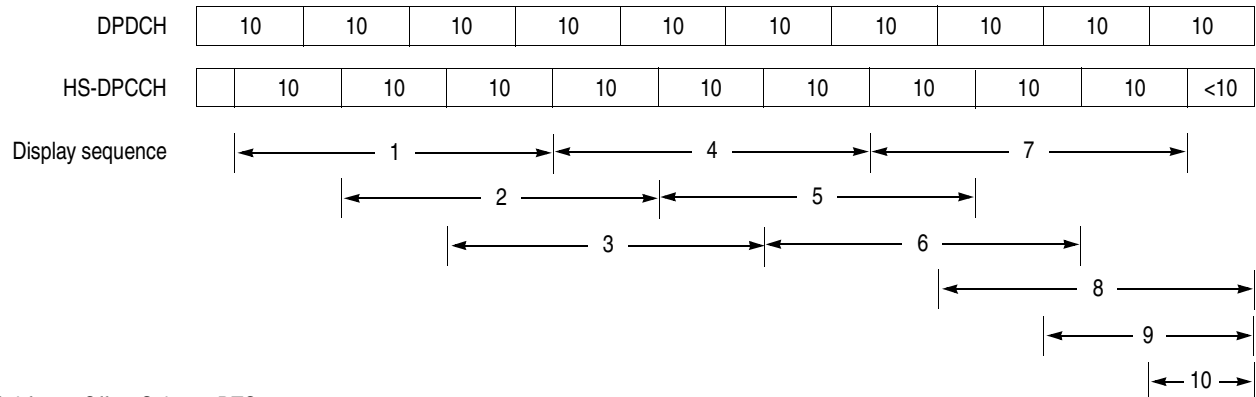

Subframe Offset Select = DTO

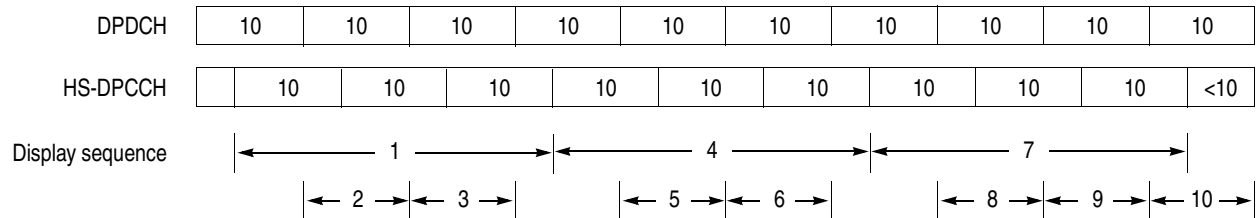

**NOTE.** "10" in the box represents the number of symbols in a time slot.

**Figure 2-18: HS-DPCCH display method**



## Scale and Format of View

The following main views are specific for the measurement items of the 3GPP-R6 uplink analysis in Demod mode:

- Code domain power
- Power codogram
- Code power versus Time slot
- Code power versus Symbol
- Symbol constellation
- Symbol EVM
- Symbol eye diagram
- Symbol table
- Modulation accuracy
- Modulation accuracy versus Time slot
- Gain ratio

The scale and format of view are controlled by the View menu. This section describes the View: Define menu and the View: Scale menu for each view.

**View: Define Menu** The View: Define menu is common to all main views of the 3GPP-R6 uplink measurement items. It contains the following controls:

**Show Views.** Selects the view style:

- **Single.** Displays only the view selected by the VIEW: **SELECT** key.
- **Multi.** *Default.* Displays the overview, subview, and main view.

**Overview Content...** Selects a view to display in the overview:

- Waveform (power versus time)
- Spectrogram

**Subview Content...** Selects a view to display in the subview:

- Spectrum
- Code Domain Power
- Power Codogram
- CDP vs Time Slot (Code Domain Power versus Time Slot)
- CDP vs Symbol (Code Domain Power versus Symbol)
- Symbol Constellation
- Symbol EVM
- Symbol Eye Diagram
- Symbol Table
- Modulation Accuracy

**Time Slot.** Sets a time-slot number to position the marker.

Range:  $-\text{[(the number of time slots in the analysis range) - 1]}$  to 0.

Zero (0) represents the latest slot.

**Symbol Rate...** Sets the symbol rate to display symbol constellation:

- 1920 k
- 960 k
- 480 k
- 240 k
- 120 k
- 60 k
- 30 k
- 15 k
- Composite

The default is Composite for multi-rate.

**Channel Number.** Selects a channel to position the marker when the View Format is set to Channel. Range: Channel 0 to 12.

**Channelization Code.** Selects a channelization code to position the marker when the View Format is set to I/Q Split. Range: Channel 0 to 255.

**I/Q Branch.** Selects the I/Q branch when the View Format is set to I/Q Split.

- **I.** Displays the measurement result for the I branch.
- **Q.** Displays the measurement result for the Q branch.
- **I/Q.** Displays the measurement result for both I and Q branches.

When the View Format is set to Channel, the I/Q Branch is set to Auto, indicating that the I/Q branch is automatically determined.

**View Format.** Selects the view format (see Figure 2-20).

- **Channel.** Displays the measurement result for the channels of 0 to 12. Table 2-4 shows the channel number and the corresponding channel.

**Table 2-4: Channel number**

Channel number	Channel name
0	DPCCH
1 to 6	DPDCH
7	HS-DPCCH
8	E-DPCCH
9 to 12	E-DPDCH

Use the **Channel Number** side key to select the channel to position the marker.

- **I/Q Split.** Displays the measurement result for the I and/or Q branch along with the channelization codes of 0 to 255. Select the branch using the **I/Q Branch** side key. Use the **Channelization Code** side key to select the code to position the marker.

Figure 2-20 shows an example of the View Format setting in the code domain power measurement.

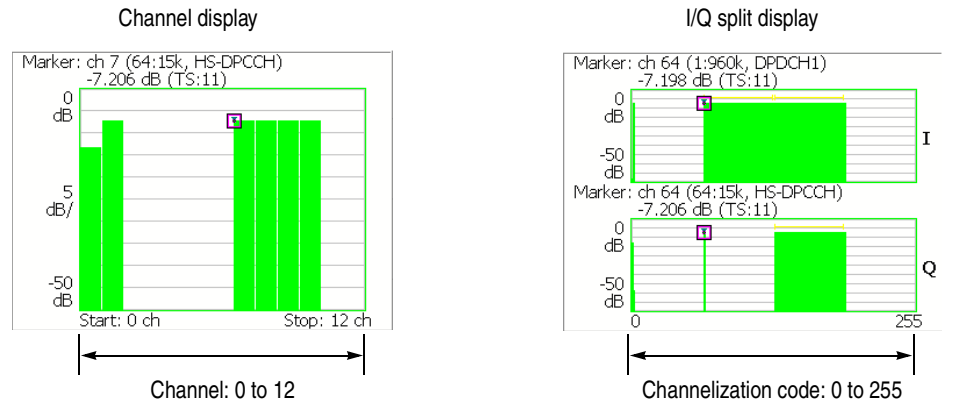

**Figure 2-20: View Format setting (code domain power)**

**Column Items to Display...** Turns on or off the column items, as listed in Table 2-5, in the time-slot table.

**Table 2-5: Time-slot table contents selection**

Column title	Channel	Value
SIG	-	Signature number in the preamble.
PRE	-	Preamble.
TPC	DPCCH	TPC (Transmit Power Control) value.
TFCI	DPCCH	TFCI (Transport Format Combination Indicator) value.
ACK	HS-DPCCH	ACK, NACK, PRE, POST, and DTX.
CQI	HS-DPCCH	CQI (Channel Quality Indicator) value.
Offset	HS-DPCCH	Subframe to Time-slot Offset (STO). Refer to page 2-36.
RSN	E-DPCCH	RSN (Retransmission Sequence Number).
E-TFCI	E-DPCCH	E-TFCI (Enhanced TFCI) value.
Happy	E-DPCCH	Happy bit value.

The time slot table is displayed in the main view, as shown in Figure 2-21, with waveforms and measurement results.

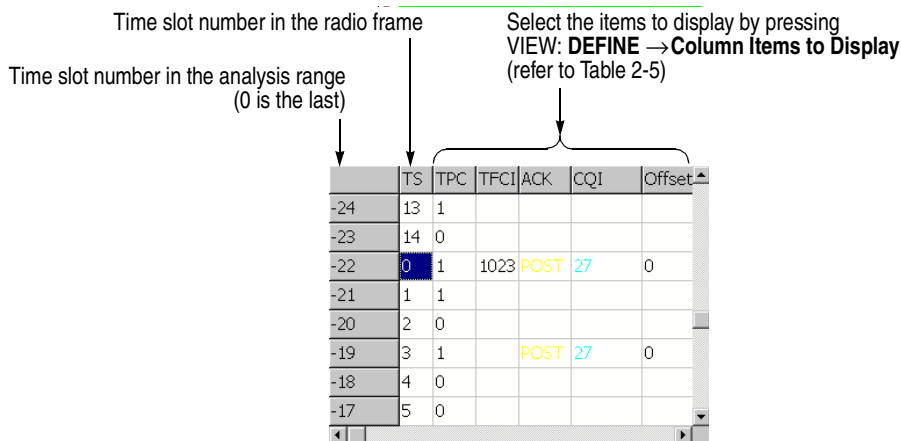

**Figure 2-21: Time slot table (at the lower left of the screen)**

**Scroll Timeslot Table.** Scrolls the time slot table to the right and left.

**Menu Off.** Turns off the side menu on screen to expand the waveform and measurement result display. Press the **MENU** side key when you return to the original display.

## Code Domain Power

When you select Code Domain Power in the Measure menu, the code domain power is displayed for each channel, as shown in Figure 2-22.

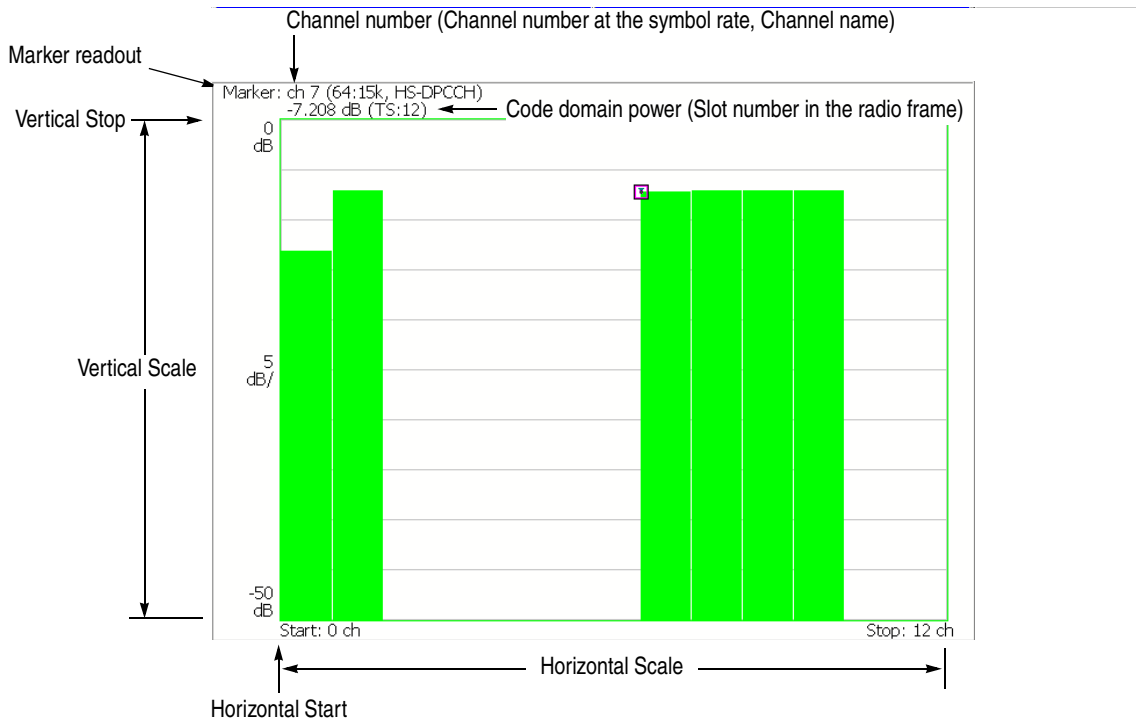

Figure 2-22: Code domain power



**View: Scale Menu** Use the following controls to scale the view:

**Auto Scale.** Sets the start value and the scale of the vertical axis automatically to fit the waveform to the screen.

**Horizontal Scale.** Sets the scale of the horizontal axis.

Range: 1.625 to 13 channels (View Format: Channel)

16 to 256 channels (View Format: I/Q Split)

Refer to page 2-44 for View Format.

**Horizontal Start.** Sets the start channel number of the horizontal axis.

Range: 0 to [(initial value of Horizontal Scale) – (set value of Horizontal Scale)].

**Vertical Scale.** Sets the scale of the vertical axis.

Range: 50  $\mu$  to 50 dB.

**Vertical Stop.** Sets the maximum value (top edge) of the vertical axis.

Range: –50 to Vertical Scale [dB].

**Full Scale.** Sets the scale of the vertical axis to the default full-scale value.

**Y Axis.** Selects whether to represent the vertical axis (amplitude) with relative or absolute values.

- **Relative.** The vertical axis represents relative power to the reference power selected in the Power Reference menu item.
- **Absolute.** The vertical axis represents absolute power of each channel.

**Power Reference...** Selects the power reference when Y Axis is set to Relative.

- **Total Power.** Selects the total power of all channels as the reference.
- **DPCCH Power.** Selects the DPCCH power as the reference.

**Number of Graphs.** Selects the number of graphs in the main view (1 or 2). The number of graphs and display format depend on the settings of View Format and IQ Branch as shown in the table below. For View Format and IQ Branch, refer to pages 2-43 and 2-44.

View Format	I/Q Branch	Number of Graphs	Display format
Channel	-	1 (fixed)	Channel display
I/Q Split	I	1	I branch display
		2	I and Q branches display
	Q	1	Q branch display
		2	I and Q branches display
	I/Q	2 (fixed)	I and Q branches display

## Power Codogram

When you select Power Codogram in the Measure menu, the code domain power is displayed in spectrogram, as shown in Figure 2-23.

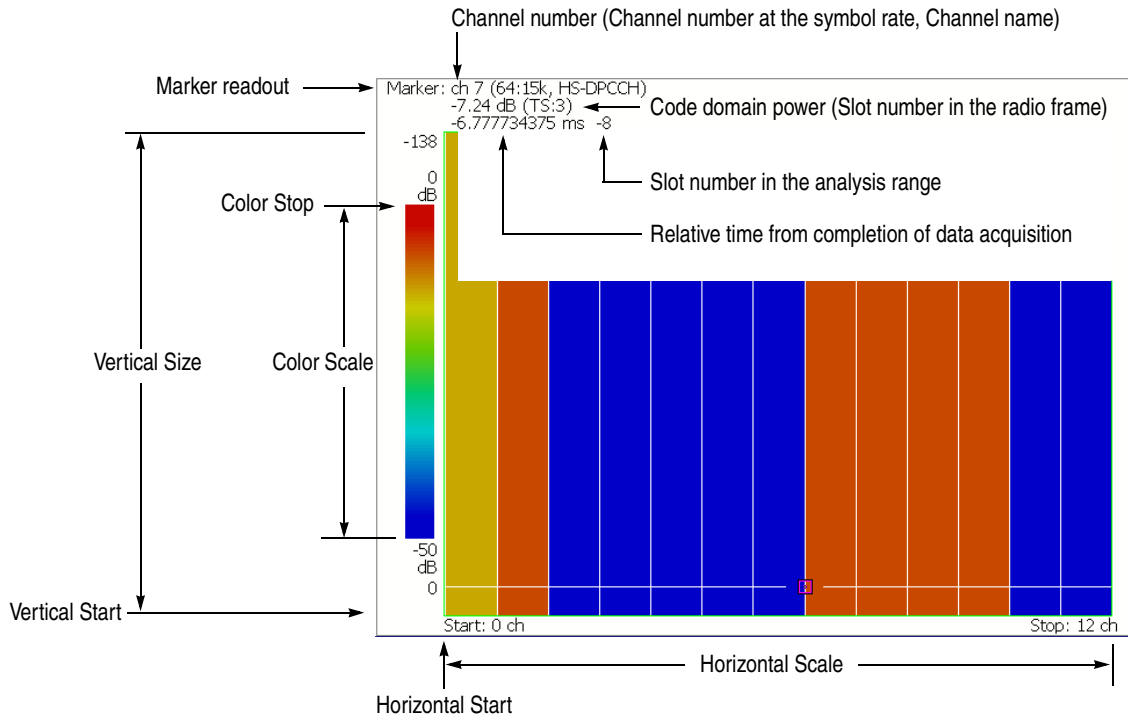

**Figure 2-23: Power codogram**

### View: Scale Menu

Use the following controls to scale the view:

**Auto Scale.** Sets the start value and the scale of the vertical axis automatically to fit the waveform to the screen.

**Horizontal Scale.** Sets the scale of the horizontal axis.

Range: 1.625 to 13 channels (View Format: Channel)

16 to 256 channels (View Format: I/Q Split)

Refer to page 2-44 for View Format.

**Horizontal Start.** Sets the start channel number of the horizontal axis.

Range: 0 to [(initial value of Horizontal Scale) – (set value of Horizontal Scale)].

**Vertical Size.** Sets the full scale of the vertical axis in frames.

Range: 58 to 59392.

**Vertical Start.** Sets the start frame number of the vertical axis.

**Color Scale.** Sets the range of the color axis:

- 5 dB
- 10 dB
- 20 dB
- 50 dB

The spectrogram is displayed in 100 steps (100 colors) from the minimum value (blue) to the maximum value (red) in the default state.

**Color Stop.** Sets the maximum value (top edge) of the color axis.  
Range: –50 to 50 dB.

**Full Scale.** Sets Color Stop to 0 (zero) and Color Scale to 50 dB.

**Y Axis.** Selects whether to represent the Y (color) axis with relative or absolute values.

- **Relative.** The Y axis represents relative power to the reference power selected in the Power Reference menu item.
- **Absolute.** The Y axis represents absolute power of each channel.

**Power Reference...** Selects the power reference when Y Axis is set to Relative.

- **Total Power.** Selects the total power of all channels as the reference.
- **DPCCH Power.** Selects the DPCCH power as the reference.

**Number of Graphs.** Selects the number of graphs in the main view (1 or 2). The number of graphs and display format depend on the settings of View Format and IQ Branch as shown in the following table. For View Format and IQ Branch, refer to pages 2-43 and 2-44.

View Format	I/Q Branch	Number of Graphs	Display format
Channel	-	1 (fixed)	Channel display
I/Q Split	I	1	I branch display
		2	I and Q branches display
	Q	1	Q branch display
		2	I and Q branches display
	I/Q	2 (fixed)	I and Q branches display

## Code Power versus Time Slot

When you select Code Power versus Time Slot in the Measure menu, the code domain power is displayed for each slot, as shown in Figure 2-24.

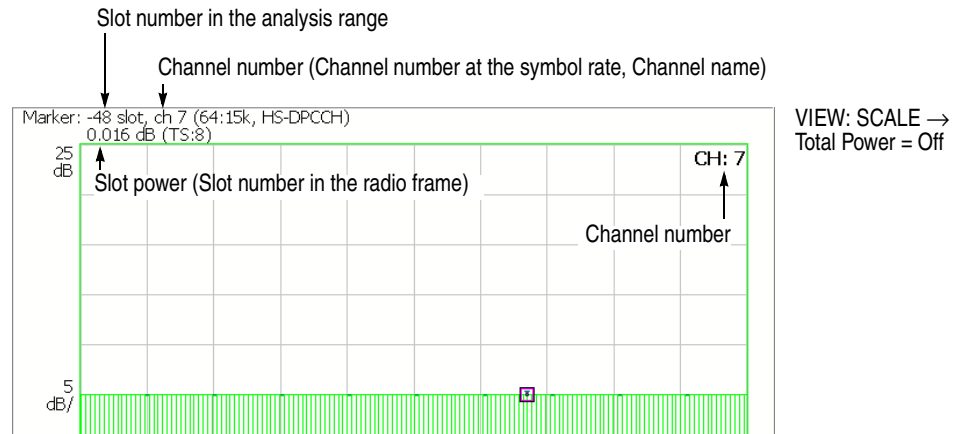
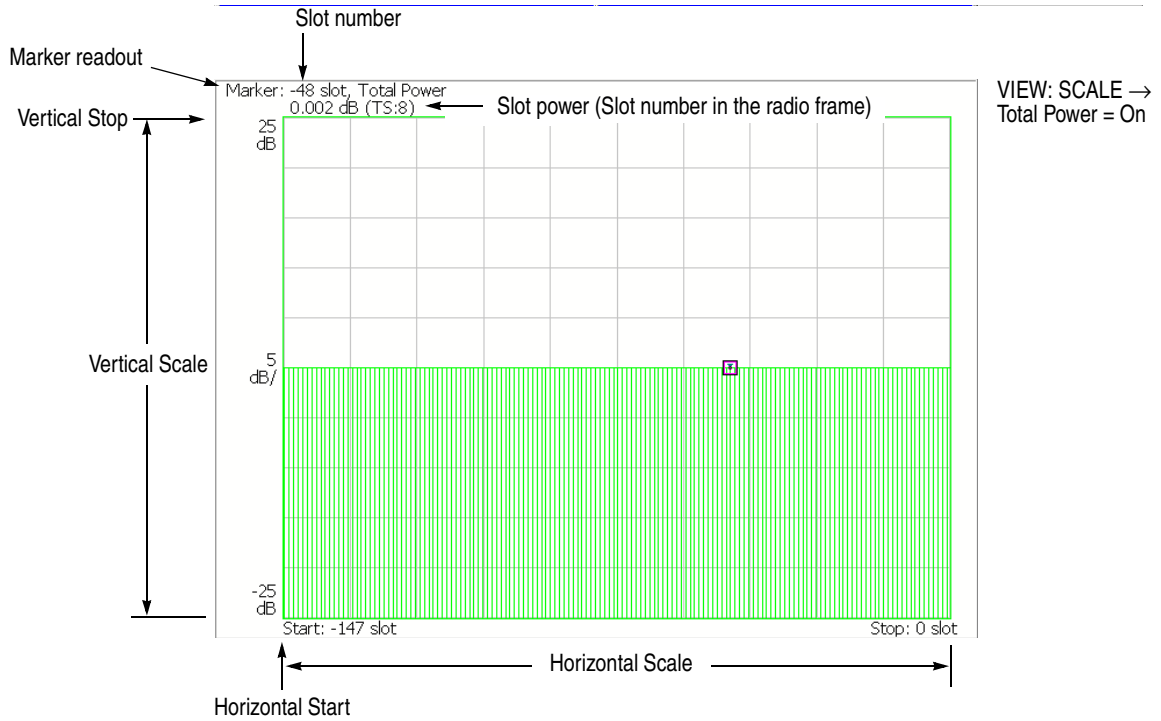

Figure 2-24: Code power versus Time slot

**View: Scale Menu**

Use the following controls to scale the view:

**Auto Scale.** Sets the start value and the scale of the vertical axis automatically to fit the waveform to the screen.

**Horizontal Scale.** Sets the scale of the horizontal axis (number of slots).  
Range:  $N/8$  to  $N$  slots ( $N$ : the number of slots in the analysis range.)

**Horizontal Start.** Sets the start slot number of the horizontal axis.  
Range:  $-(N - 1)$  to  $[1 - (\text{Horizontal Scale})]$ .

**Vertical Scale.** Sets the scale of the vertical axis.  
Range:  $50 \mu$  to  $50$  dB.

**Vertical Stop.** Sets the maximum value (top edge) of the vertical axis.  
Range:  $-25$  to  $[(\text{Vertical Scale}) + 25]$  dB.

**Full Scale.** Sets the scale of the vertical axis to the default full scale value.

**Y Axis.** Selects whether to represent the vertical (amplitude) axis with relative or absolute values.

- **Relative.** The vertical axis represents time slot power relative to the power of the first time slot in the analysis range.
- **Absolute.** The vertical axis represents absolute power of time slots.

**Total Power.** Determines whether to display the total power for each time slot.

- **On. Default.** Displays the total power of all channels for each time slot.
- **Off.** Displays power of the channel specified with Channel Number in the View: Define menu (refer to page 2-42).

## Code Power versus Symbol

When you select Code Power versus Symbol in the Measure menu, the code domain power is displayed for each symbol, as shown in Figure 2-25.

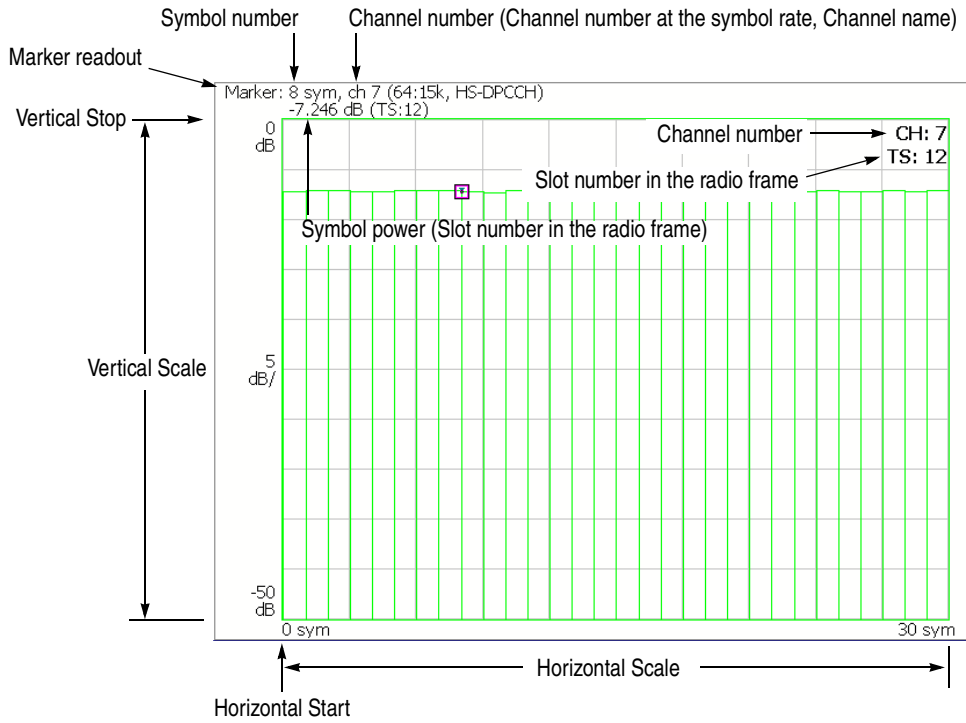

Figure 2-25: Code domain power versus Symbol

**View: Scale Menu**

Use the following controls to scale the view:

**Auto Scale.** Sets the start value and the scale of the vertical axis automatically to fit the waveform to the screen.

**Horizontal Scale.** Sets the scale of the horizontal axis (number of symbols).  
Range: 0 to 1280 symbols.

**Horizontal Start.** Sets the start symbol number of the horizontal axis.  
Range: 0 to [(initial value of Horizontal Scale) – (set value of Horizontal Scale)].

**Vertical Scale.** Sets the scale of the vertical axis.  
Range: 50  $\mu$  to 50 dB.

**Vertical Stop.** Sets the maximum value (top edge) of the vertical axis.  
Range: –50 to Vertical Scale [dB].

**Full Scale.** Sets the scale of the vertical axis to the default full-scale value.

**Y Axis.** Selects whether to represent the vertical (amplitude) axis with relative or absolute values.

- **Relative.** The vertical axis represents relative power to the reference power selected in the Power Reference menu item.
- **Absolute.** The vertical axis represents absolute power of each channel.

**Power Reference...** Selects the power reference when Y Axis is set to Relative.

- **Total Power.** Selects the total power of all channels as the reference.
- **DPCCH Power.** Selects the DPCCH power as the reference.

## Symbol Constellation

The symbol constellation is displayed when you select Symbol Constellation in the Measure menu, as shown in Figure 2-26.

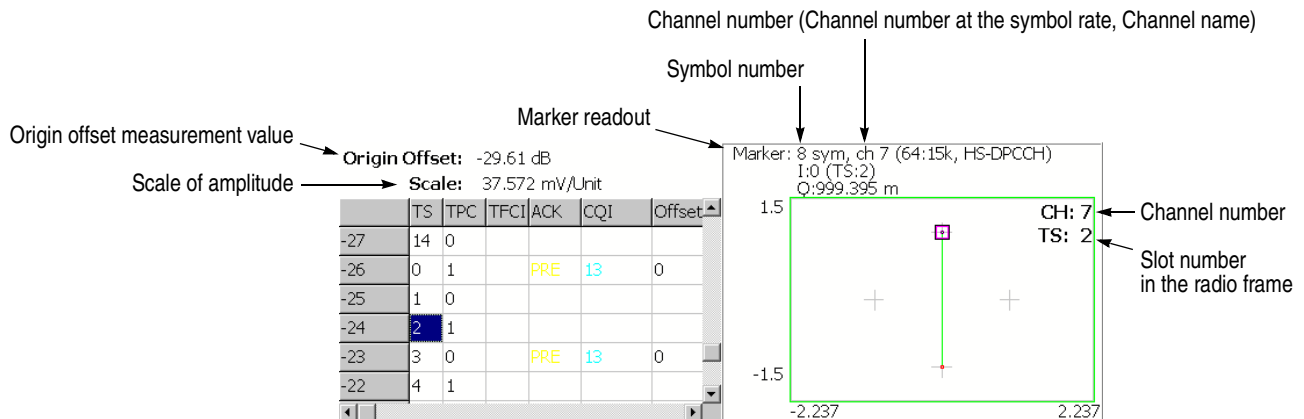

Figure 2-26: Symbol constellation

### View: Scale Menu

Use the following controls to set the scale:

**Measurement Content...** Selects vector or constellation display.

- **Vector.** Selects vector display. A signal represented by phase and amplitude is displayed in polar coordinate or IQ diagram. The red point indicates the symbol position of the measured signal, and the yellow trace indicates the locus of the signal between symbols.
- **Constellation.** Selects constellation display. It is the same as the vector display, except that only symbols of the measured signal are indicated in red, and the locus between symbols is not shown. The cross marks indicate the symbol positions of an ideal signal.

**IQ Composite.** Selects whether or not to display IQ composite. This setting is effective when you select **VIEW: DEFINE** → **View Format** → **Channel**. Specify the channel using **Channel Number**. (Refer to page 2-43 and 2-44.)

- **On.** Displays IQ composite of the specified channel and other channel(s) transmitted simultaneously.
- **Off. Default.** Displays the I or Q component only for the specified channel.

You can select degree or radian for the angular unit by pressing **SYSTEM** → **Instrument Setup...** → **Angular Units...**



## Symbol EVM

When you select Symbol EVM in the Measure menu, EVM (Error Vector Magnitude) is displayed for each symbol, as shown in Figure 2-27.

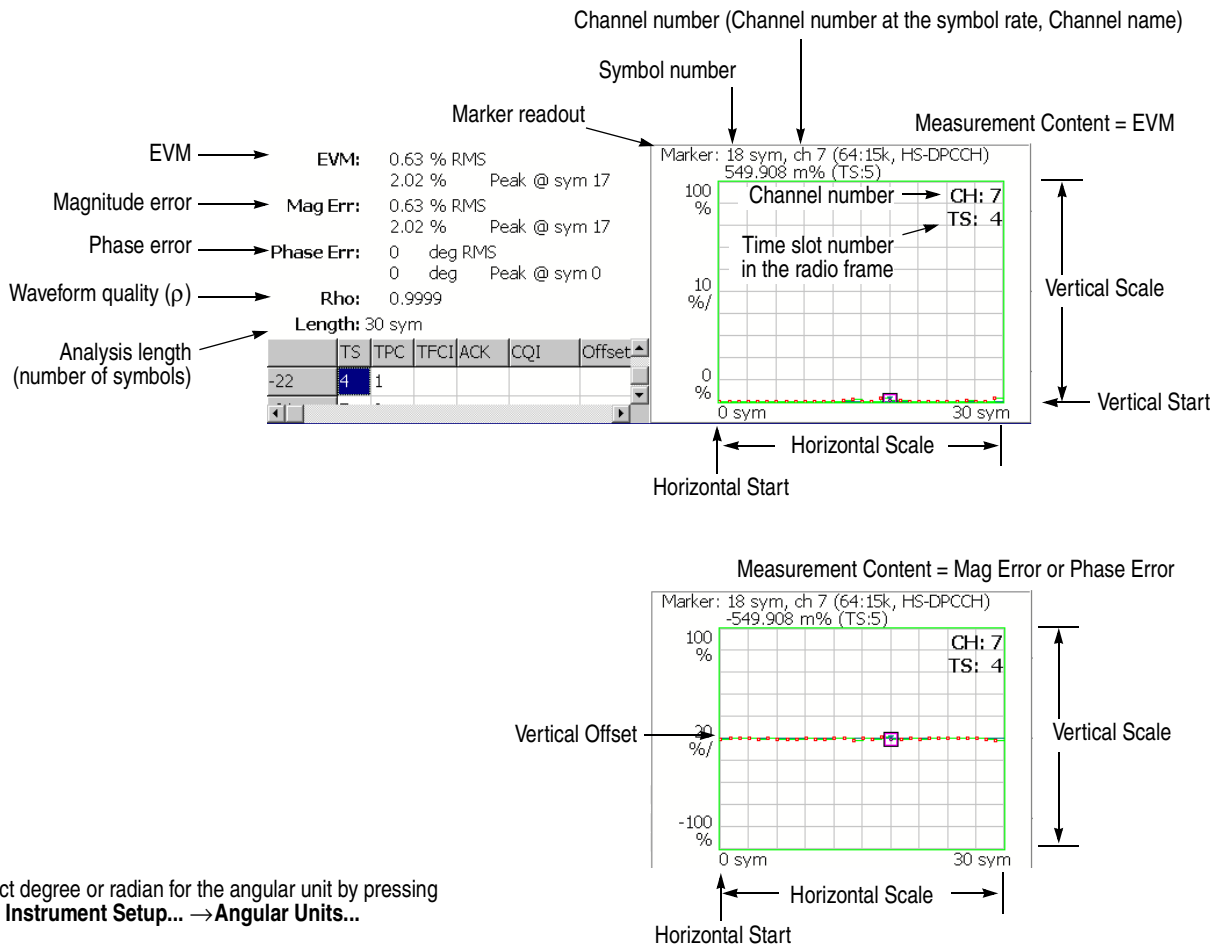

You can select degree or radian for the angular unit by pressing **SYSTEM** → **Instrument Setup...** → **Angular Units...**

**Figure 2-27: Symbol EVM**

**NOTE.** For the symbol EVM, the measurement results of EVM, magnitude and phase error are calculated and displayed with EVM IQ Origin Offset (refer to page 2-36) set to Include even if you set it to Exclude.

When the Measurement Content (refer to page 2-56) is Phase Error, the measurement results are not displayed if you set as follows:

- View Format to IQ Split and I/Q Branch to I or Q
- View Format to Channel and I/Q Composite to Off

For View Format and IQ Split, refer to pages 2-43 and 2-44.

For I/Q Composite, refer to page 2-56.

**View: Scale Menu**

Use the following controls to scale the view:

**Auto Scale.** Sets the start value and the scale of the vertical axis automatically to display the entire waveform.

**Horizontal Scale.** Sets the scale of the horizontal axis (number of symbols).  
Range: 0 to 1280 symbols.

**Horizontal Start.** Sets the start symbol number of the horizontal axis.  
Range: 0 to [(initial value of Horizontal Scale) – (set value of Horizontal Scale)].

**Vertical Scale.** Sets the scale of the vertical axis.

**Vertical Start.** Sets the minimum value (bottom edge) of the vertical axis when the measurement content is EVM. Refer to Table 2-6 for the setting range.

**Vertical Offset.** Sets the center value ((maximum + minimum) / 2) of the vertical axis when the measurement content is Mag Error or Phase Error. Refer to Table 2-6 for the setting range.

**Full Scale.** Sets the scale of vertical axis to the default full-scale value.

**Measurement Content...** Selects the parameter for the vertical axis.  
(Refer to Table 2-6.)

- **EVM.** Represents the vertical axis with EVM (Error Vector Magnitude).
- **Mag Error.** Represents the vertical axis with magnitude error.
- **Phase Error.** Represents the vertical axis with phase error.

**Table 2-6: Vertical scale setting range, Symbol EVM**

Measurement Content...	Vertical Scale	Vertical Start	Vertical Offset
EVM	100μ to 100%	-100 to 100%	-
Mag Error	200μ to 200%	-	-200 to 200%
Phase Error	450μ to 450°	-	-450 to 450°

**IQ Composite.** Selects whether or not to display IQ composite. This setting is effective when you select **VIEW: DEFINE** → **View Format** → **Channel**. Specify the channel using **Channel Number**. (Refer to page 2-43 and 2-44.)

- **On.** Displays IQ composite of the specified channel and other channel(s) transmitted simultaneously.
- **Off. Default.** Displays the I or Q component only for the specified channel.

## Symbol Eye Diagram

The symbol eye diagram is displayed when you select Symbol Eye Diagram in the Measure menu, as shown in Figure 2-28.

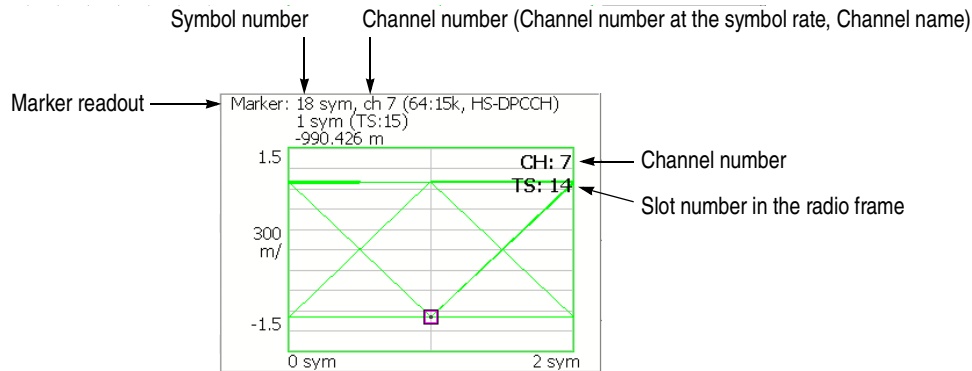

**Figure 2-28: Symbol eye diagram**

**View: Scale Menu** Use the following controls to scale the view.

**Measurement Content...** Selects the vertical axis of eye diagram.

**NOTE.** The measurement content is automatically selected in the uplink analysis.

- **I.** Displays I data on the vertical axis.
- **Q.** Displays Q data on the vertical axis.
- **Trellis.** Displays phase on the vertical axis.

The Measurement Content depends on the settings of View Format and I/Q Branch as shown in the table below. For View Format and IQ Branch, refer to pages 2-43 and 2-44

View Format	I/Q Branch	Measurement Content
Channel	-	Determined automatically for each channel.
I/Q Split	I	I (fixed)
	Q	Q (fixed)
	I/Q	Trellis (fixed)

**Eye Length.** Enters the number of display symbols on the horizontal axis.  
Range: 1 to 16 (default: 2)

## Symbol Table

The symbol table is displayed when you select Symbol Table in the Measure menu, as shown in Figure 2-29.

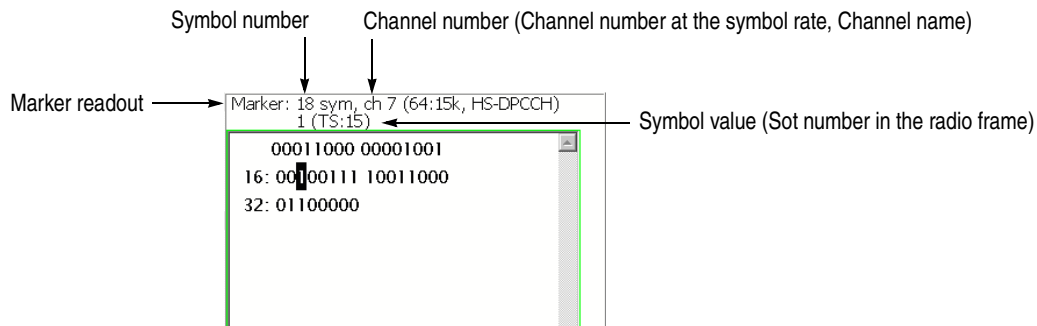

**Figure 2-29: Symbol table**

When the TS index is changed to a time slot that does not contain the beginning of an HS-DPCCH subframe, the symbol table text is all white. When an ACK or NACK time slot is selected, the symbol table text color changes to show the position of the ACK/NACK symbols (yellow) and the CQI symbols (blue).

**NOTE.** For the uplink symbol table, the measurement results are not displayed when you set View Format to IQ Split and I/Q Branch to I/Q. (For View Format and IQ Split, refer to pages 2-43 and 2-44.)

### View: Scale Menu

Use the following controls to scale the view:

**Radix.** Selects the radix for displaying the table:

- **Hex (packed).** Displays data in the hexadecimal form every 4 bits.
- **Hex.** Displays data in the hexadecimal form every modulation symbol.
- **Oct.** Displays data in the octal form every modulation symbol.
- **Bin.** *Default.* Displays data in the binary form.

Hex and Oct indicate values of binary data string in units of modulation symbol. When a signal contains one or two-bit data in a symbol, you can select Hex (packed) to represent multiple symbols as a hexadecimal digit every 4 bits. For example, the BPSK modulation signal contains one-bit data in a symbol, so the symbol table has the same values for Hex, Oct, and Bin. But Hex (packed) represents every 4 symbols as a hexadecimal digit.

**Rotate.** Sets the start position. Range: 0 to 3.

## Modulation Accuracy

When you select Modulation Accuracy in the Measure menu, the constellation of all channels before the de-spread is displayed with the measurement results of PCDE (Peak Code Domain Error), EVM, frequency error and others.

When you press the VIEW: **SELECT** key on the front panel to select the constellation view, the measurement results for the time slot are displayed instead of the overview, as shown in Figure 2-30.

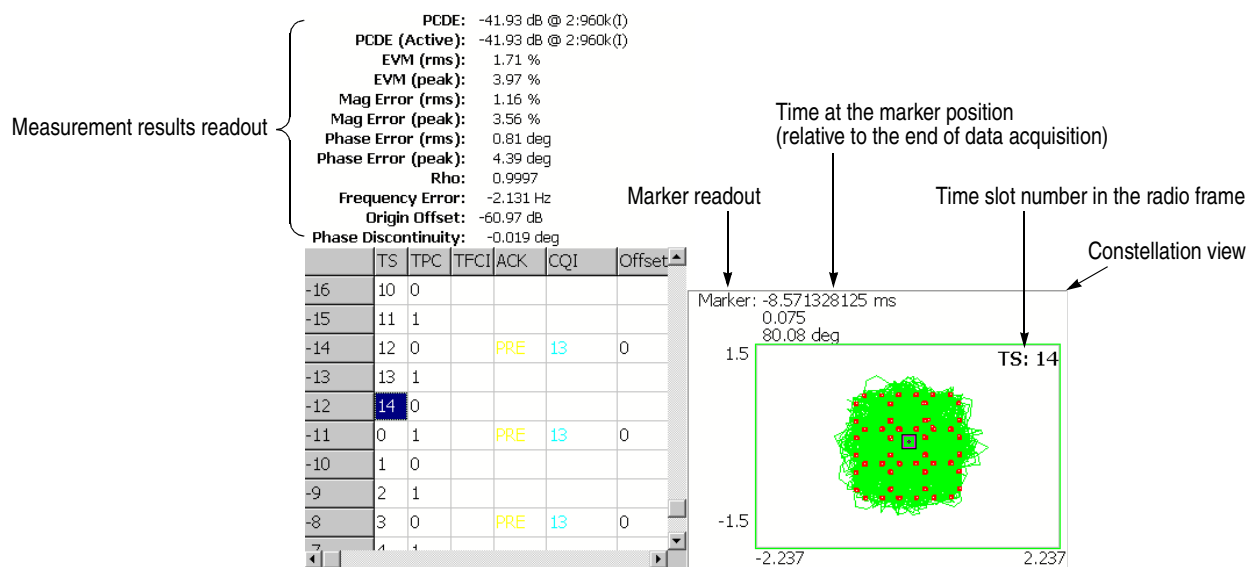

**Figure 2-30: Modulation accuracy**

The following table shows the measurement results readout.

Measurement results	Description
PCDE	PCDE [dB] @ channel: symbol rate (I/Q)
PCDE (Active)	PCDE [dB] for active channels only @ channel: symbol rate (I/Q)
EVM (rms)	RMS value of EVM [%]
(Peak)	Peak value of EVM [%]
Mag Error (rms)	RMS value of magnitude error [%]
(Peak)	Peak value of magnitude error [%]
Phase Error (rms)	RMS value of phase error [degrees or radians]
(Peak)	Peak value of phase error [degrees or radians]
Rho	Waveform quality ( $\rho$ )
Frequency Error	Frequency error [Hz]
Origin Offset	Origin offset (IQ feedthrough) [dB]
Phase Discontinuity	Phase difference between the beginning of the currently selected time slot and the end of the previous time slot.

**View: Scale Menu** Use the following controls to set the scale:

**Measurement Content...** Selects vector or constellation display.

- **Vector.** Selects vector display. A signal represented with phase and amplitude is displayed in polar coordinate or IQ diagram. The red point indicates the symbol position of measured signal, and the yellow trace indicates the locus of the signal between symbols.
- **Constellation.** Selects constellation display. It is the same as the vector display, except that only symbols of measured signal are indicated in red, and the locus between symbols is not shown. The cross marks indicate the symbol positions of an ideal signal.

You can select degree or radian for the angular unit by pressing **SYSTEM**  
→ **Instrument Setup...** → **Angular Units...**

## Modulation Accuracy versus Time Slot

The Modulation accuracy versus Time slot measurement displays EVM, magnitude error, phase error, PCDE (Peak Code Domain Error), or Frequency error for each time slot in the main view. Figure 2-31 shows an example of EVM (rms).

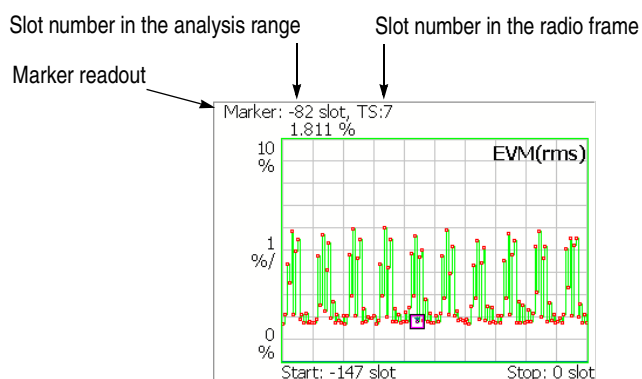

**Figure 2-31: Modulation accuracy versus Time slot, EVM (rms)**

**View: Scale Menu** Use the following controls to scale the view.

**Auto Scale.** Sets the start value and the scale of the vertical axis automatically to fit the waveform to the screen.

**Horizontal Scale.** Sets the range of the horizontal axis (number of time slots). Range: 18.5 to 148 slots.

**Horizontal Start.** Sets the start symbol number of the horizontal axis. Range: -147 to  $[1 - (\text{Horizontal Scale})]$ .

**Vertical Scale.** Sets the scale of the vertical axis. Refer to Table 2-7 for the setting range.

**Vertical Start.** Sets the minimum value (bottom edge) of the vertical axis when the measurement content is EVM. Refer to Table 2-7 for the setting range.

**Vertical Stop.** Sets the maximum value (top edge) of the vertical axis when the measurement content is PCDE. Refer to Table 2-7 for the setting range.

**Vertical Offset.** Sets the center value  $((\text{maximum} + \text{minimum}) / 2)$  of the vertical axis when the measurement content is Mag Error or Phase Error. Refer to Table 2-7 for the setting range.

**Full Scale.** Sets the scale of vertical axis to the default full-scale value.

**Measurement Content...** Selects the measurement content (refer to Table 2-7).

**Table 2-7: Vertical scale setting range, Modulation accuracy versus Time slot**

Measurement Content...	Vertical Scale	Vertical Start	Vertical Stop	Vertical Offset
EVM (rms)	100 $\mu$ to 100%	-100 to 100%	-	-
EVM (peak)	100 $\mu$ to 100%	-100 to 100%	-	-
Mag Error (rms)	200 $\mu$ to 200%	-	-	-200 to 200%
Mag Error (peak)	200 $\mu$ to 200%	-	-	-200 to 200%
Phase Error (rms)	450 $\mu$ to 450°	-	-	-450 to 450°
Phase Error (peak)	450 $\mu$ to 450°	-	-	-450 to 450°
PCDE (Peak Code Domain Error)	100 $\mu$ to 100 dB	-	-100 to 100 dB	-
Frequency Error	10 m to 10 kHz	-	-	-10 k to 10 kHz

You can select degree or radian for the angular unit by pressing **SYSTEM**  
→ **Instrument Setup...** → **Angular Units...**



## Gain Ratio

The Gain Ratio measurement displays the gain ratio (the ratio of channel power to total power) for each channel along with time slots as shown in Figure 2-32. The measurement results are color-coded for each channel. The height of a color band at a given slot number represents the gain ratio of the corresponding channel at that slot. On the left side of the main view, the color assignment and the  $\beta$  value (relative channel power to DPCCH or DPDCH power whichever are greater as the reference value (1)) are indicated for each channel.

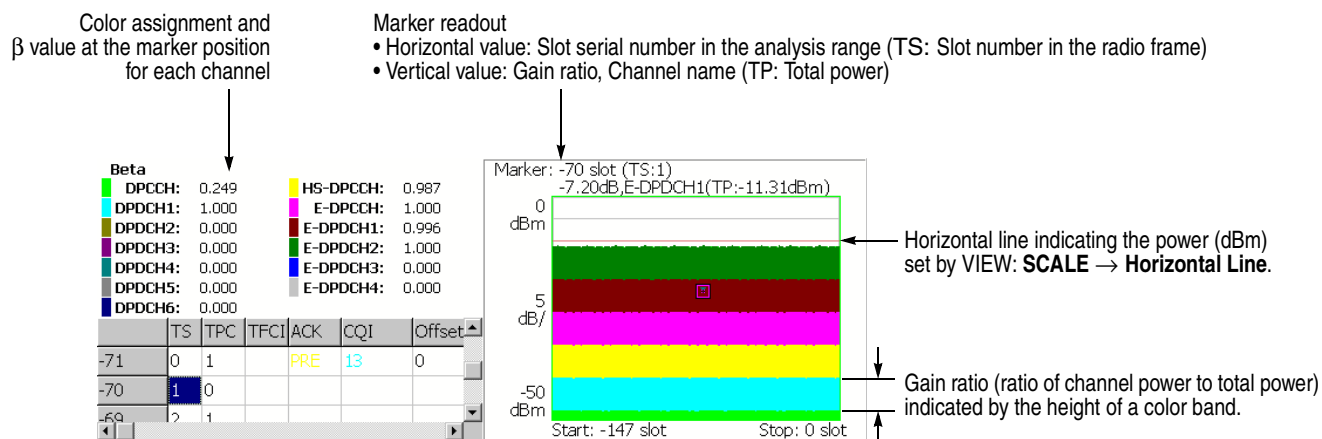

Figure 2-32: Gain ratio

**View: Scale Menu** Use the following controls to scale the view.

**Auto Scale.** Sets the start value and the scale of the vertical axis automatically to fit the waveform to the screen.

**Horizontal Scale.** Sets the scale of the horizontal axis (number of slots). Range:  $N/8$  to  $N$  slots ( $N$ : the number of slots in the analysis range.)

**Horizontal Start.** Sets the start slot number of the horizontal axis. Range:  $-(N - 1)$  to  $[1 - (\text{Horizontal Scale})]$ .

**Vertical Scale.** Sets the scale of the vertical axis. Range:  $50 \mu$  to 50 dB.

**Vertical Stop.** Sets the maximum value (top edge) of the vertical axis. Range:  $-52$  to  $[(\text{Vertical Scale}) - 2]$  dBm.

**Full Scale.** Sets the scale of vertical axis to the default full-scale value.

**Horizontal Line.** Sets the horizontal line position. Range:  $-100$  to 30 dBm.





# Appendices



# Appendix A: Scale Setting Range

This section lists the setting ranges of the horizontal and the vertical scales for the views used in the 3GPP-R6 analysis.

**Table A-1: Display format and scale**

Display format	Horizontal range	Vertical range
Spectrum	0 Hz to 36 MHz	-200 to +100 dBm
Spectrogram	0 Hz to 36 MHz	Frame -15999 to 0 Frame -63999 to 0 (Option 02)
Time domain view	$-(T_f \times N_f)$ to 0 s <sup>1</sup>	-200 to +100 dBm (Amplitude) -30 to +30 V (I/Q level) -300 to +300% (AM) -38.4 to +38.4 MHz (FM/FVT) -675 to +675 deg. (PM)
CDP <sup>2</sup>	0 to 511 channels (downlink) 0 to 255 channels (uplink)	-200 to +100 dB/dBm
CDP spectrogram <sup>2</sup>	0 to 511 channels (downlink) 0 to 255 channels (uplink)	Slot -3999 to 0 Slot -15999 to 0 (Option 02)
CDP vs. Symbol <sup>2</sup>	0 to 639 symbols (downlink) 0 to 1279 symbols (uplink)	-200 to +100 dB/dBm
CDP vs. Time slot <sup>2</sup>	Slot -3999 to 0 Slot -15999 to 0 (Option 02)	-200 to +100 dB/dBm
Symbol constellation <sup>3</sup>	Fixed	Fixed
Symbol EVM	0 to 639 symbols (downlink) 0 to 1279 symbols (uplink)	-100 to +200% (EVM) -300 to +300% (amplitude error) -675 to +675 deg. (phase error)
Symbol eye diagram	0 to 639 symbols (downlink) 0 to 1279 symbols (uplink)	Fixed
Symbol table	0 to $(1024 \times N_f)$ symbols	NA

1. **T<sub>f</sub>**: Frame time; **N<sub>f</sub>**: Frame number

2. **CDP**: Code Domain Power

3. **The maximum number of symbols: 640 (downlink) / 1280 (uplink)**



## Appendix B: Saving Measurement Results

You can save measurement results to files in the CSV (Comma Separated Values) format using the **SAVE** key on the front panel, allowing you to import the file into Microsoft Excel or other database systems. This section provides information about file save specific to Option 40 3GPP-R6 analysis. For details on standard file operations, refer to the *RSA3408A User Manual*.

---

**NOTE.** *If the hard disk space is less than 10 MB, the software stops saving the measurement results.*

---

### Save Menu

The Save menu for the 3GPP-R6 analysis has the following controls:

**Save State.** Saves the instrument settings.

**Save Data...** Saves the input waveform (IQ data in the time domain) to a file in the IQT format.

- **All Blocks.** Saves all the acquired blocks.
- **Current Block.** Saves the block currently displayed in the overview.
- **Current Area.** Saves the data in the analysis range.

**Item...** Select the measurement item to save.

- Code Domain Power
- Symbol Power
- Symbol EVM
- Symbol Table
- Modulation Accuracy

The saved file format is listed in the next section.

**Time Slot Offset.** Sets the start time-slot to save. (See Figure B-1.)  
Range:  $-\text{[(the number of time slots in the analysis range) - 1]}$  to 0.  
Zero (0) represents the latest slot.

**Number of Time Slots.** Sets the number of time slots to save. (See Figure B-1.)  
Range: 1 to  $-\text{[(Time Slot Offset) + 1]}$  (up to 4000 time slots).

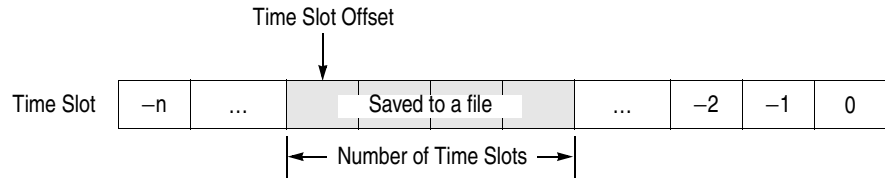

Figure B-1: Setting the time slots to save

**Measurement Content...** *Symbol EVM only.* Selects the measurement content.

- **EVM.** Selects EVM.
- **Mag Error.** Selects the magnitude error.
- **Phase Error.** Selects the phase error.
- **All.** Selects all of the above.

**Filename...** Specify a file name to save the results. For details on file operations, refer to the *RSA3408A User Manual*.

## Saved File Format

The file lists descriptions or measurement values under each header as shown in Figure B-2. The saved file format depends on measurements. The following subsections provide the format for each measurement.

	A	B	C	D	E	F	G
1	#Measurement	Code Domain Power					
2	#DateTime	#####					
3	#Timeslot Index	Timeslot No.	Total Power[dBm]	PSCH Power[dBm]	SSCH Power[dBm]	Code Power[dBm]	
4	-14	6	-11.5133	-44.7227	-26.7004	-27.5313	-27.523
5						0@SF256	1@SF256
6						-72.0156	-75.835
7						142@SF512	143@SF51:
8						-81.1641	-71.335
9						270@SF512	271@SF51:
10						-74.5391	-77.359
11						401@SF512	402@SF51:
12	-13	7	-11.5197	-31.5173	-32.9625	-27.5234	-27.546
13						0@SF256	1@SF256
14						-73.8438	-77.898
15						142@SF512	143@SF51:
16						-73.75	-70.578
17						270@SF512	271@SF51:
18						-76.3984	-74.296
19						401@SF512	402@SF51:
20	-12	8	-11.5164	-33.8998	-32.7139	-27.5391	-27.539
21						0@SF256	1@SF256
22						-73.4844	-73.039

Figure B-2: CSV file example (code domain power measurement)



**Downlink** This subsection shows the saved file format for the downlink measurements.

**Code Domain Power.** The saved file format depends on the setting of Symbol Rate in the View Define menu.

■ Symbol Rate: Composite

Header	Content
Measurement	Code domain power
Date Time	Date and time
Timeslot Index	Time slot serial number in the analysis range
Timeslot No.	Time slot number in the radio frame (0 to 14)
Total Power [dBm]	Total power [dBm]
PSCH Power [dBm]	P-SCH power [dBm]
SSCH Power [dBm]	S-SCH power [dBm]
Code Power [dBm]	Code power for each channel at the detected spreading factor, and Channelization code at the detected spreading factor @ spreading factor

■ Symbol Rate: Other than Composite

Header	Content
Measurement	Code domain power
Date Time	Date and time
Timeslot Index	Time slot serial number in the analysis range
Timeslot No.	Time slot number in the radio frame (0 to 14)
Total Power [dBm]	Total power [dBm]
PSCH Power [dBm]	P-SCH power [dBm]
SSCH Power [dBm]	S-SCH power [dBm]
Code Power [dBm]	Code power for each channel at the specified spreading factor

**Code domain power versus Symbol.**

<b>Header</b>	<b>Content</b>
Measurement	CDP vs Symbol
Date Time	Date and time of the waveform acquisition
Channelization Code No. @SF256	Channelization code at the spreading factor of 256
Timeslot Index	Time slot serial number in the analysis range
Timeslot No.	Time slot number in the radio frame (0 to 14)
Channelization Code No.	Channelization code at the detected or specified spreading factor @ spreading factor
Total Power [dBm]	Total power [dBm]
Symbol Power [dBm]	Power for each symbol [dBm]

**Symbol EVM.** The saved file format depends on the setting of Measurement Content in the Save menu.

Measurement Content: Other than All

Header	Content
Measurement	Symbol EVM
Date Time	Date and time of the waveform acquisition
Channelization Code No. @SF256	Channelization code at the spreading factor of 256
Timeslot Index	Time slot serial number in the analysis range
Timeslot No.	Time slot number in the radio frame (0 to 14)
Channelization Code No.	Channelization code at the detected or specified spreading factor @ spreading factor
Symbol EVM [%] or Symbol Mag Error [%] or Symbol Phase Error [deg]	Symbol EVM [%], mag error [%], or phase error [degrees] <sup>1</sup> depending on the selection in Measurement Content.

<sup>1</sup> You can select the unit of phase by pressing **SYSTEM** → **Instrument Setup** → **Angular Units**.

Measurement Content: All

Header	Content
Measurement	Symbol EVM
Date Time	Date and time of the waveform acquisition
Channelization Code No. @SF256	Channelization code at the spreading factor of 256
Timeslot Index	Time slot serial number in the analysis range
Timeslot No.	Time slot number in the radio frame (0 to 14)
Channelization Code No.	Channelization code at the detected or specified spreading factor @ spreading factor
Symbol EVM [%]	Symbol EVM [%]
Symbol Mag Error [%]	Mag error [%]
Symbol Phase Error [deg]	Phase error [degrees] <sup>1</sup>

<sup>1</sup> You can select the unit of phase by pressing **SYSTEM** → **Instrument Setup** → **Angular Units**.

**Symbol Table.**

Header	Content
Measurement	Symbol EVM
Date Time	Date and time of the waveform acquisition
Channelization Code No. @SF256	Channelization code at the spreading factor of 256
Timeslot Index	Time slot serial number in the analysis range
Timeslot No.	Time slot number in the radio frame (0 to 14)
Channelization Code No.	Channelization code at the detected or specified spreading factor @ spreading factor
Modulation Type	QPSK or 16QAM
Symbol Value	Symbol value: 0 to 3 (QPSK) / 0 to 15 (16QAM). No rotation.

**Modulation Accuracy.**

Header	Content
Measurement	Modulation Accuracy
Date Time	Date and time of the waveform acquisition
Timeslot Index	Time slot serial number in the analysis range
Timeslot No.	Time slot number in the radio frame (0 to 14)
EVM (rms) [%]	RMS EVM [%]
EVM (peak) [%]	Peak EVM [%]
Mag Error (rms) [%]	RMS magnitude error [%]
Mag Error (peak) [%]	Peak magnitude error [%]
Phase Error (rms) [deg]	RMS phase error [deg] <sup>1</sup>
Phase Error (peak) [deg]	Peak phase error [deg] <sup>1</sup>
PCDE [dB]	PCDE (Peak Code Domain Error) [dB]
PCDE (Active) [dB]	PCDE for active channels only [dB]
Rho	Waveform quality
Frequency Error [Hz]	Frequency error [Hz]
Origin Offset [dB]	Origin offset [dB]
SSCH, SCG, SCN, AGS, AGV, RG, ACK	Time slot table for the items selected by VIEW: DEFINE → Column Items to Display

<sup>1</sup> You can select the unit of phase by pressing SYSTEM → Instrument Setup → Angular Units.

**Uplink** This subsection shows the saved file format for the uplink measurements.

**Code Domain Power.** The saved file format depends on the settings of View Format and Symbol Rate in the View Define menu.

■ View Format: Channel

Header	Content
Measurement	Code domain power
Date Time	Date and time of the waveform acquisition
Spreading Factor	Composite, or 2 to 256
Timeslot Index	Time slot serial number in the analysis range
Timeslot No.	Time slot number in the radio frame (0 to 14)
Total Power [dBm]	Total power [dBm]
Total Power (Offset) [dBm]	Offset total power for HS-DPCCH [dBm]
DPCCH Power (Offset) [dBm]	Offset DPCCH power for HS-DPCCH [dBm]
Code Power [dBm]	Code power for each channel (0 to 12) [dBm]

■ View Format: I/Q Split, Symbol Rate: Composite

Header	Content
Measurement	Code domain power
Date Time	Date and time of the waveform acquisition
Spreading Factor	Composite, or 2 to 256
Timeslot Index	Time slot serial number in the analysis range
Timeslot No.	Time slot number in the radio frame (0 to 14)
Total Power [dBm]	Total power [dBm]
Total Power (Offset) [dBm]	Offset total power for HS-DPCCH [dBm]
DPCCH Power (Offset) [dBm]	Offset DPCCH power for HS-DPCCH [dBm]
Code Power [dBm]	Code power for each channel at the detected spreading factor [dBm] Channelization code at the detected spreading factor @ spreading factor

■ Symbol Rate: Other than Composite

Header	Content
Measurement	Code domain power
Date Time	Date and time of the waveform acquisition
Spreading Factor	Composite, or 2 to 256
Timeslot Index	Time slot serial number in the analysis range
Timeslot No.	Time slot number in the radio frame (0 to 14)
Total Power [dBm]	Total power [dBm]
Total Power (Offset) [dBm]	Offset total power for HS-DPCCH [dBm]
DPCCH Power (Offset) [dBm]	Offset DPCCH power for HS-DPCCH [dBm]
Code Power [dBm]	
I	Code power for each channel on the I branch at the specified spreading factor [dBm]
Q	Code power for each channel on the Q branch at the specified spreading factor [dBm]

**Code Domain Power versus Symbol.** The saved file format depends on the settings of View Format in the View Define menu.

■ View Format: Channel

Header	Content
Measurement	CDP vs Symbol
Date Time	Date and time of the waveform acquisition
Channel No.	Channel number
Channel Name	Channel name
Timeslot Index	Time slot serial number in the analysis range
Timeslot No.	Time slot number in the radio frame (0 to 14)
Channelization Code No.	Channelization code at the detected or specified spreading factor @ spreading factor
I/Q Branch	I or Q (determined by channel)
Total Power [dBm]	Total power [dBm]
DPCCH Power [dBm]	DPCCH power [dBm]
Symbol Power [dBm]	Power for each symbol [dBm]

■ View Format: I/Q Split

Header	Content
Measurement	CDP vs Symbol
Date Time	Date and time of the waveform acquisition
Channelization Code No. @SF256	Channelization code at the spreading factor of 256
I/Q Branch	I/Q Branch setting
Timeslot Index	Time slot serial number in the analysis range
Timeslot No.	Time slot number in the radio frame (0 to 14)
Channel Name	Channel name (blank if the channel has no name or I/Q Branch is set to I/Q)
Channelization Code No.	Channelization code at the detected or specified spreading factor @ spreading factor
Total Power [dBm]	Total power [dBm]
DPCCH Power [dBm]	DPCCH power [dBm]
Symbol Power [dBm]	Power for each symbol [dBm]

**Symbol EVM.** The saved file format depends on the settings of View Format in the View Define menu.

■ View Format: Channel

Header	Content
Measurement	Symbol EVM
Date Time	Date and time of the waveform acquisition
Channel No.	Channel number
Channel Name	Channel name
Timeslot Index	Time slot serial number in the analysis range
Timeslot No.	Time slot number in the radio frame (0 to 14)
Channelization Code No.	Channelization code at the detected or specified spreading factor @ spreading factor
I/Q Branch	I or Q (determined by channel)
Symbol EVM [%] or Symbol Mag Error [%] or Symbol Phase Error [deg]	Symbol EVM [%], mag error [%], or phase error [degrees] <sup>1</sup> depending on the selection in the VIEW: SCALE → Measurement Content.

<sup>1</sup> You can select the unit of phase by pressing SYSTEM → Instrument Setup → Angular Units.

■ View Format: I/Q Split

Header	Content
Measurement	Symbol EVM
Date Time	Date and time of the waveform acquisition
Channelization Code No. @SF256	Channelization code at the spreading factor of 256
I/Q Branch	I/Q Branch setting
Timeslot Index	Time slot serial number in the analysis range
Timeslot No.	Time slot number in the radio frame (0 to 14)
Channel Name	Channel name (blank if the channel has no name or I/Q Branch is set to I/Q)
Channelization Code No.	Channelization code at the detected or specified spreading factor @ spreading factor
I/Q Branch	I or Q (determined by channel)
Symbol EVM [%] or Symbol Mag Error [%] or Symbol Phase Error [deg]	Symbol EVM [%], mag error [%], or phase error [degrees] <sup>1</sup> depending on the selection in the VIEW: SCALE → Measurement Content.

<sup>1</sup> You can select the unit of phase by pressing SYSTEM → Instrument Setup → Angular Units.



**Symbol Table.** The saved file format depends on the settings of View Format in the View Define menu.

■ View Format: Channel

Header	Content
Measurement	Symbol EVM
Date Time	Date and time of the waveform acquisition
Channel No.	Channel number
Channel Name	Channel name
Timeslot Index	Time slot serial number in the analysis range
Timeslot No.	Time slot number in the radio frame (0 to 14)
Channelization Code No.	Channelization code at the detected or specified spreading factor @ spreading factor
I/Q Branch	I or Q (determined by channel)
Symbol Value	Symbol value: 0, 1, or X. No rotation.

■ View Format: I/Q Split

Header	Content
Measurement	Symbol EVM
Date Time	Date and time of the waveform acquisition
Channelization Code No. @SF256	Channelization code at the spreading factor of 256
I/Q Branch	I/Q Branch setting
Timeslot Index	Time slot serial number in the analysis range
Timeslot No.	Time slot number in the radio frame (0 to 14)
Channel Name	Channel name (blank if the channel has no name or I/Q Branch is set to I/Q)
Channelization Code No.	Channelization code at the detected or specified spreading factor @ spreading factor
Symbol Value	Symbol value: 0, 1, or X. No rotation.

**Modulation Accuracy.**

<b>Header</b>	<b>Content</b>
Measurement	Modulation Accuracy
Date Time	Date and time of the waveform acquisition
Timeslot Index	Time slot serial number in the analysis range
Timeslot No.	Time slot number in the radio frame (0 to 14)
EVM (rms) [%]	RMS EVM [%]
EVM (peak) [%]	Peak EVM [%]
Mag Error (rms) [%]	RMS magnitude error [%]
Mag Error (peak) [%]	Peak magnitude error [%]
Phase Error (rms) [deg]	RMS phase error [deg] <sup>1</sup>
Phase Error (peak) [deg]	Peak phase error [deg] <sup>1</sup>
PCDE [dB]	PCDE (Peak Code Domain Error) [dB]
PCDE (Active) [dB]	PCDE for active channels only [dB]
Rho	Waveform quality
Frequency Error [Hz]	Frequency error [Hz]
Origin Offset [dB]	Origin offset [dB]
SIG, PRE, TPC, TFCI, ACK, CQI, Offset, RSN, E-TFCI, Happy	Time slot table for the items selected by VIEW: DEFINE → Column Items to Display

<sup>1</sup> You can select the unit of phase by pressing **SYSTEM** → **Instrument Setup** → **Angular Units**.



# **Glossary and Index**



# Glossary

## Acronyms

**3GPP**

3<sup>rd</sup> Generation Partnership Project

**BPSK**

Binary Phase Shift Keying

**CDP**

Code Domain Power

**CPICH**

Common Pilot Channel

**CQI**

Channel Quality Indicator

**DCH**

Dedicated Channel

**DPCCH**

Dedicated Physical Control Channel

**DPDCH**

Dedicated Physical Data Channel

**DL**

Down Link

**DTX**

Discontinuous Transmission

**E-AGCH**

E-DCH Absolute Grant Channel

**E-DCH**

Enhanced Dedicated Channel

**E-DPCCH**

Enhanced Dedicated Physical Control Channel

**E-DPDCH**

Enhanced Dedicated Physical Data Channel

**E-HICH**

E-DCH HARQ ACK Indicator Channel

**E-RGCH**

E-DCH Relative Grant Channel

**E-TFC**

E-DCH Transport Format Combination

**EVM**

Error Vector Magnitude

**HARQ**

Hybrid Automatic Repeat Request

**HSDPA**

High Speed Downlink Packet Access

**HS-DPCCH**

Dedicated Physical Control Channel for HS-DSCH

**HS-DSCH**

High-Speed Downlink Shared Channel

**PCDE**

Peak Code Domain Error

**PRACH**

Physical Random Access Data Channel

**PCPCH**

Physical Common Packet Channel

**P-SCH**

Primary Synchronization Channel

**QAM**

Quadrature Amplitude Modulation

**QPSK**

Quadrature Phase Shift Keying

**RLS**

Radio Link Set

**RSN**

Retransmission Sequence Number

**SCG**

Scrambling Code Group

**SCH**

Synchronization Channel  
(consisting of Primary and Secondary synchronization channels)

**SCN**

Scrambling Code Number

**S-SCH**

Secondary Synchronization Channel

**STTD**

Space Time block coding based Transmit antenna Diversity

**TFC**

Transport Format Combination

**TFCI**

Transport Format Combination Indicator

**TPC**

Transmit Power Control

**TS**

Time Slot

**UL**

Up Link





# Index

## A

Additional functions in Option 40, 1-1

## C

Changing the view  
  downlink analysis, 2-11  
  uplink analysis, 2-42  
Code domain power  
  downlink, 2-14  
  uplink, 2-46  
Code power versus Symbol  
  downlink, 2-20  
  uplink, 2-52  
Code power versus Time slot  
  downlink, 2-18  
  uplink, 2-50  
CQI, 1-4

## D

Definition  
  Downlink analysis, 1-2  
  Uplink analysis, 1-3  
Display method, HS-DPCCH, 2-38  
Downlink analysis, 2-3  
  Meas Setup menu, 2-7  
  measurement procedure, 2-4  
Downlink time offset, 2-37  
DTO, 2-36  
DTX, 1-4

## G

Gain ratio  
  uplink, 2-63

## H

HS-DPCCH, Display method, 2-38

## M

Manual, related, v  
Meas Setup menu  
  downlink analysis, 2-7  
  uplink analysis, 2-34  
Measurement procedure

  downlink analysis, 2-4  
  uplink analysis, 2-32  
Measurement results, save, B-1  
Modulation accuracy  
  downlink, 2-27  
  uplink, 2-59  
Modulation accuracy versus Time slot  
  downlink, 2-28  
  uplink, 2-61

## O

Offset  
  downlink time, 2-37  
  subframe to time slot, 2-36

## P

PDF manual, v  
Power codogram  
  downlink, 2-16  
  uplink, 2-48

## R

Range, scale setting, A-1  
Related manuals, v  
  PDF, v  
Results, save, B-1

## S

Save format, B-2  
Save, measurement results, B-1  
Scale setting range, A-1  
STO, 2-36  
Subframe to TS offset, 2-36  
Symbol constellation  
  downlink, 2-22  
  uplink, 2-54  
Symbol EVM  
  downlink, 2-23  
  uplink, 2-55  
Symbol eye diagram  
  downlink, 2-25  
  uplink, 2-57  
Symbol table  
  downlink, 2-26  
  uplink, 2-58

## U

Uplink analysis, 2-31  
  measurement procedure, 2-32

## V

View  
  downlink analysis, 2-10  
  uplink analysis, 2-41