

TDP3500
3.5 GHz Differential Probe
Technical Reference

Revision A

www.tektronix.com

071-2297-00

Tektronix

Copyright © Tektronix. All rights reserved. Licensed software products are owned by Tektronix or its subsidiaries or suppliers, and are protected by national copyright laws and international treaty provisions.

Tektronix products are covered by U.S. and foreign patents, issued and pending. Information in this publication supersedes that in all previously published material. Specifications and price change privileges reserved.

TEKTRONIX and TEK are registered trademarks of Tektronix, Inc.

Contacting Tektronix

Tektronix, Inc.
14200 SW Karl Braun Drive
P.O. Box 500
Beaverton, OR 97077
USA

For product information, sales, service, and technical support:

- In North America, call 1-800-833-9200.
- Worldwide, visit www.tektronix.com to find contacts in your area.

Warranty 2

Tektronix warrants that this product will be free from defects in materials and workmanship for a period of one (1) year from the date of shipment. If any such product proves defective during this warranty period, Tektronix, at its option, either will repair the defective product without charge for parts and labor, or will provide a replacement in exchange for the defective product. Parts, modules and replacement products used by Tektronix for warranty work may be new or reconditioned to like new performance. All replaced parts, modules and products become the property of Tektronix.

In order to obtain service under this warranty, Customer must notify Tektronix of the defect before the expiration of the warranty period and make suitable arrangements for the performance of service. Customer shall be responsible for packaging and shipping the defective product to the service center designated by Tektronix, with shipping charges prepaid. Tektronix shall pay for the return of the product to Customer if the shipment is to a location within the country in which the Tektronix service center is located. Customer shall be responsible for paying all shipping charges, duties, taxes, and any other charges for products returned to any other locations.

This warranty shall not apply to any defect, failure or damage caused by improper use or improper or inadequate maintenance and care. Tektronix shall not be obligated to furnish service under this warranty a) to repair damage resulting from attempts by personnel other than Tektronix representatives to install, repair or service the product; b) to repair damage resulting from improper use or connection to incompatible equipment; c) to repair any damage or malfunction caused by the use of non-Tektronix supplies; or d) to service a product that has been modified or integrated with other products when the effect of such modification or integration increases the time or difficulty of servicing the product.

THIS WARRANTY IS GIVEN BY TEKTRONIX WITH RESPECT TO THE PRODUCT IN LIEU OF ANY OTHER WARRANTIES, EXPRESS OR IMPLIED. TEKTRONIX AND ITS VENDORS DISCLAIM ANY IMPLIED WARRANTIES OF MERCHANTABILITY OR FITNESS FOR A PARTICULAR PURPOSE. TEKTRONIX' RESPONSIBILITY TO REPAIR OR REPLACE DEFECTIVE PRODUCTS IS THE SOLE AND EXCLUSIVE REMEDY PROVIDED TO THE CUSTOMER FOR BREACH OF THIS WARRANTY. TEKTRONIX AND ITS VENDORS WILL NOT BE LIABLE FOR ANY INDIRECT, SPECIAL, INCIDENTAL, OR CONSEQUENTIAL DAMAGES IRRESPECTIVE OF WHETHER TEKTRONIX OR THE VENDOR HAS ADVANCE NOTICE OF THE POSSIBILITY OF SUCH DAMAGES.

Table of Contents

General Safety Summary	iii
Preface	v
Specifications	1
Warranted Characteristics	2
Typical Characteristics	3
Nominal Characteristics	6
Probe Tip Adapter Specifications	7
Performance Verification	11
Required Equipment	11
Special Adapters	12
Preparation	14
DC Attenuation Accuracy	15
Differential Signal Range	17
Rise Time	18
Maintenance	23
Inspection and Cleaning	23
Replacement Parts	23
Preparation for Shipment	23

General Safety Summary

Review the following safety precautions to avoid injury and prevent damage to this product or any products connected to it.

To avoid potential hazards, use this product only as specified.

Only qualified personnel should perform service procedures.

While using this product, you may need to access other parts of a larger system. Read the safety sections of the other component manuals for warnings and cautions related to operating the system.

To Avoid Fire or Personal Injury

Connect and Disconnect Properly. Do not connect or disconnect probes or test leads while they are connected to a voltage source.

Ground the Product. This product is indirectly grounded through the grounding conductor of the mainframe power cord. To avoid electric shock, the grounding conductor must be connected to earth ground. Before making connections to the input or output terminals of the product, ensure that the product is properly grounded.

Observe All Terminal Ratings. To avoid fire or shock hazard, observe all ratings and markings on the product. Consult the product manual for further ratings information before making connections to the product.

Connect the probe reference lead to earth ground only.

Do not apply a potential to any terminal, including the common terminal, that exceeds the maximum rating of that terminal.

Do Not Operate Without Covers. Do not operate this product with covers or panels removed.

Do Not Operate With Suspected Failures. If you suspect that there is damage to this product, have it inspected by qualified service personnel.

Avoid Exposed Circuitry. Do not touch exposed connections and components when power is present.

Do Not Operate in Wet/Damp Conditions.

Do Not Operate in an Explosive Atmosphere.

Keep Product Surfaces Clean and Dry.

Terms in this Manual

These terms may appear in this manual:



WARNING. *Warning statements identify conditions or practices that could result in injury or loss of life.*



CAUTION. *Caution statements identify conditions or practices that could result in damage to this product or other property.*

Symbols and Terms on the Product

These terms may appear on the product:

- DANGER indicates an injury hazard immediately accessible as you read the marking.
- WARNING indicates an injury hazard not immediately accessible as you read the marking.
- CAUTION indicates a hazard to property including the product.

The following symbol(s) may appear on the product:



Preface

This is the Technical Reference Manual for the TDP3500 differential probe. This manual provides specifications and performance verification procedures for the probe.

Specifications

The specifications in Tables 1 through 4 apply to a TDP3500 differential probe installed on a Tektronix DPO7000 oscilloscope. When the probe is used with another oscilloscope, the oscilloscope must have an input impedance of 50 Ω and a bandwidth of 1 GHz. The probe must have a warm-up period of at least 20 minutes and be in an environment that does not exceed the limits described. (See Table 1.) The probe calibration and Autozero routines should be run on the host instrument before verifying the warranted probe specifications. Specifications for the TDP3500 differential probe fall into three categories: warranted, typical, and nominal characteristics.

Warranted Characteristics

Warranted characteristics describe guaranteed performance within tolerance limits or certain type-tested requirements. (See Table 1.) Warranted characteristics that have checks in the *Performance Verification* section are marked with the ✓ symbol.

Table 1: Warranted electrical characteristics

Specification	TDP3500
✓ Differential signal range (DC coupled)	$\pm 2.0 V_{(DC + \text{peak AC})}$
Common-mode signal range (DC coupled)	+5 V to $-4 V_{(DC + \text{peak AC})}$
Maximum non destructive input voltage between signal and common of the same channel	$\pm 15 V_{(DC + \text{peak AC})}$
✓ DC attenuation accuracy	$\pm 2\%$ of input
Bandwidth (probe only)	DC to ≥ 3.5 GHz
✓ Rise time, probe only (10–90%, + 20 °C to + 30 °C)	≤ 140 ps
Common-mode rejection ratio	>60 dB at DC >55 dB at 1 MHz >45 dB at 30 MHz >25 dB at 1 GHz
Temperature	Operating: 0 to +40 °C (32 °F to +104 °F) Nonoperating: -40 to +71 °C (-40 °F to -159 °F) ¹
Humidity	Operating: 0-90% RH, tested at + 30 to +40 °C Nonoperating: 0-90% RH, tested at +30 to +60 °C

¹ See warning that follows.



WARNING. To avoid a burn hazard at high ambient temperatures, do not touch the probe with bare hands at nonoperating temperatures above +50 °C .

Typical Characteristics

Typical characteristics describe typical but not guaranteed performance.

Table 2: Typical electrical characteristics

Differential input resistance, DC coupled	100 k Ω
Common mode input resistance	50 k Ω
Differential input capacitance	<0.3 pF at 10 MHz
Common-mode input capacitance	<0.45 pF per side at 100 MHz
Offset accuracy	± 10 mV
Differential offset range	± 1 V
Common mode rejection ratio	(See Figure 3 on page 4.)
System noise	
Referred to probe input	<35 nV/ $\sqrt{\text{Hz}}$ @ 100 MHz
Input impedance	(See Figure 4 on page 5.)
Propagation delay	5.4 ns ± 2 ns from probe tip to output

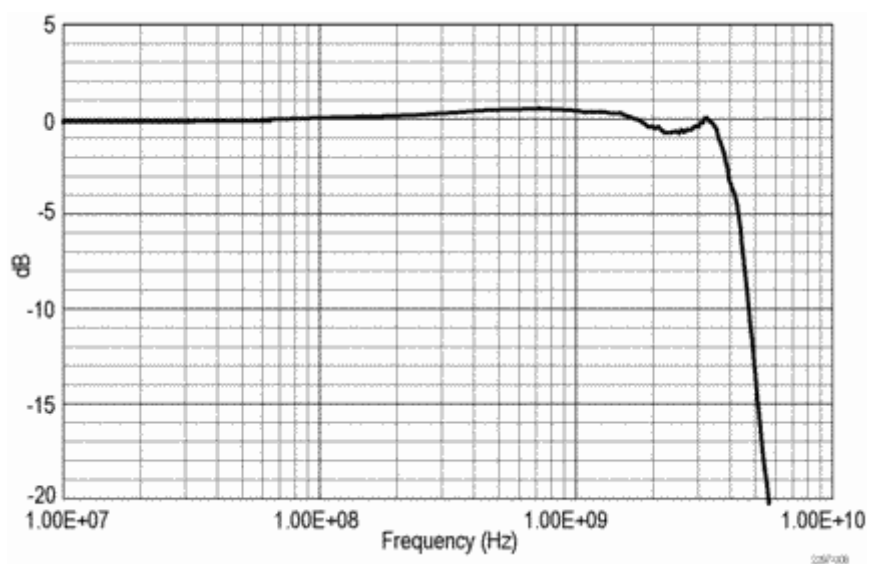

Figure 1: Typical bandwidth

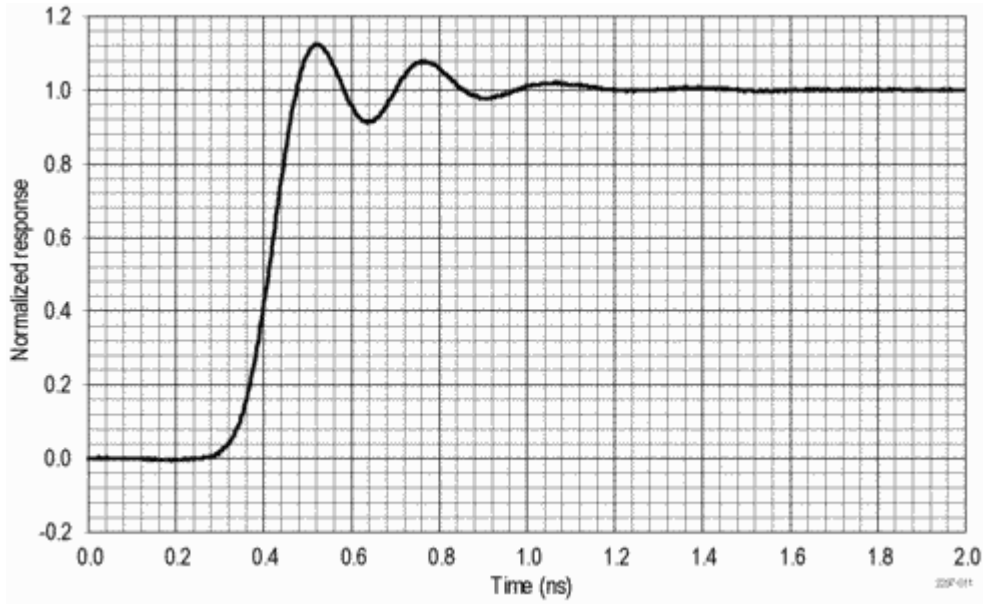

Figure 2: Typical rise time

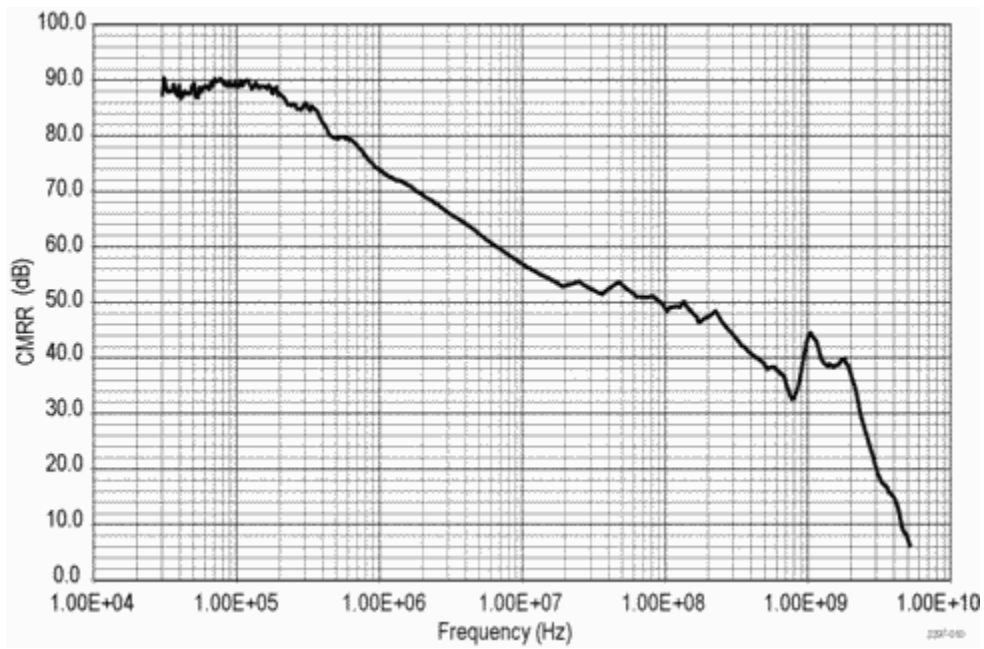

Figure 3: Typical Common-Mode Rejection Ratio

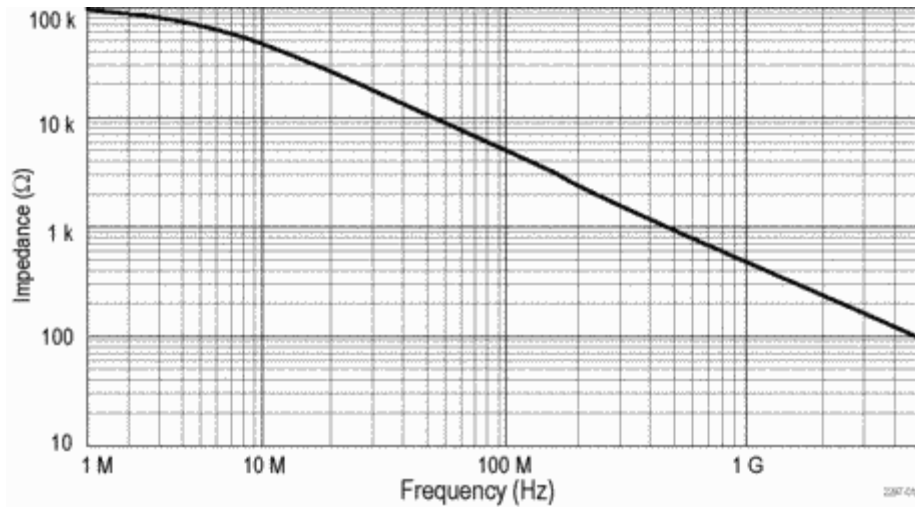

Figure 4: Typical input impedance versus frequency

Table 3: Typical mechanical characteristics

Dimensions, input connection	0.63 mm (0.025 in) square pin sockets on 2.54 mm (0.100 in) centers
Dimensions, control box	117 mm × 41 mm × 29 mm (4.6 in × 1.6 in × 1.15 in)
Dimensions, probe head	86 mm × 11 mm × 8.9 mm (3.4 in × 0.45 in × 0.35 in)
Dimensions, output cable	1.22 m (48 in)
Unit weight (probe only)	144.5 g (5.1 oz)

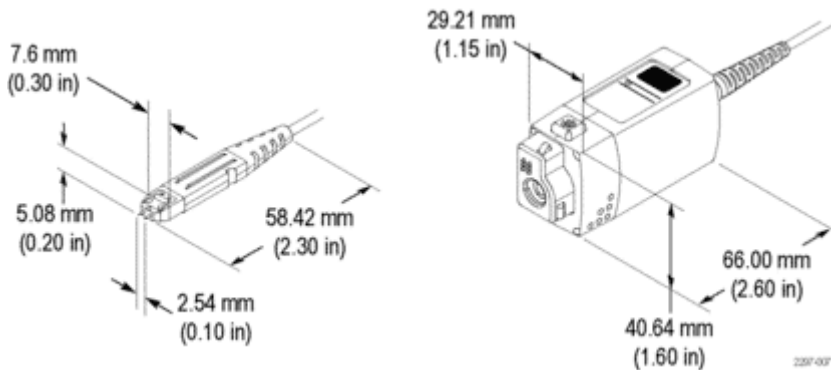

Figure 5: Probe dimensions

Nominal Characteristics

Nominal characteristics describe guaranteed traits, but the traits do not have tolerance limits.

Table 4: Nominal electrical characteristics

Input configuration	Differential (two inputs, + and -), with case ground
Output coupling	DC coupling
Voltage range	+/-2 V
Termination	Terminate output into 50 Ω

Probe Tip Adapter Specifications

This section describes the characteristics of the adapters that are included in your accessory kit. The adapters are listed in order of performance, beginning with the fastest. You will get the best probe performance by connecting the probe directly to square pins on your circuit. However, as test points are not always as convenient, these adapters make taking measurements easier while maintaining the best signal fidelity.

NOTE. All adapter specifications are typical unless otherwise indicated.

Variable Spacing Adapter

Tektronix part number: 016-1885-xx

Bandwidth: <3.5 GHz

10/90 Rise time: <110 ps

This adapter has adjustable pins that can span from 0.020 to 0.180 inch apart.

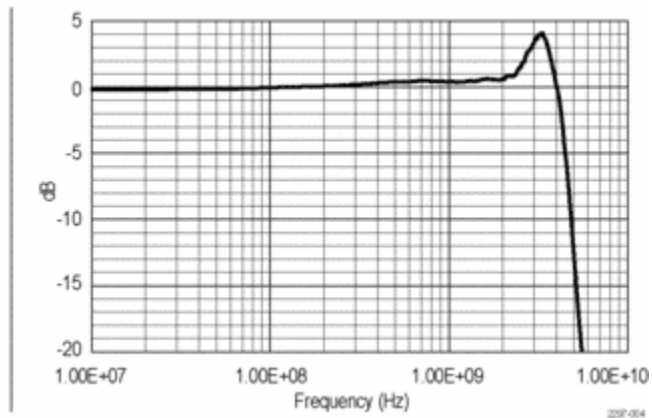
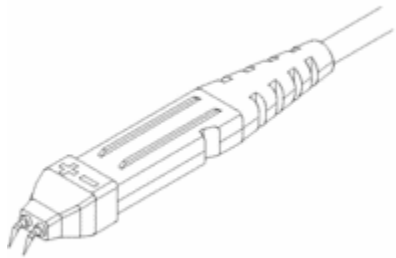

Square Pin Adapter

Tektronix part number: 016-1884-xx

Bandwidth: <3.3 GHz

10/90 Rise time: <110 ps

Use this adapter to provide easy access to square-pin test points that you frequently check, or to other probe accessories.

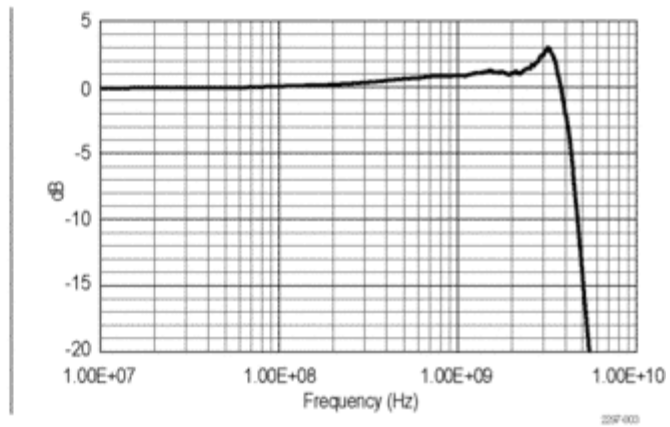
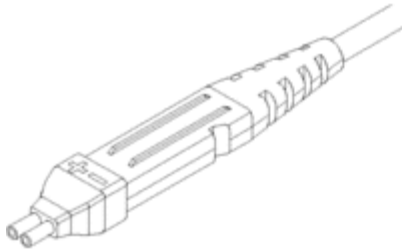

Solder-in Adapter Kit

Tektronix part number: 020-2505-xx Solder-in Adapter Kit

(Includes two adapters, Tektronix part number 016-1926-xx, and a Resistor/Wire Kit, Tektronix part number 020-2506-xx)

You can reorder either kit. The Resistor/Wire Kit includes ten each resistors (10 Ω and 20 Ω bonded to 0.020 in wire), and ten lengths of 0.020 in solder wire. The kit also includes ten each resistors (10 Ω and 20 Ω bonded to 0.008 in wire), and ten lengths of 0.008 in solder wire.

Bandwidth: <4.3 GHz (Solder wire), <3.8 GHz (10 Ω resistor), <3.7 GHz (20 Ω resistor)

10/90 Rise time: <124 ps (Solder wire), <131 ps (10 Ω resistor), <140 ps (20 Ω resistor)

Use this adapter on test points that you frequently check that do not have square pins or other convenient connections. Solder the wire or resistor leads that come with the kit to your test points.



CAUTION. To prevent short circuits, solder and dress the adapter leads carefully, and make sure that the leads do not touch other conductors when the adapter is not connected to the probe.

To prevent damaging this adapter, do not connect it to 0.025" square pins. Instead, use the square-pin adapter included in the probe accessory kit.

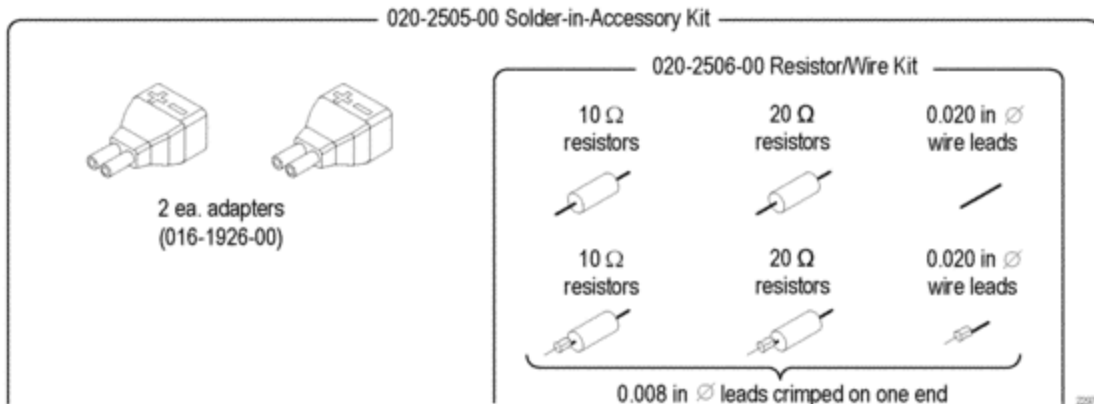
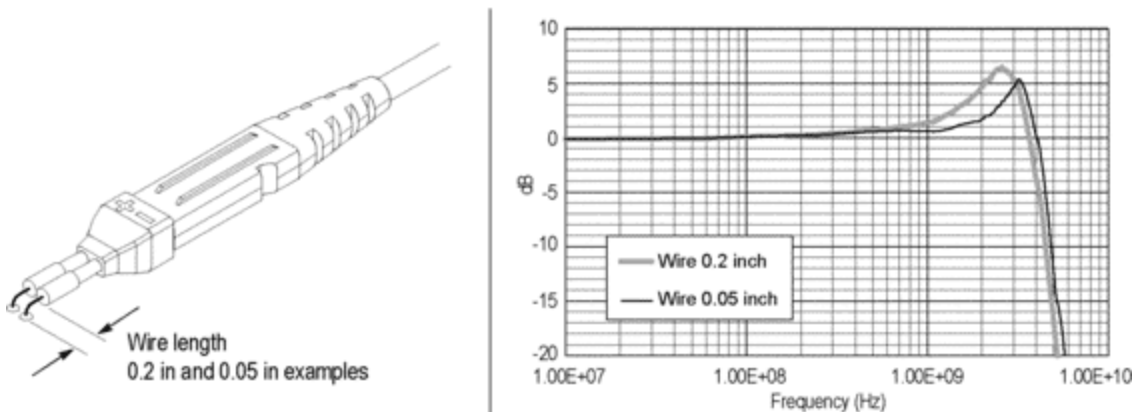

Y-Lead Adapter

Tektronix part number: 196-3434-xx

Usable Bandwidth: <100 MHz

Calculated rise time: 1.4 ns

Use this adapter for DC and low-frequency measurements. The socket ends plug onto square pins, component leads, and the MicroCKT Test Tip adapters included with the probe.

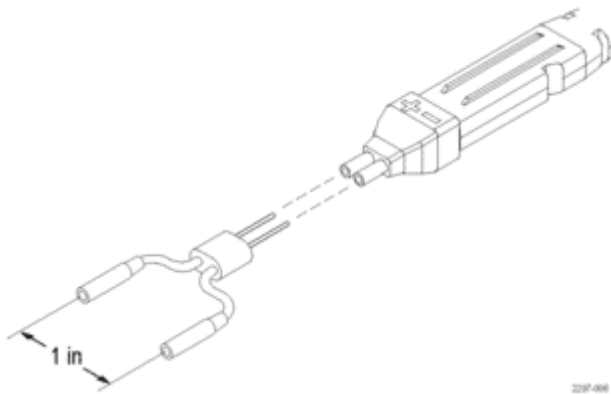

MicroCKT Test Tips

Tektronix part number: 206-0569-xx

Usable Bandwidth: <100 MHz

Calculated rise time: 3.5 ns

Use the MicroCKT Test Tips with the Y-lead adapters. Due to the length of these adapters, they are only recommended for DC and low-frequency measurements.

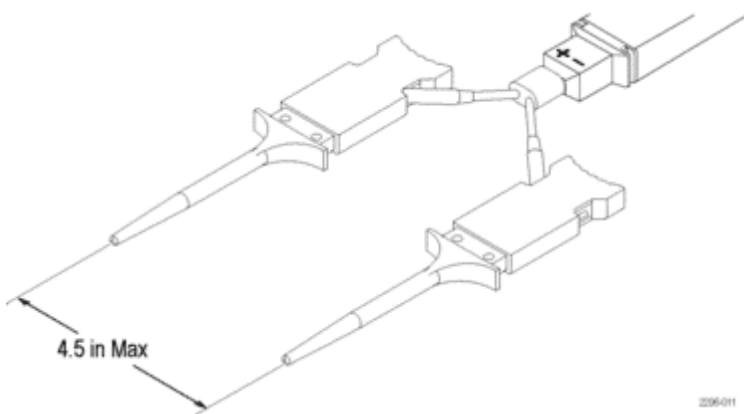

Performance Verification

Use the following procedures to verify the warranted specifications of the TDP3500 Differential Probe. Before beginning these procedures, photocopy the test record and use it to record the performance test results. (See Table 6 on page 22.) The recommended calibration interval is one year.

These procedures test the following specifications:

- DC attenuation accuracy
- Differential signal range
- Rise time

Required Equipment

Table 5 lists the equipment required to perform the performance verification procedures. The types and quantities of connectors may vary depending on the specific equipment you use.

Table 5: Test equipment

Description	Minimum requirements	Example product
Digitizing oscilloscope with TekVPI interface	Fully compatible with TekVPI interface	Tektronix DPO7000 series oscilloscope (w/V3.02 or higher firmware)
Sampling oscilloscope		Tektronix TDS8000 series oscilloscope
Sampling module		Tektronix 80E0x
Sampling module	TDR output; 250 mV step, <100 ps rise time	Tektronix 80E04
TekVPI calibration fixture	Optional probe accessory	Tektronix part number 067-1701-xx
Probe calibration fixture	Optional probe accessory	Tektronix part number 067-0419-xx
BNC-to-probe tip adapter	Optional probe accessory	Tektronix part number 067-1734-xx
BNC Male-to-SMA Female adapter	As per description	Tektronix part number 015-0572-xx
Calibrated DC voltage source	Adjustable from 0 V to ≥ 10 V. Outputs must be isolated from earth ground.	Keithley 2400
DMM (2 required)	DC Accuracy $\geq 0.5\%$ on range to measure 10 V, averaging mode.	Fluke 187
BNC cables (2)	50 Ω , 42 inch	Tektronix part number 012-0057-xx
SMA cables (2)	50 Ω , 28 inch	Tektronix part number 012-0649-xx
Banana-to-banana patch cords (2)	1 red 1 black	Tektronix part number 012-0031-xx Tektronix part number 012-0039-xx
Dual-male-banana-to-female BNC adapter	As per description	Tektronix part number 103-0090-xx
Precision inline BNC terminator	50 $\Omega \pm 0.1\%$	Tektronix part number 011-0129-xx
Y-lead adapter	Standard accessory included w/probe	Tektronix part number 196-3434-xx
MicroCKT test tips (2)	Standard accessory included w/probe	Tektronix part number 206-0569-xx

Special Adapters

Some of the adapters used in these procedures are available only from Tektronix. These adapters are described on the following pages.

TekVPI Calibration Fixture

The TekVPI calibration fixture, Tektronix part number 067-1701-xx, connects between the host instrument and the probe under test. (See Figure 6.) An SMA connector on the rear of the fixture provides access to the probe output signal for performance verification measurements.

1. SMA connector for probe output measurements
2. TekVPI socket for probe under test
3. BNC connection used for some tests

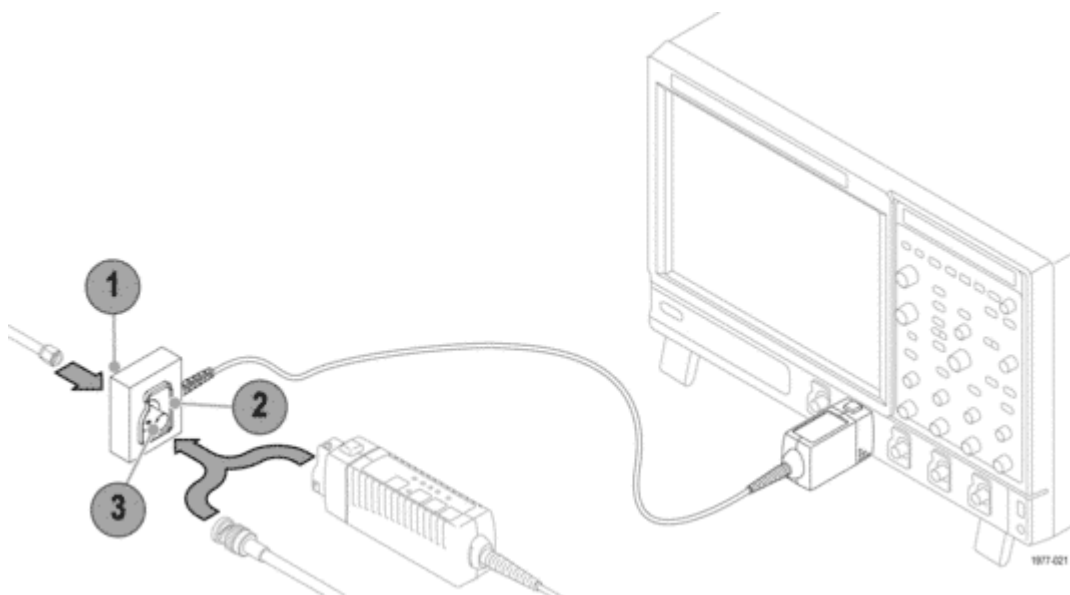

Figure 6: TekVPI calibration fixture

Probe Calibration Fixture

The Probe calibration fixture, Tektronix part number 067-0419-xx, provides a means to check the rise time specification of the probe. (See Figure 7.) A probe positioner can be helpful to keep the probe in contact with the fixture.

1. SMA connectors for input/output signals and terminations
2. Common Mode (CM) test points
3. Differential Mode (DM) test points

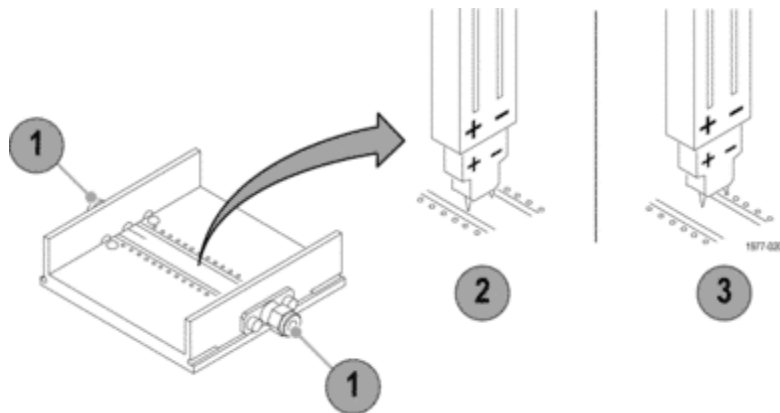

Figure 7: Probe calibration fixture connections

Preparation

Prepare the equipment as follows:

1. Turn on the TekVPI oscilloscope.
2. Connect the TekVPI Calibration Fixture to the oscilloscope.
3. Connect the SMA M-to-BNC F adapter to the SMA output of the TekVPI Calibration Fixture.
4. Connect the precision termination to the BNC end of the SMA M-to-BNC F adapter.
5. Connect one end of the BNC cable to the precision termination.
6. Connect the other end of the BNC cable to the BNC-to-dual banana adapter.
7. Connect the BNC-to-dual banana adapter to the DMM input.
8. Connect the probe to the TekVPI Calibration Fixture.
9. Connect the Square Pin adapter and Y-lead adapter to the probe. Observe proper polarity: red to (+), black to (-).
10. Connect the MicroCKT test tips to the Y-lead adapter.
11. Set the vertical offset to 0 V. (Check that the offset is set to zero before performing each test unless instructed otherwise.)

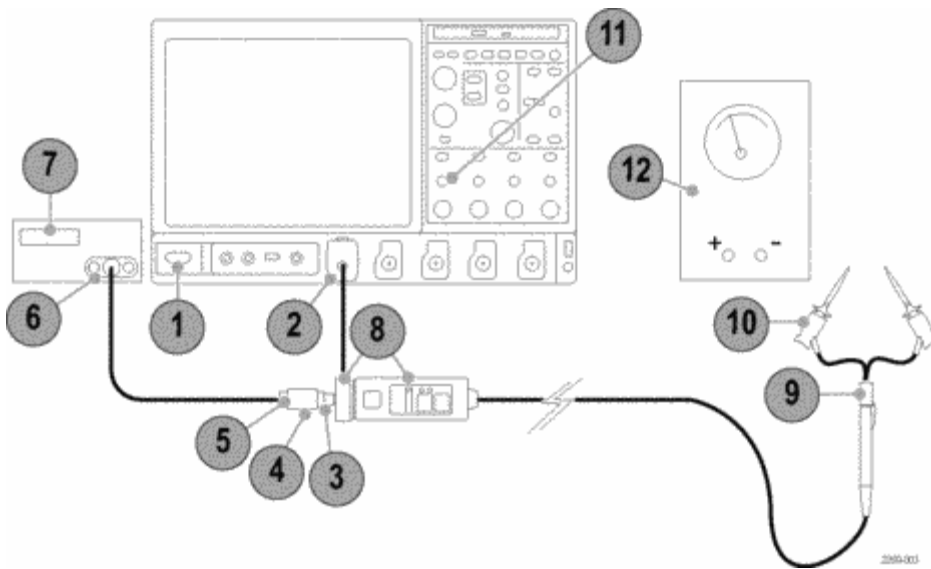

Figure 8: Preliminary test setup

12. Turn on the remaining test equipment listed in the table.
13. Allow the probe and test equipment to warm up for 20 minutes at an ambient temperature of 20 °C to 30 °C.
14. Photocopy the test record and use it to record the test results. (See Table 6 on page 22.)

Perform the verification procedures in order.

DC Attenuation Accuracy

This test checks the probe gain by measuring known voltages with a multimeter. The probe is then used to measure the same voltages, and then a comparison calculation is made.

Preparation

1. Set the vertical offset to 0 V.
2. Connect the MicroCKT test tips to the DC source. Observe proper polarity: red to (+), black to (-).
3. Connect a second DMM to the DC source.

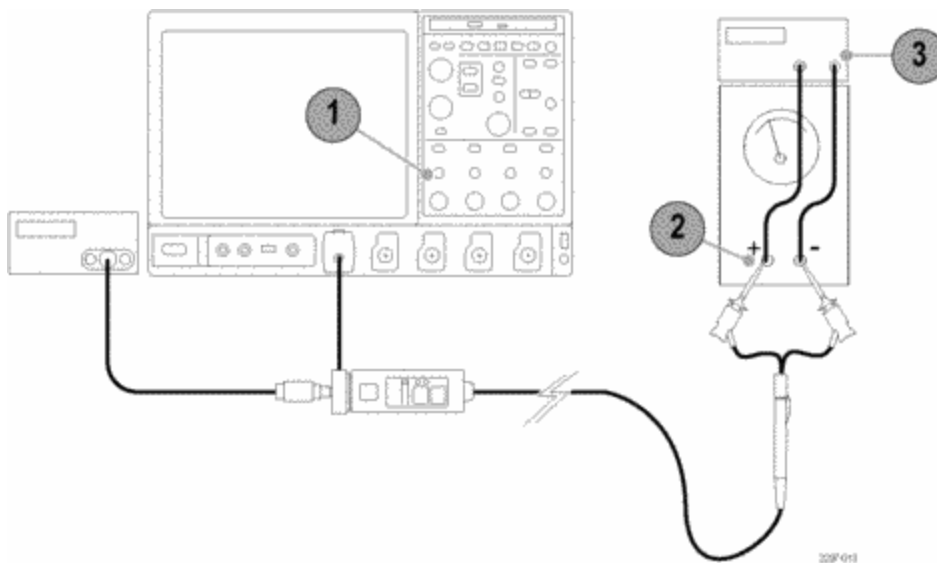

Figure 9: Setup for differential-mode tests

Verification

4. Set the input voltage on the DC source to approximately 1.4 V. Record the actual voltage as V_{in1} .
5. Record the output voltage as V_{out1} .
6. Reverse the polarity of the input voltage on the DC source. (Swap the MicroCKT test tips or the Y-lead adapter.) Record the actual voltage as V_{in2} .
7. Record the output voltage as V_{out2} .
8. Calculate the attenuation using the values from the measurements as follows:

$$\text{Attenuation} = (V_{in1} - V_{in2}) \div (V_{out1} - V_{out2})$$

Example:

$$= [1.4 \text{ V} - (-1.4 \text{ V})] \div [0.28 \text{ V} - (-0.28 \text{ V})]$$

$$= 2.8 \text{ V} \div 0.56 \text{ V}$$

$$= 5.0$$

9. Verify that the attenuation is in the range of 4.9 to 5.1. Record the results in the test record.

Leave the probe connected for the next test.

Differential Signal Range

This procedure verifies the differential signal range of the probe. This procedure uses the setup from the previous test.

Verification

1. Set the vertical offset to 0 V.
2. Set the input voltage on the DC source to 0 V, and verify that it is 0 V with the multimeter. (See Figure 10.)
3. Measure the probe output voltage as V_{offset} . You will use this offset voltage to get more accurate results in the calculations below.

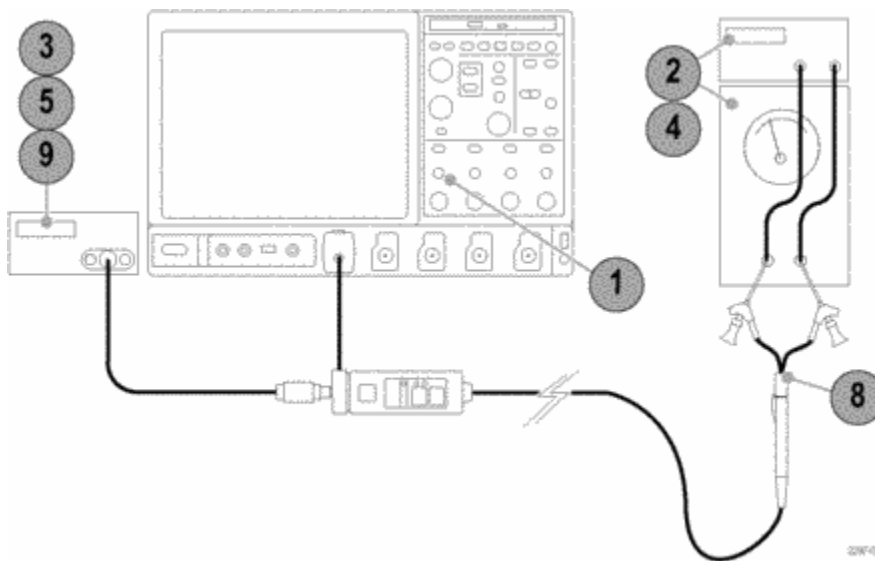

Figure 10: Differential signal range test

4. Set the input voltage on the DC source to $2\text{ V} \pm 100\text{ mV}$, and record the actual voltage as V_{in} .
5. Measure and record the output voltage as V_{out} .
6. Calculate attenuation as $|V_{\text{in}} \div (V_{\text{out}} - V_{\text{offset}})|$.
7. Verify that the attenuation is in the range of 4.75 to 5.25. Record the results in the test record.
8. Reverse the polarity of the input voltage for the following measurements. (Swap the MicroCKT test tips or the Y-lead adapter.)
9. Measure and record the output voltage as V_{out} .
10. Calculate attenuation using the formula in step 6.
11. Verify that the attenuation is in the range of 4.75 to 5.25. Record the results in the test record.

Disconnect the probe from the test setup and connect it to any oscilloscope channel to keep the probe at operating temperature.

Rise Time

This procedure verifies that the probe meets the warranted rise time specification. Two rise times are measured; the test system alone, and then the test system with the probe included. The probe rise time is calculated using the two measurements.

This test uses the TDR function of the 80E04 sampling head as a fast rise time signal source. A second 80E0X sampling head is used to take the measurements. Although the following procedure assigns the TDR and measurement functions to specific oscilloscope channels, any channels can be used. However, the TDR function is only available on 80E04 sampling heads.



CAUTION. To prevent damage, use care when working with SMA connectors: support equipment to avoid mechanical strain on the connectors, and when tightening connections, use a torque wrench to 7.5 in-lbs.

Test System Rise Time

1. Connect the 80E04 sampling head to Channel 1 of the sampling oscilloscope. (See Figure 11.)
2. Connect the 80E0X sampling head to Channel 8 of the sampling oscilloscope.
3. Connect SMA cables to Channels 1 and 8 on the sampling heads.
4. Connect the SMA cable from Channel 1 to an SMA-to-BNC adapter, and then to the BNC connector on the TekVPI adapter.
5. Connect the SMA cable from Channel 8 to the SMA connector on the TekVPI adapter.
6. Turn on Channel 8 and set the vertical scale to 50 mV/div.

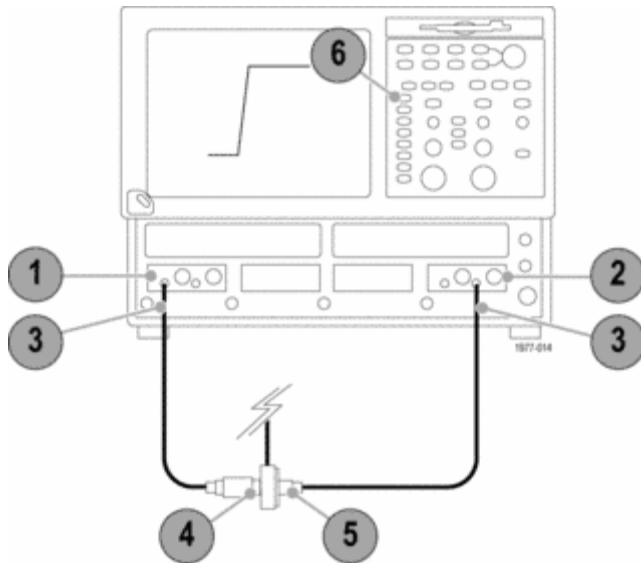

Figure 11: Test system rise time setup

7. Set the Channel 1 sampling head to TDR mode: press the **SETUP DIALOGS** button and select the TDR tab. (See Figure 12 on page 19.)
8. Set the Channel 1 (C1) **Polarity** to positive (rising).
9. Set the **Preset** of Channel 1 on. TDR Preset sets Internal Clock in the Trigger menu, turns on the TDR Step in the TDR Setups menu, turns on the channel and selects the acquisition Units in the TDR Setups menu, and sets the horizontal scale, position, and reference. The sampling module will turn on a red light next to the SELECT channel button, indicating that TDR is activated for that channel.

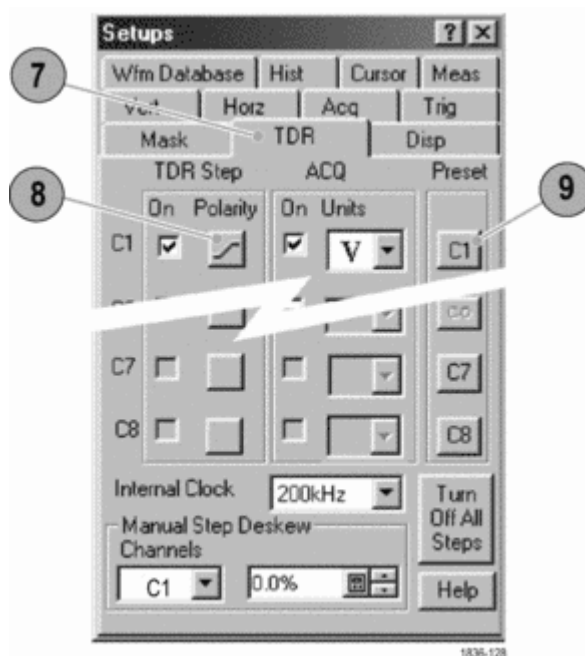

Figure 12: TDR parameter setup

10. Turn off the display for Channel 1 so that only Channel 8 is shown on screen.
11. Adjust the oscilloscope horizontal and vertical position controls to display a signal similar to that shown. (See Figure 11.)
12. Set the oscilloscope horizontal scale to 50 ps/div and center the waveform.
13. Use the oscilloscope measurement capability to display rise time. Increase the stability of the pulse edge measurement by using averaging, if available. Rise time is determined from the 10% and 90% amplitude points on the waveform. Record the rise time as t_s .

Test System and Probe Rise Time

14. Disconnect the SMA cable and BNC adapter from the Channel-1 side of the TekVPI Calibration fixture. (See Figure 13.)
15. Connect the SMA cable from Channel 1 of the sampling oscilloscope to the SMA connector on the Probe Calibration Fixture. Leave the 50 Ω termination on the other SMA connector.
16. Plug the probe into the TekVPI Calibration fixture.
17. Probe the DM pins on the Probe Calibration Fixture. A probe positioner may be helpful. (See Figure 7 on page 13.)
18. Set the TekVPI oscilloscope offset to 0.0 V.

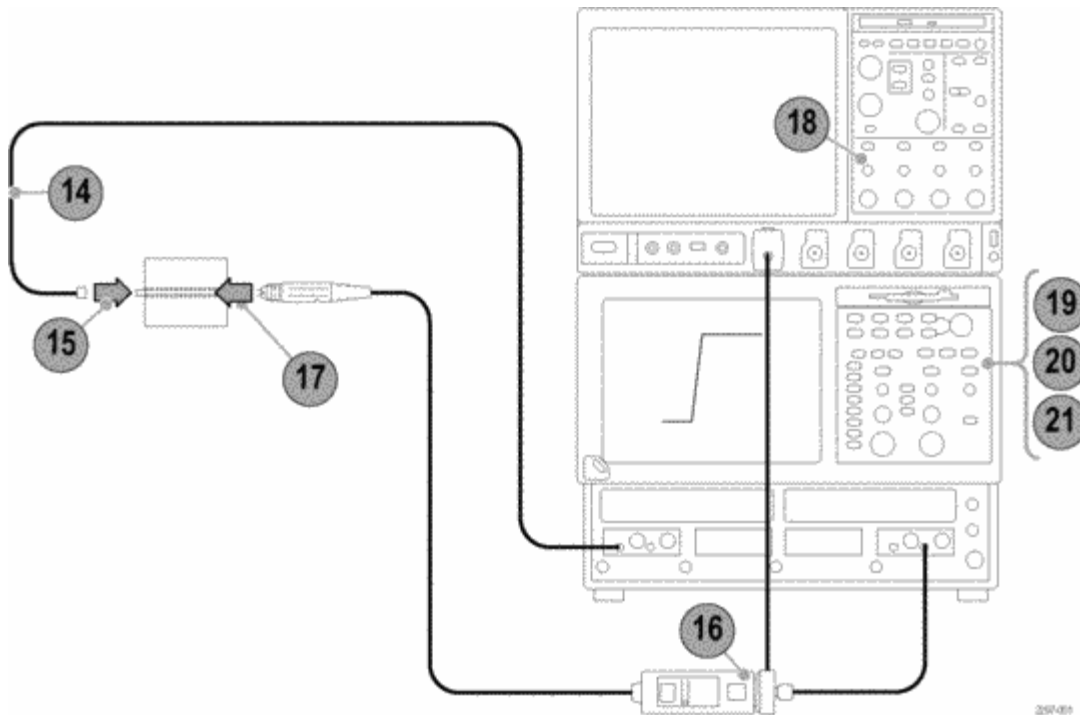

Figure 13: Probe rise time setup

NOTE. The following measurements are taken with the sampling oscilloscope. The TekVPI oscilloscope only provides power and offset to the probe.

19. On the sampling oscilloscope, expand the horizontal scale to locate the step edge: set the vertical scale to 10 mV/div, and adjust horizontal range to 200 ps/div while maintaining the edge view. For a more stable measurement display, turn on averaging.
20. Adjust the position controls on the sampling oscilloscope to display the entire leading edge waveform.
21. Use the measurement capability of the sampling oscilloscope to display rise time. Increase the stability of the pulse edge measurement by using averaging, if available. Rise time is determined from the 10% and 90% amplitude points on the waveform. Record the rise time as t_{s+p} .

22. Using the test system rise time (t_s) that you measured in step 13, and the test system and probe rise time (t_{s+p}) that you measured in step 21, calculate the probe-only rise time using the formula shown.

$$t_p = \sqrt{t_{(s+p)}^2 - t_s^2}$$

Example:

$$t_p = \sqrt{(147^2 - 50^2)}$$

$$t_p = \sqrt{21600 - 2500}$$

$$t_p = \sqrt{19100}$$

$$t_p = 137.8 \text{ ps}$$

This completes the performance verification.

Table 6: Test Record

Probe Model/Serial Number: _____ Certificate Number: _____

Temperature: _____ RH % : _____

Date of Calibration: _____ Technician: _____

Performance test	Minimum	Measured/Calculated	Maximum
DC attenuation accuracy	4.9	_____	5.1
Differential signal range			
standard polarity	4.75	_____	5.25
with connections reversed	4.75	_____	5.25
Rise time			
TDP3500 at 3.5 GHz	≤140 ps	_____	N/A

Maintenance

This section contains maintenance information for the TDP3500 Differential Probe.

Inspection and Cleaning

Protect the probe from adverse weather conditions. The probe is not waterproof.



CAUTION. To prevent damage to the probe, do not expose it to sprays, liquids, or solvents. Do not use chemical cleaning agents; they may damage the probe. Avoid using chemicals that contain benzene, toluene, xylene, acetone, or similar solvents.

Clean the exterior surfaces of the probe with a dry, lint-free cloth or a soft-bristle brush. If dirt remains, use a soft cloth or swab dampened with a 75% isopropyl alcohol solution. A swab is useful for cleaning narrow spaces on the probe. Do not use abrasive compounds on any part of the probe.



CAUTION. To prevent damage to the probe, avoid getting moisture inside the probe during exterior cleaning, and use only enough solution to dampen the swab or cloth. Use a 75% isopropyl alcohol solution as a cleanser, and rinse with deionized water.

Replacement Parts

Due to the sophisticated design of these differential probes, there are no user replaceable parts within the probes. Refer to the *Quick Start User Manual* for a list of replaceable accessories for your probe.

If your probe does not meet the specifications tested in the Performance Verification, you can send the probe to Tektronix for repair. Follow the procedure below to prevent damage to the probe during shipping.

Preparation for Shipment

If the original packaging is unfit for use or not available, use the following packaging guidelines:

1. Use a corrugated cardboard shipping carton having inside dimensions at least one inch greater than the probe dimensions. The box should have a carton test strength of at least 200 pounds.
2. Put the probe into an antistatic bag or wrap to protect it from dampness.
3. Place the probe into the box and stabilize it with light packing material.
4. Seal the carton with shipping tape.
5. Refer to *Contacting Tektronix* on the copyright page for the shipping address.