

**RSA3303B, RSA3308B, and RSA3408B  
Real-Time Spectrum Analyzers  
User Manual**

This document applies to firmware version 1.0 and above.

[www.tektronix.com](http://www.tektronix.com)

071-2395-00



Copyright © Tektronix. All rights reserved. Licensed software products are owned by Tektronix or its subsidiaries or suppliers, and are protected by national copyright laws and international treaty provisions.

Tektronix products are covered by U.S. and foreign patents, issued and pending. Information in this publication supersedes that in all previously published material. Specifications and price change privileges reserved.

TEKTRONIX and TEK are registered trademarks of Tektronix, Inc.

Additional trademark statements can be added here.

## **Contacting Tektronix**

Tektronix, Inc.  
14200 SW Karl Braun Drive  
P.O. Box 500  
Beaverton, OR 97077  
USA

For product information, sales, service, and technical support:

- In North America, call 1-800-833-9200.
- Worldwide, visit [www.tektronix.com](http://www.tektronix.com) to find contacts in your area.

## Warranty 2

Tektronix warrants that this product will be free from defects in materials and workmanship for a period of one (1) year from the date of shipment. If any such product proves defective during this warranty period, Tektronix, at its option, either will repair the defective product without charge for parts and labor, or will provide a replacement in exchange for the defective product. Parts, modules and replacement products used by Tektronix for warranty work may be new or reconditioned to like new performance. All replaced parts, modules and products become the property of Tektronix.

In order to obtain service under this warranty, Customer must notify Tektronix of the defect before the expiration of the warranty period and make suitable arrangements for the performance of service. Customer shall be responsible for packaging and shipping the defective product to the service center designated by Tektronix, with shipping charges prepaid. Tektronix shall pay for the return of the product to Customer if the shipment is to a location within the country in which the Tektronix service center is located. Customer shall be responsible for paying all shipping charges, duties, taxes, and any other charges for products returned to any other locations.

This warranty shall not apply to any defect, failure or damage caused by improper use or improper or inadequate maintenance and care. Tektronix shall not be obligated to furnish service under this warranty a) to repair damage resulting from attempts by personnel other than Tektronix representatives to install, repair or service the product; b) to repair damage resulting from improper use or connection to incompatible equipment; c) to repair any damage or malfunction caused by the use of non-Tektronix supplies; or d) to service a product that has been modified or integrated with other products when the effect of such modification or integration increases the time or difficulty of servicing the product.

THIS WARRANTY IS GIVEN BY TEKTRONIX WITH RESPECT TO THE PRODUCT IN LIEU OF ANY OTHER WARRANTIES, EXPRESS OR IMPLIED. TEKTRONIX AND ITS VENDORS DISCLAIM ANY IMPLIED WARRANTIES OF MERCHANTABILITY OR FITNESS FOR A PARTICULAR PURPOSE. TEKTRONIX' RESPONSIBILITY TO REPAIR OR REPLACE DEFECTIVE PRODUCTS IS THE SOLE AND EXCLUSIVE REMEDY PROVIDED TO THE CUSTOMER FOR BREACH OF THIS WARRANTY. TEKTRONIX AND ITS VENDORS WILL NOT BE LIABLE FOR ANY INDIRECT, SPECIAL, INCIDENTAL, OR CONSEQUENTIAL DAMAGES IRRESPECTIVE OF WHETHER TEKTRONIX OR THE VENDOR HAS ADVANCE NOTICE OF THE POSSIBILITY OF SUCH DAMAGES.



---

# Table of Contents

General Safety Summary .....	iv
Preface .....	vii
About This Manual .....	vii
Related Documents .....	vii
Conventions .....	viii
Product Overview .....	1
Features .....	1
Application .....	2
Installation.....	3
Unpacking to Check Contents.....	3
Setting Up the Stand.....	3
Applying Power.....	5
Functional Check .....	8
Powering Off the Analyzer .....	12
Restarting the Analyzer .....	13
Backing Up User Files .....	13
About Installation of Other Applications .....	14
Calibration.....	15
Cal Menu .....	15
Calibrating Gain .....	16
Calibrating Center Offset .....	17
Calibrating DC Offset .....	17
Calibrating IF Flatness (RSA3408B Only) .....	18
Display Brightness Adjustment .....	18
Confirming Performance.....	19
Functional Overview .....	21
Interface Maps .....	21
Menu Operations.....	30
Appendix A: Specifications .....	37
Electrical Characteristics.....	38
Physical Characteristics.....	59
Environmental Characteristics .....	59
Certifications and Compliances .....	60
Digital IQ Output Connector Pin Assignment (RSA3408B Option 05 Only) .....	62
Index	

## List of Figures

Figure 1: Setting up the stand .....	4
Figure 2: AC Input (rear panel).....	5
Figure 3: Principal power switch (rear panel).....	6
Figure 4: Front panel power switch (ON/STANDBY switch).....	6
Figure 5: Initial screen .....	7
Figure 6: RF INPUT connector .....	8
Figure 7: Spectrum of the RSA3408B calibration signal (100 MHz, about -20 dBm) .....	9
Figure 8: Setup display .....	10
Figure 9: Reference level setting and A/D overflow indicator .....	11
Figure 10: Spectrogram display.....	12
Figure 11: Calibration menu structure .....	15
Figure 12: UNCAL display .....	16
Figure 13: Center offset.....	17
Figure 14: DC offset .....	18
Figure 15: System menu.....	19
Figure 16: Front panel .....	21
Figure 17: Rear panel .....	22
Figure 18: Side panel .....	24
Figure 19: Operation with mouse and keyboard .....	25
Figure 20: Display screen configuration (RSA3408B shown) .....	26
Figure 21: Status display (RSA3408B shown).....	27
Figure 22: Pre- and post-trigger regions .....	28
Figure 23: Key lock display.....	28
Figure 24: Setup display (RSA3408B shown) .....	29
Figure 25: Examples of menu item display.....	31
Figure 26: Numeric setting menu.....	32
Figure 27: Changing value with the knob .....	33
Figure 28: Changing value with the keypad.....	34
Figure 29: Numeric keypad .....	34
Figure 30: Changing the step size for the center frequency .....	35
Figure 31: Changing the step size for the center frequency .....	35
Figure 32: Definition of the setup and hold time.....	58
Figure 33: Digital IQ output connector pin assignment.....	62

## List of Tables

Table 1: Span and RBW .....	10
Table 2: Key functions of the keyboard.....	25
Table 3: Status display .....	27
Table 4: Setup display.....	29
Table 5: Menu item types.....	32
Table 6: Frequency .....	38
Table 7: RSA3300B Spectrum purity .....	39
Table 8: RSA3300B Noise sideband .....	39
Table 9: RSA3408B Noise sideband .....	40
Table 10: Input.....	42
Table 11: RSA3408B Amplitude .....	43
Table 12: RSA3300B Amplitude .....	44
Table 13: Spurious response.....	44
Table 14: RSA3408B Acquisition .....	47
Table 15: RSA3300B Acquisition .....	48
Table 16: Trigger .....	48
Table 17: RSA3408B RBW (Resolution Bandwidth).....	49
Table 18: RSA3300B RBW (Resolution Bandwidth).....	49
Table 19: Trace and display line .....	50
Table 20: Display .....	50
Table 21: RSA3408B Measurement function .....	51
Table 22: RSA3300B Measurement function .....	51
Table 23: Analog demodulation accuracy .....	51
Table 24: Pulse measurement .....	52
Table 25: Digital demodulation (Option 21 only) .....	52
Table 26: ACLR measurement (Option 30) .....	55
Table 27: RSA3408B Wireless LAN measurement (Option 29).....	56
Table 28: Digital phosphor spectrum processing (DPX).....	56
Table 29: Controller.....	57
Table 30: External output connector .....	57
Table 31: Power requirements .....	58
Table 32: Physical characteristics .....	59
Table 33: Environmental characteristics .....	59
Table 34: I OUTPUT connector pin assignment.....	62
Table 35: Q OUTPUT connector pin assignment.....	64

## General Safety Summary

Review the following safety precautions to avoid injury and prevent damage to this product or any products connected to it.

To avoid potential hazards, use this product only as specified.

*Only qualified personnel should perform service procedures.*

### To Avoid Fire or Personal Injury

**Use Proper Power Cord.** Use only the power cord specified for this product and certified for the country of use.

**Connect and Disconnect Properly.** Do not connect or disconnect probes or test leads while they are connected to a voltage source.

**Ground the Product.** This product is grounded through the grounding conductor of the power cord. To avoid electric shock, the grounding conductor must be connected to earth ground. Before making connections to the input or output terminals of the product, ensure that the product is properly grounded.

**Observe All Terminal Ratings.** To avoid fire or shock hazard, observe all ratings and markings on the product. Consult the product manual for further ratings information before making connections to the product.

**Do Not Operate Without Covers.** Do not operate this product with covers or panels removed.

**Do Not Operate With Suspected Failures.** If you suspect that there is damage to this product, have it inspected by qualified service personnel.

**Avoid Exposed Circuitry.** Do not touch exposed connections and components when power is present.

**Do Not Operate in Wet/Damp Conditions.**

**Do Not Operate in an Explosive Atmosphere.**

**Keep Product Surfaces Clean and Dry.**

**Provide Proper Ventilation.** Refer to the manual's installation instructions for details on installing the product so it has proper ventilation.



**Terms in this Manual** These terms may appear in this manual:



**WARNING.** *Warning statements identify conditions or practices that could result in injury or loss of life.*



**CAUTION.** *Caution statements identify conditions or practices that could result in damage to this product or other property.*

**Symbols and Terms on the Product**

These terms may appear on the product:

- DANGER indicates an injury hazard immediately accessible as you read the marking.
- WARNING indicates an injury hazard not immediately accessible as you read the marking.
- CAUTION indicates a hazard to property including the product.

The following symbol(s) may appear on the product:



CAUTION  
Refer to Manual



Protective Ground  
(Earth) Terminal



---

# Preface

This is the operator manual for the RSA3303B, RSA3308B, and RSA3408B Real-Time Spectrum Analyzers. It covers the following information:

- Describes the capabilities of the analyzers and how to install them
- Explains how to operate the analyzer
- Lists specifications and accessories of the analyzer

More detailed operating information is available through the online Help for the instruments and in the user manuals for the measurement options.

## About This Manual

This manual is composed of the following chapters:

- *Getting Started* describes the product overview, architecture, installation, and calibration of the analyzer.
- *Operating Basics* explains the functions of the front, rear, and side panels and menu items of the analyzer.
- *Appendices* provide specifications for the spectrum analyzer.

## Related Documents

In addition to this user manual, the following documentation is available for your analyzer. The most recent versions of these manuals are available on the Tektronix Web site ([www.tektronix.com](http://www.tektronix.com)).

- *RSA3408B Programmer Manual* contains an alphabetical listing of the programming commands and other information related to controlling the analyzer over the GPIB interface.
- *RSA3300B Programmer Manual* contains an alphabetical listing of the programming commands and other information related to controlling the analyzer over the GPIB interface.
- *RSA3408B Service Manual* describes how to verify the characteristics of, adjust, disassemble, assemble, and troubleshoot the analyzer, and contains the information required for repair, including module replacement, and calibration.
- *RSA3300B Service Manual* describes how to verify the characteristics of, adjust, disassemble, assemble, and troubleshoot the analyzer, and contains the information required for repair, including module replacement, and calibration.

## Conventions

This manual uses the following conventions:

- Front-panel button and control labels are printed in the manual in upper case text. For example, SPAN, PEAK, PRINT. If it is part of a procedure, the button or control label is printed in boldface. For example:

Press **SPAN**.

- To easily find buttons on the front panel, the area name label is printed together with the button by concatenating with a colon (:), as in MODE: **DEMOD**, VIEW: **SCALE**, MARKERS: **SELECT**. For example:

Press the MODE: **DEMOD** key.

- Menu and on-screen form titles are printed in the manual in the same case (initial capitals) as they appear on the analyzer screen, such as Span, Source, and Channel Power. If it is part of a procedure, the menu title is shown in boldface. For example:

Press the **Source** side key.

- A list of keys, controls, and/or menu items separated by an arrow symbol (→) indicates the order in which to perform the listed tasks. For example:

Select **RBW/FFT** → **Filter Shape...** → **Gaussian**.

---

# Product Overview

The RSA3303B, RSA3308B, and RSA3408B are portable real-time spectrum analyzers. The real-time spectrum analyzer has a vastly different architecture from traditional tools, and is uniquely capable of capturing continuous, intermittent, or random signals with equal ease. The acquired data is analyzed in time, amplitude, phase, and frequency domains correlating with time. Furthermore, DPX spectrum processing provides an intuitive understanding of time-varying RF signals with color-graded displays based on frequency of occurrence.

## Features

- DC to 8 GHz measurement frequency range, depending on model
- RSA3408B: 100 Hz to 3 GHz measurement span and 36 MHz vector span
- RSA3300B: 50 Hz to 3 GHz measurement span and 15 MHz vector span
- Real-time analysis for seamless capture of time-varying RF signals
- DPX spectrum display makes it easier to see intermittent signals
- Spectrogram provides a 3-D representation of a time-varying spectrum
- Spectrum analysis of power, ACPR, C/N, OBW, EBW, and spurious
- Analog modulation analysis of AM, PM, FM, ASK and FSK signals
- Digital modulation analysis ranging from BPSK to 256QAM (Option 21)
- Time characteristic analysis including pulse measurements
- Constellation analysis
- EVM analysis
- AM/AM and AM/PM distortion analyses
- RFID analysis
- Time characteristic analysis
- Pulse measurements
- Signal source analysis
- CCDF analysis
- 8.4 inch TFT color display and sturdy cabinet
- USB, LAN, and GPIB interfaces

## Application

The RSA3303B, RSA3308B, and RSA3408B can perform real-time analysis for the following purposes:

- Signal quality analysis of analog and digital modulation
- Understanding frequency and spectral occupancy behavior over time
- Capture and characterization of undesired, unknown, or interfering signals
- Device/system design or operational diagnostic measurement
- Getting answers to elusive EMI problems
- VCO/synthesizer design
- RFID device characterization
- General purpose digital modulation vector signal analysis (Option)
- Spectrum monitoring
- Radar measurements
- Characterization, troubleshooting, and verification of wireless designs (RSA3000B Series Options):
  - GSM/EDGE
  - W-CDMA
  - HSDPA
  - cdma2000 1x
  - cdma2000 1xEV-DO
  - TD-SCDMA
  - WLAN 802.11a/b/g/n (RSA3408B only)

# Installation

This section describes how to install this instrument. The topics are organized as follows:

- Unpacking to check contents
- Setting up the stand
- Applying the power
- Functional check
- Powering off the analyzer
- Restart
- Backing up the user file

Before starting installation, you should become familiar with the *General Safety Summary*. (See page iv.)

## Unpacking to Check Contents

1. This product is packed in a cardboard box for delivery. Before opening the box, make sure that there is no damage on the surface.
2. Open the box, check that the product has no damage. If you find any damaged or missing components, contact your local Tektronix representative.
3. It is recommended to keep the box and packing materials. You may need them to send this product to Tektronix for calibration or repair.



---

**CAUTION.** *The analyzer has exhaust fans on the side panel. Leave a space of at least 5 cm (2 in) on both sides for proper air circulation.*

---

## Setting Up the Stand

To set up the stand, place the analyzer on a table. Lift the front of the analyzer and pull out the stand until it is perpendicular to the analyzer.

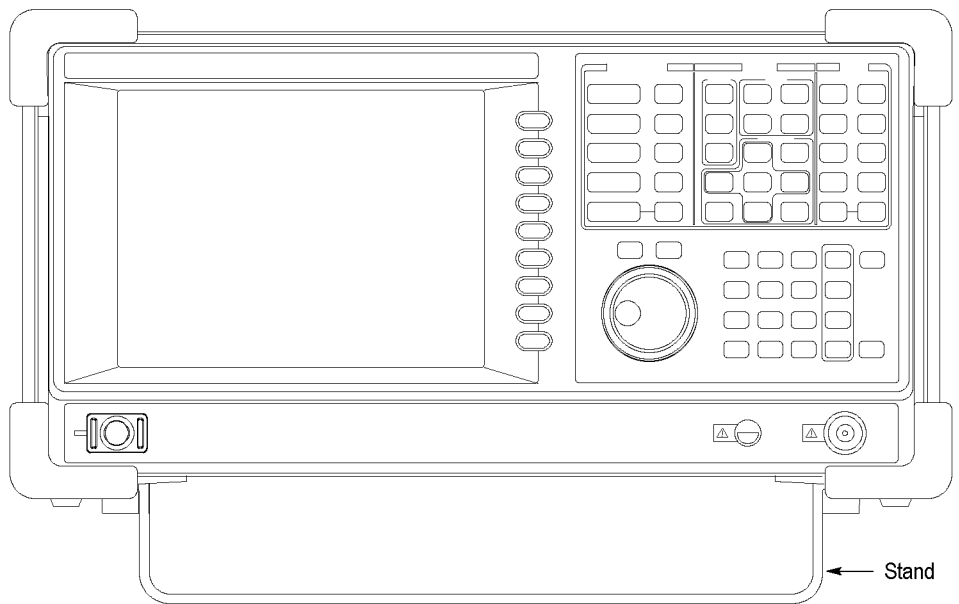
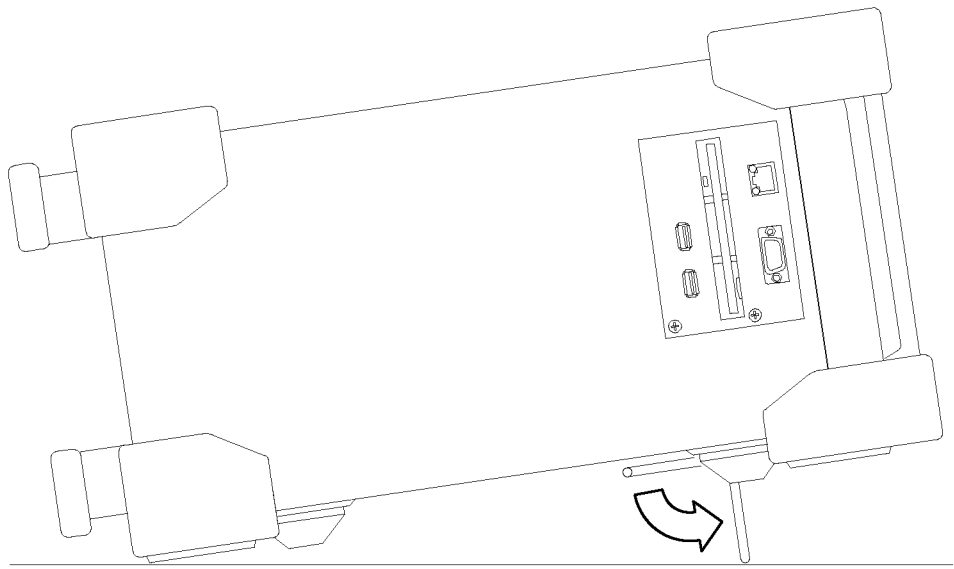

**Figure 1: Setting up the stand**



## Applying Power

Power on the analyzer using the following procedure:

### AC Power Requirements

The analyzer operates from an AC line frequency of 47-63 Hz, over the range of 90-250 Volts, without the need for configuration, except the power cord.

The maximum power consumption is 350 W (RSA3300B) or 400 W (RSA3408B). The *Specifications* section contains additional information on power and environmental requirements. (See page 37, *Specifications*.)



**CAUTION.** Use only power cords that are approved for the country of use. Using non-approved power cords could result in fire or shock hazard.

### Connecting the Power Cord

1. Plug the power cord into the AC input on the rear panel.

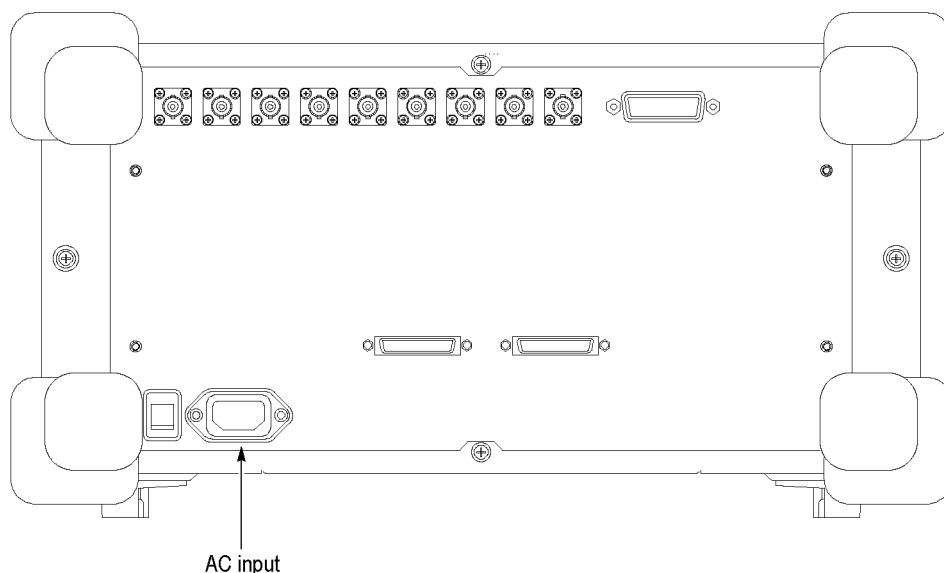
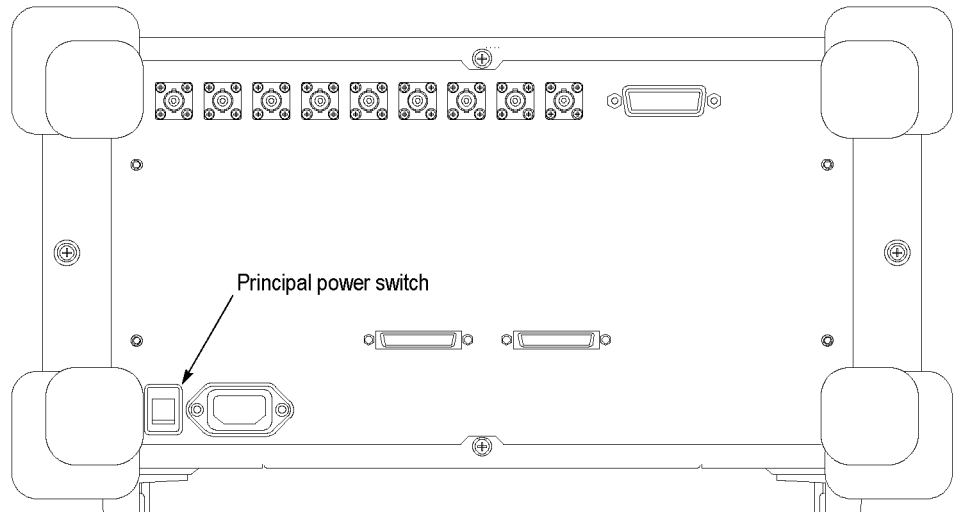

**Figure 2: AC Input (rear panel)**

2. Connect the plug of the power cord to a properly grounded outlet.

**Turning on the Analyzer**

1. Turn on the principal power switch on the rear panel.



**Figure 3: Principal power switch (rear panel)**

When you turn on the principal power switch, a voltage is applied to the analyzer standby circuit. Make sure the LED next to the power switch on the front panel lights up in orange.

2. Turn on the power switch (**ON/STANDBY**) on the lower left of the front panel. The LED next to the power switch changes to green.

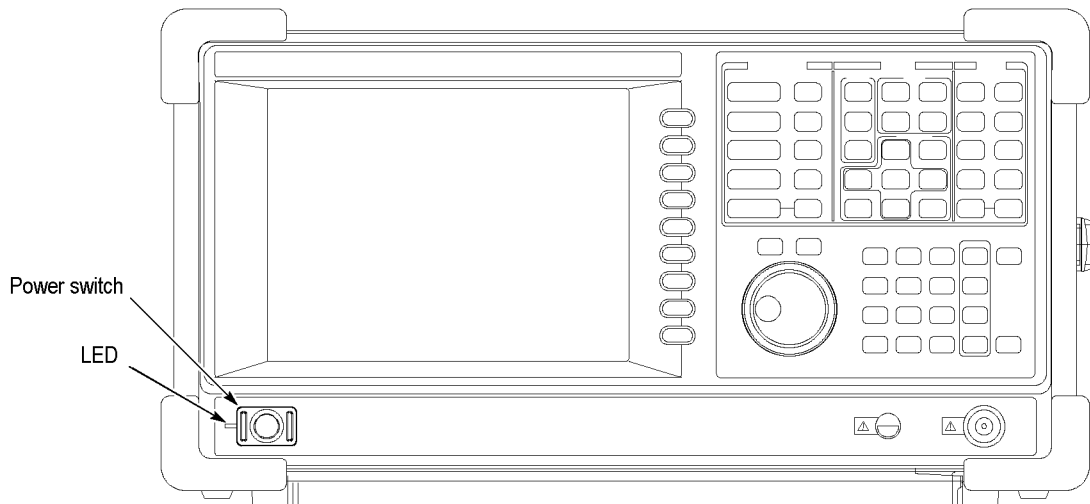

**Figure 4: Front panel power switch (ON/STANDBY switch)**

When you turn on the analyzer, the Windows operating system boots up. After several minutes, the analyzer application starts up.

The initial screen appears. (See Figure 5.) The displayed spectrum represents the noise floor of the analyzer.

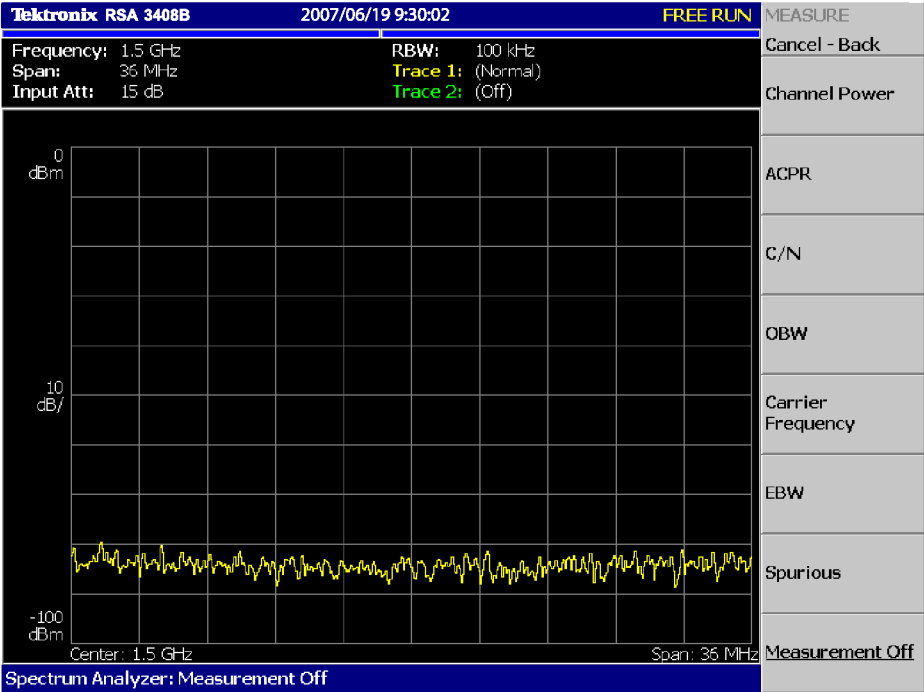

Figure 5: Initial screen

If "UNCAL" is displayed on top of the screen, run the gain calibration routine. (See page 16, *Calibrating Gain.*)

**CAUTION.** Never apply signals with a combined amplitude greater than +30 dBm to the RF INPUT connector. Signals greater than +30 dBm can permanently damage the analyzer. (See Figure 6.)

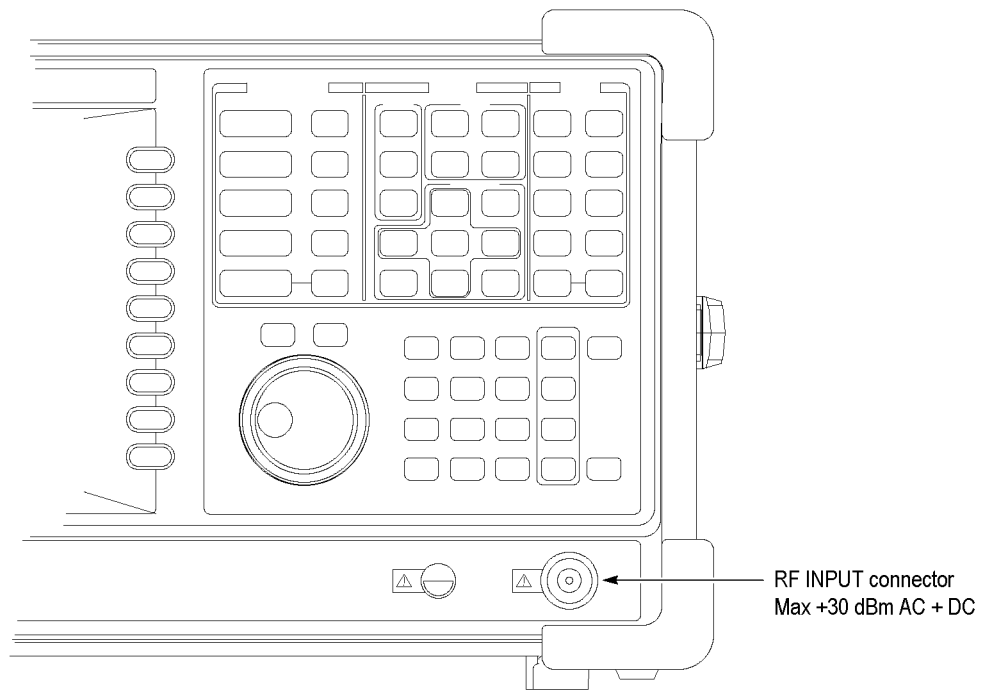

Figure 6: RF INPUT connector

## Functional Check

The analyzer has a built-in calibration signal source with a frequency of 100 MHz (RSA3408B) or 50 MHz (RSA3300B) and an amplitude of approximately -20 dBm. Use the built-in source to perform this quick functional check to verify that your instrument is operating correctly.

1. Turn on the analyzer.
2. Display the spectrum of the calibration signal:
  - a. Press the **S/A** key on the front panel and then press the **Spectrum Analyzer** side key.
  - b. Press the **PRESET** key on the front panel to reset the analyzer.
  - c. Press the **INPUT** key on the front panel.
  - d. Press the **Signal Input Port...** side key to select **Cal100M** (RSA3408B) or **Cal** (RSA3300B).

The spectrum of the calibration signal appears.

- e. Check that "INPUT: CAL" and "FREE RUN" are displayed in the status indicator at the upper right of the screen. (See Figure 7.)

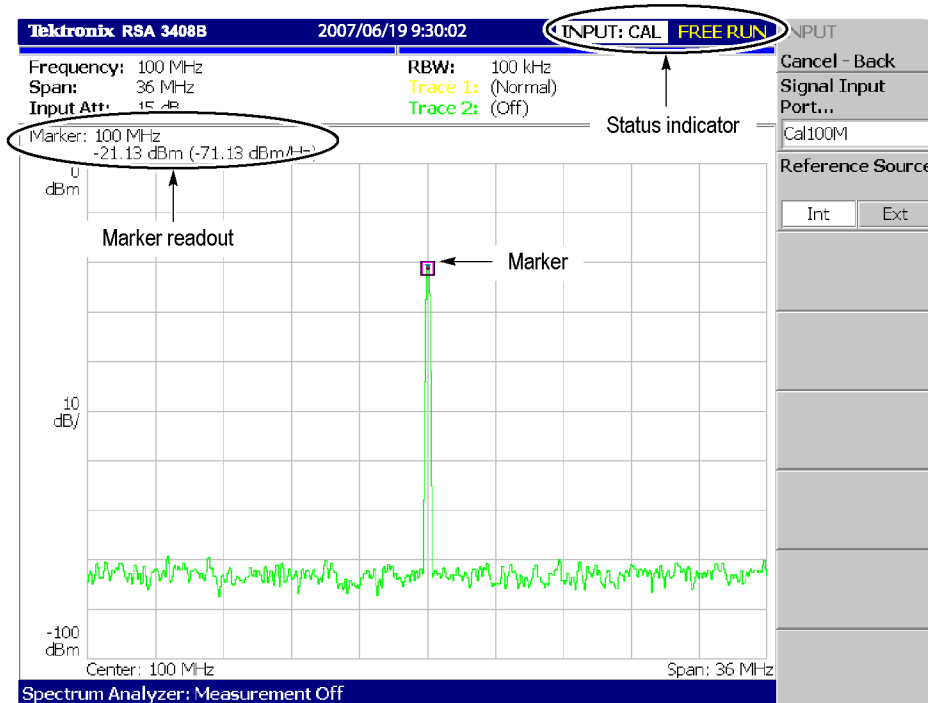

Figure 7: Spectrum of the RSA3408B calibration signal (100 MHz, about -20 dBm)

3. Check the center frequency and peak amplitude using the marker:
  - a. Press the **PEAK** key on the front panel to place the marker on the peak. (See Figure 7.)
  - b. Check the marker readouts on screen. The frequency should be 100 MHz (RSA3408B) or 50 MHz (RSA3300B) and the amplitude should be approximately -20 dBm.
  - c. Press the **MARKER SETUP** key on the front panel and then the **Markers** side key to select Off. Check that the marker disappears.
4. Check the RBW (Resolution Bandwidth) while changing the span setting.
  - a. Press the **SPAN** key on the front panel.
  - b. Confirm that the span is 36 MHz (RSA3408B) or 15 MHz (RSA3300B) and the RBW is 100 kHz (RSA3408B) or 80 kHz (RSA3300B) in the setup display on the upper part of the screen. (See Figure 8.)

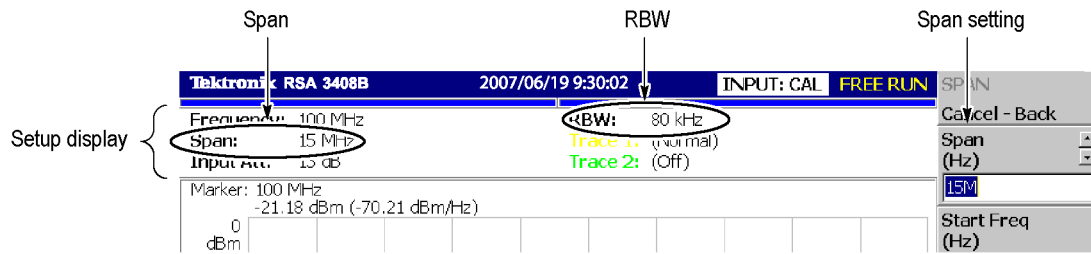

Figure 8: Setup display

- c. Using the general purpose knob, change the span setting as listed below and check that the RBW is displayed correctly.

Table 1: Span and RBW

Span	RBW
36 MHz (RSA3408B)	100 kHz
15 MHz	80 kHz
5 MHz	20 kHz
100 kHz	500 Hz
1 kHz	20 Hz

- d. Using the numeric keypad, set the span back to 36 MHz (RSA3408B) or 15 MHz (RSA3300B). (For example, press **3** → **6** → **MHz**, in that order, on the keypad.)
5. Check the reference level:
- a. Press the **AMPLITUDE** key on the front panel.
  - b. Make sure that the reference level is set to 0 dBm with the **Ref Level** side key. Check that 0 dBm is displayed on the upper left side of the graticule. (See Figure 9.)
  - c. Use the general purpose knob to set the reference level to -30 dBm.
  - d. Confirm that A/D OVERFLOW is indicated in the red box at the top center of the screen. Make sure that -30 dBm is displayed on the upper left side of the graticule and that the spectrum waveform is distorted. (See Figure 9.)

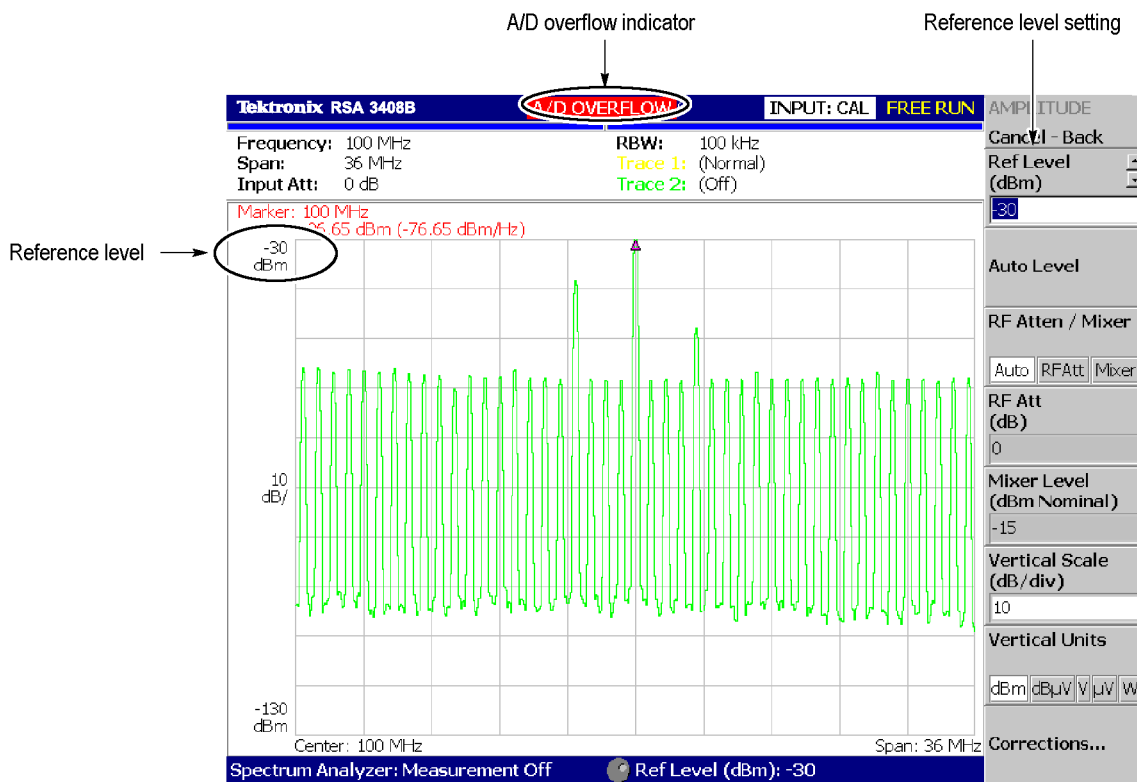

Figure 9: Reference level setting and A/D overflow indicator

- e. Using the numeric keypad, set the reference level back to 0 dBm. (Press **0** → **ENTER**, in that order, on the keypad.)
6. Check the spectrogram display:
  - a. Press the **S/A** key on the front panel.
  - b. Press the **S/A with Spectrogram** side key. Check that the spectrogram is displayed on the lower side of the screen. (See Figure 10.)
  - c. Press the **RUN/STOP** key on the front panel to stop data acquisition. Confirm that the trace display freezes and **PAUSE** is displayed in the status indicator at the top right of the screen.

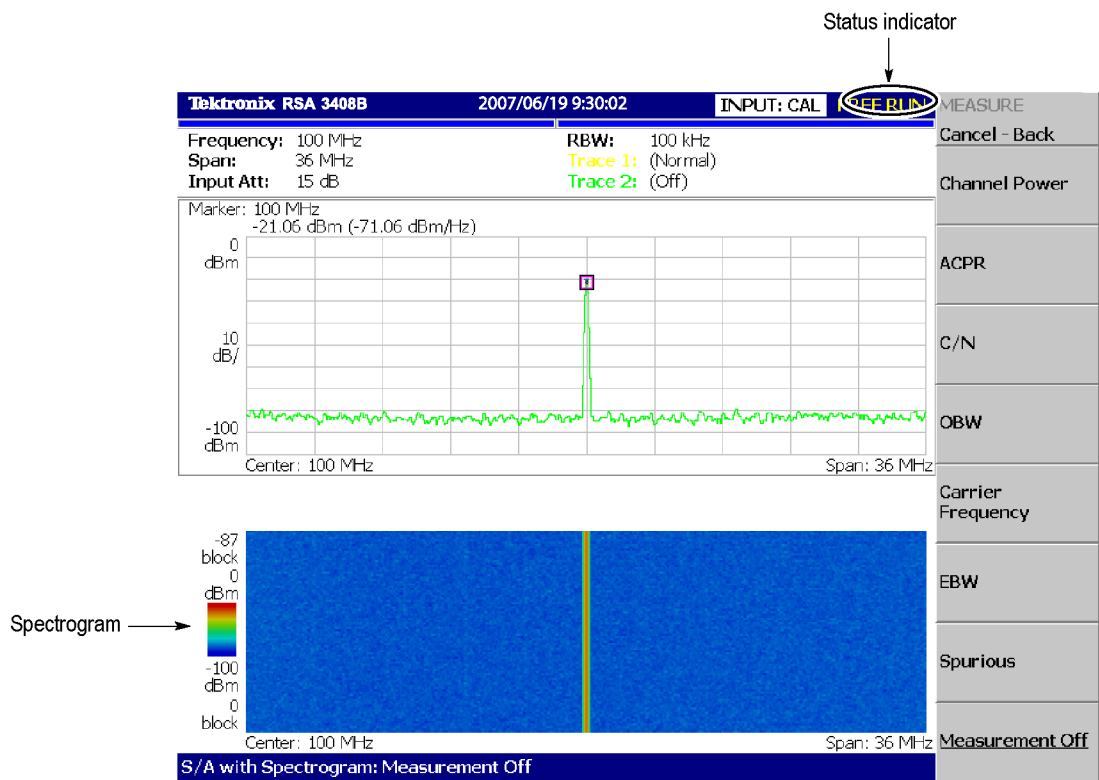

Figure 10: Spectrogram display

## Powering Off the Analyzer

Turn off the power switch on the front panel.



**CAUTION.** When you power on or off the analyzer, you must use the front-panel power switch. Failure to do so may cause the operating system to shut down improperly.

When you power on the analyzer again, wait at least 10 seconds after the last power off.

When you press the front-panel ON/STANDBY switch, the analyzer starts a shutdown process (including a Windows shutdown) to preserve settings and then power off. The LED next to the power switch changes to orange. Avoid using the rear-panel power switch or disconnecting the power cord to power off the analyzer.

To completely remove power to the analyzer, perform the shutdown just described, and then set the power switch on the rear panel to off.



---

**NOTE.** *Turning off the front-panel power switch does not shut down the principal power supply completely. To turn off the principal power supply, press the principal power switch on the rear panel. Turning off the principal power switch turns off the front-panel LED. When you do not use the analyzer for a long time or in case of emergency, you should unplug the power cord.*

---

## Restarting the Analyzer

When the analyzer operates abnormally, use the following procedure to turn the analyzer off and on again.

---

**NOTE.** *When the analyzer operates abnormally, it will not be shut down by turning off the front-panel power switch alone.*

---

1. Make sure that the front-panel power switch is in the turned-off position.
2. Turn off the principal power switch on the rear panel.
3. Wait at least 10 seconds and then turn on the principal power switch again.
4. Turn on the front-panel power switch.

### When Scan Disk Appears

If the analyzer was not shut down properly, Windows Scan Disk may run when you turn on the analyzer. When the Scan Disk screen appears, wait until the Scan Disk is completed. If an error is detected, refer to the Windows manual for treatment.

### When the Display Brightness Is Not Even

It is a characteristic of the LCD (Liquid Crystal Display) panel to sometimes have uneven brightness, dead pixels (dots that never turn on) or stuck pixels (dots that always stay on). This is neither a malfunction nor a defect, and not a cause for repair or exchange.

## Backing Up User Files

You should back up your user files on a regular basis as an insurance against system failures. The Back Up tool is located in the System Tool folder in the Accessory folder of Windows. Start this tool to select the files and folders to back up. For more information, use Windows online help.

The following files should be backed up more frequently:

- Status files (\*.sta)
- Data files (\*.iqt)
- Trace files (\*.trc)
- Correction files (\*.cor)

**Using a LAN** The analyzer is equipped with a LAN Ethernet interface that lets you save data to peripheral devices such as other PCs and hard disks.

## About Installation of Other Applications

The analyzer incorporates Windows XP as the operating system. Some combinations of internal measurement applications and external applications may cause deterioration in the basic performance or conflicts between these applications.

It is not recommended that you install other applications, including Microsoft Word, Excel, and Outlook, on the analyzer. If you install an external application, you do so at your own risk, keeping in mind that it may lower the performance of the analyzer.

# Calibration

Perform these routines to optimize the analyzer performance:

- Gain calibration
- Center offset calibration
- DC offset calibration
- IF flatness calibration
- Display brightness adjustment

Each item is explained in this section.

## Cal Menu

Use the **CAL** key to calibrate the analyzer.

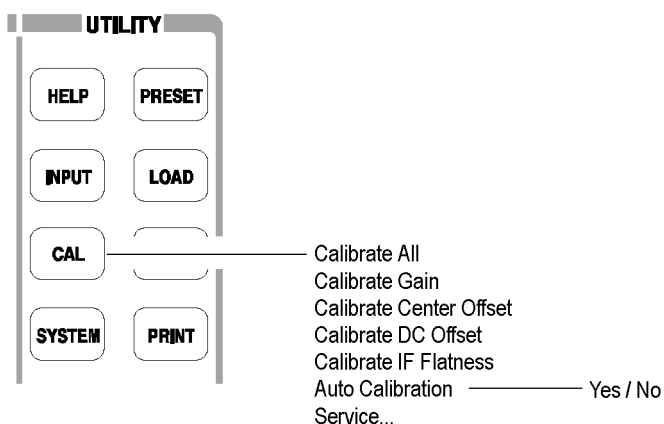

**Figure 11: Calibration menu structure**

The Cal menu contains the following controls:

**Calibrate All.** Performs all possible calibration operations.

**Calibrate Gain.** Calibrates the internal gain steps. (See page 16, *Calibrating Gain*.)

**Calibrate Center Offset.** This calibration cancels a center offset. (See page 17, *Calibrating Center Offset*.)

**Calibrate DC Offset.** This calibration cancels DC offset in baseband. (See page 17, *Calibrating DC Offset*.)

**Calibrate IF Flatness.** Calibrates the IF (intermediate frequency) flatness. (See page 18, *Calibrating IF Flatness (RSA3408B Only)*.)

**Auto Calibration.** Determines whether to automatically perform all possible calibration operations. The default setting is On.

**Service...** Only used by qualified personnel for repair and calibration.

If you want to perform all possible calibration operations together, press the **Calibrate All** side key. When **Auto Calibration** is set to Yes, they will be performed automatically any time the analyzer is in an uncal state.

**NOTE.** *When you run the calibration during signal acquisition, the calibration starts after the acquisition is completed.*

## Calibrating Gain

The gain calibration calibrates the analyzer’s amplifier gain using the internal signal generator. Run this internal calibration routine as required when you boot the analyzer or when UNCAL (uncalibrated) is displayed during operation.

Allow the analyzer to warm up for 20 minutes before you begin the calibration. The warm-up period allows electrical performance of the analyzer to stabilize.

During normal operation, when the ambient temperature changes by more than  $\pm 5$  °C from the temperature at the last calibration, UNCAL is displayed in the yellow box at the top of the screen. (See Figure 12.) If this happens, run the gain calibration.

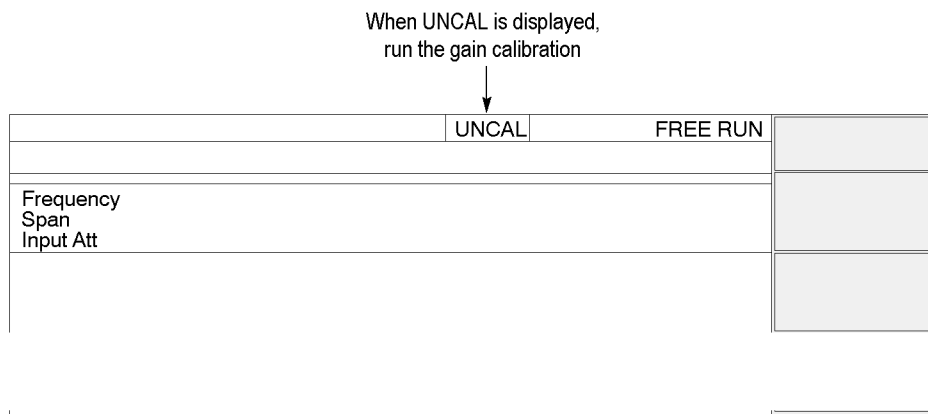

**Figure 12: UNCAL display**

To run the gain calibration, do the following:

1. Press the **CAL** key on the front panel.
2. Press the **Calibrate Gain** side key.

The calibration runs. It takes several seconds to complete the process.

## Calibrating Center Offset

When you display a spectrum and no input signal is present, a spurious emission at the center frequency may appear regardless of frequency settings. The center offset calibration cancels those spurious emissions. If the spurious emission is too obvious when you narrow the span, run the calibration.

---

**NOTE.** *Option 03 only. When you input I and Q signals from the rear panel connectors, set the IQ input signal level to zero externally.*

---

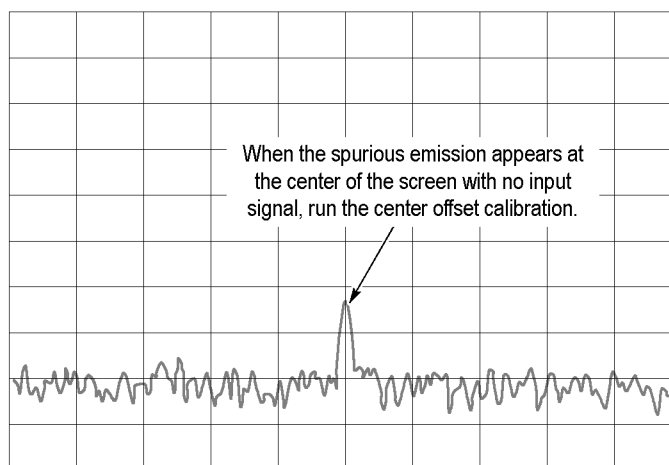

**Figure 13: Center offset**

To run the center offset calibration, do the following:

1. Press the **CAL** key on the front panel.
2. Press the **Calibrate Center Offset** side key.

The calibration runs. It takes several seconds to complete the process.

## Calibrating DC Offset

The DC offset calibration cancels DC offset that appears at 0 Hz in the baseband (RSA3408B: DC to 40 MHz, RSA3300B: DC to 20 MHz). When you change the amplitude setting and the DC offset is too obvious, run the DC offset calibration.

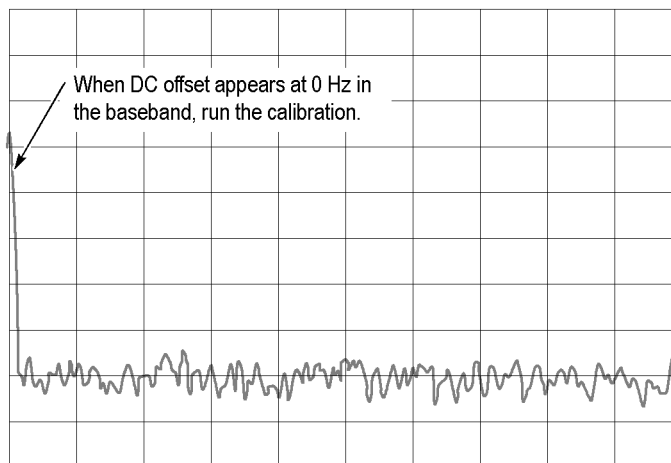

**Figure 14: DC offset**

To run the DC offset calibration, do the following:

1. Press the **CAL** key on the front panel.
2. Press the **Calibrate DC Offset** side key.

The calibration runs. It takes several seconds to complete the process.

## Calibrating IF Flatness (RSA3408B Only)

The IF flatness calibration adjusts the IF (intermediate frequency) flatness using the internal signal generator. It optimizes the flatness of gain and phase within the IF bandwidth automatically. This calibration is recommended in digital modulation analysis.

To run the IF flatness calibration, do the following:

1. Press the **CAL** key on the front panel.
2. Press the **Calibrate IF Flatness** side key.

The calibration runs. It takes several seconds to complete the process.

## Display Brightness Adjustment

Adjust the brightness of the display according to your environment.

1. Press the **SYSTEM** key on the front panel. (See Figure 15.)

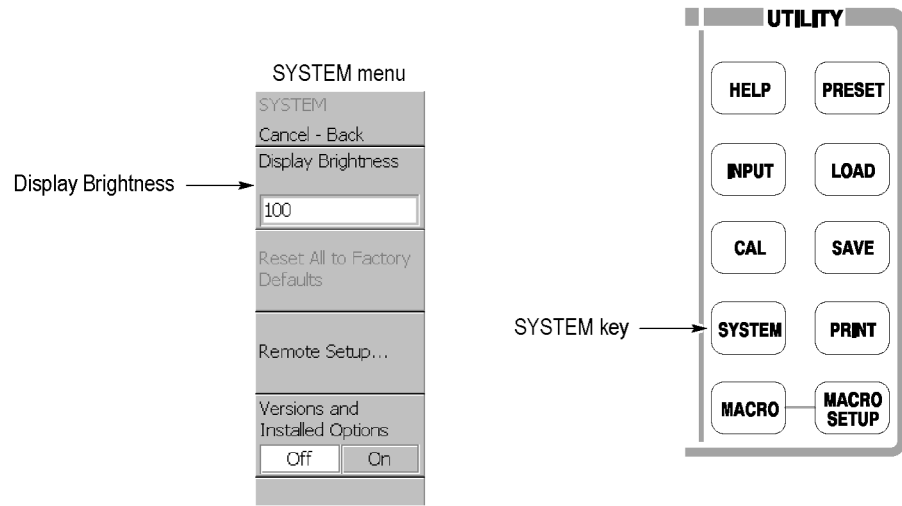

Figure 15: System menu

2. Press the **Display Brightness** side key.
3. Turn the general purpose knob to adjust the brightness. The setting range is 0 to 100.

## Confirming Performance

The electrical characteristics described in *Appendix A: Specifications* can be checked only by our service personnel. If you need any service, contact your local Tektronix representative.





# Functional Overview

This section describes the controls, connectors, display, and menu operation.

## Interface Maps

### Controls and Connectors

The following Figures show the controls and connectors on the front, the side, and the rear panels.

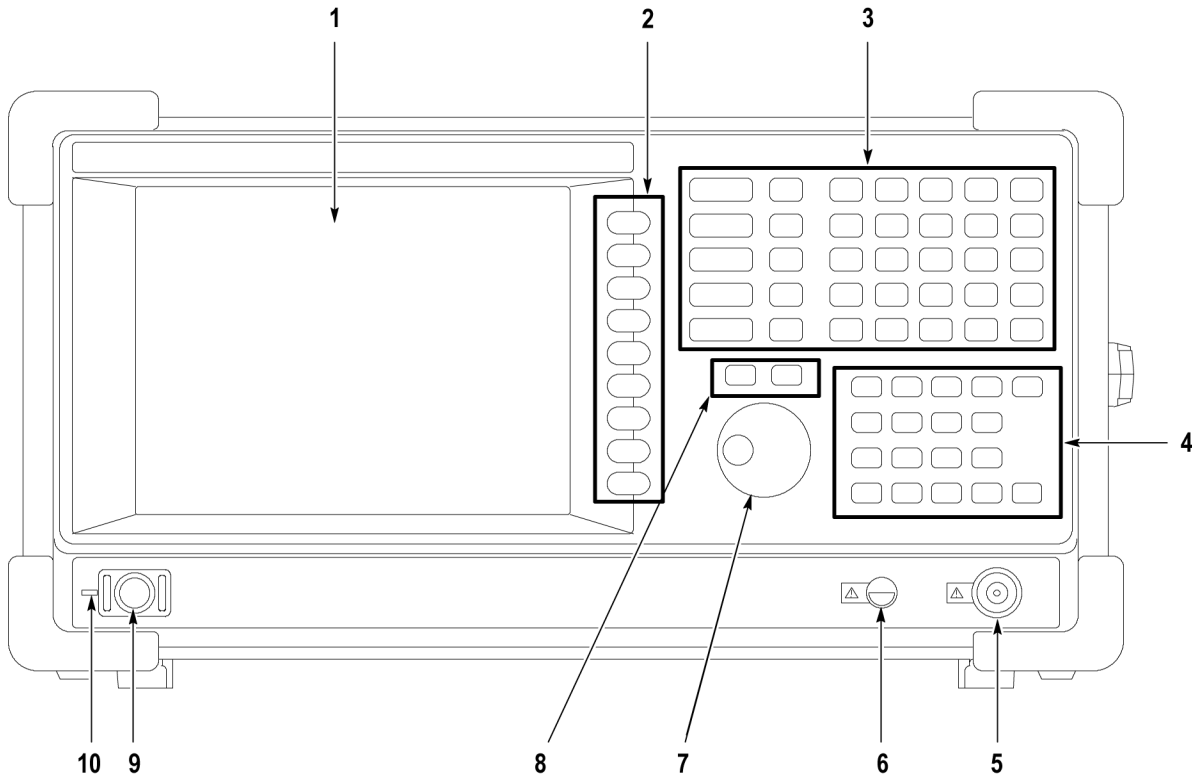

Figure 16: Front panel

1. **Display.** Size: 21.3 cm (8.4 inch) Resolution: 800 X 600 dots Color: 256 colors maximum
2. **Side Keys.** Select menu items associated with menu keys.
3. **Menu keys.** Select menus.
4. **Keypad.** Enters alpha and numeric characters.
5. **RF input connector.** Connects an input signal. N-type connector, Input impedance: 50  $\Omega$ . Maximum capacity of non-breakdown input: 30 dBm.
6. **Preamplifier power source.** Provides power source for a preamplifier (optional accessory). (See Table 30 on page 57.)
7. **General purpose knob.** Changes a value.
8. **Up/Down keys.** Increase or decrease a value.
9. **Power switch (ON/STANDBY).** (See page 6, *Turning on the Analyzer.*)
10. **LED.** Green on operating, orange on standby.



**CAUTION.** Applying a signal of more than +30 dBm may damage the instrument.

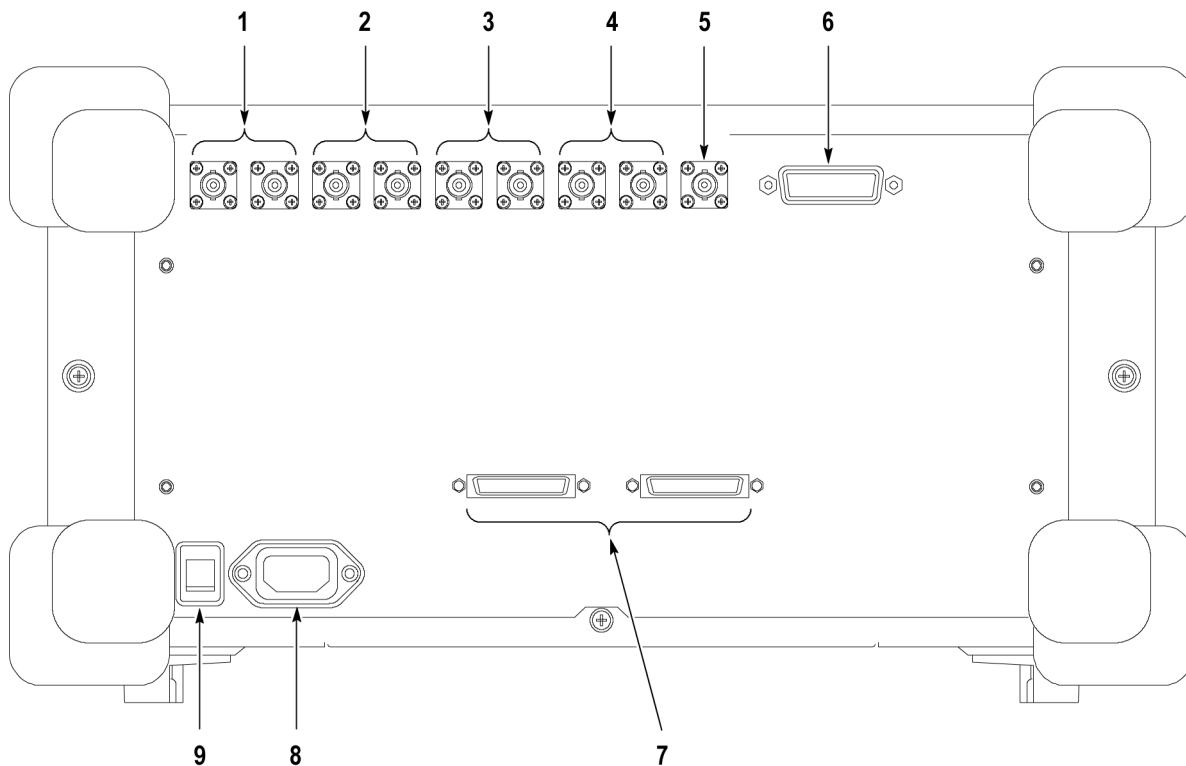
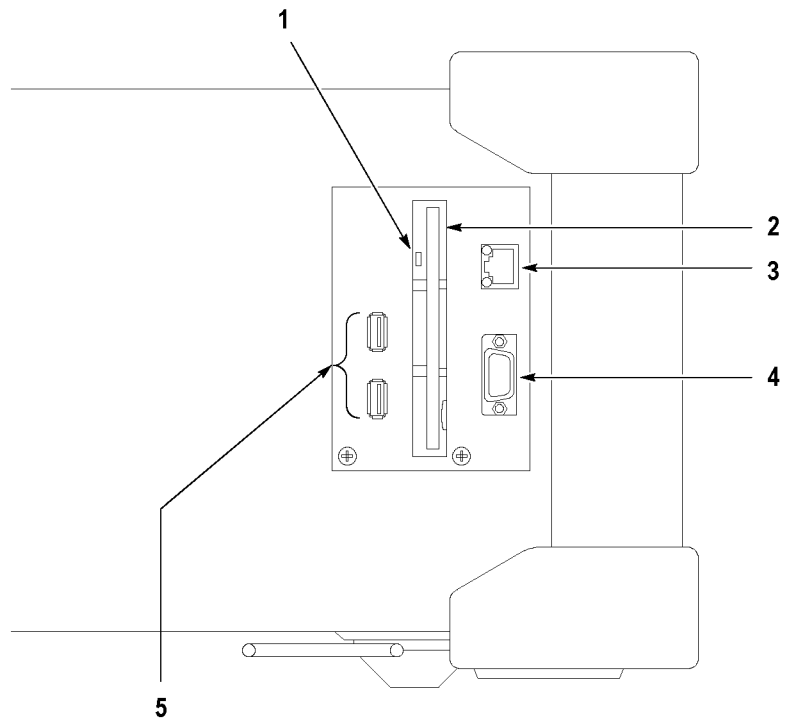

Figure 17: Rear panel

1. **REF IN/OUT connector.** 50  $\Omega$  BNC connector for reference signal input/output. (See Table 10 on page 42.)
2. **I+/I- INPUT connector (Option 03 only).** 50  $\Omega$  BNC connector for I signal differential input. When using one connector as a single-ended input, terminate the other end in 50  $\Omega$ .
3. **Q+/Q- INPUT connector (Option 03 only).** 50  $\Omega$  BNC connector for Q signal differential input. When using one connector as a single-ended input, terminate the other end in 50  $\Omega$ .
4. **TRIG IN/OUT connector.** 50  $\Omega$  BNC connector for trigger signal input/output. (See Table 16 on page 48.)
5. **421 MHz IF OUT connector. (RSA3408B only)** 50  $\Omega$  BNC connector for 421 MHz IF (Intermediate Frequency) output.
6. **GPIB connector.** Used to control the analyzer from an external controller. Refer to the programmer manual for GPIB control.
7. **DIGITAL IQ OUT (RSA3408B Option 05 only).** MDR (3M) 50-pin connectors for generating I and Q data after A/D conversion to store and analyze on an external PC. (See Table 30 on page 57.)
8. **AC input.** Connect AC power cable.
9. **PRINCIPAL POWER SWITCH.** When this switch is on, the internal standby circuit is energized. (See page 6, *Turning on the Analyzer.*)



**Figure 18: Side panel**

**1. Indicator.** Indicates whether the disk drive is active.



**CAUTION.** *When this indicator is lit, you must not remove the disk from the disk drive. If you do so, the data stored on the medium may be destroyed or an error may occur.*

- 2. Disk drive.** Saves and loads data and settings. A 3.5-inch 2HD (1.44MB) or 2DD (720KB) disk formatted for MS-DOS can be used.
- 3. LAN Ethernet connector.** 10/100BASE-T connector. Connects this instrument to a network.
- 4. VGA output connector.** Sends the display of this instrument to another monitor. 15 pin D-sub connector (female)
- 5. USB connector.** Connect a mouse, a keyboard and a printer that meets USB specifications.

## Using a Mouse and Keyboard

You can operate the analyzer using the standard accessory mouse and keyboard instead of the side keys and the front panel keypad.

The mouse and keyboard operations are as follows:

- Click the menu item instead of pressing the side keys.
- If the menu item has arrow buttons, click them to select the value.

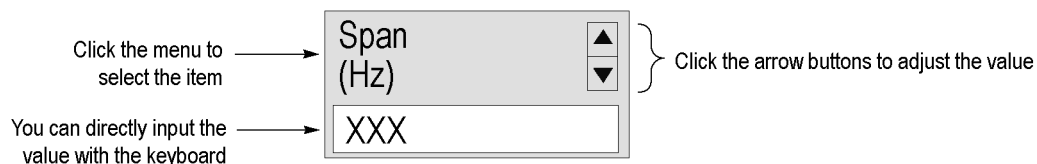

**Figure 19: Operation with mouse and keyboard**

**Table 2: Key functions of the keyboard**

Key	Purpose	Function
Numeric keys	Numeric input	Enter a numeric value in a numeric input field.
Left/Right arrow keys	Caret move	Moves the caret in an alpha or numeric input field.
Home	Caret move	Moves the caret to the beginning of an input field.
End	Caret move	Moves the caret to the end of an input field.
Backspace	Alphanumeric input	Deletes the character before the caret.
Delete	Alphanumeric input	Deletes the character after the caret.
ESC	Alphanumeric input	Aborts a numeric entry and restores the original value.
ENTER	Alphanumeric input	Accepts a value in the input field.
K or k key	Alphanumeric input	Kilo ( $10^3$ ). Press ENTER to complete entry of the value.
M key	Alphanumeric input	Mega ( $10^6$ ). Press ENTER to complete entry of the value.
G or g key	Alphanumeric input	Giga ( $10^9$ ). Press ENTER to complete entry of the value.
m key	Alphanumeric input	milli ( $10^{-3}$ ). Press ENTER to complete entry of the value.

**Table 2: Key functions of the keyboard (cont.)**

Key	Purpose	Function
U or u key	Alphanumeric input	micro (10 <sup>-6</sup> ). Press ENTER to complete entry of the value.
N or n key	Alphanumeric input	nano (10 <sup>-9</sup> ). Press ENTER to complete entry of the value.

**Display Screen**

The following Figure shows the elements of the display screen.

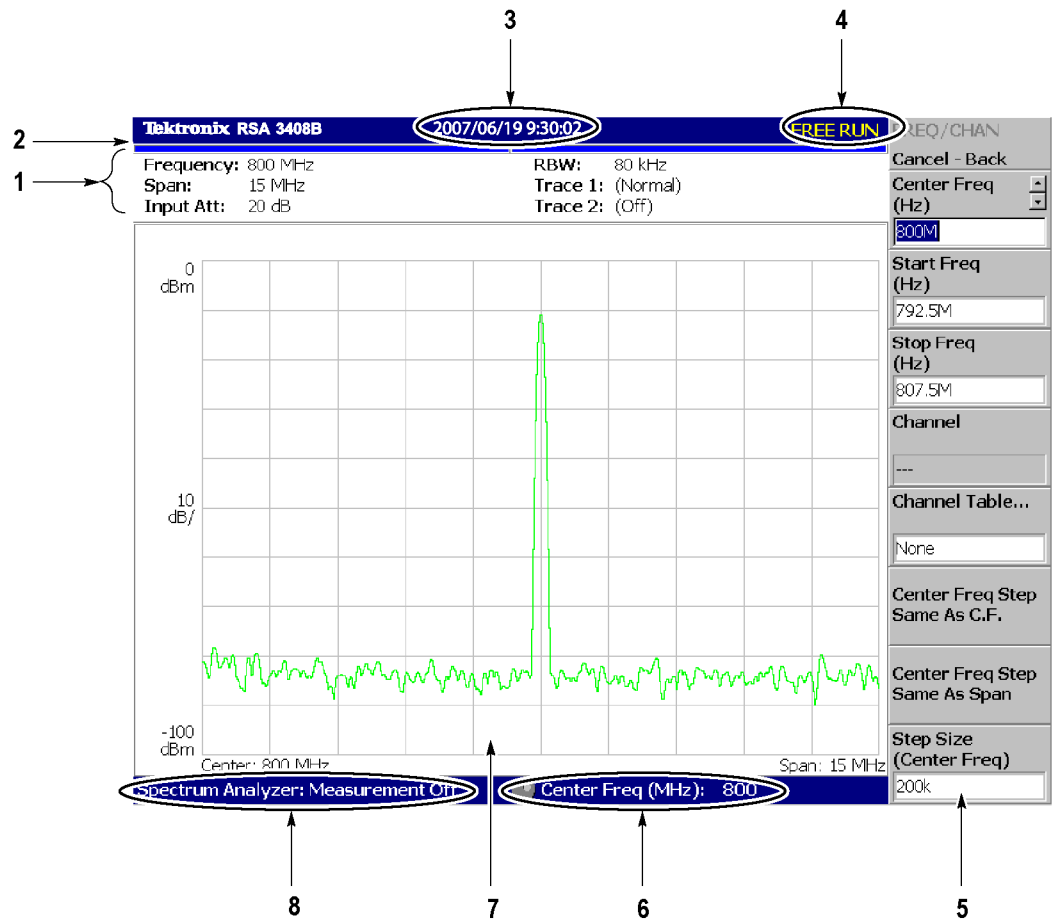

**Figure 20: Display screen configuration (RSA3408B shown)**

1. **Setup display area.** Displays the current hardware value. (See page 29, *Setup Display*.)
2. **Progress bar.** Indicates the progress of the acquisition cycle on the left bar and the measurement cycle on the right bar. The progress fills up in blue from left to right.
3. **Date/Time display area.** Shows the current date and time.
4. **Status display area.** Shows the trigger status. (See page 27, *Status Display*.)
5. **Side menu display area.** When you press a menu key on the front panel, the menu associated with that key is displayed.
6. **Menu setting display area.** Displays the last setting of the menu item that can be set with the general purpose knob.
7. **View.** The View window displays the waveform or the measurement results. Multiple views can be displayed on one display screen, depending on the measurement mode.
8. **Measurement function display area.** Displays the measurement function currently in use (the settings of the Mode and Measure menus).

## Status Display

The status display area in the upper right side of the screen shows the instrument status as listed in the table below. (See Figure 21.)

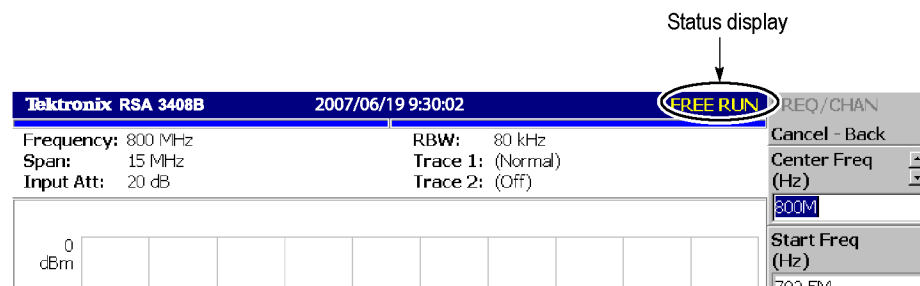

Figure 21: Status display (RSA3408B shown)

Table 3: Status display

Item	Description
ARM	The pre-trigger portion of the acquisition record is filling. A trigger event occurring during this state will not be recognized.
READY	Pre-trigger data has been acquired, and the instrument is waiting for a trigger event.
TRIG'D	Pre-trigger data has been acquired, and a trigger event has been detected. The instrument is now acquiring post-trigger data.

**Table 3: Status display (cont.)**

Item	Description
FREE RUN	The instrument acquires and measures without waiting for a trigger event.
PAUSE	The user has temporarily stopped acquisition/measurement cycling.

The acquired data is stored in the data memory from address zero in order of acquisition. When you set a trigger condition, the acquired data is stored in the pre-trigger region until the trigger event occurs. Thereafter, it is stored in the post-trigger region. (See Figure 22.)

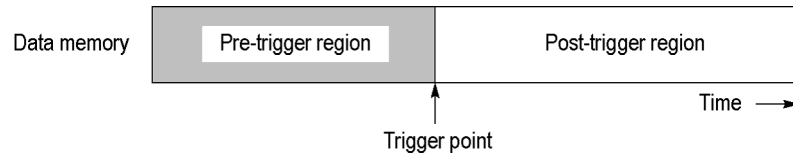

**Figure 22: Pre- and post-trigger regions**

**Front Panel Key Lock**

When controlling this instrument through GPIB, you can disable all the keys on the front panel except the power switch using the :SYSTEM:KLOCK command. At this time, the message "PANEL LOCK" is displayed on the top side key. (See Figure 23.)

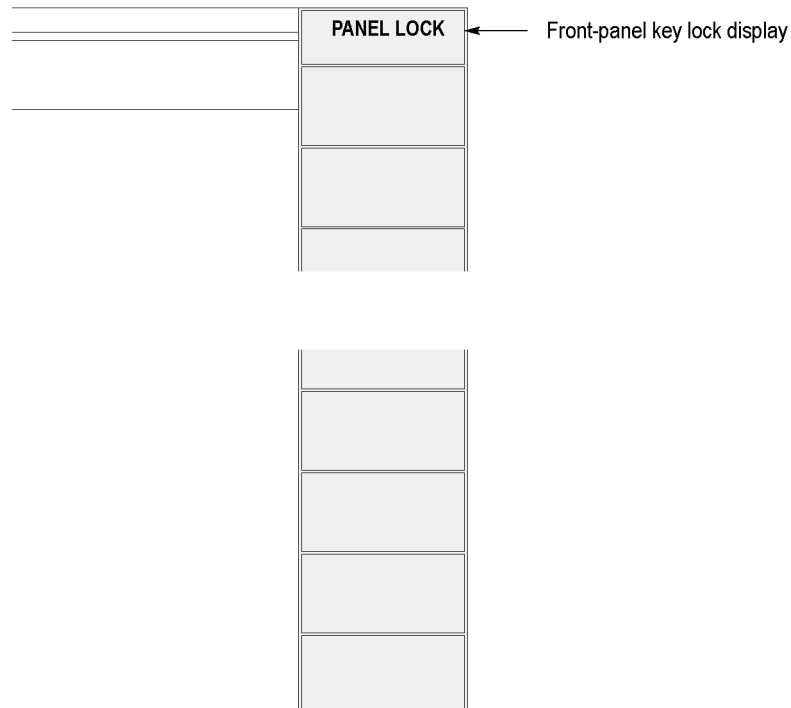

**Figure 23: Key lock display**



To cancel the key lock, the following two methods can be used:

- Use the :SYSTEM:KLOCK command to cancel.
- Turn off the power and then on.

Refer to the programmer manual for information about the GPIB commands.

### Setup Display

The setup display area in the upper part of the screen shows the analyzer hardware settings. (See Figure 24.) The contents differ depending on the measurement mode: spectrum analysis (S/A), modulation analysis (Demod), or time analysis (Time), as shown in the table below.

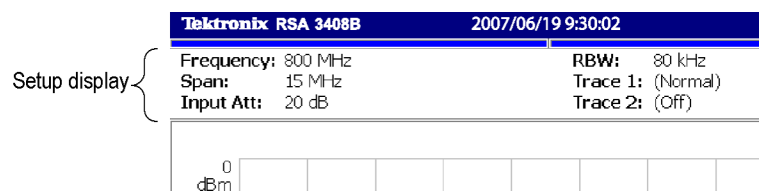

Figure 24: Setup display (RSA3408B shown)

Table 4: Setup display

Item	Description	Mode
Frequency	Indicates the center frequency.	All
Span	Indicates the span.	
Input Att	Indicates the attenuation of an input signal before it enters the internal mixer.	
RBW	Indicates RBW (Resolution Bandwidth) for compatibility with swept spectrum analyzers.	S/A
NBW	Indicates NBW (Noise Bandwidth) instead of RBW when FFT-processed data does not go through RBW process.	
Trace 1 and 2	Indicates the Trace 1 and 2 trace type.	

**Table 4: Setup display (cont.)**

<b>Item</b>	<b>Description</b>	<b>Mode</b>
Spectrum Length	Indicates time length of a 1024-point FFT frame. It is determined by the span.	Real Time S/A
Spectrum Interval	Indicates time interval between FFT frames.	
Acquisition Length	Indicates time to acquire a block of data. It can be set in the Timing menu.	Demod and Time

## Menu Operations

This section describes basic operations of the analyzer menus and how to select menu items and input numeric values.

### Menu Item Information

Up to nine soft keys can be displayed down the right side of the screen. (See Figure 25.) Cancel - Back is always displayed at the top, and the other eight keys select menu items.

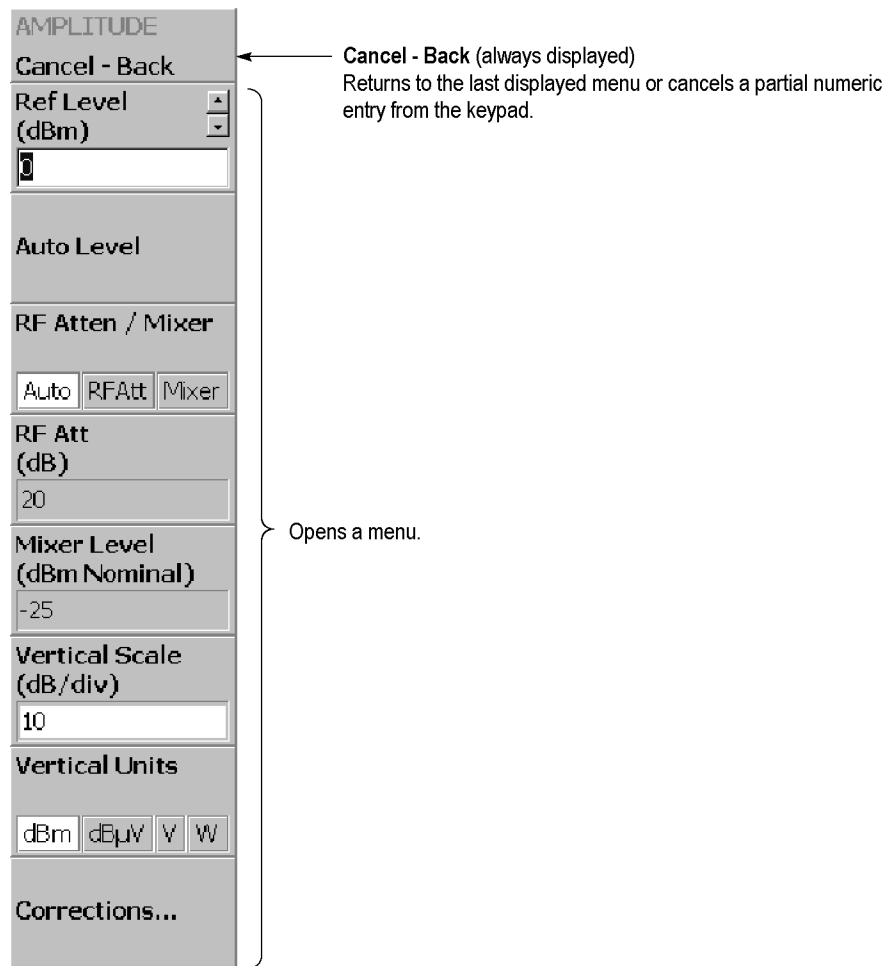



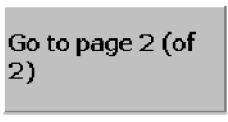



Figure 25: Examples of menu item display

**NOTE.** When the setting is prohibited or is not available, the item is displayed in gray.

**Menu Item Types** The different types of menu items are shown below.

**Table 5: Menu item types**

	<p><b>Numeric entry</b> The current value of parameter is displayed. To change the value, press the associated side key and use the general purpose knob, up/down keys, or the keypad.</p>
	<p><b>Toggle</b> You can switch selection items by pressing the associated side key.</p>
	<p><b>Function execution</b> The function indicated on the label is executed by pressing associated side key. In this example, the "Channel Power" measurement is performed.</p>
	<p><b>Move to sub-menu</b> If the label is followed by "...", you can move to a lower-level menu by pressing the associated side key.</p>
	<p><b>Move between pages</b> When the number of menu items is greater than seven, this menu appears. To move to the next page, press the associated side key. If you are on the last page, you will return to the first page.</p>
	<p><b>Invalid</b> Menu items without labels do not cause any action.</p>

**Numeric Input** An example numeric input field is shown below. In this type of field, you can change the numeric value by turning the general purpose knob, by pressing the up/down (▲▼) keys, or by entering a value using the keypad.

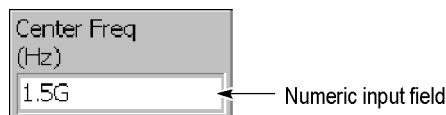
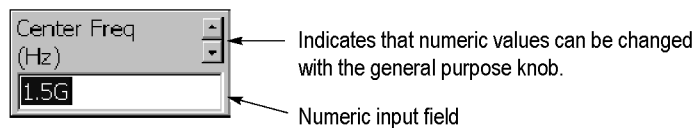

**Figure 26: Numeric setting menu**

### Changing Value Using the General Purpose Knob or the Up and Down keys.

1. Press the side key to set a numeric value. For example, press **FREQUENCY/CHANNEL** → **Center Freq** to set a center frequency.

The menu item changes to the display as shown below.



**Figure 27: Changing value with the knob**

2. Turn the general purpose knob to increase or decrease the value.

You can also use the up and down (▲▼) keys to increase or decrease a setting value, respectively.

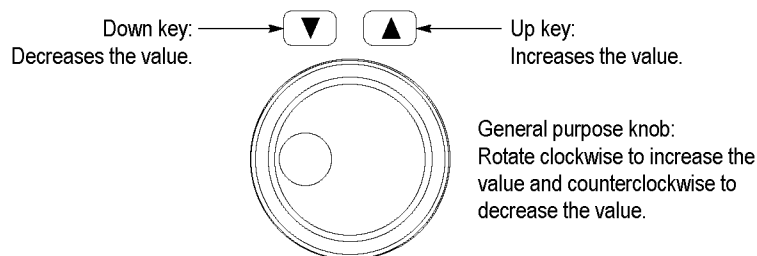

The up and down keys have the same functions as the general purpose knob except the step size (the amount per click by which the general purpose knob changes a setting value or the amount per press for the up and down keys) as follows:

- For the general purpose knob, the step size is determined internally. You can not change the step size.
- For the up and down keys, the step size is set with the **Step Size** side key. (See page 34, *Changing the Step Size*.)

The changed value is immediately reflected on the analyzer settings and displays.

**Entering a Value Using the Keypad.** You can enter values using the front panel keypad. (See Figure 29.)

1. Press the side key for setting a numeric value. For example, press **FREQUENCY/CHANNEL** → **Center Freq** to set a center frequency.

The menu item changes to the display shown below.

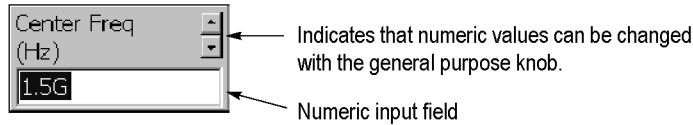

**Figure 28: Changing value with the keypad**

2. Press the keys required to enter the desired numeric value. For example, to enter the frequency 123.45 MHz, press **1 2 3 . 4 5 MHz**.

To delete an entered number, press the **BKSP** (Backspace) key.

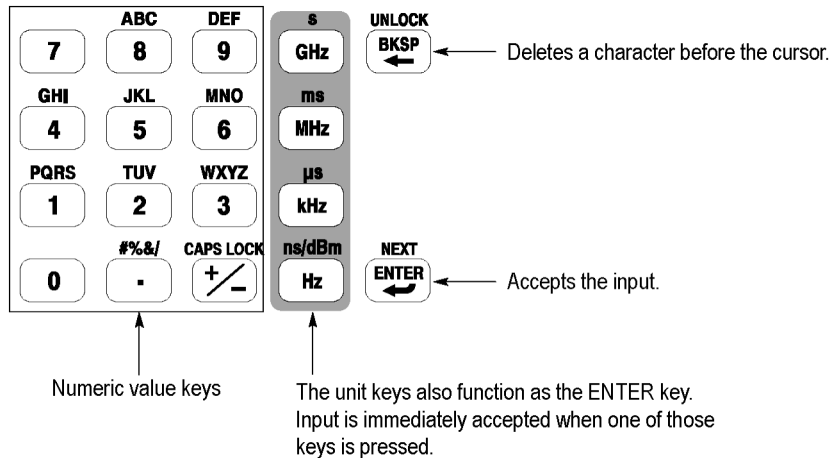

**Figure 29: Numeric keypad**

3. Confirm the input by pressing the unit key or **ENTER** key. The confirmed value is immediately reflected to the analyzer settings and display.

Press the **Cancel - Back** side key to cancel the change.

### Changing the Step Size

When using the up and down (▲▼) keys to increase or decrease a setting value, you can change the step size (the amount per press by which the up or down key changes the setting value) with the Step Size.

In the example below, the step size for the start frequency is set to 100 kHz; the displayed frequency set value changes by 100 kHz step for each press of the up or down key.

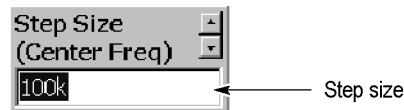

**Figure 30: Changing the step size for the center frequency**

**Step Size for Center Frequency.** The step size is set with the **Step Size** side key. The center frequency step size can be also set with two side keys in the Frequency/Channel menu. (See Figure 31.)

- **Center Freq Step Same As C.F.** Useful for quickly locating harmonics of a signal seen at the center frequency.
- **Center Freq Step Same As Span.** Useful for quickly analyzing a larger frequency area without overlapping span windows.

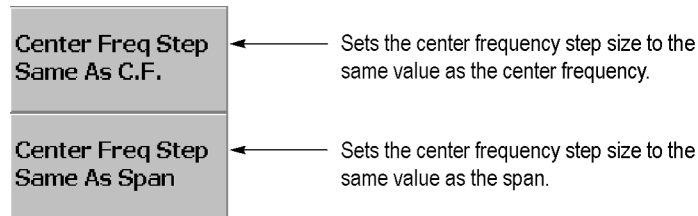

**Figure 31: Changing the step size for the center frequency**





---

## Appendix A: Specifications

This appendix lists the electrical, physical, and environmental characteristics of the RSA3408B and RSA3300B analyzers, and it specifies the performance requirements for those characteristics. Characteristics apply to both the RSA3408B and RSA3300B analyzers, except where noted.

Unless otherwise stated, the following tables of electrical characteristics and features apply to the analyzer after a 20 minute warm-up period (within the environmental limits) and after all calibration procedures have been carried out.

## Electrical Characteristics

**Table 6: Frequency**

Characteristics	Description
<b>Measurement frequency</b>	
RSA3408B Frequency range	Overall: DC to 8 GHz Baseband: DC to 40 MHz RF1: 40 MHz to 3.5 GHz RF2: 3.5 GHz to 6.5 GHz RF3: 5 GHz to 8 GHz
RSA3300B Frequency range	Baseband: DC to 20 MHz RF: 15 MHz to 3 GHz (RSA3303B) RF1: 15 MHz to 3.5 GHz (RSA3308B) RF2: 3.5 GHz to 6.5 GHz (RSA3308B) RF3: 5 GHz to 8 GHz (RSA3308B)
Center frequency setting resolution	0.1 Hz
RSA3408B Frequency marker readout accuracy	Baseband: $\pm(\text{RE} \times \text{MF} + 0.001 \times \text{Span} + 0.2)$ Hz RF1 to 3: $\pm(\text{RE} \times \text{MF} + 0.001 \times \text{Span} + 2)$ Hz RE: Reference frequency error; MF: Marker frequency [Hz] The first term of these formula shows the frequency uncertainty due to the reference frequency error. The second term shows the uncertainty due to the limited bin number. Because more than 500 bins are available in the frequency display, 0.5 bin uncertainty corresponds to 0.001. The third term shows the residual FM.
RSA3300B Frequency marker readout accuracy	Baseband: $\pm(\text{RE} \times \text{MF} + 0.001 \times \text{Span} + 0.2)$ Hz RF, RF1 to 3: $\pm(\text{RE} \times \text{MF} + 0.001 \times \text{Span} + 2)$ Hz RE: Reference frequency error; MF: Marker frequency [Hz]
At specified frequency	Baseband, Frequency = 10 MHz, Span = 1 MHz Marker: $\pm 1$ kHz; Carrier frequency measurement: $\pm 1.2$ kHz RF/RF1, Frequency = 2 GHz, Span = 1 MHz Marker: $\pm 1.2$ kHz; Carrier frequency measurement: $\pm 210$ Hz RF2, Frequency = 5 GHz, Span = 1 MHz (RSA3308B only) Marker: $\pm 1.5$ kHz; Carrier frequency measurement: $\pm 510$ kHz RF3, Frequency = 7 GHz, Span = 1 MHz (RSA3308B only) Marker: $\pm 1.7$ kHz; Carrier frequency measurement: $\pm 710$ kHz
Residual FM ( <i>Typical</i> )	2 Hz p-p
Span accuracy	$\pm 1$ bin
RBW filter bandwidth accuracy	0.1% against noise bandwidth
<b>Reference frequency</b>	

**Table 6: Frequency (cont.)**

Characteristics	Description
Aging per day	$1 \times 10^{-9}$ (after 30 days of operation)
Aging per year	$1 \times 10^{-7}$ (after 30 days of operation)
Temperature drift	$1 \times 10^{-7}$ (10 to 40 °C)
Total frequency error	$2 \times 10^{-7}$ (within one year after calibration)
Reference output level	>0 dBm
External reference input	10 MHz, -10 to +6 dBm. Spurious level must be <-80 dBc within 100 kHz offset.

**Table 7: RSA3300B Spectrum purity**

Characteristics	Description
Spectrum purity (Frequency = 1500 MHz)	
Carrier offset = 10 kHz, span = 100 kHz	-100 dBc/Hz
Carrier offset = 100 kHz, span = 1 MHz	-105 dBc/Hz
Carrier offset = 1 MHz, span = 5 MHz	-125 dBc/Hz

**Table 8: RSA3300B Noise sideband**

Characteristics	Description	
	Noise sideband	Offset
Frequency = 1000 MHz	-100 dBc/Hz	1 kHz
	-105 dBc/Hz	10 kHz
	-105 dBc/Hz	20 kHz
	-105 dBc/Hz	30 kHz
	-112 dBc/Hz	100 kHz
	-132 dBc/Hz	1 MHz
	-135 dBc/Hz	5 MHz
	-135 dBc/Hz	7 MHz
Frequency = 2000 MHz	-96 dBc/Hz	1 kHz
	-104 dBc/Hz	10 kHz
	-105 dBc/Hz	20 kHz
	-105 dBc/Hz	30 kHz
	-112 dBc/Hz	100 kHz
	-132 dBc/Hz	1 MHz
	-135 dBc/Hz	5 MHz
	-135 dBc/Hz	7 MHz
Frequency = 6000 MHz (RSA3308B only)	-87 dBc/Hz	1 kHz
	-104 dBc/Hz	10 kHz
	-105 dBc/Hz	20 kHz
	-105 dBc/Hz	30 kHz
	-112 dBc/Hz	100 kHz
	-128 dBc/Hz	1 MHz
	-130 dBc/Hz	5 MHz
	-130 dBc/Hz	7 MHz

Table 8: RSA3300B Noise sideband (cont.)

Characteristics	Description	
	Noise sideband	Offset
Frequency = 1000 MHz, <i>Typical</i>	-103 dBc/Hz	1 kHz
	-108 dBc/Hz	10 kHz
	-108 dBc/Hz	20 kHz
	-108 dBc/Hz	30 kHz
	-115 dBc/Hz	100 kHz
	-135 dBc/Hz	1 MHz
	-138 dBc/Hz	5 MHz
	-138 dBc/Hz	7 MHz
Frequency = 2000 MHz, <i>Typical</i>	-99 dBc/Hz	1 kHz
	-107 dBc/Hz	10 kHz
	-108 dBc/Hz	20 kHz
	-108 dBc/Hz	30 kHz
	-115 dBc/Hz	100 kHz
	-135 dBc/Hz	1 MHz
	-138 dBc/Hz	5 MHz
	-138 dBc/Hz	7 MHz
Frequency = 6000 MHz, <i>Typical</i> (RSA3308B only)	-90 dBc/Hz	1 kHz
	-107 dBc/Hz	10 kHz
	-108 dBc/Hz	20 kHz
	-108 dBc/Hz	30 kHz
	-115 dBc/Hz	100 kHz
	-131 dBc/Hz	1 MHz
	-133 dBc/Hz	5 MHz
	-133 dBc/Hz	7 MHz

Table 9: RSA3408B Noise sideband

Characteristics	Description	
	Noise sideband	Offset
Frequency = 1000 MHz	-105 dBc/Hz	1 kHz
	-110 dBc/Hz	10 kHz
	-110 dBc/Hz	20 kHz
	-110 dBc/Hz	30 kHz
	-112 dBc/Hz	100 kHz
	-132 dBc/Hz	1 MHz
	-138 dBc/Hz	5 MHz
	-138 dBc/Hz	7 MHz
	-138 dBc/Hz	10 MHz

Table 9: RSA3408B Noise sideband (cont.)

Characteristics	Description	
	Noise sideband	Offset
Frequency = 2000 MHz	-103 dBc/Hz	1 kHz
	-109 dBc/Hz	10 kHz
	-109 dBc/Hz	20 kHz
	-109 dBc/Hz	30 kHz
	-112 dBc/Hz	100 kHz
	-132 dBc/Hz	1 MHz
	-138 dBc/Hz	5 MHz
	-138 dBc/Hz	7 MHz
	-138 dBc/Hz	10 MHz
Frequency = 6000 MHz	-97 dBc/Hz	1 kHz
	-106 dBc/Hz	10 kHz
	-106 dBc/Hz	20 kHz
	-106 dBc/Hz	30 kHz
	-111 dBc/Hz	100 kHz
	-132 dBc/Hz	1 MHz
	-137 dBc/Hz	5 MHz
	-137 dBc/Hz	7 MHz
	-137 dBc/Hz	10 MHz
Frequency = 1000 MHz, <i>Typical</i>	-107 dBc/Hz	1 kHz
	-112 dBc/Hz	10 kHz
	-112 dBc/Hz	20 kHz
	-112 dBc/Hz	30 kHz
	-115 dBc/Hz	100 kHz
	-135 dBc/Hz	1 MHz
	-140 dBc/Hz	5 MHz
	-140 dBc/Hz	7 MHz
	-140 dBc/Hz	10 MHz
Frequency = 2000 MHz, <i>Typical</i>	-105 dBc/Hz	1 kHz
	-111 dBc/Hz	10 kHz
	-111 dBc/Hz	20 kHz
	-111 dBc/Hz	30 kHz
	-115 dBc/Hz	100 kHz
	-135 dBc/Hz	1 MHz
	-140 dBc/Hz	5 MHz
	-140 dBc/Hz	7 MHz
	-140 dBc/Hz	10 MHz
Frequency = 6000 MHz, <i>Typical</i>	-99 dBc/Hz	1 kHz
	-108 dBc/Hz	10 kHz
	-108 dBc/Hz	20 kHz
	-108 dBc/Hz	30 kHz
	-113 dBc/Hz	100 kHz
	-134 dBc/Hz	1 MHz
	-139 dBc/Hz	5 MHz
	-139 dBc/Hz	7 MHz
	-139 dBc/Hz	10 MHz

**Table 10: Input**

Characteristics	Description
Signal input	
Input connector	N type (RF and baseband input); BNC type (Option 03 IQ input)
Input impedance	50 $\Omega$
VSWR	<1.4 (2.5 GHz, RF attenuation $\geq$ 10 dB) <1.8 (7.5 GHz, RF attenuation $\geq$ 10 dB (RSA3308B and RSA3408B only))
<i>Typical</i>	<1.4 (300 kHz to 40 MHz, RF attenuation $\geq$ 10 dB) <1.3 (40 MHz to 3 GHz, RF attenuation $\geq$ 10 dB) <1.4 (3 GHz to 8 GHz, RF attenuation $\geq$ 10 dB (RSA3308B and RSA3408B only))
Maximum input level	
Maximum DC voltage	$\pm$ 0.2 V (RF (RSA3303B), RF1 to 3) $\pm$ 5 V (Baseband) $\pm$ 5 V (Option 03 IQ input)
Maximum input power	+30 dBm (RF (RSA3303B), RF1 to 3, RF attenuation $\geq$ 10 dB)
Input attenuator (RSA3408B)	
RF/Baseband attenuator	0 to 55 dB (5 dB step)
I/Q attenuator (Option 03)	0 to 35 dB (5 dB step)
Input attenuator (RSA3300B)	
RF/Baseband attenuator	0 to 50 dB (2 dB step in RF/RF1/Baseband; 10 dB step in RF2/RF3)

Table 10: Input (cont.)

Characteristics	Description
I/Q attenuator (Option 03)	0 to 30 dB (10 dB step)

Table 11: RSA3408B Amplitude

Characteristics	Description
Reference level	
Reference level setting range	Baseband: -30 to +20 dBm (5 dB step) RF: -50 to +30 dBm (1 dB step) Option 03 IQ input: -10 to +20 dBm (5 dB step)
Accuracy (-10 to -50 dBm)	±0.2 dB (at 100 MHz, 10 dB attenuation, 20 to 30 °C)
Frequency response (RF attenuation ≥10 dB)	
at 20 to 30 °C	±0.5 dB (100 kHz to 40 MHz) ±1.2 dB (40 MHz to 3.5 GHz) ±1.7 dB (3.5 GHz to 6.5 GHz) ±1.7 dB (5 GHz to 8 GHz)
<i>Typical</i>	±0.3 dB (100 kHz to 40 MHz) ±0.5 dB (40 MHz to 3.5 GHz) ±1.0 dB (3.5 GHz to 6.5 GHz) ±1.0 dB (5 GHz to 8 GHz)
at 10 to 40 °C	±0.7 dB (100 kHz to 40 MHz) ±1.5 dB (40 MHz to 3.5 GHz) ±2.0 dB (3.5 GHz to 6.5 GHz) ±2.0 dB (5 GHz to 8 GHz)
Absolute amplitude accuracy at calibration point (20 to 30 °C)	Baseband: ±0.3 dB (at 25 MHz, -10 dBm signal) RF: ±0.5 dB (at 100 MHz, -20 dBm signal, 0 dB attenuation)
Input attenuator setting uncertainty	±0.2 dB (at 100 MHz)
Level linearity in display range	±0.2 dB (0 to -50 dBfs); ±0.12 dB (0 to -50 dBfs, <i>Typical</i> )

**Table 12: RSA3300B Amplitude**

Characteristics	Description
Reference level	
Reference level setting range	Baseband: -30 to +20 dBm (2 dB step) RF/RF1: -51 to +30 dBm (1 dB step) RF2/RF3 (RSA3308B only): -50 to +30 dBm (1 dB step) Option 03 IQ input: -10 to +20 dBm (10 dB step)
Accuracy (-10 to -50 dBm)	±0.2 dB (at 50 MHz, 10 dB attenuation, 20 to 30 °C)
Frequency response (RF attenuation ≥10 dB)	
at 20 to 30 °C	±0.5 dB (Baseband) ±1.2 dB (RF/RF1) ±1.7 dB (RF2, RSA3308B only) ±1.7 dB (RF3, RSA3308B only)
<i>Typical</i>	±0.3 dB (100 kHz to 20 MHz) ±0.5 dB (10 MHz to 3 GHz) ±0.5 dB (10 MHz to 3.5 GHz, RSA3308B only) ±1.0 dB (3.5 GHz to 6.5 GHz, RSA3308B only) ±1.0 dB (5 GHz to 8 GHz, RSA3308B only)
at 10 to 40 °C	±0.7 dB (Baseband) ±1.5 dB (RF/RF1) ±2.0 dB (RF2, RSA3308B only) ±2.0 dB (RF3, RSA3308B only)
Absolute amplitude accuracy at calibration point (0 dB attenuation, 20 to 30 °C)	±0.3 dB (Baseband at 10 MHz, -10 dBm signal) ±0.5 dB (at 50 MHz, -20 dBm signal)
Input attenuator setting uncertainty	±0.5 dB (at 50 MHz)
Level linearity in display range	±0.2 dB (0 to -40 dBfs) ±0.2 dB (0 to -50 dBfs), <i>Typical</i> ±0.12 dB (0 to -50 dBfs), <i>Typical</i>
Channel power measurement accuracy for W-CDMA signal at 20 to 30 °C	±0.6 dB (Signal frequency: 1900 to 2200 MHz; Signal power: +10 to -30 dBm; RF attenuation: 0 to 20 dB; After Auto Level operation at 10 MHz span)

**Table 13: Spurious response**

Characteristics	Description
1 dB compression input	+2 dBm (RF attenuation = 0 dB, 2 GHz)
RSA3408B: 2 <sup>nd</sup> harmonic distortion (-30 dBm tone at input mixer)	-65 dBc (10 MHz to 1400 MHz) -70 dBc (1400 MHz to 1750 MHz)
RSA3300B: 2 <sup>nd</sup> harmonic distortion (-30 dBm tone at input mixer)	-56 dBc (10 MHz to 1500 MHz) -56 dBc (10 MHz to 1750 MHz, RSA3308B only)
RSA3408B: 3 <sup>rd</sup> order intermodulation distortion (Reference level = +5 dBm , RF attenuation adjusted optimally, Total signal power = -7 dBm)	



Table 13: Spurious response (cont.)

Characteristics	Description
Center frequency = 2 GHz	-78 dBc
100 MHz to 3 GHz	-75 dBc
3 GHz to 8 GHz	-72 dBc
RSA3300B: 3 <sup>rd</sup> order intermodulation distortion (Reference level = +5 dBm , RF attenuation = Adjusted, Total signal power = -7 dBm)	
Center frequency = 2 GHz	-74 dBc
100 MHz to 3 GHz	-74 dBc
3 GHz to 8 GHz (RSA3308B only)	-72 dBc
Displayed average noise level	-144 dBm/Hz (1 kHz to 10 kHz, RSA3300B only) -144 dBm/Hz (100 Hz to 10 kHz, RSA3408B) -151 dBm/Hz (10 kHz to 10 MHz) -151 dBm/Hz (10 MHz to 100 MHz) -150 dBm/Hz (100 MHz to 1 GHz) -150 dBm/Hz (1 GHz to 2 GHz) -150 dBm/Hz (2 GHz to 3 GHz) -142 dBm/Hz (3 GHz to 5 GHz) -142 dBm/Hz (5 GHz to 8 GHz)
RSA3300B: ACLR (3GPP down link, test model 1, 16 ch)	60 dB (5 MHz offset) 63 dB (10 MHz offset)
<i>Typical</i>	66 dB (5 MHz offset) 70 dB (10 MHz offset)
Local feed-through to input connector ( <i>Typical</i> )	-40 dBm (local frequency 4.2 to 5 GHz) -55 dBm (local frequency 5 to 6 GHz) -60 dBm (local frequency 6 to 7 GHz) -60 dBm (local frequency 7 to 7.7 GHz, RSA3308B and RSA3408B only)
RSA3408B Image Suppression ( <i>Typical</i> )	
1 <sup>st</sup> IF	75 dB (40 MHz to 3.5 GHz) 70 dB (3.5 GHz to 8 GHz)
2 <sup>nd</sup> and 3 <sup>rd</sup> IF	80 dB (40 MHz to 3.5 GHz) 75 dB (3.5 GHz to 8 GHz)
RSA3300B Image Suppression ( <i>Typical</i> )	
1 <sup>st</sup> IF	75 dB (RF/RF1) 70 dB (RF2/RF3, RSA3300B only)
2 <sup>nd</sup> and 3 <sup>rd</sup> IF	80 dB (RF/RF1) 75 dB (RF2/RF3, RSA3300B only)
Alias suppression ( <i>Typical</i> )	65 dB (DC to 40 MHz, RSA3408B) 65 dB (Baseband, RSA3300B)
RSA3408B Residual response (Reference level = -30 dBm, RBW = 100 kHz)	

**Table 13: Spurious response (cont.)**

<b>Characteristics</b>	<b>Description</b>
Baseband, 1 to 40 MHz	-93 dBm (Span = 40 MHz)
RF1, 0.5 to 3.5 GHz	-90 dBm (Span = 3 GHz)
RF2, 3.5 to 6.5 GHz	-85 dBm (Span = 3 GHz)
RF3, 5 to 8 GHz	-85 dBm (Span = 3 GHz)
RSA3300B Residual response (Reference level = -30 dBm, RBW = 100 kHz)	
Baseband, 1 to 20 MHz	-93 dBm (Span = 20 MHz)
RF, 0.5 to 3 GHz (RSA3303B)	-90 dBm (Span = 2.5 GHz)
RF1, 0.5 to 3 GHz (RSA3308B)	-90 dBm (Span = 3 GHz)
RF2, 3.5 to 6.5 GHz (RSA3308B)	-85 dBm (Span = 3 GHz)
RF3, 5 to 8 GHz (RSA3308B)	-85 dBm (Span = 3 GHz)
RSA3408B Spurious response (Span = 10 MHz, Reference level = 0 dBm, RBW = 50 kHz)	
Baseband, 25 MHz	-73 dBc (Signal frequency = 25 MHz, Signal level = -5 dBm)
RF1, 2 GHz	-73 dBc (Signal frequency = 2 GHz, Signal level = -5 dBm)
RF2, 5 GHz	-70 dBc (Signal frequency = 5 GHz, Signal level = -5 dBm)
RF3, 7 GHz	-70 dBc (Signal frequency = 7 GHz, Signal level = -5 dBm)
RSA3300B Spurious response (Span = 10 MHz, Reference level = 0 dBm, RBW = 50 kHz)	
Baseband, 10 MHz	-73 dBc (Signal frequency = 10 MHz, Signal level = -5 dBm)
RF1, 2 GHz	-73 dBc (Signal frequency = 2 GHz, Signal level = -5 dBm)

**Table 13: Spurious response (cont.)**

Characteristics	Description
RF2, 5 GHz (RSA3308B only)	-70 dBc (Signal frequency = 5 GHz, Signal level = -5 dBm)
RF3, 7 GHz (RSA3308B only)	-70 dBc (Signal frequency = 7 GHz, Signal level = -5 dBm)

**Table 14: RSA3408B Acquisition**

Characteristics	Description
Real-time capture bandwidth	Baseband: 40 MHz; RF: 36 MHz; IQ: 40 MHz (Option 03 only)
A/D converter	14 bits, 102.4 Msps
Sampling rate (Real Time S/A, Demod, and Time modes)	
40 MHz span (Baseband)	51.2 Msps
40 MHz span (IQ, Option 03)	51.2 Msps
36 MHz span (RF)	51.2 Msps
20 MHz span	25.6 Msps
10 MHz span	12.8 Msps
5 MHz span	6.4 Msps
2 MHz span	2.56 Msps
1 MHz span	1.28 Msps
500 kHz span	640 ksps
200 kHz span	256 ksps
100 kHz span	128 ksps
50 kHz span	64 ksps
20 kHz span	25.6 ksps
10 kHz span	12.8 ksps
5 kHz span	6.4 ksps
2 kHz span	2.56 ksps
1 kHz span	1.28 ksps
500 Hz span	640 sps
200 Hz span	256 sps
100 Hz span	128 sps
Acquisition length (Real Time S/A, Demod, and Time modes)	Minimum: 1024 samples Maximum: 16,384,000 samples (Standard); 65,536,000 samples (Option 02)
Acquisition length setting resolution	1024 samples (Real Time S/A, Demod, and Time modes)
Acquisition memory size	Standard: 64 MB; Option 02: 256 MB

**Table 15: RSA3300B Acquisition**

<b>Characteristics</b>	<b>Description</b>
Real-time capture bandwidth	Baseband: 20 MHz; RF, RF1 to 3: 15 MHz; IQ: 20 MHz (Option 03 only)
A/D converter	14 bits, 51.2 Msps
Vector span	Baseband: 20 MHz; RF, RF1 to 3: 15 MHz; IQ: 20 MHz (Option 03 only)
Number of data samples in one frame	1024 (Vector mode)
Block size	1 to 16,000 frames (Standard); 1 to 64,000 frames (Option 02)
Acquisition memory size	64 MB (Standard); 256 MB (Option 02)
Acquisition mode	Single and Continuous
Sampling rate (Real Time S/A, Demod, and Time modes)	
20 MHz span (Baseband)	25.6 Msps
15 MHz span (RF, RF1 to 3)	25.6 Msps
10 MHz span	12.8 Msps
5 MHz span	6.4 Msps
2 MHz span	3.2 Msps
1 MHz span	1.6 Msps
500 kHz span	800 ksps
200 kHz span	320 ksps
100 kHz span	160 ksps
50 kHz span	80 ksps
20 kHz span	32 ksps
10 kHz span	16 ksps
5 kHz span	8 ksps
2 kHz span	3.2 ksps
1 kHz span	1.6 ksps
500 Hz span	800 sps
200 Hz span	320 sps
100 Hz span	160 sps

**Table 16: Trigger**

<b>Characteristics</b>	<b>Description</b>
Trigger mode	Free run, Triggered
Trigger event source	Power (Span BW), Frequency mask (Option 02), External
Pre/Post trigger setting	Trigger position is settable from 0 to 100% of total data length.
Power trigger	0 to -40 dBfs
Frequency mask trigger (Option 02)	

Table 16: Trigger (cont.)

Characteristics	Description
Mask resolution	1 bin
Level range	0 to -60 dBfs
RSA3408B Real-time event detection bandwidth	Baseband: 40 MHz (1024 point FFT, 50% overlapping) RF: 36 MHz (1024 point FFT, 50% overlapping)
RSA3300B Real-time event detection bandwidth	Baseband: 20 MHz (1024 point FFT, 50% overlapping) RF: 15 MHz (1024 point FFT, 50% overlapping)
External trigger	
Threshold voltage	-1.5 to +1.5 V settable
Setting Resolution	0.1 V
Input impedance	>2 k $\Omega$
Trigger output voltage	High: >2.0 V, Low: <0.4 V (output current <1 mA)
Trigger marker position timing uncertainty	$\pm 2$ sample points (Power/External trigger)

Table 17: RSA3408B RBW (Resolution Bandwidth)

Characteristics	Description
Filter shape	Gaussian, Rectangle, Root Nyquist
Setting range	1 Hz to 10 MHz
Minimum settable RBW (extended resolution on)	
Span >2 GHz	100 kHz
1 GHz < Span $\leq$ 2 GHz	50 kHz
500 MHz < Span $\leq$ 1 GHz	20 kHz
20 MHz < Span $\leq$ 500 MHz	10 kHz
500 kHz < Span $\leq$ 20 MHz	1 kHz
200 kHz < Span $\leq$ 500 kHz	500 Hz
100 kHz < Span $\leq$ 200 kHz	200 Hz
50 kHz < Span $\leq$ 100 kHz	100 Hz
20 kHz < Span $\leq$ 50 kHz	50 Hz
10 kHz < Span $\leq$ 20 kHz	20 Hz
5 kHz < Span $\leq$ 10 kHz	10 Hz
2 kHz < Span $\leq$ 5 kHz	5 Hz
1 kHz < Span $\leq$ 2 kHz	2 Hz
100 Hz $\leq$ Span $\leq$ 1 kHz	1 Hz

Table 18: RSA3300B RBW (Resolution Bandwidth)

Characteristics	Description
Filter shape	Gaussian, Rectangle, Root Nyquist
Setting range	1 Hz to 10 MHz

**Table 18: RSA3300B RBW (Resolution Bandwidth) (cont.)**

Characteristics	Description
Minimum settable RBW (S/A mode))	
Span >2 GHz	100 kHz
1 GHz < Span ≤1.99 GHz	50 kHz
500 MHz < Span ≤990 MHz	20 kHz
200 MHz < Span ≤490 MHz	10 kHz
100 MHz < Span ≤190 MHz	10 kHz
50 MHz < Span ≤90 MHz	10 kHz
20 MHz < Span ≤40 MHz	10 kHz
10 MHz Span	1 kHz
5 MHz Span	1 kHz
2 MHz Span	1 kHz
1 MHz Span	1 kHz
500 kHz Span	500 Hz
200 kHz Span	200 Hz
100 kHz Span	100 Hz
50 kHz Span	50 Hz
20 kHz Span	20 Hz
10 kHz Span	10 Hz
5 kHz Span	5 Hz
2 kHz Span	2 Hz
1 kHz Span	1 Hz
500 Hz Span	1 Hz
200 Hz Span	1 Hz
100 Hz Span	1 Hz

**Table 19: Trace and display line**

Characteristics	Description
Number of traces	2
Trace type	Normal, Average, Max Hold, Min Hold
Display detector	Positive peak, Negative peak, and Positive-Negative peak
Display line	Horizontal line 1 and 2, Vertical line 1 and 2

**Table 20: Display**

Characteristics	Description
Views	

**Table 20: Display (cont.)**

Characteristics	Description
S/A mode	Spectrum
S/A with Spectrogram mode	Spectrum and Spectrogram
Real Time S/A mode	Spectrum and Spectrogram
Analog Demod mode	Overview: Power versus Time/Spectrogram Subview: Spectrum Main view: Measurement Results
Time mode	Overview: Power versus Time/Spectrogram Subview: Spectrum Main view: Measurement results
LCD	
Size	213 mm (8.4 in)
Resolution	800 × 600 pixels
Color	Maximum 256 colors

**Table 21: RSA3408B Measurement function**

Characteristics	Description
S/A mode	Channel power, Adjacent channel power ratio, Occupied bandwidth, Emission bandwidth, Carrier to Noise ratio, Carrier frequency, Spurious
Analog Demod mode	I/Q versus Time, AM depth, FM deviation, PM deviation
Time mode	I/Q versus Time, Power versus Time, Frequency versus Time, CCDF

**Table 22: RSA3300B Measurement function**

Characteristics	Description
S/A mode	Noise power, Channel power, Adjacent channel power ratio, Occupied bandwidth, Emission bandwidth, Carrier to Noise ratio, Carrier frequency, Spurious
Demod mode	Analog demodulation: AM, FM, PM; Digital Demodulation: I/Q versus Time, Power versus Time, Frequency versus time.
Time mode	I/Q versus Time, Power versus Time, Frequency versus Time, CCDF, Pulse measurement

**Table 23: Analog demodulation accuracy**

Characteristics	Description
Accuracy ( <i>Typical</i> )	
AM demodulation	±2% (-10 dBfs input at center, 10 to 60% modulation depth)
PM demodulation	±3° (-10 dBfs input at center)
FM demodulation	±1% of span (-10 dBfs input at center)

**Table 24: Pulse measurement**

Characteristics	Description
Measurement functions	Pulse width, Pulse peak power, On/Off ratio, Pulse ripple, Pulse repetition interval, Duty cycle, Pulse-Pulse phase, Channel power, OBW, EBW, Frequency deviation
Pulse length	Minimum 20 samples; Maximum 260,000 samples

**Table 25: Digital demodulation (Option 21 only)**

Characteristics	Description
Demodulator	
Carrier type	Continuous and Burst
Modulation format	BPSK, QPSK, $\pi/4$ shift DQPSK, OQPSK, 8PSK, 16QAM, 64QAM, 256QAM, GMSK, GFSK, ASK, FSK
Measurement filter	Root cosine
Reference filter	Cosine, Gauss
Filter parameter	$\alpha/BT$ : 0.0001 to 1, 0.0001 step
Maximum symbol rate	51.2 Msps (RSA3408B) 12.8 Msps (RSA3300B)
Standard setup	PDC, PHS, NADC, TETRA, GSM, CDPD, and Bluetooth
Measurement functions	Constellation, EVM, I/Q versus Time, Eye diagram, Symbol table, AM/AM, AM/PM, CCDF, PDF
Display format	
Vector diagram	Symbol/Locus display, Frequency error measurement, and Origin offset measurement
Constellation diagram	Symbol display, Frequency error measurement, and Origin offset measurement
Eye diagram	I, Q, and Trellis displays ( 1 to 16 symbols )
Error vector diagram	EVM, Magnitude error, Phase error, Waveform quality ( $\rho$ ) measurement, Frequency error measurement, and Origin offset measurement
Symbol table	Binary, Octal, Hexadecimal
AM/AM	Measured amplitude versus Reference amplitude 1 dB compression measurement
AM/PM	Phase error versus Reference amplitude
CCDF	Probability of exceed versus Power level, Crest factor measurement
PDF	Probability of occurrence versus Power level
Accuracy	



Table 25: Digital demodulation (Option 21 only) (cont.)

Characteristics	Description	
RSA3408B QPSK EVM	<i>EVM (Typical)</i>	<i>Symbol rate</i>
Center frequency = 1 GHz	0.5%	100 kHz
	0.5%	1 MHz
	0.6%	4 MHz
	0.9%	10 MHz
	1.6%	20 MHz
Center frequency = 2 GHz	0.5%	100 kHz
	0.5%	1 MHz
	0.6%	4 MHz
	0.9%	10 MHz
	1.8%	20 MHz
Center frequency = 3 GHz	0.5%	100 kHz
	0.5%	1 MHz
	0.6%	4 MHz
	0.9%	10 MHz
	1.8%	20 MHz
Center frequency = 5 GHz	0.7%	100 kHz
	0.7%	1 MHz
	0.9%	4 MHz
	1.6%	10 MHz
	2.4%	20 MHz
RSA3300B QPSK EVM	<i>EVM (Typical)</i>	<i>Symbol rate</i>
Center frequency = 1 GHz	0.5%	100 kHz
	0.5%	1 MHz
	1.2%	4 MHz
	2.7%	10 MHz
Center frequency = 2 GHz	0.5%	100 kHz
	0.5%	1 MHz
	1.2%	4 MHz
	2.7%	10 MHz
Center frequency = 3 GHz	0.7%	100 kHz
	0.7%	1 MHz
	1.5%	4 MHz
	2.9%	10 MHz
Center frequency = 5 GHz (RSA3308B only)	0.7%	100 kHz
	0.7%	1 MHz
	1.5%	4 MHz
	3.0%	10 MHz

Table 25: Digital demodulation (Option 21 only) (cont.)

Characteristics	Description	
RSA3408B $\pi/4$ DQPSK EVM	EVM (Typical)	Symbol rate
Center frequency = 1 GHz	0.6%	100 kHz
	0.6%	1 MHz
	0.6%	4 MHz
	0.9%	10 MHz
	1.8%	20 MHz
Center frequency = 2 GHz	0.6%	100 kHz
	0.6%	1 MHz
	0.6%	4 MHz
	0.9%	10 MHz
	1.8%	20 MHz
Center frequency = 3 GHz	0.6%	100 kHz
	0.6%	1 MHz
	0.6%	4 MHz
	0.9%	10 MHz
	1.8%	20 MHz
Center frequency = 5 GHz	0.7%	100 kHz
	0.7%	1 MHz
	0.9%	4 MHz
	1.6%	10 MHz
	2.4%	20 MHz
RSA3300B $\pi/4$ DQPSK EVM	EVM (Typical)	Symbol rate
Center frequency = 1 GHz	0.6%	100 kHz
	0.6%	1 MHz
	1.2%	4 MHz
	2.7%	10 MHz
Center frequency = 2 GHz	0.6%	100 kHz
	0.6%	1 MHz
	1.2%	4 MHz
	2.7%	10 MHz
Center frequency = 3 GHz	0.7%	100 kHz
	0.7%	1 MHz
	1.5%	4 MHz
	2.9%	10 MHz
Center frequency = 5 GHz (RSA3308B only)	0.7%	100 kHz
	0.7%	1 MHz
	1.5%	4 MHz
	3.0%	10 MHz

Table 25: Digital demodulation (Option 21 only) (cont.)

Characteristics	Description	
RSA3408B 16/64QAM EVM	<i>EVM (Typical)</i>	<i>Symbol rate</i>
Center frequency = 1 GHz	0.5%	100 kHz
	0.5%	1 MHz
	0.5%	4 MHz
	0.7%	10 MHz
	1.2%	20 MHz
Center frequency = 2 GHz	0.5%	100 kHz
	0.5%	1 MHz
	0.5%	4 MHz
	0.7%	10 MHz
	1.2%	20 MHz
Center frequency = 3 GHz	0.5%	100 kHz
	0.5%	1 MHz
	0.5%	4 MHz
	0.7%	10 MHz
	1.2%	20 MHz
Center frequency = 5 GHz	0.9%	100 kHz
	0.5%	1 MHz
	0.7%	4 MHz
	1.3%	10 MHz
	2.0%	20 MHz
RSA3300B 16QAM EVM	<i>EVM (Typical)</i>	<i>Symbol rate</i>
Center frequency = 1 GHz	0.9%	100 kHz
	0.5%	1 MHz
	1.2%	4 MHz
	2.2%	10 MHz
Center frequency = 2 GHz	0.9%	100 kHz
	0.5%	1 MHz
	1.2%	4 MHz
	2.2%	10 MHz
Center frequency = 3 GHz	0.9%	100 kHz
	0.5%	1 MHz
	1.2%	4 MHz
	2.5%	10 MHz
Center frequency = 5 GHz (RSA3308B only)	0.9%	100 kHz
	0.5%	1 MHz
	1.2%	4 MHz
	2.5%	10 MHz

Table 26: ACLR measurement (Option 30)

Characteristics	Description
ACLR (3GPP down link, Test model 1, 1 DPCH ch, 1800 to 2200 MHz carrier frequency)	

**Table 26: ACLR measurement (Option 30) (cont.)**

Characteristics	Description
Real-Time measurement	66 dB (5 MHz offset) 68 dB (10 MHz offset)
Sweep measurement with noise correction (Typical)	70 dB (5 MHz offset) 72 dB (10 MHz offset)

**Table 27: RSA3408B Wireless LAN measurement (Option 29)**

Characteristics	Description
Residual EVM (Typical)	
IEEE 802.11a/g, 54 Mbps OFDM	≤-44 dB (center frequency = 2.447 GHz) ≤-42 dB (center frequency = 5.5 GHz)
IEEE 802.11b, 11 Mbps CCK	≤0.7% (center frequency = 2.447 GHz)

**Table 28: Digital phosphor spectrum processing (DPX)**

Characteristics	Description
Spectrum processing rate (Typical)	≥48,000 per second (span independent)
Minimum signal duration for 100% probability of intercept (Typical)	≤31 μs(RSA3408B), ≤41 μs(RSA3000B)
Minimum RBW settings	300 kHz (36 MHz span, RSA3408B) 200 kHz (20 MHz span, RSA3408B) 100 kHz (10 MHz span) 50 kHz (5 MHz span) 20 kHz (2 MHz span) 10 kHz (1 MHz span) 5 kHz (500 kHz span) 2 kHz (200 kHz span) 1 kHz (100 kHz span) 500 Hz (50 kHz span) 200 Hz (20 kHz span) 100 Hz (10 kHz span) 50 Hz (5 kHz span) 20 Hz (2 kHz span) 10 Hz (1 kHz span) 5 Hz (500 Hz span) 2 Hz (200 Hz span) 1 Hz (100 Hz span)
RBW accuracy	+1%, -7%
RBW range	1 Hz to 5 MHz (1–2–3–5 sequence)

**Table 28: Digital phosphor spectrum processing (DPX) (cont.)**

Characteristics	Description
Span accuracy	±0.3%
Amplitude accuracy	±0.5 dB

**Table 29: Controller**

Characteristics	Description
Controller	
CPU	Intel Celeron 1.2 GHz (RSA3408B) Intel Pentium III 850 MHz (RSA3300B)
DRAM	512 MB DIMM (RSA3408B) 256 MB DIMM (RSA3300B)
OS	Windows XP
System bus	PCI
Storage medium	
Hard disk	≥40 GB, 2.5 inch IDE (RSA3408B) ≥20 GB, 2.5 inch IDE (RSA3300B)
Floppy disk	1.44 MB 3.5 inch
Interface	
Printer port	USB
GPIB	IEEE 488.2
LAN	10/100 BASE-T (IEEE 802.3)
Mouse	USB
Keyboard	USB
Monitor out	VGA (D-SUB 15 pins)

**Table 30: External output connector**

Characteristics	Description
Preamp power connector	
Connector type	LEMO 6 poles
Pin assignment	Pin 1: NC, Pin 2: ID1, Pin 3: ID2, Pin 4: -12 V, Pin 5: GND, Pin 6: +12 V
RSA3408B Digital I/Q output (Option 05)	

**Table 30: External output connector (cont.)**

Characteristics	Description
Connector type	MDR (3M) 50 pins × 2
Pin assignment	(See page 62, <i>Digital IQ Output Connector Pin Assignment (RSA3408B Option 05 Only)</i> .)
Data output	I data: 16-bit LVDS; Q data: 16-bit LVDS
Control output	Clock: LVDS, max 51.2 MHz; Data valid: LVDS, not used
Control input	Output enable: Connecting GND enables output
Setup time	>5 ns (data transition to clock rising edge). (See Figure 32.)
Hold time	>5 ns (clock rising edge to data transition). (See Figure 32.)
Flatness of output data before correction	
Amplitude	+1/-5 dB (36 MHz span); +1/-2 dB (20 MHz span)
Phase	±100 ° (36 MHz span); ±15 ° (20 MHz span)

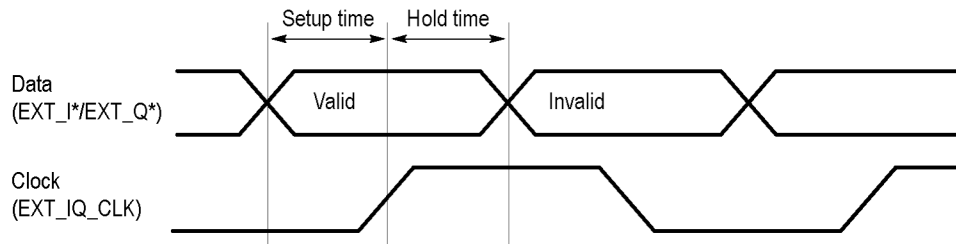

**Figure 32: Definition of the setup and hold time**

**Table 31: Power requirements**

Characteristics	Description
Rating voltage	100 to 240 VAC
Voltage range	90 to 250 VAC
Line frequency	47 to 63 Hz
Mains Fuse Data	Densei-Lambda supplies: 5 A, Time-delayed, 250 V (not operator replaceable) Cosel supply: 2 A, Time-delayed, 250 V (not operator replaceable)
Heat dissipation	
Maximum power	400 VA (RSA3408B) 350 VA (RSA3300B)
Maximum line current	5 A rms at 50 Hz (90 V line with 5% clipping)
Surge current	Maximum 52 A peak (25 °C) for ≤5 line cycles after the product has been turned off for at least 30 s.

## Physical Characteristics

Table 32: Physical characteristics

Characteristics	Description
Dimensions	
Width	425 mm (16.7 in) without belts
Height	215 mm (8.5 in) without feet
Depth	425 mm (16.7 in) without cover and feet
Net weight	
	20 kg (RSA3408B)
	19 kg (RSA3300B)

## Environmental Characteristics

Table 33: Environmental characteristics

Characteristics	Description
Temperature	
Operating	+10 to +40 °C
Nonoperating	-20 to +60 °C
Relative humidity	
Operating and nonoperating	20 to 80% (no condensation), maximum wet-bulb temperature 29 °C
Altitude	
Operating	Up to 3000 m (10000 ft)
Nonoperating	Up to 12000 m (40000 ft)
Vibration	
Operating	2.16 m/s <sup>2</sup> rms (0.22 G rms), 5 to 500 Hz
Nonoperating	22.3 m/s <sup>2</sup> rms (2.28 G rms), 5 to 500 Hz
Shock	
Nonoperating	196 m/s <sup>2</sup> (20 G), half-sine, 11 ms duration Three shocks in each direction along each major axis, total of 18 shocks
Cooling clearance	
Bottom	20 mm (0.79 in)
Both sides	50 mm (1.97 in)
Rear	50 mm (1.97 in)

## Certifications and Compliances

### EC Declaration of Conformity - EMC

Meets intent of Directive 2004/108/EEC for Electromagnetic Compatibility. Compliance was demonstrated to the following specifications as listed in the Official Journal of the European Communities:

**EN 61326:1997.** EMC requirements for Class A electrical equipment for measurement, control, and laboratory use. Annex D <sup>1 2 3</sup>

- IEC 61000-4-2:1999. Electrostatic discharge immunity
- IEC 61000-4-3:2002. RF electromagnetic field immunity <sup>4</sup>
- IEC 61000-4-4:2004. Electrical fast transient / burst immunity
- IEC 61000-4-5:2005. Power line surge immunity
- IEC 61000-4-6:2003. Conducted RF immunity
- IEC 61000-4-11:2004. Voltage dips and interruptions immunity

**EN 61000-3-2:2002.** AC power line harmonic emissions

**EN 61000-3-3:1995.** Voltage changes, fluctuations, and flicker

- <sup>1</sup> This product is intended for use in nonresidential areas only. Use in residential areas may cause electromagnetic interference.
- <sup>2</sup> Emissions which exceed the levels required by this standard may occur when this equipment is connected to a test object.
- <sup>3</sup> To ensure compliance with the EMC standards listed here, high quality shielded interface cables should be used.
- <sup>4</sup> Performance Criteria with disturbance signal frequencies within 50 MHz of EUT Center Frequency: Residual spurious signals can increase to -60 dBm with exposure to the disturbance levels of the test.

**European Contact.** For further information in Europe, contact:

Tektronix UK, Ltd.  
Western Peninsula  
Western Road  
Bracknell, RG12 1RF  
United Kingdom

### Australia / New Zealand Declaration of Conformity - EMC

Complies with EMC provision of Radiocommunications Act per the following standard, in accordance with ACMA:

- EN 61326:1997. EMC requirements for electrical equipment for measurement, control, and laboratory use.



<b>EC Declaration of Conformity - Low Voltage</b>	<p>Compliance was demonstrated to the following specification as listed in the Official Journal of the European Communities:</p> <ul style="list-style-type: none"> <li>■ Low Voltage Directive 2006/96/EC</li> <li>■ EN 61010-1: 2001. Safety requirements for electrical equipment for measurement control and laboratory use.</li> </ul>
<b>U.S. Nationally Recognized Testing Laboratory Listing</b>	<ul style="list-style-type: none"> <li>■ UL 61010B-1:2004, 2nd Edition. Standard for electrical measuring and test equipment.</li> </ul>
<b>Canadian Certification</b>	<ul style="list-style-type: none"> <li>■ CAN/CSA C22.2 No. 61010-1-2004. Safety requirements for electrical equipment for measurement control and laboratory use. Part 1.</li> </ul>
<b>Additional Compliance</b>	<ul style="list-style-type: none"> <li>■ IEC 61010-1:2001: Safety requirements for electrical equipment for measurement, control, and laboratory use.</li> </ul>
<b>Equipment Type</b>	Test and measuring equipment.
<b>Safety Class</b>	Class I (as defined in IEC61010-1) – grounded product.
<b>Pollution Degree Description</b>	<p>A measure of the contaminates that could occur in the environment around and within a product. Typically the internal environment inside a product is considered to be the same as the external. Products should be used only in the environment for which they are rated.</p> <ul style="list-style-type: none"> <li>■ Pollution Degree 1. No pollution or only dry, nonconductive pollution occurs. Products in this category are generally encapsulated, hermetically sealed, or located in clean rooms.</li> <li>■ Pollution Degree 2. Normally only dry, nonconductive pollution occurs. Occasionally a temporary conductivity that is caused by condensation must be expected. This location is a typical office/home environment. Temporary condensation occurs only when the product is out of service.</li> <li>■ Pollution Degree 3. Conductive pollution, or dry, nonconductive pollution that becomes conductive due to condensation. These are sheltered locations where neither temperature nor humidity is controlled. The area is protected from direct sunshine, rain, or direct wind.</li> <li>■ Pollution Degree 4. Pollution that generates persistent conductivity through conductive dust, rain, or snow. Typical outdoor locations.</li> </ul>
<b>Pollution Degree</b>	Pollution Degree 2 (as defined in IEC 61010-1). Note: Rated for indoor use only.

**Installation (Overvoltage) Category Descriptions**

Terminals on this product may have different installation (overvoltage) category designations. The installation categories are:

- Measurement Category III. For measurements performed in the building installation.
- Measurement Category II. For measurements performed on circuits directly connected to the low-voltage installation.
- Measurement Category I. For measurements performed on circuits not directly connected to MAINS.

**Overvoltage Category**      Overvoltage Category II (as defined in IEC 61010-1)

**Digital IQ Output Connector Pin Assignment (RSA3408B Option 05 Only)**

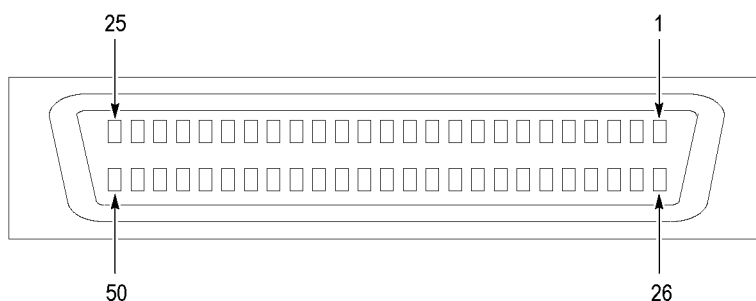

**Figure 33: Digital IQ output connector pin assignment**

**Table 34: I OUTPUT connector pin assignment**

Pin number	Signal name	Description
1	IQ_ENABLE*	IQ output enable signal input Open: IQ output disable Connect to GND: IQ output enable
26	GND	Ground
2	GND	Ground
27	GND	
3	EXT_I0-	I output data (bit 0), LVDS
28	EXT_I0+	
4	EXT_I1-	I output data (bit 1), LVDS
29	EXT_I1+	
5	EXT_I2-	I output data (bit 2), LVDS
30	EXT_I2+	

**Table 34: I OUTPUT connector pin assignment (cont.)**

<b>Pin number</b>	<b>Signal name</b>	<b>Description</b>
6	EXT_I3-	I output data (bit 3), LVDS
31	EXT_I3+	
7	GND	Ground
32	GND	
8	EXT_I4-	I output data (bit 4), LVDS
33	EXT_I4+	
9	EXT_I5-	I output data (bit 5), LVDS
34	EXT_I5+	
10	EXT_I6-	I output data (bit 6), LVDS
35	EXT_I6+	
11	EXT_I7-	I output data (bit 7), LVDS
36	EXT_I7+	
12	GND	Ground
37	GND	
13	EXT_I8-	I output data (bit 8), LVDS
38	EXT_I8+	
14	EXT_I9-	I output data (bit 9), LVDS
39	EXT_I9+	
15	EXT_I10-	I output data (bit 10), LVDS
40	EXT_I10+	
16	EXT_I11-	I output data (bit 11), LVDS
41	EXT_I11+	
17	GND	Ground
42	GND	
18	EXT_I12-	I output data (bit 12), LVDS
43	EXT_I12+	
19	EXT_I13-	I output data (bit 13), LVDS
44	EXT_I13+	
20	EXT_I14-	I output data (bit 14), LVDS
45	EXT_I14+	
21	EXT_I15-	I output data (bit 15), LVDS
46	EXT_I15+	
22	GND	Ground
47	GND	
23	GND	
48	GND	

**Table 34: I OUTPUT connector pin assignment (cont.)**

Pin number	Signal name	Description
24	EXT_IQ_DAV-	Not used
49	EXT_IQ_DAV+	
25	EXT_IQ_CLK-	IQ output clock, LVDS
50	EXT_IQ_CLK+	

**Table 35: Q OUTPUT connector pin assignment**

Pin number	Signal name	Description
1	IQ_ENABLE*	IQ output enable signal input Open: IQ output disable Connect to GND: IQ output enable
26	GND	Ground
2	GND	Ground
27	GND	
3	EXT_Q0-	Q output data (bit 0), LVDS
28	EXT_Q0+	
4	EXT_Q1-	Q output data (bit 1), LVDS
29	EXT_Q1+	
5	EXT_Q2-	Q output data (bit 2), LVDS
30	EXT_Q2+	
6	EXT_Q3-	Q output data (bit 3), LVDS
31	EXT_Q3+	
7	GND	Ground
32	GND	
8	EXT_Q4-	Q output data (bit 4), LVDS
33	EXT_Q4+	
9	EXT_Q5-	Q output data (bit 5), LVDS
34	EXT_Q5+	
10	EXT_Q6-	Q output data (bit 6), LVDS
35	EXT_Q6+	
11	EXT_Q7-	Q output data (bit 7), LVDS
36	EXT_Q7+	
12	GND	Ground
37	GND	
13	EXT_Q8-	Q output data (bit 8), LVDS
38	EXT_Q8+	

Table 35: Q OUTPUT connector pin assignment (cont.)

Pin number	Signal name	Description
14	EXT_Q9-	Q output data (bit 9), LVDS
39	EXT_Q9+	
15	EXT_Q10-	Q output data (bit 10), LVDS
40	EXT_Q10+	
16	EXT_Q11-	Q output data (bit 11), LVDS
41	EXT_Q11+	
17	GND	Ground
42	GND	
18	EXT_Q12-	Q output data (bit 12), LVDS
43	EXT_Q12+	
19	EXT_Q13-	Q output data (bit 13), LVDS
44	EXT_Q13+	
20	EXT_Q14-	Q output data (bit 14), LVDS
45	EXT_Q14+	
21	EXT_Q15-	Q output data (bit 15), LVDS
46	EXT_Q15+	
22	GND	Ground
47	GND	
23	GND	
48	GND	
24	NC	Not used
49	NC	
25	NC	
50	NC	



# Index

## A

AC line frequency, 5

## B

Backing up user files, 13

Brightness

adjusting, 18

uneven, 13

## C

Cal menu, 15

Calibration, 15

Center offset calibration, 17

Characteristics

electrical, 38

environmental, 59

physical, 59

Connectors, 21

Conventions, viii

## D

DC offset calibration, 17

Digital IQ output (Option 05)

rear panel connectors, 23

Dimensions, 59

Display

dead pixel, 13

Documentation list, vii

## E

Electrical characteristics, 38

Environmental characteristics, 59

## F

Features, 1

Functional check, 8

## G

Gain calibration, 16

General purpose knob, 22

## H

How to adjust

center offset, 17

DC offset, 17

gain, 16

IF flatness, 18

## I

IF flatness calibration, 18

Installation, 3

Interface

maps, 21

IQ

digital IQ output (Option 05), 23

## K

Key

lock, 28

Keyboard

operation, 25

Keypad, 22

using, 33

## M

Manuals list, vii

Map

interface, 21

Menu

operation, 30

Menu keys, 22

Mouse

operation, 25

## N

NBW, setup display, 29

Numeric input, 32

## P

Physical characteristics, 59

Power

AC requirements, 5

connecting the cord, 5

Power switch, 6

Powering off, 12

Powering on, 5, 6

Principal power switch, 6

Product description, 1

## R

Rear panel, 22

Restarting, 13

## S

Safety Summary, iv

Scan Disk, 13

Screen

configuration, 26

Setup

display, 29

Side keys, 22

Side panel, 24

Stand

setting up, 3

Status

display, 27

Step size

center frequency, 35

setting, 34

## T

Troubleshooting, 13

## U

UNCAL, 7

Unpacking, 3