

Keithley Instruments
28775 Aurora Road
Cleveland, Ohio 44139
1-800-935-5595
<http://www.keithley.com>

Description

The Model 2600B-PM-2 Protection Module is a stand-alone, self-powered module that provides fast transient ($< 100 \mu\text{s}$) current spike limiting and overvoltage ($> 220 \text{ V}$) clamping for use in current and voltage-sensitive devices and applications.

Figure 1: Model 2600B-PM-2 Protection Module



The protection module is designed for use with the following source-measure units (SMUs):

- Model 2601B Single-Channel System SourceMeter® Instrument
- Model 2602B Dual-Channel System SourceMeter® Instrument
- Model 2611B Single-Channel System SourceMeter® Instrument
- Model 2612B Dual-Channel System SourceMeter® Instrument

The protection module is intended for use in applications where a device or interconnection current, voltage breakdown, or other potential signal level failure could result in damage to the device under test.

Mechanical dimensions

Figure 2: Model 2600B-PM-2 dimensions

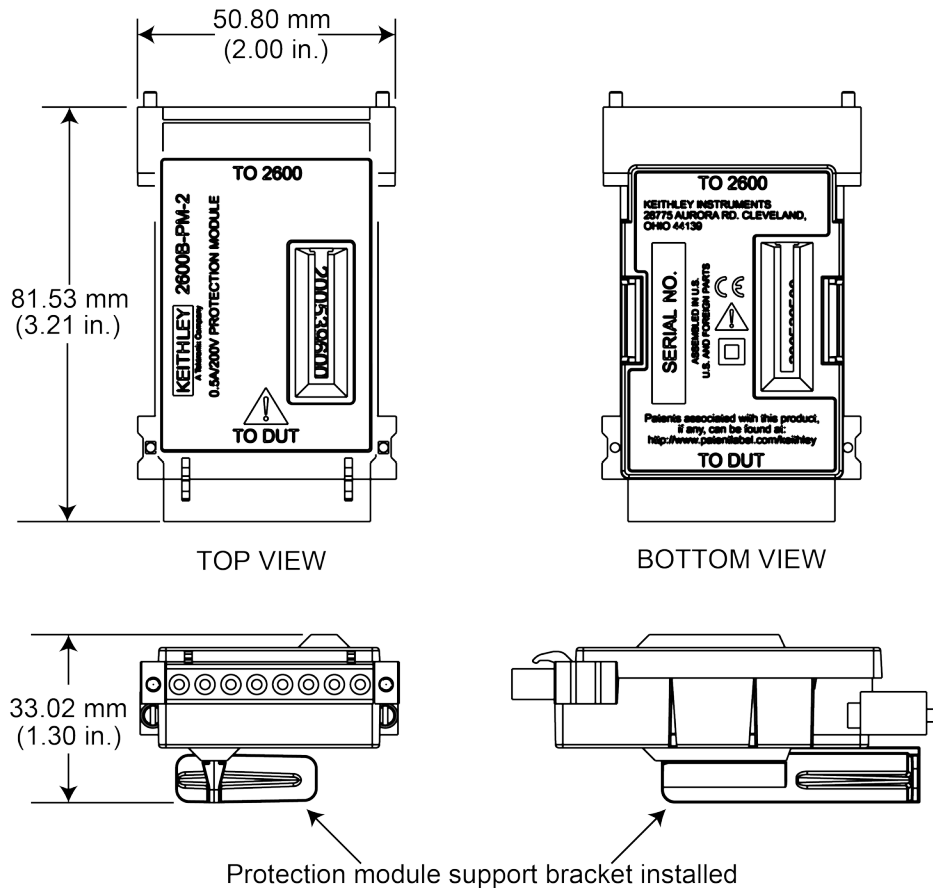

Electrical and physical characteristics

Specifications and characteristics are typical and subject to change without notice.

- Maximum DC voltage (V): 220 V (Hi to Lo)
- Maximum DC current (I): 0.5 A up to 20 V maximum (SMU panel Force Hi to Lo 2-wire mode)
- Maximum current (I) pulse / duty cycle: 0.75 A (up to 20 V maximum)
 - Maximum on time: 30 ms
 - Minimum off time: 70 ms
 - Maximum 30% duty cycle, 10 Hz to 500 Hz cycle
- Mounting location: Rear panel with support bracket or in line, standard Model 2601/02/11/12B connector
 - Supplied support bracket reversible for CH 1 and CH 2 use with Model 2602/12B dual-channel SMUs
- Mean time between failures (MTBF): > 250,000 hours at continuous maximum DC or pulse power rating

CAUTION

The Model 2600B-PM-2 is not designed to protect against user shock risk or contact hazards and should not be relied upon for operator shock safety protection.

Installing the support bracket

A support bracket is included with the Model 2600B-PM-2 Protection Module. The bracket must be installed before connecting the module to your SourceMeter® instrument. See the following graphics for instructions.

NOTE

Make sure you follow the correct diagram for your installation. The bracket may be difficult to remove once it is installed.

Figure 3: Installing the support bracket for use in channel A

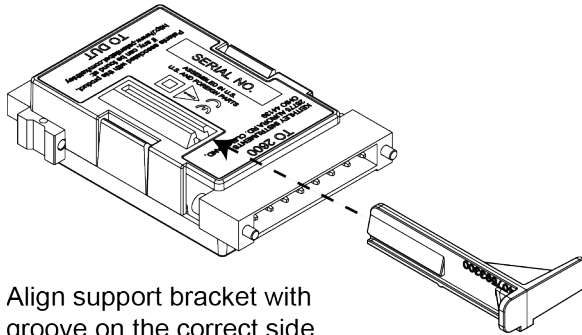

Align support bracket with groove on the correct side of the protection module.

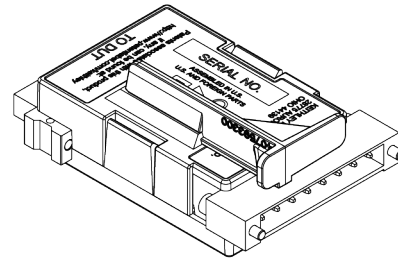

Bracket is properly installed when you hear a click.

Figure 4: Installing the support bracket for use in channel B

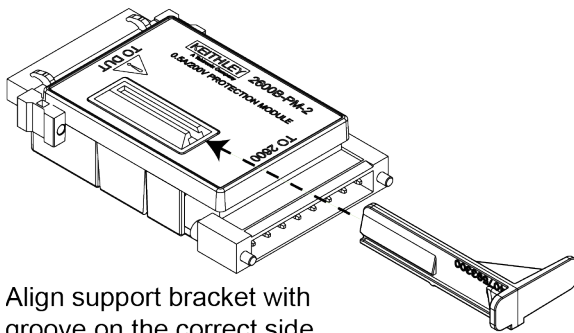

Align support bracket with groove on the correct side of the protection module.

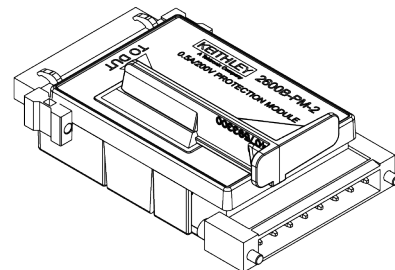

Bracket is properly installed when you hear a click.

Connecting to the Models 2601B, 2602B, 2611B, and 2612B SourceMeter Instruments

Refer to the next figure to connect the Model 2600B-PM-2 to your source-measure unit (SMU). The Model 2612B SourceMeter® Instrument is used as an example in the following graphic, but the installation is the same for all compatible models.

NOTE

Make sure you have installed the support bracket on the protection module before connecting the module to your SourceMeter® instrument. See the [Installing the support bracket](#) (on page 3) topic for guidance.

Figure 5: Connecting the Model 2600B-PM-2 to your SMU

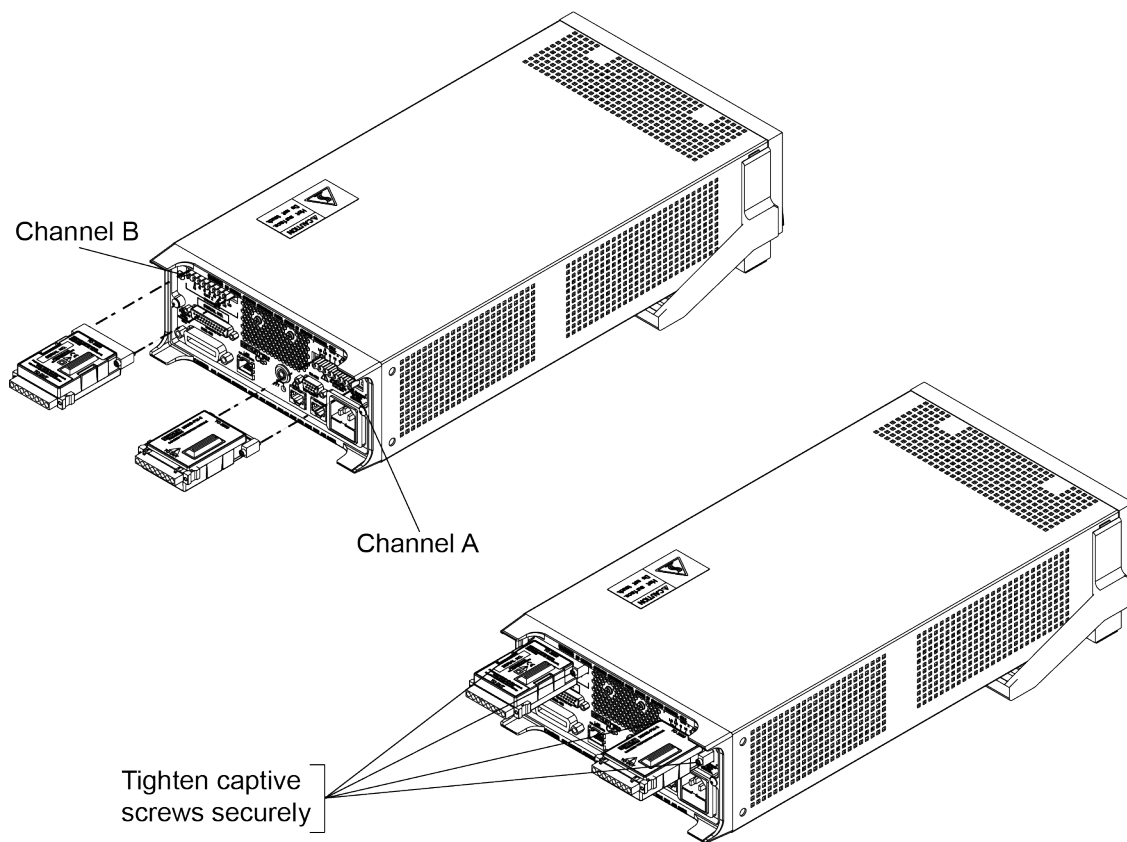

The following safety precautions should be observed before using this product and any associated instrumentation. Although some instruments and accessories would normally be used with nonhazardous voltages, there are situations where hazardous conditions may be present.

This product is intended for use by qualified personnel who recognize shock hazards and are familiar with the safety precautions required to avoid possible injury. Read and follow all installation, operation, and maintenance information carefully before using the product. Refer to the user documentation for complete product specifications.

If the product is used in a manner not specified, the protection provided by the product warranty may be impaired.

The types of product users are:

Responsible body is the individual or group responsible for the use and maintenance of equipment, for ensuring that the equipment is operated within its specifications and operating limits, and for ensuring that operators are adequately trained.

Operators use the product for its intended function. They must be trained in electrical safety procedures and proper use of the instrument. They must be protected from electric shock and contact with hazardous live circuits.

Maintenance personnel perform routine procedures on the product to keep it operating properly, for example, setting the line voltage or replacing consumable materials. Maintenance procedures are described in the user documentation. The procedures explicitly state if the operator may perform them. Otherwise, they should be performed only by service personnel.

Service personnel are trained to work on live circuits, perform safe installations, and repair products. Only properly trained service personnel may perform installation and service procedures.

Keithley Instruments products are designed for use with electrical signals that are measurement, control, and data I/O connections, with low transient overvoltages, and must not be directly connected to mains voltage or to voltage sources with high transient overvoltages. Measurement Category II (as referenced in IEC 60664) connections require protection for high transient overvoltages often associated with local AC mains connections. Certain Keithley measuring instruments may be connected to mains. These instruments will be marked as category II or higher.

Unless explicitly allowed in the specifications, operating manual, and instrument labels, do not connect any instrument to mains.

Exercise extreme caution when a shock hazard is present. Lethal voltage may be present on cable connector jacks or test fixtures. The American National Standards Institute (ANSI) states that a shock hazard exists when voltage levels greater than 30 V RMS, 42.4 V peak, or 60 VDC are present. A good safety practice is to expect that hazardous voltage is present in any unknown circuit before measuring.

Operators of this product must be protected from electric shock at all times. The responsible body must ensure that operators are prevented access and/or insulated from every connection point. In some cases, connections must be exposed to potential human contact. Product operators in these circumstances must be trained to protect themselves from the risk of electric shock. If the circuit is capable of operating at or above 1000 V, no conductive part of the circuit may be exposed.

Do not connect switching cards directly to unlimited power circuits. They are intended to be used with impedance-limited sources. NEVER connect switching cards directly to AC mains. When connecting sources to switching cards, install protective devices to limit fault current and voltage to the card.

Before operating an instrument, ensure that the line cord is connected to a properly-grounded power receptacle. Inspect the connecting cables, test leads, and jumpers for possible wear, cracks, or breaks before each use.

When installing equipment where access to the main power cord is restricted, such as rack mounting, a separate main input power disconnect device must be provided in close proximity to the equipment and within easy reach of the operator.

For maximum safety, do not touch the product, test cables, or any other instruments while power is applied to the circuit under test. ALWAYS remove power from the entire test system and discharge any capacitors before: connecting or disconnecting cables or jumpers, installing or removing switching cards, or making internal changes, such as installing or removing jumpers.

Do not touch any object that could provide a current path to the common side of the circuit under test or power line (earth) ground. Always make measurements with dry hands while standing on a dry, insulated surface capable of withstanding the voltage being measured.

For safety, instruments and accessories must be used in accordance with the operating instructions. If the instruments or accessories are used in a manner not specified in the operating instructions, the protection provided by the equipment may be impaired.

Do not exceed the maximum signal levels of the instruments and accessories, as defined in the specifications and operating information, and as shown on the instrument or test fixture panels, or switching card.

When fuses are used in a product, replace with the same type and rating for continued protection against fire hazard.

Chassis connections must only be used as shield connections for measuring circuits, NOT as protective earth (safety ground) connections.

If you are using a test fixture, keep the lid closed while power is applied to the device under test. Safe operation requires the use of a lid interlock.

If a  screw is present, connect it to protective earth (safety ground) using the wire recommended in the user documentation.

The  symbol on an instrument means caution, risk of danger. The user must refer to the operating instructions located in the user documentation in all cases where the symbol is marked on the instrument.

The  symbol on an instrument means caution, risk of electric shock. Use standard safety precautions to avoid personal contact with these voltages.

The  symbol on an instrument shows that the surface may be hot. Avoid personal contact to prevent burns.

The  symbol indicates a connection terminal to the equipment frame.

If this  symbol is on a product, it indicates that mercury is present in the display lamp. Please note that the lamp must be properly disposed of according to federal, state, and local laws.

The **WARNING** heading in the user documentation explains dangers that might result in personal injury or death. Always read the associated information very carefully before performing the indicated procedure.

The **CAUTION** heading in the user documentation explains hazards that could damage the instrument. Such damage may invalidate the warranty.

Instrumentation and accessories shall not be connected to humans.

Before performing any maintenance, disconnect the line cord and all test cables.

To maintain protection from electric shock and fire, replacement components in mains circuits — including the power transformer, test leads, and input jacks — must be purchased from Keithley Instruments. Standard fuses with applicable national safety approvals may be used if the rating and type are the same. Other components that are not safety-related may be purchased from other suppliers as long as they are equivalent to the original component (note that selected parts should be purchased only through Keithley Instruments to maintain accuracy and functionality of the product). If you are unsure about the applicability of a replacement component, call a Keithley Instruments office for information.

To clean an instrument, use a damp cloth or mild, water-based cleaner. Clean the exterior of the instrument only. Do not apply cleaner directly to the instrument or allow liquids to enter or spill on the instrument. Products that consist of a circuit board with no case or chassis (e.g., a data acquisition board for installation into a computer) should never require cleaning if handled according to instructions. If the board becomes contaminated and operation is affected, the board should be returned to the factory for proper cleaning/servicing.

Safety precaution revision as of January 2013.