



**TekExpress® 100G-TXE Compliance Solution
Printable Application Help**





**TekExpress® 100G-TXE Compliance Solution
Printable Application Help**

Copyright © Tektronix. All rights reserved. Licensed software products are owned by Tektronix or its subsidiaries or suppliers, and are protected by national copyright laws and international treaty provisions. Tektronix products are covered by U.S. and foreign patents, issued and pending. Information in this publication supersedes that in all previously published material. Specifications and price change privileges reserved.

TEKTRONIX and TEK are registered trademarks of Tektronix, Inc.

Contacting Tektronix

Tektronix, Inc.
14150 SW Karl Braun Drive
P.O. Box 500
Beaverton, OR 97077
USA

For product information, sales, service, and technical support:

- In North America, call 1-800-833-9200.
- Worldwide, visit www.tek.com to find contacts in your area.

Table of Contents

| | |
|---------------|---|
| Welcome | v |
|---------------|---|

Getting help and support

| | |
|-----------------------------|---|
| Related documentation | 1 |
| Conventions | 2 |
| Technical support | 2 |

Getting started

| | |
|--|---|
| Minimum system requirements | 5 |
| Instruments and accessories required | 6 |
| Installing the software | 7 |
| View software version | 7 |
| Application directories | 8 |
| File name extensions | 9 |

Operating basics

| | |
|--|----|
| Launch the application | 11 |
| Application panels overview | 12 |
| Global application controls | 13 |
| Application controls | 13 |
| Options menu overview | 15 |
| TekExpress instrument control settings | 17 |
| View connected instruments | 18 |
| Configure email settings | 19 |
| Setup panel | 20 |
| Setup panel overview | 20 |
| Set DUT parameters | 21 |
| Select tests | 23 |
| Set acquisition tab parameters | 25 |
| Set configuration tab parameters | 26 |
| Set preferences tab parameters | 29 |
| Status panel | 30 |
| Status panel overview | 30 |
| Results panel | 31 |
| Results panel overview | 31 |

| | |
|-------------------------------|----|
| View test-related files | 32 |
| Reports panel | 33 |
| Reports panel overview | 33 |
| Select report options | 34 |
| View a report | 35 |
| Report contents | 36 |

Running tests

| | |
|------------------------------------|----|
| Equipment connection diagram | 37 |
| Prerequisite | 45 |
| Compensate the signal path | 45 |
| Deskew | 45 |
| Running tests | 47 |

Saving and recalling test setup

| | |
|---|----|
| Test setup files overview | 49 |
| Save a test setup | 49 |
| Open (load) a saved test setup | 50 |
| Create a test setup from default settings | 50 |
| Create a test setup using an existing one | 50 |

CAUI4 TXE compliance measurements

| | |
|--|----|
| DC common mode output voltage | 51 |
| Diff peak to peak output voltage - Tx disabled | 52 |
| Diff peak to peak output voltage - Tx enabled | 52 |
| AC common mode output voltage | 53 |
| Single ended output voltage | 54 |
| Signaling rate | 55 |
| Eye width and Eye height | 56 |
| Vertical eye closure | 58 |
| Transition time | 59 |

CR4 / KR4 TXE compliance measurements

| | |
|--|----|
| DC common mode output voltage | 61 |
| Diff peak to peak output voltage - Tx disabled | 62 |
| Diff peak to peak output voltage - Tx enabled | 63 |
| AC common mode output voltage | 64 |

| | |
|--|----|
| Signaling rate | 65 |
| Transmitter waveform requirements | 66 |
| Common procedure for transmitter waveform requirements | 66 |
| Linear fit pulse peak | 66 |
| Steady state voltage | 67 |
| Minimum pre-cursor full scale ratio | 67 |
| Minimum post-cursor full scale ratio | 68 |
| Normalized coefficient step size | 68 |
| Signal to noise and distortion ratio | 70 |
| Output Jitter | 71 |
| Even-odd jitter peak to peak | 71 |
| Effective bounded and total uncorrelated jitter peak to peak | 72 |

SCPI commands

| | |
|--|----|
| About SCPI command | 73 |
| Socket configuration for SCPI commands | 73 |
| TEKEXP:*IDN? | 81 |
| TEKEXP:*OPC? | 81 |
| TEKEXP:ACQUIRE_MODE | 82 |
| TEKEXP:ACQUIRE_MODE? | 82 |
| TEKEXP:EXPORT | 83 |
| TEKEXP:INFO? | 83 |
| TEKEXP:INSTRUMENT | 84 |
| TEKEXP:INSTRUMENT? | 84 |
| TEKEXP:LASTERROR? | 85 |
| TEKEXP:LIST? | 85 |
| TEKEXP:MODE | 86 |
| TEKEXP:MODE? | 87 |
| TEKEXP:POPUP | 87 |
| TEKEXP:POPUP? | 88 |
| TEKEXP:REPORT | 88 |
| TEKEXP:REPORT? | 89 |
| TEKEXP:RESULT? | 89 |
| TEKEXP:SELECT | 90 |
| TEKEXP:SELECT? | 91 |
| TEKEXP:SETUP | 91 |
| TEKEXP:STATE | 92 |
| TEKEXP:STATE? | 92 |
| TEKEXP:VALUE | 93 |

Table of Contents

TEKEXP:VALUE? 94
Command parameters list 95
Examples 101

References

Welcome

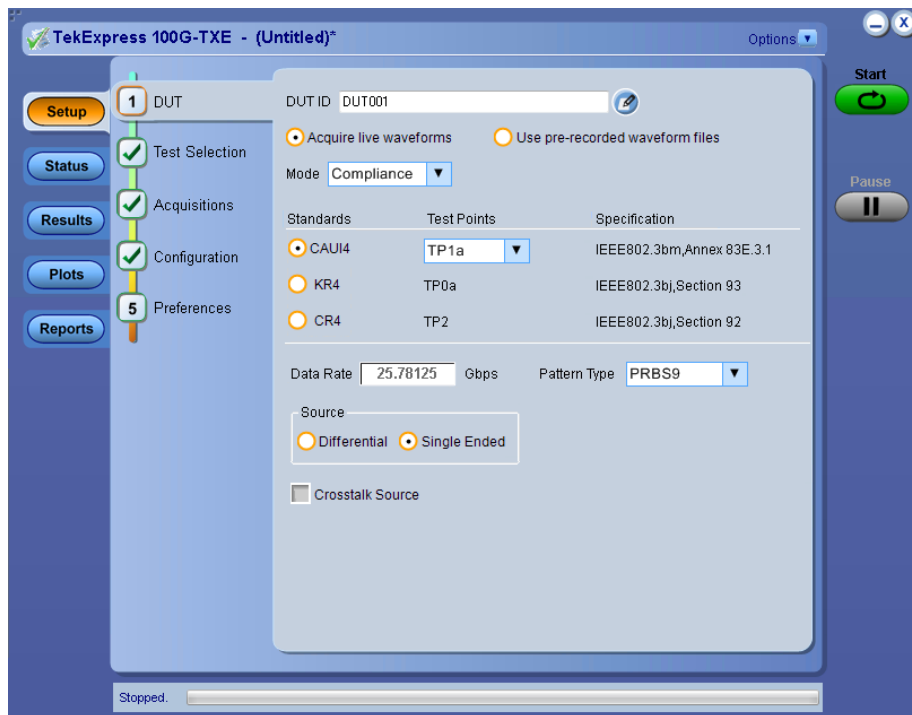

Welcome to the Tektronix 100G-TXE, an Tektronix oscilloscope application software that addresses 100GBASE-CR4, 100GBASE-KR4, and CAUI-4 standards of IEEE. These three electrical standards make up the backbone of the current 100G Ethernet industry, and the TekExpress 100G-TXE automation test solution facilitates turnkey electrical transmitter validation of most 100G Ethernet systems today.

The 100G-TXE solution specifically targets sections 83 of the IEEE 802.3bm standard as well as sections 92 and 93 of the IEEE 802.3bj specification. These tools allow quick verification to these IEEE electrical standards, while offering comprehensive test automation, results margining, data logging, and results reporting in an advanced testing framework.

Key features of TekExpress 100G-TXE include:



- 100G-TXE offers Transmitter 100GBASE-CR4 time domain transmitter characterization, tracking Table 92-6 Transmitter characteristics at TP2 from the IEEE 802.3bj cabled I/O specification. This offers a checklist approach to performing all jitter, Linear impulse response pulse peak and Signal to Noise and Distortion Ratio measurements, as well as basic AC parametric and timing operations.
- 100G-TXE also incorporates 100GBASE-KR4 time domain transmitter characterization, tracking Table 93-4 Transmitter characteristics at TP0a from the IEEE 802.3bj backplane specification. While the measurements are identical to 100GBASE-CR4, the electrical limits for 100GBASE-KR4 are more stringent.
- 100G-TXE includes a third electrical test suite, for Annex 83 of IEEE 802.3bm, tracking Chip-to-module 100 Gb/s four-lane Attachment Unit Interface (CAUI-4), Table 83E-1 at TP1a and TP4. The user defined test point selection allows unique test limits relevant to host channel or module validation. The CAUI-4 support offers advance CTLE scanning provisions to find optimal eye opening/width.

Getting help and support

Related documentation

The following documentation is available as part of the TekExpress® 100G-TXE Solution application.

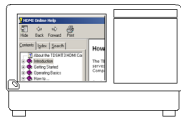
Table 1: Product documentation

| Item | Purpose | Location |
|-----------------|---|---|
| Help | Application operation and User Interface help |  |
| PDF of the help | Printable version of the compiled help |  <p>PDF file that ships with 100G-TXE Solution software distribution (<i>TekExpress 100G-TXE-Automated-Test-Solution-Software-Printable-Help-EN-US.pdf</i>).</p> |



See also [Technical support](#)

Conventions

Help uses the following conventions:

- The term "Application," and "Software" refers to the TekExpress 100G-TXE Solution application.
- The term "CAUI4" refers to CAUI-4, IEEE 802.3bm standard.
- The term "KR4 / CR4" refers to 100GBASE-KR4 or 100GBASE-CR4, IEEE 802.3bj standard.
- The term "DUT" is an abbreviation for Device Under Test.
- The term "select" is a generic term that applies to the two methods of choosing a screen item (button, control, list item): using a mouse or using the touch screen.

Table 2: Icon descriptions

| Icon | Meaning |
|---|--|
|  | This icon identifies important information. |
|  | This icon identifies conditions or practices that could result in loss of data. |
|  | This icon identifies additional information that will help you use the application more efficiently. |

Technical support

Tektronix values your feedback on our products. To help us serve you better, please send us your suggestions, ideas, or comments on your application or oscilloscope. Contact Tektronix through mail, telephone, or the Web site. See [Contacting Tektronix](#) at the front of this document for contact information.

When you contact Tektronix Technical Support, please include the following information (be as specific as possible):

General information

- All instrument model numbers
- Hardware options, if any
- Modules used
- Your name, company, mailing address, phone number, FAX number
- Please indicate if you would like to be contacted by Tektronix about your suggestion or comments.

Application specific information

- Software version number
- Description of the problem such that technical support can duplicate the problem
- If possible, save the setup files for all the instruments used and the application
- If possible, save the TekExpress setup files, log.xml, *.TekX (session files and folders), and status messages text file

Getting started

Minimum system requirements

The following table shows the minimum system requirements to install and run the TekExpress 100G-TXE solution.

Table 3: System requirements

| Component | Description |
|------------------|--|
| Oscilloscope | <ul style="list-style-type: none">■ Tektronix DPO70K series scope■ Opt DJA and DJAN |
| Processor | Same as the oscilloscope |
| Operating System | Same as the oscilloscope: |
| Memory | Same as the oscilloscope |
| Hard Disk | Same as the oscilloscope |
| Display | Super VGA resolution or higher video adapter (800 x 600 minimum video resolution for small fonts or 1024 x 768 minimum video resolution for large fonts). The application is best viewed at 96 dpi display settings ¹ |
| Firmware | <ul style="list-style-type: none">■ Firmware Version: 10.3.0 or above |
| Software | <ul style="list-style-type: none">■ IronPython 2.7.3 installed■ PyVisa 1.0.0.25 installed■ Microsoft .NET 4.0 Framework■ Microsoft Internet Explorer 7.0 SP1 or greater, or other Web browser for viewing reports■ Adobe Reader software 7.0 or greater for viewing portable document format (PDF) files |

¹ If TekExpress is running on an instrument that has a video resolution less than 800x600, connect and configure a second monitor to the instrument.

Instruments and accessories required

TekExpress100G-TXE application is launched on DPO70K series scope. The following table lists the instruments and accessories required for this application.

Table 4: Instruments and accessories required for 100G-TXE application

| Instrument/Accessory | Model number | Quantity |
|----------------------|---|----------|
| Oscilloscope | DPO72304SX, DPO72304DX, MSO72304DX, DPO72504DX, MSO72504DX, DPO73304SX, DPO73304DX, MSO73304DX, DPO75002SX, DPO75902SX, DPO77002SX, DPS75004SX, DPS75904SX, DPS77004SX | 1 |
| Adapter ² | Broadband Balun with bandwidth >= 40 GHz | 1 |
| Cables | Compatible SMA cables with bandwidth greater than 40 GHz for connecting single ended sources ATI channel. | 1 |
| Fixtures | <ul style="list-style-type: none"> ■ Host compliance board for CAUI4 at TP1a and CR4 at TP2 ■ Module compliance board for CAUI4 at TP4 ■ Transmitter test fixture for KR4 at TP0a ³ | 1 |
| DC Blocks | Compatible DC block with bandwidth range 50 KHz to 65 GHz | 2 |
| Attenuator | 3, 6, or 10 dB attenuators | 2 |
| Probes ⁴ | Tektronix P7600 or P7700 series | 1 |

² Required to operate in differential mode for single stack ATI scopes.

³ If required, De-Embed the fixtures using filter files.

⁴ Required to acquire signal at TP0a test point for KR4 suite.

Installing the software

Follow the steps to download and install the latest TekExpress 100G-TXE Solution. See [Minimum system requirements](#) for compatibility.

1. Type the URL www.tek.com in the address bar of web browser and click Software Downloads
2. Enter **TekExpress 100G-TXE Solution** in the *Enter your keywords* field, and click **Search**
3. Select the latest version of software and follow the instructions to download. Copy the executable file into the oscilloscope.
4. Double-click the executable and follow the on-screen instructions. The software is installed at C:\Program Files\Tektronix\TekExpress\TekExpress 100G-TXE\
5. Select **Analyze > TekExpress 100G-TXE** from the TekScope menu to [launch the application](#)

View software version

Use the following instructions to view version information for the application and for the application modules such as the Programmatic Interface and the Programmatic Interface Client.

To view version information for 100G-TXE, click  button in the TekExpress application and select **About TekExpress**.



NOTE. This example shows a typical Version Details dialog box, and may not reflect the actual values as shown when you open this item in the application.

Application directories

TekExpress 100G-TXE application

The TekExpress 100G-TXE application files are installed at the following location:

C:\Program Files\Tektronix\TekExpress\TekExpress 100G-TXE

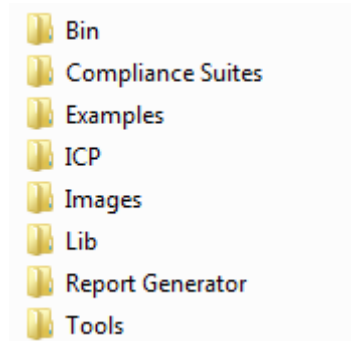

The following table lists the application directory names and their purpose.

Table 5: Application directories and usage

| Directory names | Usage |
|-------------------|--|
| Bin | Contains TekExpress 100G-TXE application libraries |
| Compliance Suites | Contains compliance-specific files |
| Examples | Contains various support files |
| ICP | Contains instrument and TekExpress 100G-TXE application-specific interface libraries |
| Images | Contains images of the TekExpress 100G-TXE application |
| Lib | Contains utility files specific to the TekExpress 100G-TXE application |
| Report Generator | Contains style sheets for report generation |
| Tools | Contains instrument and TekExpress 100G-TXE application-specific files |

See also [View test-related files](#)
[File name extensions](#)

File name extensions

The TekExpress 100G-TXE application uses the following file name extensions:

| File name extension | Description |
|---------------------|--|
| .TekX | Application session files (the extensions may not be displayed) |
| .py | Python sequence file |
| .xml | Test-specific configuration information (encrypted) files Application log files |
| .csv | Test result reports Plot data |
| .mht | Test result reports (default) Test reports can also be saved in HTML format |
| .pdf | Test result reports Application help document |
| .xslt | Style sheet used to generate reports |

See also [View test-related files](#)
[Application directories](#)

Operating basics

Launch the application

To launch the TekExpress 100G-TXE solution, select **Analyze > TekExpress 100G-TXE** from the TekScope menu.

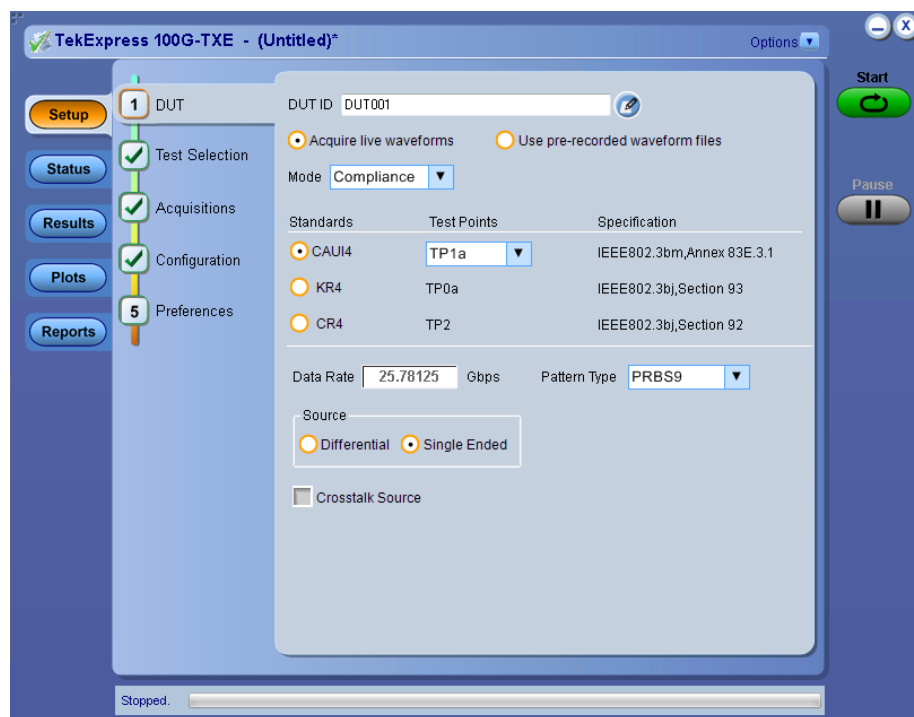

When you launch the application for the first time, the file C:\Users\\My Documents\My TekExpress\100G-TXE\Resources.xml is mapped to drive X:. This file contains information about available network-connected instruments. The session files are stored in X:\100G-TXE\. If this file is not found, then the application runs Instrument Discovery Program to detect the network-connected instruments before launching 100G-TXE solution.

If the application is behind the oscilloscope application, click **Analyze > TekExpress 100G-TXE** to bring it to the front. To keep the 100G-TXE application window on top, select **Keep On Top** from the 100G-TXE *Options menu*.

See also [Application controls](#)
[Application panel overview](#)

Application panels overview

TekExpress 100G-TXE solution uses panels to group Configuration, Results, and Reports settings. Click any button to open the associated panel. A panel may have one or more tabs that list the selections available in that panel. Controls in a tab can change depending on settings made in the same tab or another tab.

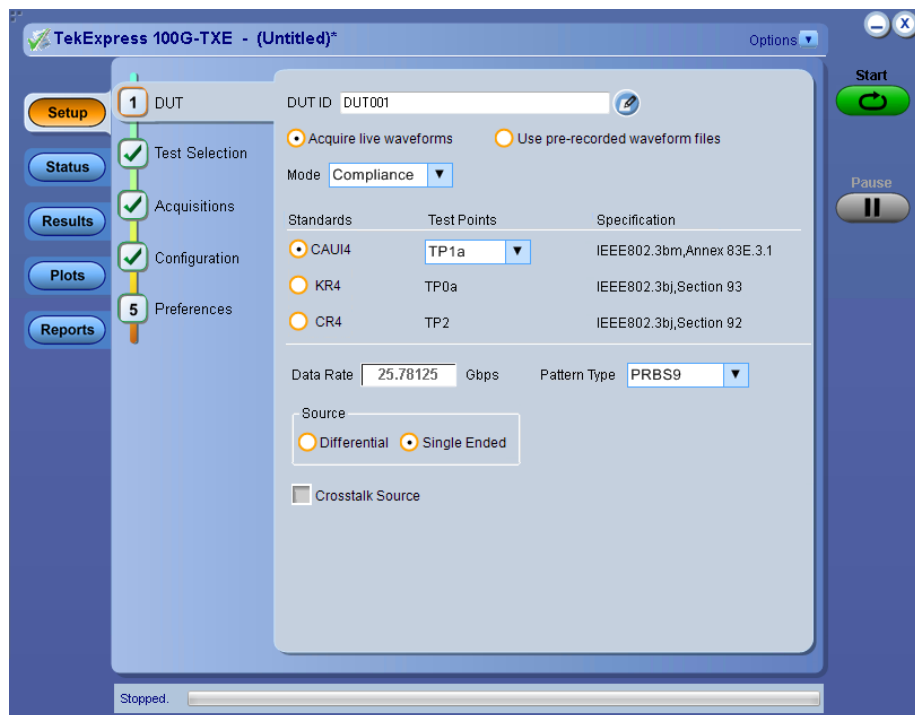

Table 6: Application panels overview





| Panel Name | Purpose |
|-------------------------------|---|
| Setup panel | The Setup panel shows the test setup controls. Click the Setup button to open this panel. Use this panel to: <ul style="list-style-type: none"> ■ Set DUT tab parameters ■ Select tests ■ Set acquisition tab parameters ■ Set configuration tab parameters ■ Set preferences tab parameters |
| Status panel | View the progress and analysis status of the selected tests, and view test logs. |
| Results panel | View the summary of test results and select result viewing preferences. |
| Reports panel | Browse for reports, save reports as specific file types, specify report naming conventions, select report content to include (summary information, detailed information, user comments, setup configuration, application configuration), and select report viewing options. |



See also [Application controls](#)

Global application controls

Application controls This section describes the application controls.

Table 7: Application controls description

| Item | Description |
|--|---|
| <p><i>Options menu</i></p>  | <p>To select global application controls.</p> |
| <p><i>Test Panel buttons</i></p>  | <p>Controls that open tabs for configuring test settings and options.</p> |
| <p>Start / Stop button</p>  | <p>Use the Start button to start the test run of the measurements in the selected order. If prior acquired measurements are not cleared, then new measurements are added to the existing set. The button toggles to the Stop mode while tests are running. Use the Stop button to abort the test.</p> |
| <p>Pause / Continue button</p>  | <p>Use the Pause button to pause the acquisition. When a test is paused, this button changes as Continue.</p> |
| <p>Clear button</p>  | <p>Use the Clear button to clear all existing measurement results. Adding or deleting a measurement, or changing a configuration parameter of an existing measurement, also clears measurements. This is to prevent the accumulation of measurement statistics or sets of statistics that are not coherent. This button is available only on Results panel.</p> |

| Item | Description |
|---|---|
| Application window move icon  | Place the cursor over the three-dot pattern in the upper left corner of the application window. When the cursor changes to a hand, drag the window to the desired location. |
| Minimize icon  | Click to minimize the application. |
| Close icon  | Click to close the application. |

See also. [Application panel overview](#)

Options menu overview

To access Options menu, click  in the upper-right corner of the application. It has the following:

Options menu

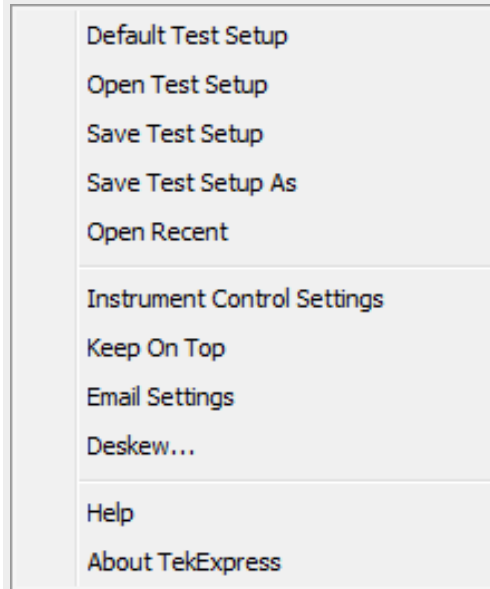

| Menu | Function |
|---|--|
| Default Test Setup | Opens an untitled test setup with defaults selected Acquire Live Waveforms Mode: User Defined Standards: CAUI4 Specification: IEEE802.3bm, Annex 83E.3.1 Data rate: 25.78125 Pattern Type: PRBS9 Source: Single ended |
| Open Test Setup | Opens a saved test setup |
| Save Test Setup | Saves the current test setup |
| Save Test Setup As | Saves the current test setup with a different file name or file type |
| Open Recent | Displays the recently opened test setups to open |
| Instrument Control Settings | Detects, lists, and refreshes the connected instruments found on specified connections (LAN, GPIB, USB, and so on) |
| Keep On Top | Keeps the TekExpress 100G-TXE application on top of all the application |
| Email Settings | Use to configure email options for test run and results notifications |
| Deskew | Allows to read the skew and attenuation values from the TekScope application. Before using this option, manually compensate for skew and attenuations in Tekscope application. |
| Help | Displays the TekExpress 100G-TXE help |
| About TekExpress | <ul style="list-style-type: none"> ■ Displays application details such as software name, version number, and copyright ■ Provides a link to the end-user license agreement ■ Provides a link to the Tektronix Web site |

See also. [Application controls](#)

TekExpress instrument control settings

Use TekExpress Instrument Control Settings dialog box to search the instruments (resources) connected to the application. You can use the Search Criteria to search the connected instruments depending on the connection type. The details of the connected instrument is displayed in the Retrieved Instruments window.

You can access this dialog box from the **Options** menu.

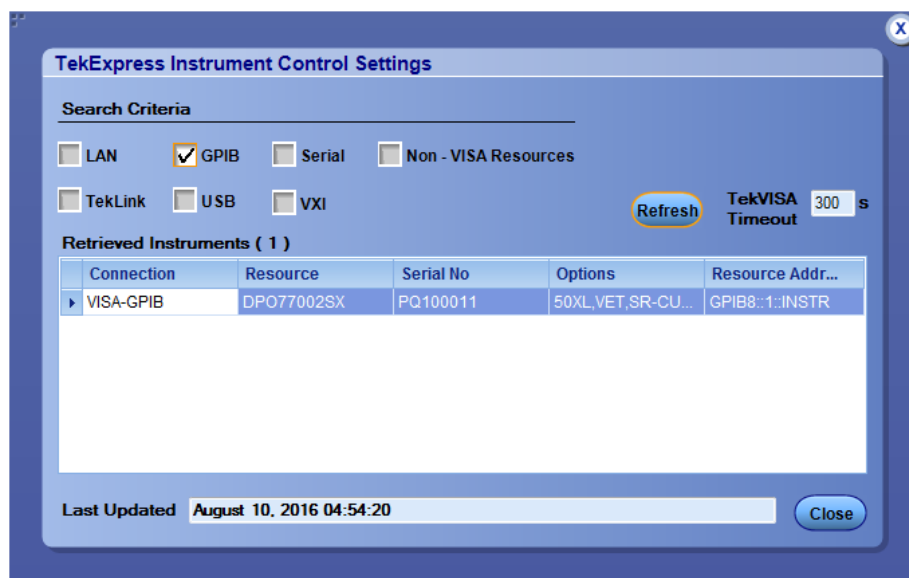

The connected instruments displayed here can be selected for use under Global Settings in the test configuration section.

NOTE. Select GPIB (Default) when using TekExpress 100G-TXE application.

See also. [Options menu overview](#)

View connected instruments

Use TekExpress Instrument Control Settings dialog box to search the instruments (resources) connected to the application. The application uses TekVISA to discover the connected instruments.

NOTE. *The instruments required for the test setup must be connected and it must be recognized by the application before running the test.*

To refresh the list of connected instruments:

1. From the Options menu, select **Instrument Control Settings**.
2. In the **Search Criteria** section of the Instrument Control Settings dialog box, select the connection types of the instruments to search.

Instrument search is based on the VISA layer, but different connections determine the resource type, such as LAN, GPIB, and USB. For example, if you choose LAN, the search will include all the instruments supported by TekExpress that are communicating over the LAN.

3. Click **Refresh**. TekExpress searches for connected instruments.

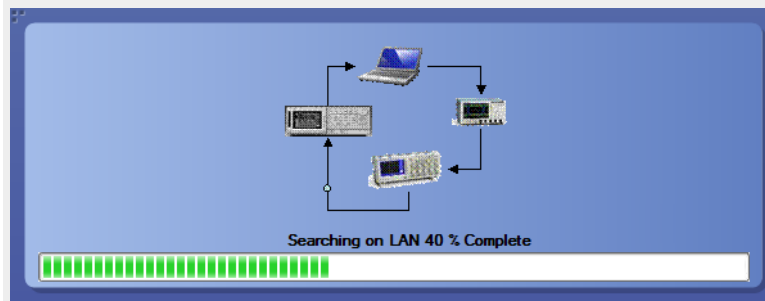

4. After searching, the dialog box lists the instrument-related details based on the search criteria. For example, For the Search Criteria as LAN and GPIB, the application displays all LAN and GPIB instruments connected to the application.

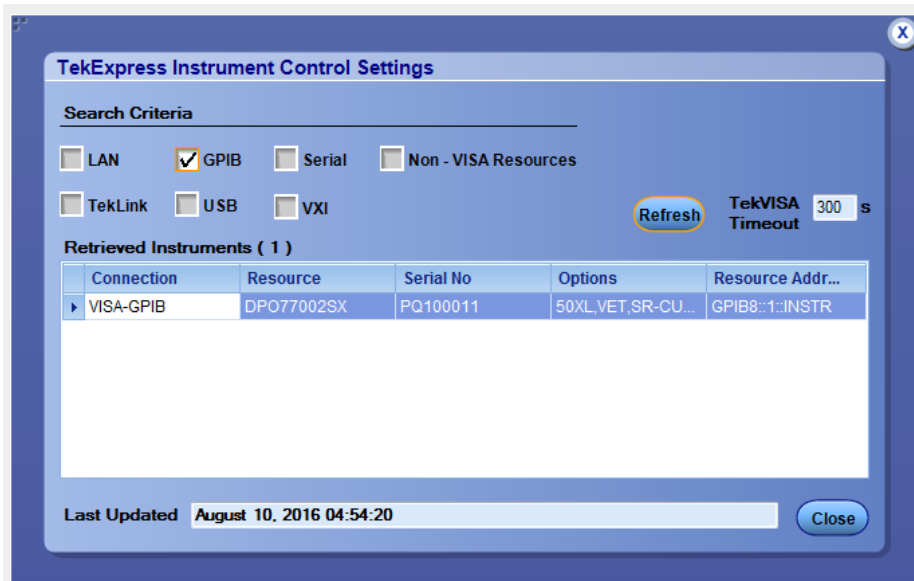

The details of the instruments are displayed in the Retrieved Instruments table. The time and date of instrument refresh is displayed in the Last Updated field.

See also. [Equipment connection setup](#)

Configure email settings

Use the Email Settings utility to get notified by email when a measurement completes, or produces any error condition. Follow the steps to configure email settings:

1. Select **Options > Email Settings** to open the *Email Settings* dialog box.
2. (Required) For Recipient email Address(es), enter one or more recipient email addresses. To include multiple addresses, separate the addresses with commas.
3. (Required) For Sender's Address, enter the email address used by the instrument. This address consists of the instrument name, followed by an underscore, followed by the instrument serial number, then the @ symbol, and the email server ID. For example: user@yourcompany.com.
4. (Required) In the Server Configuration section, type the SMTP Server address of the Mail server configured at the client location, and the SMTP Port number, in the corresponding fields.

If this server requires password authentication, enter a valid login name, password, and host name in the corresponding fields.

NOTE. *If any of the above required fields are left blank, the settings will not be saved and email notifications will not be sent.*

5. In the Email Attachments section, select from the following options:
 - **Reports:** Select to receive the test report with the notification email.
 - **Status Log:** Select to receive the test status log with the notification email. If you select this option, then also select whether you want to receive the full log or just the last 20 lines.
6. In the Email Configuration section:
 - Enter a maximum file size for the email message. Messages with attachments larger than this limit will not be sent. The default is 5 MB.
 - Enter the number in the Number of Attempts to Send field, to limit the number of attempts that the system makes to send a notification. The default is 1. You can also specify a timeout period.
7. Select the **Email Test Results When complete or on error** check box. Use this check box to quickly enable or disable email notifications.
8. To test your email settings, click **Test Email**.
9. To apply your settings, click **Apply**.
10. Click **Close** when finished.

Email Settings

Email Settings

Recipient e-mail Address(es)

Note: Separate Email addresses with a comma

Sender's Address

Email Attachments

Reports

Status Log Last 20 Lines Full Log

Server Configuration

SMTP Server SMTP Port

Login

Password

Host Name

Email Configuration

Max Email Size (MB) Number of Attempts to Send

Timeout (Sec)

Email Test Results When complete or on error

Setup panel

Setup panel overview

The Setup panel contains sequentially ordered tabs that help you guide through the test setup and execution process.

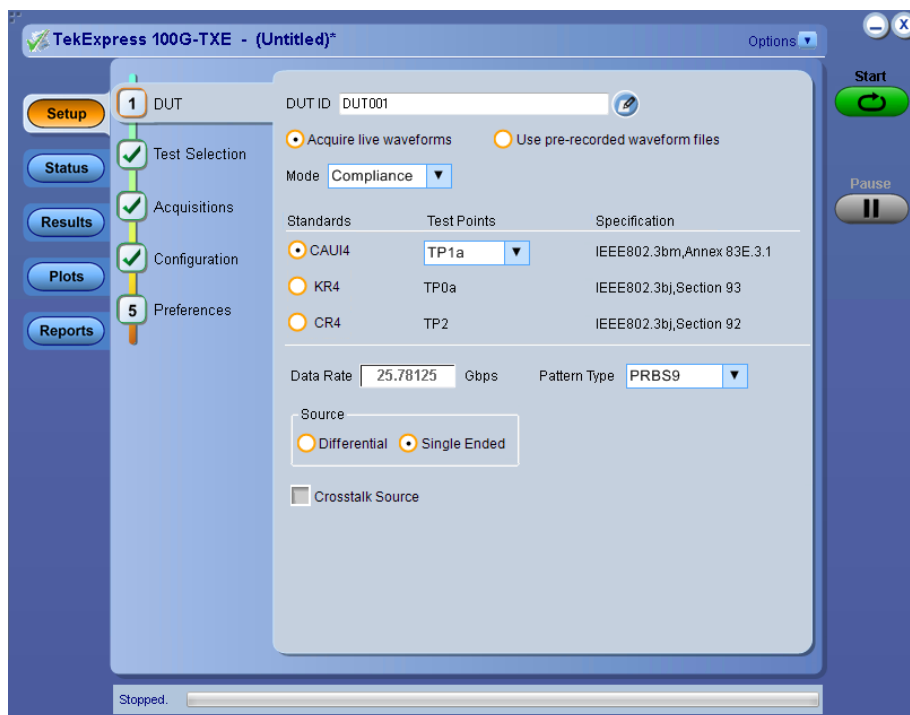

Set DUT parameters

Use the DUT tab to select parameters for the device under test. These settings are global and apply to all tests of current session. DUT settings also affect the list of available tests in the Test Selection tab.

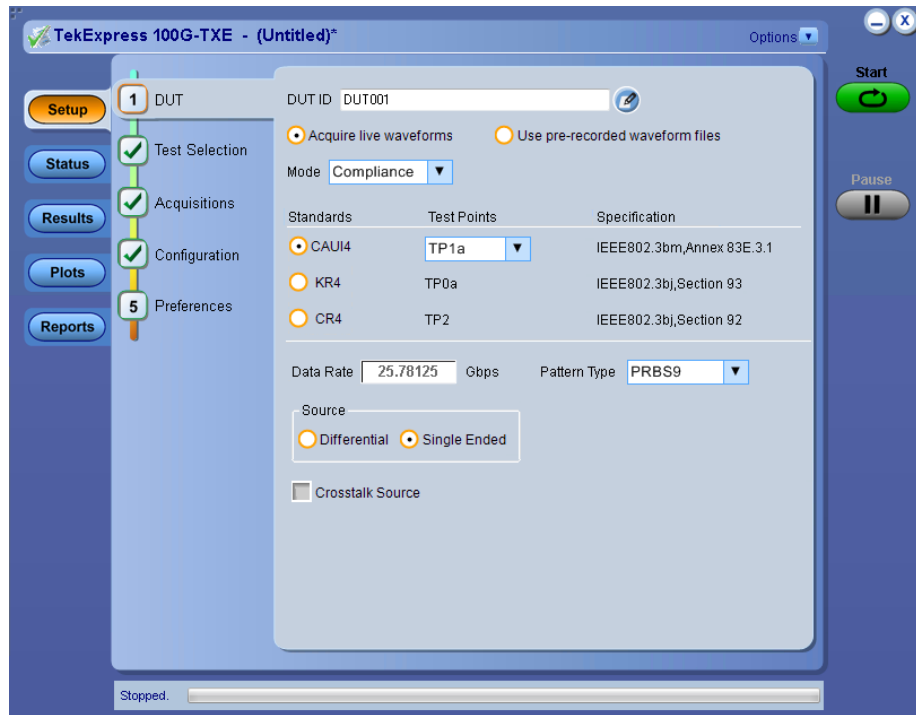

Click **Setup > DUT** to access the DUT parameters:

Table 8: DUT tab settings

| Setting | Description |
|--|--|
| DUT ID | Adds an optional text label for the DUT to reports. The default value is DUT001. The maximum number of characters is 32. You cannot use the following characters in an ID name: (,.,,.,.,., \,/:? "<> *) |
|  Comments icon (to the right of the DUT ID field) | Opens Comments dialog box to enter text to add to the report. Maximum size is 256 characters. To enable or disable comments appearing on the test report, see Select report options . |
| Acquire live waveforms | Perform analysis on live waveforms. |
| Use pre-recorded waveform files | Perform analysis on pre-recorded waveforms. |
| Mode | <ul style="list-style-type: none"> ■ Compliance ■ User Defined |
| Standards | Test Points Specification |
| CAUI4 ¹ | TP1a IEEE802.3bm, Annex 83E.3.1 |
| | TP4 IEEE802.3bm, Annex 83E.3.2 |

¹ CAUI4 (CAUI-4) is 100G chip-to-module IEEE 802.3bm interface, operating on four 25 Gb/s lanes.

| Setting | Description | |
|------------------|--|-------------------------|
| KR4 ² | TP0a | IEEE802.3bj, Section 93 |
| CR4 ³ | TP2 | IEEE802.3bj, Section 92 |
| Data Rate | Set the data rate to be tested within the range 18 to 28.05. The default value is 25.78125 | |
| Pattern Type | Select the pattern type. The available options are PRBS7, 9, 11, and 15. By default, it is PRBS9. | |
| Source | <ul style="list-style-type: none"> ■ Differential - Source as differential signal ■ Single Ended -Source as single-ended signals | |
| Crosstalk Source | Select crosstalk source when cross talk generator is connected. This is applicable for Eye width and Eye height measurements only. | |

See also. [Select tests](#)

Select tests Use the Test Selection tab to select the tests. The test measurements available depends on the standards selected in the DUT tab.

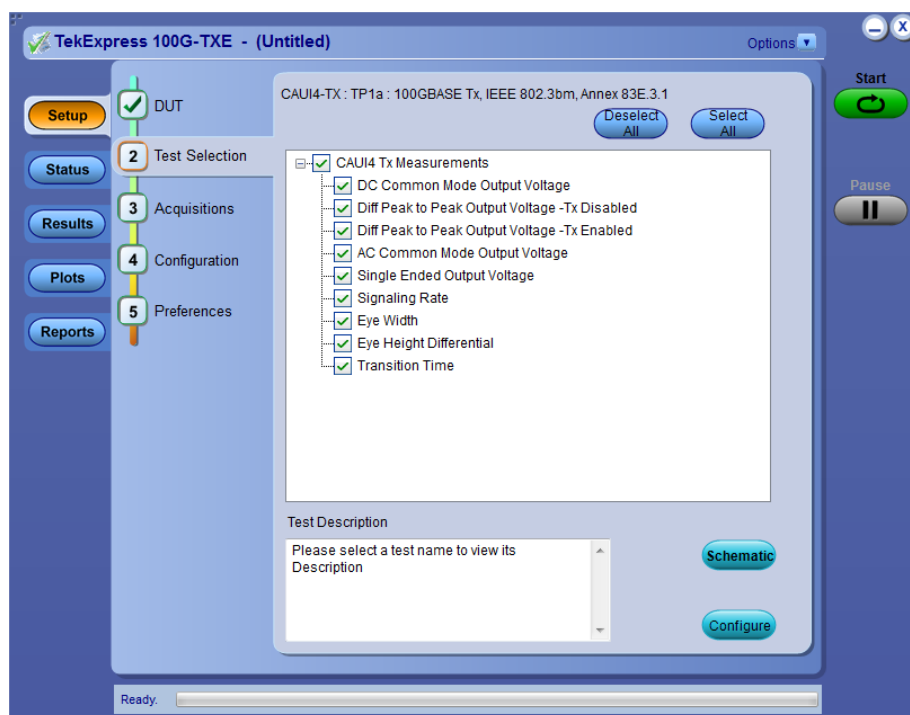

Figure 1: CAUI4 TX measurements

² KR4 (100GBASE-KR4) is an Ethernet IEEE 802.3bj standard for 100G backplanes.

³ CR4 (100GBASE-CR4) is an Ethernet IEEE802.3bj standard for 100G over twin-axial cables.

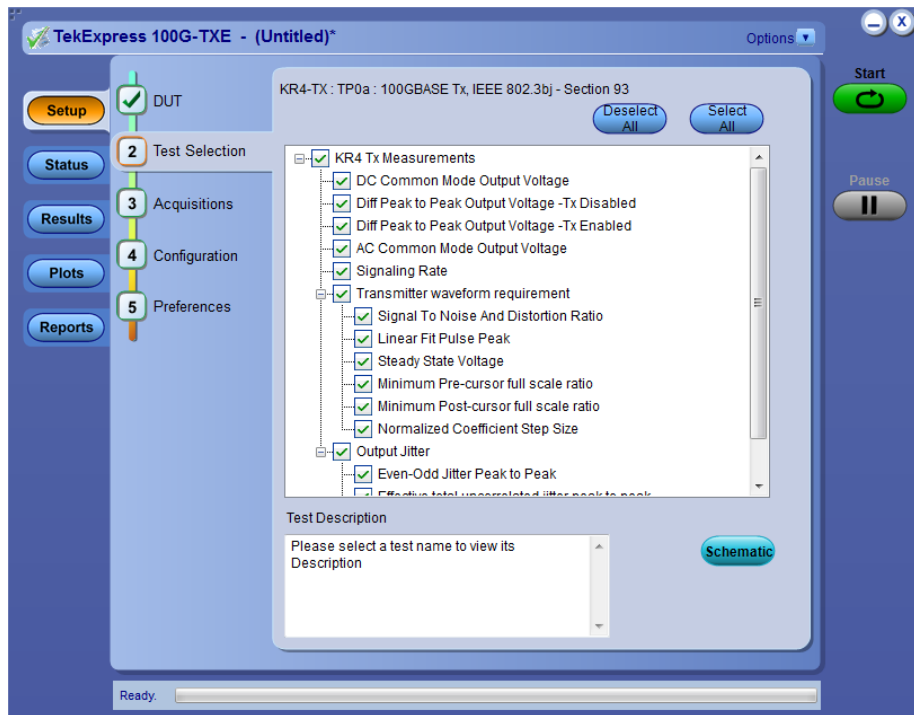

Figure 2: KR4 TX measurements

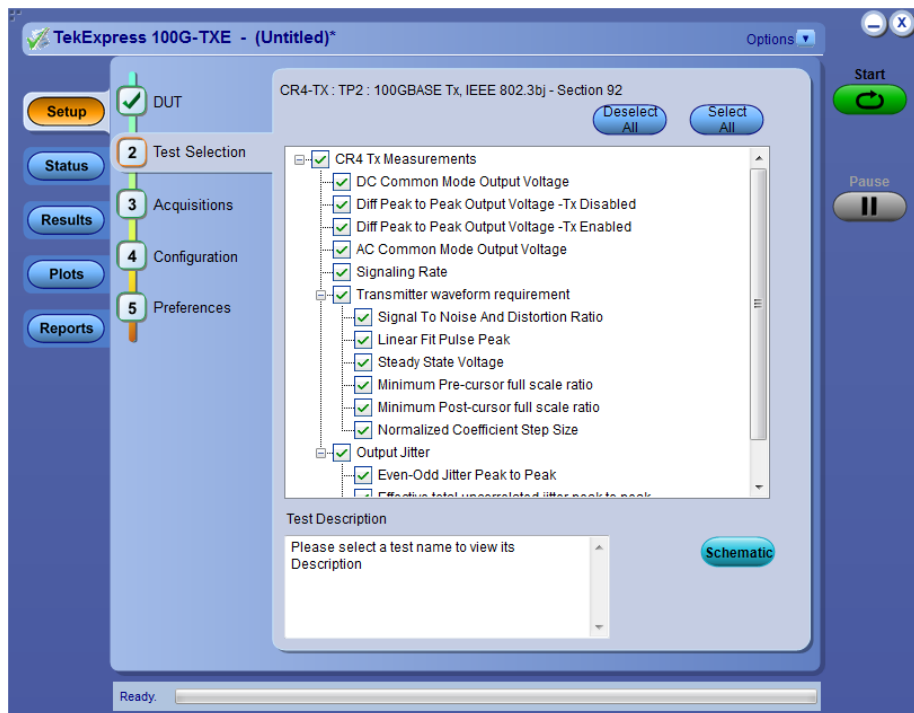

Figure 3: CR4 TX measurements

Table 9: Test Selection tab settings

| Setting | Description |
|------------------|---|
| Tests | Click on a test to select or unselect. Highlight a test to show details in the Test Description pane. |
| Test Description | Shows brief description of the highlighted test in the Test field. |

See also. [Set acquisition tab parameters](#)

Set acquisition tab parameters

Use Acquisitions tab to view the test acquisition parameters. The contents displayed on this tab depends on the DUT type and the tests selected.

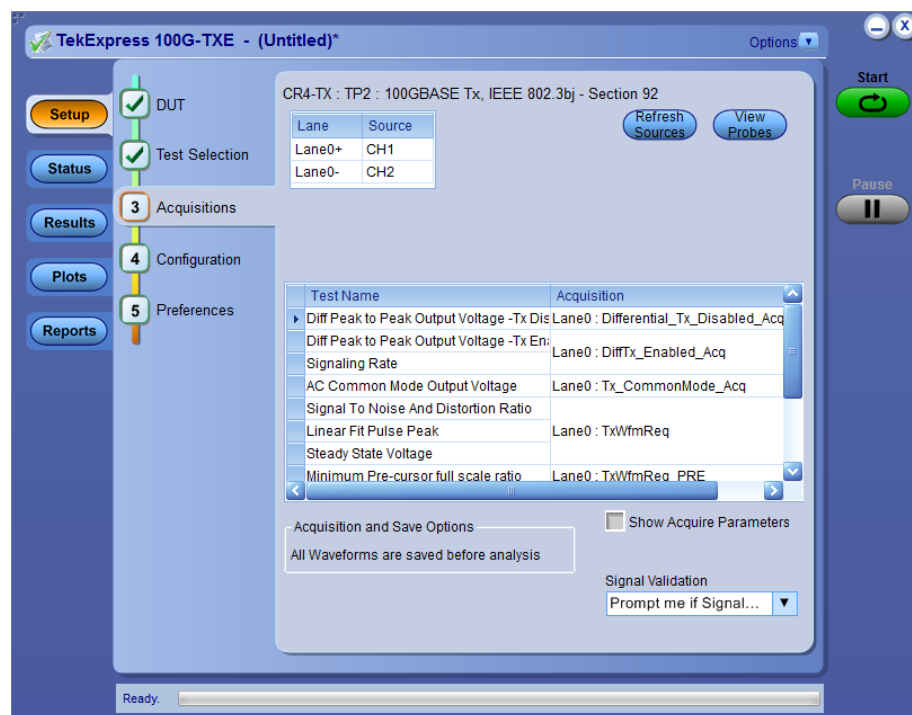

NOTE. 100G-TXE application acquires all waveforms needed by each test group before performing analysis.

Table 10: Acquisitions tab settings

| Setting | Description |
|-------------------------|--|
| Show Acquire Parameters | Select to view the acquisition parameters. |
| Signal Validation: | Sets the application to validate acquisition signals and perform the specified action to take when acquired signals do not meet requirements. Select the action from the list. |

TekExpress 100G-TXE saves all acquisition waveforms to files by default. Waveforms are saved in a unique folder for each session (a session is started when you click the Start button). The folder path is X:\100G-TXE\Untitled Session\

Saving a session moves the session file contents from the Untitled Session folder to the specified folder name, and changes the session name to the specified name.

Set configuration tab parameters

Use Configuration tab to view and configure the Global Settings and the measurement configurations. The Global Settings and the measurements with configurations available in this tab depends on the Standards selected in the DUT tab.

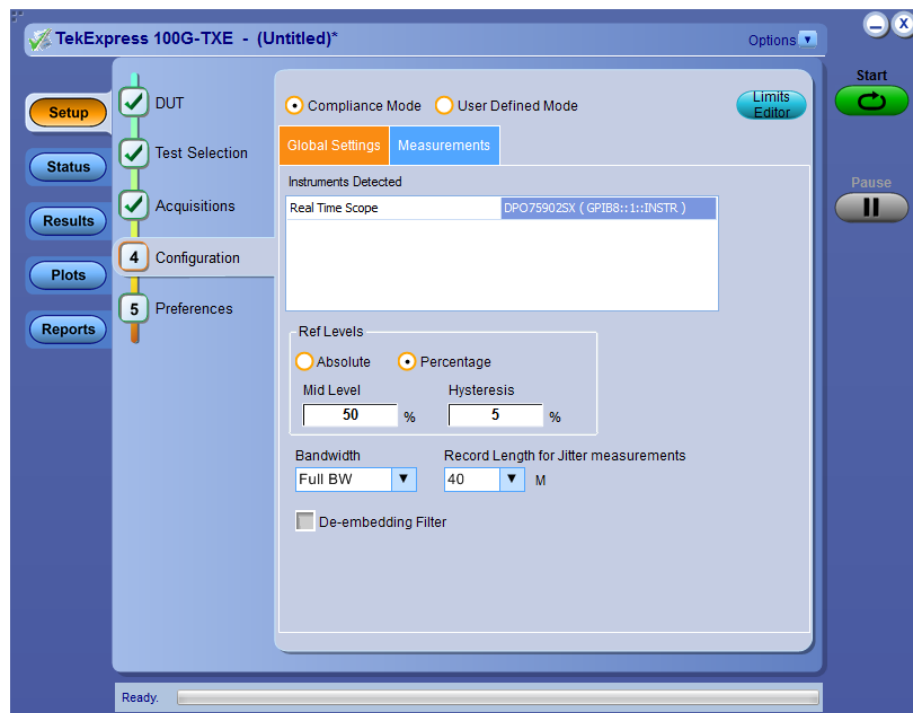

Figure 4: Configuration tab: Global Settings

Table 11: Configuration tab settings

| Setting | Description |
|---------------------------------------|---|
| Compliance Mode | Select compliance mode. By default Compliance Mode is selected. |
| User Defined Mode | Select user defined mode |
| Global Settings | |
| Instruments Detected | <p>Displays the instruments connected to this application. Click on the instrument name to open a list of available (detected) instruments.</p> <p>Select Options > Instrument Control Settings and click Refresh to update the instrument list.</p> <p>NOTE. Verify that the GPIB search criteria (default setting) in the Instrument Control Settings is selected when using TekExpress 100G-TXE application.</p> |
| Ref Levels | |
| Absolute | Select to set the Ref Levels in Absolute |
| Percentage | Select to set the Ref Levels in Percentage |
| Mid Level | Select the mid level in absolute or percentage |
| Hysteresis | Select the hysteresis in absolute or percentage |
| Bandwidth | Select the bandwidth as Full BW or 50 GHz. By default Full BW is selected. |
| Record Length for Jitter measurements | <p>Select the record length for jitter measurements. The available values are 20 M, 30 M, 40 M. By default 40 M is selected.</p> <p>NOTE. This configuration is applicable for jitter measurements only.</p> |
| Record Length for Eye measurements | <p>Select the record length for jitter measurements. The available values are 20 M, 30 M, 40 M. By default 40 M is selected.</p> <p>NOTE. This configuration is applicable for eye measurements only.</p> |

| Setting | Description |
|---------------------------------|---|
| De-Embedding Filter | <p>Select to apply the de-embed filter file. Click Browse and select the de-embedding filter files (.flt). For single ended mode, select filter file for Data Positive and Data Negative.</p> <ul style="list-style-type: none"> ■ Source file name for data Positive ■ Source file name for data negative <p>For Differential mode, select differential filter file.</p> <ul style="list-style-type: none"> ■ Differential source filter file name <hr/> <p>NOTE. <i>Browse</i> option is enabled only when you select Use filter file for de-embedding.</p> |
| CTLE Filter File | <p>Select the CTLE Filter File.</p> <p>Compliance mode</p> <ul style="list-style-type: none"> ■ All: Application will run through all CTLE filters from 1 dB - 9 dB (at TP1a) and 1 dB - 2 dB (at TP4) ■ Best CTLE: After the first run, Best CTLE filter option gets enabled. User can run the measurement with Best CLTE instead of looping through all CTLE filters in the specification. <p>User Defined mode</p> <ul style="list-style-type: none"> ■ User can run the measurement with any specified CTLE filter. The application provides CTLE filters from 0 dB - 9 dB for data rate of 25.78125 Gbps. It is recommended to create custom CTLE filter files for any other data rates. <p>Select the CTLE filters from the drop-down list or Custom to browse and select the custom CTLE filter files.</p> <hr/> <p>NOTE. <i>Custom CTLE filter files is to be named in the format <user defined name>_ndB.flt, where n is the gain of the filter.</i></p> |
| Measurements - CAUI4 TXE | |
| Analyze | Measurement Range - 20%-80% |

De-embedding filter. You can de-embed the signal path from fixture output to the scope channel input. Manual filter files can also be created using SDLA or any other method.

Mid Level. Use to prevent small amounts of noise in a waveform from producing multiple threshold crossings. Use when the rising and falling thresholds for a given reference voltage level are set to the same value.

Hysteresis. A reference voltage level that defines when the waveform state transition occurs at a given threshold.

Set preferences tab parameters

Use Preferences tab to set the application action on completion of a measurement.

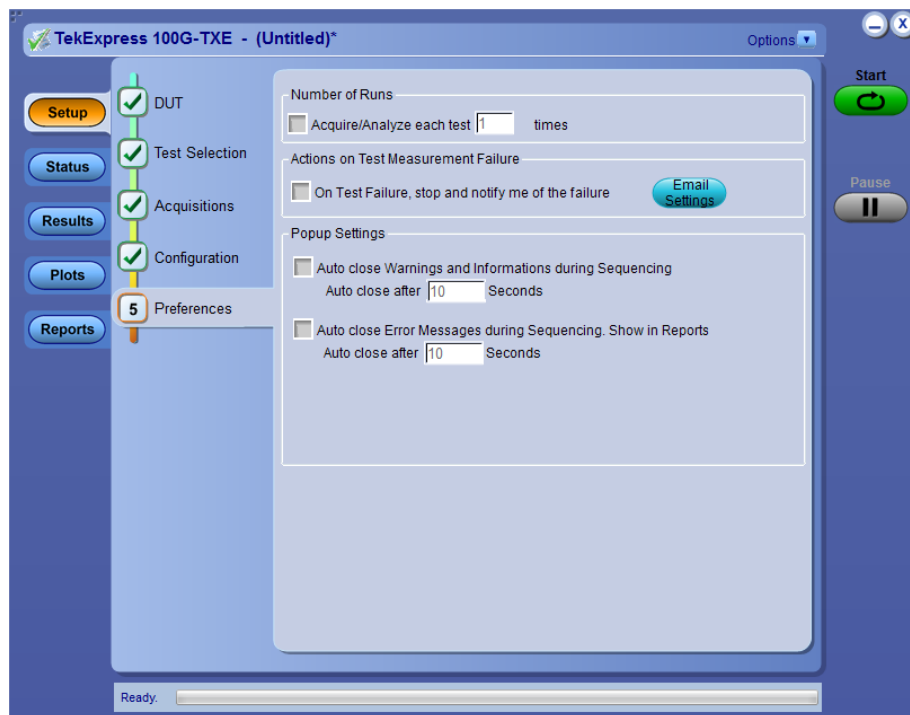

Table 12: Preferences tab settings

| Setting | Description |
|---|--|
| Number of Runs | |
| Acquire/Analyze each test <no> times (not applicable to Custom Tests) | Select to repeat the test run by setting the number of times. By default, it is selected with 1 run. |
| Actions on Test Measurement Failure | |
| On Test Failure, stop and notify me of the failure | Select to stop the test run on Test Failure, and to get notified via email. By default, it is unselected. Click Email Settings to configure. |
| Popup Settings | |

| Setting | Description |
|--|---|
| Auto close Warnings and Informations during Sequencing Auto close after <no> Seconds | Select to auto close warnings/informations during sequencing. Set the Auto close time. By default it is unselected. |
| Auto close Error Messages during Sequencing. Show in Reports Auto close after <no> Seconds | Select to auto close Error Messages during Sequencing. Set the Auto close time. By default it is unselected. |

Status panel

Status panel overview

The Status panel accesses the Test Status and Log View tabs, which provide status on test acquisition and analysis (Test Status tab) and a listing of test tasks performed (Log View tab). The application opens the Test Status tab when you start a test run. You can select the Test Status or the Log View tab to view these items while tests are running.

Test status view

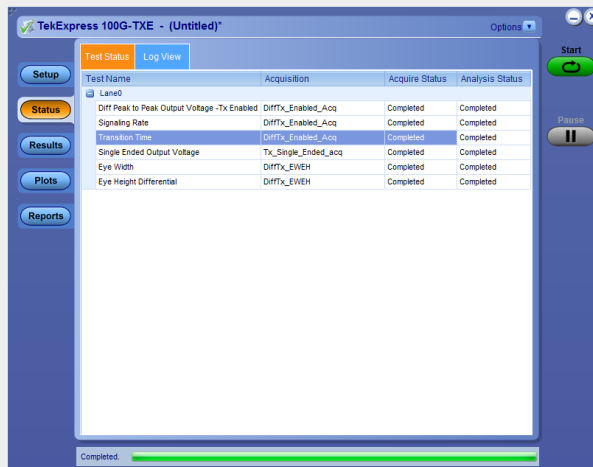

Log view

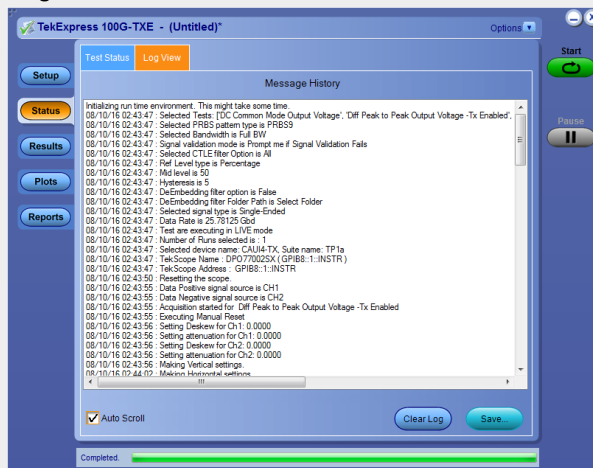

Table 13: Status panel Log View controls

| Control | Description |
|-----------------|---|
| Message History | Lists all executed test operations and timestamp information. |
| Auto Scroll | Enables automatic scrolling of the log view as information is added to the log during the test. |
| Clear Log | Clears all messages from the log view. |
| Save | Saves the log file to a text file. Use the standard Save File window to navigate to and specify the folder and file name to which to save the log text. |

See also. [Application panel overview](#)

Results panel

Results panel overview

When a test execution is complete, the application automatically opens the **Results** panel to display a summary of test results.

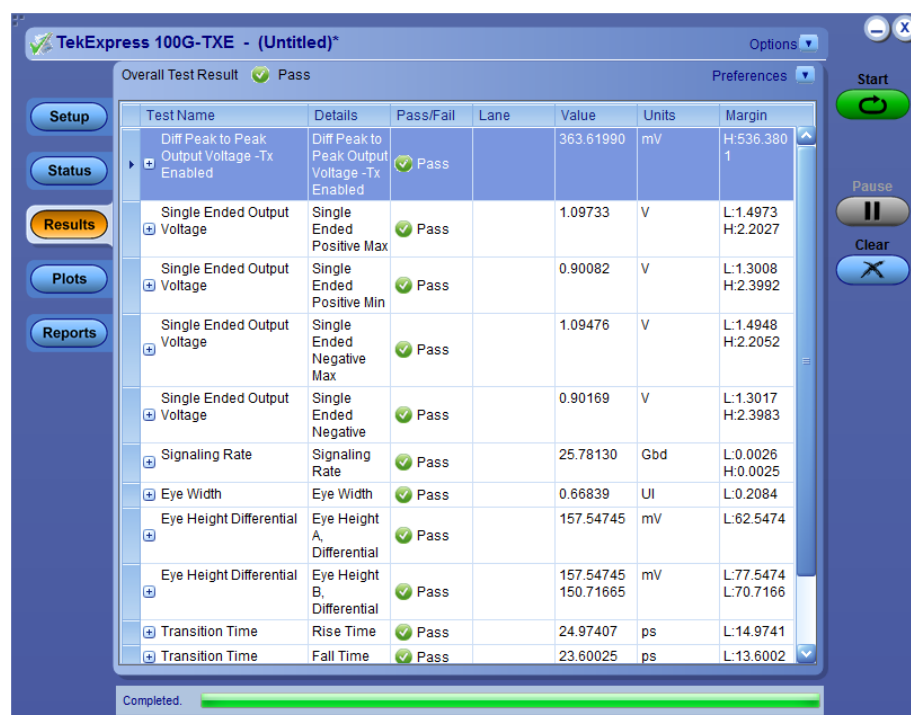

See also. [View a report](#)

[Application panels overview](#)

View test-related files

Files related to tests are stored in My TekExpress\100G-TXE\ . Each test setup in this folder has both a test setup *file* and a test setup *folder*, both with the test setup name.

The test setup file is preceded by the TekExpress icon and usually has no visible file name extension.

Inside the test setup folder is another folder named for the DUT ID used in the test sessions. The default is DUT001.

Inside the DUT001 folder are the session folders and files. Each session also has a folder and file pair, both named for the test session using the naming convention (date)_(time). Each session file is stored outside its matching session folder:

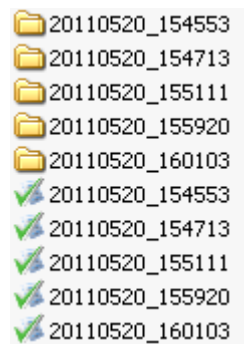

Each session folder contains image files of any plots generated from running the test session. If you selected to save all waveforms or ran tests using prerecorded waveform files, these are included here.

The first time you run a new, unsaved session, the session files are stored in the Untitled Session folder located at ..\My TekExpress\100G-TXE\. When you name and save the session, the files are placed in a folder with the name that you specify. A copy of the test files stay in the Untitled Session folder until you run a new test or until you close the 100G-TXE application.

See also. [File name extensions](#)

Reports panel

Reports panel overview Use Reports panel to browse for reports, name and save reports, select test content to include in reports, and select report viewing options.

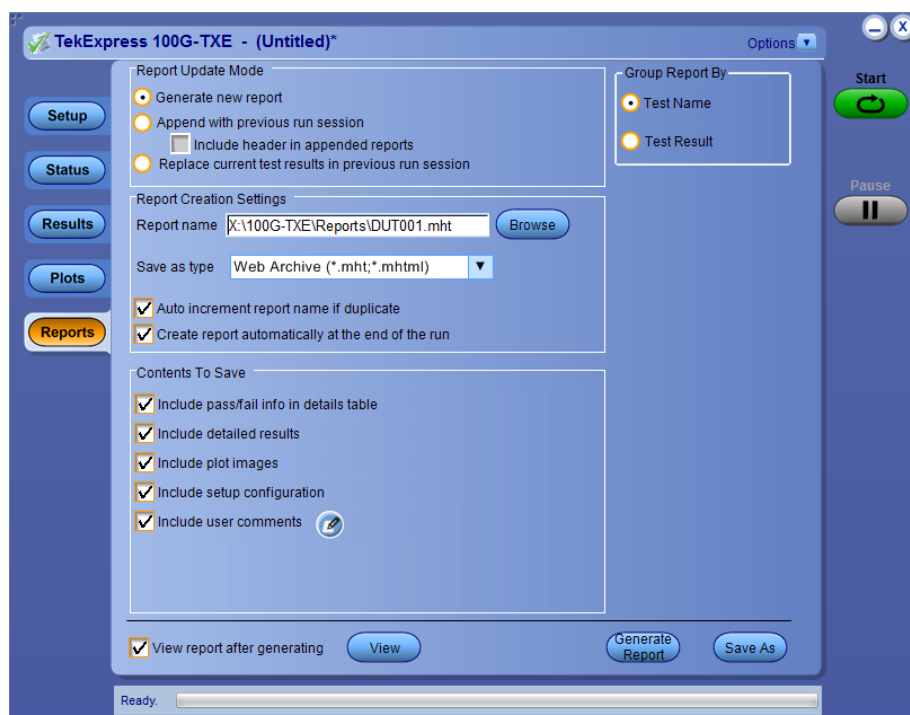

For information on setting up reports, see [Select report options](#). For information on viewing reports, see [View a report](#).

See also. [Applications panel overview](#)

Select report options Click Reports panel and use the Reports panel controls to select which test result information to include in the report, and the naming conventions to use for the report. For example, always give the report a unique name or select to have the same name increment each time you run a particular test.

Select report options before running a test or when creating and saving test setups. Report settings are included in saved test setups.

In the Reports panel, select from the following report options:

Table 14: Report options

| Setting | Description |
|---|---|
| Report Update Mode | |
| Generate new report | Creates a new report. The report can be in either .mht or .pdf file formats. |
| Append with previous run session | Appends the latest test results to the end of the current test results report. |
| Include header in appended reports | Select to include header in appended reports |
| Replace current test in previous run session | Replaces the previous test results with the latest test results. Results from newly added tests are appended to the end of the report. |
| Report Creation Settings | |
| Report name | <p>Displays the name and location from which to open a 100G-TXE report. The default location is at <i>My TekExpress\100G-TXE\Untitled Session</i>. The report file in this folder gets overwritten each time you run a test unless you specify a unique name or select to auto increment the report name.</p> <p>Change the report name or location.</p> <p>Do one of the following:</p> <ul style="list-style-type: none"> ■ In the Report Path field, type over the current folder path and name. ■ Double-click in the Report Path field and then make selections from the popup keyboard and click the Enter button. <p>Be sure to include the entire folder path, the file name, and the file extension. For example: C:\Documents and Settings\your user name\My Documents\My TekExpress\100G-TXE\DUT001.mht.</p> <p>NOTE. You cannot set the file location using the Browse button.</p> <p>Open an existing report.</p> <p>Click Browse, locate and select the report file and then click View at the bottom of the panel.</p> |
| Save as type | <p>Saves a report in the specified file type, selected from the drop-down list.</p> <p>NOTE. If you select a file type different from the default, be sure to change the report file name extension in the Report Name field to match.</p> |
| Auto increment report name if duplicate | Sets the application to automatically increment the name of the report file if the application finds a file with the same name as the one being generated. For example: DUT001, DUT002, DUT003. This option is enabled by default. |
| Create report automatically at the end of the run | Creates report at the end of the run. |

| Setting | Description |
|---|--|
| Contents To Save | |
| Include pass/fail info in details table | Includes pass/fail info in the details table of the report. |
| Include detailed results | Includes detailed results in the report. |
| Include plot images | Includes plot images in the report. |
| Include setup configuration | Sets the application to include hardware and software information in the summary box at the top of the report. Information includes: the oscilloscope model and serial number, the oscilloscope firmware version, and software versions for applications used in the measurements. |
| Include user comments | Select to include any comments about the test that you or another user added in the DUT tab of the Setup panel. Comments appear in the Comments section, under the summary box at the beginning of each report. |
| Group Report By | |
| Test Name | Select to group the tests in the report by test name. |
| Test Result | Select to group the tests in the report by test results |
| View report after generating | Automatically opens the report in a Web browser when the test completes. This option is selected by default. |
| View | Click to view the most current report. |
| Generate Report | Generates a new report based on the current analysis results. |
| Save As | Specify a name for the report. |

View a report The application automatically generates a report when test execution is complete and displays the report in your default Web browser (unless you cleared the **View Report After Generating** check box in the Reports panel before running the test). If you cleared this check box, or to view a different test report, do the following:

1. Click the **Reports** button.
2. Click the **Browse** button and locate and select the report file to view.
3. In the Reports panel, click **View**.

For information on changing the file type, file name, and other report options, see [Select report options](#).

Report contents A report shows detailed results and plots, as set in the Reports panel.

| Tektronix | | TekExpress 100G-TXE | |
|---|--|-------------------------------|-----------------------|
| | | Test Report CAUI4-TX (TP1a) | |
| Setup Information | | | |
| DUT ID | DUT001 | Master Scope Information | DPO770025X , PQ100011 |
| Date/Time | 2016-08-10 02:43:47 | Master Scope F/W Version | 10.3.0 Build 18 |
| TekExpress Version | 100G-TXE 1.0.0.203 Framework: 4.1.0.28 | Master Scope SPC Status | PASS |
| Specification Version | IEEE 802.3bm, Annex 83E.3.1 | Extension-1 Scope Information | DPO770025X , PQ100013 |
| Probing Type | Single-Ended | Extension-1 Scope F/W Version | 10.3.0 Build 18 |
| Compliance Mode | True | Extension-1 Scope SPC Status | PASS |
| Execution Mode | Live | Pattern Type | PRBS9 |
| Overall Test Result | Pass | Bandwidth | Full BW |
| Overall Execution Time | 0:06:57 | DPOJET version | "10.0.0.35" |
| DUT COMMENT: | 100G-TXE CAUI4 | | |
| Test Name Summary Table | | | |
| DC Common Mode Output Voltage | Pass | | |
| Diff Peak to Peak Output Voltage - Tx Enabled | Pass | | |
| Single Ended Output Voltage | Pass | | |
| Signaling Rate | Pass | | |
| Eye Width | Pass | | |
| Eye Height Differential | Pass | | |
| Transition Time | Pass | | |

Setup configuration information

The summary box at the beginning of the report lists setup configuration information. This information includes the oscilloscope model and serial number, optical module model and serial number, and software version numbers of all associated applications.

To exclude this information from a report, clear the **Include Setup Configuration** check box in the Reports panel before running the test.

User comments

If you selected to include comments in the test report, any comments you added in the DUT tab are shown at the top of the report.

See also. [Results panel overview](#)

[View test-related files](#)

Running tests

Equipment connection diagram

Click **Setup** > **Test Selection** > **Schematic** to view the equipment setup diagram(s).

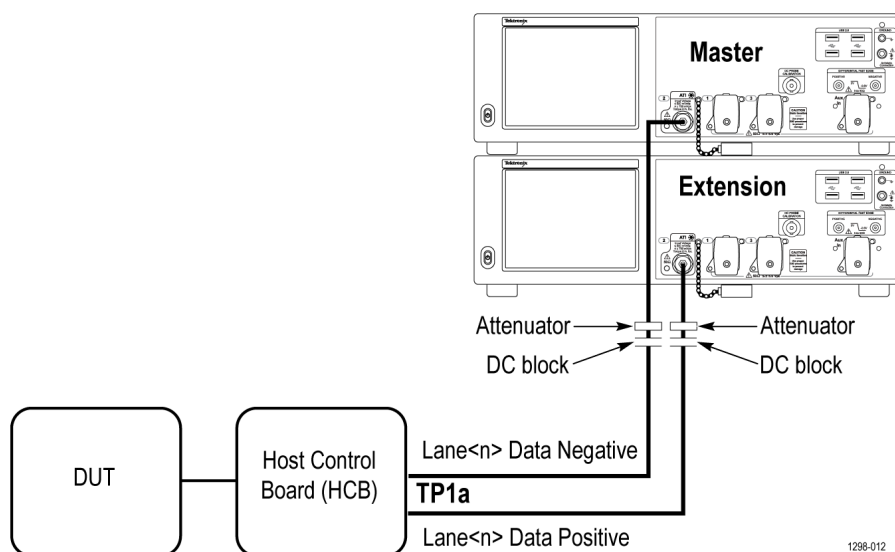

Figure 5: CAUI4 TP1a (Single ended)

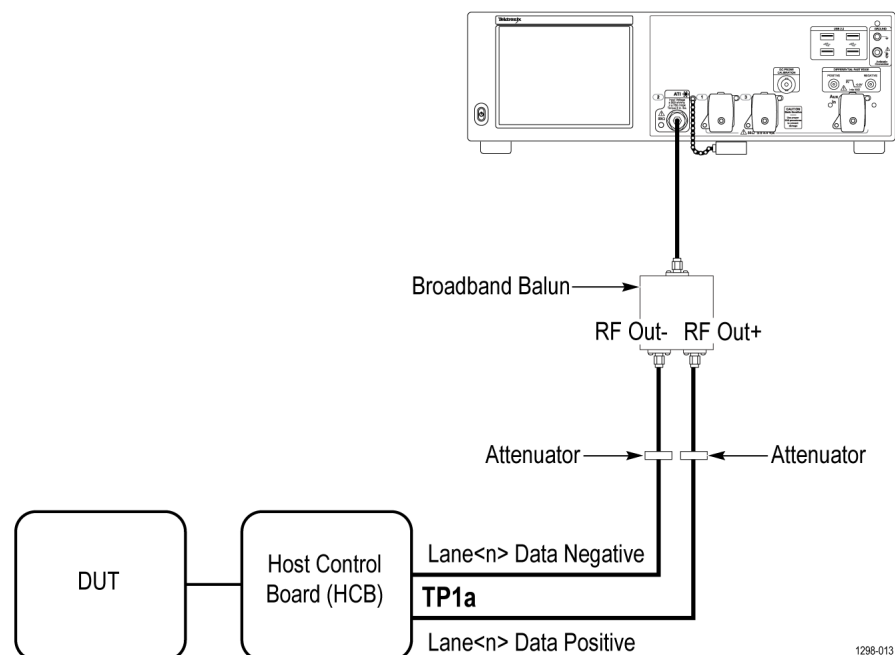

Figure 6: CAUI4 TP1a (Differential)

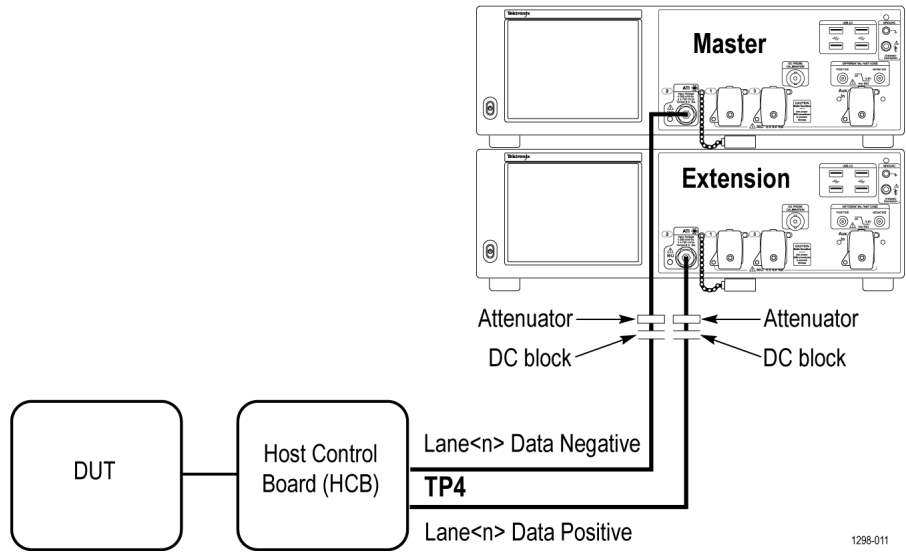

Figure 7: CAUI4 TP4 (Single ended)

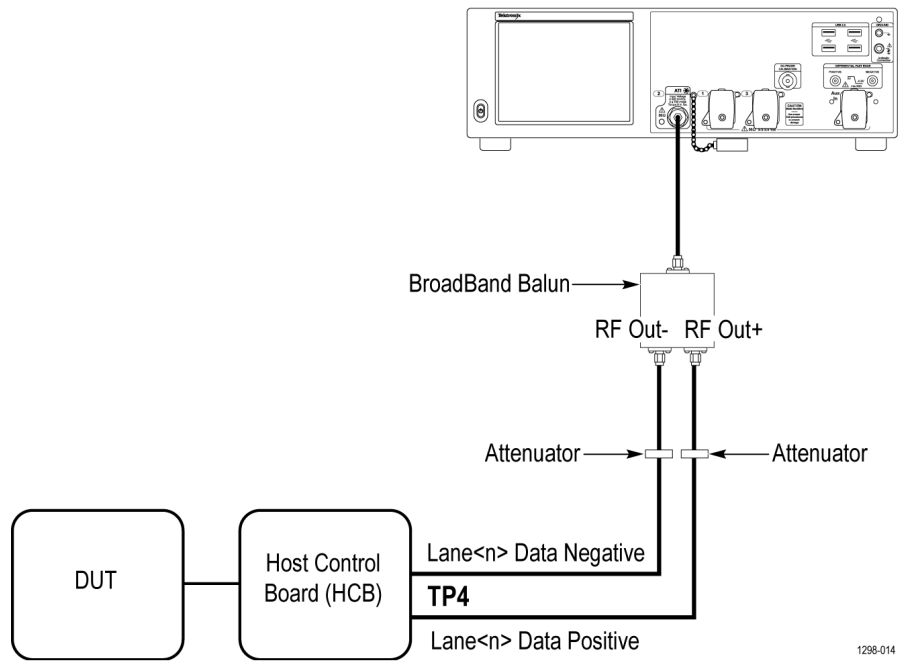

Figure 8: CAUI4 TP4 (Differential)

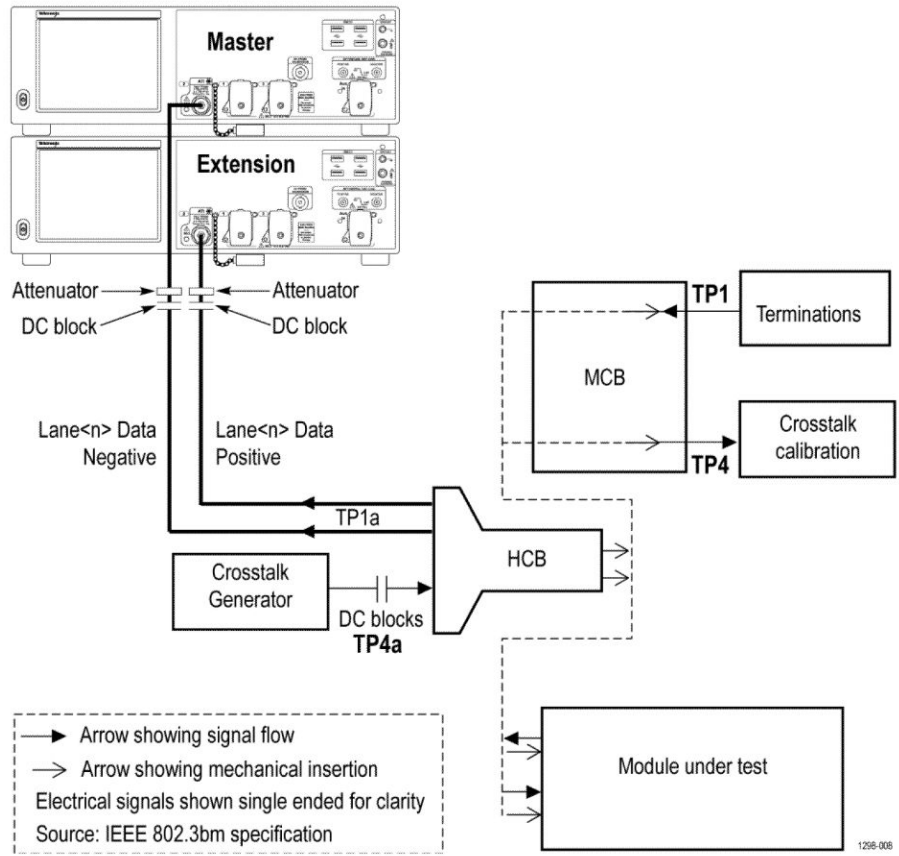

Figure 9: CAUI4 Eye Width / Eye Height TP1a (Single ended)

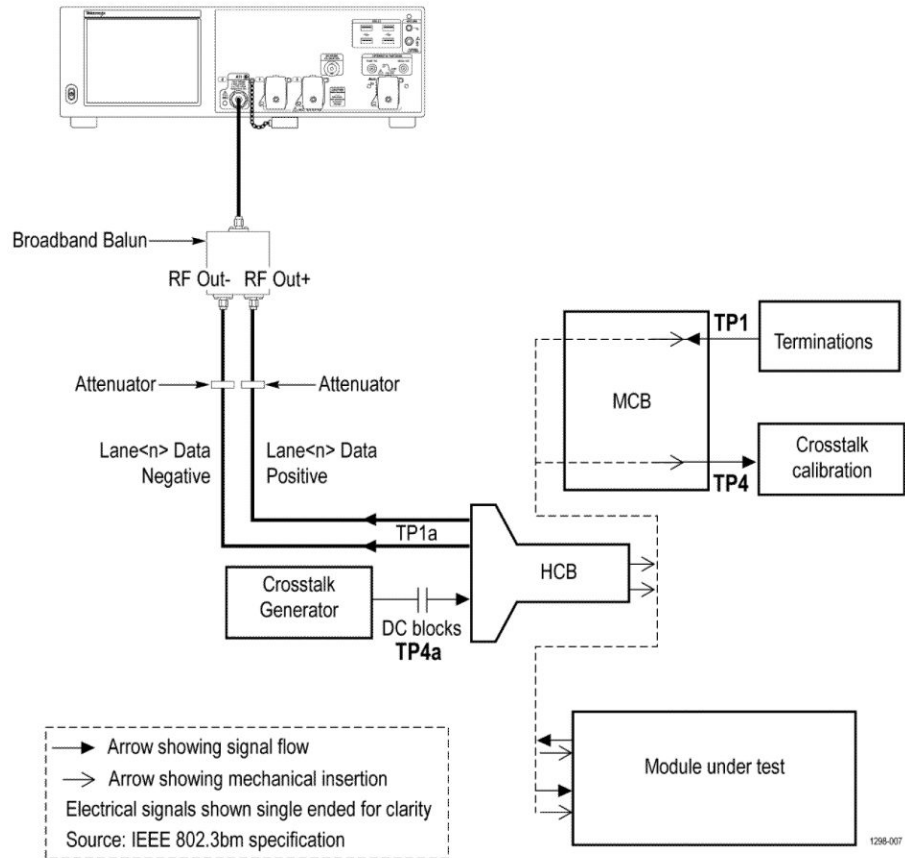

Figure 10: CAUI4 Eye Width / Eye Height TP1a (Differential)

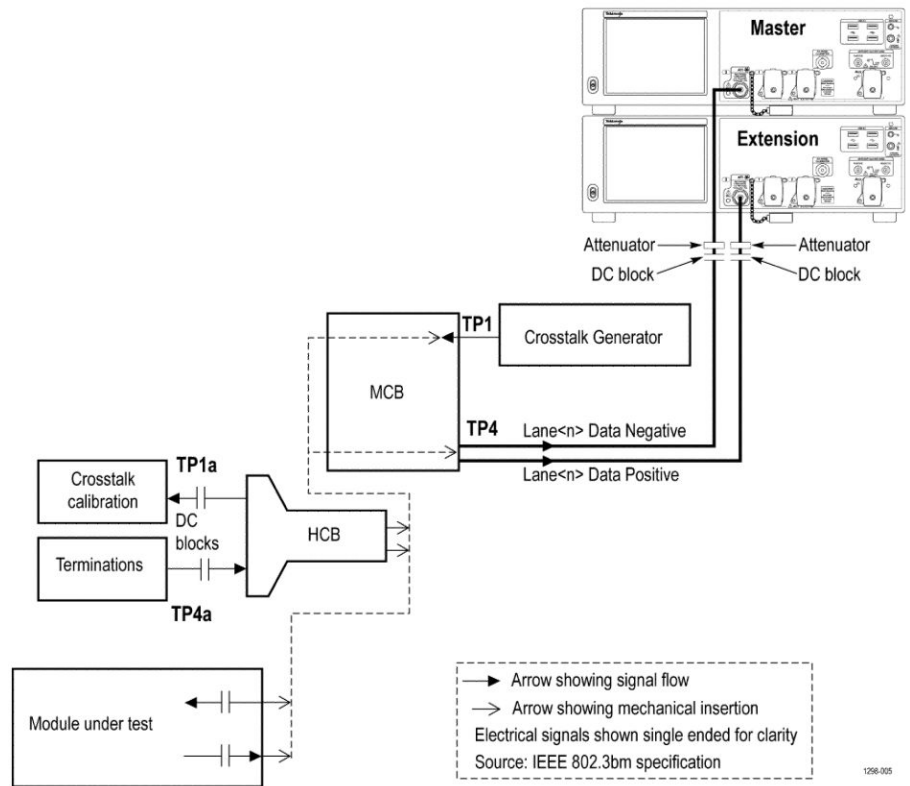

Figure 11: CAUI4 Eye Width / Eye Height TP4 (Single ended)

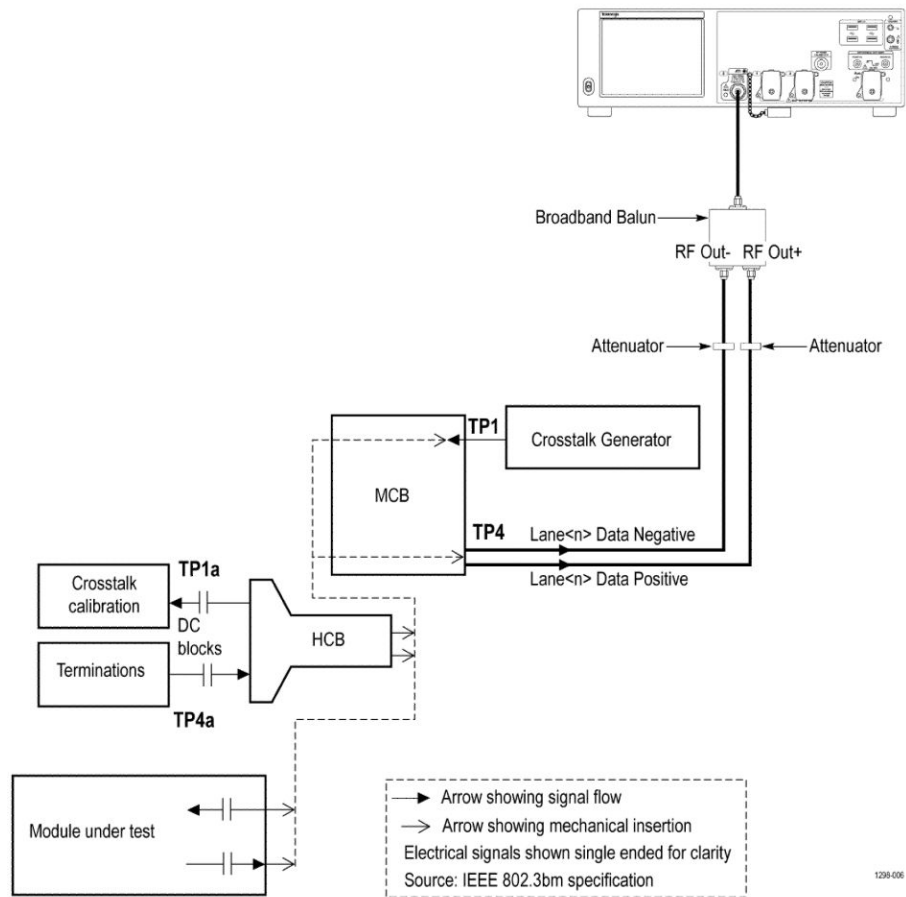

Figure 12: CAUI4 Eye Width / Eye Height TP4 (Differential)

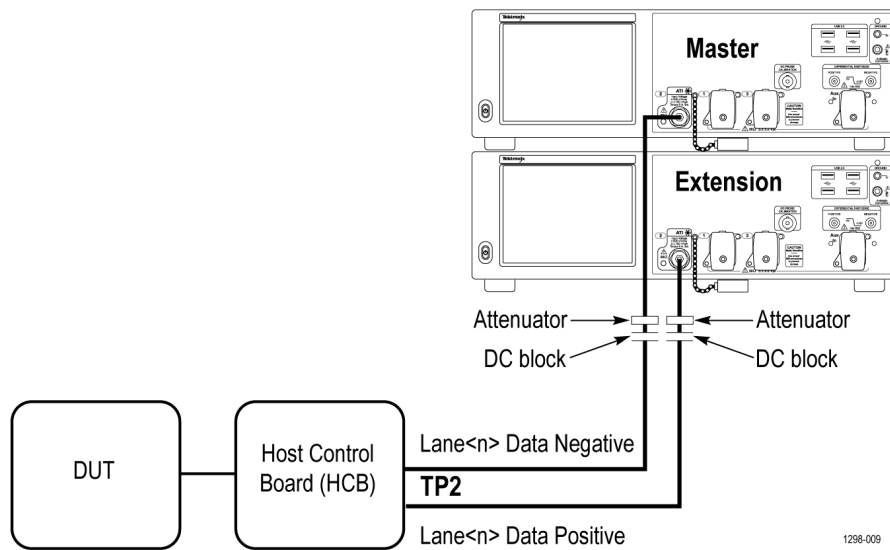

Figure 13: CR4 TP2 (Single ended)

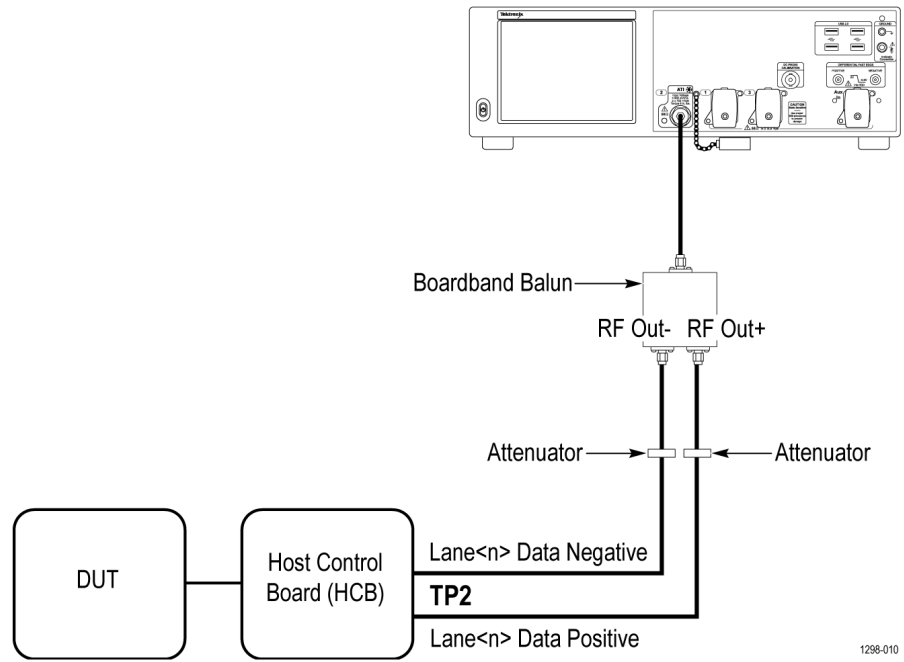

Figure 14: CR4 TP2 (Differential)

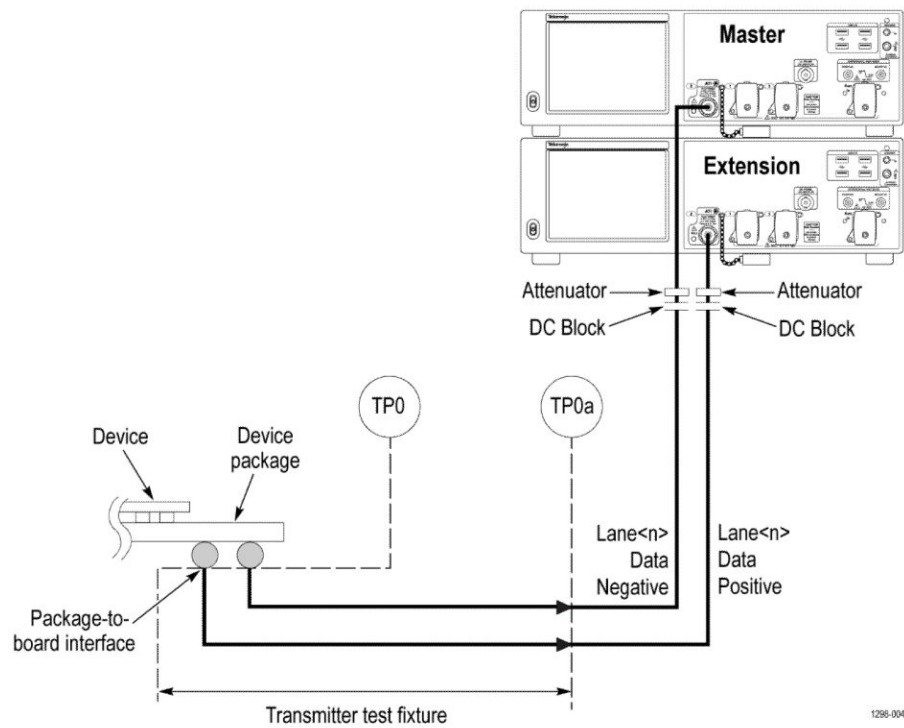

Figure 15: KR4 TP0a (Single ended)

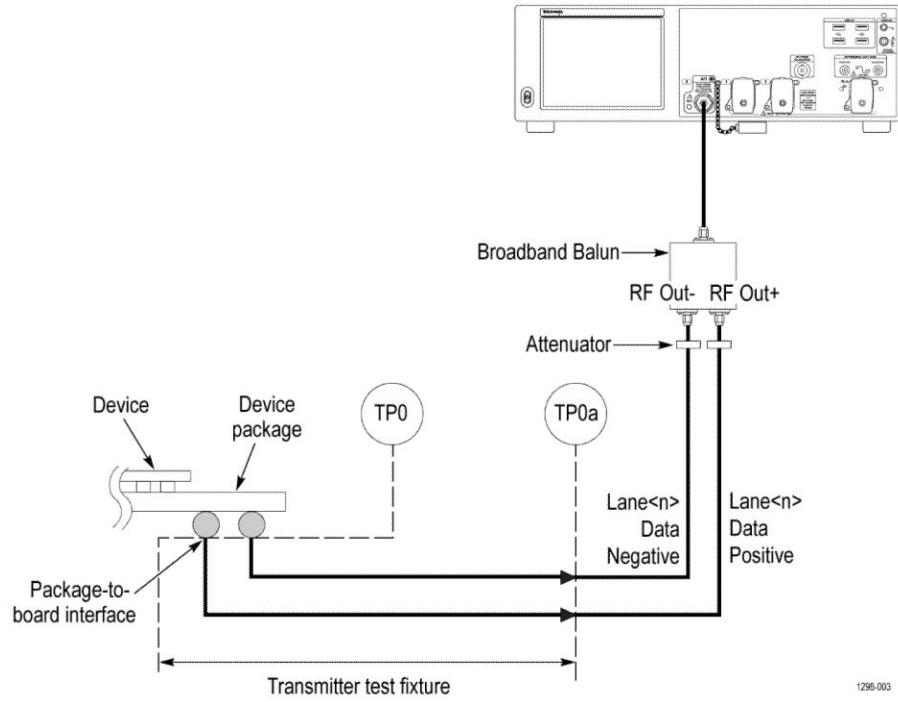

Figure 16: KR4 TP0a (Differential)

Prerequisite

Compensate the signal path

Use the following procedure to compensate the internal signal acquisition path. Perform this procedure if the ambient temperature has changed more than 5 °C (9 °F) since you performed the last signal path compensation. Perform the signal path compensation once a week. Failure to do so may result in the instrument not meeting warranted performance levels.

1. Power on and wait for the instrument to complete its warm up period before continuing with this procedure.
2. Disconnect any probes you have connected to the input channels.
3. Set the instrument to Menu mode.
4. Select Instrument Calibration from the Utilities menu.
5. Note any instructions that appear in the resulting control window.
6. Click Run SPC to begin the procedure. The procedure may take several minutes to complete.
7. Verify that the Status changes to Compensated after the procedure is complete. If the Calibration Status field indicates anything other than Compensated, see Signal Path Compensation Status for information on the readout and recommended action.

NOTE. *When making measurements at vertical scale settings less than or equal to 5 mV, you should perform the signal path compensation at least once a week. Failure to do so may result in the instrument not meeting warranted performance levels at those volts/div settings.*

Deskew

If skew is present between positive and negative channels, then the channels need to be deskewed before being used for waveform measurements. TekExpress 100G-TXE provides support for channel deskew and attenuation using the following method:

1. Determine what the skew is for each channel.
2. From the TekScope menu, select Vertical > Deskew.
3. In the Deskew/Attenuation window, click the channel (1 – 4) button for the first channel to be deskewed.
4. Click in the Ch(x) Deskew Time entry field and enter the skew. The skew can be +ve or –ve.
5. Click the channel button for the next channel and repeat step 4.
6. After entering the skew for all the channels that require it, from the Options menu in TekExpress 100G-TXE, select Deskew.

7. In the Deskew dialog box, select the desired level:
 - Less than 100 mV signal amplitude: Select this if the signal amplitude is such that the oscilloscope's vertical setting is less than 100 mV/division.
 - 100 mV or greater signal amplitude: Select this if the signal amplitude is such that the oscilloscope's vertical setting is greater than 100 mV/division.

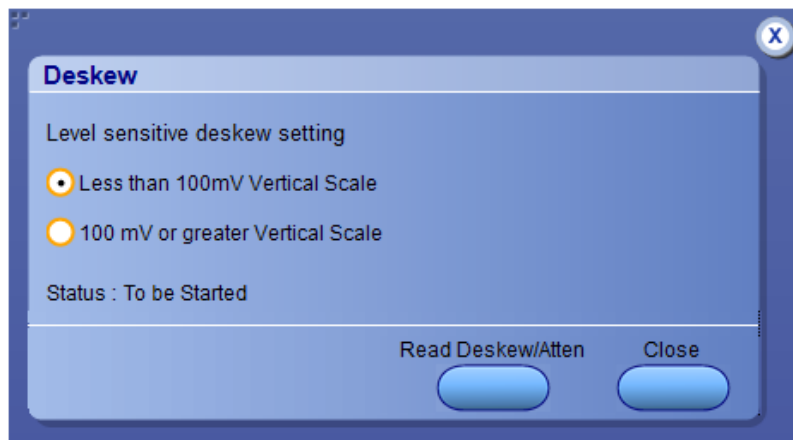

Figure 17: Deskew

8. Click Read Deskew/Attn.
9. When the status in the dialog box indicates the deskew is finished, click Close.

Each input channel has its own deskew settings. Deskew compensates individual channels for probes or cables of different lengths. The instrument applies the delay values after each completed acquisition. The deskew values are saved as part of the instrument setup. The deskew values for the selected channel are retained until you change the probe, you restore a saved setup, or you recall the factory setup.

Running tests

Select tests, set acquisition parameters, set configuration parameters, set preferences parameters, and click **Start** to run the tests. While tests are running, you cannot access the Setup or Reports panels. To monitor the test progress, switch between the Status panel and the Results panel.

While the tests are running, other applications may display windows in the background. The TekScope application takes precedence over other applications, but you can switch to other applications by using **Alt + Tab** key combination. To keep the TekExpress 100G-TXE application on top, select **Keep On Top** from the TekExpress Options menu.

The application displays report when the tests execution is complete.

Prerun checklist

1. Make sure that the instruments are warmed up (approximately 20 minutes) and stabilized.
2. Perform compensation: In the oscilloscope main menu, select **Utilities > Instrument Compensation**. Click **Help** in the compensation window for steps to perform instrument compensation.

Saving and recalling test setup

Test setup files overview

Saved test setup information (such as the selected oscilloscope, general parameters, acquisition parameters, measurement limits, waveforms (if applicable), and other configuration settings) are saved under the setup name at **X:\100G-TXE**.

Use test setups to:

- Run a new session, acquiring live waveforms, using a saved test configuration.
- Create a new test setup using an existing one.
- View all the information associated with a saved test, including the log file, the history of the test status as it executed, and the results summary.
- Run a saved test using saved waveforms.

See also [Save a test setup](#)
[Open \(load\) a saved test setup](#)

Save a test setup

You can save a test setup before or after running a test. You can create a test setup from [already created test setup](#), or using [default test setup](#). When you select the default test setup, the parameters are set to the application's default value.

Select **Options > Save Test Setup** to save the opened setup.

Select **Options > Save Test Setup As** to save the setup with different name.

Open (load) a saved test setup

To Open (load) a saved test setup, do the following:

1. Select **Options > Open Test Setup**.
2. Select the setup from the list and click **Open**. Setup files are located at **X:\100G-TXE**.

See also [About test setups](#)

[Create a test setup using an existing one](#)

[Create a test setup from default settings](#)

Create a test setup from default settings

To create a test setup using default settings, follow the steps:

1. Select **Options > Default Test Setup**. For default test setup, the parameters are set to the application's default value.
2. Click application [Setup](#) and set the parameters
3. Click application [Reports](#) and set the report options
4. Optional: Click **Start** to run the test and verify that it runs correctly and captures the specified test information and reports. If it does not, then edit the parameters and repeat this step until the test runs to your satisfaction
5. Select **Options > Save Test Setup**. Enter the file name and click Save. The application saves the file to X:\100G-TXE*<session_name>*

Create a test setup using an existing one

To create a test setup using an existing one, follow the steps:

1. Select **Options > Open Test Setup**
2. Select a setup from the list and then click **Open**
3. Click application [Setup](#) and modify the parameters
4. Click application [Reports](#) and modify the report options
5. Select **Options > Save Test Setup As**
6. Enter test setup name, and click **Save**

CAUI4 TXE compliance measurements

DC common mode output voltage

This section verifies that the mean of the common mode signal is within the conformable limits according to the specification.

Required test equipment

Minimum system requirements

Equipment connection diagram

| Standards | Test points | Specification |
|-----------|-------------|--|
| CAUI4 | TP1a | IEEE 802.3bm, Section 83E.3.1.2, Table 83E-1 |
| | TP4 | IEEE 802.3bm, Section 83E.3.1.2, Table 83E-3 |

Measurement procedure

The supported voltage range of ATI channel of the scope is ± 0.3 V and the DC voltage of the DUT can be beyond the supported voltage limits. Hence, use external digital multimeter to measure the voltage and enter it in the application.

Limits

At TP1a: -0.3 V to 2.8 V

At TP4: -0.35 V to 2.85 V

Diff peak to peak output voltage - Tx disabled

This section verifies that the peak to peak differential output voltage when the transmitter is disabled is within the conformable limits according to the specification.

Required test equipment

[Minimum system requirements](#)

[Equipment connection diagram](#)

| Standards | Test points | Specification |
|-----------|-------------|--|
| CAUI4 | TP1a | IEEE 802.3bm, Section 83E.3.1.2, Table 83E-1 |

Inputs

- Differential signal created using two single ended sources (Positive and Negative) without any filtering.

Measurement procedure

1. Add Peak to Peak measurement.
2. The value of the pk-pk voltage is the differential output voltage (pk-pk).

Limits

At TP1a:

- Lower limit: NA
- Higher limit: 35 mV

Diff peak to peak output voltage - Tx enabled

This section verifies that the peak to peak differential output voltage is within the conformable limits according to the specification.

Required test equipment

[Minimum system requirements](#)

[Equipment connection diagram](#)

| Standards | Test points | Specification |
|-----------|-------------|--|
| CAUI4 | TP1a | IEEE 802.3bm, Section 83E.3.1.2, Table 83E-1 |
| | TP4 | IEEE 802.3bm, Section 83E.3.1.2, Table 83E-3 |

Inputs

- Differential signal created using two single ended sources (Positive and Negative) and filtered through fourth order 33 GHz Bessel Thomson filter.

Measurement procedure

1. Add Peak to Peak measurement.
2. The value of the pk-pk voltage is the differential output voltage (pk-pk).

Limits

At TP1a and TP4:

- Lower limit: NA
- Higher limit: 900 mV

AC common mode output voltage

This section verifies that the RMS value of the common mode signal is within the conformable limits according to the specification.

Required test equipment

Minimum system requirements

Equipment connection diagram

| Standards | Test points | Specification |
|-----------|-------------|--|
| CAUI4 | TP1a | IEEE 802.3bm, Section 83E.3.1.2, Table 83E-1 |
| | TP4 | IEEE 802.3bm, Section 83E.3.1.2, Table 83E-3 |

Inputs

- Differential signal created using two single ended sources (Positive and Negative) and filtered through fourth order 33 GHz Bessel Thomson filter.

Measurement procedure

1. Create a common mode signal using Math = (Data Positive + Data Negative)/2.
2. Create Vertical histogram on the common mode signal.
3. Add Standard deviation measurement.
4. Standard deviation of the signal is measured as AC common mode voltage.

Limits

At TP1a and TP4:

- Lower limit: NA
- Higher limit: 17.5 mV

Single ended output voltage

This section verifies that the max and min of data positive and negative signals are within conformable limits as per the specification.

Required test equipment

Minimum system requirements

Equipment connection diagram

| Standards | Test points | Specification |
|-----------|-------------|--|
| CAUI4 | TP1a | IEEE 802.3bm, Section 83E.3.1.2, Table 83E-1 |

Inputs

- Two single ended sources (Positive and Negative) filtered through fourth order 33 GHz Bessel Thomson filter.

Measurement procedure

- Find the max and min of the signal using base scope measurement option (select **Measure** > **Amplitude**. Select Maximum and Minimum).
- Single Ended output voltage (max) = *DC Common mode voltage* + Max of Single Ended signal (without DC).
- Single Ended output voltage (min) = *DC Common mode voltage* + Min of Single Ended signal (without DC).
- Perform Step 2 and 3 on single ended data positive and data negative signals.

Limits

At TP1a:

- Lower limit: -0.4 V
- Higher limit: 3.3 V

Signaling rate

This section verifies that the signaling rate (data rate) of the DUT per lane is within the conformable limits according to the specification.

Required test equipment

Minimum system requirements

Equipment connection diagram

| Standards | Test points | Specification |
|-----------|-------------|--|
| CAUI4 | TP1a | IEEE 802.3bm, Section 83E.3.1.1, Table 83E-1 |
| | TP4 | IEEE 802.3bm, Section 83E.3.1.1, Table 83E-3 |

Inputs

- Differential signal created using two single ended sources (Positive and Negative) and filtered through fourth order 33 GHz Bessel Thomson filter.

Measurement procedure

1. This measurement is performed using DPOJET Period measurement as prerequisite.
2. Period is found edge to edge which gives the Unit interval (UI) of the signal.
3. The result of the period measurement (UI) is used to find the data rate of the signal. Data Rate = 1/Unit interval.

Limits

At TP1a and TP4:

- Lower limit: Configured Date Rate - 100 ppm
- Higher limit: Configured Date Rate + 100 ppm

Eye width and Eye height

This section verifies that the eye width and eye height are within the conformable limits according to the specification.

Required test equipment

Minimum system requirements

Equipment connection diagram

| Standards | Test points | Specification |
|-----------|-------------|--|
| CAUI4 | TP1a | IEEE 802.3bm, Section 83E.3.1.6, Table 83E-1 |
| | TP4 | IEEE 802.3bm, Section 83E.3.2.1, Table 83E-3 |

Inputs

- Differential signal created using two single ended sources (Positive and Negative) and filtered through fourth order 33 GHz Bessel Thomson filter.

Calibration:

Before running the Eye width / Eye height measurement, the below setup has to be calibrated with a crosstalk generator, as mentioned in the following settings:

- For Host (TP1a): Calibrate the crosstalk generator at TP4 with target differential peak-to-peak amplitude of 900 mV and target transition time of 12 ps (section 83E.3.1.6).
- For Module (TP4): Calibrate the crosstalk generator at TP1a with target differential peak-to-peak amplitude of 900 mV and target transition time of 19 ps (section 83E.3.2.1).

Measurement procedure

Eye width and Eye height calculation

Signal is captured such that it has more than 1e6 edges. Measurements are done using Dual-Dirac jitter model as specified in section 83E.4.

$$EW_{15} = EW_6 - 3.19 \cdot (RJR + RJL)$$

Where,

EW₁₅ is the eye width extrapolated to 10⁻¹⁵ probability

EW₆ is the eye width at 10⁻⁶ probability

RJL is the RMS value of the jitter estimated from CDFL

RJR is the RMS value of the jitter estimated from CDFR

$$EW_{15} = EW_6 - 3.19 \cdot (RN_0 - RN_1)$$

Where,

EW₁₅ is the eye width extrapolated to 10⁻¹⁵ probability

EW₆ is the eye width at 10⁻⁶ probability

RJL is the RMS value of the jitter estimated from CDF1

RJR is the RMS value of the jitter estimated from CDF0

Compliance method to find Eye width and Eye height results

The signal filtered through Bessel Thomson filter is equalized using different CTLE filters (1 dB - 9 dB for Host) and (1 dB - 2 dB for Module). CTLE filter result which has the maximum Eye area (Eye width * Eye height) and passing both Eye height and Eye width results is chosen as reference CTLE filter.

Host (TP1a): The CTLE peaking in the reference receiver shall be set to three values:

1. The recommended CTLE peaking value provided by the host (CTLE 1 dB to 9 dB)
2. The value 1 dB higher if present
3. The value 1 dB lower if present

A compliant host should pass both the eye width and eye height A limit using at least one of the settings and passes eye height B in two or three settings.

Module (TP4): A compliant module has to pass both eye width and eye height at least one of the CTLE settings (CTLE 1 dB to 2 dB).

Limits

At TP1a:

- Eye Width: LL: 0.46 UI and UL: NA
- Eye Height A: LL: 95 mV and UL: NA
- Eye Height B: LL: 80 mV and UL: NA

At TP4:

- Eye Width: LL: 0.57 UI and UL: NA
- Eye Height: LL: 228 mV and UL: NA

Vertical eye closure

This section verifies that the vertical eye closure of the signal is within the conformable limits according to the specification IEEE 802.3bm, and Section 83E.4.2.1.

Required test equipment

Minimum system requirements

Equipment connection diagram

| Standards | Test points | Specification |
|-----------|-------------|--|
| CAUI4 | TP4 | IEEE 802.3bm, Section 83E.4.2.1, Table 83E-3 |

Inputs

- Differential signal created using two single ended sources (Positive and Negative) and filtered through fourth order 33 GHz Bessel Thomson filter.

Measurement procedure

1. The filtered signal is equalized using reference or best CTLE filter. If reference CTLE filter is not present, the application will loop through required CTLE filters to find the reference CTLE filter.
2. Eye height@BER of 1e-15 and Eye amplitude are calculated for the equalized signal using Dual-Dirac jitter separation model as explained section 83E.3.2.1.
3. Vertical eye closure is calculated using the following formula:

$$VEC = 20\log(AV/EH15)$$

Where,

VEC is vertical eye closure in dB

AV is the eye amplitude of the equalized waveform. Eye amplitude is defined as the mean value of logic one minus the mean value of logic zero in the central 5% of the eye

EH15 is the eye height at BER of 1e-15

Limits

At TP4:

- Lower limit: NA
- Higher limit: 5.5 dB

Transition time

This section verifies that the transition time of the DUT is within the conformable limits according to the specification.

Required test equipment

Minimum system requirements

Equipment connection diagram

| Standards | Test points | Specification |
|-----------|-------------|--|
| CAUI4 | TP1a | IEEE 802.3bm, Section 83E.3.1.5, Table 83E-1 |
| | TP4 | IEEE 802.3bm, Section 83E.3.1.5, Table 83E-3 |

Inputs

- Differential signal created using two single ended sources (Positive and Negative) and filtered through fourth order 33 GHz Bessel Thomson filter.

Measurement procedure

1. Measure the nominal Unit interval of the filtered signal.
2. For PRBS9, measure Voltage High in region 000001111 for Rise Time and Voltage Low in region 1111111100000 for fall time. Within these regions, take average amplitude in -3 UI to -2 UI range from edge for finding voltage low. Also take average amplitude in 2 UI to 3 UI range from edge for finding voltage high.
3. Find the transition time in search patterns (000001111 for Rise and 1111111100000 for Fall) by taking difference in time from 20% to 80% of the signal amplitude.

Limits

At TP1a:

- Lower limit: 10 ps
- Higher limit: NA

At TP4:

- Lower limit: 12 ps
- Higher limit: NA

CR4 / KR4 TXE compliance measurements

DC common mode output voltage

This section verifies that the mean of the common mode signal is within the conformable limits according to the specification.

| Standards | Test points | Specification |
|-----------|-------------|--|
| CR4 | TP2 | IEEE 802.3bj, Section 92.8.3.1, Table 92-6 |
| KR4 | TP0a | IEEE 802.3bj, Section 93.8.1.3, Table 93-4 |

Required test equipment

[Minimum system requirements](#)

[Equipment connection diagram](#)

Measurement procedure

The supported voltage range of the scope is ± 0.3 V and the DC voltage of the DUT can be beyond the supported voltage limits. Hence, use external digital multimeter to measure the voltage and enter it in the application.

Limits

| | |
|-----|--------------|
| CR4 | 0 V to 1.9 V |
| KR4 | 0 V to 1.9 V |

Diff peak to peak output voltage - Tx disabled

This section verifies that the peak to peak differential output voltage when transmitter is disabled is within the conformable limits according to the specification.

| Standards | Test points | Specification |
|-----------|-------------|--|
| CR4 | TP2 | IEEE 802.3bj, Section 92.8.3.1, Table 92-6 |
| KR4 | TP0a | IEEE 802.3bj, Section 93.8.1.3, Table 93-4 |

Required test equipment

Minimum system requirements

Equipment connection diagram

Inputs

- Differential signal created using two single ended sources (Positive and Negative) without any filtering.

Measurement procedure

1. Add Peak to Peak measurement.
2. The value of the pk-pk voltage is measured as differential output voltage (pk-pk).

Limits

| | |
|------------|---|
| CR4 | Peak-to-Peak Differential output (Tx Disabled) ≤ 35 mV |
| KR4 | Peak-to-Peak Differential output (Tx Disabled) ≤ 30 mV |

Diff peak to peak output voltage - Tx enabled

This section verifies that the peak to peak differential output voltage is within the conformable limits according to the specification.

| Standards | Test points | Specification |
|-----------|-------------|--|
| CR4 | TP2 | IEEE 802.3bj, Section 92.8.3.1, Table 92-6 |
| KR4 | TP0a | IEEE 802.3bj, Section 93.8.1.3, Table 93-4 |

Required test equipment

Minimum system requirements

Equipment connection diagram

Inputs

- Differential signal created using two single ended sources (Positive and Negative) and filtered through fourth order 33 GHz Bessel Thomson filter.

Measurement procedure

1. Add Peak to Peak measurement.
2. The value of the pk-pk voltage is measured as differential output voltage (pk-pk).

Limits

| | |
|-----|---|
| CR4 | Peak-to-Peak Differential output \leq 1200 mV |
| KR4 | Peak-to-Peak Differential output \leq 1200 mV |

AC common mode output voltage

This section verifies that the RMS value of the common mode signal is within the conformable limits according to the specification.

| Standards | Test points | Specification |
|-----------|-------------|--|
| CR4 | TP2 | IEEE 802.3bj, Section 92.8.3.1, Table 92-6 |
| KR4 | TP0a | IEEE 802.3bj, Section 93.8.1.3, Table 93-4 |

Required test equipment

Minimum system requirements

Equipment connection diagram

Inputs

- Differential signal created using two single ended sources (Positive and Negative) and filtered through fourth order 33 GHz Bessel Thomson filter.

Measurement procedure

1. Create a common mode signal using Math = (Data Positive + Data Negative)/ 2.
2. Create Vertical histogram on the common mode signal.
3. Add Standard deviation measurement.
4. Standard deviation of the signal is measured as AC common mode voltage.

Limits

| | |
|-----|--|
| CR4 | AC Common mode output voltage <= 30 mV RMS with respect to ground |
| KR4 | AC Common mode output voltage <= 12 mV RMS with respect to ground |

Signaling rate

This section verifies that the signaling rate (data rate) of the DUT per lane is within the conformable limits according to the specification.

| Standards | Test points | Specification |
|-----------|-------------|--|
| CR4 | TP2 | IEEE 802.3bj, Section 92.8.3.9, Table 92-6 |
| KR4 | TP0a | IEEE 802.3bj, Section 93.8.1.2, Table 93-4 |

Required test equipment

Minimum system requirements

Equipment connection diagram

Inputs

- Differential signal created using two single ended sources (Positive and Negative) and filtered through fourth order 33 GHz Bessel Thomson filter.

Measurement procedure

1. This measurement is performed using DPOJET Period measurement as prerequisite.
2. Period is found edge to edge which gives the Unit interval (UI) of the signal.
3. The result of the period measurement (UI) is used to find the data rate of the signal. Data Rate = 1/Unit interval.

Limits

| | |
|------------|--|
| CR4 | At TP1a and TP4: <ul style="list-style-type: none"> ■ Lower limit: Configured Date Rate - 100 ppm ■ Higher limit: Configured Date Rate + 100 ppm |
| KR4 | At TP1a and TP4: <ul style="list-style-type: none"> ■ Lower limit: Configured Date Rate - 100 ppm ■ Higher limit: Configured Date Rate + 100 ppm |

Transmitter waveform requirements

Common procedure for transmitter waveform requirements

This section describes the general procedure to be performed for Transmitter output waveform measurements. Perform the general procedure and the measurement specific procedure for each sub-measurements.

Required test equipment

Minimum system requirements

Equipment connection diagram

Inputs

- Differential signal created using two single ended sources (Positive and Negative) and filtered through fourth order 33 GHz Bessel Thomson filter.

Common procedure for transmitter waveform requirements

1. Configure the DUT to transmit the PRBS 7, 9, 11, or 15 signal continuously at the specified data rate.
2. Acquire the signal at a sampling rate of 200 Gbps and record length of 5M samples.
3. Oversample the signal to get more than 32 samples per bit and average the signal across the PRBS patterns.
4. Process the signal using steps as per specification section 92.8.3.5 to measure the various Transmitter waveform parameters.

Linear fit pulse peak

This section verifies that the linear fit pulse peak value is within the conformable limits according to the specification.

| Standards | Test points | Specification |
|-----------|-------------|--|
| CR4 | TP2 | IEEE 802.3bj, Section 92.8.3.5.2, Table 92-6 |
| KR4 | TP0a | IEEE 802.3bj, Section 93.8.1.5.2, Table 93-4 |

Measurement procedure

1. Set the DUT in PRESET mode by setting the coefficients C(-1), C(0) and C(1) to zero.
2. Capture the signal and calculate linear fit filter coefficients of the signal. The peak value of the linear fit curve is measured as Linear Fit pulse peak.

Limits

| | |
|------------|---|
| CR4 | Linear Fit Pulse Peak > 0.45 * Steady state voltage |
| KR4 | Linear Fit Pulse Peak > 0.71 * Steady state voltage |

Steady state voltage

This section verifies that the steady state voltage is within the conformable limits according to the specification.

| Standards | Test points | Specification |
|-----------|-------------|--|
| CR4 | TP2 | IEEE 802.3bj, Section 92.8.3.5.2, Table 92-6 |
| KR4 | TP0a | IEEE 802.3bj, Section 93.8.1.5.2, Table 93-4 |

Measurement procedure

1. Set the DUT in PRESET mode by setting coefficients C(-1), C(0) and C(1) to zero.
2. Capture the signal and calculate linear fit pulse of the signal. The average value of the linear fit curve is measured as Steady state output voltage (DC voltage) of the signal.

Limits

| | |
|-----|---|
| CR4 | <ul style="list-style-type: none"> ■ Min: 0.34 V ■ Max: 0.6 V |
| KR4 | <ul style="list-style-type: none"> ■ Min: 0.4 V ■ Max: 0.6 V |

Minimum pre-cursor full scale ratio

This section verifies that the minimum pre-cursor equalization ratio is within the conformable limits according to the specification.

| Standards | Test points | Specification |
|-----------|-------------|--|
| CR4 | TP2 | IEEE 802.3bj, Section 92.8.3.5.5, Table 92-6 |
| KR4 | TP0a | IEEE 802.3bj, Section 93.8.1.5.5, Table 93-4 |

Measurement procedure

1. Set the DUT in PRESET mode and compute the filter coefficients.
2. Calculate equalizer coefficients C(-1), C(0) and C(1). Minimum pre-cursor equalization ratio is calculated as below:

$$\text{Min Pre-Cursor Eq Ratio} = [C(0) - C(-1)] / [C(0) + C(-1)]$$

Limits

| | |
|-----|---|
| CR4 | Minimum pre cursor equalization ratio ≥ 1.54 |
| KR4 | Minimum pre cursor equalization ratio ≥ 1.54 |

Minimum post-cursor full scale ratio

This section verifies that the minimum pre-cursor equalization ratio is within the conformable limits according to the specification.

| Standards | Test points | Specification |
|-----------|-------------|--|
| CR4 | TP2 | IEEE 802.3bj, Section 92.8.3.5.5, Table 92-6 |
| KR4 | TP0a | IEEE 802.3bj, Section 93.8.1.5.5, Table 93-4 |

Measurement procedure

1. Set the DUT in PRESET mode and compute the filter coefficients.
2. Calculate equalizer coefficients C(-1), C(0) and C(1). Minimum Post cursor equalization ratio is calculated as below:

$$\text{Min Post-Cursor Eq Ratio} = [C(0) - C(1)] / [C(0) + C(1)]$$

Limits

| | |
|-----|---|
| CR4 | Minimum post cursor equalization ratio >= 4 |
| KR4 | Minimum post cursor equalization ratio >= 4 |

Normalized coefficient step size

This section verifies that the increment and decrement step size of transmitter equalizer coefficients (C(-1), C(0) and C(1)) of the DUT are in conformable limits according to the specification.

| Standards | Test points | Specification |
|-----------|-------------|--|
| CR4 | TP2 | IEEE 802.3bj, Section 92.8.3.5.4, Table 92-6 |
| KR4 | TP0a | IEEE 802.3bj, Section 93.8.1.5.4, Table 93-4 |

Measurement procedure

C(-1) Increment step size and C(-1) Decrement step size:

1. Set the DUT in PRESET state; acquire the signal and calculate the filter coefficients.
2. Configure all the DUT's transmitter equalizer coefficients to INITIALIZE state.
3. Measure the C(-1) coefficient value and denote as C(-1)_Initilaize
4. Configure the DUT's transmitter equalizer coefficient C(-1) to INCREMENT, C(0) and C(1) to HOLD state.
5. Measure the C(-1) coefficient value and denote as C(-1)_Increment
6. C(-1) Increment step size is calculated as: $\Delta c = C(-1)_Increment - C(-1)_Initialize$
7. Configure the DUT's transmitter equalizer coefficient C(-1) to DECREMENT, C(0) and C(1) to HOLD state.

8. Measure the C(-1) coefficient value and denote as C(-1)_Decrement
9. C(-1) Increment step size is calculated as: $\Delta c = C(-1)_Decrement - C(-1)_Increment$

C(0) Increment step size and C(0) Decrement step size:

1. Set the DUT in PRESET state; acquire the signal and calculate the filter coefficients.
2. Configure all the DUT's transmitter equalizer coefficients to INITIALIZE state.
3. Measure the C(0) coefficient value and denote as C(0)_Initilaize
4. Configure the DUT's transmitter equalizer coefficient C(0) to INCREMENT, C(-1) and C(1) to HOLD state.
5. Measure the C(0) coefficient value and denote as C(0)_Increment
6. C(0) Increment step size is calculated as: $\Delta c = C(0)_Increment - C(0)_Initialize$
7. Configure the DUT's transmitter equalizer coefficient C(0) to DECREMENT, C(-1) and C(1) to HOLD state.
8. Measure the C(0) coefficient value and denote as C(0)_Decrement
9. C(0) Increment step size is calculated as: $\Delta c = C(0)_Decrement - C(0)_Increment$

C(1) Increment step size and C(1) Decrement step size:

1. Set the DUT in PRESET state; acquire the signal and calculate the filter coefficients.
2. Configure all the DUT's transmitter equalizer coefficients to INITIALIZE state.
3. Measure the C(1) coefficient value and denote as C(1)_Initilaize
4. Configure the DUT's transmitter equalizer coefficient C(1) to INCREMENT, C(-1) and C(0) to HOLD state.
5. Measure the C(1) coefficient value and denote as C(1)_Increment
6. C(1) Increment step size is calculated as: $\Delta c = C(1)_Increment - C(1)_Initialize$
7. Configure the DUT's transmitter equalizer coefficient C(1) to DECREMENT, C(-1) and C(0) to HOLD state.
8. Measure the C(1) coefficient value and denote as C(1)_Decrement
9. C(1) Increment step size is calculated as: $\Delta c = C(1)_Decrement - C(1)_Increment$

Limits

| | |
|------------|--|
| CR4 | <ul style="list-style-type: none"> ■ Min: 0.0083 ■ Max: 0.05 |
| KR4 | <ul style="list-style-type: none"> ■ Min: 0.0083 ■ Max: 0.05 |

Signal to noise and distortion ratio

This section verifies that the signal to noise and distortion ratio of the DUT is within the conformable limits according to the specification.

| Standards | Test points | Specification |
|-----------|-------------|--|
| CR4 | TP2 | IEEE 802.3bj, Section 92.8.3.7, Table 92-6 |
| KR4 | TP0a | IEEE 802.3bj, Section 93.8.1.6, Table 93-4 |

Required test equipment

Minimum system requirements

Equipment connection diagram

Inputs

- Differential signal created using two single ended sources (Positive and Negative) and filtered through fourth order 33 GHz Bessel Thomson filter.

Measurement procedure

1. Configure the DUT in OPTIMAL state and capture the signal for measurement.
2. Compute the Linear fit pulse response (Pmax) and the RMS value of the linear fit error $\sigma(e)$ from the signal.
3. Measure the RMS deviation of voltage from the mean and denote it as $\sigma(n)$. This has to be measured at the flat portion of the waveform where the slope is close to zero.
4. Signal to Noise an Distortion ratio is measured using below equation:

$$SNDR = 10 \log_{10} \left(\frac{p_{max}^2}{\sigma_e^2 + \sigma_n^2} \right) dB$$

Limits

| | |
|-----|--------------|
| CR4 | SNDR > 26 dB |
| KR4 | SNDR > 27 dB |

Output Jitter

Even-odd jitter peak to peak

This section verifies that the value of the even odd jitter is within the conformable limits according to the specification.

| Standards | Test points | Specification |
|-----------|-------------|--|
| CR4 | TP2 | IEEE 802.3bj, Section 92.8.3.8, Table 92-6 |
| KR4 | TP0a | IEEE 802.3bj, Section 93.8.1.7, Table 93-4 |

Required test equipment

Minimum system requirements

Equipment connection diagram

Inputs

- Differential signal created using two single ended sources (Positive and Negative) and filtered through fourth order 33 GHz Bessel Thomson filter.

Measurement procedure

1. Capture a long sequence of PRBS pattern.
2. Even Odd Jitter is measured as the magnitude of the difference between the average deviation of all even numbered transitions and the average deviation of all odd numbered transitions, where even odd transitions are not possible transitions, but actual transitions.
3. The Even Odd Jitter is carried out by DPOJET using F/n measurement with n being set to 2.

Limits

| | |
|-----|-----------------------------|
| CR4 | Even Odd Jitter <= 0.035 UI |
| KR4 | Even Odd Jitter <= 0.035 UI |

Effective bounded and total uncorrelated jitter peak to peak

This section verifies that the jitter components are within the conformable limits according to the specification.

| Standards | Test points | Specification |
|-----------|-------------|--|
| CR4 | TP2 | IEEE 802.3bj, Section 92.8.3.8, Table 92-6 |
| KR4 | TP0a | IEEE 802.3bj, Section 93.8.1.7, Table 93-4 |

Required test equipment

Minimum system requirements

Equipment connection diagram

Inputs

- Differential signal created using two single ended sources (Positive and Negative) and filtered through fourth order 33 GHz Bessel Thomson filter.

Measurement procedure

1. Capture PRBS signal with minimum of 2e3 edges present in the signal.
2. For calculating jitter application, consider the edges attached with long sequence of ones and zeros. This makes sure that the only uncorrelated jitter is measured. Application performs this measurement with longer record length to get more accurate results.
3. EBUJ (Effective bounded uncorrelated jitter) and ERJ (Effective random jitter) are calculated from the signal using dual-dirac jitter analysis as given in specification section 92.8.3.8.2.

Effective total uncorrelated jitter is calculated using the equation Effective total uncorrelated jitter = 7.9 * ERJ + EBUJ.

Limits

| | |
|--------------------|--|
| CR4 and KR4 | Effective bounded uncorrelated jitter <= 0.1 UI peak-to-peak |
| | Effective total uncorrelated jitter <= 0.18 UI peak-to-peak |

SCPI commands

About SCPI command

You can use Standard Commands for Programmable Instruments (SCPI) to communicate with the TekExpress application.

Socket configuration for SCPI commands

This section describes the steps for TCP/IP socket configuration and TekVISA configuration to execute the SCPI commands.

TCP/IP socket configuration

1. Click **Start > Control Panel > System and Security > Windows Firewall > Advanced settings**

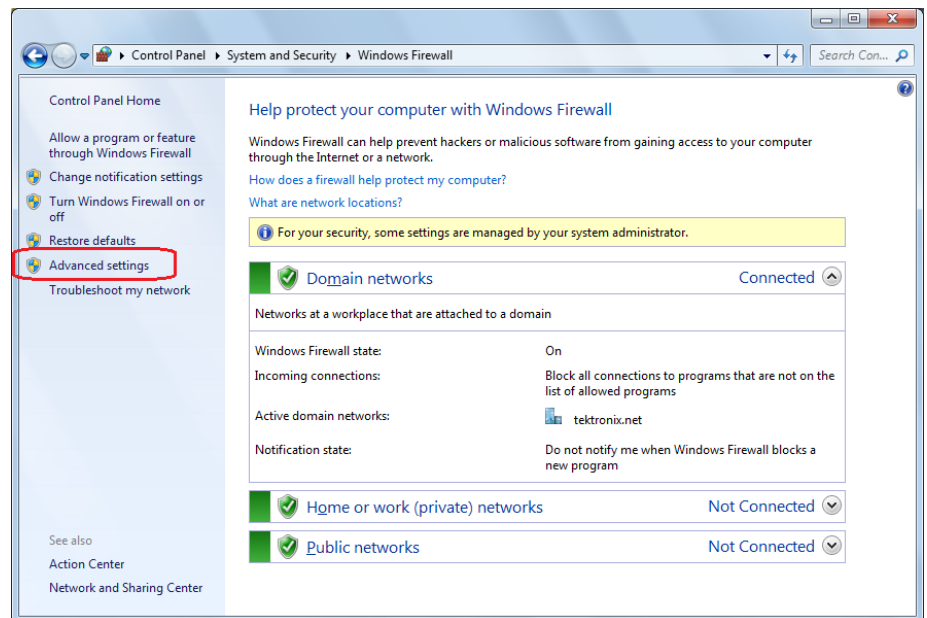

2. In Windows Firewall with Advanced Security menu, select **Windows Firewall with Advanced Security on Local Computer > Inbound Rules** and click **New Rule...**

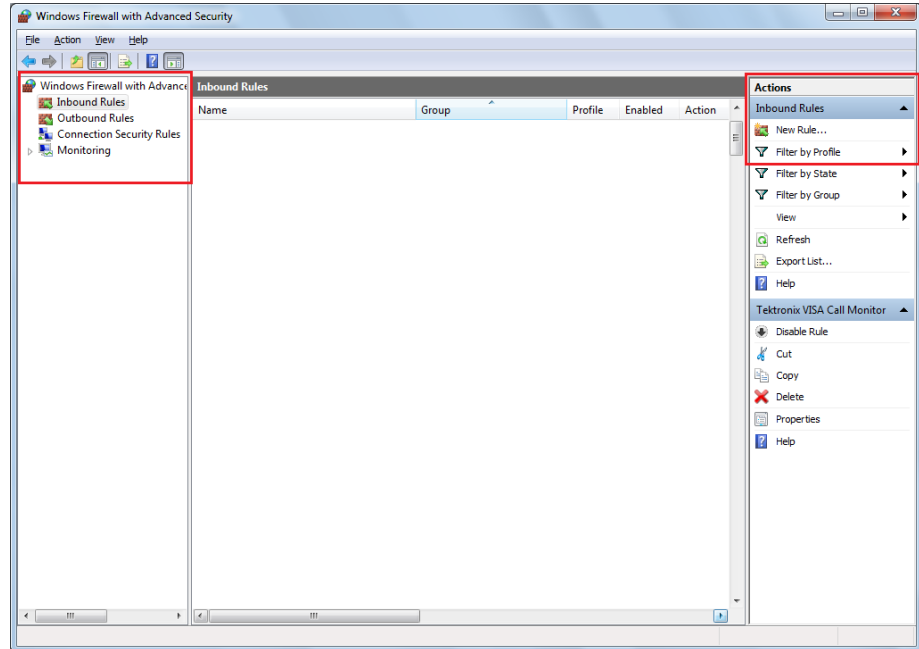

3. In New Inbound Rule Wizard menu
 - a. Select **Port** and click **Next**

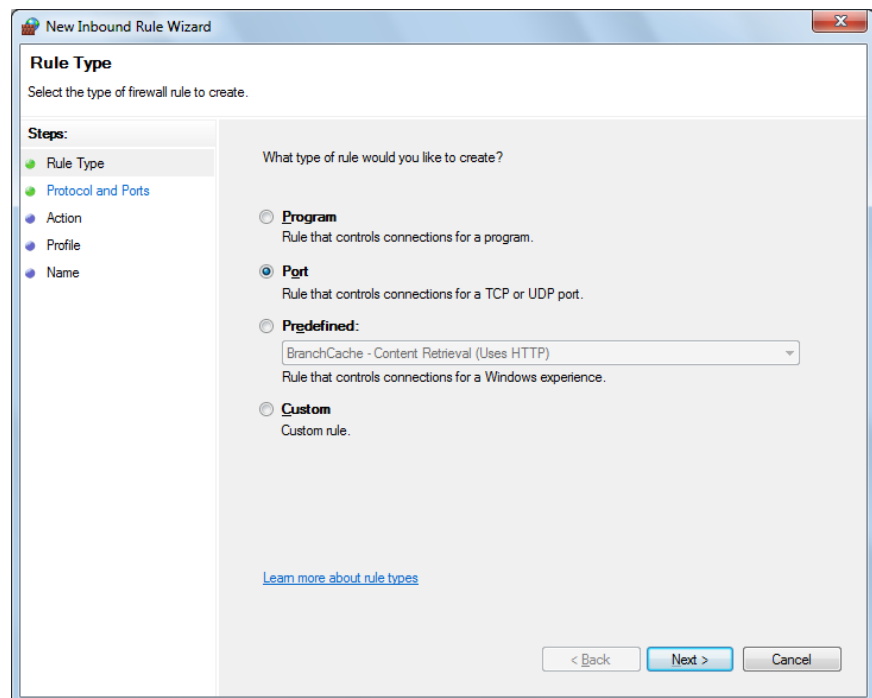

- b. Select **TCP** as rule apply and enter 5000 for **Specific local ports** and click **Next**

The screenshot shows the 'New Inbound Rule Wizard' dialog box, specifically the 'Protocol and Ports' step. The title bar reads 'New Inbound Rule Wizard'. The main heading is 'Protocol and Ports' with the instruction 'Specify the protocols and ports to which this rule applies.' On the left, a 'Steps:' list shows 'Rule Type', 'Protocol and Ports', 'Action', 'Profile', and 'Name', with 'Protocol and Ports' selected. The main area contains two questions: 'Does this rule apply to TCP or UDP?' with radio buttons for 'TCP' (selected) and 'UDP'; and 'Does this rule apply to all local ports or specific local ports?' with radio buttons for 'All local ports' and 'Specific local ports:' (selected). The 'Specific local ports:' field contains '5000' and has an example 'Example: 80, 443, 5000-5010' below it. A link 'Learn more about protocol and ports' is at the bottom. At the bottom right are buttons for '< Back', 'Next >', and 'Cancel'.

- c. Select **Allow the connection** and click **Next**

The screenshot shows the 'New Inbound Rule Wizard' dialog box, specifically the 'Action' step. The title bar reads 'New Inbound Rule Wizard'. The main heading is 'Action' with the instruction 'Specify the action to be taken when a connection matches the conditions specified in the rule.' On the left, a 'Steps:' list shows 'Rule Type', 'Protocol and Ports', 'Action', 'Profile', and 'Name', with 'Action' selected. The main area contains the question 'What action should be taken when a connection matches the specified conditions?' with three radio button options: 'Allow the connection' (selected), 'Allow the connection if it is secure', and 'Block the connection'. The 'Allow the connection if it is secure' option has a 'Customize...' button below it. A link 'Learn more about actions' is at the bottom. At the bottom right are buttons for '< Back', 'Next >', and 'Cancel'.

d. Select **Domain**, **Private**, **Public** and click **Next**

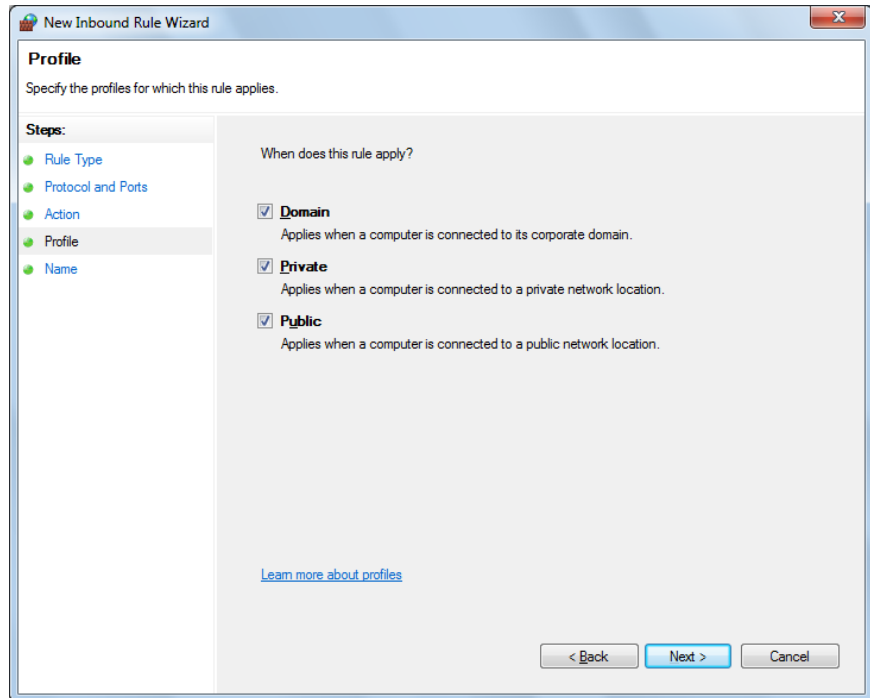

e. Enter **Name**, Description (optional), and click **Finish**

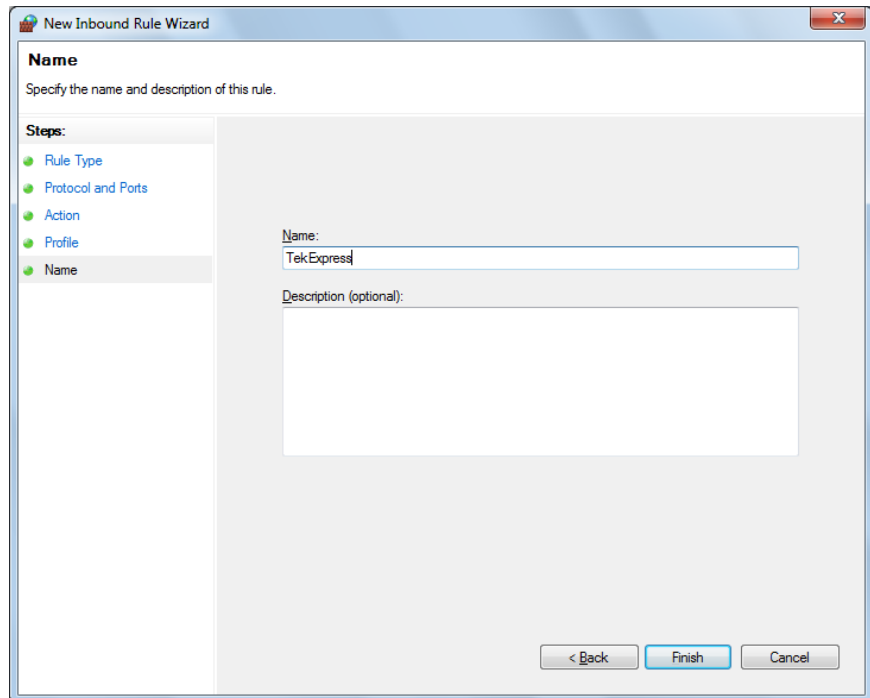

4. Check whether the Rule name is displayed in **Windows Firewall with Advanced Security** menu > **Inbound Rules**

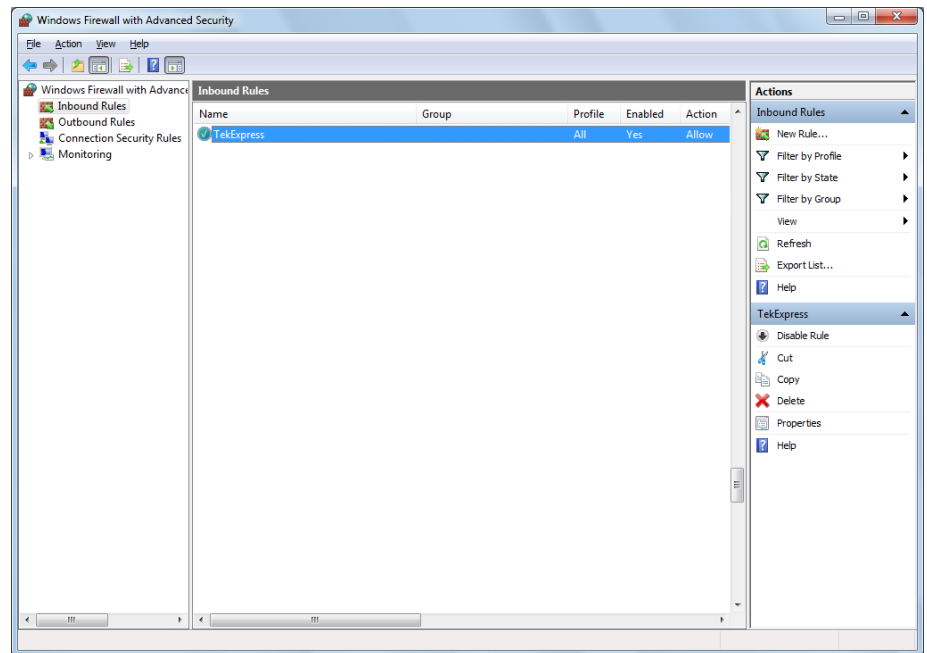

- TekVISA configuration** 1. Click **Start > All Programs > TekVISA > OpenChoice Instrument Manager**

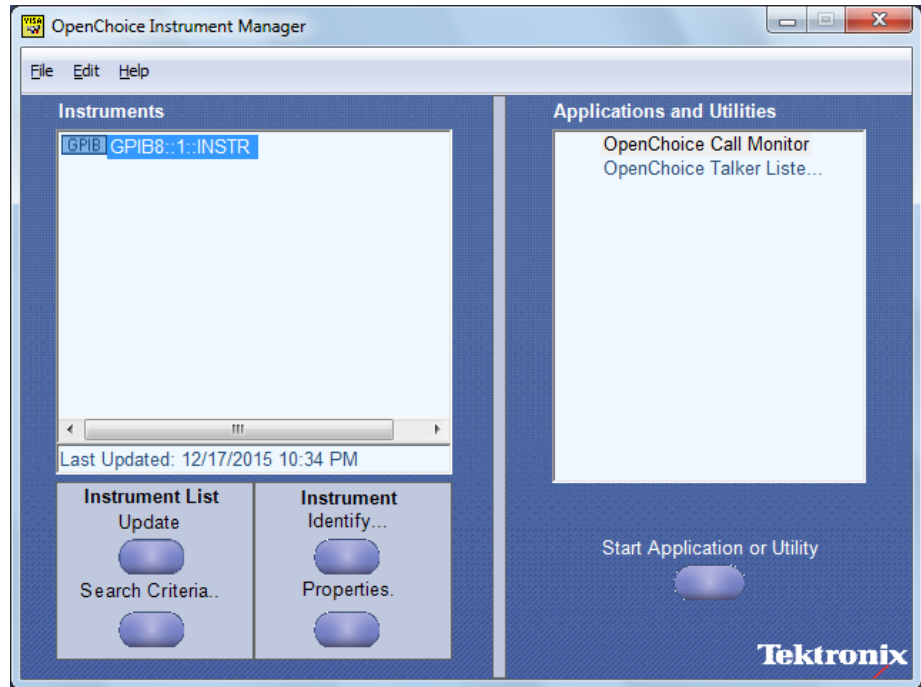

2. Click **Search Criteria**. In Search Criteria menu, click **LAN** to Turn-on. Select **Socket** from the drop-down list, enter the IP address of the

TekExpress device in **Hostname** and type **Port** as 5000. Click  to configure the IP address with Port.

Enter the Hostname as 127.0.0.1 if the TekVISA and TekExpress application are in the same system, else enter the IP address of the TekExpress application system.

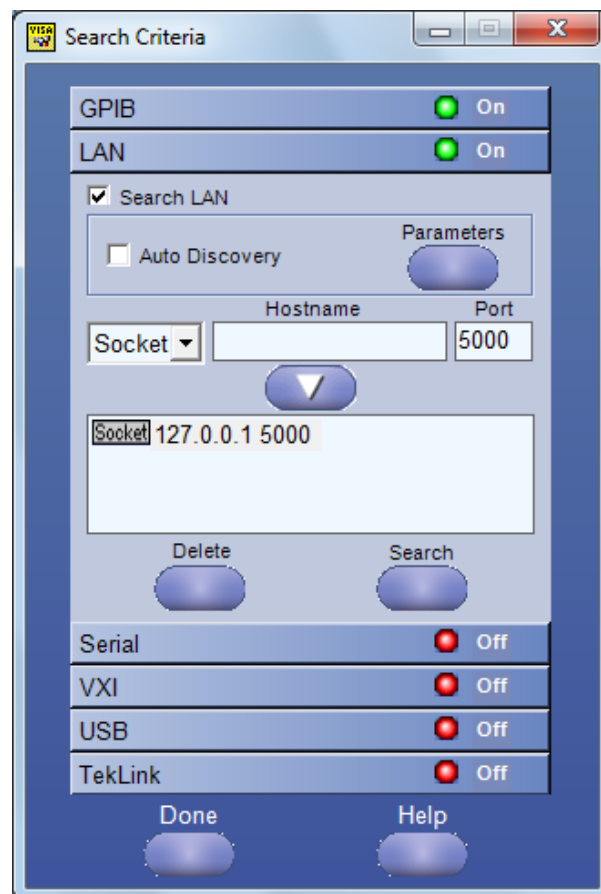

- Click **Search** to setup the TCPIP connection with the host. Check whether the TCPIP host name is displayed in **OpenChoice Instrument Manager > Instruments**

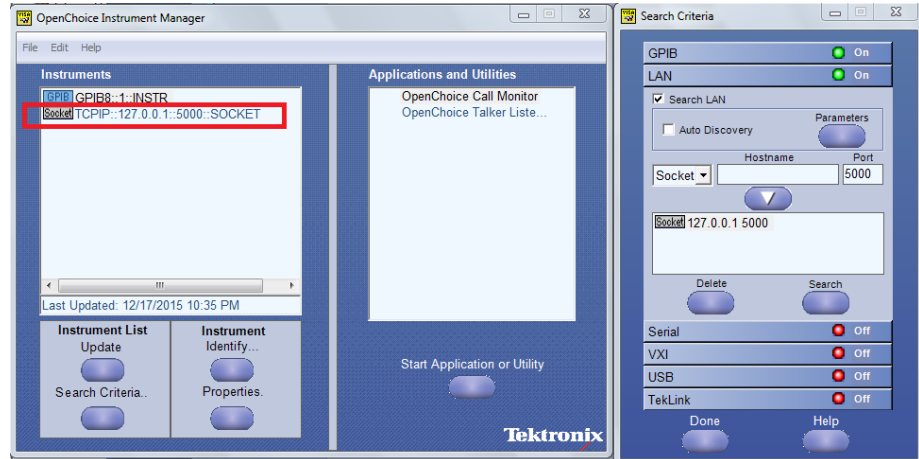

- Double-click **OpenChoice Talker Listener** and enter the Command ***IDN?** in command entry field and click **Query**. Check that the Operation is successful and Talker Listener Readout displays the Command / Data.

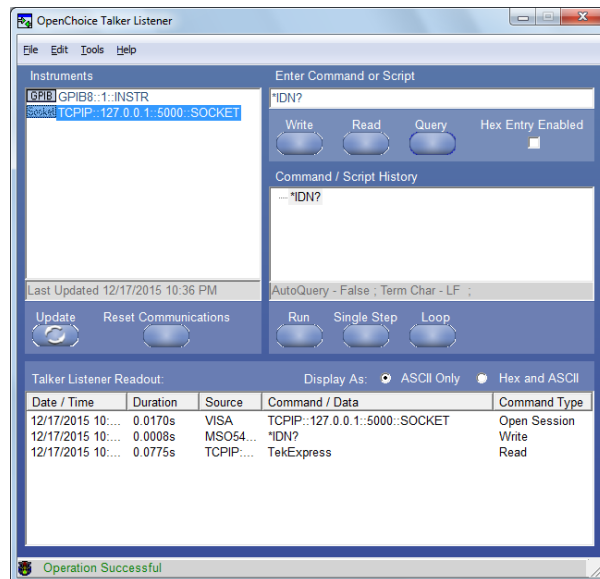

TEKEXP:*IDN?

This command queries the active TekExpress application name running on the scope.

Syntax TEKEXP:*IDN?\n

Inputs NA

Outputs Returns active TekExpress application name running on the scope



TIP. [Click here](#) for examples.

TEKEXP:*OPC?

This command queries the execution status of the last executed command.

Syntax TEKEXP:*OPC?\n

Inputs NA

Outputs 0 - last command execution is not complete
1 - last command execution is complete



TIP. [Click here](#) for examples.

TEKEXP:ACQUIRE_MODE

This command sets the acquire mode as live or pre-recorded.

Syntax `TEKEXP:ACQUIRE_MODE {LIVE | PRE-RECORDED}\n`

Inputs `{LIVE | PRE-RECORDED}`

Outputs NA



TIP. [Click here](#) for examples.

TEKEXP:ACQUIRE_MODE?

This command queries the acquire mode type.

Syntax `TEKEXP:ACQUIRE_MODE?\n`

Inputs NA

Outputs `{LIVE | PRE-RECORDED}`



TIP. [Click here](#) for examples.

TEKEXP:EXPORT

This command returns all the bytes of data to the specified file.

| Syntax | Outputs |
|------------------------------------|--|
| TEKEXP:EXPORT REPORT\n | Returns the report file in bytes |
| TEKEXP:EXPORT WFM,"<FileName>"\n | Returns the specified waveform file in bytes |
| TEKEXP:EXPORT IMAGE,"<FileName>"\n | Returns the specified image file in bytes |

Inputs FileName - Specifies the file name



TIP. [Click here](#) for examples.

TEKEXP:INFO?

This command queries the information about the file(s).

| Syntax | Outputs |
|-----------------------|---|
| TEKEXP:INFO? REPORT\n | <ReportFileSize>,"<ReportFileName.mht>" |
| TEKEXP:INFO? WFM\n | <WfmFile1Size>,"<WfmFileName1.wfm>" ;<WfmFile2Size>,"<WfmFileName2.wfm>" ;... |
| TEKEXP:INFO? IMAGE\n | <Image1FileSize>,"<Image1FileName>" ;<Image2FileSize>,"<Image2FileName>" ;... |



TIP. [Click here](#) for examples.

TEKEXP:INSTRUMENT

This command sets the value for the selected instrument type.

Syntax `TEKEXP:INSTRUMENT "<InstrumentType>",<Value>"\n`

Inputs InstrumentType
 Value



TIP. Check [Command parameters list](#) for *InstrumentType* and *Value* parameters.

Outputs NA



TIP. [Click here](#) for examples.

TEKEXP:INSTRUMENT?

This command queries the instrument selected for the specified instrument type.

Syntax `TEKEXP:INSTRUMENT? "<InstrumentType>"\n`

Inputs InstrumentType



TIP. Check [Command parameters list](#) for *InstrumentType* parameters.

Outputs Returns the instrument selected for the specified instrument type



TIP. [Click here for examples.](#)

TEKEXP:LASTERROR?

This command queries the last error string occurred for the current TCP session. If there are no errors since startup, or since the last call to TEKEXP:LASTERROR?\n, this command returns an empty string.

Syntax TEKEXP:LASTERROR?\n

Inputs NA

Outputs <string>



TIP. [Click here for examples.](#)

TEKEXP:LIST?

This command queries the list of available device, suite, test, version or instrument.

| Syntax | Outputs |
|---|---|
| TEKEXP:LIST? DEVICE\n | Returns the list of available device(s) as comma separated values. |
| TEKEXP:LIST? SUITE\n | Returns the list of available suite(s) as comma separated values. |
| TEKEXP:LIST? TEST\n | Returns the list of available test(s) as comma separated values. |
| TEKEXP:LIST? VERSION\n | Returns the list of available version(s) as comma separated values. |
| TEKEXP:LIST? INSTRUMENT,"<InstrumentType>\n | Returns the list of available instruments' for the given Instrument type as comma separated values. |

NOTE. This command returns the list of items within double quotes (""). Iterate the receive procedure until the list ends with double quotes otherwise the next query commands won't work as expected.

Inputs InstrumentType



TIP. Check [Command parameters list](#) for InstrumentType parameters.



TIP. [Click here](#) for examples.

TEKEXP:MODE

This command sets the execution mode as compliance or user defined.

Syntax TEKEXP:MODE {COMPLIANCE | USER-DEFINED}\n

Inputs {COMPLIANCE | USER-DEFINED}

Outputs NA



TIP. [Click here](#) for examples.

TEKEXP:MODE?

This command queries the execution mode type.

Syntax `TEKEXP:MODE?\n`

Inputs NA

Outputs {COMPLIANCE | USER-DEFINED}



TIP. [Click here](#) for examples.

TEKEXP:POPUP

This command sets the response to the active popup shown in the application.

Syntax `TEKEXP:POPUP "<PopupResponse>"\n`

Inputs PopupResponse

Outputs NA



TIP. [Click here](#) for examples.

TEKEXP:POPUP?

This command queries the active popup information shown in the application.

Syntax `TEKEXP:POPUP?\n`

Inputs NA

Outputs Returns the active popup information in the application.



TIP. [Click here](#) for examples.

TEKEXP:REPORT

This command generates the report for the current session.

Syntax `TEKEXP:REPORT GENERATE\n`

Inputs GENERATE

Outputs NA



TIP. [Click here](#) for examples.

TEKEXP:REPORT?

This command queries the queried header field value in the report.

Syntax `TEKEXP:REPORT? "<HeaderField>"\n`

Inputs HeaderField - Specifies to return the measured value for the indicated test.



TIP. Check **Report** for HeaderField parameters.

Outputs Returns the queried header field value in the report



TIP. [Click here](#) for examples.

TEKEXP:RESULT?

This command queries the result available in report summary/details table.

| Syntax | Outputs |
|---|--|
| <code>TEKEXP:RESULT? "<TestName>"\n</code> | Return Pass/Fail status of the test. |
| <code>TEKEXP:RESULT? "<TestName>","<ColumnName>"\n</code> | Returns all the row values of the specified column for the test. |
| <code>TEKEXP:RESULT? "<TestName>","<ColumnName>",<RowNumber>\n</code> | Returns the column value for the specified row number ¹ |

¹ Row number starts from zero.

- Inputs**
- TestName - Specifies the name of the test for which to obtain the test result value.
 - ColumnName - Specifies the column name for the measurement
 - RowNumber - Specifies the row number of the measurement

 **TIP.** Check **Results** panel for TestName, ColumnName, and RowNumber parameters.

 **TIP.** [Click here](#) for examples.

TEKEXP:SELECT

This command selects the device, suite, version, or test.

Syntax

```
TEKEXP:SELECT <string1>,<string2>,<string4>\n
TEKEXP:SELECT TEST,<string3>,<string4>\n
```

Inputs

- <string1> = {DEVICE | SUITE | VERSION}
- <string2> = {DeviceName | SuiteName | VersionName}
- <string3> = {"<TestName>" | ALL | REQUIRED }
- <string4> = {TRUE | FALSE}

 **TIP.** Check [Command parameters list](#) for DeviceName, SuiteName, VersionName, and TestName parameters.

 **TIP.** [Click here](#) for examples.

Outputs NA

TEKEXP:SELECT?

This command queries the name of the selected device, suite, version, or test.

Syntax TEKEXP:SELECT? {DEVICE | SUITE | TEST | VERSION}\n

Inputs {DEVICE | SUITE | TEST | VERSION}

Outputs Returns the name of the selected device, suite, version, or test.



TIP. [Click here](#) for examples.

TEKEXP:SETUP

This command sets the value of the current setup.

| Syntax | Outputs |
|-------------------------------------|--------------------------|
| TEKEXP:SETUP DEFAULT\n | Restore to default Setup |
| TEKEXP:SETUP OPEN,"<SessionName>"\n | Open the session |
| TEKEXP:SETUP SAVE\n | Save the session |
| TEKEXP:SETUP SAVE,"<SessionName>"\n | Save the session |

Inputs SessionName - The name of the session



TIP. [Click here](#) for examples.

TEKEXP:STATE

This command sets the execution state of the application.

Syntax `TEKEXP:STATE {RUN | STOP | PAUSE | RESUME}\n`

Inputs `{RUN | STOP | PAUSE | RESUME}`

Outputs NA



TIP. [Click here](#) for examples.

TEKEXP:STATE?

This command queries the current setup state.

| Syntax | Outputs |
|---------------------|--|
| TEKEXP:STATE? | RUNNING PAUSED WAIT ERROR READY STOPPED |
| TEKEXP:STATE? SETUP | SAVED NOT_SAVED |



TIP. [Click here](#) for examples.

TEKEXP:VALUE

This command sets the value of parameters of type General, Acquire, Analyze, or DUTID.

Syntax `TEKEXP:VALUE GENERAL,"<ParameterName>","<Value>"\n`
`TEKEXP:VALUE ACQUIRE,"<TestName>","<AcquireType>","`
`"<ParameterName>","<Value>"\n`
`TEKEXP:VALUE ANALYZE,"<TestName>","<ParameterName>".<Value>"`
`\n`
`TEKEXP:VALUE DUTID,"<Value>"\n`

Inputs `ParameterName` - Specifies the parameter name
`TestName` - Specifies the test name
`AcquireType` - Specifies the acquire type
`Value` - Specifies the value to set



TIP. Check [Command parameters list](#) for `ParameterName`, `AcquireType`, and `Value` parameters.

Outputs NA



TIP. [Click here](#) for examples.

TEKEXP:VALUE?

This command queries the value of the parameter for type General, Acquire, Analyze, or DUTID.

| Syntax | Outputs |
|--|--|
| TEKEXP:VALUE? GENERAL,"<ParameterName>"\n | Returns the value of Parameter for type GENERAL |
| TEKEXP:VALUE? ACQUIRE,"<TestName>", "<AcquireType>","<ParameterName>"\n | Returns the value of Parameter for type ACQUIRE |
| TEKEXP:VALUE? ANALYZE, "<TestName>","<ParameterName>"\n | Returns the value of Parameter for type ANALYZE |
| TEKEXP:VALUE? DUTID\n | Returns the DUTID value |

- Inputs**
- ParameterName - Specifies the parameter name
 - TestName - Specifies the test name
 - AcquireType - Specifies the acquire type



TIP. Check [Command parameters list](#) for ParameterName and AcquireType parameters.

- Outputs**
- Returns the value of Parameter for type GENERAL | ACQUIRE | ANALYZE | DUTID.



TIP. [Click here](#) for examples.

Command parameters list

This section provides the parameters list for the SCPI commands.

| Parameters | Description |
|----------------|---|
| InstrumentType | Specifies the instrument type. Valid values are: <ul style="list-style-type: none"> ■ AWG ■ Real Time Scope |
| Value | Specifies the value parameters. <ul style="list-style-type: none"> ■ For InstrumentType, valid values are: <ul style="list-style-type: none"> ■ Do not use ■ GPIB8::1::INSTR ■ For DUTID, valid value is: <ul style="list-style-type: none"> ■ Comment |
| DeviceName | Specifies the device name. Valid values are: <ul style="list-style-type: none"> ■ CAUI4-TX ■ KR4-TX ■ CR4-TX |
| SuiteName | Specifies the suite name. Valid values are: <ul style="list-style-type: none"> ■ TP1a, TP4 for CAUI4 ■ TP0a for CR4 ■ TP2 for KR4 |
| VersionName | Specifies the version name. Valid values are <ul style="list-style-type: none"> ■ 100GBASE Tx, IEEE 802.3bm, Annex 83E.3.1 ■ 100GBASE Tx, IEEE 802.3bm, Annex 83E.3.2 ■ 100GBASE Tx, IEEE 802.3bj - Section 93 ■ 100GBASE Tx, IEEE 802.3bj - Section 92 |

| Parameters | Description |
|---------------------------|---|
| TestName for CAUI4 | <ul style="list-style-type: none"> ■ DC Common Mode Output Voltage ■ Diff Peak to Peak Output Voltage -Tx Disabled ■ Diff Peak to Peak Output Voltage -Tx Enabled ■ AC Common Mode Output Voltage ■ Single Ended Output Voltage ■ Signaling Rate ■ Eye Width ■ Eye Height Differential ■ Transition Time ■ Vertical Eye closure |

| Parameters | Description |
|-------------------------|--|
| TestName for KR4 | <ul style="list-style-type: none"> ■ DC Common Mode Output Voltage ■ Diff Peak to Peak Output Voltage -Tx Disabled ■ Diff Peak to Peak Output Voltage -Tx Enabled ■ AC Common Mode Output Voltage ■ Single Ended Output Voltage ■ Signaling Rate ■ Linear Fit Pulse Peak ■ Minimum Pre-cursor full scale ratio ■ Minimum Post-cursor full scale ratio ■ Normalized Coefficient Step Size ■ Signal To Noise And Distortion Ratio ■ Steady State Voltage ■ Even-Odd Jitter Peak to Peak ■ Effective total uncorrelated jitter peak to peak ■ Effective bounded uncorrelated jitter peak to peak |
| TestName for CR4 | <ul style="list-style-type: none"> ■ DC Common Mode Output Voltage ■ Diff Peak to Peak Output Voltage -Tx Disabled ■ Diff Peak to Peak Output Voltage -Tx Enabled ■ AC Common Mode Output Voltage ■ Single Ended Output Voltage ■ Signaling Rate ■ Linear Fit Pulse Peak ■ Minimum Pre-cursor full scale ratio ■ Minimum Post-cursor full scale ratio ■ Normalized Coefficient Step Size ■ Signal To Noise And Distortion Ratio ■ Steady State Voltage ■ Even-Odd Jitter Peak to Peak ■ Effective total uncorrelated jitter peak to peak ■ Effective bounded uncorrelated jitter peak to peak |

ParameterName and Value for General, Acquire and Analyze

Specifies the ParameterName and Value for General, Acquire and Analyze. The configuration parameters available are not same for measurements.

Table 15: ParameterName and Value for General

| ParameterName | Value |
|---|---|
| Report Update Mode | <ul style="list-style-type: none"> ■ New ■ Append ■ Replace |
| Auto increment report name if duplicate | TRUE or FALSE |
| Include Pass/Fail Results Summary | TRUE or FALSE |
| Include Detailed Results | TRUE or FALSE |
| Include Plot Images | TRUE or FALSE |
| Include Setup Configuration | TRUE or FALSE |
| Include User Comments | TRUE or FALSE |
| Save As Type | <ul style="list-style-type: none"> ■ Web Archive (*.mht;*.mhtml) ■ PDF (*.pdf;) ■ CSV (*.csv;) |
| View Report After Generating | TRUE or FALSE |
| Report Group Mode | <ul style="list-style-type: none"> ■ Test Name ■ Test Result |
| Create report at the end | <ul style="list-style-type: none"> ■ Included ■ Excluded |
| DUTID Comment | User comment |
| Run Test More than Once | TRUE or FALSE |
| Number of Runs | 1 to 200 |
| On Failure Stop and Notify | TRUE or FALSE |
| Timer Warning Info Message Popup | <ul style="list-style-type: none"> ■ "True" ■ "FALSE" |
| Timer Warning Info Message Popup Duration | 1 to 300 |
| Timer Error Message Popup | <ul style="list-style-type: none"> ■ "True" ■ "False" |
| Timer Error Message Popup Duration | 1 to 300 |
| Probing Type | <ul style="list-style-type: none"> ■ SINGLE ENDED ■ Differential |

| ParameterName | Value |
|-----------------------------------|---|
| Signal Validation | <ul style="list-style-type: none"> ■ Prompt me if Signal Validation Fails ■ Skip Test if Signal Validation Fails ■ Use signal as is - Don't Validate |
| Pattern Type | <ul style="list-style-type: none"> ■ PRBS7 ■ PRBS9 ■ PRBS11 ■ PRBS15 |
| Data Rate | valid value is 18 to 28.05 |
| MODE | <ul style="list-style-type: none"> ■ COMPLIANCE ■ USER-DEFINED |
| ACQUIRE_MODE | <ul style="list-style-type: none"> ■ LIVE ■ PRE-RECORDED |
| Bandwidth | <ul style="list-style-type: none"> ■ Full BW ■ 50GHz |
| Crosstalk Source | <ul style="list-style-type: none"> ■ True ■ False |
| RL for Jitter | <ul style="list-style-type: none"> ■ 20 ■ 30 ■ 40 |
| RL for Eye | <ul style="list-style-type: none"> ■ 20 ■ 30 ■ 40 |
| Apply Filter | True or False |
| Data Negative De-Embedding filter | Filter path Example: TEKEXP:VALUE GENERAL,"De-Embedding filter","C:\Users\sqetest\Desktop" |
| Data Positive De-Embedding filter | Filter path Example: TEKEXP:VALUE GENERAL,"De-Embedding filter","C:\Users\sqetest\Desktop" |
| Ref levels | <ul style="list-style-type: none"> ■ Absolute ■ Percentage |
| Hysteresis | <ul style="list-style-type: none"> ■ For Percentage, valid value is 0 to 10 ■ For Absolute, valid value is -2 to 2 |

| ParameterName | Value |
|---|--|
| Mid level | <ul style="list-style-type: none"> ■ For Percentage, valid value is 45 to 55 ■ For Absolute, valid value is -10 to 10 |
| CTLE FilterFile | <ul style="list-style-type: none"> ■ ALL(1-9dB) ■ CTLE_0dB.ftt ■ CTLE_1dB.ftt ■ CTLE_2dB.ftt ■ CTLE_3dB.ftt ■ CTLE_4dB.ftt ■ CTLE_5dB.ftt ■ CTLE_6dB.ftt ■ CTLE_7dB.ftt ■ CTLE_8dB.ftt ■ CTLE_9dB.ftt ■ Custom ■ BestCTLE |
| Custom Filter Path (when CTLE FilterFile is Custom) | CTLE filter file path Example: TEKEXP:VALUE GENERAL,"Custom Filter Path","C:\Program Files\Tektronix\TekExpress\TekExpress 100G-TXE\Compliance Suites\CAUI4-TX\TP1a\CTLE Filters\25.78125" |
| Custom Filter File (to select multiple custom CTLE filter file) | Names of CTLE filter files to select Example: TEKEXP:VALUE GENERAL,"Custom Filter File","CTLE_5dB.ftt;CTLE_2dB.ftt" |

Table 16: ParameterName and Value for Analyze

| Test Name | ParameterName | Value |
|-----------------|-------------------|---|
| Transition Time | Measurement Range | <ul style="list-style-type: none"> ■ 10% - 90% |

Examples

This section provides the examples for the SCPI commands.

| Example | Description |
|---|---|
| TEKEXP:*IDN?\n | It returns the active TekExpress application name running on the scope. |
| TEKEXP:*OPC?\n | It returns the last command execution status. |
| TEKEXP:ACQUIRE_MODE PRE-RECORDED\n | It sets the acquire mode as pre-recorded. |
| TEKEXP:ACQUIRE_MODE?\n | It returns LIVE when acquire mode is set to live. |
| TEKEXP:EXPORT REPORT\n | It returns the report file in bytes. This can be written into another file for further analysis. |
| TEKEXP:INFO? REPORT\n | It returns "100,"ReportFileName.mht"", when 100 is the filesize in bytes for the filename ReportFileName. |
| TEKEXP:INFO? WFM\n | It returns "100,"WfmFileName1.wfm""; "200,"WfmFileName2.wfm"" when 100 is the filesize in bytes for the filename WfmFileName1.wfm and 200 is the filesize in bytes for the filename WfmFileName2.wfm. |
| TEKEXP:INSTRUMENT "Real Time Scope",DPO72504D (GPIB8::1::INSTR)\n | It sets the instrument value as DPO72504D (GPIB8::1::INSTR) for the selected instrument type Real Time Scope. |
| TEKEXP:INSTRUMENT? "Real Time Scope"\n | It returns "IDPO72504D (GPIB8::1::INSTR), when DPO72504D (GPIB8::1::INSTR) is the selected instrument for the instrument type Real Time Scope. |
| TEKEXP:LASTERROR?\n | It returns ERROR: INSTRUMENT_NOT_FOUND, when no instrument is found. |
| TEKEXP:LIST? DEVICE\n | It returns "TX-Device,RX-Device" when TX-Device, RX-Device are the available device. |
| TEKEXP:LIST? INSTRUMENT,"Real Time Scope"\n | It returns "DPO72504D (GPIB8::1::INSTR),MSO72504 (TCP/IP::134.64.248.91::INSTR)" when DPO72504D (GPIB8::1::INSTR), MSO72504 (TCP/IP::134.64.248.91::INSTR) are the list of available instruments. |
| TEKEXP:MODE COMPLIANCE\n | It sets the execution mode as compliance. |
| TEKEXP:MODE?\n | It returns COMPLIANCE when the execution mode is compliance. |
| TEKEXP:POPOP "OK"\n | It sets OK as the response to active popup in the application. |
| TEKEXP:POPOP?\n | It returns "OK", when OK is the active popup information shown in the application. |
| TEKEXP:REPORT GENERATE\n | It generates report for the current session. |
| TEKEXP:REPORT? "Scope Model"\n | It returns "DPO73304SX" when DPO73304SX is the scope model. |
| TEKEXP:REPORT? "DUT ID"\n | It returns "DUT001" when DNI_DUT001 is the DUT ID. |
| TEKEXP:RESULT? "Period using SCOPE (Acquire-Analyze Combined)"\n | It returns Pass when the test result is Pass. |
| TEKEXP:RESULT? "Period using SCOPE (Acquire-Analyze Combined)","Margin",1\n | It returns "L:-50.000ps H:2000.000ps" when L:-50.000ps H: 2000.000ps is the value. |
| TEKEXP:SELECT DEVICE, TX_Device, TRUE\n | It selects TX_Device |
| TEKEXP:SELECT? DEVICE\n | It returns "TX-Device" when TX-Device is the selected device type. |

| Example | Description |
|--|--|
| TEKEXP:SETUP DEFAULT\n | It restores the application to default setup. |
| TEKEXP:STATE STOP\n | It stops the test execution. |
| TEKEXP:STATE?\n | It returns as READY when the application is ready to run next measurement. |
| TEKEXP:STATE? SETUP\n | It returns as NOT_SAVED when the current setup is not saved. |
| TEKEXP:VALUE GENERAL,"Signal Type", "N1N0"\n | It sets the signal type parameter value to N1N0. |
| TEKEXP:VALUE? GENERAL,"Signal Type"\n | It returns "N1N0" when N1N0 is the Signal Type value. |

References

Index

100G-TXE features, vi
100GBASE-CR4, vi
100GBASE-KR4, vi

A

About TekExpress, vi
Acquire parameters
 including in test reports, 34
 viewing in reports, 35
Acquisition tab, 25
Analysis options, 29
Application directories, 8
Application panels overview, 12
Application version (show), 7

B

Button
 calibration, 25
 clear log, 30
 Email settings, 29
 save, 30
 view optical modules, 25

C

Calibration button, 25
CAUI-4, vi
CAUI4 measurements
 AC common mode output voltage, 53, 54
 DC common mode output voltage, 51
 Diff peak to peak output voltage - Tx disabled, 52
 Diff peak to peak output voltage - Tx enabled, 52
 Eye width and Eye height, 56
 Signaling rate (data rate), 55
 Transition time, 59
 Vertical eye closure, 58
CLTE filters for eye width, 56
Compensate the signal path, 45
Configuration tab, 20
Configuration tab parameter

 instruments detected, 26
Configuration tab parameters
 global settings, 26
Connected instruments
 searching for, 17, 18
Connection requirements, 37
Contacting Tektronix, 2
CR4 / KR4 measurements
 AC common mode output voltage, 64
 DC common mode output voltage, 61
 Diff peak to peak output voltage - Tx disabled, 62
 Diff peak to peak output voltage - Tx enabled, 63
 Output jitter
 Effective bounded uncorrelated jitter peak to peak, 72
 Effective total uncorrelated jitter peak to peak, 72
 Even-odd jitter peak to peak, 71
 Signaling rate (data rate), 65
 Transmitter waveform requirement
 Linear fit pulse peak, 66
 Minimum post-cursor full scale ratio, 68
 Minimum pre-cursor full scale ratio, 67
 Normalized coefficient step size, 68
 Signal to noise and distortion ratio, 70
 Steady state voltage, 67
Create a test setup from default settings, 50
Create a test setup using an existing one, 50

D

DUT ID, 22
DUT parameter
 device, 22
 device profile, 22
 optical module settings, 22
 optical power, 22
DUT type
 device, 22
DUT-instrument setup, 37

E

Email notification and setup, 19
Equipment setup, 37

Extensions, file names, 9

F

Features (100G-TXE), vi

File name extensions, 9

G

GPIO, 17

H

Help conventions, 2

I

Installing the software

 TekExpress 100G-TXE Solution, 7

Instrument-DUT setup, 37

Instruments

 discovering connected, 17

 viewing connected, 18

Instruments and accessories required, 6

Instruments detected, 26

K

Keep on top, 11

L

LAN, 17

License agreement (show), 7

Live waveforms, 22

Loading a test setup, 50

Log view

 save file, 30

M

Menus

 Options, 15

Minimum system requirements, 5

My TekExpress folder

 files stored in, 32

N

Names, file extensions, 9

Non-VISA, 17

O

Opening a saved test setup, 50

Options menu

 Instrument control settings, 17

 keep on top, 11

Oscilloscope compensation, 45

P

Panels, 12

Pattern, 22

Pattern type, 22

Preferences menu, 31

Preferences tab

 send an Email, 29

 setup panel, 29

R

Recalling a test setup, 50

Related documentation, 1

Report contents, 36

Report name, 34

Report options, 34

Report sections, 35

Reports

 receiving in email notifications, 19

Reports panel, 12, 33

Resource file, 11

Results panel

 summary of test results, 31

 test name, 31

Running tests, 47

S

Save log file, 30

Saving tests, 32

Schematic button (DUT-instrument setup), 37

SCPI commands

 Command parameters list, 95

 Examples, 101

- TEKEXP:*IDN?, 81
- TEKEXP:*OPC?, 81
- TEKEXP:ACQUIRE_MODE, 82
- TEKEXP:ACQUIRE_MODE?, 82
- TEKEXP:EXPORT, 83
- TEKEXP:INFO?, 83
- TEKEXP:INSTRUMENT, 84
- TEKEXP:INSTRUMENT?, 84
- TEKEXP:LASTERROR?, 85
- TEKEXP:LIST?, 85
- TEKEXP:MODE, 86
- TEKEXP:MODE?, 87
- TEKEXP:POPOP, 87
- TEKEXP:POPOP?, 88
- TEKEXP:REPORT, 88
- TEKEXP:REPORT?, 89
- TEKEXP:RESULT?, 89
- TEKEXP:SELECT, 90
- TEKEXP:SELECT?, 91
- TEKEXP:SETUP, 91
- TEKEXP:STATE, 92
- TEKEXP:STATE?, 92
- TEKEXP:VALUE, 93
- TEKEXP:VALUE?, 94
- Search for connected instruments, 18
- Selecting test report contents, 34
- Selecting tests, 23
- Serial, 17
- Session folders and files, 32
- Setting up equipment, 37
- Setup
 - acquisition tab, 25
- Setup files, 49
- Setup panel
 - DUT parameter, 20
 - preferences tab, 20
 - test selection, 20
- Show acquire parameters, 25
- Signal conditioning
 - bandwidth, 22
 - filter, 22
- Software installation
 - TekExpress 100G-TXE Solution, 7
- Source, 22

- Status panel
 - log view, 30
 - message history, 30
 - test status tab, 30
- Support, 2
- System requirements, 5

T

- Technical support, 2
- Tek Link, 17
- Test Name, 25
- Test reports, 35
- Test results
 - send by email, 19
- Test selection
 - 100G-TXE, 23
 - optical tests, 23
 - test description, 23
- Test selection controls, 23
- Test setup files, 32, 49
- Test setups
 - load, 50
 - open, 50
 - recalling, 50
- Test status
 - acquire status, 30
 - analysis status, 30
 - auto scroll, 30
- Test-related files, 32
- Tests
 - running, 47
 - selecting, 23

U

- USB, 17
- User Comments
 - including in reports, 35

V

- View a report, 35
- View application license agreement, 7
- View application software version, 7
- View optical modules button, 25

VXI, 17

W

Waveform files

locating and storing, 32

Wavelength, 22