

Model 2700S Integra Series

Quick Start Guide

2700S-903-01 Rev. B / February 2016



2700S-903-01B

A Greater Measure of Confidence



Model 2700S Integra Series Quick Start Guide

©2016, Keithley Instruments
All rights reserved.
Cleveland, Ohio, U.S.A.
Document Number: 2700S-903-01 Rev. B / February 2016

Manual Print History

The print history shown below lists the printing dates of all Revisions and Addenda created for this manual. The Revision Level letter increases alphabetically as the manual undergoes subsequent updates. Addenda, which are released between Revisions, contain important change information that the user should incorporate immediately into the manual. Addenda are numbered sequentially. When a new Revision is created, all Addenda associated with the previous Revision of the manual are incorporated into the new Revision of the manual. Each new Revision includes a revised copy of this print history page.

Revision B (Document Number 2700S-903-01) May 2003

The following safety precautions should be observed before using this product and any associated instrumentation. Although some instruments and accessories would normally be used with non-hazardous voltages, there are situations where hazardous conditions may be present.

This product is intended for use by qualified personnel who recognize shock hazards and are familiar with the safety precautions required to avoid possible injury. Read and follow all installation, operation, and maintenance information carefully before using the product. Refer to the manual for complete product specifications.

If the product is used in a manner not specified, the protection provided by the product may be impaired.

The types of product users are:

Responsible body is the individual or group responsible for the use and maintenance of equipment, for ensuring that the equipment is operated within its specifications and operating limits, and for ensuring that operators are adequately trained.

Operators use the product for its intended function. They must be trained in electrical safety procedures and proper use of the instrument. They must be protected from electric shock and contact with hazardous live circuits.

Maintenance personnel perform routine procedures on the product to keep it operating properly, for example, setting the line voltage or replacing consumable materials. Maintenance procedures are described in the manual. The procedures explicitly state if the operator may perform them. Otherwise, they should be performed only by service personnel.

Service personnel are trained to work on live circuits, and perform safe installations and repairs of products. Only properly trained service personnel may perform installation and service procedures.

Keithley products are designed for use with electrical signals that are rated Measurement Category I and Measurement Category II, as described in the International Electrotechnical Commission (IEC) Standard IEC 60664. Most measurement, control, and data I/O signals are Measurement Category I and must not be directly connected to mains voltage or to voltage sources with high transient over-voltages. Measurement Category II connections require protection for high transient over-voltages often associated with local AC mains connections. Assume all measurement, control, and data I/O connections are for connection to Category I sources unless otherwise marked or described in the Manual.

Exercise extreme caution when a shock hazard is present. Lethal voltage may be present on cable connector jacks or test fixtures. The American National Standards Institute (ANSI) states that a shock hazard exists when voltage levels greater than 30V RMS, 42.4V peak, or 60VDC are present. **A good safety practice is to expect that hazardous voltage is present in any unknown circuit before measuring.**

Operators of this product must be protected from electric shock at all times. The responsible body must ensure that operators are prevented access and/or insulated from every connection point. In some cases, connections must be exposed to potential human contact. Product operators in these circumstances must be trained to protect themselves from the risk of electric shock. If the circuit is capable of operating at or above 1000 volts, **no conductive part of the circuit may be exposed.**

Do not connect switching cards directly to unlimited power circuits. They are intended to be used with impedance limited sources. NEVER connect switching cards directly to AC mains. When connecting sources to switching cards, install protective devices to limit fault current and voltage to the card.

Before operating an instrument, make sure the line cord is connected to a properly grounded power receptacle. Inspect the connecting cables, test leads, and jumpers for possible wear, cracks, or breaks before each use.

When installing equipment where access to the main power cord is restricted, such as rack mounting, a separate main input power disconnect device must be provided, in close proximity to the equipment and within easy reach of the operator.

For maximum safety, do not touch the product, test cables, or any other instruments while power is applied to the circuit under test. ALWAYS remove power from the entire test system and discharge any capacitors before connecting or disconnecting ca-

bles or jumpers, installing or removing switching cards, or making internal changes, such as installing or removing jumpers.

Do not touch any object that could provide a current path to the common side of the circuit under test or power line (earth) ground. Always make measurements with dry hands while standing on a dry, insulated surface capable of withstanding the voltage being measured.

The instrument and accessories must be used in accordance with its specifications and operating instructions or the safety of the equipment may be impaired.

Do not exceed the maximum signal levels of the instruments and accessories, as defined in the specifications and operating information, and as shown on the instrument or test fixture panels, or switching card.

When fuses are used in a product, replace with same type and rating for continued protection against fire hazard.

Chassis connections must only be used as shield connections for measuring circuits, NOT as safety earth ground connections.

If you are using a test fixture, keep the lid closed while power is applied to the device under test. Safe operation requires the use of a lid interlock.

If a  screw is present, connect it to safety earth ground using the wire recommended in the user documentation.

The  symbol on an instrument indicates that the user should refer to the operating instructions located in the manual.

The  symbol on an instrument shows that it can source or measure 1000 volts or more, including the combined effect of normal and common mode voltages. Use standard safety precautions to avoid personal contact with these voltages.

The  symbol indicates a connection terminal to the equipment frame.

The **WARNING** heading in a manual explains dangers that might result in personal injury or death. Always read the associated information very carefully before performing the indicated procedure.

The **CAUTION** heading in a manual explains hazards that could damage the instrument. Such damage may invalidate the warranty.

Instrumentation and accessories shall not be connected to humans.

Before performing any maintenance, disconnect the line cord and all test cables.

To maintain protection from electric shock and fire, replacement components in mains circuits, including the power transformer, test leads, and input jacks, must be purchased from Keithley Instruments. Standard fuses, with applicable national safety approvals, may be used if the rating and type are the same. Other components that are not safety related may be purchased from other suppliers as long as they are equivalent to the original component. (Note that selected parts should be purchased only through Keithley Instruments to maintain accuracy and functionality of the product.) If you are unsure about the applicability of a replacement component, call a Keithley Instruments office for information.

To clean an instrument, use a damp cloth or mild, water based cleaner. Clean the exterior of the instrument only. Do not apply cleaner directly to the instrument or allow liquids to enter or spill on the instrument. Products that consist of a circuit board with no case or chassis (e.g., data acquisition board for installation into a computer) should never require cleaning if handled according to instructions. If the board becomes contaminated and operation is affected, the board should be returned to the factory for proper cleaning/servicing.

Quick Start Guide

Integra Series

Topics

Getting started – page 3

- Introduction – page 3
- Measure and switching capabilities – page 3
- Front and rear panels (mainframe) – page 5
- Power-up – page 8
- Edit keys – page 8
- Factory defaults – page 9
- Communication interfaces – page 9
 - Start-up software – page 11
- Trigger and return readings – page 11

Front panel input connections – page 12

Basic measurements – page 14

- Measure volts, amps and ohms – page 14
- Measure temperature – page 16
- Measure frequency and period – page 18
- Testing continuity – page 19

Optimizing performance – page 20

- Warm-up – page 20
- Display resolution (digits) – page 20
- Measurement speed (rate) – page 21
- Filter – page 22
- Line cycle synchronization (lsync) – page 24
- Autozero – page 25

Math operations – page 25

- Relative (rel) – page 26
- Math
 - $mX+b$ – page 27
 - Percent – page 28
 - Reciprocal (1/X) – page 28
- Ratio and channel average – page 29

Buffer – page 31

- Storing and recalling readings – page 31
 - Storing readings – page 31
 - Recalling readings (and statistics) – page 31

Model 7700 switching module – page 34

- Input connections and measurements – page 35
 - 2-wire measurements – page 36
 - 4-wire measurements – page 36
- Channel assignments – page 38
- Closing and opening channels – page 39
- Simple scanning – page 41

Getting started

Introduction

This Quick Start Guide is intended to get a new user familiar with the operation of the instrument. It summarizes operation for all basic measurement functions and most features of the Integra instruments. It also summarizes the operation of the Model 7700 switching module, which adds switching and scanning capabilities to an Integra measurement system.

Topics that are not discussed in this guide include the following: Setups (saving and restoring), details on triggering, dry circuit ohms (Model 2750), limits and digital I/O, multiple channel operation and advanced scanning.

NOTE In this guide, the term “Model 2700S” refers to all three Integra instruments (Models 2700, 2701, and 2750).

Reference Details on all Model 2700S operations are provided in the Model 2700S User’s Manual. This includes important additional information on topics covered in the guide, and full details on topics not covered in this guide.

Details on the Model 7700 switching module is covered in the Model 2700S User’s Manual. Details on Model 7700 installation and connections are provided in the User’s Guide supplied with the switching module.

Details on other Keithley switching modules are covered in the supplied User’s Guide.

WARNING **Exercise extreme caution when a shock hazard is present.**

Lethal voltage may be present on cable connections or test fixtures. The American National Standards Institute (ANSI) states that a shock hazard exists when voltage levels greater than 30V RMS, 42.4V peak, or 60VDC are present. A good safety practice is to expect that hazardous voltage is present in any unknown circuit before measuring.

While learning to operate an Integra system, it is strongly recommended that only non-lethal signal levels be connected to the front panel or switching module inputs.

Measure and switching capabilities

The basic measurement capabilities of an Integra system are summarized in [Figure 1](#).

CAUTION The maximum input for the mainframe is 1000V peak. However, if a measure switch module (e.g., module 7700) is installed, the maximum allowable input voltage for the system (including the mainframe) is degraded to the maximum voltage rating of the card. The maximum signal levels for the Model 7700 switching module are listed in [Table 2](#) on [page 35](#).

Topics

Figure 1
Integra measurement capabilities

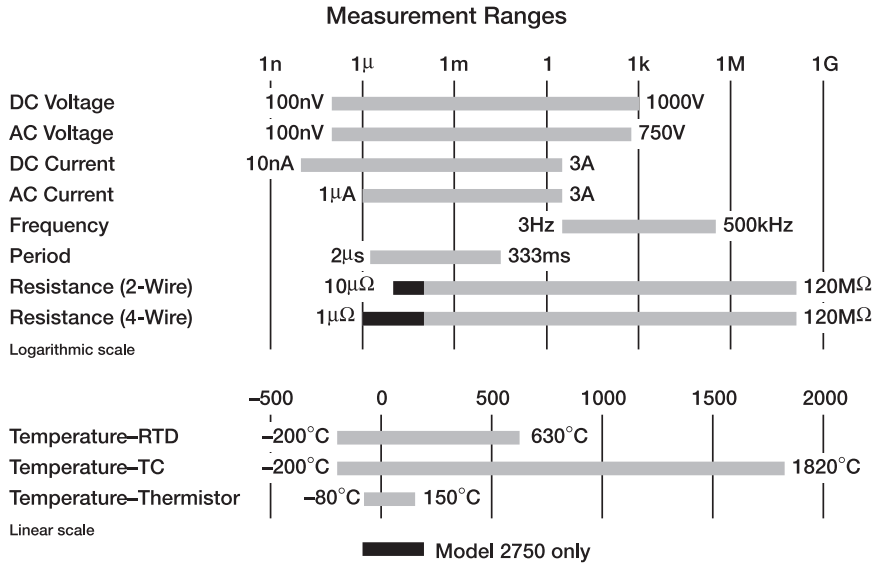

Topics

Model 7700 switching module capabilities

The Model 7700 has 20 input channels (1 through 20) for all Integra measurements, except amps. For 2-wire measurements, any of these 20 2-pole input channels can be connected (via relay switches) to the DMM of the mainframe. For 4-wire measurements (e.g., Ω4), the channels are paired. Input channels 1 through 10 are paired to sense channels 11 through 20. When an input channel (e.g., 1) is closed, the paired sense channel (e.g., 11) also closes to connect the 4-wire input to the input and sense terminals of the DMM.

For amps measurements, two dedicated channels (22 and 23) are provided to measure current. For temperature measurements, the switching module has a built-in cold (reference) junction that allows thermocouples to be connected directly to the screw terminals (channels 1 through 20) of the module.

NOTE Details on the “[Model 7700 switching module](#)” are provided on [page 34](#).

Topics

Front and rear panels (mainframe)

The front and rear panels of the Models 2700, 2701 and 2750 are shown in [Figure 2](#), [Figure 3](#), and [Figure 4](#). These illustrations show all controls and connectors.

Figure 2
Model 2700 front and rear panels

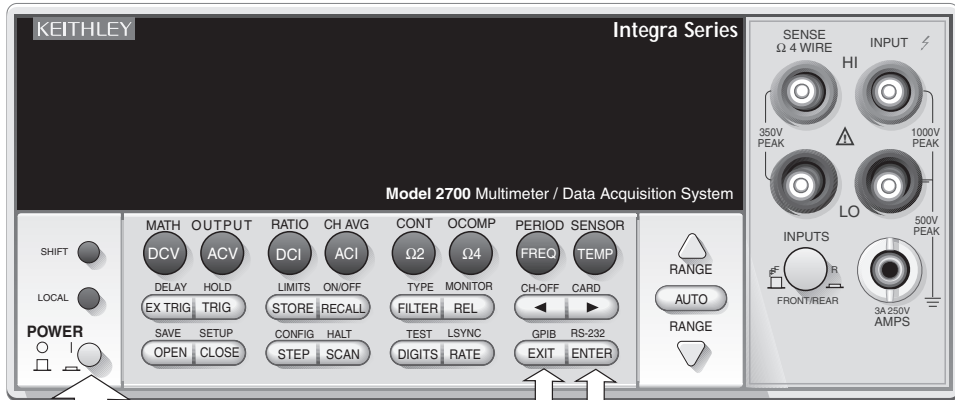

Power switch – Turn on the 2700 by pressing to the on (I) position. To turn off, release the switch to the off (O) position.

Communications configuration:

RS-232 – Press SHIFT and then ENTER (RS-232) to access menu. Use the edit keys to enable (ON) RS-232, and set the terminator (TX TERM), FLOW control, and BAUD rate.

GPIB – Press SHIFT and then EXIT (GPIB) to access menu. Use the edit keys to enable (ON) the GPIB and set the address (ADDR).

For **RS-232 communication**, connect to serial port of computer using a straight-through RS-232 cable (DB-9). Do not use a null modem cable.

For **GPIB communication**, connect to GPIB port of computer using an IEEE-488 cable (Keithley 7007).

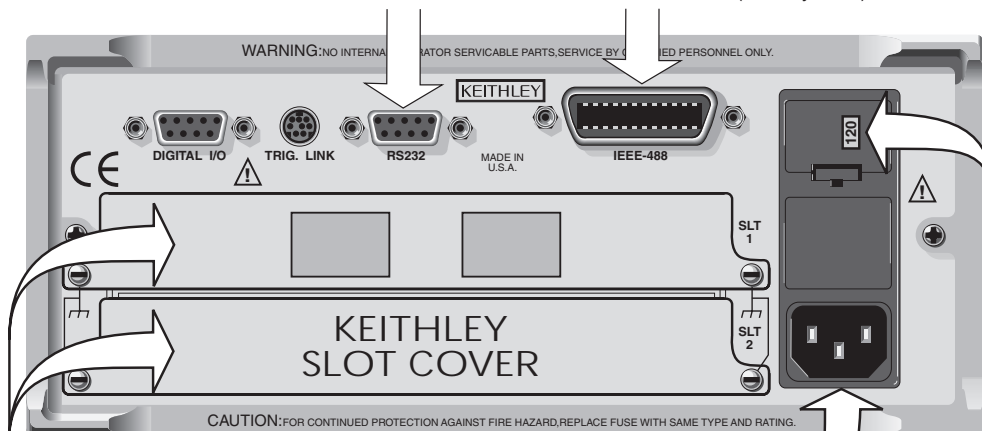

Two slots for Keithley switching modules

Using the **supplied line cord**, connect to a grounded AC power outlet. The line voltage setting shown in the window of the fuse holder must match line the voltage at the AC power outlet.

Window shows line voltage setting

Figure 3
Model 2701 front and rear panels

Topics

Topics

Topics

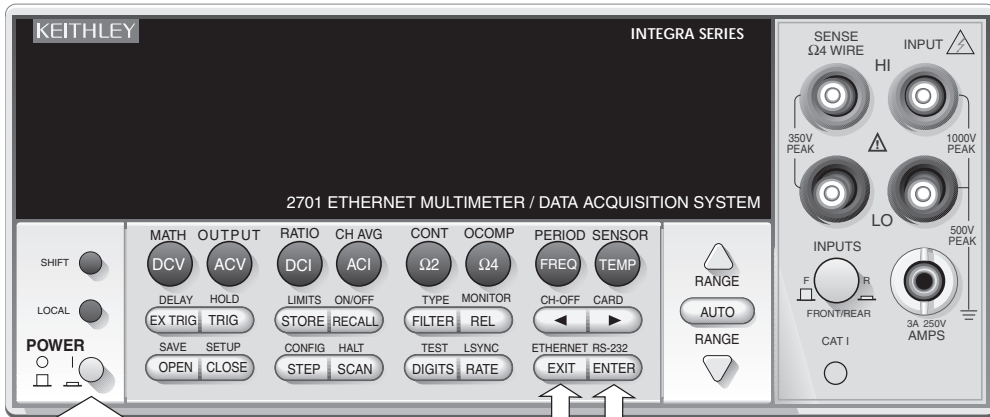

Power switch – Turn on the 2701 by pressing to the on (I) position. To turn off, release the switch to the off (O) position.

Communications configuration:

RS-232 – Press SHIFT and then ENTER (RS-232) to access menu. Use the edit keys to enable (ON) RS-232, and set the terminator (TX TERM), FLOW control, and BAUD rate.

Ethernet – Press SHIFT and then EXIT (ETHERNET) to access menu. Use the edit keys to enable the Ethernet (ON) set DHCP (ON or OFF), and set the address (ADDR), SUBNET and GATEWAY.

For **Ethernet communication**, connect to Ethernet port of a computer, or to a hub or receptacle of an Ethernet system (see Note below).

For **RS-232 communication**, connect to serial port of computer using a straight-through RS-232 cable (DB-9). Do not use a null modem cable.

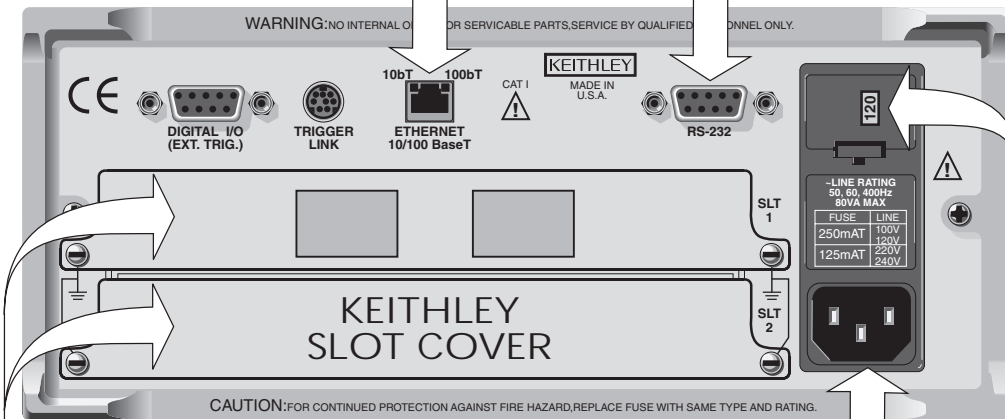

Two slots for Keithley switching modules

Using the **supplied line cord**, connect to a grounded AC power outlet. The line voltage setting shown in the window of the fuse holder must match line the voltage at the AC power outlet.

Window shows line voltage setting

Note **Ethernet communication** – If connecting the 2701 directly to a computer, use an Ethernet cross-over cable (RJ-45, male/male). If connecting to an Ethernet system hub or receptacle, use a standard Ethernet cable (RJ-45, male/male).

Figure 4
Model 2750 front and rear panels

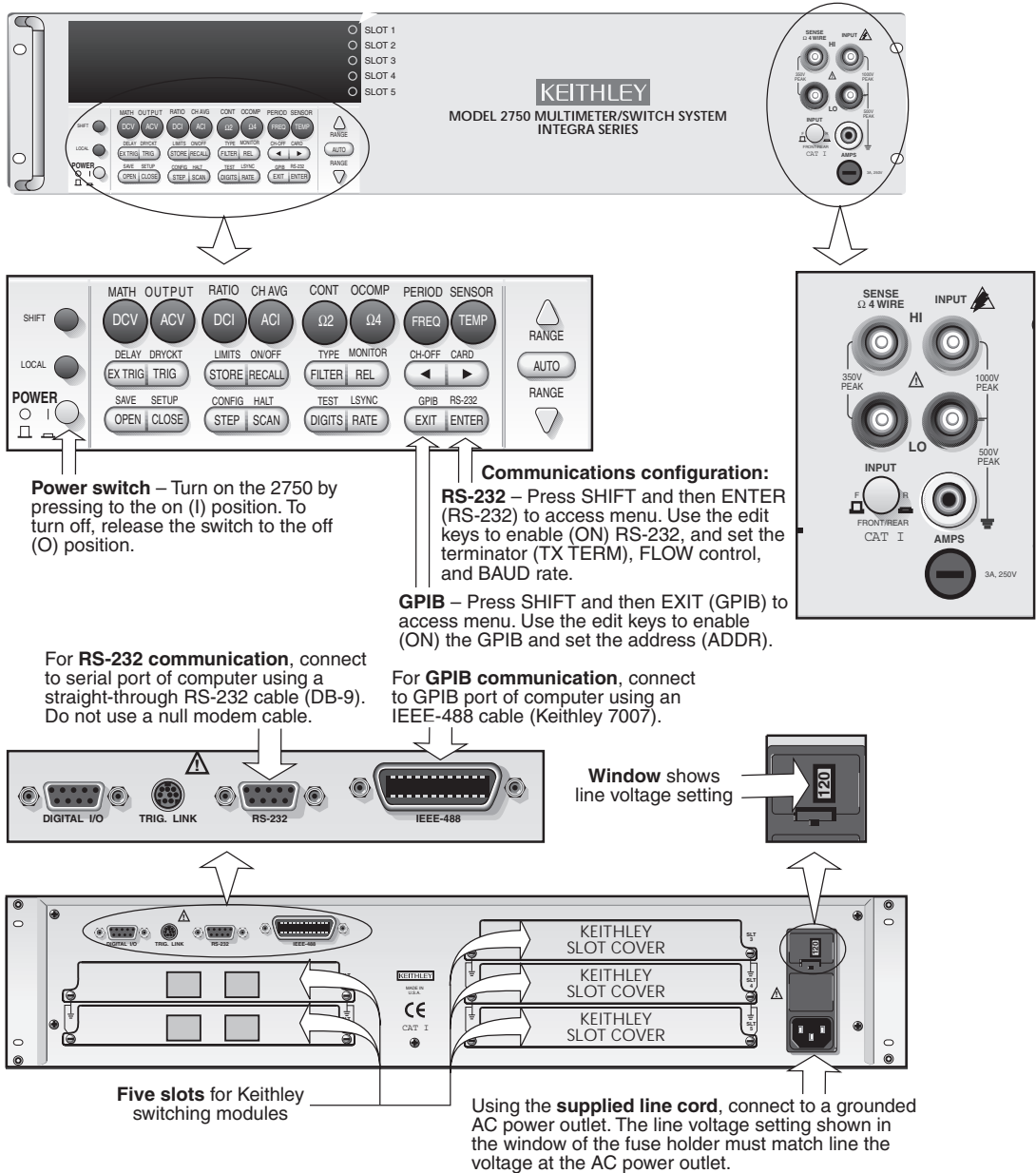

Power-up

NOTE For the following power-up procedure, refer to [Figure 2](#) (Model 2700), [Figure 3](#) (Model 2701), or [Figure 4](#) (Model 2750).

1. Check to see that the line voltage indicated in the window of the fuse holder assembly is correct for the operating voltage in your area. If not, refer to Section 1 of the Model 2700S User's Manual (see "Setting line voltage and replacing fuse").

CAUTION **Operating the instrument on an incorrect line voltage may cause damage to the instrument, possibly voiding the warranty.**

2. Before plugging in the power cord, make sure the front panel power switch is in the off (O) position.
3. Connect the female end of the supplied power cord to the AC receptacle on the rear panel. Connect the other end of the power cord to a grounded AC outlet.

WARNING **The power cord supplied with the mainframe contains a separate ground wire for use with grounded outlets. When proper connections are made, instrument chassis is connected to power line ground through the ground wire in the power cord. Failure to use a grounded outlet may result in personal injury or death due to electric shock.**

4. Turn on the instrument by pressing the front panel power switch to the on (I) position. After going through its power-up sequence, the instrument begins its normal display of readings.

Edit keys

Edit keys are used to navigate through a menu structure to make selections and enter values. The keys shown in [Figure 5](#) automatically become edit keys when in a menu structure. To see an example of a menu structure, press the STORE key. In this menu structure, you set the number of readings to store and enable the buffer.

The β and \odot keys control cursor position. The cursor is identified as a blinking digit or blinking menu item. With the cursor positioned where desired, use the \uparrow and \downarrow keys to select alternate menu items or change the value. The ENTER or EXIT key is then used. The ENTER key accepts the displayed selection, while the EXIT key exits the menu structure without making any changes.

When in the STORE menu structure, use the β , \odot , \uparrow , and \downarrow keys to specify the number of readings (e.g., 100) to store in the buffer. Then press ENTER to enable the buffer. The asterisk (*) annunciator is on while readings are being stored.

Figure 5
Edit keys



Edit keys when in a menu:

- Use to control cursor position: ◀ ▶
- Use to make selections or change values: ▲ ▼
- Use to cancel selection and/or exit menu: EXIT
- Use to accept selection: ENTER

Factory defaults

The operating instructions and examples in this guide assume that the instrument has powered up to its factory default settings (continuous measurement mode, DCV function, auto range enabled, 6H-digit resolution, filter enabled, etc.). If it did not return to factory defaults, or you are not sure, perform the following steps:

1. Press the SHIFT key and then the CLOSE (SETUP) key to access the setup menu.
2. With RESTORE: FACT displayed, press the ENTER key. Factory defaults will be restored and the instrument will continuously measure and display readings.

Remote programming – Send the following command to restore factory defaults:

```
SYST:PRES
```

Communication interfaces

Reference Detailed information on the GPIB (IEEE-488 interface) and RS-232 interfaces are provided in the Model 2700 and 2750 User's Manual.

Detailed information on the Ethernet interface is provided in the Model 2701 User's Manual and the Model 2701 Instrument Networking Instruction Manual.

For remote programming, the following interfaces can be used for communications between the computer and the Integra mainframe:

- Models 2700 and 2750 – GPIB (IEEE-488 interface) or RS-232.
- Model 2701 – Ethernet or RS-232.

Communication connections

Use the information in [Figure 2 \(2700\)](#), [Figure 3 \(2701\)](#), or [Figure 4 \(2750\)](#) to connect the desired communications port of the instrument.

WARNING Before making or breaking connections, turn off the instrument, disconnect the line cord, and disconnect any external circuitry connected to the mainframe or switching modules.

Communication configuration

Factory communication settings

Models 2700 and 2750 – These Integra instruments are shipped from the factory with the GPIB communications selected and set to primary address 16.

Model 2701 – This Integra instrument is shipped from the factory with the Ethernet interface selected and with the following settings:

IP Address:	192.168.000.002
Subnet Mask:	255.255.255.000
Gateway:	192.168.000.001

The interface settings for your computer must be compatible with the interface settings for the Model 2700S. You can change the interface settings for your computer or you can change the interface settings of the Model 2700S.

Checking and/or changing Integra communications settings

Use the “Communications configuration” information in [Figure 1 \(2700\)](#), [Figure 2 \(2701\)](#), or [Figure 3 \(2750\)](#) to check and/or change communications settings. While in the menu structure for a communication interface, use the edit keys (see [Figure 5](#)) to check or change settings.

NOTE If you select the alternate interface type (e.g., enabling (ON) the RS-232 while the GPIB is presently selected), the instrument will reboot. You will have to re-enter the menu structure to check/change the other settings.

Software

Models 2700, 2701, and 2750 – The latest software and software drivers for the Integra series products are available on the Keithley website: www.tek.com/keithley.

Model 2701 – A built-in web page is available to allow for easy Ethernet communication between the instrument and the computer. From this web page, you can read and set network parameters and other data stored in the Model 2701. It also takes readings and allows you to send command strings and receive data.

To access the built-in web page for the Model 2701, open your web browser and type the IP address of the Model 2701 into the address bar. Assuming the default IP Address is being used, the following intranet address will open the web page: **http://192.168.0.2**

NOTE Details on using the Ethernet web page with the Model 2701 is provided in Section 10 (see “Internal web page”) of the Model 2701 User’s Manual.

Trigger and return readings

Remote programming – The following SCPI command sequence is used to trigger a finite number of measurements and return the readings. It is assumed that [Factory defaults](#) have been previously restored.

INIT:CONT OFF	‘ Disables continuous measurements. Measurements will not be performed until the instrument is triggered.
TRIG:COUN <n>	‘ Sets the trigger count: <n> = 1 to 9999. This specifies the number of measurements to be performed.
READ?	‘ Triggers measurement(s) and requests reading(s).

Included with each returned reading is a timestamp and a reading number (Reading, Timestamp, Reading Number). For example:

```
1.00000000E+01VDC, +8694.16SECS, +6141RDNG#
```

The 10VDC reading is returned in exponent format. When the Model 2700S was turned on, the timestamp and reading number started at zero. For the above example, the measurement occurred 8,694.16 seconds after the unit was turned on, and the reading was the 6,141st taken since the unit was turned on.

Front panel input connections

NOTE Information on “[Input connections and measurements](#)” for the Model 7700 switching module is provided on [page 35](#) of this guide.

Front panel input connections are shown in [Figure 6](#). Note that the Front/Rear INPUTS switch must be in the out (F) position in order to use the front panel inputs.

2-wire measurements – The 2-wire connections to front panel inputs are shown in [Figure 6A](#). Use these connections for DCV, AVC, DCI, ACI, $\Omega 2$, FREQ, PERIOD, and TEMP (thermistor) measurements. Notice that DCI and ACI measurements use the AMPS and LO terminals shown in [Figure 6A \(e\)](#). All other 2-wire measurements use the INPUT HI and LO terminals.

4-wire measurements – The 4-wire connections to front panel inputs are shown in [Figure 6B](#). Use these connections for $\Omega 4$ and TEMP (4-wire RTD) measurements.

Maximum inputs (front panel)

The maximum allowable inputs for the front panel inputs are listed in [Table 1](#).

CAUTION To prevent damage to the Model 2700S do not exceed the maximum allowable inputs shown in [Table 1](#).

When using a switching module, the maximum allowable input voltage anywhere in the test system (including front panel inputs) is degraded to the maximum allowable input voltage of the switching module. Maximum inputs for the Model 7700 switching module are listed in [Table 2](#) on [page 35](#).

Table 1
Maximum front panel inputs

Function	Maximum input
DC Volts	1000V peak
AC Volts	750V RMS, 1000V peak, $8 \times 10^7 \bullet \text{Hz}$
DC Amps and AC Amps	3A DC or RMS
Frequency and Period	1000V peak, $8 \times 10^7 \bullet \text{Hz}$

Figure 6
Front panel input connections

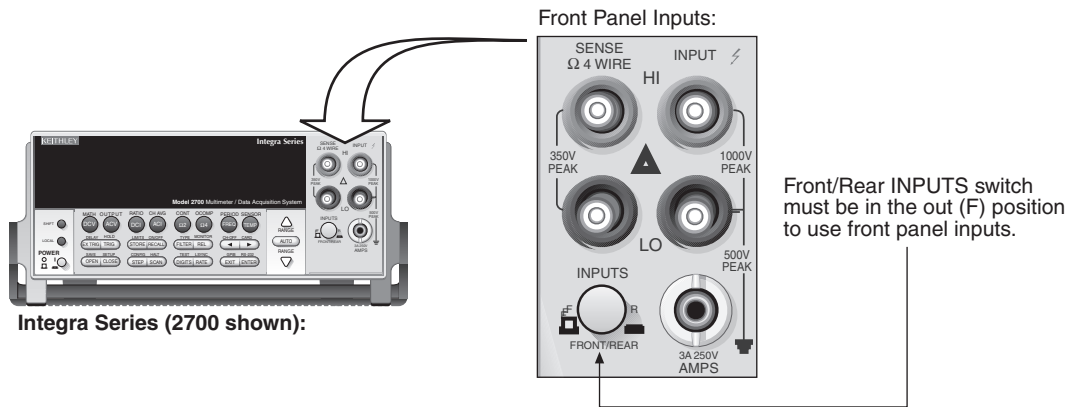

A) Front panel input connections for 2-wire functions

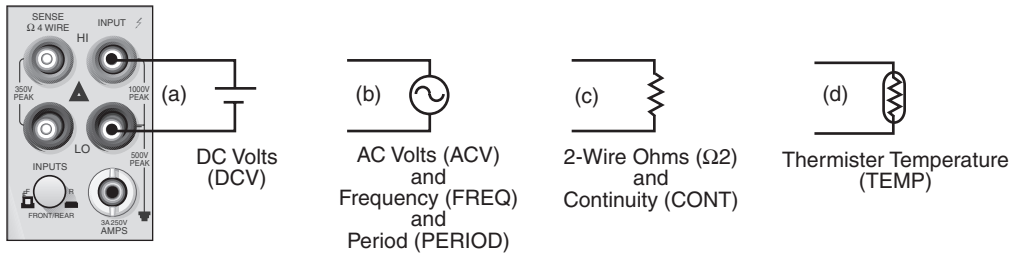

B) Front panel input connections for 4-wire functions

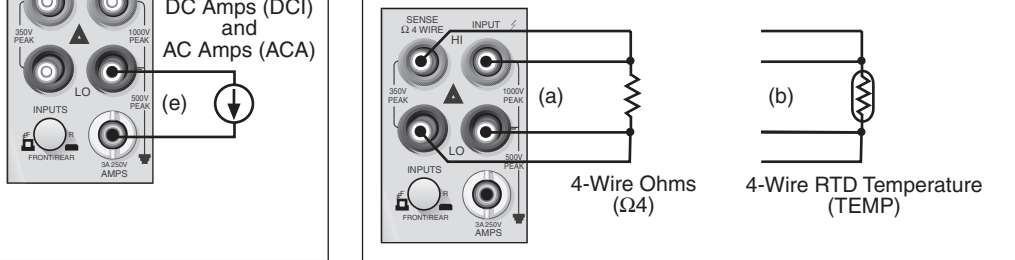

Basic measurements

NOTE The following measurement procedures assume front panel input connections. “[Input connections and measurements](#)” for the Model 7700 switching module are covered on [page 35](#).

[Figure 7](#) shows the front panel controls used to select a measurement function and set the measurement range. Each function “remembers” its own unique range setting.

The measurement range can be set manually or auto range can be used. When setting range manually, select a range that will accommodate the applied input. If the range is too low, the “OVRFLW” message will be displayed. Select a higher range.

With auto range selected, the Model 2700S will automatically select the best range to measure the applied input. With auto range enabled, the “AUTO” annunciator is on.

Figure 7
Function and range selection

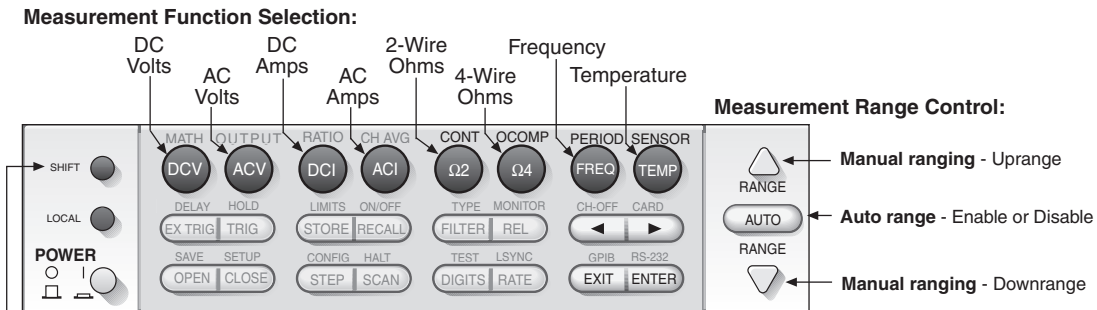

Use to select a shifted function:

CONTINUITY: To select, press SHIFT and then press $\Omega 2$ (CONT).

Offset Compensated Ohms: To select, press SHIFT and then $\Omega 4$ (OCOMP).

PERIOD: To select, press SHIFT and then FREQ (PERIOD).

Measure volts, amps and ohms

- Front panel connections** – Connect the DUT as shown in [Figure 6](#).
 - Use [Figure 6A](#) for volts (a), amps (e), and 2-wire ohms (c) connections.
 - Use [Figure 6B](#) for 4-wire ohms (a) connections.
- Function** – As shown in [Figure 7](#), press the DCV, ACV, DCI, ACI, $\Omega 2$, or $\Omega 4$ key to select the measurement function.
- Range** – As shown in [Figure 7](#), enable auto range or manually select a measurement range.
- Reading** – Take a reading from the display.

Offset compensated (OCOMP) ohms measurements

For more accurate low resistance measurements, all Integra systems provide the offset compensation mode to eliminate errors from the thermoelectric EMF effects. During the measurement cycle, the built-in ohms current source is turned off, and then turned on again, and the resulting EMF error is automatically subtracted. This technique is typically used when measuring values less than 100 Ω . Use 4-wire connections, as shown in [Figure 6B](#) (a).

With the $\Omega 4$ function selected, OCOMP is enabled by pressing the SHIFT key and then the $\Omega 4$ (OCOMP) key. When enabled, the "OCOMP" annunciator is on. Valid measurement ranges for OCOMP is 10k Ω or less, or use Auto range. OCOMP is disabled by again pressing SHIFT and then $\Omega 4$.

SCPI programming commands (volts, amps, and ohms)

DC Volts

SENS:FUNC 'VOLT:DC' † Select DC Volts function.
 SENS:VOLT:DC:RANG:AUTO † Enable or disable auto range: = ON or OFF.
 SENS:VOLT:DC:RANG <n> † To set range, specify expected magnitude of input:
 † <n> = 0 to 1010 (V).

AC Volts

SENS:FUNC 'VOLT:AC' † Select AC Volts function.
 SENS:VOLT:AC:RANG:AUTO † Enable or disable auto range: = ON or OFF.
 SENS:VOLT:AC:RANG <n> † To set range, specify expected magnitude of input:
 † <n> = 0 to 757.5 (V).

DC Amps

SENS:FUNC 'CURR:DC' † Select DC Amps function.
 SENS:CURR:DC:RANG:AUTO † Enable or disable auto range: = ON or OFF.
 SENS:CURR:DC:RANG <n> † To set range, specify expected magnitude of input:
 † <n> = 0 to 3 (A).

AC Amps

SENS:FUNC 'CURR:AC' † Select AC Amps function.
 SENS:CURR:AC:RANG:AUTO † Enable or disable auto range: = ON or OFF.
 SENS:CURR:AC:RANG <n> † To set range, specify expected magnitude of input:
 † <n> = 0 to 3 (A).

2-Wire Ohms

SENS:FUNC 'RES' † Select 2-Wire Ohms function.
 SENS:RES:RANG:AUTO † Enable or disable auto range: = ON or OFF.
 SENS:RES:RANG <n> † To set range, specify expected resistance at input:
 † <n> = 0 to 120e6 (Ω).

4-Wire Ohms

SENS:FUNC 'FRES' † Select 4-Wire Ohms function.
 SENS:FRES:RANG:AUTO † Enable or disable auto range: = ON or OFF.
 SENS:FRES:OCOM † Enable or disable offset compensated ohms.
 SENS:FRES:RANG <n> † To set range, specify expected resistance at input:
 † <n> = 0 to 120e6 (Ω).

Remote programming example (2-wire ohms)

INIT:CONT OFF	‘ Disables continuous initiation.
TRIG:COUN 1	‘ Sets trigger count to one.
SENS:FUNC ‘RES’	‘ Select 2-Wire Ohms function.
READ?	‘ Triggers measurement and requests one reading.

NOTE When finished with remote programming, press the LOCAL key to restore front panel control.

Measure temperature

A thermistor or 4-wire RTD can be connected directly to the front panel inputs to perform temperature measurements. A thermocouple cannot be connected directly to the front panel inputs.

NOTE **Thermocouple** – Front panel thermocouple temperature measurements can be performed if using a simulated reference junction (such as an ice bath) as explained in Section 3 of the Model 2700S User’s Manual.

The Model 7700 switching module has a built-in cold (reference) junction that allows a thermocouple to be connected directly to the input terminals of the module. “[Input connections and measurements](#)” for the Model 7700 are covered on [page 35](#). Step 3 of the following procedure explains how to select and configure the thermocouple sensor.

- Connections** – Connect the thermistor as shown in [Figure 6A\(d\)](#).
- Function** – As shown in [Figure 7](#), press the TEMP key to select the Temperature function.
- Temperature configuration** – Press SHIFT and then TEMP (SENSOR) to access the menu. Use the front panel edit keys to select and configure thermistor, 4-wire RTD or thermocouple temperature measurements:
 - Thermistor:
 - Set measurement UNITS (°C, °F, or K).
 - Select the THRMSTR sensor.
 - Select thermistor type (2252W, 5000W, or 10kW).
 - 4-Wire RTD:
 - Set measurement UNITS (°C, °F, or K).
 - Select the 4W-RTD sensor.
 - Select RTD type (PT100, D100, F100, PT385, PT3916, or USER*).

* The parameters for the USER RTD type can only be set using remote programming (see Section 3 of the Model 2700S User’s Manual for details).
- Thermocouple:**
 - Set measurement UNITS (°C, °F, or K).
 - Select the TCOUPLE sensor.

- c. Select the thermocouple type: K, J, N, B, S, R, E, or T.
 - d. Select the reference junction (JUNC):
 - Select SIM if using a simulated reference junction (e.g., ice bath). You will then be prompted to enter the temperature of the simulated junction. For example, if using an ice bath, set the simulated temperature to 0°C (or 32°F or 273K).
 - Select INT if the thermocouple is connected to a Keithley switching module that has a cold junction, such as the Model 7700.
 - e. Enable (Y) or disable open thermocouple detection (OPEN DET). When enabled, an open thermocouple will display the OVRFLW message.
4. **Reading** – Take a reading from the display.

NOTE Thermocouples cannot be directly connected to the front panel inputs. In order to use front panel inputs for thermocouple temperature measurements, a simulated reference junction (such as an ice bath) must be used (see Section 3 of Model 2700S User's Manual for details).

Thermocouples can be directly connected to a Keithley switching module that has a cold junction for thermocouples (such as the Keithley 7707 switching module). Details on "[Model 7700 switching module](#)" are provided on [page 34](#).

SCPI programming commands (temperature)

NOTE Not all temperature commands are documented here. For details on all temperature commands, refer to the Model 2700S User's Manual (see Section 3).

SENS:FUNC 'TEMP' † Select Frequency function.
 SENS:UNIT:TEMP <name> † Set temperature units: <name> = C, F, or K.

Thermistor

SENS:TEMP:TRAN THER † Select thermistor transducer.
 SENS:TEMP:THER <NRf> † Set thermistor type: <NRf> = 1950 to 10050 (ohms).

4-Wire RTD

SENS:TEMP:TRAN FRTD † Select 4-wire RTD transducer.
 SENS:TEMP:FRTD:TYPE <name> † Select FRTD type: <name> = PT100, D100, F100, PT3916, PT385, or USER*.

Thermocouple

SENS:TEMP:TRAN TC † Select thermocouple transducer.
 SENS:TC:TYPE <type> † Select T/C type: <type> = J, K, T, E, R, S, B, or N.
 SENS:TC:ODET † Enable or disable open T/C detector: = ON or OFF.

* The commands to specify the constants for the USER FRTD type are provided in the Model 2700S User's Manual.

Remote programming example (thermistor)

INIT:CONT OFF † Disables continuous initiation.

TRIG:COUN 1	' Sets trigger count to one.
SENS:FUNC 'TEMP'	' Select Frequency function.
SENS:TEMP:TRAN THER	' Select thermistor transducer.
SENS:TEMP:THER 5000	' Select 5000 ohm thermistor.
READ?	' Triggers measurement and requests one reading.

NOTE When finished with remote programming, press the LOCAL key to restore front panel control.

Measure frequency and period

The Model 2700S can measure frequency or period (Period = 1 / Frequency).

1. **Connections** – Connect the AC signal as shown in [Figure 6A \(b\)](#).
2. **Function** – Referring to [Figure 7](#), select the Frequency or Period function:
 - Frequency – Press the **FREQ** key.
 - Period – Press the **SHIFT** key, then press **FREQ (PERIOD)**.
3. Select a measure range that will accommodate the expected AC input level.
4. **Reading** – Take a reading from the display.

SCPI programming commands (frequency and period)

Frequency

SENS:FUNC 'FREQ'	' Select Frequency function.
SENS:FREQ:THR <NRf>	' Specify expected input level (in volts): <NRf> = 0 to 1010.

Period

SENS:FUNC 'PER'	' Select Period function.
SENS:PER:THR <NRf>	' Specify expected input level (in volts): <NRf> = 0 to 1010.

Remote programming example (frequency)

INIT:CONT OFF	' Disables continuous initiation.
TRIG:COUN 1	' Sets trigger count to one.
SENS:FUNC 'FREQ'	' Selects Frequency function.
SENS:FREQ:THR 10	' Selects 10V threshold range for expected input.
READ?	' Triggers measurement and requests one reading.

NOTE When finished with remote programming, press the LOCAL key to restore front panel control.

Testing continuity

The Model 2700S can test continuity using the 1k Ω range. Threshold can be set from 1 to 1000 Ω . When the measured test circuit is below the set threshold level, the instrument will beep and display the resistance reading. When the measured level is above the threshold level, the message “OPEN” will display.

1. **Connections** – Connect the test circuit as shown in [Figure 6A \(c\)](#).
2. **Function** – Referring to [Figure 7](#), select the Continuity function by pressing SHIFT, and then $\Omega 2$ (CONT).
3. Using the front panel edit keys, set the threshold LEVEL from 1 to 1000 Ω .
4. **Continuity Test** – If the tested circuit is below the set threshold (pass condition), the unit will beep and display the resistance reading. If the tested circuit is above the threshold (fail condition), the message “OPEN” will be displayed.

SCPI programming commands (continuity)

SENS:FUNC 'CONT' † Selects Continuity function.
 SENS:CONT:THR <NRf> † Set threshold level: <NRf> = 1 to 1000.

Remote programming example (continuity)

INIT:CONT OFF † Disables continuous initiation.
 TRIG:COUN 1 † Sets trigger count to one.
 SENS:FUNC 'CONT' † Selects Continuity function.
 SENS:CONT:THR 10 † Sets threshold to 10 ohms.
 READ? † Trigger measurement and request one reading.

For the pass condition, READ? will return the measured resistance reading. For the fail condition (open), the value +9.9E37 will instead be returned.

NOTE When finished with remote programming, press the LOCAL key to restore front panel control.

Optimizing performance

Factors that affect measurement performance include instrument warm-up, display resolution, measurement speed, filter, line cycle synchronization and autozero.

Figure 8
Measurement performance control

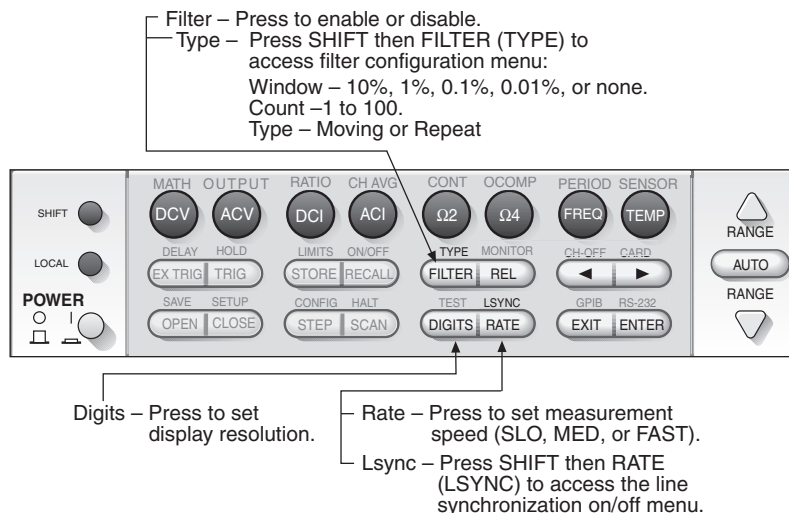

Warm-up

The instrument can be used as soon as it is turned on. However, to achieve rated accuracy, it must be allowed to warm up for at least two hours to allow internal temperatures to stabilize. If the instrument has been exposed to extreme temperatures, allow extra warm up time.

Display resolution (digits)

As shown in [Figure 8](#), use the DIGITS key to set the display resolution (3H to 6H-digits) for all functions, except Continuity (which is fixed).

Press the DIGITS key until the desired resolution is displayed. For front panel operation, the selected display resolution is the same for all functions.

SCPI programming commands (digits)

For remote programming, each valid function can have it's own unique setting:

SENS:VOLT:DC:DIG <n>	' Set display resolution for DC Volts.
SENS:VOLT:AC:DIG <n>	' Set display resolution for AC Volts.
SENS:CURR:DC:DIG <n>	' Set display resolution for DC Amps.
SENS:CURR:AC:DIG <n>	' Set display resolution for AC Amps.
SENS:RES:DIG <n>	' Set display resolution for 2-Wire Ohms.
SENS:FRES:DIG <n>	' Set display resolution for 4-Wire Ohms.
SENS:TEMP:DIG <n>	' Set display resolution for Temperature.
SENS:FREQ:DIG <n>	' Set display resolution for Frequency.
SENS:PER:DIG <n>	' Set display resolution for Period.

<n> = 4 to 7 Where 4 = 3H-digits, 5 = 4H-digits, 6 = 5H-digits and 7 = 6H-digits.

Remote programming example (digits)

SENS:CURR:DC:DIG 5 ' Sets DC Amps display resolution for 4H-digits.

NOTE When finished with remote programming, press the LOCAL key to restore front panel control.

Measurement speed (rate)

For the volts, amps, ohms, and temperature measurements, the RATE key sets the integration time (measurement speed) of the A/D converter. The integration time is the period of time the input signal is measured.

Integration time is specified in parameters based on a number of power line cycles (NPLC), where 1 PLC for 60Hz is 16.67ms (1/60). For 50Hz (and 400Hz), 1 PLC is 20ms (1/50).

As speed (rate) increases, reading noise also increases. Typically, the desired rate setting is a compromise between speed and noise. From the front panel, setting the rate affects all other valid measurement functions.

Front panel rate settings:

- FAST sets integration time to 0.1PLC. Use this setting when speed is of primary importance (at the expense of noise).
- MEDium sets integration time to 1 PLC. This setting is a compromise between noise and speed.
- SLOW sets integration time to 5 PLC. Use this setting for better noise performance at the expense of speed.

Setting measurement speed

Referring to [Figure 8](#), press RATE until the desired speed annunciator (FAST, MED, or SLOW) turns on.

NOTE For AC functions, measurement bandwidth is affected by the measurement speed setting (see Model 2700S User's Manual for details).

SCPI programming commands (nplc)

For remote programming, the :NPLC command is used to set measurement speed (rate). Each valid function can have its own unique nplc rate setting:

SENS:VOLT:DC:NPLC <n>	' Set rate for DC Volts in PLCs
SENS:VOLT:AC:NPLC <n>	' Set rate for AC Volts.
SENS:CURR:DC:NPLC <n>	' Set rate for DC Amps.
SENS:CURR:AC:NPLC <n>	' Set rate for AC Amps.
SENS:RES:NPLC <n>	' Set rate for 2-Wire Ohms.
SENS:FRES:NPLC <n>	' Set rate for 4-Wire Ohms.
SENS:TEMP:NPLC <n>	' Set rate for Temperature.

<n> = 0.01 to x For 60Hz line power, x = 60.

For 50Hz or 400Hz line power, x = 50.

NOTE Measurement speed can also be set using the :APERature command (see Model 2700S User's Manual for details).

NOTE For AC volts and amps, :BANDwidth commands can be used to set measurement bandwidth (see Model 2700S User's Manual for details).

Remote programming example (nplc)

SENS:VOLT:DC:NPLC 2 ' Sets rate for DC Amps to 2 PLC.

NOTE When finished with remote programming, press the LOCAL key to restore front panel control.

Filter

The digital filter is used to stabilize noisy measurements. A final filtered reading is a windowed-average of a number of reading conversions (up to 100) temporarily stored in a buffer stack. Readings not within the specified window are not put in the stack.

Filter window – As long as the input signal remains within the selected filter window, readings continue to fill the stack. If a reading is outside of the window, the filter resets and starts over. A window is expressed as a percent of range (or percent of maximum temperature reading). For example, on the 10V range, a 10% window means that the filter window is $\pm 1V$.

Filter count – This specifies the number of readings to average (1 to 100). For a filter count of 1, no averaging is done.

Filter type – There are two filter types: Moving average and repeating:

- **Moving filter** – The moving average filter uses a “first-in, first-out” stack. When the stack becomes full, the readings are averaged to yield a single filtered reading that is displayed. For each subsequent reading placed in the stack, the oldest reading is discarded, and the stack is re-averaged to yield a new filtered reading.
- **Repeat filter** – The repeating filter uses a “fill and then average” stack. Each time the stack is filled, it is averaged to yield a single filtered reading. The stack is then emptied and the process starts over.

Configuring and controlling filter

Referring to [Figure 8](#), perform the following steps to configure and enable filter.

1. Press SHIFT and then FILTER (TYPE) to access filter menu.
2. Using the edit keys (see [Figure 5](#)), set the WINDOW to 0.1%, 1%, 10% or NONE. With NONE selected, a window is not used.
3. Using the edit keys, set the filter count (1 to 100 RDGS).
4. Using the edit keys, set the filter TYPE (MOVNG AV or REPEAT).

SCPI programming commands (filter)

For remote programming, :AVER commands are used to configure and control (enable/disable) the digital filter. Each valid function can have its own unique filter configuration:

DC Volts

SENS:VOLT:DC:AVER:WIND <NRf>	‘ Set filter window in %: <NRf> = 0 to 10.
SENS:VOLT:DC:AVER:COUN <n>	‘ Set filter count: <n> = 1 to 100.
SENS:VOLT:DC:AVER:TCON <name>	‘ Select filter type: <name> = MOV or REP.
SENS:VOLT:DC:AVER:STAT 	‘ Enable or disable filter: = ON or OFF.

AC Volts

SENS:VOLT:AC:AVER:WIND <NRf>	‘ Set filter window in %: <NRf> = 0 to 10.
SENS:VOLT:AC:AVER:COUN <n>	‘ Set filter count: <n> = 1 to 100.
SENS:VOLT:AC:AVER:TCON <name>	‘ Select filter type: <name> = MOV or REP.
SENS:VOLT:AC:AVER:STAT 	‘ Enable or disable filter: = ON or OFF.

DC Amps

SENS:CURR:DC:AVER:WIND <NRf>	‘ Set filter window in %: <NRf> = 0 to 10.
SENS:CURR:DC:AVER:COUN <n>	‘ Set filter count: <n> = 1 to 100.
SENS:CURR:DC:AVER:TCON <name>	‘ Select filter type: <name> = MOV or REP.
SENS:CURR:DC:AVER:STAT 	‘ Enable or disable filter: = ON or OFF.

AC Amps

SENS:CURR:AC:AVER:WIND <NRf>	‘ Set filter window in %: <NRf> = 0 to 10.
SENS:CURR:AC:AVER:COUN <n>	‘ Set filter count: <n> = 1 to 100.
SENS:CURR:AC:AVER:TCON <name>	‘ Select filter type: <name> = MOV or REP.
SENS:CURR:AC:AVER:STAT 	‘ Enable or disable filter: = ON or OFF.

2-Wire Ohms

SENS:RES:AVER:WIND <NRf> ' Set filter window in %: <NRf> = 0 to 10.
 SENS:RES:AVER:COUN <n> ' Set filter count: <n> = 1 to 100.
 SENS:RES:AVER:TCON <name> ' Select filter type: <name> = MOV or REP.
 SENS:RES:AVER:STAT ' Enable or disable filter: = ON or OFF.

4-Wire Ohms

SENS:FRES:AVER:WIND <NRf> ' Set filter window in %: <NRf> = 0 to 10.
 SENS:FRES:AVER:COUN <n> ' Set filter count: <n> = 1 to 100.
 SENS:FRES:AVER:TCON <name> ' Select filter type: <name> = MOV or REP.
 SENS:FRES:AVER:STAT ' Enable or disable filter: = ON or OFF.

Temperature

SENS:TEMP:WIND <NRf> ' Set filter window in %: <NRf> = 0 to 10.
 SENS:TEMP:AVER:COUN <n> ' Set filter count: <n> = 1 to 100.
 SENS:TEMP:AVER:TCON <name> ' Select filter type: <name> = MOV or REP.
 SENS:TEMP:AVER:STAT ' Enable or disable filter: = ON or OFF.

Remote programming example (filter for 2-wire ohms)

SENS:RES:AVER:WIND 2 ' Sets filter window to 2%.
 SENS:RES:AVER:COUN 10 ' Set filter count to 10.
 SENS:RES:AVER:TCON REP ' Select Repeat filter type.
 SENS:RES:AVER:STAT ON ' Enable filter.

NOTE When finished with remote programming, press the LOCAL key to restore front panel control.

Line cycle synchronization (lsync)

Synchronizing A/D conversions with the frequency of the power line increases common mode and normal mode noise rejection. When line cycle synchronization is enabled, the measurement is initialized at the first positive-going zero crossing of the power line cycle after the trigger.

Enabling or disabling line cycle synchronization

1. Referring to [Figure 8](#), press SHIFT and then RATE (LSYNC) to display the present state of line synchronization (off or on).
2. Use the edit keys to (see [Figure 5](#)) enable (ON) or disable (OFF) line synchronization.

SCPI programming commands (lsync)

SYST:LSYN:STAT ' Enable or disable line synchronization: = ON or OFF.

Remote programming example (lsync)

SYST:LSYN:STAT ON ' Enable line synchronization.

NOTE When finished with remote programming, press the LOCAL key to restore front panel control.

Autozero

To help maintain stability and accuracy over time and changes in temperature, the instrument periodically performs internal measurements. These autozero measurements are then used in the algorithm to accurately calculate the reading of the input signal.

When autozero is disabled, the internal measurements are not performed. This increases measurement speed. However, the internal reference points will eventually drift resulting in inaccurate readings of the input signal. It is recommended that autozero only be disabled for short periods of time.

Enabling or disabling autozero

Remote programming (:AZER command) is used to enable or disable autozero. However, it can be disabled by restoring “Factory defaults” (see page 9).

SYST:AZER:STAT ‘ Enable or disable autozero: = ON or OFF.

Remote programming example (autozero)

SYST:AZER:STAT ON ‘ Enable autozero.
 SYST:AZER:STAT OFF ‘ Disable autozero.

NOTE When finished with remote programming, press the LOCAL key to restore front panel control.

Math operations

The following math operations can be performed on an input signal: relative, $mX+b$, percent, reciprocal ($1/X$), ratio, and channel average.

Figure 9
Math operations

Math – Press SHIFT then DCV (MATH) to access math menu: Percent, 1/X, or $mX+B$.

Rel – Press to enable or disable relative.

Ratio – Press SHIFT and then DCI (RATIO):
 Ratio = Chan A / Chan B

Ch Avg – Press SHIFT and then ACI (CH AVG):
 Ch Avg = (Chan A + Chan B) / 2

NOTE A switching module must be installed in order to use RATIO and CH AVG.

Relative (rel)

For all measurement functions, except Continuity, relative is used to null offsets or establish a baseline for future readings. When Rel is enabled, the displayed reading is determined as follows:

Displayed Reading = Actual Input - Reference

The reference value is established when the REL key is pressed (REL annunciator on). The reference is also called the rel value.

Nulling an offset

With the offset reading displayed, press the REL key to zero the display (REL annunciator on). Future readings for the input signal will not include the offset. Pressing REL again will disable relative.

Establishing a baseline

Apply the baseline level to the input and press REL to enable it (REL annunciator on). The reference (rel) level becomes the zero baseline. Future readings will be the difference between the actual input and the reference (rel) level. For example, for a +1 reference level, future readings will be the actual input minus 1V.

SCPI programming commands (relative)

DC Volts

SENS:VOLT:DC:REF <n> ' Specify rel value: <n> = -1010 to 1010 (V).
 SENS:VOLT:DC:REF:STAT ' Enable or disable rel: = ON or OFF.
 SENS:VOLT:DC:REF:ACQ ' Use input signal as rel value.

AC Volts

SENS:VOLT:AC:REF <n> ' Specify rel value: <n> = -757.5 to 757.5 (V).
 SENS:VOLT:AC:REF:STAT ' Enable or disable rel: = ON or OFF.
 SENS:VOLT:AC:REF:ACQ ' Use input signal as rel value.

DC Amps

SENS:CURR:DC:REF <n> ' Specify rel value: <n> = -3.1 to 3.1 (A).
 SENS:CURR:DC:REF:STAT ' Enable or disable rel: = ON or OFF.
 SENS:CURR:DC:REF:ACQ ' Use input signal as rel value.

AC Amps

SENS:CURR:AC:REF <n> ' Specify rel value: <n> = -3.1 to 3.1 (A).
 SENS:CURR:AC:REF:STAT ' Enable or disable rel: = ON or OFF.
 SENS:CURR:AC:REF:ACQ ' Use input signal as rel value.

2-Wire Ohms

SENS:RES:REF <n> ' Specify rel value: <n> = -120e6 to 120e6 (Ω).
 SENS:RES:REF:STAT ' Enable or disable rel: = ON or OFF.
 SENS:RES:REF:ACQ ' Use input signal as rel value.

4-Wire Ohms

SENS:FRES:REF <n> ' Specify rel value: <n> = -120e6 to 120e6 (Ω).
 SENS:FRES:REF:STAT ' Enable or disable rel: = ON or OFF.
 SENS:FRES:REF:ACQ ' Use input signal as rel value.

Temperature

SENS:TEMP:REF <n> ' Specify rel value: <n> = -200 to 1820 (°C).
 SENS:TEMP:REF:STAT ' Enable or disable rel: = ON or OFF.
 SENS:TEMP:REF:ACQ ' Use input signal as rel value.

Frequency

SENS:FREQ:REF <n> ' Specify rel value: <n> = 0 to 1.5e7 (Hz).
 SENS:FREQ:REF:STAT ' Enable or disable rel: = ON or OFF.
 SENS:FREQ:REF:ACQ ' Use input signal as rel value.

Period

SENS:PER:REF <n> ' Specify rel value: <n> = 0 to 1 (sec).
 SENS:PER:REF:STAT ' Enable or disable rel: = ON or OFF.
 SENS:PER:REF:ACQ ' Use input signal as rel value.

Remote programming example (rel)

SENS:VOLT:DC:REF:ACQ ' Uses input signal as rel value.
 SENS:VOLT:DC:REF:STAT ON ' Enables rel.

NOTE When finished with remote programming, press the LOCAL key to restore front panel control.

Math**mX+b**

This math operation manipulates the normal display reading (X) according to the following calculation:

$$Y = mX + b$$

Where: X is the normal display reading.
 m and b are user-entered constants (scale factor and offset).

mX + b operation

1. Referring to [Figure 9](#), press SHIFT and then DCV (MATH) to access the Math menu.
2. Using the edit keys (see [Figure 5](#)), select the mX+B menu item.
3. Using the edit keys, enter the scale offset value (M).
4. Using the edit keys, enter the offset value (B).
5. Using the edit keys, select the UNITS for the display readings (A through Z, Ω or °).

The displayed readings will be the result of the mX + b calculation. To disable the mX + b math operation, press SHIFT and DCV (MATH).

Percent

This math operation determines percent deviation from a specified reference value, and is calculated as follows:

$$\text{Percent} = \frac{\text{Input} - \text{Reference}}{\text{Reference}} \times 100\%$$

Where: Input is the normal display reading.

Reference is the user entered constant.

Percent is the displayed result.

Percent operation

1. Referring to [Figure 9](#), press SHIFT and then DCV (MATH) to access the Math menu.
2. Using the edit keys (see [Figure 5](#)), select the PERCENT menu item.
3. Using the edit keys, enter the reference (REF) value.

The displayed readings will be the result of the Percent calculation (in %). To disable the Percent math operation, press SHIFT and DCV (MATH).

Reciprocal (1/X)

The reciprocal of a reading is displayed when the reciprocal (1/X) math function is enabled:

$$\text{Reciprocal} = 1/X$$

Where: X is the normal input reading

The displayed units designator for reciprocal readings is "R." This units designator cannot be changed.

Example – Assume the normal display reading is 2.5Ω. The reciprocal of resistance is conductance. When 1/X is enabled, the following conductance reading will be displayed: 0.4R

Reciprocal (1/X) operation

1. Referring to [Figure 9](#), press SHIFT and then DCV (MATH) to access the Math menu.
2. Using the edit keys (see [Figure 5](#)), select the 1/X menu item.

The displayed readings will be the result of the 1/X calculation (in R units). To disable the 1/X math operation, press SHIFT and DCV (MATH).

SCPI programming commands (math)

CALC1:FORM <name> † Select calculation: <name> = MXB, PERC, REC, or NONE.
 CALC1:STAT † Enable or disable math: = ON or OFF.
 CALC1:DATA? † Read result of selected calculation.

mX +b

CALC1:KMAT:MMF <NRf> † Set “m” factor: <NRf> = -100e6 to 100e6.
 CALC1:KMAT:MBF <NRf> † Set “b” factor: <NRf> = -100e6 to 100e6.
 CALC1:KMAT:MUN <char> † Set units: <char> = ‘A’ through ‘Z’, ‘a’ through ‘z’, ‘[’ (W
 † symbol), or ‘\’ (° symbol).

Percent

CALC1:KMAT:PER <NRf> † Set reference: <NRf> = -4294967295 to +4294967295.
 CALC1:KMAT:PER:ACQ † Use input signal as reference.

Remote programming example (percent - acquire reference)

Apply the signal that you wish to use as the reference for the Percent calculation, and continue as follows:

INIT:CONT OFF † Disables continuous initiation.
 TRIG:COUN 1 † Sets trigger count to one.
 INIT † Measures input signal.
 CALC1:FORM PERC † Selects Percent calculation.
 CALC1:STAT ON † Enables math.
 INIT † Triggers one measurement.
 CALC1:KMAT:PER:ACQ † Uses the measured input signal as reference.

Now connect the signal to be measured, and continue as follows:

CALC1:DATA? † Requests result of Percent math reading.
 CALC1:STAT OFF † Disables math.

NOTE When finished with remote programming, press the LOCAL key to restore front panel control.

Ratio and channel average

The ratio or average of two switching module channels can be calculated and displayed. Ratio is valid for the DCV function, and channel average is valid for DCV and TEMP (thermocouples only).

$$\text{Ratio} = \frac{\text{Channel A}}{\text{Channel B}}$$

$$\text{Channel Average} = \frac{\text{Channel A} + \text{Channel B}}{2}$$

Where: Channel A is an input channel and Channel B is its paired sense channel.

Paired switching module channels are used for ratio and channel average. For the Model 7700 switching module, input channels 1 through 10 are paired to sense channels 11 through 20. Closing channel 1 also closes channel 11, closing channel 2 also closes channel 12, and so on.

Information on “[Input connections and measurements](#)” for the Model 7700 switching module are provided on [page 35](#). [Figure 13](#) shows connection examples for ratio and channel average.

Ratio and channel average operation

NOTE In order to perform the ratio or channel average operation, a Keithley switching module (e.g., Model 7700) must be installed in the main-frame, or a pseudocard must be assigned to an empty slot. Details to assign a 7700 “[Pseudocard](#)” to an empty slot are provided on [page 34](#).

Ratio (DCV) – As shown in [Figure 9](#), Ratio is enabled by pressing SHIFT and then DCI (RATIO). When an input channel is closed, the instrument will measure the input channel and then the sense channel. It will then calculate the ratio and display the result. To disable Ratio, again press SHIFT and then DCI (RATIO).

Channel Average (DCV or thermocouple TEMP) – As shown in [Figure 9](#), Channel average is enabled by pressing SHIFT and then ACI (CH-AVG). When an input channel is closed, the instrument will measure the input channel and then the sense channel. It will then calculate the average and display the result. To disable Channel average, again press SHIFT and then ACI (CH-AVG).

WARNING **Switching module installation and connections are only to be performed by qualified service personnel. For details on these procedures, refer to the User’s Guide that is supplied with the switching module.**

SCPI programming commands (ratio and channel average)

NOTE Not all ratio and channel average commands are documented here. (see Section 5 of the Model 2700S User’s Manual.)

SENS:RAT 	‘ Enable or disable Ratio: = ON or OFF.
SENS:CAV 	‘ Enable or disable Channel Average: = ON or OFF.

Remote programming example (ratio)

Assume two DCV signals connected to channels 1 and 11 of a Model 7700 installed in slot 1 of the mainframe.

INIT:CONT OFF	' Disables continuous initiation.
TRIG:COUN 1	' Sets trigger count to one.
SENS:FUNC 'VOLT:DC'	' Selects DCV function.
SENS:RAT ON	' Enables Ratio.
READ?	' Triggers measurements and read the result of the calculation.
SENS:RAT OFF	' Disable Ratio.

NOTE When finished with remote programming, press the LOCAL key to restore front panel control.

Buffer

The Model 2700S has a data store (buffer) to store readings. The Model 2700 and 2701 can store up to 55,000 readings. The Model 2750 can store up to 110,000 readings.

The data store also provides statistical data on measured readings stored in the buffer. Statistics include minimum, maximum, average, peak-to-peak, and standard deviation. Details on statistics are provided in the Model 2700S User's Manual (see Section 6).

Storing and recalling readings

Storing readings

1. Referring to [Figure 10](#), press the STORE key.
2. Use the edit keys (see [Figure 5](#)) to ENTER then number of readings (RDGS) to store.
3. The asterisk (*) annunciator indicates that the buffer is enabled.
4. The asterisk (*) annunciator will turn off when the buffer becomes full.

Recalling readings (and statistics)

1. Referring to [Figure 10](#), press RECALL to access the data recall mode.
2. [Figure 10](#) shows how five stored readings are organized in the circular buffer. Use the range \uparrow and \downarrow keys to position the buffer pointer, and use the cursor \leftarrow and \rightarrow keys to view the reading (or statistic) and timestamps.

NOTE Each stored reading is referenced to either a relative timestamp or to a real-time clock timestamp. The real-time clock timestamps each reading with the time and date. Details on the real-time clock timestamp are provided in the Model 2700S User's Manual (see Section 6). The default timestamp is the relative timestamp and is explained as follows.

For the relative timestamp, there are two timestamp types: absolute or delta. The absolute timestamp (S) references each stored reading to zero seconds, which is the timestamp for the first stored reading. The delta timestamp (dS) indicates the time (in seconds) between the displayed reading and reading before it.

3. When finished, press EXIT to leave the data recall mode.

SCPI programming commands (buffer)

NOTE Not all buffer commands are documented here. For details on all buffer commands, refer to the Model 2700S User's Manual (see Section 6).

Store and recall readings

TRAC:CLE † Clear the buffer.

TRAC:TST:FORM<name> † Select relative timestamp type: <name> = ABS or DELT.

TRAC:POIN <NRf> † Specify number of readings to store: <NRf> = 2 to 55000 (2700 and 2701) or 2 to 110000 (2750).

TRAC:FEED <name> † Select readings source: <name> = SENS, CALC1, or NONE.
 † SENS stores pre-math readings, CALC1 stores post-math readings. NONE disables storage in the buffer.

TRAC:FEED:CONT <name> † Set buffer control: <name> = NEXT, ALW, or NEV. NEXT enables the buffer, ALWays places buffer in continuous filling mode (overwrites after buffer full), and NEV disables the buffer.

TRAC:DATA? † Read all readings in buffer.

Read buffer statistics

CALC2:FORM<name> † Select buffer statistic: <name> = MIN, MAX, MEAN, SDEV, PKPK, or NONE.

CALC2:STAT † Enable or disable statistics: = ON or OFF.

CALC2:IMM † Calculate statistics.

CALC2:DATA? † Read the selected buffer statistic.

Remote programming example (buffer - store 100 DC volt readings)

- SYST:PRES ' Restores factory defaults.
- TRAC:CLE ' Clears the buffer.
- TRAC:TST:FORMABS ' Selects the absolute timestamp.
- TRAC:POIN 20 ' Sets buffer to store 20 readings.
- TRAC:FEED SENS ' Sets buffer to store raw (pre-math) input readings.
- TRAC:FEED:CONT NEXT ' Enables buffer (storage process starts immediately).
- TRAC:DATA? ' Requests all stored readings.

After sending TRAC:DATA?, addressing the unit to talk returns the 20 stored readings.

- CALC2:FORMMEAN ' Selects the average (mean) statistic.
- CALC2:STAT ON ' Enables the statistic.
- CALC2:IMM ' Calculates the average (mean) of the stored readings.
- CALC2:DATA? ' Read the average (mean) statistic.

After sending CALC2:DATA?, addressing the unit to talk returns the statistic reading.

NOTE When finished with remote programming, press the LOCAL key to restore front panel control.

Figure 10
Buffer



STORE – Press to configure buffer.

RECALL – Press to recall readings and statistics

Data Recall Mode ←

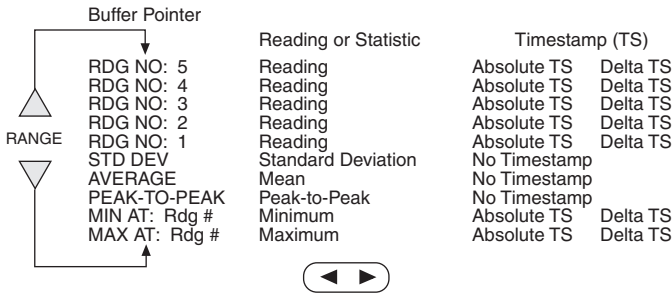

Model 7700 switching module

NOTE It is not necessary to connect input signals in order to exercise operation of the Model 7700 switching module. If a switching module is not installed in the mainframe, you can use remote programming to assign a 7700 pseudocard to an empty mainframe slot.

Pseudocard

With a pseudocard “installed” in an empty slot, the Model 2700S will operate as if the switching module is installed. Send the following command to assign a 7700 pseudocard to an empty slot:

SYST:PCARx C7700 where x = slot number

Example: SYST:PCAR1 C7700 ‘ Assigns 7700 pseudocard to slot 1.

System channel operation

This guide explains how to use system (single) channel operation to close and open input channels. When a single input channel is closed, all other required relays (channels) close automatically to route the input signal through the module to the DMM. When an input channel closes, a previously closed input channel opens.

There is an operating mode to open/close channels: multiple channel operation. For multiple channel operation, all switching module channels (relays) are controlled individually. This provides versatility by allowing multiple channels to be closed at the same time. Instructions to use multiple channel operation are not provided in this guide. Refer to the 2700S User’s manual for more information.

WARNING **Careless multiple (MULTI) channel operation can create electric shock hazards that could result in severe injury or death. Improper operation can also cause damage to the switching modules and external circuitry.**

Multiple channel operation should be restricted to experienced test engineers who recognize the dangers associated with multiple channel closures. For details on operation, refer to Section 2 (Multiple channel operation) of the Model 2700S User’s Manual.

Input connections and measurements

WARNING The following summary on Model 7700 input connections is for informational use only. It is only intended to show how a an input signal is connected and routed through the switching module to the mainframe DMM.

Module connections and installation into the mainframe are only to be performed by qualified service personnel. For details on these procedures, refer to the User's Guide that is supplied with the switching module.

CAUTION To prevent damage to the switching module, do not exceed the maximum signal levels listed in [Table 2](#).

Table 2
Maximum inputs for Model 7700

Channel	Maximum signal level
Channels 1- 20	300V DC or rms, 1A switched, 60W, 125VA maximum.
Channels 21 and 22	60V DC or rms, 3A switched, 60W, 125V maximum.

The Model 7700 has 20 input channels (1 through 20) for volts, ohms, frequency, period, and temperature measurements. It also has 2 channels for amps measurements (channels 21 and 22).

The Model 7700 switching module uses screw terminal blocks for test connections to input circuits. The screw terminals are accessed by removing the top cover of the module (see [Figure 11A](#)). Turn the locking screw to unlock and open the cover. [Figure 11B](#) shows an example of how the module is to be wired. Use insulated wire (up 20 AWG) for connections. When replacing the cover, push in the screw to lock.

[Figure 12](#) and [Figure 13](#) show the various input connections and how the input signal is routed through the switching module to the mainframe DMM.

Figure 11
Model 7700 switching module

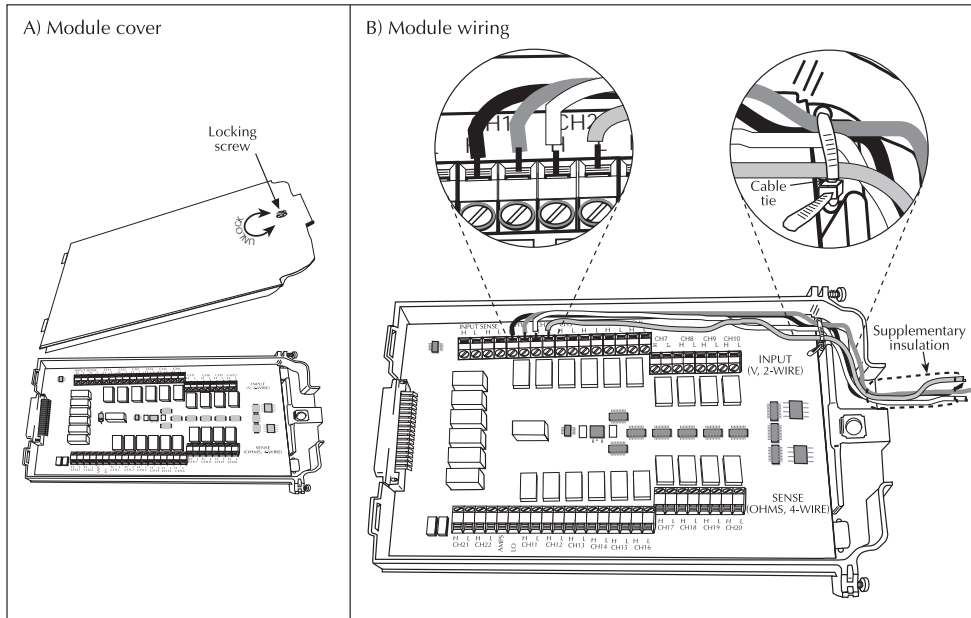

2-wire measurements

Figure 12A shows example 2-wire connections for all functions, except AMPS. Input channels 1 through 20 of the Model 7700 can be used for these measurements. The input signal connects to the DMM when the appropriate input channel is closed.

For example, assume a DC Volts signal is connected to channel 1. When channel 1 is closed, channel 25 also closes to connect the input to the DMM.

Figure 12B shows an example of 2-wire connections for the AMPS function. Input channels 21 and 22 can be used for amps measurements. When input channel 21 or 22 is closed, the amps input is connected to the DMM for measurement.

4-wire measurements

Channel pairing is used for 4-wire measurements. With a 4-wire function (e.g., W4) selected, closing an input channel also closes a corresponding sense channel. Figure 13 shows examples of connections for functions that require 4-wire connections.

For a 4-wire function, the input(s) is connected to an input channel and its corresponding sense channel. Input channels 1 through 10 are paired to channels 11 through 20. When an input channel is closed, its paired channel and the backplane isolation relays (channels 24 and 25) also close.

For example, closing channel 1 also closes channels 11, 24, and 25.

Figure 12

7700 switching module connections – 2-wire measurements

A) DCV, ACV, FREQ, PERIOD, W2, CONT and TEMP (thermocouple and thermistor)

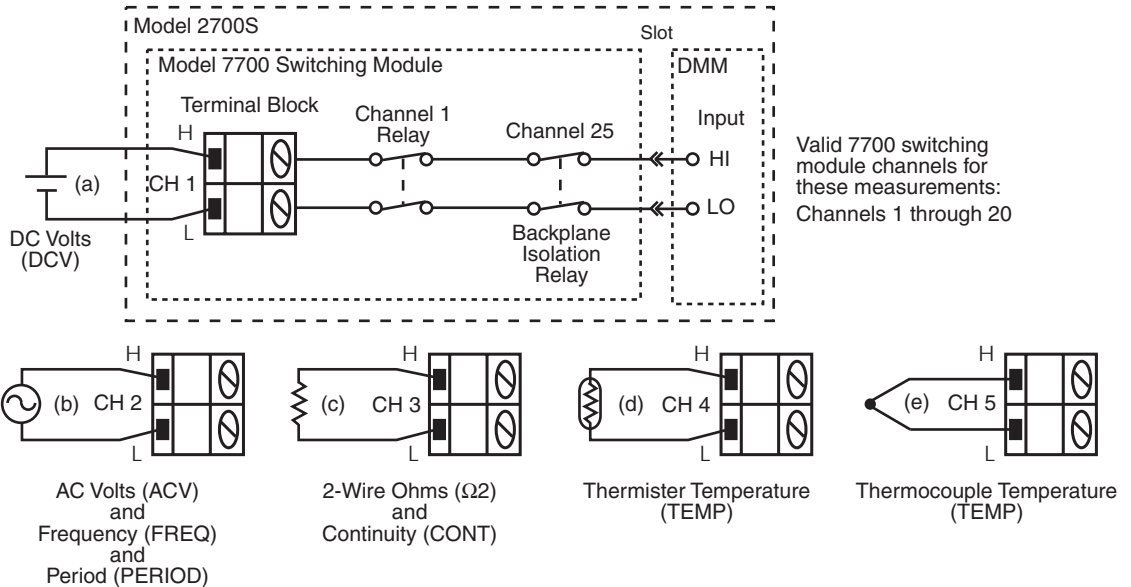

B) AMPS

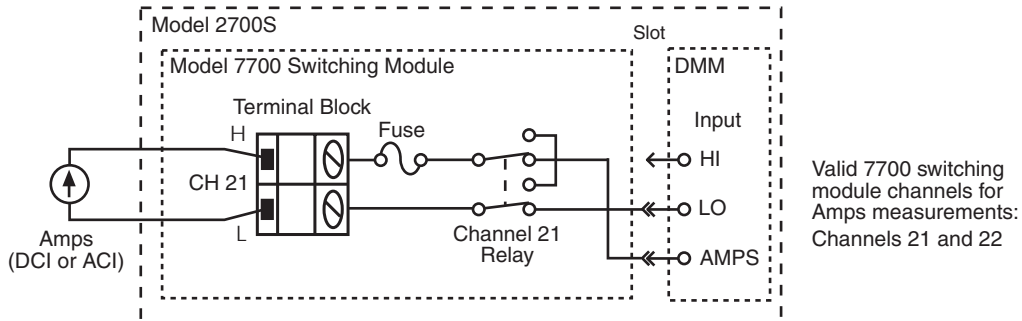
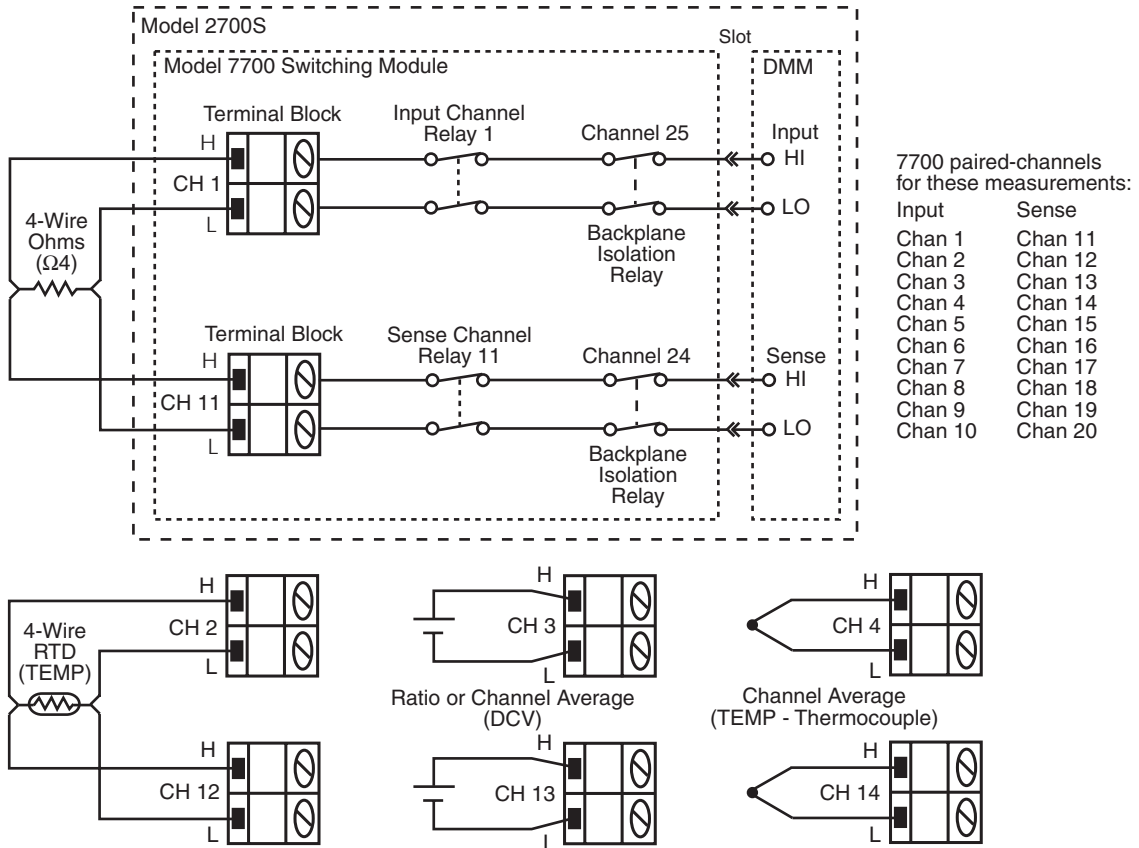

Figure 13
7700 switching module connections – 4-wire measurements



Channel assignments

For mainframe operation, the slot number for an installed switching module is used to specify a channel for system channel operation. The system channel number is made of three digits:

XYX where: X is the slot number of the installed module.
 YY is input channel of the module.

Example: 106 Channel 6 for module installed in slot 1.

Topics

Topics

Topics

Figure 14
Close/open channels

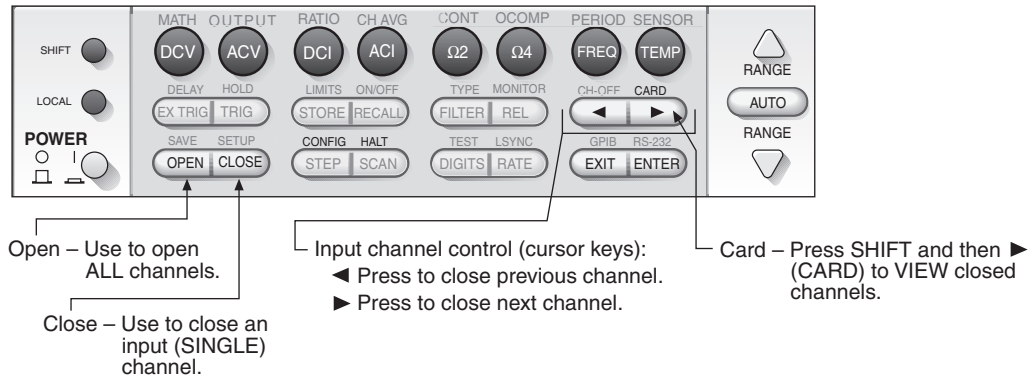

Closing and opening channels

Channels can be controlled using the CLOSE and OPEN keys, or the cursor keys (◀ and ▶ keys). The keys to close and open channels are shown in Figure 14.

CLOSE and OPEN keys

Closing channels

1. Press the CLOSE key and use the edit keys to select the SINGLE menu option.
2. Use the edit keys (see Figure 5) to key in the channel number.
3. With the desired channel displayed, press ENTER to close the input channel.

Only the specified input channel and the channels required to connect the input(s) to the DMM will close. All other channels will be open.

Opening all channels

Press the OPEN key and, with the ALL menu option displayed, press ENTER. All switching module channels will open.

Cursor keys (◀ and ▶)

The cursor keys (shown in Figure 14) allow you to close and open channels in an ascending sequence or a descending sequence. With all channels open, pressing the ▶ key closes the first input channel (and all other channels required to connect the input(s) to the DMM). Again pressing the ▶ key opens all channels and then closes the next input channel. After sequencing past the last input channel, operation wraps back around to the beginning where all channels will open.

The β key operates in a similar manner except it sequences input channels in a descending order.

SCPI programming commands (close/open channels)

NOTE Not all close/open commands are documented here. For details on all switching module commands, refer to the Model 2700S User's Manual (see Section 2).

- ROUT:CLOS <clist> ' Specify one input channel to close: <clist> = (@SCH), where S is the slot number and CH is the channel number.
- ROUT:CLOS? ' Returns list of closed input channels.
- ROUT:OPEN:ALL ' Open all channels (also disables ratio and channel average).

Remote programming example (close and open channels)

- ROUT:CLOS (@106) ' Closes input channel 6 of module in slot 1.
- ROUT:OPEN:ALL ' Opens all channels.

NOTE When finished with remote programming, press the LOCAL key to restore front panel control.

Figure 15
Simple scanning

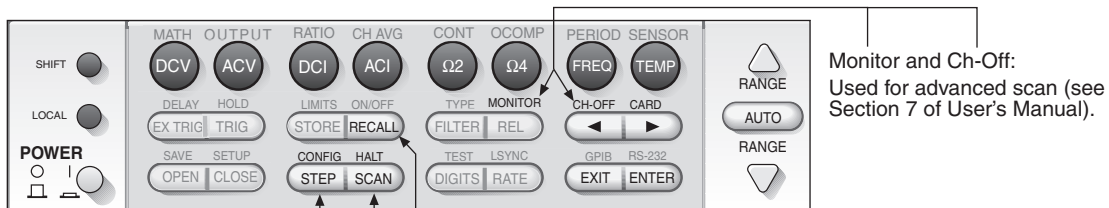

Topics

Topics

Topics

Simple scanning

The Model 2700S can scan the channels of one or more installed switching modules. When STEP or SCAN is pressed, all input channels in the scan list are scanned, measured and stored in the buffer.

For front panel operation, options for a simple scan include the following:

- **Scan list** – Scan sequence is configured by specifying the minimum (first) channel and the maximum (last) channel for the scan list.
- **Timer** – When used, a time interval is set by the user:
 - **STEP** – The timer interval is invoked between each channel in the scan.

Example – Step operation for a three channel scan list:

Scan Ch101 > After timer interval expires, Scan Ch102 > After timer interval expires, Scan Ch 103.

- **SCAN** – The timer interval is invoked between the start of scans.

Example – Scan operation for two scans of a three channel scan list:

Scan Ch1 and start timer > Scan Ch102 > Scan Ch 103 > After timer interval expires, Scan Ch101 > Scan Ch102 > Scan Ch 103.

NOTE

Trigger delay – A trigger delay is used to provide sufficient setting time before performing a measurement. By default, an auto delay is used to automatically set a suitable settling time. The delay can be set manually for measurements that require longer delay periods. See Section 7 of the Model 2700S User's Manual to set delay.

- **Reading count:**
 - **STEP** – Reading count specifies the number of channels to scan. For example, if there are 10 channels in the scan list, the reading count is typically set to 10. If reading count is <10, then <10 channels will be scanned. If reading count is >10, operation will wrap around to the beginning of the scan list and continue to scan until the reading count is satisfied.
 - **SCAN** – Reading count specifies the number of scans to perform. In general, use a multiple of the scan list count to specify the number of scans to perform. For example, if there are 10 channels in the scan list, set the reading count to 10 to perform one scan. For two scans, set the reading count to 20. For three scans, set the reading count to 30.

Configuring a simple scan

1. Referring to [Figure 14](#), press SHIFT and then STEP (CONFIG) to access the scan configuration menu.
2. Use the edit keys (see [Figure 5](#)) to select the SIMPLE scan.

NOTE Other scan options:

An ADVANCED scan allows each scan channel to have its own unique measurement configuration. See Section 7 of the Model 2700S User's Manual for information on an advanced scan.

A scan RESET returns the scan configuration to the default setup for a simple scan.

3. Use edit keys to specify the minimum (first) channel for the scan.
4. Use edit keys to specify the maximum (last) channel for the scan.
5. Use edit keys to enable (YES) or disable (NO) the timer. If YES, you will then be prompted to enter the timer interval (Hour:Minute:Second format).
6. Use edit keys to set the reading count (RDG CT).

Running a simple scan

1. Configure the Model 2700S for the desired measurement. This configuration will be used for every scan channel.
2. Press STEP or SCAN to start the scan process.
3. After the scan finishes, use RECALL to view the stored readings and statistics. Details on the "Buffer" are provided on [page 31](#).
4. Press SHIFT and then SCAN (HALT) to exit the scan mode.

SCPI programming commands (simple scanning)

NOTE Not all scan commands are documented. For details on all scan commands, refer to the Model 2700S User's Manual (see Section 7).

For remote programming, the TRIG:COUN command specifies the number of scans to be performed and the SAMP:COUN specifies the number of channels to scan. The timer interval is invoked between scans.

ROUT:SCAN <clist>	' Specify scan list: <clist> = (@SCH), where S = slot number, CH = channel number (see Note 1).
ROUT:SCAN:TSO <list>	' Select trigger(s) to start scan: <list> = IMM or reading limits (see Note 2).
ROUT:SCAN:LSEL<name>	' Enable or disable scan: <name> = INT (on) or NONE (off).
TRIG:SOUR <name>	' Select control source: <name> = IMM, TIM, MAN, BUS or EXT (see Note 3).
TRIG:TIM <n>	' Set timer interval (in seconds): <n> + 0.001 to 999999.999.
TRIG:COUN <NRf>	' Specify number of scans: <NRf> = 1 to 9999 or INFinite.
SAMP:COUN <NRf>	' Specify the number of channels to scan. Should match the number of channels in the scan list: <NRf> = 1 to max (see Note 4).

NOTES:

1. <clist> examples: (@101) slot 1, channel 1
 (@101, 204) slot 1, channel 1 and slot 2 channel 4
 (@101:110) slot 1, channels 1 through 10
2. IMM starts the scan immediately when triggered. Reading limits can instead be used to trigger the start of a scan. The parameters for reading limits (HLIM1, LLIM1, HLIM2 and LLIM2) are not explained in this guide. See Section 7 (Monitor scan) of the Model 2700S User's Manual for information.
3. With the IMM control source selected, the trigger is detected immediately. Use TIM for a timer controlled scan. Use the TRIG:TIM command to set the timer interval. The other control sources (MAN, BUS and EXT) are covered in Section 8 of the Model 2700S User's Manual.
4. Maximum sample count: Max = 55000 (2700 and 2701)
 = 110000 (2750)

Remote programming example (simple scan)

The following command scans 10 channels (101 through 110):

TRAC:CLE	' Clears buffer.
INIT:CONT OFF	' Disables continuous initiation.
TRIG:SOUR IMM	' Selects the immediate trigger control source.
TRIG:COUN 1	' Sets to perform one scan.
SAMP:COUN 10	' Sets to scan 10 channels.
ROUT:SCAN (@101:110)	' Defines scan list.
ROUT:SCAN:TSO IMM	' Start scan when enabled and triggered.
ROUT:SCAN:LSEL INT	' Enables scan.
READ?	' Triggers scan and requests the readings.
ROUT:SCAN:LSEL NONE	' Disables scan.

NOTE When finished with remote programming, press the LOCAL key to restore front panel control.

Specifications are subject to change without notice.
All Keithley trademarks and trade names are the property of Keithley Instruments.
All other trademarks and trade names are the property of their respective companies.

Keithley Instruments

Corporate Headquarters • 28775 Aurora Road • Cleveland, Ohio 44139 • 440-248-0400 • Fax: 440-248-6168 • 1-800-935-5595 • www.tek.com/keithley



A Greater Measure of Confidence