



5 Series Mixed Signal Oscilloscope MS054, MS056, MS058

Service Manual

Revision A

Register now!
Click the following link to protect your product.
tek.com/register



077-1307-05 July 2024

Copyright © 2024, Tektronix. 2024 All rights reserved. Licensed software products are owned by Tektronix or its subsidiaries or suppliers, and are protected by national copyright laws and international treaty provisions. Tektronix products are covered by U.S. and foreign patents, issued and pending. Information in this publication supersedes that in all previously published material. Specifications and price change privileges reserved. All other trade names referenced are the service marks, trademarks, or registered trademarks of their respective companies.

TEKTRONIX and TEK are registered trademarks of Tektronix, Inc.

Tektronix, Inc.
14150 SW Karl Braun Drive
P.O. Box 500
Beaverton, OR 97077
US

For product information, sales, service, and technical support visit [tek.com](https://www.tek.com) to find contacts in your area. For warranty information visit [tek.com/warranty](https://www.tek.com/warranty).

Contents

List of Figures.....	5
List of Tables.....	6
Important safety information.....	7
General safety summary.....	7
Service safety summary.....	9
Terms in the manual.....	10
Terms on the product.....	10
Symbols on the product.....	10
Introduction.....	11
Preface.....	11
Supported products.....	11
Replaceable parts.....	11
Where to find operating information.....	11
Theory of operation.....	12
Theory of operation.....	12
Power supply.....	13
Carrier interface assembly.....	13
Main board and front-end board.....	14
Front panel and display.....	14
Adjustment procedures.....	15
Adjustment procedures.....	15
Adjustment interval.....	15
Adjustment after repair.....	15
Maintenance.....	16
Preventing ESD.....	16
Inspection and cleaning.....	16
Exterior cleaning (other than display).....	16
Flat panel display cleaning.....	17
Interior cleaning.....	17
Lubrication.....	18
Returning the instrument for service.....	19
Removal and replace procedures.....	20
Required equipment.....	20
Remove front-panel knobs.....	20
Remove SATA riser board assembly.....	21
Remove feet.....	21
Remove handle.....	22
Remove rear grill and case.....	22
Remove rear chassis assembly.....	23
Remove the baffle bracket.....	24
Remove the power supply assembly.....	27
Remove carrier interface assembly.....	29
Remove the AFG riser assembly.....	33
Remove handle hub assembly.....	34

Remove the main fan assembly.....	34
Remove M.2 memory board.....	36
Troubleshooting 5 Series MSO 6 Series MSO 5 Series B MSO.....	37
Service level.....	37
Check for common problems.....	37
Equipment required.....	38
Troubleshooting flow chart.....	39
Troubleshoot the power supply.....	41
Instrument self tests.....	43
Software updates.....	43
Power supply module replacement.....	43
Replaceable parts.....	44
Parts ordering information.....	44
Module servicing.....	44
Abbreviations.....	44
Using the replaceable parts list.....	45
Front cover and rear case.....	46
Carrier interface board and rear chassis.....	48
Baffle and power supply module.....	51
Mid-plane chassis.....	53
Front panel and display.....	55

List of Figures

Figure 1: Block diagram.....	12
Figure 2: Primary troubleshooting tree.....	39
Figure 3: Power status LEDs.....	41
Figure 4: Front cover and rear case exploded view.....	46
Figure 5: Carrier interface board and rear chassis exploded view.....	48
Figure 6: Rear chassis baffle and power supply exploded view.....	51
Figure 7: Mid-plane chassis exploded view.....	53
Figure 8: Front panel and display exploded view.....	55

List of Tables

Table 1: External inspection checklist.....	17
Table 2: Internal inspection checklist.....	18
Table 3: Required equipment for removal and replacement.....	20
Table 4: Failure symptoms and possible causes.....	38
Table 5: Parts list column descriptions.....	45
Table 6: Parts list column descriptions.....	45
Table 7: Front cover and rear case.....	46
Table 8: Carrier interface board and rear chassis.....	48
Table 9: Baffle and power supply module.....	51
Table 10: Mid-plane chassis.....	53
Table 11: Front panel and display.....	55

Important safety information

This manual contains information and warnings that must be followed by the user for safe operation and to keep the product in a safe condition.

To safely perform service on this product, see the *Service safety summary* that follows the *General safety summary*.

General safety summary

Use the product only as specified. Review the following safety precautions to avoid injury and prevent damage to this product or any products connected to it. Carefully read all instructions. Retain these instructions for future reference.

This product shall be used in accordance with local and national codes.

For correct and safe operation of the product, it is essential that you follow generally accepted safety procedures in addition to the safety precautions specified in this manual.

The product is designed to be used by trained personnel only.

Only qualified personnel who are aware of the hazards involved should remove the cover for repair, maintenance, or adjustment.

Before use, always check the product with a known source to be sure it is operating correctly.

This product is not intended for detection of hazardous voltages.

Use personal protective equipment to prevent shock and arc blast injury where hazardous live conductors are exposed.

While using this product, you may need to access other parts of a larger system. Read the safety sections of the other component manuals for warnings and cautions related to operating the system.

When incorporating this equipment into a system, the safety of that system is the responsibility of the assembler of the system.

To avoid fire or personal injury

Use proper power cord	Use only the power cord specified for this product and certified for the country of use. Do not use the provided power cord for other products.
Ground the product	This product is grounded through the grounding conductor of the power cord. To avoid electric shock, the grounding conductor must be connected to earth ground. Before making connections to the input or output terminals of the product, ensure that the product is properly grounded. Do not disable the power cord grounding connection.
Power disconnect	The power cord disconnects the product from the power source. See instructions for the location. Do not position the equipment so that it is difficult to operate the power cord; it must remain accessible to the user at all times to allow for quick disconnection if needed.
Connect and disconnect properly	Do not connect or disconnect probes or test leads while they are connected to a voltage source. Use only insulated voltage probes, test leads, and adapters supplied with the product, or indicated by Tektronix to be suitable for the product.
Observe all terminal ratings	To avoid fire or shock hazard, observe all rating and markings on the product. Consult the product manual for further ratings information before making connections to the product. Do not exceed the Measurement Category (CAT) rating and voltage or current rating of the lowest rated individual component of a product, probe, or accessory. Use caution when using 1:1 test leads because the probe tip voltage is directly transmitted to the product.

Do not apply a potential to any terminal, including the common terminal, that exceeds the maximum rating of that terminal.

Do not float the common terminal above the rated voltage for that terminal.

Do not operate without covers Do not operate this product with covers or panels removed, or with the case open. Hazardous voltage exposure is possible.

Avoid exposed circuitry Do not touch exposed connections and components when power is present.

Do not operate with suspected failures If you suspect that there is damage to this product, have it inspected by qualified service personnel.

Disable the product if it is damaged. Do not use the product if it is damaged or operates incorrectly. If in doubt about safety of the product, turn it off and disconnect the power cord. Clearly mark the product to prevent its further operation.

Before use, inspect voltage probes, test leads, and accessories for mechanical damage and replace when damaged. Do not use probes or test leads if they are damaged, if there is exposed metal, or if a wear indicator shows.

Examine the exterior of the product before you use it. Look for cracks or missing pieces.

Use only specified replacement parts.

Do not operate in wet/damp conditions Be aware that condensation may occur if a unit is moved from a cold to a warm environment.

Do not operate in an explosive atmosphere

Keep product surfaces clean and dry Remove the input signals before you clean the product.

Provide proper ventilation Refer to the installation instructions in the manual for details on installing the product so it has proper ventilation.

Slots and openings are provided for ventilation and should never be covered or otherwise obstructed. Do not push objects into any of the openings.

Provide a safe working environment Always place the product in a location convenient for viewing the display and indicators.

Avoid improper or prolonged use of keyboards, pointers, and button pads. Improper or prolonged keyboard or pointer use may result in serious injury.

Be sure your work area meets applicable ergonomic standards. Consult with an ergonomics professional to avoid stress injuries.

Use care when lifting and carrying the product. This product is provided with a handle or handles for lifting and carrying.



WARNING: The product is heavy. To reduce the risk of personal injury or damage to the device get help when lifting or carrying the product.

Use only the Tektronix rackmount hardware specified for this product.

Probes and test leads

Before connecting probes or test leads, connect the power cord from the power connector to a properly grounded power outlet.

Keep fingers behind the protective barrier, protective finger guard, or tactile indicator on the probes.

Remove all probes, test leads and accessories that are not in use.

Use only correct Measurement Category (CAT), voltage, temperature, altitude, and amperage rated probes, test leads, and adapters for any measurement.

Beware of high voltages

Understand the voltage ratings for the probe you are using and do not exceed those ratings. Two ratings are important to know and understand:

- The maximum measurement voltage from the probe tip to the probe reference lead
- The maximum floating voltage from the probe reference lead to earth ground

These two voltage ratings depend on the probe and your application. Refer to the Specifications section of the manual for more information.



WARNING: To prevent electrical shock, do not exceed the maximum measurement or maximum floating voltage for the oscilloscope input BNC connector, probe tip, or probe reference lead.

Connect and disconnect properly

Connect the probe output to the measurement product before connecting the probe to the circuit under test. Connect the probe reference lead to the circuit under test before connecting the probe input. Disconnect the probe input and the probe reference lead from the circuit under test before disconnecting the probe from the measurement product.

Connect the probe reference lead to earth ground only.

Do not connect a current probe to any wire that carries voltages or frequencies above the current probe voltage rating.

Inspect the probe and accessories

Before each use, inspect probe and accessories for damage (cuts, tears, or defects in the probe body, accessories, or cable jacket). Do not use if damaged.

Ground-referenced oscilloscope use

Do not float the reference lead of this probe when using with ground-referenced oscilloscopes. The reference lead must be connected to earth potential (0 V).

Service safety summary

The *Service safety summary* section contains additional information required to safely perform service on the product. Only qualified personnel should perform service procedures. Read this *Service safety summary* and the *General safety summary* before performing any service procedures.

To avoid electric shock

Do not touch exposed connections.

Do not service alone

Do not perform internal service or adjustments of this product unless another person capable of rendering first aid and resuscitation is present.

Disconnect power

To avoid electric shock, switch off the product power and disconnect the power cord from the mains power before removing any covers or panels, or opening the case for servicing.

Use care when servicing with power on

Dangerous voltages or currents may exist in this product. Disconnect power, remove battery (if applicable), and disconnect test leads before removing protective panels, soldering, or replacing components.

Verify safety after repair Always recheck ground continuity and mains dielectric strength after performing a repair.

Terms in the manual

These terms may appear in this manual:



WARNING: Warning statements identify conditions or practices that could result in injury or loss of life.



CAUTION: Caution statements identify conditions or practices that could result in damage to this product or other property.

Terms on the product

These terms may appear on the product:

- DANGER indicates an injury hazard immediately accessible as you read the marking.
- WARNING indicates an injury hazard not immediately accessible as you read the marking.
- CAUTION indicates a hazard to property including the product.

Symbols on the product



When this symbol is marked on the product, be sure to consult the manual to find out the nature of the potential hazards and any actions which have to be taken to avoid them. (This symbol may also be used to refer the user to ratings in the manual.)

The following symbols may appear on the product:



Introduction

Preface

This manual contains service information for your instrument.

Read the General and Service safety summaries before servicing the product.

Be sure to read the introductions to all procedures. These introductions provide important information needed to perform the service correctly, safely, and efficiently.

Supported products

This manual contains information that is necessary to service the following products:

- MSO64
- MSO54
- MSO56
- MSO58

Check for a specific product designation in the header at the top of the page, in a heading, table or figure title, or within text. Material that does not have any specific product designation applies to all products in the manual.

Replaceable parts

This manual refers to any field-replaceable assembly or mechanical part specifically by its name or generically as a replaceable part. In general, a replaceable part is any circuit board or assembly (such as the hard disk drive) or a mechanical part (such as the I/O port connectors) that is listed in the replaceable parts list that can be replaced in the field. (See [Replaceable parts list](#)).

Where to find operating information

For information on installing, operating, and networking the instrument, refer to the online help or user manual that was provided with your oscilloscope. You can also find the manual at www.tek.com/manuals, by searching for your product.

Theory of operation

Theory of operation

This chapter describes the electrical operation of the oscilloscope to the module level. The block diagram shows the oscilloscope module interconnections.



Note: A removable Embedded OS drive comes standard on instruments with a serial number of B020000 and above or C040000 and above.

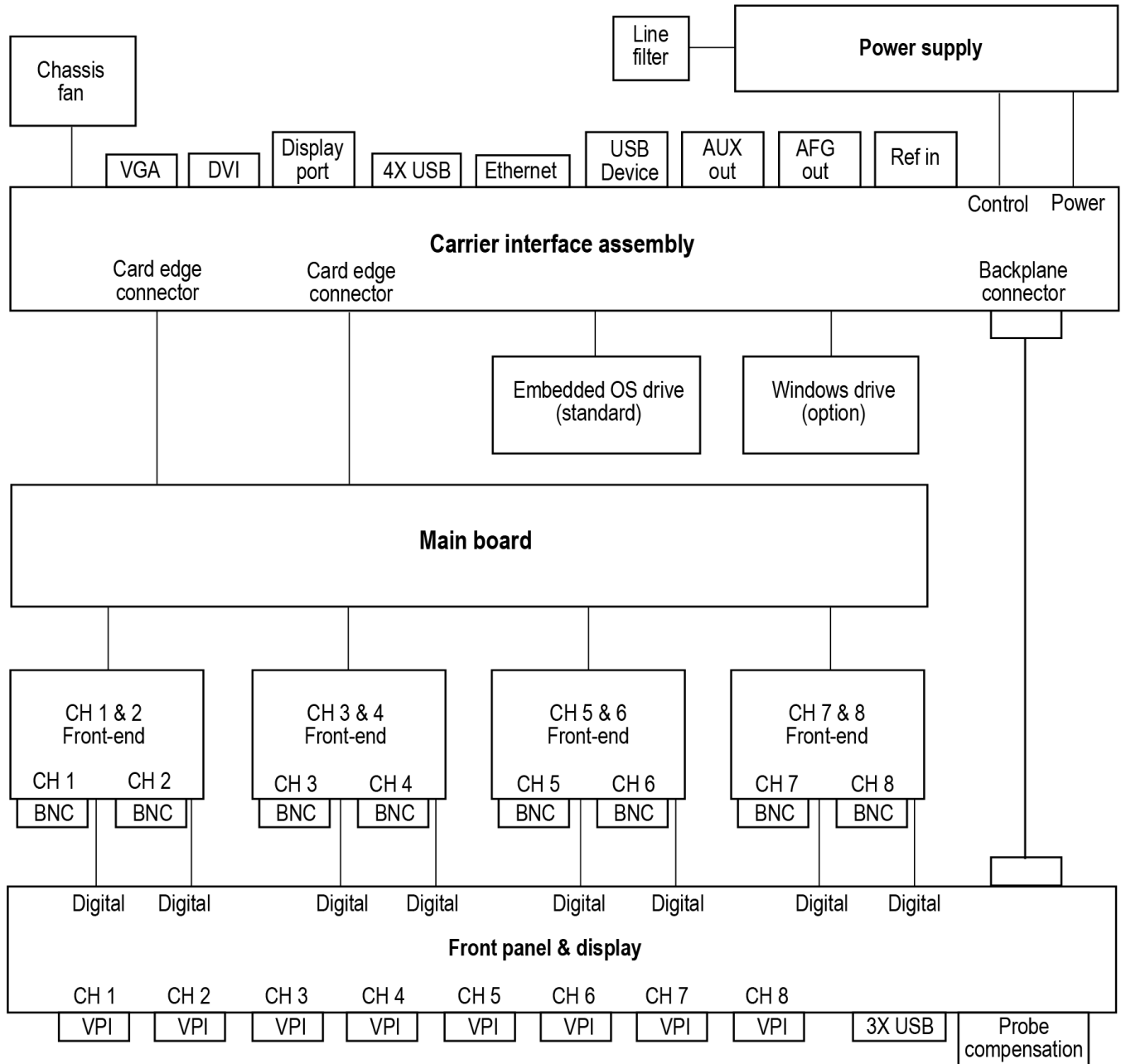

1307-005

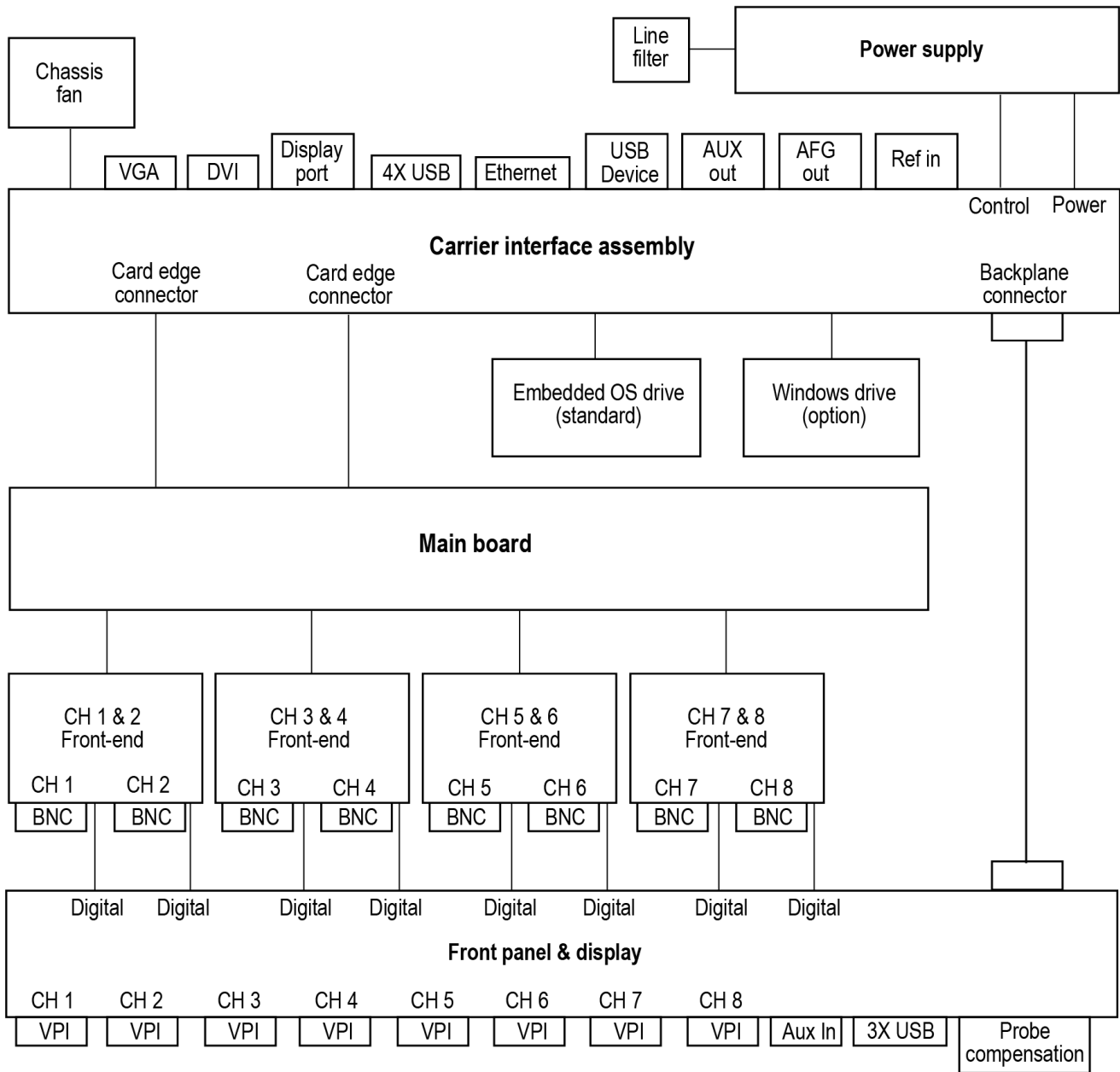

1728-004

Figure 1: Block diagram

Power supply

The Power Supply board converts AC line voltage to +12 V to power for all internal circuits.

Carrier interface assembly

The Carrier interface assembly contains the following functions:

Processor system	The processor system contains a microprocessor that controls the entire instrument. The processor system also contains the solid state drive for the operating system, system RAM, and interfaces to I/O ports and the acquisition system.
Rear panel I/O ports	The Carrier interface assembly contains USB ports, an Ethernet port (LAN), a VGA Video port, a DVI Video port, a DisplayPort Video port, the USB-TMC port, an AUX OUT BNC connector, an EXT REF IN BNC connector, and the AFG Out generator BNC connector.
Power converter	The Carrier interface assembly converts the +12 V power to all voltages used for the analog and digital circuitry throughout the system. Standby power is used to keep portions of the Carrier interface assembly and Main board powered at all times that AC power is connected to the instrument.
Other functions	The Carrier interface assembly also houses the AFG generator, USB-TMC controller and interfaces to the Power supply and various cooling fans. The Carrier interface assembly also provides the interface to the optional Windows drive.

Main board and front-end board

The Main and Analog boards contain the following functions:

Acquisition system	The Acquisition system begins with the analog signal path and ends with a digitized signal in memory. The signal enters a channel input, and then passes through an attenuator and preamplifier. The analog signal from each preamplifier goes through a digitizer, and then into acquisition memory. The analog signal from each preamplifier is also distributed to a trigger circuit.
Front-end	All of the analog and digital inputs are routed to the Front-end board. The analog channels are amplified and attenuated through the front-end circuitry, and are output to the Main board. The digital channels simply pass through the front-end board to the Main board. The front-end board has a controller that is used as an I/O controller for the front-end board.
Power converter	The Main board converts the +12 V power to some of the other voltages used for the analog and digital circuitry throughout the system. This is in addition to the power conversion provided by the Processor assembly.

Front panel and display

The Front Panel board contains digital logic that reads the front-panel buttons and controls and sends this information to the processor system on the Processor assembly. The Front Panel board also generates the probe compensation output signal, provides USB ports on the front panel and houses the main power switch. The front panel routes the digital front-end signals from the probe directly to the front-end board. The front panel also provides the video interface to the internal HD display.

Adjustment procedures

Adjustment procedures

Adjustment and calibration can be performed only by a Tektronix Service Center. See Contacting Tektronix, following the title page in this manual, for information on contacting Tektronix Service Support.

Adjustment interval

The voltage and timing references inside the instrument are very stable over time and do not need routine adjustment.

If the instrument fails the performance tests in the Specifications and Performance Verification manual, adjustment may be required. To download the 5 Series MSO5 Series B MSO6 Series MSO Specification and Performance Verification manual (Tektronix part number 077-1306-XX077-1725-XX077-1461-XX), go to www.tek.com/product-support, enter the manual part number (with no dashes) in the field, click GO, and then select the Specification and Performance Verification document to download.

If your organization requires periodic calibration, a general rule is to verify performance and make adjustments (only if needed) every 2000 hours of operation or once a year if the instrument is used infrequently.

Adjustment after repair

After removal and replacement of any module, you must perform the Performance Verification procedures, found in the Specifications and Performance Verification manual (Tektronix part number 077-1306-XX077-1461-XX077-1725-XX), available to download from the Tektronix web site (www.tek.com/product-support).

If the instrument fails any Performance Verification tests, it must be returned to a Tektronix Service Center for adjustment and calibration.

Maintenance

Preventing ESD

Before servicing this product, read the *General Safety Summary* and the *Service Safety Summary* at the front of the manual, as well as the following ESD information.



CAUTION: Electrostatic discharge (ESD) can damage any semiconductor component in this instrument.

When performing any service that requires internal access to the instrument, adhere to the following precautions to avoid damaging internal modules and their components due to electrostatic discharge:

1. Minimize handling of static-sensitive circuit boards and components.
2. Transport and store static-sensitive modules in their static protected containers or on a metal rail. Label any package that contains static-sensitive boards.
3. Discharge the static voltage from your body by wearing a grounded antistatic wrist strap while handling these modules.
4. Service static-sensitive modules only at a static-free work station.
5. Do not allow any items capable of generating or holding a static charge on the work station surface.
6. Handle circuit boards by the edges when possible.
7. Do not slide the circuit boards over any surface.
8. Avoid handling circuit boards in areas that have a floor or work-surface covering capable of generating a static charge.

Inspection and cleaning

Inspection and Cleaning describes how to inspect for dirt and damage. It also describes how to clean the exterior and interior of the instrument. Inspection and cleaning are done as preventive maintenance. Preventive maintenance, when done regularly, may prevent instrument malfunction and enhance its reliability.

Preventive maintenance consists of visually inspecting and cleaning the instrument and using general care when operating it.

How often to perform maintenance depends on the severity of the environment in which the instrument is used. A proper time to perform preventive maintenance is just before instrument adjustment.

Exterior cleaning (other than display)

Clean the exterior surfaces of the chassis with a dry lint-free cloth or a soft-bristle brush. If any dirt remains, use a cloth or swab dipped in a 75% isopropyl alcohol solution. Use a swab to clean narrow spaces around controls and connectors. Do not use abrasive compounds on any part of the chassis that may damage the chassis.

Clean the On/Standby switch using a cleaning towel dampened with deionized water. Do not spray or wet the switch itself.



CAUTION: Avoid the use of chemical cleaning agents which might damage the plastics used in this instrument. Use only deionized water when cleaning the front-panel buttons. Use a 75% isopropyl alcohol solution as a cleaner for cabinet parts. Before using any other type of cleaner, consult your Tektronix Service Center or representative.

Inspection - Exterior. Inspect the outside of the instrument for damage, wear, and missing parts. Immediately repair defects that could cause personal injury or lead to further damage to the instrument.

Table 1: External inspection checklist

Item	Inspect for	Repair action
Cabinet, front panel, and cover	Cracks, scratches, deformations, damaged hardware	Repair or replace defective module
Front-panel knobs	Missing, damaged, or loose knobs	Repair or replace missing or defective knobs
Connectors	Broken shells, cracked insulation, and deformed contacts. Dirt in connectors	Repair or replace defective modules. Clear or brush out dirt
Carrying handle and cabinet feet	Correct operation	Repair or replace defective module
Accessories	Missing items or parts of items, bent pins, broken or frayed cables, and damaged connectors	Repair or replace damaged or missing items, frayed cables, and defective modules

Flat panel display cleaning

Clean the flat panel display surface by gently rubbing the display with a clean-room wipe (such as Wypall Medium Duty Wipes, #05701, available from Kimberly-Clark Corporation), or an abrasive-free cleaning cloth.

If the display is very dirty, moisten the wipe or cloth with distilled water, a 75% isopropyl alcohol solution, or standard glass cleaner, and gently rub the display surface. Use only enough liquid to dampen the cloth or wipe. Avoid using excess force or you may damage the display surface.

CAUTION: Improper cleaning agents or methods can damage the flat panel display.



- Do not use abrasive cleaners or surface cleaners to clean the display.
- Do not spray liquids directly on the display surface.
- Do not scrub the display with excessive force.



CAUTION: To prevent getting moisture inside the instrument during external cleaning, do not spray any cleaning solutions directly onto the screen or instrument.

Interior cleaning

You can only clean the interior of the rear chassis assembly. To access the rear chassis assembly, see the *Removal and Installation Procedures* topics.

Do not disassemble or clean the front chassis assembly (other than cleaning the front panel display and removing panel knobs). Disassembling the front chassis assembly requires that the instrument be returned to your nearest Tektronix Service Center for calibration.



WARNING: To avoid electric shock or damage to the instrument, remove instrument power. Before performing any procedure that follows, power down the instrument and disconnect it from line voltage.

- Blow off dust with dry, low-pressure (approximately 9 psi), deionized air.
- Use a soft-bristle, non-static-producing brush for cleaning around components.
- Remove any remaining dust with a lint-free cloth dampened in isopropyl alcohol (75% solution). (A cotton-tipped applicator is useful for cleaning in narrow spaces and on circuit boards).
- If you must use a liquid for minor rear chassis interior cleaning, use a clean-room wipe (such as Wypall Medium Duty Wipes, #05701, available from Kimberly-Clark Corporation) dampened with a 75% isopropyl alcohol solution.
- Inspect the internal portions of the instrument for damage and wear. See [Table 2](#) on page 18. Defects should be repaired immediately.
- If any circuit board is repaired or replaced, you must perform the Performance Verification procedure in the specifications and performance verification manual, which was provided with your instrument. This manual is also available at www.tektronix.com/

manuals, by searching for your product name. If the instrument fails the Performance Verification tests, it must be returned to a Tektronix Service Center for repair and calibration.



CAUTION: To prevent damage from electrical arcing, ensure that circuit boards and components are dry before applying power to the instrument.

Table 2: Internal inspection checklist

Item	Inspect for	Repair action
Circuit boards	Loose, broken, or corroded solder connections. Burned circuit boards. Burned, broken, or cracked circuit-run plating.	Remove and replace damaged circuit board.
Resistors	Burned, cracked, broken, blistered condition.	
Capacitors	Damaged or leaking cases. Corroded solder on leads or terminals.	
Wiring and cables	Loose plugs or connectors. Burned, broken, or frayed wiring.	Firmly seat connectors. Replace defective cables.
Chassis	Dents, deformations, and damaged hardware.	Straighten, repair, or replace defective hardware.

Lubrication

There is no periodic lubrication required for this instrument.

Returning the instrument for service

If the instrument has removable batteries, remove the batteries before repacking the instrument and do not include the batteries in the shipment.



Note: Do not ship removable batteries to Tektronix Service Centers.

When repacking the instrument for shipment, use the original packaging. If the packaging is unavailable or unfit for use, contact your local Tektronix representative to obtain new packaging.

Seal the shipping carton with an industrial stapler or strapping tape.

Before returning the instrument for service, contact the Service Center to get an RMA (return material authorization) number, and any return or shipping information you may need.

If the instrument is being shipped to a Tektronix Service Center, enclose the following information:

- The RMA number.
- The owner's address.
- Name and phone number of a contact person.
- Type and serial number of the instrument.
- Reason for returning.
- A complete description of the required service.

Mark the address of the Tektronix Service Center and the return address on the shipping carton in two prominent locations.

Removal and replace procedures

This section contains procedures for removal and installation of replaceable modules in the instrument. Refer to [Replaceable parts](#) [Replaceable Parts List](#) [Replaceable parts](#) for lists and exploded views of replaceable modules.

Any module inside of the chassis that does not have a remove and replace procedure requires that the entire instrument be returned to Tektronix Service Center for service.

WARNING: Before performing this or any other procedure in this manual, read the safety summaries found at the beginning of this manual. Also, to prevent possible injury to service personnel or damage to the instrument components, read [Preventing ESD](#) on page 16.



Before performing any procedure in this subsection, disconnect the power cord from the line voltage source. Failure to do so could cause serious injury or death.

Before removing the rear chassis, order the 8 pieces of pre-cut aluminum tape (Tektronix part number 253-0582-XX). The existing tape has to be removed from the chassis to access the interior and cannot be re-applied after removal. The aluminum tape is only needed for instruments with a serial number below B020000 or below C040000.



Note: Read the cleaning procedure before disassembling the instrument for cleaning.

Required equipment

Most assemblies in this instrument can be removed with a T-10 or T8 Torx® screwdriver tip.

Table 3: Required equipment for removal and replacement

Item No.	Name	Description
1	Screwdriver handle	Accepts Torx-driver bits
2	T-10 Torx tip	Used for removing instrument screws. Torx-driver bit for T-10 size screw heads
3	T-8 Torx tip	Used for removing instrument screws. Torx-driver bit for T-8 size screw heads
4	3/16 inch open-end wrench	Used to remove nut posts
5	Needle-nosed pliers, small or medium size	Used to pull off aluminum shielding tape from rear case and flat cable.
56	Proper antistatic work environment	To prevent electrostatic damage to components whenever you work on the instrument, wear properly-grounded electrostatic prevention wrist and foot straps, and work in a tested antistatic environment on an antistatic mat.

Remove front-panel knobs

Use this procedure to remove and replace front-panel knob assemblies.

Before you begin

- To prevent electrostatic damage to components whenever you work on the instrument, wear properly-grounded electrostatic prevention wrist and foot straps, and work in a tested antistatic environment on an antistatic mat.

About this task

There are eight knob assemblies that can be removed from the front case.

Procedure

1. To remove a knob assembly, pull the knob straight out of the front panel. Finger strength is adequate to pull knobs. Do not use pliers.
2. To reinstall a knob, align the knob with the shaft indent and press the knob onto the shaft. Turn the knob to make sure there is a smooth rotation.

Remove SATA riser board assembly

Use this procedure to remove and replace the external hard drive SATA riser board assembly.

Before you begin

- To prevent electrostatic damage to components whenever you work on the instrument, wear properly-grounded electrostatic prevention wrist and foot straps, and work in a tested antistatic environment on an antistatic mat.

About this task

See figure [Carrier interface board and rear chassis](#). Remove the external hard drive SATA riser bracket and board from the chassis using the following steps:

Procedure

1. Set instrument on its back, with the bottom facing you.
2. Open and remove the hard drive door from the bottom of the instrument.
3. Remove the three T-10 Torx screws securing the SATA riser board bracket assembly to the chassis.
4. Remove the SATA riser board bracket assembly from bottom of chassis.
5. To remove the SATA riser board, remove the two T-10 Torx screws securing the SATA riser board to the riser bracket.
6. To reinstall, reverse the steps. Tighten the T-10 Torx screws to 0.65 N·m.

Remove feet

Use this procedure to remove and replace bottom feet assemblies or gain access to the rear chassis assembly.

Before you begin

- To prevent electrostatic damage to components whenever you work on the instrument, wear properly-grounded electrostatic prevention wrist and foot straps, and work in a tested antistatic environment on an antistatic mat.

About this task

Remove the two flip feet assemblies from the rear chassis using the following steps.

Procedure

1. Remove all cables and the power cord from the rear panel.
2. Set the instrument on its back side so the bottom is facing you.
3. Flip open both feet assemblies.
4. Use a screwdriver with T-10 Torx tip to remove the four screws from each foot assembly.

5. Remove the feet assemblies.
6. To reinstall, reverse the steps. Use a screwdriver with T-10 Torx tip to secure the eight screws. First insert and tighten the screws that are near the front edge of the instrument, then insert and tighten the screws that are near the rear edge of the instrument. Tighten to 0.65 N·m.

Remove handle

Use this procedure to remove and replace the handle assemblies.

Before you begin

- To prevent electrostatic damage to components whenever you work on the instrument, wear properly-grounded electrostatic prevention wrist and foot straps, and work in a tested antistatic environment on an antistatic mat.

About this task

Remove the handle assemblies ([table 6, index #13](#)) using the following steps.

Procedure

1. Use a screwdriver with T-10 Torx tip to remove two screws ([table 6, index #18](#)) from each side of the handle.
2. Disengage the handle from the pins on the couplers ([table 6, index #17](#)) and remove the handle.
3. Remove the two couplers.
4. To reinstall, reverse the steps. Use a screwdriver with T-10 Torx tip to secure the screws. Tighten to 0.65 N·m.

Remove rear grill and case

Use this procedure to remove and replace the rear grill and rear case.

Before you begin

- To prevent electrostatic damage to components whenever you work on the instrument, wear properly-grounded electrostatic prevention wrist and foot straps, and work in a tested antistatic environment on an antistatic mat.
- [Remove handle](#) on page 22.
- [Remove feet](#) on page 21.
- Remove hard drive door.

About this task

Remove the grill ([table 6, index #14](#)) and rear case ([table 6, index #10](#)) using the following steps:

Procedure

1. Use a screwdriver with T-8 Torx tip to remove the six screws securing the grill to the rear case ([table 6, index #15](#)).
2. Put fingers in handle hub holes on each side of the grill and pull the grill off of the rear case.
3. Use a screwdriver with T-10 Torx tip to remove the six screws securing the rear case to the rear chassis ([table 6, index #9](#)).
4. Slide the rear case off of the rear chassis.
5. To reinstall, reverse the steps. Tighten the six T-10 Torx rear case screws to 0.65 N·m. Tighten the six T-8 Torx rear grill screws to 0.45 N·m.

Remove rear chassis assembly

Use this procedure to remove and replace the rear chassis, to access rear chassis assemblies (power supply, main fan, Carrier interface assembly, AFG Riser board).

Before you begin

- To prevent electrostatic damage to components whenever you work on the instrument, wear properly-grounded electrostatic prevention wrist and foot straps, and work in a tested antistatic environment on an antistatic mat.
- [Remove rear grill and case](#) on page 22



CAUTION: Order Tektronix part number 253-0582-XX (TAPE, ALUMINUM, BOTTOM PRE-CUT) before removing the rear chassis. The aluminum tape that is installed on the bottom front between the rear chassis and the front chassis cannot be reused. The tape must be replaced after reinstalling the rear chassis assembly.

The aluminum tape is only needed for instruments with a serial number below B020000 or below C040000.

About this task

Remove the rear chassis assembly from the front chassis assembly using the following steps.

Procedure

- Make a note of the location and size of the aluminum tape pieces along the bottom edge that are taped across the joint between the rear chassis and the front chassis, and across the ribbon cables.
- Use a needle nose plier to carefully remove all the aluminum tape. Discard or recycle the removed aluminum tape pieces.



WARNING: Do not use fingers to remove the aluminum tape. The tape is sharp and can cause injury.

The aluminum tape is only needed for instruments with a serial number below B020000 or below C040000.



CAUTION: Be careful when removing tape from across cables to prevent damage. Pull the tape off parallel to (across) the chassis surface; do not pull the tape off by pulling straight out from the chassis. Hold down the exposed cable when removing the rest of the tape.

- Use a screwdriver with a with T-10 Torx tip to remove the 18 screws 19 screws securing the rear chassis to the front chassis. There are five screws each along the top and bottom, and four screws on each side.
- Place the instrument face down on a soft surface or fixture.



CAUTION: Place the instrument face down carefully to prevent damage to the knobs.

- Insert a large flat blade screwdriver no more than 1/4 inch into a rectangular slot on the corner of the rear chassis (see following image). Rotate the screwdriver to lift the corner of the rear chassis from the front chassis. Repeat on each corner. There may be a little resistance from the front right corner of the bottom edge, where the rear chassis interconnects to the front chassis.

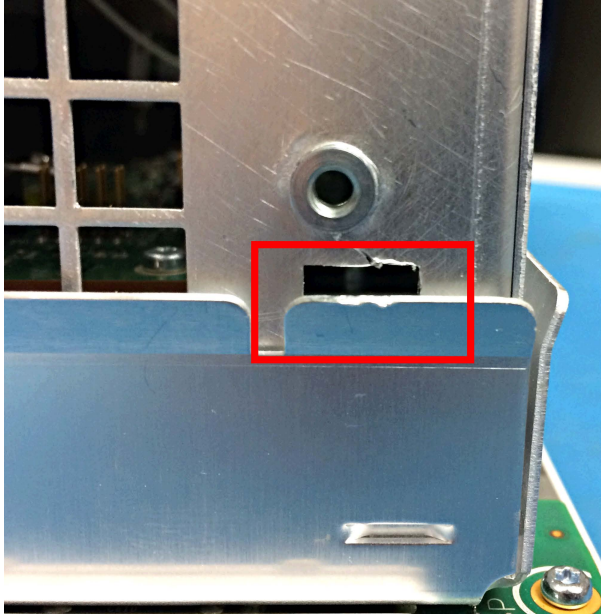

6. Lift the rear chassis off of the front chassis.
7. To reinstall, reverse the steps:
 - a) Align the rear chassis assembly with the front chassis, slide in, and push gently to seat the connectors.
 - b) Use a screwdriver with T-10 Torx tip to install the 18 chassis 19 chassis screws securing the rear chassis to the front chassis. Tighten to 0.65 N·m.
 - c) Use a cloth dampened with 75% isopropyl alcohol to clean the chassis area where the aluminum tape pieces will be installed
 - d) Install the new pre-cut aluminum tape (Tektronix part number 253-0582-XX) on the chassis at the positions noted in step 1 on page 23. The aluminum tape is only needed for instruments with a serial number below B020000 or below C040000. Install the chassis joint pieces first, then the pieces from the flat cables to the chassis tape pieces.

Remove the baffle bracket

Use this procedure to remove and replace the baffle bracket from the rear chassis, to gain access to the power supply assembly.

Before you begin

- To prevent electrostatic damage to components whenever you work on the instrument, wear properly-grounded electrostatic prevention wrist and foot straps, and work in a tested antistatic environment on an antistatic mat.
- [Remove rear chassis assembly](#) on page 23

Procedure

1. Set the rear chassis with the rear side down.



CAUTION: Position the chassis carefully to prevent damage to the BNCs.

2. Remove the four five twelve T-10 Torx screws from the baffle bracket. The middle two screws are Loctite patch screws (see [Replaceable Parts List](#)).

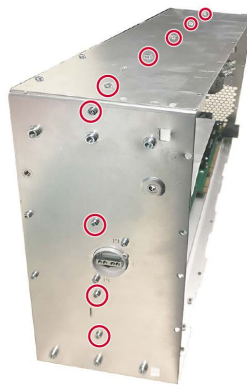
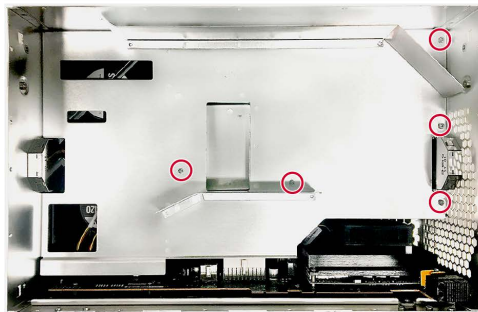
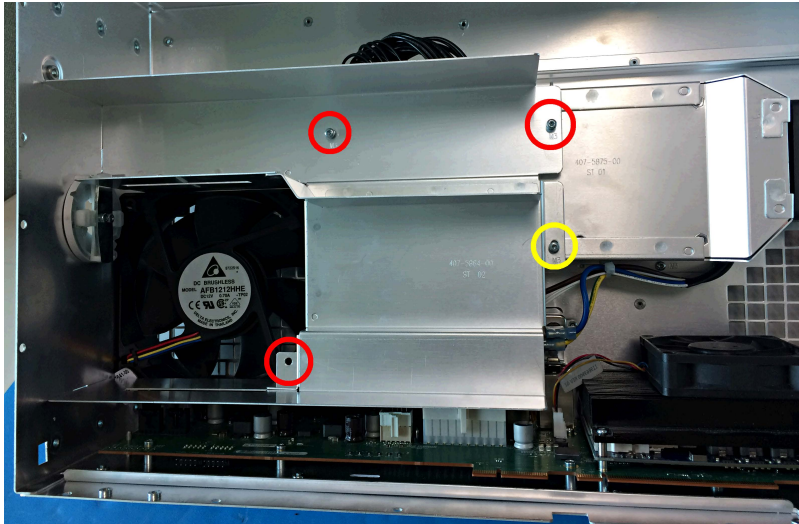

3. Remove the 14 T-10 Torx screws from outside the chassis that secure the baffle bracket in place.

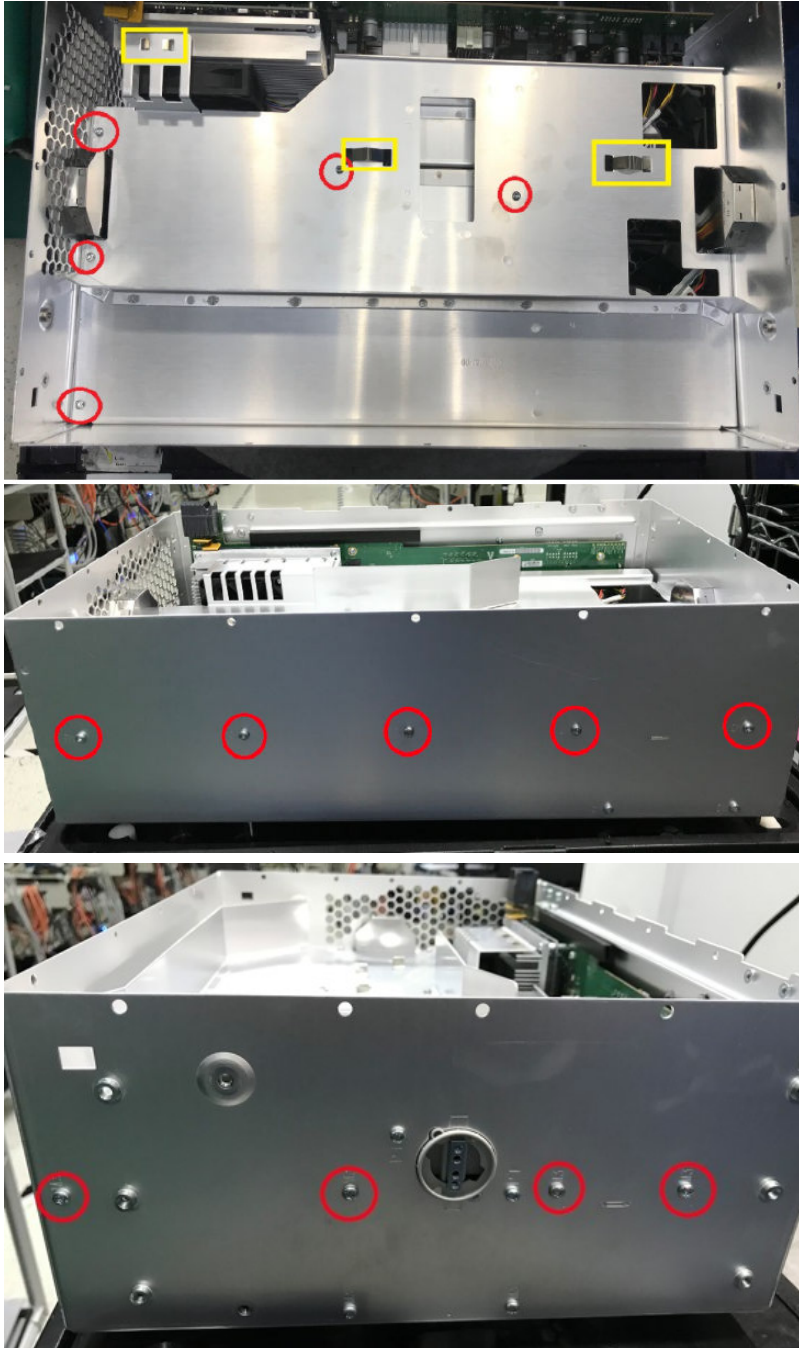

4. Lift the baffle from the right side, gently working the baffle from its registration tabs on the inside edge of the main fan, then lift up and pull away from side of chassis. There are tabs on the left end of the baffle bracket that fit into the side of the chassis. Lift the baffle from the right side and pull the baffle from the instrument. The baffle fits tight and can require some effort to remove.
5. To reinstall, reverse the steps. Note the tabs that must fit into the side of the chassis, and the registration bumps along the right edge of the main fan assembly. Install the yellow-marked screw last. Use a T-10 Torx screwdriver to tighten the screws to 0.65 N·m.

Remove the power supply assembly

Use this procedure to remove and replace the power supply assembly.

Before you begin

- To prevent electrostatic damage to components whenever you work on the instrument, wear properly-grounded electrostatic prevention wrist and foot straps, and work in a tested antistatic environment on an antistatic mat.
- [Remove the baffle bracket](#) on page 24

About this task

Use the following steps to remove the power supply assembly from the rear chassis and access the power supply bracket, board, cable, and fan.

Procedure

1. Disconnect the cables connecting the power supply to the carrier interface assembly, AFG riser board, and AC line filter.

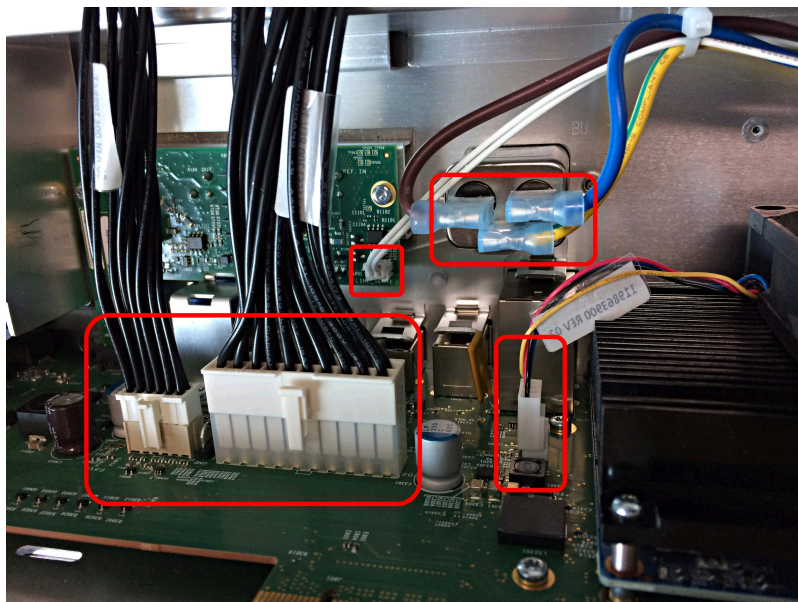

2. Use a T-10 Torx bit screwdriver to remove the four screws securing the power supply assembly to the chassis. Tighten screws to 0.65 N·m when reinstalling.

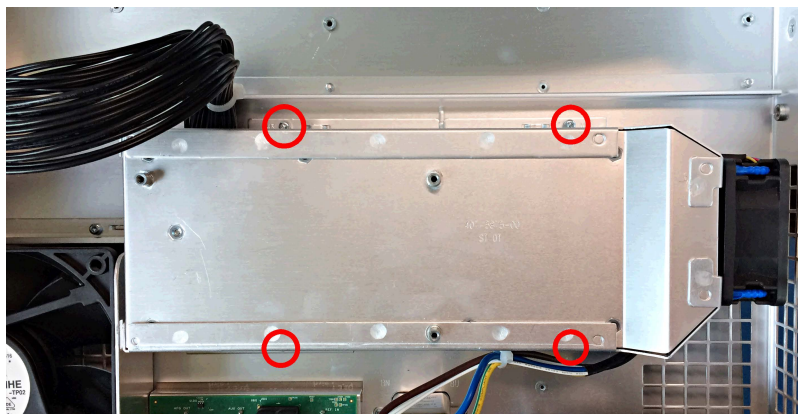

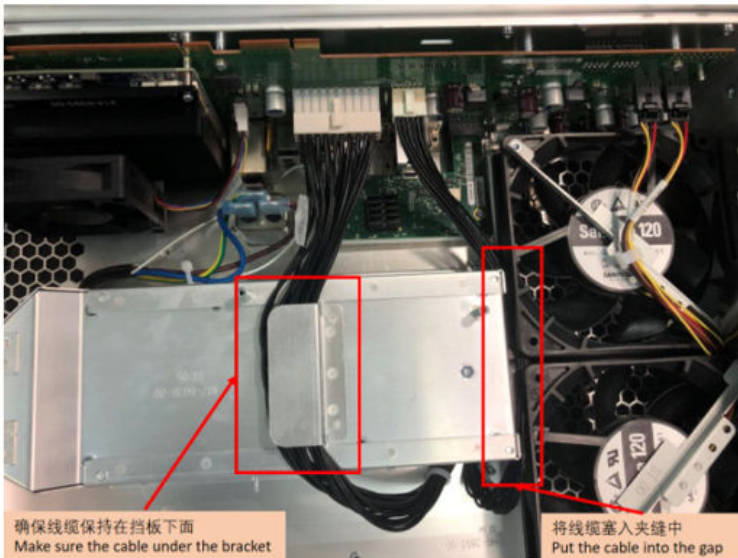
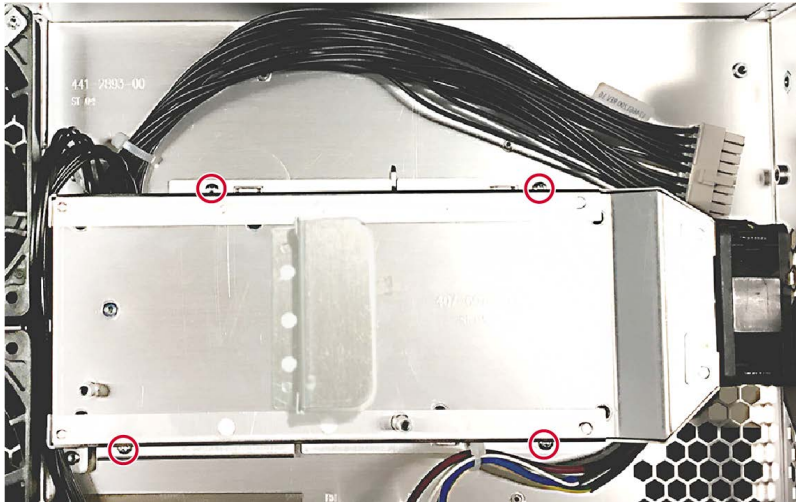

CAUTION: Dress the cable under the bracket first then insert it into the connector
先理线再插入接口。

3. Remove the power supply assembly from the rear chassis.
4. Disconnect the three power supply cables from the power supply board.



5. Disconnect the fan connector from the power supply.
6. Remove the fan from the four elastic retaining grommets that secure the fan to the bracket. To reinstall the fan, use needle nose pliers to pull the grommet ends through the fan mounting holes.
7. Use a T-10 Torx bit screwdriver to remove the seven screws securing the power supply board to the power supply bracket.

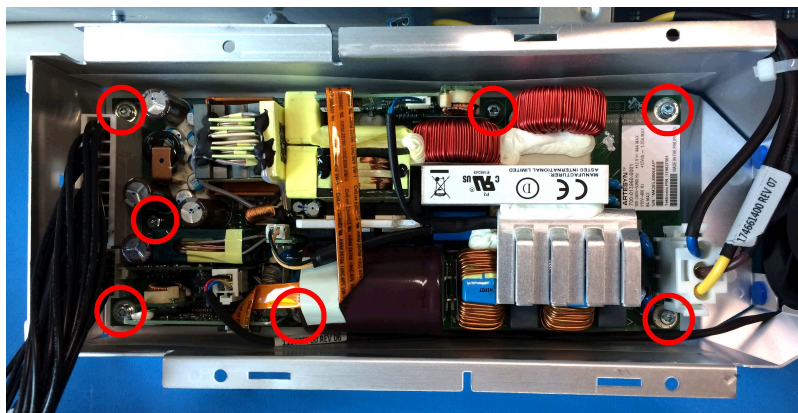

8. Remove the power supply board from the power supply shield and bracket.
9. Remove the power supply shield from power supply bracket.
10. To reinstall, reverse the steps. Tighten all T-10 Torx screws to 0.65 N·m when reinstalling. Make sure black cables dress cleanly through the side slot, and do not get pinched between the power supply bracket and rear chassis when reinstalling the power supply assembly. Install new tie down straps (zip ties) if you removed them during disassembly.



Note: Make sure to properly align the power supply board with the power supply shield before securing the board to the power supply bracket.

Remove carrier interface assembly

Use this procedure to remove and replace the carrier interface assembly.

Before you begin

- To prevent electrostatic damage to components whenever you work on the instrument, wear properly-grounded electrostatic prevention wrist and foot straps, and work in a tested antistatic environment on an antistatic mat.
- [Remove SATA riser board assembly](#) on page 21
- [Remove rear chassis assembly](#) on page 23
- [Remove the baffle bracket](#) on page 24

About this task

The carrier interface assembly contains the AFG Riser assembly and the M.2 SSD memory board with the system OS. Use this procedure only to sanitize the instrument before sending for repairs at a Tektronix Service Center.



Note: The M.2 memory board is only in instruments with a serial number below B020000 or below C040000.

Procedure

1. Use a T-10 Torx screwdriver to remove the screw between the BNC connectors on the rear panel of the chassis. Use a 3/16-inch open end wrench to remove the four jack screws from the video connectors on the rear panel.

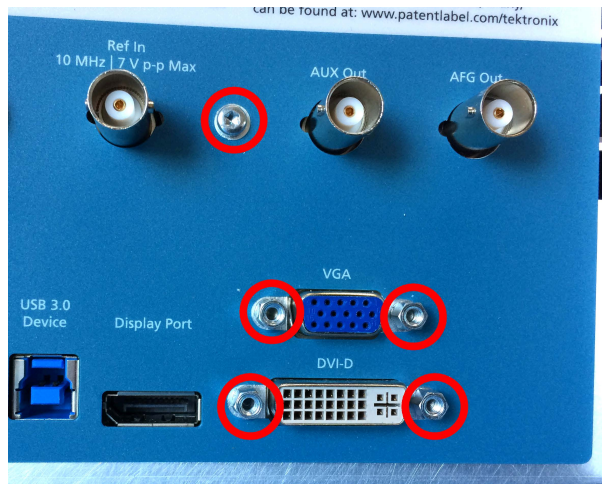

2. Disconnect the black cables connecting the power supply to the carrier interface assembly and the white cable on the AFG riser board. You do not need to disconnect the AC line filter cables.

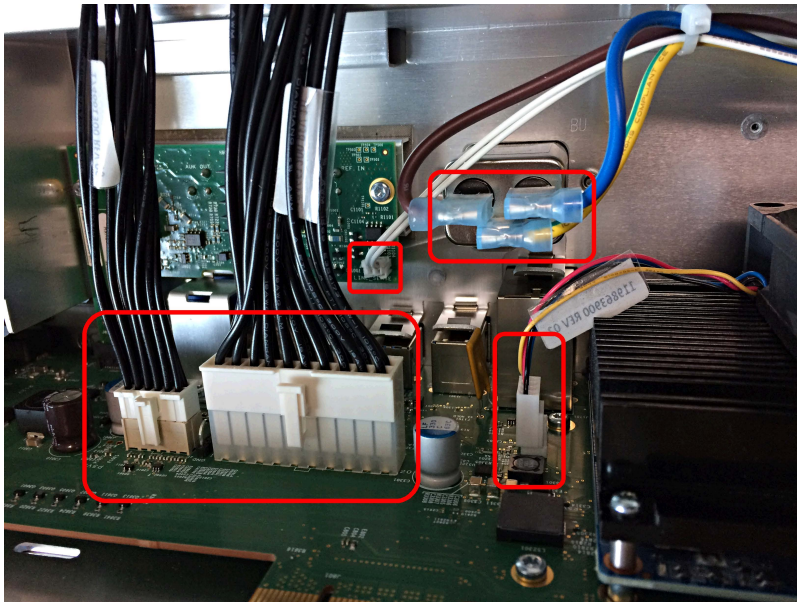

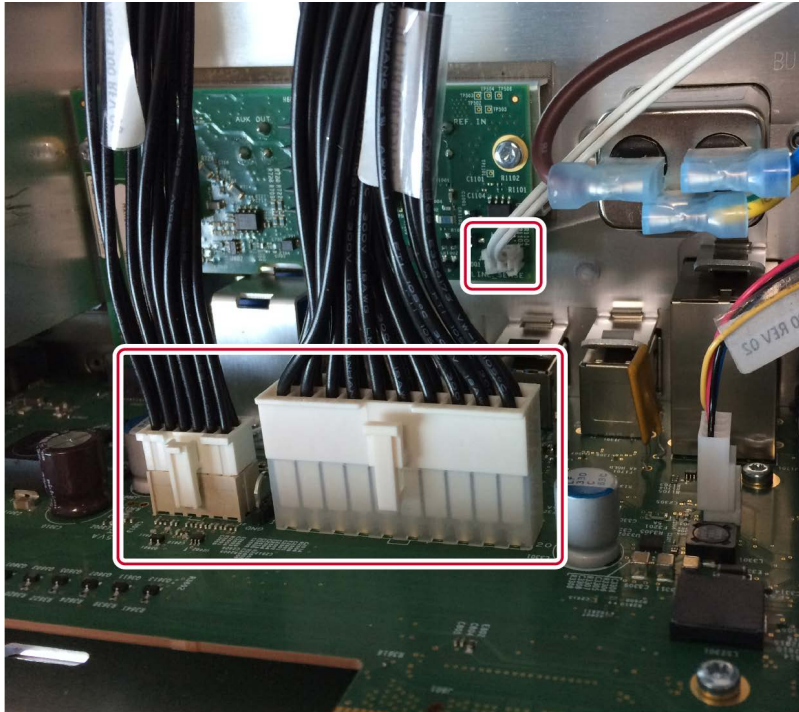

3. Disconnect fan cable. Disconnect fan cables.

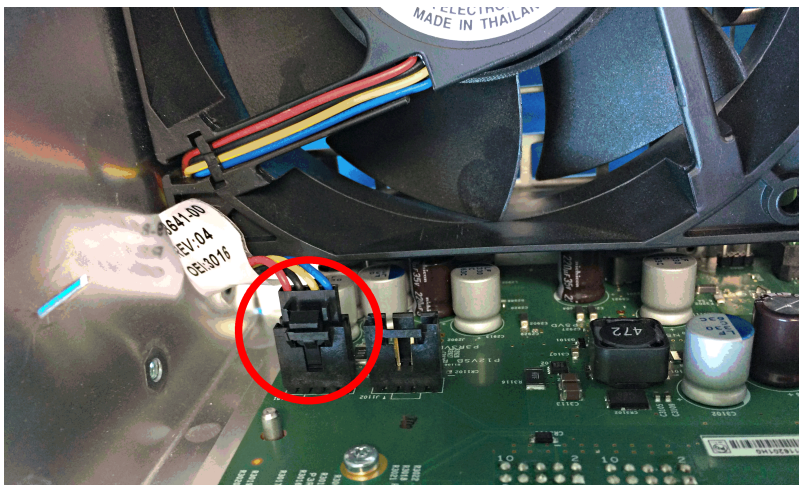

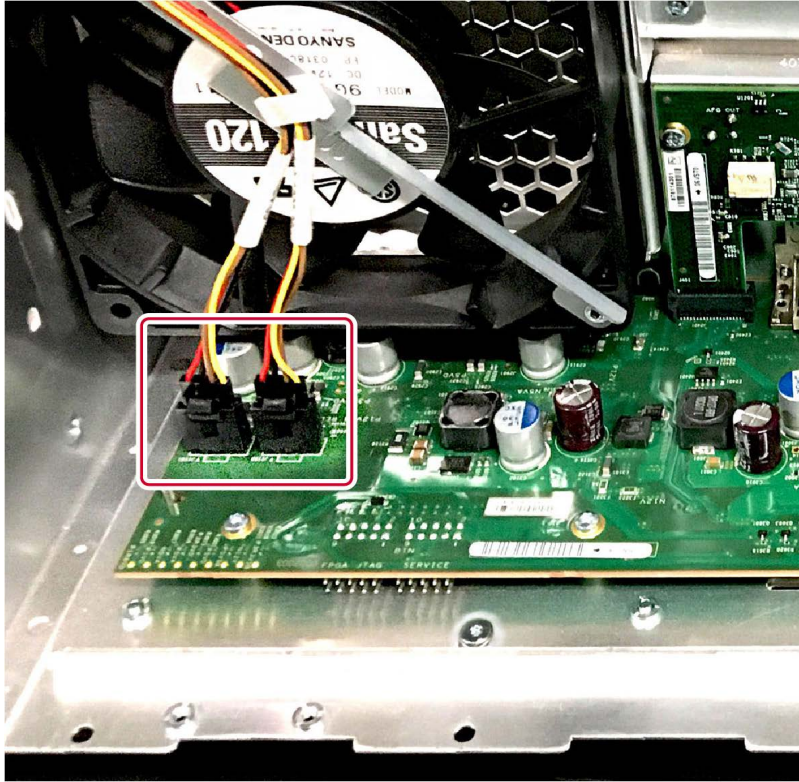

1408-003

4. Use a T-10 Torx screwdriver to remove the eight screws on the bottom of the chassis.

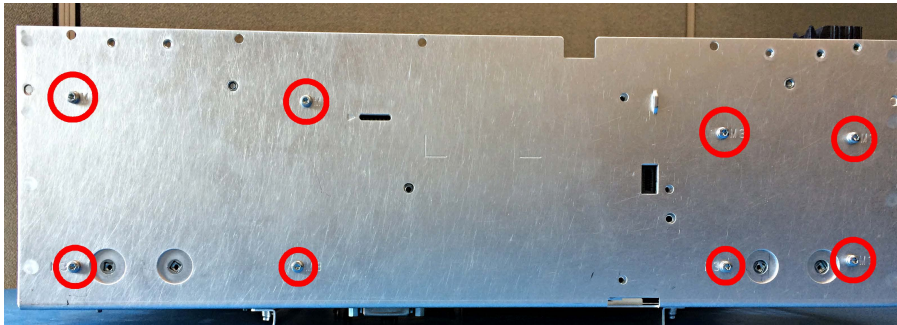

5. Use a T-8 Torx screwdriver to remove the two screws on the top front edge of the of the carrier interface chassis.

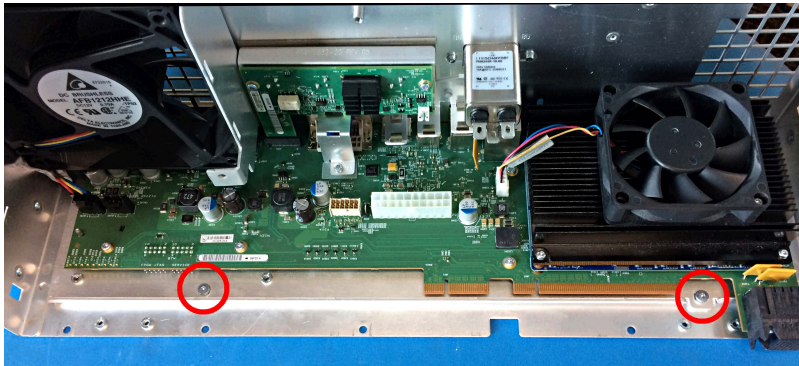

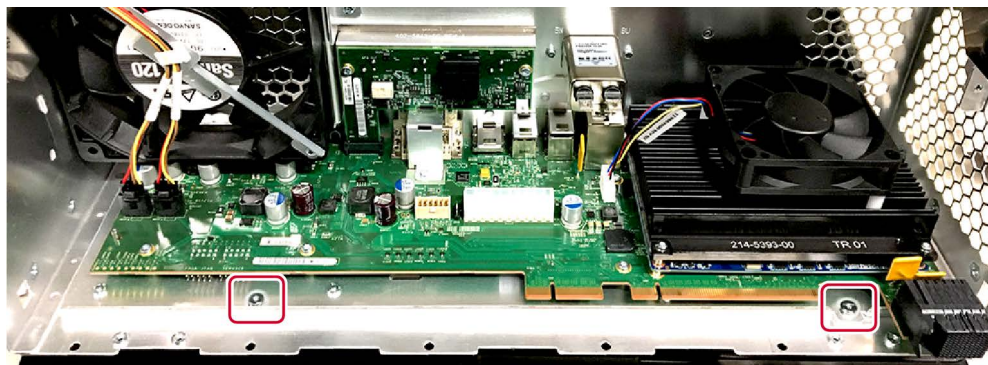

1408-002

6. Lift the front edge of the carrier interface assembly tray to clear the two shallow screw posts from the last step, then pull away from the chassis. There will be a slight resistance due to the springs on the rear of the chassis for the I/O connectors.
7. To reinstall, reverse the steps. Tighten all T-10 Torx screws to 0.65 N·m when reinstalling. Tighten all T-8 Torx screws to 0.45 N·m when reinstalling. Tighten the jack screws to 0.45 N·m when reinstalling. Reconnect the main fan cable and the power supply cables. Reconnect the main fan cables and the power supply cables.

Remove the AFG riser assembly

Use this procedure to remove and replace the AFG riser assembly from the carrier interface assembly. Only use this procedure as part of the sanitize process before sending the instrument for repairs at a Tektronix Service Center.

Before you begin

- To prevent electrostatic damage to components whenever you work on the instrument, wear properly-grounded electrostatic prevention wrist and foot straps, and work in a tested antistatic environment on an antistatic mat.
- [Remove carrier interface assembly](#) on page 29. The carrier interface assembly must be removed from the rear chassis before removing the AFG riser assembly. There is not enough clearance for the BNC and video connectors to remove the assembly while it is installed in the chassis.

Procedure

1. Use a T-10 Torx screwdriver to remove the one screw on the AFG riser assembly bracket.



2. Lift the AFG riser assembly straight up from the carrier interface assembly.
3. To reinstall, reverse the steps. Tighten the T-10 Torx screw to 0.65 N·m when reinstalling.

Remove handle hub assembly

Use this procedure to remove and replace the handle hubs from the rear chassis. You will need to remove the left side hub if you want to remove the main fan.

Before you begin

- To prevent electrostatic damage to components whenever you work on the instrument, wear properly-grounded electrostatic prevention wrist and foot straps, and work in a tested antistatic environment on an antistatic mat.
- [Remove rear chassis assembly](#) on page 23
- [Remove the baffle bracket](#) on page 24

Procedure

1. Remove the left and right handle hub assemblies from the inside walls of the chassis using a T-10 Torx bit screwdriver. Two screws will be removed for each hub assembly.
2. To reinstall, reverse the steps. Use a screwdriver with a T-10 Torx tip to tighten the screws to 0.65 N·m.

Remove the main fan assembly

Use this procedure to remove and replace the main fan from the rear chassis.

Before you begin

- To prevent electrostatic damage to components whenever you work on the instrument, wear properly-grounded electrostatic prevention wrist and foot straps, and work in a tested antistatic environment on an antistatic mat.
- [Remove the baffle bracket](#) on page 24
- [Remove handle hub assembly](#) on page 34 next to the main fan
- [Remove carrier interface assembly](#) on page 29

Procedure

1. Use a T-10 Torx screwdriver to remove the four screws from the main fan assembly bracket. to remove the eight screws from the main fan assembly bracket and rear chassis.

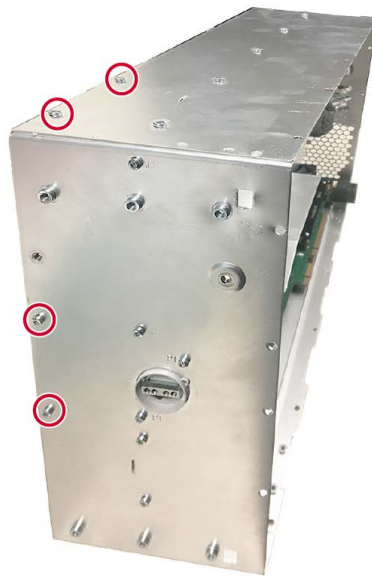
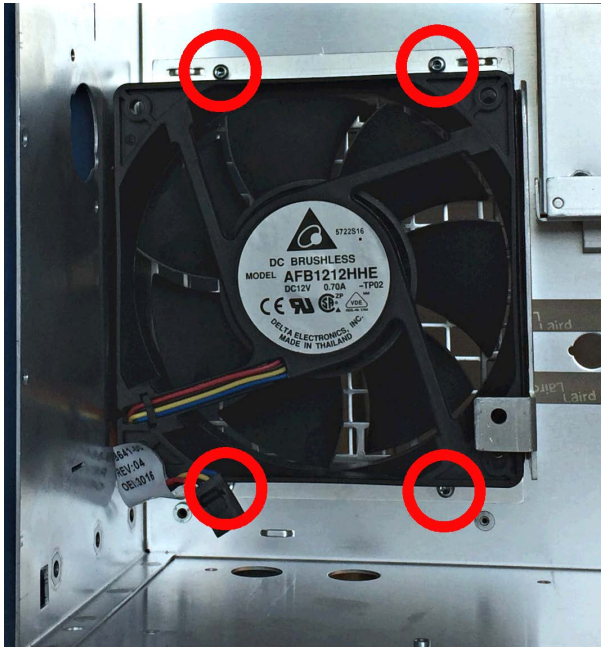

2. Remove the main fan assembly from the rear chassis.
3. To remove the fan from the bracket, carefully pull the fan from each corner of the bracket to disconnect the elastic fan attachments.
4. To reinstall, reverse the steps. Install the fan on the bracket in the correct orientation for the fan power cable (see photo). Use a needle nose plier to reinstall the fan elastic attachments on each corner. Tighten the T-10 Torx screws to 0.65 N·m when reinstalling.

Remove M.2 memory board

Use this procedure to remove the M.2 memory board from the carrier interface assembly to sanitize the instrument before sending for repairs at a Tektronix Service Center.

Before you begin

- To prevent electrostatic damage to components whenever you work on the instrument, wear properly-grounded electrostatic prevention wrist and foot straps, and work in a tested antistatic environment on an antistatic mat.
- [Remove carrier interface assembly](#) on page 29
- [Remove the AFG riser assembly](#) on page 33

About this task

Removing the M.2 memory board sanitizes the instrument, ensuring that user settings and acquisition data are no longer on the instrument. Removing the M.2 board also removes the instrument calibration constants and any option licenses that you have installed.



Note: The M.2 memory board is only in instruments with a serial number below B020000 or below C040000.



Note: If the M.2 board is removed before sending the instrument to Tektronix for repair, Tektronix will install a new M.2 board and you will be charged for the new board.

You will need to reassemble the instrument and send it to your nearest Tektronix Service Center to have a new M.2 board installed and the instrument recalibrated.

After the instrument is returned, you will need to reinstall any option licenses.

Procedure

1. Remove the seven T-10 Torx screws from the carrier board (marked in red). Remove the five T-8 Torx screws from the carrier board heat sink (marked in yellow).

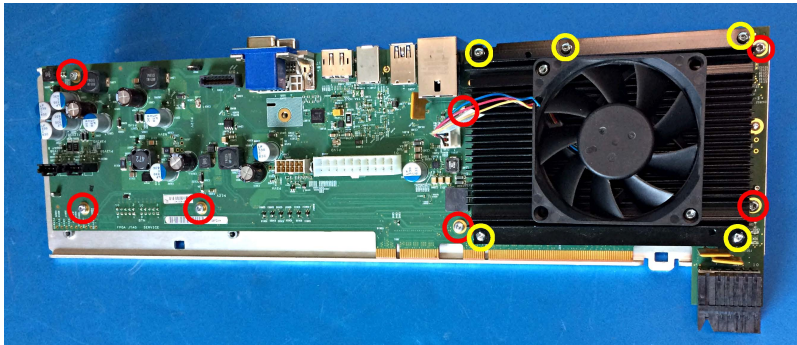

2. Carefully hold together the carrier interface assembly and turn it upside down so that the metal carrier tray is facing up. Support the end of the carrier interface assembly away from the heat sink assembly so that it is level.
3. Carefully lift the metal tray from the assembly to expose the bottom of the carrier interface board and the M.2 SSD memory.

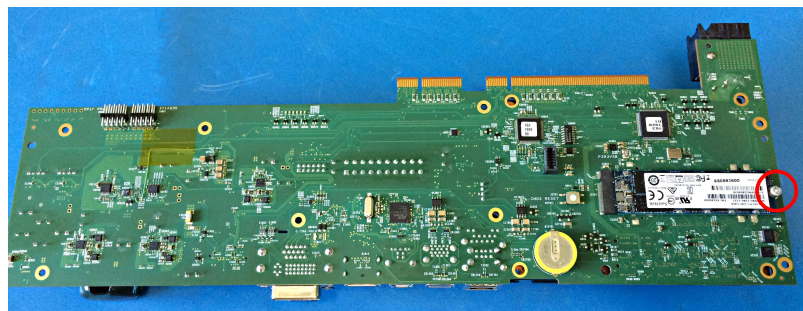

4. Remove the one T-8 Torx screw and remove the M.2 SSD memory board. Store or destroy the M.2 SSD memory board in accordance with your organization's guidelines.
5. Carefully align and set the carrier board tray back onto the carrier interface assembly.
6. Carefully hold together the carrier interface assembly and tray and turn it so that the circuit board and heat sink assembly are facing up.
7. Install the seven T-10 Torx carrier board screws. Tighten to 0.65 N·m.
8. Install the five T-8 Torx screws on the carrier board heat sink. Tighten to 0.45 N·m.
9. Reassemble the instrument and return it to the nearest Tektronix Service Center for replacement of the M.2 SSD board and recalibration.

Troubleshooting 5 Series MSO 6 Series MSO 5 Series B MSO

CAUTION: Before performing this or any other procedure in this manual, read the General Safety Summary and Service Safety Summary found at the beginning of this manual.



To prevent possible injury to service personnel or damage to electrical components, please read information on Preventing ESD. (See [Preventing ESD](#) on page 16.)

This section contains information and procedures designed to help you isolate faults to a module.

This section requires that service personnel have the appropriate skills to work on this instrument, including PC troubleshooting and Microsoft Windows operating system skills. Details of PC and Windows operation and service are not in this manual.

For assistance, contact your local Tektronix Service Center.

Service level

This subsection contains information and procedures to help you determine if a faulty power supply is the problem with your instrument. If replacing the power supply does not fix the fault, you will need to return the instrument to a Tektronix Service Center for repair, as no other internal electronic assemblies or modules are user-replaceable.

Check for common problems

Use the following table to help isolate possible failures. The table lists problems and possible causes. The list is not exhaustive, but it may help you eliminate a problem that is quick to fix, such as a loose power cord.

Table 4: Failure symptoms and possible causes

Symptom	Possible cause(s)
Instrument will not power on	Power cord not plugged in.
	Faulty power supply.
	Defective micro-controller assembly.
Instrument powers on, but one or more fans will not operate	Faulty fan power cable.
	Fan power cable not connected to circuit board.
	Defective fan .
	Faulty power supply.
	One or more defective point of load regulators.
Instrument with Option 5-WIN (external Windows 10 OS SSD) doesn't boot up, but removing the Opt 5-WIN drive lets the instrument power on correctly.	Option 5-WIN SSD defective drive.
	Defective SATA riser board.
Flat-panel display blank or has streaks in display	Faulty LCD screen or video circuitry.

Equipment required

- Digital voltmeter to check power supply voltages.
- 0.1 inch spacing 2-pin jumper.
- An antistatic work environment. To prevent electrostatic damage to components whenever you work on the instrument, wear properly-grounded electrostatic prevention wrist and foot straps, and work in a tested antistatic environment on an antistatic mat.

Troubleshooting flow chart

Follow the troubleshooting flow chart to determine the action for a fault condition.

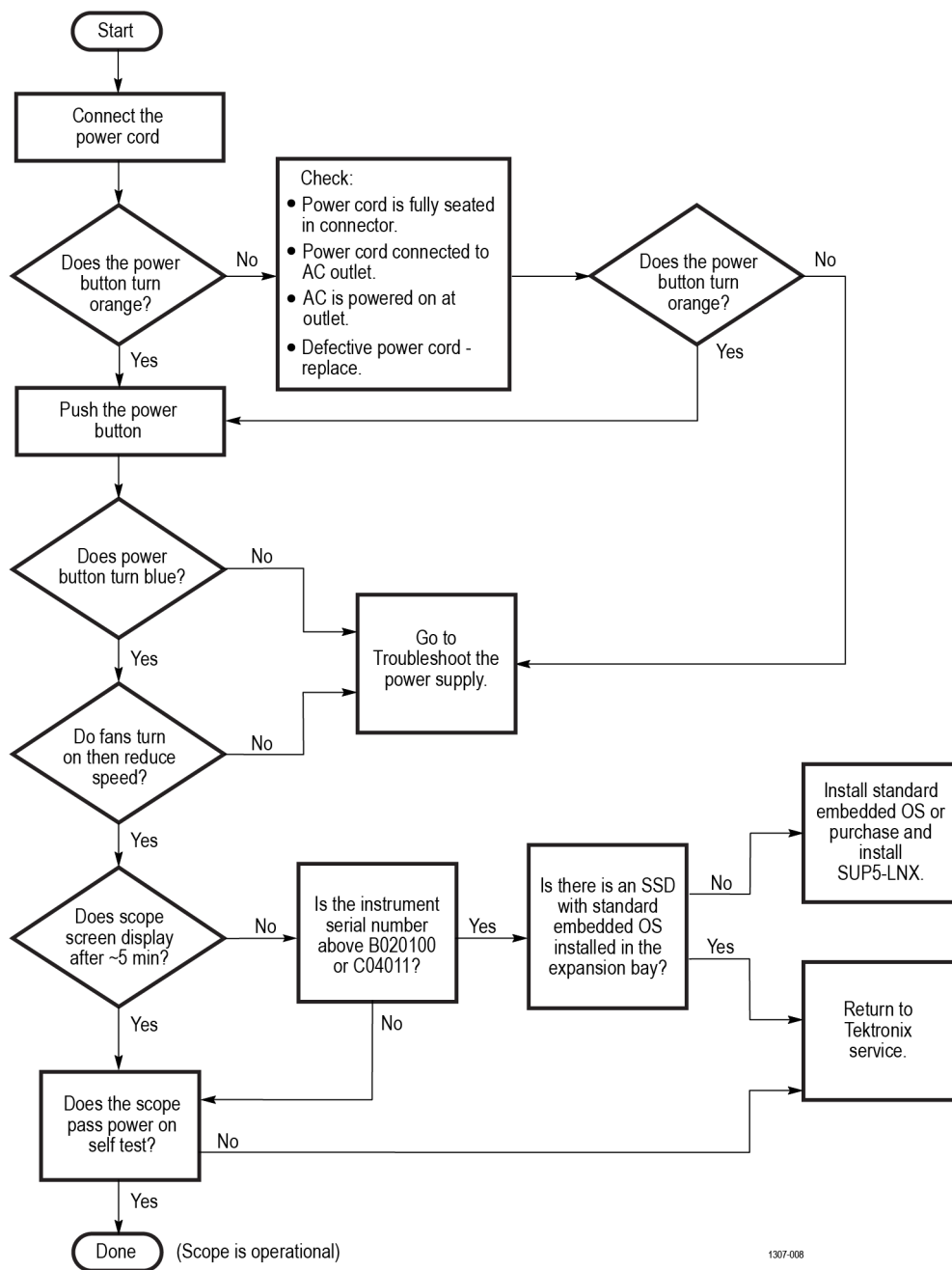

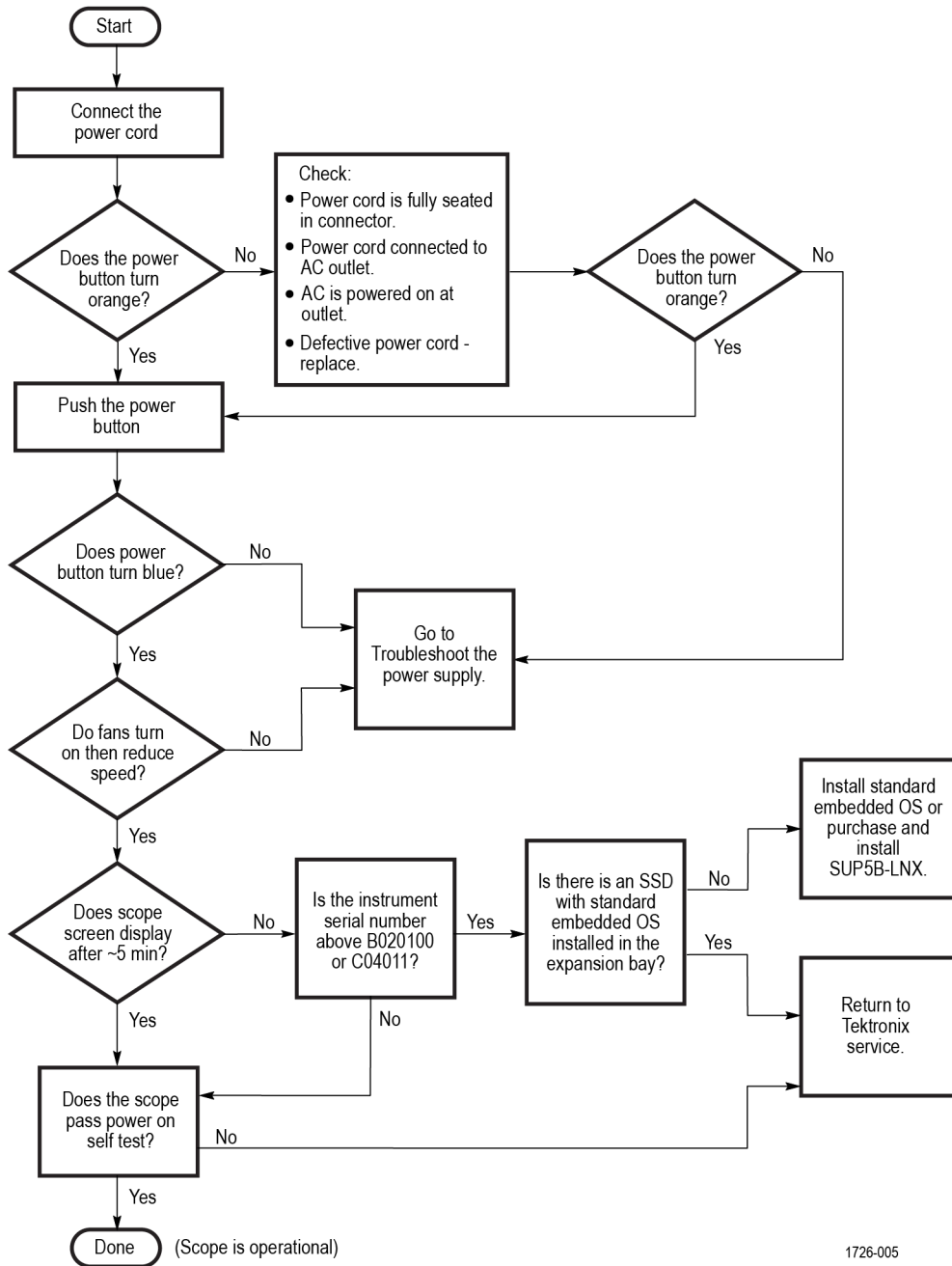

1726-005

Figure 2: Primary troubleshooting tree

Status LEDs. A set of six bi-color LEDs report the power management status of the instrument. These LEDs are located under the cover on the bottom of the instrument.

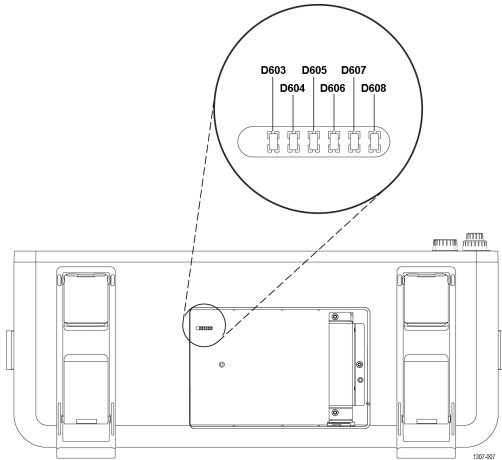

Figure 3: Power status LEDs

All of these LEDs should be green a few moments after powering on the instrument. If any of these LEDs are red, or are not lit, return the instrument to a Tektronix Service Center for repair.

Troubleshoot the power supply

Use this procedure to determine if the power supply is defective and needs replaced.

Before you begin

- To prevent electrostatic damage to components whenever you work on the instrument, wear properly-grounded electrostatic prevention wrist and foot straps, and work in a tested antistatic environment on an antistatic mat.
- [Remove rear chassis assembly](#) on page 23
- [Remove the baffle bracket](#) on page 24

Procedure

1. Connect the power cord to the AC connector on the back of the rear chassis.
2. Measure for **+12 V_{DC}** between chassis and pin 10 of J3203 (large connector). If there is +12 V_{DC} at pin 10, go to step 3 on page 42. If you do not measure +12 V_{DC} at Pin 10 of J3203 connected to the circuit board:

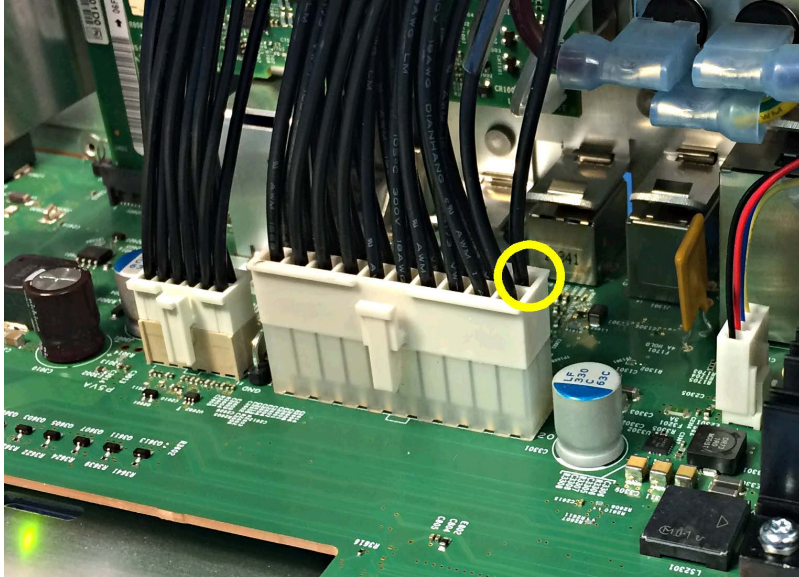

- a) Disconnect the AC power cord.
- b) Disconnect J3203 from the circuit board.
- c) Connect the AC power cord.
- d) Measure for **+12 V_{DC}** between pin 10 (+12 V_{DC}) and pin 18 (ground) on the disconnected cable.
 If there is no +12 V_{DC} value on pin 10, carefully check for **115 V_{AC}** at the connectors of the AC line filter. If there is AC at the line filter, replace the power supply module or reassemble and return the instrument to a Tektronix Service Center for repair.



WARNING: Be careful when measuring the AC line voltage to avoid injury to yourself or damage to the instrument.

3. If there is **+12 V_{DC}** at pin 10 of the disconnected J3203 cable, do the following:
 - a) Disconnect the AC power cord.
 - b) Reconnect J3203 to the circuit board.
 - c) Connect the AC power cord.
 - d) Insert for one (1) second and then remove a 0.1-inch-spaced shorting jumper between pins 9 and 10 of the Service connector pins on the edge of the circuit board (see following image). Wait five (5) seconds as the fans turn on and the power supply powers on.

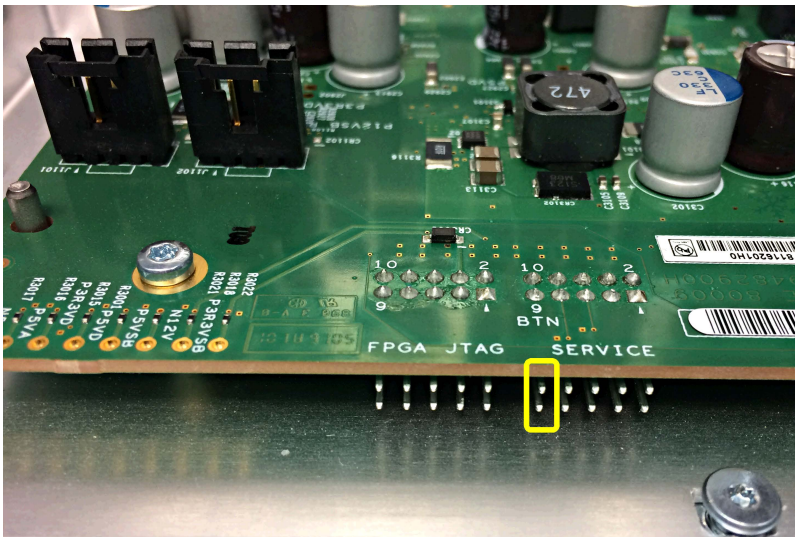

- e) Measure for **+12 V_{DC}** between chassis (ground) and pins 1 through 4 and pins 11 through 15 on J3203. If all these pins have +12 V_{DC} present, then the power supply is working correctly. Disconnect the AC power cord, reassemble the instrument, and return the instrument to a Tektronix Service Center for repair.

Instrument self tests

The instrument runs self test diagnostics during every power on. The power on self tests ensure that the hardware and software are functionally working. The tests provide limited diagnostic information, and provide no performance information.

If the instrument detects errors during power on, a pop-up message indicates that a failure has occurred. To display the self test menu and results, select **Utility > Self Test**. Select a test mode and run the self tests. If you continue to get errors on one or more tests, you will need to return the instrument to your nearest Tektronix Service Center for repair.

Software updates

To update the application software:

1. Go to www.tek.com/en/support/product-support.
2. Enter a model number (MSO54, MSO56, or MSO58MSO64MSO54B, MSO56B, or MSO58B) in the Enter Product or Product Series Name field and click **Go**. Any 5 Series B model number will do, as all models use the same software update.
3. Click the **Software** tab.
4. On the oscilloscope, tap **Help > About**.
5. Compare the version number of the installed software to the version on the web:
 - a. If the version number on the oscilloscope is the same as the version on the web, you have the latest version. You do not need to install new software. Exit this procedure.
 - b. If the version number on the oscilloscope is a lower number than the version on the web, you can download and install new software. Continue with the rest of this procedure.
6. Select the highest-numbered version (**5 Series MSO Embedded OS Firmware - VX.X5 Series B MSO Embedded OS Firmware - VX.X6 Series MSO Embedded OS Firmware - VX.X**).
7. Click **Download File** to start the download.
8. When done downloading, unzip the downloaded file.
9. Open the file `install.txt` and follow the instructions in the file.

Power supply module replacement

After removal and replacement of the power supply module, you must perform the Performance Verification procedures, found in the *Specifications and Performance Verification* manual (Tektronix part number 077-1306-xx)(Tektronix part number 077-1461-xx)(Tektronix part number 077-1711-xx). Download this manual from the Tektronix Web site (www.tek.com).

If the instrument fails the Performance Verification tests, it must be returned to a Tektronix Service Center for adjustment.

Replaceable parts

Parts ordering information

Use the lists in the appropriate section to identify and order replacement parts for your product. Replacement parts are available through your local Tektronix field office or representative.

Standard accessories for these products are listed in your user manual. The user manual is available at www.tek.com/manuals.

Changes to Tektronix products are sometimes made to accommodate improved components as they become available and to give you the benefit of the latest improvements. Therefore, when ordering parts, it is important to include the following information in your order:

- Part number
- Instrument type or model number
- Instrument serial number
- Instrument modification number, if applicable

If you order a part that has been replaced with a different or improved part, your local Tektronix field office or representative will contact you concerning any change in part number.

Module servicing

Modules can be serviced by selecting one of the following three options. Contact your local Tektronix Service Center or representative for repair assistance.

Module exchange. In some cases, you may exchange your module for a remanufactured module. These modules cost significantly less than new modules and meet the same factory specifications. For more information about the module exchange program, call 1-800-833-9200. Outside North America, contact a Tektronix sales office or distributor; see the Tektronix Web site (www.tek.com) for a list of offices.

Module repair and return. You may ship your module to us for repair, after which we will return it to you.

New modules. You may purchase replacement modules in the same way as other replacement parts.

Abbreviations

Abbreviations conform to the American National Standard ANSI Y1.1-1972.

Using the replaceable parts list

This section contains a list of the replaceable mechanical and/or electrical components. Use this list to identify and order replacement parts. The following table describes each column in the parts list.

Table 5: Parts list column descriptions

Column	Column name	Description
1	Figure and index number	Items in this section are referenced by figure and index numbers to the exploded view illustrations that follow.
2	Tektronix part number	Use this part number when ordering replacement parts from Tektronix.
3 and 4	Serial number	Column three indicates the serial number at which the part was first effective. Column four indicates the serial number at which the part was discontinued. No entry indicates the part is good for all serial numbers.
5	Quantity	This indicates the quantity of parts used.
6	Name and description	An item name is separated from the description by a colon (:). Because of space limitations, an item name may sometimes appear as incomplete. Use the U.S. Federal Catalog handbook H6-1 for further item name identification.

Table 6: Parts list column descriptions

Column	Column name	Description
1	Figure & index number	Items in this section are referenced by figure and index numbers to the exploded view illustrations that follow.
2	Tektronix part number	Use this part number when ordering replacement parts from Tektronix.
3	Qty	This indicates the quantity of parts used.
4	Name and description	An item name is separated from the description by a colon (:). Because of space limitations, an item name may sometimes appear as incomplete. Use the U.S. Federal Catalog handbook H6-1 for further item name identification.

Front cover and rear case

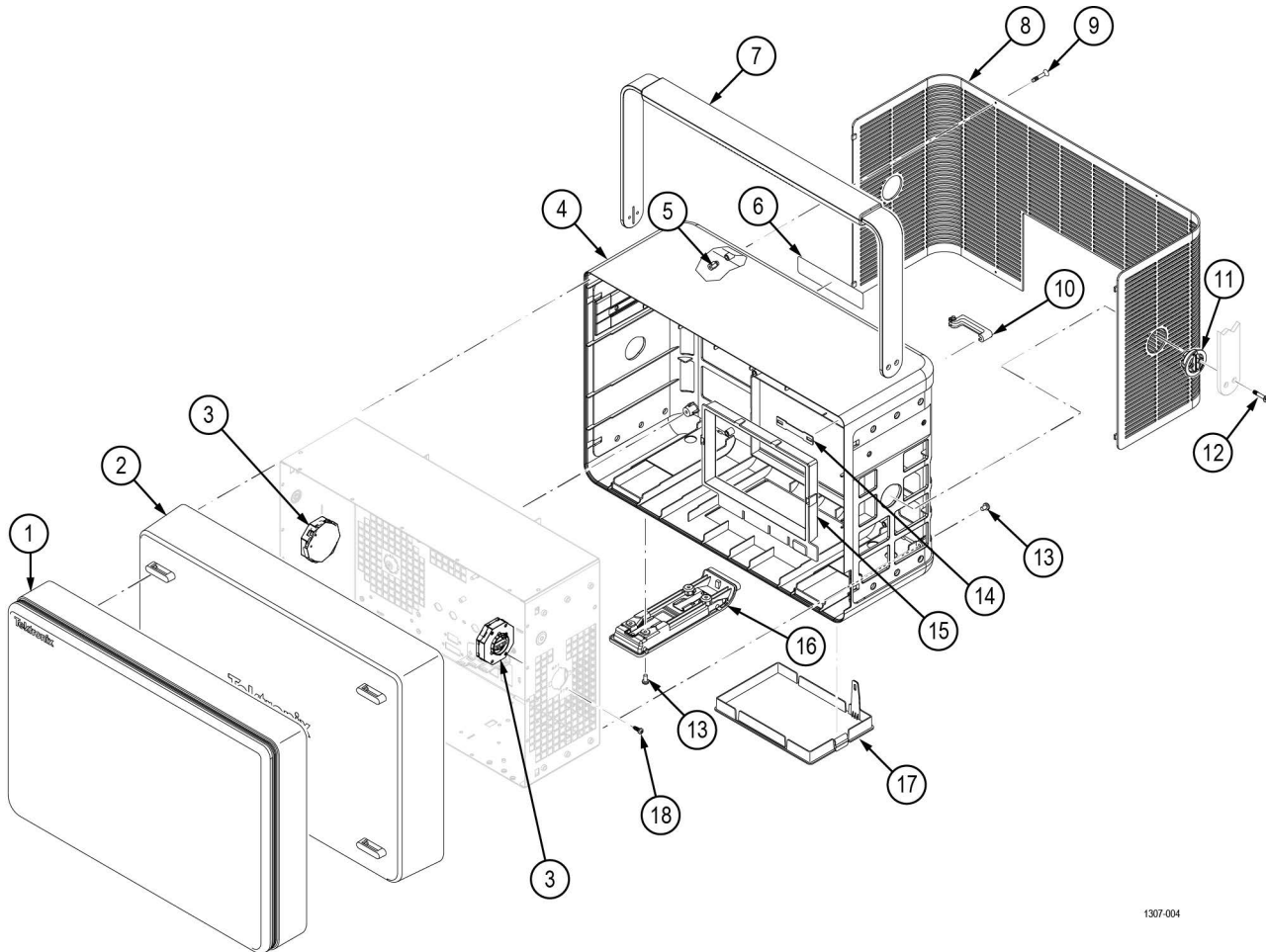

1307-004

Figure 4: Front cover and rear case exploded view

Table 7: Front cover and rear case

Index number	Tektronix part number	Qty	Name and description
Figure 4 on page 46			
-1	016-2106-XX	1	CASE, ACCESSORY FRONT COVER
-2	200-5406-XX	1	COVER, FRONT PROTECTIVE
-3	065-1078-XX	1	MODULE ASSY: SERVICE REPLACEMENT KIT; HANDLE HUB LEFT & RIGHT (SET)
-4	202-0521-XX	1	CASE, REAR, SAFETY CONTROLLED
-5	220-0325-XX	6	INSERT, 2.5MM, SNAP IN

Table continued...

Index number	Tektronix part number	Qty	Name and description
-6	335-3850-XX	1	MARKER, IDENTIFICATION, SERVICE US PLUS, ENGLISH
	335-3851-XX	1	MARKER, IDENTIFICATION, SERVICE EUROPE, ENGLISH
	335-3852-XX	1	MARKER, IDENTIFICATION, SERVICE JAPAN, JAPANESE
	335-3853-XX	1	MARKER, IDENTIFICATION, SERVICE CHINA, SIMPLIFIED CHINESE
	335-3854-XX	1	MARKER, IDENTIFICATION, SERVICE OTHER, ENGLISH
-7	050-3904-XX	1	MODULE ASSY: SERVICE REPLACEMENT KIT; METAL HANDLE W/PLASTIC GRIP AND HARDWARE
-8	378-0952-XX	1	GRILL, COSMETIC, REAR, SAFETY CONTROLLED
-9	211-1573-XX	6	SCREW, CAPTIVE; M2.5 X .45 X 14 FLAT HEAD, TORX T8, W/ DOGPOINT
-10	105-1186-XX	2	HOOK, CORD WRAP, SAFETY CONTROLLED
-11	376-0256-XX	2	COUPLER, HUB HANDLE, SAFETY CONTROLLED
-12	211-1610-XX	4	SCREW, MACHINE; M3 X 0.5 X 16, FLAT HEAD, STL, TORX 10
-13	211-1584-XX	12	SCREW, MACHINE, M3 X 0.5 X 6MM PAN HEAD, TORX T10
-14	214-5526-XX	2	SPRING, CORD WRAP
-15	437-0544-XX	1	TRIM, REAR I/O
-16	065-1008-XX	2	MODULE ASSY: SERVICE REPLACEMENT KIT; FLIP FEET
-17	200-5339-XX	1	DOOR, HARD DRIVE
-18	211-1585-XX	4	SCREW, DELTA-PT, 3MM X 8MM, T10

Carrier interface board and rear chassis

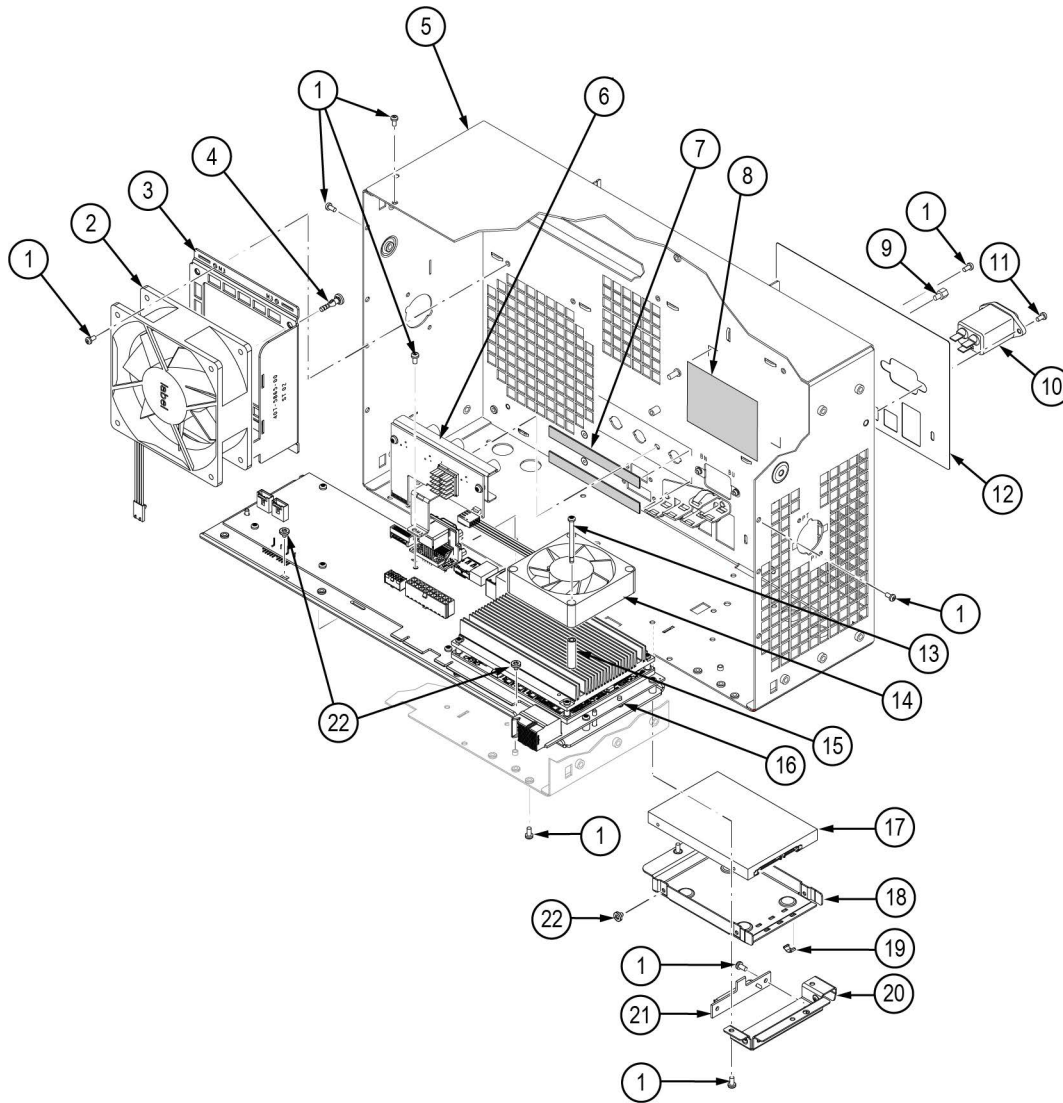

1307-003

Figure 5: Carrier interface board and rear chassis exploded view

Table 8: Carrier interface board and rear chassis

Index number	Tektronix part number	Serial no. effective	Qty	Name & description
<i>Figure 5</i> on page 48				
-1	211-1584-XX		20	SCREW, MACHINE, M3 X 0.5 X 6MM PAN HEAD, TORX T10
-2	119-8641-XX		1	FAN ASSEMBLY, 119864200 W / TERMINATION, SAFETY CONTROLLED
-3	407-5865-XX		1	BRKT, 120MM X 38MM FAN, SAFETY CONTROLLED
-4	348-2082-XX		4	GROMMET, FAN MOUNT, NOISE DAMPING
Table continued...				

Index number	Tektronix part number	Serial no. effective	Qty	Name & description
-5	441-2826-XX	Below B020000 Below C040000	1	CHASSIS, REAR, SAFETY CONTROLLED
	441-2945-XX	B020000 and above C040000 and above	1	CHASSIS, REAR
-6	878-1143-XX		1	CIRCUIT BOARD SUBASSY; AFG RISER BOARD UNTESTED; 389494600 Return the instrument to Tektronix for service.
-7	348-2264-XX		2	GASKET, CONDUCTIVE, FOF, 1MM X 10MM X 100MM
-8	337-4731-XX		1	SHIELD, INSULATOR, POWER SUPPLY, SAFETY CONTROLLED
-9	214-3903-XX		4	SCREW, JACK; 4-40 X 0.312 LONG, 0.188 HEX HEAD STAND OFF W/ ASSEMBLED SPLIT LOCK WASHER, 4-40 INT THD, X 0.312 THD EXT 4-40, STEEL, ZINC PLATED
-10	119-8742-XX		1	FILTER, EMI; AC LINE FILTER; 10.0A, 120-250VAC, DC-400 HZ, IEC INPUT ,FAST-ON/SOLDER LUG OUTPUT, CHASSIS MOUNT; FN9244R10-06; SAFETY CONTROLLED
-11	211-1686-XX		2	SCREW, MACHINE, M3 X 0.5 X 10 FLATHEAD, 90 DEG, BLACK ZINC,TUFLOK, TORX T10
-12	335-3420-XX		1	LABEL, REAR, IO, SAFETY CONTROLLED
-13	211-1571-XX		4	SCREW, MACHINE, M3 X 0.5 X 40MM PAN HEAD, TORX T8 WITH NYLON PATCH
-14	119-8639-XX		1	FAN ASSEMBLY,119864000 W / TERMINATION, SAFETY CONTROLLED
-15	361-1883-XX		4	SPACER, RND, 6MM OD X 3.2MM ID X 25MMLG
-16	065-1005-XX	Below B020000 Below C040000	1	MODULE ASSY: SERVICE REPLACEMENT KIT; CARRIER INTERFACE BOARD; WITH BIOS AND SSD; FULLY TESTED; MSO5 SERIES Return the instrument to Tektronix for service.
	065-1076-XX	B020000 and above C040000 and above	1	MODULE ASSY: SERVICE REPLACEMENT KIT;CARRIER INTERFACE BOARD;WITH BIOS AND SSD; FULLY TESTED; MSO5 SERIES Return the instrument to Tektronix for service.

Table continued...

Replaceable parts

Index number	Tektronix part number	Serial no. effective	Qty	Name & description
-17	119-8250-XX		1	DISK DRIVE; SOLID STATE, 512GB (WAS 480), 2.5 IN, SATA III, 6.0 GB/ S, MLC, 7 MM; SAFETY CONTROLLED, (Option 5-WIN), UNPROGRAMMED Service will image the SSD according to appropriate OS and processor type or purchase SUP5-WIN. Backup any important data before replacing the OS drive.
	119-8773-XX	B020000 and above C040000 and above	1	DISK DRIVE; SOLID STATE, 256GB, 2.5 IN, SATA III; 6.0GB/S, TLC, 7MM, (Option 5-LNX) Service will image the SSD according to appropriate OS and processor type or purchase SUP5-LNX. Backup any important data before replacing the OS drive.
-18	407-5877-XX		1	BRACKET, HARDDRIVE
-19	131-6643-XX		3	CONTACT, ELECTRICAL
-20	407-5896-XX		1	BRACKET, SATA RISER
-21	878-1100-XX		1	CIRCUIT BOARD SUBASSY; SATA RISER CARD; UNTESTED; 389491600
-22	211-1631-XX		6	SCREW, MACHINE, M3-0.5, 3.5L, T8 (UNDER HEAD SERRATIONS)

Baffle and power supply module

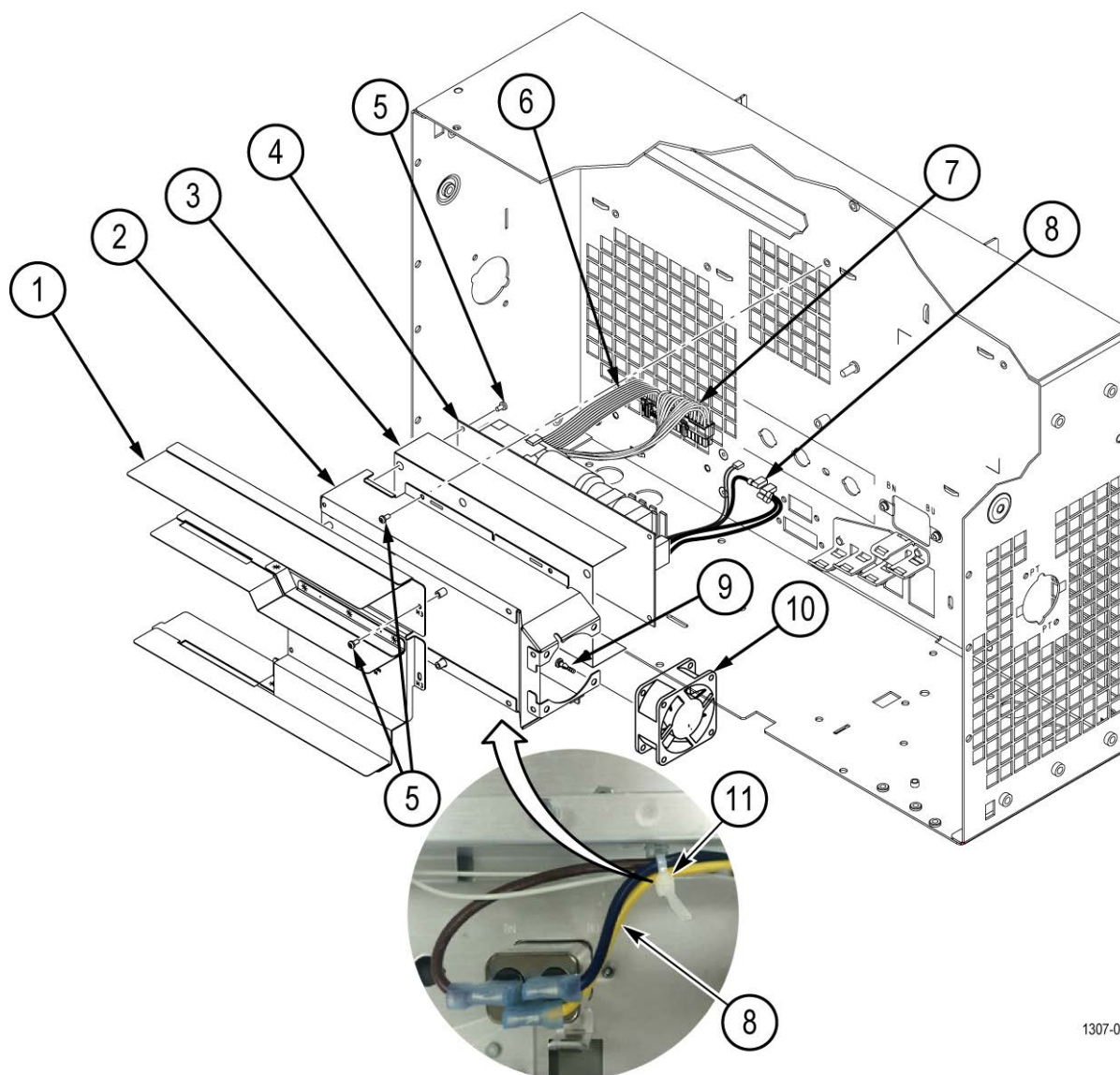

1307-010

Figure 6: Rear chassis baffle and power supply exploded view

Table 9: Baffle and power supply module

Index number	Tektronix part number	Qty	Name and description
Figure 6 on page 51			
-1	407-6242-XX	1	BRACKET, BAFFLE, SINGLE FAN, HYBRID
-2	407-5875-XX	1	BRACKET, POWER SUPPLY, 750W, SAFETY CONTROLLED
-3	337-4717-XX	1	SHIELD, MOUNT, POWER SUPPLY, SAFETY CONTROLLED

Table continued...

Replaceable parts

Index number	Tektronix part number	Qty	Name and description
-4	119-8375-XX	1	POWER SUPPLY; INTERNAL, AC-DC; 90-264VAC 47-63HZ, 103-127VAC 360-440HZ IN; +12V 44A, +12VSB 1.25A OUT; I2C, PSON, ACOK, PWRGOOD SIGNALS; SAFETY CONTROLLED, SAFETY CONTROLLED
-5	211-1584-XX	20	SCREW, MACHINE, M3 X 0.5 X 6MM PAN HEAD, TORX T10
-6	174-6612-XX	1	CABLE, POWER, PWR SUP TO CARRIER, SAFETY CONTROLLED
-7	174-6613-XX	1	CABLE, PS TO CARRIER, SIGNALS (2X6 DISCRETE, .100 CTRS, LATCHING), SAFETY CONTROLLED
-8	174-6614-XX	1	CABLE ASSEMBLY (LINE INPUT), SAFETY CONTROLLED
-9	348-2082-XX	4	GROMMET, FAN MOUNT, NOISE DAMPING
-10	119-8397-XX	1	FAN WITH 2X2 CONN, 60X25MM, 12V, SAFETY CONTROLLED
-11	343-0549-XX	1	STRAP, TIEDOWN; 0.098 W X 4.0 L, ZYTEL

Mid-plane chassis

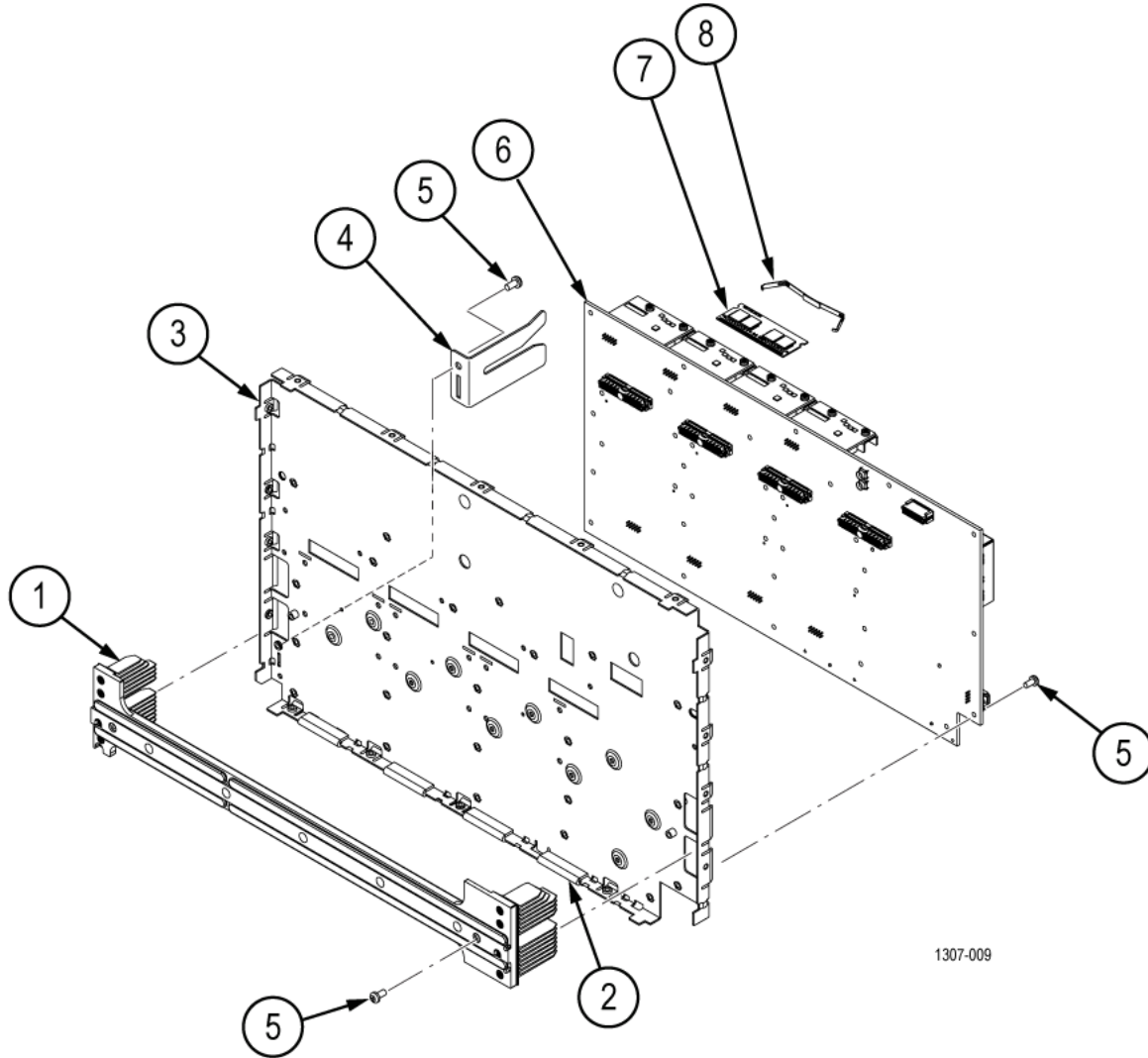

1307-009

Figure 7: Mid-plane chassis exploded view

Table 10: Mid-plane chassis

Index number	Tektronix part number	Qty	Name and description
<i>Figure 7</i> on page 53			
-1	214-5469-XX	1	HEATSINK, AFE 4-8 CHANNEL Return the instrument to Tektronix for service.
-2	348-2298-XX	4	GASKET, CONDUCTIVE FOAM W/PSA 12MM X 29MM X 1.5MM THICK
-3	441-2951-XX	1	ASSEMBLY, CHASSIS, MID-PLANE Return the instrument to Tektronix for service.

Table continued...

Replaceable parts

Index number	Tektronix part number	Qty	Name and description
-4	407-6020-XX	1	BRACKET, GUIDE, BAFFLE Return the instrument to Tektronix for service.
-5	211-1584-XX	20	SCREW, MACHINE, M3 X 0.5 X 6MM PAN HEAD, TORX T10
-6	870-1721-XX	1	CIRCUIT BOARD ASSY;MSO54B, 4CH MAIN, TESTED 8781721XX Return the instrument to Tektronix for service.
	870-1733-XX	1	CIRCUIT BOARD ASSY;MSO58B/56B, 8CH/6CH MAIN, TESTED 8781733XX Return the instrument to Tektronix for service.
-7	167-2568-XX	-	IC, MEMORY, DRAM; DDR3, 2GB 256MX72, DDR3-1866, ECC, SODIMM 204 Return the instrument to Tektronix for service.
		2	4 channel quantity
		4	6 and 8 channel quantity
-8	407-5956-XX	-	BRACKET, SO-DIMM RETENTION, ASSEMBLY Return the instrument to Tektronix for service.
		2	4 channel quantity
		4	6 and 8 channel quantity

Front panel and display

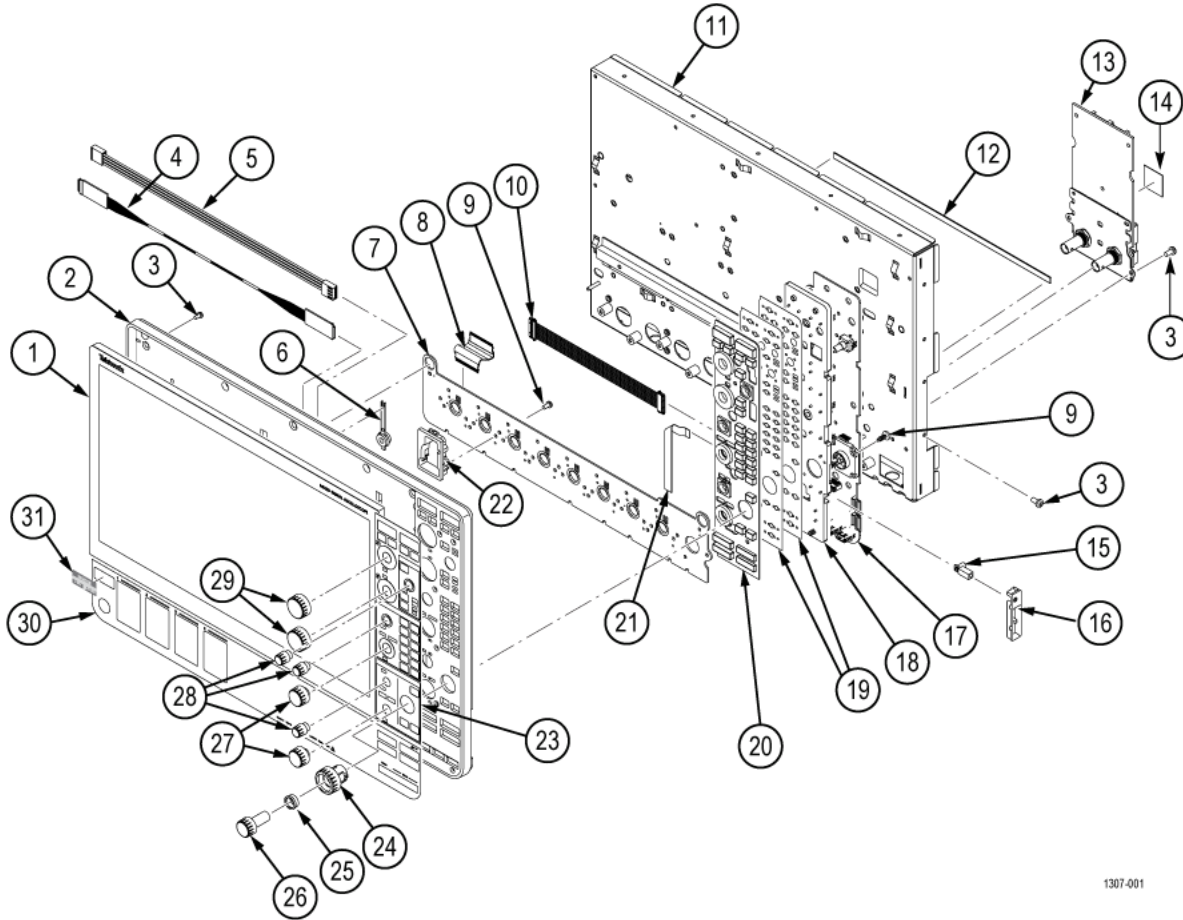

1307-001

Figure 8: Front panel and display exploded view

Table 11: Front panel and display

Index number	Tektronix part number	Serial no. effective	Qty	Name & description
<i>Figure 8</i> on page 55				
-1	119-8396-XX	Below B020000 Below C040000	1	TOUCHSCREEN-LCD ASSEMBLY, SAFETY CONTROLLED Return the instrument to Tektronix for service.
	065-1077-XX	B020000 and above C040000 and above	1	MODULE ASSY; SERVICE REPLACEMENT; 119910100 DISPLAY W/ MECHANICALS Return the instrument to Tektronix for service.
-2	202-0520-XX	Below B020000 Below C040000	1	CASE, FRONT, SAFETY CONTROLLED Return the instrument to Tektronix for service.
	202-0582-XX	B020000 and above C040000 and above	1	CASE, FRONT Return the instrument to Tektronix for service.

Table continued...

Index number	Tektronix part number	Serial no. effective	Qty	Name & description
-3	211-1584-XX		-	SCREW, MACHINE, M3 X 0.5 X 6MM PAN HEAD, TORX T10
			34	4 channel quantity
			40	6 channel quantity
			46	8 channel quantity
-4	174-6610-XX		1	CABLE ASSY, DISPLAY-FRONT PANEL Return the instrument to Tektronix for service.
-5	174-6698-XX	Below B020000 Below C040000	1	CABLE, TOUCH SCREEN TO FRONT PANEL Return the instrument to Tektronix for service.
	174-7244-XX	B020000 and above C040000 and above	1	CABLE, DISCRETE WIRE TOUCH CONTROLLER TO FRONT PANEL Return the instrument to Tektronix for service.
-6	366-0920-XX		1	BUTTON, POWER SWITCH, SAFETY CONTROLLED Return the instrument to Tektronix for service.
-7	878-1042-XX	Below B020000 Below C040000	1	CIRCUIT BD ASSY; PROBE INTERFACE; 389483000;UNTESTED Return the instrument to Tektronix for service.
	878-1717-XX	B020000 and above C040000 and above	1	CIRCUIT BOARD ASSY;PROBE INTERFACE, 3895488XX Return the instrument to Tektronix for service.
-8	174-7380-XX		-	CABLE, FLAT FLEX, SHIELD W/GND 0.5MM PITCH Return the instrument to Tektronix for service.
			2	4 channel quantity
			3	6 channel quantity
			4	8 channel quantity
-9	211-1585-XX		-	SCREW, 3 X 0.5 X 8.0 THREAD FORMING PAN HEAD, TORX T10
			43	4 channel quantity
			51	6 channel quantity
			59	8 channel quantity
-10	174-6879-XX		1	CABLE, PICO-LOCK, 10 PIN Return the instrument to Tektronix for service.
-11	441-2827-XX	Below B020000 Below C040000	1	CHASSIS, FRONT, SAFETY CONTROLLED Return the instrument to Tektronix for service.
	441-2941-XX	B020000 and above C040000 and above	1	CHASSIS, FRONT Return the instrument to Tektronix for service.
-12	348-2297-XX	B020000 and above C040000 and above	1	GASKET, CONDUCTIVE, FOF W/PSA 1MM X 7MM X 290MM

Table continued...

Index number	Tektronix part number	Serial no. effective	Qty	Name & description
-XXX	131-6417-XX		5	CONTACT, ELECTRICAL (GROUNDING) Return the instrument to Tektronix for service.
-13	870-1198-XX		-	CIRCUIT BD ASSY; CIRCUIT BOARD SUBASSY; 2GHZ ANALOG BOARD; 389499900; TESTED Return the instrument to Tektronix for service.
			2	4 channel quantity
			3	6 channel quantity
			4	8 channel quantity
	870-1039-XX		-	CIRCUIT BD ASSY; CIRCUIT BOARD SUBASSY; 350MHz-1GHz ANALOG BOARD; 389482700; TESTED Return the instrument to Tektronix for service.
			2	4 channel quantity
			3	6 channel quantity
			4	8 channel quantity
-14	253-0560-XX		-	THERMAL INTERFACE MATERIAL Return the instrument to Tektronix for service. Applies to models with 2GHz boards only. If Thermal Interface Material is removed during service replace it during reassembly.
			4	4 channel quantity
			6	6 channel quantity
			8	8 channel quantity
-15	131-9410-XX		1	CONNECTOR, RECEPTACLE, GROUND JACK Return the instrument to Tektronix for service.
-16	380-1277-XX		1	HOUSING, PROBE COMP Return the instrument to Tektronix for service.
-17	878-1145-XX		1	CIRCUIT BOARD SUBASSY; FRONT PANEL ENCODER BOARD, UNTESTED, 389493700 Return the instrument to Tektronix for service.
-18	361-1873-XX		1	SPACER, FRONT PANEL, SAFETY CONTROLLED Return the instrument to Tektronix for service.

Table continued...

Replaceable parts

Index number	Tektronix part number	Serial no. effective	Qty	Name & description
-19	065-1024-XX	Below B020000 Below C040000	1	MODULE ASSY: SERVICE REPLACEMENT KIT; FRONT PANEL 8781144XX AND 259022300 Return the instrument to Tektronix for service.
	065-1072-XX	B020000 and above C040000 and above	1	MODULE ASSY; SERVICE REPLACEMENT KIT; FRONT PANEL LED 8781719XX AND 2590245XX Return the instrument to Tektronix for service.
-20	260-3144-XX		1	SWITCH, KEYPAD, ELASTOMERIC Return the instrument to Tektronix for service.
-21	174-6880-XX		1	CABLE, FFC, FRONT-PANEL TO PIB Return the instrument to Tektronix for service.
-22	351-1150-XX		-	GUIDE, PROBE VPI PLUS Return the instrument to Tektronix for service.
			4	4 channel quantity
			6	6 channel quantity
			8	8 channel quantity
-23	335-3680-XX		1	MARKER IDENTIFICATION, LABEL FRONT PANEL, MSO, 4 CHANNEL, SAFETY CONTROLLED
	335-3678-XX		1	MARKER IDENTIFICATION, LABEL FRONT PANEL, MSO, 6 CHANNEL, SAFETY CONTROLLED
	335-3676-XX		1	MARKER IDENTIFICATION, LABEL FRONT PANEL, MSO, 8 CHANNEL, SAFETY CONTROLLED
-24	366-0946-XX		1	ASSEMBLY, KNOB, PAN WITH OVERMOLD
-25	358-0890-XX		1	BUSHING, SPACER, RING JOG-SHUTTLE
-26	366-0947-XX		1	ASSEMBLY, KNOB, ZOOM WITH OVERMOLD
-27	366-0944-XX		2	ASSEMBLY, KNOB, MEDIUM WITH OVERMOLD
-28	366-0943-XX		3	ASSEMBLY, KNOB, SMALL WITH OVERMOLD
-29	366-0945-XX		2	ASSEMBLY, KNOB, LARGE WITH OVERMOLD
-30	335-3681-XX		1	MARKER IDENTIFICATION, LABEL PROBE INTERFACE MSO 4CH, SAFETY CONTROLLED
	335-3679-XX		1	MARKER IDENTIFICATION, LABEL PROBE INTERFACE MSO 6CH, SAFETY CONTROLLED
	335-3678-XX		1	MARKER IDENTIFICATION, LABEL FRONT PANEL, MSO, 6 CHANNEL, SAFETY CONTROLLED

Table continued...

Index number	Tektronix part number	Serial no. effective	Qty	Name & description
-31	335-3682-XX		1	MARKER, IDENTIFICATION; LABEL NOMENCLATURE, MSO, 8 CH, 2GHZ, SAFETY CONTROLLED
	335-3683-XX		1	MARKER, IDENTIFICATION; LABEL NOMENCLATURE, MSO, 8CH, 1GHZ, SAFETY CONTROLLED
	335-3684-XX		1	MARKER, IDENTIFICATION; LABEL NOMENCLATURE, MSO, 8CH, 500MHZ, SAFETY CONTROLLED
	335-3685-XX		1	MARKER, IDENTIFICATION; LABEL NOMENCLATURE, MSO, 8CH, 350 MHZ, SAFETY CONTROLLED
	335-3686-XX		1	MARKER, IDENTIFICATION; LABEL NOMENCLATURE, MSO, 6CH, 2GHZ, SAFETY CONTROLLED
	335-3687-XX		1	MARKER, IDENTIFICATION; LABEL NOMENCLATURE, MSO, 6CH, 1GHZ, SAFETY CONTROLLED
	335-3688-XX		1	MARKER, IDENTIFICATION; LABEL NOMENCLATURE, MSO, 6CH, 500MHZ, SAFETY CONTROLLED
	335-3689-XX		1	MARKER, IDENTIFICATION; LABEL NOMENCLATURE, MSO, 6CH, 350MHZ, SAFETY CONTROLLED
	335-3690-XX		1	MARKER, IDENTIFICATION; LABEL NOMENCLATURE, MSO, 4CH, 2GHZ, SAFETY CONTROLLED
	335-3691-XX		1	MARKER, IDENTIFICATION; LABEL NOMENCLATURE, MSO, 4CH, 1GHZ, SAFETY CONTROLLED
	335-3692-XX		1	MARKER, IDENTIFICATION; LABEL NOMENCLATURE, MSO, 4CH, 500MHZ, SAFETY CONTROLLED
	335-3693-XX		1	MARKER, IDENTIFICATION; LABEL NOMENCLATURE, MSO, 4CH, 350MHZ, SAFETY CONTROLLED