

Model 7063 RF Switch Card

Instruction Manual

Contains Operating and Servicing Information

KEITHLEY

WARRANTY

Keithley Instruments, Inc. warrants this product to be free from defects in material and workmanship for a period of 1 year from date of shipment.

Keithley Instruments, Inc. warrants the following items for 90 days from the date of shipment: probes, cables, rechargeable batteries, diskettes, and documentation.

During the warranty period, we will, at our option, either repair or replace any product that proves to be defective.

To exercise this warranty, write or call your local Keithley representative, or contact Keithley headquarters in Cleveland, Ohio. You will be given prompt assistance and return instructions. Send the product, transportation prepaid, to the indicated service facility. Repairs will be made and the product returned, transportation prepaid. Repaired or replaced products are warranted for the balance of the original warranty period, or at least 90 days.

LIMITATION OF WARRANTY

This warranty does not apply to defects resulting from product modification without Keithley's express written consent, or misuse of any product or part. This warranty also does not apply to fuses, software, non-rechargeable batteries, damage from battery leakage, or problems arising from normal wear or failure to follow instructions.

THIS WARRANTY IS IN LIEU OF ALL OTHER WARRANTIES, EXPRESSED OR IMPLIED, INCLUDING ANY IMPLIED WARRANTY OF MERCHANTABILITY OR FITNESS FOR A PARTICULAR USE. THE REMEDIES PROVIDED HEREIN ARE BUYER'S SOLE AND EXCLUSIVE REMEDIES.

NEITHER KEITHLEY INSTRUMENTS, INC. NOR ANY OF ITS EMPLOYEES SHALL BE LIABLE FOR ANY DIRECT, INDIRECT, SPECIAL, INCIDENTAL OR CONSEQUENTIAL DAMAGES ARISING OUT OF THE USE OF ITS INSTRUMENTS AND SOFTWARE EVEN IF KEITHLEY INSTRUMENTS, INC., HAS BEEN ADVISED IN ADVANCE OF THE POSSIBILITY OF SUCH DAMAGES. SUCH EXCLUDED DAMAGES SHALL INCLUDE, BUT ARE NOT LIMITED TO: COSTS OF REMOVAL AND INSTALLATION, LOSSES SUSTAINED AS THE RESULT OF INJURY TO ANY PERSON, OR DAMAGE TO PROPERTY.



Keithley Instruments, Inc. • 28775 Aurora Road • Cleveland, OH 44139 • 440-248-0400 • Fax: 440-248-6168 • <http://www.keithley.com>

BELGIUM: Keithley Instruments B.V.
CHINA: Keithley Instruments China
FRANCE: Keithley Instruments Sarl
GERMANY: Keithley Instruments GmbH
GBRAT BRITAIN: Keithley Instruments Ltd
INDIA: Keithley Instruments GmbH
ITALY: Keithley Instruments s.r.l.
NETHERLANDS: Keithley Instruments B.V.
SWITZERLAND: Keithley Instruments SA
TAIWAN: Keithley Instruments Taiwan

Bergenseesteeuweg 709 • B-1600 Sint-Pieters-Leeuw • 02/363 00 40 • Fax: 02/363 00 64
Yuan Chen Xin Building, Room 705 • 12 Yuanlin Road, Dewai, Madian • Beijing 100029 • 8610-62022886 • Fax: 8610-62022892
B.P. 60 • 3, allée des Garays • 91122 Palaiseau Cédex • 01 64 53 20 20 • Fax: 01 60 11 77 26
Landaberger Strasse 65 • D-82110 Glemming • 089/84 93 07-40 • Fax: 089/84 93 07-34
The Minster • 58 Portman Road • Reading, Berkshire RG30 1BA • 0118-9 57 56 66 • Fax: 0118-9 59 64 69
Piat 2B, WIL.OCRISSA • 14, Rest House Crescent • Bangalore 560 001 • 91-80-509-1320/21 • Fax: 91-80-509-1322
Viale S. Oaagnano, 38 • 20146 Milano • 02/48 30 30 08 • Fax: 02/48 30 22 74
Postbus 359 • 4200 AN Gorinchem • 0183-635313 • Fax: 0183-650821
Kriesbacherstrasse 4 • 86600 Dillendorf • 01-821 94 44 • Fax: 01-820 30 81
1 Fl. 85 Po Ai Street • Hsinchu, Taiwan, R.O.C. • 886-3572-9077 • Fax: 886-3572-9031

Model 7063 RF Switch Card Instruction Manual

©1984, Keithley Instruments, Inc.
All rights reserved.
Cleveland, Ohio, U.S.A.
December 1984, First Printing
Document Number: 7063-901-01 Rev. A

Safety Precautions

The following safety precautions should be observed before using this product and any associated instrumentation. Although some instruments and accessories would normally be used with non-hazardous voltages, there are situations where hazardous conditions may be present.

This product is intended for use by qualified personnel who recognize shock hazards and are familiar with the safety precautions required to avoid possible injury. Read the operating information carefully before using the product.

The types of product users are:

Responsible body is the individual or group responsible for the use and maintenance of equipment, for ensuring that the equipment is operated within its specifications and operating limits, and for ensuring that operators are adequately trained.

Operators use the product for its intended function. They must be trained in electrical safety procedures and proper use of the instrument. They must be protected from electric shock and contact with hazardous live circuits.

Maintenance personnel perform routine procedures on the product to keep it operating, for example, setting the line voltage or replacing consumable materials. Maintenance procedures are described in the manual. The procedures explicitly state if the operator may perform them. Otherwise, they should be performed only by service personnel.

Service personnel are trained to work on live circuits, and perform safe installations and repairs of products. Only properly trained service personnel may perform installation and service procedures.

Exercise extreme caution when a shock hazard is present. Lethal voltage may be present on cable connector jacks or test fixtures. The American National Standards Institute (ANSI) states that a shock hazard exists when voltage levels greater than 30V RMS, 42.4V peak, or 60VDC are present. **A good safety practice is to expect that hazardous voltage is present in any unknown circuit before measuring.**

Users of this product must be protected from electric shock at all times. The responsible body must ensure that users are prevented access and/or insulated from every connection point. In some cases, connections must be exposed to potential human contact. Product users in these circumstances must be trained to protect themselves from the risk of electric shock. If the circuit is capable of operating at or above 1000 volts, **no conductive part of the circuit may be exposed.**

As described in the International Electrotechnical Commission (IEC) Standard IEC 664, digital multimeter measuring circuits (e.g., Keithley Models 175A, 199, 2000, 2001, 2002, and 2010) are Installation Category II. All other instruments' signal terminals are Installation Category I and must not be connected to mains.

Do not connect switching cards directly to unlimited power circuits. They are intended to be used with impedance limited sources. **NEVER** connect switching cards directly to AC mains. When connecting sources to switching cards, install protective devices to limit fault current and voltage to the card.

Before operating an instrument, make sure the line cord is connected to a properly grounded power receptacle. Inspect the connecting cables, test leads, and jumpers for possible wear, cracks, or breaks before each use.

For maximum safety, do not touch the product, test cables, or any other instruments while power is applied to the circuit under test. **ALWAYS** remove power from the entire test system and discharge any capacitors before: connecting or disconnecting cables or jumpers, installing or

removing switching cards, or making internal changes, such as installing or removing jumpers. Do not touch any object that could provide a current path to the common side of the circuit under test or power line (earth) ground. Always make measurements with dry hands while standing on a dry, insulated surface capable of withstanding the voltage being measured.

The instrument and accessories must be used in accordance with its specifications and operating instructions or the safety of the equipment may be impaired.

Do not exceed the maximum signal levels of the instruments and accessories, as defined in the specifications and operating information, and as shown on the instrument or test fixture panels, or switching card.

When fuses are used in a product, replace with same type and rating for continued protection against fire hazard.

Chassis connections must only be used as shield connections for measuring circuits, NOT as safety earth ground connections.

If you are using a test fixture, keep the lid closed while power is applied to the device under test. Safe operation requires the use of a lid interlock.

If a  screw is present, connect it to safety earth ground using the wire recommended in the user documentation.

The  symbol on an instrument indicates that the user should refer to the operating instructions located in the manual.

The  symbol on an instrument shows that it can source or measure 1000 volts or more, including the combined effect of normal and common mode voltages. Use standard safety precautions to avoid personal contact with these voltages.

The **WARNING** heading in a manual explains dangers that might result in personal injury or death. Always read the associated information very carefully before performing the indicated procedure.

The **CAUTION** heading in a manual explains hazards that could damage the instrument. Such damage may invalidate the warranty.

Instrumentation and accessories shall not be connected to humans.

Before performing any maintenance, disconnect the line cord and all test cables.

To maintain protection from electric shock and fire, replacement components in mains circuits, including the power transformer, test leads, and input jacks, must be purchased from Keithley Instruments. Standard fuses, with applicable national safety approvals, may be used if the rating and type are the same. Other components that are not safety related may be purchased from other suppliers as long as they are equivalent to the original component. (Note that selected parts should be purchased only through Keithley Instruments to maintain accuracy and functionality of the product.) If you are unsure about the applicability of a replacement component, call a Keithley Instruments office for information.

To clean an instrument, use a damp cloth or mild, water based cleaner. Clean the exterior of the instrument only. Do not apply cleaner directly to the instrument or allow liquids to enter or spill on the instrument. Products that consist of a circuit board with no case or chassis (e.g., data acquisition board for installation into a computer) should never require cleaning if handled according to instructions. If the board becomes contaminated and operation is affected, the board should be returned to the factory for proper cleaning/servicing.

SPECIFICATIONS

7063 RF SWITCH CARD

SWITCHES PER CARD: 2 (with isolated grounds).
CHANNELS PER SWITCH: 5
SWITCH CONFIGURATION: 1-pole, 5 throw.
EXPANSION: A through connector is provided for cascading switches.
CONNECTOR TYPE: BNC.
DRIVE CURRENT: 200mA typical per channel.
ACTUATION TIME: 10ms (exclusive of mainframe).
RELEASE TIME: 8mS.
CHARACTERISTIC IMPEDANCE: 50 Ω .
TERMINATIONS: 50 Ω on unselected channels.
PROPAGATION DELAY: <2ns typical.

	< 20MHz	< 250MHz	< 500MHz
Insertion Loss	< 0.1db	< 1.0db	< 3.0db
Isolation:			
Channel-Channel	> 75db	> 60db	> 55 db
Switch-Switch	> 80db	> 65db	> 60db
VSWR	1:1 to 1 max.		

SIGNAL LEVEL (switched): 5V AC + DC rms; 50mA; 0.5 watt maximum.
CONTACT LIFE: > 10⁵ closures at maximum signal levels.
CONTACT RESISTANCE: < 2 Ω input to output.
THERMAL OFFSET: < 20 μ V.

GENERAL

OPERATING ENVIRONMENT: 0° to 50°C, up to 35°C at 70% RH.
STORAGE ENVIRONMENT: -25 to 65°C.
DIMENSIONS, WEIGHT: 32mm high \times 114mm wide \times 278mm long (1 $\frac{1}{4}$ " \times 4 $\frac{1}{2}$ " \times 11"), net weight 0.66kg (1 lb, 7 oz.).

TABLE OF CONTENTS

SECTION 1—GENERAL INFORMATION

1.1	Introduction	1
1.2	Warranty Information	1
1.3	Manual Addenda	1
1.4	Safety Symbols and Terms	2
1.5	Unpacking and Inspection	2
1.6	Specifications	2

SECTION 2—OPERATION

2.1	Introduction	3
2.2	Safety Precautions	3
2.3	Wiring	3
2.3.1	1 of 11 Switch	4
2.3.2	1 of 11 Matrix	6
2.4	Installation	8
2.4.1	Removal	8
2.5	Operation	8
2.6	Switch Terminology	10

SECTION 3—SERVICE INFORMATION

3.1	Introduction	13
3.2	Required Test Equipment	13
3.3	Performance Verification Procedure	14
3.3.1	Insertion Loss	14
3.3.2	Channel Isolation	14

SECTION 4—REPLACEABLE PARTS

4.1	Introduction	17
4.2	Replaceable Parts	17
4.3	Ordering Information	17
4.4	Factory Service	17
4.5	Component Layout and Schematic Diagram	17

LIST OF ILLUSTRATIONS

2-1	Simplified 7063 Diagram	5
2-2	1 of 11 Switch	7
2-3	Switch Terminology	12
3-1	Insertion Loss Test Set Up	14
4-1	Component Layout	20
4-2	Schematic Diagram	21

LIST OF TABLES

2-1	Connector/Mainframe Display Relationship	9
2-2	Model 706 Connector/Channel Assignment	11
2-3	Model 705 Connector/Channel Assignment	12
3-1	Recommended Test Equipment	13
4-1	Model 7063 Replacable Parts	18

SECTION 1 GENERAL INFORMATION

1.1 INTRODUCTION

The Model 7063 is an RF scanner card that switches RF signals (up to 500MHz) from one channel to another. All channels switched are terminated into 50Ω when not selected. When a channel is closed, the RF signal is routed from the input to the output. The Model 7063 works in conjunction with a scanner mainframe such as the Keithley Model 705 or Model 706.

The Model 7063 incorporates two 1×5 , switches on each card. Each switch has a separate common (ground). This allows two signals to be switched at the same time. One 1×5 switch could be cascaded with the other 1×5 switch (on the same card) for a 1×10 switch configuration. Thus, the Model 7063 is configurable for several different switch configurations.

Specified relay life is greater than 100,000 closures. Cables are routed from the rear of the card. The front plugs into the mainframe (e.g. Model 705 or Model 706). The mainframe must be in the matrix mode or 2-pole mode to operate the channels on the Model 7063 card. BNC connectors allow easy connections to input/output signal paths.

1.2 WARRANTY INFORMATION

Warranty information is stated on the inside front cover of this manual. If there is a need for service, contact the Keithley representative or authorized repair facility in your area. Check the back cover for addresses. The service form supplied at the end of the manual should be used to provide the service facility with adequate information concerning any difficulty.

1.3 MANUAL ADDENDA

Improvements or changes to this manual will be explained on an addendum included with the manual. It is recommended that this information be incorporated immediately into the appropriate places in the manual.

If an additional instruction manual is required, order the manual package (Keithley Part Number 7063-901-00). The manual package includes an instruction manual and all pertinent addenda.

1.4 SAFETY SYMBOLS AND TERMS

The symbol  denotes that the user should refer to the operating instructions.

The symbol  denotes that a high voltage may be present on the terminal(s).

The **WARNING** used in this manual explains dangers that could result in personal injury or death.

The **CAUTION** used in this manual explains hazards that could damage the instrument.

1.5 UNPACKING AND INSPECTION

The Model 7063 is inspected both electrically and mechanically before shipment. Upon receiving the Model 7063, unpack all items from the shipping container and check for any obvious damage that may have occurred during transit. Report any damage to the shipping agent. Retain and use the original packaging materials in case reshipment is necessary. The following items are shipped with every Model 7063:

Model 7063 Scanner Card
Model 7063 Instruction Manual

1.6 SPECIFICATIONS

For detailed specifications, refer to the specifications that precede this section.

SECTION 2 OPERATION

2.1 INTRODUCTION

This section provides the information necessary to use the Model 7063 with an appropriate Keithley scanner mainframe such as the Model 705 or Model 706. Once the card is configured and placed in the appropriate slot in the scanner mainframe, refer to the scanner mainframe's instruction manual for complete operating details. This section is divided into five parts: Safety Precautions, Wiring, Installation, Operation and Switch Terminology.

2.2 SAFETY PRECAUTIONS

1. Make sure the scanner mainframe is grounded through a properly earth grounded receptacle before operation.
2. Inspect all test lead connections for wear and defects such as cracks, exposed wires, (etc). Correct any defect found before operating the scanner card with the mainframe.
3. Do not exceed the Model 7063's maximum allowable signal level as defined in the specifications.
4. Turn off all power supplies and discharge any residual power before installing or removing the Model 7063 from the scanner mainframe.
5. Turn off all power supplies and discharge any residual power before installing or removing any wires from the Model 7063.

2.3 WIRING

Each channel on the Model 7063 consists of two single pole, Form C relays and a 50Ω terminating resistor. The 50Ω terminating resistor consists of two 100Ω resistors in parallel. Having two resistors in parallel reduces the overall inductance of the resistors at higher frequencies. Input/output connections should be made using a high quality 50Ω coaxial cable with a standard male BNC connector on the Model 7063 end. Wiring diagram nomenclature is contained on schematic diagram 7063-106 located at the end of this manual.

Cables are routed to the rear of the card, while the front plugs into the scanner mainframe (e.g. Model 705 or Model 706). The mainframe must be in the matrix mode or the 2-pole mode to operate the

channels on the Model 7063 card. Refer to Tables 2-1 and 2-2. To configure a card for operation, it must have a minimum of two connections. These two connections are listed as follows:

1. Input
2. Output

In general:

1. The input is the signal path that is switch to one of several points. The selected output is the path (channel) to which the input is switched.
2. The output is the selection of one of several sources. Any of seven inputs selected can be routed to the output for measurement or processing. The 1×5 switch has six inputs which consist of five channel selects and a through connection. The through connector may be left open or connected to a source or terminator.

NOTE

Keep in mind that when a channel is open it is terminated through 50Ω to ground.

2.3.1 1×5 Switch

With a 1×5 switch, the Model 7063 can switch one signal to any one of five signal paths. Also, any one of five channels can be switched to one signal path. Using the through connection as a sixth channel (1 of 6) any one of six inputs can switch to one output. Also, one input can be switched to any of six outputs. For example: Switch 1 OUT/IN can switch a signal to channels 1-1, 2-1, 3-1, 4-1 and 5-1. Also, channels 1-1, 2-1, 3-1, 4-1 or 5-1 can switch to SWITCH 1 OUT/IN. Only one channel will switch at a time on a 1×5 switch.

The Model 7063 incorporates two 1×5 switches so that two signals can be switch at the same time. Each of the 1×5 switches incorporates a separate common (ground). For example: SWITCH 1 OUT/IN can switch a signal to channels 1-1, 2-1, 3-1, 4-1 or 5-1; while SWITCH 2 OUT/IN switches another signal to channels 1-2, 2-2, 3-2, 4-2 or 5-2. Refer to Figure 2-1.

The advantage of using the 1×5 switch is that one channel will access any one of five outputs. Also, one of five channels will access one output. There are two separate 1×5 switches on each Model 7063. This allows two separate signals to be switched simultaneously.

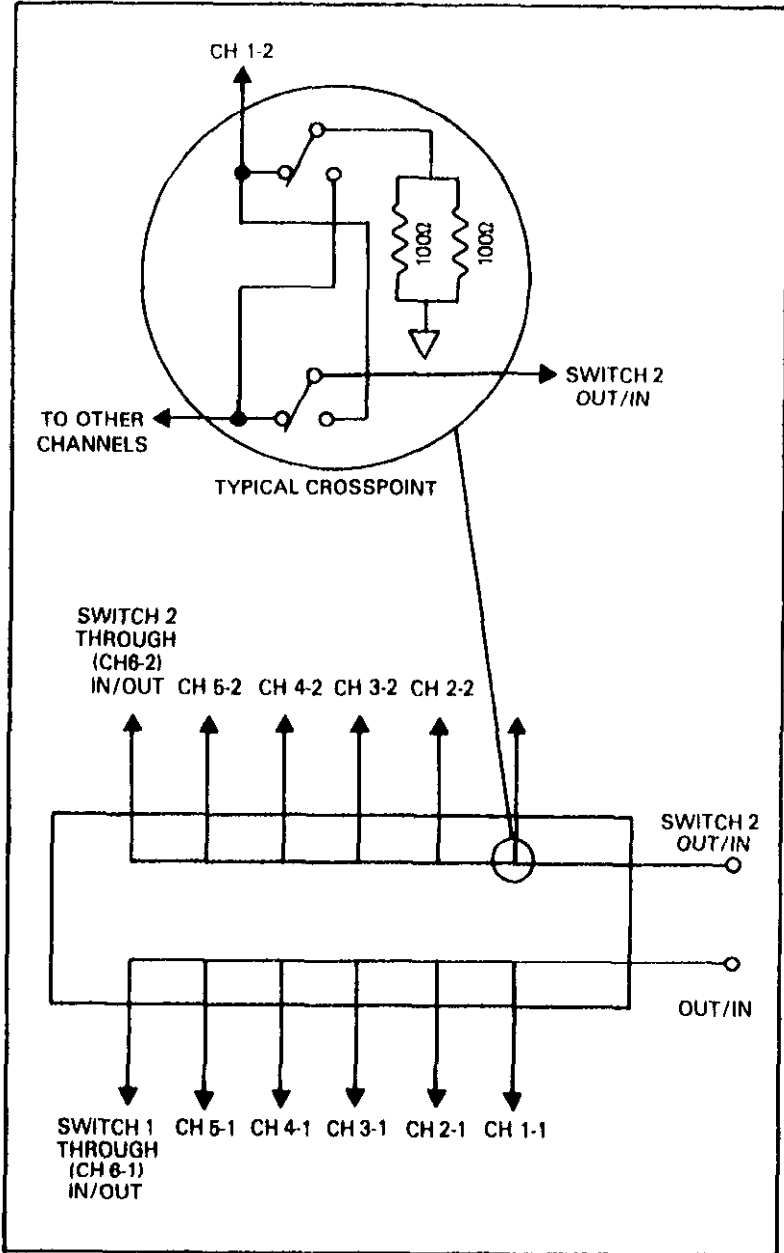

Figure 2-1. Simplified 7063 Diagram

To operate the channels (open or close) once they are configured, plug the scanner card into the scanner mainframe and consult the scanner mainframe's instruction manual for complete details.

CAUTION

Do not exceed the voltage and frequency specifications of the Model 7063 scanner card. Instrument damage may occur.

2.3.2 1 of 11 Switch

The Model 7063 can be configured as a 1 of 11 switch. To configure the 1 of 11 switch, SWITCH 1 THROUGH IN/OUT must be connected to SWITCH 2 OUT/IN (J1007 connected to J1008). Another possible 1 of 11 switch is SWITCH 2 THROUGH IN/OUT connected to SWITCH 1 OUT/IN (J1014 connected to J1001). In either of these configurations one channel can be switched to any one of 11 signal paths. Also, any one of 11 channels can be switched to one signal path. For example; SWITCH 1 OUT/IN will switch to any one of the following channels:

1. CH1-1
2. CH2-1
3. CH3-1
4. CH4-1
5. CH5-1
6. CH1-2
7. CH2-2
8. CH3-2
9. CH4-2
10. CH5-2
11. CH6-2

Refer to Tables 2-1 and 2-2. Refer to schematic diagram 7063-106 at the end of this manual.

In another example, if SWITCH 1 OUT/IN is connected to SWITCH 2 THROUGH IN/OUT (J1001 connected to J1014), then SWITCH 2 OUT/IN will switch to any one of the following channels:

1. CH1-1
2. CH2-1
3. CH3-1
4. CH4-1
5. CH5-1
6. CH6-1
7. CH1-2
8. CH2-2
9. CH3-2
10. CH4-2
11. CH5-2

The advantage of cascading the two 1×5 switches is that one channel can access any one of 11 channels instead of one of five channels. Refer to Figure 2-2.

To operate the channels (open or close) once they are configured, plug the Model 7063 into the scanner mainframe and consult the mainframe's instruction manual for details. The mainframe must be in the matrix mode or the 2-pole mode to operate the channels on the Model 7063 card.

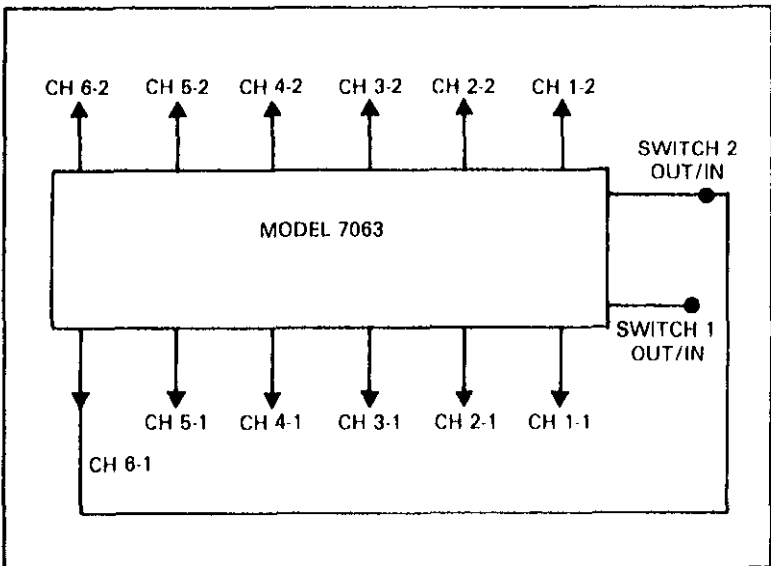

Figure 2-2. 1 of 11 Switch

2.4 INSTALLATION

WARNING

Turn off the mainframe and disconnect all other equipment from the scanner card before installing/removing the card.

Before installing the Model 7063 into the scanner mainframe, it must be wired with the desired configuration. Refer to paragraph 2.3. Once the card is configured, install it into the scanner mainframe. Plug the scanner card into the appropriate slot in the rear panel of the mainframe. In some mainframes, the scanner card is placed horizontally into the unit. The cards are labeled top or bottom. In other mainframes, the scanner cards are placed vertically in the unit and numbered 1-10. The scanner card is placed in the mainframe with the card edge first. Align the card with the grooves in the slot and insert the card to its full depth into the mainframe. Make sure the card is properly seated into the connector in the mainframe. When the card is fully inserted, the locking tabs should be pushed forward to the center of the card to lock it in the mainframe.

NOTE

Refer to the scanner mainframe's instruction manual for complete details.

2.4.1 Removal

To remove a scanner card, first turn off the mainframe and all other equipment connected to the card. Unfasten the locking tabs on the card by pulling the tab outward. Grasp the end of the card and carefully pull it out of the mainframe.

2.5 OPERATION

Model 7063 operation consists of two parts:

1. Wiring the Model 7063 for the desired configuration.
2. Mainframe control of the channels.

Refer to paragraph 2.3 for wiring information. Refer to the scanner mainframe for information concerning the control of the channels.

Refer to Table 2-1 for Model 7063 connector/mainframe relationship. The scanner mainframe must be in the matrix mode (Program 6, pole 0) or the 2-pole mode (Program 6, pole 2) to operate the channels of the Model 7063 card.

Table 2-1. Connector/Mainframe Display Relationship

7063 Connector	Matrix Mode *Mainframe Display		2-Pole Mode †Mainframe Display	
	706	705	706	705
J1002	001 1	01 1	001	01
J1003	002 1	02 1	002	02
J1004	003 1	03 1	003	03
J1005	004 1	04 1	004	04
J1006	005 1	05 1	005	05
J1007	**	**	**	**
J1009	001 2	01 2	006	06
J1010	002 2	02 2	007	07
J1011	003 2	03 2	008	08
J1012	004 2	04 2	009	09
J1013	005 2	05 2	010	10
J1014	***	***	***	***

*Mainframe must be in the matrix mode (Program 6, pole 0).
Use with separate 1 × 5 switches.

**Channel 6-1 is normally closed.

***Channel 6-2 is normally closed.

†Mainframe must be in the 2-pole mode (Program 6, pole 2).

Use when the card is connected as a 1 × 10 or larger switch.

The preceding connector/channel assignment is for slot 1 of the Model 706 and top card slot of the Model 705. More channels are available when connecting several Model 7063 cards and several mainframes together. The Model 705 has two card slots. This means that for every Model 706 a matrix of 1 of 21 could be constructed. With a maximum of five Model 705s daisy chained, a switch of 1 of 101 could be constructed.

NOTE

The frequency response for the larger switching schemes is not as good as a single 1×5 switch.

The Model 706 has 10 card slots. This means that for every Model 706 a switch of 1 of 101 could be constructed. With a maximum of five Model 706s daisy chained, a switch of 1 of 1001 could be constructed.

NOTE

Refer to the mainframe's instruction manual for information concerning daisy chain operation.

To construct such a large switching scheme, 50 Model 7063 cards and five Model 706 mainframes are required. Connections between the cards and mainframes is accomplished using the following format.

Connect card 1, CH6-1 to SWITCH 2. To connect one card to another, connect card 1, CH6-2 to card 2, SWITCH 1. The rest of the cards are wired in the same manner. The connector/channel assignment for the larger configurations are described in Tables 2-2 and 2-3.

2.6 SWITCH TERMINOLOGY

Throughout this manual the terminology Form C is used. The term Form C is used in switch terminology and is described as follows:

1. Form A is a single pole normally open (SPNO) switch. Refer to Figure 2-3. Example: A 2-pole switch normally open is classified as a 2 Form A.
2. Form B is similar to Form A except that its contacts are normally closed. Refer to Figure 2-3. Example: A 2-pole switch that is normally closed is classified as a 2 Form B.
3. Form C is shown in Figure 2-3 as a single pole double throw switch. It could also be a multiple switch such as a 2-pole. This would be classified as a 2 Form C.

Table 2-2. Model 706 Connector/Channel Assignment

*Matrix Mode					
Card #	Master	Slave #1	Slave #2	Slave #3	Slave #4
1	001-005	051-055	101-105	151-155	201-205
2	006-010	056-060	106-110	156-160	206-210
3	011-015	061-065	111-115	161-165	211-215
4	016-020	066-070	116-120	166-170	216-220
5	021-025	071-075	121-125	171-175	221-225
6	026-030	076-080	126-130	176-180	226-230
7	031-035	081-085	131-135	181-185	231-235
8	036-040	086-090	136-140	186-190	236-240
9	041-045	091-095	141-145	191-195	241-245
10	046-050	096-100	146-150	196-200	246-250
**2-Pole Mode					
1	001-010	101-110	201-210	301-310	401-410
2	011-020	111-120	211-220	311-320	411-420
3	021-030	121-130	221-230	321-330	421-430
4	031-040	131-140	231-240	331-340	431-440
5	041-050	141-150	241-250	341-350	441-450
6	051-060	151-160	251-260	351-360	451-460
7	061-070	161-170	261-270	361-370	461-470
8	071-080	171-180	271-280	371-380	471-480
9	081-090	181-190	281-290	381-390	481-490
10	091-100	191-200	291-300	391-400	491-500

*For each of the connector/channel assignments there are two channels. These are the - 1 and the - 2 channels. Refer to the schematic diagram 7062-106. Also, the matrix mode must be used when using separate 1 × 5 switches.

**The 2-pole mode must be used when the card is connected as a 1 × 10 or larger switch.

Table 2-3. Model 705 Connector/Channel Assignment

Matrix Mode					
Card #	Master	Slave #1	Slave #2	Slave #3	Slave #4
Top	01-05	11-15	21-25	31-35	41-45
Bottom	06-10	16-20	26-30	36-40	46-50
2-Pole Mode					
Top	01-10	21-30	41-50	61-70	81-90
Bottom	11-20	31-40	51-60	71-80	91-100

*For each of the connector/channel assignments there are two channels. These are the -1 and the -2 channels. Refer to the schematic diagram 7062-106. Also, the matrix mode must be used when using separate 1 × 5 switches.

**2-pole mode must be used when using connected 1 × 10 or larger switches.

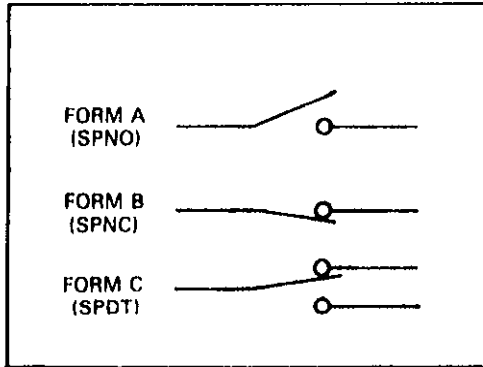

Figure 2-3. Switch Terminology

SECTION 3 SERVICING INFORMATION

3.1 INTRODUCTION

This section contains a performance verification procedure. Since there are no calibration adjustments, calibration is not necessary. Recommended maintenance includes inspection of the scanner card and the card edge connector to ensure good electrical contact. The verification procedure should be performed upon receipt of the scanner card or at the time maintenance is performed on the card.

3.2 REQUIRED TEST EQUIPMENT

Recommended test equipment for performance verification is provided in Table 3-1. Test equipment other than the recommended equipment may be substituted if specifications equal or exceed the stated specifications in Table 3-1.

Table 3-1. Recommended Test Equipment

Item	Description	Specification	Mfg.	Model
A	Scanner Mainframe	—	Keithley	705 or 706
B	Network Analyzer	0-1GHz	H-P	8754A
C	Transmission/ Reflection Test Set	—	H-P	8502A
D	Cable Set	—	H-P	11851A
E	RF-Scanner Card	—	Keithley	7063

The performance verification procedure should be performed in an environment of 23°C ±3°C and a relative humidity of less than 80%.

3.3 PERFORMANCE VERIFICATION PROCEDURE

This section gives several necessary procedures to verify operation of Model 7063 is within specifications.

3.3.1 Insertion Loss

NOTE

For this test the operator must be familiar with operating the recommended network analyzer.

1. The equipment required for this test includes: the Model 7063, scanner mainframe and a network analyzer.
2. Set up the configuration shown in Figure 3-1.
3. Turn on the power to the equipment and let it warm up.
4. Calibrate the set up by following the recommended procedure in the Model 8754A Instruction Manual.
5. Close channel CH1-1 and note the loss in dB at 20MHz, 50MHz, 250MHz and 500MHz. The loss should be less than 0.1dB at 20MHz, 0.2dB at 50MHz, 1dB at 250MHz and 3dB at 500MHz.

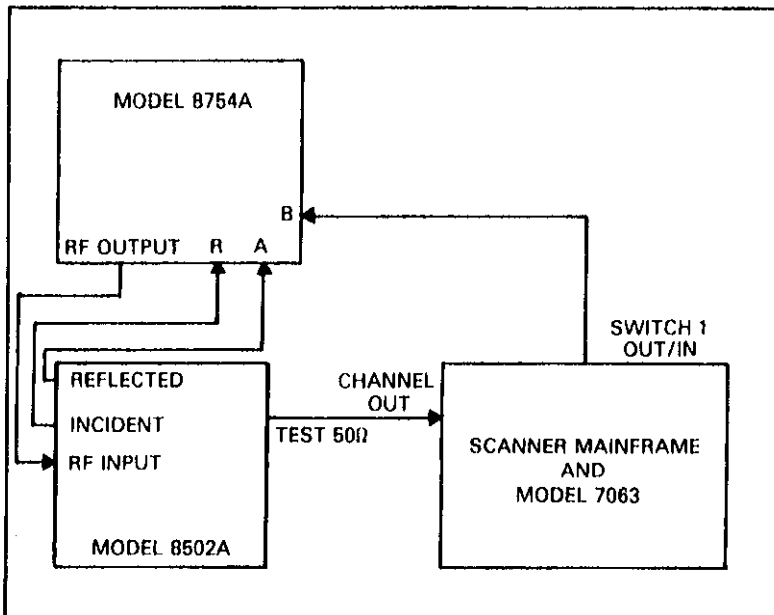

Figure 3-1. Insertion Loss Test Set Up

3.3.2 Channel Isolation

NOTE

For this test the operator must be familiar with operating the recommended network analyzer.

1. The equipment required for this test includes: the Model 7062, scanner mainframe and a network analyzer.
2. Set up the configuration shown in Figure 3-1. Connect the 50 Ω test to CH1-1. Connect B on the Model 8754A to CH1-2.
3. Turn on the power to the equipment and let it warm up.
4. Calibrate the set up as described in the Model 8754A Instruction Manual.
5. Open CH1-1 and note the isolation at 20MHz, 250MHz and 500MHz. The isolation should be greater than 75dB at 20MHz, 60dB at 250MHz and 55dB at 500MHz.
6. Repeat step 5 for each channel on the card.

SECTION 4 REPLACEABLE PARTS

4.1 INTRODUCTION

This section contains replacement parts information, a schematic diagram and a component layout for the Model 7063.

4.2 REPLACEABLE PARTS

Parts are listed alpha-numerically in order of their circuit designation. Table 4-1 contains parts list information for the Model 7063.

4.3 ORDERING INFORMATION

To place an order or to obtain information concerning replacement parts, contact your Keithley representative or the factory. See the back cover for addresses. When ordering include the following information:

1. Instrument Model Number
2. Instrument Serial Number
3. Part Description
4. Circuit Description (if applicable)
5. Keithley Part Number

4.4 FACTORY SERVICE

If the instrument is to be returned for service, photo copy and complete the service form which follows this section and return it with the instrument.

4.5 COMPONENT LAYOUT AND SCHEMATIC DIAGRAM

Figure 4-1 contains a component layout of the Model 7063. Figure 4-2 contains a schematic diagram of the Model 7063.

Table 4-1. Model 7063 Replaceable Parts

Circuit Desig.	Description	Keithley Part No.
C101	Not Used	
C102	Capacitor, 0.1 μ F, 50V, Ceramic Film	C-237-0.1
C103	Capacitor, 0.1 μ F, 50V, Ceramic Film	C-237-0.1
C104	Capacitor, 0.1 μ F, 50V, Ceramic Film	C-237-0.1
C105	Capacitor, 0.1 μ F, 50V, Ceramic Film	C-237-0.1
J1001	Connector, BNC, right angle	CS-503
J1002	Connector, BNC, right angle	CS-503
J1003	Connector, BNC, right angle	CS-503
J1004	Connector, BNC, right angle	CS-503
J1005	Connector, BNC, right angle	CS-503
J1006	Connector, BNC, right angle	CS-504
J1007	Connector, BNC, right angle	CS-504
J1008	Connector, BNC, right angle	CS-503
J1009	Connector, BNC, right angle	CS-503
J1010	Connector, BNC, right angle	CS-503
J1011	Connector, BNC, right angle	CS-503
J1012	Connector, BNC, right angle	CS-503
J1013	Connector, BNC, right angle	CS-504
J1014	Connector, BNC, right angle	CS-504
K101	Relay	RL-91
K102	Relay	RL-91
K103	Relay	RL-91
K104	Relay	RL-91
K105	Relay	RL-91
K106	Relay	RL-91
K107	Relay	RL-91
K108	Relay	RL-91
K109	Relay	RL-91
K110	Relay	RL-91
K111	Relay	RL-91
K112	Relay	RL-91
K113	Relay	RL-91
K114	Relay	RL-91
K115	Relay	RL-91
K116	Relay	RL-91
K117	Relay	RL-91
K118	Relay	RL-91
K119	Relay	RL-91
K120	Relay	RL-91
L101	Choke	CH-16

Table 4-1. Model 7063 Replaceable Parts

Circuit Desig.	Description	Keithley Part No.
R101	Resistor, 100, 5%, ¼W, Composition	R-331-100
R102	Resistor, 100, 5%, ¼W, Composition	R-331-100
R103	Resistor, 100, 5%, ¼W, Composition	R-331-100
R104	Resistor, 100, 5%, ¼W, Composition	R-331-100
R105	Resistor, 100, 5%, ¼W, Composition	R-331-100
R106	Resistor, 100, 5%, ¼W, Composition	R-331-100
R107	Resistor, 100, 5%, ¼W, Composition	R-331-100
R108	Resistor, 100, 5%, ¼W, Composition	R-331-100
R109	Resistor, 100, 5%, ¼W, Composition	R-331-100
R110	Resistor, 100, 5%, ¼W, Composition	R-331-100
R111	Resistor, 100, 5%, ¼W, Composition	R-331-100
R112	Resistor, 100, 5%, ¼W, Composition	R-331-100
R113	Resistor, 100, 5%, ¼W, Composition	R-331-100
R114	Resistor, 100, 5%, ¼W, Composition	R-331-100
R115	Resistor, 100, 5%, ¼W, Composition	R-331-100
R116	Resistor, 100, 5%, ¼W, Composition	R-331-100
R117	Resistor, 100, 5%, ¼W, Composition	R-331-100
R118	Resistor, 100, 5%, ¼W, Composition	R-331-100
R119	Resistor, 100, 5%, ¼W, Composition	R-331-100
R120	Resistor, 100, 5%, ¼W, Composition	R-331-100
	Handle	FA-119
	Rivet	FA-121

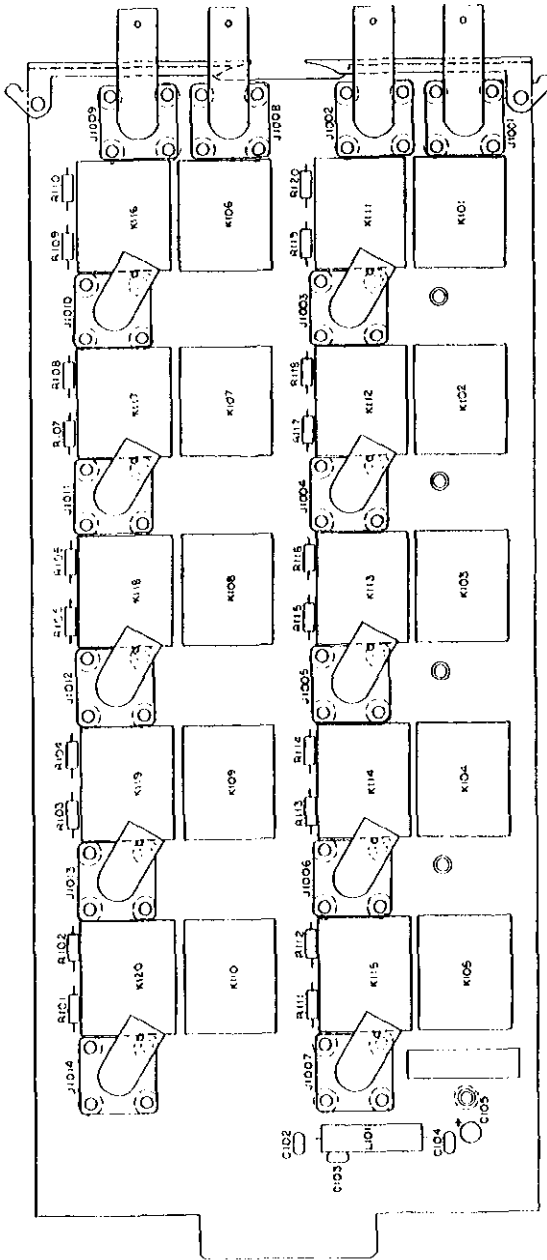

Figure 4-1. Component Layout

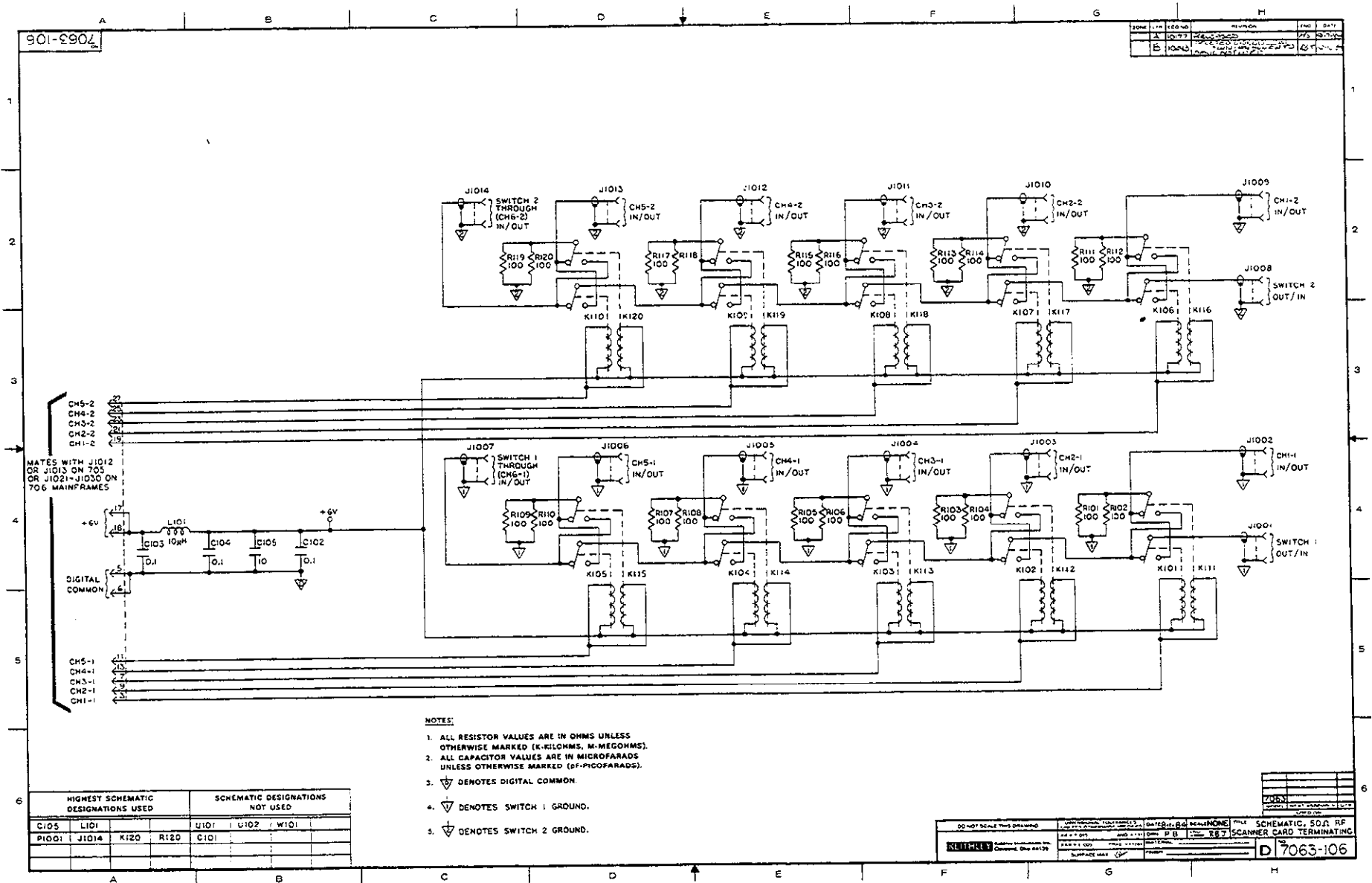

Figure 4-2. Schematic Diagram



Service Form

Model No. _____ Serial No. _____ Date _____
Name and Telephone No. _____
Company _____

List all control settings, describe problem and check boxes that apply to problem.
.....
.....

- | | | |
|--|--|--|
| <input type="checkbox"/> Intermittent | <input type="checkbox"/> Analog output follows display | <input type="checkbox"/> Particular range or function bad; specify _____ |
| <input type="checkbox"/> IEEE failure | <input type="checkbox"/> Obvious problem on power-up | <input type="checkbox"/> Batteries and fuses are OK |
| <input type="checkbox"/> Front panel operational | <input type="checkbox"/> All ranges or functions are bad | <input type="checkbox"/> Checked all cables |

Display or output (check one)

- | | |
|---|--|
| <input type="checkbox"/> Drifts | <input type="checkbox"/> Unable to zero |
| <input type="checkbox"/> Unstable | <input type="checkbox"/> Will not read applied input |
| <input type="checkbox"/> Overload | |
| <input type="checkbox"/> Calibration only | <input type="checkbox"/> Certificate of calibration required |
| <input type="checkbox"/> Data required | |

(attach any additional sheets as necessary)

Show a block diagram of your measurement system including all instruments connected (whether power is turned on or not). Also, describe signal source.

Where is the measurement being performed? (factory, controlled laboratory, out-of-doors, etc.)
.....

What power line voltage is used? _____ Ambient temperature? _____ °F

Relative humidity? _____ Other? _____

Any additional information. (If special modifications have been made by the user, please describe.)
.....

Be sure to include your name and phone number on this service form.

KEITHLEY

Keithley Instruments, Inc.

28775 Aurora Road
Cleveland, Ohio 44139

Printed in the U.S.A.