

**KEITHLEY**

# REL-16 Series<sup>®</sup>

User's Guide

A GREATER MEASURE OF CONFIDENCE

# WARRANTY

## Hardware

Keithley Instruments, Inc. warrants that, for a period of one (1) year from the date of shipment (3 years for Models 2000, 2001, 2002, 2010 and 2700), the Keithley Hardware product will be free from defects in materials or workmanship. This warranty will be honored provided the defect has not been caused by use of the Keithley Hardware not in accordance with the instructions for the product. This warranty shall be null and void upon: (1) any modification of Keithley Hardware that is made by other than Keithley and not approved in writing by Keithley or (2) operation of the Keithley Hardware outside of the environmental specifications therefore.

Upon receiving notification of a defect in the Keithley Hardware during the warranty period, Keithley will, at its option, either repair or replace such Keithley Hardware. During the first ninety days of the warranty period, Keithley will, at its option, supply the necessary on site labor to return the product to the condition prior to the notification of a defect. Failure to notify Keithley of a defect during the warranty shall relieve Keithley of its obligations and liabilities under this warranty.

## Other Hardware

The portion of the product that is not manufactured by Keithley (Other Hardware) shall not be covered by this warranty, and Keithley shall have no duty of obligation to enforce any manufacturers' warranties on behalf of the customer. On those other manufacturers' products that Keithley purchases for resale, Keithley shall have no duty of obligation to enforce any manufacturers' warranties on behalf of the customer.

## Software

Keithley warrants that for a period of one (1) year from date of shipment, the Keithley produced portion of the software or firmware (Keithley Software) will conform in all material respects with the published specifications provided such Keithley Software is used on the product for which it is intended and otherwise in accordance with the instructions therefore. Keithley does not warrant that operation of the Keithley Software will be uninterrupted or error-free and/or that the Keithley Software will be adequate for the customer's intended application and/or use. This warranty shall be null and void upon any modification of the Keithley Software that is made by other than Keithley and not approved in writing by Keithley.

If Keithley receives notification of a Keithley Software nonconformity that is covered by this warranty during the warranty period, Keithley will review the conditions described in such notice. Such notice must state the published specification(s) to which the Keithley Software fails to conform and the manner in which the Keithley Software fails to conform to such published specification(s) with sufficient specificity to permit Keithley to correct such nonconformity. If Keithley determines that the Keithley Software does not conform with the published specifications, Keithley will, at its option, provide either the programming services necessary to correct such nonconformity or develop a program change to bypass such nonconformity in the Keithley Software. Failure to notify Keithley of a nonconformity during the warranty shall relieve Keithley of its obligations and liabilities under this warranty.

## Other Software

OEM software that is not produced by Keithley (Other Software) shall not be covered by this warranty, and Keithley shall have no duty or obligation to enforce any OEM's warranties on behalf of the customer.

## Other Items

Keithley warrants the following items for 90 days from the date of shipment: probes, cables, rechargeable batteries, diskettes, and documentation.

## Items not Covered under Warranty

This warranty does not apply to fuses, non-rechargeable batteries, damage from battery leakage, or problems arising from normal wear or failure to follow instructions.

## Limitation of Warranty

This warranty does not apply to defects resulting from product modification made by Purchaser without Keithley's express written consent, or by misuse of any product or part.

## Disclaimer of Warranties

EXCEPT FOR THE EXPRESS WARRANTIES ABOVE KEITHLEY DISCLAIMS ALL OTHER WARRANTIES, EXPRESS OR IMPLIED, INCLUDING WITHOUT LIMITATION, ALL IMPLIED WARRANTIES OF MERCHANTABILITY AND FITNESS FOR A PARTICULAR PURPOSE. KEITHLEY DISCLAIMS ALL WARRANTIES WITH RESPECT TO THE OTHER HARDWARE AND OTHER SOFTWARE.

## Limitation of Liability

KEITHLEY INSTRUMENTS SHALL IN NO EVENT, REGARDLESS OF CAUSE, ASSUME RESPONSIBILITY FOR OR BE LIABLE FOR: (1) ECONOMICAL, INCIDENTAL, CONSEQUENTIAL, INDIRECT, SPECIAL, PUNITIVE OR EXEMPLARY DAMAGES, WHETHER CLAIMED UNDER CONTRACT, TORT OR ANY OTHER LEGAL THEORY, (2) LOSS OF OR DAMAGE TO THE CUSTOMER'S DATA OR PROGRAMMING, OR (3) PENALTIES OR PENALTY CLAUSES OF ANY DESCRIPTION OR INDEMNIFICATION OF THE CUSTOMER OR OTHERS FOR COSTS, DAMAGES, OR EXPENSES RELATED TO THE GOODS OR SERVICES PROVIDED UNDER THIS WARRANTY.



Keithley Instruments, Inc.

28775 Aurora Road • Cleveland, Ohio 44139 • 440-248-0400 • Fax: 440-248-6168  
1-888-KEITHLEY (534-8453) • [www.keithley.com](http://www.keithley.com)

Sales Offices:	BELGIUM:	Bergensesteenweg 709 • B-1600 Sint-Pieters-Leeuw • 02-363 00 40 • Fax: 02/363 00 64
	CHINA:	Yuan Chen Xin Building, Room 705 • 12 Yumin Road, Dewai, Madian • Beijing 100029 • 8610-6202-2886 • Fax: 8610-6202-2892
	FINLAND:	Tietäjäntie 2 • 02130 Espoo • Phone: 09-54 75 08 10 • Fax: 09-25 10 51 00
	FRANCE:	3, allée des Garays • 91127 Palaiseau Cédex • 01-64 53 20 20 • Fax: 01-60 11 77 26
	GERMANY:	Landsberger Strasse 65 • 82110 Germering • 089/84 93 07-40 • Fax: 089/84 93 07-34
	GREAT BRITAIN:	Unit 2 Commerce Park, Brunel Road • Theale • Berkshire RG7 4AB • 0118 929 7500 • Fax: 0118 929 7519
	INDIA:	Flat 2B, Willocrissa • 14, Rest House Crescent • Bangalore 560 001 • 91-80-509-1320/21 • Fax: 91-80-509-1322
	ITALY:	Viale San Gimignano, 38 • 20146 Milano • 02-48 39 16 01 • Fax: 02-48 30 22 74
	JAPAN:	New Pier Takeshiba North Tower 13F • 11-1, Kaigan 1-chome • Minato-ku, Tokyo 105-0022 • 81-3-5733-7555 • Fax: 81-3-5733-7556
	KOREA:	2FL., URI Building • 2-14 Yangjae-Dong • Seocho-Gu, Seoul 137-888 • 82-2-574-7778 • Fax: 82-2-574-7838
	NETHERLANDS:	Postbus 559 • 4200 AN Gorinchem • 0183-635333 • Fax: 0183-630821
	SWEDEN:	c/o Regus Business Centre • Frosundaviks Allé 15, 4tr • 169 70 Solna • 08-509 04 679 • Fax: 08-655 26 10
	SWITZERLAND:	Kriesbachstrasse 4 • 8600 Dübendorf • 01-821 94 44 • Fax: 01-820 30 81
	TAIWAN:	1FL., 85 Po Ai Street • Hsinchu, Taiwan, R.O.C. • 886-3-572-9077 • Fax: 886-3-572-9031

The information contained in this manual is believed to be accurate and reliable. However, Keithley Instruments, Inc., assumes no responsibility for its use or for any infringements of patents or other rights of third parties that may result from its use. No license is granted by implication or otherwise under any patent rights of Keithley Instruments, Inc.

KEITHLEY INSTRUMENTS, INC., SHALL NOT BE LIABLE FOR ANY SPECIAL, INCIDENTAL, OR CONSEQUENTIAL DAMAGES RELATED TO THE USE OF THIS PRODUCT. THIS PRODUCT IS NOT DESIGNED WITH COMPONENTS OF A LEVEL OF RELIABILITY SUITABLE FOR USE IN LIFE SUPPORT OR CRITICAL APPLICATIONS.

Refer to your Keithley Instruments license agreement and Conditions of Sale document for specific warranty and liability information.

MetraByte is a trademark of Keithley Instruments, Inc. All other brand and product names are trademarks or registered trademarks of their respective companies.

© Copyright Keithley Instruments, Inc., 1994, 1998, 1999.

All rights reserved. Reproduction or adaptation of any part of this documentation beyond that permitted by Section 117 of the 1976 United States Copyright Act without permission of the Copyright owner is unlawful.

**Keithley Instruments, Inc.**

28775 Aurora Road, Cleveland, OH 44139

# **REL-16 Series User's Guide**

Revision E - April 2001  
Part Number: 79360

The following safety precautions should be observed before using this product and any associated instrumentation. Although some instruments and accessories would normally be used with non-hazardous voltages, there are situations where hazardous conditions may be present.

This product is intended for use by qualified personnel who recognize shock hazards and are familiar with the safety precautions required to avoid possible injury. Read and follow all installation, operation, and maintenance information carefully before using the product. Refer to the manual for complete product specifications.

If the product is used in a manner not specified, the protection provided by the product may be impaired.

The types of product users are:

**Responsible body** is the individual or group responsible for the use and maintenance of equipment, for ensuring that the equipment is operated within its specifications and operating limits, and for ensuring that operators are adequately trained.

**Operators** use the product for its intended function. They must be trained in electrical safety procedures and proper use of the instrument. They must be protected from electric shock and contact with hazardous live circuits.

**Maintenance personnel** perform routine procedures on the product to keep it operating properly, for example, setting the line voltage or replacing consumable materials. Maintenance procedures are described in the manual. The procedures explicitly state if the operator may perform them. Otherwise, they should be performed only by service personnel.

**Service personnel** are trained to work on live circuits, and perform safe installations and repairs of products. Only properly trained service personnel may perform installation and service procedures.

Keithley products are designed for use with electrical signals that are rated Installation Category I and Installation Category II, as described in the International Electrotechnical Commission (IEC) Standard IEC 60664. Most measurement, control, and data I/O signals are Installation Category I and must not be directly connected to mains voltage or to voltage sources with high transient over-voltages. Installation Category II connections require protection for high transient over-voltages often associated with local AC mains connections. Assume all measurement, control, and data I/O connections are for connection to Category I sources unless otherwise marked or described in the Manual.

Exercise extreme caution when a shock hazard is present. Lethal voltage may be present on cable connector jacks or test fixtures. The American National Standards Institute (ANSI) states that a shock hazard exists when voltage levels greater than 30V RMS, 42.4V peak, or 60VDC are present. **A good safety practice is to expect that hazardous voltage is present in any unknown circuit before measuring.**

Operators of this product must be protected from electric shock at all times. The responsible body must ensure that operators are prevented access and/or insulated from every connection point. In some cases, connections must be exposed to potential human contact. Product operators in these circumstances must be trained to protect themselves from the risk of electric shock. If the circuit is capable of operating at or above 1000 volts, **no conductive part of the circuit may be exposed.**

Do not connect switching cards directly to unlimited power circuits. They are intended to be used with impedance limited sources. NEVER connect switching cards directly to AC mains. When connecting sources to switching cards, install protective devices to limit fault current and voltage to the card.

Before operating an instrument, make sure the line cord is connected to a properly grounded power receptacle. Inspect the connecting cables, test leads, and jumpers for possible wear, cracks, or breaks before each use.

When installing equipment where access to the main power cord is restricted, such as rack mounting, a separate main input power disconnect device must be provided, in close proximity to the equipment and within easy reach of the operator.

For maximum safety, do not touch the product, test cables, or any other instruments while power is applied to the circuit under test. ALWAYS remove power from the entire test system and discharge any capacitors before: connecting or disconnecting cables or jumpers, installing or removing switching cards, or making internal changes, such as installing or removing jumpers.

Do not touch any object that could provide a current path to the common side of the circuit under test or power line (earth) ground. Always make measurements with dry hands while standing on a dry, insulated surface capable of withstanding the voltage being measured.



The instrument and accessories must be used in accordance with its specifications and operating instructions or the safety of the equipment may be impaired.

Do not exceed the maximum signal levels of the instruments and accessories, as defined in the specifications and operating information, and as shown on the instrument or test fixture panels, or switching card.

When fuses are used in a product, replace with same type and rating for continued protection against fire hazard.

Chassis connections must only be used as shield connections for measuring circuits, NOT as safety earth ground connections.

If you are using a test fixture, keep the lid closed while power is applied to the device under test. Safe operation requires the use of a lid interlock.

If  or  is present, connect it to safety earth ground using the wire recommended in the user documentation.

The  symbol on an instrument indicates that the user should refer to the operating instructions located in the manual.

The  symbol on an instrument shows that it can source or measure 1000 volts or more, including the combined effect of normal and common mode voltages. Use standard safety precautions to avoid personal contact with these voltages.

The **WARNING** heading in a manual explains dangers that might result in personal injury or death. Always read the associated information very carefully before performing the indicated procedure.

The **CAUTION** heading in a manual explains hazards that could damage the instrument. Such damage may invalidate the warranty.

Instrumentation and accessories shall not be connected to humans.

Before performing any maintenance, disconnect the line cord and all test cables.

To maintain protection from electric shock and fire, replacement components in mains circuits, including the power transformer, test leads, and input jacks, must be purchased from Keithley Instruments. Standard fuses, with applicable national safety approvals, may be used if the rating and type are the same. Other components that are not safety related may be purchased from other suppliers as long as they are equivalent to the original component. (Note that selected parts should be purchased only through Keithley Instruments to maintain accuracy and functionality of the product.) If you are unsure about the applicability of a replacement component, call a Keithley Instruments office for information.

To clean an instrument, use a damp cloth or mild, water based cleaner. Clean the exterior of the instrument only. Do not apply cleaner directly to the instrument or allow liquids to enter or spill on the instrument. Products that consist of a circuit board with no case or chassis (e.g., data acquisition board for installation into a computer) should never require cleaning if handled according to instructions. If the board becomes contaminated and operation is affected, the board should be returned to the factory for proper cleaning/servicing.

# Table of Contents

	<b>Preface</b>	
<b>1</b>	<b>Overview</b>	
	General Description .....	1-1
	Supporting Software .....	1-3
	Accessories .....	1-4
	Important Safety Instructions .....	1-5
<b>2</b>	<b>Installation</b>	
	Inventorying Required Installation Resources .....	2-2
	Installing DriverLINX Software and Documentation .....	2-2
	Configuring Your Installation .....	2-5
	Preparing and Installing Your Board .....	2-6
	Unpacking and Inspecting .....	2-7
	Setting the Base Address .....	2-7
	Installing the Board .....	2-9
	Checking Your Installation .....	2-10
	I/O Bit Tests .....	2-10
	General Information .....	2-10
	Output Set Test .....	2-15
	Input Read Test .....	2-20
	Using Power from a REL-16 Series Board .....	2-20
<b>3</b>	<b>Cabling and Wiring</b>	
	Attaching an STA-U or STP-37/FC Accessory .....	3-2
	Attaching an STC-37 Accessory .....	3-3
<b>4</b>	<b>Programming</b>	
<b>5</b>	<b>Troubleshooting</b>	
	Problem Isolation .....	5-1
	Identifying Symptoms and Possible Causes .....	5-1
	Testing the Board and Host Computer .....	5-3
	Testing the Accessory Slot and I/O Connections .....	5-4
	Technical Support .....	5-5



- A Specifications**
- B Connector Pin Assignments**
- C Register Maps**

**Index**

**List of Figures**

Figure 1-1	Block Diagram of the REL-16 and REL-16/W Boards .....	1-2
Figure 2-1	Base Address Switch Location .....	2-8
Figure 2-2	An AIO Panel example .....	2-11
Figure 2-3	DIO channel tab example .....	2-12
Figure 2-4	Configuring the digital I/O channels as inputs and outputs .....	2-14
Figure 2-5	Configuring channel 0 for output bit pattern A .....	2-14
Figure 2-6	An AIO Panel example .....	2-16
Figure 2-7	Configuring the digital I/O channels as inputs and outputs .....	2-17
Figure 2-8	Configuring channel 0 for output bit pattern A .....	2-18
Figure 2-9	Configuring channel 0 for output bit pattern B .....	2-19
Figure 3-1	Pin Assignments for the Main I/O Connector ..	3-1
Figure 3-2	Attaching an STA-U or STP-37/FC to an REL-16 Series Board .....	3-2
Figure 3-3	Layout of STC-37 Screw Terminal Connector Panel .....	3-3
Figure 3-4	Attaching an STC-37 Accessory .....	3-4
Figure B-1	Main I/O Connector Pin Assignments .....	B-1

## List of Tables

Table 2-1	Values of Base Address Switch Positions . . . . .	2-8
Table 5-1	Troubleshooting Information . . . . .	5-2
Table A-1	General Output Specifications . . . . .	A-1
Table A-2	REL-16 Contact Ratings . . . . .	A-1
Table A-3	REL-16/W Contact Ratings . . . . .	A-2
Table A-4	Environmental Specifications . . . . .	A-2
Table A-5	Power Consumption Specifications . . . . .	A-2
Table C-1	I/O Map and Functions . . . . .	C-1
Table C-2	Relay Addresses for Ports A and B . . . . .	C-2

# Preface

The *REL-16 Series User's Guide* describes board capabilities, board setup and installation, use of wiring accessories, included-software characteristics and installation, and combined board and software configuration. There is also a section on troubleshooting.

This guide serves data acquisition system designers, engineers, programmers, and other users responsible for setting up, cabling, and wiring signals to REL-16 Series boards. To follow the information and instructions contained in this manual, you must be familiar with data acquisition principles, with the Windows<sup>®</sup> 95/98/NT operating system, and with your application.

The *REL-16 Series User's Guide* is organized as follows:

- Section 1 provides an overview of the hardware, a block diagram, a description of the included DriverLINX software, and a description of accessories.
- Section 2 describes how to install the DriverLINX software and documentation, how to unpack, set up, and install the board, and how to configure and check the installation.
- Section 3 describes how to attach the accessories used for wiring signals to the board.
- Section 4 briefly describes the need to program through the DriverLINX interface provided with your board, and tells how to access the extensive DriverLINX documentation.
- Section 5 describes common problems and solutions, troubleshooting procedures, and instructions for obtaining technical support.

- Appendix A contains specifications for REL-16 Series boards.
- Appendix B contains pin assignments for the main connector of REL-16 Series boards.
- Appendix C provides register maps, for background reference only (you program REL-16 Series boards through the DriverLINX interface, not at the register level).
- An index completes the manual.

# Overview

This chapter describes the REL-16 Series boards, supporting software, and applicable accessories. Also included is a block diagram of REL-16 Series boards.

## General Description

---

REL-16 Series boards are 16-channel, electromechanical-relay boards containing a Form A (SPST) relay module for each channel. Applications for the boards include control switching, analog multiplexing, lighting control, alarm control, and motor starter control. The combined REL-16 Series board and supplied software installs and runs in any IBM PC-compatible computer that runs the Microsoft Windows® 95/98/NT operating system (Pentium®-series processor recommended).

The boards are available in two versions: the REL-16 and the REL-16/W. Differences between the two versions are in their relays. Relays on the REL-16 are rhodium plated with a rating to 500mA (resistive). Relays on the REL-16/W are mercury wetted with a rating to 1A (resistive).

---

**Note:** Mercury amalgam relays are insensitive to position; an REL-16 board can therefore be oriented in any direction. Mercury wetted relays are sensitive to position; an REL-16/W board must therefore be oriented vertically.

---

Port configuration for the REL-16 provides two independent, 8-bit ports (A and B). Control of the relays requires an 8-bit word to be written to each of the ports.

The boards use a power-up reset to put all relays in their power-off (normally open) state when power is applied to the host computer.

I/O connections are made through a 37-pin, type D connector. A +5V power connection at this connector is brought out from the computer to power external devices.

Figure 1-1 shows a block diagram of the REL-16 Series boards.

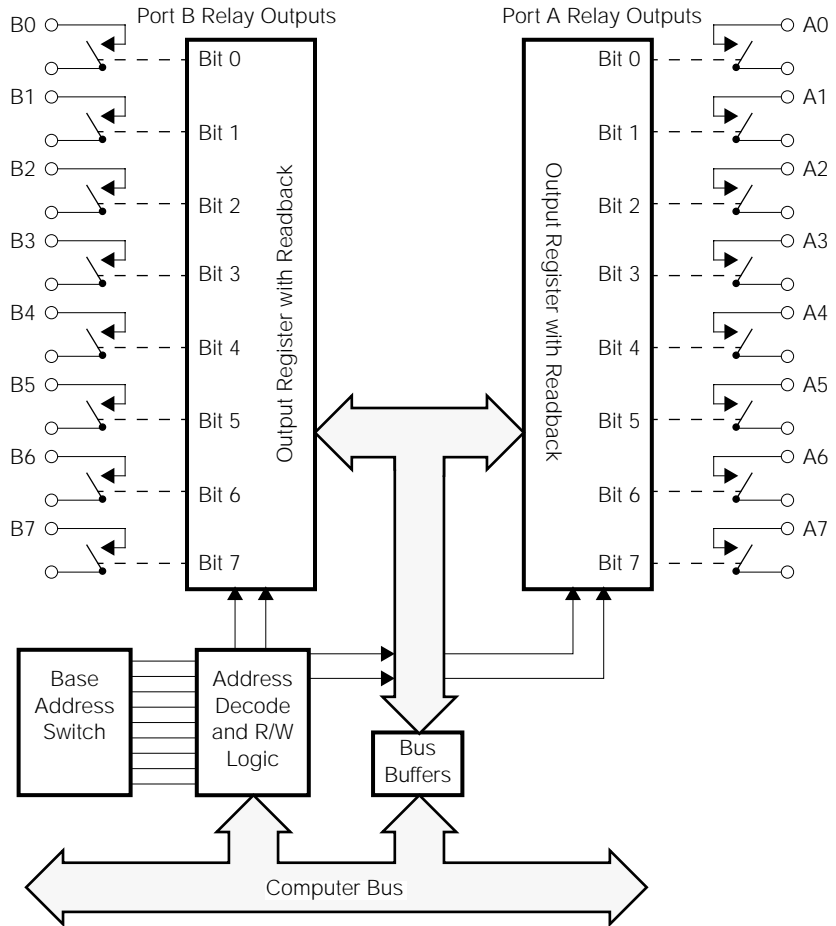

**Figure 1-1. Block Diagram of the REL-16 and REL-16/W Boards**

# Supporting Software

---

DriverLINX software is supplied by Keithley with the REL-16 Series boards. DriverLINX provides convenient interfaces to configure and set I/O bits without register-level programming.

Most importantly, however, DriverLINX supports those programmers who wish to create custom applications using Visual C/C++, Visual Basic, or Delphi. DriverLINX accomplishes foreground and background tasks to perform data acquisition. The software includes memory and data buffer management, event triggering, extensive error checking, and context sensitive online help.

More specifically, DriverLINX provides application developers a standardized interface to over 100 services for creating foreground and background tasks for the following:

- Analog input and output
- Digital input and output
- Time and frequency measurement
- Event counting
- Pulse output
- Period measurement

In addition to basic I/O support, DriverLINX also provides:

- Built-in capabilities to handle memory and data buffer management
- A selection of starting and stopping trigger events, including pre-triggering, mid-point triggering and post-triggering protocols
- Extensive error checking
- Context-sensitive on-line help system

DriverLINX is essentially hardware independent, because its portable APIs work across various operating systems. This capability eliminates unnecessary programming when changing operating system platforms.

# Accessories

---

The following accessories are available for use with REL-16 Series boards at voltages up to 30V RMS, 42.4V peak, or 60VDC, only.

- **SFC-37** — connector for the main I/O connector of REL-16 Series boards. This accessory allows you to wire directly to the I/O of the boards.
- **STA-U** — screw terminal panel. This accessory connects to the main I/O connector of a board through a C1800 cable to connect all I/O lines to labeled screw terminals.
- **STC-37** — screw terminal connector panel. This accessory connects directly to the main I/O connector of a board to provide general-purpose, screw-terminal connections in a compact form factor.
- **STP-37/FC** — screw terminal panel. This accessory connects to the main I/O connector of REL-16 Series boards through a C-1800/M cable. The printed-circuit area of this accessory is covered to provide extra protection against personal or tool contact with signals.
- **C1800** — cable. The C1800 is an 18-inch ribbon cable terminated at both ends with 37-pin, D-type connectors.
- **C-1800/M** — cable. The C-1800/M is an 18-inch ribbon cable terminated at one end with a connector to fit the main I/O connector of an REL-16 Series board and terminated at the other end with a connector to fit the I/O connector of an STP-37/FC accessory.

---

## Warning



Do not use the STA-U, STC-37, STP-37/FC, C1800, and C-1800/M accessories at voltages above 30V RMS, 42.4V peak, or 60VDC. These accessories are rated for 30V RMS, 42.4V peak, or 60VDC maximum. Use at higher voltages may result in shock hazard.

---

Refer to Section 3 for information on connecting these accessories to REL-16 Series boards.



# Important Safety Instructions

---

REL-16 Series boards are prominently labeled to warn of shock hazard. Before you install your REL-16 Series board, perform the following steps:

1. Read the warnings in this section.
2. When installing, cabling, and wiring your board, pay close attention to the warnings on the board labels and those described in this section, and follow the instructions in Sections 2 and 3.
3. When using the board, do not exceed the ratings specified in Appendix A.

## Warning



---

Because you can connect the relay contacts of an REL-16 Series board to high voltage, you can turn some areas of the board surface into a shock hazard. A shock hazard can exist on those board areas even when your computer is powered off. To protect you from exposure to areas of shock hazard, Keithley furnishes REL-16 Series boards only with fully installed protective covers (front and rear), attached to the board on each side by nylon screws. While you can remove the covers to service an REL-16 Series board, **you must never use this board with its covers removed!** In addition, you must disconnect all cables and wiring before servicing this board.

---

## Installation

### Warning



---

The procedures in the section are intended for qualified service personnel. Do not perform these procedures unless you are qualified to do so.

---

This section contains the following procedures, in the order in which they are to be performed:

- Inventorying installation resources
- Installing the DriverLINX software needed to operate your REL-16 Series board
- Configuring the installation in software
- Unpacking and inspecting the board, setting the base address of the board, and installing the board in your computer
- Checking the installation

If you encounter any problems with the installation, refer to Section 5 for troubleshooting information.

---

**Note:** Install the DriverLINX software before installing the REL-16 Series board. Otherwise, the device drivers will be more difficult to install.

---

# Inventorying Required Installation Resources

---

Before installing DriverLINX and the board, do the following:

1. Inventory your REL-16 Series board's configuration settings.
2. Determine the resources your REL-16 Series board requires.
3. Inventory your computer's resources already allocated to other installed devices.
4. Determine whether your computer has sufficient resources for your REL-16 Series board.
5. Determine whether your REL-16 Series board can use your computer's free resources.
6. Continue with the next section, "Installing DriverLINX Software and Documentation."

---

**Note:** *The DriverLINX Installation and Configuration Guide*, Section 1, amplifies the inventory process in checklist items 1-5. (Disregard the rest of the checklist items for now.) To display this manual from your DriverLINX PIO Series CD-ROM, open the Windows Explorer, then double click on **X:\Drvlinx4\Docs\Instconf.pdf**, where **X** = the letter of the CD-ROM drive. Acrobat Reader must already be installed on the other system. If necessary, you can first install Acrobat Reader directly from the CD-ROM by double clicking **X:\Acrobat\setup.exe**.

---

## Installing DriverLINX Software and Documentation

---

---

**Note:** Even if DriverLINX versions other than the PIO Series version are already installed on your system, you must also install the PIO Series DriverLINX version. In the process, some DriverLINX capabilities shared by all boards may be upgraded (test utilities, for example).

---

This section discusses installation of drivers, interfaces, and documentation. The component installation options provided by the DriverLINX setup program are as follows:

- **Install Drivers** — This required component installs only the files you need for configuring your hardware and running third-party data-acquisition applications that require DriverLINX.
- **Install Interfaces** — This optional component installs the files and example programs that you will need to develop custom applications for DriverLINX using C/C++, Visual Basic, and Delphi.
- **Install Documentation** — This optional component installs electronic documentation for DriverLINX that you can read, search, and print using the Adobe Acrobat Reader.
- **Install Acrobat** — This optional component installs the Adobe Acrobat Reader for the DriverLINX electronic documentation.

Install the DriverLINX software and board as follows:

1. Place the DriverLINX PIO Series CD-ROM in your drive and wait a few seconds. On most systems, setup starts automatically. If not, run the setup.exe file, found in the root directory of the CD-ROM.

A DriverLINX Browser Introduction screen appears. Thereafter, the DriverLINX CD Navigator screen appears automatically after waiting a few seconds or after clicking **Next**.

---

**Note:** On the DriverLINX CD Navigator and other DriverLINX Browser screens, place the cursor over a menu item to see an explanation. A star next to a menu item means that it was selected previously.

Before continuing with this installation, Keithley suggests clicking **Read Me First** on the DriverLINX CD Navigator and reviewing the brief information that appears.

---

2. On the DriverLINX CD Navigator screen, click **Install DriverLINX**. An Install These DriverLINX Components screen appears.

3. Click **Install Drivers**, and then follow the series of on-screen instructions. When done, the Install These DriverLINX Components screen reappears.
4. If you do not plan to develop custom application software for your REL-16 Series board, then skip to Step 5. If you do plan to develop custom application software, you must install DriverLINX interfaces before writing the software. Install them now by clicking **Install Interfaces** and following the series of on-screen instructions. When done, the Install These DriverLINX Components screen reappears.
5. Click **Install Documentation** and follow the series of on-screen instructions. This step installs the manuals. When done, the Install These DriverLINX Components screen reappears.
6. If Acrobat Reader is not already installed on your system, install it now. You need Acrobat Reader to read the manuals, a section of which you must access in step 9. Click on **Install Acrobat** and follow the series of on-screen instructions. When done, the Install These DriverLINX Components screen reappears.
7. Click **Exit**. Then, on the screen that appears saying “Thank you for using DriverLINX,” click **Done**. The System Settings Changed dialog box appears.
8. On the System Settings Changed dialog box, click **No**. (The system will be rebooted and configured later under “Configuring Your Installation” on page 2-5.) The screen returns to the Windows desktop.
9. Print out one section of a DriverLINX manual that you will briefly review later during system configuration. Proceed as follows:
  - a. In the **Start** menu under **Programs** → **DriverLINX**, click **On-line Manuals**. A menu document appears.
  - b. In the menu document, scroll until you find the major category **Configuration**.
  - c. Under **Configuration** click **Hardware References**. A list of documents appears.

- d. In the list of documents, click **Keithley PIO Series**. Acrobat Reader opens and the manual entitled *Using DriverLINX with Your Hardware—Keithley PIO Series* appears.
- e. Print the following section from the *Using DriverLINX with Your Hardware—Keithley PIO Series* manual: “Configuring the PIO Series.”

---

**Note:** If your data acquisition system is not connected to a printer, you can display and print the *Using DriverLINX with Your Hardware—Keithley PIO Series* manual sections from another system, directly from the CD-ROM (without installing anything). To display the manual, open the Windows Explorer, then double click on **X:\Drvlinx4\Docs\Notes\kmbpio.pdf**, where **X** = the letter of the CD-ROM drive. Acrobat Reader must already be installed on the other system. If necessary, you can first install Acrobat Reader directly from the CD-ROM by double clicking **X:\Acrobat\setup.exe**.

---

10. Continue with the next section, “Checking Your Installation.”

## Configuring Your Installation

---

Configure the installation as follows:

1. Locate and briefly review the DriverLINX manual section, “Configuring the PIO Series,” that you printed earlier during step 9 of “Installing DriverLINX Software and Documentation.” Reviewing this section will help prepare you to input information and select options when configuring your installation.

---

**Note:** Be sure to note and follow all configuration differences between installations for Windows NT and Windows 95/98.

---

2. Reboot your computer. The DriverLINX Plug and Play Wizard appears on your screen automatically at the end of the boot cycle.

---

**Note:** If you do not run the DriverLINX Plug and Play Wizard now, it will not reappear during the current computer session, although it may appear after a subsequent reboot. If you wish to configure your board sometime later, you can start the Plug and Play Wizard manually from a batch file. In the Windows Explorer, double click **X:\Drvlinx4\Help\kmbpio.bat**, where **X** is the letter of the drive on which DriverLINX is installed.

---

3. On the Plug and Play Wizard, click **Wizard** and follow the series of on-screen instructions that appear. The wizard will first lead you through the steps of installing your hardware—from a software viewpoint—and configuring it.

---

**Note:** If your operating system is Windows NT, use Windows NT Diagnostics to find the free resources that the Plug and Play Wizard asks you to assign. However, if your board requires an interrupt, to reliably find a free ISA interrupt you may need to 1) configure your computer as having as a non-Plug and Play operating system, using BIOS setup, and then 2) individually assign the interrupt to the ISA bus.

---

4. Continue with the next section, “Preparing and Installing Your Board.”

## Preparing and Installing Your Board

---

**Caution:** Ensure that the computer is turned OFF before installing or removing a board. Installing or removing a board while power is ON can damage your computer, the board, or both.

Handle the board in a static-controlled workstation; wear a grounded wrist strap. Discharge static voltage differences between the wrapped board and the handling environment before removing the board from its protective wrapper. Failure to discharge static electricity before and during handling may damage semiconductor circuits on the board.

Handle the board using the mounting bracket. Do not touch the circuit traces or connector contacts when handling the board.

---

## Unpacking and Inspecting

---

**Caution:** A discharge of static electricity from your hands can seriously damage certain electrical components on any circuit board. Before handling any board, discharge static electricity from yourself by touching a grounded conductor such as your computer chassis (your computer must be turned OFF).

---

Use the following procedure to unwrap and inspect an REL-16 Series board.

1. Factory packaging of the REL-16 Series board includes a final wrap of protective, anti-static material. Remove the board from its anti-static wrapping material. You may wish to store the wrapping material for possible future use.
2. Inspect the board for signs of damage. If damage is apparent, arrange to return the board to the factory (see “Technical Support” on page 5-5).
3. Check the remaining contents of your package against the packing list to be sure your order is complete. Report any missing items immediately.
4. When you are satisfied with the inspection, proceed with the next procedure, “Setting the Base Address.”

## Setting the Base Address

The base address is specified through switch settings. The location and factory default setting of this switch is shown in Figure 2-1.



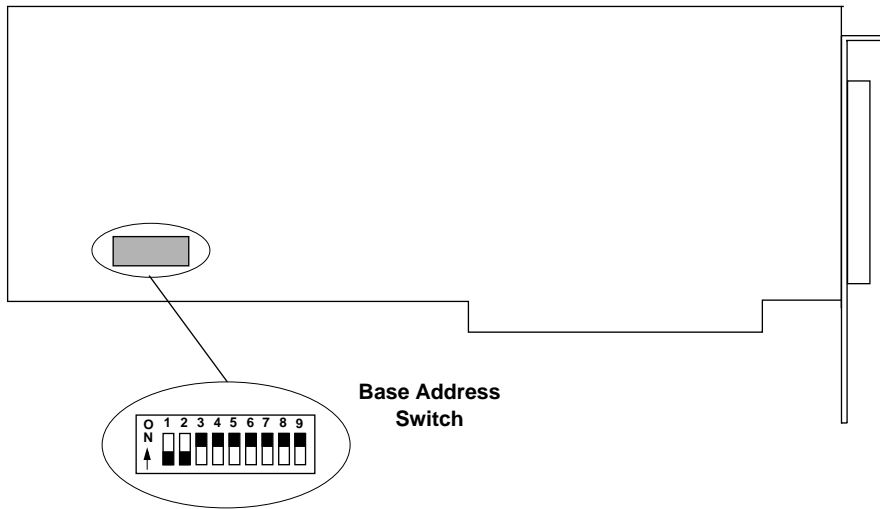

**Figure 2-1. Base Address Switch Location**

The base address switch is preset at the factory for 300h (see Figure 2-1). If 300h was also assigned to the board when you ran the DriverLINX Plug and Play Wizard, you do not need to reset the address switch. Otherwise, reset the base address switch to conform to the base address assigned when you ran the Wizard. The address you specify must be within the range of 200h to 3FCh (512 to 1020 decimal) and on a 2-byte boundary. Table 2-1 lists the values of individual base address switches. Use this table as a guide when selecting a base address.

**Table 2-1. Values of Base Address Switch Positions**

Switch Position	Address Line	Value When Switch Is OFF	
		Decimal	Hexadecimal
1	A9	512	200
2	A8	256	100
3	A7	128	80
4	A6	64	40
5	A5	32	20

**Table 2-1. Values of Base Address Switch Positions (cont.)**

Switch Position	Address Line	Value When Switch Is OFF	
		Decimal	Hexadecimal
6	A4	16	10
7	A3	8	8
8	A2	4	4
9	A1	2	2

When you have finished setting the base address, continue with the next procedure, “Installing the Board.”

## Installing the Board

### Warning



---

Because you can connect the relay contacts of an REL-16 Series board to high voltage, you can turn some areas of the board surface into a shock hazard. A shock hazard can exist on those board areas even when your computer is powered off. To protect you from exposure to areas of shock hazard, Keithley furnishes REL-16 Series boards only with fully installed protective covers (front and rear), attached to the board on each side by nylon screws. While you can remove the covers to service an REL-16 Series board, **you must never use this board with its covers removed!** In addition, you must disconnect all cables and wiring before servicing this board.

---

---

**Caution:** Installing or removing a board while power is on can damage your computer.

---

Before installing a board, check its base address switch for proper settings. Then, use the following steps to install a REL-16 Series board in an accessory slot of your computer:

1. Turn off power to the computer and all attached equipment.
2. Remove the computer chassis cover.

3. Select an unoccupied accessory slot, and remove the corresponding blank plate from the I/O connector panel.
4. Insert and secure the board in the selected slot.
5. Replace the computer cover.
6. Continue with the next section, “Checking Your Installation.”

## Checking Your Installation

---

The ability to start the DriverLINX AIO Panel utility, which is available after you install DriverLINX, verifies that DriverLINX and the board are installed and configured satisfactorily.

You can also test the functions of the REL-16 Series board, without needing to write an application program, by connecting appropriate digital signals and observing the responses with the DriverLINX AIO Panel. Before connecting signals, first read the next section, “Cabling and Wiring.”

After you configure and check your installation, read the next section, “Using Power from a REL-16 Series Board.”

---

**Note:** Refer also to the *DriverLINX Installation and Configuration Guide* and *Using DriverLINX with Your Hardware—Keithley PIO Series* manuals.

---

## I/O Bit Tests

---

### General Information

1. Start the AIO Panel as follows:
  - a. In the **Start** menu, click **Programs**.
  - b. Find the **DriverLINX ▶ Test Panels** folder, under which you should find the **AIO Panel** entry.

- c. Click on the **AIO Panel** entry. The **Analog I/O Panel** should appear, similar to the example in Figure 2-2. (If you have other DriverLINX devices installed in addition to the digital input/output card you are testing, they will also be listed. In that case, select the desired digital I/O card and the proper device number before proceeding.)

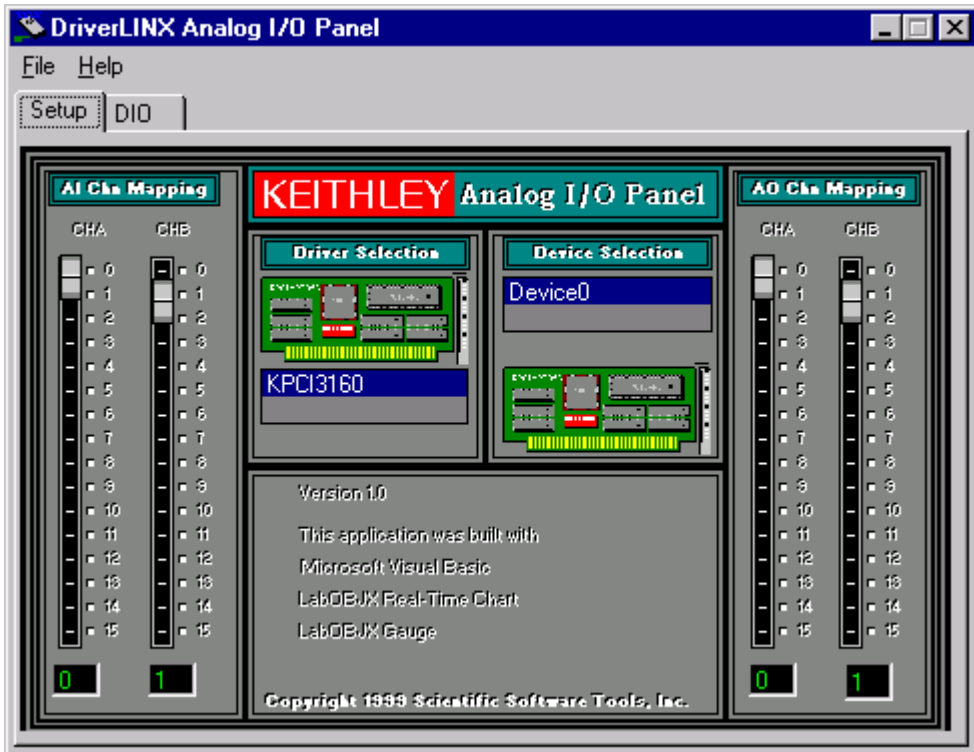

Figure 2-2. An AIO Panel example

---

**Note:** The “Driver Selection” column will show the actual DriverLINX driver(s) you have installed.

---

2. On the AIO Control Panel, click the DIO tab.

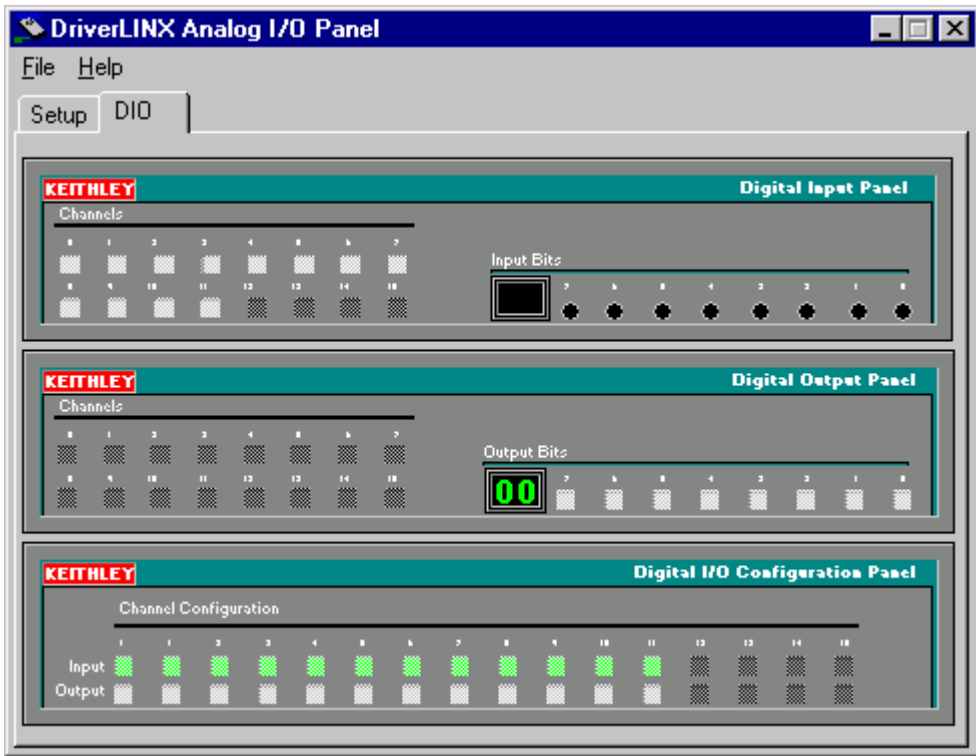

Figure 2-3. DIO channel tab example

---

**Note:** The on-screen digital I/O controller works as follows:

- Channels 0 to 15 refer to the 8-bit general-purpose registers of your digital input-output card. (Depending on which card is used, the number of valid 8-bit registers will vary.) Bits displayed on the **Digital Input Panel** and the **Digital Output Panel** are numbered 0-7 for every channel. Refer elsewhere in this manual for a description of the available ports and their direction.
- Invalid channels and settings appear as dark gray squares. For example:
  - Non-existent channels always appear as dark gray squares.
  - Channels configured as inputs will appear as dark gray squares on the output panel.
- Valid channels and settings appear as white squares when OFF and green squares when ON. (When the manual is printed in black and white, valid channels and settings appear as white squares when OFF and as light gray squares when ON.)
- The two-digit numeric displays under **Input Bits** and **Output Bits** show the hexadecimal values of the adjacent bit patterns.
- To configure a valid channel either for input or output, use the **Digital Channel Configuration Panel**. Click on either the **Input** or **Output** square below the channel number. Note: this selection will be disabled for channels which are fixed as input or output by hardware design.
- To turn ON output-channel bits, use the **Digital Output Panel**. First select the channel number of the bits to be turned on by clicking on the appropriate square under **Channels**. Then, turn ON a bit by clicking the appropriate square under **Output Bits**. Turn OFF a bit in the same way.
- To read an input-channel bit, use the **Digital Input Panel**. First select the channel number to be checked by clicking the appropriate square under **Channels**. Then, read the numbered bit under **Input Bits**. OFF input bits appear as black dots and ON input bits appear as green dots. (When the manual is printed in black and white, OFF input bits appear as black dots and ON input bits appear as light gray dots.)

- Under **Digital I/O Configuration Panel**, configure channels as shown in Figure 2-4. (Actual channels available will vary according to your hardware.)

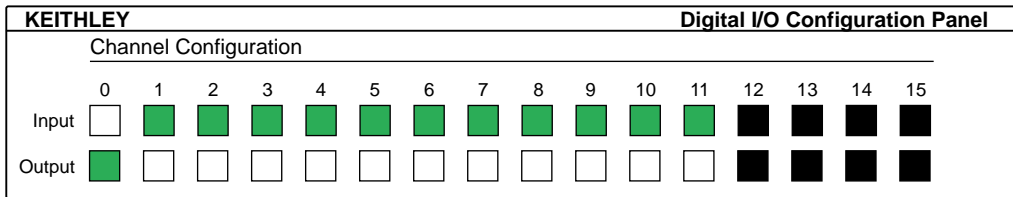
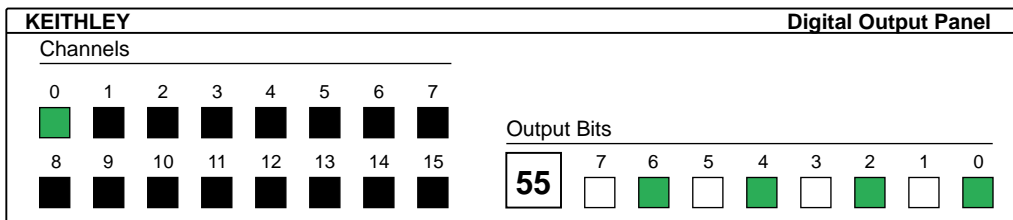

**Figure 2-4. Configuring the digital I/O channels as inputs and outputs**

**Note:** For clarity when the manual is printed in black and white, the control colors in Figure 2-4 and subsequent drawings will be shown as follows:

Illustration	Color on Actual Panel	Function
BLACK	DARK GRAY	Invalid
WHITE	LIGHT GRAY	OFF
GRAY	GREEN	ON

- In the **Digital Output Panel** under **Channels**, click on a channel (here, channel 0) as shown in Figure 2-5.



**Figure 2-5. Configuring channel 0 for output bit pattern A**

5. In the **Digital Output Panel** under **Output Bits**, set the bits of the channel as desired as shown in Figure 2-5. (Click on each bit position to turn it ON or OFF.)
6. In the **Digital Input Panel** under **Channels**, click on a channel to select it and display the logical state of its input lines.

## Output Set Test

The output set test checks whether logic levels measured at all output pins agree with output bit patterns set by software, using a DriverLINX graphical interface (AIO Panel).

---

**Note:** This test is performed without user circuits being connected to the outputs.

---

Perform the output set test as follows:

1. Ready the following equipment:
  - A digital voltmeter (DVM) or a digital multimeter (DMM) set to measure voltages, or a logic probe capable of reading TTL logic levels.
  - A suitable accessory and cable for the board being tested.
2. Turn OFF the host computer.
3. Connect the cable and accessory to your board.
4. Turn ON the host computer and boot Windows 95/98/NT.
5. Click the Windows 95/98/NT **Start** tab.



6. Start the AIO Panel as follows:
  - a. In the **Start** menu, click **Programs**.
  - b. Find the **DriverLINX ▶ Test Panels** folder, under which you should find the **AIO Panel** entry.
  - c. Click on the **AIO Panel** entry. The **Analog I/O Panel** should appear, similar to the example in Figure 2-6. (If you have other DriverLINX devices installed in addition to the digital input/output card you are testing, they will also be listed. In that case, select the desired digital I/O card and the proper device number before proceeding.)

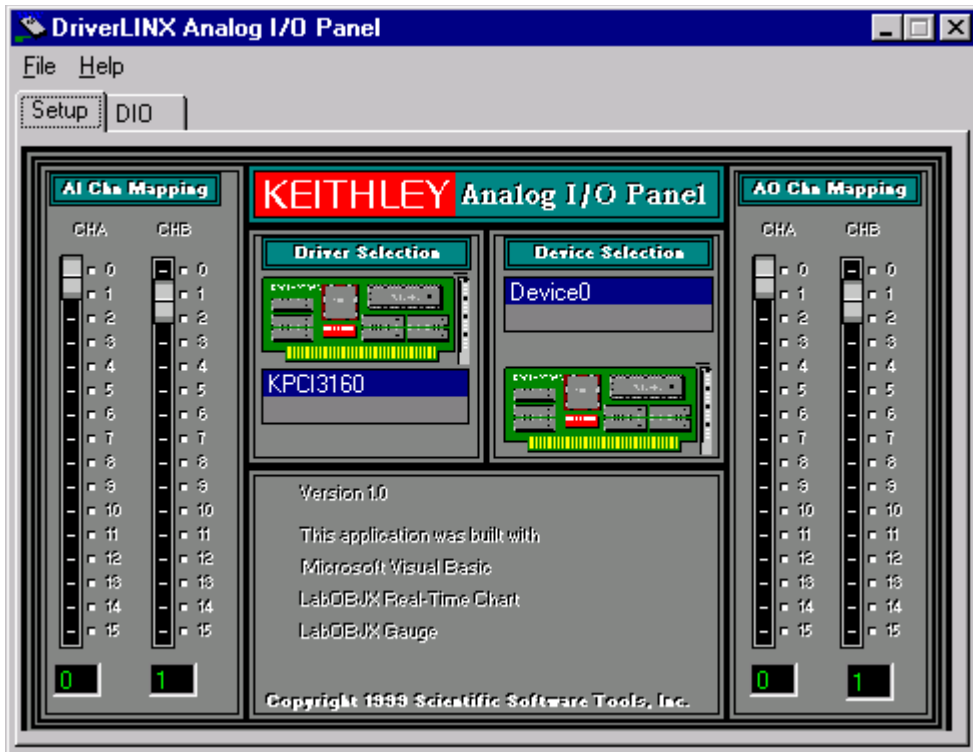

Figure 2-6. An AIO Panel example

7. On the **AIO Panel**, click the **DIO** tab.

---

**Note:** To read an input-channel bit, use the **Digital Input Panel**. First, select the channel number to be checked by clicking the appropriate square under **Channels**. Then, read the numbered bit under **Input Bits**. OFF input bits appear as black dots and ON input bits appear as green dots. (When the manual is printed in black and white, OFF input bits appear as black dots and ON input bits appear as light gray dots.) Further information about this panel, how to make changes, and how to interpret displays, is given in “I/O Bit Tests” of this section.

---

8. Under **Digital I/O Configuration Panel**, configure the output channels to be tested as shown in Figure 2-7. (Actual output channels available will vary according to your hardware.)

KEITHLEY		Digital I/O Configuration Panel															
Channel Configuration		0	1	2	3	4	5	6	7	8	9	10	11	12	13	14	15
Input		<input type="checkbox"/>	<input type="checkbox"/>	<input type="checkbox"/>	<input checked="" type="checkbox"/>	<input checked="" type="checkbox"/>	<input checked="" type="checkbox"/>	<input checked="" type="checkbox"/>	<input checked="" type="checkbox"/>	<input checked="" type="checkbox"/>	<input checked="" type="checkbox"/>	<input checked="" type="checkbox"/>	<input checked="" type="checkbox"/>	<input checked="" type="checkbox"/>	<input checked="" type="checkbox"/>	<input checked="" type="checkbox"/>	<input checked="" type="checkbox"/>
Output		<input checked="" type="checkbox"/>	<input checked="" type="checkbox"/>	<input checked="" type="checkbox"/>	<input type="checkbox"/>	<input type="checkbox"/>	<input type="checkbox"/>	<input type="checkbox"/>	<input type="checkbox"/>	<input type="checkbox"/>	<input type="checkbox"/>	<input type="checkbox"/>	<input type="checkbox"/>	<input checked="" type="checkbox"/>	<input checked="" type="checkbox"/>	<input checked="" type="checkbox"/>	<input checked="" type="checkbox"/>

**Figure 2-7. Configuring the digital I/O channels as inputs and outputs**

---

**Note:** In Figure 2-7 and subsequent drawings of digital I/O controller panels, the squares below invalid channels are colored black instead of dark gray—for clarity when the manual is printed in black and white.

---

9. In the **Digital Output Panel** under **Channels**, click on an output channel (channel 0 in this example) as shown in Figure 2-8.

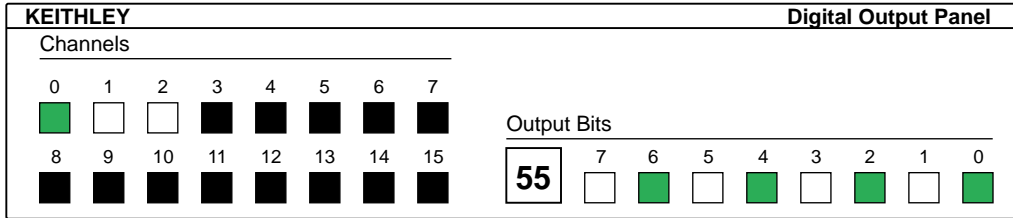

**Figure 2-8. Configuring channel 0 for output bit pattern A**

10. In the **Digital Output Panel** under **Output Bits**, set the bits of channel 0 for bit pattern A as shown in Figure 2-8.
11. Measure the voltage between signal ground and each bit of the output port with a DMM or DVM. Make measurements at the cabled mating connector of your accessory.
12. Each bit set to ON in the **AIO Panel** should output a logic-high signal at the corresponding I/O terminal, reading typically about 4 volts (minimum of 2.2 volts) at a DMM/DVM. Each bit set to OFF in the **AIO Panel** should output a logic-low signal at the corresponding I/O terminal, reading typically about 0 volts (maximum of 0.8 volts) at a DMM/DVM. Do one of the following:

---

**Note:** The typical values shown are valid for boards with TTL compatible outputs. For boards with relay outputs (REL-16, PDISO-8, and PIO-32) the output will be a relay contact closure. For boards with open collector outputs (PIO-HV) use a pull up resistor to an appropriate voltage to detect output state. Refer to the hardware description in this user's guide for more details on the output's electrical specification.

---

- If the bit patterns set on the **AIO Panel** do not agree with the logic levels measured at the I/O terminals, the board is not functioning properly. Stop here, and determine why.
- If the bit patterns set on the **AIO Panel** agree with the logic levels measured at the I/O terminals, then repeat steps 9, 10, and 11 for remaining output channels.

13. In the **Digital Output Panel** under **Channels**, click on the output channel to test (channel 0 in this example) as shown in Figure 2-9.

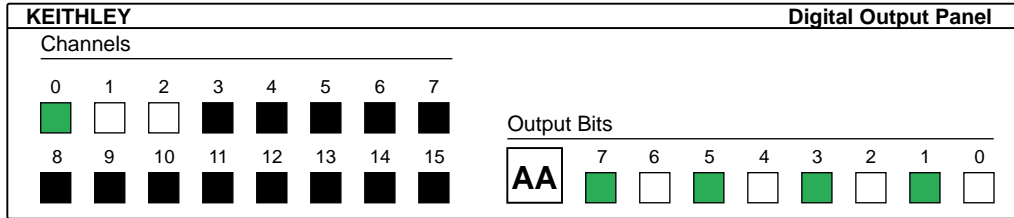

**Figure 2-9. Configuring channel 1 for output bit pattern B**

14. In the **Digital Output Panel** under **Output Bits**, set the bits of channel 0 for bit pattern B as shown in Figure 2-9.
15. Measure the voltage between signal ground and each bit of the output port with a DMM or DVM. Make measurements at the STA-50 terminals or the cabled mating connector that is connected to the selected CONN-3160-D1 50-pin connector.
16. Again, each bit set to ON in the **AIO Panel** should output a logic-high signal at the corresponding I/O terminal, reading typically about 4 volts (minimum of 2.2 volts) at a DMM/DVM. Each bit set to OFF in the **AIO Panel** should output a logic-low signal at the corresponding I/O terminal, reading typically about 0 volts (maximum of 0.8 volts) at a DMM/DVM.

---

**Note:** The typical values shown are valid for boards with TTL compatible outputs. For boards with relay outputs (REL-16, PDISO-8, and PIO-32) the output will be a relay contact closure. For boards with open collector outputs (PIO-HV) use a pull up resistor to an appropriate voltage to detect output state. Refer to the hardware description in this user's guide for more details on the output's electrical specification.

---

- If the bit patterns set on the **AIO Panel** do not agree with the logic levels measured at the I/O terminals, the board is not functioning properly. Stop here, and determine why.
  - If the bit patterns set on the **AIO Panel** do agree with the logic levels measured at the I/O terminals, and you have performed an output set test for all ports, the board is functioning properly.
17. Repeat steps 13, 14, and 15 for additional output channels.

## Input Read Test

A similar test of input circuitry can be performed by applying an input signal of suitable type to each input line and verifying that the appropriate input indicator changes state. Refer to the hardware description in this user's guide for more details on the input's electrical specifications.

## Using Power from a REL-16 Series Board

---

Power from the computer supply is available on the main I/O connector of the REL-16 Series board. In situations where the board is used with a dedicated peripheral (for example, a switch pad) and the cabling and design loads are fixed, you may find it more appropriate to use the REL-16 power outputs. In most other cases, however, you are advised to power external devices from their own supplies.

In general, you are advised **not** to use computer power unless you can safely avoid the following conditions:

- Short circuits, overloads, or the application of other external voltages. All of these conditions may damage the PC system board and result in costly repairs. The PC power supply is designed to shut down on a short circuit, but you should not rely on this characteristic to protect your system.
- A power draw that exceeds the capacity of the computer power supply and its internal loads (see the technical reference manual for your computer). Because of computer board connector and trace width limitations, it is recommended that you limit power draw to 1A from the +5V.

You are now ready to attach accessories as needed and wire the external signals to the board. Refer to Section 3, "Cabling and Wiring," for instructions.

## Cabling and Wiring

### Warning



The procedures in this section are intended for qualified service personnel. Do not perform these procedures unless you are qualified to do so.

Users of this product must be protected from electric shock at all times. The responsible body must ensure that users are prevented access and/or insulated from every connection point. In some cases, connections must be exposed to potential human contact. Product users in these circumstances must be trained to protect themselves from the risk of electric shock.

This section shows the cabling and connections required for attaching accessories and I/O lines to the main I/O connector of your REL-16 Series boards. The main I/O connector is a male, 37-pin, D-type. Pin assignments for this connector are shown in Figure 3-1.

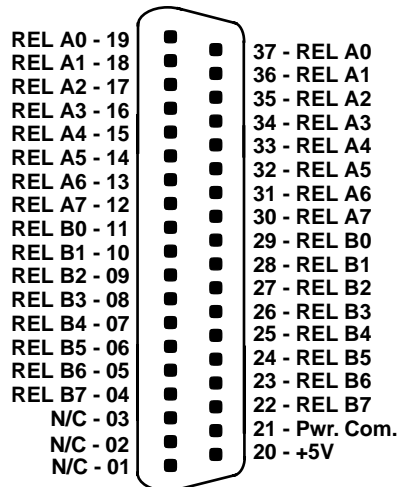

Figure 3-1. Pin Assignments for the Main I/O Connector

---

**Caution:** To avoid electrical damage, turn off power to the computer and any attached accessories before making connections to REL-16 Series boards.

---

## Attaching an STA-U or STP-37/FC Accessory

---

### Warning



Do not use the STA-U, STP-37/FC, C1800, and C-1800/M accessories at voltages above 30V RMS, 42.4V peak, or 60VDC. These accessories are rated for 30V RMS, 42.4V peak, or 60VDC maximum. Use at higher voltages may result in shock hazard.

---

When connecting voltages up to 30V RMS, 42.4V peak, or 60VDC, only, you may attach the REL-16 board to an STA-U or STP-37/FC screw terminal accessory as follows:

- When attaching an STA-U accessory, use a C1800 cable.
- When attaching an STP-37/FC accessory, use a C-1800/M cable.

You may make these connections as shown in Figure 3-2.

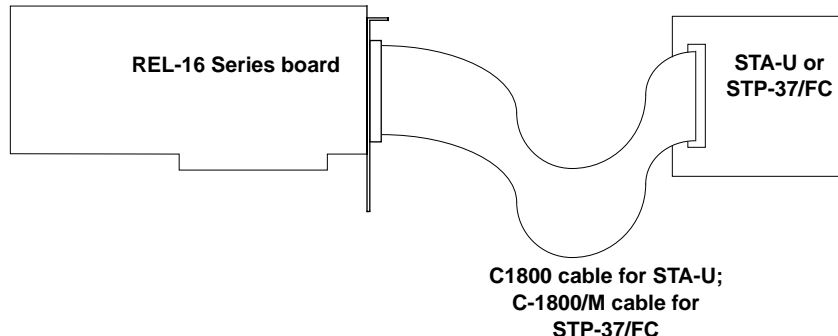

**Figure 3-2. Attaching an STA-U or STP-37/FC to an REL-16 Series Board**

---

**Note:** Use the STP-37/FC accessory with a C-1800/M cable for extra protection against the possibility of personal or tool contact with signals.

---

## Attaching an STC-37 Accessory

---

### Warning



Do not use the STC-37/FC accessory at voltages above 30V RMS, 42.4V peak, or 60VDC. This accessory is rated for 30V RMS, 42.4V peak, or 60VDC maximum. Use at higher voltages may result in shock hazard.

---

The STC-37, shown in Figure 3-3, is a directly connected screw terminal panel for use at voltages up to 30V RMS, 42.4V peak, or 60VDC.

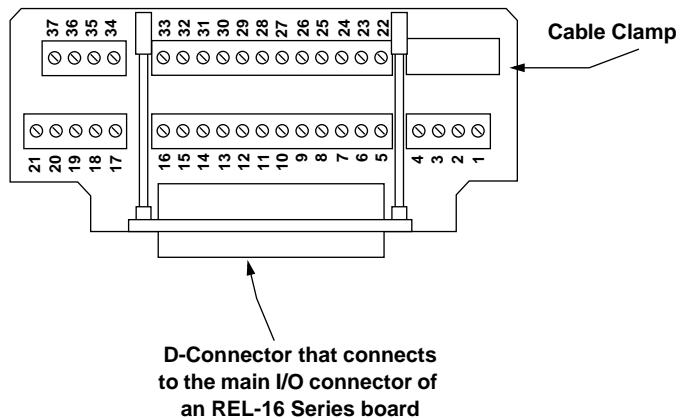

**Figure 3-3. Layout of STC-37 Screw Terminal Connector Panel**

The STC-37 connects to the main I/O connector on an REL-16 Series board as shown in Figure 3-4. The screw terminal numbers of the STC-37 correspond to the pin numbers of the main I/O connector.



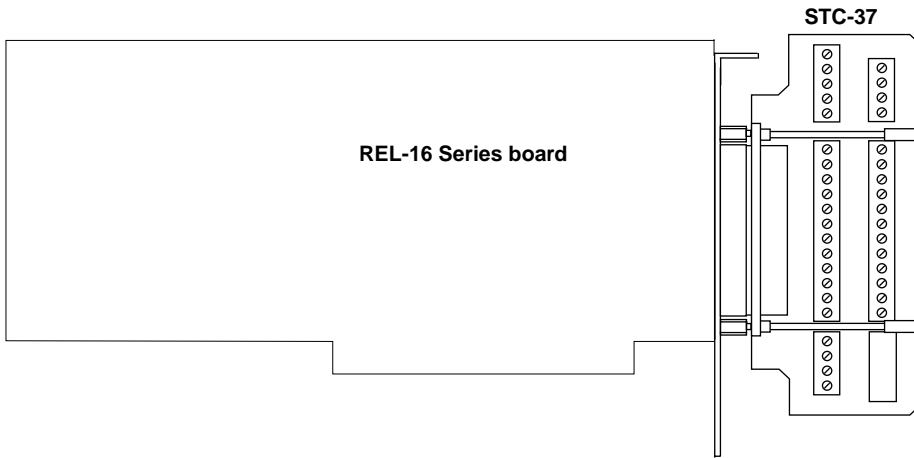

**Figure 3-4. Attaching an STC-37 Accessory**

# 4

## Programming

You do not program the registers of your REL-16 Series board directly through Windows 95/98/NT. Instead, you program register changes through the application programming interface (API) of DriverLINX. DriverLINX is provided on the CD-ROM that comes with your board and should now be installed on your system. (Refer to Section 2, “Installation.”) Using DriverLINX, you can program the board in Visual C/C++, Visual Basic, and Delphi.

DriverLINX features are summarized in Section 1, under “Supporting Software” on page 1-3. For detailed information about DriverLINX in general and about programming with DriverLINX specifically, refer to your DriverLINX documentation.

---

**Note:** To access the DriverLINX documents on-line, Acrobat Reader (version 3.0 or greater) must be installed on your computer.

---

To access the DriverLINX documentation after you have installed it on your computer, do the following:

1. Click the Windows 95/98/NT **Start** tab.
2. In the **Start** menu, click **Programs**.
3. Find the **DriverLINX** entry, under which you should find the **On-line Manuals** entry.
4. Click on the **On-line Manuals** entry. The DriverLINX Printable Documentation table of contents opens via Acrobat Reader.

5. Scroll through the DriverLINX Printable Documentation table of contents and find the document or document category that you want.
6. Click on the wanted document or document category. Either the selected document appears or a list of documents that fit the selected category appears.
7. If a list appears, click on the title of the document that you want. The desired document appears.

To access the DriverLINX documentation from the CD-ROM that came with your board, do the following:

1. In Windows Explorer, double click on **X:\Drvlinx4\Docs\Toc.pdf**, where **X** is the drive letter of your CD-ROM drive. The DriverLINX Printable Documentation table of contents opens via Acrobat Reader.
2. Scroll through the DriverLINX Printable Documentation table of contents and find the document or document category that you want.
3. Click on the wanted document or document category. Either the selected document appears or a list of documents that fit the selected category appears.
4. If a list appears, click on the title of the document that you want. The desired document appears.

## Troubleshooting

### Warning



---

The procedures in this section are intended for qualified service personnel. Do not perform these procedures unless you are qualified to do so.

---

If your REL-16 Series board is not operating properly, use the information in this section to isolate the problem. If the problem appears serious enough to warrant technical support, refer to “Technical Support” on page 5-5 for information on how to contact an applications engineer.

## Problem Isolation

---

If you encounter a problem with an REL-16 Series board, use the instructions in this section to isolate the cause of the problem before calling Keithley Hardware Applications Engineering.

## Identifying Symptoms and Possible Causes

Use the troubleshooting information in Table 5-1 to try to isolate the problem. Table 5-1 lists general symptoms and possible solutions for problems with REL-16 Series boards.

**Table 5-1. Troubleshooting Information**

Symptom	Possible Cause	Possible Solution
Board does not respond	DriverLINX is not installed correctly or the combined DriverLINX/board installation is not properly configured.	Reinstall and/or reconfigure DriverLINX if necessary. Refer to “Configuring Your Installation” on page 2-5 and to “Configuring the PIO Series” in the manual <i>Using DriverLINX With Your Hardware—Keithley PIO Series</i> .
	Base address is incorrect or not consistent with what the program is addressing.	Check the base address switch setting. If the base address is set correctly, make sure no other computer device is using any of the I/O locations beginning at the specified base address. If necessary, reconfigure the base address. Refer to “Setting the Base Address” on page 2-7 for instructions on setting the base address.
	The board configuration is incorrect.	Check the remaining settings.
	The board is incorrectly aligned in the accessory slot.	Check the board for proper seating.
	The board is damaged.	Contact the Keithley Hardware Applications Engineering Department; see “Technical Support” on page 5-5.
Intermittent operation	The most common cause of this problem is that the I/O bus speed is in excess of 8MHz.	Reduce I/O bus speed to a maximum of 8MHz (to change the I/O bus speed, run BIOS setup). See your computer documentation for instructions on running BIOS setup.
	Vibrations or loose connections exist.	Cushion source of vibration and tighten connections.
	The board is overheating.	Check environmental and ambient temperature. See the documentation for your computer.
	Electrical noise exists.	Provide better shielding or reroute unshielded wiring.

**Table 5-1. Troubleshooting Information (cont.)**

<b>Symptom</b>	<b>Possible Cause</b>	<b>Possible Solution</b>
Data appears to be invalid	The most common cause of this problem is that the I/O bus speed is in excess of 8MHz.	Reduce I/O bus speed to a maximum of 8MHz (to change the I/O bus speed, run BIOS setup). See the documentation for your computer for instructions on running BIOS setup.
	An open connection exists.	Check wiring to screw terminal and to REL-16 Series board.
	Another system resource is using the specified base address.	Reconfigure the base address of the REL-16 board; refer to “Setting the Base Address” on page 2-7 for more information. Check the I/O assignments of other system resources and reconfigure, if necessary.
Computer does not boot	Board not seated properly.	Check the installation of the board.
	The base address setting of the REL-16 board conflicts with that of another system resource.	Check the base address settings of your system resources; each address must be unique.
	The power supply of the host computer is too small to handle all the system resources.	Check the needs of all system resources and obtain a larger power supply.

If your board is not operating properly after using the information in Table 5-1, continue with the next two sections to further isolate the problem.

## Testing the Board and Host Computer

To isolate the problem to an REL-16 Series board or to the host computer, use the following steps:

1. Turn the power to the host computer OFF, and remove power connections to the computer.

---

**Caution:** Removing a board with the power ON can cause damage to your board and/or computer.

---

2. While keeping connections to accessory board intact, unplug the accessory connector or cable from the REL-16 Series board.
3. Remove the REL-16 Series board from the computer and visually check for damage. If a board is obviously damaged, refer to “Technical Support” on page 5-5 for information on returning the board.
4. With the REL-16 Series board out of the computer, check the computer for proper operation. Power up the computer and perform any necessary diagnostics.

At this point, if you have another REL-16 Series board that you know is functional, you can test the slot and I/O connections using the instructions in the next section. If you do not have another board, refer to the instructions on “Technical Support” on page 5-5 before calling Keithley Technical Support.

## Testing the Accessory Slot and I/O Connections

When you are sure that the computer is operating properly, test the computer accessory slot and I/O connections using another REL-16 Series board that you know is functional. To test the computer accessory slot and the I/O connections, follow these steps:

1. Remove computer power again, and install an REL-16 Series board that you know is functional. Do not make any I/O connections.
2. Turn computer power ON and check operation with the functional board in place. This test checks the computer accessory slot. If you were using more than one REL-16 Series board when the problem occurred, use the functional board to test the other slot, as well.
3. If the accessory slots are functional, use the functional board to check the I/O connections. Reconnect and check the operation of the I/O connections, one at a time.
4. If operation fails for an I/O connection, check the individual inputs one at a time for shorts and opens.

5. If operation remains normal to this point, the problem is in the REL-16 Series board(s) originally in the computer. If you were using more than one board, try each board one at a time in the computer to determine which is faulty.
6. If you cannot isolate the problem, refer to the next section for instructions on obtaining assistance.

## Technical Support

---

Before returning any equipment for repair, call the Keithley Hardware Applications Engineering Department at:

**1-888-KEITHLEY**

**Monday - Friday, 8:00 a.m. - 5:00 p.m., Eastern Time**

An applications engineer will help you diagnose and resolve your problem over the telephone.

Please make sure that you have the following information page available before you call:

<b>REL-16 Series Board Configuration</b>	Model	_____
	Serial #	_____
	Revision code	_____
	Base address setting	_____
<b>Computer</b>	Manufacturer	_____
	CPU type	_____
	Clock speed (MHz)	_____
	MB of RAM	_____
	Video system	_____
	BIOS type	_____
<b>Operating System</b>	Windows version	_____
<b>Compiler (if applicable)</b>	Language	_____
	Manufacturer	_____
	Version	_____
<b>Accessories</b>	Type	_____
	Type	_____
	Type	_____



If a telephone resolution is not possible, the applications engineer will issue you a Return Material Authorization (RMA) number and ask you to return the equipment. Include the RMA number with any documentation regarding the equipment.

When returning equipment for repair, include the following information:

- Your name, address, and telephone number.
- The invoice or order number and date of equipment purchase.
- A description of the problem or its symptoms.
- The RMA number on the **outside** of the package.

Repackage the equipment, using the original anti-static wrapping, if possible, and handling it with ground protection. Ship the equipment to:

**ATTN: RMA # \_\_\_\_\_**  
**Repair Department**  
**Keithley Instruments, Inc.**  
**28775 Aurora Road**  
**Cleveland, Ohio 44139**

**Telephone 1-888-KEITHLEY**  
**FAX (440) 248-6168**

---

**Notes:** If you are submitting your equipment for repair under warranty, you must include the invoice number and date of purchase.

To enable Keithley to respond as quickly as possible, you must include the RMA number on the outside of the package.

---

# A

## Specifications

This appendix provides specifications for the REL-16 Series relay boards.

**Table A-1. General Output Specifications**

<b>Feature</b>	<b>Specification</b>
Number of outputs	16 SPST (Form A) relays
Operation time	2.0ms maximum
Relay isolation resistance	$10^9\Omega$ @ 100VDC

**Table A-2. REL-16 Contact Ratings**

<b>Feature</b>	<b>Specification</b>
Contact type	Rhodium plated
Contact rating	10W @ 0.5A or 125V RMS (resistive), Installation Category I*
Contact resistance	100m $\Omega$ maximum, initial
Contact life	$10^7$ operations at rated load

\*Do not connect to mains or unlimited power circuits.

**Table A-3. REL-16/W Contact Ratings**

<b>Feature</b>	<b>Specification</b>
Contact type	Mercury wetted (position-sensitive; board must be mounted within $\pm 30^\circ$ of vertical)
Contact rating	50W @ 1A or 125V RMS (resistive), Installation Category I*
Contact resistance	50m $\Omega$ maximum, initial
Contact life	$10^7$ operations at rated load

\*Do not connect to mains or unlimited power circuits.

**Table A-4. Environmental Specifications**

<b>Feature</b>	<b>Specification</b>
Operating temperature	0° to 60°C
Storage temperature	-40° to 100°C
Humidity	0 to 90%, non-condensing
Mounting	The REL-16/W must be mounted within 30° of vertical. The REL-16 can be mounted at any angle.
Dimensions	9.0 x 4.25 x 0.85 in. (22.9 x 10.8 x 2.2 cm)

**Table A-5. Power Consumption Specifications**

<b>Feature</b>	<b>Specification</b>
+5V	510mA plus 22mA maximum for each activated relay
$\pm 12V$	Not used

# B

## Connector Pin Assignments

The connection between an external I/O device and an REL-16 Series board is made at the main I/O connector, which is a standard 37-pin, D-type male connector. The mating connector is a 37-pin, D-type female connector (part# SFC-37). Figure B-1 illustrates pin assignments of the main I/O connector.

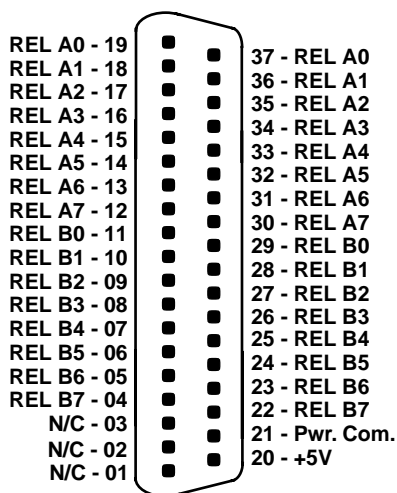

Figure B-1. Main I/O Connector Pin Assignments

# C

## Register Maps

---

**Note:** Register maps are provided here only for background reference purposes. You do not program registers directly in Windows 95/98/NT. Instead, you program register changes through the application programming interface (API) of DriverLINX, which is provided on the CD-ROM that comes with your board. Refer to the DriverLINX documentation that is installed on your system. (If it is not yet installed, you can find it on the CD-ROM in the X:\DrvLINX4\Docs and X:\DrvLINX4\Docs\Notes folders, where X is the drive letter of the CD-ROM drive.)

In some cases, the base address is chosen automatically by Windows. Check the difference in addressing for Windows 95/98 and Windows NT. Refer to “Configuring the PIO Series” in *Using DriverLINX with Your Hardware—Keithley PIO Series* manual, which you printed in step 9 of “Installing DriverLINX Software and Documentation” on page 2-2.

---

REL-16 Series boards use two consecutive addresses in the computer’s I/O space for access to the two registers that control the relays. The base address is selected by a DIP switch on the board, as described in Section 2. The I/O map and functions for the two registers are shown in Table C-1.

**Table C-1. I/O Map and Functions**

I/O Address	Function	Read/Write
Base address +0h	Write port A	R/W
Base address +1h	Write port B	R/W

Data is written to all eight relays of a port in a single byte, and all relays of a port are updated simultaneously. Writing a 0 to a relay deactivates the relay, while writing a 1 to a relay activates the relay. Table C-2 shows the register addresses of the relays of both ports.

**Table C-2. Relay Addresses for Ports A and B**

<b>Address</b>	<b>Bit 7</b>	<b>Bit 6</b>	<b>Bit 5</b>	<b>Bit 4</b>	<b>Bit 3</b>	<b>Bit 2</b>	<b>Bit 1</b>	<b>Bit 0</b>
Base Address +0h	A7	A6	A5	A4	A3	A2	A1	A0
Base Address +1h	B7	B6	B5	B4	B3	B2	B1	B0

For example, to turn on relay A5 of an REL-16 board at a base address of 300h, 00100000 binary is written to I/O address 300h. Similarly, to turn on relays B7, B1, and B0 of the same board, 10000011 binary is written to I/O address 301h.

# Index

## A

accessory

SFC-37 1-4

STA-U 1-4

STC-37 1-4

STP-37/FC 1-4, 3-2

AIO Panel

checking installation with 2-10

anti-static wrapping material 2-7

applications, REL-16 1-1

attaching

STA-U 3-2

STC-37 accessory 3-3

## B

base address switch 2-7, 2-8

block diagram 1-2

board

grounding during handling to protect 2-6

handling 2-6

## C

C1800 cable 1-4

C-1800/M cable 1-4

cable

C1800 1-4

C-1800/M 1-4

cabling and wiring 3-1

checking the installation 2-10

computer I/O space C-1

computer resources

determination for installation 2-2

configuring

DriverLINX 2-5

installation 2-5

connector, main I/O 3-1

contact ratings A-1

## D

documentation, DriverLINX

accessing 2-4, 4-1

installing 2-2

documentation, this manual, installing 2-2

DriverLINX

configuring 2-5

description 1-3

documentation, accessing 2-4, 4-1

documentation, installing 2-2

installing 2-2

programming 4-1

## E

environmental specifications A-2

## F

factory-default setting 2-7

Form A (SPST) 1-1

## G

grounding, during board handling 2-6

## I

I/O bit tests 2-10

general information 2-10

input read test 2-20

output set test 2-15

I/O map [C-1](#)  
installation  
    checking [2-10](#)  
    configuring [2-5](#)  
    resource inventory [2-2](#)  
installing  
    documentation [2-2](#)  
    REL-16 board [2-9](#)  
    software, DriverLINX [2-2](#)  
interfaces  
    installing for applications [2-3](#)

## M

main I/O connector [B-1](#)  
manuals, DriverLINX  
    accessing [2-4](#), [4-1](#)  
    installing [2-2](#)  
maps, register [C-1](#)  
mercury  
    amalgam [1-1](#)  
    wetted [1-1](#)

## O

output specifications [A-1](#)

## P

pin assignments [3-1](#), [B-1](#)  
power consumption specifications [A-2](#)  
power, using from the REL-16 [2-20](#)  
precautions, installation  
    board [2-6](#)  
    DriverLINX before board [2-1](#)  
problem isolation [5-1](#)  
programming  
    DriverLINX [4-1](#)  
    overview [1-3](#)  
    registers [4-1](#)

## R

register addresses [C-2](#)  
registers  
    maps [C-1](#)  
    programming [4-1](#)  
resources, installation, inventory [2-2](#)  
RMA number [5-6](#)

## S

safety instructions [1-5](#)  
setting a base address [2-8](#)  
SFC-37 accessory [1-4](#)  
software, DriverLINX  
    description [1-3](#)  
    installing [2-2](#)  
    programming [4-1](#)  
specifications  
    environmental [A-2](#)  
    output [A-1](#)  
    power consumption [A-2](#)  
static electricity [2-7](#)  
STA-U accessory [1-4](#)  
STA-U, attaching [3-2](#)  
STC-37 accessory [1-4](#)  
STC-37, attaching [3-3](#)  
STP-37/FC accessory [1-4](#)  
STP-37/FC, attaching [3-2](#)  
symptoms and possible solutions [5-1](#)

## T

technical support [5-5](#)

## U

unpacking and inspecting [2-7](#)



Specifications are subject to change without notice.

All Keithley trademarks and trade names are the property of Keithley Instruments, Inc. All other trademarks and trade names are the property of their respective companies.



**Keithley Instruments, Inc.**

28775 Aurora Road • Cleveland, Ohio 44139 • 440-248-0400 • Fax: 440-248-6168  
**1-888-KEITHLEY (534-8453) • www.keithley.com**

**Sales Offices:** **BELGIUM:**

Bergensesteenweg 709 • B-1600 Sint-Pieters-Leeuw • 02-363 00 40 • Fax: 02/363 00 64

**CHINA:**

Yuan Chen Xin Building, Room 705 • 12 Yumin Road, Dewai, Madian • Beijing 100029 • 8610-6202-2886 • Fax: 8610-6202-2892

**FINLAND:**

Tietäjäsentie 2 • 02130 Espoo • Phone: 09-54 75 08 10 • Fax: 09-25 10 51 00

**FRANCE:**

3, allée des Garays • 91127 Palaiseau Cédex • 01-64 53 20 20 • Fax: 01-60 11 77 26

**GERMANY:**

Landsberger Strasse 65 • 82110 Germering • 089/84 93 07-40 • Fax: 089/84 93 07-34

**GREAT BRITAIN:**

Unit 2 Commerce Park, Brunel Road • Theale • Berkshire RG7 4AB • 0118 929 7500 • Fax: 0118 929 7519

**INDIA:**

Flat 2B, Willocrissa • 14, Rest House Crescent • Bangalore 560 001 • 91-80-509-1320/21 • Fax: 91-80-509-1322

**ITALY:**

Viale San Gimignano, 38 • 20146 Milano • 02-48 39 16 01 • Fax: 02-48 30 22 74

**JAPAN:**

New Pier Takeshiba North Tower 13F • 11-1, Kaigan 1-chome • Minato-ku, Tokyo 105-0022 • 81-3-5733-7555 • Fax: 81-3-5733-7556

**KOREA:**

2FL., URI Building • 2-14 Yangjae-Dong • Seocho-Gu, Seoul 137-888 • 82-2-574-7778 • Fax: 82-2-574-7838

**NETHERLANDS:**

Postbus 559 • 4200 AN Gorinchem • 0183-635333 • Fax: 0183-630821

**SWEDEN:**

c/o Regus Business Centre • Frosundavik Allé 15, 4tr • 169 70 Solna • 08-509 04 679 • Fax: 08-655 26 10

**SWITZERLAND:**

Kriesbachstrasse 4 • 8600 Dübendorf • 01-821 94 44 • Fax: 01-820 30 81

**TAIWAN:**

1FL., 85 Po Ai Street • Hsinchu, Taiwan, R.O.C. • 886-3-572-9077 • Fax: 886-3-572-9031