

AWGSYNC01
Synchronization Hub
Safety and Installation Manual



AWGSYNC01
Synchronization Hub
Safety and Installation Manual

Revision A

www.tektronix.com
071-3292-01

Tektronix

Copyright © Tektronix. All rights reserved. Licensed software products are owned by Tektronix or its subsidiaries or suppliers, and are protected by national copyright laws and international treaty provisions. Tektronix products are covered by U.S. and foreign patents, issued and pending. Information in this publication supersedes that in all previously published material. Specifications and price change privileges reserved.

TEKTRONIX and TEK are registered trademarks of Tektronix, Inc.

Contacting Tektronix

Tektronix, Inc.
14150 SW Karl Braun Drive
P.O. Box 500
Beaverton, OR 97077
USA

For product information, sales, service, and technical support:

- In North America, call 1-800-833-9200.
- Worldwide, visit www.tektronix.com to find contacts in your area.

Warranty

Tektronix warrants that this product will be free from defects in materials and workmanship for a period of one (1) year from the date of shipment. If any such product proves defective during this warranty period, Tektronix, at its option, either will repair the defective product without charge for parts and labor, or will provide a replacement in exchange for the defective product. Parts, modules and replacement products used by Tektronix for warranty work may be new or reconditioned to like new performance. All replaced parts, modules and products become the property of Tektronix.

In order to obtain service under this warranty, Customer must notify Tektronix of the defect before the expiration of the warranty period and make suitable arrangements for the performance of service. Customer shall be responsible for packaging and shipping the defective product to the service center designated by Tektronix, with shipping charges prepaid. Tektronix shall pay for the return of the product to Customer if the shipment is to a location within the country in which the Tektronix service center is located. Customer shall be responsible for paying all shipping charges, duties, taxes, and any other charges for products returned to any other locations.

This warranty shall not apply to any defect, failure or damage caused by improper use or improper or inadequate maintenance and care. Tektronix shall not be obligated to furnish service under this warranty a) to repair damage resulting from attempts by personnel other than Tektronix representatives to install, repair or service the product; b) to repair damage resulting from improper use or connection to incompatible equipment; c) to repair any damage or malfunction caused by the use of non-Tektronix supplies; or d) to service a product that has been modified or integrated with other products when the effect of such modification or integration increases the time or difficulty of servicing the product.

THIS WARRANTY IS GIVEN BY TEKTRONIX WITH RESPECT TO THE PRODUCT IN LIEU OF ANY OTHER WARRANTIES, EXPRESS OR IMPLIED. TEKTRONIX AND ITS VENDORS DISCLAIM ANY IMPLIED WARRANTIES OF MERCHANTABILITY OR FITNESS FOR A PARTICULAR PURPOSE. TEKTRONIX' RESPONSIBILITY TO REPAIR OR REPLACE DEFECTIVE PRODUCTS IS THE SOLE AND EXCLUSIVE REMEDY PROVIDED TO THE CUSTOMER FOR BREACH OF THIS WARRANTY. TEKTRONIX AND ITS VENDORS WILL NOT BE LIABLE FOR ANY INDIRECT, SPECIAL, INCIDENTAL, OR CONSEQUENTIAL DAMAGES IRRESPECTIVE OF WHETHER TEKTRONIX OR THE VENDOR HAS ADVANCE NOTICE OF THE POSSIBILITY OF SUCH DAMAGES.

[W2 – 15AUG04]

Table of Contents

Important safety information	iii
General safety summary	iii
Service safety summary	v
Terms in the manual	v
Terms on the product	vi
Symbols on the product	vi
Compliance Information	vii
EMC compliance	vii
Safety compliance	viii
Environmental compliance	xi
Preface	xiii

Install the instrument

Standard accessories	1
Options	2
Operating requirements	2
Clearance requirements	2
Environment requirements	2
Power requirements	2
Power-on and power-off procedures	3

Operating basics

Front-panel connectors	5
Rear-panel connectors	5
Connect the instruments	6
Enable the Slave AWG70000 instruments	9
Configure the Master AWG70000	9
Calibrate (deskew) the AWG70000 output channels	11
Output synchronized signals	14

Specifications

General specifications	15
Inputs, outputs	15
Physical characteristics	18
Environment	18

Important safety information

This manual contains information and warnings that must be followed by the user for safe operation and to keep the product in a safe condition.

To safely perform service on this product, see the *Service safety summary* that follows the *General safety summary*.

General safety summary

Use the product only as specified. Review the following safety precautions to avoid injury and prevent damage to this product or any products connected to it. Carefully read all instructions. Retain these instructions for future reference.

Comply with local and national safety codes.

For correct and safe operation of the product, it is essential that you follow generally accepted safety procedures in addition to the safety precautions specified in this manual.

The product is designed to be used by trained personnel only.

Only qualified personnel who are aware of the hazards involved should remove the cover for repair, maintenance, or adjustment.

Before use, always check the product with a known source to be sure it is operating correctly.

Use personal protective equipment to prevent shock and arc blast injury where hazardous live conductors are exposed.

While using this product, you may need to access other parts of a larger system. Read the safety sections of the other component manuals for warnings and cautions related to operating the system.

When incorporating this equipment into a system, the safety of that system is the responsibility of the assembler of the system.

To avoid fire or personal injury

Use proper power cord. Use only the power cord specified for this product and certified for the country of use. Do not use the provided power cord for other products.

Ground the product. This product is grounded through the grounding conductor of the power cord. To avoid electric shock, the grounding conductor must be connected to earth ground. Before making connections to the input or output terminals of the product, ensure that the product is properly grounded. Do not disable the power cord grounding connection.

Power disconnect. The power cord disconnects the product from the power source. See instructions for the location. Do not position the equipment so that it is difficult to operate the power cord; it must remain accessible to the user at all times to allow for quick disconnection if needed.

Observe all terminal ratings.

Do not operate without covers. Do not operate this product with covers or panels removed, or with the case open. Hazardous voltage exposure is possible.

Avoid exposed circuitry. Do not touch exposed connections and components when power is present.

Do not operate with suspected failures. If you suspect that there is damage to this product, have it inspected by qualified service personnel.

Disable the product if it is damaged. Do not use the product if it is damaged or operates incorrectly. If in doubt about safety of the product, turn it off and disconnect the power cord. Clearly mark the product to prevent its further operation.

Before use, inspect voltage probes, test leads, and accessories for mechanical damage and replace when damaged. Do not use probes or test leads if they are damaged, if there is exposed metal, or if a wear indicator shows.

Examine the exterior of the product before you use it. Look for cracks or missing pieces.

Do not operate in wet/damp conditions. Be aware that condensation may occur if a unit is moved from a cold to a warm environment.

Do not operate in an explosive atmosphere.

Keep product surfaces clean and dry. Remove the input signals before you clean the product.

Provide proper ventilation. Refer to the manual's installation instructions for details on installing the product so it has proper ventilation.

Slots and openings are provided for ventilation and should never be covered or otherwise obstructed. Do not push objects into any of the openings.

Provide a safe working environment. Always place the product in a location convenient for viewing the display and indicators.

Be sure your work area meets applicable ergonomic standards. Consult with an ergonomics professional to avoid stress injuries.

Use only the Tektronix rackmount hardware specified for this product.

Service safety summary

The *Service safety summary* section contains additional information required to safely perform service on the product. Only qualified personnel should perform service procedures. Read this *Service safety summary* and the *General safety summary* before performing any service procedures.

To avoid electric shock. Do not touch exposed connections.

Do not service alone. Do not perform internal service or adjustments of this product unless another person capable of rendering first aid and resuscitation is present.

Disconnect power. To avoid electric shock, switch off the product power and disconnect the power cord from the mains power before removing any covers or panels, or opening the case for servicing.

Use care when servicing with power on. Dangerous voltages or currents may exist in this product. Disconnect power, remove battery (if applicable), and disconnect test leads before removing protective panels, soldering, or replacing components.

Verify safety after repair. Always recheck ground continuity and mains dielectric strength after performing a repair.

Terms in the manual

These terms may appear in this manual:



WARNING. *Warning statements identify conditions or practices that could result in injury or loss of life.*



CAUTION. *Caution statements identify conditions or practices that could result in damage to this product or other property.*

Terms on the product

These terms may appear on the product:

- DANGER indicates an injury hazard immediately accessible as you read the marking.
- WARNING indicates an injury hazard not immediately accessible as you read the marking.
- CAUTION indicates a hazard to property including the product.

Symbols on the product



When this symbol is marked on the product, be sure to consult the manual to find out the nature of the potential hazards and any actions which have to be taken to avoid them. (This symbol may also be used to refer the user to ratings in the manual.)

The following symbols may appear on the product:



Standby

Compliance Information

This section lists the EMC (electromagnetic compliance), safety, and environmental standards with which the instrument complies.

EMC compliance

EC Declaration of Conformity – EMC

Meets intent of Directive 2004/108/EC for Electromagnetic Compatibility. Compliance was demonstrated to the following specifications as listed in the Official Journal of the European Communities:

EN 61326-1 2006 . EMC requirements for electrical equipment for measurement, control, and laboratory use. ^{1 2}

- CISPR 11:2003. Radiated and conducted emissions, Group 1, Class A
- IEC 61000-4-2:2001. Electrostatic discharge immunity
- IEC 61000-4-3:2002. RF electromagnetic field immunity
- IEC 61000-4-4:2004. Electrical fast transient / burst immunity
- IEC 61000-4-5:2001. Power line surge immunity
- IEC 61000-4-6:2003. Conducted RF immunity
- IEC 61000-4-11:2004. Voltage dips and interruptions immunity

EN 61000-3-2:2006. AC power line harmonic emissions

EN 61000-3-3:1995. Voltage changes, fluctuations, and flicker

European contact.

Tektronix UK, Ltd.
Western Peninsula
Western Road
Bracknell, RG12 1RF
United Kingdom

¹ This product is intended for use in nonresidential areas only. Use in residential areas may cause electromagnetic interference.

² Emissions which exceed the levels required by this standard may occur when this equipment is connected to a test object.

**Australia / New Zealand
Declaration of Conformity
– EMC**

Complies with the EMC provision of the Radiocommunications Act per the following standard, in accordance with ACMA:

- CISPR 11:2003. Radiated and conducted emissions, Group 1, Class A, in accordance with EN 61326- 1:2006.
- CISPR 11:2003. Radiated and conducted emissions, Group 1, Class A, in accordance with EN 61326- 1:2006 and EN 61326-2-1:2006.
- EN 55022:1987. Radiated and conducted emissions, Class A, in accordance with EN 55103-1:1996.
- EN 55022:1987. Radiated and conducted emissions, Class B, in accordance with EN 55103-1:1996.

Australia / New Zealand contact.

Baker & McKenzie
Level 27, AMP Centre
50 Bridge Street
Sydney NSW 2000, Australia

Safety compliance

This section lists the safety standards with which the product complies and other safety compliance information.

**EU declaration of
conformity – low voltage**

Compliance was demonstrated to the following specification as listed in the Official Journal of the European Union:

Low Voltage Directive 2006/95/EC.

- EN 61010-1. Safety Requirements for Electrical Equipment for Measurement, Control, and Laboratory Use – Part 1: General Requirements.

**U.S. nationally recognized
testing laboratory listing**

- UL 61010-1. Safety Requirements for Electrical Equipment for Measurement, Control, and Laboratory Use – Part 1: General Requirements.

Canadian certification	<ul style="list-style-type: none">■ CAN/CSA-C22.2 No. 61010-1. Safety Requirements for Electrical Equipment for Measurement, Control, and Laboratory Use – Part 1: General Requirements.
Additional compliances	<ul style="list-style-type: none">■ IEC 61010-1. Safety Requirements for Electrical Equipment for Measurement, Control, and Laboratory Use – Part 1: General Requirements.
Equipment type	Test and measuring equipment.
Safety class	Class 1 – grounded product.
Safety certification of plug-in or VXI modules	The safety certification is valid only when installed in an appropriately approved (by a USA NRTL or a Canada Certified Organization) mainframe.
Pollution degree description	<p>A measure of the contaminants that could occur in the environment around and within a product. Typically the internal environment inside a product is considered to be the same as the external. Products should be used only in the environment for which they are rated.</p> <ul style="list-style-type: none">■ Pollution Degree 1. No pollution or only dry, nonconductive pollution occurs. Products in this category are generally encapsulated, hermetically sealed, or located in clean rooms.■ Pollution Degree 2. Normally only dry, nonconductive pollution occurs. Occasionally a temporary conductivity that is caused by condensation must be expected. This location is a typical office/home environment. Temporary condensation occurs only when the product is out of service.■ Pollution Degree 3. Conductive pollution, or dry, nonconductive pollution that becomes conductive due to condensation. These are sheltered locations where neither temperature nor humidity is controlled. The area is protected from direct sunshine, rain, or direct wind.■ Pollution Degree 4. Pollution that generates persistent conductivity through conductive dust, rain, or snow. Typical outdoor locations.

Pollution degree Pollution Degree 2 (as defined in IEC 61010-1). Note: Rated for indoor, dry location use only.

IP rating IP20 (as defined in IEC 60529).

Measurement and overvoltage category descriptions Measurement terminals on this product may be rated for measuring mains voltages from one or more of the following categories (see specific ratings marked on the product and in the manual).

- Measurement Category II. For measurements performed on circuits directly connected to the low-voltage installation.
- Measurement Category III. For measurements performed in the building installation.
- Measurement Category IV. For measurements performed at the source of low-voltage installation.

NOTE. *Only mains power supply circuits have an overvoltage category rating. Only measurement circuits have a measurement category rating. Other circuits within the product do not have either rating.*

Mains overvoltage category rating Overvoltage Category II (as defined in IEC 61010-1)

Environmental compliance

This section provides information about the environmental impact of the product.

Product end-of-life handling

Observe the following guidelines when recycling an instrument or component:

Equipment recycling. Production of this equipment required the extraction and use of natural resources. The equipment may contain substances that could be harmful to the environment or human health if improperly handled at the product's end of life. To avoid release of such substances into the environment and to reduce the use of natural resources, we encourage you to recycle this product in an appropriate system that will ensure that most of the materials are reused or recycled appropriately.



This symbol indicates that this product complies with the applicable European Union requirements according to Directives 2002/96/EC and 2006/66/EC on waste electrical and electronic equipment (WEEE) and batteries. For information about recycling options, check the Support/Service section of the Tektronix Web site (www.tektronix.com).

Restriction of hazardous substances

This product is classified as an industrial monitoring and control instrument, and is not required to comply with the substance restrictions of the recast RoHS Directive 2011/65/EU until July 22, 2017.

Preface

This manual describes the installation and basic operation of the Tektronix AWGSYNC01 Synchronization Hub instrument. This instrument can synchronize (provide simultaneous signal output) from two to four Tektronix AWG70000 series instruments.

Key features

- Synchronize signal output from two to eight AWG70000 channels
- Synchronize to within 10 ps
- Triggers all channels to same resolution

Where to get more information

For additional operating information, refer to the AWGSYNC01 topics on your AWG70000 series instrument application help.

Install the instrument

Unpack the instrument and check that you received all items listed as Standard Accessories, and any optional accessories you may have ordered. Check the Tektronix Web site (www.tektronix.com) for the most current information.

Standard accessories

Table 1: Standard accessories

Accessory	Tektronix part number
AWGSYNC01 Synchronization Hub Safety and Installation Manual	071-3292-xx
Phase stable clock cable, blue (ships with 4 cables)	174-6568-xx (one cable)
Calibration deskew cable, silver (ships with 4 cables)	174-6606-xx (set of four matched cables)
AWG synchronization communication cable, orange (ships with 4 cables)	174-6157-xx (one cable)
Power cord – one of the following:	
	North America (Option A0)
	Universal Euro (Option A1)
	United Kingdom (Option A2)
	Australia (Option A3)
	Switzerland (Option A5)
	Japan (Option A6)
	China (Option A10)
	India (Option A11)
	No power cord or AC adapter (Option A99)

Options

Table 2: Optional accessories

Accessory	Tektronix part number
AWG70000 Series Rackmount Kit	016-2071-xx

Operating requirements

Use the following operating requirements when installing and operating your instrument.

Clearance requirements

Instrument side	Minimum clearance
Top, bottom, left, right	0 cm (0 in)
Front, rear	5.08 cm (2 in)

Environment requirements

For instrument accuracy, ensure that the instrument has warmed up for 20 minutes and meets the environmental requirements listed in the following table.

Requirement	Description
Temperature (operating)	0 °C to 50 °C (+32 °F to +122 °F)
Humidity (operating)	5% to 90% relative humidity at up to 30 °C (86 °F) 5% to 45% relative humidity above 30 °C (86 °F) up to +50 °C (122 °F) noncondensing
Altitude (operating)	Up to 3,000 m (9,843 feet)

Power requirements



WARNING. To reduce the risk of fire and shock, ensure that the mains supply voltage fluctuations do not exceed 10% of the operating voltage range.

Source voltage and frequency	Power consumption
100 VAC to 240 VAC, 50/60 Hz	110 W

Power-on and power-off procedures

1. Connect the AC power cord to the rear of the instrument.
2. Push the front-panel power button to power on the instrument.
3. Reverse steps 1 and 2 to power off the instrument.

Operating basics

Front-panel connectors

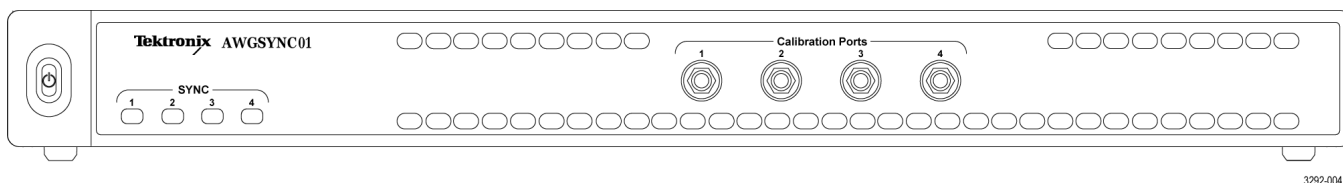

3292-004

Table 3: Front-panel connectors

Connector	Description
Power	Powers on and off the instrument.
Sync	LED that indicate which AWG70000 instruments are enabled for synchronization.
Calibration Ports	Four SMA type connectors used to deskew the instrument signal delays. Only use the supplied matched silver calibration cables to deskew the AWG70000 instrument signal outputs.

Rear-panel connectors

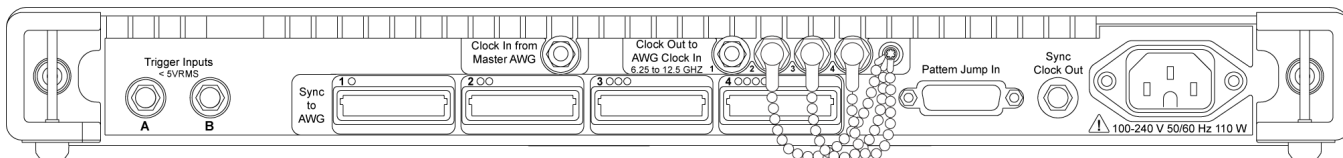

3992-005

Table 4: Rear-panel connectors

Connector	Description
Trigger Inputs (A, B)	External trigger inputs.
Sync to AWG (1-4)	Communication ports used to synchronize all connected AWG70000 instruments. The AWG70000 connected to Port 1 is the Master AWG70000, which sets up and controls synchronization of the other connected AWG instruments. You must connect an AWG70000 to Port 1. AWG70000 instruments connected to Ports 2 through 4 are Slave AWG70000 instruments. Use the supplied orange cable assemblies to connect these ports to the AWG70000 instruments.
Clock in from Master AWG	Input for the synchronization clock signal. <ul style="list-style-type: none"> ■ If using the Master AWG70000 instrument as the clock source, then connect the Clock Out port on the Master instrument to this connector on the AWG70000. Use the supplied phase-matched blue clock cable provided with the instrument. ■ If using an external clock signal to synchronize all instruments, then connect the external clock signal to this port on the AWG70000.

Connector	Description
Clock Out to AWG Clock In 	Provides a synchronized clock signal to the Slave AWG70000 instruments when the Master AWG70000 is the clock source, or to all AWG70000 instruments when using an external clock source. Use the supplied phase-matched blue clock cables to connect the Clock Out signal to the AWG70000 Clock In connectors.
	CAUTION. Always attach a termination cap to any unused Clock Out connectors.
Pattern Jump In	15-pin DSUB connector to provide a pattern jump event for sequencing.
Sync Clock Out	Provides a synchronized clock signal output to connect to other equipment or DUT.

NOTE. There is no Ethernet connection on the AWGSYNC01. The AWGSYNC01 is controlled by the Master AWG70000 instrument.

Connect the instruments

The following diagrams show how to connect the AWGSYNC01 to two or more AWG70000 instruments.



CAUTION. Use proper electrostatic discharge (ESD) handling procedures when connecting cables to the AWGSYNC01 and AWG70000 instruments to prevent damage.



CAUTION. To be sure of proper cooling, do not install the AWGSYNC01 side-by-side with AWG70000 instruments.

NOTE. You must connect an AWG70000 to the 'Sync to AWG' connector port 1. The AWG70000 connected to port 1 is the Master AWG70000 that controls and synchronizes all signals output from the connected AWG70000 instruments.

NOTE. Refer to the AWG70000 Series application help for information on connecting and configuring other cables such as Ethernet to the AWG70000 instruments.

NOTE. Torque all SMA connectors to 7.5 in-lb.

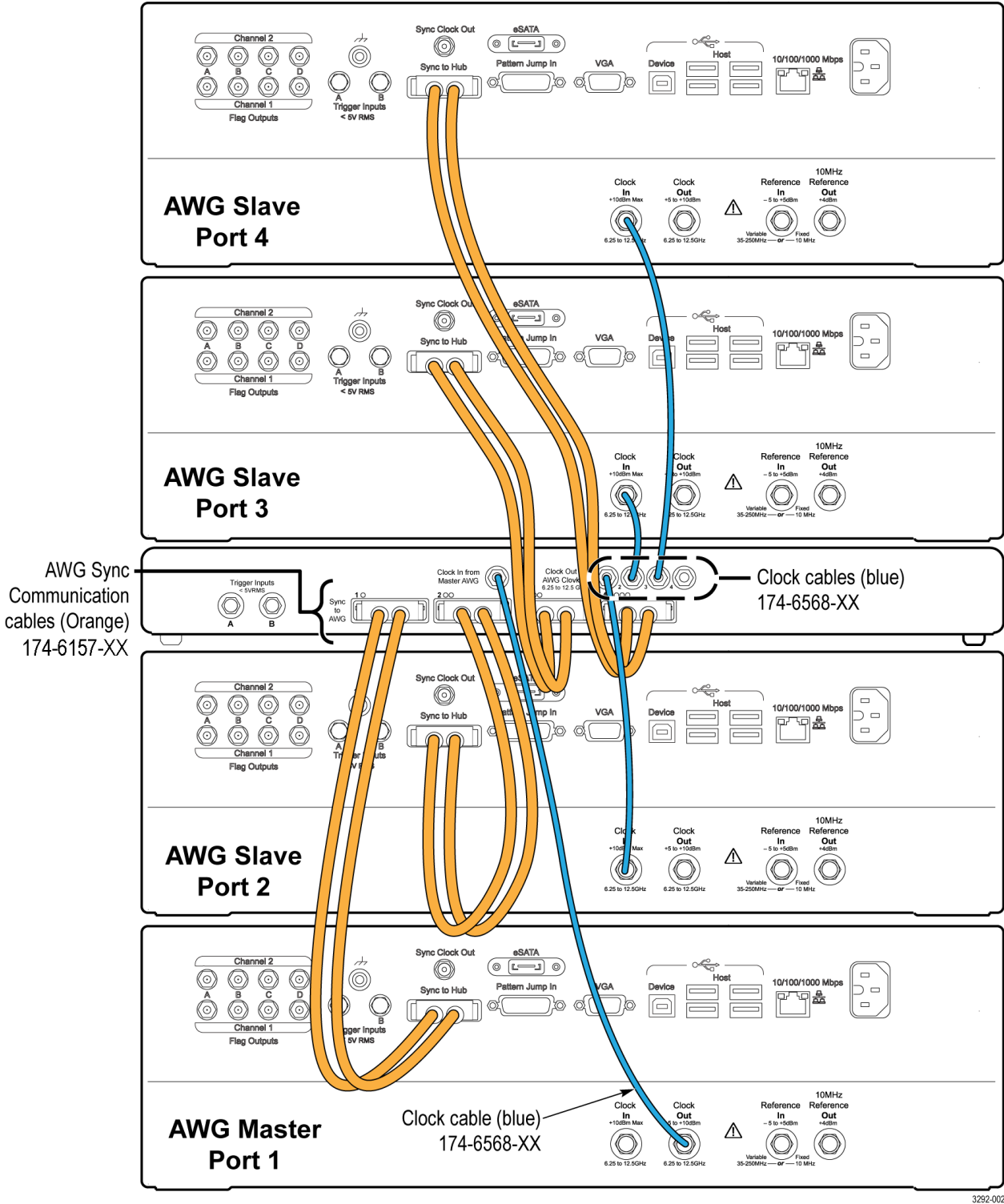
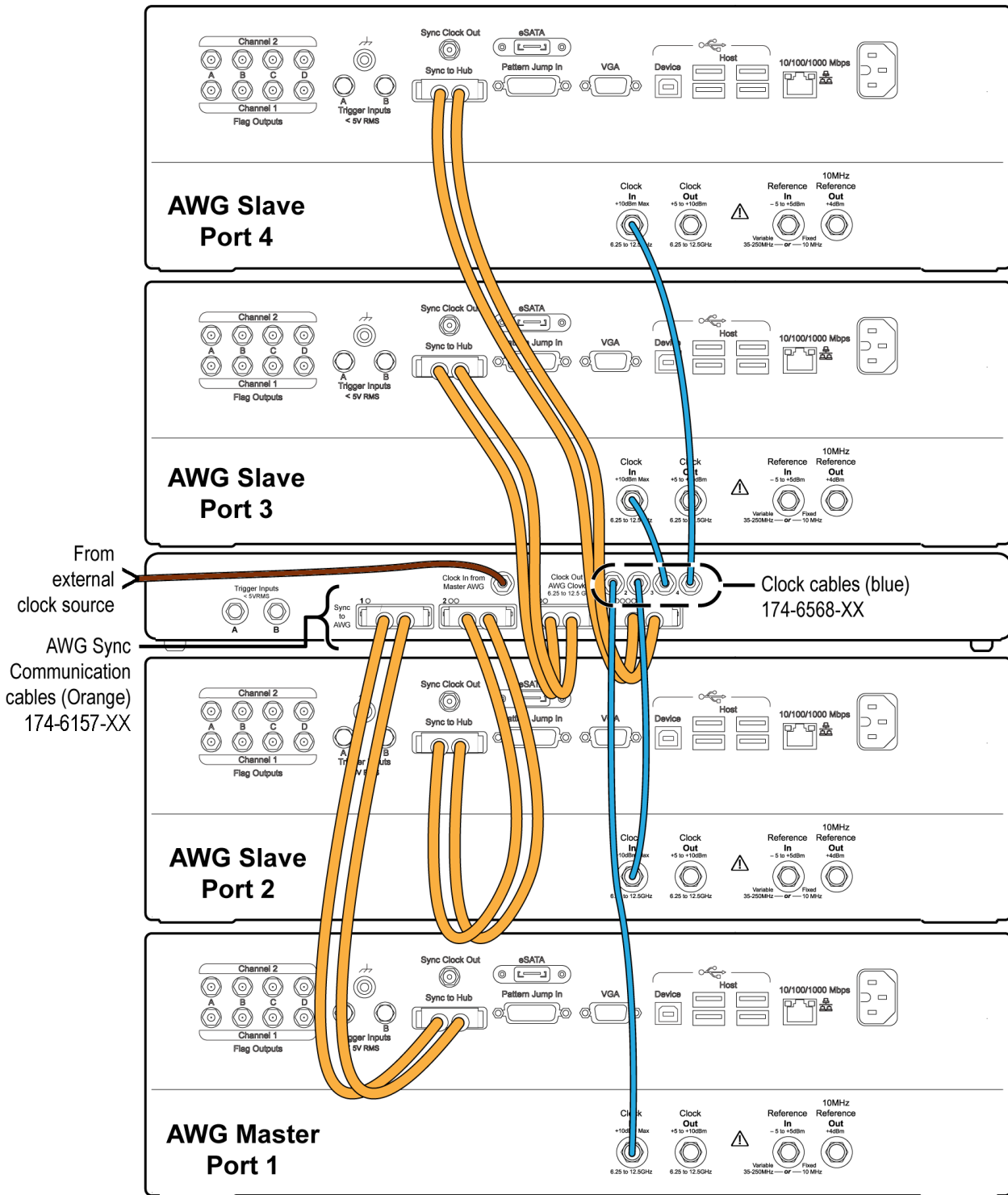

Figure 1: Rear panel connections: clock source = Master AWG7000



3292-003

Figure 2: Rear panel connections: clock source = external clock signal

Enable the Slave AWG70000 instruments

Prerequisite: All instruments are connected to the AWGSYNC01. (See *Connect the AWGSYNC01 to AWG70000 instruments.*)

NOTE. You can use the Master AWG70000 UI to connect or disconnect from individual Slave AWG70000 instruments as long as you have enabled synchronization on the Slave AWG70000 instruments.

1. Open the UI of a Slave AWG70000 instrument.
2. Click the **Setup** tab.
3. Click the **Sync** tab.
4. Select **Enable** to make the AWG70000 accessible for synchronization with the Master AWG70000.
5. Repeat steps 1 through 4 for each Slave AWG to enable.
6. Go to the *Configure the Master AWG70000* procedure.

Configure the Master AWG70000

Enter a short description of your concept here (optional).

Prerequisite: Connected Slave AWG70000 instruments have been enabled for synchronization. (See *Enable the Slave AWG70000 instruments.*)

1. Open the UI of the Master AWG70000.
2. Click the **Setup** tab.
3. Click the **Sync** tab.

4. Click **Enable**.

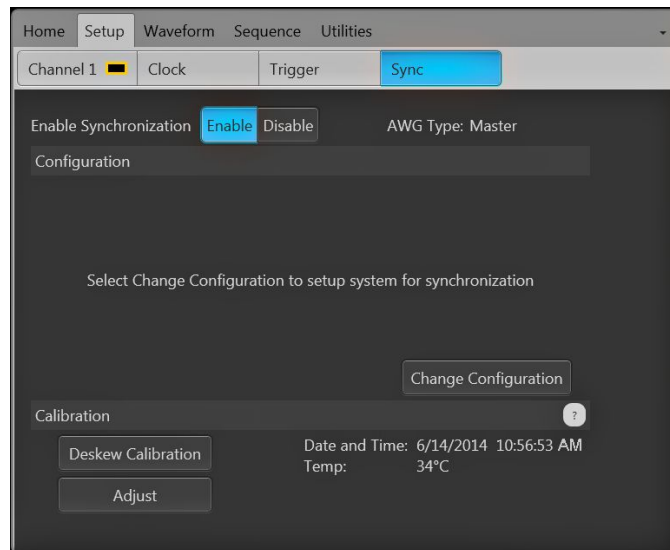

5. Click **Change Configuration**. Select the slave ports to enable.

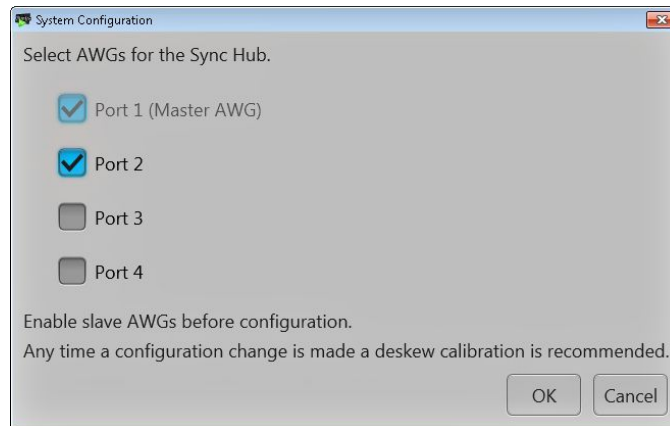

- Click **OK**. The Master AWG70000 instrument connects to the selected Slave AWG70000 instruments and displays the connections on the Sync tab screen. If the Master AWG70000 cannot connect to a Slave AWG70000, the Master shows an error message after a minute or so.

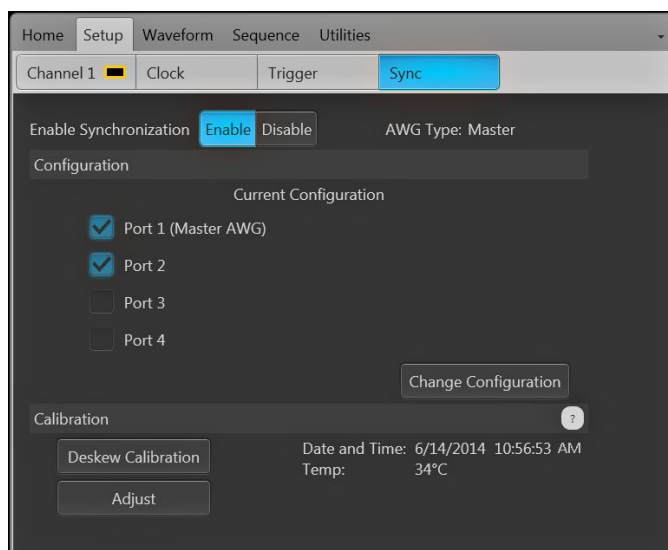

Calibrate (deskew) the AWG70000 output channels

This procedure aligns the channel 1 outputs of all connected and enabled instruments to within ± 10 ps of each other. You should run the deskew process when you first set up the instruments, and whenever you make any configuration change, such as replacing an AWG70000, swapping an AWG70000 within the same configuration, changing the deskew cables, or changing the Master AWG70000.

Prerequisites:

- All instruments are connected to the AWGSYNC01 (see *Connect the instruments*).
- All Slave AWG70000 instruments have been enabled (from each Slave instrument and from the Master instrument).
- The deskew calibration cables are connected as shown in the following diagram.



CAUTION. Use proper ESD-handling procedures when connecting cables to the AWGSYNC01 and AWG70000 instruments to prevent electrostatic discharge damage.

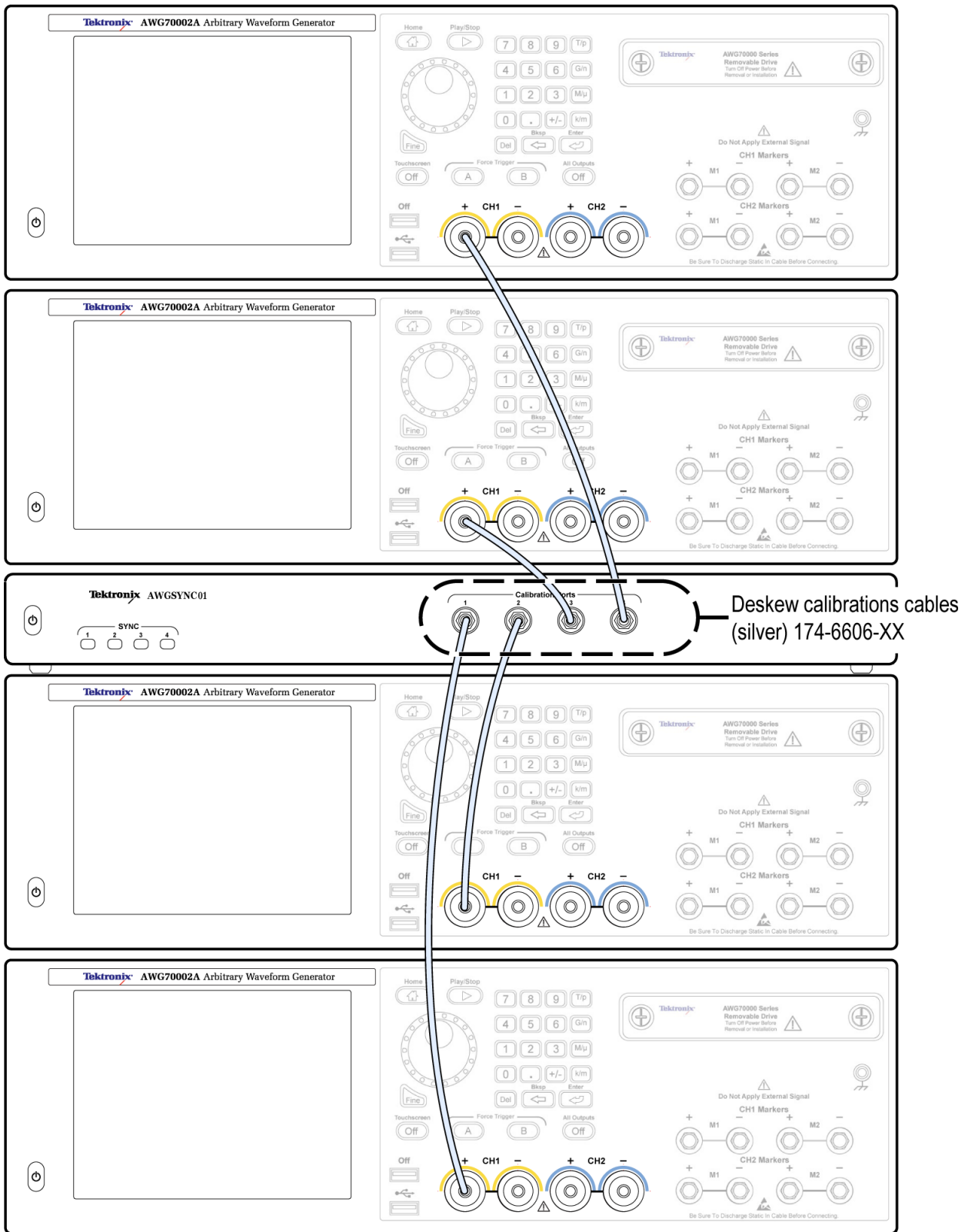

3292-001

Figure 3: Connect the calibration deskew cables (front panel)

1. Use the supplied matched silver calibration cables to connect the Calibration ports on the front of the AWGSYNC01 to the same CH1+ or CH1– output on all AWG70000 Master and Slave instruments. The order of the connections is important. Connect Calibration Port 1 to the CH1 output on the Master AWG70000 instrument, connect Calibration Port 2 to the CH1 output on the Port 2 AWG70000 Slave instrument, and so on. You can use CH1– for deskew if you connect to the CH1– output on all instruments. The following diagram shows the calibration cables connected to the CH1+ outputs on all AWG70000 instruments.

NOTE. Torque all SMA connectors to 7.5 in-lb.

NOTE. Do not use CH2 for deskew calibration.

2. Allow all instruments to warm up for 20 minutes.
3. Enable the Slave AWG70000 instruments (see *Enable the Slave AWG70000 instruments*).
4. Configure the Master AWG70000 (see *Configure the Master AWG70000*).
5. Click **Setup > Deskew Calibration** on the Master AWG70000. An in-progress dialog is shown on all instruments while running the calibration. Deskew calibration takes approximately 20 to 30 minutes if using the Master AWG70000 as the clock source, or about a minute if using an external clock source (see *Deskew and clock source* below).

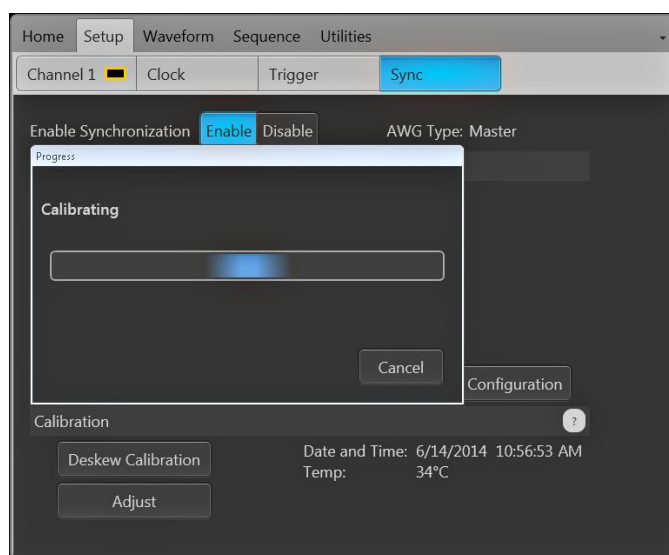

6. The Master AWG70000 saves the deskew calibration settings at the completion of the calibration process, and displays the date, time, and instrument temperature of the most-recent successful calibration process.

Deskew and clock source

You can deskew the AWG70000 instruments when using either the Master AWG70000 clock out signal or an external clock signal. Keep the following points in mind:

- If using the Master AWG70000 as the clock source, the instrument deskews for all available AWG70000 sample rates. Deskewing for all sample rates takes about 20–30 minutes.
- If using an external clock source, the instrument deskews only for the single sample rate frequency of the clock signal. This significantly reduces the time to deskew from about 30 minutes to a minute or so.
- You can deskew for multiple external clock frequencies. Connect the first external clock signal, run the deskew process, connect the second external clock source, run deskew again, and so on. The deskew values are stored in nonvolatile memory on each instrument.

The Adjust button

If the internal temperature of a slave instrument has changed more than ± 5 °C since the last sample rate clock adjustment, the following message is shown on status bar of that slave instrument:

Synchronization Adjust recommended on Master

Current temperature x% degrees outside of recommended tolerance

When this message occurs, click the Adjust button on the Master instrument to force a synchronization clock sample rate adjustment on all active (selected) slave instruments so that all waveform playback remains in sync.

If the system is playing waveforms when Adjust is clicked, all waveform play stops, the master runs the sample rate adjust routine, and then resumes waveform play.

Output synchronized signals

Refer to the AWG70000 Series Help file for information on configuring the Master AWG70000 output signals, settings, clocks, and triggers.

1. Load waveforms into all AWG70000 instruments (Master and Slaves).
2. Open the UI for the Master AWG70000.
3. Set the clock, trigger, and other controls.
4. Enable the Master AWG70000 to play sequences and waveforms.
5. When the trigger event occurs, the Master AWG70000 signals all enabled Slave AWG70000 instruments, and itself, to simultaneously output their respective waveforms.

Specifications

General specifications

Jitter

Random Jitter (typical)	315 fs RMS
Total jitter (typical)	13 psp-p at 12.5 Gb/s

Skew

Instrument to instrument skew	±10 ps
Skew repeatability/accuracy	≤5 ps

After changes of sample rate or power cycle and within ±5 °C from deskew calibration.

Inputs, outputs

Calibration Ports	Four SMA type connectors used to deskew the instrument signal delays. Only use the supplied matched silver calibration cables with these connectors when deskewing the AWG70000 instrument signal outputs.
-------------------	--

Trigger Inputs (A, B)	External trigger inputs
Connector	SMA
Number of trigger inputs	2
Impedance	50 Ω or 1 kΩ selectable
Polarity	Positive or negative selectable
Input voltage range	50 Ω: <5 VRMS 1 kΩ: ±10 VRMS
Threshold range	-5.0 V to 5.0 V
Threshold resolution	0.1 V
Minimum trigger pulse width	20 ns
Trigger holdoff	>1.4 μs
Trigger delay to analog output	Asynchronous trigger mode: $32,480 / (2 * f_{clk}) \pm 20$ ns Synchronous trigger mode: $30,880 / (2 * f_{clk}) \pm 20$ ns fclk is the frequency of the DAC sampling clock The DAC sampling clock frequency is displayed on the clock settings tab when the external clock output is enabled.

Trigger asynchronous jitter	80/sampling clock frequency The asynchronous jitter performance is directly proportional the sync clock out frequency. The sync clock out is derived from the DAC sampling clock. The DAC sampling clock frequency is displayed on the clock settings tab when the external clock output is enabled.
Trigger synchronous jitter	Clock In = 12.5 GHz: 300 fsRMS, 4.2 ps RJp-p BER@10-12 Variable Reference In = 156.25 MHz: 400 fsRMS, 5.6 ps RJp-p BER@10-12 Fixed Reference In = 10 MHz: 1.7 psRMS, 23.8 ps RJp-p BER@10-12 Sample rate = 25 GS/s
Sync to AWG (1-4)	Communication ports used by to synchronize all connected AWG70000 instruments. The AWG70000 connected to Port 1 is the Master AWG70000, which sets up and controls synchronization of the connected instruments. You must connect an AWG70000 to Port 1. AWG70000 instruments connected to Ports 2 through 4 are Slave AWG70000 instruments. Use the supplied orange cable assemblies to connect these ports to the AWG70000 instruments.
Clock in from Master AWG	Synchronizing clock signal input from the master AWG70000 Clock Out port, or from an external clock signal source.
Connector	SMA
Input impedance	50 Ω , AC coupled
Input frequency range	6.25 GHz to 12.5 GHz
Input amplitude	+5 dBm to +10 dBm
Clock Out to AWG Clock In	
Connector	SMA
Impedance	50 Ω , AC coupled
Frequency range	6.25 GHz to 12.5 GHz
Output amplitude	+5 dBm to +10 dBm
Sync Clock Out	
Connector	SMA
Impedance	50 Ω , AC coupled
Frequency	10 MHz \pm (1 ppm + aging)
Output amplitude	1.0 V \pm 150 mVp-p
Pattern Jump In	
Number of jump destinations	256
Connector	15-pin D-sub female connector on rear panel
Input levels	3.3 V LVCMOS 5 V TTL compliant (input impedance pull up to 5 V by 1 k Ω resistor)
Strobe	Polarity: Data is clocked in on negative edge Minimum pulse width: 64 ns

Latency to analog output 102,125/fclk +20 ns ± 20 ns
 The DAC sampling clock frequency is displayed on the clock settings tab when the external clock output is enabled

Holdoff time >18 µs
 Strobe hold off is the amount of delay required at the end of a waveform before another strobe pulse can be processed

Connector pin/signal assignment

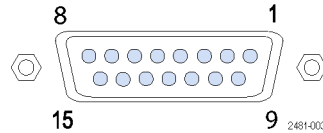

Pin	Signal
1, 6, 8, 9, 14, 15	GND
2	Data bit 0, input
3	Data bit 1, input
4	Data bit 2, input
5	Data bit 3, input
7	Strobe input
10	Data bit 4, input
11	Data bit 5, input
12	Data bit 6, input
13	Data bit 7, input

Physical characteristics

Dimensions

Height	44.45 mm (1.75 in)
Width	460.5 mm (18.13 in)
Depth	603 mm (23.76 in)

Weight

Instrument only	5.4 kg (12 lb)
With packaging	9.1 kg (20 lb)

Cooling clearance

Top, bottom, left, right	0 mm (0 in)
Rear	50 mm (2 in)

Power

AC line input	100 to 240 V AC, 50/60 Hz
Consumption	110 W

Environment

Temperature

Operating	0 °C to +50 °C (32 °F to +122 °F)
Nonoperating	-20 °C to +60 °C (140 °F to +150 °F)

Humidity

Operating (noncondensing)	5% to 90% relative humidity (% RH) at up to 30 °C
	5% to 45% relative humidity above 30 °C up to 50 °C
Nonoperating (noncondensing)	5% to 90% relative humidity (% RH) at up to 30 °C
	5% to 45% relative humidity above 30 °C up to 60 °C

Altitude

Operating	Up to 3,000 meters (9,843 feet)
	Derate maximum operating temperature by 1 °C per 300 meters above 1500 meters
Nonoperating	Up to 12,000 meters (39,370 feet)

Regulatory

Safety	UL61010-1, CAN/CSA-22.2, No.61010-1, EN61010-1, IEC61010-1
EMC Emissions	IEC61326, EN55011 (Class A), IEC61000-3-2, IEC61000-3-3

EMC Immunity	IEC61326, IEC61000-4-2/3/4/5/6/11
Regional certifications	Europe: EN61326
	Australia/New Zealand: AS/NZS 2064
