



5 Series B MSO MS054B, MS056B, MS058B

Specifications and Performance Verification

Warning: The servicing instructions are for use by qualified personnel only. To avoid personal injury, do not perform any servicing unless you are qualified to do so. Refer to all safety summaries prior to performing service.

Revision C.

Supports product Firmware V1 and above.

Register now!

Click the following link to protect your product.

tek.com/register



077-1725-01 January 2025

Copyright © 2024 Tektronix 2024. All rights reserved. Licensed software products are owned by Tektronix or its subsidiaries or suppliers, and are protected by national copyright laws and international treaty provisions. Tektronix products are covered by U.S. and foreign patents, issued and pending. Information in this publication supersedes that in all previously published material. Specifications and price change privileges reserved.

TEKTRONIX and TEK are registered trademarks of Tektronix, Inc.

FlexChannel, e*Scope, and TekVPI are registered trademarks of Tektronix, Inc.

Contacting Tektronix

Tektronix, Inc.

14150 SW Karl Braun Drive

P.O. Box 500

Beaverton, OR 97077

USA

For product information, sales, service, and technical support:

- In North America, call 1-800-833-9200.
- Worldwide, visit www.tek.com to find contacts in your area.

Contents

List of Figures.....	5
List of Tables.....	6
Important safety information.....	7
General safety summary.....	7
To avoid fire or personal injury.....	7
Terms in this manual and on the product.....	9
Symbols on the product.....	9
Specifications.....	10
Analog channel input and vertical specification.....	10
Timebase system.....	19
Trigger system.....	21
Serial Trigger specifications.....	24
Digital acquisition system.....	27
Digital volt meter (DVM).....	27
Trigger frequency counter.....	28
Arbitrary Function Generator system.....	28
Display system.....	30
Processor system.....	31
Input/Output port specifications.....	31
Data storage specifications.....	33
Power supply system.....	34
Safety characteristics.....	34
Environmental specifications.....	34
Mechanical specifications.....	35
Performance verification procedures.....	36
Test record.....	37
Input Impedance test record.....	37
DC Balance test record.....	38
DC Gain Accuracy test record.....	44
DC Offset Accuracy test record.....	50
Analog Bandwidth test record.....	53
Random Noise, sample acquisition mode test record.....	88
Random Noise, High Res mode test record.....	112
Long term sample rate through AFG DC offset accuracy test records.....	134
Performance tests.....	159
Prerequisites.....	159
Self test.....	159
Check input impedance.....	161
Check DC balance.....	162
Check DC gain accuracy.....	164
Check DC offset accuracy.....	166
Check analog bandwidth.....	168
Check random noise, sample acquisition mode.....	170
Check random noise, High Res mode.....	172

Check long term sample rate.....	174
Check delta time measurement accuracy.....	175
Check digital threshold accuracy.....	177
Check DVM voltage accuracy (DC).....	178
Check DVM voltage accuracy (AC).....	179
Check trigger frequency accuracy and maximum input frequency.....	180
Arbitrary function generator.....	180
Check AFG sine and ramp frequency accuracy.....	181
Check AFG square and pulse frequency accuracy.....	182
Check AFG signal amplitude accuracy.....	183
Check AFG DC offset accuracy.....	184
Index.....	186

List of Figures

Figure 1: Frequency/period test.....	181
Figure 2: Frequency/period test.....	182
Figure 3: 50 Ω terminator accuracy.....	183
Figure 4: Amplitude test.....	183
Figure 5: 50 Ω terminator accuracy.....	184
Figure 6: DC offset tests.....	185

List of Tables

Table 1: 5 Series B MSO	21
Table 2: Expected gain worksheet.....	165
Table 3: Maximum bandwidth frequency worksheet.....	169
Table 4: CF (Calibration Factor) = $1.414 \times ((50 / \text{Measurement } \Omega) + 1)$	183
Table 5: CF (Calibration Factor) = $0.5 \times ((50 / \text{Measurement } \Omega) + 1)$	184

Important safety information

This manual contains information and warnings that must be followed by the user for safe operation and to keep the product in a safe condition.

General safety summary

Use the product only as specified. Review the following safety precautions to avoid injury and prevent damage to this product or any products connected to it. Carefully read all instructions. Retain these instructions for future reference.

This product shall be used in accordance with local and national codes.

For correct and safe operation of the product, it is essential that you follow generally accepted safety procedures in addition to the safety precautions specified in this manual.

The product is designed to be used by trained personnel only.

Only qualified personnel who are aware of the hazards involved should remove the cover for repair, maintenance, or adjustment.

Before use, always check the product with a known source to be sure it is operating correctly.

This product is not intended for detection of hazardous voltages.

Use personal protective equipment to prevent shock and arc blast injury where hazardous live conductors are exposed.

To avoid fire or personal injury

Use proper power cord

Use only the power cord specified for this product and certified for the country of use. Do not use the provided power cord for other products.

Ground the product

This product is grounded through the grounding conductor of the power cord. To avoid electric shock, the grounding conductor must be connected to earth ground. Before making connections to the input or output terminals of the product, ensure that the product is properly grounded. Do not disable the power cord grounding connection.

Power disconnect

The power cord disconnects the product from the power source. See instructions for the location. Do not position the equipment so that it is difficult to operate the power cord; it must remain accessible to the user at all times to allow for quick disconnection if needed.

Connect and disconnect properly

Do not connect or disconnect probes or test leads while they are connected to a voltage source.

Use only insulated voltage probes, test leads, and adapters supplied with the product, or indicated by Tektronix to be suitable for the product.

Observe all terminal ratings

To avoid fire or shock hazard, observe all rating and markings on the product. Consult the product manual for further ratings information before making connections to the product.

Do not exceed the Measurement Category (CAT) rating and voltage or current rating of the lowest rated individual component of a product, probe, or accessory. Use caution when using 1:1 test leads because the probe tip voltage is directly transmitted to the product.

Do not apply a potential to any terminal, including the common terminal, that exceeds the maximum rating of that terminal.

Do not operate without covers

Do not operate this product with covers or panels removed, or with the case open. Hazardous voltage exposure is possible.

Avoid exposed circuitry

Do not touch exposed connections and components when power is present.

Do not operate with suspected failures

If you suspect that there is damage to this product, have it inspected by qualified service personnel.

Disable the product if it is damaged. Do not use the product if it is damaged or operates incorrectly. If in doubt about safety of the product, turn it off and disconnect the power cord. Clearly mark the product to prevent its further operation.

Before use, inspect voltage probes, test leads, and accessories for mechanical damage and replace when damaged. Do not use probes or test leads if they are damaged, if there is exposed metal, or if a wear indicator shows.

Examine the exterior of the product before you use it. Look for cracks or missing pieces.

Use only specified replacement parts.

Do not operate in wet/damp conditions

Be aware that condensation may occur if a unit is moved from a cold to a warm environment.

Do not operate in an explosive atmosphere

Keep product surfaces clean and dry

Remove the input signals before you clean the product.

Provide proper ventilation

Refer to the installation instructions in the manual for details on installing the product so it has proper ventilation.

Slots and openings are provided for ventilation and should never be covered or otherwise obstructed. Do not push objects into any of the openings.

Provide a safe working environment

Always place the product in a location convenient for viewing the display and indicators.

Avoid improper or prolonged use of keyboards, pointers, and button pads. Improper or prolonged keyboard or pointer use may result in serious injury.

Be sure your work area meets applicable ergonomic standards. Consult with an ergonomics professional to avoid stress injuries.

Use care when lifting and carrying the product. This product is provided with a handle or handles for lifting and carrying.



WARNING: The product is heavy. To reduce the risk of personal injury or damage to the device get help when lifting or carrying the product.

Use only the Tektronix rackmount hardware specified for this product.

Terms in this manual and on the product

These terms may appear in this manual:



WARNING: Warning statements identify conditions or practices that could result in injury or loss of life.



CAUTION: Caution statements identify conditions or practices that could result in damage to this product or other property.

These terms may appear on the product:

- DANGER indicates an injury hazard immediately accessible as you read the marking.
- WARNING indicates an injury hazard not immediately accessible as you read the marking.
- CAUTION indicates a hazard to property including the product.

Symbols on the product



When this symbol is marked on the product, be sure to consult the manual to find out the nature of the potential hazards and any actions which have to be taken to avoid them. (This symbol may also be used to refer the user to ratings in the manual.)

The following symbol(s) may appear on the product.



CAUTION: Refer to
Manual



Protective Ground
(Earth) Terminal



Earth Terminal



Chassis Ground



Standby

Specifications

This chapter contains specifications for the instrument. All specifications are guaranteed unless noted as "typical." Typical specifications are provided for your convenience but are not guaranteed. Specifications that are marked with the ✓ symbol are checked in this manual. All specifications apply to all models unless noted otherwise.

To meet specifications, these conditions must first be met:

- The instrument must have been calibrated in an ambient temperature between 18 °C and 28 °C (64 °F and 82 °F).
- The instrument must be operating within the environmental limits. (See [Environmental specifications](#) on page 34.)
- The instrument must be powered from a source that meets the specifications. (See [Power supply system](#) on page 34.)
- The instrument must have been operating continuously for at least 20 minutes within the specified operating temperature range.
- You must perform the Signal Path Compensation procedure after the warmup period. See the online help for instructions on how to perform signal path compensation. If the ambient temperature changes more than 5 °C (9 °F), repeat the procedure.

Analog channel input and vertical specification

Number of input channels	MSO54B: 4 BNC MSO56B: 6 BNC MSO58B: 8 BNC
Input coupling	DC, AC
Input resistance selection	1 M Ω or 50 Ω
✓ Input impedance 1 MΩ DC coupled	1 M Ω \pm 1%
Input capacitance 1 MΩ DC coupled, typical	14.5 pF \pm 1.5 pF, 2 GHz model 13 pF \pm 1.5 pF, 1 GHz, 500 MHz, 350 MHz models
✓ Input impedance 50 Ω, DC coupled	50 Ω \pm 1% (VSWR \leq 1.5:1, typical)
Maximum input voltage, 1 MΩ	300 V _{RMS} at the BNC. Installation Category II Derate at 20 dB/decade between 4.5 MHz and 45 MHz; derate 14 dB/decade between 45 MHz and 450 MHz. Above 450 MHz, 5.5 V _{RMS} Maximum peak input voltage at the BNC: \pm 425 V
Maximum input voltage, 50 Ohm	5 V _{RMS} , with peaks \leq \pm 20 V (DF \leq 6.25%)
DC balance	✓ 0.1 div with DC-50 Ω oscilloscope input impedance (50 Ω BNC terminated) ✓ 0.2 div at 1 mV/div with DC-50 Ω oscilloscope input impedance (50 Ω BNC terminated) 0.4 div at 500 μ V/div with DC-50 Ω oscilloscope input impedance (50 Ω BNC terminated) ✓ 0.2 div with DC-1 M Ω oscilloscope input impedance (50 Ω BNC terminated) 0.4 div at 500 μ V/div with DC-1 M Ω oscilloscope input impedance (50 Ω BNC terminated)



Note: 500 $\mu\text{V}/\text{div}$ is a 2X digital zoom of 1 mV/div . As such, it is guaranteed by testing the 1 mV/div setting.

Number of digitized bits	8 bits at 6.25 GS/s
	12 bits at 3.125 GS/s
	13 bits at 1.25 GS/s
	14 bits at 625 MS/s
	15 bits at 312.5 MS/s
	16 bits at 125 MS/s

Displayed vertically with 25 digitization levels (DL) for 8-bit and 400 digitization levels for 12-bit per division, 10.24 divisions dynamic range. DL is the abbreviation for digitization level. A DL is the smallest voltage level change that can be resolved by an 8-bit A-D Converter. This value is also known as an LSB (least significant bit).

Sensitivity range, coarse

1 MΩ	500 $\mu\text{V}/\text{div}$ to 10 V/div in a 1-2-5 sequence
50 Ω	500 $\mu\text{V}/\text{div}$ to 1 V/div in a 1-2-5 sequence
	Note: 500 $\mu\text{V}/\text{div}$ is a 2X digital zoom of 1 mV/div

Sensitivity range, fine

Allows continuous adjustment from 1 mV/div to 10 V/div , 1 M Ω and from 1 mV/div to 1 V/div , 50 Ω

1 MΩ	500 $\mu\text{V}/\text{div}$ to 10 V/div
50 Ω	500 $\mu\text{V}/\text{div}$ to 1 V/div

Sensitivity resolution, fine $\leq 1\%$ of current setting

✓ DC gain accuracy

2 GHz model, Step Gain, 50 Ω	$\pm 1.2\%$, ($\pm 2.5\%$ at 1 mV/div and 500 $\mu\text{V}/\text{div}$ settings), de-rated at 0.100%/ $^{\circ}\text{C}$ above 30 $^{\circ}\text{C}$
2 GHz model, Step Gain, 1 MΩ	$\pm 1.0\%$, ($\pm 2.0\%$ at 1 mV/div and 500 $\mu\text{V}/\text{div}$ settings), de-rated at 0.100%/ $^{\circ}\text{C}$ above 30 $^{\circ}\text{C}$
1 GHz, 500 MHz, 350 MHz models, Step Gain, 50 Ohm	$\pm 1.2\%$, ($\pm 2.5\%$ at 1 mV/Div and 500 $\mu\text{V}/\text{Div}$ Settings), de-rated at 0.100%/ $^{\circ}\text{C}$ above 30 $^{\circ}\text{C}$
1 GHz, 500 MHz, 350 MHz models, Step Gain, 1 Meg Ohm	$\pm 1.0\%$, ($\pm 2.0\%$ at 1 mV/Div and 500 $\mu\text{V}/\text{Div}$ Settings), de-rated at 0.100%/ $^{\circ}\text{C}$ above 30 $^{\circ}\text{C}$
Variable gain	$\pm 1.5\%$, de-rated at 0.100%/ $^{\circ}\text{C}$ above 30 $^{\circ}\text{C}$.



Note: 500 $\mu\text{V}/\text{div}$ is a 2X digital zoom of 1 mV/div . As such, it is guaranteed by testing the 1 mV/div setting.

Offset ranges, maximum

2 GHz models	Input signal cannot exceed maximum input voltage for the 50 Ω input path.
---------------------	--

Volts/div Setting	Maximum offset range, 50 Ω Input
500 μV/div - 50 mV/div	±1 V
51 mV/div - 99 mV/div	± (-10 * (Volts/div Setting) + 1.5 V)
100 mV/div - 500 mV/div	±10 V
501 mV/div - 1 V/div	± (-10 * (Volts/div Setting) + 15 V)

Volts/div Setting	Maximum offset range, 1 MΩ Input
500 μV/div - 63 mV/div	±1 V
64 mV/div - 999 mV/div	±10 V
1 V/div - 10 V/div	±100 V

≤ 1 GHz models

Input signal cannot exceed maximum input voltage for the 50 Ω input path.

Volts/div Setting	Maximum offset range	
	50 Ω Input	1 MΩ Input
500 μV/div - 63 mV/div	±1 V	±1 V
64 mV/div - 999 mV/div	±10 V	±10 V
1 V/div - 10 V/div	±10 V	±100 V



Note: 500 μV/div is a 2X digital zoom of 1 mV/div. As such, it is guaranteed by testing the 1 mV/div setting.

- Position range** ±5 divisions
- ✓ Offset accuracy** ±(0.005 X | offset - position | + DC balance)
- Number of waveforms for average acquisition mode** 2 to 10,240 Waveforms, default 16 waveforms

DC voltage measurement accuracy, Average acquisition mode

Measurement Type	DC Accuracy (In Volts)
Average of ≥ 16 waveforms	±((DC Gain Accuracy) * reading - (offset - position) + Offset Accuracy + 0.1 * V/div setting)
Delta volts between any two averages of ≥ 16 waveforms acquired with the same oscilloscope setup and ambient conditions	±(DC Gain Accuracy * reading + 0.05 div)

DC voltage measurement accuracy, sample acquisition mode, typical

Measurement Type	DC Accuracy (In Volts)
Any Sample	±(DC Gain Accuracy * reading - (offset - position) + Offset Accuracy + 0.15 div + 0.6 mV)

Table continued...

Measurement Type	DC Accuracy (In Volts)
Delta Volts between any two samples acquired with the same oscilloscope setup and ambient conditions	$\pm(\text{DC Gain Accuracy} * \text{reading} + 0.15 \text{ div} + 1.2 \text{ mV})$

Bandwidth selections

50 Ω : 20 MHz, 250 MHz, and the full bandwidth value of your model

1 M Ω : 20 MHz, 250 MHz, 350 MHz, 500 MHz. 350 MHz models cannot be configured to 500 MHz in 1 M Ω mode.

✓ Analog bandwidth 50 Ω DC coupled**2 GHz models**

Volts/Div Setting	Bandwidth
10 mV/div - 1 V/div	DC - 2.00 GHz
5 mV/div - 9.98 mV/div	DC - 1.50 GHz
2 mV/div - 4.98 mV/div	DC - 350 MHz
1 mV/div - 1.99 mV/div	DC - 175 MHz
500 μ V/div - 995 μ V/div	DC - 175 MHz

1 GHz models

Volts/Div Setting	Bandwidth
1 mV/div - 1 V/div	DC - 1.00 GHz
500 μ V/div - 995 μ V/div	DC - 250 MHz

500 MHz models

Volts/Div Setting	Bandwidth
1 mV/div - 1 V/div	DC - 500 MHz
500 μ V/div - 995 μ V/div	DC - 250 MHz

350 MHz models

Volts/Div Setting	Bandwidth
1 mV/div - 1 V/div	DC - 350 MHz
500 μ V/div - 995 μ V/div	DC - 250 MHz

Analog bandwidth, 1 M Ω , typical**All model bandwidths except 350 MHz**

The limits stated above are for ambient temperature of ≤ 30 °C and the bandwidth selection set to FULL. Reduce the upper bandwidth frequency by 1% for each °C above 30 °C.

Volts/Div Setting	Bandwidth
1 mV/div - 10 V/div	DC - 500 MHz
500 μ V/div - 995 μ V/div	DC - 250 MHz

350 MHz models

Volts/Div Setting	Bandwidth
1 mV/div - 10 V/div	DC - 350 MHz
500 μ V/div - 995 μ V/div	DC - 250 MHz

Analog bandwidth with TPP0500, TPP1000 probes, typical

The limits are for ambient temperature of ≤ 30 °C and the bandwidth selection set to FULL. Reduce the upper bandwidth frequency by 1% for each °C above 30 °C.

Instrument	Volts/Div Setting	Bandwidth
2 GHz, 1 GHz	5 mV/div - 100 V/div	DC - 1 GHz (TPP1000 Probe)
500 MHz	5 mV/div - 100 V/div	DC - 500 MHz (TPP0500 Probe)
350 MHz	5 mV/div - 100 V/div	DC - 350 MHz (TPP0500 Probe)

Lower frequency limit, AC coupled, typical

< 10 Hz when AC 1 M Ω coupled. The AC coupled lower frequency limits are reduced by a factor of 10 (< 1 Hz) when 10X passive probes are used.

Upper frequency limit, 250 MHz bandwidth limited, typical

250 MHz, $\pm 25\%$

Upper frequency limit, 20 MHz bandwidth limited, typical

20 MHz, $\pm 20\%$

Calculated rise time, typical

Model	50 Ω	TPP0500 Probe	TP1000 Probe
Vertical	500 μ V-1 V	5 mV-10 V	5 mV-10 V
2 GHz	225 ps	800 ps	400 ps
1 GHz	400 ps	800 ps	400 ps
500 MHz	800 ps	800 ps	800 ps
350 MHz	1.15 ns	1.15 ns	1.15 ns

Peak Detect or Envelope mode pulse response, typical

Minimum pulse width is > 640 ps (6.25 GS/s)

Effective bits (ENOB), typical

Typical effective bits for a 9-division p-p sine-wave input, 50 mV/div, 50 Ω

2 GHz models, Sample mode, 50 Ω

Bandwidth	Input frequency	6.25 GS/s
2 GHz	10 MHz	6.20
2 GHz	600 MHz	6.20
250 MHz	10 MHz	7.30
250 MHz	200 MHz	7.30
20 MHz	10 MHz	7.60

2 GHz models, High Res mode, 50 Ω

Bandwidth	Input frequency	6.25 GS/s
1 GHz	10 MHz	7.00
1 GHz	300 MHz	7.00
250 MHz	10 MHz	7.80
250 MHz	100 MHz	7.80
20 MHz	10 MHz	8.70

1 GHz, 500 MHz, 350 MHz models, Sample mode, 50 Ω

Bandwidth	Input Frequency	6.25 GS/s
1 GHz	10 MHz	7.10
1 GHz	300 MHz	7.10
500 MHz	10 MHz	7.40
500 MHz	150 MHz	7.40
350 MHz	10 MHz	7.60
350 MHz	100 MHz	7.60
250 MHz	10 MHz	7.50
250 MHz	100 MHz	7.50
20 MHz	10 MHz	7.70

1 GHz, 500 MHz, 350 MHz models, High Res mode, 50 Ω

Bandwidth	Input frequency	6.25 GS/s
1 GHz	10 MHz	7.60
1 GHz	300 MHz	7.50
500 MHz	10 MHz	7.90
500 MHz	150 MHz	7.80
350 MHz	10 MHz	8.20
350 MHz	100 MHz	8.20
250 MHz	10 MHz	8.10
250 MHz	100 MHz	8.10
20 MHz	10 MHz	8.90

Random noise, sample acquisition mode

Bandwidth at 1 mV/div is limited to 175 MHz in 50 Ω . Bandwidth at 2 mV/div is limited to 350 MHz in 50 Ω . Bandwidth at 5 mV/div is limited to 1.5 GHz in 50 Ω .

✓ 2 GHz models, Sample mode (RMS)

V/div	50 Ω			1 M Ω		
	2 GHz	250 MHz	20 MHz	500 MHz	250 MHz	20 MHz
1 mV/div	89.8 μ V	89.8 μ V	39.6 μ V	270 μ V	158 μ V	85.5 μ V
Table continued...						

2 GHz models	50 Ω			1 MΩ		
	2 GHz	250 MHz	20 MHz	500 MHz	250 MHz	20 MHz
V/div						
2 mV/div	152 μV	114 μV	50.6 μV	291 μV	158 μV	90.1 μV
5 mV/div	456 μV	155 μV	88.9 μV	315 μV	185 μV	121 μV
10 mV/div	643 μV	244 μV	174 μV	377 μV	271 μV	201 μV
20 mV/div	1.06 mV	436 μV	347 μV	572 μV	462 μV	373 μV
50 mV/div	2.51 mV	1.06 mV	869 μV	1.32 mV	1.11 mV	922 μV
100 mV/div	6.15 mV	2.38 mV	1.74 mV	2.75 mV	2.24 mV	1.88 mV
1 V/div	39.6 mV	21.1 mV	17.4 mV	28.6 mV	23.5 mV	18.7 mV

2 GHz models, Sample mode (RMS), typical

2 GHz models	50 Ω			1 MΩ		
	2 GHz	250 MHz	20 MHz	500 MHz	250 MHz	20 MHz
V/div						
1 mV/div	69.4 μV	69.4 μV	30.6 μV	208 μV	122 μV	66 μV
2 mV/div	117 μV	88.0 μV	39.1 μV	225 μV	122 μV	69.7 μV
5 mV/div	353 μV	120 μV	68.7 μV	243 μV	143 μV	93.8 μV
10 mV/div	497 μV	188 μV	125 μV	291 μV	209 μV	156 μV
20 mV/div	816 μV	337 μV	251 μV	442 μV	357 μV	288 μV
50 mV/div	1.94 mV	822 μV	627 μV	1.02 mV	857 μV	712 μV
100 mV/div	4.75 mV	1.84 mV	1.25 mV	2.13 mV	1.73 mV	1.45 mV
1 V/div	30.6 mV	16.3 mV	12.5 mV	22.1 mV	18.2 mV	14.5 mV

✓ 2 GHz models, High Res mode (RMS)

2 GHz models	50 Ω			1 MΩ		
	1 GHz	250 MHz	20 MHz	500 MHz	250 MHz	20 MHz
V/div						
1 mV/div	86.5 μV	86.5 μV	35.2 μV	269 μV	152 μV	83.6 μV
2 mV/div	125 μV	100 μV	36.9 μV	290 μV	152 μV	86.6 μV
5 mV/div	261 μV	140 μV	48.4 μV	308 μV	172 μV	88.9 μV
10 mV/div	356 μV	191 μV	72.6 μV	359 μV	224 μV	108 μV
20 mV/div	607 μV	325 μV	137 μV	538 μV	360 μV	162 μV
50 mV/div	1.43 mV	763 μV	327 μV	1.19 mV	803 μV	351 μV
100 mV/div	3.56 mV	1.91 mV	779 μV	2.45 mV	1.76 mV	780 μV
1 V/div	23.8 mV	14 mV	6.05 mV	26.3 mV	18.9 mV	8.46 mV

2 GHz models, High Res mode (RMS), typical

2 GHz models	50 Ω			1 MΩ		
	1 GHz	250 MHz	20 MHz	500 MHz	250 MHz	20 MHz
V/div						
1 mV/div	66.8 μV	66.8 μV	27.2 μV	208 μV	117 μV	64.6 μV

Table continued...

2 GHz models	50 Ω			1 MΩ		
	1 GHz	250 MHz	20 MHz	500 MHz	250 MHz	20 MHz
2 mV/div	96.9 μV	77.5 μV	28.5 μV	224 μV	117 μV	66.7 μV
5 mV/div	202 μV	108 μV	37.4 μV	238 μV	133 μV	68.7 μV
10 mV/div	275 μV	147 μV	56.1 μV	277 μV	173 μV	83.6 μV
20 mV/div	469 μV	251 μV	106 μV	416 μV	278 μV	125 μV
50 mV/div	1.10 mV	589 μV	253 μV	916 μV	620 μV	271 μV
100 mV/div	2.75 mV	1.47 mV	602 μV	1.90 mV	1.36 mV	603 μV
1 V/div	18.4 mV	10.8 mV	4.68 mV	20.3 mV	14.6 mV	6.54 mV

✓ 1 GHz, 500 MHz, 350 MHz models, Sample mode (RMS)

< 2 GHz models	50 Ω					1 MΩ			
	1 GHz	500 MHz	350 MHz	250 MHz	20 MHz	500 MHz	350 MHz	250 MHz	20 MHz
1 mV/div	372 μV	253 μV	181 μV	153 μV	91.4 μV	258 μV	188 μV	158 μV	87.9 μV
2 mV/div	376 μV	262 μV	190 μV	164 μV	102 μV	254 μV	193 μV	158 μV	92.0 μV
5 mV/div	395 μV	292 μV	222 μV	201 μV	136 μV	272 μV	207 μV	185 μV	116 μV
10 mV/div	449 μV	359 μV	284 μV	272 μV	197 μV	319 μV	264 μV	251 μV	188 μV
20 mV/div	614 μV	529 μV	436 μV	435 μV	347 μV	455 μV	422 μV	422 μV	347 μV
50 mV/div	1.26 mV	1.14 mV	962 μV	982 μV	869 μV	1.03 mV	898 μV	1.00 mV	869 μV
100 mV/div	2.85 mV	2.50 mV	2.08 mV	2.09 mV	1.74 mV	2.18 mV	1.91 mV	2.06 mV	1.74 mV
1 V/div	24.6 mV	22.4 mV	18.9 mV	19.4 mV	17.4 mV	23.1 mV	21.1 mV	21.6 mV	17.4 mV

1 GHz, 500 MHz, 350 MHz models, Sample mode (RMS), typical

< 2 GHz models	50 Ω					1 MΩ			
	1 GHz	500 MHz	350 MHz	250 MHz	20 MHz	500 MHz	350 MHz	250 MHz	20 MHz
1 mV/div	287 μV	196 μV	140 μV	118 μV	70.6 μV	199 μV	145 μV	122 μV	67.9 μV
2 mV/div	290 μV	202 μV	147 μV	127 μV	78.9 μV	196 μV	149 μV	122 μV	71.1 μV
5 mV/div	305 μV	226 μV	171 μV	156 μV	105 μV	210 μV	160 μV	143 μV	89.8 μV
10 mV/div	347 μV	277 μV	219 μV	210 μV	153 μV	246 μV	204 μV	194 μV	146 μV
20 mV/div	475 μV	409 μV	337 μV	336 μV	257 μV	352 μV	326 μV	326 μV	251 μV
50 mV/div	977 μV	883 μV	743 μV	758 μV	627 μV	796 μV	694 μV	775 μV	627 μV
100 mV/div	2.20 mV	1.93 mV	1.60 mV	1.61 mV	1.25 mV	1.68 mV	1.48 mV	1.59 mV	1.25 mV
1 V/div	19.0 mV	17.3 mV	14.6 mV	15.0 mV	12.5 mV	17.9 mV	16.3 mV	16.7 mV	12.5 mV

✓ 1 GHz, 500 MHz, 350 MHz models, High Res mode (RMS)

V/div	50 Ω					1 MΩ			
	1 GHz	500 MHz	350 MHz	250 MHz	20 MHz	500 MHz	350 MHz	250 MHz	20 MHz
1 mV/div	329 μV	256 μV	183 μV	152 μV	90.6 μV	245 μV	184 μV	153 μV	83.8 μV
2 mV/div	330 μV	256 μV	185 μV	157 μV	91.2 μV	251 μV	188 μV	156 μV	85.4 μV
5 mV/div	339 μV	262 μV	195 μV	172 μV	94.3 μV	254 μV	197 μV	169 μV	90.1 μV
10 mV/div	367 μV	282 μV	218 μV	205 μV	103 μV	274 μV	216 μV	200 μV	101 μV
20 mV/div	462 μV	354 μV	287 μV	288 μV	132 μV	348 μV	277 μV	289 μV	135 μV
50 mV/div	876 μV	667 μV	564 μV	595 μV	254 μV	634 μV	530 μV	621 μV	268 μV
100 mV/div	2.09 mV	1.60 mV	1.31 mV	1.34 mV	601 μV	1.51 mV	1.25 mV	1.36 mV	615 μV
1 V/div	16.8 mV	12.8 mV	10.9 mV	11.6 mV	4.88 mV	17.6 mV	13.7 mV	14.4 mV	7.08 mV

1 GHz, 500 MHz, 350 MHz models, High Res mode (RMS), typical

V/div	50 Ω					1 MΩ			
	1 GHz	500 MHz	350 MHz	250 MHz	20 MHz	500 MHz	350 MHz	250 MHz	20 MHz
1 mV/div	254 μV	198 μV	141 μV	118 μV	70.0 μV	189 μV	143 μV	118 μV	64.8 μV
2 mV/div	255 μV	198 μV	143 μV	121 μV	70.4 μV	194 μV	145 μV	121 μV	66.0 μV
5 mV/div	262 μV	202 μV	150 μV	133 μV	72.8 μV	196 μV	152 μV	130 μV	69.6 μV
10 mV/div	283 μV	218 μV	169 μV	158 μV	79.8 μV	212 μV	167 μV	154 μV	78.2 μV
20 mV/div	357 μV	273 μV	222 μV	223 μV	102 μV	269 μV	214 μV	223 μV	104 μV
50 mV/div	677 μV	516 μV	436 μV	460 μV	196 μV	490 μV	410 μV	480 μV	207 μV
100 mV/div	1.61 mV	1.23 mV	1.02 mV	1.04 mV	464 μV	1.16 mV	964 μV	1.05 mV	475 μV
1 V/div	13.0 mV	9.88 mV	8.41 mV	8.94 mV	3.77 mV	13.6 mV	10.6 mV	11.1 mV	5.47 mV

Delay between analog channels, full bandwidth, typical

≤ 100 ps for any two channels with input impedance set to 50 Ω, DC coupling with equal Volts/div or above 10 mV/div

Deskew range

-125 ns to +125 ns with a resolution of 40 ps

Crosstalk (channel isolation), typical

≥ 200:1 up to the rated bandwidth for any two channels having equal Volts/div settings

Overdrive recovery time, typical

50 Ω, no probe, 1 GHz bandwidth

Vertical scale	500% overdrive			5000% overdrive		
	5%	1%	0.2%	5%	1%	0.2%
1 mV/div	<1 μs	2.0 ms	2.0 ms	---	---	---
10 mV/div	<1 μs	3.0 ms	33 μs	<1.2 μs	<4.7 μs	---
100 mV/div	<1 μs	<1 μs	5.8 μs	---	---	---

50 Ω , no probe, 2 GHz bandwidth

Vertical scale	500% overdrive			5000% overdrive		
	5%	1%	0.2%	5%	1%	0.2%
1 mV/div	<1 μ s	110 μ s	2.0 ms	---	---	---
10 mV/div	<1 μ s	<1 μ s	2.0 ms	<1 μ s	<1 μ s	---
100 mV/div	<1 μ s	<1 μ s	2.3 ms	---	---	---

TPP1000 Probe

Vertical scale	500% overdrive			5000% overdrive		
	5%	1%	0.2%	5%	1%	0.2%
10 mV/div	20 μ s	2.0 ms	2.0 ms	30 μ s	50 μ s	2.2 ms
20 mV/div	14 μ s	2.0 ms	2.0 ms	30 μ s	50 μ s	110 μ s
50 mV/div	12 μ s	60 μ s	2.0 ms	---	---	---
100 mV/div	12 μ s	60 μ s	2.0 ms	---	---	---

Total probe power

TekVPI Compliant probe interfaces (8 per MSO58B, 6 per MSO56B, 4 per MSO54B)

MSO58B and MSO56B: 80 W maximum, (40 W maximum for channels 1 through 4, 40 W maximum for channels 5 through 8)

MSO54B: 40 W maximum

Probe power per channel

Voltage	Max Amperage	Voltage Tolerance
5 V	60 mA	\pm 10%
12 V	2 A (20 W maximum software limit)	\pm 10%

TekVPI interconnect

All analog channel inputs on the front panel conform to the TEKVPI specification.

Timebase system

Sample rate

Max HW Capability	Number of Channels
6.25 GS/s	1- 8

Interpolated waveform rate range

500 GS/sec, 250 GS/sec, 125 GS/sec, 62.5 GS/sec, 25 GS/sec, and 12.5 GS/sec

Record length range

Standard

1 kpoints to 62.5 Mpoints in single sample increments

- Optional 5-RL-125M 125 Mpoints
- Optional 5-RL-250M 250 Mpoints
- Optional 5-RL-500M 500 Mpoints

Seconds/Division range

Model	1 K	10 K	100 K	1 M	10 M	62.5 M	125 M
MSO5X Standard 62.5 M	200 ps - 64 s	200 ps - 640 s	200 ps - 1000 s				
MSO5X Option 5-RL-125M	200 ps - 64 s	200 ps - 640 s	200 ps - 1000 s				

Maximum triggered acquisition rate, typical

Analog or digital channels: single channel [Analog or Digital 8-bit channel] on screen, measurements and math turned off. >40 wfm/sec

FastAcq Update Rate (analog only): >500 K/second with one channel active and >100 K/second with all eight active.

FastAcq Update Rate (analog and analog/digital): >400 K/second with two channels active and >100 K/second with all eight analog channels active.

Digital channel: >40/second with one channel (8-bits) active. There is no FastAcq for digital channels, but they do not slow down FastAcq for active analog channels.

Aperture uncertainty

$\leq 0.450 \text{ fs} + (1 * 10^{-11} * \text{Measurement Duration})_{\text{RMS}}$, for measurements having duration $\leq 100 \text{ ms}$

✓ Timebase accuracy

$\pm 2.5 * 10^{-6}$ over any $\geq 1 \text{ ms}$ time interval

Description	Specification
Factory Tolerance	$\pm 5.0 * 10^{-7}$ At calibration, 23 °C ambient, over any $\geq 1 \text{ ms}$ interval
Temperature stability	$\pm 5.0 * 10^{-7}$ Tested at operating temperatures
Crystal aging	$\pm 1.5 * 10^{-6}$ Frequency tolerance change at 25 °C over a period of 1 year

✓ Delta-time measurement accuracy, typical

The formula to calculate delta-time measurement accuracy (DTA) for a given instrument setting and input signal is given below (assumes insignificant signal content above Nyquist)

SR_1 = Slew Rate (1st Edge) around 1st point in measurement

SR_2 = Slew Rate (2nd Edge) around 2nd point in measurement

N = input-referred guaranteed noise limit. If N_{typ} is what's specified, then N is computed by multiplying N_{typ} by some scale factor (e.g., 1.5)

TBA = timebase accuracy or Reference Frequency Error +/-5 ppm

t_p = delta-time measurement duration (sec)

$$DTA_{PP} = 10 \times \sqrt{\left(\frac{N}{SR_1}\right)^2 + \left(\frac{N}{SR_2}\right)^2 + [450fs + (10^{-11} \cdot t_p)]^2} + TBA \cdot t_p$$

$$DTA_{rms} = \sqrt{\left(\frac{N}{SR_1}\right)^2 + \left(\frac{N}{SR_2}\right)^2 + [450fs + (10^{-11} \cdot t_p)]^2} + TBA \cdot t_p$$

The term under the square root sign is the stability and is due to TIE (Time Interval Error). The errors due to this term occur throughout a single-shot measurement. The second term is due to both the absolute center-frequency accuracy and the center-frequency stability of the timebase and varies between multiple single-shot measurements over the observation interval (the amount of time from the first single-shot measurement to the final single-shot measurement).



Note: The formulas assume negligible errors due to measurement interpolation, and apply only when the interpolated sample rate is 25 GS/s or higher.

Trigger system

Trigger bandwidth (edge, pulse, and logic), typical

2 GHz models, Edge	2 GHz
2 GHz models, Pulse and Logic	1 GHz
1 GHz models	1 GHz
500 MHz models	500 MHz
350 MHz models	350 MHz

Edge-type trigger sensitivity, DC coupled, typical

Table 1: 5 Series B MSO

Path	Range	Specification
1 M Ω path (all models)	0.5 mV/div to 0.99 mV/div	4.5 mV from DC to instrument bandwidth
	≥ 1 mV/div	The greater of 5 mV or 0.7 div from DC to lesser of 500 MHz or instrument BW, & 6 mV or 0.8 div from > 500 MHz to instrument bandwidth
50 Ω path, 1 GHz, 500 MHz, 350 MHz models		The greater of 5.6 mV or 0.7 div from DC to the lesser of 500 MHz or instrument BW, & 7 mV or 0.8 div from > 500 MHz to instrument bandwidth
50 Ω path, 2 GHz models	0.5 mV/div to 0.99 mV/div	3.0 div from DC to instrument bandwidth
	1 mV/div to 9.98 mV/div	1.5 divisions from DC to instrument bandwidth
	≥ 10 mV/div	< 1.0 division from DC to instrument bandwidth
Line		Fixed
AUX Trigger in		200 mV _{PP} , DC to 250 MHz

Trigger jitter, typical

- ≤ 5 ps_{RMS} for sample mode and edge-type trigger
- ≤ 7 ps_{RMS} for edge-type trigger and FastAcq mode
- ≤ 40 ps_{RMS} for non edge-type trigger modes
- ≤ 40 ps_{RMS} for AUX trigger in, Sample acquisition mode, edge trigger (MSO58LP only)

AUX In trigger skew between instruments, typical

±100 ps jitter on each instrument with 150 ps skew; ≤350 ps total between instruments. With manual deskewing of individual channels, total instrument skew can reach 200 ps between different instrument channels.

Skew improves for sinusoidal input voltages ≥500 mV

Edge-type trigger sensitivity, not DC coupled, typical

Trigger Coupling	Typical Sensitivity
NOISE REJ	2.5 times the DC Coupled limits
HF REJ	1.0 times the DC Coupled limits from DC to 50 kHz. Attenuates signals above 50 kHz.
LF REJ	1.5 times the DC Coupled limits for frequencies above 50 kHz. Attenuates signals below 50 kHz.

Lowest frequency for successful operation of Set Level to 50% function, typical

45 Hz

Logic-type, logic qualified trigger, or events-delay sensitivities, DC coupled, typical

2.0 divisions, at vertical settings ≥5 mV/div.

Pulse-type runt trigger sensitivities, typical

2.0 division at vertical settings ≥5 mV/div.

Pulse-type trigger width and glitch sensitivities, typical

2.0 divisions at vertical settings ≥5 mV/div.

Logic-type triggering, minimum logic or rearm time, typical

For Logic, time between channels refers to the length of time a logic state derived from more than one channel must exist to be recognized. For Events, the time is the minimum time between a main and delayed event that will be recognized if more than one channel is used.

Triggering type	Pulse width	Rearm time	Time skew needed for 100% and no triggering
Logic	160 ps + t _{rise}	160 ps + t _{rise}	>360 ps / <150 ps
Time qualified logic	320 ps + t _{rise}	320 ps + t _{rise}	>360 ps / <150 ps

t_{rise} is rise time of the instrument.

Minimum clock pulse widths for setup/hold time violation trigger, typical

Active pulsewidth is the width of the clock pulse from its active edge (as defined in the Clock Edge menu item) to its inactive edge. Inactive pulsewidth is the width of the pulse from its inactive edge to its active edge.

Minimum pulsewidth, clock active	Minimum pulsewidth, clock inactive
User's Hold Time $80 \text{ ps} + t_{\text{rise}}$	$320 \text{ ps} + t_{\text{rise}}$

t_{rise} is rise time of the instrument.

Setup/hold violation trigger, setup and hold time ranges, typical

Feature	Min	Max
Setup Time	0 ns	20 s
Hold Time	0 ns	20 s
Setup + Hold Time	80 ps	22 s

Input coupling on clock and data channels must be the same.

For Setup Time, positive numbers mean a data transition before the clock.

For Hold Time, positive numbers mean a data transition after the clock edge.

Setup + Hold Time is the algebraic sum of the Setup Time and the Hold Time programmed by the user.

Pulse type trigger, minimum pulse, rearm time, transition time

Pulse class	Minimum pulse width	Minimum rearm time
Runt	$160 \text{ ps} + t_{\text{rise}}$	$160 \text{ ps} + t_{\text{rise}}$
Time-Qualified Runt	$160 \text{ ps} + t_{\text{rise}}$	$160 \text{ ps} + t_{\text{rise}}$
Width	$160 \text{ ps} + t_{\text{rise}}$	$160 \text{ ps} + t_{\text{rise}}$
Slew Rate (minimum transition time)	$160 \text{ ps} + t_{\text{rise}}$	$160 \text{ ps} + t_{\text{rise}}$

For trigger class width, pulse width refers to the width of the pulse being measured. Rearm time refers to the time between pulses.

For trigger class runt, pulse width refers to the width of the pulse being measured. Rearm time refers to the time between pulses.

For trigger class slew rate, pulse width refers to the delta time being measured. Rearm time refers to the time it takes the signal to cross the two trigger thresholds again.

t_{rise} is rise time of the instrument.

Active pulsewidth is the width of the clock pulse from its active edge (as defined in the Clock Edge menu item) to its inactive edge

Inactive pulsewidth is the width of the pulse from its inactive edge to its active edge.

Transition time trigger, delta time range

160 ps to 20 s.

Time range for glitch, pulse width, timeout, time-qualified runt, or time-qualified window triggering

160 ps to 20 s.

Time accuracy for pulse, glitch, timeout, or width triggering

Time Range	Accuracy
320 ps to 500 ns	$\pm(160 \text{ ps} + (\text{Time-Base-Accuracy} * \text{Setting}))$
520 ns to 10 s	$\pm(160 \text{ ps} + (\text{Time-Base-Accuracy} * \text{Setting}))$

B trigger after events, minimum pulse width and maximum event frequency, typical

Minimum pulse width: $160 \text{ ps} + t_{\text{rise}}$
 Maximum event frequency: Instrument bandwidth.
 t_{rise} is rise time of the instrument.

B trigger, minimum time between arm and trigger, typical

320 ps
 For trigger after time, this is the time between the end of the time period and the B trigger event.
 For trigger after events, this is the time between the last A trigger event and the first B trigger event.

B trigger after time, time range 160 ps to 20 seconds

B trigger after events, event range 1 to 65,471

Trigger level ranges

Source	Range
Any Channel	± 5 divs from center of screen
Aux In Trigger	$\pm 5 \text{ V}$
Line	Fixed at about 50% of line voltage

This specification applies to logic and pulse thresholds.

Trigger level accuracy, DC coupled, typical

For signals having rise and fall times $\geq 10 \text{ ns}$:

Source	Range
Any Input Channel	$\pm 0.20 \text{ div}$
AUX IN	N/A
Line	N/A

Trigger holdoff range 0 ns to 20 seconds

Serial Trigger specifications

Maximum serial trigger bits 128 bits

Optional serial bus interface triggering

I²C

Address Triggering: 7 & 10 bits of user-specified addresses supported

Data Trigger: 1 - 5 Bytes of user-specified data

	<p>Trigger on: Start, Repeated Start, Stop, Missing Ack, Data, Address, or Address & Data</p> <p>Maximum Data Rate: 10 Mb/s</p>
SPI	<p>Data Trigger: 1 - 16 Bytes of user-specified data</p> <p>Trigger on: SS Active, Data</p> <p>Maximum Data Rate: 20 Mb/s</p>
CAN	<p>Data Trigger: 1 - 8 Bytes of user-specified data, including qualifiers of equal to (=), not equal to (≠), less than (<), greater than (>), less than or equal to (<=), greater than or equal to (>=)</p> <p>Trigger on: Start of Frame, Type of Frame, Identifier, Data, Identifier & Data, End of Frame, Missing Ack, or Bit Stuffing Errors</p> <p>Frame Type: Data, Remote, Error, Overload</p> <p>Identifier: Standard (11 bit) and Extended (29 bit) identifiers</p> <p>Maximum Data Rate: 1 Mb/s</p>
LIN	<p>Identifier Trigger: 6 bits of user-specified data, equal to (=)</p> <p>Data Trigger: 1 - 8 Bytes of user-specified data, including qualifiers of equal to (=), not equal to (≠), less than (<), greater than (>), less than or equal to (<=), greater than or equal to (>=), inside range, outside range</p> <p>Error Trigger: Sync, Identifier Parity, Checksum</p> <p>Trigger on: Sync, Identifier, Data, Identifier & Data, Wakeup Frame, Sleep Frame, or Error</p> <p>Maximum Data Rate: 100 kb/s</p>
Flexray	<p>Indicator Bits: Normal (01XX), Payload (11XX), Null (00XX), Sync (XX10), Startup (XX11)</p> <p>Frame ID Trigger: 11 bits of user-specified data, including qualifiers of equal to (=), not equal to (≠), less than (<), greater than (>), less than or equal to (<=), greater than or equal to (>=)</p> <p>Cycle Count Trigger: 6 bits of user-specified data, including qualifiers of equal to (=), not equal to (≠), less than (<), greater than (>), less than or equal to (<=), greater than or equal to (>=)</p> <p>Header Fields Trigger: 40 bits of user-specified data comprising Indicator Bits, Identifier, Payload Length, Header CRC, and Cycle Count, equal to (=)</p> <p>Data Trigger: 1 - 16 Bytes of user-specified data, with 0 to 253, or "don't care" bytes of data offset, including qualifiers of equal to (=), not equal to (≠), less than (<), greater than (>), less than or equal to (<=), greater than or equal to (>=), Inside Range, Outside Range</p> <p>End Of Frame: User-chosen types Static, Dynamic (DTS), and All</p> <p>Error Trigger: Header CRC, Trailer CRC, Null Frame-static, Null Frame-dynamic, Sync Frame, Startup frame (No Sync)</p> <p>Trigger on: Start of Frame, Frame ID, Indicator Bits, Cycle Count, Header Fields, Data, Identifier & Data, End of Frame, or Error</p> <p>Maximum Data Rate: 40 Mb/s</p>
Audio (I²S)	<p>Data Trigger: 32 bits of user-specified data in a left word, right word, or either, including qualifiers of equal to (=), not equal to (≠), less than (<), greater than (>), less than or equal to (<=), greater than or equal to (>=), inside range, outside range</p>

Trigger on: Word Select, Data

Maximum Data Rate: 12.5 Mb/s

Left Justified (LJ)

Data Trigger: 32 bits of user-specified data in a left word, right word, or either, including qualifiers of equal to (=), not equal to (\neq), less than (<), greater than (>), less than or equal to (<=), greater than or equal to (>=), inside range, outside range

Trigger on: Word Select, Data

Maximum Data Rate: 12.5 Mb/s

Right Justified (RJ)

Data Trigger: 32 bits of user-specified data in a left word, right word, or either, including qualifiers of equal to (=), not equal to (\neq), less than (<), greater than (>), less than or equal to (<=), greater than or equal to (>=), inside range, outside range

Trigger on: Word Select, Data

Maximum Data Rate: 12.5 Mb/s

TDM

Data Trigger: 32 bits of user-specified data in a channel 1-64, including qualifiers of equal to (=), not equal to (\neq), less than (<), greater than (>), less than or equal to (<=), greater than or equal to (>=), inside range, outside range

Trigger on: Frame Sync, Data

Maximum Data Rate: 25 Mb/s

RS232

Bit Rate: 50 bps - 10 Mbps

Data Bits: 7, 8, or 9

Parity: None, Odd, or Even

Trigger on: Start, End of Packet, Data, Parity Error

MIL-STD-1553

Bit Rate: 1 Mb/s

Trigger on:

Sync

Word Type (Command, Status, Data)

Command Word (set RT Address (=, \neq , <, >, \leq , \geq , inside range, outside range), T/R, Sub-address/ Mode, Data Word Count/Mode Code, and Parity individually)

Status Word (set RT Address ((=, \neq , <, >, \leq , \geq , inside range, outside range), Message Error, Instrumentation, Service Request Bit, Broadcast Command Received, Busy, Subsystem Flag, Dynamic Bus Control Acceptance (DBCA), Terminal Flag, and Parity individually)

Data Word (user-specified 16-bit data value)

Error (Sync, Parity, Manchester, Non-contiguous data)

Idle Time (minimum time selectable from 4 μ s to 100 μ s; maximum time selectable from 12 μ s to 100 μ s; trigger on < minimum, > maximum, inside range, outside range)

For MIL-STD-1553, Trigger selection of Command Word will trigger on Command and ambiguous Command/Status words. Trigger selection of Status Word will trigger on Status and ambiguous Command/Status words

USB

Data Rates Supported: High: 480 Mbs, Full: 12 Mbs, Low: 1.5Mbs

Trigger On: Sync, Reset, Suspend, Resume, End of Packet, Token Packet, Data Packet, Handshake Packet, Special Packet, Error

Ethernet

Bit Rate: 10 BASE-T, 10 Mbps; 100 BASE-TX, 100 Mbps

Trigger On: Start of Frame, MAC Address, MAC Length/Type, IP Header, TCP Header, Client Data, End of Packet, Idle, FCS (CRC) Error, MAC Q-Tag control Information

Digital acquisition system

Digital channel maximum sample rate 6.25 GS/s

Transition detect (digital peak detect) Displayed data at sample rates less than 6.25 GS/s (decimated data), that contains multiple transitions between sample points will be displayed with a bright white colored edge.

Digital-To-Analog trigger skew 1 ns

Digital to digital skew 320 ps from bit 0 of any TekVPI channel to bit 0 of any TekVPI channel.

Digital skew within a FlexChannel 160 ps within any TekVPI channel

Digital volt meter (DVM)

Measurement types DC, AC_{RMS}+DC, AC_{RMS}

Voltage resolution 4 digits

✓ **Voltage accuracy**

DC: $\pm((1.5\% * |\text{reading} - \text{offset} - \text{position}|) + (0.5\% * |(\text{offset} - \text{position})|) + (0.1 * \text{Volts/div}))$

De-rated at 0.100%/°C of $|\text{reading} - \text{offset} - \text{position}|$ above 30 °C

Signal ± 5 divisions from screen center

AC: $\pm 2\%$ (40 Hz to 1 kHz) with no harmonic content outside 40 Hz to 1 kHz range

AC, typical: $\pm 2\%$ (20 Hz to 10 kHz)

For AC measurements, the input channel vertical settings must allow the V_{pp} input signal to cover between 4 and 10 divisions and must be fully visible on the screen

Trigger frequency counter

- Resolution** 8-digits
- ✓ **Accuracy** $\pm(1 \text{ count} + \text{time base accuracy} * \text{input frequency})$
The signal must be at least 8 mV_{pp} or 2 div, whichever is greater.
- ✓ **Maximum input frequency** 10 Hz to maximum bandwidth of the analog channel
The signal must be at least 8 mV_{pp} or 2 div, whichever is greater.

Arbitrary Function Generator system

Function types Arbitrary, sine, square, pulse, ramp, triangle, DC level, Gaussian, Lorentz, exponential rise/fall, sin(x)/x, random noise, Haversine, Cardiac

Amplitude range Values are peak-to-peak voltages

Waveform	50 Ω	1 MΩ
Arbitrary	10 mV to 2.5 V	20 mV to 5 V
Sine	10 mV to 2.5 V	20 mV to 5 V
Square	10 mV to 2.5 V	20 mV to 5 V
Pulse	10 mV to 2.5 V	20 mV to 5 V
Ramp	10 mV to 2.5 V	20 mV to 5 V
Triangle	10 mV to 2.5 V	20 mV to 5 V
Gaussian	10 mV to 1.25 V	20 mV to 2.5 V
Lorentz	10 mV to 1.2 V	20 mV to 2.4 V
Exponential Rise	10 mV to 1.25 V	20 mV to 2.5 V
Exponential Fall	10 mV to 1.25 V	20 mV to 2.5 V
Sine(x)/x	10 mV to 1.5 V	20 mV to 3.0 V
Random Noise	10 mV to 2.5 V	20 mV to 5 V
Haversine	10 mV to 1.25 V	20 mV to 2.5 V
Cardiac	10 mV to 2.5 V	20 mV to 5 V

- Maximum sample rate** 250 MS/s
- Arbitrary function record length** 128 K Samples
- Sine waveform**
 - Frequency range** 0.1 Hz to 100 MHz
 - Frequency setting resolution** 0.1 Hz
 - Frequency accuracy** 130 ppm (frequency ≤ 10 kHz), 50 ppm (frequency > 10 kHz)

	This is for Sine, Ramp, Square and Pulse waveforms only.
Amplitude range	20 mV _{pp} to 5 V _{pp} into Hi-Z; 10 mV _{pp} to 2.5 V _{pp} into 50 Ω
Amplitude flatness, typical	±0.5 dB at 1 kHz ±1.5 dB at 1 kHz for < 20 mV _{pp} amplitudes
Total harmonic distortion, typical	1% for amplitude ≥ 200 mV _{pp} into 50 Ω load 2.5% for amplitude > 50 mV AND < 200 mV _{pp} into 50 Ω load This is for Sine wave only.
Spurious free dynamic range, typical	40 dB (V _{pp} ≥ 0.1 V); 30 dB (V _{pp} ≥ 0.02 V), 50 Ω load
Square and pulse waveform	
Frequency range	0.1 Hz to 50 MHz
Frequency setting resolution	0.1 Hz
Duty cycle range	10% - 90% or 10 ns minimum pulse, whichever is larger Minimum pulse time applies to both on and off time, so maximum duty cycle will reduce at higher frequencies to maintain 10 ns off time
Duty cycle resolution	0.1%
Minimum pulse width, typical	10 ns. This is the minimum time for either on or off duration.
Rise/Fall time, typical	5 ns, 10% - 90%
Pulse width resolution	100 ps
Overshoot, typical	< 6% for signal steps greater than 100 mV _{pp} This applies to overshoot of the positive-going transition (+overshoot) and of the negative-going (-overshoot) transition
Asymmetry, typical	±1% ±5 ns, at 50% duty cycle
Jitter, typical	< 60 ps TIE _{RMS} , ≥ 100 mV _{pp} amplitude, 40%-60% duty cycle
Cardiac maximum frequency	1 MHz
Ramp and triangle waveform	
Frequency range	0.1 Hz to 1 MHz
Frequency setting resolution	0.1 Hz
Variable symmetry	0% - 100%
Symmetry resolution	0.1%
DC level range	±2.5 V into Hi-Z

±1.25 V into 50 Ω

Gaussian pulse, Haversine, and Lorentz pulse

Maximum frequency 10 MHz

Exponential rise fall maximum frequency 10 MHz

Sin(x)/x

Maximum frequency 4 MHz

Random noise amplitude range 20 mV_{pp} to 5 V_{pp} into Hi-Z
10 mV_{pp} to 2.5 V_{pp} into 50 Ω

For both isolated noise signal and additive noise signal.

✓ Sine and ramp frequency accuracy 1.3 x 10⁻⁴ (frequency ≤10 kHz)
5.0 x 10⁻⁵ (frequency >10 kHz)

✓ Square and pulse frequency accuracy 1.3 x 10⁻⁴ (frequency ≤10 KHz);
5.0 x 10⁻⁵ (frequency >10 KHz)

Signal amplitude resolution 1 mV (Hi-Z)
500 μV (50 Ω)

✓ Signal amplitude accuracy ±[(1.5% of peak-to-peak amplitude setting) + (1.5% of absolute DC offset setting) + 1 mV] (frequency = 1 kHz)

DC offset range ±2.5 V into Hi-Z
±1.25 V into 50 Ω

DC offset resolution 1 mV (Hi-Z)
500 μV (50 Ω)

✓ DC offset accuracy ±[(1.5% of absolute offset voltage setting) + 1 mV]
Add 3 mV of uncertainty per 10 °C change from 25 °C ambient. Refer to the DC Offset Accuracy test record.

Display system

Display type Display size: 15.6 inches diagonal
Display type: TFT liquid crystal display (LCD)

Display resolution	1,920 horizontal × 1,080 vertical pixels (High Definition)
Luminance, typical	250 cd/m ² , (Minimum: 200 cd/m ²), Display luminance is specified for a new display set at full brightness.
Color Support	262 K colors (6-bit RGB)
Display Options	
Persistence	Off, Infinite, Variable (Persistence Time is variable) or Auto
Waveform styles	Vectors, dots
Graticule	Grid, Time, Full or None
Graticule Intensity	Variable
Display Mode	Overlay or Stacked
Interpolation	Sin(x)/x or Linear
Waveform Intensity	Variable

Processor system

Host processor	Intel Core i5-8400H @ Coffee Lake 2.5 GHz 64-bit Quad Core Processor
Operating system	Default instrument: Closed Linux Instrument with option 5B-WIN installed: Microsoft Windows 10

Input/Output port specifications

Ethernet interface	An 8-pin RJ-45 connector that supports 10/100/1000 Mb/s
DVI connector	A 29-pin DVI-D connector; connect to show the oscilloscope display on an external monitor or projector Maximum supported resolution, Windows: 1920 x 1200 @ 60 Hz Maximum supported resolution, Linux: 1920 x 1080 @ 60 Hz Only a single TMDS link is provided Analog VGA signaling is not provided
DisplayPort connector	A 20-pin DisplayPort connector; connect to show the oscilloscope display on an external monitor or projector Maximum supported resolution, Windows: 2560 x 1440 @ 60Hz Maximum supported resolution, Linux: 1920 x 1080 @ 60 Hz DP++ adapter: Maximum supported resolution: 2560 x1440 @ 60 Hz
Simultaneous displays	Up to 3 displays (including the internal display) with a maximum of 1 display per port.
USB interface (Host, Device ports)	5 Series MSO Front panel USB Host ports: Two USB 2.0 Hi-Speed ports, one USB 3.0 SuperSpeed port

All instruments, Rear panel USB Host ports: Two USB 2.0 Hi-Speed ports, two USB 3.0 SuperSpeed ports

All instruments, Rear panel USB Device port: One USB 3.0 SuperSpeed Device port providing USBTMC support

Probe compensator signal output voltage and frequency, typical

Characteristic	Value
Output Voltage	Default: 0-2.5 V amplitude
Impedance	1 kΩ
Frequency	1 kHz

✓ Auxiliary output, AUX OUT, Trigger Out, Event, or Reference Clock Out

Selectable output Acquisition Trigger Out
Reference Clock Out
AFG Trigger Out

Acquisition Trigger Out User selectable transition from HIGH to LOW, or LOW to HIGH, indicates the trigger occurred. The signal returns to its previous state after approximately 100 ns

Acquisition trigger jitter 300 ps (peak-to-peak)

Reference Clock Out Reference clock output tracks the acquisition system and can be referenced from either the internal clock reference or the external clock reference

AFG Trigger Out The output frequency is dependent on the frequency of the AFG signal as shown in the following table:

AFG signal frequency	AFT trigger frequency
≤ 4.9 MHz	Signal frequency
> 4.9 MHz to 14.7 MHz	Signal frequency / 3
> 14.7 MHz to 24.5 MHz	Signal frequency / 5
> 24.5 MHz to 34.3 MHz	Signal frequency / 7
> 34.3 MHz to 44.1 MHz	Signal frequency / 9
> 44.1 MHz to 50 MHz	Signal frequency / 11

AUX OUT Output Voltage

Characteristic	Limits
Vout (HI)	≥ 2.5 V open circuit; ≥ 1.0 V into a 50 Ω load to ground
Vout (LO)	≤ 0.7 V into a load of ≤ 4 mA; ≤0.25 V into a 50 Ω load to ground

External reference input

Nominal input frequency 10 MHz

Frequency Variation Tolerance 9.99996 MHz to 10.00004 MHz ($\pm 4.0 \times 10^{-6}$)

Sensitivity, typical	$V_{in} 1.5 V_{p-p}$ using a 50 Ω termination
Maximum input signal	7 V_{pp}
Impedance	1.2 K Ohms $\pm 20\%$ in parallel with 18 pf ± 5 pf at 10 MHz

Data storage specifications

Nonvolatile memory retention time, typical No time limit for front panel settings, saved waveforms, setups, product licensing, and calibration constants.

Real-time clock A programmable clock providing time in years, months, days, hours, minutes, and seconds.

Nonvolatile memory capacity

Instrument S/N	A 2 kbit EEPROM on the main board that stores the instrument serial number, instrument start up count, total uptime and administration passwords.
Companion CvP	A pair of 16 Mbit flash memory devices that stores a portion of the Companion FPGA image data. One device serves as a backup for the other device.
AFG S/N	A 2 kbit EEPROM on the AFG riser card that stores a copy of the instrument serial number which is used to validate the AFG calibration.
Front Panel ID	A 64 kbit EEPROM on the LED board that stores the USB vendor ID and device ID for the internal front panel controller.
BIOS	A 128 Mbit flash memory device that stores the firmware image and device configuration for the host processor and chipset sub-processors. This includes the Basic Input Output System (BIOS), Management Engine (ME), Embedded Controller (EC) and Network Interface Controller (NIC). The Ethernet MAC address is stored in this device.
CMOS Memory	The host processor chipset includes an integrated memory device, powered by the real-time clock (RTC) battery, which stores BIOS configuration settings. A customer accessible switch disconnects the RTC battery from the chipset which clears the contents of the integrated CMOS memory device.
Memory SPD	Each SODIMM (memory module) contains a serial presence detect (SPD) memory device implemented using an unspecified memory technology. Each SPD device contains the parameter data specific to its memory module. All SPD devices are treated by the instrument as read only. The size of a given SPD is unspecified. The 4 channel instrument includes 4 SPD devices. The 6 channel and 8 channel instruments include 6 SPD devices.
UCD9248	The instrument includes 3 UCD9248 power supply controllers. Each controller contains an <i>unspecified</i> quantity of nonvolatile memory that stores various power supply configuration settings.
PMU	A power management unit (PMU) microcontroller is used to manage instrument power supplies and hardware initialization. The PMU includes 32 KB of nonvolatile memory for storage of its own binary executable and redundant storage of UCD9248 device settings.
Analog Board Controller	A microcontroller is used to manage analog board operation. The PMU includes 64 KB of nonvolatile memory for storage of its own binary executable.
Carrier FPGA	The carrier FPGA stores its own configuration in its own internal 0.33 Mbit nonvolatile memory. The carrier FPGA implements simple "glue logic" for the instrument.

Mass storage device capacity

Linux	≥ 250 GB. Form factor is a 2.5 inch SSD with a SATA-3 interface. Waveforms and setups are stored on the solid state drive. Provides storage for saved customer data and the Linux operating system.
Windows (optional)	≥ 500 GB. Form factor is a 2.5 inch SSD with a SATA-3 interface. This drive is customer installable and provides storage for the Windows operating system option, and saved customer data.

Power supply system

Power

Power consumption	400 Watts maximum
Source voltage	100 - 240 V ±10% (50 Hz to 60 Hz)
Source frequency	50 Hz to 60 Hz ±10%, at 100 - 240 V ±10% 400 Hz ±10% at 115 V ±10%
Fuse Rating	12.5 A, 250 V _{ac}

Safety characteristics

Safety certification	US NRTL Listed - UL61010-1 and UL61010-2-030 Canadian Certification - CAN/CSA-C22.2 No. 61010.1 and CAN/CSA-C22.2 No 61010.2.030 EU Compliance - Low Voltage Directive 2014-35-EU and EN61010-1. International Compliance - IEC 61010-1 and IEC61010-2-030
Pollution degree	Pollution degree 2, indoor, dry location use only

Environmental specifications

Temperature

Operating	+0 °C to +50 °C (32 °F to 122 °F)
Non-operating	-20 °C to +60 °C (-4 °F to 140 °F)

Humidity

Operating	5% to 90% relative humidity (% RH) at up to +40 °C 5% to 55% RH above +40 °C up to +50 °C, noncondensing, and as limited by a maximum wet-bulb temperature of +39 °C
Non-operating	5% to 90% relative humidity (% RH) at up to +40 °C 5% to 39% RH above +40 °C up to +50 °C, noncondensing, and as limited by a maximum wet-bulb temperature of +39 °C

Altitude

Operating	Up to 3,000 meters (9,843 feet)
------------------	---------------------------------

Non-operating	Up to 12,000 meters (39,370 feet)
Temperature	
Operating	+0 °C to +50 °C (32 °F to 122 °F)
Non-operating	-20 °C to +60 °C (-4 °F to 140 °F)
Humidity	
Operating	5% to 90% relative humidity (% RH) at up to +40 °C 5% to 55% RH above +40 °C up to +50 °C, noncondensing, and as limited by a maximum wet-bulb temperature of +39 °C
Non-operating	5% to 90% relative humidity (% RH) at up to +40 °C 5% to 39% RH above +40 °C up to +50 °C, noncondensing, and as limited by a maximum wet-bulb temperature of +39 °C
Altitude	
Operating	Up to 3,000 meters (9,843 feet)
Non-operating	Up to 12,000 meters (39,370 feet)

Mechanical specifications

Weight	Weight of instruments by model:MSO54B 1 GHz: 22.7 lbs (10.3 Kg) MSO54B 2 GHz: 23.6 lbs (10.7 Kg) MSO56B 1 GHz: 23.5 lbs (10.7 Kg) MSO56B 2 GHz: 24.3 lbs (11.0 Kg) MSO58B 1 GHz: 23.8 lbs (10.8 Kg) MSO58B 2 GHz: 24.7 lbs (11.2 Kg)
Dimensions	
Height:	371 mm (14.6 in) feet folded in, handle folded up 309 mm (12.2 in) feet folded in, handle folded to the backside of the instrument
Width:	454 mm (17.9 in) from handle hub to handle hub
Depth:	205 mm (8.0 in) from back of feet to front of knobs 297 mm (11.7 in) feet folded in, handle folded to the backside of the instrument
Clearance requirements	The clearance requirement for adequate cooling is 2.0 in (50.8 mm) on the right side (when looking at the front of the instrument) and on the rear of the instrument

Performance verification procedures

This chapter contains performance verification procedures for the specifications marked with the ✓ symbol. The following equipment, or a suitable equivalent, is required to complete these procedures.

The performance verification procedures verify the performance of your instrument. They do not adjust your instrument. If your instrument fails any of the performance verification tests, repeat the failing test, verifying that the test equipment and settings are correct. If the instrument continues to fail a test, contact Tektronix Customer Support for assistance.

These procedures cover all 5 Series B MSO instruments (MSO54B, MSO56B, MSO58B).

Print the test records on the following pages and use them to record the performance test results for your oscilloscope. Disregard checks and test records that do not apply to the specific model you are testing.



Note: Completion of the performance verification procedure does not update the instrument time and date.

Required equipment:

Required equipment	Minimum requirements	Examples
DC voltage source	3 mV to 4 V, $\pm 0.1\%$ accuracy	Fluke 9500B Oscilloscope Calibrator with a 9530 Output Module
Leveled sine wave generator	50 kHz to 2 GHz, $\pm 4\%$ amplitude accuracy	
Time mark generator	80 ms period, $\pm 1.0 \times 10^{-6}$ accuracy, rise time < 50 ns	
Logic probe	Low capacitance digital probe, 8 channels.	TLP058 probe
BNC-to-0.1 inch pin adapter to connect the logic probe to the signal source.	BNC-to-0.1 inch pin adapter; female BNC to 2x16 .01 inch pin headers.	Tektronix adapter part number 878-1429-00; to connect the Fluke 9500B to the TLP058 probe.
Digital multimeter (DMM)	0.1% accuracy or better	Tektronix DMM4020
One 50 Ω terminator	Impedance 50 Ω ; connectors: female BNC input, male BNC output	Tektronix part number 011-0049-02
One 50 Ω BNC cable	Male-to-male connectors	Tektronix part number 012-0057-01
Optical mouse	USB, PS2	Tektronix part number 119-7054-00
RF vector signal generator	Maximum bandwidth of instrument	Tektronix TSG4100A

You might need additional cables and adapters, depending on the actual test equipment you use.

Test record

Instrument information, self test record

Model	Serial #	Procedure performed by	Date

Test	Passed	Failed
Self Test		

Input Impedance test record

Input Impedance				
Performance checks	Vertical scale	Low limit	Test result	High limit
All models				
Channel 1 Input Impedance, 1 M Ω	100 mV/div	990 k Ω		1.01 M Ω
Channel 1 Input Impedance, 50 Ω	10 mV/div	49.5 Ω		50.5 Ω
	100 mV/div	49.5 Ω		50.5 Ω
Channel 2 Input Impedance, 1 M Ω	100 mV/div	990 k Ω		1.01 M Ω
Channel 2 Input Impedance, 50 Ω	10 mV/div	49.5 Ω		50.5 Ω
	100 mV/div	49.5 Ω		50.5 Ω
Channel 3 Input Impedance, 1 M Ω	100 mV/div	990 k Ω		1.01 M Ω
Channel 3 Input Impedance, 50 Ω	10 mV/div	49.5 Ω		50.5 Ω
	100 mV/div	49.5 Ω		50.5 Ω
Channel 4 Input Impedance, 1 M Ω	100 mV/div	990 k Ω		1.01 M Ω
Channel 4, Input Impedance, 50 Ω	10 mV/div	49.5 Ω		50.5 Ω
	100 mV/div	49.5 Ω		50.5 Ω

MSO56B, MSO58B models				
Channel 5 Input Impedance, 1 M Ω	100 mV/div	990 k Ω		1.01 M Ω
Channel 5 Input Impedance, 50 Ω	10 mV/div	49.5 Ω		50.5 Ω
	100 mV/div	49.5 Ω		50.5 Ω
Channel 6 Input Impedance, 1 M Ω	100 mV/div	990 k Ω		1.01 M Ω
Channel 6 Input Impedance, 50 Ω	10 mV/div	49.5 Ω		50.5 Ω
	100 mV/div	49.5 Ω		50.5 Ω

Table continued...

MSO56B, MSO58B models				
MSO58B model				
Channel 7 Input Impedance, 1 MΩ	100 mV/div	990 kΩ		1.01 MΩ
Channel 7 Input Impedance, 50 Ω	10 mV/div	49.5 Ω		50.5 Ω
	100 mV/div	49.5 Ω		50.5 Ω
Channel 8 Input Impedance, 1 MΩ	100 mV/div	990 kΩ		1.01 MΩ
Channel 8, Input Impedance, 50 Ω	10 mV/div	49.5 Ω		50.5 Ω
	100 mV/div	49.5 Ω		50.5 Ω

DC Balance test record

DC Balance				
Performance checks	Vertical scale	Low limit	Test result	High limit
All models				
Channel 1 DC Balance, 50 Ω, 20 MHz BW	1 mV/div	-0.2 mV		0.2 mV
	2 mV/div	-0.2 mV		0.2 mV
	5 mV/div	-0.5 mV		0.5 mV
	10 mV/div	-1 mV		1 mV
	20 mV/div	-2 mV		2 mV
	49.8 mV/div	-4.98 mV		4.98 mV
	50 mV/div	-5 mV		5 mV
	100 mV/div	-10 mV		10 mV
	200 mV/div	-20 mV		20 mV
	500 mV/div	-50 mV		50 mV
	1 V/div	-100 mV		100 mV
Channel 1 DC Balance, 1 MΩ, 20 MHz BW	1 mV/div	-0.2 mV		0.2 mV
	2 mV/div	-0.4 mV		0.4 mV
	5 mV/div	-1 mV		1 mV
	10 mV/div	-2 mV		2 mV
	20 mV/div	-4 mV		4 mV
	100 mV/div	-20 mV		20 mV
	500 mV/div	-100 mV		100 mV
	1 V/div	-200 mV		200 mV
	10 V/div	-2 V		2 V
Channel 1 DC Balance, 50 Ω, 250 MHz BW	20 mV/div	-2 mV		2 mV

Table continued...

DC Balance				
Performance checks	Vertical scale	Low limit	Test result	High limit
Channel 1 DC Balance, 1 M Ω , 250 MHz BW	20 mV/div	-4 mV		4 mV
Channel 1 DC Balance, 50 Ω , Full BW	20 mV/div	-2 mV		2 mV
Channel 1 DC Balance, 1 M Ω , Full BW	20 mV/div	-4 mV		4 mV
Channel 2 DC Balance, 50 Ω , 20 MHz BW	1 mV/div	-0.2 mV		0.2 mV
	2 mV/div	-0.2 mV		0.2 mV
	5 mV/div	-0.5 mV		0.5 mV
	10 mV/div	-1 mV		1 mV
	20 mV/div	-2 mV		2 mV
	49.8 mV/div	-4.98 mV		4.98 mV
	50 mV/div	-5 mV		5 mV
	100 mV/div	-10 mV		10 mV
	200 mV/div	-20 mV		20 mV
	500 mV/div	-50 mV		50 mV
	1 V/div	-100 mV		100 mV
Channel 2 DC Balance, 1 M Ω , 20 MHz BW	1 mV/div	-0.2 mV		0.2 mV
	2 mV/div	-0.4 mV		0.4 mV
	5 mV/div	-1 mV		1 mV
	10 mV/div	-2 mV		2 mV
	20 mV/div	-4 mV		4 mV
	100 mV/div	-20 mV		20 mV
	500 mV/div	-100 mV		100 mV
	1 V/div	-200 mV		200 mV
	10 V/div	-2 V		2 V
Channel 2 DC Balance, 50 Ω , 250 MHz BW	20 mV/div	-2 mV		2 mV
Channel 2 DC Balance, 1 M Ω , 250 MHz BW	20 mV/div	-4 mV		4 mV
Channel 2 DC Balance, 50 Ω , Full BW	20 mV/div	-2 mV		2 mV
Channel 2 DC Balance, 1 M Ω , Full BW	20 mV/div	-4 mV		4 mV
Channel 3 DC Balance, 50 Ω , 20 MHz BW	1 mV/div	-0.2 mV		0.2 mV
	2 mV/div	-0.2 mV		0.2 mV
	5 mV/div	-0.5 mV		0.5 mV
	10 mV/div	-1 mV		1 mV

Table continued...

DC Balance				
Performance checks	Vertical scale	Low limit	Test result	High limit
	20 mV/div	-2 mV		2 mV
	49.8 mV/div	-4.98 mV		4.98 mV
	50 mV/div	-5 mV		5 mV
	100 mV/div	-10 mV		10 mV
	200 mV/div	-20 mV		20 mV
	500 mV/div	-50 mV		50 mV
	1 V/div	-100 mV		100 mV
Channel 3 DC Balance, 1 M Ω , 20 MHz BW	1 mV/div	-0.2 mV		0.2 mV
	2 mV/div	-0.4 mV		0.4 mV
	5 mV/div	-1 mV		1 mV
	10 mV/div	-2 mV		2 mV
	20 mV/div	-4 mV		4 mV
	100 mV/div	-20 mV		20 mV
	500 mV/div	-100 mV		100 mV
	1 V/div	-200 mV		200 mV
	10 V/div	-2 V		2 V
Channel 3 DC Balance, 50 Ω , 250 MHz BW	20 mV/div	-2 mV		2 mV
Channel 3 DC Balance, 1 M Ω , 250 MHz BW	20 mV/div	-4 mV		4 mV
Channel 3 DC Balance, 50 Ω , Full BW	20 mV/div	-2 mV		2 mV
Channel 3 DC Balance, 1 M Ω , Full BW	20 mV/div	-4 mV		4 mV
Channel 4 DC Balance, 50 Ω , 20 MHz BW	1 mV/div	-0.2 mV		0.2 mV
	2 mV/div	-0.2 mV		0.2 mV
	5 mV/div	-0.5 mV		0.5 mV
	10 mV/div	-1 mV		1 mV
	20 mV/div	-2 mV		2 mV
	49.8 mV/div	-4.98 mV		4.98 mV
	50 mV/div	-5 mV		5 mV
	100 mV/div	-10 mV		10 mV
	200 mV/div	-20 mV		20 mV
	500 mV/div	-50 mV		50 mV
	1 V/div	-100 mV		100 mV
Channel 4 DC Balance, 1 M Ω , 20 MHz BW	1 mV/div	-0.2 mV		0.2 mV
	2 mV/div	-0.4 mV		0.4 mV

Table continued...

DC Balance				
Performance checks	Vertical scale	Low limit	Test result	High limit
	5 mV/div	-1 mV		1 mV
	10 mV/div	-2 mV		2 mV
	20 mV/div	-4 mV		4 mV
	100 mV/div	-20 mV		20 mV
	500 mV/div	-100 mV		100 mV
	1 V/div	-200 mV		200 mV
	10 V/div	-2 V		2 V
Channel 4 DC Balance, 50 Ω , 250 MHz BW	20 mV/div	-2 mV		2 mV
Channel 4 DC Balance, 1 M Ω , 250 MHz BW	20 mV/div	-4 mV		4 mV
Channel 4 DC Balance, 50 Ω , Full BW	20 mV/div	-2 mV		2 mV
Channel 4 DC Balance, 1 M Ω , Full BW	20 mV/div	-4 mV		4 mV

MSO56B, MSO58B models				
Channel 5 DC Balance, 50 Ω , 20 MHz BW	1 mV/div	-0.2 mV		0.2 mV
	2 mV/div	-0.2 mV		0.2 mV
	5 mV/div	-0.5 mV		0.5 mV
	10 mV/div	-1 mV		1 mV
	20 mV/div	-2 mV		2 mV
	49.8 mV	-4.98 mV/div		4.98 mV
	50 mV/div	-5 mV		5 mV
	100 mV/div	-10 mV		10 mV
	200 mV/div	-20 mV		20 mV
	500 mV/div	-50 mV		50 mV
	1 V/div	-100 mV		100 mV
Channel 5 DC Balance, 1 M Ω , 20 MHz BW	1 mV/div	-0.2 mV		0.2 mV
	2 mV/div	-0.4 mV		0.4 mV
	5 mV/div	-1 mV		1 mV
	10 mV/div	-2 mV		2 mV
	20 mV/div	-4 mV		4 mV
	100 mV/div	-20 mV		20 mV
	500 mV/div	-100 mV		100 mV
	1 V/div	-200 mV		200 mV
	10 V/div	-2 V		2 V

Table continued...

MSO56B, MSO58B models				
Channel 5 DC Balance, 50 Ω , 250 MHz BW	20 mV/div	-2 mV		2 mV
Channel 5 DC Balance, 1 M Ω , 250 MHz BW	20 mV/div	-4 mV		4 mV
Channel 5 DC Balance, 50 Ω , Full BW	20 mV/div	-2 mV		2 mV
Channel 5 DC Balance, 1 M Ω , Full BW	20 mV/div	-4 mV		4 mV
Channel 6 DC Balance, 50 Ω , 20 MHz BW	1 mV/div	-0.2 mV		0.2 mV
	2 mV/div	-0.2 mV		0.2 mV
	5 mV/div	-0.5 mV		0.5 mV
	10 mV/div	-1 mV		1 mV
	20 mV/div	-2 mV		2 mV
	49.8 mV/div	-4.98 mV		4.98 mV
	50 mV/div	-5 mV		5 mV
	100 mV/div	-10 mV		10 mV
	200 mV/div	-20 mV		20 mV
	500 mV/div	-50 mV		50 mV
	1 V/div	-100 mV		100 mV
Channel 6 DC Balance, 1 M Ω , 20 MHz BW	1 mV/div	-0.2 mV		0.2 mV
	2 mV/div	-0.4 mV		0.4 mV
	5 mV/div	-1 mV		1 mV
	10 mV/div	-2 mV		2 mV
	20 mV/div	-4 mV		4 mV
	100 mV/div	-20 mV		20 mV
	500 mV/div	-100 mV		100 mV
	1 V/div	-200 mV		200 mV
	10 V/div	-2 V		2 V
Channel 6 DC Balance, 50 Ω , 250 MHz BW	20 mV/div	-2 mV		2 mV
Channel 6 DC Balance, 1 M Ω , 250 MHz BW	20 mV/div	-4 mV		4 mV
Channel 6 DC Balance, 50 Ω , Full BW	20 mV/div	-2 mV		2 mV
Channel 6 DC Balance, 1 M Ω , Full BW	20 mV/div	-4 mV		4 mV
MSO58B models				
Channel 7 DC Balance, 50 Ω , 20 MHz BW	1 mV/div	-0.2 mV		0.2 mV
	2 mV/div	-0.2 mV		0.2 mV

Table continued...

MSO56B, MSO58B models				
	5 mV/div	-0.5 mV		0.5 mV
	10 mV/div	-1 mV		1 mV
	20 mV/div	-2 mV		2 mV
	49.8 mV/div	-4.98 mV		4.98 mV
	50 mV/div	-5 mV		5 mV
	100 mV/div	-10 mV		10 mV
	200 mV/div	-20 mV		20 mV
	500 mV/div	-50 mV		50 mV
	1 V/div	-100 mV		100 mV
Channel 7 DC Balance, 1 M Ω , 20 MHz BW	1 mV/div	-0.2 mV		0.2 mV
	2 mV/div	-0.4 mV		0.4 mV
	5 mV/div	-1 mV		1 mV
	10 mV/div	-2 mV		2 mV
	20 mV/div	-4 mV		4 mV
	100 mV/div	-20 mV		20 mV
	500 mV/div	-100 mV		100 mV
	1 V/div	-200 mV		200 mV
	10 V/div	-2 V		2 V
Channel 7 DC Balance, 50 Ω , 250 MHz BW	20 mV/div	-2 mV		2 mV
Channel 7 DC Balance, 1 M Ω , 250 MHz BW	20 mV/div	-4 mV		4 mV
Channel 7 DC Balance, 50 Ω , Full BW	20 mV/div	-2 mV		2 mV
Channel 7 DC Balance, 1 M Ω , Full BW	20 mV/div	-4 mV		4 mV
Channel 8 DC Balance, 50 Ω , 20 MHz BW	1 mV/div	-0.2 mV		0.2 mV
	2 mV/div	-0.2 mV		0.2 mV
	5 mV/div	-0.5 mV		0.5 mV
	10 mV/div	-1 mV		1 mV
	20 mV/div	-2 mV		2 mV
	49.8 mV/div	-4.98 mV		4.98 mV
	50 mV/div	-5 mV		5 mV
	100 mV/div	-10 mV		10 mV
	200 mV/div	-20 mV		20 mV
	500 mV/div	-50 mV		50 mV
	1 V/div	-100 mV		100 mV

Table continued...

MSO56B, MSO58B models				
Channel 8 DC Balance, 1 MΩ, 20 MHz BW	1 mV/div	-0.2 mV		0.2 mV
	2 mV/div	-0.4 mV		0.4 mV
	5 mV/div	-1 mV		1 mV
	10 mV/div	-2 mV		2 mV
	20 mV/div	-4 mV		4 mV
	100 mV/div	-20 mV		20 mV
	500 mV/div	-100 mV		100 mV
	1 V/div	-200 mV		200 mV
	10 V/div	-2 V		2 V
Channel 8 DC Balance, 50 Ω, 250 MHz BW	20 mV/div	-2 mV		2 mV
Channel 8 DC Balance, 1 MΩ, 250 MHz BW	20 mV/div	-4 mV		4 mV
Channel 8 DC Balance, 50 Ω, Full BW	20 mV/div	-2 mV		2 mV
Channel 8 DC Balance, 1 MΩ, Full BW	20 mV/div	-4 mV		4 mV

DC Gain Accuracy test record

DC Gain Accuracy, all models					
Performance checks	Bandwidth	Vertical scale	Low limit	Test result	High limit
Channel 1 DC Gain Accuracy, 0 V offset, 0 V vertical position, 50 Ω	20 MHz	1 mV/div	-2.5%		2.5%
		2 mV/div	-1.2%		1.2%
		5 mV/div	-1.2%		1.2%
		10 mV/div	-1.2%		1.2%
		20 mV/div	-1.2%		1.2%
		50 mV/div	-1.2%		1.2%
		100 mV/div	-1.2%		1.2%
		200 mV/div	-1.2%		1.2%
		500 mV/div	-1.2%		1.2%
	1 V/div	-1.2%		1.2%	
	250 MHz	20 mV/div	-1.2%		1.2%
	FULL	20 mV/div	-1.2%		1.2%
Channel 1 DC Gain Accuracy, 0 V offset, 0 V vertical position, 1 MΩ	20 MHz	1 mV/div	-2%		2%
		2 mV/div	-1%		1%
		5 mV/div	-1%		1%

Table continued...

DC Gain Accuracy, all models					
Performance checks	Bandwidth	Vertical scale	Low limit	Test result	High limit
		10 mV/div	-1%		1%
		20 mV/div	-1%		1%
		50 mV/div	-1%		1%
		100 mV/div	-1%		1%
		200 mV/div	-1%		1%
		500 mV/div	-1%		1%
		1 V/div	-1%		1%
	250 MHz	20 mV/div	-1%		1%
	FULL	20 mV/div	-1%		1%
Channel 2 DC Gain Accuracy, 0 V offset, 0 V vertical position, 50 Ω	20 MHz	1 mV/div	-2.5%		2.5%
		2 mV/div	-1.2%		1.2%
		5 mV/div	-1.2%		1.2%
		10 mV/div	-1.2%		1.2%
		20 mV/div	-1.2%		1.2%
		50 mV/div	-1.2%		1.2%
		100 mV/div	-1.2%		1.2%
		200 mV/div	-1.2%		1.2%
		500 mV/div	-1.2%		1.2%
		1 V/div	-1.2%		1.2%
	250 MHz	20 mV/div	-1.2%		1.2%
	FULL	20 mV/div	-1.2%		1.2%
Channel 2 DC Gain Accuracy, 0 V offset, 0 V vertical position, 1 M Ω	20 MHz	1 mV/div	-2%		2%
		2 mV/div	-1%		1%
		5 mV/div	-1%		1%
		10 mV/div	-1%		1%
		20 mV/div	-1%		1%
		50 mV/div	-1%		1%
		100 mV/div	-1%		1%
		200 mV/div	-1%		1%
		500 mV/div	-1%		1%
		1 V/div	-1%		1%
	50 MHz	20 mV/div	-1%		1%
	FULL	20 mV/div	-1%		1%
	Channel 3 DC Gain Accuracy, 0 V offset,	20 MHz	1 mV/div	-2.5%	
2 mV/div			-1.2%		1.2%

Table continued...

DC Gain Accuracy, all models						
Performance checks	Bandwidth	Vertical scale	Low limit	Test result	High limit	
0 V vertical position, 50 Ω		5 mV/div	-1.2%		1.2%	
		10 mV/div	-1.2%		1.2%	
		20 mV/div	-1.2%		1.2%	
		50 mV/div	-1.2%		1.2%	
		100 mV/div	-1.2%		1.2%	
		200 mV/div	-1.2%		1.2%	
		500 mV/div	-1.2%		1.2%	
		1 V/div	-1.2%		1.2%	
		250 MHz	20 mV/div	-1.2%		1.2%
	FULL	20 mV/div	-1.2%		1.2%	
Channel 3 DC Gain Accuracy, 0 V offset, 0 V vertical position, 1 MΩ	20 MHz	1 mV/div	-2%		2%	
		2 mV/div	-1%		1%	
		5 mV/div	-1%		1%	
		10 mV/div	-1%		1%	
		20 mV/div	-1%		1%	
		50 mV/div	-1%		1%	
		100 mV/div	-1%		1%	
		200 mV/div	-1%		1%	
		500 mV/div	-1%		1%	
		1 V/div	-1%		1%	
		250 MHz	20 mV/div	-1%		1%
		FULL	20 mV/div	-1%		1%
Channel 4 DC Gain Accuracy, 0 V offset, 0 V vertical position, 50 Ω	20 MHz	1 mV/div	-2.5%		2.5%	
		2 mV/div	-1.2%		1.2%	
		5 mV/div	-1.2%		1.2%	
		10 mV/div	-1.2%		1.2%	
		20 mV/div	-1.2%		1.2%	
		50 mV/div	-1.2%		1.2%	
		100 mV/div	-1.2%		1.2%	
		200 mV/div	-1.2%		1.2%	
		500 mV/div	-1.2%		1.2%	
		1 V/div	-1.2%		1.2%	
		250 MHz	20 mV/div	-1.2%		1.2%
		FULL	20 mV/div	-1.2%		1.2%
Channel 4 DC Gain Accuracy, 0 V offset,	20 MHz	1 mV/div	-2%		2%	

Table continued...

DC Gain Accuracy, all models					
Performance checks	Bandwidth	Vertical scale	Low limit	Test result	High limit
0 V vertical position, 1 M Ω		2 mV/div	-1%		1%
		5 mV/div	-1%		1%
		10 mV/div	-1%		1%
		20 mV/div	-1%		1%
		50 mV/div	-1%		1%
		100 mV/div	-1%		1%
		200 mV/div	-1%		1%
		500 mV/div	-1%		1%
		1 V/div	-1%		1%
	250 MHz	20 mV/div	-1%		1%
	FULL	20 mV/div	-1%		1%

MSO56B and MSO58B models					
Channel 5 DC Gain Accuracy, 0 V offset, 0 V vertical position, 50 Ω	20 MHz	1 mV/div	-2.5%		2.5%
		2 mV/div	-1.2%		1.2%
		5 mV/div	-1.2%		1.2%
		10 mV/div	-1.2%		1.2%
		20 mV/div	-1.2%		1.2%
		50 mV/div	-1.2%		1.2%
		100 mV/div	-1.2%		1.2%
		200 mV/div	-1.2%		1.2%
		500 mV/div	-1.2%		1.2%
	1 V/div	-1.2%		1.2%	
	250 MHz	20 mV/div	-1.2%		1.2%
FULL	20 mV/div	-1.2%		1.2%	
Channel 5 DC Gain Accuracy, 0 V offset, 0 V vertical position, 1 M Ω	20 MHz	1 mV/div	-2%		2%
		2 mV/div	-1%		1%
		5 mV/div	-1%		1%
		10 mV/div	-1%		1%
		20 mV/div	-1%		1%
		50 mV/div	-1%		1%
		100 mV/div	-1%		1%
		200 mV/div	-1%		1%
		500 mV/div	-1%		1%
		1 V/div	-1%		1%

Table continued...

MSO56B and MSO58B models					
	250 MHz	20 mV/div	-1%		1%
	FULL	20 mV/div	-1%		1%
Channel 6 DC Gain Accuracy, 0 V offset, 0 V vertical position, 50 Ω	20 MHz	1 mV/div	-2.5%		2.5%
		2 mV/div	-1.2%		1.2%
		5 mV/div	-1.2%		1.2%
		10 mV/div	-1.2%		1.2%
		20 mV/div	-1.2%		1.2%
		50 mV/div	-1.2%		1.2%
		100 mV/div	-1.2%		1.2%
		200 mV/div	-1.2%		1.2%
		500 mV/div	-1.2%		1.2%
		1 V/div	-1.2%		1.2%
	250 MHz	20 mV/div	-1.2%		1.2%
FULL	20 mV/div	-1.2%		1.2%	
Channel 6 DC Gain Accuracy, 0 V offset, 0 V vertical position, 1 MΩ	20 MHz	1 mV/div	-2%		2%
		2 mV/div	-1%		1%
		5 mV/div	-1%		1%
		10 mV/div	-1%		1%
		20 mV/div	-1%		1%
		50 mV/div	-1%		1%
		100 mV/div	-1%		1%
		200 mV/div	-1%		1%
		500 mV/div	-1%		1%
		1 V/div	-1%		1%
	250 MHz	20 mV/div	-1%		1%
FULL	20 mV/div	-1%		1%	
MSO58B models					
Channel 7 DC Gain Accuracy, 0 V offset, 0 V vertical position, 50 Ω	20 MHz	1 mV/div	-2.5%		2.5%
		2 mV/div	-1.2%		1.2%
		5 mV/div	-1.2%		1.2%
		10 mV/div	-1.2%		1.2%
		20 mV/div	-1.2%		1.2%
		50 mV/div	-1.2%		1.2%
		100 mV/div	-1.2%		1.2%
		200 mV/div	-1.2%		1.2%
		500 mV/div	-1.2%		1.2%
		1 V/div	-1.2%		1.2%

Table continued...

MSO56B and MSO58B models					
	250 MHz	20 mV/div	-1.2%		1.2%
	FULL	20 mV/div	-1.2%		1.2%
Channel 7 DC Gain Accuracy, 0 V offset, 0 V vertical position, 1 M Ω	20 MHz	1 mV/div	-2%		2%
		2 mV/div	-1%		1%
		5 mV/div	-1%		1%
		10 mV/div	-1%		1%
		20 mV/div	-1%		1%
		50 mV/div	-1%		1%
		100 mV/div	-1%		1%
		200 mV/div	-1%		1%
		500 mV/div	-1%		1%
		1 V/div	-1%		1%
	250 MHz	20 mV/div	-1%		1%
	FULL	20 mV/div	-1%		1%
Channel 8 DC Gain Accuracy, 0 V offset, 0 V vertical position, 50 Ω	20 MHz	1 mV/div	-2.5%		2.5%
		2 mV/div	-1.2%		1.2%
		5 mV/div	-1.2%		1.2%
		10 mV/div	-1.2%		1.2%
		20 mV/div	-1.2%		1.2%
		50 mV/div	-1.2%		1.2%
		100 mV/div	-1.2%		1.2%
		200 mV/div	-1.2%		1.2%
		500 mV/div	-1.2%		1.2%
		1 V/div	-1.2%		1.2%
	250 MHz	20 mV/div	-1.2%		1.2%
	FULL	20 mV/div	-1.2%		1.2%
Channel 8 DC Gain Accuracy, 0 V offset, 0 V vertical position, 1 M Ω	20 MHz	1 mV/div	-2%		2%
		2 mV/div	-1%		1%
		5 mV/div	-1%		1%
		10 mV/div	-1%		1%
		20 mV/div	-1%		1%
		50 mV/div	-1%		1%
		100 mV/div	-1%		1%
		200 mV/div	-1%		1%
		500 mV/div	-1%		1%
		1 V/div	-1%		1%
	250 MHz	20 mV/div	-1%		1%

Table continued...

MSO56B and MSO58B models					
	FULL	20 mV/div	-1%		1%

DC Offset Accuracy test record

Use the vertical offset value for both the calibrator output and the oscilloscope offset setting.

Offset Accuracy					
Performance checks	Vertical scale	Vertical offset	Low limit	Test result	High limit
All models					
Channel 1 DC Offset Accuracy, 20 MHz BW, 50 Ω	1 mV/div	900 mV	895.3 mV		904.7 mV
	1 mV/div	-900 mV	-904.7 mV		-895.3 mV
	100 mV/div	5.0 V	4.965 V		5.035 V
	100 mV/div	-5.0 V	-5.035 V		-4.965 V
Channel 1 DC Offset Accuracy, 20 MHz BW, 1 MΩ	1 mV/div	900 mV	895.3 mV		904.7 mV
	1 mV/div	-900 mV	-904.7 mV		-895.3 mV
	100 mV/div	1.0 V	0.975 V		1.025 V
	100 mV/div	- 1.0 V	-1.025 V		-0.975 V
	500 mV/div	9.0 V	8.855 V		9.145 V
	500 mV/div	- 9.0 V	-9.145 V		-8.855 V
	1.01 V/div	10.0 V	9.75 V		10.25 V
	1.01 V/div	-10.0 V	-10.25 V		-9.75 V
	5 V/div	10.0 V	8.95 V		11.05 V
	5 V/div	-10.0 V	-11.05 V		-8.95 V
Channel 2 DC Offset Accuracy, 20 MHz BW, 50 Ω	1 mV/div	900 mV	895.3 mV		904.7 mV
	1 mV/div	-900 mV	-904.7 mV		-895.3 mV
	100 mV/div	5.0 V	4.965 V		5.035 V
	100 mV/div	-5.0 V	-5.035 V		-4.965 V
Channel 2 DC Offset Accuracy, 20 MHz BW, 1 MΩ	1 mV/div	900 mV	895.3 mV		904.7 mV
	1 mV/div	-900 mV	-904.7 mV		-895.3 mV
	100 mV/div	1.0 V	0.935 V		1.065 V
	100 mV/div	- 1.0 V	-1.065 V		-0.935 V
	500 mV/div	9.0 V	8.855 V		9.145 V
	500 mV/div	- 9.0 V	-9.145 V		-8.855 V
	1.01 V/div	10.0 V	9.3 V		10.7 V
	1.01 V/div	-10.0 V	-10.7 V		-9.3 V
	5 V/div	10.0 V	8.5 V		11.5 V
	5 V/div	-10.0 V	-11.5 V		-8.5 V

Table continued...

Offset Accuracy					
Performance checks	Vertical scale	Vertical offset	Low limit	Test result	High limit
Channel 3 DC Offset Accuracy, 20 MHz BW, 50 Ω	1 mV/div	900 mV	895.3 mV		904.7 mV
	1 mV/div	-900 mV	-904.7 mV		-895.3 mV
	100 mV/div	5.0 V	4.965 V		5.035 V
	100 mV/div	-5.0 V	-5.035 V		-4.965 V
Channel 3 DC Offset Accuracy, 20 MHz BW, 1 MΩ	1 mV/div	900 mV	895.3 mV		904.7 mV
	1 mV/div	-900 mV	-904.7 mV		-895.3 mV
	100 mV/div	1.0 V	0.935 V		1.065 V
	100 mV/div	- 1.0 V	-1.065 V		-0.935 V
	500 mV/div	9.0 V	8.855 V		9.145 V
	500 mV/div	- 9.0 V	-9.145 V		-8.855 V
	1.01 V/div	10.0 V	9.3 V		10.7 V
	1.01 V/div	-10.0 V	-10.7 V		-9.3 V
	5 V/div	10.0 V	8.5 V		11.5 V
	5 V/div	-10.0 V	-11.5 V		-8.5 V
Channel 4 DC Offset Accuracy, 20 MHz BW, 50 Ω	1 mV/div	900 mV	895.3 mV		904.7 mV
	1 mV/div	-900 mV	-904.7 mV		-895.3 mV
	100 mV/div	5.0 V	4.965 V		5.035 V
	100 mV/div	-5.0 V	-5.035 V		-4.965 V
Channel 4 DC Offset Accuracy, 20 MHz BW, 1 MΩ	1 mV/div	900 mV	895.3 mV		904.7 mV
	1 mV/div	-900 mV	-904.7 mV		-895.3 mV
	100 mV/div	1.0 V	0.935 V		1.065 V
	100 mV/div	- 1.0 V	-1.065 V		-0.935 V
	500 mV/div	9.0 V	8.855 V		9.145 V
	500 mV/div	- 9.0 V	-9.145 V		-8.855 V
	1.01 V/div	10.0 V	9.3 V		10.7 V
	1.01 V/div	-10.0 V	-10.7 V		-9.3 V
	5 V/div	10.0 V	8.5 V		11.5 V
	5 V/div	-10.0 V	-11.5 V		-8.5 V

MSO56B, MSO58B models					
Channel 5 DC Offset Accuracy, 20 MHz BW, 50 Ω	1 mV/div	900 mV	895.3 mV		904.7 mV
	1 mV/div	-900 mV	-904.7 mV		-895.3 mV
	100 mV/div	5.0 V	4.965 V		5.035 V
	100 mV/div	-5.0 V	-5.035 V		-4.965 V

Table continued...

MSO56B, MSO58B models					
Channel 5 DC Offset Accuracy, 20 MHz BW, 1 MΩ	1 mV/div	900 mV	895.3 mV		904.7 mV
	1 mV/div	-900 mV	-904.7 mV		-895.3 mV
	100 mV/div	1.0 V	0.935 V		1.065 V
	100 mV/div	- 1.0 V	-1.065 V		-0.935 V
	500 mV/div	9.0 V	8.855 V		9.145 V
	500 mV/div	- 9.0 V	-9.145 V		-8.855 V
	1.01 V/div	10.0 V	9.3 V		10.7 V
	1.01 V/div	-10.0 V	-10.7 V		-9.3 V
	5 V/div	10.0 V	8.5 V		11.5 V
	5 V/div	-10.0 V	-11.5 V		-8.5 V
Channel 6 DC Offset Accuracy, 20 MHz BW, 50 Ω	1 mV/div	900 mV	895.3 mV		904.7 mV
	1 mV/div	-900 mV	-904.7 mV		-895.3 mV
	100 mV/div	5.0 V	4.965 V		5.035 V
	100 mV/div	-5.0 V	-5.035 V		-4.965 V
Channel 6 DC Offset Accuracy, 20 MHz BW, 1 MΩ	1 mV/div	900 mV	895.3 mV		904.7 mV
	1 mV/div	-900 mV	-904.7 mV		-895.3 mV
	100 mV/div	1.0 V	0.935 V		1.065 V
	100 mV/div	- 1.0 V	-1.065 V		-0.935 V
	500 mV/div	9.0 V	8.855 V		9.145 V
	500 mV/div	- 9.0 V	-9.145 V		-8.855 V
	1.01 V/div	10.0 V	9.3 V		10.7 V
	1.01 V/div	-10.0 V	-10.7 V		-9.3 V
	5 V/div	10.0 V	8.5 V		11.5 V
	5 V/div	-10.0 V	-11.5 V		-8.5 V
MSO58B models					
Channel 7 DC Offset Accuracy, 20 MHz BW, 50 Ω	1 mV/div	900 mV	895.3 mV		904.7 mV
	1 mV/div	-900 mV	-904.7 mV		-895.3 mV
	100 mV/div	5.0 V	4.965 V		5.035 V
	100 mV/div	-5.0 V	-5.035 V		-4.965 V
Channel 7 DC Offset Accuracy, 20 MHz BW, 1 MΩ	1 mV/div	900 mV	895.3 mV		904.7 mV
	1 mV/div	-900 mV	-904.7 mV		-895.3 mV
	100 mV/div	1.0 V	0.935 V		1.065 V
	100 mV/div	- 1.0 V	-1.065 V		-0.935 V
	500 mV/div	9.0 V	8.855 V		9.145 V
	500 mV/div	- 9.0 V	-9.145 V		-8.855 V
	1.01 V/div	10.0 V	9.3 V		10.7 V
	1.01 V/div	-10.0 V	-10.7 V		-9.3 V

Table continued...

MSO56B, MSO58B models					
	5 V/div	10.0 V	8.5 V		11.5 V
	5 V/div	-10.0 V	-11.5 V		-8.5 V
Channel 8 DC Offset Accuracy, 20 MHz BW, 50 Ω	1 mV/div	900 mV	895.3 mV		904.7 mV
	1 mV/div	-900 mV	-904.7 mV		-895.3 mV
	100 mV/div	5.0 V	4.965 V		5.035 V
	100 mV/div	-5.0 V	-5.035 V		-4.965 V
Channel 8 DC Offset Accuracy, 20 MHz BW, 1 M Ω	1 mV/div	900 mV	895.3 mV		904.7 mV
	1 mV/div	-900 mV	-904.7 mV		-895.3 mV
	100 mV/div	1.0 V	0.935 V		1.065 V
	100 mV/div	- 1.0 V	-1.065 V		-0.935 V
	500 mV/div	9.0 V	8.855 V		9.145 V
	500 mV/div	- 9.0 V	-9.145 V		-8.855 V
	1.01 V/div	10.0 V	9.3 V		10.7 V
	1.01 V/div	-10.0 V	-10.7 V		-9.3 V
	5 V/div	10.0 V	8.5 V		11.5 V
	5 V/div	-10.0 V	-11.5 V		-8.5 V

Analog Bandwidth test record

Analog Bandwidth							
Performance checks							
Bandwidth at Channel	Impedance	Vertical scale	Horizontal scale	V_{in-pp}	V_{bw-pp}	Limit	Test result Gain = V_{bw-pp}/V_{in-pp}
2 GHz models							
Channel 1	50 Ω	1 mV/div	5 ns/div (175 MHz)			≥ 0.707	
		2 mV/div	2.5 ns/div (350 MHz)			≥ 0.707	
		5 mV/div	1 ns/div (1.5 GHz)			≥ 0.707	
		10 mV/div	1 ns/div (Full BW)			≥ 0.707	
		50 mV/div	1 ns/div			≥ 0.707	

Table continued...

Analog Bandwidth							
Performance checks							
Bandwidth at Channel	Impedance	Vertical scale	Horizontal scale	V_{in-pp}	V_{bw-pp}	Limit	Test result Gain = V_{bw-pp}/V_{in-pp}
			(Full BW)				
		100 mV/div	1 ns/div (Full BW)			≥ 0.707	
		1 V/div	1 ns/div (Full BW)			≥ 0.707	
Channel 1	1 M Ω , typical	1 mV/div	5 ns/div (500 MHz)			≥ 0.707	
		2 mV/div	2.5 ns/div (500 MHz)			≥ 0.707	
		5 mV/div	1 ns/div (500 MHz)			≥ 0.707	
		10 mV/div	1 ns/div (500 MHz)			≥ 0.707	
		50 mV/div	1 ns/div (500 MHz)			≥ 0.707	
		100 mV/div	1 ns/div (500 MHz)			≥ 0.707	
		1 V/div	1 ns/div (500 MHz)			≥ 0.707	
Channel 2	50 Ω	1 mV/div	5 ns/div (175 MHz)			≥ 0.707	
		2 mV/div	2.5 ns/div (350 MHz)			≥ 0.707	
		5 mV/div	1 ns/div (1.5 GHz)			≥ 0.707	
		10 mV/div	1 ns/div			≥ 0.707	

Table continued...

Analog Bandwidth							
Performance checks							
Bandwidth at Channel	Impedance	Vertical scale	Horizontal scale	V_{in-pp}	V_{bw-pp}	Limit	Test result Gain = V_{bw-pp}/V_{in-pp}
			(Full BW)				
		50 mV/div	1 ns/div (Full BW)			≥ 0.707	
		100 mV/div	1 ns/div (Full BW)			≥ 0.707	
		1 V/div	1 ns/div (Full BW)			≥ 0.707	
Channel 2	1 M Ω , typical	1 mV/div	5 ns/div (500 MHz)			≥ 0.707	
		2 mV/div	2.5 ns/div (500 MHz)			≥ 0.707	
		5 mV/div	1 ns/div (500 MHz)			≥ 0.707	
		10 mV/div	1 ns/div (500 MHz)			≥ 0.707	
		50 mV/div	1 ns/div (500 MHz)			≥ 0.707	
		100 mV/div	1 ns/div (500 MHz)			≥ 0.707	
		1 V/div	1 ns/div (500 MHz)			≥ 0.707	
Channel 3	50 Ω	1 mV/div	5 ns/div (175 MHz)			≥ 0.707	
		2 mV/div	2.5 ns/div (350 MHz)			≥ 0.707	
		5 mV/div	1 ns/div			≥ 0.707	

Table continued...

Analog Bandwidth							
Performance checks							
Bandwidth at Channel	Impedance	Vertical scale	Horizontal scale	V_{in-pp}	V_{bw-pp}	Limit	Test result Gain = V_{bw-pp}/V_{in-pp}
			(1.5 GHz)				
		10 mV/div	1 ns/div (Full BW)			≥ 0.707	
		50 mV/div	1 ns/div (Full BW)			≥ 0.707	
		100 mV/div	1 ns/div (Full BW)			≥ 0.707	
		1 V/div	1 ns/div (Full BW)			≥ 0.707	
Channel 3	1 M Ω , typical	1 mV/div	5 ns/div (500 MHz)			≥ 0.707	
		2 mV/div	2.5 ns/div (500 MHz)			≥ 0.707	
		5 mV/div	1 ns/div (500 MHz)			≥ 0.707	
		10 mV/div	1 ns/div (500 MHz)			≥ 0.707	
		50 mV/div	1 ns/div (500 MHz)			≥ 0.707	
		100 mV/div	1 ns/div (500 MHz)			≥ 0.707	
		1 V/div	1 ns/div (500 MHz)			≥ 0.707	
Channel 4	50 Ω	1 mV/div	5 ns/div (175 MHz)			≥ 0.707	
		2 mV/div	2.5 ns/div			≥ 0.707	

Table continued...

Analog Bandwidth							
Performance checks							
Bandwidth at Channel	Impedance	Vertical scale	Horizontal scale	V_{in-pp}	V_{bw-pp}	Limit	Test result Gain = V_{bw-pp}/V_{in-pp}
			(350 MHz)				
		5 mV/div	1 ns/div (1.5 GHz)			≥ 0.707	
		10 mV/div	1 ns/div (Full BW)			≥ 0.707	
		50 mV/div	1 ns/div (Full BW)			≥ 0.707	
		100 mV/div	1 ns/div (Full BW)			≥ 0.707	
		1 V/div	1 ns/div (Full BW)			≥ 0.707	
Channel 4	1 M Ω , typical	1 mV/div	5 ns/div (500 MHz)			≥ 0.707	
		2 mV/div	2.5 ns/div (500 MHz)			≥ 0.707	
		5 mV/div	1 ns/div (500 MHz)			≥ 0.707	
		10 mV/div	1 ns/div (500 MHz)			≥ 0.707	
		50 mV/div	1 ns/div (500 MHz)			≥ 0.707	
		100 mV/div	1 ns/div (500 MHz)			≥ 0.707	
		1 V/div	1 ns/div (500 MHz)			≥ 0.707	
2 GHz MSO56B and MSO58B models							
Table continued...							

Analog Bandwidth							
Performance checks							
Bandwidth at Channel	Impedance	Vertical scale	Horizontal scale	V_{in-pp}	V_{bw-pp}	Limit	Test result Gain = V_{bw-pp}/V_{in-pp}
Channel 5	50 Ω	1 mV/div	5 ns/div (175 MHz)			≥ 0.707	
		2 mV/div	2.5 ns/div (350 MHz)			≥ 0.707	
		5 mV/div	1 ns/div (1.5 GHz)			≥ 0.707	
		10 mV/div	1 ns/div (Full BW)			≥ 0.707	
		50 mV/div	1 ns/div (Full BW)			≥ 0.707	
		100 mV/div	1 ns/div (Full BW)			≥ 0.707	
		1 V/div	1 ns/div (Full BW)			≥ 0.707	
Channel 5	1 M Ω , typical	1 mV/div	5 ns/div (500 MHz)			≥ 0.707	
		2 mV/div	2.5 ns/div (500 MHz)			≥ 0.707	
		5 mV/div	1 ns/div (500 MHz)			≥ 0.707	
		10 mV/div	1 ns/div (500 MHz)			≥ 0.707	
		50 mV/div	1 ns/div (500 MHz)			≥ 0.707	
		100 mV/div	1 ns/div (500 MHz)			≥ 0.707	

Table continued...

Analog Bandwidth							
Performance checks							
Bandwidth at Channel	Impedance	Vertical scale	Horizontal scale	V_{in-pp}	V_{bw-pp}	Limit	Test result Gain = V_{bw-pp}/V_{in-pp}
		1 V/div	1 ns/div (500 MHz)			≥ 0.707	
Channel 6	50 Ω	1 mV/div	5 ns/div (175 MHz)			≥ 0.707	
		2 mV/div	2.5 ns/div (350 MHz)			≥ 0.707	
		5 mV/div	1 ns/div (1.5 GHz)			≥ 0.707	
		10 mV/div	1 ns/div (Full BW)			≥ 0.707	
		50 mV/div	1 ns/div (Full BW)			≥ 0.707	
		100 mV/div	1 ns/div (Full BW)			≥ 0.707	
		1 V/div	1 ns/div (Full BW)			≥ 0.707	
Channel 6	1 M Ω , typical	1 mV/div	5 ns/div (500 MHz)			≥ 0.707	
		2 mV/div	2.5 ns/div (500 MHz)			≥ 0.707	
		5 mV/div	1 ns/div (500 MHz)			≥ 0.707	
		10 mV/div	1 ns/div (500 MHz)			≥ 0.707	
		50 mV/div	1 ns/div (500 MHz)			≥ 0.707	

Table continued...

Analog Bandwidth							
Performance checks							
Bandwidth at Channel	Impedance	Vertical scale	Horizontal scale	V_{in-pp}	V_{bw-pp}	Limit	Test result Gain = V_{bw-pp}/V_{in-pp}
		100 mV/div	1 ns/div (500 MHz)			≥ 0.707	
		1 V/div	1 ns/div (500 MHz)			≥ 0.707	
2 GHz MSO58B models							
Channel 7	50 Ω	1 mV/div	5 ns/div (175 MHz)			≥ 0.707	
		2 mV/div	2.5 ns/div (350 MHz)			≥ 0.707	
		5 mV/div	1 ns/div (1.5 GHz)			≥ 0.707	
		10 mV/div	1 ns/div (Full BW)			≥ 0.707	
		50 mV/div	1 ns/div (Full BW)			≥ 0.707	
		100 mV/div	1 ns/div (Full BW)			≥ 0.707	
		1 V/div	1 ns/div (Full BW)			≥ 0.707	
Channel 7	1 M Ω , typical	1 mV/div	5 ns/div (500 MHz)			≥ 0.707	
		2 mV/div	2.5 ns/div (500 MHz)			≥ 0.707	
		5 mV/div	1 ns/div (500 MHz)			≥ 0.707	
		10 mV/div	1 ns/div			≥ 0.707	

Table continued...

Analog Bandwidth							
Performance checks							
Bandwidth at Channel	Impedance	Vertical scale	Horizontal scale	V_{in-pp}	V_{bw-pp}	Limit	Test result Gain = V_{bw-pp}/V_{in-pp}
			(500 MHz)				
		50 mV/div	1 ns/div (500 MHz)			≥ 0.707	
		100 mV/div	1 ns/div (500 MHz)			≥ 0.707	
		1 V/div	1 ns/div (500 MHz)			≥ 0.707	
Channel 8	50 Ω	1 mV/div	5 ns/div (175 MHz)			≥ 0.707	
		2 mV/div	2.5 ns/div (350 MHz)			≥ 0.707	
		5 mV/div	1 ns/div (1.5 GHz)			≥ 0.707	
		10 mV/div	1 ns/div (Full BW)			≥ 0.707	
		50 mV/div	1 ns/div (Full BW)			≥ 0.707	
		100 mV/div	1 ns/div (Full BW)			≥ 0.707	
		1 V/div	1 ns/div (Full BW)			≥ 0.707	
Channel 8	1 M Ω , typical	1 mV/div	5 ns/div (500 MHz)			≥ 0.707	
		2 mV/div	2.5 ns/div (500 MHz)			≥ 0.707	
		5 mV/div	1 ns/div			≥ 0.707	

Table continued...

Analog Bandwidth							
Performance checks							
Bandwidth at Channel	Impedance	Vertical scale	Horizontal scale	V_{in-pp}	V_{bw-pp}	Limit	Test result Gain = V_{bw-pp}/V_{in-pp}
			(500 MHz)				
		10 mV/div	1 ns/div (500 MHz)			≥ 0.707	
		50 mV/div	1 ns/div (500 MHz)			≥ 0.707	
		100 mV/div	1 ns/div (500 MHz)			≥ 0.707	
		1 V/div	1 ns/div (500 MHz)			≥ 0.707	
1 GHz models (MSO54B, MSO56B, MSO58B)							
Channel 1	50 Ω	1 mV/div	5 ns/div (1 GHz)			≥ 0.707	
		2 mV/div	2.5 ns/div (1.0 GHz)			≥ 0.707	
		5 mV/div	1 ns/div (1.0 GHz)			≥ 0.707	
		10 mV/div	1 ns/div (1.0 GHz)			≥ 0.707	
		50 mV/div	1 ns/div (1.0 GHz)			≥ 0.707	
		100 mV/div	1 ns/div (1.0 GHz)			≥ 0.707	
		1 V/div	1 ns/div (1.0 GHz)			≥ 0.707	
Channel 1	1 M Ω , typical	1 mV/div	5 ns/div (500 MHz)			≥ 0.707	

Table continued...

Analog Bandwidth							
Performance checks							
Bandwidth at Channel	Impedance	Vertical scale	Horizontal scale	V_{in-pp}	V_{bw-pp}	Limit	Test result Gain = V_{bw-pp}/V_{in-pp}
		2 mV/div	2.5 ns/div (500 MHz)			≥ 0.707	
		5 mV/div	1 ns/div (500 MHz)			≥ 0.707	
		10 mV/div	1 ns/div (500 MHz)			≥ 0.707	
		50 mV/div	1 ns/div (500 MHz)			≥ 0.707	
		100 mV/div	1 ns/div (500 MHz)			≥ 0.707	
		1 V/div	1 ns/div (500 MHz)			≥ 0.707	
Channel 2	50 Ω	1 mV/div	5 ns/div (1 GHz)			≥ 0.707	
		2 mV/div	2.5 ns/div (1.0 GHz)			≥ 0.707	
		5 mV/div	1 ns/div (1.0 GHz)			≥ 0.707	
		10 mV/div	1 ns/div (1.0 GHz)			≥ 0.707	
		50 mV/div	1 ns/div (1.0 GHz)			≥ 0.707	
		100 mV/div	1 ns/div (1.0 GHz)			≥ 0.707	
		1 V/div	1 ns/div (1.0 GHz)			≥ 0.707	

Table continued...

Analog Bandwidth							
Performance checks							
Bandwidth at Channel	Impedance	Vertical scale	Horizontal scale	V_{in-pp}	V_{bw-pp}	Limit	Test result Gain = V_{bw-pp}/V_{in-pp}
Channel 2	1 M Ω , typical	1 mV/div	5 ns/div (500 MHz)			≥ 0.707	
		2 mV/div	2.5 ns/div (500 MHz)			≥ 0.707	
		5 mV/div	1 ns/div (500 MHz)			≥ 0.707	
		10 mV/div	1 ns/div (500 MHz)			≥ 0.707	
		50 mV/div	1 ns/div (500 MHz)			≥ 0.707	
		100 mV/div	1 ns/div (500 MHz)			≥ 0.707	
		1 V/div	1 ns/div (500 MHz)			≥ 0.707	
Channel 3	50 Ω	1 mV/div	5 ns/div (1 GHz)			≥ 0.707	
		2 mV/div	2.5 ns/div (1.0 GHz)			≥ 0.707	
		5 mV/div	1 ns/div (1.0 GHz)			≥ 0.707	
		10 mV/div	1 ns/div (1.0 GHz)			≥ 0.707	
		50 mV/div	1 ns/div (1.0 GHz)			≥ 0.707	
		100 mV/div	1 ns/div (1.0 GHz)			≥ 0.707	

Table continued...

Analog Bandwidth							
Performance checks							
Bandwidth at Channel	Impedance	Vertical scale	Horizontal scale	V_{in-pp}	V_{bw-pp}	Limit	Test result Gain = V_{bw-pp}/V_{in-pp}
		1 V/div	1 ns/div (1.0 GHz)			≥ 0.707	
Channel 3	1 M Ω , typical	1 mV/div	5 ns/div (500 MHz)			≥ 0.707	
		2 mV/div	2.5 ns/div (500 MHz)			≥ 0.707	
		5 mV/div	1 ns/div (500 MHz)			≥ 0.707	
		10 mV/div	1 ns/div (500 MHz)			≥ 0.707	
		50 mV/div	1 ns/div (500 MHz)			≥ 0.707	
		100 mV/div	1 ns/div (500 MHz)			≥ 0.707	
		1 V/div	1 ns/div (500 MHz)			≥ 0.707	
Channel 4	50 Ω	1 mV/div	5 ns/div (1 GHz)			≥ 0.707	
		2 mV/div	2.5 ns/div (1.0 GHz)			≥ 0.707	
		5 mV/div	1 ns/div (1.0 GHz)			≥ 0.707	
		10 mV/div	1 ns/div (1.0 GHz)			≥ 0.707	
		50 mV/div	1 ns/div (1.0 GHz)			≥ 0.707	

Table continued...

Analog Bandwidth							
Performance checks							
Bandwidth at Channel	Impedance	Vertical scale	Horizontal scale	V_{in-pp}	V_{bw-pp}	Limit	Test result Gain = V_{bw-pp}/V_{in-pp}
		100 mV/div	1 ns/div (1.0 GHz)			≥ 0.707	
		1 V/div	1 ns/div (1.0 GHz)			≥ 0.707	
Channel 4	1 M Ω , typical	1 mV/div	5 ns/div (500 MHz)			≥ 0.707	
		2 mV/div	2.5 ns/div (500 MHz)			≥ 0.707	
		5 mV/div	1 ns/div (500 MHz)			≥ 0.707	
		10 mV/div	1 ns/div (500 MHz)			≥ 0.707	
		50 mV/div	1 ns/div (500 MHz)			≥ 0.707	
		100 mV/div	1 ns/div (500 MHz)			≥ 0.707	
		1 V/div	1 ns/div (500 MHz)			≥ 0.707	
1 GHz MSO56B, MSO58B models							
Channel 5	50 Ω	1 mV/div	5 ns/div (1 GHz)			≥ 0.707	
		2 mV/div	2.5 ns/div (1.0 GHz)			≥ 0.707	
		5 mV/div	1 ns/div (1.0 GHz)			≥ 0.707	
		10 mV/div	1 ns/div			≥ 0.707	

Table continued...

Analog Bandwidth							
Performance checks							
Bandwidth at Channel	Impedance	Vertical scale	Horizontal scale	V_{in-pp}	V_{bw-pp}	Limit	Test result Gain = V_{bw-pp}/V_{in-pp}
			(1.0 GHz)				
		50 mV/div	1 ns/div (1.0 GHz)			≥ 0.707	
		100 mV/div	1 ns/div (1.0 GHz)			≥ 0.707	
		1 V/div	1 ns/div (1.0 GHz)			≥ 0.707	
Channel 5	1 M Ω , typical	1 mV/div	5 ns/div (500 MHz)			≥ 0.707	
		2 mV/div	2.5 ns/div (500 MHz)			≥ 0.707	
		5 mV/div	1 ns/div (500 MHz)			≥ 0.707	
		10 mV/div	1 ns/div (500 MHz)			≥ 0.707	
		50 mV/div	1 ns/div (500 MHz)			≥ 0.707	
		100 mV/div	1 ns/div (500 MHz)			≥ 0.707	
		1 V/div	1 ns/div (500 MHz)			≥ 0.707	
Channel 6	50 Ω	1 mV/div	5 ns/div (1 GHz)			≥ 0.707	
		2 mV/div	2.5 ns/div (1.0 GHz)			≥ 0.707	
		5 mV/div	1 ns/div			≥ 0.707	

Table continued...

Analog Bandwidth							
Performance checks							
Bandwidth at Channel	Impedance	Vertical scale	Horizontal scale	V_{in-pp}	V_{bw-pp}	Limit	Test result Gain = V_{bw-pp}/V_{in-pp}
			(1.0 GHz)				
		10 mV/div	1 ns/div (1.0 GHz)			≥ 0.707	
		50 mV/div	1 ns/div (1.0 GHz)			≥ 0.707	
		100 mV/div	1 ns/div (1.0 GHz)			≥ 0.707	
		1 V/div	1 ns/div (1.0 GHz)			≥ 0.707	
Channel 6	1 M Ω , typical	1 mV/div	5 ns/div (500 MHz)			≥ 0.707	
		2 mV/div	2.5 ns/div (500 MHz)			≥ 0.707	
		5 mV/div	1 ns/div (500 MHz)			≥ 0.707	
		10 mV/div	1 ns/div (500 MHz)			≥ 0.707	
		50 mV/div	1 ns/div (500 MHz)			≥ 0.707	
		100 mV/div	1 ns/div (500 MHz)			≥ 0.707	
		1 V/div	1 ns/div (500 MHz)			≥ 0.707	
1 GHz MSO58B models							
Channel 7	50 Ω	1 mV/div	5 ns/div (1 GHz)			≥ 0.707	

Table continued...

Analog Bandwidth							
Performance checks							
Bandwidth at Channel	Impedance	Vertical scale	Horizontal scale	V_{in-pp}	V_{bw-pp}	Limit	Test result Gain = V_{bw-pp}/V_{in-pp}
		2 mV/div	2.5 ns/div (1.0 GHz)			≥ 0.707	
		5 mV/div	1 ns/div (1.0 GHz)			≥ 0.707	
		10 mV/div	1 ns/div (1.0 GHz)			≥ 0.707	
		50 mV/div	1 ns/div (1.0 GHz)			≥ 0.707	
		100 mV/div	1 ns/div (1.0 GHz)			≥ 0.707	
		1 V/div	1 ns/div (1.0 GHz)			≥ 0.707	
Channel 7	1 M Ω , typical	1 mV/div	5 ns/div (500 MHz)			≥ 0.707	
		2 mV/div	2.5 ns/div (500 MHz)			≥ 0.707	
		5 mV/div	1 ns/div (500 MHz)			≥ 0.707	
		10 mV/div	1 ns/div (500 MHz)			≥ 0.707	
		50 mV/div	1 ns/div (500 MHz)			≥ 0.707	
		100 mV/div	1 ns/div (500 MHz)			≥ 0.707	
		1 V/div	1 ns/div (500 MHz)			≥ 0.707	

Table continued...

Analog Bandwidth							
Performance checks							
Bandwidth at Channel	Impedance	Vertical scale	Horizontal scale	V_{in-pp}	V_{bw-pp}	Limit	Test result Gain = V_{bw-pp}/V_{in-pp}
Channel 8	50 Ω	1 mV/div	5 ns/div (1 GHz)			≥ 0.707	
		2 mV/div	2.5 ns/div (1.0 GHz)			≥ 0.707	
		5 mV/div	1 ns/div (1.0 GHz)			≥ 0.707	
		10 mV/div	1 ns/div (1.0 GHz)			≥ 0.707	
		50 mV/div	1 ns/div (1.0 GHz)			≥ 0.707	
		100 mV/div	1 ns/div (1.0 GHz)			≥ 0.707	
		1 V/div	1 ns/div (1.0 GHz)			≥ 0.707	
Channel 8	1 M Ω , typical	1 mV/div	5 ns/div (500 MHz)			≥ 0.707	
		2 mV/div	2.5 ns/div (500 MHz)			≥ 0.707	
		5 mV/div	1 ns/div (500 MHz)			≥ 0.707	
		10 mV/div	1 ns/div (500 MHz)			≥ 0.707	
		50 mV/div	1 ns/div (500 MHz)			≥ 0.707	
		100 mV/div	1 ns/div (500 MHz)			≥ 0.707	

Table continued...

Analog Bandwidth							
Performance checks							
Bandwidth at Channel	Impedance	Vertical scale	Horizontal scale	V_{in-pp}	V_{bw-pp}	Limit	Test result Gain = V_{bw-pp}/V_{in-pp}
		1 V/div	1 ns/div (500 MHz)			≥ 0.707	
500 MHz models (MSO54B, MSO56B, MSO58B)							
Channel 1	50 Ω	1 mV/div	5 ns/div (500 MHz)			≥ 0.707	
		2 mV/div	2.5 ns/div (500 MHz)			≥ 0.707	
		5 mV/div	1 ns/div (500 MHz)			≥ 0.707	
		10 mV/div	1 ns/div (500 MHz)			≥ 0.707	
		50 mV/div	1 ns/div (500 MHz)			≥ 0.707	
		100 mV/div	1 ns/div (500 MHz)			≥ 0.707	
		1 V/div	1 ns/div (500 MHz)			≥ 0.707	
Channel 1	1 M Ω , typical	1 mV/div	5 ns/div (500 MHz)			≥ 0.707	
		2 mV/div	2.5 ns/div (500 MHz)			≥ 0.707	
		5 mV/div	1 ns/div (500 MHz)			≥ 0.707	
		10 mV/div	1 ns/div (500 MHz)			≥ 0.707	
		50 mV/div	1 ns/div			≥ 0.707	

Table continued...

Analog Bandwidth							
Performance checks							
Bandwidth at Channel	Impedance	Vertical scale	Horizontal scale	V_{in-pp}	V_{bw-pp}	Limit	Test result Gain = V_{bw-pp}/V_{in-pp}
			(500 MHz)				
		100 mV/div	1 ns/div (500 MHz)			≥ 0.707	
		1 V/div	1 ns/div (500 MHz)			≥ 0.707	
Channel 2	50 Ω	1 mV/div	5 ns/div (500 MHz)			≥ 0.707	
		2 mV/div	2.5 ns/div (500 MHz)			≥ 0.707	
		5 mV/div	1 ns/div (500 MHz)			≥ 0.707	
		10 mV/div	1 ns/div (500 MHz)			≥ 0.707	
		50 mV/div	1 ns/div (500 MHz)			≥ 0.707	
		100 mV/div	1 ns/div (500 MHz)			≥ 0.707	
		1 V/div	1 ns/div (500 MHz)			≥ 0.707	
Channel 2	1 M Ω , typical	1 mV/div	5 ns/div (500 MHz)			≥ 0.707	
		2 mV/div	2.5 ns/div (500 MHz)			≥ 0.707	
		5 mV/div	1 ns/div (500 MHz)			≥ 0.707	
		10 mV/div	1 ns/div			≥ 0.707	

Table continued...

Analog Bandwidth							
Performance checks							
Bandwidth at Channel	Impedance	Vertical scale	Horizontal scale	V_{in-pp}	V_{bw-pp}	Limit	Test result Gain = V_{bw-pp}/V_{in-pp}
			(500 MHz)				
		50 mV/div	1 ns/div (500 MHz)			≥ 0.707	
		100 mV/div	1 ns/div (500 MHz)			≥ 0.707	
		1 V/div	1 ns/div (500 MHz)			≥ 0.707	
Channel 3	50 Ω	1 mV/div	5 ns/div (500 MHz)			≥ 0.707	
		2 mV/div	2.5 ns/div (500 MHz)			≥ 0.707	
		5 mV/div	1 ns/div (500 MHz)			≥ 0.707	
		10 mV/div	1 ns/div (500 MHz)			≥ 0.707	
		50 mV/div	1 ns/div (500 MHz)			≥ 0.707	
		100 mV/div	1 ns/div (500 MHz)			≥ 0.707	
		1 V/div	1 ns/div (500 MHz)			≥ 0.707	
Channel 3	1 M Ω , typical	1 mV/div	5 ns/div (500 MHz)			≥ 0.707	
		2 mV/div	2.5 ns/div (500 MHz)			≥ 0.707	
		5 mV/div	1 ns/div			≥ 0.707	

Table continued...

Analog Bandwidth							
Performance checks							
Bandwidth at Channel	Impedance	Vertical scale	Horizontal scale	V_{in-pp}	V_{bw-pp}	Limit	Test result Gain = V_{bw-pp}/V_{in-pp}
			(500 MHz)				
		10 mV/div	1 ns/div (500 MHz)			≥ 0.707	
		50 mV/div	1 ns/div (500 MHz)			≥ 0.707	
		100 mV/div	1 ns/div (500 MHz)			≥ 0.707	
		1 V/div	1 ns/div (500 MHz)			≥ 0.707	
Channel 4	50 Ω	1 mV/div	5 ns/div (500 MHz)			≥ 0.707	
		2 mV/div	2.5 ns/div (500 MHz)			≥ 0.707	
		5 mV/div	1 ns/div (500 MHz)			≥ 0.707	
		10 mV/div	1 ns/div (500 MHz)			≥ 0.707	
		50 mV/div	1 ns/div (500 MHz)			≥ 0.707	
		100 mV/div	1 ns/div (500 MHz)			≥ 0.707	
		1 V/div	1 ns/div (500 MHz)			≥ 0.707	
Channel 4	1 M Ω , typical	1 mV/div	5 ns/div (500 MHz)			≥ 0.707	
		2 mV/div	2.5 ns/div			≥ 0.707	

Table continued...

Analog Bandwidth							
Performance checks							
Bandwidth at Channel	Impedance	Vertical scale	Horizontal scale	V_{in-pp}	V_{bw-pp}	Limit	Test result Gain = V_{bw-pp}/V_{in-pp}
			(500 MHz)				
		5 mV/div	1 ns/div (500 MHz)			≥ 0.707	
		10 mV/div	1 ns/div (500 MHz)			≥ 0.707	
		50 mV/div	1 ns/div (500 MHz)			≥ 0.707	
		100 mV/div	1 ns/div (500 MHz)			≥ 0.707	
		1 V/div	1 ns/div (500 MHz)			≥ 0.707	
500 MHz models (MSO56B, MSO58B)							
Channel 5	50 Ω	1 mV/div	5 ns/div (500 MHz)			≥ 0.707	
		2 mV/div	2.5 ns/div (500 MHz)			≥ 0.707	
		5 mV/div	1 ns/div (500 MHz)			≥ 0.707	
		10 mV/div	1 ns/div (500 MHz)			≥ 0.707	
		50 mV/div	1 ns/div (500 MHz)			≥ 0.707	
		100 mV/div	1 ns/div (500 MHz)			≥ 0.707	
		1 V/div	1 ns/div (500 MHz)			≥ 0.707	

Table continued...

Analog Bandwidth							
Performance checks							
Bandwidth at Channel	Impedance	Vertical scale	Horizontal scale	V_{in-pp}	V_{bw-pp}	Limit	Test result Gain = V_{bw-pp}/V_{in-pp}
Channel 5	1 M Ω , typical	1 mV/div	5 ns/div (500 MHz)			≥ 0.707	
		2 mV/div	2.5 ns/div (500 MHz)			≥ 0.707	
		5 mV/div	1 ns/div (500 MHz)			≥ 0.707	
		10 mV/div	1 ns/div (500 MHz)			≥ 0.707	
		50 mV/div	1 ns/div (500 MHz)			≥ 0.707	
		100 mV/div	1 ns/div (500 MHz)			≥ 0.707	
		1 V/div	1 ns/div (500 MHz)			≥ 0.707	
Channel 6	50 Ω	1 mV/div	5 ns/div (500 MHz)			≥ 0.707	
		2 mV/div	2.5 ns/div (500 MHz)			≥ 0.707	
		5 mV/div	1 ns/div (500 MHz)			≥ 0.707	
		10 mV/div	1 ns/div (500 MHz)			≥ 0.707	
		50 mV/div	1 ns/div (500 MHz)			≥ 0.707	
		100 mV/div	1 ns/div (500 MHz)			≥ 0.707	

Table continued...

Analog Bandwidth							
Performance checks							
Bandwidth at Channel	Impedance	Vertical scale	Horizontal scale	V_{in-pp}	V_{bw-pp}	Limit	Test result Gain = V_{bw-pp}/V_{in-pp}
		1 V/div	1 ns/div (500 MHz)			≥ 0.707	
Channel 6	1 M Ω , typical	1 mV/div	5 ns/div (500 MHz)			≥ 0.707	
		2 mV/div	2.5 ns/div (500 MHz)			≥ 0.707	
		5 mV/div	1 ns/div (500 MHz)			≥ 0.707	
		10 mV/div	1 ns/div (500 MHz)			≥ 0.707	
		50 mV/div	1 ns/div (500 MHz)			≥ 0.707	
		100 mV/div	1 ns/div (500 MHz)			≥ 0.707	
		1 V/div	1 ns/div (500 MHz)			≥ 0.707	
500 MHz models (MSO58B)							
Channel 7	50 Ω	1 mV/div	5 ns/div (500 MHz)			≥ 0.707	
		2 mV/div	2.5 ns/div (500 MHz)			≥ 0.707	
		5 mV/div	1 ns/div (500 MHz)			≥ 0.707	
		10 mV/div	1 ns/div (500 MHz)			≥ 0.707	
		50 mV/div	1 ns/div			≥ 0.707	

Table continued...

Analog Bandwidth							
Performance checks							
Bandwidth at Channel	Impedance	Vertical scale	Horizontal scale	V_{in-pp}	V_{bw-pp}	Limit	Test result Gain = V_{bw-pp}/V_{in-pp}
			(500 MHz)				
		100 mV/div	1 ns/div (500 MHz)			≥ 0.707	
		1 V/div	1 ns/div (500 MHz)			≥ 0.707	
Channel 7	1 M Ω , typical	1 mV/div	5 ns/div (500 MHz)			≥ 0.707	
		2 mV/div	2.5 ns/div (500 MHz)			≥ 0.707	
		5 mV/div	1 ns/div (500 MHz)			≥ 0.707	
		10 mV/div	1 ns/div (500 MHz)			≥ 0.707	
		50 mV/div	1 ns/div (500 MHz)			≥ 0.707	
		100 mV/div	1 ns/div (500 MHz)			≥ 0.707	
		1 V/div	1 ns/div (500 MHz)			≥ 0.707	
Channel 8	50 Ω	1 mV/div	5 ns/div (500 MHz)			≥ 0.707	
		2 mV/div	2.5 ns/div (500 MHz)			≥ 0.707	
		5 mV/div	1 ns/div (500 MHz)			≥ 0.707	
		10 mV/div	1 ns/div			≥ 0.707	

Table continued...

Analog Bandwidth							
Performance checks							
Bandwidth at Channel	Impedance	Vertical scale	Horizontal scale	V_{in-pp}	V_{bw-pp}	Limit	Test result Gain = V_{bw-pp}/V_{in-pp}
			(500 MHz)				
		50 mV/div	1 ns/div (500 MHz)			≥ 0.707	
		100 mV/div	1 ns/div (500 MHz)			≥ 0.707	
		1 V/div	1 ns/div (500 MHz)			≥ 0.707	
Channel 8	1 M Ω , typical	1 mV/div	5 ns/div (500 MHz)			≥ 0.707	
		2 mV/div	2.5 ns/div (500 MHz)			≥ 0.707	
		5 mV/div	1 ns/div (500 MHz)			≥ 0.707	
		10 mV/div	1 ns/div (500 MHz)			≥ 0.707	
		50 mV/div	1 ns/div (500 MHz)			≥ 0.707	
		100 mV/div	1 ns/div (500 MHz)			≥ 0.707	
		1 V/div	1 ns/div (500 MHz)			≥ 0.707	
350 MHz models (MSO54B, MSO56B, MSO58B)							
Channel 1	50 Ω	1 mV/div	5 ns/div (350 MHz)			≥ 0.707	
		2 mV/div	2.5 ns/div (350 MHz)			≥ 0.707	

Table continued...

Analog Bandwidth							
Performance checks							
Bandwidth at Channel	Impedance	Vertical scale	Horizontal scale	V_{in-pp}	V_{bw-pp}	Limit	Test result Gain = V_{bw-pp}/V_{in-pp}
		5 mV/div	1 ns/div (350 MHz)			≥ 0.707	
		10 mV/div	1 ns/div (350 MHz)			≥ 0.707	
		50 mV/div	1 ns/div (350 MHz)			≥ 0.707	
		100 mV/div	1 ns/div (350 MHz)			≥ 0.707	
		1 V/div	1 ns/div (350 MHz)			≥ 0.707	
Channel 1	1 M Ω , typical	1 mV/div	5 ns/div (350 MHz)			≥ 0.707	
		2 mV/div	2.5 ns/div (350 MHz)			≥ 0.707	
		5 mV/div	1 ns/div (350 MHz)			≥ 0.707	
		10 mV/div	1 ns/div (350 MHz)			≥ 0.707	
		50 mV/div	1 ns/div (350 MHz)			≥ 0.707	
		100 mV/div	1 ns/div (350 MHz)			≥ 0.707	
		1 V/div	1 ns/div (350 MHz)			≥ 0.707	
Channel 2	50 Ω	1 mV/div	5 ns/div (350 MHz)			≥ 0.707	

Table continued...

Analog Bandwidth							
Performance checks							
Bandwidth at Channel	Impedance	Vertical scale	Horizontal scale	V_{in-pp}	V_{bw-pp}	Limit	Test result Gain = V_{bw-pp}/V_{in-pp}
		2 mV/div	2.5 ns/div (350 MHz)			≥ 0.707	
		5 mV/div	1 ns/div (350 MHz)			≥ 0.707	
		10 mV/div	1 ns/div (350 MHz)			≥ 0.707	
		50 mV/div	1 ns/div (350 MHz)			≥ 0.707	
		100 mV/div	1 ns/div (350 MHz)			≥ 0.707	
		1 V/div	1 ns/div (350 MHz)			≥ 0.707	
Channel 2	1 M Ω , typical	1 mV/div	5 ns/div (350 MHz)			≥ 0.707	
		2 mV/div	2.5 ns/div (350 MHz)			≥ 0.707	
		5 mV/div	1 ns/div (350 MHz)			≥ 0.707	
		10 mV/div	1 ns/div (350 MHz)			≥ 0.707	
		50 mV/div	1 ns/div (350 MHz)			≥ 0.707	
		100 mV/div	1 ns/div (350 MHz)			≥ 0.707	
		1 V/div	1 ns/div (350 MHz)			≥ 0.707	

Table continued...

Analog Bandwidth							
Performance checks							
Bandwidth at Channel	Impedance	Vertical scale	Horizontal scale	V_{in-pp}	V_{bw-pp}	Limit	Test result Gain = V_{bw-pp}/V_{in-pp}
Channel 3	50 Ω	1 mV/div	5 ns/div (350 MHz)			≥ 0.707	
		2 mV/div	2.5 ns/div (350 MHz)			≥ 0.707	
		5 mV/div	1 ns/div (350 MHz)			≥ 0.707	
		10 mV/div	1 ns/div (350 MHz)			≥ 0.707	
		50 mV/div	1 ns/div (350 MHz)			≥ 0.707	
		100 mV/div	1 ns/div (350 MHz)			≥ 0.707	
		1 V/div	1 ns/div (350 MHz)			≥ 0.707	
Channel 3	1 M Ω , typical	1 mV/div	5 ns/div (350 MHz)			≥ 0.707	
		2 mV/div	2.5 ns/div (350 MHz)			≥ 0.707	
		5 mV/div	1 ns/div (350 MHz)			≥ 0.707	
		10 mV/div	1 ns/div (350 MHz)			≥ 0.707	
		50 mV/div	1 ns/div (350 MHz)			≥ 0.707	
		100 mV/div	1 ns/div (350 MHz)			≥ 0.707	

Table continued...

Analog Bandwidth							
Performance checks							
Bandwidth at Channel	Impedance	Vertical scale	Horizontal scale	V_{in-pp}	V_{bw-pp}	Limit	Test result Gain = V_{bw-pp}/V_{in-pp}
		1 V/div	1 ns/div (350 MHz)			≥ 0.707	
Channel 4	50 Ω	1 mV/div	5 ns/div (350 MHz)			≥ 0.707	
		2 mV/div	2.5 ns/div (350 MHz)			≥ 0.707	
		5 mV/div	1 ns/div (350 MHz)			≥ 0.707	
		10 mV/div	1 ns/div (350 MHz)			≥ 0.707	
		50 mV/div	1 ns/div (350 MHz)			≥ 0.707	
		100 mV/div	1 ns/div (350 MHz)			≥ 0.707	
		1 V/div	1 ns/div (350 MHz)			≥ 0.707	
Channel 4	1 M Ω , typical	1 mV/div	5 ns/div (350 MHz)			≥ 0.707	
		2 mV/div	2.5 ns/div (350 MHz)			≥ 0.707	
		5 mV/div	1 ns/div (350 MHz)			≥ 0.707	
		10 mV/div	1 ns/div (350 MHz)			≥ 0.707	
		50 mV/div	1 ns/div (350 MHz)			≥ 0.707	

Table continued...

Analog Bandwidth							
Performance checks							
Bandwidth at Channel	Impedance	Vertical scale	Horizontal scale	V_{in-pp}	V_{bw-pp}	Limit	Test result Gain = V_{bw-pp}/V_{in-pp}
		100 mV/div	1 ns/div (350 MHz)			≥ 0.707	
		1 V/div	1 ns/div (350 MHz)			≥ 0.707	

350 MHz models (MSO56B, MSO58B)							
Channel 5	50 Ω	1 mV/div	5 ns/div (350 MHz)			≥ 0.707	
		2 mV/div	2.5 ns/div (350 MHz)			≥ 0.707	
		5 mV/div	1 ns/div (350 MHz)			≥ 0.707	
		10 mV/div	1 ns/div (350 MHz)			≥ 0.707	
		50 mV/div	1 ns/div (350 MHz)			≥ 0.707	
		100 mV/div	1 ns/div (350 MHz)			≥ 0.707	
		1 V/div	1 ns/div (350 MHz)			≥ 0.707	
Channel 5	1 M Ω , typical	1 mV/div	5 ns/div (350 MHz)			≥ 0.707	
		2 mV/div	2.5 ns/div (350 MHz)			≥ 0.707	
		5 mV/div	1 ns/div (350 MHz)			≥ 0.707	
		10 mV/div	1 ns/div			≥ 0.707	

Table continued...

350 MHz models (MSO56B, MSO58B)						
			(350 MHz)			
		50 mV/div	1 ns/div (350 MHz)			≥ 0.707
		100 mV/div	1 ns/div (350 MHz)			≥ 0.707
		1 V/div	1 ns/div (350 MHz)			≥ 0.707
Channel 6	50 Ω	1 mV/div	5 ns/div (350 MHz)			≥ 0.707
		2 mV/div	2.5 ns/div (350 MHz)			≥ 0.707
		5 mV/div	1 ns/div (350 MHz)			≥ 0.707
		10 mV/div	1 ns/div (350 MHz)			≥ 0.707
		50 mV/div	1 ns/div (350 MHz)			≥ 0.707
		100 mV/div	1 ns/div (350 MHz)			≥ 0.707
		1 V/div	1 ns/div (350 MHz)			≥ 0.707
Channel 6	1 MΩ, typical	1 mV/div	5 ns/div (350 MHz)			≥ 0.707
		2 mV/div	2.5 ns/div (350 MHz)			≥ 0.707
		5 mV/div	1 ns/div (350 MHz)			≥ 0.707
		10 mV/div	1 ns/div			≥ 0.707

Table continued...

350 MHz models (MSO56B, MSO58B)							
			(350 MHz)				
		50 mV/div	1 ns/div (350 MHz)			≥ 0.707	
		100 mV/div	1 ns/div (350 MHz)			≥ 0.707	
		1 V/div	1 ns/div (350 MHz)			≥ 0.707	
350 MHz models (MSO58B)							
Channel 7	50 Ω	1 mV/div	5 ns/div (350 MHz)			≥ 0.707	
		2 mV/div	2.5 ns/div (350 MHz)			≥ 0.707	
		5 mV/div	1 ns/div (350 MHz)			≥ 0.707	
		10 mV/div	1 ns/div (350 MHz)			≥ 0.707	
		50 mV/div	1 ns/div (350 MHz)			≥ 0.707	
		100 mV/div	1 ns/div (350 MHz)			≥ 0.707	
		1 V/div	1 ns/div (350 MHz)			≥ 0.707	
Channel 7	1 MΩ, typical	1 mV/div	5 ns/div (350 MHz)			≥ 0.707	
		2 mV/div	2.5 ns/div (350 MHz)			≥ 0.707	
		5 mV/div	1 ns/div (350 MHz)			≥ 0.707	
		10 mV/div	1 ns/div			≥ 0.707	

Table continued...

350 MHz models (MSO56B, MSO58B)						
			(350 MHz)			
		50 mV/div	1 ns/div (350 MHz)			≥ 0.707
		100 mV/div	1 ns/div (350 MHz)			≥ 0.707
		1 V/div	1 ns/div (350 MHz)			≥ 0.707
Channel 8	50 Ω	1 mV/div	5 ns/div (350 MHz)			≥ 0.707
		2 mV/div	2.5 ns/div (350 MHz)			≥ 0.707
		5 mV/div	1 ns/div (350 MHz)			≥ 0.707
		10 mV/div	1 ns/div (350 MHz)			≥ 0.707
		50 mV/div	1 ns/div (350 MHz)			≥ 0.707
		100 mV/div	1 ns/div (350 MHz)			≥ 0.707
		1 V/div	1 ns/div (350 MHz)			≥ 0.707
Channel 8	1 MΩ, typical	1 mV/div	5 ns/div (350 MHz)			≥ 0.707
		2 mV/div	2.5 ns/div (350 MHz)			≥ 0.707
		5 mV/div	1 ns/div (350 MHz)			≥ 0.707
		10 mV/div	1 ns/div			≥ 0.707

Table continued...

350 MHz models (MSO56B, MSO58B)						
			(350 MHz)			
		50 mV/div	1 ns/div (350 MHz)			≥ 0.707
		100 mV/div	1 ns/div (350 MHz)			≥ 0.707
		1 V/div	1 ns/div (350 MHz)			≥ 0.707

Random Noise, sample acquisition mode test record

For bandwidth, "full" is the highest bandwidth setting you can select.

Random Noise, sample acquisition mode: 2 GHz models						
Performance checks			1 MΩ		50 Ω	
	V/div	Bandwidth	Test result (mV)	High limit (mV)	Test result (mV)	High limit (mV)
2 GHz models (MSO54B, MSO56B, MSO58B)						
Channel 1	1 mV/div	Full		0.270		0.090
		250 MHz limit		0.158		0.090
		20 MHz limit		0.086		0.040
	2 mV/div	Full		0.291		0.152
		250 MHz limit		0.158		0.114
		20 MHz limit		0.090		0.051
	5 mV/div	Full		0.315		0.456
		250 MHz limit		0.185		0.155
		20 MHz limit		0.121		0.089
	10 mV/div	Full		0.377		0.643
		250 MHz limit		0.271		0.244
		20 MHz limit		0.201		0.174
	20 mV/div	Full		0.572		1.06
		250 MHz limit		0.462		0.436
		20 MHz limit		0.373		0.347
	50 mV/div	Full		1.32		2.51
		250 MHz limit		1.11		1.06
		20 MHz limit		0.922		0.869
	100 mV/div	Full		2.75		6.15

Table continued...

Random Noise, sample acquisition mode: 2 GHz models						
Performance checks			1 M Ω		50 Ω	
	V/div	Bandwidth	Test result (mV)	High limit (mV)	Test result (mV)	High limit (mV)
	1 V/div	250 MHz limit		2.24		2.38
		20 MHz limit		1.88		1.74
		Full		28.6		39.6
		250 MHz limit		23.5		21.1
		20 MHz limit		18.7		17.4
Channel 2	1 mV/div	Full		0.270		0.090
		250 MHz limit		0.158		0.090
		20 MHz limit		0.086		0.040
	2 mV/div	Full		0.291		0.152
		250 MHz limit		0.158		0.114
		20 MHz limit		0.090		0.051
	5 mV/div	Full		0.315		0.456
		250 MHz limit		0.185		0.155
		20 MHz limit		0.121		0.089
	10 mV/div	Full		0.377		0.643
		250 MHz limit		0.271		0.244
		20 MHz limit		0.201		0.174
	20 mV/div	Full		0.572		1.06
		250 MHz limit		0.462		0.436
		20 MHz limit		0.373		0.347
	50 mV/div	Full		1.32		2.51
		250 MHz limit		1.11		1.06
		20 MHz limit		0.922		0.869
	100 mV/div	Full		2.75		6.15
		250 MHz limit		2.24		2.38
		20 MHz limit		1.88		1.74
	1 V/div	Full		28.6		39.6
		250 MHz limit		23.5		21.1
		20 MHz limit		18.7		17.4
Channel 3	1 mV/div	Full		0.270		0.090
		250 MHz limit		0.158		0.090
		20 MHz limit		0.086		0.040
	2 mV/div	Full		0.291		0.152
		250 MHz limit		0.158		0.114
		20 MHz limit		0.090		0.051

Table continued...

Random Noise, sample acquisition mode: 2 GHz models						
Performance checks			1 M Ω		50 Ω	
	V/div	Bandwidth	Test result (mV)	High limit (mV)	Test result (mV)	High limit (mV)
	5 mV/div	Full		0.315		0.456
		250 MHz limit		0.185		0.155
		20 MHz limit		0.121		0.089
	10 mV/div	Full		0.377		0.643
		250 MHz limit		0.271		0.244
		20 MHz limit		0.201		0.174
	20 mV/div	Full		0.572		1.06
		250 MHz limit		0.462		0.436
		20 MHz limit		0.373		0.347
	50 mV/div	Full		1.32		2.51
		250 MHz limit		1.11		1.06
		20 MHz limit		0.922		0.869
	100 mV/div	Full		2.75		6.15
		250 MHz limit		2.24		2.38
		20 MHz limit		1.88		1.74
1 V/div	Full		28.6		39.6	
	250 MHz limit		23.5		21.1	
	20 MHz limit		18.7		17.4	
Channel 4	1 mV/div	Full		0.270		0.090
		250 MHz limit		0.158		0.090
		20 MHz limit		0.086		0.040
	2 mV/div	Full		0.291		0.152
		250 MHz limit		0.158		0.114
		20 MHz limit		0.090		0.051
	5 mV/div	Full		0.315		0.456
		250 MHz limit		0.185		0.155
		20 MHz limit		0.121		0.089
	10 mV/div	Full		0.377		0.643
		250 MHz limit		0.271		0.244
		20 MHz limit		0.201		0.174
	20 mV/div	Full		0.572		1.06
		250 MHz limit		0.462		0.436
		20 MHz limit		0.373		0.347
50 mV/div	Full		1.32		2.51	
	250 MHz limit		1.11		1.06	

Table continued...

Random Noise, sample acquisition mode: 2 GHz models							
Performance checks			1 M Ω		50 Ω		
	V/div	Bandwidth	Test result (mV)	High limit (mV)	Test result (mV)	High limit (mV)	
		20 MHz limit		0.922		0.869	
	100 mV/div	Full		2.75		6.15	
		250 MHz limit		2.24		2.38	
		20 MHz limit		1.88		1.74	
	1 V/div	Full		28.6		39.6	
		250 MHz limit		23.5		21.1	
		20 MHz limit		18.7		17.4	
2 GHz models (MSO56B, MSO58B)							
Channel 5	1 mV/div	Full		0.270		0.090	
		250 MHz limit		0.158		0.090	
		20 MHz limit		0.086		0.040	
	2 mV/div	Full		0.291		0.152	
		250 MHz limit		0.158		0.114	
		20 MHz limit		0.090		0.051	
	5 mV/div	Full		0.315		0.456	
		250 MHz limit		0.185		0.155	
		20 MHz limit		0.121		0.089	
	10 mV/div	Full		0.377		0.643	
		250 MHz limit		0.271		0.244	
		20 MHz limit		0.201		0.174	
	20 mV/div	Full		0.572		1.06	
		250 MHz limit		0.462		0.436	
		20 MHz limit		0.373		0.347	
	50 mV/div	Full		1.32		2.51	
		250 MHz limit		1.11		1.06	
		20 MHz limit		0.922		0.869	
	100 mV/div	Full		2.75		6.15	
		250 MHz limit		2.24		2.38	
		20 MHz limit		1.88		1.74	
	1 V/div	Full		28.6		39.6	
		250 MHz limit		23.5		21.1	
		20 MHz limit		18.7		17.4	
	Channel 6	1 mV/div	Full		0.270		0.090
			250 MHz limit		0.158		0.090
			20 MHz limit		0.086		0.040

Table continued...

Random Noise, sample acquisition mode: 2 GHz models							
Performance checks			1 M Ω		50 Ω		
	V/div	Bandwidth	Test result (mV)	High limit (mV)	Test result (mV)	High limit (mV)	
	2 mV/div	Full		0.291		0.152	
		250 MHz limit		0.158		0.114	
		20 MHz limit		0.090		0.051	
	5 mV/div	Full		0.315		0.456	
		250 MHz limit		0.185		0.155	
		20 MHz limit		0.121		0.089	
	10 mV/div	Full		0.377		0.643	
		250 MHz limit		0.271		0.244	
		20 MHz limit		0.201		0.174	
	20 mV/div	Full		0.572		1.06	
		250 MHz limit		0.462		0.436	
		20 MHz limit		0.373		0.347	
	50 mV/div	Full		1.32		2.51	
		250 MHz limit		1.11		1.06	
		20 MHz limit		0.922		0.869	
	100 mV/div	Full		2.75		6.15	
		250 MHz limit		2.24		2.38	
		20 MHz limit		1.88		1.74	
	1 V/div	Full		28.6		39.6	
		250 MHz limit		23.5		21.1	
		20 MHz limit		18.7		17.4	
	2 GHz models (MSO58B)						
	Channel 7	1 mV/div	Full		0.270		0.090
			250 MHz limit		0.158		0.090
20 MHz limit				0.086		0.040	
2 mV/div		Full		0.291		0.152	
		250 MHz limit		0.158		0.114	
		20 MHz limit		0.090		0.051	
5 mV/div		Full		0.315		0.456	
		250 MHz limit		0.185		0.155	
		20 MHz limit		0.121		0.089	
10 mV/div		Full		0.377		0.643	
		250 MHz limit		0.271		0.244	
		20 MHz limit		0.201		0.174	
20 mV/div		Full		0.572		1.06	
Table continued...							

Random Noise, sample acquisition mode: 2 GHz models						
Performance checks			1 M Ω		50 Ω	
	V/div	Bandwidth	Test result (mV)	High limit (mV)	Test result (mV)	High limit (mV)
		250 MHz limit		0.462		0.436
		20 MHz limit		0.373		0.347
	50 mV/div	Full		1.32		2.51
		250 MHz limit		1.11		1.06
		20 MHz limit		0.922		0.869
	100 mV/div	Full		2.75		6.15
		250 MHz limit		2.24		2.38
		20 MHz limit		1.88		1.74
	1 V/div	Full		28.6		39.6
		250 MHz limit		23.5		21.1
		20 MHz limit		18.7		17.4
	Channel 8	1 mV/div	Full		0.270	
250 MHz limit				0.158		0.090
20 MHz limit				0.086		0.040
2 mV/div		Full		0.291		0.152
		250 MHz limit		0.158		0.114
		20 MHz limit		0.090		0.051
5 mV/div		Full		0.315		0.456
		250 MHz limit		0.185		0.155
		20 MHz limit		0.121		0.089
10 mV/div		Full		0.377		0.643
		250 MHz limit		0.271		0.244
		20 MHz limit		0.201		0.174
20 mV/div		Full		0.572		1.06
		250 MHz limit		0.462		0.436
		20 MHz limit		0.373		0.347
50 mV/div		Full		1.32		2.51
		250 MHz limit		1.11		1.06
		20 MHz limit		0.922		0.869
100 mV/div		Full		2.75		6.15
		250 MHz limit		2.24		2.38
		20 MHz limit		1.88		1.74
1 V/div		Full		28.6		39.6
		250 MHz limit		23.5		21.1
		20 MHz limit		18.7		17.4

For bandwidth, "full" is the highest bandwidth setting you can select.

Random Noise, sample acquisition mode: 1 GHz models							
Performance checks			1 M Ω		50 Ω		
	V/div	Bandwidth	Test result (mV)	High limit (mV)	Test result (mV)	High limit (mV)	
1 GHz models (MSO54B, MSO56B, MSO58B)							
Channel 1	1 mV/div	Full		0.258		0.372	
		250 MHz limit		0.158		0.153	
		20 MHz limit		0.088		0.091	
	2 mV/div	Full		0.254		0.376	
		250 MHz limit		0.158		0.164	
		20 MHz limit		0.092		0.102	
	5 mV/div	Full		0.272		0.395	
		250 MHz limit		0.185		0.201	
		20 MHz limit		0.116		0.136	
	10 mV/div	Full		0.319		0.449	
		250 MHz limit		0.251		0.272	
		20 MHz limit		0.188		0.197	
	20 mV/div	Full		0.455		0.614	
		250 MHz limit		0.422		0.435	
		20 MHz limit		0.347		0.347	
	50 mV/div	Full		1.03		1.26	
		250 MHz limit		1.00		0.982	
		20 MHz limit		0.869		0.869	
	100 mV/div	Full		2.18		2.85	
		250 MHz limit		2.06		2.09	
		20 MHz limit		1.74		1.74	
	1 V/div	Full		23.1		24.6	
		250 MHz limit		21.6		19.4	
		20 MHz limit		17.4		17.4	
	Channel 2	1 mV/div	Full		0.258		0.372
			250 MHz limit		0.158		0.153
			20 MHz limit		0.088		0.091
2 mV/div		Full		0.254		0.376	
		250 MHz limit		0.158		0.164	
		20 MHz limit		0.092		0.102	
5 mV/div		Full		0.272		0.395	
		250 MHz limit		0.185		0.201	
		20 MHz limit		0.116		0.136	

Table continued...

Random Noise, sample acquisition mode: 1 GHz models						
Performance checks			1 M Ω		50 Ω	
	V/div	Bandwidth	Test result (mV)	High limit (mV)	Test result (mV)	High limit (mV)
	10 mV/div	Full		0.319		0.449
		250 MHz limit		0.251		0.272
		20 MHz limit		0.188		0.197
	20 mV/div	Full		0.455		0.614
		250 MHz limit		0.422		0.435
		20 MHz limit		0.347		0.347
	50 mV/div	Full		1.03		1.26
		250 MHz limit		1.00		0.982
		20 MHz limit		0.869		0.869
	100 mV/div	Full		2.18		2.85
		250 MHz limit		2.06		2.09
		20 MHz limit		1.74		1.74
	1 V/div	Full		23.1		24.6
		250 MHz limit		21.6		19.4
		20 MHz limit		17.4		17.4
Channel 3	1 mV/div	Full		0.258		0.372
		250 MHz limit		0.158		0.153
		20 MHz limit		0.088		0.091
	2 mV/div	Full		0.254		0.376
		250 MHz limit		0.158		0.164
		20 MHz limit		0.092		0.102
	5 mV/div	Full		0.272		0.395
		250 MHz limit		0.185		0.201
		20 MHz limit		0.116		0.136
	10 mV/div	Full		0.319		0.449
		250 MHz limit		0.251		0.272
		20 MHz limit		0.188		0.197
	20 mV/div	Full		0.455		0.614
		250 MHz limit		0.422		0.435
		20 MHz limit		0.347		0.347
	50 mV/div	Full		1.03		1.26
		250 MHz limit		1.00		0.982
		20 MHz limit		0.869		0.869
	100 mV/div	Full		2.18		2.85
		250 MHz limit		2.06		2.09

Table continued...

Random Noise, sample acquisition mode: 1 GHz models						
Performance checks			1 M Ω		50 Ω	
	V/div	Bandwidth	Test result (mV)	High limit (mV)	Test result (mV)	High limit (mV)
		20 MHz limit		1.74		1.74
	1 V/div	Full		23.1		24.6
		250 MHz limit		21.6		19.4
		20 MHz limit		17.4		17.4
Channel 4	1 mV/div	Full		0.258		0.372
		250 MHz limit		0.158		0.153
		20 MHz limit		0.088		0.091
	2 mV/div	Full		0.254		0.376
		250 MHz limit		0.158		0.164
		20 MHz limit		0.092		0.102
	5 mV/div	Full		0.272		0.395
		250 MHz limit		0.185		0.201
		20 MHz limit		0.116		0.136
	10 mV/div	Full		0.319		0.449
		250 MHz limit		0.251		0.272
		20 MHz limit		0.188		0.197
	20 mV/div	Full		0.455		0.614
		250 MHz limit		0.422		0.435
		20 MHz limit		0.347		0.347
	50 mV/div	Full		1.03		1.26
		250 MHz limit		1.00		0.982
		20 MHz limit		0.869		0.869
	100 mV/div	Full		2.18		2.85
		250 MHz limit		2.06		2.09
		20 MHz limit		1.74		1.74
	1 V/div	Full		23.1		24.6
		250 MHz limit		21.6		19.4
		20 MHz limit		17.4		17.4
1 GHz models (MSO56B, MSO58B)						
Channel 5	1 mV/div	Full		0.258		0.372
		250 MHz limit		0.158		0.153
		20 MHz limit		0.088		0.091
	2 mV/div	Full		0.254		0.376
		250 MHz limit		0.158		0.164
		20 MHz limit		0.092		0.102

Table continued...

Random Noise, sample acquisition mode: 1 GHz models						
Performance checks			1 M Ω		50 Ω	
	V/div	Bandwidth	Test result (mV)	High limit (mV)	Test result (mV)	High limit (mV)
	5 mV/div	Full		0.272		0.395
		250 MHz limit		0.185		0.201
		20 MHz limit		0.116		0.136
	10 mV/div	Full		0.319		0.449
		250 MHz limit		0.251		0.272
		20 MHz limit		0.188		0.197
	20 mV/div	Full		0.455		0.614
		250 MHz limit		0.422		0.435
		20 MHz limit		0.347		0.347
	50 mV/div	Full		1.03		1.26
		250 MHz limit		1.00		0.982
		20 MHz limit		0.869		0.869
	100 mV/div	Full		2.18		2.85
		250 MHz limit		2.06		2.09
		20 MHz limit		1.74		1.74
1 V/div	Full		23.1		24.6	
	250 MHz limit		21.6		19.4	
	20 MHz limit		17.4		17.4	
Channel 6	1 mV/div	Full		0.258		0.372
		250 MHz limit		0.158		0.153
		20 MHz limit		0.088		0.091
	2 mV/div	Full		0.254		0.376
		250 MHz limit		0.158		0.164
		20 MHz limit		0.092		0.102
	5 mV/div	Full		0.272		0.395
		250 MHz limit		0.185		0.201
		20 MHz limit		0.116		0.136
	10 mV/div	Full		0.319		0.449
		250 MHz limit		0.251		0.272
		20 MHz limit		0.188		0.197
	20 mV/div	Full		0.455		0.614
		250 MHz limit		0.422		0.435
		20 MHz limit		0.347		0.347
50 mV/div	Full		1.03		1.26	
	250 MHz limit		1.00		0.982	

Table continued...

Random Noise, sample acquisition mode: 1 GHz models						
Performance checks			1 M Ω		50 Ω	
	V/div	Bandwidth	Test result (mV)	High limit (mV)	Test result (mV)	High limit (mV)
		20 MHz limit		0.869		0.869
	100 mV/div	Full		2.18		2.85
		250 MHz limit		2.06		2.09
		20 MHz limit		1.74		1.74
	1 V/div	Full		23.1		24.6
		250 MHz limit		21.6		19.4
		20 MHz limit		17.4		17.4
1 GHz models (MSO58B)						
Channel 7	1 mV/div	Full		0.258		0.372
		250 MHz limit		0.158		0.153
		20 MHz limit		0.088		0.091
	2 mV/div	Full		0.254		0.376
		250 MHz limit		0.158		0.164
		20 MHz limit		0.092		0.102
	5 mV/div	Full		0.272		0.395
		250 MHz limit		0.185		0.201
		20 MHz limit		0.116		0.136
	10 mV/div	Full		0.319		0.449
		250 MHz limit		0.251		0.272
		20 MHz limit		0.188		0.197
	20 mV/div	Full		0.455		0.614
		250 MHz limit		0.422		0.435
		20 MHz limit		0.347		0.347
	50 mV/div	Full		1.03		1.26
		250 MHz limit		1.00		0.982
		20 MHz limit		0.869		0.869
	100 mV/div	Full		2.18		2.85
		250 MHz limit		2.06		2.09
		20 MHz limit		1.74		1.74
1 V/div	Full		23.1		24.6	
	250 MHz limit		21.6		19.4	
	20 MHz limit		17.4		17.4	
Channel 8	1 mV/div	Full		0.258		0.372
		250 MHz limit		0.158		0.153
		20 MHz limit		0.088		0.091

Table continued...

Random Noise, sample acquisition mode: 1 GHz models						
Performance checks			1 M Ω		50 Ω	
	V/div	Bandwidth	Test result (mV)	High limit (mV)	Test result (mV)	High limit (mV)
	2 mV/div	Full		0.254		0.376
		250 MHz limit		0.158		0.164
		20 MHz limit		0.092		0.102
	5 mV/div	Full		0.272		0.395
		250 MHz limit		0.185		0.201
		20 MHz limit		0.116		0.136
	10 mV/div	Full		0.319		0.449
		250 MHz limit		0.251		0.272
		20 MHz limit		0.188		0.197
	20 mV/div	Full		0.455		0.614
		250 MHz limit		0.422		0.435
		20 MHz limit		0.347		0.347
	50 mV/div	Full		1.03		1.26
		250 MHz limit		1.00		0.982
		20 MHz limit		0.869		0.869
	100 mV/div	Full		2.18		2.85
		250 MHz limit		2.06		2.09
		20 MHz limit		1.74		1.74
1 V/div	Full		23.1		24.6	
	250 MHz limit		21.6		19.4	
	20 MHz limit		17.4		17.4	

For bandwidth, "full" is the highest bandwidth setting you can select.

Random Noise, sample acquisition mode: 500 MHz models						
Performance checks			1 M Ω		50 Ω	
	V/div	Bandwidth	Test result (mV)	High limit (mV)	Test result (mV)	High limit (mV)
500 MHz models (MSO54B, MSO56B, MSO58B)						
Channel 1	1 mV/div	Full		0.258		0.253
		250 MHz limit		0.158		0.153
		20 MHz limit		0.088		0.091
	2 mV/div	Full		0.254		0.262
		250 MHz limit		0.158		0.164
		20 MHz limit		0.092		0.102
	5 mV/div	Full		0.272		0.292
		250 MHz limit		0.185		0.201

Table continued...

Random Noise, sample acquisition mode: 500 MHz models						
Performance checks			1 M Ω		50 Ω	
	V/div	Bandwidth	Test result (mV)	High limit (mV)	Test result (mV)	High limit (mV)
	10 mV/div	20 MHz limit		0.116		0.136
		Full		0.319		0.359
		250 MHz limit		0.251		0.272
	20 mV/div	20 MHz limit		0.188		0.197
		Full		0.455		0.529
		250 MHz limit		0.422		0.435
	50 mV/div	20 MHz limit		0.347		0.347
		Full		1.03		1.14
		250 MHz limit		1.00		0.982
	100 mV/div	20 MHz limit		0.869		0.869
		Full		2.18		2.5
		250 MHz limit		2.06		2.09
	1 V/div	20 MHz limit		1.74		1.74
		Full		23.1		22.4
		250 MHz limit		21.6		19.4
Channel 2	1 mV/div	20 MHz limit		17.4		17.4
		Full		0.258		0.253
		250 MHz limit		0.158		0.153
	2 mV/div	20 MHz limit		0.088		0.091
		Full		0.254		0.262
		250 MHz limit		0.158		0.164
	5 mV/div	20 MHz limit		0.092		0.102
		Full		0.272		0.292
		250 MHz limit		0.185		0.201
	10 mV/div	20 MHz limit		0.116		0.136
		Full		0.319		0.359
		250 MHz limit		0.251		0.272
	20 mV/div	20 MHz limit		0.188		0.197
		Full		0.455		0.529
		250 MHz limit		0.422		0.435
	50 mV/div	20 MHz limit		0.347		0.347
		Full		1.03		1.14
		250 MHz limit		1.00		0.982
	100 mV/div	20 MHz limit		0.869		0.869
		Full		2.18		2.5

Table continued...

Random Noise, sample acquisition mode: 500 MHz models						
Performance checks			1 M Ω		50 Ω	
	V/div	Bandwidth	Test result (mV)	High limit (mV)	Test result (mV)	High limit (mV)
	1 V/div	250 MHz limit		2.06		2.09
		20 MHz limit		1.74		1.74
		Full		23.1		22.4
		250 MHz limit		21.6		19.4
		20 MHz limit		17.4		17.4
Channel 3	1 mV/div	Full		0.258		0.253
		250 MHz limit		0.158		0.153
		20 MHz limit		0.088		0.091
	2 mV/div	Full		0.254		0.262
		250 MHz limit		0.158		0.164
		20 MHz limit		0.092		0.102
	5 mV/div	Full		0.272		0.292
		250 MHz limit		0.185		0.201
		20 MHz limit		0.116		0.136
	10 mV/div	Full		0.319		0.359
		250 MHz limit		0.251		0.272
		20 MHz limit		0.188		0.197
	20 mV/div	Full		0.455		0.529
		250 MHz limit		0.422		0.435
		20 MHz limit		0.347		0.347
	50 mV/div	Full		1.03		1.14
		250 MHz limit		1.00		0.982
		20 MHz limit		0.869		0.869
	100 mV/div	Full		2.18		2.5
		250 MHz limit		2.06		2.09
		20 MHz limit		1.74		1.74
	1 V/div	Full		23.1		22.4
		250 MHz limit		21.6		19.4
		20 MHz limit		17.4		17.4
Channel 4	1 mV/div	Full		0.258		0.253
		250 MHz limit		0.158		0.153
		20 MHz limit		0.088		0.091
	2 mV/div	Full		0.254		0.262
		250 MHz limit		0.158		0.164
		20 MHz limit		0.092		0.102

Table continued...

Random Noise, sample acquisition mode: 500 MHz models						
Performance checks			1 M Ω		50 Ω	
	V/div	Bandwidth	Test result (mV)	High limit (mV)	Test result (mV)	High limit (mV)
	5 mV/div	Full		0.272		0.292
		250 MHz limit		0.185		0.201
		20 MHz limit		0.116		0.136
	10 mV/div	Full		0.319		0.359
		250 MHz limit		0.251		0.272
		20 MHz limit		0.188		0.197
	20 mV/div	Full		0.455		0.529
		250 MHz limit		0.422		0.435
		20 MHz limit		0.347		0.347
	50 mV/div	Full		1.03		1.14
		250 MHz limit		1.00		0.982
		20 MHz limit		0.869		0.869
	100 mV/div	Full		2.18		2.5
		250 MHz limit		2.06		2.09
		20 MHz limit		1.74		1.74
	1 V/div	Full		23.1		22.4
		250 MHz limit		21.6		19.4
		20 MHz limit		17.4		17.4
500 MHz models (MSO56B, MSO58B)						
Channel 5	1 mV/div	Full		0.258		0.253
		250 MHz limit		0.158		0.153
		20 MHz limit		0.088		0.091
	2 mV/div	Full		0.254		0.262
		250 MHz limit		0.158		0.164
		20 MHz limit		0.092		0.102
	5 mV/div	Full		0.272		0.292
		250 MHz limit		0.185		0.201
		20 MHz limit		0.116		0.136
	10 mV/div	Full		0.319		0.359
		250 MHz limit		0.251		0.272
		20 MHz limit		0.188		0.197
	20 mV/div	Full		0.455		0.529
		250 MHz limit		0.422		0.435
		20 MHz limit		0.347		0.347
	50 mV/div	Full		1.03		1.14

Table continued...

Random Noise, sample acquisition mode: 500 MHz models						
Performance checks			1 M Ω		50 Ω	
	V/div	Bandwidth	Test result (mV)	High limit (mV)	Test result (mV)	High limit (mV)
		250 MHz limit		1.00		0.982
		20 MHz limit		0.869		0.869
	100 mV/div	Full		2.18		2.5
		250 MHz limit		2.06		2.09
		20 MHz limit		1.74		1.74
	1 V/div	Full		23.1		22.4
		250 MHz limit		21.6		19.4
		20 MHz limit		17.4		17.4
	Channel 6	1 mV/div	Full		0.258	
250 MHz limit				0.158		0.153
20 MHz limit				0.088		0.091
2 mV/div		Full		0.254		0.262
		250 MHz limit		0.158		0.164
		20 MHz limit		0.092		0.102
5 mV/div		Full		0.272		0.292
		250 MHz limit		0.185		0.201
		20 MHz limit		0.116		0.136
10 mV/div		Full		0.319		0.359
		250 MHz limit		0.251		0.272
		20 MHz limit		0.188		0.197
20 mV/div		Full		0.455		0.529
		250 MHz limit		0.422		0.435
		20 MHz limit		0.347		0.347
50 mV/div		Full		1.03		1.14
		250 MHz limit		1.00		0.982
		20 MHz limit		0.869		0.869
100 mV/div		Full		2.18		2.5
		250 MHz limit		2.06		2.09
		20 MHz limit		1.74		1.74
1 V/div		Full		23.1		22.4
		250 MHz limit		21.6		19.4
		20 MHz limit		17.4		17.4
500 MHz models (MSO58B)						
Channel 7	1 mV/div	Full		0.258		0.253
		250 MHz limit		0.158		0.153
Table continued...						

Random Noise, sample acquisition mode: 500 MHz models						
Performance checks			1 M Ω		50 Ω	
	V/div	Bandwidth	Test result (mV)	High limit (mV)	Test result (mV)	High limit (mV)
	2 mV/div	20 MHz limit		0.088		0.091
		Full		0.254		0.262
		250 MHz limit		0.158		0.164
	5 mV/div	20 MHz limit		0.092		0.102
		Full		0.272		0.292
		250 MHz limit		0.185		0.201
	10 mV/div	20 MHz limit		0.116		0.136
		Full		0.319		0.359
		250 MHz limit		0.251		0.272
	20 mV/div	20 MHz limit		0.188		0.197
		Full		0.455		0.529
		250 MHz limit		0.422		0.435
	50 mV/div	20 MHz limit		0.347		0.347
		Full		1.03		1.14
		250 MHz limit		1.00		0.982
	100 mV/div	20 MHz limit		0.869		0.869
		Full		2.18		2.5
		250 MHz limit		2.06		2.09
	1 V/div	20 MHz limit		1.74		1.74
		Full		23.1		22.4
		250 MHz limit		21.6		19.4
Channel 8	1 mV/div	20 MHz limit		17.4		17.4
		Full		0.258		0.253
		250 MHz limit		0.158		0.153
	2 mV/div	20 MHz limit		0.088		0.091
		Full		0.254		0.262
		250 MHz limit		0.158		0.164
	5 mV/div	20 MHz limit		0.092		0.102
		Full		0.272		0.292
		250 MHz limit		0.185		0.201
	10 mV/div	20 MHz limit		0.116		0.136
		Full		0.319		0.359
		250 MHz limit		0.251		0.272
	20 mV/div	20 MHz limit		0.188		0.197
		Full		0.455		0.529

Table continued...

Random Noise, sample acquisition mode: 500 MHz models						
Performance checks			1 M Ω		50 Ω	
	V/div	Bandwidth	Test result (mV)	High limit (mV)	Test result (mV)	High limit (mV)
	50 mV/div	250 MHz limit		0.422		0.435
		20 MHz limit		0.347		0.347
		Full		1.03		1.14
		250 MHz limit		1.00		0.982
		20 MHz limit		0.869		0.869
		100 mV/div	Full		2.18	
	100 mV/div	250 MHz limit		2.06		2.09
		20 MHz limit		1.74		1.74
		1 V/div	Full		23.1	
	1 V/div	250 MHz limit		21.6		19.4
		20 MHz limit		17.4		17.4

For bandwidth, "full" is the highest bandwidth setting you can select.

Random Noise, sample acquisition mode: 350 MHz models						
Performance checks			1 M Ω		50 Ω	
	V/div	Bandwidth	Test result (mV)	High limit (mV)	Test result (mV)	High limit (mV)
350 MHz models (MSO54B, MSO56B, MSO58B)						
Channel 1	1 mV/div	Full		0.188		0.181
		250 MHz limit		0.158		0.153
		20 MHz limit		0.088		0.091
	2 mV/div	Full		0.193		0.190
		250 MHz limit		0.158		0.164
		20 MHz limit		0.092		0.102
	5 mV/div	Full		0.207		0.222
		250 MHz limit		0.185		0.201
		20 MHz limit		0.116		0.136
	10 mV/div	Full		0.264		0.284
		250 MHz limit		0.251		0.272
		20 MHz limit		0.188		0.197
	20 mV/div	Full		0.422		0.436
		250 MHz limit		0.422		0.435
		20 MHz limit		0.347		0.347
	50 mV/div	Full		0.898		0.962
		250 MHz limit		1.00		0.982
		20 MHz limit		0.869		0.869

Table continued...

Random Noise, sample acquisition mode: 350 MHz models							
Performance checks			1 M Ω		50 Ω		
	V/div	Bandwidth	Test result (mV)	High limit (mV)	Test result (mV)	High limit (mV)	
	100 mV/div	Full		1.91		2.08	
		250 MHz limit		2.06		2.09	
		20 MHz limit		1.74		1.74	
	1 V/div	Full		21.1		18.9	
		250 MHz limit		21.6		19.4	
		20 MHz limit		17.4		17.4	
	Channel 2	1 mV/div	Full		0.188		0.181
			250 MHz limit		0.158		0.153
			20 MHz limit		0.088		0.091
2 mV/div		Full		0.193		0.190	
		250 MHz limit		0.158		0.164	
		20 MHz limit		0.092		0.102	
5 mV/div		Full		0.207		0.222	
		250 MHz limit		0.185		0.201	
		20 MHz limit		0.116		0.136	
10 mV/div		Full		0.264		0.284	
		250 MHz limit		0.251		0.272	
		20 MHz limit		0.188		0.197	
20 mV/div		Full		0.422		0.436	
		250 MHz limit		0.422		0.435	
		20 MHz limit		0.347		0.347	
50 mV/div		Full		0.898		0.962	
		250 MHz limit		1.00		0.982	
		20 MHz limit		0.869		0.869	
100 mV/div		Full		1.91		2.08	
		250 MHz limit		2.06		2.09	
		20 MHz limit		1.74		1.74	
1 V/div		Full		21.1		18.9	
		250 MHz limit		21.6		19.4	
		20 MHz limit		17.4		17.4	
Channel 3		1 mV/div	Full		0.188		0.181
			250 MHz limit		0.158		0.153
			20 MHz limit		0.088		0.091
	2 mV/div	Full		0.193		0.190	
		250 MHz limit		0.158		0.164	

Table continued...

Random Noise, sample acquisition mode: 350 MHz models						
Performance checks			1 M Ω		50 Ω	
	V/div	Bandwidth	Test result (mV)	High limit (mV)	Test result (mV)	High limit (mV)
	5 mV/div	20 MHz limit		0.092		0.102
		Full		0.207		0.222
		250 MHz limit		0.185		0.201
	10 mV/div	20 MHz limit		0.116		0.136
		Full		0.264		0.284
		250 MHz limit		0.251		0.272
	20 mV/div	20 MHz limit		0.188		0.197
		Full		0.422		0.436
		250 MHz limit		0.422		0.435
	50 mV/div	20 MHz limit		0.347		0.347
		Full		0.898		0.962
		250 MHz limit		1.00		0.982
	100 mV/div	20 MHz limit		0.869		0.869
		Full		1.91		2.08
		250 MHz limit		2.06		2.09
	1 V/div	20 MHz limit		1.74		1.74
		Full		21.1		18.9
		250 MHz limit		21.6		19.4
Channel 4	1 mV/div	20 MHz limit		17.4		17.4
		Full		0.188		0.181
		250 MHz limit		0.158		0.153
	2 mV/div	20 MHz limit		0.088		0.091
		Full		0.193		0.190
		250 MHz limit		0.158		0.164
	5 mV/div	20 MHz limit		0.092		0.102
		Full		0.207		0.222
		250 MHz limit		0.185		0.201
	10 mV/div	20 MHz limit		0.116		0.136
		Full		0.264		0.284
		250 MHz limit		0.251		0.272
	20 mV/div	20 MHz limit		0.188		0.197
		Full		0.422		0.436
		250 MHz limit		0.422		0.435
	50 mV/div	20 MHz limit		0.347		0.347
		Full		0.898		0.962
		250 MHz limit		1.00		0.982

Table continued...

Random Noise, sample acquisition mode: 350 MHz models							
Performance checks			1 M Ω		50 Ω		
	V/div	Bandwidth	Test result (mV)	High limit (mV)	Test result (mV)	High limit (mV)	
	100 mV/div	250 MHz limit		1.00		0.982	
		20 MHz limit		0.869		0.869	
		Full		1.91		2.08	
	1 V/div	250 MHz limit		2.06		2.09	
		20 MHz limit		1.74		1.74	
		Full		21.1		18.9	
			250 MHz limit		21.6		19.4
			20 MHz limit		17.4		17.4
			Full				
350 MHz models (MSO56B, MSO58B)							
Channel 5	1 mV/div	Full		0.188		0.181	
		250 MHz limit		0.158		0.153	
		20 MHz limit		0.088		0.091	
	2 mV/div	Full		0.193		0.190	
		250 MHz limit		0.158		0.164	
		20 MHz limit		0.092		0.102	
	5 mV/div	Full		0.207		0.222	
		250 MHz limit		0.185		0.201	
		20 MHz limit		0.116		0.136	
	10 mV/div	Full		0.264		0.284	
		250 MHz limit		0.251		0.272	
		20 MHz limit		0.188		0.197	
	20 mV/div	Full		0.422		0.436	
		250 MHz limit		0.422		0.435	
		20 MHz limit		0.347		0.347	
	50 mV/div	Full		0.898		0.962	
		250 MHz limit		1.00		0.982	
		20 MHz limit		0.869		0.869	
	100 mV/div	Full		1.91		2.08	
		250 MHz limit		2.06		2.09	
		20 MHz limit		1.74		1.74	
	1 V/div	Full		21.1		18.9	
		250 MHz limit		21.6		19.4	
		20 MHz limit		17.4		17.4	
Channel 6	1 mV/div	Full		0.188		0.181	
		250 MHz limit		0.158		0.153	

Table continued...

Random Noise, sample acquisition mode: 350 MHz models						
Performance checks			1 M Ω		50 Ω	
	V/div	Bandwidth	Test result (mV)	High limit (mV)	Test result (mV)	High limit (mV)
		20 MHz limit		0.088		0.091
	2 mV/div	Full		0.193		0.190
		250 MHz limit		0.158		0.164
		20 MHz limit		0.092		0.102
	5 mV/div	Full		0.207		0.222
		250 MHz limit		0.185		0.201
		20 MHz limit		0.116		0.136
	10 mV/div	Full		0.264		0.284
		250 MHz limit		0.251		0.272
		20 MHz limit		0.188		0.197
	20 mV/div	Full		0.422		0.436
		250 MHz limit		0.422		0.435
		20 MHz limit		0.347		0.347
	50 mV/div	Full		0.898		0.962
		250 MHz limit		1.00		0.982
		20 MHz limit		0.869		0.869
	100 mV/div	Full		1.91		2.08
		250 MHz limit		2.06		2.09
		20 MHz limit		1.74		1.74
	1 V/div	Full		21.1		18.9
		250 MHz limit		21.6		19.4
		20 MHz limit		17.4		17.4
350 MHz models (MSO58B)						
Channel 7	1 mV/div	Full		0.188		0.181
		250 MHz limit		0.158		0.153
		20 MHz limit		0.088		0.091
	2 mV/div	Full		0.193		0.190
		250 MHz limit		0.158		0.164
		20 MHz limit		0.092		0.102
	5 mV/div	Full		0.207		0.222
		250 MHz limit		0.185		0.201
		20 MHz limit		0.116		0.136
	10 mV/div	Full		0.264		0.284
		250 MHz limit		0.251		0.272
		20 MHz limit		0.188		0.197
Table continued...						

Random Noise, sample acquisition mode: 350 MHz models						
Performance checks			1 M Ω		50 Ω	
	V/div	Bandwidth	Test result (mV)	High limit (mV)	Test result (mV)	High limit (mV)
	20 mV/div	Full		0.422		0.436
		250 MHz limit		0.422		0.435
		20 MHz limit		0.347		0.347
	50 mV/div	Full		0.898		0.962
		250 MHz limit		1.00		0.982
		20 MHz limit		0.869		0.869
	100 mV/div	Full		1.91		2.08
		250 MHz limit		2.06		2.09
		20 MHz limit		1.74		1.74
	1 V/div	Full		21.1		18.9
		250 MHz limit		21.6		19.4
		20 MHz limit		17.4		17.4
Channel 8	1 mV/div	Full		0.188		0.181
		250 MHz limit		0.158		0.153
		20 MHz limit		0.088		0.091
	2 mV/div	Full		0.193		0.190
		250 MHz limit		0.158		0.164
		20 MHz limit		0.092		0.102
	5 mV/div	Full		0.207		0.222
		250 MHz limit		0.185		0.201
		20 MHz limit		0.116		0.136
	10 mV/div	Full		0.264		0.284
		250 MHz limit		0.251		0.272
		20 MHz limit		0.188		0.197
	20 mV/div	Full		0.422		0.436
		250 MHz limit		0.422		0.435
		20 MHz limit		0.347		0.347
	50 mV/div	Full		0.898		0.962
		250 MHz limit		1.00		0.982
		20 MHz limit		0.869		0.869
	100 mV/div	Full		1.91		2.08
		250 MHz limit		2.06		2.09
		20 MHz limit		1.74		1.74
	1 V/div	Full		21.1		18.9
		250 MHz limit		21.6		19.4

Table continued...

Random Noise, sample acquisition mode: 350 MHz models						
Performance checks			1 M Ω		50 Ω	
	V/div	Bandwidth	Test result (mV)	High limit (mV)	Test result (mV)	High limit (mV)
		20 MHz limit		17.4		17.4

Random Noise, High Res mode test record

For bandwidth, "full" is the highest bandwidth setting you can select.

Random Noise, High Res mode: 2 GHz models							
Performance checks			1 M Ω		50 Ω		
	V/div	Bandwidth	Test result (mV)	High limit (mV)	Test result (mV)	High limit (mV)	
2 GHz models (MSO54B, MSO56B, MSO58B)							
Channel 1	1 mV/div	Full		0.269		0.087	
		250 MHz limit		0.152		0.087	
		20 MHz limit		0.084		0.035	
	2 mV/div	Full		0.290		0.125	
		250 MHz limit		0.152		0.100	
		20 MHz limit		0.084		0.037	
	5 mV/div	Full		0.308		0.261	
		250 MHz limit		0.172		0.140	
		20 MHz limit		0.089		0.048	
	10 mV/div	Full		0.359		0.356	
		250 MHz limit		0.224		0.191	
		20 MHz limit		0.108		0.073	
	20 mV/div	Full		0.538		0.607	
		250 MHz limit		0.360		0.325	
		20 MHz limit		0.162		0.137	
	50 mV/div	Full		1.19		1.43	
		250 MHz limit		0.803		0.763	
		20 MHz limit		0.351		0.327	
	100 mV/div	Full		2.45		3.56	
		250 MHz limit		1.76		1.91	
		20 MHz limit		0.780		0.779	
	1 V/div	Full		26.3		23.8	
		250 MHz limit		18.9		14.0	
		20 MHz limit		8.46		6.05	
	Channel 2	1 mV/div	Full		0.269		0.087
			250 MHz limit		0.152		0.087
			20 MHz limit		0.084		0.035
2 mV/div		Full		0.290		0.125	
		250 MHz limit		0.152		0.100	
		20 MHz limit		0.084		0.037	
5 mV/div		Full		0.308		0.261	
		250 MHz limit		0.172		0.140	

Table continued...

Random Noise, High Res mode: 2 GHz models							
Performance checks			1 M Ω		50 Ω		
	V/div	Bandwidth	Test result (mV)	High limit (mV)	Test result (mV)	High limit (mV)	
	10 mV/div	20 MHz limit		0.089		0.048	
		Full		0.359		0.356	
		250 MHz limit		0.224		0.191	
	20 mV/div	20 MHz limit		0.108		0.073	
		Full		0.538		0.607	
		250 MHz limit		0.360		0.325	
	50 mV/div	20 MHz limit		0.162		0.137	
		Full		1.19		1.43	
		250 MHz limit		0.803		0.763	
	100 mV/div	20 MHz limit		0.351		0.327	
		Full		2.45		3.56	
		250 MHz limit		1.76		1.91	
	1 V/div	20 MHz limit		0.780		0.779	
		Full		26.3		23.8	
		250 MHz limit		18.9		14.0	
	Channel 3	1 mV/div	20 MHz limit		8.46		6.05
			Full		0.269		0.087
			250 MHz limit		0.152		0.087
2 mV/div		20 MHz limit		0.084		0.035	
		Full		0.290		0.125	
		250 MHz limit		0.152		0.100	
5 mV/div		20 MHz limit		0.084		0.037	
		Full		0.308		0.261	
		250 MHz limit		0.172		0.140	
10 mV/div		20 MHz limit		0.089		0.048	
		Full		0.359		0.356	
		250 MHz limit		0.224		0.191	
20 mV/div		20 MHz limit		0.108		0.073	
		Full		0.538		0.607	
		250 MHz limit		0.360		0.325	
50 mV/div		20 MHz limit		0.162		0.137	
		Full		1.19		1.43	
		250 MHz limit		0.803		0.763	
100 mV/div	20 MHz limit		0.351		0.327		
	Full		2.45		3.56		

Table continued...

Random Noise, High Res mode: 2 GHz models						
Performance checks			1 M Ω		50 Ω	
	V/div	Bandwidth	Test result (mV)	High limit (mV)	Test result (mV)	High limit (mV)
		250 MHz limit		1.76		1.91
		20 MHz limit		0.780		0.779
	1 V/div	Full		26.3		23.8
		250 MHz limit		18.9		14.0
		20 MHz limit		8.46		6.05
Channel 4	1 mV/div	Full		0.269		0.087
		250 MHz limit		0.152		0.087
		20 MHz limit		0.084		0.035
	2 mV/div	Full		0.290		0.125
		250 MHz limit		0.152		0.100
		20 MHz limit		0.084		0.037
	5 mV/div	Full		0.308		0.261
		250 MHz limit		0.172		0.140
		20 MHz limit		0.089		0.048
	10 mV/div	Full		0.359		0.356
		250 MHz limit		0.224		0.191
		20 MHz limit		0.108		0.073
	20 mV/div	Full		0.538		0.607
		250 MHz limit		0.360		0.325
		20 MHz limit		0.162		0.137
	50 mV/div	Full		1.19		1.43
		250 MHz limit		0.803		0.763
		20 MHz limit		0.351		0.327
	100 mV/div	Full		2.45		3.56
		250 MHz limit		1.76		1.91
		20 MHz limit		0.780		0.779
	1 V/div	Full		26.3		23.8
		250 MHz limit		18.9		14.0
		20 MHz limit		8.46		6.05
2 GHz models (MSO56B, MSO58B)						
Channel 5	1 mV/div	Full		0.269		0.087
		250 MHz limit		0.152		0.087
		20 MHz limit		0.084		0.035
	2 mV/div	Full		0.290		0.125
		250 MHz limit		0.152		0.100

Table continued...

Random Noise, High Res mode: 2 GHz models							
Performance checks			1 M Ω		50 Ω		
	V/div	Bandwidth	Test result (mV)	High limit (mV)	Test result (mV)	High limit (mV)	
	5 mV/div	20 MHz limit		0.084		0.037	
		Full		0.308		0.261	
		250 MHz limit		0.172		0.140	
	10 mV/div	20 MHz limit		0.089		0.048	
		Full		0.359		0.356	
		250 MHz limit		0.224		0.191	
	20 mV/div	20 MHz limit		0.108		0.073	
		Full		0.538		0.607	
		250 MHz limit		0.360		0.325	
	50 mV/div	20 MHz limit		0.162		0.137	
		Full		1.19		1.43	
		250 MHz limit		0.803		0.763	
	100 mV/div	20 MHz limit		0.351		0.327	
		Full		2.45		3.56	
		250 MHz limit		1.76		1.91	
	1 V/div	20 MHz limit		0.780		0.779	
		Full		26.3		23.8	
		250 MHz limit		18.9		14.0	
	Channel 6	1 mV/div	20 MHz limit		8.46		6.05
			Full		0.269		0.087
			250 MHz limit		0.152		0.087
		2 mV/div	20 MHz limit		0.084		0.035
			Full		0.290		0.125
			250 MHz limit		0.152		0.100
5 mV/div		20 MHz limit		0.084		0.037	
		Full		0.308		0.261	
		250 MHz limit		0.172		0.140	
10 mV/div		20 MHz limit		0.089		0.048	
		Full		0.359		0.356	
		250 MHz limit		0.224		0.191	
20 mV/div		20 MHz limit		0.108		0.073	
		Full		0.538		0.607	
		250 MHz limit		0.360		0.325	
50 mV/div		20 MHz limit		0.162		0.137	
		Full		1.19		1.43	
		250 MHz limit		0.803		0.763	

Table continued...

Random Noise, High Res mode: 2 GHz models							
Performance checks			1 M Ω		50 Ω		
	V/div	Bandwidth	Test result (mV)	High limit (mV)	Test result (mV)	High limit (mV)	
		250 MHz limit		0.803		0.763	
		20 MHz limit		0.351		0.327	
		Full		2.45		3.56	
	100 mV/div	250 MHz limit		1.76		1.91	
		20 MHz limit		0.780		0.779	
		Full		26.3		23.8	
	1 V/div	250 MHz limit		18.9		14.0	
		20 MHz limit		8.46		6.05	
		Full					
2 GHz models (MSO58B)							
Channel 7	1 mV/div	Full		0.269		0.087	
		250 MHz limit		0.152		0.087	
		20 MHz limit		0.084		0.035	
	2 mV/div	Full		0.290		0.125	
		250 MHz limit		0.152		0.100	
		20 MHz limit		0.084		0.037	
	5 mV/div	Full		0.308		0.261	
		250 MHz limit		0.172		0.140	
		20 MHz limit		0.089		0.048	
	10 mV/div	Full		0.359		0.356	
		250 MHz limit		0.224		0.191	
		20 MHz limit		0.108		0.073	
	20 mV/div	Full		0.538		0.607	
		250 MHz limit		0.360		0.325	
		20 MHz limit		0.162		0.137	
	50 mV/div	Full		1.19		1.43	
		250 MHz limit		0.803		0.763	
		20 MHz limit		0.351		0.327	
	100 mV/div	Full		2.45		3.56	
		250 MHz limit		1.76		1.91	
		20 MHz limit		0.780		0.779	
	1 V/div	Full		26.3		23.8	
		250 MHz limit		18.9		14.0	
		20 MHz limit		8.46		6.05	
	Channel 8	1 mV/div	Full		0.269		0.087
			250 MHz limit		0.152		0.087

Table continued...

Random Noise, High Res mode: 2 GHz models						
Performance checks			1 M Ω		50 Ω	
	V/div	Bandwidth	Test result (mV)	High limit (mV)	Test result (mV)	High limit (mV)
		20 MHz limit		0.084		0.035
	2 mV/div	Full		0.290		0.125
		250 MHz limit		0.152		0.100
		20 MHz limit		0.084		0.037
	5 mV/div	Full		0.308		0.261
		250 MHz limit		0.172		0.140
		20 MHz limit		0.089		0.048
	10 mV/div	Full		0.359		0.356
		250 MHz limit		0.224		0.191
		20 MHz limit		0.108		0.073
	20 mV/div	Full		0.538		0.607
		250 MHz limit		0.360		0.325
		20 MHz limit		0.162		0.137
	50 mV/div	Full		1.19		1.43
		250 MHz limit		0.803		0.763
		20 MHz limit		0.351		0.327
	100 mV/div	Full		2.45		3.56
		250 MHz limit		1.76		1.91
		20 MHz limit		0.780		0.779
	1 V/div	Full		26.3		23.8
		250 MHz limit		18.9		14.0
		20 MHz limit		8.46		6.05

For bandwidth, "full" is the highest bandwidth setting you can select.

Random Noise, High Res mode: 1 GHz models						
Performance checks			1 M Ω		50 Ω	
	V/div	Bandwidth	Test result (mV)	High limit (mV)	Test result (mV)	High limit (mV)
1 GHz models (MSO54B, MSO56B, MSO58B)						
Channel 1	1 mV/div	Full		0.245		0.329
		250 MHz limit		0.153		0.152
		20 MHz limit		0.084		0.091
	2 mV/div	Full		0.251		0.330
		250 MHz limit		0.156		0.157
		20 MHz limit		0.085		0.091
	5 mV/div	Full		0.254		0.339

Table continued...

Random Noise, High Res mode: 1 GHz models						
Performance checks			1 M Ω		50 Ω	
	V/div	Bandwidth	Test result (mV)	High limit (mV)	Test result (mV)	High limit (mV)
		250 MHz limit		0.169		0.172
		20 MHz limit		0.090		0.094
	10 mV/div	Full		0.274		0.367
		250 MHz limit		0.200		0.205
		20 MHz limit		0.101		0.103
	20 mV/div	Full		0.348		0.462
		250 MHz limit		0.289		0.288
		20 MHz limit		0.135		0.132
	50 mV/div	Full		0.634		0.876
		250 MHz limit		0.621		0.595
		20 MHz limit		0.268		0.254
	100 mV/div	Full		1.51		2.09
		250 MHz limit		1.36		1.34
		20 MHz limit		0.615		0.601
	1 V/div	Full		17.6		16.8
250 MHz limit			14.4		11.6	
20 MHz limit			7.08		4.88	
Channel 2	1 mV/div	Full		0.245		0.329
		250 MHz limit		0.153		0.152
		20 MHz limit		0.084		0.091
	2 mV/div	Full		0.251		0.330
		250 MHz limit		0.156		0.157
		20 MHz limit		0.085		0.091
	5 mV/div	Full		0.254		0.339
		250 MHz limit		0.169		0.172
		20 MHz limit		0.090		0.094
	10 mV/div	Full		0.274		0.367
		250 MHz limit		0.200		0.205
		20 MHz limit		0.101		0.103
	20 mV/div	Full		0.348		0.462
		250 MHz limit		0.289		0.288
		20 MHz limit		0.135		0.132
50 mV/div	Full		0.634		0.876	
	250 MHz limit		0.621		0.595	
	20 MHz limit		0.268		0.254	

Table continued...

Random Noise, High Res mode: 1 GHz models							
Performance checks			1 M Ω		50 Ω		
	V/div	Bandwidth	Test result (mV)	High limit (mV)	Test result (mV)	High limit (mV)	
	100 mV/div	Full		1.51		2.09	
		250 MHz limit		1.36		1.34	
		20 MHz limit		0.615		0.601	
	1 V/div	Full		17.6		16.8	
		250 MHz limit		14.4		11.6	
		20 MHz limit		7.08		4.88	
	Channel 3	1 mV/div	Full		0.245		0.329
			250 MHz limit		0.153		0.152
			20 MHz limit		0.084		0.091
2 mV/div		Full		0.251		0.330	
		250 MHz limit		0.156		0.157	
		20 MHz limit		0.085		0.091	
5 mV/div		Full		0.254		0.339	
		250 MHz limit		0.169		0.172	
		20 MHz limit		0.090		0.094	
10 mV/div		Full		0.274		0.367	
		250 MHz limit		0.200		0.205	
		20 MHz limit		0.101		0.103	
20 mV/div		Full		0.348		0.462	
		250 MHz limit		0.289		0.288	
		20 MHz limit		0.135		0.132	
50 mV/div		Full		0.634		0.876	
		250 MHz limit		0.621		0.595	
		20 MHz limit		0.268		0.254	
100 mV/div		Full		1.51		2.09	
		250 MHz limit		1.36		1.34	
		20 MHz limit		0.615		0.601	
1 V/div		Full		17.6		16.8	
		250 MHz limit		14.4		11.6	
		20 MHz limit		7.08		4.88	
Channel 4	1 mV/div	Full		0.245		0.329	
		250 MHz limit		0.153		0.152	
		20 MHz limit		0.084		0.091	
	2 mV/div	Full		0.251		0.330	
		250 MHz limit		0.156		0.157	
	Table continued...						

Random Noise, High Res mode: 1 GHz models							
Performance checks			1 M Ω		50 Ω		
	V/div	Bandwidth	Test result (mV)	High limit (mV)	Test result (mV)	High limit (mV)	
	5 mV/div	20 MHz limit		0.085		0.091	
		Full		0.254		0.339	
		250 MHz limit		0.169		0.172	
	10 mV/div	20 MHz limit		0.090		0.094	
		Full		0.274		0.367	
		250 MHz limit		0.200		0.205	
	20 mV/div	20 MHz limit		0.101		0.103	
		Full		0.348		0.462	
		250 MHz limit		0.289		0.288	
	50 mV/div	20 MHz limit		0.135		0.132	
		Full		0.634		0.876	
		250 MHz limit		0.621		0.595	
	100 mV/div	20 MHz limit		0.268		0.254	
		Full		1.51		2.09	
		250 MHz limit		1.36		1.34	
	1 V/div	20 MHz limit		0.615		0.601	
		Full		17.6		16.8	
		250 MHz limit		14.4		11.6	
	1 GHz models (MSO56B, MSO58B)	1 mV/div	20 MHz limit		7.08		4.88
			Full		0.245		0.329
			250 MHz limit		0.153		0.152
2 mV/div		20 MHz limit		0.084		0.091	
		Full		0.251		0.330	
		250 MHz limit		0.156		0.157	
5 mV/div		20 MHz limit		0.085		0.091	
		Full		0.254		0.339	
		250 MHz limit		0.169		0.172	
10 mV/div		20 MHz limit		0.090		0.094	
		Full		0.274		0.367	
		250 MHz limit		0.200		0.205	
20 mV/div		20 MHz limit		0.101		0.103	
		Full		0.348		0.462	
		250 MHz limit		0.289		0.288	
		20 MHz limit		0.135		0.132	

Table continued...

Random Noise, High Res mode: 1 GHz models							
Performance checks			1 M Ω		50 Ω		
	V/div	Bandwidth	Test result (mV)	High limit (mV)	Test result (mV)	High limit (mV)	
	50 mV/div	Full		0.634		0.876	
		250 MHz limit		0.621		0.595	
		20 MHz limit		0.268		0.254	
	100 mV/div	Full		1.51		2.09	
		250 MHz limit		1.36		1.34	
		20 MHz limit		0.615		0.601	
	1 V/div	Full		17.6		16.8	
		250 MHz limit		14.4		11.6	
		20 MHz limit		7.08		4.88	
Channel 6	1 mV/div	Full		0.245		0.329	
		250 MHz limit		0.153		0.152	
		20 MHz limit		0.084		0.091	
	2 mV/div	Full		0.251		0.330	
		250 MHz limit		0.156		0.157	
		20 MHz limit		0.085		0.091	
	5 mV/div	Full		0.254		0.339	
		250 MHz limit		0.169		0.172	
		20 MHz limit		0.090		0.094	
	10 mV/div	Full		0.274		0.367	
		250 MHz limit		0.200		0.205	
		20 MHz limit		0.101		0.103	
	20 mV/div	Full		0.348		0.462	
		250 MHz limit		0.289		0.288	
		20 MHz limit		0.135		0.132	
	50 mV/div	Full		0.634		0.876	
		250 MHz limit		0.621		0.595	
		20 MHz limit		0.268		0.254	
	100 mV/div	Full		1.51		2.09	
		250 MHz limit		1.36		1.34	
		20 MHz limit		0.615		0.601	
	1 V/div	Full		17.6		16.8	
		250 MHz limit		14.4		11.6	
		20 MHz limit		7.08		4.88	
	1 GHz models (MSO58B)						
	Channel 7	1 mV/div	Full		0.245		0.329

Table continued...

Random Noise, High Res mode: 1 GHz models						
Performance checks			1 M Ω		50 Ω	
	V/div	Bandwidth	Test result (mV)	High limit (mV)	Test result (mV)	High limit (mV)
		250 MHz limit		0.153		0.152
		20 MHz limit		0.084		0.091
		Full		0.251		0.330
	2 mV/div	250 MHz limit		0.156		0.157
		20 MHz limit		0.085		0.091
		Full		0.254		0.339
	5 mV/div	250 MHz limit		0.169		0.172
		20 MHz limit		0.090		0.094
		Full		0.274		0.367
	10 mV/div	250 MHz limit		0.200		0.205
		20 MHz limit		0.101		0.103
		Full		0.348		0.462
	20 mV/div	250 MHz limit		0.289		0.288
		20 MHz limit		0.135		0.132
		Full		0.634		0.876
	50 mV/div	250 MHz limit		0.621		0.595
		20 MHz limit		0.268		0.254
		Full		1.51		2.09
	100 mV/div	250 MHz limit		1.36		1.34
		20 MHz limit		0.615		0.601
		Full		17.6		16.8
1 V/div	250 MHz limit		14.4		11.6	
	20 MHz limit		7.08		4.88	
	Full		0.245		0.329	
Channel 8	1 mV/div	250 MHz limit		0.153		0.152
		20 MHz limit		0.084		0.091
		Full		0.251		0.330
	2 mV/div	250 MHz limit		0.156		0.157
		20 MHz limit		0.085		0.091
		Full		0.254		0.339
	5 mV/div	250 MHz limit		0.169		0.172
		20 MHz limit		0.090		0.094
		Full		0.274		0.367
	10 mV/div	250 MHz limit		0.200		0.205
		20 MHz limit		0.101		0.103

Table continued...

Random Noise, High Res mode: 1 GHz models						
Performance checks			1 M Ω		50 Ω	
	V/div	Bandwidth	Test result (mV)	High limit (mV)	Test result (mV)	High limit (mV)
	20 mV/div	Full		0.348		0.462
		250 MHz limit		0.289		0.288
		20 MHz limit		0.135		0.132
	50 mV/div	Full		0.634		0.876
		250 MHz limit		0.621		0.595
		20 MHz limit		0.268		0.254
	100 mV/div	Full		1.51		2.09
		250 MHz limit		1.36		1.34
		20 MHz limit		0.615		0.601
	1 V/div	Full		17.6		16.8
		250 MHz limit		14.4		11.6
		20 MHz limit		7.08		4.88

For bandwidth, "full" is the highest bandwidth setting you can select.

Random Noise, High Res mode: 500 MHz models						
Performance checks			1 M Ω		50 Ω	
	V/div	Bandwidth	Test result (mV)	High limit (mV)	Test result (mV)	High limit (mV)
500 MHz models (MSO54B, MSO56B, MSO58B)						
Channel 1	1 mV/div	Full		0.245		0.256
		250 MHz limit		0.153		0.152
		20 MHz limit		0.084		0.091
	2 mV/div	Full		0.251		0.226
		250 MHz limit		0.156		0.157
		20 MHz limit		0.085		0.091
	5 mV/div	Full		0.254		0.262
		250 MHz limit		0.169		0.172
		20 MHz limit		0.090		0.094
	10 mV/div	Full		0.274		0.282
		250 MHz limit		0.200		0.205
		20 MHz limit		0.101		0.103
	20 mV/div	Full		0.348		0.354
		250 MHz limit		0.289		0.288
		20 MHz limit		0.135		0.132
	50 mV/div	Full		0.634		0.667
		250 MHz limit		0.621		0.595

Table continued...

Random Noise, High Res mode: 500 MHz models							
Performance checks			1 M Ω		50 Ω		
	V/div	Bandwidth	Test result (mV)	High limit (mV)	Test result (mV)	High limit (mV)	
	100 mV/div	20 MHz limit		0.268		0.254	
		Full		1.51		1.60	
		250 MHz limit		1.36		1.34	
	1 V/div	20 MHz limit		0.615		0.601	
		Full		17.6		12.8	
		250 MHz limit		14.4		11.6	
	Channel 2	1 mV/div	20 MHz limit		7.08		4.88
			Full		0.245		0.256
			250 MHz limit		0.153		0.152
2 mV/div		20 MHz limit		0.084		0.091	
		Full		0.251		0.226	
		250 MHz limit		0.156		0.157	
5 mV/div		20 MHz limit		0.085		0.091	
		Full		0.254		0.262	
		250 MHz limit		0.169		0.172	
10 mV/div		20 MHz limit		0.090		0.094	
		Full		0.274		0.282	
		250 MHz limit		0.200		0.205	
20 mV/div		20 MHz limit		0.101		0.103	
		Full		0.348		0.354	
		250 MHz limit		0.289		0.288	
50 mV/div		20 MHz limit		0.135		0.132	
		Full		0.634		0.667	
		250 MHz limit		0.621		0.595	
100 mV/div		20 MHz limit		0.268		0.254	
		Full		1.51		1.60	
		250 MHz limit		1.36		1.34	
1 V/div		20 MHz limit		0.615		0.601	
		Full		17.6		12.8	
		250 MHz limit		14.4		11.6	
Channel 3		1 mV/div	20 MHz limit		7.08		4.88
			Full		0.245		0.256
			250 MHz limit		0.153		0.152
	2 mV/div	20 MHz limit		0.084		0.091	
		Full		0.251		0.226	
		250 MHz limit		0.156		0.157	

Table continued...

Random Noise, High Res mode: 500 MHz models						
Performance checks			1 M Ω		50 Ω	
	V/div	Bandwidth	Test result (mV)	High limit (mV)	Test result (mV)	High limit (mV)
		250 MHz limit		0.156		0.157
		20 MHz limit		0.085		0.091
		Full		0.254		0.262
	5 mV/div	250 MHz limit		0.169		0.172
		20 MHz limit		0.090		0.094
		Full		0.274		0.282
	10 mV/div	250 MHz limit		0.200		0.205
		20 MHz limit		0.101		0.103
		Full		0.348		0.354
	20 mV/div	250 MHz limit		0.289		0.288
		20 MHz limit		0.135		0.132
		Full		0.634		0.667
	50 mV/div	250 MHz limit		0.621		0.595
		20 MHz limit		0.268		0.254
		Full		1.51		1.60
	100 mV/div	250 MHz limit		1.36		1.34
		20 MHz limit		0.615		0.601
		Full		17.6		12.8
1 V/div	250 MHz limit		14.4		11.6	
	20 MHz limit		7.08		4.88	
	Full		0.245		0.256	
Channel 4	1 mV/div	250 MHz limit		0.153		0.152
		20 MHz limit		0.084		0.091
		Full		0.251		0.226
	2 mV/div	250 MHz limit		0.156		0.157
		20 MHz limit		0.085		0.091
		Full		0.254		0.262
	5 mV/div	250 MHz limit		0.169		0.172
		20 MHz limit		0.090		0.094
		Full		0.274		0.282
	10 mV/div	250 MHz limit		0.200		0.205
		20 MHz limit		0.101		0.103
		Full		0.348		0.354
	20 mV/div	250 MHz limit		0.289		0.288
		20 MHz limit		0.135		0.132
		Full				

Table continued...

Random Noise, High Res mode: 500 MHz models						
Performance checks			1 M Ω		50 Ω	
	V/div	Bandwidth	Test result (mV)	High limit (mV)	Test result (mV)	High limit (mV)
	50 mV/div	Full		0.634		0.667
		250 MHz limit		0.621		0.595
		20 MHz limit		0.268		0.254
	100 mV/div	Full		1.51		1.60
		250 MHz limit		1.36		1.34
		20 MHz limit		0.615		0.601
	1 V/div	Full		17.6		12.8
		250 MHz limit		14.4		11.6
		20 MHz limit		7.08		4.88
500 MHz models (MSO56B, MSO58B)						
Channel 5	1 mV/div	Full		0.245		0.256
		250 MHz limit		0.153		0.152
		20 MHz limit		0.084		0.091
	2 mV/div	Full		0.251		0.226
		250 MHz limit		0.156		0.157
		20 MHz limit		0.085		0.091
	5 mV/div	Full		0.254		0.262
		250 MHz limit		0.169		0.172
		20 MHz limit		0.090		0.094
	10 mV/div	Full		0.274		0.282
		250 MHz limit		0.200		0.205
		20 MHz limit		0.101		0.103
	20 mV/div	Full		0.348		0.354
		250 MHz limit		0.289		0.288
		20 MHz limit		0.135		0.132
	50 mV/div	Full		0.634		0.667
		250 MHz limit		0.621		0.595
		20 MHz limit		0.268		0.254
	100 mV/div	Full		1.51		1.60
		250 MHz limit		1.36		1.34
		20 MHz limit		0.615		0.601
	1 V/div	Full		17.6		12.8
		250 MHz limit		14.4		11.6
		20 MHz limit		7.08		4.88
Channel 6	1 mV/div	Full		0.245		0.256

Table continued...

Random Noise, High Res mode: 500 MHz models						
Performance checks			1 M Ω		50 Ω	
	V/div	Bandwidth	Test result (mV)	High limit (mV)	Test result (mV)	High limit (mV)
		250 MHz limit		0.153		0.152
		20 MHz limit		0.084		0.091
	2 mV/div	Full		0.251		0.226
		250 MHz limit		0.156		0.157
		20 MHz limit		0.085		0.091
	5 mV/div	Full		0.254		0.262
		250 MHz limit		0.169		0.172
		20 MHz limit		0.090		0.094
	10 mV/div	Full		0.274		0.282
		250 MHz limit		0.200		0.205
		20 MHz limit		0.101		0.103
	20 mV/div	Full		0.348		0.354
		250 MHz limit		0.289		0.288
		20 MHz limit		0.135		0.132
	50 mV/div	Full		0.634		0.667
		250 MHz limit		0.621		0.595
		20 MHz limit		0.268		0.254
	100 mV/div	Full		1.51		1.60
		250 MHz limit		1.36		1.34
		20 MHz limit		0.615		0.601
1 V/div	Full		17.6		12.8	
	250 MHz limit		14.4		11.6	
	20 MHz limit		7.08		4.88	
500 MHz models (MSO58B)						
Channel 7	1 mV/div	Full		0.245		0.256
		250 MHz limit		0.153		0.152
		20 MHz limit		0.084		0.091
	2 mV/div	Full		0.251		0.226
		250 MHz limit		0.156		0.157
		20 MHz limit		0.085		0.091
	5 mV/div	Full		0.254		0.262
		250 MHz limit		0.169		0.172
		20 MHz limit		0.090		0.094
	10 mV/div	Full		0.274		0.282
250 MHz limit			0.200		0.205	
Table continued...						

Random Noise, High Res mode: 500 MHz models						
Performance checks			1 M Ω		50 Ω	
	V/div	Bandwidth	Test result (mV)	High limit (mV)	Test result (mV)	High limit (mV)
	20 mV/div	20 MHz limit		0.101		0.103
		Full		0.348		0.354
		250 MHz limit		0.289		0.288
	50 mV/div	20 MHz limit		0.135		0.132
		Full		0.634		0.667
		250 MHz limit		0.621		0.595
	100 mV/div	20 MHz limit		0.268		0.254
		Full		1.51		1.60
		250 MHz limit		1.36		1.34
	1 V/div	20 MHz limit		0.615		0.601
		Full		17.6		12.8
		250 MHz limit		14.4		11.6
Channel 8	1 mV/div	20 MHz limit		7.08		4.88
		Full		0.245		0.256
		250 MHz limit		0.153		0.152
	2 mV/div	20 MHz limit		0.084		0.091
		Full		0.251		0.226
		250 MHz limit		0.156		0.157
	5 mV/div	20 MHz limit		0.085		0.091
		Full		0.254		0.262
		250 MHz limit		0.169		0.172
	10 mV/div	20 MHz limit		0.090		0.094
		Full		0.274		0.282
		250 MHz limit		0.200		0.205
	20 mV/div	20 MHz limit		0.101		0.103
		Full		0.348		0.354
		250 MHz limit		0.289		0.288
	50 mV/div	20 MHz limit		0.135		0.132
		Full		0.634		0.667
		250 MHz limit		0.621		0.595
	100 mV/div	20 MHz limit		0.268		0.254
		Full		1.51		1.60
		250 MHz limit		1.36		1.34
	1 V/div	20 MHz limit		0.615		0.601
		Full		17.6		12.8
			250 MHz limit		14.4	

Table continued...

Random Noise, High Res mode: 500 MHz models						
Performance checks			1 M Ω		50 Ω	
	V/div	Bandwidth	Test result (mV)	High limit (mV)	Test result (mV)	High limit (mV)
		20 MHz limit		7.08		4.88

For bandwidth, "full" is the highest bandwidth setting you can select.

Random Noise, High Res mode: 350 MHz models							
Performance checks			1 M Ω		50 Ω		
	V/div	Bandwidth	Test result (mV)	High limit (mV)	Test result (mV)	High limit (mV)	
350 MHz models (MSO54B, MSO56B, MSO58B)							
Channel 1	1 mV/div	Full		0.184		0.183	
		250 MHz limit		0.153		0.152	
		20 MHz limit		0.084		0.091	
	2 mV/div	Full		0.188		0.185	
		250 MHz limit		0.156		0.157	
		20 MHz limit		0.085		0.091	
	5 mV/div	Full		0.197		0.195	
		250 MHz limit		0.169		0.172	
		20 MHz limit		0.090		0.094	
	10 mV/div	Full		0.216		0.218	
		250 MHz limit		0.200		0.205	
		20 MHz limit		0.101		0.103	
	20 mV/div	Full		0.277		0.287	
		250 MHz limit		0.289		0.288	
		20 MHz limit		0.135		0.132	
	50 mV/div	Full		0.530		0.564	
		250 MHz limit		0.621		0.595	
		20 MHz limit		0.268		0.254	
	100 mV/div	Full		1.25		1.31	
		250 MHz limit		1.36		1.34	
		20 MHz limit		0.615		0.601	
	1 V/div	Full		13.7		10.9	
		250 MHz limit		14.4		11.6	
		20 MHz limit		7.08		4.88	
	Channel 2	1 mV/div	Full		0.184		0.183
			250 MHz limit		0.153		0.152
			20 MHz limit		0.084		0.091
2 mV/div		Full		0.188		0.185	

Table continued...

Random Noise, High Res mode: 350 MHz models						
Performance checks			1 M Ω		50 Ω	
	V/div	Bandwidth	Test result (mV)	High limit (mV)	Test result (mV)	High limit (mV)
		250 MHz limit		0.156		0.157
		20 MHz limit		0.085		0.091
	5 mV/div	Full		0.197		0.195
		250 MHz limit		0.169		0.172
		20 MHz limit		0.090		0.094
	10 mV/div	Full		0.216		0.218
		250 MHz limit		0.200		0.205
		20 MHz limit		0.101		0.103
	20 mV/div	Full		0.277		0.287
		250 MHz limit		0.289		0.288
		20 MHz limit		0.135		0.132
	50 mV/div	Full		0.530		0.564
		250 MHz limit		0.621		0.595
		20 MHz limit		0.268		0.254
	100 mV/div	Full		1.25		1.31
		250 MHz limit		1.36		1.34
		20 MHz limit		0.615		0.601
	1 V/div	Full		13.7		10.9
		250 MHz limit		14.4		11.6
		20 MHz limit		7.08		4.88
Channel 3	1 mV/div	Full		0.184		0.183
		250 MHz limit		0.153		0.152
		20 MHz limit		0.084		0.091
	2 mV/div	Full		0.188		0.185
		250 MHz limit		0.156		0.157
		20 MHz limit		0.085		0.091
	5 mV/div	Full		0.197		0.195
		250 MHz limit		0.169		0.172
		20 MHz limit		0.090		0.094
	10 mV/div	Full		0.216		0.218
		250 MHz limit		0.200		0.205
		20 MHz limit		0.101		0.103
	20 mV/div	Full		0.277		0.287
		250 MHz limit		0.289		0.288
		20 MHz limit		0.135		0.132

Table continued...

Random Noise, High Res mode: 350 MHz models							
Performance checks			1 M Ω		50 Ω		
	V/div	Bandwidth	Test result (mV)	High limit (mV)	Test result (mV)	High limit (mV)	
	50 mV/div	Full		0.530		0.564	
		250 MHz limit		0.621		0.595	
		20 MHz limit		0.268		0.254	
	100 mV/div	Full		1.25		1.31	
		250 MHz limit		1.36		1.34	
		20 MHz limit		0.615		0.601	
	1 V/div	Full		13.7		10.9	
		250 MHz limit		14.4		11.6	
		20 MHz limit		7.08		4.88	
Channel 4	1 mV/div	Full		0.184		0.183	
		250 MHz limit		0.153		0.152	
		20 MHz limit		0.084		0.091	
	2 mV/div	Full		0.188		0.185	
		250 MHz limit		0.156		0.157	
		20 MHz limit		0.085		0.091	
	5 mV/div	Full		0.197		0.195	
		250 MHz limit		0.169		0.172	
		20 MHz limit		0.090		0.094	
	10 mV/div	Full		0.216		0.218	
		250 MHz limit		0.200		0.205	
		20 MHz limit		0.101		0.103	
	20 mV/div	Full		0.277		0.287	
		250 MHz limit		0.289		0.288	
		20 MHz limit		0.135		0.132	
	50 mV/div	Full		0.530		0.564	
		250 MHz limit		0.621		0.595	
		20 MHz limit		0.268		0.254	
	100 mV/div	Full		1.25		1.31	
		250 MHz limit		1.36		1.34	
		20 MHz limit		0.615		0.601	
	1 V/div	Full		13.7		10.9	
		250 MHz limit		14.4		11.6	
		20 MHz limit		7.08		4.88	
	350 MHz models (MSO56B, MSO58B)						
	Channel 5	1 mV/div	Full		0.184		0.183

Table continued...

Random Noise, High Res mode: 350 MHz models						
Performance checks			1 M Ω		50 Ω	
	V/div	Bandwidth	Test result (mV)	High limit (mV)	Test result (mV)	High limit (mV)
		250 MHz limit		0.153		0.152
		20 MHz limit		0.084		0.091
	2 mV/div	Full		0.188		0.185
		250 MHz limit		0.156		0.157
		20 MHz limit		0.085		0.091
	5 mV/div	Full		0.197		0.195
		250 MHz limit		0.169		0.172
		20 MHz limit		0.090		0.094
	10 mV/div	Full		0.216		0.218
		250 MHz limit		0.200		0.205
		20 MHz limit		0.101		0.103
	20 mV/div	Full		0.277		0.287
		250 MHz limit		0.289		0.288
		20 MHz limit		0.135		0.132
	50 mV/div	Full		0.530		0.564
		250 MHz limit		0.621		0.595
		20 MHz limit		0.268		0.254
	100 mV/div	Full		1.25		1.31
		250 MHz limit		1.36		1.34
		20 MHz limit		0.615		0.601
	1 V/div	Full		13.7		10.9
		250 MHz limit		14.4		11.6
		20 MHz limit		7.08		4.88
	Channel 6	1 mV/div	Full		0.184	
250 MHz limit				0.153		0.152
20 MHz limit				0.084		0.091
2 mV/div		Full		0.188		0.185
		250 MHz limit		0.156		0.157
		20 MHz limit		0.085		0.091
5 mV/div		Full		0.197		0.195
		250 MHz limit		0.169		0.172
		20 MHz limit		0.090		0.094
10 mV/div		Full		0.216		0.218
		250 MHz limit		0.200		0.205
		20 MHz limit		0.101		0.103

Table continued...

Random Noise, High Res mode: 350 MHz models							
Performance checks			1 M Ω		50 Ω		
	V/div	Bandwidth	Test result (mV)	High limit (mV)	Test result (mV)	High limit (mV)	
	20 mV/div	Full		0.277		0.287	
		250 MHz limit		0.289		0.288	
		20 MHz limit		0.135		0.132	
	50 mV/div	Full		0.530		0.564	
		250 MHz limit		0.621		0.595	
		20 MHz limit		0.268		0.254	
	100 mV/div	Full		1.25		1.31	
		250 MHz limit		1.36		1.34	
		20 MHz limit		0.615		0.601	
	1 V/div	Full		13.7		10.9	
		250 MHz limit		14.4		11.6	
		20 MHz limit		7.08		4.88	
350 MHz models (MSO58B)							
Channel 7	1 mV/div	Full		0.184		0.183	
		250 MHz limit		0.153		0.152	
		20 MHz limit		0.084		0.091	
	2 mV/div	Full		0.188		0.185	
		250 MHz limit		0.156		0.157	
		20 MHz limit		0.085		0.091	
	5 mV/div	Full		0.197		0.195	
		250 MHz limit		0.169		0.172	
		20 MHz limit		0.090		0.094	
	10 mV/div	Full		0.216		0.218	
		250 MHz limit		0.200		0.205	
		20 MHz limit		0.101		0.103	
	20 mV/div	Full		0.277		0.287	
		250 MHz limit		0.289		0.288	
		20 MHz limit		0.135		0.132	
	50 mV/div	Full		0.530		0.564	
		250 MHz limit		0.621		0.595	
		20 MHz limit		0.268		0.254	
	100 mV/div	Full		1.25		1.31	
		250 MHz limit		1.36		1.34	
		20 MHz limit		0.615		0.601	
	1 V/div	Full		13.7		10.9	
	Table continued...						

Random Noise, High Res mode: 350 MHz models						
Performance checks			1 M Ω		50 Ω	
	V/div	Bandwidth	Test result (mV)	High limit (mV)	Test result (mV)	High limit (mV)
		250 MHz limit		14.4		11.6
		20 MHz limit		7.08		4.88
Channel 8	1 mV/div	Full		0.184		0.183
		250 MHz limit		0.153		0.152
		20 MHz limit		0.084		0.091
	2 mV/div	Full		0.188		0.185
		250 MHz limit		0.156		0.157
		20 MHz limit		0.085		0.091
	5 mV/div	Full		0.197		0.195
		250 MHz limit		0.169		0.172
		20 MHz limit		0.090		0.094
	10 mV/div	Full		0.216		0.218
		250 MHz limit		0.200		0.205
		20 MHz limit		0.101		0.103
	20 mV/div	Full		0.277		0.287
		250 MHz limit		0.289		0.288
		20 MHz limit		0.135		0.132
	50 mV/div	Full		0.530		0.564
		250 MHz limit		0.621		0.595
		20 MHz limit		0.268		0.254
	100 mV/div	Full		1.25		1.31
		250 MHz limit		1.36		1.34
		20 MHz limit		0.615		0.601
1 V/div	Full		13.7		10.9	
	250 MHz limit		14.4		11.6	
	20 MHz limit		7.08		4.88	

Long term sample rate through AFG DC offset accuracy test records

Long Term Sample Rate			
Performance checks	Low limit	Test result	High limit
Long Term Sample Rate	-2 divisions		+2 divisions

Delta Time Measurement Accuracy, 2 GHz models
Performance checks
Table continued...

Delta Time Measurement Accuracy, 2 GHz models					
All 2 GHz models (MSO54B, MSO56B, MSO58B)					
Channel 1	Sample rate = 25 GS/s, 10 ns/Div, Sample mode				
	V/Div	Source V _{PP}	Source freq	Test result	High limit
	5 mV 1.5 GHz BW	40 mV	847.5 MHz		6.17 ps
	10 mV 2 GHz BW	80 mV	1.13 GHz		3.33 ps
	20 mV 2 GHz BW	160 mV	1.13 GHz		2.77 ps
	50 mV 2 GHz BW	400 mV	1.13 GHz		2.64 ps
Sample rate = 25 GS/s, 10 ns/Div, High Res mode					
	5 mV 1 GHz BW	40 mV	565 MHz		5.79 ps
	10 mV 1 GHz BW	80 mV	565 MHz		4.125 ps
	20 mV 1 GHz BW	160 mV	565 MHz		3.6 ps
	50 mV 1 GHz BW	400 mV	565 MHz		3.42 ps

Table continued...

Delta Time Measurement Accuracy, 2 GHz models					
Channel 2	Sample rate = 25 GS/s, 10 ns/Div, Sample mode				
	5 mV 1.5 GHz BW	40 mV	847.5 MHz		6.17 ps
	10 mV 2 GHz BW	80 mV	1.13 GHz		3.33 ps
	20 mV 2 GHz BW	160 mV	1.13 GHz		2.77 ps
	50 mV 2 GHz BW	400 mV	1.13 GHz		2.64 ps
	Sample rate = 25 GS/s, 10 ns/Div, High Res mode				
	5 mV 1 GHz BW	40 mV	565 MHz		5.79 ps
	10 mV 1 GHz BW	80 mV	565 MHz		4.125 ps
	20 mV 1 GHz BW	160 mV	565 MHz		3.6 ps
	50 mV 1 GHz BW	400 mV	565 MHz		3.42 ps

Table continued...

Delta Time Measurement Accuracy, 2 GHz models					
Channel 3	Sample rate = 25 GS/s, 10 ns/Div, Sample mode				
	5 mV 1.5 GHz BW	40 mV	847.5 MHz		6.17 ps
	10 mV 2 GHz BW	80 mV	1.13 GHz		3.33 ps
	20 mV 2 GHz BW	160 mV	1.13 GHz		2.77 ps
	50 mV 2 GHz BW	400 mV	1.13 GHz		2.64 ps
	Sample rate = 25 GS/s, 10 ns/Div, High Res mode				
	5 mV 1 GHz BW	40 mV	565 MHz		5.79 ps
	10 mV 1 GHz BW	80 mV	565 MHz		4.125 ps
	20 mV 1 GHz BW	160 mV	565 MHz		3.6 ps
	50 mV 1 GHz BW	400 mV	565 MHz		3.42 ps

Table continued...

Delta Time Measurement Accuracy, 2 GHz models						
Channel 4	Sample rate = 25 GS/s, 10 ns/Div, Sample mode					
	5 mV 1.5 GHz BW	40 mV	847.5 MHz		6.17 ps	
	10 mV 2 GHz BW	80 mV	1.13 GHz		3.33 ps	
	20 mV 2 GHz BW	160 mV	1.13 GHz		2.77 ps	
	50 mV 2 GHz BW	400 mV	1.13 GHz		2.64 ps	
	Sample rate = 25 GS/s, 10 ns/Div, High Res mode					
	5 mV 1 GHz BW	40 mV	565 MHz		5.79 ps	
	10 mV 1 GHz BW	80 mV	565 MHz		4.125 ps	
	20 mV 1 GHz BW	160 mV	565 MHz		3.6 ps	
	50 mV 1 GHz BW	400 mV	565 MHz		3.42 ps	
	2 GHz models (MSO56B, MSO58B)					
	Sample rate = 25 GS/s, 10 ns/Div, Sample mode					
	Channel 5	V/Div	Source V _{PP}	Source frequency	Test result	High limit
		5 mV 1.5 GHz BW	40 mV	847.5 MHz		6.17 ps
10 mV 2 GHz BW		80 mV	1.13 GHz		3.33 ps	
20 mV 2 GHz BW		160 mV	1.13 GHz		2.77 ps	
50 mV 2 GHz BW		400 mV	1.13 GHz		2.64 ps	
Sample rate = 25 GS/s, 10 ns/Div, High Res mode						

Table continued...

Delta Time Measurement Accuracy, 2 GHz models					
	5 mV 1 GHz BW	40 mV	565 MHz		5.79 ps
	10 mV 1 GHz BW	80 mV	565 MHz		4.125 ps
	20 mV 1 GHz BW	160 mV	565 MHz		3.6 ps
	50 mV 1 GHz BW	400 mV	565 MHz		3.42 ps
Channel 6	Sample rate = 25 GS/s, 10 ns/Div, Sample mode				
	V/Div	Source V_{PP}	Source frequency	Test result	High limit
	5 mV 1.5 GHz BW	40 mV	847.5 MHz		6.17 ps
	10 mV 2 GHz BW	80 mV	1.13 GHz		3.33 ps
	20 mV 2 GHz BW	160 mV	1.13 GHz		2.77 ps
	50 mV 2 GHz BW	400 mV	1.13 GHz		2.64 ps
	Sample rate = 25 GS/s, 10 ns/Div, High Res mode				
	5 mV 1 GHz BW	40 mV	565 MHz		5.79 ps
	10 mV 1 GHz BW	80 mV	565 MHz		4.125 ps
	20 mV 1 GHz BW	160 mV	565 MHz		3.6 ps
	50 mV 1 GHz BW	400 mV	565 MHz		3.42 ps
2 GHz models (MSO58B)					

Table continued...

Delta Time Measurement Accuracy, 2 GHz models					
Channel 7	Sample rate = 25 GS/s, 10 ns/Div, Sample mode				
	V/Div	Source V _{pp}	Source frequency	Test result	High limit
	5 mV 1.5 GHz BW	40 mV	847.5 MHz		6.17 ps
	10 mV 2 GHz BW	80 mV	1.13 GHz		3.33 ps
	20 mV 2 GHz BW	160 mV	1.13 GHz		2.77 ps
	50 mV 2 GHz BW	400 mV	1.13 GHz		2.64 ps
Sample rate = 25 GS/s, 10 ns/Div, High Res mode					
	5 mV 1 GHz BW	40 mV	565 MHz		5.79 ps
	10 mV 1 GHz BW	80 mV	565 MHz		4.125 ps
	20 mV 1 GHz BW	160 mV	565 MHz		3.6 ps
	50 mV 1 GHz BW	400 mV	565 MHz		3.42 ps

Table continued...

Delta Time Measurement Accuracy, 2 GHz models					
Channel 8	Sample rate = 25 GS/s, 10 ns/Div, Sample mode				
	V/Div	Source V _{PP}	Source frequency	Test result	High limit
	5 mV 1.5 GHz BW	40 mV	847.5 MHz		6.17 ps
	10 mV 2 GHz BW	80 mV	1.13 GHz		3.33 ps
	20 mV 2 GHz BW	160 mV	1.13 GHz		2.77 ps
	50 mV 2 GHz BW	400 mV	1.13 GHz		2.64 ps
	Sample rate = 25 GS/s, 10 ns/Div, High Res mode				
	5 mV 1 GHz BW	40 mV	565 MHz		5.79 ps
	10 mV 1 GHz BW	80 mV	565 MHz		4.125 ps
	20 mV 1 GHz BW	160 mV	565 MHz		3.6 ps
	50 mV 1 GHz BW	400 mV	565 MHz		3.42 ps

Delta Time Measurement Accuracy, 1 GHz models					
Performance checks					
1 GHz models (MSO54B, MSO56B, MSO58B)					
Channel 1	Sample rate = 25 GS/s, 10 ns/Div				
	V/Div	Source V _{PP}	Source frequency	Test result	High limit
	5 mV	40 mV	565 MHz		8.41 ps
	10 mV	80 mV	565 MHz		5.04 ps
	20 mV	160 mV	565 MHz		3.63 ps
	50 mV	400 mV	565 MHz		3.1 ps
	Sample rate = 25 GS/s, 10 ns/Div, High Res				
	5 mV	40 mV	565 MHz		7.3 ps
	10 mV	80 mV	565 MHz		4.22 ps

Table continued...

Delta Time Measurement Accuracy, 1 GHz models						
	20 mV	160 mV	565 MHz		2.88 ps	
	50 mV	400 mV	565 MHz		2.33 ps	
Channel 2	Sample rate = 25 GS/s, 10 ns/Div					
	V/Div	Source V _{PP}	Source frequency	Test result	High limit	
	5 mV	40 mV	565 MHz		8.41 ps	
	10 mV	80 mV	565 MHz		5.04 ps	
	20 mV	160 mV	565 MHz		3.63 ps	
	50 mV	400 mV	565 MHz		3.1 ps	
	Sample rate = 25 GS/s, 10 ns/Div, High Res					
	5 mV	40 mV	565 MHz		7.3 ps	
	10 mV	80 mV	565 MHz		4.22 ps	
	20 mV	160 mV	565 MHz		2.88 ps	
	50 mV	400 mV	565 MHz		2.33 ps	
	Channel 3	Sample rate = 25 GS/s, 10 ns/Div				
		V/Div	Source V _{PP}	Source frequency	Test result	High limit
		5 mV	40 mV	565 MHz		8.41 ps
10 mV		80 mV	565 MHz		5.04 ps	
20 mV		160 mV	565 MHz		3.63 ps	
50 mV		400 mV	565 MHz		3.1 ps	
Sample rate = 25 GS/s, 10 ns/Div, High Res						
5 mV		40 mV	565 MHz		7.3 ps	
10 mV		80 mV	565 MHz		4.22 ps	
20 mV		160 mV	565 MHz		2.88 ps	
50 mV		400 mV	565 MHz		2.33 ps	
Channel 4		Sample rate = 25 GS/s, 10 ns/Div				
		V/Div	Source V _{PP}	Source frequency	Test result	High limit
		5 mV	40 mV	565 MHz		8.41 ps
	10 mV	80 mV	565 MHz		5.04 ps	
	20 mV	160 mV	565 MHz		3.63 ps	
	50 mV	400 mV	565 MHz		3.1 ps	
	Sample rate = 25 GS/s, 10 ns/Div, High Res					
	5 mV	40 mV	565 MHz		7.3 ps	
	10 mV	80 mV	565 MHz		4.22 ps	
	20 mV	160 mV	565 MHz		2.88 ps	
	50 mV	400 mV	565 MHz		2.33 ps	
	1 GHz models (MSO56B, MSO58B)					
	Channel 5	Sample rate = 25 GS/s, 10 ns/Div				
	Table continued...					

Delta Time Measurement Accuracy, 1 GHz models					
	V/Div	Source V_{PP}	Source frequency	Test result	High limit
	5 mV	40 mV	565 MHz		8.41 ps
	10 mV	80 mV	565 MHz		5.04 ps
	20 mV	160 mV	565 MHz		3.63 ps
	50 mV	400 mV	565 MHz		3.1 ps
	Sample rate = 25 GS/s, 10 ns/Div, High Res				
	5 mV	40 mV	565 MHz		7.3 ps
	10 mV	80 mV	565 MHz		4.22 ps
	20 mV	160 mV	565 MHz		2.88 ps
	50 mV	400 mV	565 MHz		2.33 ps
Channel 6	Sample rate = 25 GS/s, 10 ns/Div				
	V/Div	Source V_{PP}	Source frequency	Test result	High limit
	5 mV	40 mV	565 MHz		8.41 ps
	10 mV	80 mV	565 MHz		5.04 ps
	20 mV	160 mV	565 MHz		3.63 ps
	50 mV	400 mV	565 MHz		3.1 ps
	Sample rate = 25 GS/s, 10 ns/Div, High Res				
	5 mV	40 mV	565 MHz		7.3 ps
	10 mV	80 mV	565 MHz		4.22 ps
	20 mV	160 mV	565 MHz		2.88 ps
	50 mV	400 mV	565 MHz		2.33 ps
1 GHz models (MSO58B)					
Channel 7	Sample rate = 25 GS/s, 10 ns/Div				
	V/Div	Source V_{PP}	Source frequency	Test result	High limit
	5 mV	40 mV	565 MHz		8.41 ps
	10 mV	80 mV	565 MHz		5.04 ps
	20 mV	160 mV	565 MHz		3.63 ps
	50 mV	400 mV	565 MHz		3.1 ps
	Sample rate = 25 GS/s, 10 ns/Div, Source freq = 565 MHz, High Res				
	5 mV	40 mV	565 MHz		7.3 ps
	10 mV	80 mV	565 MHz		4.22 ps
	20 mV	160 mV	565 MHz		2.88 ps
	50 mV	400 mV	565 MHz		2.33 ps
Channel 8	Sample rate = 25 GS/s, 10 ns/Div, Source freq = 565 MHz				
	V/Div	Source V_{PP}	Source frequency	Test result	High limit
	5 mV	40 mV	565 MHz		8.41 ps
	10 mV	80 mV	565 MHz		5.04 ps

Table continued...

Delta Time Measurement Accuracy, 1 GHz models					
	20 mV	160 mV	565 MHz		3.63 ps
	50 mV	400 mV	565 MHz		3.1 ps
Sample rate = 25 GS/s, 10 ns/Div, High Res					
	5 mV	40 mV	565 MHz		7.3 ps
	10 mV	80 mV	565 MHz		4.22 ps
	20 mV	160 mV	565 MHz		2.88 ps
	50 mV	400 mV	565 MHz		2.33 ps

Delta Time Measurement Accuracy, 500 MHz models					
Performance checks					
500 MHz models (MSO54B, MSO56B, MSO58B)					
Channel 1	Sample rate = 25 GS/s, 10 ns/Div, Source freq = 282.5 MHz, 500 MHz BW				
	V/Div	Source V_{PP}	Source frequency	Test result	High limit
	5 mV	40 mV	282.5 MHz		11.55 ps
	10 mV	80 mV	282.5 MHz		6.95 ps
	20 mV	160 mV	282.5 MHz		5.32 ps
	50 mV	400 mV	282.5 MHz		4.69 ps
Sample rate = 25 GS/s, 10 ns/Div, Source freq = 282.5 MHz, 500 MHz BW, High Res					
	5 mV	40 mV	282.5 MHz		10.85 ps
	10 mV	80 mV	282.5 MHz		6.48 ps
	20 mV	160 mV	282.5 MHz		3.97 ps
	50 mV	400 mV	282.5 MHz		3.23 ps
Channel 2	Sample rate = 25 GS/s, 10 ns/Div, Source freq = 282.5 MHz, 500 MHz BW				
	V/Div	Source V_{PP}	Source frequency	Test result	High limit
	5 mV	40 mV	282.5 MHz		11.55 ps
	10 mV	80 mV	282.5 MHz		6.95 ps
	20 mV	160 mV	282.5 MHz		5.32 ps
	50 mV	400 mV	282.5 MHz		4.69 ps
Sample rate = 25 GS/s, 10 ns/Div, Source freq = 282.5 MHz, 500 MHz BW, High Res					
	5 mV	40 mV	282.5 MHz		10.85 ps
	10 mV	80 mV	282.5 MHz		6.48 ps
	20 mV	160 mV	282.5 MHz		3.97 ps
	50 mV	400 mV	282.5 MHz		3.23 ps
Channel 3	Sample rate = 25 GS/s, 10 ns/Div, Source freq = 282.5 MHz, 500 MHz BW				
	V/Div	Source V_{PP}	Source frequency	Test result	High limit
	5 mV	40 mV	282.5 MHz		11.55 ps
	10 mV	80 mV	282.5 MHz		6.95 ps

Table continued...

Delta Time Measurement Accuracy, 500 MHz models					
	20 mV	160 mV	282.5 MHz		5.32 ps
	50 mV	400 mV	282.5 MHz		4.69 ps
	Sample rate = 25 GS/s, 10 ns/Div, Source freq = 282.5 MHz, 500 MHz BW, High Res				
	5 mV	40 mV	282.5 MHz		10.85 ps
	10 mV	80 mV	282.5 MHz		6.48 ps
	20 mV	160 mV	282.5 MHz		3.97 ps
	50 mV	400 mV	282.5 MHz		3.23 ps
Channel 4	Sample rate = 25 GS/s, 10 ns/Div, Source freq = 282.5 MHz, 500 MHz BW				
	V/Div	Source V_{PP}	Source frequency	Test result	High limit
	5 mV	40 mV	282.5 MHz		11.55 ps
	10 mV	80 mV	282.5 MHz		6.95 ps
	20 mV	160 mV	282.5 MHz		5.32 ps
	50 mV	400 mV	282.5 MHz		4.69 ps
	Sample rate = 25 GS/s, 10 ns/Div, Source freq = 282.5 MHz, 500 MHz BW, High Res				
	5 mV	40 mV	282.5 MHz		10.85 ps
	10 mV	80 mV	282.5 MHz		6.48 ps
	20 mV	160 mV	282.5 MHz		3.97 ps
	50 mV	400 mV	282.5 MHz		3.23 ps
500 MHz models (MSO56B, MSO58B)					
Channel 5	Sample rate = 25 GS/s, 10 ns/Div, Source freq = 282.5 MHz, 500 MHz BW				
	V/Div	Source V_{PP}	Source frequency	Test result	High limit
	5 mV	40 mV	282.5 MHz		11.55 ps
	10 mV	80 mV	282.5 MHz		6.95 ps
	20 mV	160 mV	282.5 MHz		5.32 ps
	50 mV	400 mV	282.5 MHz		4.69 ps
	Sample rate = 25 GS/s, 10 ns/Div, Source freq = 282.5 MHz, 500 MHz BW, High Res				
	5 mV	40 mV	282.5 MHz		10.85 ps
	10 mV	80 mV	282.5 MHz		6.48 ps
	20 mV	160 mV	282.5 MHz		3.97 ps
	50 mV	400 mV	282.5 MHz		3.23 ps
Channel 6	Sample rate = 25 GS/s, 10 ns/Div, Source freq = 282.5 MHz, 500 MHz BW				
	V/Div	Source V_{PP}	Source frequency	Test result	High limit
	5 mV	40 mV	282.5 MHz		11.55 ps
	10 mV	80 mV	282.5 MHz		6.95 ps
	20 mV	160 mV	282.5 MHz		5.32 ps
	50 mV	400 mV	282.5 MHz		4.69 ps
	Sample rate = 25 GS/s, 10 ns/Div, Source freq = 282.5 MHz, 500 MHz BW, High Res				

Table continued...

Delta Time Measurement Accuracy, 500 MHz models					
	5 mV	40 mV	282.5 MHz		10.85 ps
	10 mV	80 mV	282.5 MHz		6.48 ps
	20 mV	160 mV	282.5 MHz		3.97 ps
	50 mV	400 mV	282.5 MHz		3.23 ps
500 MHz models (MSO58B)					
Channel 7	Sample rate = 25 GS/s, 10 ns/Div, Source freq = 282.5 MHz, 500 MHz BW				
	V/Div	Source V_{PP}	Source frequency	Test result	High limit
	5 mV	40 mV	282.5 MHz		11.55 ps
	10 mV	80 mV	282.5 MHz		6.95 ps
	20 mV	160 mV	282.5 MHz		5.32 ps
	50 mV	400 mV	282.5 MHz		4.69 ps
	Sample rate = 25 GS/s, 10 ns/Div, Source freq = 282.5 MHz, 500 MHz BW, High Res				
	5 mV	40 mV	282.5 MHz		10.85 ps
	10 mV	80 mV	282.5 MHz		6.48 ps
	20 mV	160 mV	282.5 MHz		3.97 ps
	50 mV	400 mV	282.5 MHz		3.23 ps
Channel 8	Sample rate = 25 GS/s, 10 ns/Div, Source freq = 282.5 MHz, 500 MHz BW				
	V/Div	Source V_{PP}	Source frequency	Test result	High limit
	5 mV	40 mV	282.5 MHz		11.55 ps
	10 mV	80 mV	282.5 MHz		6.95 ps
	20 mV	160 mV	282.5 MHz		5.32 ps
	50 mV	400 mV	282.5 MHz		4.69 ps
	Sample rate = 25 GS/s, 10 ns/Div, Source freq = 282.5 MHz, 500 MHz BW, High Res				
	5 mV	40 mV	282.5 MHz		10.85 ps
	10 mV	80 mV	282.5 MHz		6.48 ps
	20 mV	160 mV	282.5 MHz		3.97 ps
	50 mV	400 mV	282.5 MHz		3.23 ps

Delta Time Measurement Accuracy, 350 MHz models					
Performance checks					
350 MHz models (MSO54B, MSO56B, MSO58B)					
Channel 1	Sample rate = 25 GS/s, 10 ns/Div, Source freq = 197.75 MHz, 350 MHz BW				
	V/Div	Source V_{PP}	Source frequency	Test result	High limit
	5 mV	40 mV	197.75 MHz		13.2 ps
	10 mV	80 mV	197.75 MHz		8.65 ps
	20 mV	160 mV	197.75 MHz		6.31 ps
	50 mV	400 mV	197.75 MHz		5.59 ps

Table continued...

Delta Time Measurement Accuracy, 350 MHz models					
	Sample rate = 25 GS/s, 10 ns/Div, Source freq = 197.75 MHz, 350 MHz BW, High Res				
	5 mV	40 mV	197.75 MHz		11.78 ps
	10 mV	80 mV	197.75 MHz		6.84 ps
	20 mV	160 mV	197.75 MHz		4.7 ps
	50 mV	400 mV	197.75 MHz		3.82 ps
Channel 2	Sample rate = 25 GS/s, 10 ns/Div, Source freq = 197.75 MHz, 350 MHz BW				
	V/Div	Source V_{PP}	Source frequency	Test result	High limit
	5 mV	40 mV	197.75 MHz		13.2 ps
	10 mV	80 mV	197.75 MHz		8.65 ps
	20 mV	160 mV	197.75 MHz		6.31 ps
	50 mV	400 mV	197.75 MHz		5.59 ps
	Sample rate = 25 GS/s, 10 ns/Div, Source freq = 197.75 MHz, 350 MHz BW, High Res				
	5 mV	40 mV	197.75 MHz		11.78 ps
	10 mV	80 mV	197.75 MHz		6.84 ps
	20 mV	160 mV	197.75 MHz		4.7 ps
	50 mV	400 mV	197.75 MHz		3.82 ps
Channel 3	Sample rate = 25 GS/s, 10 ns/Div, Source freq = 197.75 MHz, 350 MHz BW				
	V/Div	Source V_{PP}	Source frequency	Test result	High limit
	5 mV	40 mV	197.75 MHz		13.2 ps
	10 mV	80 mV	197.75 MHz		8.65 ps
	20 mV	160 mV	197.75 MHz		6.31 ps
	50 mV	400 mV	197.75 MHz		5.59 ps
	Sample rate = 25 GS/s, 10 ns/Div, Source freq = 197.75 MHz, 350 MHz BW, High Res				
	5 mV	40 mV	197.75 MHz		11.78 ps
	10 mV	80 mV	197.75 MHz		6.84 ps
	20 mV	160 mV	197.75 MHz		4.7 ps
	50 mV	400 mV	197.75 MHz		3.82 ps
Channel 4	Sample rate = 25 GS/s, 10 ns/Div, Source freq = 197.75 MHz, 350 MHz BW				
	V/Div	Source V_{PP}	Source frequency	Test result	High limit
	5 mV	40 mV	197.75 MHz		13.2 ps
	10 mV	80 mV	197.75 MHz		8.65 ps
	20 mV	160 mV	197.75 MHz		6.31 ps
	50 mV	400 mV	197.75 MHz		5.59 ps
	Sample rate = 25 GS/s, 10 ns/Div, Source freq = 197.75 MHz, 350 MHz BW, High Res				
	5 mV	40 mV	197.75 MHz		11.78 ps
	10 mV	80 mV	197.75 MHz		6.84 ps

Table continued...

Delta Time Measurement Accuracy, 350 MHz models						
	20 mV	160 mV	197.75 MHz		4.7 ps	
	50 mV	400 mV	197.75 MHz		3.82 ps	
350 MHz models (MSO56B, MSO58B)						
Channel 5	Sample rate = 25 GS/s, 10 ns/Div, Source freq = 197.75 MHz, 350 MHz BW					
	V/Div	Source V _{PP}	Source frequency	Test result	High limit	
	5 mV	40 mV	197.75 MHz		13.2 ps	
	10 mV	80 mV	197.75 MHz		8.65 ps	
	20 mV	160 mV	197.75 MHz		6.31 ps	
	50 mV	400 mV	197.75 MHz		5.59 ps	
	Sample rate = 25 GS/s, 10 ns/Div, Source freq = 197.75 MHz, 350 MHz BW, High Res					
	5 mV	40 mV	197.75 MHz		11.78 ps	
	10 mV	80 mV	197.75 MHz		6.84 ps	
	20 mV	160 mV	197.75 MHz		4.7 ps	
	50 mV	400 mV	197.75 MHz		3.82 ps	
	Channel 6	Sample rate = 25 GS/s, 10 ns/Div, Source freq = 197.75 MHz, 350 MHz BW				
		V/Div	Source V _{PP}	Source frequency	Test result	High limit
		5 mV	40 mV	197.75 MHz		13.2 ps
10 mV		80 mV	197.75 MHz		8.65 ps	
20 mV		160 mV	197.75 MHz		6.31 ps	
50 mV		400 mV	197.75 MHz		5.59 ps	
Sample rate = 25 GS/s, 10 ns/Div, Source freq = 197.75 MHz, 350 MHz BW, High Res						
5 mV		40 mV	197.75 MHz		11.78 ps	
10 mV		80 mV	197.75 MHz		6.84 ps	
20 mV		160 mV	197.75 MHz		4.7 ps	
50 mV		400 mV	197.75 MHz		3.82 ps	
350 MHz MSO58B models:						
Channel 7		350 MHz MSO58B models:				
		V/Div	Source V _{PP}	Source frequency	Test result	High limit
	5 mV	40 mV	197.75 MHz		13.2 ps	
	10 mV	80 mV	197.75 MHz		8.65 ps	
	20 mV	160 mV	197.75 MHz		6.31 ps	
	50 mV	400 mV	197.75 MHz		5.59 ps	
	Sample rate = 25 GS/s, 10 ns/Div, Source freq = 197.75 MHz, 350 MHz BW, High Res					
	5 mV	40 mV	197.75 MHz		11.78 ps	
	10 mV	80 mV	197.75 MHz		6.84 ps	
	20 mV	160 mV	197.75 MHz		4.7 ps	
	50 mV	400 mV	197.75 MHz		3.82 ps	

Table continued...

Delta Time Measurement Accuracy, 350 MHz models					
Channel 8	Sample rate = 25 GS/s, 10 ns/Div, Source freq = 197.75 MHz, 350 MHz BW				
	V/Div	Source V_{pp}	Source frequency	Test result	High limit
	5 mV	40 mV	197.75 MHz		13.2 ps
	10 mV	80 mV	197.75 MHz		8.65 ps
	20 mV	160 mV	197.75 MHz		6.31 ps
	50 mV	400 mV	197.75 MHz		5.59 ps
	Sample rate = 25 GS/s, 10 ns/Div, Source freq = 197.75 MHz, 350 MHz BW, High Res				
	5 mV	40 mV	197.75 MHz		11.78 ps
	10 mV	80 mV	197.75 MHz		6.84 ps
	20 mV	160 mV	197.75 MHz		4.7 ps
	50 mV	400 mV	197.75 MHz		3.82 ps

Digital Threshold Accuracy, typical						
Performance checks:						
Digital channel	Threshold	V_{s-}	V_{s+}	Low limit	Test result	High limit
All models (MSO54B, MSO56B, MSO58B)						
Channel 1						
D0	0 V			-0.1 V		0.1 V
D1	0 V			-0.1 V		0.1 V
D2	0 V			-0.1 V		0.1 V
D3	0 V			-0.1 V		0.1 V
D4	0 V			-0.1 V		0.1 V
D5	0 V			-0.1 V		0.1 V
D6	0 V			-0.1 V		0.1 V
D7	0 V			-0.1 V		0.1 V
Channel 2						
D0	0 V			-0.1 V		0.1 V
D1	0 V			-0.1 V		0.1 V
D2	0 V			-0.1 V		0.1 V
D3	0 V			-0.1 V		0.1 V
D4	0 V			-0.1 V		0.1 V
D5	0 V			-0.1 V		0.1 V
D6	0 V			-0.1 V		0.1 V
D7	0 V			-0.1 V		0.1 V
Channel 3						
D0	0 V			-0.1 V		0.1 V
D1	0 V			-0.1 V		0.1 V

Table continued...

Digital Threshold Accuracy, typical						
Performance checks:						
Digital channel	Threshold	V _{s-}	V _{s+}	Low limit	Test result	High limit
D2	0 V			-0.1 V		0.1 V
D3	0 V			-0.1 V		0.1 V
D4	0 V			-0.1 V		0.1 V
D5	0 V			-0.1 V		0.1 V
D6	0 V			-0.1 V		0.1 V
D7	0 V			-0.1 V		0.1 V
Channel 4						
D0	0 V			-0.1 V		0.1 V
D1	0 V			-0.1 V		0.1 V
D2	0 V			-0.1 V		0.1 V
D3	0 V			-0.1 V		0.1 V
D4	0 V			-0.1 V		0.1 V
D5	0 V			-0.1 V		0.1 V
D6	0 V			-0.1 V		0.1 V
D7	0 V			-0.1 V		0.1 V

MSO56B, MSO58B models						
Channel 5						
Digital channel	Threshold	V _{s-}	V _{s+}	Low limit	Test result	High limit
D0	0 V			-0.1 V		0.1 V
D1	0 V			-0.1 V		0.1 V
D2	0 V			-0.1 V		0.1 V
D3	0 V			-0.1 V		0.1 V
D4	0 V			-0.1 V		0.1 V
D5	0 V			-0.1 V		0.1 V
D6	0 V			-0.1 V		0.1 V
D7	0 V			-0.1 V		0.1 V
Channel 6						
D0	0 V			-0.1 V		0.1 V
D1	0 V			-0.1 V		0.1 V
D2	0 V			-0.1 V		0.1 V
D3	0 V			-0.1 V		0.1 V
D4	0 V			-0.1 V		0.1 V
D5	0 V			-0.1 V		0.1 V
D6	0 V			-0.1 V		0.1 V
D7	0 V			-0.1 V		0.1 V

Table continued...

MSO58B models					
Channel 7					
D0	0 V			-0.1 V	0.1 V
D1	0 V			-0.1 V	0.1 V
D2	0 V			-0.1 V	0.1 V
D3	0 V			-0.1 V	0.1 V
D4	0 V			-0.1 V	0.1 V
D5	0 V			-0.1 V	0.1 V
D6	0 V			-0.1 V	0.1 V
D7	0 V			-0.1 V	0.1 V
Channel 8					
D0	0 V			-0.1 V	0.1 V
D1	0 V			-0.1 V	0.1 V
D2	0 V			-0.1 V	0.1 V
D3	0 V			-0.1 V	0.1 V
D4	0 V			-0.1 V	0.1 V
D5	0 V			-0.1 V	0.1 V
D6	0 V			-0.1 V	0.1 V
D7	0 V			-0.1 V	0.1 V

DVM voltage accuracy (DC)					
Channel 1					
Vertical Scale	Input Voltage	Offset Voltage	Low limit	Test result	High limit
1	-5	-5	-5.125		-4.875
0.5	-2	-2	-2.06		-1.94
0.5	-1	-0.5	-1.06		-0.94
0.2	-0.5	-0.5	-0.5225		-0.4775
0.01	0.002	0	0.00097		0.00303
0.2	0.5	0.5	0.4775		0.5225
0.5	1	0.5	0.94		1.06
0.5	2	2	1.94		2.06
1	5	5	4.875		5.125
Channel 2					
Vertical Scale	Input Voltage	Offset Voltage	Low limit	Test result	High limit
1	-5	-5	-5.125		-4.875
0.5	-2	-2	-2.06		-1.94
0.5	-1	-0.5	-1.06		-0.94
0.2	-0.5	-0.5	-0.5225		-0.4775

Table continued...

DVM voltage accuracy (DC)					
0.01	0.002	0	0.00097		0.00303
0.2	0.5	0.5	0.4775		0.5225
0.5	1	0.5	0.94		1.06
0.5	2	2	1.94		2.06
1	5	5	4.875		5.125
Channel 3					
Vertical Scale	Input Voltage	Offset Voltage	Low limit	Test result	High limit
1	-5	-5	-5.125		-4.875
0.5	-2	-2	-2.06		-1.94
0.5	-1	-0.5	-1.06		-0.94
0.2	-0.5	-0.5	-0.5225		-0.4775
0.01	0.002	0	0.00097		0.00303
0.2	0.5	0.5	0.4775		0.5225
0.5	1	0.5	0.94		1.06
0.5	2	2	1.94		2.06
1	5	5	4.875		5.125
Channel 4					
Vertical Scale	Input Voltage	Offset Voltage	Low limit	Test result	High limit
1	-5	-5	-5.125		-4.875
0.5	-2	-2	-2.06		-1.94
0.5	-1	-0.5	-1.06		-0.94
0.2	-0.5	-0.5	-0.5225		-0.4775
0.01	0.002	0	0.00097		0.00303
0.2	0.5	0.5	0.4775		0.5225
0.5	1	0.5	0.94		1.06
0.5	2	2	1.94		2.06
1	5	5	4.875		5.125

DVM voltage accuracy (DC)					
Channel 5					
Vertical Scale	Input Voltage	Offset Voltage	Low limit	Test result	High limit
1	-5	-5	-5.125		-4.875
0.5	-2	-2	-2.06		-1.94
0.5	-1	-0.5	-1.06		-0.94
0.2	-0.5	-0.5	-0.5225		-0.4775
0.01	0.002	0	0.00097		0.00303
0.2	0.5	0.5	0.4775		0.5225

Table continued...

DVM voltage accuracy (DC)					
0.5	1	0.5	0.94		1.06
0.5	2	2	1.94		2.06
1	5	5	4.875		5.125
Channel 6					
Vertical Scale	Input Voltage	Offset Voltage	Low limit	Test result	High limit
1	-5	-5	-5.125		-4.875
0.5	-2	-2	-2.06		-1.94
0.5	-1	-0.5	-1.06		-0.94
0.2	-0.5	-0.5	-0.5225		-0.4775
0.01	0.002	0	0.00097		0.00303
0.2	0.5	0.5	0.4775		0.5225
0.5	1	0.5	0.94		1.06
0.5	2	2	1.94		2.06
1	5	5	4.875		5.125

DVM voltage accuracy (DC)					
Channel 7					
Vertical Scale	Input Voltage	Offset Voltage	Low limit	Test result	High limit
1	-5	-5	-5.125		-4.875
0.5	-2	-2	-2.06		-1.94
0.5	-1	-0.5	-1.06		-0.94
0.2	-0.5	-0.5	-0.5225		-0.4775
0.01	0.002	0	0.00097		0.00303
0.2	0.5	0.5	0.4775		0.5225
0.5	1	0.5	0.94		1.06
0.5	2	2	1.94		2.06
1	5	5	4.875		5.125
Channel 8					
Vertical Scale	Input Voltage	Offset Voltage	Low limit	Test result	High limit
1	-5	-5	-5.125		-4.875
0.5	-2	-2	-2.06		-1.94
0.5	-1	-0.5	-1.06		-0.94
0.2	-0.5	-0.5	-0.5225		-0.4775
0.01	0.002	0	0.00097		0.00303
0.2	0.5	0.5	0.4775		0.5225
0.5	1	0.5	0.94		1.06
0.5	2	2	1.94		2.06
1	5	5	4.875		5.125

DVM voltage accuracy (AC)				
All models (MSO54B, MSO56B, MSO58B)				
Channel 1				
Vertical Scale	Input Signal	Low limit	Test result	High limit
5 mV	20 mV _{pp} at 1 kHz	9.800 mV		10.200 mV
10 mV	50 mV _{pp} at 1 kHz	24.5 mV		25.500 mV
100 mV	0.5 V _{pp} at 1 kHz	245.000 mV		255.000 mV
200 mV	1 V _{pp} at 1 kHz	490.000 mV		510.000 mV
1 V	5 V _{pp} at 1 kHz	2.450 V		2.550 V
Channel 2				
Vertical Scale	Input Signal	Low limit	Test result	High limit
5 mV	20 mV _{pp} at 1 kHz	9.800 mV		10.200 mV
10 mV	50 mV _{pp} at 1 kHz	24.5 mV		25.500 mV
100 mV	0.5 V _{pp} at 1 kHz	245.000 mV		255.000 mV
200 mV	1 V _{pp} at 1 kHz	490.000 mV		510.000 mV
1 V	5 V _{pp} at 1 kHz	2.450 V		2.550 V
Channel 3				
Vertical Scale	Input Signal	Low limit	Test result	High limit
5 mV	20 mV _{pp} at 1 kHz	9.800 mV		10.200 mV
10 mV	50 mV _{pp} at 1 kHz	24.5 mV		25.500 mV
100 mV	0.5 V _{pp} at 1 kHz	245.000 mV		255.000 mV
200 mV	1 V _{pp} at 1 kHz	490.000 mV		510.000 mV
1 V	5 V _{pp} at 1 kHz	2.450 V		2.550 V
Channel 4				
Vertical Scale	Input Signal	Low limit	Test result	High limit
5 mV	20 mV _{pp} at 1 kHz	9.800 mV		10.200 mV
10 mV	50 mV _{pp} at 1 kHz	24.5 mV		25.500 mV
100 mV	0.5 V _{pp} at 1 kHz	245.000 mV		255.000 mV
200 mV	1 V _{pp} at 1 kHz	490.000 mV		510.000 mV
1 V	5 V _{pp} at 1 kHz	2.450 V		2.550 V
DVM voltage accuracy (AC)				
MSO56B, MSO58B models				
Channel 5				
Vertical Scale	Input Signal	Low limit	Test result	High limit
5 mV	20 mV _{pp} at 1 kHz	9.800 mV		10.200 mV

Table continued...

DVM voltage accuracy (AC)				
10 mV	50 mV _{pp} at 1 kHz	24.5 mV		25.500 mV
100 mV	0.5 V _{pp} at 1 kHz	245.000 mV		255.000 mV
200 mV	1 V _{pp} at 1 kHz	490.000 mV		510.000 mV
1 V	5 V _{pp} at 1 kHz	2.450 V		2.550 V
Channel 6				
Vertical Scale	Input Signal	Low limit	Test result	High limit
5 mV	20 mV _{pp} at 1 kHz	9.800 mV		10.200 mV
10 mV	50 mV _{pp} at 1 kHz	24.5 mV		25.500 mV
100 mV	0.5 V _{pp} at 1 kHz	245.000 mV		255.000 mV
200 mV	1 V _{pp} at 1 kHz	490.000 mV		510.000 mV
1 V	5 V _{pp} at 1 kHz	2.450 V		2.550 V

DVM voltage accuracy (AC)				
MSO58B models				
Channel 7				
Vertical Scale	Input Signal	Low limit	Test result	High limit
5 mV	20 mV _{pp} at 1 kHz	9.800 mV		10.200 mV
10 mV	50 mV _{pp} at 1 kHz	24.5 mV		25.500 mV
100 mV	0.5 V _{pp} at 1 kHz	245.000 mV		255.000 mV
200 mV	1 V _{pp} at 1 kHz	490.000 mV		510.000 mV
1 V	5 V _{pp} at 1 kHz	2.450 V		2.550 V
Channel 8				
Vertical Scale	Input Signal	Low limit	Test result	High limit
5 mV	20 mV _{pp} at 1 kHz	9.800 mV		10.200 mV
10 mV	50 mV _{pp} at 1 kHz	24.5 mV		25.500 mV
100 mV	0.5 V _{pp} at 1 kHz	245.000 mV		255.000 mV
200 mV	1 V _{pp} at 1 kHz	490.000 mV		510.000 mV
1 V	5 V _{pp} at 1 kHz	2.450 V		2.550 V

Trigger frequency accuracy and trigger frequency counter maximum input frequency				
All models (MSO54B, MSO56B, MSO58B)				
Channel 1				
	Hz	Low limit	Test result	High limit
	100 Hz	99.99974 Hz		100.00026 Hz
	1 kHz	999.9974 Hz		1.000026 KHz
	10 kHz	9.999974 KHz		10.000026 kHz

Table continued...

Trigger frequency accuracy and trigger frequency counter maximum input frequency				
	100 kHz	99.99974 kHz		100.00026 kHz
	1 MHz	999.9974 kHz		1.0000026 MHz
	10 MHz	9.999974 kHz		10.000026 MHz
	100 MHz	99.99974 MHz		100.00026 MHz
	1 GHz (1 GHz models only)	999.9974 MHz		1.0000026 GHz
	2 GHz (2 GHz models only)	1.999994 GHz		2.0000051 GHz
Channel 2				
	Hz	Low limit	Test result	High limit
	100 Hz	99.99974 Hz		100.00026 Hz
	1 kHz	999.9974 Hz		1.0000026 KHz
	10 kHz	9.999974 KHz		10.000026 kHz
	100 kHz	99.99974 kHz		100.00026 kHz
	1 MHz	999.9974 kHz		1.0000026 MHz
	10 MHz	9.999974 kHz		10.000026 MHz
	100 MHz	99.99974 MHz		100.00026 MHz
	1 GHz	999.9974 MHz		1.0000026 GHz
	2 GHz	1.999994 GHz		2.0000051 GHz
Channel 3				
	Hz	Low limit	Test result	High limit
	100 Hz	99.99974 Hz		100.00026 Hz
	1 kHz	999.9974 Hz		1.0000026 KHz
	10 kHz	9.999974 KHz		10.000026 kHz
	100 kHz	99.99974 kHz		100.00026 kHz
	1 MHz	999.9974 kHz		1.0000026 MHz
	10 MHz	9.999974 kHz		10.000026 MHz
	100 MHz	99.99974 MHz		100.00026 MHz
	1 GHz	999.9974 MHz		1.0000026 GHz
	2 GHz	1.999994 GHz		2.0000051 GHz
Channel 4				
	Hz	Low limit	Test result	High limit
	100 Hz	99.99974 Hz		100.00026 Hz
	1 kHz	999.9974 Hz		1.0000026 KHz
	10 kHz	9.999974 KHz		10.000026 kHz
	100 kHz	99.99974 kHz		100.00026 kHz
	1 MHz	999.9974 kHz		1.0000026 MHz
	10 MHz	9.999974 kHz		10.000026 MHz

Table continued...

Trigger frequency accuracy and trigger frequency counter maximum input frequency				
	100 MHz	99.99974 MHz		100.00026 MHz
	1 GHz	999.9974 MHz		1.0000026 GHz
	2 GHz	1.999994 GHz		2.0000051 GHz

Trigger frequency accuracy and trigger frequency counter maximum input frequency				
MSO56B, MSO58B models				
Channel 5				
	Hz	Low limit	Test result	High limit
	100 Hz	99.99974 Hz		100.00026 Hz
	1 kHz	999.9974 Hz		1.0000026 KHz
	10 kHz	9.999974 KHz		10.000026 kHz
	100 kHz	99.99974 kHz		100.00026 kHz
	1 MHz	999.9974 kHz		1.0000026 MHz
	10 MHz	9.999974 kHz		10.000026 MHz
	100 MHz	99.99974 MHz		100.00026 MHz
	1 GHz	999.9974 MHz		1.0000026 GHz
	2 GHz	1.999994 GHz		2.0000051 GHz
Channel 6				
	Hz	Low limit	Test result	High limit
	100 Hz	99.99974 Hz		100.00026 Hz
	1 kHz	999.9974 Hz		1.0000026 KHz
	10 kHz	9.999974 KHz		10.000026 kHz
	100 kHz	99.99974 kHz		100.00026 kHz
	1 MHz	999.9974 kHz		1.0000026 MHz
	10 MHz	9.999974 kHz		10.000026 MHz
	100 MHz	99.99974 MHz		100.00026 MHz
	1 GHz	999.9974 MHz		1.0000026 GHz
	2 GHz	1.999994 GHz		2.0000051 GHz

Trigger frequency accuracy and trigger frequency counter maximum input frequency				
MSO58B models				
Channel 7				
	Hz	Low limit	Test result	High limit
	100 Hz	99.99974 Hz		100.00026 Hz
	1 kHz	999.9974 Hz		1.0000026 KHz
	10 kHz	9.999974 KHz		10.000026 kHz
	100 kHz	99.99974 kHz		100.00026 kHz
	1 MHz	999.9974 kHz		1.0000026 MHz

Table continued...

Trigger frequency accuracy and trigger frequency counter maximum input frequency				
	10 MHz	9.999974 kHz		10.000026 MHz
	100 MHz	99.99974 MHz		100.00026 MHz
	1 GHz	999.9974 MHz		1.0000026 GHz
	2 GHz	1.999994 GHz		2.0000051 GHz
Channel 8				
	Hz	Low limit	Test result	High limit
	100 Hz	99.99974 Hz		100.00026 Hz
	1 kHz	999.9974 Hz		1.0000026 KHz
	10 kHz	9.999974 KHz		10.000026 kHz
	100 kHz	99.99974 kHz		100.00026 kHz
	1 MHz	999.9974 kHz		1.0000026 MHz
	10 MHz	9.999974 kHz		10.000026 MHz
	100 MHz	99.99974 MHz		100.00026 MHz
	1 GHz	999.9974 MHz		1.0000026 GHz
	2 GHz	1.999994 GHz		2.0000051 GHz

AFG sine and ramp frequency accuracy				
Performance checks				
	Waveform type	Minimum	Test result	Maximum
	Sine	0.999950 MHz		1.000050 MHz
	Ramp	499.975 kHz		500.025 kHz

AFG square and pulse frequency accuracy				
Performance checks				
	Waveform type	Minimum	Test result	Maximum
	Square	0.999950 MHz		1.000050 MHz
	Pulse	0.999950 MHz		1.000050 MHz

AFG signal amplitude accuracy				
Performance checks				
	Amplitude	Minimum	Test result	Maximum
	30.0 mV _{PP}	28.55 mV _{PP}		31.45 mV _{PP}
	300.0 mV _{PP}	294.5 mV _{PP}		305.5 mV _{PP}
	800.0 mV _{PP}	787.0 mV _{PP}		813.0 mV _{PP}
	1.500 V _{PP}	1.4765 V _{PP}		1.5235 V _{PP}
	2.000 V _{PP}	1.9690 V _{PP}		2.0310 V _{PP}
	2.500 V _{PP}	2.4615 V _{PP}		2.5385 V _{PP}

AFG DC offset accuracy				
Performance checks				
	Offset	Minimum	Test result	Maximum
	1.25 V	1.23025 Vdc		1.26975 Vdc
	0 V	- 0.001 Vdc		+ 0.001 Vdc
	-1.25 V	- 1.26975 Vdc		- 1.23025 Vdc

Performance tests

This section contains a collection of manual procedures for checking that the instrument performs as warranted. They check all the characteristics that are designated as checked in *Specifications*. (The characteristics that are checked appear with a ✓ in *Specifications*).

Prerequisites

The tests in this section comprise an extensive, valid confirmation of performance and functionality when the following requirements are met:

- The instrument must be in its normal operating configuration (no covers removed).
- You must have performed and passed the procedures under *Self Test*. (See [Self test](#) on page 167.)
- A signal-path compensation must have been done within the recommended calibration interval and at a temperature within ± 5 °C (± 9 °F) of the present operating temperature. (If the temperature was within the limits just stated at the time you did the prerequisite *Self Test*, consider this prerequisite met). A signal-path compensation must have been done at an ambient humidity within 25% of the current ambient humidity and after having been at that humidity for at least 4 hours.
- The instrument must have been last adjusted at an ambient temperature between +18 °C and +28 °C (+64 °F and +82 °F), must have been operating for a warm-up period of at least 20 minutes, and must be operating at an ambient temperature as listed in the specifications. The warm-up requirement is usually met in the course of meeting the *Self Test* prerequisites listed above.
- The instrument must be powered from a source maintaining voltage and frequency within the limits described in the *Specifications* section.
- The instrument must be in an environment with temperature, altitude, humidity, and vibration within the operating limits described in the *Specifications* section.

Self test

This procedure verifies that the instrument passes the internal diagnostics and performs signal path compensation. No test equipment or hookups are required.

Equipment required	Prerequisites
None	Power on the instrument and allow a 20 minute warm-up period before performing this procedure.

1. Run the System Diagnostics (may take a few minutes).
 - a. Disconnect all probes and/or cables from the oscilloscope inputs.
 - b. Tap **Utility > Self Test**. This displays the **Self Test** configuration menu.
 - c. Tap the **Run Self Test** button.

- d. The internal diagnostics perform an exhaustive verification of proper instrument function. This verification may take several minutes. When the verification is finished, the status of each self test is shown in the menu.
 - e. Verify that the status of all tests is passed.
 - f. Tap anywhere outside the menu to exit the menu.
2. Run the signal-path compensation routine (may take 5 to 15 minutes per channel).
 - a. Tap **Utility > Calibration**. This displays the **Calibration** configuration menu.
 - b. Tap the **Run SPC** button to start the routine.
 - c. Signal-path compensation may take 5 to 15 minutes to run per channel.
 - d. Verify that the **SPC Status** is **Passed**.
3. Return to regular service: Tap anywhere outside the menu to exit the **Calibration** menu.

The self test procedures are completed. If any of the above tests failed, run the tests again. If there are still failures, contact Tektronix Customer Support.



Note: You cannot run the remaining performance tests until the self tests pass and the SPC has successfully run.

Check input impedance

This test checks the input impedance on all channels.

1. Connect the output of the oscilloscope calibrator (for example, Fluke 9500) to the oscilloscope channel 1 input, as shown in the following illustration.



WARNING: Be sure to set the generator to Off or 0 volts before connecting, disconnecting, and/or moving the test hookup during the performance of this procedure. The generator is capable of providing dangerous voltages.



Note: Impedance measuring equipment that produces a voltage across the channel that exceeds the measurement range of the instrument may report erroneous impedance results. A measurement voltage exceeds the measurement range of the instrument when the resulting trace is not visible on the graticule.

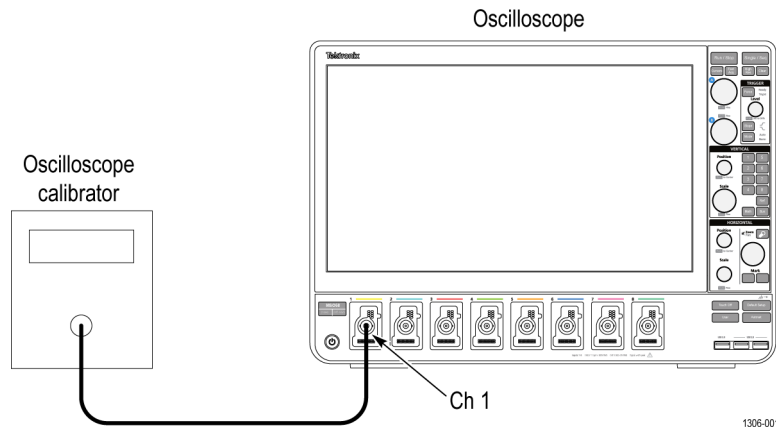

2. Set the calibrator to measure 1 M Ω impedance.
3. Tap **File > Default Setup**.
4. Test 1 M Ω input impedance.
 - a. Tap the channel 1 button on the Settings bar.
 - b. Double tap the **Ch 1** badge to open its menu.
 - c. Set **Termination** to **1 M Ω** .
 - d. Set the **Vertical Scale** to the value to test in the test record (first value is **10 mV/div**).
5. Use the calibrator to measure the input impedance of the oscilloscope and enter the value in the test record.
6. Repeat steps 4.d on page 161 and 5 on page 161 for all vertical scale settings in the test record for the channel.
7. Test 50 Ω input impedance as follows:
 - a. Set the calibrator impedance to measure 50 Ω impedance.
 - b. Double-tap the **Ch 1** badge and set **Termination** to **50 Ω** .
 - c. Repeat steps 4.d on page 161 through 6 on page 161 for all vertical scale settings in the test record for the channel.
8. Repeat the procedures for all remaining channels.
 - a. Turn the calibrator output Off.
 - b. Move the calibrator connection to the next channel to test.
 - c. Double-tap the channel badge of the channel that you have finished testing and set **Display** to **Off**.
 - d. Tap the channel button on the Settings bar of the next channel to test.
 - e. Starting from step 2 on page 161, repeat the procedures until all channels have been tested.

Check DC balance

This test checks the DC balance. You do not need to connect any test equipment (other than the 50 Ω terminator) to the oscilloscope to perform this check.

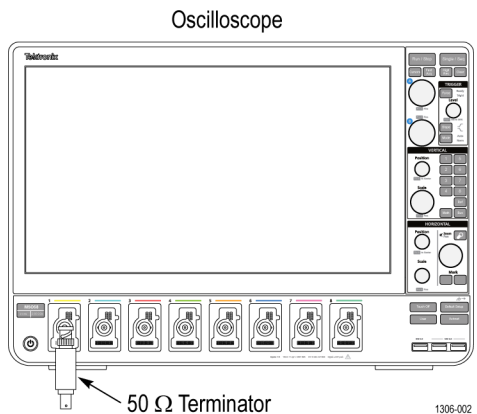

1. Attach a 50 Ω terminator to the oscilloscope channel 1 input.
2. Tap **File > Default Setup**.
3. Double-tap the **Horizontal** badge on the Settings bar and set the **Horizontal Scale** to **1 ms/div**.
4. Tap the channel 1 button on the oscilloscope Settings bar to display a channel badge.
5. Double tap the **Ch 1** badge to open its menu.
6. Set the **Vertical Scale** to **1 mV/div**.
7. Set the channel 1 **Termination** to **50 Ω** .
8. Tap the **Bandwidth Limit** field and select **20 MHz**.
9. Tap outside the menu to close it.
10. Double-tap the **Acquisition** badge and set the **Acquisition Mode** to **Average**.
11. Set the **Number of Waveforms** to **16**.
12. Tap outside the menu to close it.
13. Double-tap the **Trigger** badge and set the **Source** to **AC line**.
14. Tap outside the menu to close it.
15. Add a Mean amplitude measurement for channel 1 to the Results bar:
 - a. Tap the **Add New... Measure** button to open the **Add Measurements** menu.
 - b. Set the **Source** to **Ch 1**.
 - c. In the **Amplitude Measurements** panel, double-tap the **Mean** button to add the **Mean** measurement badge to the Results bar.
16. Tap outside the menu to close it.
17. Double-tap the **Mean** results badge.
18. Tap **Show Statistics in Badge**.
19. Tap **FILTER/LIMIT RESULTS** to open the panel.
20. Tap **Limit Measurement Population** to toggle it to **On**.
21. Tap outside the menu to close it.
22. Enter the mean value as the test result in the test record.
23. Repeat steps 6 on page 162 through 22 on page 162 for each vertical scale setting in the test record.
24. Repeat steps 3 on page 162 through 23 on page 162 for each bandwidth setting in the test record table.
25. Repeat the channel tests at 1 M Ω impedance as follows:

-
- a. Double-tap the channel 1 badge.
 - b. Set the **Termination** to **1M Ω** .
 - c. Repeat steps 8 on page 162 through 24 on page 162.
26. Repeat the procedure for all remaining channels as follows:
- a. Move the 50 Ω terminator to the next channel input to be tested.
 - b. Double-tap the channel badge of the channel that you have finished testing and set **Display** to **Off**.
 - c. Tap the channel button on the Settings bar of the next channel to test.
 - d. Starting from step 6 on page 162, repeat the procedures until all channels have been tested. To change the source for the Mean measurement for each channel test:
 - i. Double-tap the **Mean** measurement badge.
 - ii. Tap the **Configure** panel.
 - iii. Tap the **Source 1** field and select the next channel to test.
27. Tap outside the menu area to close the configuration menu.

Check DC gain accuracy

This test checks the DC gain accuracy

1. Connect the oscilloscope to a calibrated DC voltage source. If you are using the Fluke 9500 calibrator, connect the calibrator head to the oscilloscope channel to test.

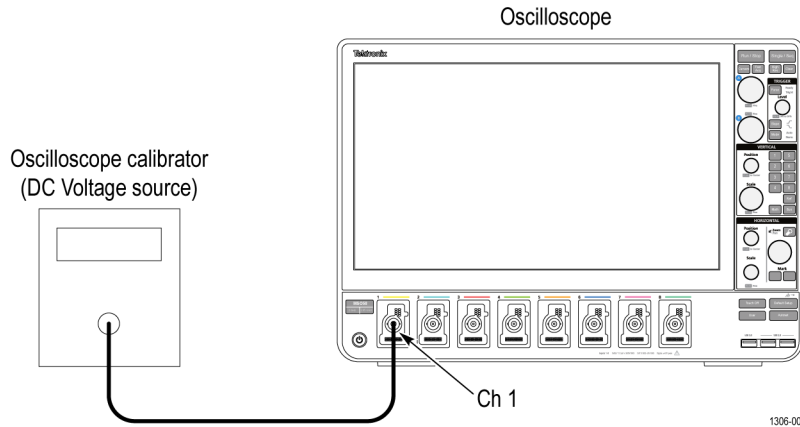

WARNING: Set the generator output to Off or 0 volts before connecting, disconnecting, and/or moving the test hookup during the performance of this procedure. The generator is capable of providing dangerous voltages.

2. Tap **File > Default Setup**.
3. Double-tap the **Acquisition** badge and set **Acquisition Mode** to **Average**.
4. Set the **Number of Waveforms** to **16**.
5. Tap outside the menu to close the menu.
6. Double-tap the **Trigger** badge and set the trigger **Source** to **AC line**.
7. Tap outside the menu to close it.
8. Add the **Mean** measurement to the Results bar:
 - a. Tap the **Add New... Measure** button to open the **Add Measurements** menu.
 - b. Set the **Source** to **Ch 1**.
 - c. In the **Amplitude Measurements** panel, double-tap the **Mean** button to add the Mean measurement badge to the Results bar.
9. Tap outside the menu to close it.
10. Double-tap the **Mean** results badge.
11. Tap **Show Statistics in Badge**.
12. Tap **FILTER/LIMIT RESULTS** to open the panel.
13. Tap **Limit Measurement Population** to toggle it to **On**.
14. Tap outside the menu to close it.
15. Tap the channel button of the channel to test, to add the channel badge to the Settings bar.
16. Double tap the channel to test badge to open its menu and set the channel settings:
 - a. Set **Vertical Scale** to **1 mV/div**.
 - b. Set **Termination** to **50 Ω**.
 - c. Tap **Bandwidth Limit** and set to **20 MHz**.
 - d. Tap outside the menu to close it.
17. Record the negative-measured and positive-measured mean readings in the *Expected gain worksheet* as follows:
 - a. On the calibrator, set the DC Voltage Source to the V_{negative} value as listed in the 1 mV row of the worksheet.
 - b. Double-tap the **Acquisition** badge and tap **Clear** to reset the measurement statistics.

- c. Enter the **Mean** reading in the worksheet as $V_{\text{negative-measured}}$.
- d. On the calibrator, set the DC Voltage Source to V_{positive} value as listed in the 1 mV row of the worksheet.
- e. Double-tap the **Acquisition** badge (if not open) and tap **Clear**.
- f. Enter the **Mean** reading in the worksheet as $V_{\text{positive-measured}}$.

Table 2: Expected gain worksheet

Oscilloscope vertical scale setting	$V_{\text{diffExpected}}$	V_{negative}	V_{positive}	$V_{\text{negative-measured}}$	$V_{\text{positive-measured}}$	V_{diff}	Test result (Gain accuracy)
1 mV/div	9 mV	-4.5 mV	+4.5 mV				
2 mV/div	18 mV	-9 mV	+9 mV				
5 mV/div	45 mV	-22.5 mV	+22.5 mV				
10 mV/div	90 mV	-45 mV	+45 mV				
20 mV/div	180 mV	-90 mV	+90 mV				
50 mV/div	450 mV	-225 mV	+225 mV				
100 mV/div	900 mV	-450 mV	+450 mV				
200 mV/div	1800 mV	-900 mV	+900 mV				
500 mV/div	4900 mV	-2450 mV	+2450 mV				
1.0 V/div	9000 mV	-4500 mV	+4500 mV				
20 mV/div at 250 MHz	180 mV	-90 mV	+90 mV				
20 mV/div at Full BW	180 mV	-90 mV	+90 mV				

18. Calculate Gain Accuracy as follows:
- a. Calculate V_{diff} as follows:

$$V_{\text{diff}} = | V_{\text{negative-measured}} - V_{\text{positive-measured}} |$$
 - b. Enter V_{diff} in the worksheet.
 - c. Calculate *Gain Accuracy* as follows:

$$\text{Gain Accuracy} = ((V_{\text{diff}} - V_{\text{diffExpected}}) / V_{\text{diffExpected}}) \times 100\%$$
 - d. Enter the *Gain Accuracy* value in the worksheet and in the test record.
19. Repeat steps 16 on page 164 through 18 on page 165 for all vertical scale settings in the work sheet and the test record.
20. Repeat tests at 1 M Ω impedance as follows:
- a. Set the calibrator to 0 volts and 1 M Ω output impedance.
 - b. Double-tap the badge of the channel being tested.
 - c. Set the **Termination** to 1 M Ω .

- d. Repeat steps 16 on page 164 through 19 on page 165 for all vertical scale settings in the test record.
21. Repeat the procedure for all remaining channels:
 - a. Set the calibrator to 0 volts and 50 Ω output impedance.
 - b. Move the calibrator output to the next channel input to be tested.
 - c. Double-tap the channel badge of the channel that you have finished testing and set **Display** to **Off**.
 - d. Double-tap the **Mean** measurement badge.
 - e. Tap the **Configure** panel.
 - f. Tap the **Source 1** field and select the next channel to test.
 - g. Starting from step 16 on page 164, set the values from the test record for the channel under test, and repeat the above steps until all channels have been tested.
22. Touch outside a menu to close the menu.

Check DC offset accuracy

This test checks the offset accuracy at 50 Ω and 1 M Ω input impedance.

1. Connect the oscilloscope to a calibrated DC voltage source. If you are using the Fluke 9500B calibrator as the DC voltage source, connect the calibrator head to the oscilloscope channel 1.

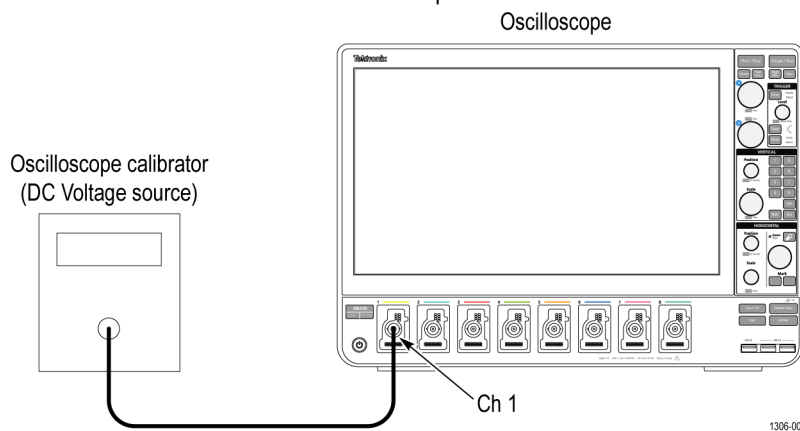

WARNING: Set the generator output to Off or 0 volts before connecting, disconnecting, or moving the test hookup during the performance of this procedure. The generator is capable of providing dangerous voltages.

2. Tap **File > Default Setup**.
3. Double-tap the **Acquisition** badge and set **Acquisition Mode** to **Average**.
4. Set the **Number of Waveforms** to **16**.
5. Tap outside the menu to close the menu.
6. Double-tap the **Trigger** badge and set the trigger **Source** to **AC line**.
7. Add the **Mean** measurement to the Results bar:
 - a. Tap the **Add New... Measure** button to open the **Add Measurements** menu.
 - b. Set the **Source** to **Ch 1**.
 - c. In the **Amplitude Measurements** panel, double-tap the **Mean** button to add the Mean measurement badge to the Results bar.
8. Tap outside the menu to close it.
9. Double-tap the **Mean** results badge.
10. Tap **Show Statistics in Badge**.
11. Tap **FILTER/LIMIT RESULTS** to open the panel.

12. Tap **Limit Measurement Population** to toggle it to **On**.
13. Tap outside the menu to close it.
14. Tap the channel button (starting with channel 1) on the Settings bar to add the channel under test to the Settings bar.
15. Double-tap the channel under test badge to open its configuration menu and change the vertical settings:
 - a. Set **Vertical Scale** to **1 mV/div**.
 - b. Set **Offset** to **900 mV**.
 - c. Set **Position** to 0 by tapping **Set to 0**.
 - d. Set **Termination** to **50 Ω**.
 - e. Tap **Bandwidth Limit** and set to **20 MHz**.
 - f. Tap outside the menu to close it.
16. Set the calibrator output to **+900 mV**, as shown in the test record, and turn the calibrator output On.
17. Enter the Mean measurement value in the test record.
18. Double-tap the channel under test badge to open its configuration menu and change the **Offset** to **-900 mV**.
19. Set the calibrator output to **-900 mV**, as shown in the test record.
20. Enter the Mean measurement value in the test record.
21. Repeat step 15 on page 167 through 20 on page 167, changing the channel vertical settings and the calibrator output as listed in the test record for the channel under test.
22. Repeat the channel tests at 1 MΩ impedance.
 - a. Set the calibrator output to Off or 0 volts.
 - b. Change the calibrator impedance to **1 MΩ** and voltage to **+900 mV**.
 - c. Turn the calibrator output On.
 - d. Repeat steps 15 on page 167 through 20 on page 167, changing the channel **Termination** to **1 MΩ** and the vertical Offset value and the calibrator output as listed in the 1 MΩ test record for the channel under test.
23. Repeat the procedure for all remaining channels.
 - a. Double-tap the **Mean** measurement badge.
 - b. Tap the **Configure** panel.
 - c. Tap the **Source 1** field and select the next channel to test.
 - d. Set the calibrator to **0** volts and **50 Ω** output impedance.
 - e. Move the calibrator output to the next channel input to test.
 - f. Double-tap the channel badge of the channel that you have finished testing and set **Display** to **Off**.
 - g. Tap the channel button on the oscilloscope Settings bar of the next channel to test.
 - h. Starting from step 2 on page 166, repeat the procedure until all channels have been tested.

Check analog bandwidth

This test checks the bandwidth at 50 Ω and 1 M Ω terminations for each channel. The typical bandwidth at 1 M Ω termination is checked on the products as a functional check.

1. Connect the output of the calibrated leveled sine wave generator to the oscilloscope channel 1 input as shown in the following illustration.

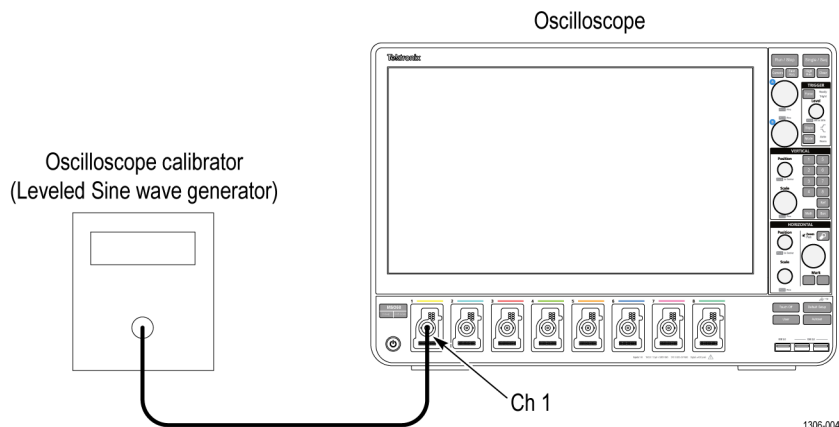

WARNING: Set the generator to off or 0 volts before connecting, disconnecting, and/or moving the test hookup during the performance of this procedure. The generator is capable of providing dangerous voltages.

2. Tap **File > Default Setup** to reset the instrument and add the channel 1 badge and signal to the display.
3. Add the peak-to-peak measurement.
 - a. Tap the **Add New. Measure** button.
 - b. Set the **Source** to the channel under test.
 - c. In the **Amplitude Measurements** panel, double-tap the **Peak-to-Peak** measurement button to add the measurement badge to the Results bar.
 - d. Tap outside the menu to close it.
 - e. Double-tap the **Peak-to-Peak** results badge.
 - f. Tap **Show Statistics in Badge**.
 - g. Tap **FILTER/LIMIT RESULTS** to open the panel.
 - h. Tap **Limit Measurement Population** to toggle it to **On**.
 - i. Tap outside the menu to close it.
4. Set the channel under test settings:
 - a. Double-tap the badge of the channel under test to open its configuration menu.
 - b. Set **Vertical Scale** to **1 mV/div**.
 - c. Set **Termination** to **50 Ω** .
 - d. Tap outside the menu to close it.
5. Adjust the leveled sine wave signal source to display a waveform of 8 vertical divisions at the selected vertical scale with a set frequency of **10 MHz**. For example, at 5 mV/div, use a ≥ 40 mV_{p-p} signal; at 2 mV/div, use a ≥ 16 mV_{p-p} signal.



Note: At some V/div settings, the generator may not provide 8 vertical divisions of signal. Set the generator output to obtain as many vertical divisions of signal as possible.

6. Double-tap the **Horizontal** badge in the Settings bar.
7. Set the **Horizontal Scale** to **1 ms/division**.
8. Tap outside the menu to close it.

9. Record the **Peak-to-Peak** measurement in the V_{in-pp} entry of the test record.
10. Double-tap the **Horizontal** badge in the Settings bar.
11. Set the **Horizontal Scale** to **4 ns/division**.
12. Adjust the signal source to the maximum bandwidth frequency for the bandwidth and model being tested, as shown in [Table 3](#) on page 169.
13. Record the peak-to-peak measurement.
 - a. Record the **Peak-to-Peak** measurement at the new frequency in the V_{bw-pp} entry of the test record.



Note: For more information on the contents of this table, refer to the bandwidth specifications.

Table 3: Maximum bandwidth frequency worksheet

Impedance	Vertical Scale	Maximum bandwidth
2 GHz models		
50 Ω	10 mV/div - 1 V/div	2 GHz
	5 mV/div - 9.95 mV/div	1.5 GHz
	2 mV/div - 4.98 mV/div	350 MHz
	1 mV/div - 1.99 mV/div	175 MHz
1 M Ω	5 mV/div - 1 V/div	500 MHz, typical
	2 mV/div - 4.98 mV/div	500 MHz, typical
	1 mV/div - 1.99 mV/div	500 MHz, typical
1 GHz models		
50 Ω	5 mV/div - 1 V/div	1 GHz
	2 mV/div - 4.98 mV/div	1 GHz
	1 mV/div - 1.99 mV/div	1 GHz
1 M Ω	5 mV/div - 1 V/div	500 MHz, typical
	2 mV/div - 4.98 mV/div	500 MHz, typical
	1 mV/div - 1.99 mV/div	500 MHz, typical
500 MHz models		
50 Ω	5 mV/div - 1 V/div	500 MHz
	2 mV/div - 4.98 mV/div	500 MHz
	1 mV/div - 1.99 mV/div	500 MHz
1 M Ω	5 mV/div - 1 V/div	500 MHz, typical
	2 mV/div - 4.98 mV/div	500 MHz, typical
	1 mV/div - 1.99 mV/div	500 MHz, typical
350 MHz models		
50 Ω	2 mV/div - 1 V/div	350 MHz
	1 mV/div - 1.99 mV/div	350 MHz
1 M Ω	5 mV/div - 1 V/div	350 MHz, typical
	2 mV/div - 4.98 mV/div	350 MHz, typical
	1 mV/div - 1.99 mV/div	350 MHz, typical

14. Use the values of V_{bw-pp} and V_{in-pp} recorded in the test record, and the following equation, to calculate the Gain at bandwidth:
 $Gain = V_{bw-pp} / V_{in-pp}$.
To pass the performance measurement test, Gain should be ≥ 0.707 . Enter *Gain* in the test record.
15. Repeat steps 4 on page 168 through 14 on page 170 for all combinations of Vertical Scale and Horizontal Scale settings listed in the test record.
16. Repeat the tests at 1 M Ω impedance.
 - a. Set the calibrator output to Off or 0 volts.
 - b. Change the calibrator impedance to **1 M Ω** .
 - c. Double-tap the badge of the channel under test to open its menu.
 - d. Set the **Termination** to **1 M Ω** .
 - e. Repeat steps 4 on page 168 through 16 on page 170, but leave the termination set to **1 M Ω** .
17. Repeat the test for all remaining channels.
 - a. Set the calibrator to **0** volts and **50 Ω** output impedance.
 - b. Move the calibrator output to the next channel input to be tested.
 - c. Double-tap the channel badge of the channel that you have finished testing and set **Display** to **Off**.
 - d. Tap the channel button on the oscilloscope Settings bar of the next channel to test.
 - e. Double-tap the **Peak-to-Peak** measurement badge.
 - f. Tap the **Configure** panel.
 - g. Tap the **Source 1** field and select the next channel to test.
 - h. Starting from step 4 on page 168, repeat the procedure until all channels have been tested.

Check random noise, sample acquisition mode

This test checks random noise at 1 M Ω and 50 Ω for each channel, in Sample acquisition mode. You do not need to connect any test equipment to the oscilloscope for this test.

1. Disconnect everything from the oscilloscope inputs.
2. Tap **File > Default Setup**.
3. Add the **AC RMS** measurement:
 - a. Tap the **Add New... Measure** button.
 - b. Set the **Source** to the channel being tested.
 - c. In the **Amplitude Measurements** panel, double-tap the **AC RMS** measurement button to add the measurement badge to the Results bar.
 - d. Tap outside the menu to close it.
 - e. Double-tap the **AC RMS** measurement badge and tap **Show Statistics in Badge** to display statistics in the measurement badge.
 - f. Tap the **Filter / Limit Results** panel.
 - g. Turn on **Limit Measurement Population**.
 - h. Set the limit to **100**.
 - i. Tap outside the menu to close it.
4. Set up the Horizontal mode:
 - a. Double-tap the **Horizontal** setting badge.
 - b. Set **Horizontal Mode** to **Manual**.
 - c. Set the **Sample Rate** to **6.25 GS/s**.

- d. Set the **Record Length** to **2 Mpts**.
- e. Tap outside the menu to close it.
5. Double-tap the Channel badge of the channel being tested.
6. Set the **Vertical Scale** value to **1 mV**.
7. Check **1 M Ω** termination.
 - a. In the Channel badge menu, tap **1 M Ω** termination.
 - b. Tap the **Bandwidth Limit** field and select the highest frequency listed.
 - c. Set the channel **Position** value to **340 mdivs**.
 - d. Once the measurement count (N) in the AC RMS measurement badge reaches 100, record the AC RMS Mean value (the μ readout).
 - e. Set the channel vertical **Position** value to **360 mdivs**.
 - f. Once the measurement count (N) in the measurement badge reaches 100, record the AC RMS Mean value (the μ readout).
 - g. Average the two values and record the result in the **1 mV/div > Full** row of the **1 M Ω** column of the Test Result record.
 - h. In the channel badge menu, tap the **Bandwidth Limit** field and select **250 MHz**.
 - i. Set the channel vertical **Position** value to **340 mdivs**.
 - j. Once the measurement count (N) in the measurement badge reaches 100, record the AC RMS Mean value (the μ readout).
 - k. Set the channel vertical Position value to **360 mdivs**.
 - l. Once the measurement count (N) in the measurement badge reaches 100, record the AC RMS Mean value (the μ readout).
 - m. Average the two values and record the result in the **1 mV/div > 250MHz limit** row of the **1 M Ω** column of the Test Result record.
 - n. Tap the **Bandwidth Limit** field and select **20 MHz**.
 - o. Set the channel vertical **Position** value to **340 mdivs**.
 - p. Once the measurement count (N) in the measurement badge reaches 100, record the AC RMS Mean value (the μ readout).
 - q. Set the channel vertical **Position** value to **360 mdivs**.
 - r. Once the measurement count (N) in the measurement badge reaches 100, record the AC RMS Mean value (the μ readout).
 - s. Average the two values and record the result in the **1 mV/div > 20MHz limit** row of the **1 M Ω** column of the Test Result record.
8. Check **50 Ω** termination.
 - a. In the Channel badge, set **Termination** to **50 Ω** .
 - b. Tap the **Bandwidth Limit** field and select the highest frequency listed.
 - c. Set the channel vertical Position value to **340 mdivs**.
 - d. Once the measurement count (N) in the measurement badge reaches 100, record the AC RMS Mean value (the μ readout).
 - e. Set the channel vertical Position value to **360 mdivs**.
 - f. Once the measurement count (N) in the measurement badge reaches 100, record the AC RMS Mean value (the μ readout).
 - g. Average the two values and record the result in the **1 mV/div > Full** row of the **50 Ω** column of the Test Result record.
 - h. Tap the **Bandwidth Limit** field and select **250 MHz**.
 - i. Set the channel vertical **Position** value to **340 mdivs**.
 - j. Once the measurement count (N) in the measurement badge reaches 100, record the AC RMS Mean value (the μ readout).
 - k. Set the channel vertical **Position** value to **360 mdivs**.
 - l. Once the measurement count (N) in the measurement badge reaches 100, record the AC RMS Mean value (the μ readout).
 - m. Average the two values and record the result in the **1 mV/div > 250MHz limit** row of the **50 Ω** column of the Test Result record.
 - n. Tap the **Bandwidth Limit** field and select **20 MHz**.
 - o. Set the channel vertical **Position** value to **340 mdivs**.
 - p. Once the measurement count (N) in the measurement badge reaches 100, record the AC RMS Mean value (the μ readout).
 - q. Set the channel vertical **Position** value to **360 mdivs**.

- r. Once the measurement count (N) in the measurement badge reaches 100, record the AC RMS Mean value (the μ readout).
 - s. Average the two values and record the result in the **1 mV/div > 20MHz limit** row of the **50 Ω** column of the Test Result record.
9. Repeat 1 M Ω and 50 Ω tests at all V/div settings for the current channel.
 - a. In the Channel badge, set the **Vertical Scale** setting to the next value in the test record (2 mV, 5 mV, and so on, up to 1 V/div).
 - b. Repeat steps 7 on page 171 through 8 on page 171.
 10. Repeat all tests for the remaining input channels.
 - a. Double-tap the **AC RMS** measurement badge.
 - b. Tap the **Configure** panel.
 - c. Tap the **Source 1** field and select the next channel to test.
 - d. Double-tap the channel badge of the channel that you have finished testing and set **Display** to **Off**.
 - e. Tap the channel button on the oscilloscope Settings bar of the next channel to test.
 - f. Double-tap the channel badge for the channel being tested.
 - g. Starting at step 6 on page 171, repeat these procedures for each input channel.

Check random noise, High Res mode

This test checks random noise at 1 M Ω and 50 Ω for each channel in High Res acquisition mode. You do not need to connect any test equipment to the oscilloscope for this test.

1. Disconnect everything from the oscilloscope inputs.
2. Tap **File > Default Setup**.
3. Double-tap the **Acquisition** badge and set **Acquisition Mode** to **High Res**.
4. Add the **AC RMS** measurement:
 - a. Tap the **Add New... Measure** button to open the **Add Measurements** menu.
 - b. Set the **Source** to the channel being tested.
 - c. In the **Amplitude Measurements** panel, double-tap the **AC RMS** button to add the measurement badge to the Results bar.
 - d. Tap outside the menu to close it.
 - e. Double-tap the **AC RMS** measurement badge and tap **Show Statistics in Badge** to display statistics in the measurement badge.
 - f. Tap the **Filter/Limit Results** panel.
 - g. Turn on **Limit Measurement Population**.
 - h. Set the limit to **100**.
 - i. Tap outside the menu to close it.
5. Set up the Horizontal mode:
 - a. Double-tap the **Horizontal** setting badge.
 - b. Set Horizontal Mode to **Manual**.
 - c. Set the Sample rate to **6.25 GS/s**.
 - d. Set the Record Length to **2 Mpts**.
 - e. Tap outside the menu to close it.
6. Check **1 M Ω termination** as follows:
 - a. Double-tap the Channel badge of the channel being tested.
 - b. Set the **Vertical Scale** value to **1 mV**.
 - c. Set **Termination** to **1 M Ω** .
 - d. Tap the **Bandwidth Limit** field and select the highest frequency listed.

- e. Set the channel **Position** value to **340 mdivs**.
 - f. Once the measurement count (N) in the measurement badge reaches 100, record the AC RMS Mean value (the μ readout).
 - g. Set the channel **Position** value to **-340 mdivs**.
 - h. Once the measurement count (N) in the measurement badge reaches 100, record the AC RMS Mean value (the μ readout).
 - i. Average the two values and record the result in the **1 mV/div > Full** row of the **1 M Ω** column of the random noise, High Res mode Test Result record.
 - j. Tap the **Bandwidth Limit** field and select **250 MHz**.
 - k. Set the channel **Position** value to **340 mdivs**.
 - l. Once the measurement count (N) in the measurement badge reaches 100, record the AC RMS Mean value (the μ readout).
 - m. Set the channel **Position** value to **-340 mdivs**.
 - n. Once the measurement count (N) in the measurement badge reaches 100, record the AC RMS Mean value (the μ readout).
 - o. Average the two values and record the result in the **1 mV/div > 250MHz limit** row of the **1 M Ω** column of the random noise, High Res mode Test Result record.
 - p. Tap the **Bandwidth Limit** field and select **20 MHz**.
 - q. Set the channel **Position** value to **340 mdivs**.
 - r. Once the measurement count (N) in the measurement badge reaches 100, record the AC RMS Mean value (the μ readout).
 - s. Set the channel **Position** value to **-340 mdivs**.
 - t. Once the measurement count (N) in the measurement badge reaches 100, record the AC RMS Mean value (the μ readout).
 - u. Average the two values and record the result in the **1 mV/div > 20MHz limit** row of the **1 M Ω** column of the random noise, High Res mode Test Result record.
7. *Check 50 Ω termination as follows:*
- a. In the Channel badge, set **Termination** to **50 Ω** .
 - b. Tap the **Bandwidth Limit** field and select the highest frequency listed.
 - c. Set the channel **Position** value to **340 mdivs**.
 - d. Once the measurement count (N) in the measurement badge reaches 100, record the AC RMS Mean value (the μ readout).
 - e. Set the channel **Position** value to **-340 mdivs**.
 - f. Once the measurement count (N) in the measurement badge reaches 100, record the AC RMS Mean value (the μ readout).
 - g. Average the two values and record the result in the **1 mV/div > Full** row of the **50 Ω** column of the random noise, High Res mode Test Result record.
 - h. Tap the **Bandwidth Limit** field and select **250 MHz**.
 - i. Set the channel **Position** value to **340 mdivs**.
 - j. Once the measurement count (N) in the measurement badge reaches 100, record the AC RMS Mean value (the μ readout).
 - k. Set the channel **Position** value to **-340 mdivs**.
 - l. Once the measurement count (N) in the measurement badge reaches 100, record the AC RMS Mean value (the μ readout).
 - m. Average the two values and record the result in the **1 mV/div > 250MHz limit** row of the **50 Ω** column of the random noise, High Res mode Test Result record.
 - n. Tap the **Bandwidth Limit** field and select **20 MHz**.
 - o. Set the channel **Position** value to **340 mdivs**.
 - p. Once the measurement count (N) in the measurement badge reaches 100, record the AC RMS Mean value (the μ readout).
 - q. Set the channel **Position** value to **-340 mdivs**.
 - r. Once the measurement count (N) in the measurement badge reaches 100, record the AC RMS Mean value (the μ readout).
 - s. Average the two values and record the result in the **1 mV/div > 20MHz limit** row of the **50 Ω** column of the random noise, High Res mode Test Result record.
8. *Repeat 1 M Ω and 50 Ω tests at all V/div settings for the current channel:*

- a. In the Channel badge, set the **Vertical Scale** setting to the next value in the test record (2 mV, 5 mV, and so on, up to 1 V/div).
- b. Repeat steps 6 on page 172 through 7 on page 173.
9. Repeat all tests for the remaining input channels:
 - a. Double-tap the **AC RMS** measurement badge.
 - b. Tap the **Configure** panel.
 - c. Tap the **Source 1** field and select the next channel to test.
 - d. Double-tap the channel badge of the channel that you have finished testing and set **Display to Off**.
 - e. Tap the channel button on the oscilloscope Settings bar of the next channel to test.
 - f. Double-tap the channel badge for the channel being tested.
 - g. Starting at step 6 on page 172, repeat these procedures for each input channel.

Check long term sample rate

This test checks the sample rate and delay time accuracy (time base).

1. Connect the output of a time mark generator to the oscilloscope channel 1 input using a 50 Ω cable, as shown in the following illustration.

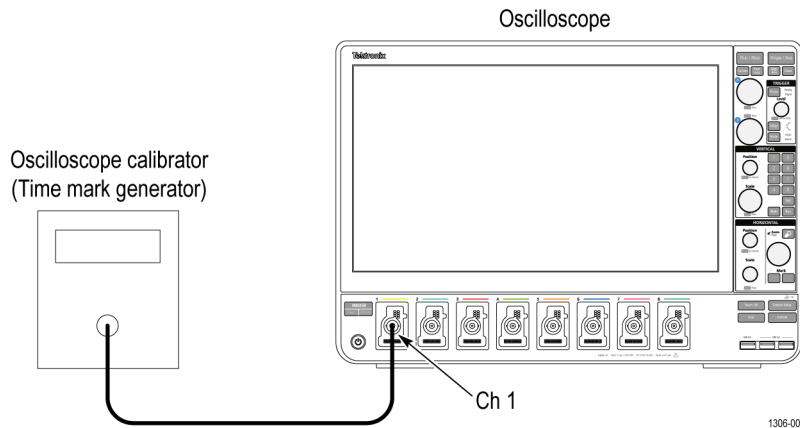

WARNING: Set the generator output to off or 0 volts before connecting, disconnecting, and/or moving the test hookup during the performance of this procedure. The generator is capable of providing dangerous voltages.

2. Set the time mark generator period to **80 ms**. Use a time mark waveform with a fast rising edge.
3. If it is adjustable, set the time mark amplitude to approximately **2 V_{P-P}**.
4. Tap **File > Default Setup**.
5. Tap the channel **1** button on the Settings bar.
6. Double-tap the Channel 1 badge to open its Configuration menu.
7. Set **Termination** to **50 Ω** .
8. Set **Vertical Scale** to **500 mV**.
9. Set the **Position** value to center the time mark signal on the screen.
10. Tap outside the menu area to close it.
11. Double-tap the **Horizontal** settings badge.
12. Set the **Horizontal Scale** to **100 ns/div**.
13. Tap outside the menu area to close it.
14. Double-tap the **Trigger** settings badge.
15. Set **Source** to the channel being tested.

16. Set the **Level** as necessary for a triggered display.
17. Tap outside the menu area to close it.
18. Double-tap the **Horizontal** settings badge.
19. Adjust the **Position** value to move the trigger point to the center of the screen.
20. Turn **Delay** to **On** and set **Position** to **80 ms**.
21. Set the **Horizontal Scale** to **100 ns/div**.
22. Observe where the rising edge of the marker crosses the center horizontal graticule line. The rising edge should cross within ± 2 divisions of the vertical center graticule. Enter the deviation in the test record.



Note: A 2.5×10^{-6} time base error is 2 divisions of displacement.

Check delta time measurement accuracy

This test checks the Delta-time measurement accuracy for a given instrument setting and input signal.

1. Connect a 50 Ω coaxial cable from the signal source to the oscilloscope channel 1, as shown in the following illustration.

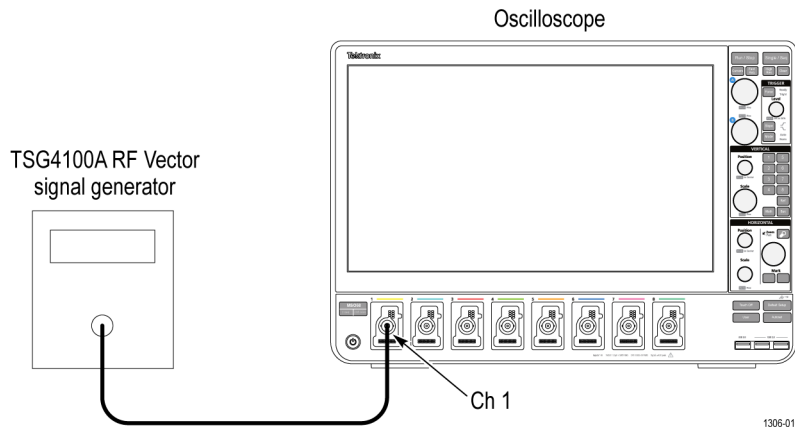

WARNING: Set the generator output to Off or 0 volts before connecting, disconnecting, or moving the test hookup during the performance of this procedure. The generator is capable of providing dangerous voltages.

2. Tap **File > Default Setup**.
3. Double-tap the badge of the channel under test to open its configuration menu.
4. Set the **Vertical Scale** to **5 mV/div**.
5. Set **Termination** to **50 Ω** .
6. Tap outside the menu to close it.
7. Double-tap the **Horizontal** badge in the Settings bar.
8. Set the **Horizontal Scale** to **10 ns/div**.
9. Set the **Horizontal Mode** to **Manual**.
10. Set the **Sample Rate** to an unchecked value listed in the test record. Adjust the **Record Length** value until the correct **Horizontal Scale** value is set.
11. Tap outside the menu to close it.
12. Double-tap the **Trigger** settings badge.
13. Set **Source** to the channel being tested.
14. Set the **Level** as necessary for a triggered display.
15. Tap outside the menu area to close it.

16. Add a **Delay** measurement for the channel under test:
 - a. Tap the **Add New... Measure** button.
 - b. Tap the **Time Measurements** panel.
 - c. Double-tap the **Delay** measurement to add the measurement badge to the Results bar.
 - d. Tap outside the menu to close it.
17. Set the Delay measurement settings:
 - a. Double-tap the **Delay** measurement badge.
 - b. Check **Show Statistics in Badge**.
 - c. Tap the **Configure** panel.
 - d. Set both **Source 1** and **Source 2** to the channel under test.
 - e. Set **From Edge** to the rising edge button.
 - f. Set **To Edge** to the falling edge button.
 - g. Tap the **Reference Levels** panel.
 - h. Tap % in the **Set Levels In** control.
 - i. Tap the **Filter/Limit Results** panel.
 - j. Tap **Limit Measurement Population** to turn it on.
 - k. Set the **Limit** field to **500**.
 - l. Tap outside the menu to close it.
18. *Check the performance as follows:*
 - a. Set the calibrator signal source to the frequency and amplitude as shown in the test record.



Note: To provide consistent results, set the signal source frequency such that the zero crossing does not occur very close to the beginning or end of the record.
 - b. Wait 5 - 10 seconds for the oscilloscope to acquire 500 samples before taking the reading.
 - c. Enter the standard deviation readout in the **Delay** measurement badge in the test record. The value should be less than the upper limit shown in the test record.
 - d. Repeat the check for each combination of oscilloscope and source signal settings in the test record.
19. *Repeat tests for the remaining channels:*
 - a. Double-tap the channel badge of the channel that you have finished testing and set **Display** to **Off**.
 - b. Tap the channel button of the next channel to test.
 - c. Set the calibrator to **0** volts.
 - d. Move the calibrator output to the next channel input to be tested.
 - e. Repeat the procedure from step 3 on page 175 until all channels have been tested. To change the source for the Delay measurement for each channel test:
 - i. Double-tap the **Delay** measurement badge.
 - ii. Tap the **Configure** panel label.
 - iii. Set the **Source 1** and **Source 1** fields to the next channel to test.

Check digital threshold accuracy

This test checks the threshold accuracy of the logic probe digital channels D0-D7 at 0 V and 25 °C, for all oscilloscope input channels.



Note: Threshold Accuracy is a function of the logic probe only. It is a typical specification. The Threshold Accuracy test checks the typical logic probe performance, and may be considered a functional check of the oscilloscope digital input.

1. Connect the TLP058 digital probe to channel 1.

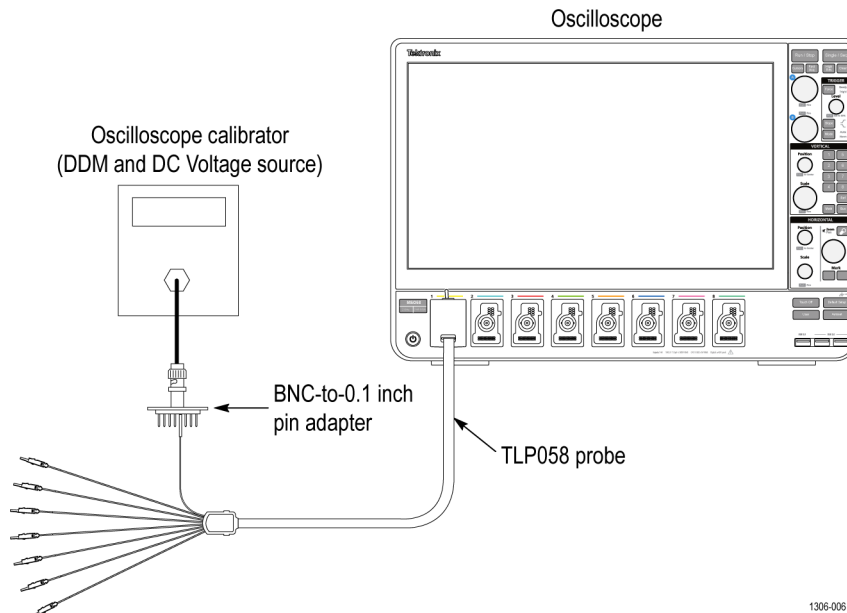

2. Connect the DC voltage source to digital channel D0.



WARNING: Set the generator output to Off or 0 volts before connecting, disconnecting, or moving the test hookup during the performance of this procedure. The generator is capable of providing dangerous voltages.

If you are using the Fluke 9500 calibrator as the DC voltage source, connect the calibrator head to the digital channel D0, using the BNC-to-0.1 inch pin adapter listed in the [Required equipment](#) table. Be sure to connect channel D0 to both the corresponding signal pin and to a ground pin on the adapter.

3. Tap **File > Default Setup**. This resets the instrument and adds the channel 1 badge and signal to the display.
4. *Display the digital channels and set the thresholds as follows:*
 - a. Double-tap the badge of the channel under test on the Settings bar.
 - b. Double-tap the **Threshold** field at the bottom of the menu and set the value to **0 V**.
 - c. Tap **Set All Thresholds**. All thresholds are now set for the 0 V threshold check.
 - d. Tap outside the menu to close it.
5. Double-tap the **Horizontal** badge in the Settings bar.
6. Set the **Horizontal Scale** to **10 ns/div**.
7. Tap outside the menu to close it.
8. Set the calibrator DC voltage output (V_s) to **-400 mV**.
9. Wait 1 second. Verify that the logic level is low on **D0**.
10. Increment V_s by **+10 mV**. Wait 1 second and check the logic level of the channel D0 signal display.

If the signal level is a logic low or is alternating between high and low, continue to increment V_s by +10 mV, wait 1 second, and check the logic level until the logic state is a steady high.

11. Record this V_s value as **Vs-** for D0 of the test record.

12. Double-tap the **Trigger** badge and set the **Slope** to **Falling** edge.
13. Set the DC voltage source (V_s) to **+400 mV**.
14. Wait 1 second. Verify that the logic level is high.
15. Decrement V_s by **-10 mV**. Wait 1 second and check the logic level of the channel D0 signal display.
If the signal level is a logic high or is alternating between high and low, continue to decrement V_s by -10 mV, wait 1 second, and check the logic level until the logic state is a steady low.
16. Record this V_s value as **V_{s+}** for D0 of the test record.
17. Find the average using this formula: $V_{sAvg} = (V_{s-} + V_{s+})/2$.
18. Record the average as the test result for D0 in the test record. The test result should be between the low and high limits.
19. Repeat the procedure for all remaining digital channels as follows:
 - a. Connect the next digital channel to be tested (D1, D2, and so on) to the DC voltage source.
 - b. Repeat steps 8 on page 177 through 19 on page 178, until all digital channels have been tested for this input channel.
20. Repeat the procedure for all remaining input channels as follows:
 - a. Move the TLP058 digital probe from channel 1 to channel 2.
 - b. Set the generator output to 0 volts and Off.
 - c. Repeat steps starting at 2 on page 177 for the channel being tested (channel 2, channel 3, and so on).

Check DVM voltage accuracy (DC)

This test checks the DC voltage accuracy of the Digital Volt Meter (DVM) option. The DVM option is available for free when you register the instrument at tek.com.

Procedure

1. Connect the oscilloscope to a DC voltage source to run this test. If using the Fluke 9500 calibrator as the DC voltage source, connect the calibrator head to the oscilloscope channel to test.

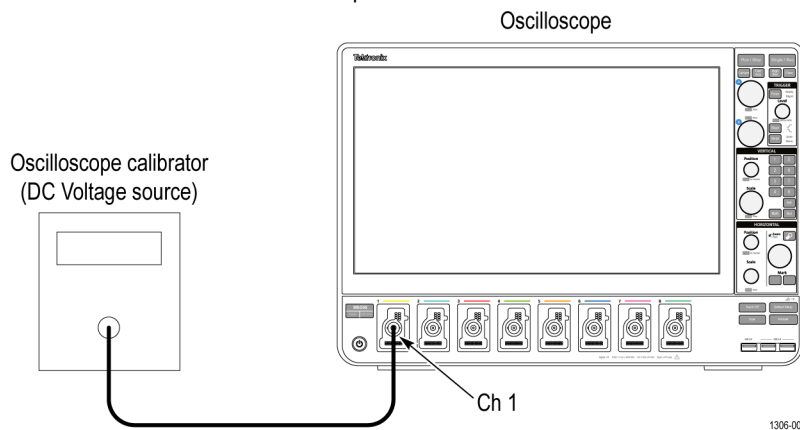

WARNING: Set the generator output to Off or 0 volts before connecting, disconnecting, or moving the test hookup during the performance of this procedure. The generator is capable of providing dangerous voltages.

2. Set the calibrator impedance to **1 MΩ**.
3. Tap **File > Default Setup**. This resets the instrument and adds the channel 1 badge and signal to the display.
4. Set the channel settings.
 - a) Double tap the badge of the channel under test to open its menu.
 - b) Check that **Position** is set to **0 divs**. If not, set the position to 0 divisions.

- c) Confirm that **Termination** is set to **1 M Ω** .
- d) Set the **Bandwidth Limit** to **20 MHz**.
5. Set the calibrator impedance to **1 M Ω** .
6. Double-tap the **Horizontal** badge and set **Horizontal Scale** to **1 ms/div**.
7. Tap outside the menu to close it.
8. Double-tap the **Acquisition** badge and set the **Acquisition Mode** to **Average**.
9. Verify or set the **Number of Waveforms** to **16**.
10. Tap outside the menu to close it.
11. Double-tap the **Trigger** badge and set the **Source** to **AC Line**.
12. Tap outside the menu to close it.
13. Tap the **DVM** button to add the DVM badge to the Results bar.
14. In the **DVM** menu, set **Source** to the channel to be tested.
15. Set **Mode** to **DC**.
16. Tap outside the menu to close it.
17. Set the calibrator to the input voltage shown in the test record (for example, -5 V for a 1V/div setting).
18. In the channel under test menu, set the **Offset** value to that shown in the test record (for example, -5 V for -5 V input and 1 V/div setting).
19. Set the **Vertical Scale** field to match the value in the test record (for example, 1 V/div).
20. Enter the measured value on the DVM badge into the DVM Voltage Accuracy Tests record.
21. Repeat the procedure (steps 17 on page 179, 18 on page 179, 19 on page 179 and 20 on page 179) for each volts/division setting shown in the test record.
22. Repeat all steps, starting with step 4 on page 178, for each oscilloscope channel to check. To set the next channel to test:
 - a) Double tap the badge of the channel under test to open its menu.
 - b) Set **Display** to **Off**.
 - c) Tap the channel button in the Settings bar of the next channel to test to add that channel badge and signal to the display.

Check DVM voltage accuracy (AC)

This test checks the AC voltage accuracy of the Digital Volt Meter (DVM) option. The DVM option is available for free when you register the instrument at tek.com.

Procedure

1. Connect the output of the leveled square wave generator (for example, Fluke 9500) to the oscilloscope channel 1 input.



WARNING: Set the generator output to Off or 0 volts before connecting, disconnecting, or moving the test hookup during the performance of this procedure. The generator is capable of providing dangerous voltages.
2. Set the generator to **50 Ω** output impedance (50 Ω source impedance).
3. Set the generator to produce a square wave of the amplitude and frequency listed in the test record (for example, 20 mV_{pp} at 1 kHz).
4. Tap **File > Default Setup** to reset the instrument and add the channel 1 badge and signal to the display.
5. Tap the **DVM** button to add the DVM badge to the Results bar.
6. Set the DVM **Mode** to **AC RMS**.
7. In the DVM menu, set **Source** to the channel to be tested.
8. Double-tap the channel badge of the channel being tested to open its configuration menu.
9. Set **Termination** to **50 Ω** .

10. Use the **Vertical Scale** controls to set the signal height so that the signal covers between 4 and 8 vertical divisions on the screen.
11. Enter the DVM measured value in the test record.
12. Repeat steps 10 on page 180 and 11 on page 180 for each voltage and frequency combination shown in the record.
13. Repeat all steps to test all remaining oscilloscope channels. To set the next channel to test:
 - a) Double tap the badge of the channel under test to open its menu.
 - b) Set **Display** to **Off**.
 - c) Tap the channel button in the Settings bar of the next channel to test to add that channel badge and signal to the display.

Check trigger frequency accuracy and maximum input frequency

This test checks trigger frequency counter accuracy. The trigger frequency counter is part of the free DVM and trigger frequency option that is available when you register the instrument at tek.com.

Procedure

1. Tap **File > Default Setup** to reset the instrument and add the channel 1 badge and signal to the display.
2. Connect the **10 MHz Reference out** from the time mark generator to the **Ref In** connector on the back of the oscilloscope.
3. Connect the output of the time mark generator to the oscilloscope channel input being tested using a 50 Ω cable. Set the time mark generator to a 50 Ω source and a fast rising edge waveform (≥ 3 mV/ns).
4. Set the time mark generator frequency to the first value shown in the test record, starting at **100 Hz**.
5. Set the mark amplitude to **1 V_{pp}**, which makes a 2 divisions high waveform.
6. Double-tap the channel badge being tested (starting with channel 1) and set **Termination** to **50 Ω** .
7. Set the channel **Vertical Scale** to **500 mV/div**.
8. Tap outside the menu to close it.
9. Double-tap the **Acquisition** badge and set the **Timebase Reference Source** to **External (10 MHz)**.
10. Tap outside the menu to close it.
11. Double-tap the **Horizontal** badge and use the **Horizontal Scale** controls to display at least 2 cycles of the waveform.
12. Tap outside the menu to close it.
13. Double-tap the **Trigger** badge to open its menu.
 - a) Set the **Source** field to the input channel being tested.
 - b) Tap the **Set to 50%** button to obtain a stable display.
 - c) Tap the **Mode & Holdoff** panel to open the **Mode & Holdoff** configuration menu.
 - d) In the **Mode & Hold Off** menu, set the **Trigger Frequency Counter** to **On**. The trigger frequency readout is at the bottom of the Trigger badge.
 - e) Tap outside the menu to close it.
14. Double-tap the channel badge being tested (starting with channel 1) and use the **Position** controls to vertically center the time mark in the waveform graticule.
15. Enter the value of the trigger frequency (**F** readout in the **Trigger** badge) in the test record for that frequency.
16. Repeat this procedure for each frequency setting shown in the record. Make sure to adjust the Horizontal scale after each calibrator frequency change to show at least two cycles of the waveform on the screen.
17. Repeat all these steps to test each oscilloscope channel.

Arbitrary function generator

Check AFG sine and ramp frequency accuracy

This test verifies the frequency accuracy of the arbitrary function generator. All output frequencies are derived from a single internally generated frequency. Only one frequency point of channel 1 is required to be checked.

1. Connect a 50 Ω cable from the **AFG Out** connector to the frequency counter input as shown in the following figure.

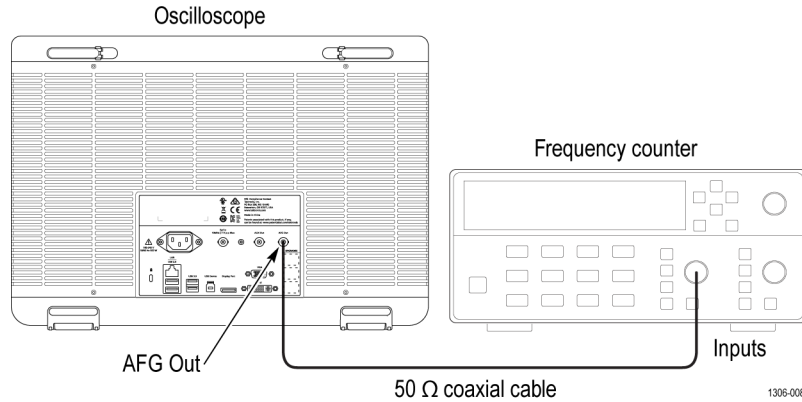

Figure 1: Frequency/period test

2. Tap **File > Default Setup** to set the instrument to the factory default settings.
3. Tap the **AFG** button to open the **AFG** menu.
4. Set the arbitrary function generator output as follows:

Select menu	Setting
Output	On
Waveform Type	Sine
Frequency	1.000000 MHz
Amplitude	1.00 V _{PP}

5. Turn on the frequency counter:
 - a. Double-tap the **Trigger** badge to open its menu.
 - b. Set the **Source** field to the input channel being tested.
 - c. Tap the **Set to 50%** button to obtain a stable display.
 - d. Tap the **Mode & Holdoff** panel to open the **Mode & Holdoff** configuration menu
 - e. In the **Mode & Holdoff** menu, set the **Trigger Frequency Counter** to **On**. The trigger frequency readout is at the bottom of the **Trigger** badge.
 - f. Tap outside the menu to close it.
6. Check that the reading of the frequency counter is between **0.999950 MHz** and **1.000050 MHz**. Enter the value in the Test record.
7. Set the arbitrary function generator output as follows:

Select menu	Setting
Waveform Type	Ramp
Frequency	500 kHz

8. Check that reading of the frequency counter is between **499.975 kHz** and **500.025 kHz**. Enter the value in the Test record.

Check AFG square and pulse frequency accuracy

This test verifies the frequency accuracy of the arbitrary function generator. All output frequencies are derived from a single internally generated frequency. Only one frequency point of channel 1 is required to be checked.

1. Connect the arbitrary function generator to the frequency counter as shown in the following figure.

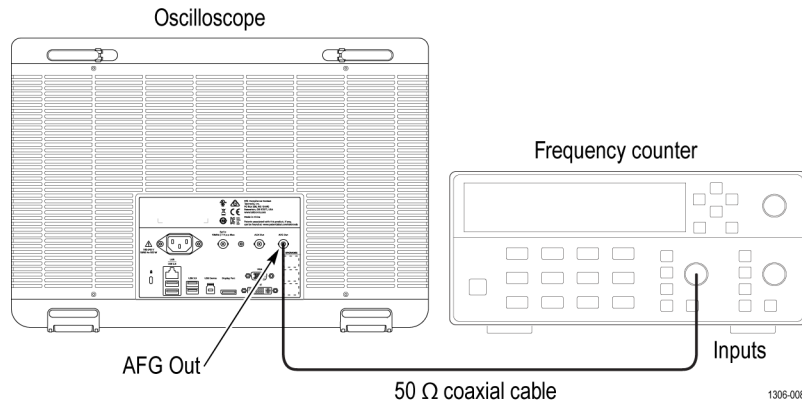

Figure 2: Frequency/period test

2. Tap **File > Default Setup** to set the instrument to the factory default settings.
3. Tap the **AFG** button to open the AFG menu.
4. Set the arbitrary function generator as follows:

Select menu	Setting
Waveform Type	Square
Frequency	1.000000 MHz
Amplitude	1.00 V _{PP}
Output	On

5. Turn on the frequency counter:
 - a. Double-tap the **Trigger** badge to open its menu.
 - b. Set the **Source** field to the input channel being tested.
 - c. Tap the **Set to 50%** button to obtain a stable display.
 - d. Tap the **Mode & Holdoff** panel to open the **Mode & Holdoff** configuration menu
 - e. In the **Mode & Holdoff** menu, set the **Trigger Frequency Counter** to **On**. The trigger frequency readout is at the bottom of the Trigger badge.
 - f. Tap outside the menu to close it.
6. Check that the frequency counter readout is between **0.999950 MHz** and **1.00005 MHz**. Enter the value in the Test record.
7. Set up the arbitrary function generator as follows:

Select menu	Setting
Waveform Type	Pulse

8. Check that reading of the frequency counter is between **0.999950 MHz** and **1.000050 MHz**. Enter the value in the Test record.

Check AFG signal amplitude accuracy

This test verifies the amplitude accuracy of the arbitrary function generator. All output amplitudes are derived from a combination of attenuators and 3 dB variable gain. Some amplitude points are checked. This test uses a 50 Ω terminator. It is necessary to know the accuracy of the 50 Ω terminator in advance of this amplitude test. This accuracy is used as a calibration factor.

1. Connect the 50 Ω terminator to the DMM as shown in the following figure and measure the resistance value.

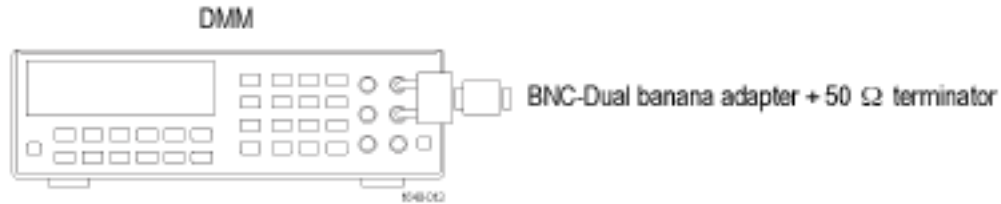

Figure 3: 50 Ω terminator accuracy

2. Calculate the 50 Ω calibration factor (CF) from the reading value and record as follows:

Table 4: CF (Calibration Factor) = $1.414 \times ((50 / \text{Measurement } \Omega) + 1)$

Measurement (reading of the DMM)	Calculated CF

Examples:

- For a measurement of 50.50 Ω, CF = $1.414 (50 / 50.50 + 1) = 2.814$.
 - For a measurement of 49.62 Ω, CF = $1.414 (50 / 49.62 + 1) = 2.839$.
3. Connect the arbitrary function generator output to the DMM as shown in the following figure. Be sure to connect the 50 Ω terminator to the **AFG Out** connector.

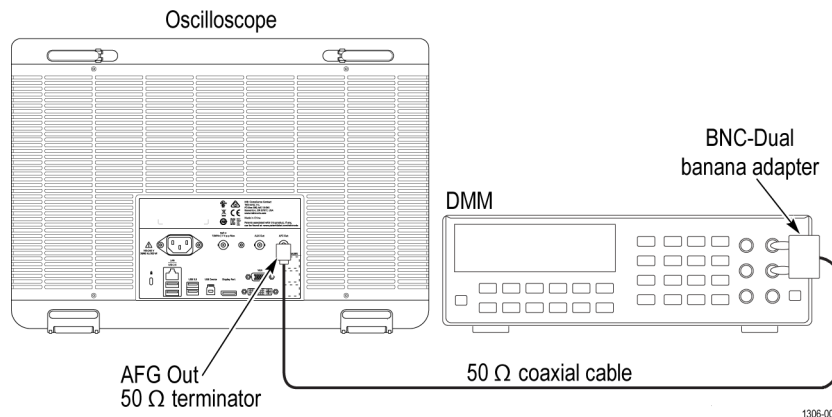

Figure 4: Amplitude test

4. Tap the **AFG** button and set up the arbitrary function generator output as follows:

Select menu	Setting
Waveform Type	Sine
Frequency	1.000000 kHz
Amplitude	30 mV _{PP}
Load Impedance	50 Ω
Table continued...	

Select menu	Setting
Output	On

5. Measure the **AC RMS** voltage readout on the DMM.
6. Multiply the DMM voltage by the calculated CF to get the corrected peak to peak voltage. Enter the resulting value in the Measurement field in the following table.
7. Change the AFG output amplitude to the next value in the table.
8. Repeat steps 5 on page 184 through 7 on page 184 for each amplitude value. Check that the peak to peak voltages are within the limits in the table below. Enter the values in the test record.

Waveform Type	Frequency	Amplitude	Measurement	Range
Sine	1.000 kHz	30.0 mV _{PP}		28.55 mV _{PP} - 31.45 mV _{PP}
Sine	1.000 kHz	300.0 mV _{PP}		294.5 mV _{PP} - 305.5 mV _{PP}
Sine	1.000 kHz	800.0 mV _{PP}		787.0 mV _{PP} - 813.0 mV _{PP}
Sine	1.000 kHz	1.500 V _{PP}		1.4765 V _{PP} - 1.5235 V _{PP}
Sine	1.000 kHz	2.000 V _{PP}		1.969 V _{PP} - 2.031 V _{PP}
Sine	1.000 kHz	2.500 V _{PP}		2.4615 V _{PP} - 2.5385 V _{PP}

Check AFG DC offset accuracy

This test verifies the DC offset accuracy of the arbitrary function generator. This test uses a 50 Ω terminator. It is necessary to know the accuracy of the 50 Ω terminator in advance of this test. This accuracy is used as a calibration factor.

1. Connect the 50 Ω terminator to the DMM as shown in the following figure and measure the resistance value.

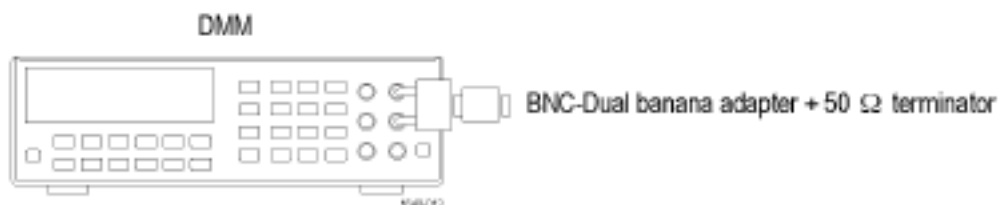

Figure 5: 50 Ω terminator accuracy

2. Calculate the 50 Ω calibration factor (CF) from the reading value and record as follows:

Table 5: CF (Calibration Factor) = $0.5 \times ((50 / \text{Measurement } \Omega) + 1)$

Measurement (reading of the DMM)	Calculated CF

Examples:

- For a measurement of 50.50 Ω, CF = $0.5 (50 / 50.50 + 1) = \mathbf{0.9951}$.
- For a measurement of 49.62 Ω, CF = $0.5 (50 / 49.62 + 1) = \mathbf{1.0038}$.

3. Connect the arbitrary function generator output to the DMM as shown in the following figure. Be sure to connect the 50 Ω terminator to the arbitrary function generator **AFG Output** connector.

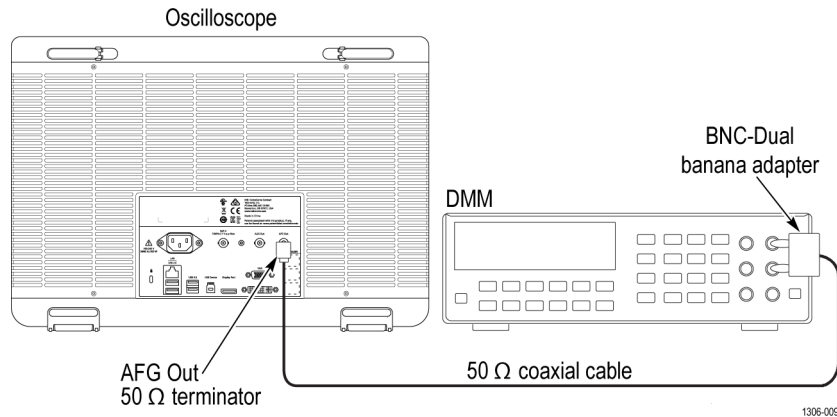

Figure 6: DC offset tests

4. Tap the **AFG** button and set up the arbitrary function generator as follows:

Select menu	Setting
Waveform Type	DC
Offset	+ 1.25 V
Output	On

5. Measure the voltage readout on the DMM.
 6. Multiply the DMM voltage by the calculated CF to get the corrected offset voltage. Enter the resulting value in the Measurement field in the following table.

Function	Offset	Measurement	Range
DC	+ 1.25 Vdc	Vdc	1.23025 Vdc to 1.26975 Vdc
DC	0.000 Vdc	Vdc	- 0.001 Vdc to + 0.001 Vdc
DC	- 1.25 Vdc	Vdc	-1.26975 Vdc to -1.23025 Vdc

7. Change the AFG output amplitude to the next value in the table, measure the voltage readout on the DMM, multiply the DMM readout by the calculated CF to get the corrected offset voltage, and enter the resulting value in the Measurement field in the table.
 8. Verify that the corrected offset measurements are within the range.

Index

P

Performance Verification

- AFG DC offset accuracy [184](#)
- AFG signal amplitude accuracy [183](#)
- AFG sine and ramp frequency accuracy [181](#)
- AFG square and pulse frequency accuracy [182](#)
- analog bandwidth [168](#)
- analog input and acquisition [161](#)
- DC balance [162](#)
- DC gain accuracy [164](#)
- DC offset accuracy [166](#)
- delta time measurement accuracy [175](#)
- digital channel threshold accuracy [177](#)
- DVM voltage accuracy (AC) [179](#)
- DVM voltage accuracy (DC) [178](#)
- equipment required [36](#)
- horizontal and time base [174](#)
- input impedance [161](#)
- long term sample rate [174](#)
- prerequisites [159](#)
- random noise, High Res mode [172](#)
- random noise, sample acquisition mode [170](#)
- self test [159](#)
- test record [37](#)
- trigger frequency accuracy and maximum input frequency [180](#)