



**OM2012**  
**nLaser Tunable C-, L-Band Laser Source**  
**Installation and Safety**  
**Instructions**



071-3154-03





**OM2012**  
**nLaser Tunable C-, L-Band Laser Source**  
**Installation and Safety**  
**Instructions**

Copyright © Tektronix. All rights reserved. Licensed software products are owned by Tektronix or its subsidiaries or suppliers, and are protected by national copyright laws and international treaty provisions.

Tektronix products are covered by U.S. and foreign patents, issued and pending. Information in this publication supersedes that in all previously published material. Specifications and price change privileges reserved.

TEKTRONIX and TEK are registered trademarks of Tektronix, Inc.

MATLAB is a registered trademark of The MathWorks, Inc.

Intel and Pentium are registered trademarks of the Intel Corporation.

## **Contacting Tektronix**

Tektronix, Inc.  
14150 SW Karl Braun Drive  
P.O. Box 500  
Beaverton, OR 97077  
USA

For product information, sales, service, and technical support:

- In North America, call 1-800-833-9200.
- Worldwide, visit [www.tek.com](http://www.tek.com) to find contacts in your area.

## Warranty

Tektronix warrants that this product will be free from defects in materials and workmanship for a period of one (1) year from the date of shipment. If any such product proves defective during this warranty period, Tektronix, at its option, either will repair the defective product without charge for parts and labor, or will provide a replacement in exchange for the defective product. Parts, modules and replacement products used by Tektronix for warranty work may be new or reconditioned to like new performance. All replaced parts, modules and products become the property of Tektronix.

In order to obtain service under this warranty, Customer must notify Tektronix of the defect before the expiration of the warranty period and make suitable arrangements for the performance of service. Customer shall be responsible for packaging and shipping the defective product to the service center designated by Tektronix, with shipping charges prepaid. Tektronix shall pay for the return of the product to Customer if the shipment is to a location within the country in which the Tektronix service center is located. Customer shall be responsible for paying all shipping charges, duties, taxes, and any other charges for products returned to any other locations.

This warranty shall not apply to any defect, failure or damage caused by improper use or improper or inadequate maintenance and care. Tektronix shall not be obligated to furnish service under this warranty a) to repair damage resulting from attempts by personnel other than Tektronix representatives to install, repair or service the product; b) to repair damage resulting from improper use or connection to incompatible equipment; c) to repair any damage or malfunction caused by the use of non-Tektronix supplies; or d) to service a product that has been modified or integrated with other products when the effect of such modification or integration increases the time or difficulty of servicing the product.

THIS WARRANTY IS GIVEN BY TEKTRONIX WITH RESPECT TO THE PRODUCT IN LIEU OF ANY OTHER WARRANTIES, EXPRESS OR IMPLIED. TEKTRONIX AND ITS VENDORS DISCLAIM ANY IMPLIED WARRANTIES OF MERCHANTABILITY OR FITNESS FOR A PARTICULAR PURPOSE. TEKTRONIX' RESPONSIBILITY TO REPAIR OR REPLACE DEFECTIVE PRODUCTS IS THE SOLE AND EXCLUSIVE REMEDY PROVIDED TO THE CUSTOMER FOR BREACH OF THIS WARRANTY. TEKTRONIX AND ITS VENDORS WILL NOT BE LIABLE FOR ANY INDIRECT, SPECIAL, INCIDENTAL, OR CONSEQUENTIAL DAMAGES IRRESPECTIVE OF WHETHER TEKTRONIX OR THE VENDOR HAS ADVANCE NOTICE OF THE POSSIBILITY OF SUCH DAMAGES.

[W2 – 15AUG04]



---

# Table of Contents

Important safety information .....	ii
General safety summary .....	ii
Service safety summary .....	iv
Terms in this manual .....	v
Symbols and terms on the product .....	v
Safety related front panel labels .....	vi
Safety related rear panel labels .....	vi
Preface .....	ix
Product description .....	ix
Related documentation .....	ix
Operating requirements .....	1
Environment requirements .....	1
Power requirements .....	2
PC requirements .....	2
Installation .....	3
Inspect the instrument .....	3
Power-related controls and connectors .....	3
Connect the power cable .....	4
Power on and off the instrument .....	4
Operate the instrument .....	5
Equipment setup .....	5
Controls and connectors .....	7
Front panel .....	7
Rear panel .....	7
Cleaning and maintenance .....	9
Cleaning .....	9
Maintenance .....	9
Compliance information .....	11
EMC compliance .....	11
Safety compliance .....	12
Environmental considerations .....	13

## Important safety information

This manual contains information and warnings that must be followed by the user for safe operation and to keep the product in a safe condition.

To safely perform service on this product, additional information is provided at the end of this section. (See page iv, *Service safety summary*.)

### General safety summary

Use the product only as specified. Review the following safety precautions to avoid injury and prevent damage to this product or any products connected to it. Carefully read all instructions. Retain these instructions for future reference.

Comply with local and national safety codes.

For correct and safe operation of the product, it is essential that you follow generally accepted safety procedures in addition to the safety precautions specified in this manual.

The product is designed to be used by trained personnel only.

Only qualified personnel who are aware of the hazards involved should remove the cover for repair, maintenance, or adjustment.

Before use, always check the product with a known source to be sure it is operating correctly.

This product is not intended for detection of hazardous voltages.

Use personal protective equipment to prevent shock and arc blast injury where hazardous live conductors are exposed.

When incorporating this equipment into a system, the safety of that system is the responsibility of the assembler of the system.

#### To avoid fire or personal injury

**Use proper power cord.** Use only the power cord specified for this product and certified for the country of use.

Do not use the provided power cord for other products.

**Ground the product.** This product is grounded through the grounding conductor of the power cord. To avoid electric shock, the grounding conductor must be connected to earth ground. Before making connections to the input or output terminals of the product, make sure that the product is properly grounded.

Do not disable the power cord grounding connection.

**Power disconnect.** The power cord disconnects the product from the power source. See instructions for the location. Do not position the equipment so that it



is difficult to disconnect the power cord; it must remain accessible to the user at all times to allow for quick disconnection if needed.

**Observe all terminal ratings.** To avoid fire or shock hazard, observe all ratings and markings on the product. Consult the product manual for further ratings information before making connections to the product.

Do not apply a potential to any terminal, including the common terminal, that exceeds the maximum rating of that terminal.

Do not float the common terminal above the rated voltage for that terminal.

The measuring terminals on this product are not rated for connection to mains or Category II, III, or IV circuits.

**Do not operate without covers.** Do not operate this product with covers or panels removed, or with the case open. Hazardous voltage exposure is possible.

**Avoid exposed circuitry.** Do not touch exposed connections and components when power is present.

**Do not operate with suspected failures.** If you suspect that there is damage to this product, have it inspected by qualified service personnel.

Disable the product if it is damaged. Do not use the product if it is damaged or operates incorrectly. If in doubt about safety of the product, turn it off and disconnect the power cord. Clearly mark the product to prevent its further operation.

Examine the exterior of the product before you use it. Look for cracks or missing pieces.

Use only specified replacement parts.

**Use proper fuse.** Use only the fuse type and rating specified for this product.

**Wear eye protection.** Wear eye protection if exposure to high-intensity rays or laser radiation exists.

**Do not operate in wet/damp conditions.** Be aware that condensation may occur if a unit is moved from a cold to a warm environment.

**Do not operate in an explosive atmosphere.**

**Keep product surfaces clean and dry.** Remove the input signals before you clean the product.

**Provide proper ventilation.** Refer to the installation instructions in the manual for details on installing the product so it has proper ventilation.

Slots and openings are provided for ventilation and should never be covered or otherwise obstructed. Do not push objects into any of the openings.

**Provide a safe working environment.** Always place the product in a location convenient for viewing the display and indicators.

Avoid improper or prolonged use of keyboards, pointers, and button pads. Improper or prolonged keyboard or pointer use may result in serious injury.

Be sure your work area meets applicable ergonomic standards. Consult with an ergonomics professional to avoid stress injuries.

Use care when lifting and carrying the product.

**Warning- Use correct controls and procedures.** Use of controls, adjustments, or procedures other than those listed in this document may result in hazardous radiation exposure.

**Do not directly view laser output.** Under no circumstances should you use any optical instruments to view the laser output directly.

## Service safety summary

The *Service safety summary* section contains additional information required to safely perform service on the product. Only qualified personnel should perform service procedures. Read this *Service safety summary* and the *General safety summary* before performing any service procedures.

**To avoid electric shock.** Do not touch exposed connections.

**Do not service alone.** Do not perform internal service or adjustments of this product unless another person capable of rendering first aid and resuscitation is present.

**Disconnect power.** To avoid electric shock, switch off the product power and disconnect the power cord from the mains power before removing any covers or panels, or opening the case for servicing.

**Use care when servicing with power on.** Dangerous voltages or currents may exist in this product. Disconnect power, remove battery (if applicable), and disconnect test leads before removing protective panels, soldering, or replacing components.

**Verify safety after repair.** Always recheck ground continuity and mains dielectric strength after performing a repair.

## Terms in this manual

These terms may appear in this manual:



**WARNING.** *Warning statements identify conditions or practices that could result in injury or loss of life.*



**CAUTION.** *Caution statements identify conditions or practices that could result in damage to this product or other property.*

## Symbols and terms on the product

These terms may appear on the product:

- DANGER indicates an injury hazard immediately accessible as you read the marking.
- WARNING indicates an injury hazard not immediately accessible as you read the marking.
- CAUTION indicates a hazard to property including the product.



When this symbol is marked on the product, be sure to consult the manual to find out the nature of the potential hazards and any actions which have to be taken to avoid them. (This symbol may also be used to refer the user to ratings in the manual.)

The following symbol(s) may appear on the product:



CAUTION  
Refer to Manual



Protective Ground  
(Earth) Terminal



Mains Disconnected  
OFF (Power)





Mains Connected  
ON (Power)

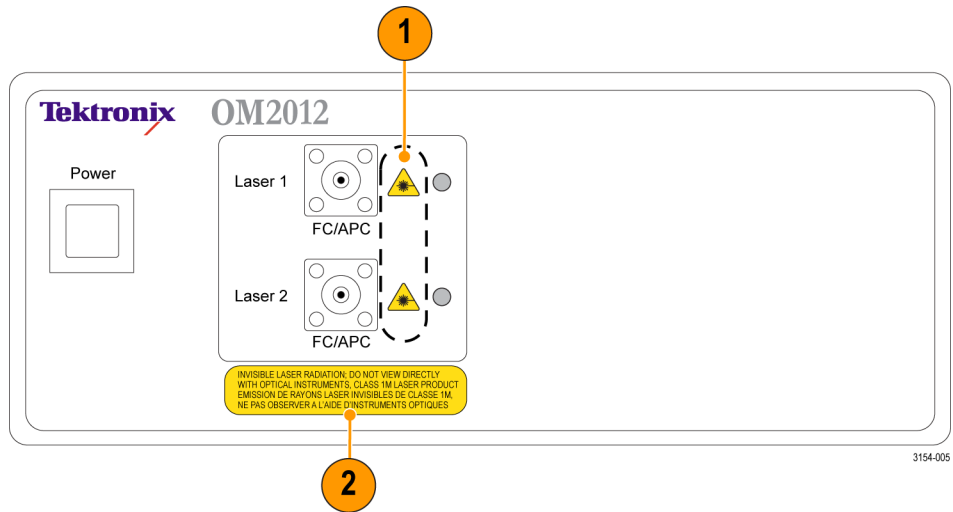

Invisible Laser  
Radiation

Safety related front panel labels

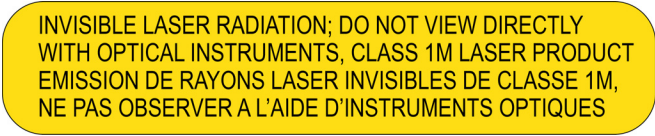

Item	Description
1	 Indicates the location of laser apertures
2	

Safety related rear panel labels

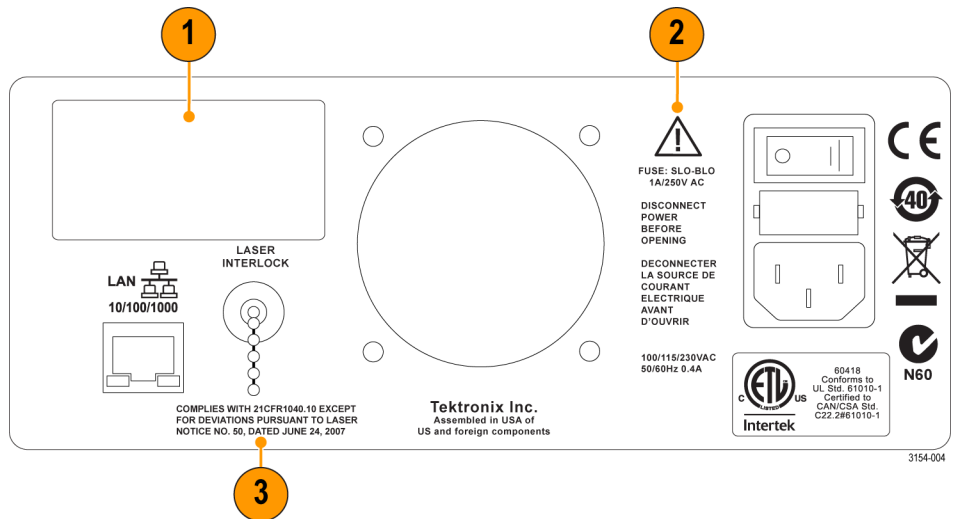

<b>Item</b>	<b>Description</b>
1	Instrument model and serial number label
2	Fuse safety information
3	<b>COMPLIES WITH 21CFR1040.10 EXCEPT FOR DEVIATIONS PURSUANT TO LASER NOTICE NO. 50, DATED JUNE 24, 2007</b>



---

# Preface

This manual describes installation and safety instructions for the OM2012 Coherent Receiver Calibration Source.

## Product description

The OM2012 provides two tunable C-band or L-band laser sources for use in laboratory or industrial facilities for a variety of fiber optic system applications. The OM2012 is controlled using software over an Ethernet connection.

A remote interlock for the laser, located on the rear of the unit, allows for remote locking of laser output.

Use the OM2012 along with the Tektronix OM4200 series, OM4000 series Analyzers and OM2210 Calibration Source for a complete optical calibration and testing setup.

### Key features

- Full C-band and/or L-band tunable continuous wave laser
- Integrated wavelength locker to support 50 GHz ITU wavelength grid
- Settable grid down to 10 GHz
- Off-grid tuning for custom wavelength applications
- User-adjustable transmit power output (+6 dBm to +15.5 dBm) and wavelength adjustment during operation
- RoHS compliant class 1M laser

## Related documentation

- *Laser Receiver Control Panel (LRCP) Software User Manual* (Tektronix part number 077-1127-xx)
- *OM1106 Optical Modulation Analysis Software User Manual* (Tektronix part number 077-1093-xx)

Go to [www.tektronix.com](http://www.tektronix.com) to download the latest document files and product information, and software updates.





# Operating requirements

Use these requirements to set up your environment and power source for proper instrument operation.

## Environment requirements



**CAUTION.** *Damage to the instrument can occur if this instrument is powered on at temperatures outside the specified temperature range.*

Table 1: OM2012 environmental requirements

Parameter		Description
Temperature	Operating	+10 °C to +35 °C (+50 °F to +95 °F)
		 <b>CAUTION.</b> <i>Damage to the instrument can occur if this instrument is powered on at temperatures outside the specified temperature range.</i>
	Nonoperating	-20 °C to +70 °C (-4.0 °F to +158 °F)
Relative Humidity	Operating	15% to 80% (No condensation)
Altitude	Operating	To 2,000 m (6,560 feet) Maximum operating temperature decreases 1 °C each 300 m above 1.5 km.
	Nonoperating	To 15,000 m (49,212 feet)
Ventilation		Top, right, left: 0 inches (0 mm) Front, rear: 2 inches (51 mm) Bottom: 0.5 inches (13 mm) (bottom clearance provided by product feet)
Cable clearance		Provide at least 2 inches (51 mm) front and rear so that connected signal and power cables are not damaged by sharp bends.

## Power requirements

Table 2: AC line power requirements

Parameter	Description
Line voltage range	100/115 V <sub>AC</sub> single phase 230 V <sub>AC</sub> single phase
Line frequency	50/60 Hz
Maximum current	0.4 A



**WARNING.** To reduce the risk of fire and shock, ensure that the AC supply voltage fluctuations do not exceed  $\pm 10\%$  of the operating voltage range.

---



**WARNING.** To avoid the possibility of electric shock, do not connect the instrument to an AC power source if the case shows any damage.

---



**WARNING.** Always connect the unit directly to a grounded power outlet. Operating the OM instrument without connection to a grounded power source could result in serious electrical shock.

---



**CAUTION.** Protective features of the instrument may be impaired if the unit is used in a manner not specified by Tektronix.

---

## PC requirements

The OM2012 product is not a stand-alone instrument; it requires Laser Receiver Control Panel (LRCP) software or OM1106 Optical Modulation Analysis software installed on a PC or oscilloscope running Microsoft Windows 7 operating system, which in turn is connected to the instrument with an Ethernet cable (directly from PC or through a network). Refer to the *Laser Receiver Control Panel (LRCP) Software User Manual (077-1127-xx)* or the *OM1106 Optical Modulation Analysis Software User Manual (077-1093-xx)* for information on PC requirements, installing software, configuring the instrument network settings, and operating the OM2012 instrument.

# Installation

## Inspect the instrument

Do the following when you receive your instrument:

1. Inspect the shipping carton for external damage, which may indicate damage to the instrument.
2. Remove the instrument from the shipping carton and check that the instrument was not damaged in transit. The instrument is thoroughly inspected for mechanical defects before shipment. The exterior should not have any scratches or impact marks.

**NOTE.** Save the shipping carton and packaging materials for instrument repackaging in case shipment becomes necessary.

3. Verify that the shipping carton contains the correct instrument, the standard accessories and any options or optional accessories that you ordered. See the included packing list.

Contact your local Tektronix Field Office or representative if there is a problem with your instrument or if your shipment is incomplete.

## Power-related controls and connectors

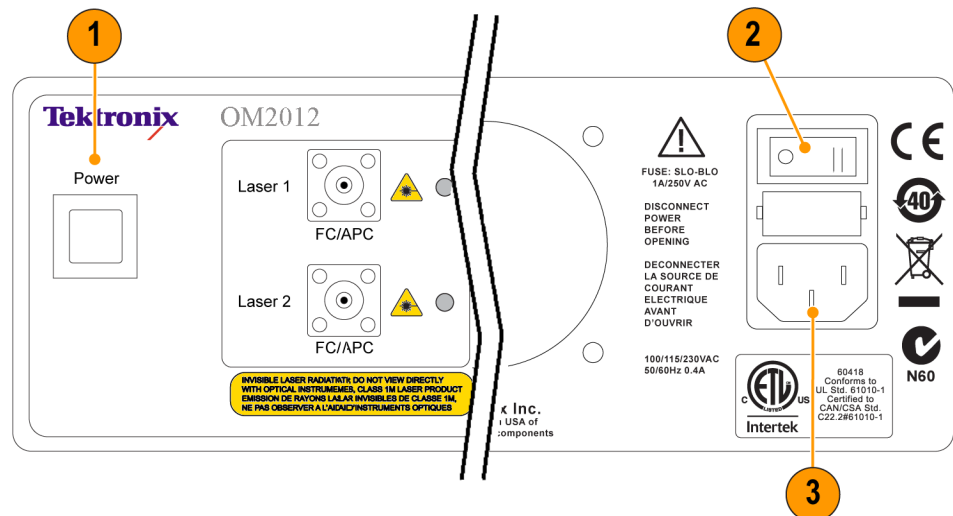

1. Power switch (On/standby)
2. AC power switch
3. AC power cable connector

## Connect the power cable

Connect the power cord to the rear panel power connector, and then connect the power cord to the AC power source.

---

**NOTE.** *Install or position the instrument to provide fast access to the rear-panel power switch and cord.*

---

## Power on and off the instrument

1. Set the rear-panel AC power switch to **On**.
2. Push the front-panel Power button. To power off the instrument, push the Power button again.
3. After powering on, listen to make sure that the instrument fan is working. If the fan is not working:
  - a. Push the front panel Power button to power off the instrument.
  - b. Set the rear panel AC power switch to Off.
  - c. Disconnect the AC power cable from the rear connector.
  - d. Wait 10 seconds.
  - e. Reconnect the power cable.
  - f. Set the rear panel power switch to On.
  - g. Push the front panel Power button to power on the instrument.
4. If the fan still does not work, repeat the power off sequence, disconnect the AC power cord, and contact your local Tektronix Field Office or representative for help.

## Operate the instrument

The OM2012 product is not a stand-alone instrument; it requires Laser Receiver Control Panel (LRCP) software or OM1106 Optical Modulation Analysis software installed on a PC or oscilloscope running Microsoft Windows 7 operating system, which in turn is connected to the instrument with an Ethernet cable (directly from PC or through a network). Refer to the *Laser Receiver Control Panel (LRCP) Software User Manual* (077-1127-xx) or the *OM1106 Optical Modulation Analysis Software User Manual* (077-1093-xx) for information on PC requirements, installing software, configuring the instrument network settings, and operating the OM2012 instrument.

## Equipment setup

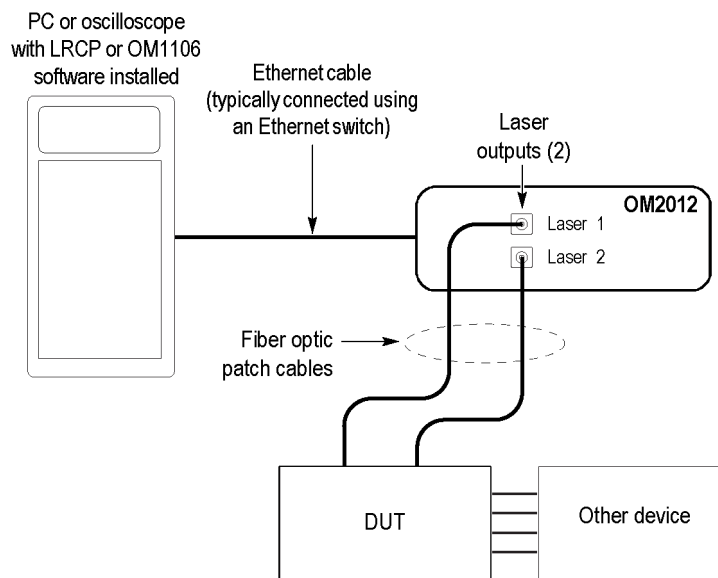
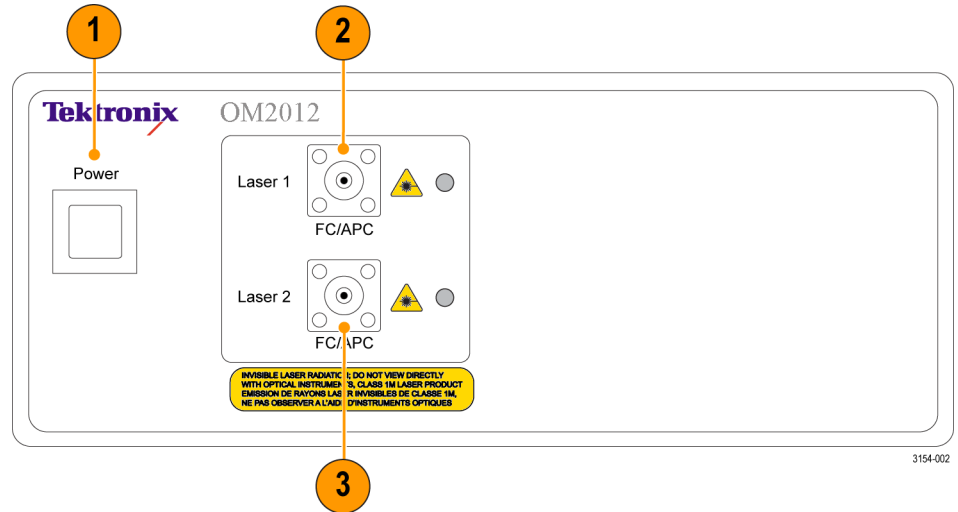

Figure 1: OM2012 connection diagram



# Controls and connectors

## Front panel



## Rear panel

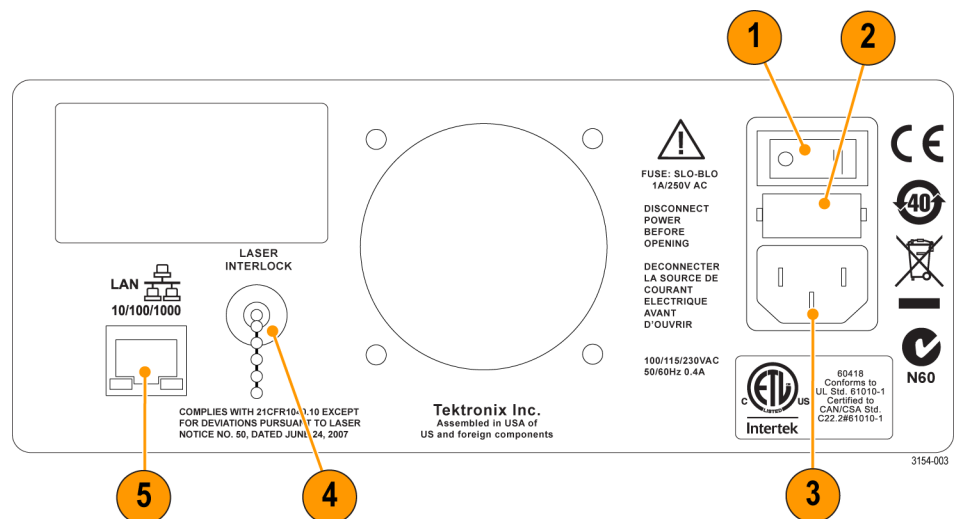

3. Power cable connector
4. BNC shorting plug for optional laser remote interlock connector
5. 10/100/1000 Ethernet port



---

# Cleaning and maintenance

## Cleaning

- Use a dry, soft cotton cloth to clean the instrument case. Do not use any liquid cleaning agents or chemicals that could possibly infiltrate the enclosure, or that could damage markings or labels.
- If the dust filter on the underside of the unit becomes clogged, use a small vacuum or brush to clean the filter.
- From time to time it is necessary to clean the optical input and output connectors on the front of the unit. Use square-ended swabs made for this purpose to clean each connector.
- Do not attempt to clean inside the instrument; cleaning of internal parts is not necessary.

## Maintenance

- Never remove the instrument cover. There are no user-serviceable components or subsystems within the OM2012. Attempting any internal repairs will void your warranty.
- If it becomes necessary to replace the fuse (on the rear panel), use a 5X20 mm “slo-blo” fuse rated at 1 A, 250 V<sub>AC</sub>. Use a small screwdriver to gently pry open the fuse drawer.



**WARNING.** *Disconnect the unit from the power source before changing the fuse to ensure that line voltage is not present during the replacement.*

---



---

# Compliance information

This section lists the EMC (electromagnetic compliance), safety, and environmental standards with which the instrument complies.

## EMC compliance

### EC declaration of conformity – EMC

Meets intent of Directive 2004/108/EC for Electromagnetic Compatibility. Compliance was demonstrated to the following specifications as listed in the Official Journal of the European Communities:

**EN 61326-1.** EMC requirements for electrical equipment for measurement, control, and laboratory use.<sup>1 2 3</sup>

- CISPR 11; IEC 61000-4-2; IEC 61000-4-3; IEC 61000-4-4; IEC 61000-4-5; IEC 61000-4-6; IEC 61000-4-11

**EN 61000-3-2.**

**EN 61000-3-3.**

#### European contact.

Tektronix UK, Ltd.  
Western Peninsula  
Western Road  
Bracknell, RG12 1RF  
United Kingdom

- <sup>1</sup> This product is intended for use in nonresidential areas only. Use in residential areas may cause electromagnetic interference.
- <sup>2</sup> Emissions which exceed the levels required by this standard may occur when this equipment is connected to a test object.
- <sup>3</sup> For compliance with the EMC standards listed here, high quality shielded interface cables should be used.

### Australia / New Zealand declaration of conformity – EMC

Complies with the EMC provision of the Radiocommunications Act per the following standard, in accordance with ACMA:

- CISPR 11

#### Australia / New Zealand contact.

Baker & McKenzie  
Level 27, AMP Centre  
50 Bridge Street  
Sydney NSW 2000, Australia

## Safety compliance

This section lists the safety standards with which the product complies and other safety compliance information.

<b>EU declaration of conformity – low voltage</b>	<p>Compliance was demonstrated to the following specification as listed in the Official Journal of the European Union:</p> <p>Low Voltage Directive 2006/95/EC.</p> <ul style="list-style-type: none"><li>■ EN 61010-1; EN 60825-1</li></ul>
<b>U.S. nationally recognized testing laboratory listing</b>	<ul style="list-style-type: none"><li>■ UL 61010-1</li></ul>
<b>Canadian certification</b>	<ul style="list-style-type: none"><li>■ CAN/CSA-C22.2 No. 61010-1</li></ul>
<b>Additional compliances</b>	<ul style="list-style-type: none"><li>■ IEC 61010-1; IEC 60825-1</li><li>■ This laser product complies with 21CFR1040.10 except for deviations pursuant to Laser Notice No. 50, dated June 24, 2007.</li></ul>
<b>Pollution degree rating</b>	<p>This product is rated for indoor, dry location use only, in a Pollution Degree 2 environment (as defined in IEC 61010-1).</p>
<b>IP rating</b>	<p>IP20 (as defined in IEC 60529).</p>
<b>Mains overvoltage category rating</b>	<p>The mains power supply circuit for this product is rated for overvoltage category II (as defined in IEC 61010-1).</p>

## Environmental considerations

This section provides information about the environmental impact of the product.

### Product end-of-life handling

Observe the following guidelines when recycling an instrument or component:

**Equipment recycling.** Production of this equipment required the extraction and use of natural resources. The equipment may contain substances that could be harmful to the environment or human health if improperly handled at the product's end of life. To avoid release of such substances into the environment and to reduce the use of natural resources, we encourage you to recycle this product in an appropriate system that will ensure that most of the materials are reused or recycled appropriately.



This symbol indicates that this product complies with the applicable European Union requirements according to Directives 2012/19/EU and 2006/66/EC on waste electrical and electronic equipment (WEEE) and batteries. For information about recycling options, check the Support/Service section of the Tektronix Web site ([www.tektronix.com](http://www.tektronix.com)).

**Perchlorate materials.** This product contains one or more type CR lithium batteries. According to the state of California, CR lithium batteries are classified as perchlorate materials and require special handling. See [www.dtsc.ca.gov/hazardouswaste/perchlorate](http://www.dtsc.ca.gov/hazardouswaste/perchlorate) for additional information.

### Restriction of hazardous substances

This product is classified as an industrial monitoring and control instrument, and is not required to comply with the substance restrictions of the recast RoHS Directive 2011/65/EU until July 22, 2017.