

P5200A Series High Voltage Differential Probes

Installation and Safety Instructions & Product Documentation CD

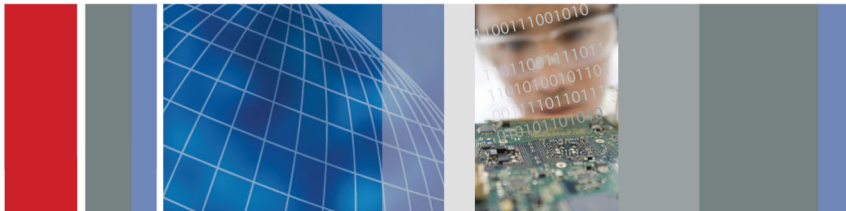

071-2889-02

Tektronix

Copyright © Tektronix. All rights reserved. Licensed software products are owned by Tektronix or its subsidiaries or suppliers, and are protected by national copyright laws and international treaty provisions.

Tektronix products are covered by U.S. and foreign patents, issued and pending. Information in this publication supersedes that in all previously published material. Specifications and price change privileges reserved.

TEKTRONIX and TEK are registered trademarks of Tektronix, Inc.

Contacting Tektronix

Tektronix, Inc.

14150 SW Karl Braun Drive

P.O. Box 500

Beaverton, OR 97077

USA

For product information, sales, service, and technical support:

- In North America, call 1-800-833-9200.
- Worldwide, visit www.tektronix.com to find contacts in your area.

General Safety Summary

Review the following safety precautions to avoid injury and prevent damage to this product or any products connected to it.

To avoid potential hazards, use this product only as specified.

Only qualified personnel should perform service procedures.

While using this product, you may need to access other parts of a larger system. Read the safety sections of the other component manuals for warnings and cautions related to operating the system.

To Avoid Fire or Personal Injury

Use Proper Power Cord. Use only the power cord specified for this product and certified for the country of use.

Ground-Referenced Oscilloscope Use Only. Do not float the output of this probe. The output cable must be connected to an earth-referenced (0 V) oscilloscope.

Avoid Electric Shock. When using probe accessories, never exceed the lowest rating of the probe or its accessory, whichever is less, including the measurement category and voltage rating.

Inspect The Probe And Accessories. Before each use, inspect probe and accessories for damage (cuts, tears, defects in the probe body, accessories, cable jacket, etc.). Do not use if damaged.

Connect and Disconnect Properly. When using the probe or accessories, keep fingers behind the finger guard of probe body and accessories.

Connect and Disconnect Properly. Do not connect or disconnect probes or test leads while they are connected to a voltage source.

Connect and Disconnect Properly. Connect the probe output to the measurement instrument before connecting the probe to the circuit under test. Connect the probe input leads one at a time. Make sure accessories are fully mated before connecting and disconnecting. Disconnect the probe input leads one at a time from the circuit under test before disconnecting the probe output from the measurement instrument.

Observe All Terminal Ratings. To avoid fire or shock hazard, observe all ratings and markings on the product. Consult the product manual for further ratings information before making connections to the product.

Avoid Electric Overload. To avoid injury or fire hazard, do not apply potential to any input, including the reference inputs, that varies from ground by more than the maximum rating for that input.

Power Disconnect. The power cord disconnects the product from the power source. Do not block the power cord; it must remain accessible to the user at all times.

Do Not Operate Without Covers. Do not operate this product with covers or panels removed.

Do Not Operate With Suspected Failures. If you suspect that there is damage to this product, have it inspected by qualified service personnel.

Avoid Exposed Circuitry. Do not touch exposed connections and components when power is present.

Use Proper AC Adapter. Use only the AC adapter specified for this product.

Do Not Operate in Wet/Damp Conditions.

Do Not Operate in an Explosive Atmosphere.

Keep Product Surfaces Clean and Dry.

Terms in this Manual

These terms may appear in this manual:



WARNING. *Warning statements identify conditions or practices that could result in injury or loss of life.*



CAUTION. *Caution statements identify conditions or practices that could result in damage to this product or other property.*

Symbols and Terms on the Product

These terms may appear on the product:

- DANGER indicates an injury hazard immediately accessible as you read the marking.
- WARNING indicates an injury hazard not immediately accessible as you read the marking.
- CAUTION indicates a hazard to property including the product.

The following symbol(s) may appear on the product:



CAUTION
Refer to Manual



WARNING
High Voltage

Compliance Information

This section lists the safety and environmental standards with which the instrument complies.

Safety Compliance

EC Declaration of Conformity – Low Voltage

Compliance was demonstrated to the following specification as listed in the Official Journal of the European Communities:

Low Voltage Directive 2006/95/EC.

- EN 61010-031/A1:2008. Safety requirements for electrical equipment for measurement, control and laboratory use - Part 031: Safety requirements for hand-held probe assemblies for electrical measurement and test.

Canadian Certification

- CAN/CSA-C22.2 NO. 61010-031-07/A1:2010, 1st Edition. Safety requirements for handheld probe assemblies for electrical measurement and test.

Additional Compliances

- IEC 61010-031/A1:2008. Safety requirements for electrical equipment for measurement, control and laboratory use - Part 031: Safety requirements for hand-held probe assemblies for electrical measurement and test.

Pollution Degree Description

A measure of the contaminants that could occur in the environment around and within a product. Typically the internal environment inside a product is considered to be the same as the external. Products should be used only in the environment for which they are rated:

- Pollution Degree 1. No pollution or only dry, nonconductive pollution occurs. Products in this category are generally encapsulated, hermetically sealed, or located in clean rooms.
- Pollution Degree 2. Normally only dry, nonconductive pollution occurs. Occasionally a temporary conductivity that is caused by condensation must be expected. This location is a typical office/home environment. Temporary condensation occurs only when the product is out of service.
- Pollution Degree 3. Conductive pollution, or dry, nonconductive pollution that becomes conductive due to condensation. These are sheltered locations where neither temperature nor humidity is controlled. The area is protected from direct sunshine, rain, or direct wind.
- Pollution Degree 4. Pollution that generates persistent conductivity through conductive dust, rain, or snow. Typical outdoor locations.

Pollution Degree

Pollution Degree 2 (as defined in IEC 61010-1). Note: Rated for indoor use only.

Installation & Measurement (Overvoltage) Category Descriptions

Terminals on this product may have different installation or measurement (overvoltage) category designations. The installation and measurement categories are:

- Overvoltage Category IV. For measurements and installations performed at the source of low-voltage installation.
- Overvoltage Category III. For measurements and installations performed in the building installation.
- Overvoltage Category II. For measurements and installations performed on circuits directly connected to the low-voltage installation.
- Overvoltage Category I. For measurements and installations performed on circuits not directly connected to MAINS.

Overvoltage Category (AC Adapter, P5200A Only)

Overvoltage Category II (as defined in IEC 61010-1)

Measurement Overvoltage Category

Refer to individual probe ratings for details.

Environmental Considerations

This section provides information about the environmental impact of the product.

Product End-of-Life Handling

Observe the following guidelines when recycling an instrument or component:

Equipment Recycling. Production of this equipment required the extraction and use of natural resources. The equipment may contain substances that could be harmful to the environment or human health if improperly handled at the product's end of life. In order to avoid release of such substances into the environment and to reduce the use of natural resources, we encourage you to recycle this product in an appropriate system that will ensure that most of the materials are reused or recycled appropriately.



This symbol indicates that this product complies with the applicable European Union requirements according to Directives 2002/96/EC and 2006/66/EC on waste electrical and electronic equipment (WEEE) and batteries. For information about recycling options, check the Support/Service section of the Tektronix Web site (www.tektronix.com).

Restriction of Hazardous Substances

This product has been classified as Monitoring and Control equipment, and is outside the scope of the 2002/95/EC RoHS Directive.

Operating Considerations

Specification	P5200A	P5202A
Bandwidth	50 MHz	100 MHz
Maximum measurable differential voltage (DC + Peak AC) ¹	50X: ± 130 V 500X: ± 1300 V	20X: ± 64 V 200X: ± 640 V
(V_{rms})	50X: $92 V_{rms}$ 500X: $920 V_{rms}$	20X: $45 V_{rms}$ 200X: $450 V_{rms}$
Maximum common mode voltage (DC + Peak AC) ²	50X: ± 130 V 500X: ± 1300 V	20X: ± 64 V 200X: ± 640 V
Maximum input voltage-to-earth (V_{rms}) ²	1000 V CAT II 600 V CAT III	300 V CAT II 450 V CAT III
CAT I Maximum Rated Over-Voltage Transient (OVT) (V_{pk}) ³	—	1760 V

- Beyond these limits, the output could be clipped. (See Figure 1 on page 10.)
- The Common Mode and input voltage-to-earth ratings are the maximum ratings of each input lead (+/-) to ground. (See Figure 1 on page 10.)
- Applies to CAT I ratings only. The OVT peak is measured on top of the Peak Working Voltage.

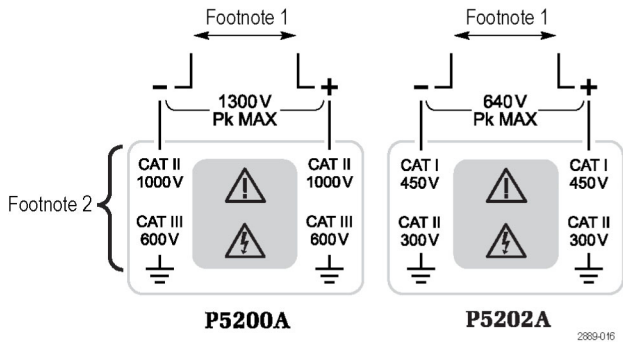

Figure 1: Specification table footnotes referring to the probe input limits on the P5200A and P5202A probes

Specification	P5205A	P5210A
Bandwidth	100 MHz	50 MHz
Maximum measurable differential voltage (DC + Peak AC) ¹	50X: ± 130 V 500X: ± 1300 V	100X: ± 560 V 1000X: ± 5600 V
(V_{rms})	50X: $92 V_{rms}$ 500X: $920 V_{rms}$	20X: $396 V_{rms}$ 200X: $2650 V_{rms}$ ²
Maximum common mode voltage (DC + Peak AC) ³	50X: ± 130 V 500X: ± 1300 V	100X: ± 320 V 1000X: ± 3200 V
Maximum input voltage-to-earth (V_{rms}) ³	1000 V CAT II 600 V CAT III	1000 V CAT III 2300 V CAT I
CAT I Maximum Rated Over-Voltage Transient (OVT) (V_{pk}) ⁴	—	2250 V

- 1 Beyond these limits, the output could be clipped. (See Figure 2 on page 12.)
- 2 This rating assumes that the common mode voltage ratings are not exceeded. (See Figure 2 on page 12.)
- 3 The Common Mode and input voltage-to-earth ratings are the maximum ratings of each input lead (+/-) to ground. (See Figure 2 on page 12.)
- 4 Applies to CAT I ratings only. The OVT peak is measured on top of the Peak Working Voltage.

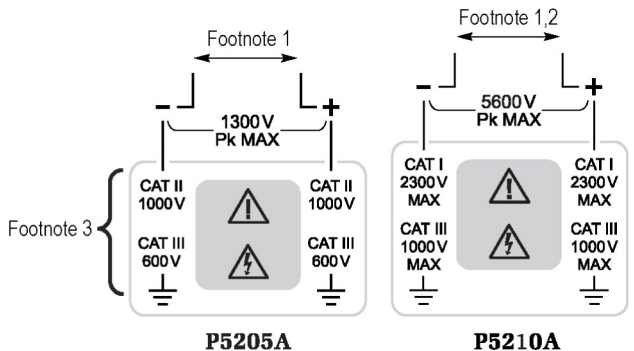
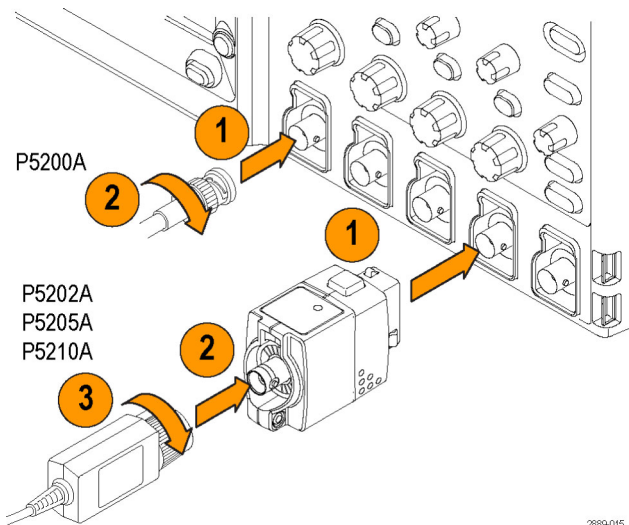

Figure 2: Specification table footnotes referring to the probe input limits on the P5205A and P5210A probes

Characteristic	Specification
Temperature	
Operating	0 °C to +40 °C (+32 °F to +104 °F)
Nonoperating	-30 °C to +70 °C (-22 °F to +158 °F)
Humidity	
Operating	5 to 85% R.H. 0 °C to +40 °C (+32 °F to +104 °F)
Nonoperating	5 to 85% R.H. 0 °C to +40 °C (+32 °F to +104 °F) 5 to 45% R.H. above 40 °C to +70 °C (+104 °F to +158 °F)
Altitude	
Operating	Up to 3000 m (10,000 ft.)
Nonoperating	Up to 15,240 m (50,000 ft.)
Pollution degree	2, Indoor use only

Installation



2889-015

To connect the P5202A, P5205A, and P5210A probes to oscilloscopes that feature the VPI interface, you must use a Tektronix TPA-BNC Adapter.

To disconnect the probes, first disconnect the probe from the circuit. Next, turn the collar counterclockwise to release the probe, and then pull out the connector.

Probe Power (P5200A Probe Only)

The P5200A probe requires DC power that is provided by an external power supply. The supply is a standard accessory for the probe.



WARNING. Use only the power supply that is included with the P5200A probe. Damage to the probe may result if a different power supply is used.

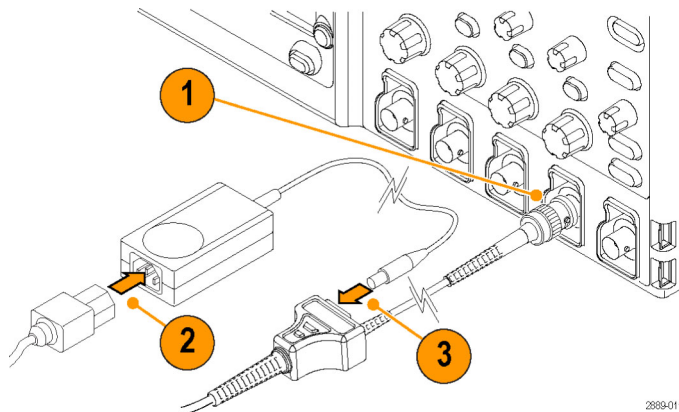

WARNING. To avoid electrical shock or fire, keep the probe body and output cable of the probe away from the circuits being measured. The probe body and output cable are not intended to be in contact with the circuits being measured.

Connecting the Probe to the Circuit



WARNING. To reduce risk of shock or fire, use only the accessories provided with the probe. Do not exceed either the voltage rating or category ratings (for example, CAT I, II, III, IV) of the probe or the probe accessory, whichever is the lesser of the two. Refer to the tables below and on the following pages for the correct accessory to use with your probe. When using multiple accessories (for example, the extender leads & hook clips), the lowest accessory/probe ratings apply to all.

To avoid electric shock, keep your fingers behind the finger guard of the probe accessory and away from the shaded area shown in the accessory illustrations below.

P5200A, P5202A & P5205A Probe standard accessory derating table

Combined probe and accessory common-mode voltage and input voltage-to-earth ratings

Accessory	P5202A	P5200A & P5205A	P5210A¹
Extender leads	450 V CAT I 300 V CAT II	1000 V CAT II 600 V CAT III	2300 V CAT I 1000 V CAT III
Hook clips (AC280-FL)	450 V CAT I 300 V CAT II	1000 V CAT II 600 V CAT III	1000 V CAT I 1000 V CAT III
Pincer clips (AC283-FL)	450 V CAT I 300 V CAT II	1000 V CAT II 600 V CAT III	1000 V CAT I 1000 V CAT III
Alligator clips (AC285-FL)	450 V CAT I 300 V CAT II	1000 V CAT II 600 V CAT III	1000 V CAT I 1000 V CAT III

¹ The P5210A probe can be used with these accessories at the reduced voltage levels listed.

Standard Accessories

P5200A, P5202A & P5205A Probe standard accessories

Item

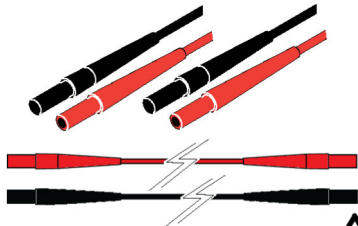

Description

Extender leads (196-3523-xx)

The female banana connectors on each end of the leads fit into the probe input jacks. Use the extender leads to connect the probe to your circuit, either directly or through any of the standard accessories described below.

WARNING. To avoid electrical shock or fire, make sure the test leads are in good condition. The input leads and extender leads have a jacket wear indicator which becomes visible if the wire jacket become excessively worn. If the wear indicator is visible, do not use the probe. Contact Tektronix Service for repair or replacement.

Maximum ratings:
2300 V CAT I
1000 V CAT III

P5200A, P5202A & P5205A Probe standard accessories, (cont.)

Item

Description

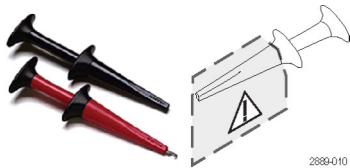

Hook clips (AC280-FL)

Use these clips to make connections to component leads.

Maximum ratings:
1000 V CAT III
600 V CAT IV



Pincer clips (AC283-FL)

These clips have a pair of finer contacts that close around leads on smaller components.

Maximum ratings:
1000 V CAT III
600 V CAT IV



Alligator clips (AC285-FL)

The large insulated clips connect easily to large bolts or bus bars. The connectors are double insulated for safety.

Maximum ratings:
1000 V CAT III
600 V CAT IV



WARNING. To avoid risk of electric shock or fire, do not use the P5210A test probe or hook tip accessories on CAT III or CAT IV circuits. Refer to the derating table below.

To avoid risk of electric shock or fire, when using the P5210A test probe or hook tip accessories with the P5200A, P5202A and P5205A probes, do not use on circuits above 1000 V.

P5210A Probe standard accessory derating table

Combined probe and accessory common-mode voltage and input voltage-to-earth ratings

Accessory	P5202A ¹	P5200A & P5205A ¹	P5210A
Extender leads	450 V CAT I 300 V CAT II	1000 V CAT II 600 V CAT III	2300 V CAT I 1000 V CAT III
Test probes (TATP)	450 V CAT I 300 V CAT II	1000 V CAT II 600 V CAT II	2300 V CAT I 1000 V CAT II
Small hook tips (TASH)	450 V CAT I 300 V CAT II	1000 V CAT II 600 V CAT II	2300 V CAT I 1000 V CAT II
Large hook tips (TALH)	450 V CAT I 300 V CAT II	1000 V CAT II 600 V CAT II	2300 V CAT I 1000 V CAT II

¹ The P5200A, P5202A & P5205A probes can also be used with the P5210A accessories, but only at the reduced voltage levels listed in this table.

P5210A Probe standard accessories

Item

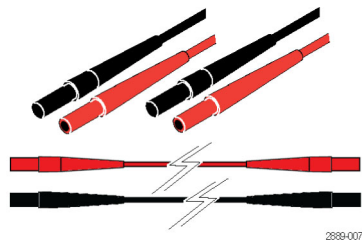

Description

Extender leads (196-3523-xx)

The female banana connectors on one end of the leads fit into the probe input leads. Use the extender leads to connect the probe to the test probes below. The test probes accept the hook tips in the P5210A Probe accessory kit.

Maximum ratings: 2300 V CAT I
1000 V CAT III

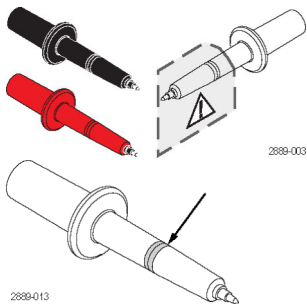

Test probes (TATP) (020-3070-xx kit)

Use these test probes to browse multiple test points or to connect the extender leads to the hook tips.

WARNING. To prevent arc flash, use caution when probing circuits with raised components. Avoid getting the metal shell between components of different potentials. Use TASH for probing in hard-to-reach areas.

Maximum ratings: 2300 V CAT I
1000 V CAT II

P5210A Probe standard accessories, (cont.)

Item

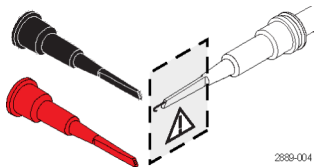

2889-004



Description

Small hook tips (TASH) (020-3070-xx kit)

Use these tips to access test points in tight spaces. Screw the hook tips onto the TATP test probes and then clamp the hooks onto the circuit.

WARNING. To reduce the risk of shock when measuring voltages above 1000 V, always keep your fingers behind the tactile indicator on the TASH and TALH hook tips.

Maximum ratings:

2300 V CAT I

1000 V CAT II

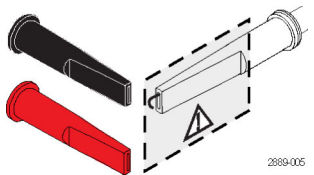

2889-005

Large hook tips (TALH) (020-3070-xx kit)

Screw the hook tips onto the TATP test probes and then clamp the hooks onto the circuit.

Maximum ratings:

2300 V CAT I

1000 V CAT II

Controls and Features

Controls and features

Item

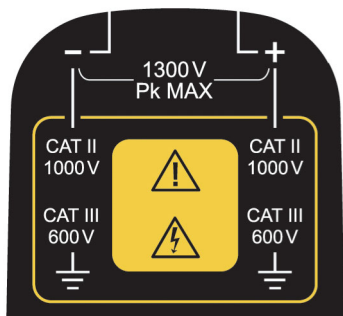

0536-001

Description

Differential inputs

The differential and common-mode input voltage ratings for the P5200A series probes differ between models.

The highest ratings are for the P5210A probe and are rated for a maximum peak voltage of 5,600 V between the inputs.

The inputs are CAT I rated to a maximum of 2,300 V_{RMS} between either input and earth ground.

The maximum Over-Voltage Transient (OVT) rating and other ratings for the all of the probe models are listed in this booklet. (See page 9, *Operating Considerations*.)

For complete specifications, refer to the *P5200A Series High Voltage Differential Probes Instruction Manual*, a pdf file on the documentation CD.

Controls and features, (cont.)

Item



Description

Attenuation selector button and indicators

Press the button to select between the voltage range (attenuation) settings of the probe. The range and units are indicated on the probe and may be displayed on the oscilloscope screen, depending on the oscilloscope model.



The Overrange LED lights if the applied voltage exceeds the selected range. To extinguish the LED, select a higher range. If a higher range is not available, do not attempt to take the measurement with the probe. (See warning below.)



WARNING. *The Overrange indicator does not detect an overrange condition of common mode voltages or voltage-to-earth potential at the probe inputs. The Overrange indicator only detects differentially between the + and - inputs, not relative to ground. Do not exceed the common mode voltage or voltage-to-earth probe ratings when taking measurements. If you are not sure, first take a single-ended measurement of each point that you intend to measure differentially. Take a single-ended measurement by tying one input lead to ground (for example, the - input) and then connecting the other lead (for example, the + input) to the points of interest, one at a time.*

Controls and features

Item



Description

Bandwidth limit button and indicators

Press the button to limit the probe bandwidth to 5 MHz. The 5 MHz filter assists in the characterization and testing of power supplies in switch mode by removing all high frequency content, noise and harmonics from the measurement. 5 MHz is close to the switching frequency of most switching transistors (FETs) in switch-mode power supplies.

Press the button again to return to the Full position, which selects the full specified bandwidth of the probe.

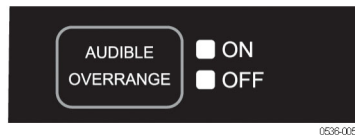

Audible Overrange On/Off button and indicators

Press the button to enable the audible alarm (the ON LED lights). The audible alarm indicates that the measured signal exceeds the selected range.

Press the button again to disable the audible feature (the OFF LED lights).

CD Contents

The documentation CD included with this booklet contains pdf files of the *P5200A Series High Voltage Differential Probes Instruction Manual*, and other documents to help you understand how to take differential measurements with your probe.

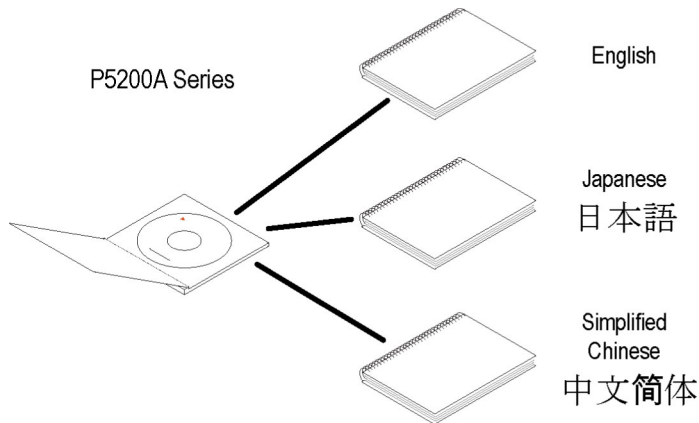

2889-019