



PCIe3.0 (BASE / CEM) Receiver Test Application Help

Register now!

Click the following link to protect your product.

www.tek.com/register



Copyright © 2026, Tektronix, Inc. All rights reserved. Licensed software products are owned by Tektronix or its subsidiaries or suppliers, and are protected by national copyright laws and international treaty provisions. Tektronix products are covered by U.S. and foreign patents, issued and pending. Information in this publication supersedes that in all previously published material. Specifications and price change privileges reserved.

TEKTRONIX and TEK are registered trademarks of Tektronix, Inc.

Supports Product Firmware

TekSecure is trademark of Tektronix, Inc.

These are the original instructions in English.

Go to tek.com/eula to read the Tektronix End User License Agreement.



Contacting Tektronix

Tektronix, Inc.
13725 SW Karl Braun Drive
P.O. Box 500
Beaverton, OR 97077
USA

For product information, sales, service, and technical support:

In North America, call 1-800-833-9200.

Worldwide, visit www.tek.com to find contacts in your area.

Contents

Welcome	10
Getting help and support	11
Related documentation	11
Technical support	11
Conventions	11
Getting started	13
Required equipment and accessories	13
Installing the software	14
Operating basics	15
Launch the application	15
Close the application	15
Launch Real-Time Oscilloscope	16
Launch TekRxService	16
Application panels	16
Application panels overview	16
Connections panel	17
Settings panel	18
Help panel	29
Calibrations panel	29
Tests panel	50
Options panel	77
Programmatic interface commands	96
TEKRXTTEST:SELECT:HOME	96
TEKRXTTEST:SELECT:PCle1	96
TEKRXTTEST:SELECT:PCle2	96
TEKRXTTEST:SELECT:PCle3	96
PREF:BERT:IP	97
PREF:RTS:IP	97
CONN:BERT	97
CONN:RTS	98
SETTINGS:RTS:POSITIVECHANNEL	98
SETTINGS:RTS:NEGATIVECHANNEL	98
SETTINGS:RTS:SAMPLERATE	99
SETTINGS:TEKRXSERVICE:ANALYSISTIMEOUT	99
SETTINGS:SIGTEST:VERSION	99
SETTINGS:AMPLITUDE:TARGET	100
SETTINGS:RJ:TARGET	100
SETTINGS:SJAT100MHZ:TARGET	100

SETTINGS:DMI:TARGET	101
SETTINGS:CMI:TARGET	101
SETTINGS:CMICALGEN3:ENABLE	101
SETTINGS:MULTITONESJCAL:ENABLE	101
SETTINGS:MULTITONESJCAL:FREQUENCYCOUNT	102
SETTINGS:MULTITONESJCAL:MAXFREQUENCY	102
SETTINGS:MULTITONESJCAL:MINFREQUENCY	102
SETTINGS:MULTITONESJCAL:POINTS	103
SETTINGS:EYE:ACQUISITIONS	103
SETTINGS:MULTITONESJCAL:DEFAULT	103
SETTINGS:MULTITONESJCAL:GENERATE	103
SETTINGS:SOCKETSERVER:IP	104
SETTINGS:SOCKETSERVER:LISTENINGPORT	104
SETTINGS:SOCKETSERVER:TIMEOUT	104
SETTINGS:RESTORE	105
SETTINGS:RECALL	105
SETTINGS:SAVE	105
SETTINGS:RECALL:STATUS	105
SETTINGS:RESTORE:STATUS	106
SETTINGS:SAVE:STATUS	106
TP1CAL:OPEN	106
TP1CAL:WIZARD:OPEN	106
TP1CAL:WIZARD:CLOSE	107
TP1CAL:DELETE	107
TP1CAL:REPORT	107
TP1CAL:SAVE	108
TP1CAL:EQUIP:INIT	108
TP1CAL:EQUIP:SKIP SIGNAL VALIDATION	108
TP1CAL:AUTO CAL	108
TP1CAL:AMPLITUDE:RUN	109
TP1CAL:PRESET:RUN	109
TP1CAL:RJ:RUN	109
TP1CAL:SJ:RUN	110
TP1CAL:MULTITONESJCAL:RUN	110
TP1CAL:EQUIP:STATUS	110
TP1CAL:AMPLITUDE:STATUS	111
TP1CAL:PRESET:STATUS	111
TP1CAL:RJ:STATUS	111
TP1CAL:SJ:STATUS	112
TP1CAL:MULTITONESJCAL:RUN	112
TP1CAL:AMPLITUDE:SETTING	112
TP1CAL:RJ:SETTING	112
TP1CAL:SJ:SETTING	113
TP1CAL:SAVE:ID	113
TP1CAL:SAVE:GENERATED BY	113
TP1CAL:SAVE:COMMENTS	113

TP1CAL:ACDC:RUN	114
TP1CAL:ACDC:STATUS	114
TP1CAL:ACDC:SETTING	114
TP1CAL:SJ@210MHz:RUN	115
TP1CAL:SJ@210MHz:STATUS	115
TP2CAL:OPEN	115
TP2CAL:WIZARD:OPEN	115
TP2CAL:WIZARD:CLOSE	116
TP2CAL:DUT:TYPE	116
TP2CAL:SELECT:TP1	116
TP2CAL:DELETE	117
TP2CAL:REPORT	117
TP2CAL:SAVE	117
TP2CAL:EQUIP:INIT	117
TP2CAL:EQUIP:SKIPSIGNALVALIDATION	118
TP2CAL:CMI:RUN	118
TP2CAL:STRESSEDEYE:RUN	118
TP2CAL:STRESSEDEYE:MANUALCALRUN	119
TP2CAL:EQUIP:STATUS	119
TP2CAL:CMI:STATUS	119
TP2CAL:STRESSEDEYE:STATUS	120
TP2CAL:DMI:SETTING	120
TP2CAL:CMI:SETTING	120
TP2CAL:SAVE:ID	121
TP2CAL:SAVE:GENERATEDBY	121
TP2CAL:SAVE:COMMENTS	121
TP2CAL:STRESSEDEYE:ACQUISITIONS	121
TP2CAL:DMI:RUN	122
TP2CAL:DMI:STATUS	122
TP2CAL:STRESSEDEYE:RJ	122
TP2CAL:STRESSEDEYE:DMI	123
TP2CAL:STRESSEDEYE:AMPLITUDE	123
TP2CAL:STRESSEDEYE:EXHAUSTIVESWEEP	123
TP2CAL:STRESSEDEYE:LINEARSWEEP	124
TP2CAL:STRESSEDEYE:EXHAUSTIVE	124
TP2CAL:STRESSEDEYE:STEP SIZE	125
TEST:SELECT:TESTDURATION	125
TEST:SELECT:STRESSCONFIGTYPE	126
TEST:SELECT:AMP	126
TEST:SELECT:DMI	126
TEST:SELECT:CMI	127
TEST:SELECT:RJ	127
TEST:SELECT:SJ	127
TEST:SELECT:BER	127
TEST:SELECT:ERRORLIMIT	128
LOOPBACK:SELECT:CONFIGURATIONTYPE	128

LOOPBACK:SELECT:PRESETSNAME.	128
LOOPBACK:SELECT:PRESETSPRESHOOT.	129
LOOPBACK:SELECT:PRESETSDEEMPHASIS.	129
LOOPBACK:SELECT:BERTCTLEMODE.	129
LOOPBACK:SELECT:BERTCTLETYPE.	130
LOOPBACK:SELECT:BERTCTLEVALUE.	130
LOOPBACK:SELECT:AUTOSEARCHMODE.	130
LOOPBACK:SELECT:PATTERNATYPE.	131
JTOLTEST:OPEN.	131
JTOLTEST:WIZARD:OPEN.	131
JTOLTEST:WIZARD:CLOSE.	132
JTOLTEST:SELECT:TP2FILE.	132
JTOLTEST:SELECT:CUSTOM:MASK.	132
JTOLTEST:LOADSTRESS.	133
JTOLTEST:MIN:FREQ.	133
JTOLTEST:MAX:FREQ.	133
JTOLTEST:FREQ:POINTS.	133
JTOLTEST:FREQ:GENERATE.	134
JTOLTEST:FREQ:DEFAULT.	134
JTOLTEST:SELECT:RELAXATION.	134
JTOLTEST:SEARCH:ALGO.	135
JTOLTEST:RUN.	135
JTOLTEST:SAVE:ID.	135
JTOLTEST:SAVE:GENERATEDBY.	136
JTOLTEST:SAVE:COMMENTS.	136
JTOLTEST:SAVE.	136
JTOLTEST:RUNSTATUS.	137
JTOLTEST:FREQ.	137
JTOLTEST:PLOT:POINTS.	137
JTOLTEST:SELECT:SJAMPUNITS.	137
JTOLTEST:SELECT:CLOCKTYPE.	138
JTOLTEST:PLOT.	138
JTOLTEST:TABLE.	138
JTOLTEST:SELECT:DUTTYPE.	139
JTOLTEST:LINKTRAINING:LOOPBACKMODEGEN3.	139
JTOLTEST:LINKTRAINING:BERTINITIALPRESET.	139
JTOLTEST:LINKTRAINING:DUTINITIALPRESET.	140
JTOLTEST:LINKTRAINING:DUTTARGETPRESET.	140
JTOLTEST:LINKTRAINING:LANENUMBER.	140
JTOLTEST:LINKTRAINING:LINKNUMBER.	140
JTOLTEST:LINKTRAINING:STRESSTYPE.	141
JTOLTEST:LINKTRAINING:CTLE.	141
JTOLTEST:LINKTRAINING:DUTPOWERONTYPE.	141
JTOLTEST:LINKTRAINING:SCRIPTLOCATION.	142
JTOLTEST:LINKTRAINING:DUTPOWERDELAY.	142
JTOLTEST:BERMEASUREMENT:PATTERN.	142

JTOLTEST:LINKTRAINING:STOP.	143
JTOLTEST:LINKTRAINING:ENABLEDUTLOOPBACKAFTERTEST.	143
JTOLTEST:LINKTRAINING:USERPATTERNLOCATION.	144
JTOLTEST:JITTERSTEP:VERYLOWFREQ.	144
JTOLTEST:JITTERSTEP:LOWFREQ.	144
JTOLTEST:JITTERSTEP:MIDDLEFREQ.	145
JTOLTEST:JITTERSTEP:HIGHFREQ.	145
JTOLTEST:CLOCK:ARCHITECTURE.	145
JTOLTEST:INSERT:SKP.	146
JTOLTEST:FILTER:SKP.	146
JTOLTEST:SKP:GEN12:SYMBOLLENGTH.	146
JTOLTEST:SKP:GEN345:SYMBOLLENGTH.	147
JTOLTEST:SKP:GEN12:DOUBLESKP.	147
JTOLTEST:SKP:GEN345:DOUBLESKP.	148
JTOLTEST:SRNS:SKP:GEN12:INTERVAL.	148
JTOLTEST:SRNS:SKP:GEN345:INTERVAL.	148
JTOLTEST:SRIS:SKP:GEN12:INTERVAL.	149
JTOLTEST:SRIS:SKP:GEN345:INTERVAL.	149
JTOLTEST:SSC:STATE.	149
JTOLTEST:LINKTRAINING:PCIESLOT.	149
JTOLTEST:COMMONCLOCK:SKP:GEN12:INTERVAL.	150
JTOLTEST:COMMONCLOCK:SKP:GEN345:INTERVAL.	150
JTOLTEST:LINKTRAINING:CTLETYPE.	150
JTOLTEST:LINKTRAINING:POWEROPTIONTYPE.	151
JTOLTEST:LINKTRAINING:CBBAUTORESET.	151
JTOLTEST:LINKTRAINING:CBBPOWERCYCLE.	151
JTOLTEST:LINKTRAINING:CBBPOWERRESET.	152
JTOLTEST:LINKTRAINING:CBBWAITINGTIME.	152
LEQRXTEST:OPEN.	152
LEQRXTEST:WIZARD:OPEN.	153
LEQRXTEST:WIZARD:CLOSE.	153
LEQRXTEST:DUTTYPE.	153
LEQRXTEST:CLOCKTYPE.	154
LEQRXTEST:SELECT:TP2FILE.	154
LEQRXTEST:SHOW:CONNECTIONDIAGRAM.	154
LEQRXTEST:LINKTRAINING:BERTINITIALPRESET.	154
LEQRXTEST:LINKTRAINING:DUTINITIALPRESET.	155
LEQRXTEST:LINKTRAINING:DUTTARGETPRESET.	155
LEQRXTEST:LINKTRAINING:LINKNUMBER.	155
LEQRXTEST:LINKTRAINING:LANENUMBER.	156
LEQRXTEST:LINKTRAINING:LOOPBACKMODEGEN3.	156
LEQRXTEST:LINKTRAINING:DUTPOWERONTYPE.	156
LEQRXTEST:LINKTRAINING:DUTPOWERDELAY.	157
LEQRXTEST:LINKTRAINING:SCRIPTLOCATION.	157
LEQRXTEST:BERMEASUREMENT:PATTERN.	157
LEQRXTEST:LINKTRAINING:STRESSTYPE.	158

LEQRXTEST:LINKTRAINING:CTLE.	158
LEQRXTEST:LINKTRAINING:ENABLEDUTLOOPBACKAFTERTEST.	159
LEQRXTEST:LINKTRAINING:USERPATTERNLOCATION.	159
LEQRXTEST:SSC:STATE.	159
LEQRXTEST:LINKTRAINING:AUTOSEARCHANDTUNECDR.	160
LOOPBACK:SELECT:BERTCTLEMODE.	160
LEQRXTEST:RUN.	160
LEQRXTEST:STATUS.	161
LEQRXTEST:LINKTRAINING:STATUS.	161
LEQRXTEST:LINKTRAINING:STOP.	161
LEQRXTEST:TEST:ADDERROR.	161
LEQRXTEST:TEST:CURRENTBER.	162
LEQRXTEST:TEST:CURRENTERRORCOUNT.	162
LEQRXTEST:TEST:CURRENTTOTALBITS.	162
LEQRXTEST:TEST:RESULT.	163
LEQRXTEST:SAVE:ID.	163
LEQRXTEST:SAVE:GENERATEDBY.	163
LEQRXTEST:SAVE:COMMENTS.	163
LEQRXTEST:SAVE.	164
LEQRXTEST:CLOCK:ARCHITECTURE.	164
LEQRXTEST:INSERT:SKP.	164
LEQRXTEST:FILTER:SKP.	165
LEQRXTEST:SKP:GEN12:SYMBOLLENGTH.	165
LEQRXTEST:SKP:GEN345:SYMBOLLENGTH.	166
LEQRXTEST:SKP:GEN12:DOUBLESKP.	166
LEQRXTEST:SKP:GEN345:DOUBLESKP.	166
LEQRXTEST:SRNS:SKP:GEN12:INTERVAL.	167
LEQRXTEST:SRNS:SKP:GEN345:INTERVAL.	167
LEQRXTEST:SRIS:SKP:GEN12:INTERVAL.	167
LEQRXTEST:SRIS:SKP:GEN345:INTERVAL.	168
LEQRXTEST:COMMONCLOCK:SKP:GEN12:INTERVAL.	168
LEQRXTEST:COMMONCLOCK:SKP:GEN345:INTERVAL.	168
LEQRXTEST:LINKTRAINING:CTLETYPE.	169
LEQRXTEST:LINKTRAINING:CBBAUTORESET.	169
LEQRXTEST:LINKTRAINING:CBBPOWERCYCLE.	169
LEQRXTEST:LINKTRAINING:CBBPOWERRESET.	170
LEQRXTEST:LINKTRAINING:CBBWAITINGTIME.	170
LEQRXTEST:LINKTRAINING:POWEROPTIONTYPE.	170
LEQTXTEST:OPEN.	170
LEQTXTEST:WIZARD:OPEN.	171
LEQTXTEST:WIZARD:CLOSE.	171
LEQTXTEST:SELECT:TP1FILE.	171
LEQTXTEST:DUTTYPE.	172
LEQTXTEST:CLOCKTYPE.	172
LEQTXTEST:SELECT:TEST.	172
LEQTXTEST:LINKTRAINING:BERTINITIALPRESET.	173

LEQTXTEST:LINKTRAINING:LINKNUMBER.....	173
LEQTXTEST:LINKTRAINING:LANENUMBER.....	173
LEQTXTEST:LINKTRAINING:DUTPOWERONTYPE.....	174
LEQTXTEST:LINKTRAINING:DUTPOWERDELAY.....	174
LEQTXTEST:LINKTRAINING:SCRIPTLOCATION.....	174
LEQTXTEST:LINKTRAINING:CTLE.....	175
LEQTXTEST:LINKTRAINING:LOOPBACKMODEGEN3.....	175
LEQTXTEST:STRESSTYPE.....	175
LEQTXTEST:AMPLITUDE.....	176
LEQTXTEST:APPLYSOFTSEQ.....	176
LEQTXTEST:FILTERFILE.....	176
LEQTXTEST:DUTWFMSCALE.....	176
LEQTXTEST:LOOPBACKRUN.....	177
LEQTXTEST:DUTID.....	177
LEQTXTEST:INITIALPRESET.....	177
LEQTXTEST:SELECTPRESET.....	178
LEQTXTEST:CLEARALL.....	178
LEQTXTEST:CHECKALL.....	178
LEQTXTEST:RUN.....	179
LEQTXTEST:STATUS.....	179
LEQTXTEST:LINKTRAINING:STATUS.....	179
LEQTXTEST:LINKTRAINING:STOP.....	180
LEQTXTEST:SAVE:ID.....	180
LEQTXTEST:SAVE:COMMENTS.....	180
LEQTXTEST:SAVE:GENERATEDBY.....	180
LEQTXTEST:SAVE.....	181
LEQTXTEST:LINKTRAINING:CTLETYPE.....	181
LEQTXTEST:LINKTRAINING:CBBAUTORESET.....	181
LEQTXTEST:LINKTRAINING:CBBPOWERCYCLE.....	182
LEQTXTEST:LINKTRAINING:CBBPOWERRESET.....	182
LEQTXTEST:LINKTRAINING:CBBWAITINGTIME.....	182
LEQTXTEST:LINKTRAINING:POWEROPTIONTYPE.....	183
LEQTXTEST:SOFTWAREQTYPE <0/1>.....	183
LOOPBACK:AAS:DELAYSEARCHTYPE.....	183
LOOPBACK:AAS:EYETHRESHOLDTYPE.....	184
LOOPBACK:SELECT:LFEDFEMODE.....	184
LOOPBACK:SELECT:AUTOSEARCH.....	184
LOOPBACK:AUTOSEARCH:TYPE.....	185

Welcome

Welcome to the PCIe3.0 (BASE / CEM) TekRxTest application. PCI Express Architecture PHY Test Specification Revision 5.0 and Version1.0.

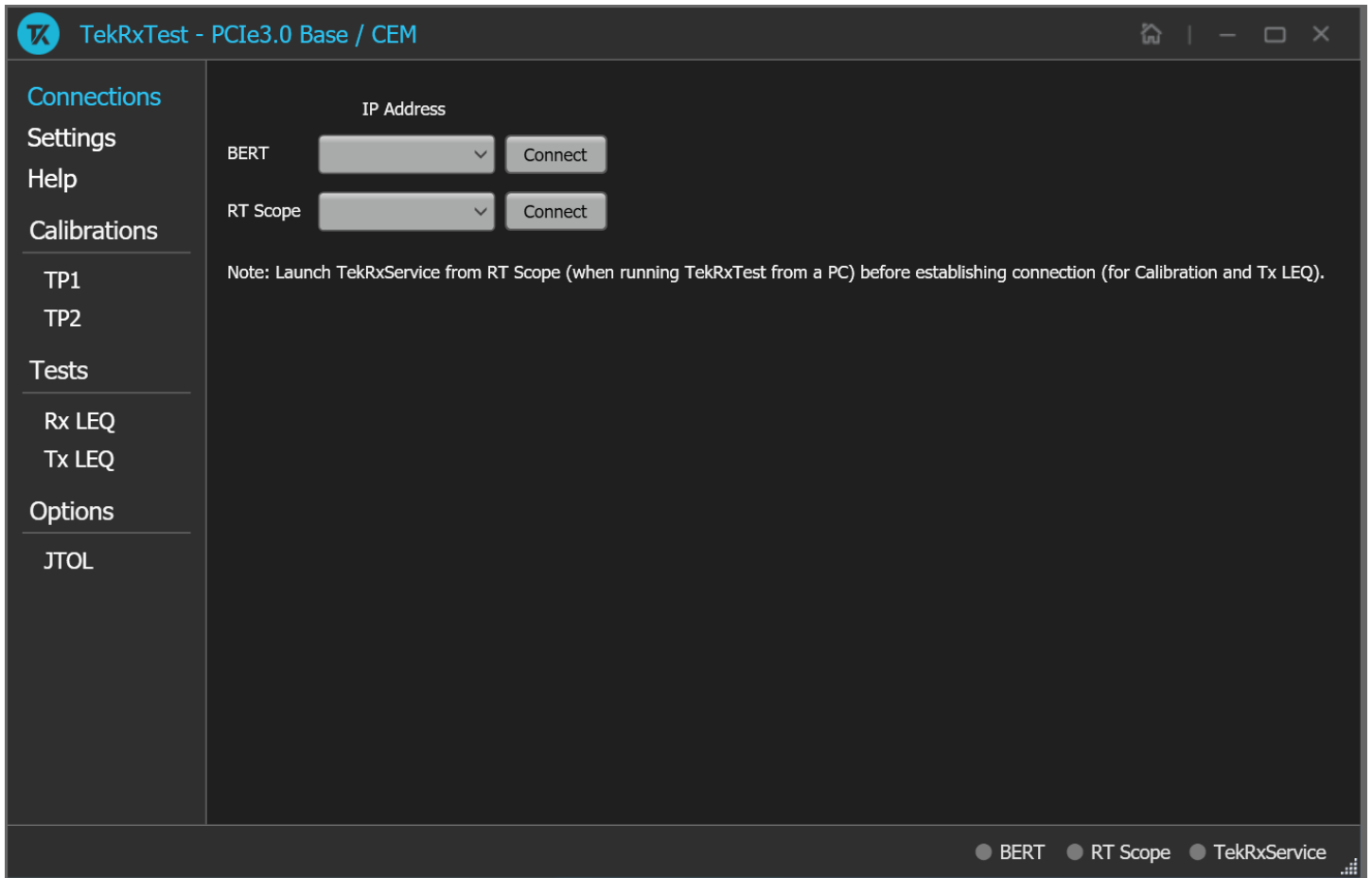

TekRxTest - PCIe3.0 BASE / CEM application

Receiver testing is accomplished by connecting the output of BERT PPG (which can produce specific PCIe test patterns) to the input of the DUT through a specialized set of fixtures and cables. The BERT can be programmed to add different amounts of random jitter, sinusoidal jitter, differential, common-mode interference along with variable signal amplitude, preshoot, and de-emphasis. Output of the DUT is connected to the BERT error detector to identify bit errors on the DUT Tx traffic, either during loopback or during sweep of one of the stress parameters. Any error detected can be assumed to be generated from the DUT Tx path as a result of either the DUT experiencing a bad bit-decision at its receiver or uncompensated back channel loss at the error detector of the BERT.

Key features and benefits

- Automated Calibration, Link Training, and Compliance Testing.
- Receiver JTOL test for AIC / System DUT.
- Jointly with Anritsu BERT MP1900A series, the receiver solution provides the tools and flexibility required to visualize and control the impairments, observe real-time eye performance for PCIe Gen3 devices.
- Reliable and accurate results reduce the test execution time and minimize the skill-set required to perform calibration and testing.

Getting help and support

Related documentation

The following documentation is available as part of the test application.

Product documentation

Item	Purpose	Location
Application Help	Application operation and User Interface details	Help panel of the application

See also

[Technical support](#) (on page 11)

Technical support

Tektronix values your feedback on our products. To help us serve you better, please send us your suggestions, ideas, or comments on your application or Real Time Oscilloscope. Contact Tektronix through mail, telephone, or the Web site. See Contacting Tektronix on page 0 at the front of this document for contact information.

When you contact Tektronix Technical Support, please include the following information (be as specific as possible):

General information

- All instrument model numbers
- Hardware options, if any
- Modules used
- Your name, company, mailing address, phone number, and FAX number
- Please indicate if you would like to be contacted by Tektronix about your suggestion or comments.

Application specific information

- Software version number
- Description of the problem such that technical support can duplicate the problem
- If possible, save the setup files for all the instruments used and the application



Conventions

Help uses the following conventions:

- The term "Application", "Software", and "" refers to the TekRxTest - Application.
- The term "DUT" is an abbreviation for Device Under Test.
- The term "select" is a generic term that applies to the two methods of choosing a screen item (button, control, list item): using a mouse or using the touch screen.

Icon descriptions

Icon	Meaning
------	---------

	This icon identifies important information.
	This icon identifies conditions or practices that could result in loss of data.
	This icon identifies additional information that will help you use the application more efficiently.

Getting started

Required equipment and accessories

Item	Vendor	R/O	Quantity	Description	Notes
MP1900A	Anritsu	Required	1	≥16 Gb/s BERT	NRZ or PAM4 Configuration can be used for Gen 3/4/5 NOTE: Configuration and Cables are required for connection between BERT modules are included by the 3rd party vendor.
DPO70K SX/DX or DPO714AX	Tektronix	Required	1	Bandwidth >= 12 GHz, 4-channel oscilloscope	
DJA	Tektronix	Required	1	DPOJET Advanced option	DPOJET advanced Jitter, Eye and Timing Analysis SW option
174-6659-01	Tektronix	Required	1	1-m Cable pair (2.92 mm SMA Male - SMP)	DUT-BERT Ref clock
PMCABLE1M	Tektronix	Required	2	1 m Cable pair (2.92 mm M-M, Straight, 1.5 ps phase-matched, 40 GHz)	Equipment connection to fixtures and DUT
174-6663-01	Tektronix	Required	1	0.5 m Cable pair (2.92 mm M-M, Straight, 1.5 ps phase-matched, 40 GHz)	Signal Connection between oscilloscope and BERT for Tx LEQ
174-6666-01	Tektronix	Required	2	0.5 m Cable pair (SMA M-M, Right Angle - Right Angle)	Connection between oscilloscope and BERT for Tx LEQ and Trigger
MPR40M	Fairview Microwave	Required	1	Power Divider pair (2 way 2.92 mm F-F-M)	Split signal from DUT Tx to the oscilloscope and Error Detector
Power USB Power Strip	Power USB	Required		Power USB – Basic	Automate DUT power cycle
SMP 50 Ohm Terminator	Any	Required		50 ohms (Female)	
ATX Power Supply for System Board Power	Any	Required	1	Any	
PCI-SIG	PCI-SIG	Required	1	Gen 3 BASE / CEM Test Fixtures	

RXSW-NLP-PCIE4	Tektronix	Required	1	PCIe Gen 3 Receiver software	Gen 3 BASE / CEM Rx test software - Node Locked; Permanent
RXSW-NL1-PCIE4C					Gen 3 Base / CEM Rx test software - Node Locked, Time Based, 1 year
RXSW-FLP-PCIE4					Gen 3 BASE / CEM Rx test software - Floating; Permanent
RXSW-FL1-PCIE4C					Gen 3 BASE / CEM Rx test software - Floating, Time Based, 1 year

Installing the software

Complete the following steps to download and install the latest PCIe3.0 (BASE / CEM) TekRx test application.

1. Go to www.tek.com.
2. Click **Downloads**. In the Download menu, select DOWNLOAD TYPE as Software and enter **PCIe3.0 (BASE / CEM)** in the MODEL OR KEYWORD field and click **SEARCH**.

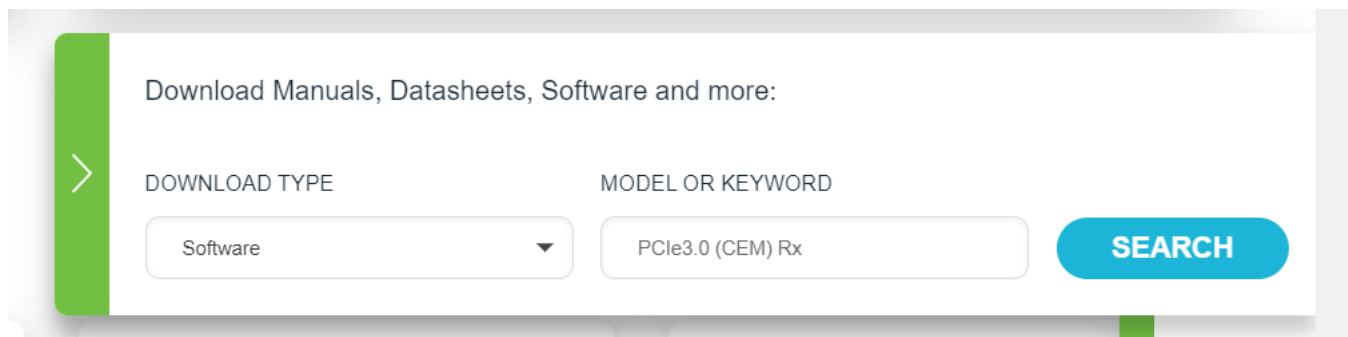

1. Select the latest version of the software and follow the instructions to download.
2. Copy the executable file into the instrument you wish to install the software (Real-time oscilloscope or PC).
3. Follow the installation instruction that is available in the website. The software is installed at **C:\Program Files\Tektronix\BERTScope\RxTest60**
4. Double click the shortcut icon on the desktop to launch the application.
 - The PCIe3.0 (BASE / CEM) TekRx test application can be installed on a Tektronix real-time oscilloscope or a PC (optional).
 - You must install the TekRxService and SigTest application in the real-time oscilloscope to successfully connect the application with the real-time oscilloscope.

Operating basics

Launch the application

To launch the PCIe3.0 (BASE / CEM) test application, double click the shortcut icon **TekRxTest** on the desktop and select **PCIe3.0 (BASE / CEM)** in the application window.

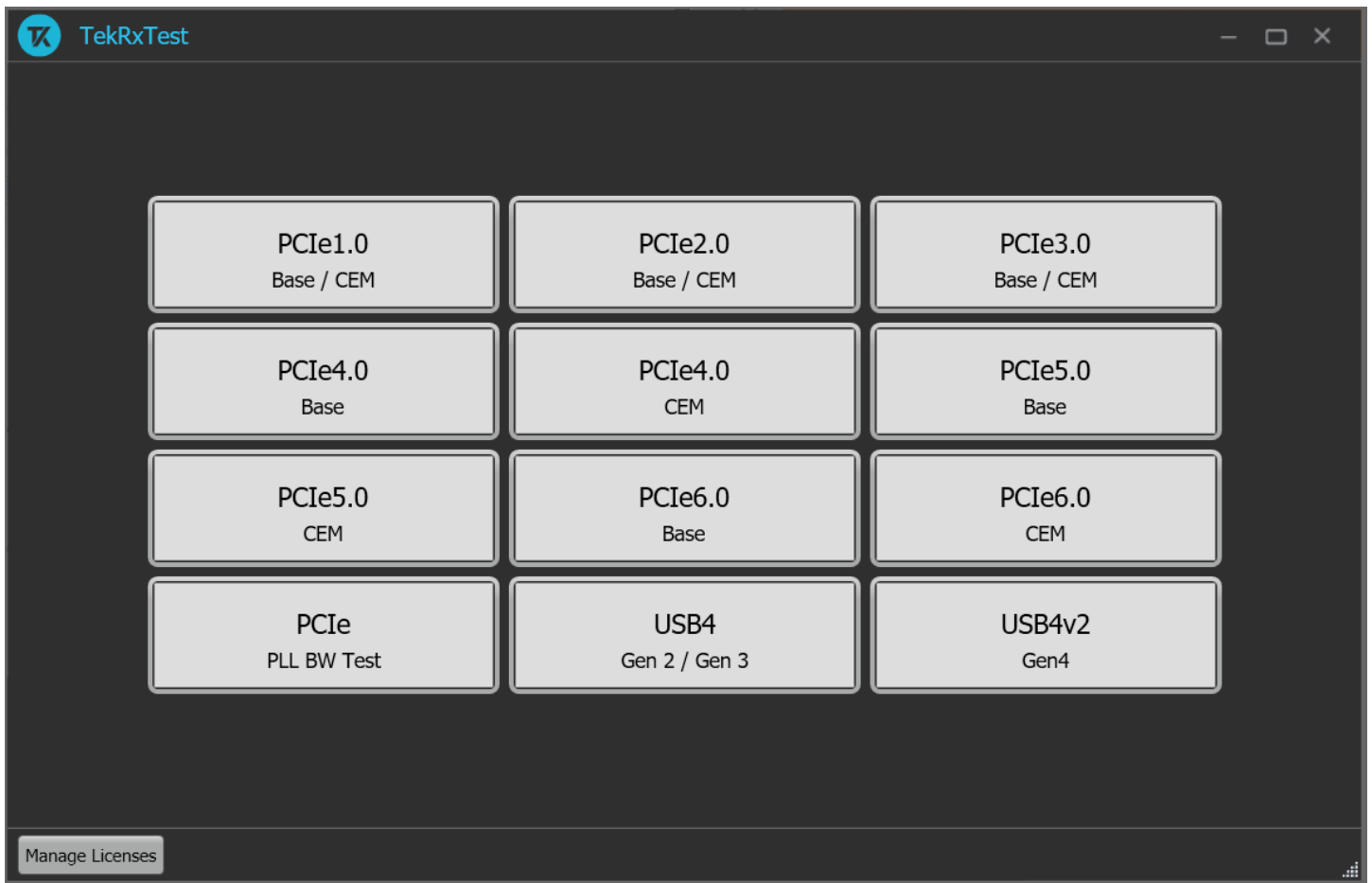

TekRxTest application window

Close the application

To exit the application, click  on the application title bar. Follow on-screen instructions to save the unsaved session or test setup.

NOTE: Using other methods to exit the application may result in abnormal termination of the application.

Launch Real-Time Oscilloscope

The TekVISA Socket Server application on the oscilloscope provides the necessary connectivity between the TekRxTest application and scope. Although it is launched in the background when the scope boots up and the socket is initialized for communication, it is recommended to verify the status by clicking on the Desktop Tray > TekVISA LAN Server Control as shown in the image below. If it is ready to exchange data, then a wizard would appear as in the below image.

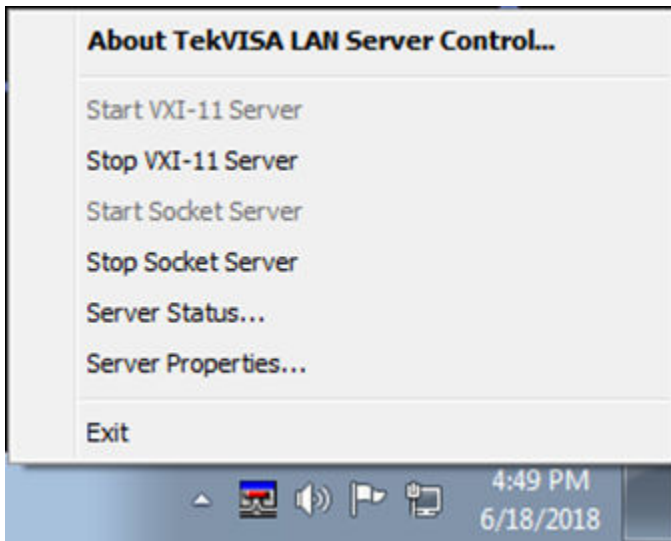

Launch Real-Time Oscilloscope

Note: In the unlikely event when the socket is not initialized, the process can be started by clicking on “Start Socket Server” which gets enabled during such a scenario.

Launch TekRxService

The PCIe3.0 (BASE / CEM) TekRxTest application interfaces with the oscilloscope for data acquisition, analysis and data retrieval utilizing TekRxService application. This software module should be launched at the time of initiating the TekRxTest application.

NOTE: TekRxService has to be launched if the application is being run on an external PC. To launch the application, double click the TekRxService batch file shortcut icon in the desktop of the real-time oscilloscope.

Application panels

Application panels overview

The PCIe3.0 (BASE / CEM) TekRxTest application uses panels to group the configurations and settings. Click on any panel to configure the associated settings. A panel may have one or more tabs that lists the selections available in that panel. Controls in a tab may change depending on the settings made in the same tab or another tab.

Application panels overview

Parameter	Description
Connections	This panel displays the real-time oscilloscope and BERT connection settings. You can connect to a real-time oscilloscope and BERT by entering the IP address of the instruments.
Settings	This panel allows configuring various settings for the Components, TP1 and TP2 Calibration.

Help	This panel displays the application help.
Calibrations	This panel allows you to configure the calibration parameters for TP1/TP2 and save the results.
Tests	This panel allows you to configure the Rx/Tx LEQ test settings and view the results.
Options	This panel allows you to configure the JTOL test settings and view the results.

Connections panel

The connections panel allows you to connect to a real-time oscilloscope and BERT with the PCIe3.0 (BASE / CEM) TekRxTest application. Enter the IP address of the instruments and click **Connect** to establish the connection.

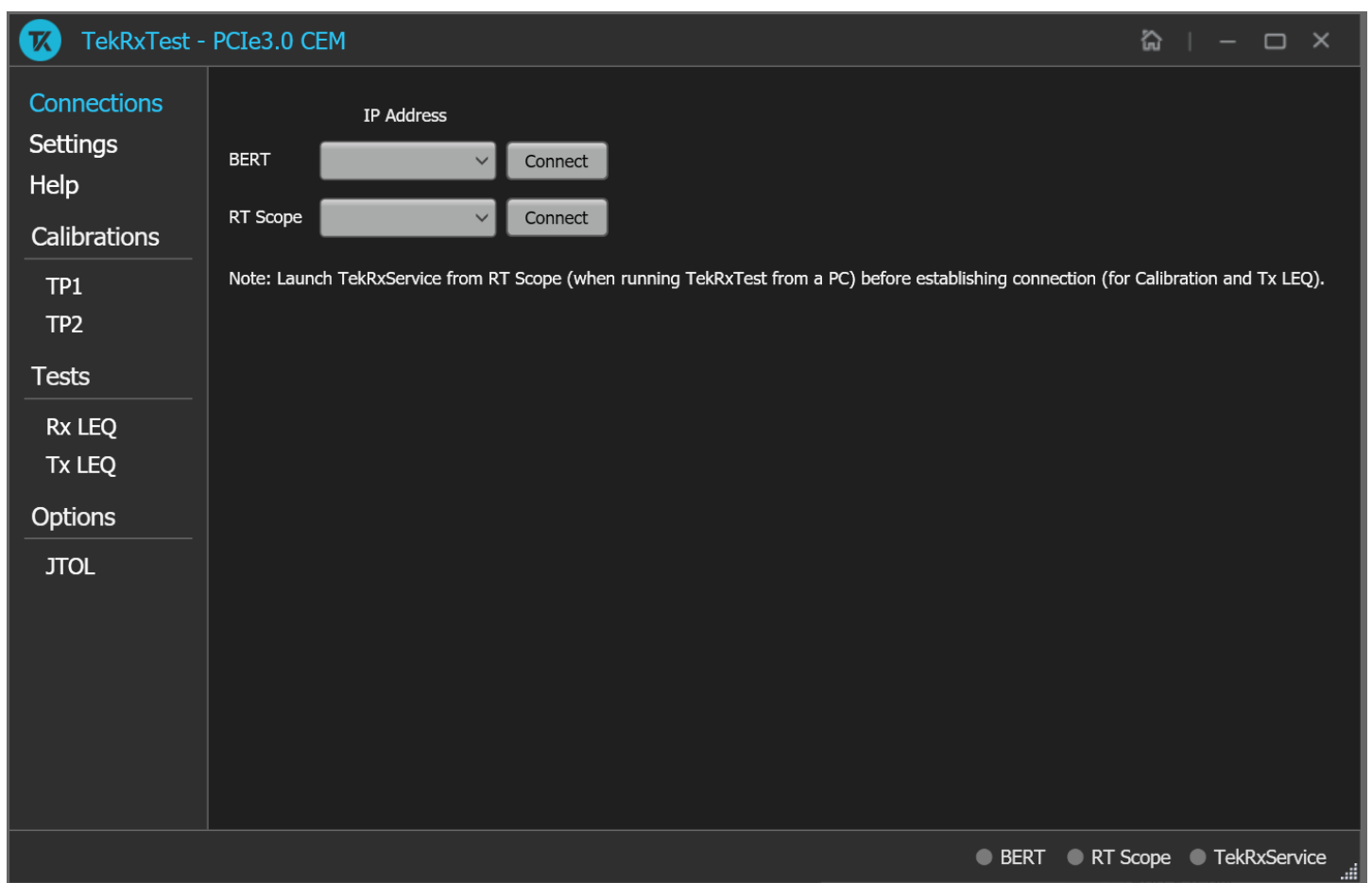

Connections panel

Connections panel

Connections	Description
BERT	Enter the BERT IP address in the address field and click Connect . When the BERT is connected successfully, the circle next to BERT in the right end corner turns green.

RT Scope	<p>Enter the RT Scope IP address in the address field and click Connect. When the RT Scope is connected successfully, the circle next to RT Scope and TekRxService in the right end corner turns green.</p> <p>Once the RT Scope connection is established, the application automatically identifies oscilloscope model. Consequently, the 'Connection Diagram' wizard will display setup figure with DPO70000SX/DX Oscilloscope or with DPO714AX Oscilloscope for TP1/TP2/LEQ Tx tests.</p> <hr/> <p>NOTE: Before you click Connect, if the TekRxTest application is running on an external PC, make sure to launch the TekRxService in the real-time oscilloscope.</p>
----------	---

Settings panel

This panel allows you to configure the settings for instruments, calibrations, and remote access. Click any tab to configure the associated settings.

Setting panel

Settings panel configurations

Item	Description
Restore Defaults	Restores the application with default settings.
Save	Saves the current test setup.
Recall	Recalls the saved test setup.

Components settings

The components settings display the parameters for RT Scope and TekRxService.

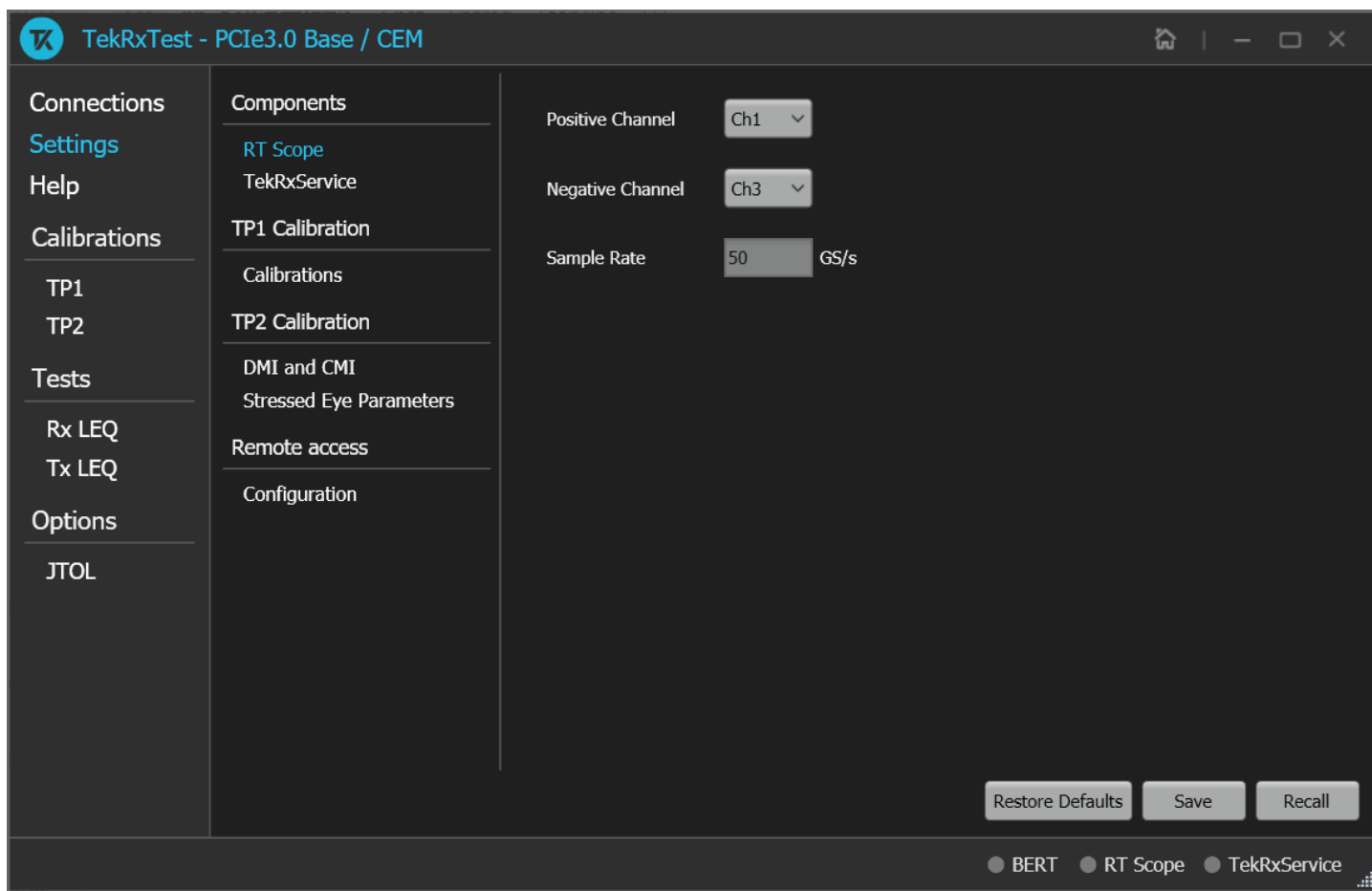

Components: RT Scope

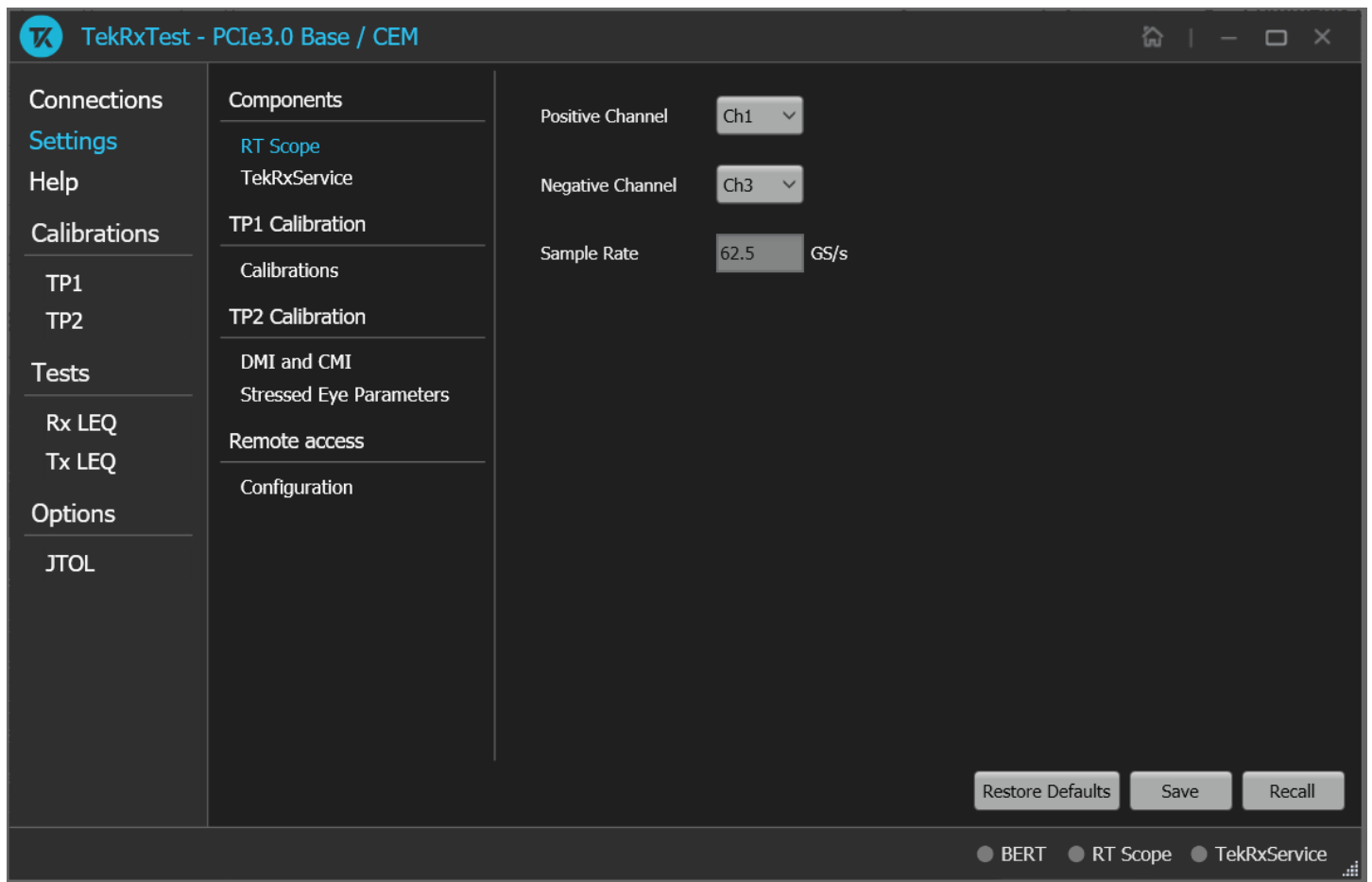

Components: RT Scope with 7 series oscilloscope

Components: RT Scope

Parameter	Description
Positive Channel	Select the generator data positive channel from BERT.
Negative Channel	Select the generator data negative channel from BERT.
Sample Rate	Displays the RT Scope sample rate in GS/s. The Sample Rate automatically updates to 62.5 when the system is connected to a DPO714AX Oscilloscope..

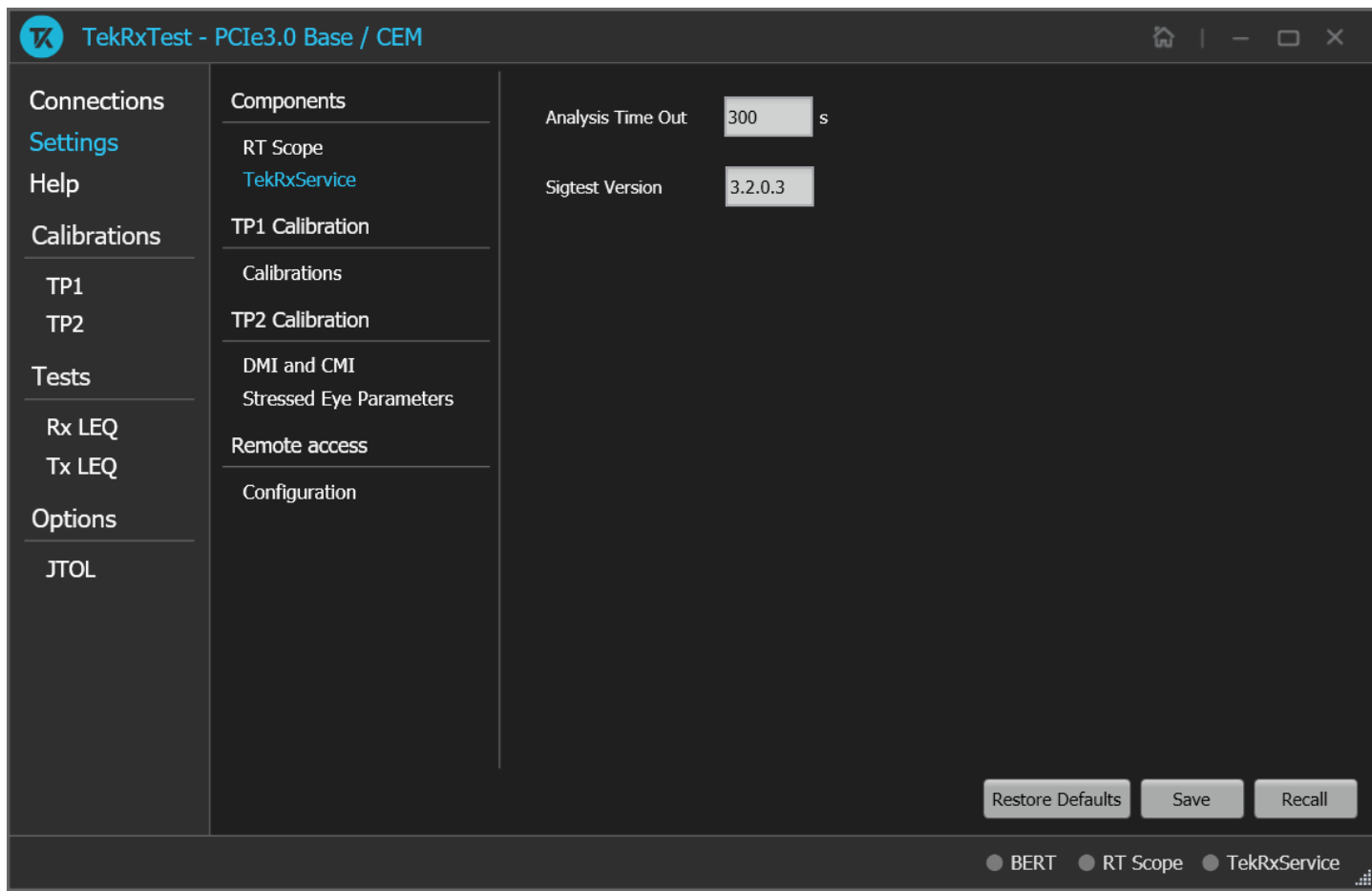

Components: TekRxService

Components: TekRxService

Parameter	Description
Analysis Time Out	Enter the timeout value for Sigtest analysis.
Sigtest Version	Enter the Sigtest version.

TP1 Calibration

The TP1 calibration tab allows you to configure the multi-tone calibration settings.

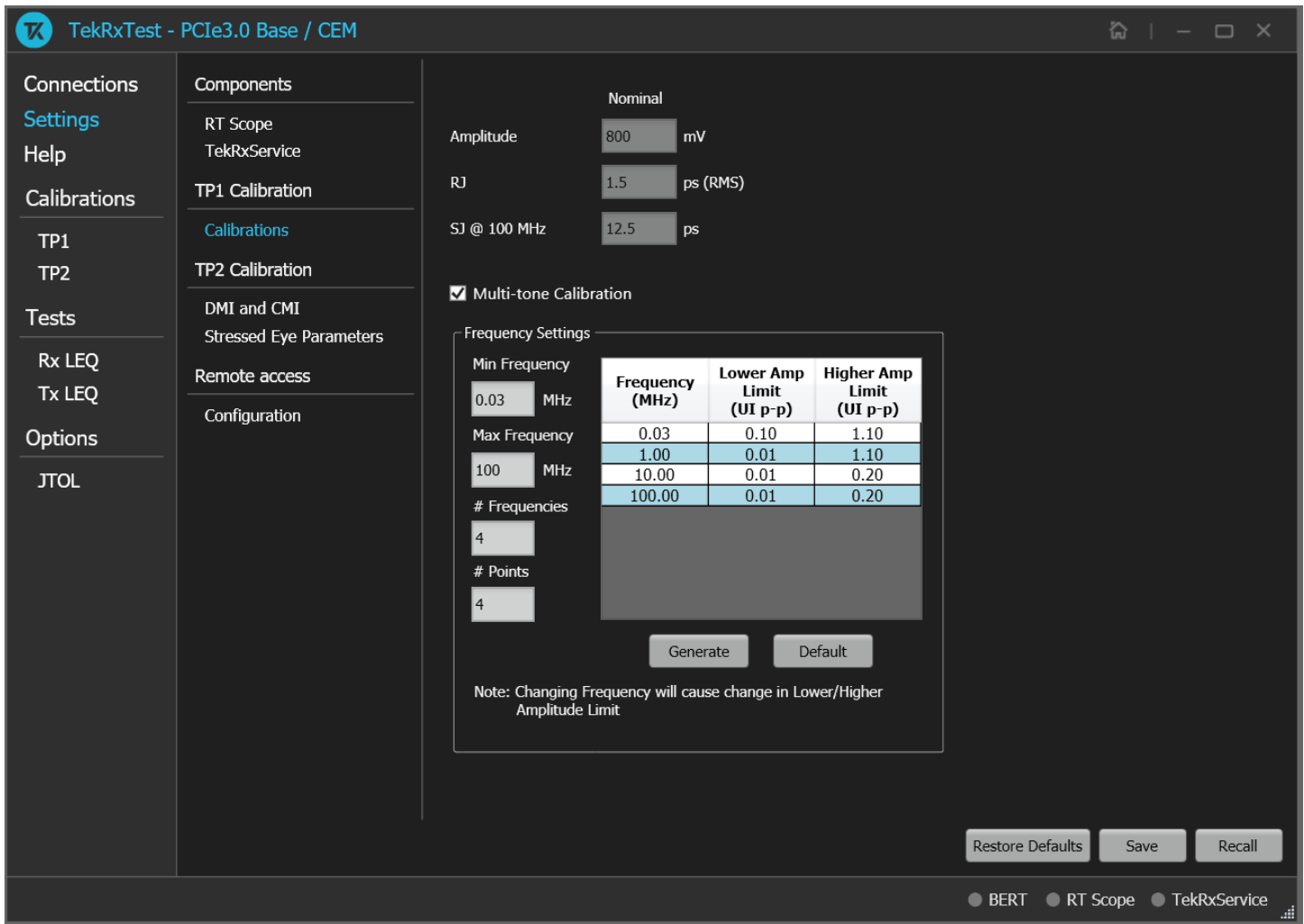

TP1 Calibration: Calibrations

TP1 Calibration: Calibrations

Parameter	Description
Amplitude	Displays the calibration target for generator amplitude source.
RJ	Displays the calibration target for random jitter source.
SJ @ 100 MHz	Displays the calibration target for sinusoidal jitter source @ 100 MHz.
Multi-tone Calibration	Select to enable the multi-tone calibration. It displays the calibration settings for multiple tones.
Frequency Settings:	Frequencies at which the SJ calibration needs to be performed for JTOL Test.
Frequency (MHz)	Displays the table of frequencies in MHz for which Multi-tone calibration is to be performed.

Lower Amplitude Limit (UI p-p)	Displays the table of lower amplitude limit values at which SJ calibration starts for that frequency.
Higher Amplitude Limit (UI p-p)	Displays the table of higher amplitude limit values at which SJ calibration ends for that frequency.
Min Frequency	Enter the minimum frequency value.
Max Frequency	Enter the maximum frequency value.
# Frequencies	Enter the desired number of frequencies within the specified range.
# Points	Enter the desired number of points used for calibration.
Generate	Click to view the table populated with the frequencies.
Default	Click to view the table populated with default list of frequencies.

TP2 Calibration

The TP2 calibration tab allows you to configure the DMI and CMI calibration, and Stressed Eye Parameters.

The screenshot shows the TekRxTest - PCIe3.0 Base / CEM application window. The left sidebar contains navigation options: Connections, Settings, Help, Calibrations (with TP1 and TP2 sub-items), Tests (with Rx LEQ and Tx LEQ sub-items), Options, and JTOL. The main content area is divided into two panes. The left pane shows the 'Components' section with 'RT Scope' and 'TekRxService' listed, followed by 'TP1 Calibration' (with 'Calibrations' sub-item) and 'TP2 Calibration' (with 'DMI and CMI' and 'Stressed Eye Parameters' sub-items). The right pane is titled 'Perform CMI Calibration' and has a checked checkbox. Below this, the 'Nominal' section shows 'DMI' set to 14 mV and 'CMI' set to 150 mV. At the bottom right of the main area are buttons for 'Restore Defaults', 'Save', and 'Recall'. The status bar at the bottom shows 'BERT', 'RT Scope', and 'TekRxService' with their respective status indicators.

TP2 Calibration: DMI and CMI

TP2 Calibration: DMI and CMI

Parameter	Description
DMI	Displays the nominal DMI value in mV.
CMI	Displays the nominal CMI value in mV.

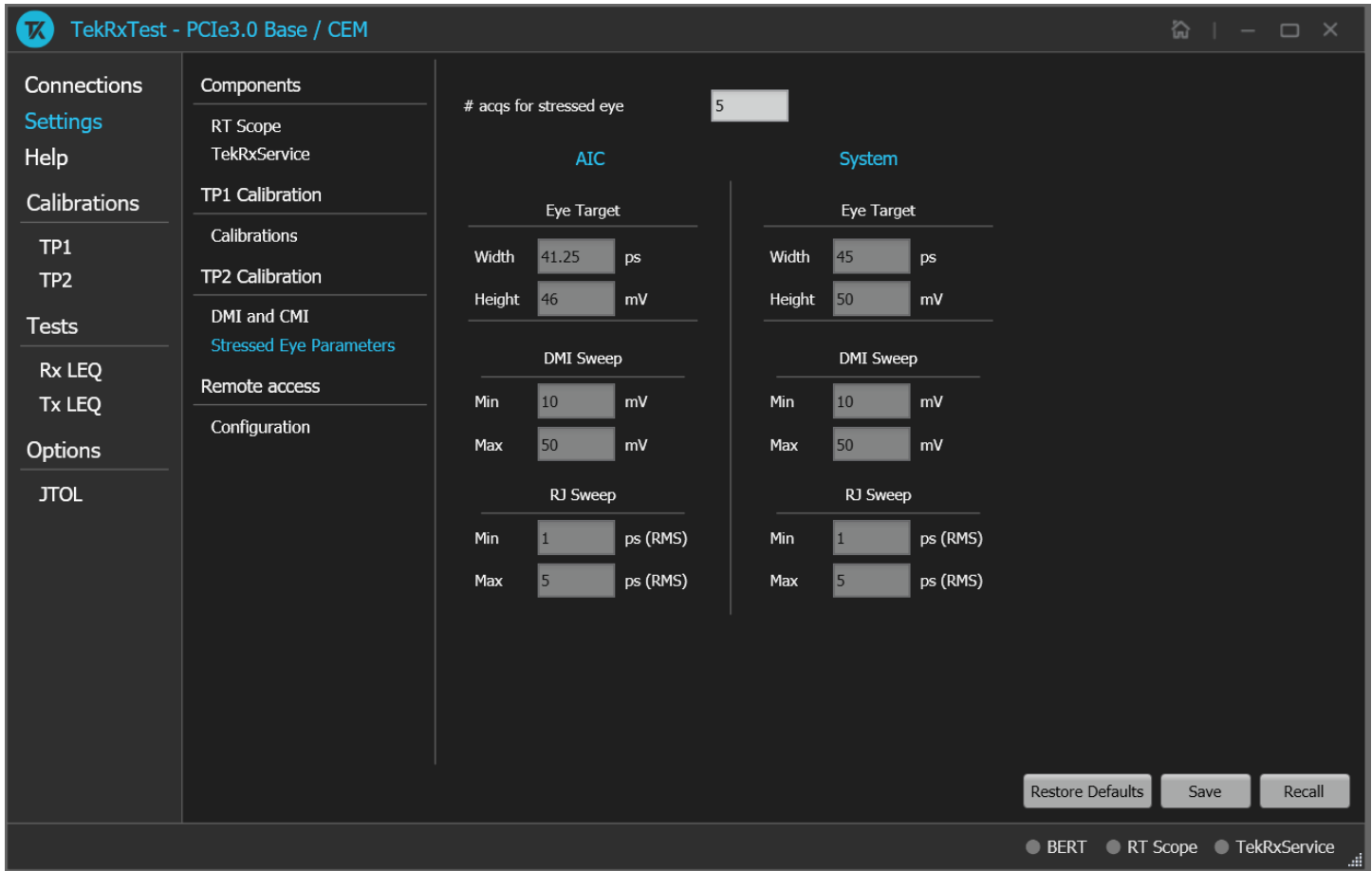

TP2 Calibration: Stressed Eye Parameters

TP2 Calibration: Stressed Eye Parameters

Parameter	Description
# acqs for stressed eye	Displays the number of acquisitions value for stressed eye.
Eye Target	
Width	Displays the target eye width value as per PCIe specification.

Height	Displays the target eye height value as per PCIe specification.
DMI Sweep	
Min	Displays the minimum value of DMI sweep during stressed eye calibration.
Max	Displays the maximum value of DMI sweep during stressed eye calibration.
SJ Sweep	
Min	Displays the minimum value of SJ sweep during stressed eye calibration.
Max	Displays the maximum value of SJ sweep during stressed eye calibration.
Amplitude Sweep	
Min	Displays the minimum value of amplitude sweep during stressed eye calibration.
Max	Displays the maximum value of amplitude sweep during stressed eye calibration.

Remote access: Configuration

The remote access tab allows you to configure the remote setting parameters to access the equipment remotely.

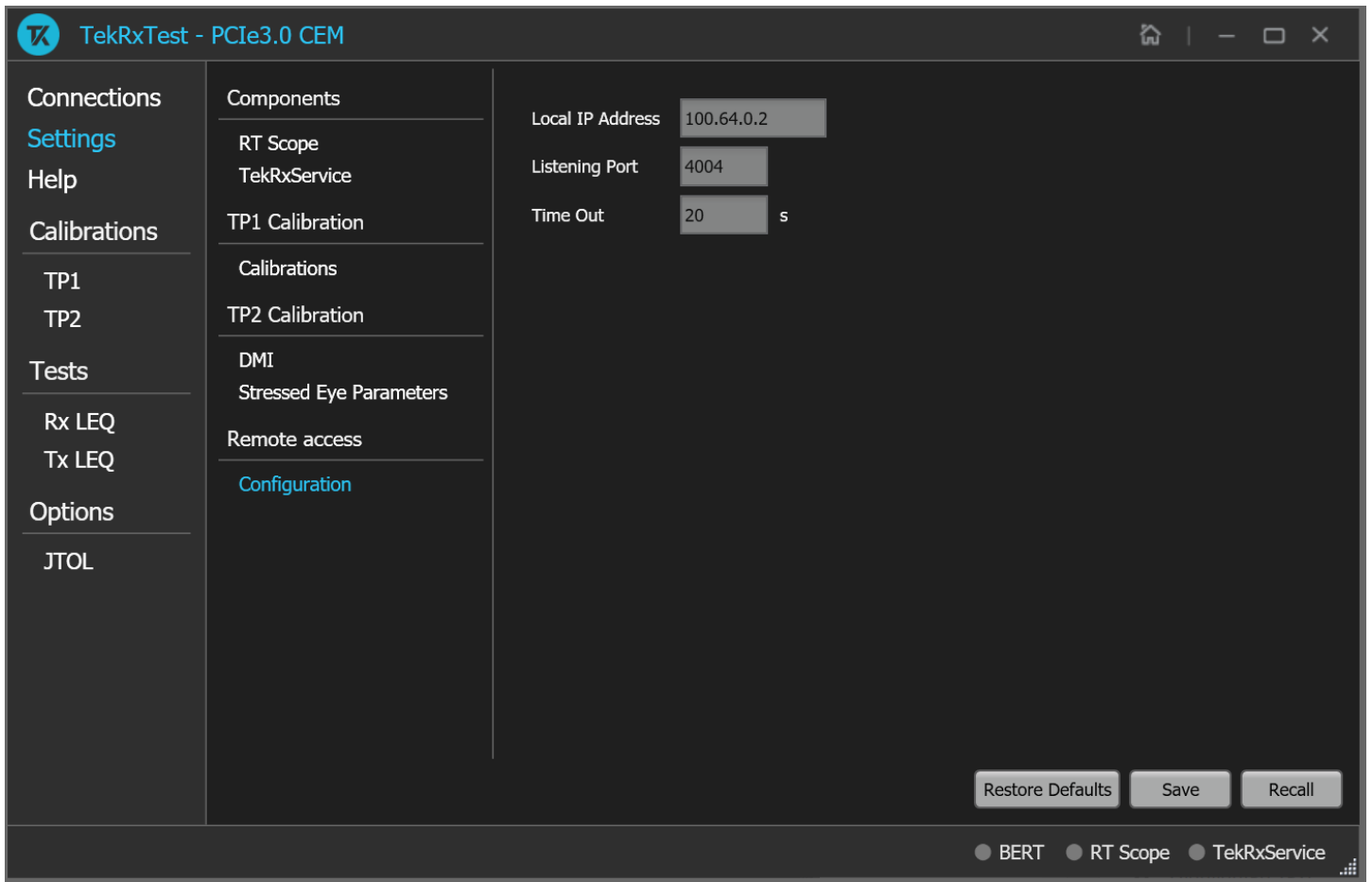

Remote access Configuration

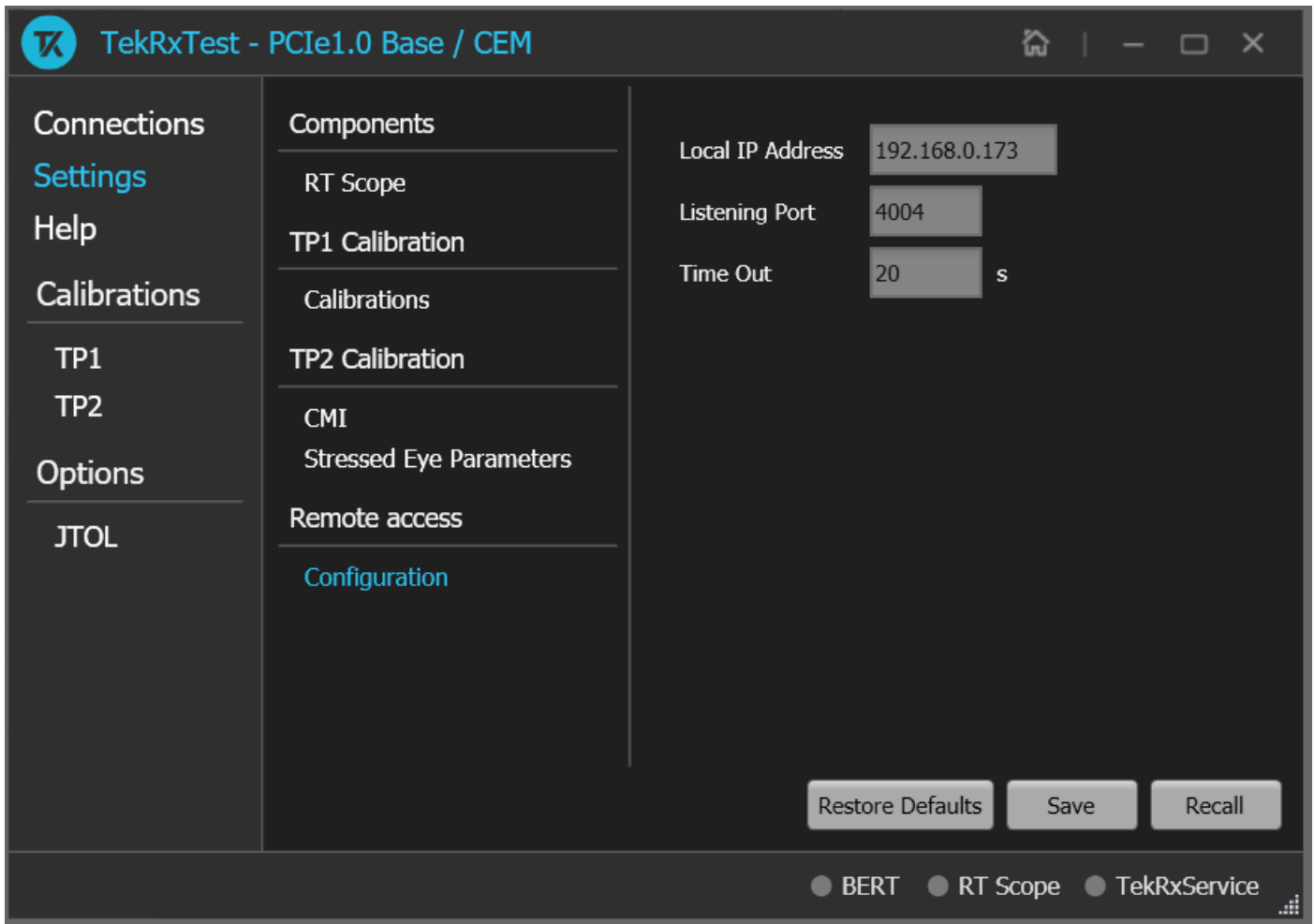

Remote access: Configuration

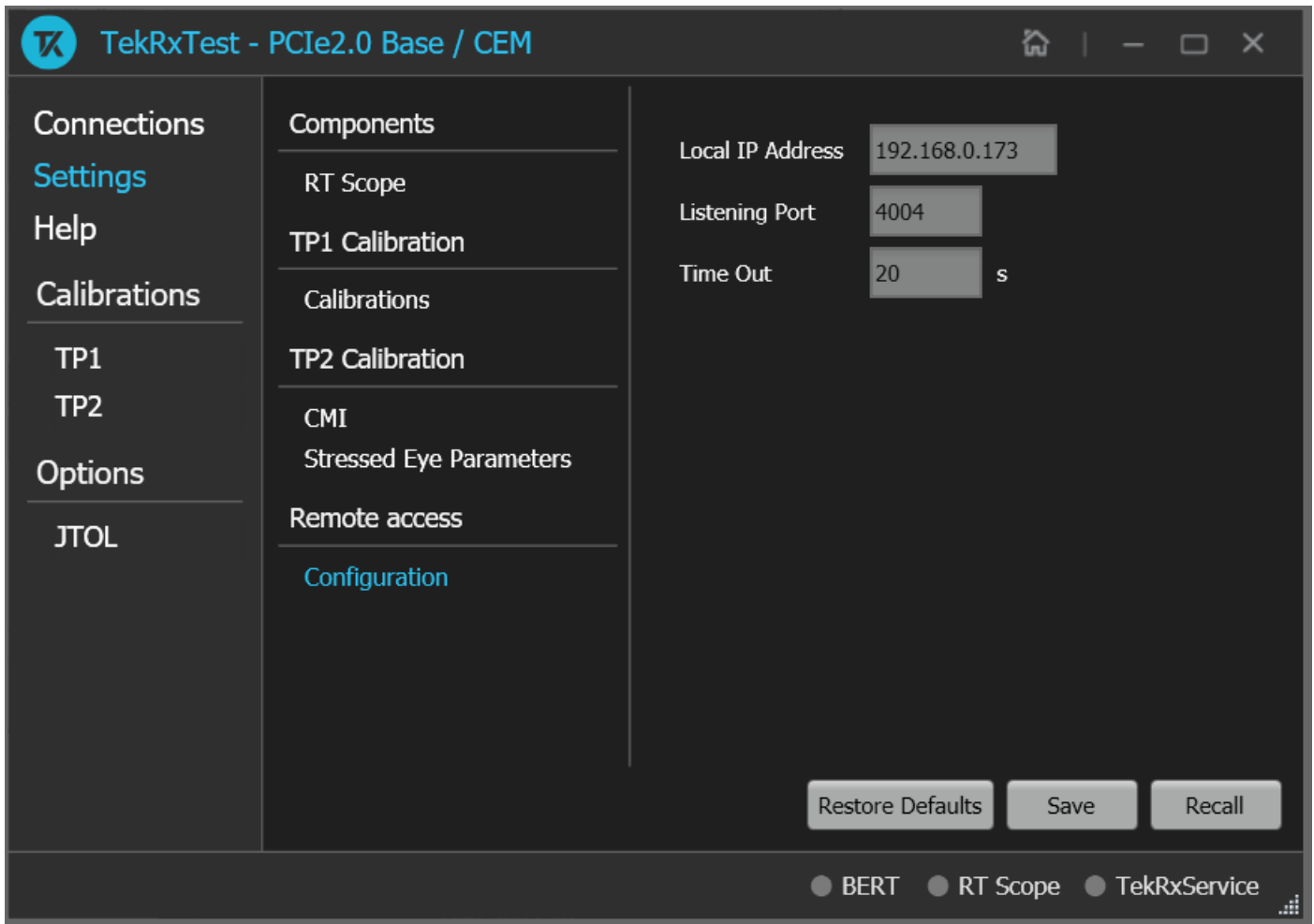

Remote access: Configuration

Remote access: Configuration

Parameter	Description
Local IP Address	Displays the IP address for connecting to the application over socket server.
Listening Port	Displays the TCP/IP port number of the port that the socket server is listening. Default Value: 4004
Time Out	Displays the timeout value used when communicating with the socket server. Default Value: 20 Seconds

Help panel

The help panel launches the PCIe3.0 (BASE / CEM) TekRxTest application help document.

Calibrations panel

Complete TP1 and TP2 calibrations before you start the DUT testing using the PCIe3.0 (BASE / CEM) test application. Follow the instructions in the calibration wizards to automate the calibration for the test points. After calibrating the test points, you can save the results.

TP1 Calibration

The TP1 calibration panel allows you to perform calibration for TP1 and save the results. You can perform calibration for Signal Amplitude, Preset, Random Jitter (RJ), Sinusoidal Jitter (SJ), and Multi-tone. Additionally, there is a provision to perform AC-DC Balancing.

The PCIe3.0 (BASE / CEM) TekRxTest application calibrates the following at TP1 :

1. Amplitude - The differential voltage swing is required to be within 720 - 800 mV. This is done only after the transition and non-transition bit levels are made equal using de-emphasis.
2. Tx Equalization Presets - The various levels of de-emphasis and preshoot are required to be calibrated within the tolerance as specified.
3. RJ - It is calibrated to be 1.5 ps (RMS value).
4. SJ - The SJ is calibrated over the desired range of 7-18 ps (pk-pk) including the nominal SJ specification of UI (12.5 ps) at 100 MHz frequency).
5. Multi-tone - It is calibrated over a specific range for multiple user-defined frequencies.

TP1 Calibration procedure

Unique ID	Completion Status	Generated By	Date/Time	Comment
[Example_TP1_Calibration]	Complete	TEK	20 Jun 2023, 07:10 AM	

TP1 Calibration



Click TP1 under the calibration tab to view the calibration results. Click  at the right end corner of the application to launch the TP1 calibration wizard. This wizard will guide you through the sequential procedure to perform the calibration.

1. **Connection Diagram:** This tab displays the connection diagram for TP1 calibration. The connection diagram is same for AIC / System.

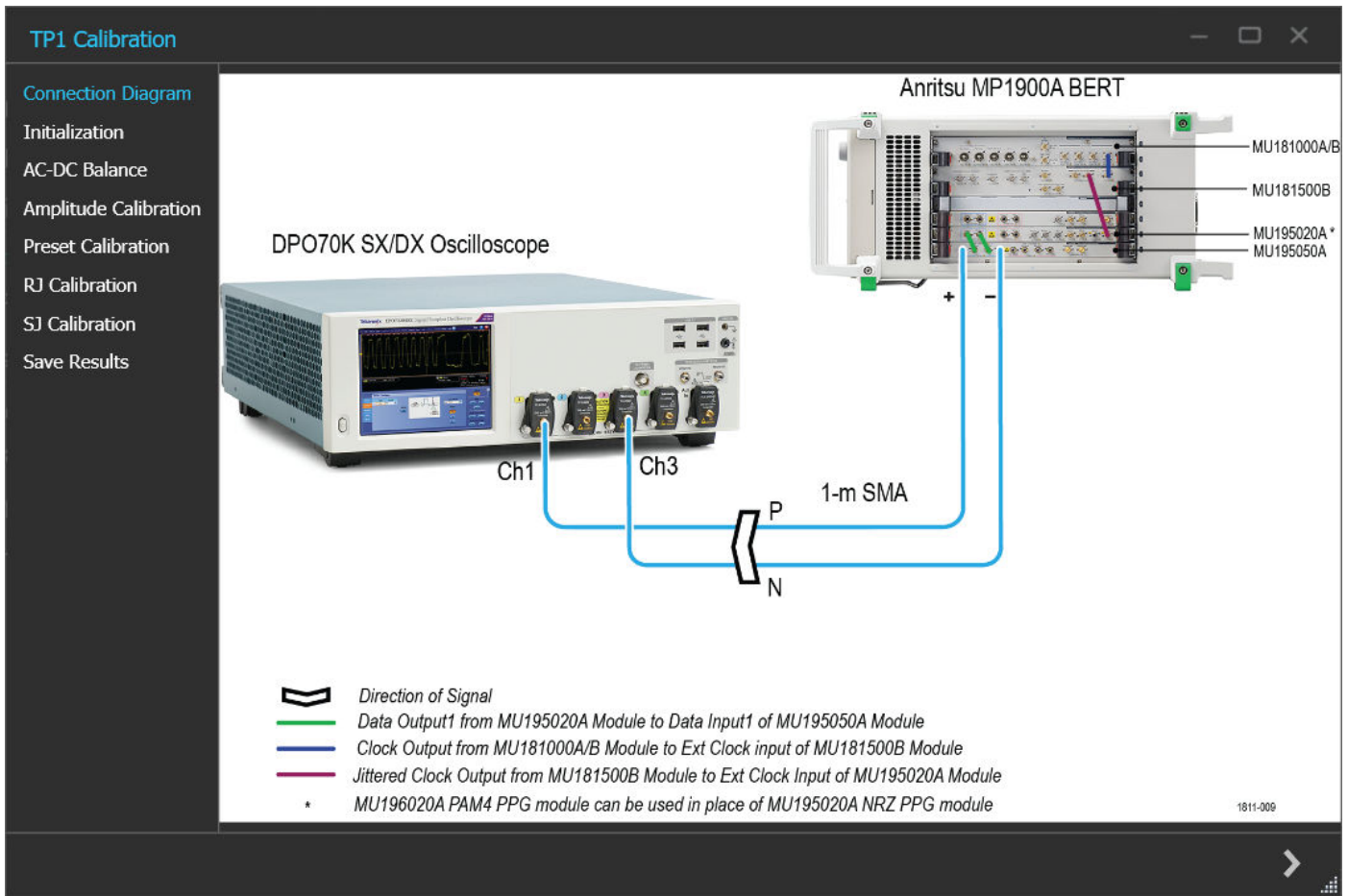

TP1 Calibration: Connection Diagram

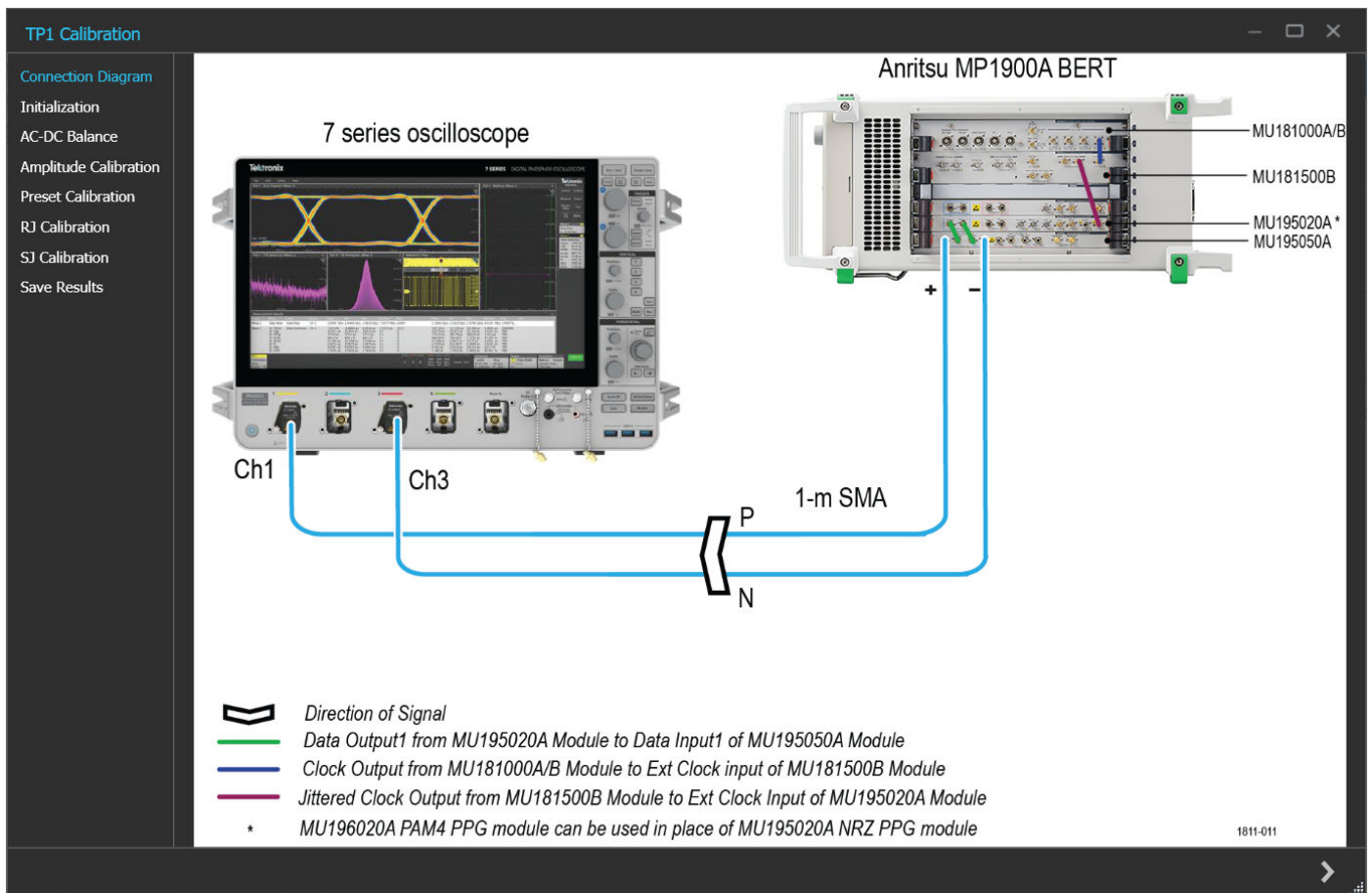

TP1 Calibration: Connection Diagram with 7 series oscilloscope



Click  to move to the next screen.

- Initialization:** This tab displays the description and allows you to initialize the equipment. Click **Initialize Equipment** and complete the initialization process.

You can click **Automatic Calibration** to perform the automatic calibration with the default settings for amplitude, Tx Equalization Presets, RJ, and SJ parameters without user intervention.

To skip the signal validation during initialization, enable the **Skip Signal Validation** check box.

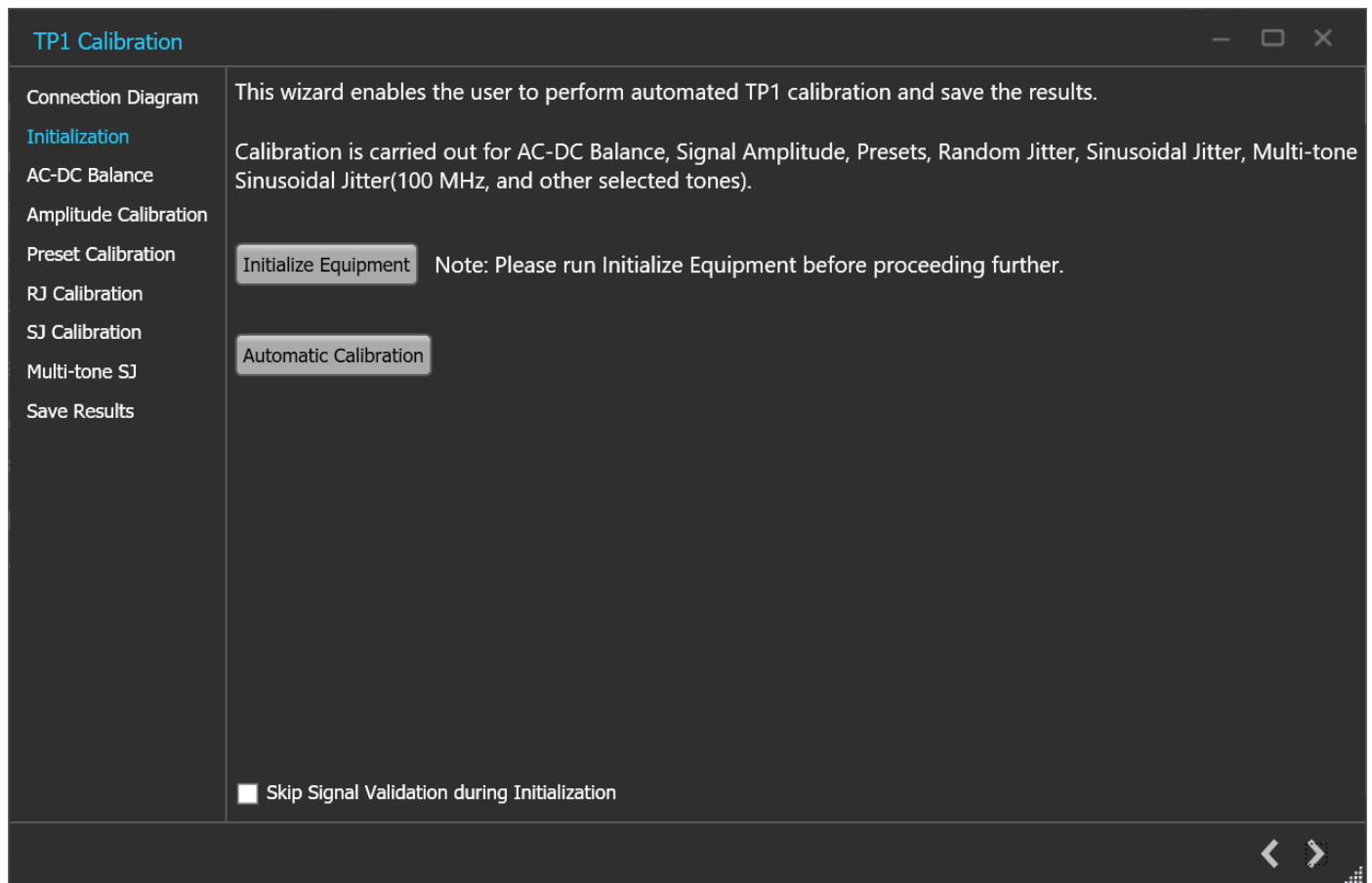

TP1 Calibration: Initialization



Click  to move to the next screen.

3. **AC-DC Balance:** This tab displays the graph plots of AC-DC balance.

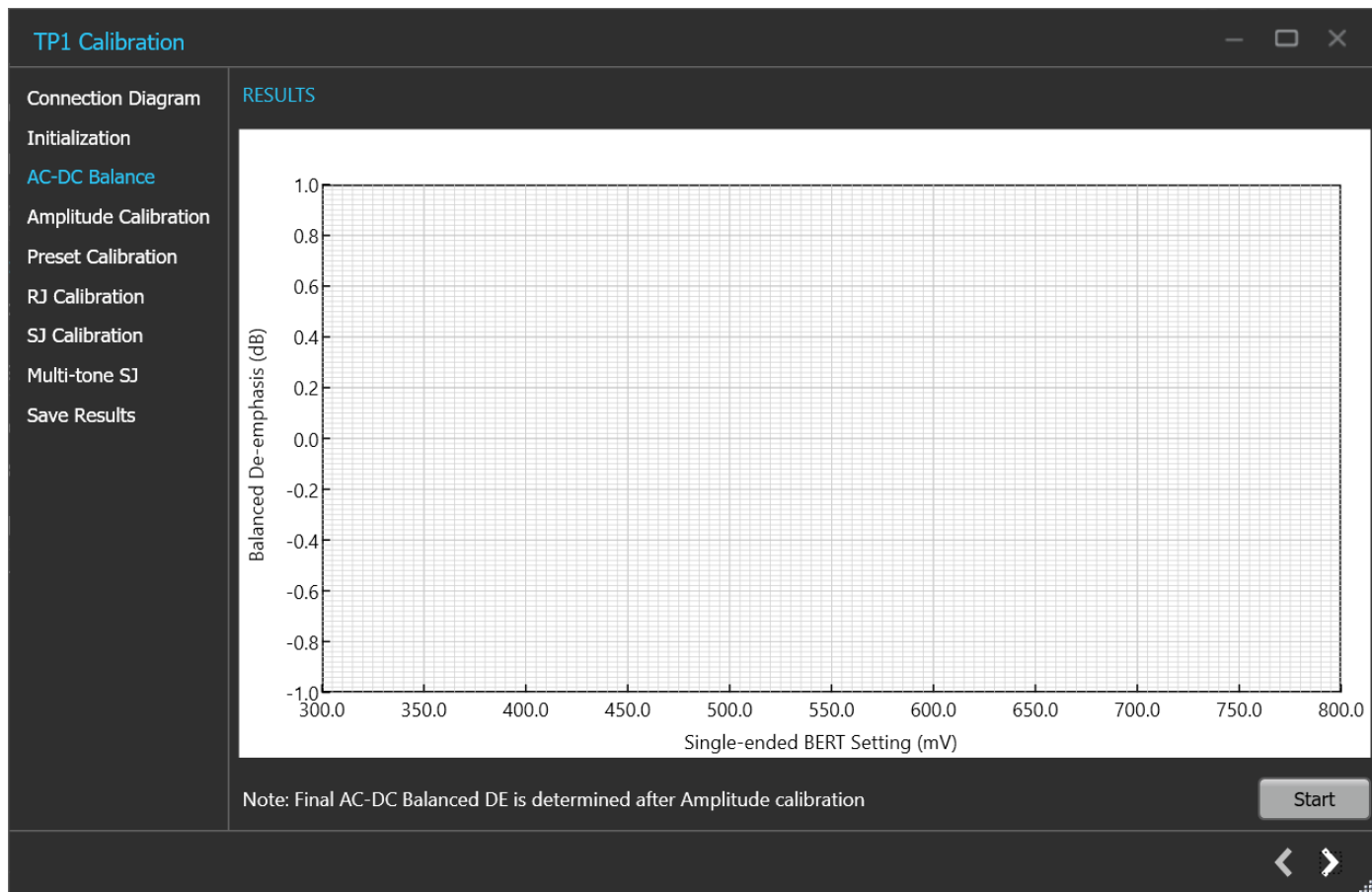

TP1 Calibration: AC-DC Balance

TP1 Calibration: AC-DC Balance

Parameter	Description
Start	Click Start to run the measurements.



Click  to move to the next screen.

4. **Amplitude Calibration:** This tab displays the graph plots of amplitude calibration.

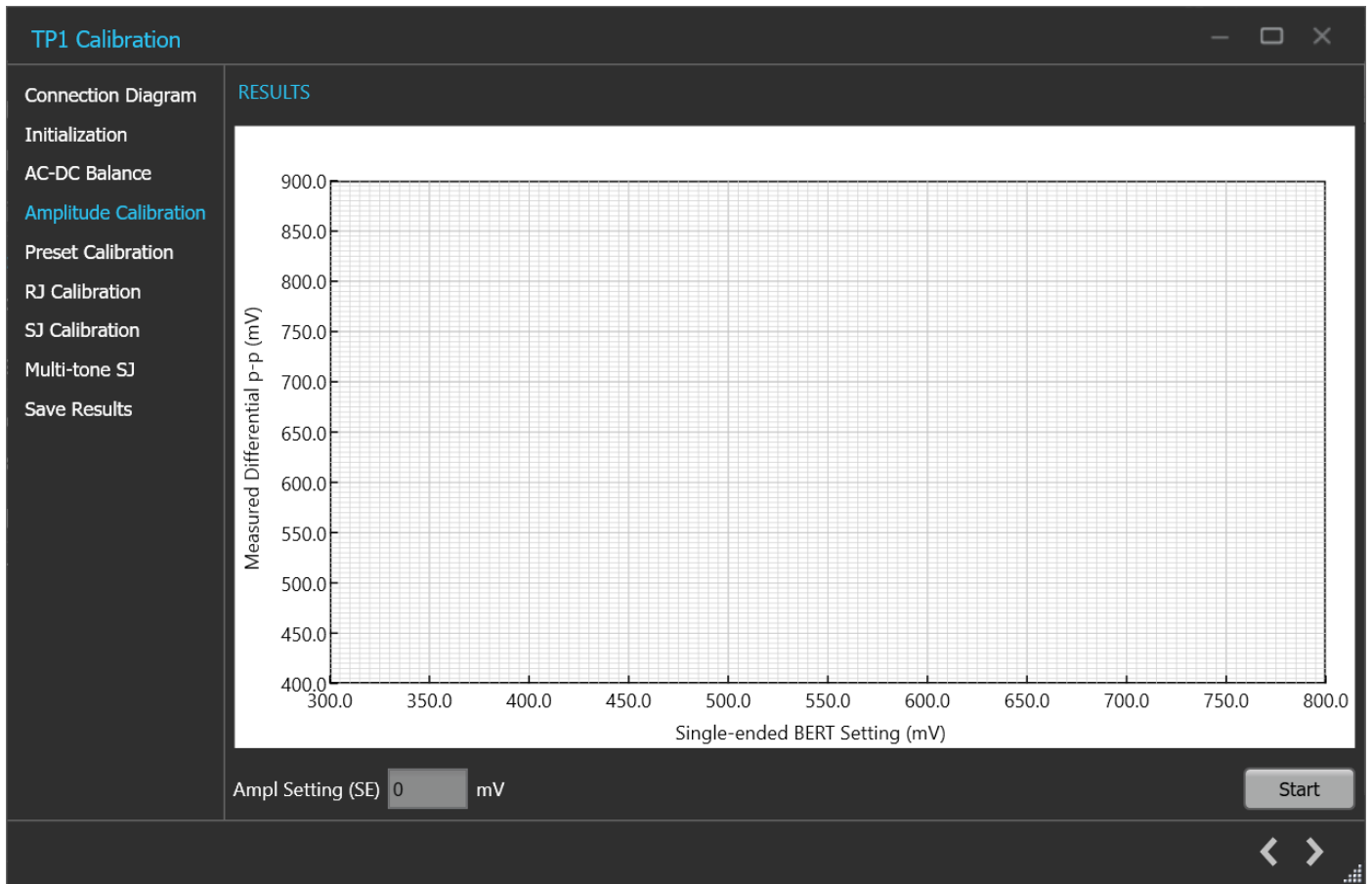

TP1 Calibration: Amplitude Calibration

TP1 Calibration: Amplitude Calibration

Parameter	Description
Ampl Setting (SE)	Displays the single-ended calibrated amplitude value corresponding to 800 mV differential.
Start	Click Start to run the measurements.



Click  to move to the next screen.

5. **Preset Calibration:** This tab displays the graph plots of preset calibration.

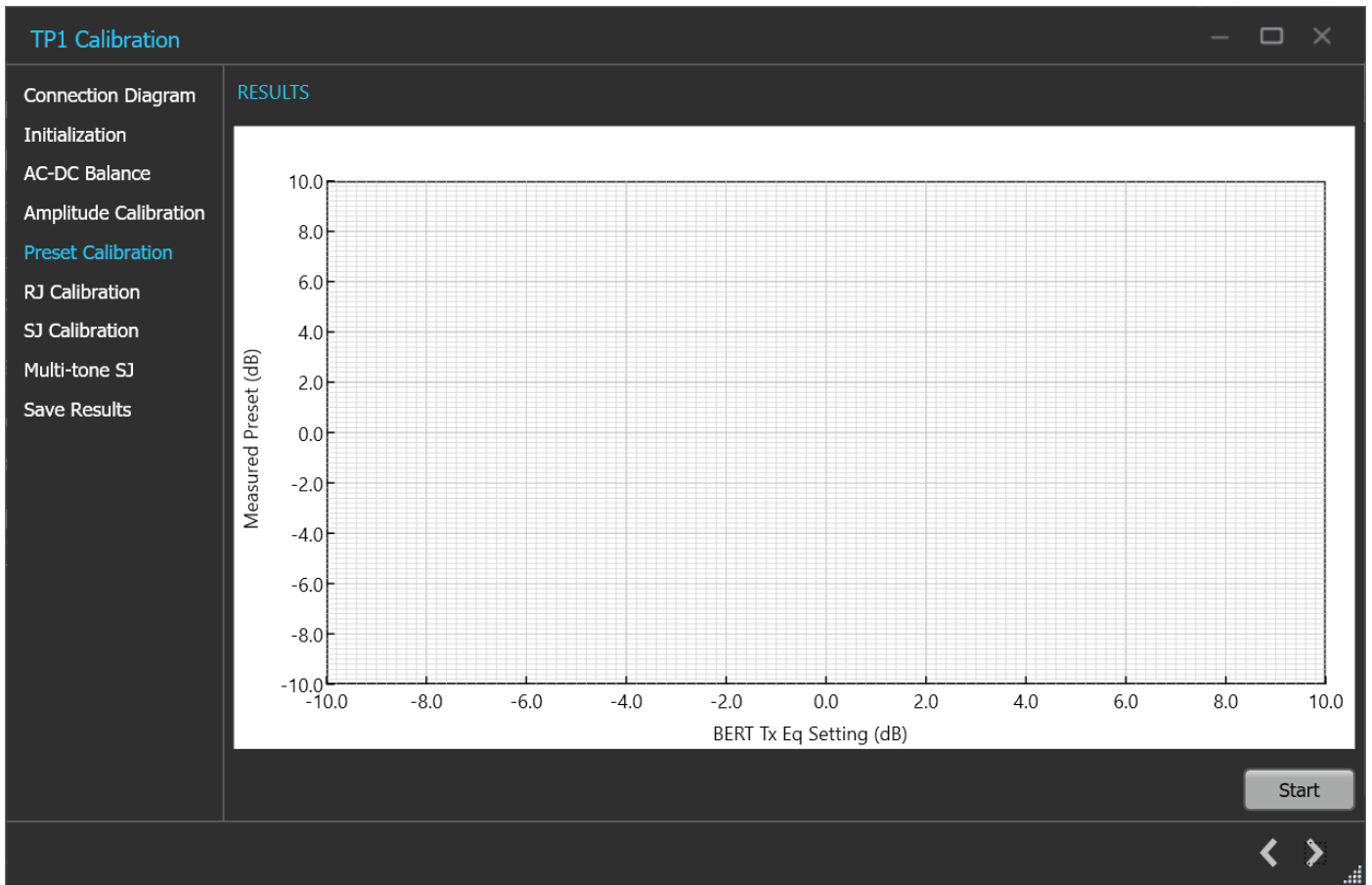

TP1 Calibration: Preset Calibration

TP1 Calibration: Preset Calibration

Parameter	Description
Start	Click Start to run the measurements.



Click  to move to the next screen.

6. **RJ Calibration:** This tab displays the graph plots of RJ calibration.

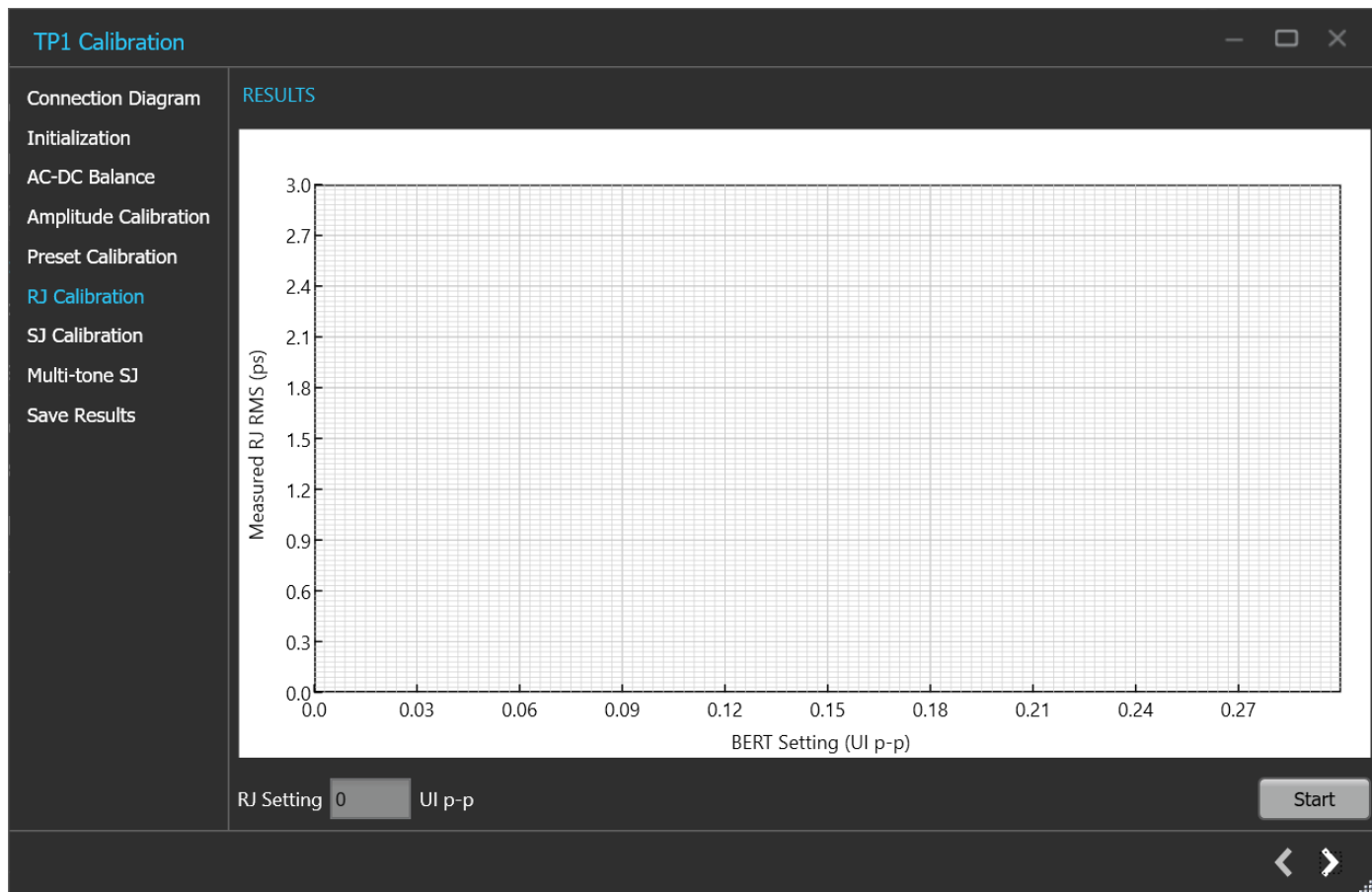

TP1 Calibration: RJ Calibration

TP1 Calibration: RJ Calibration

Parameter	Description
RJ Setting	Displays the calibrated RJ setting corresponding to the nominal value.
Start	Click Start to run the measurements.



Click  to move to the next screen.

7. **SJ Calibration:** This tab displays the graph plots of SJ calibration.

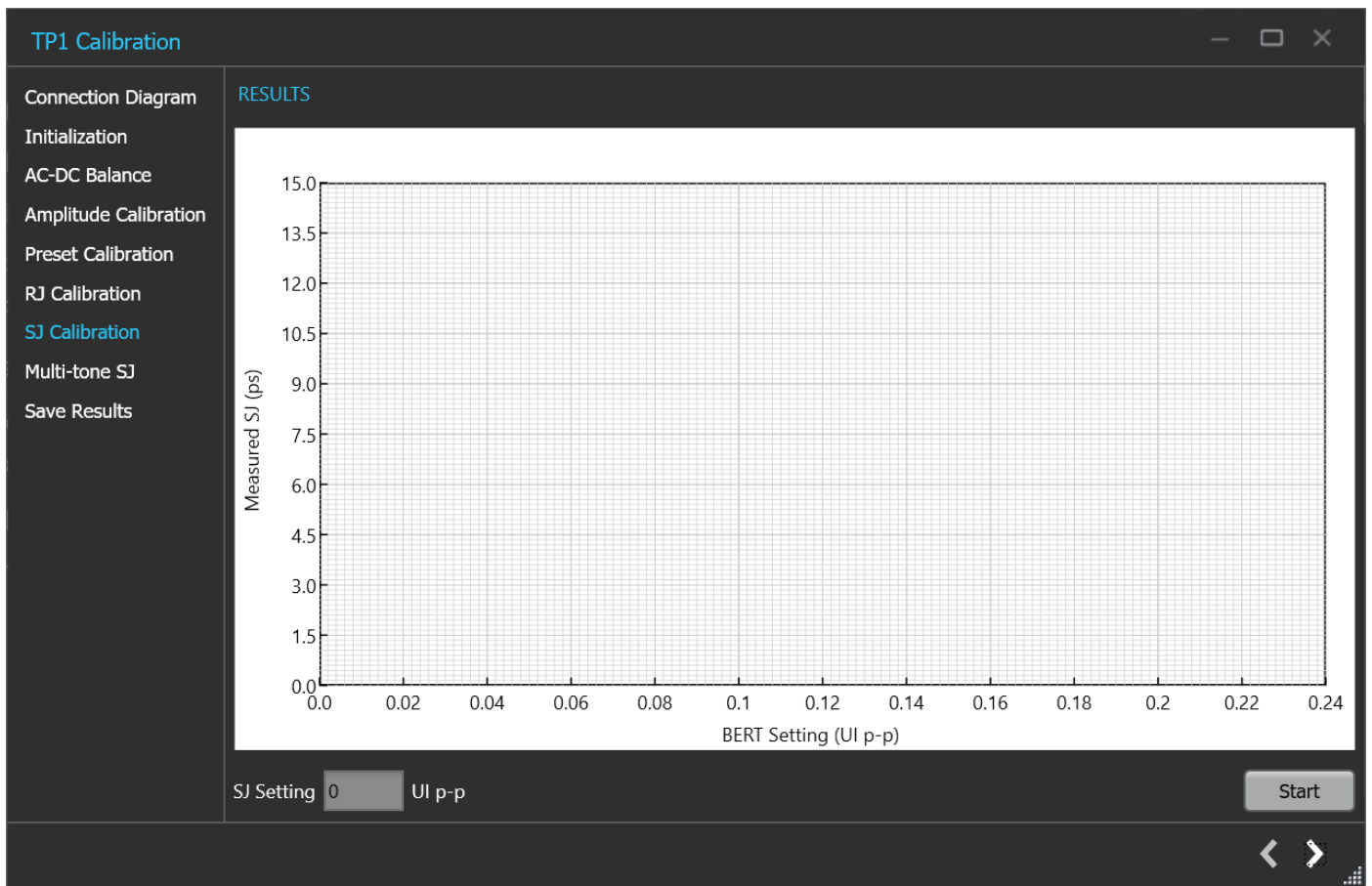

TP1 Calibration: SJ Calibration

TP1 Calibration: SJ Calibration

Parameter	Description
SJ Setting	Displays the calibrated SJ setting corresponding to the nominal target value.
Start	Click Start to run the measurements.



Click  to move to the next screen.

8. **Save Results:** This tab allows you to save all the TP1 calibration results.

TP1 Calibration: Save Results

TP1 Calibration: Save Results

Parameter	Description
Unique ID	Enter the Unique ID of the calibrated equipment in the text box.
Generated By	Enter the user name in the text box.
Comments (Optional)	Enter the required comments in the comment box.
Save	Click to save the results.

Click  to complete the TP1 calibration and close the wizard.

NOTE: Completion of the TP1 calibration process or in the event of cancellation of the process, the BERT data generator is turned off automatically by the PCIe3.0 (BASE / CEM) TekRxTest application.

TP2 Calibration

The TP2 calibration panel allows you to manually perform calibration for the equipment and save the results. TP2 Calibration is carried out for DMI, CTLE/Preset selection, and Stressed Eye. This procedure sets SJ, DMI, and Amplitude levels to achieve target eye-opening.

You must perform TP1 calibration before you start performing the calibration for TP2.

The PCIe3.0 (BASE / CEM) TekRx test application calibrates the following at TP2:

Application Help

1. DMI - The differential mode sinusoidal interference is required to be calibrated within mV (pk-pk) by capturing the 2.1 GHz sinusoidal output for a duration of at least 125 us.
2. CMI - It is needed to be configured in the settings panel. CMI is only applicable when the user is running Base calibration and test.
3. - Tx equalization presets are used to find the optimal eye area with the optimal CTLE.
4. Stressed Eye calibration - As per the specification, various signal parameters and stress levels are computed to generate a signal that meets the stressed eye targets.

TP2 Calibration procedure

Unique ID	Device	Completion Status	Stressed Eye Convergence	Generated By	Date/Time	Comment
[Example_TP2_AIC_C	Non-Root Complex / /	Complete	True	TEK	20 Jun 2023, 07:59 A	
[Example_TP2_SYSTE	Root Complex / Syste	Complete	True	TEK	21 Jun 2023, 00:56 A	

TP2 Calibration

Click TP2 under the calibration tab to view the calibration results. Click  at the right end corner of the application, to launch the TP2 calibration wizard. This wizard will guide you through the sequential procedure to perform the calibration.

You must perform TP1 calibration before you start performing the calibration for TP2.

1. **Description:** This tab displays the description and allows you to select the DUT Type as Non-Root Complex or Root Complex.

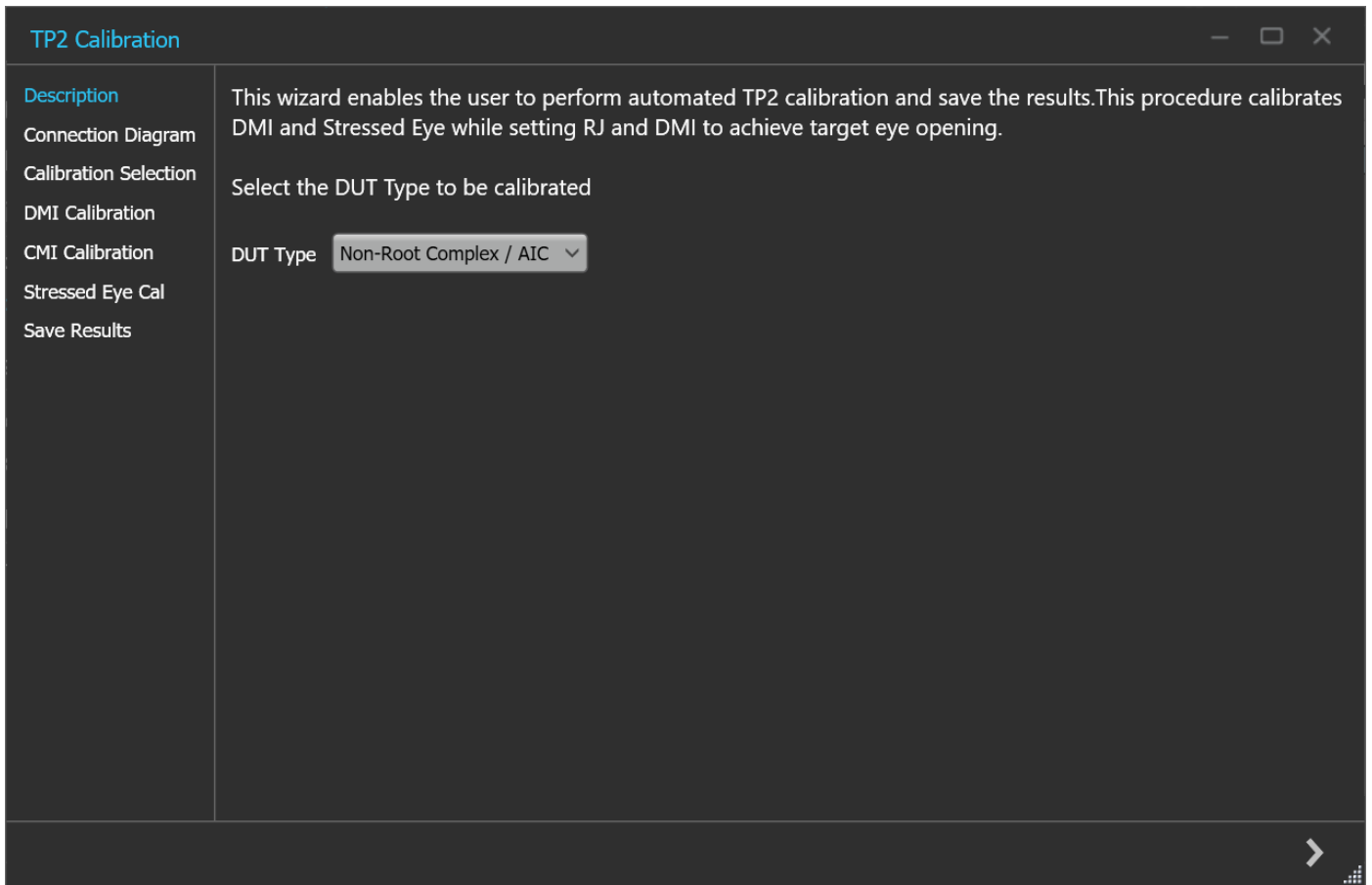

TP2 Calibration: Description

TP2 Calibration: Description

Parameter	Description
DUT Type	<ul style="list-style-type: none"> • Non-Root Complex / AIC Card • Root Complex / System



Click  to move to the next screen.

2. **Connection Diagram:** This tab displays the connection diagram for the DUT Type selected in description screen.

TP2 Calibration: Connection Diagram - AIC with 7 series oscilloscope

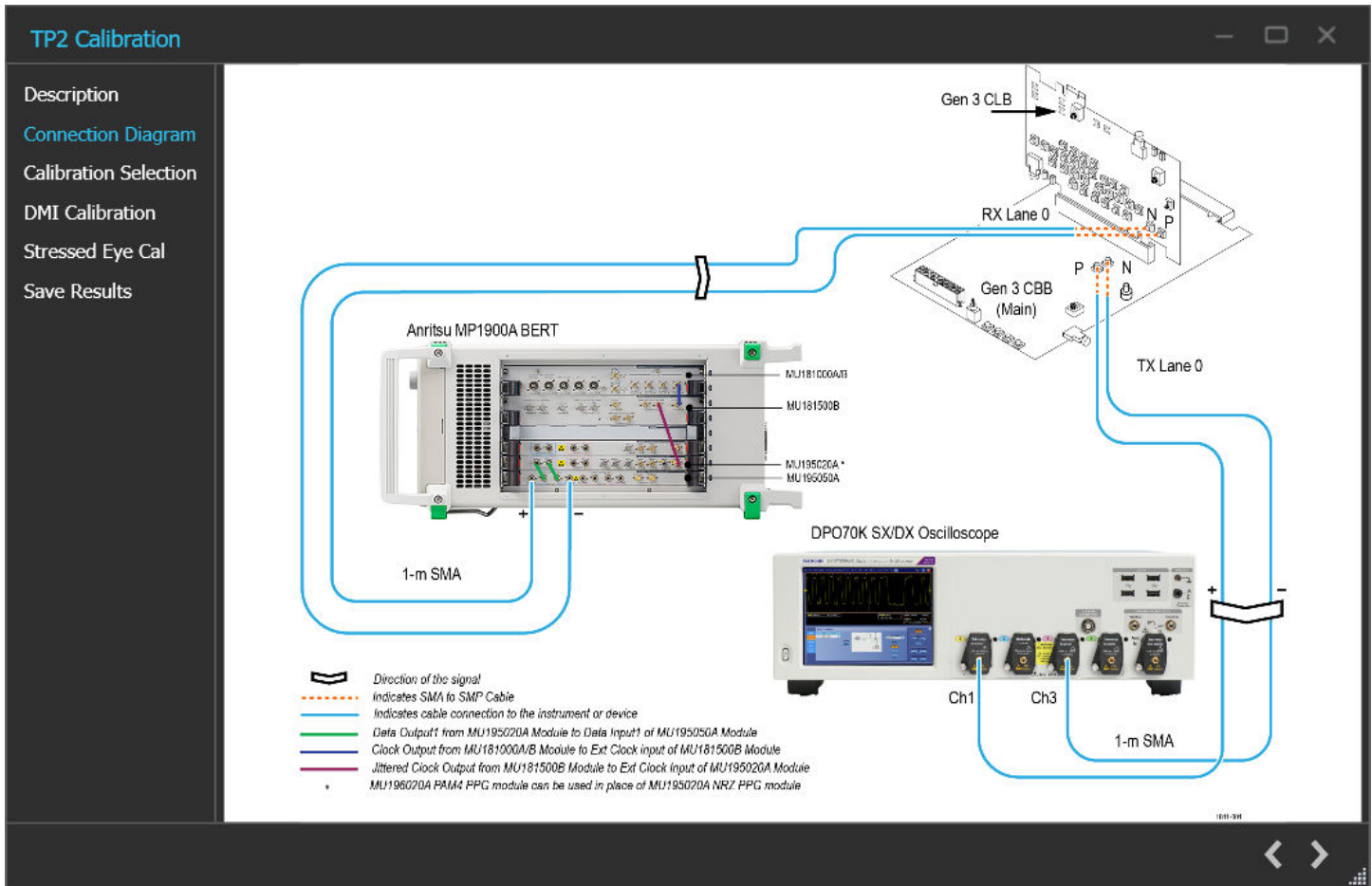

TP2 Calibration: Connection Diagram-System

NOTE:

The System Connection Diagram for TP2 Calibration is same as the connection diagram shown above for the DPO71AX Oscilloscope



Click to move to the next screen.

1. **Calibration Selection:** This tab allows you to select the TP1 Calibration file from the drop-down list and click **Initialize Equipment**.

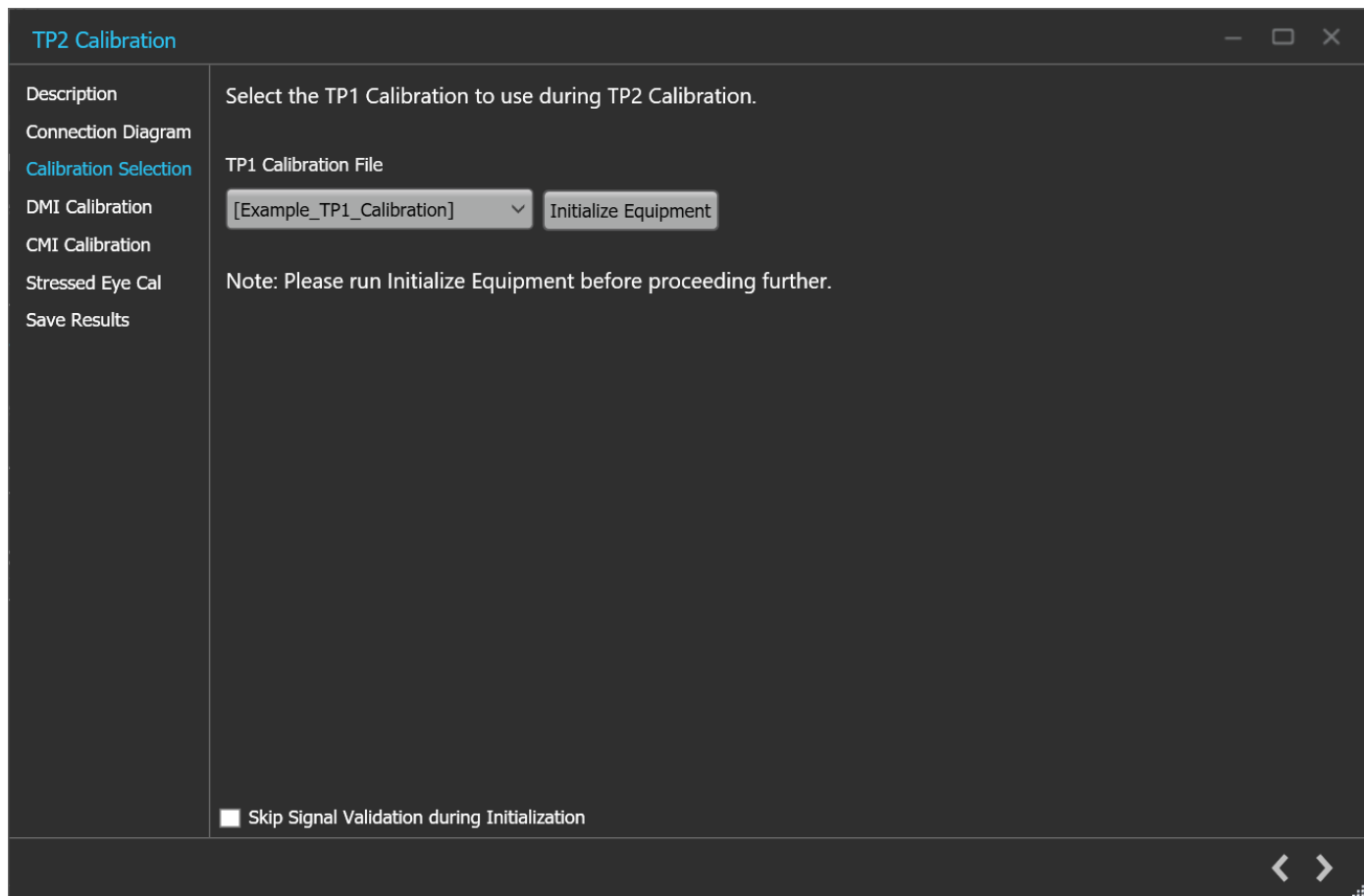

TP2 Calibration: Calibration Selection

TP2 Calibration: Calibration Selection

Parameter	Description
TP1 Calibration File	Select the desired TP1 calibration file and initialize the equipment.
Skip Signal Validation during Initialization	Check the checkbox to skip signal validation.



Click  to move to the next screen.

- DMI Calibration:** This tab displays the graph plots of DMI calibration.

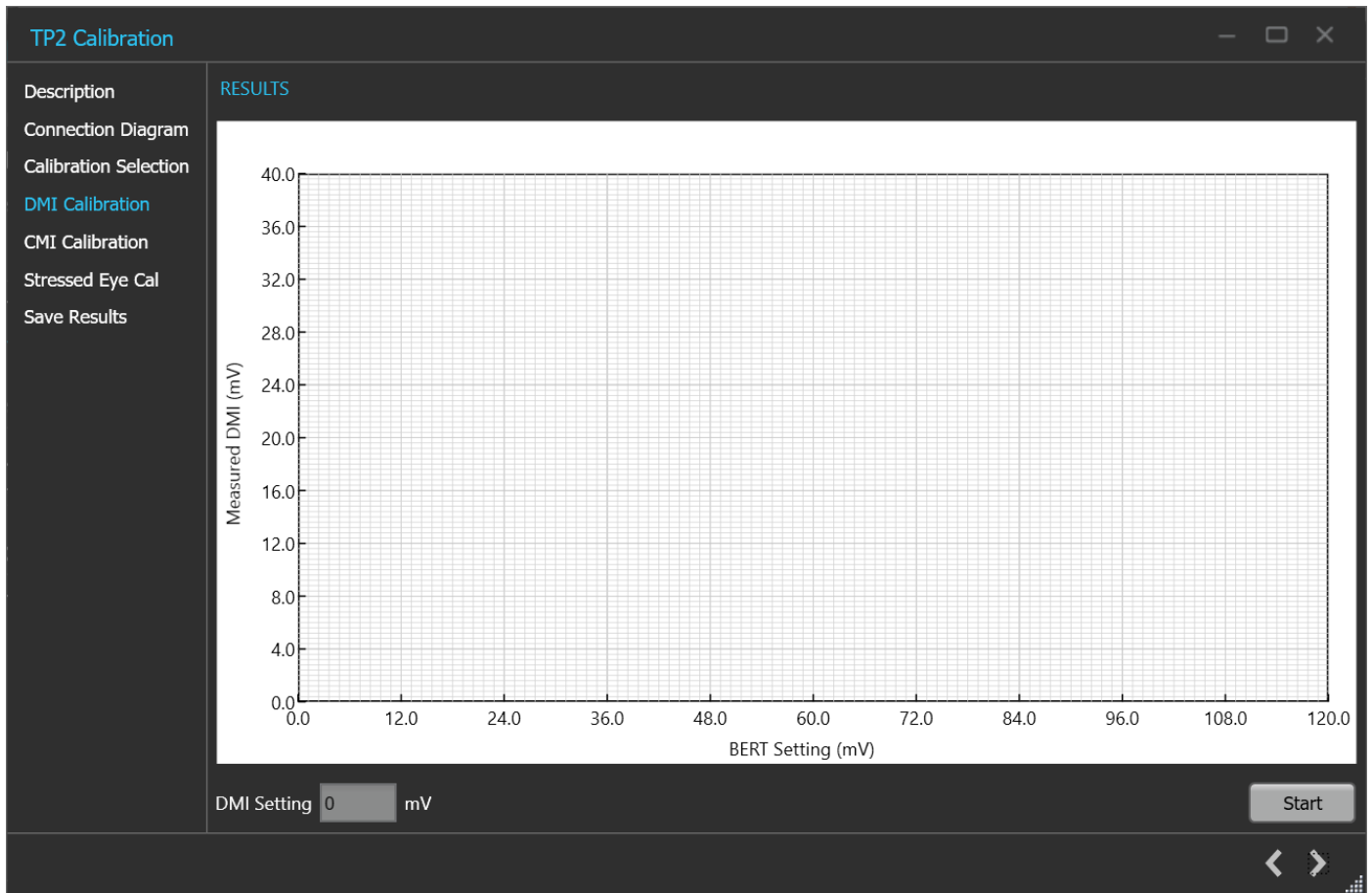

TP2 Calibration: DMI Calibration

TP2 Calibration: DMI Calibration

Parameter	Description
DMI Setting	Displays the calibrated DMI setting corresponding to nominal value.
Start	Click Start to run the measurement.



Click  to move to the next screen.

3. **CMI Calibration:** This tab displays the graph plots of CMI calibration.

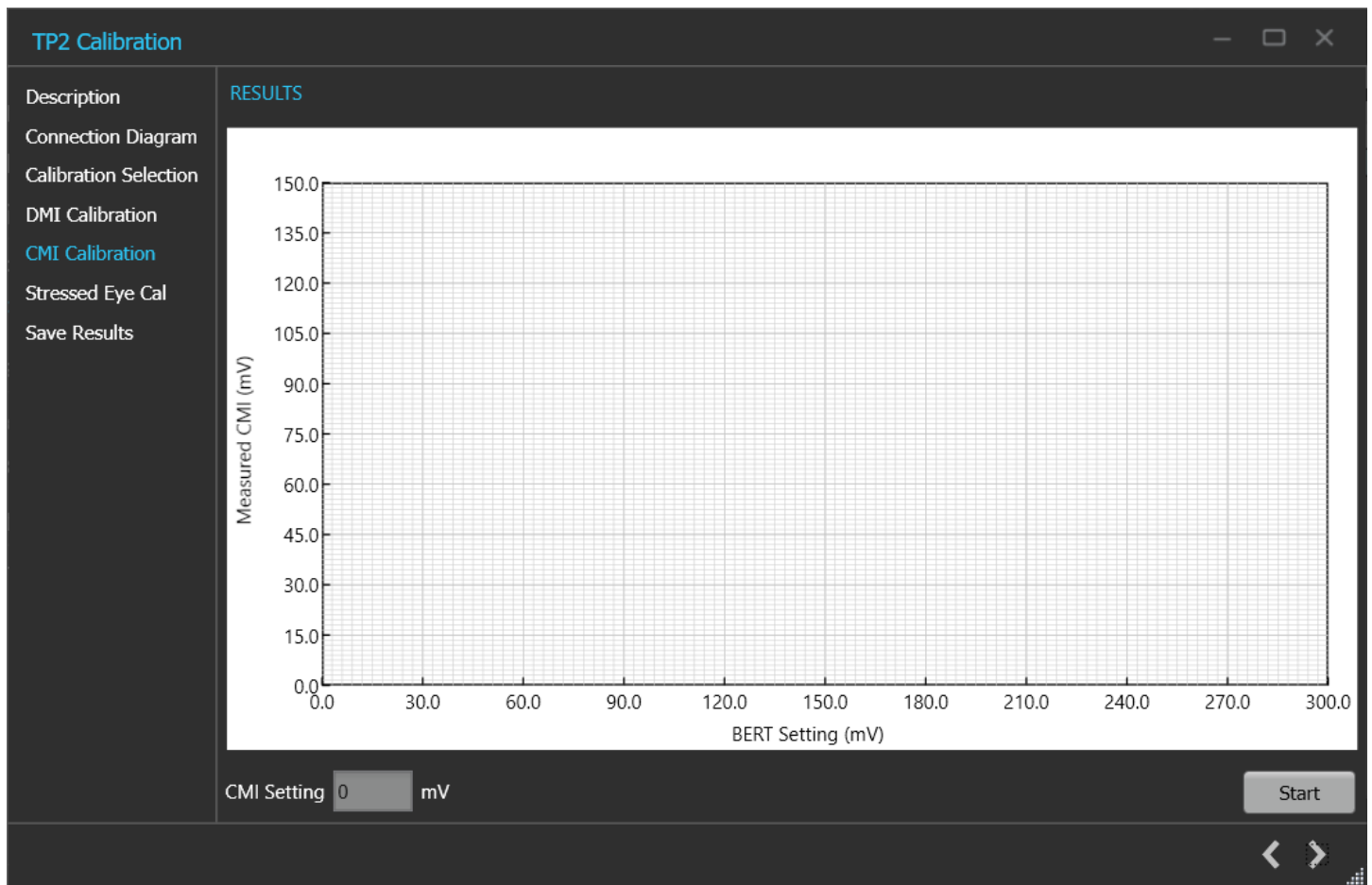

TP2 Calibration: CMI Calibration

TP2 Calibration: CMI Calibration

Parameter	Description
CMI Setting	Displays the calibrated CMI setting corresponding to nominal value.
Start	Click Start to run the measurement.



Click  to move to the next screen.

1. Stressed Eye Calibration:

TP2 calibration for stressed eye requires information from the TP1 calibration that is performed for the set-up under consideration or from one of the saved TP1 results. The relevant TP1 calibration file can be chosen from the calibration selection page shown from a drop-down button listing all the TP1 calibration files stored in the PCIe Gen3 TekRxTest application repository.

TP2 Calibration

Description

Connection Diagram

Calibration Selection

DMI Calibration

CMI Calibration

Stressed Eye Cal

Save Results

Index	RJ (ps) (RMS)	RJ Setting (UI p-p)	DMI (mV)	DMI Setting (mV)	EW (ps)	EH (mV)

Manual Calibration Run Exhaustive Sweep

RJ ps (RMS) DMI mV # acqs

Eye Height Limit: (45 - 50) mV, Eye Width Limit: (43 - 45) ps, Preset: P7, CTLE: 6dB
 RJ Limits: (1 - 5) ps, DMI Limits: (10 - 50) mV

TP2 Calibration: Stressed Eye Cal

Stressed Eye Configuration

Initial Settings

RJ ps (RMS) DMI mV

Step Size

RJ ps (RMS) DMI mV

Sweep Range

RJ

Min ps (RMS) Max ps (RMS)

DMI

Min mV Max mV

NOTE: Ensure Initial Settings are within the Sweep Range

TP2 Calibration: Stressed Eye Configuration

TP2 Calibration: Stressed Eye Cal

Parameter	Description
Manual Calibration Run	Select to manually enter the SJ, DMI and Amplitude values for Stressed Eye calibration.
SJ	Displays the SJ value at which Eye Width (EW) and Eye height (EH) needs to be computed.
DMI	Displays the DMI value at which Eye Width (EW) and Eye height (EH) needs to be computed.
Amplitude	Displays the amplitude level at which Eye Width (EW) and Eye height (EH) needs to be computed.
Exhaustive Sweep	Select to run the stressed eye calibration for all combinations of Amplitude, SJ, and DMI within the sweep range with defined step sizes.
# acqs	Enter the number of waveforms used to obtain the average EW and EH.
Configuration	<p>Select to configure initial settings, step size, sweep range.</p> <ul style="list-style-type: none"> • Initial Settings - Configure the Initial SJ / DMI / Amplitude value from which your Linear Sweep should start (Not applicable for Exhaustive Sweep). • Step Size - Configure the SJ / DMI / Amplitude step size value by which the increment or decrement of your SJ / DMI / Amplitude values should happen for Stressed Eye Calibration. • Sweep Range - Configure the SJ / DMI / Amplitude min and max sweep range for which the Stressed Eye Calibration is executed. • Default - Select to apply the initial settings, step size and sweep range to the default values. • OK - Select to apply the configured values of initial settings, step size, sweep range.
Start	Click Start to run the measurements.



Click  to move to the next screen.

2. **Save Results:** This tab allows you to save all the TP2 calibration results.

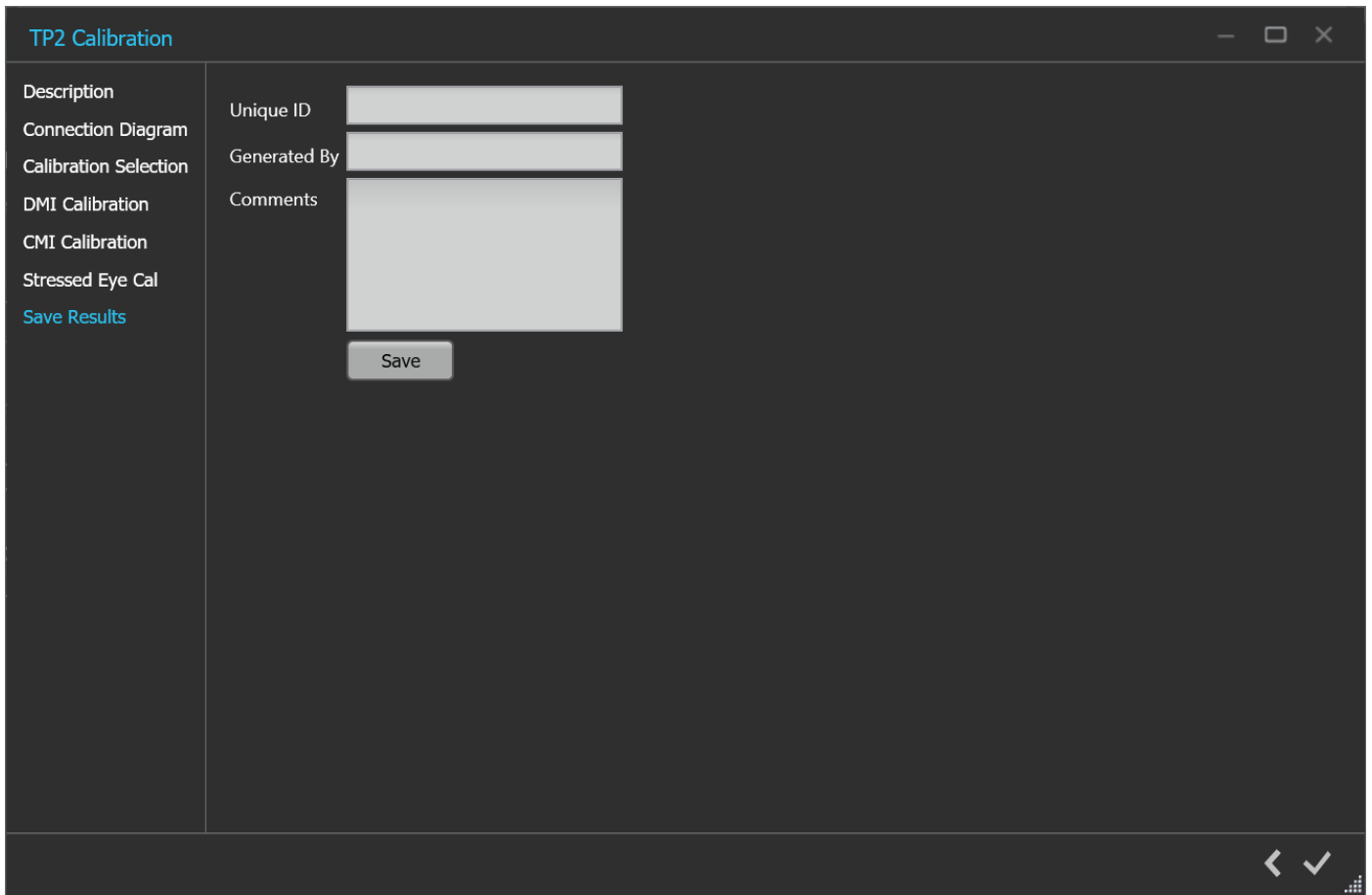

TP2 Calibration: Save Results

TP2 Calibration: Save Results

Parameter	Description
Unique ID	Enter the Unique ID of the calibrated equipment in the text box.
Generated By	Enter the user name in the text box.
ISI Pair	Enter the ISI pair used during calibration.
Comments (Optional)	Enter the required comments in the comment box.
Save	Click to save the results.

Click  to complete the TP2 calibration and close the wizard.

NOTE: Completion of the TP2 calibration process or in the event of cancellation of the process, the BERT data generator is turned off automatically by the PCIe3.0 (BASE / CEM) Test Application.

Tests panel

Rx LEQ Test

Rx LEQ Test procedure



Click **Rx LEQ Test** under the Tests panel to view the measurement results. Click  at the right end corner of the application, to launch the Rx LEQ test wizard. This wizard will guide you through the sequential procedure to perform the test.

1. **Calibration Selection:** This tab allows you to select the required DUT type, Clock Architecture, BERT Clock type and TP2 Calibration file from the drop-down list. The drop-down lists all the TP2 calibration files available as per the choice made under DUT Type selection.

Rx LEQ Test: Calibration Selection

Rx LEQ Test: Calibration Selection

Parameter	Description
DUT Type	Select the required DUT type. <ul style="list-style-type: none"> • Non-Root Complex / AIC • Root Complex / System
Clock Architecture	Select the desired clock architecture.
BERT Clock Type	Select the required BERT clock type.

TP2 Calibration File	Select the required TP2 calibration file.
----------------------	---



Click  to move to the next screen.

- 2. Connection Diagram:** This tab displays the connection diagram for the Rx LEQ test. The connection diagram is the different for AIC and System in case of Rx LEQ test.

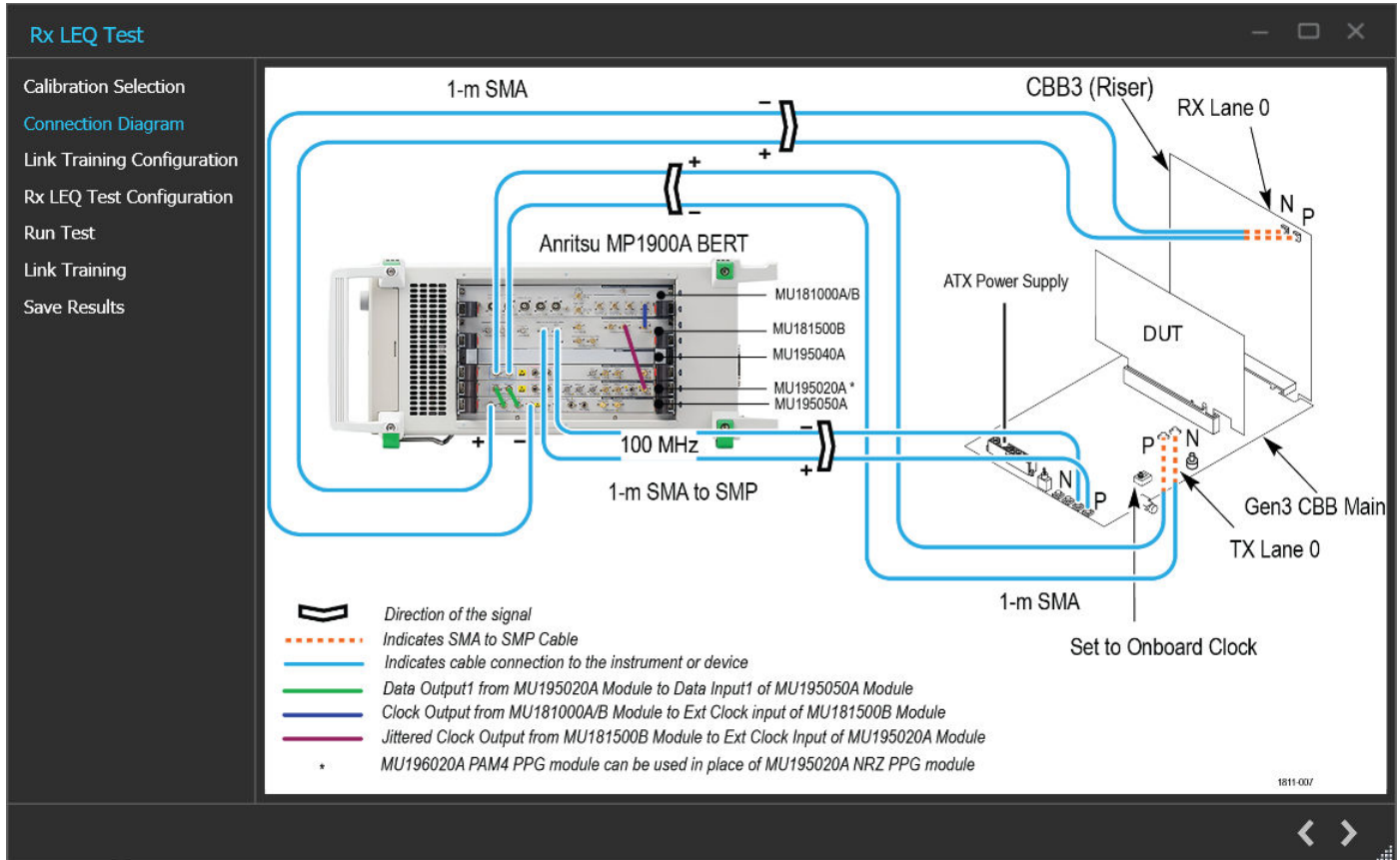

Rx LEQ Test: Connection Diagram(AIC)

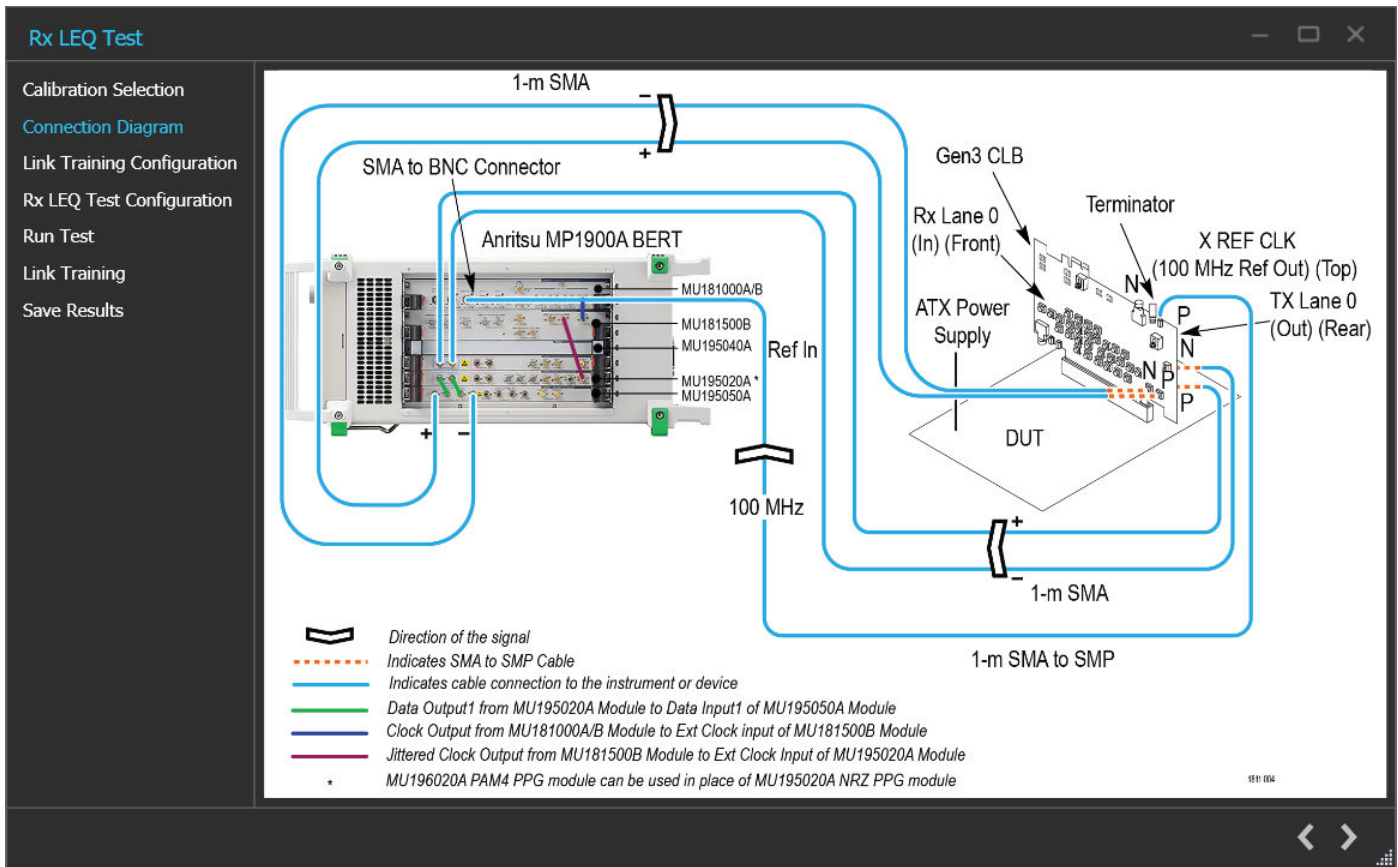

Rx LEQ Test: Connection Diagram(System)



Click to move to the next screen.

3. **Link Training Configuration:** This tab allows you to configure the parameters for link training.

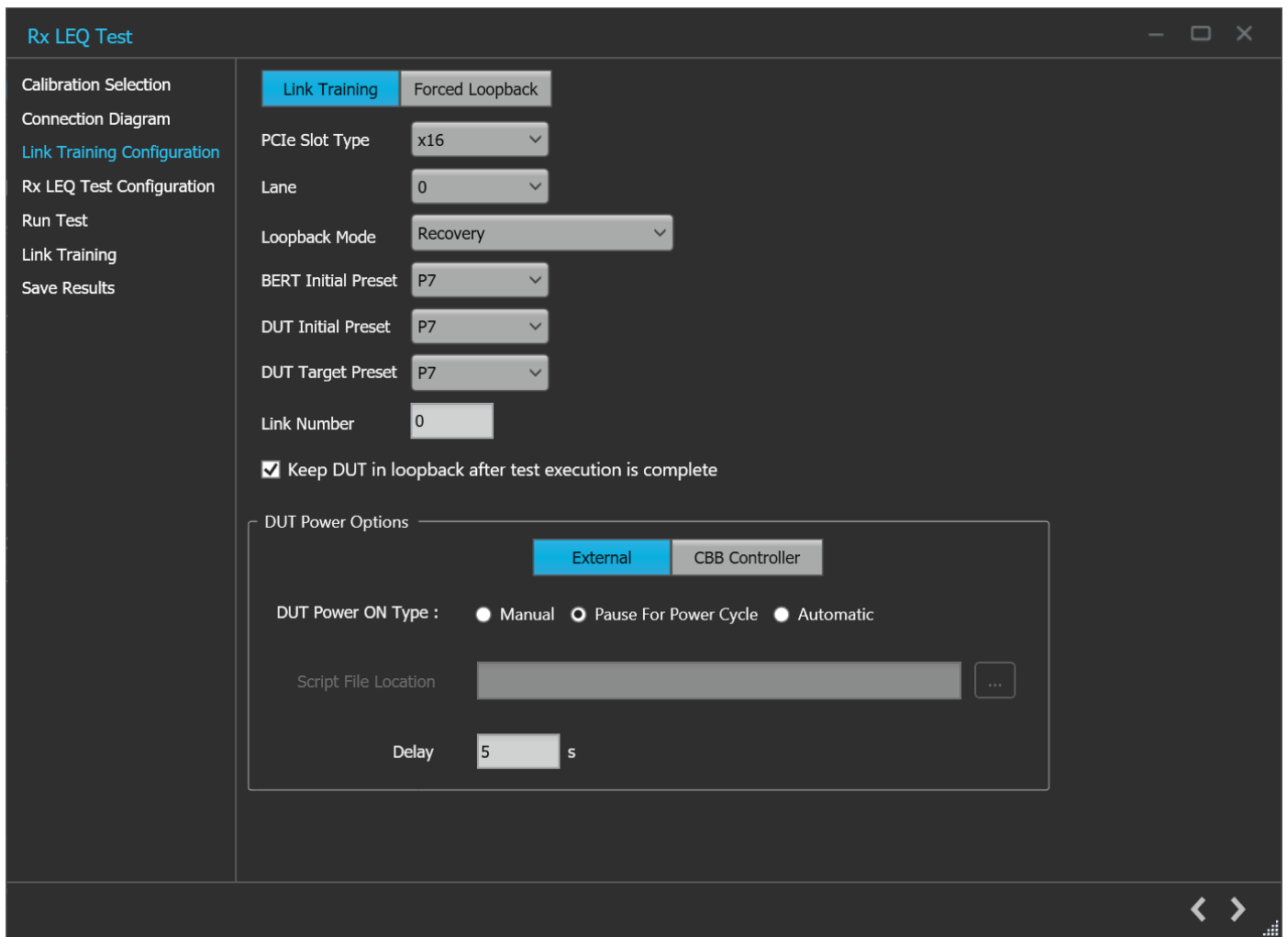

Rx LEQ Test: Link Training Configuration (Link Training-External)

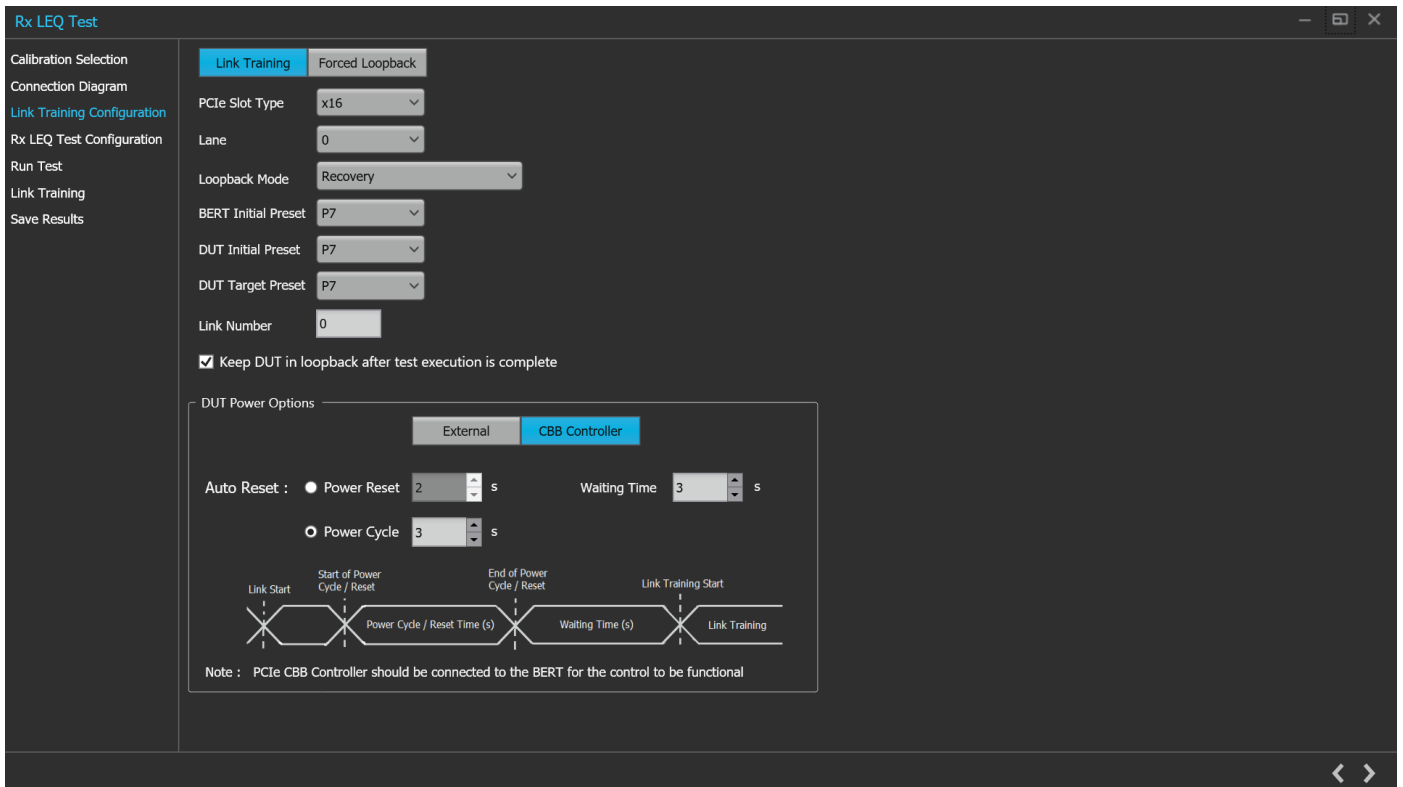

Rx LEQ Test: Link Training Configuration (Link Training-CBB Controller)

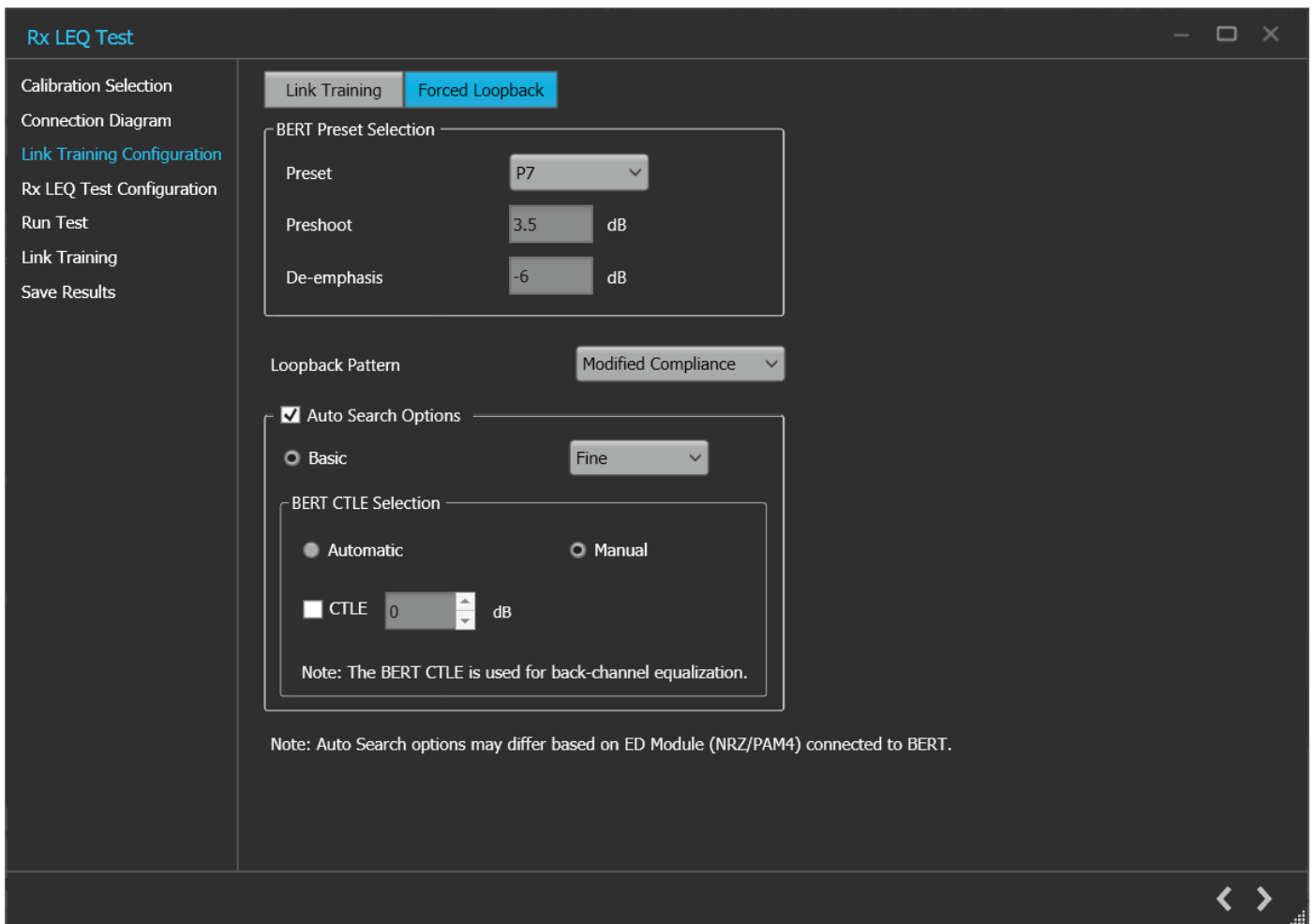

Rx LEQ Test: Link Training Configuration (Forced Loopback)

Rx LEQ Test: Link Training Configuration for Link Training

Parameter	Description
PCIe Slot Type	Select the required PCIe slot from the drop-down list.
Lane	Select the lane to be tested from the drop-down list.
Loopback Mode	Select the required loopback mode from the drop-down list.
BERT Initial Preset	Select the Preset to be set on the BERT PPG during loopback from the drop-down list.
DUT Initial Preset	Select the Preset to be set on the DUT Tx during loopback from the drop-down list.
DUT Target Preset	Select the Preset to be set on the DUT Tx as the final preset during link training.
Link Number	Enter the link number value.
Keep DUT in loopback after test execution is complete	Select to keep the DUT in the loopback after test execution is complete.
DUT Power options	Select the required DUT power options. <ul style="list-style-type: none"> • External • CBB Controller
DUT Power ON Type	Select the required DUT power ON type. <ul style="list-style-type: none"> • Manual • Pause For Power Cycle • Automatic
Script File Location	Browse and navigate to the path and select the required script file. <hr/> NOTE: Enabled only when Automatic is selected as DUT Power ON Type. <hr/>
Delay	Enter the delay time in seconds.
Auto Reset	Select the required Auto Reset and enter the values in seconds. <ul style="list-style-type: none"> • Power Cycle • Power Reset • Waiting Time <hr/> NOTE: PCIe CBB Controller should be connected to the BERT for the control to be functional. <hr/>

Rx LEQ Test: Link Training Configuration for Forced Loopback

Parameter	Description
BERT Preset Selection	
Preset	Select the BERT Tx Preset setting from the drop-down list.
Preshoot	Displays the preshoot value corresponding to the choice of preset. Editable for Custom Preset selection.
De-emphasis	Displays the de-emphasis value corresponding to the choice of preset. Editable for P10 and Custom Preset selection.
Loopback Pattern	Select the required loopback pattern from the drop-down. <ul style="list-style-type: none"> • Modified Compliance • Compliance • Clock Pattern • PRBS7 • PRBS9 • PRBS10 • PRBS11 • PRBS15 • PRBS20 • PRBS23 • PRBS31
Auto Search	Select to enable the auto search basic mode and choose from the drop-down. The drop-down contains the following elements: <ul style="list-style-type: none"> • Fine • Coarse
BERT CTLE Selection	
Automatic	Enables automatic CTLE selection for back-channel equalization in the BERT Error Detector.
Manual	Select to manually choose the BERT CTLE selection.
CTLE	Select to enable and enter the BERT Error Detector CTLE value in dB.



Click  to move to the next screen.

4. **Rx LEQ Test Configuration:** This tab allows you to configure the Rx LEQ test settings.

Rx LEQ Test: Rx LEQ Test Configuration (Basic)

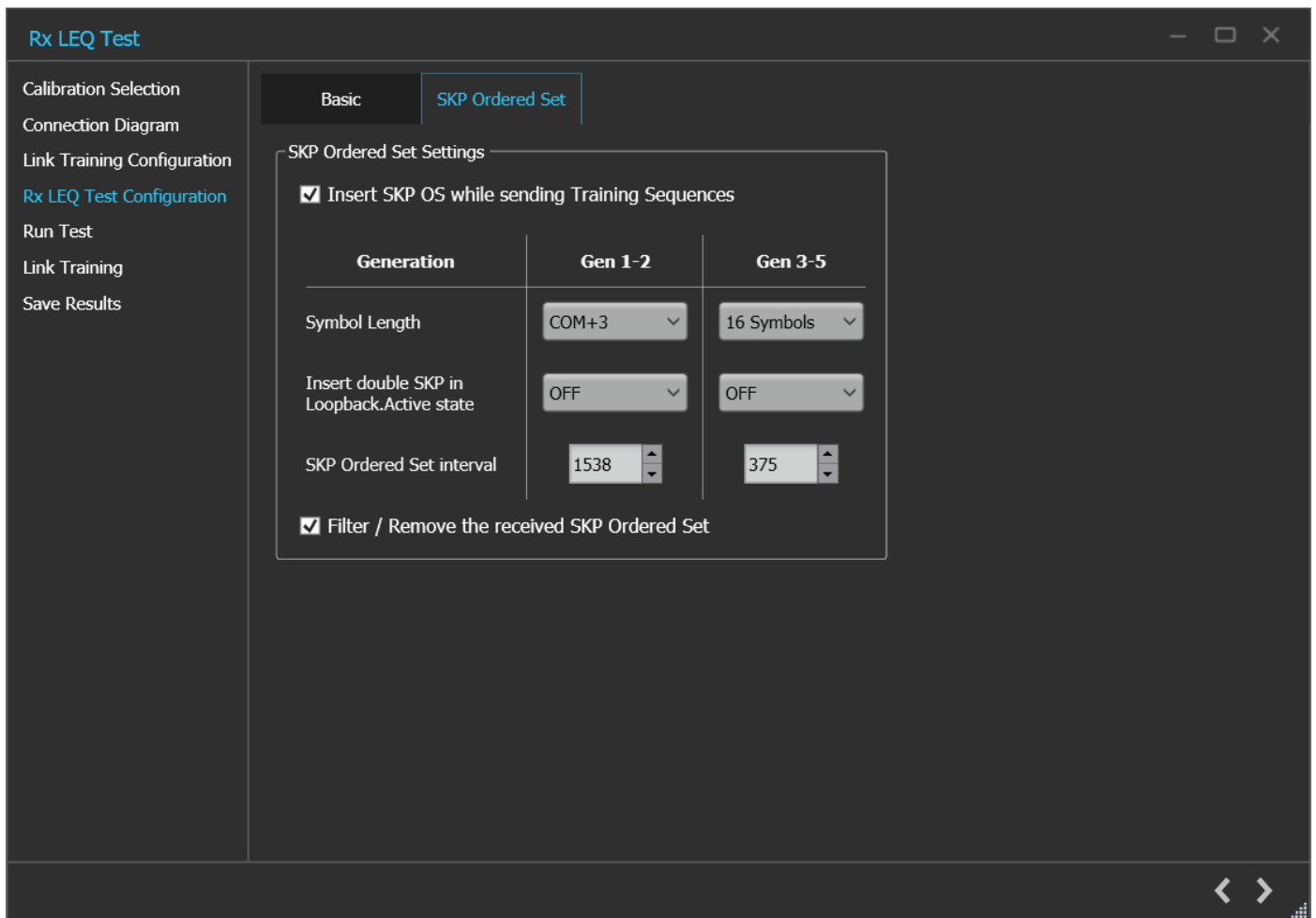

Rx LEQ Test: Rx LEQ Test Configuration (SKP Ordered Set)

Rx LEQ Test: Rx LEQ Test Configuration (Basic)

Parameter	Description
Apply SSC to data and clock output	Select to apply SSC to data and clock output.
BER	Number of bits in error that can be tolerated.
Error Limit	Enter the required error limit value. The default value is 1.
Test Length	Enter the test length value in second. <ul style="list-style-type: none"> Duration - Enter the test length duration value. Confidence - Displays the test length confidence value.
Stress Configuration	Select the stress configuration among calibrated, customized, un-calibrated.
CMI	Displays the CMI value in mV. The stress on the waveform is defined by the parameters of CMI.

DMI	Displays the DMI value in mV. The stress on the waveform is defined by the parameters of DMI.
Amplitude	Displays the amplitude value in mV. The stress on the waveform is defined by the parameters of Amplitude.
RJ	Displays the RJ value in ps. The stress on the waveform is defined by the parameters of RJ.
SJ	Displays the SJ value in ps. The stress on the waveform is defined by the parameters of SJ.
Load Stresses	Click Load Stresses to apply all the configured stress parameters CMI, DMI, SJ, and amplitude in the BERT. NOTE: Use the Load Stresses option exclusively to load preset and stress parameters into BERT.
BER Measurement Pattern	Select the required BER measurement pattern from the drop-down list. <ul style="list-style-type: none"> • Modified Compliance • Compliance • Jitter Meas • PRBS7 • PRBS9 • PRBS10 • PRBS11 • PRBS15 • PRBS20 • PRBS23 • PRBS31 • User

Rx LEQ Test: Rx LEQ Test Configuration (SKP Ordered Set)

Parameter	Description
SKP Ordered Set Settings	
Insert SKP OS while sending Training Sequence	Click to insert SKP OS while sending training sequence.
Symbol Length	Select the required symbol length from the drop-down list for the corresponding generation.
Insert double SKP in Loopback.Active state	Select the required option (ON/OFF) from the drop-down list for the corresponding generation.
SKP Ordered Set interval	Select the required interval value from the drop-down list for the corresponding generation.
Filter/Remove the received SKP Order Set	Select to enable the filter or remove the received SKP ordered set.



Click  to move to the next screen.

5. **Run Test:** This tab allows you to configure the settings to run the test.

Rx LEQ Test: Run Test (Basic)

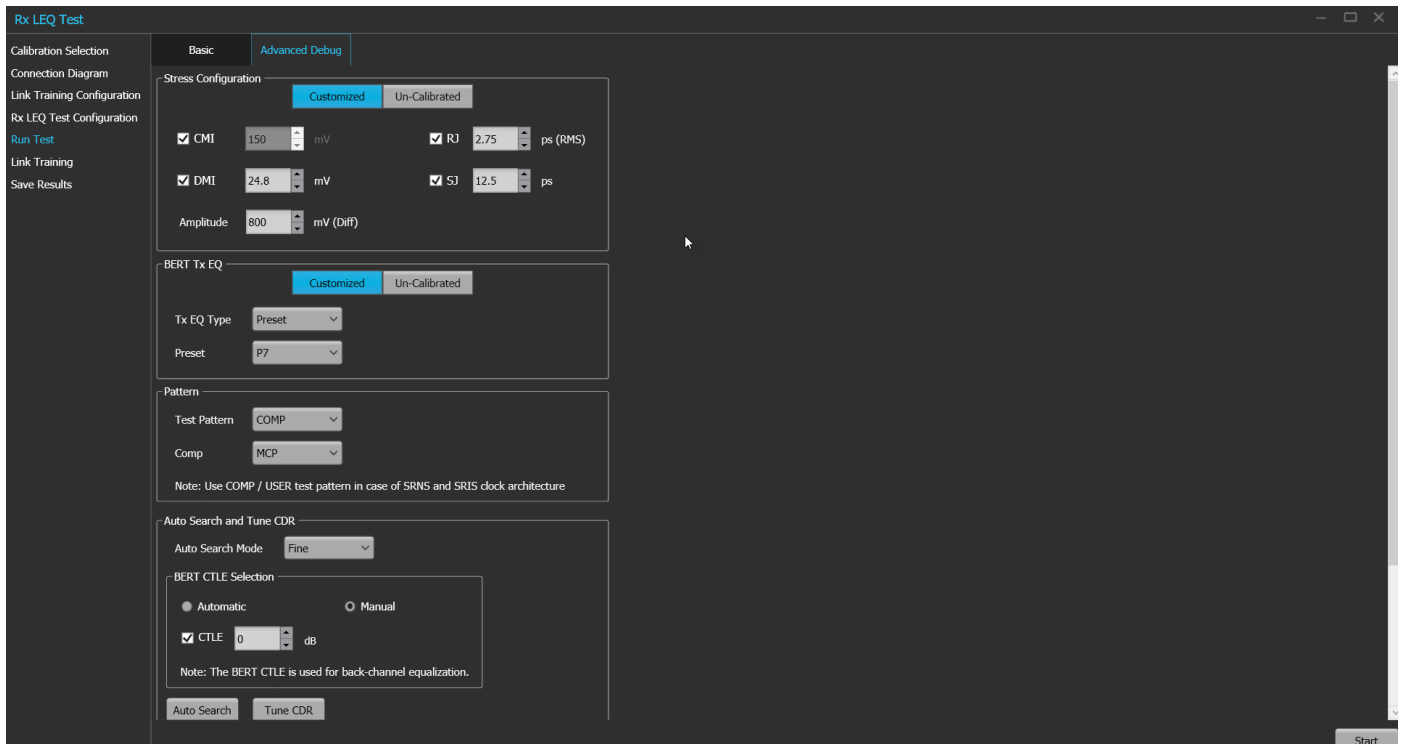

Rx LEQ Test: Run Test (Advanced Debug)

Rx LEQ Test: Run Test (Basic)

Parameter	Description
Rx LEQ Test Information	
Loopback Mode	Select the required loopback mode from the drop-down list.
BERT Initial Preset	Select the Preset to be set on the BERT PPG during loopback from the drop-down list.
DUT Initial Preset	Select the Preset to be set on the DUT Tx during loopback from the drop-down list.
DUT Target Preset	Select the Preset to be set on the DUT Tx as the final preset during link training.
Stress Type	Select the required Stress type from the drop-down list. Apply stress Inhibit stress during loopback Disable stress
Auto Search and Tune CDR	Enable to perform Auto Search and Tune CDR after Link Training: Automatic - Search and set the appropriate CTLE on the Error Detector. Manual – Sets the configured CTLE value on the Error Detector. CTLE - Enable and enter the BERT CTLE value in dB
Error Detector Information	

FBER	Displays the FBER information.
Error Count	Displays the error count information.
Total Bits	Displays the total number of bits.
Rx LEQ Test Result	Displays the Rx LEQ test result.
Start	Click to start the test execution.

Rx LEQ Test: Run Test (Advanced Debug)

Parameter	Description
Stress Configuration	Select the stress configuration among Customized and Un-Calibrated.
CMI	Click to display the CMI value in mV. The stress on the waveform is defined by the parameters of CMI.
DMI	Click to display the DMI value in mV. The stress on the waveform is defined by the parameters of DMI.
Amplitude	Click to display the amplitude value in mV. The stress on the waveform is defined by the parameters of Amplitude.
RJ	Click to display the RJ value in ps. The stress on the waveform is defined by the parameters of RJ.
SJ	Click to display the SJ value in ps. The stress on the waveform is defined by the parameters of SJ.
BERT Tx EQ	Select BERT Tx EQ among Customized and Un-calibrated
Tx EQ Type	Select the Tx EQ type from the drop-down list.
Preset	Select the Preset from the drop-down list.
Test Pattern	Select the required test pattern type from the drop-down list.
Comp	Select the required Compliance pattern type from the drop-down list.
Auto Search and Tune CDR	<ul style="list-style-type: none"> • Auto Search mode - Select to enable the auto search mode from the drop-down list. <ul style="list-style-type: none"> • Fine • Coarse • BERT CTLE Selection: <ul style="list-style-type: none"> • Automatic - Search and set the appropriate CTLE on the Error Detector. • Manual - Sets the configured CTLE value on the Error Detector. • BERT CTLE - Enter the BERT CTLE value in dB. • Auto Search - Click to enable Auto Search when the DUT is in loopback • Tune CDR - Click to enable CDR Tune when the DUT is in loopback

Error Count	Displays the error count information.
Total Bits	Displays the total number of bits.
FBER	Displays the FBER information.
Status	Displays the status information.
Export	Click to export the Advance debug settings.
Reset	Click to reset the Advance debug settings.
Redo Link Training	Select to enable the redo link training in-case of sync or clock error. Export Reset
Start	Click to start the text execution.



Click  to move to the next screen.

6. **Link Training:** This tab displays the loopback steps with its status in a tabular form

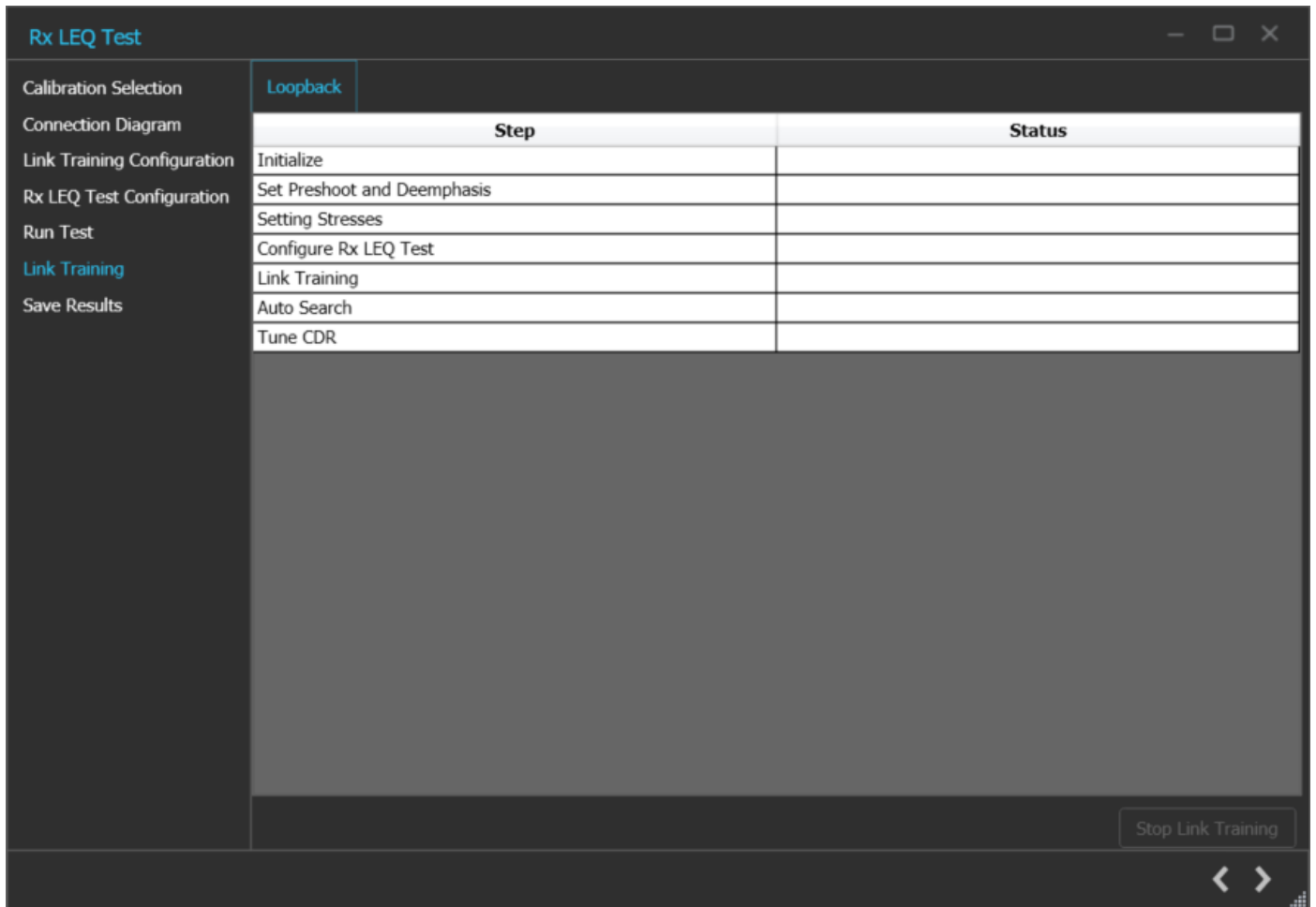

Rx LEQ Test: Link Training

Rx LEQ Test: Link Training

Parameter	Description
Step	Lists the different steps that are prerequisite for initiating link training
Status	Indicates the completion status of each activity
Initialize	Initialize the BERT for performing link training
Set Preshoot and Deemphasis	Sets the preset as per BERT Initial Preset in Link Training Configuration wizard It sets all the calibrated Presets on the BERT from P0-P9
Setting Stresses	Sets stresses as per the user selection in Configure Test wizard
Configure Rx LEQ Test	Sets the BERT, DUT initial and Target Presets, Loopback mode (Recovery, Config), Link and Lane number
Link Training	Initiates the link training process in MX183000A
Auto Search	Fine-tunes the error detector's delay, threshold, and CTLE settings for the incoming DUT TX signal.
Tune CDR	Fine-tunes the Clock and Data Recovery (CDR) settings in the error detectors for the incoming DUT TX signal.



Click  to move to the next screen.

7. **Save Results:** This tab allows you to save the Rx LEQ test results.

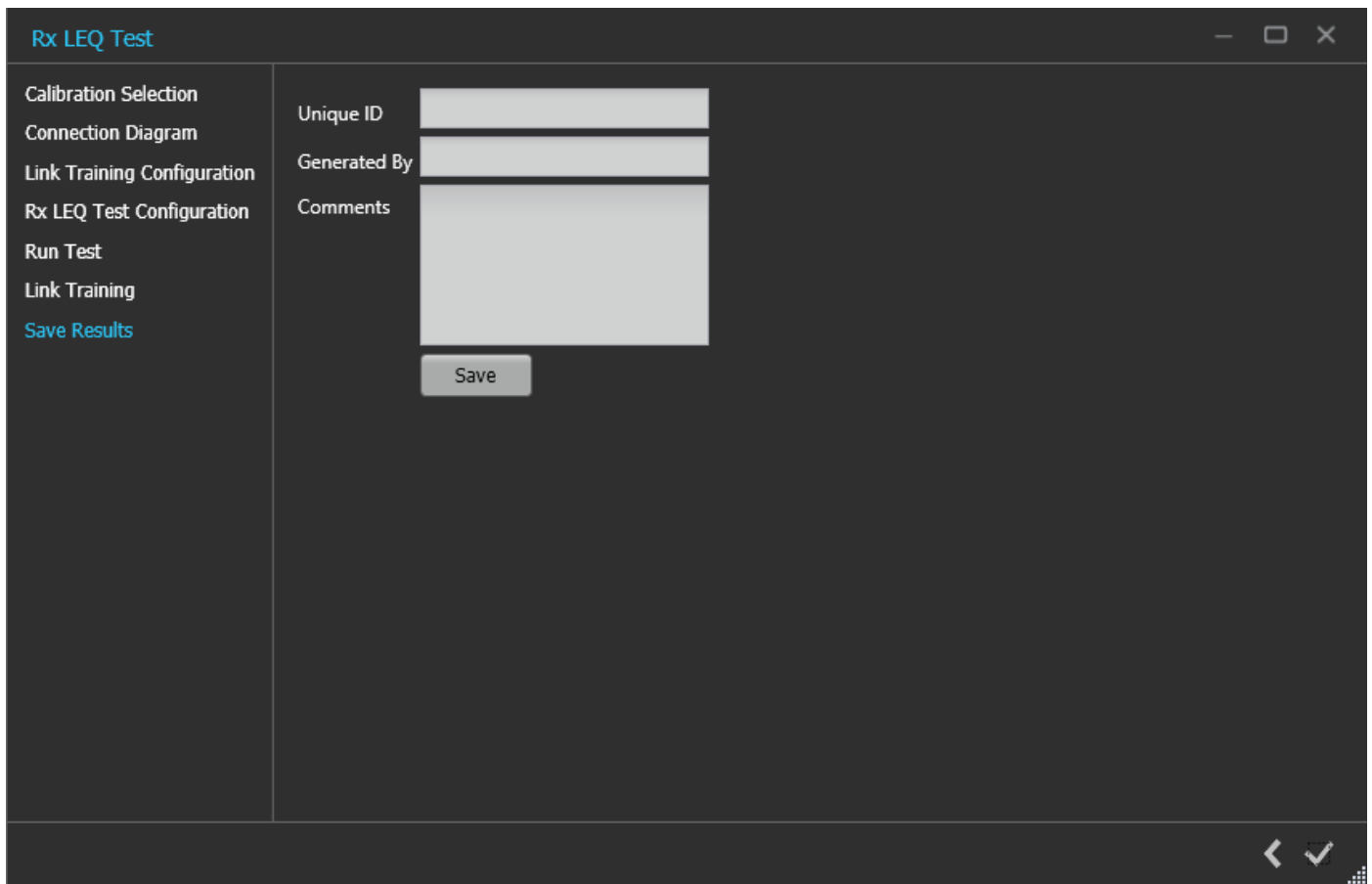

Rx LEQ Test: Save Results

Rx LEQ Test: Save Results

Parameter	Description
Unique ID	Enter the Unique ID of the calibrated equipment in the text box.
Generated By	Enter the user name in the text box.
Comments (Optional)	Enter the required comments in the comment box.
Save	Click to save the results.

Click  to complete the Rx LEQ Test and close the wizard.

Tx LEQ Test

Tx LEQ Test procedure

Click **Tx LEQ Test** under the Tests panel to view the measurement results. Click  at the right end corner of the application, to launch the Tx LEQ test wizard. This wizard will guide you through the sequential procedure to perform the test.

1. **Calibration Selection:** This tab allows you to select required DUT type, BERT Clock type and TP1 Calibration file from the drop-down list.

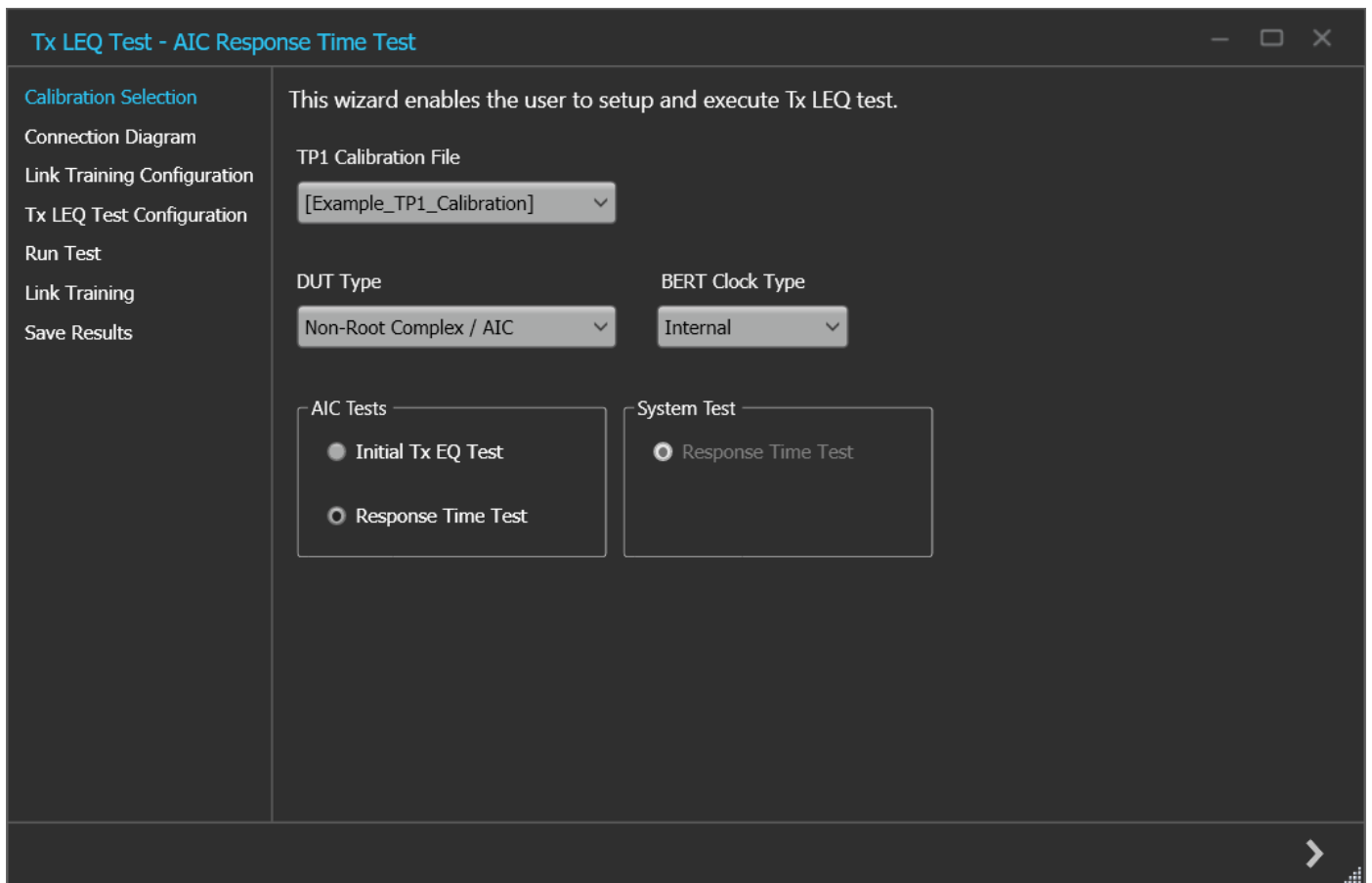

Tx LEQ Test: Calibration Selection

Tx LEQ Test: Calibration Selection

Parameter	Description
TP1 Calibration File	Select the required TP1 calibration file.
DUT Type	Select the required DUT type. <ul style="list-style-type: none"> • Non-Root Complex / AIC • Root Complex / System
BERT Clock Type	Select the required BERT clock type from the drop-down list.
AIC Tests	Select the required AIC test.
System Test	Select the required System test.



Click  to move to the next screen.

- 2. Connection Diagram:** This tab displays the connection diagram for the Tx LEQ test. The connection diagram is the different for AIC and System in case of Tx LEQ test.

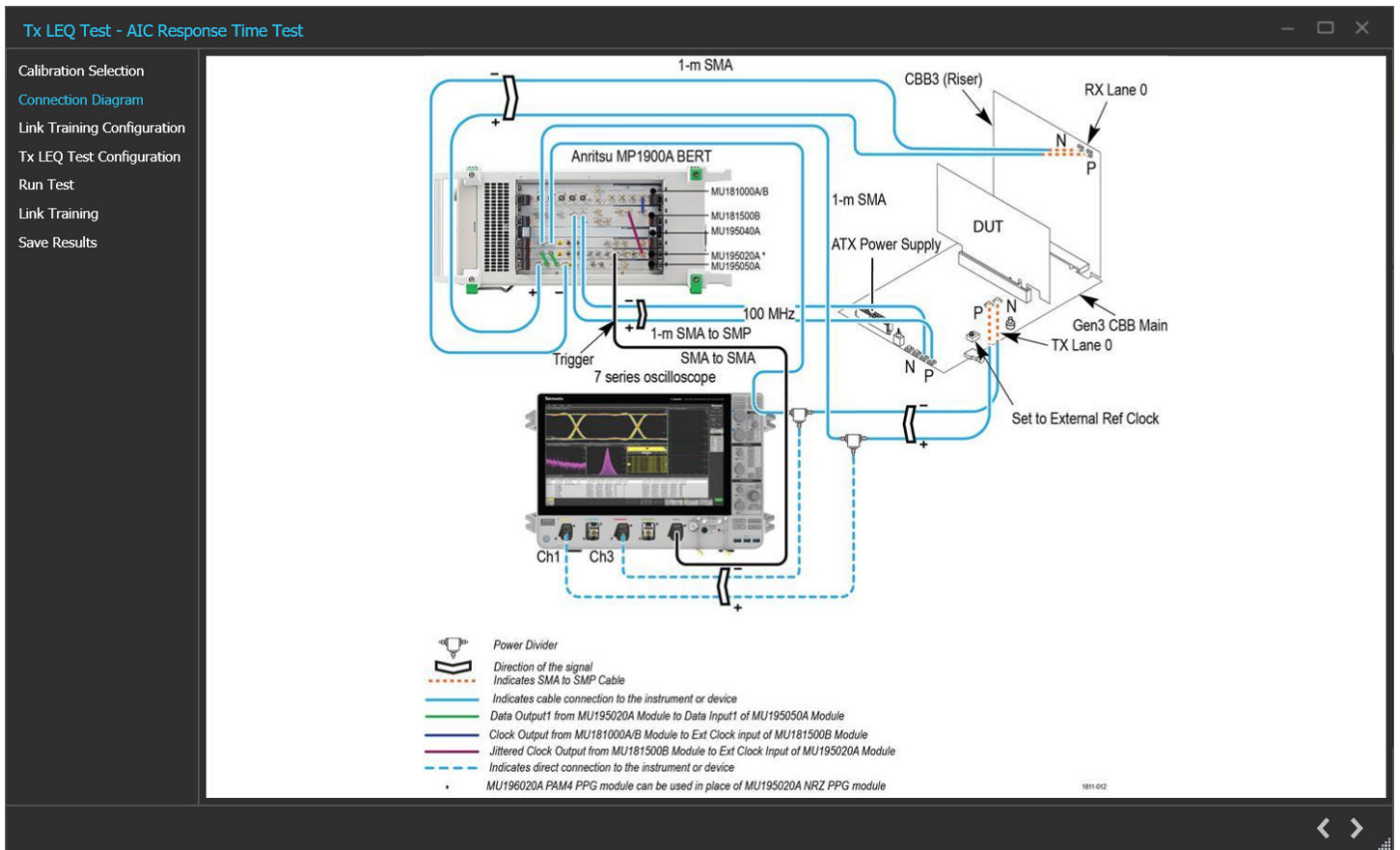

Tx LEQ Test: Connection Diagram(AIC) with 7 series oscilloscopes

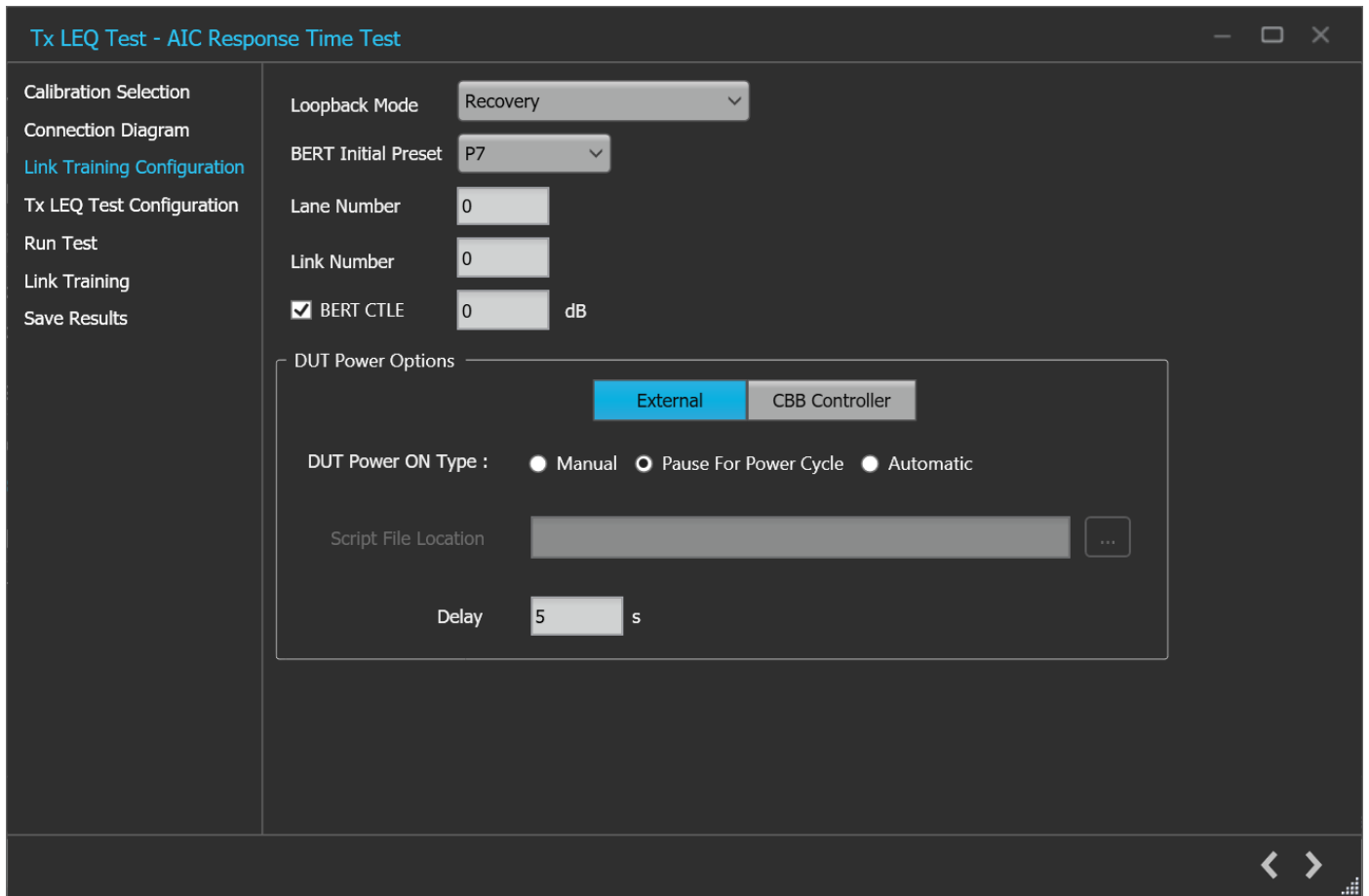

Tx LEQ Test: Link Training Configuration (External)

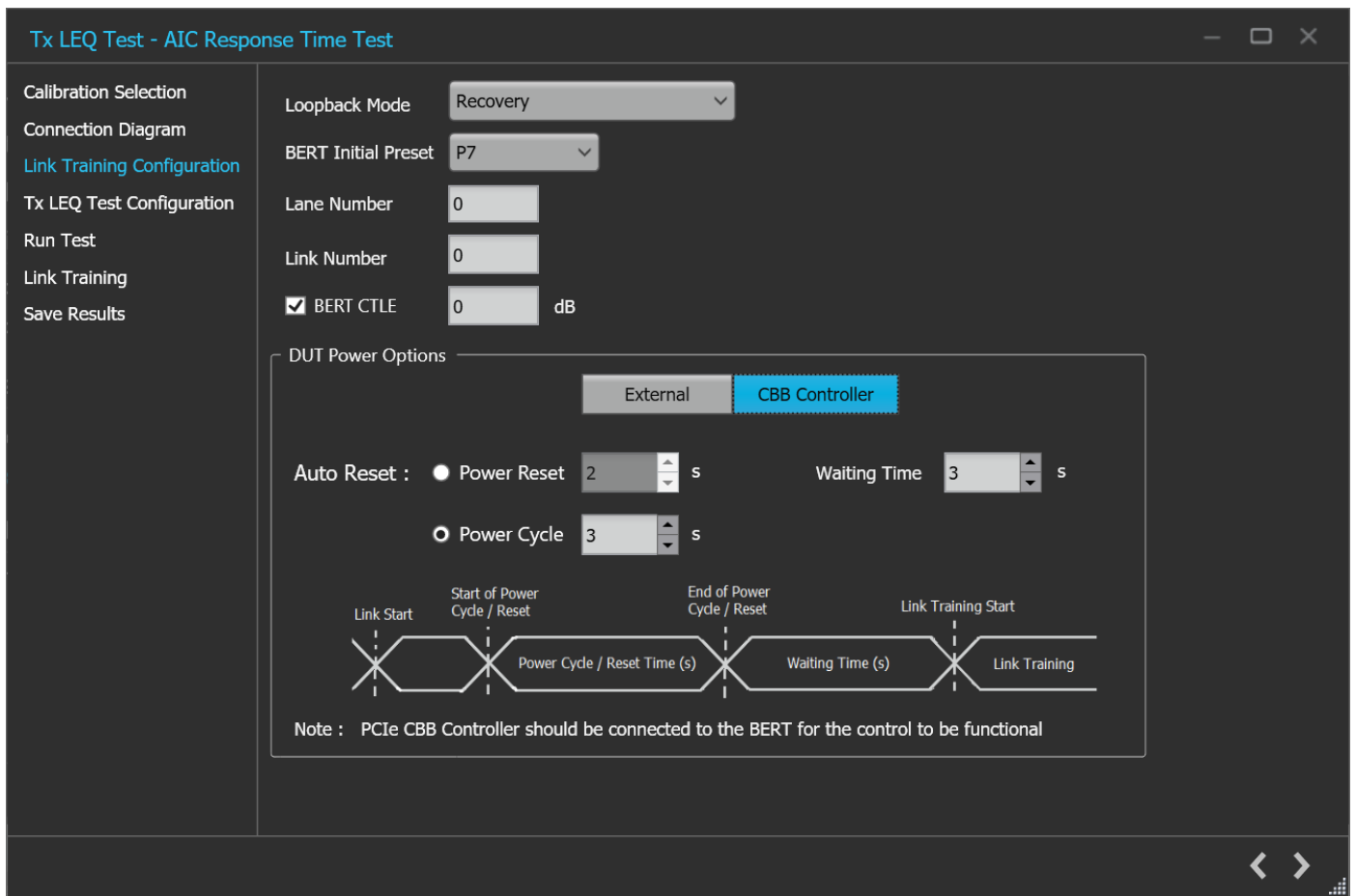

Tx LEQ Test: Link Training Configuration (CBB Controller)

Tx LEQ Test: Link Training Configuration

Parameter	Description
Loopback Mode	Select the required loopback mode from the drop-down list.
BERT Initial Preset	Select the Preset to be set on the BERT PPG during loopback from the drop-down list.
BERT CTLE	Enter the BERT Error Detector CTLE value in dB.
Lane Number	Enter the lane number value.
Link Number	Enter the link number value.
DUT Power Options	Select the required DUT power options. <ul style="list-style-type: none"> External CBB Controller
DUT Power ON Type	Select the required DUT power ON type. <ul style="list-style-type: none"> Manual Pause For Power Cycle Automatic

Script File Location	Browse and navigate to the path and select the required script file. Available only when Automatic is selected as DUT Power ON Type.
Delay	Enter the delay time in seconds.
Auto Reset	Select the required Auto Reset and enter the values in seconds. <ul style="list-style-type: none"> • Power Cycle • Power Reset • Waiting Time



Click  to move to the next screen.

2. **Tx LEQ Test Configuration:** This tab allows you to configure the Tx LEQ test settings.

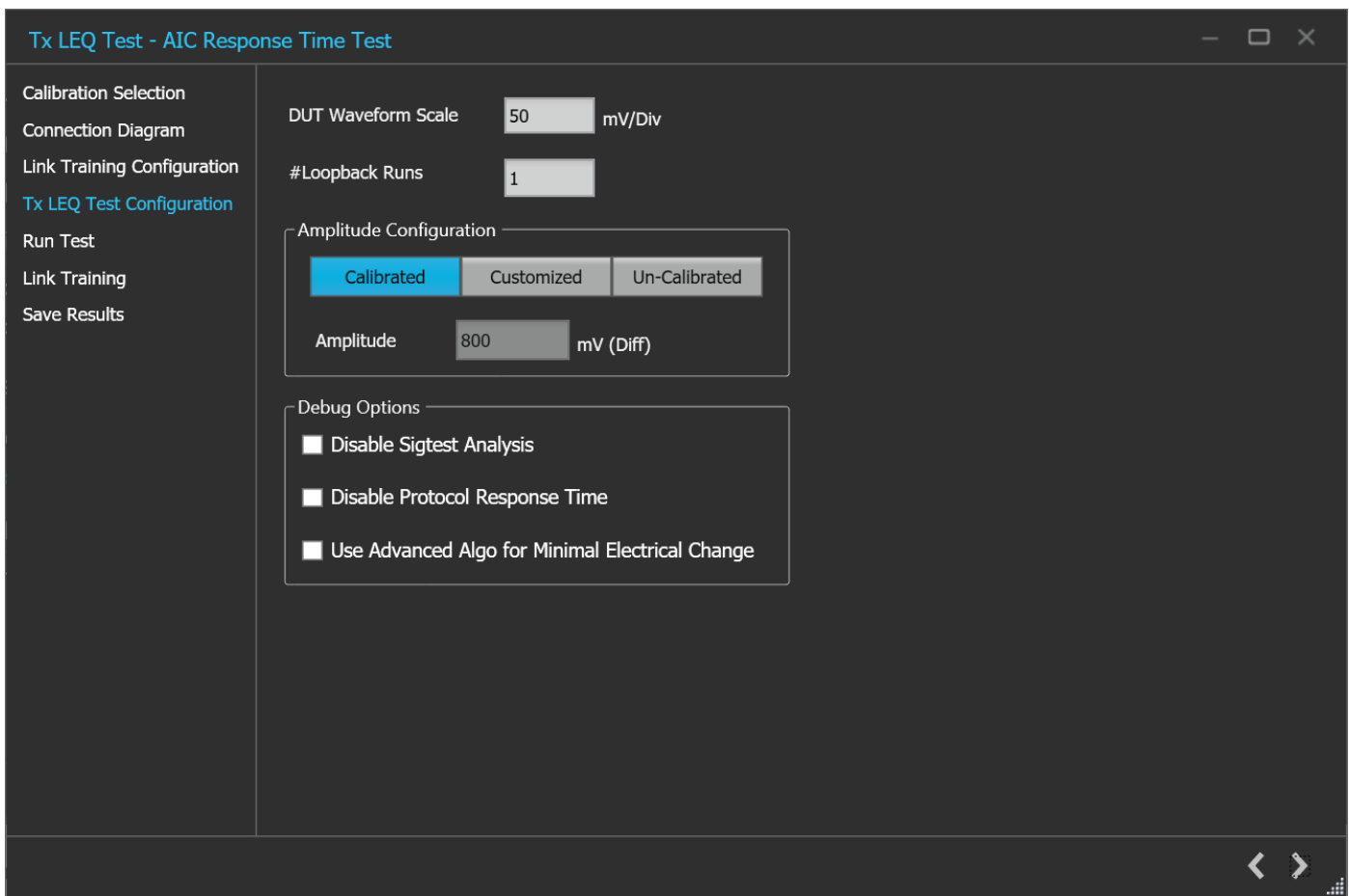

Tx LEQ Test: Tx LEQ Test Configuration

Tx LEQ Test: Tx LEQ Test Configuration

Parameter	Description
Apply Software Equalization	Select to apply equalization on the waveform using CTLE Filter files during runtime. <ul style="list-style-type: none"> ▪ Automatic - This will find the optimum CTLE for the channel and apply that during waveform acquisition. ▪ Manual - User can browse and apply CTLE filter file which will be applied during waveform acquisition.

DUT Waveform Scale	Enter the DUT waveform scale value in mV/Div.
#Loopback Runs	Enter the number of loopback runs.
Amplitude Configuration	Select the required amplitude configuration type. <ul style="list-style-type: none"> ▪ Calibrated ▪ Customized ▪ Un-Calibrated
Amplitude	Enter the amplitude value in mV.
Debug Options	Select the required Debug option <ul style="list-style-type: none"> ▪ Disable Sigtest analysis ▪ Disable protocol response time ▪ Use advanced Algo for Minimal Electrical change



Click  to move to the next screen.

3. **Run Test:** This tab allows you to display all the presets with its details in the tabular format.

Tx LEQ Test - System Response Time Test - □ ×

	Target Preset / Coeff	Preshoot (dB)	De-emphasis (dB)	Vb (mV)	Electrical Response Time (ns)	Protocol Response Time (ns)	Coeff	Result
<input checked="" type="checkbox"/>	P0	-	-	-	-	-	-	-
<input checked="" type="checkbox"/>	P0 (Coeff)	-	-	-	-	-	-	-
<input checked="" type="checkbox"/>	P1	-	-	-	-	-	-	-
<input checked="" type="checkbox"/>	P1 (Coeff)	-	-	-	-	-	-	-
<input checked="" type="checkbox"/>	P2	-	-	-	-	-	-	-
<input checked="" type="checkbox"/>	P2 (Coeff)	-	-	-	-	-	-	-
<input checked="" type="checkbox"/>	P3	-	-	-	-	-	-	-
<input checked="" type="checkbox"/>	P3 (Coeff)	-	-	-	-	-	-	-
<input checked="" type="checkbox"/>	P4	-	-	-	-	-	-	-
<input checked="" type="checkbox"/>	P4 (Coeff)	-	-	-	-	-	-	-
<input checked="" type="checkbox"/>	P5	-	-	-	-	-	-	-
<input checked="" type="checkbox"/>	P5 (Coeff)	-	-	-	-	-	-	-
<input checked="" type="checkbox"/>	P6	-	-	-	-	-	-	-
<input checked="" type="checkbox"/>	P6 (Coeff)	-	-	-	-	-	-	-
<input checked="" type="checkbox"/>	P7	-	-	-	-	-	-	-
<input checked="" type="checkbox"/>	P7 (Coeff)	-	-	-	-	-	-	-
<input checked="" type="checkbox"/>	P8	-	-	-	-	-	-	-
<input checked="" type="checkbox"/>	P8 (Coeff)	-	-	-	-	-	-	-
<input checked="" type="checkbox"/>	P9	-	-	-	-	-	-	-
<input checked="" type="checkbox"/>	P9 (Coeff)	-	-	-	-	-	-	-

DUT ID
Clear All Check All Start

◀ ▶

Tx LEQ Test: Run Test(System Response Time Test)

Tx LEQ Test - AIC Initial Tx EQ Test

	DUT Initial Preset	Preshoot (dB)	De-emphasis (dB)	Vb (mV)	Result
Calibration Selection					
Connection Diagram	<input checked="" type="checkbox"/>	P0	-	-	-
Link Training Configuration	<input checked="" type="checkbox"/>	P1	-	-	-
Tx LEQ Test Configuration	<input checked="" type="checkbox"/>	P2	-	-	-
Run Test	<input checked="" type="checkbox"/>	P3	-	-	-
Link Training	<input checked="" type="checkbox"/>	P4	-	-	-
Save Results	<input checked="" type="checkbox"/>	P5	-	-	-
	<input checked="" type="checkbox"/>	P6	-	-	-
	<input checked="" type="checkbox"/>	P7	-	-	-
	<input checked="" type="checkbox"/>	P8	-	-	-
	<input checked="" type="checkbox"/>	P9	-	-	-

DUT ID

Clear All Check All Start

< >

Tx LEQ Test: Run Test(AIC Initial Tx EQ Test)

Tx LEQ Test - AIC Response Time Test

	DUT Initial Preset	Target Preset / Coeff	Preshoot (dB)	De-emphasis (dB)	Vb (mV)	Electrical Response Time (ns)	Protocol Response Time (ns)	Coeff	Result
<input checked="" type="checkbox"/>	P4	P0	-	-	-	-	-	-	-
<input checked="" type="checkbox"/>	P4	P0 (Coeff)	-	-	-	-	-	-	-
<input checked="" type="checkbox"/>	P4	P1	-	-	-	-	-	-	-
<input checked="" type="checkbox"/>	P4	P1 (Coeff)	-	-	-	-	-	-	-
<input checked="" type="checkbox"/>	P4	P2	-	-	-	-	-	-	-
<input checked="" type="checkbox"/>	P4	P2 (Coeff)	-	-	-	-	-	-	-
<input checked="" type="checkbox"/>	P7	P3	-	-	-	-	-	-	-
<input checked="" type="checkbox"/>	P7	P3 (Coeff)	-	-	-	-	-	-	-
<input checked="" type="checkbox"/>	P7	P4	-	-	-	-	-	-	-
<input checked="" type="checkbox"/>	P7	P4 (Coeff)	-	-	-	-	-	-	-
<input checked="" type="checkbox"/>	P7	P5	-	-	-	-	-	-	-
<input checked="" type="checkbox"/>	P7	P5 (Coeff)	-	-	-	-	-	-	-
<input checked="" type="checkbox"/>	P7	P6	-	-	-	-	-	-	-
<input checked="" type="checkbox"/>	P7	P6 (Coeff)	-	-	-	-	-	-	-
<input checked="" type="checkbox"/>	P4	P7	-	-	-	-	-	-	-
<input checked="" type="checkbox"/>	P4	P7 (Coeff)	-	-	-	-	-	-	-
<input checked="" type="checkbox"/>	P4	P8	-	-	-	-	-	-	-
<input checked="" type="checkbox"/>	P4	P8 (Coeff)	-	-	-	-	-	-	-
<input checked="" type="checkbox"/>	P7	P9	-	-	-	-	-	-	-
<input checked="" type="checkbox"/>	P7	P9 (Coeff)	-	-	-	-	-	-	-

DUT ID

Tx LEQ Test: Run Test(AIC Response Time Test)

Tx LEQ Test: Run Test

Parameter	Description
DUT ID	Enter the DUT ID.
Clear All	Unchecks all the presets in the table.
Check All	Checks all the presets in the table.
Start	Click to start the test execution.



Click  to move to the next screen.

4. **Link Training:** This tab displays the loopback steps with its status in a tabular form.

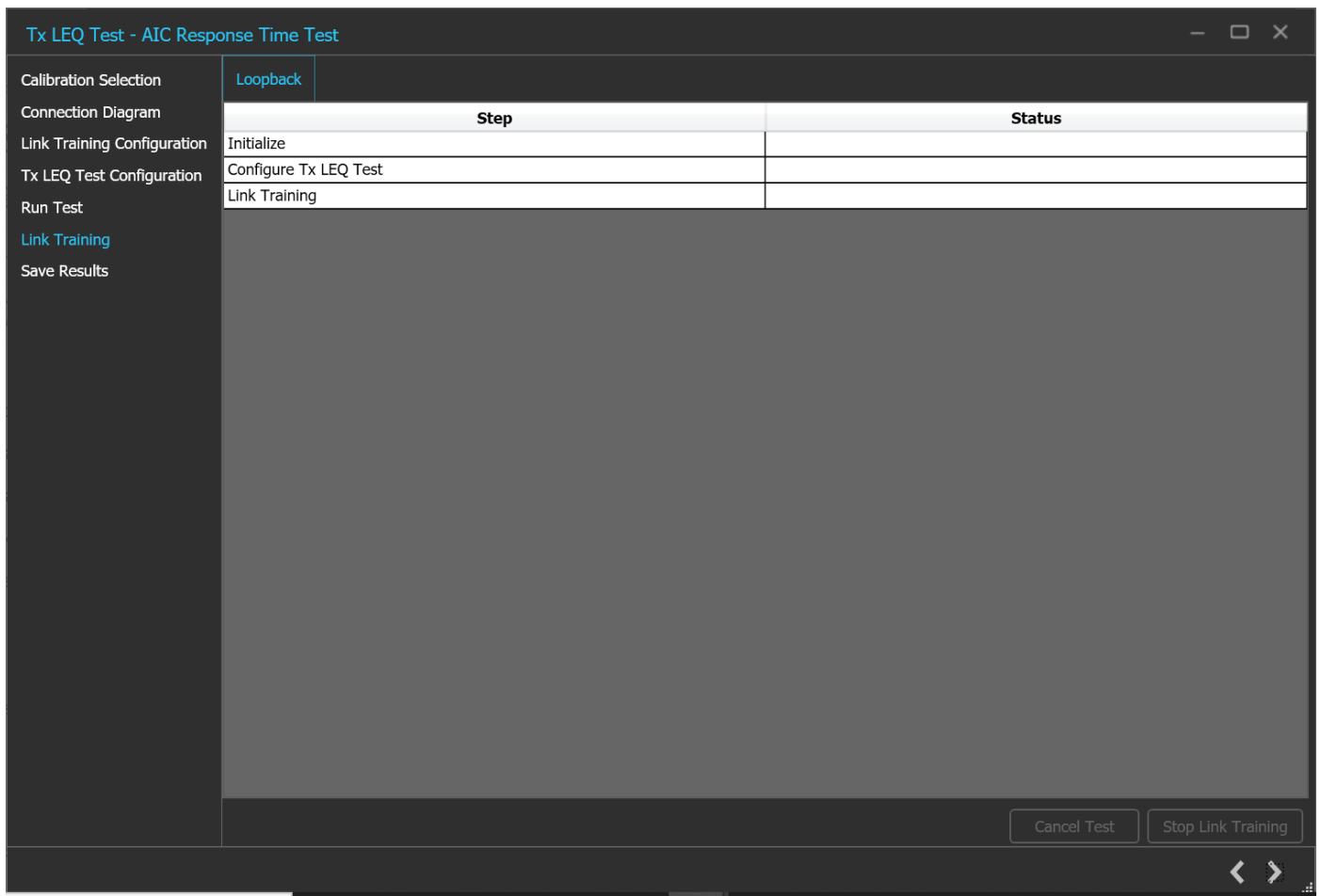

Tx LEQ Test: Link Training



Click  to move to the next screen.

5. **Save Results:** This tab allows you to save the Tx LEQ test results.

Tx LEQ Test: Save Results

Tx LEQ Test: Save Results

Parameter	Description
Unique ID	Enter the Unique ID of the calibrated equipment in the text box.
Generated By	Enter the user name in the text box.
Comments (Optional)	Enter the required comments in the comment box.
Save	Click to save the results.

Click  to complete the Tx LEQ Test and close the wizard.

Options panel

JTOL Test

To test SJ at multiple frequencies for the JTOL test, you need to perform Multi-tone SJ calibration during TP1 Calibration. You can generate 30 KHz to 100 MHz with a maximum of 14 different frequencies.

The frequency settings table lists the frequencies calibrated during Multi-tone SJ calibration while performing TP1 calibration. If the newly generated frequency doesn't match with the calibrated frequency, then nearby calibrated frequency data will be used for running the JTOL test.

JTOL Test procedure

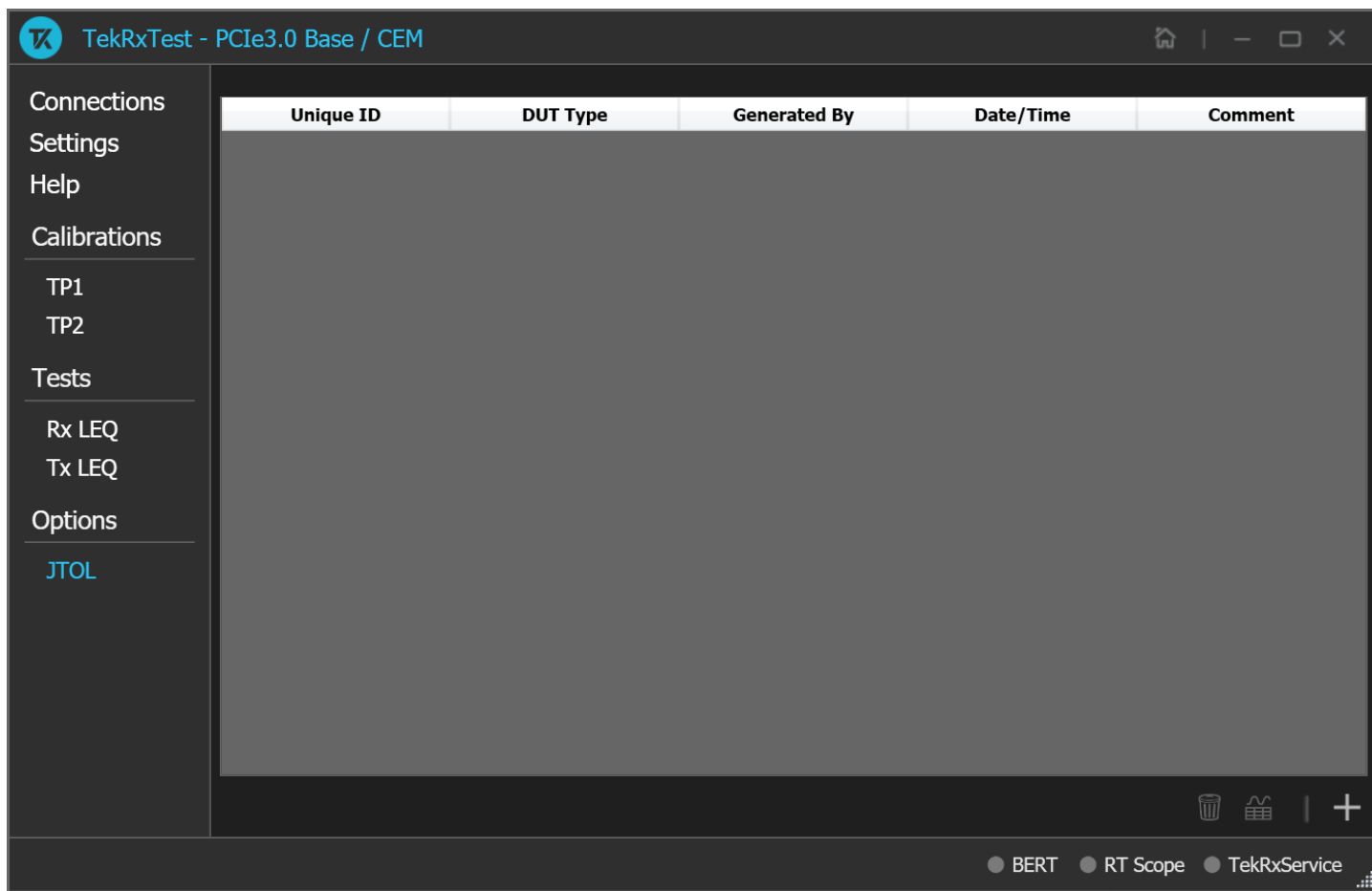

JTOL Test

Click **JTOL Test** under the Tests panel to view the measurement results. Click  at the right end corner of the application, to launch the JTOL test wizard. This wizard will guide you through the sequential procedure to perform the test.

Calibration Selection: This tab allows you to select the calibration file from the drop-down list. The drop-down lists all the TP2 calibration files available as per the choice made under DUT Type selection.

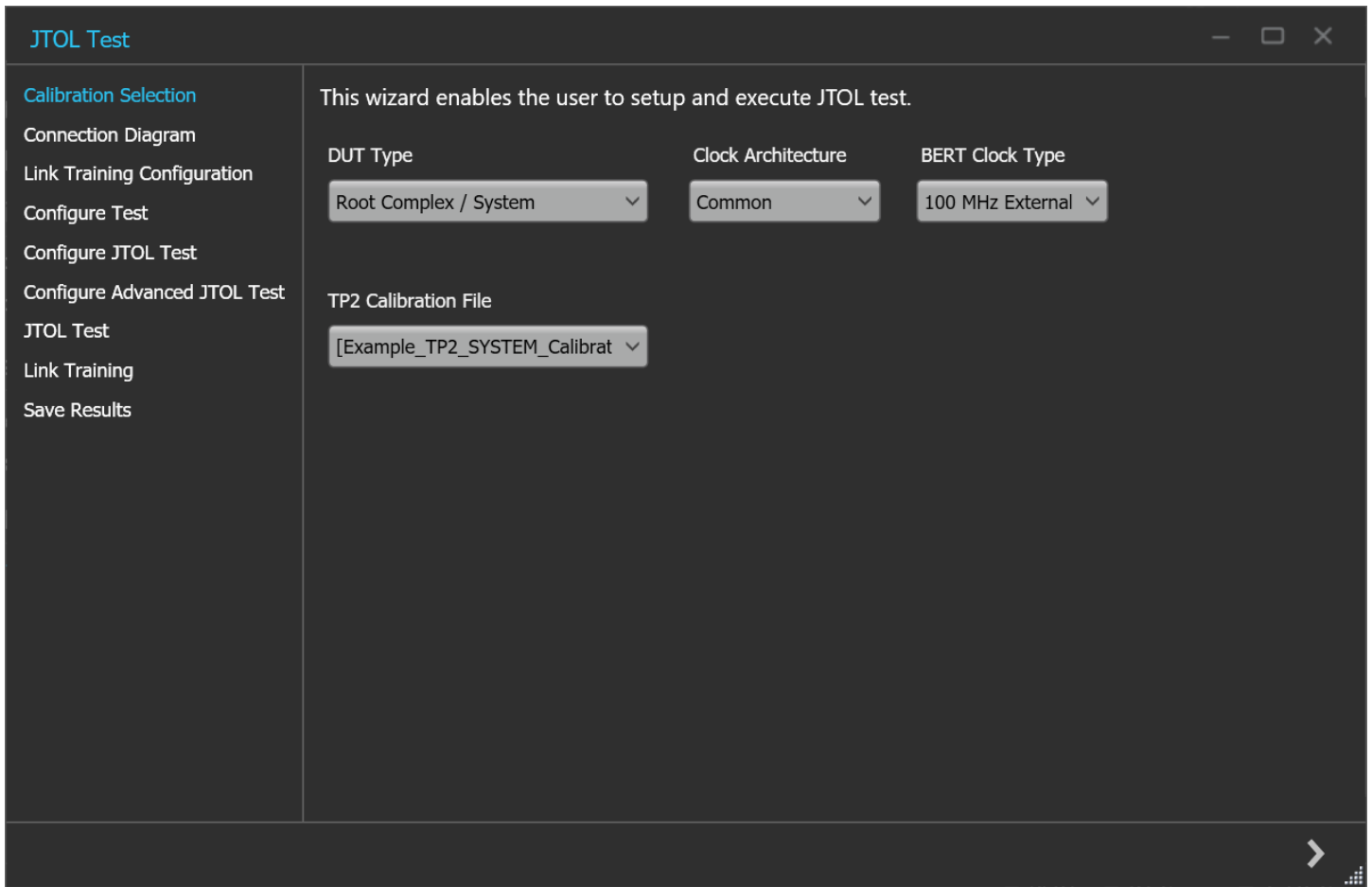

JTOL Test: Calibration Selection

JTOL Test: Calibration Selection

Parameter	Description
DUT Type	Select the required DUT type. <ul style="list-style-type: none"> Non-Root Complex / AIC Root Complex / System
Clock Architecture	Selects the clock architecture between Common, SRIS and SRNS.
BERT Clock Type	Select the required BERT clock type. <ul style="list-style-type: none"> 100 MHz External Internal
TP2 Calibration File	Select the required TP2 calibration file.



Click  to move to the next screen.

1. **Connection Diagram:** This tab displays the connection diagram for the JTOL test. The connection diagram is the different for AIC and System in case of JTOL test.

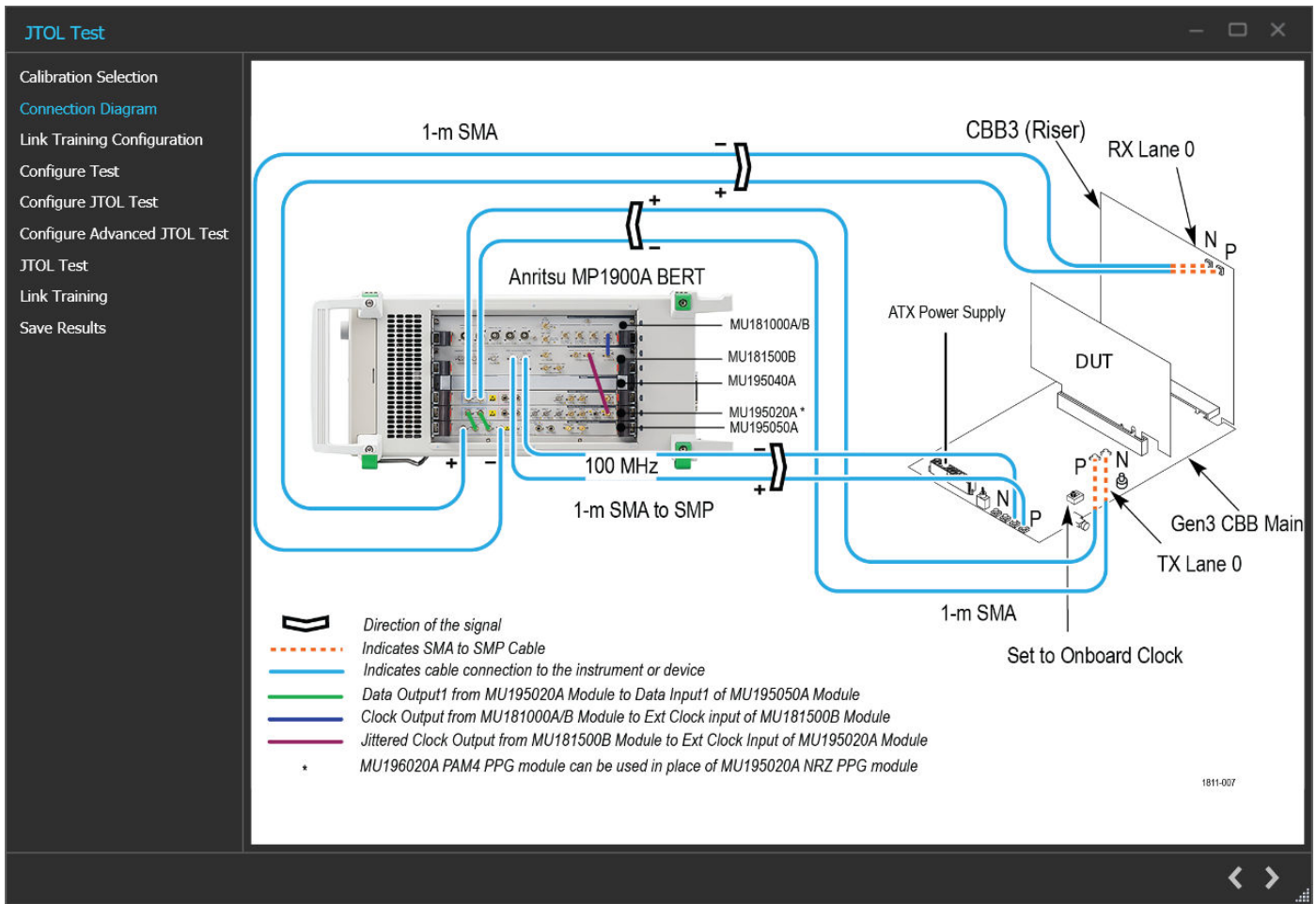

JTOL Test: Connection Diagram(AIC)

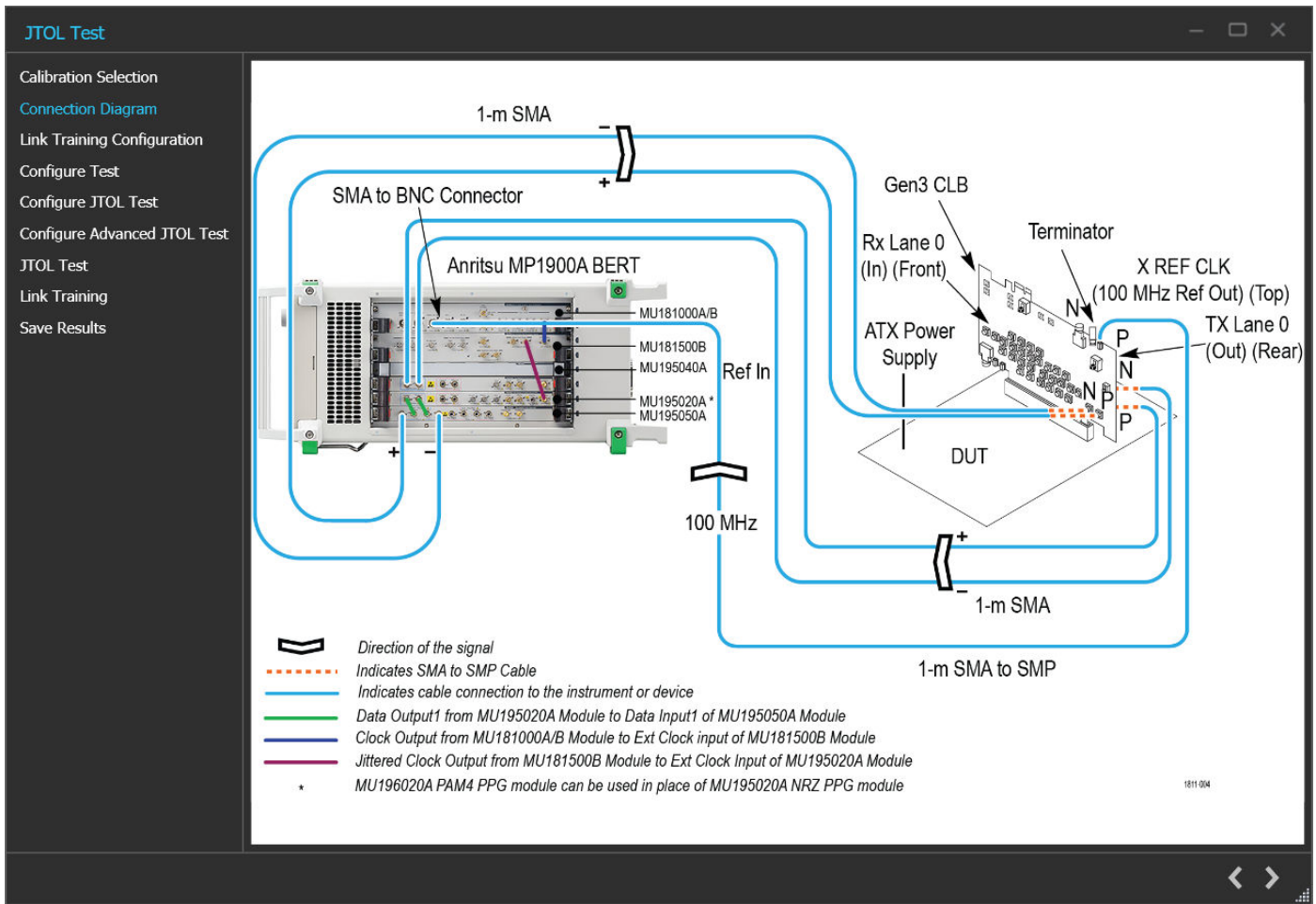

JTOL Test: Connection Diagram(System)



Click to move to the next screen.

2. **Link Training Configuration:** This tab allows you to configure the link training and forced loopback settings.

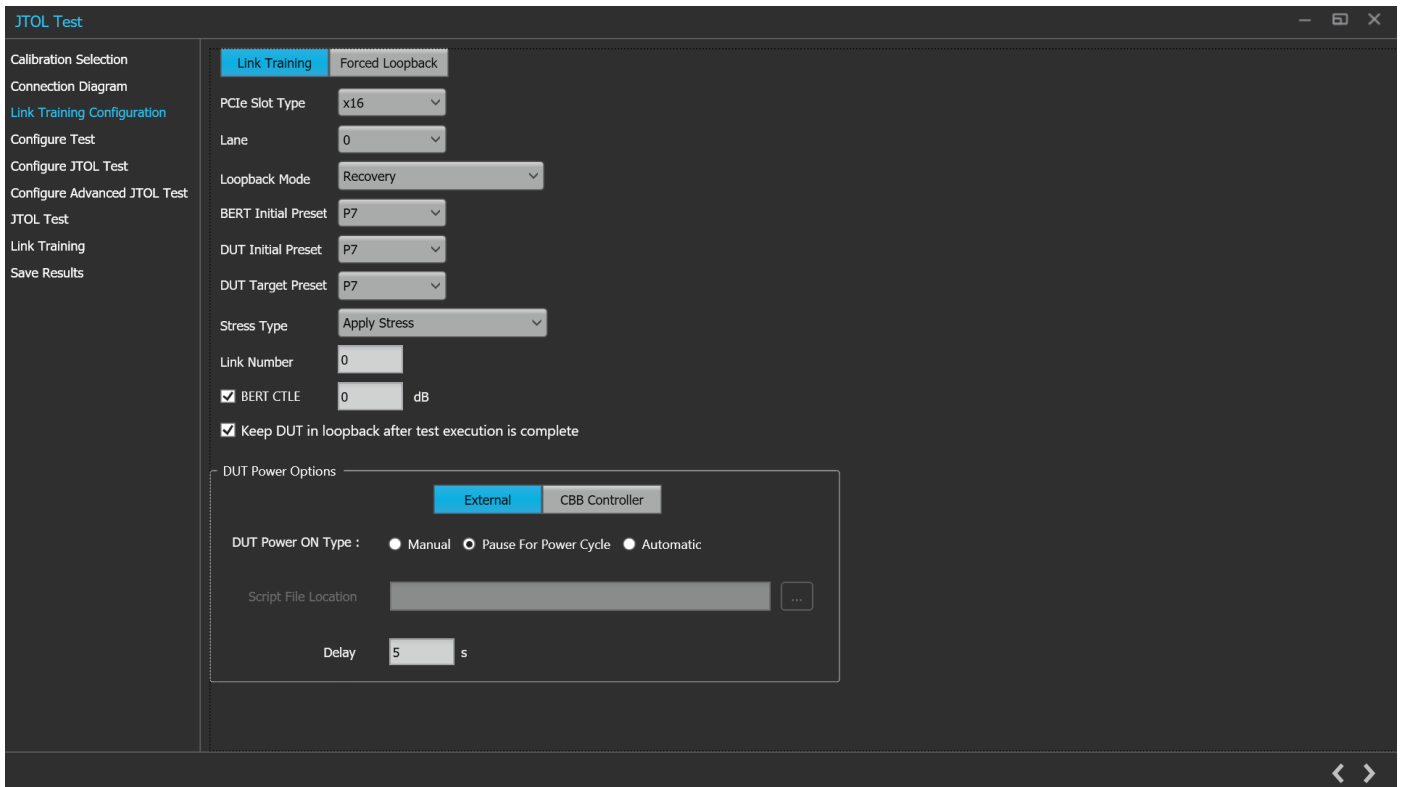

JTOL Test: Link Training Configuration (Link Training-External)

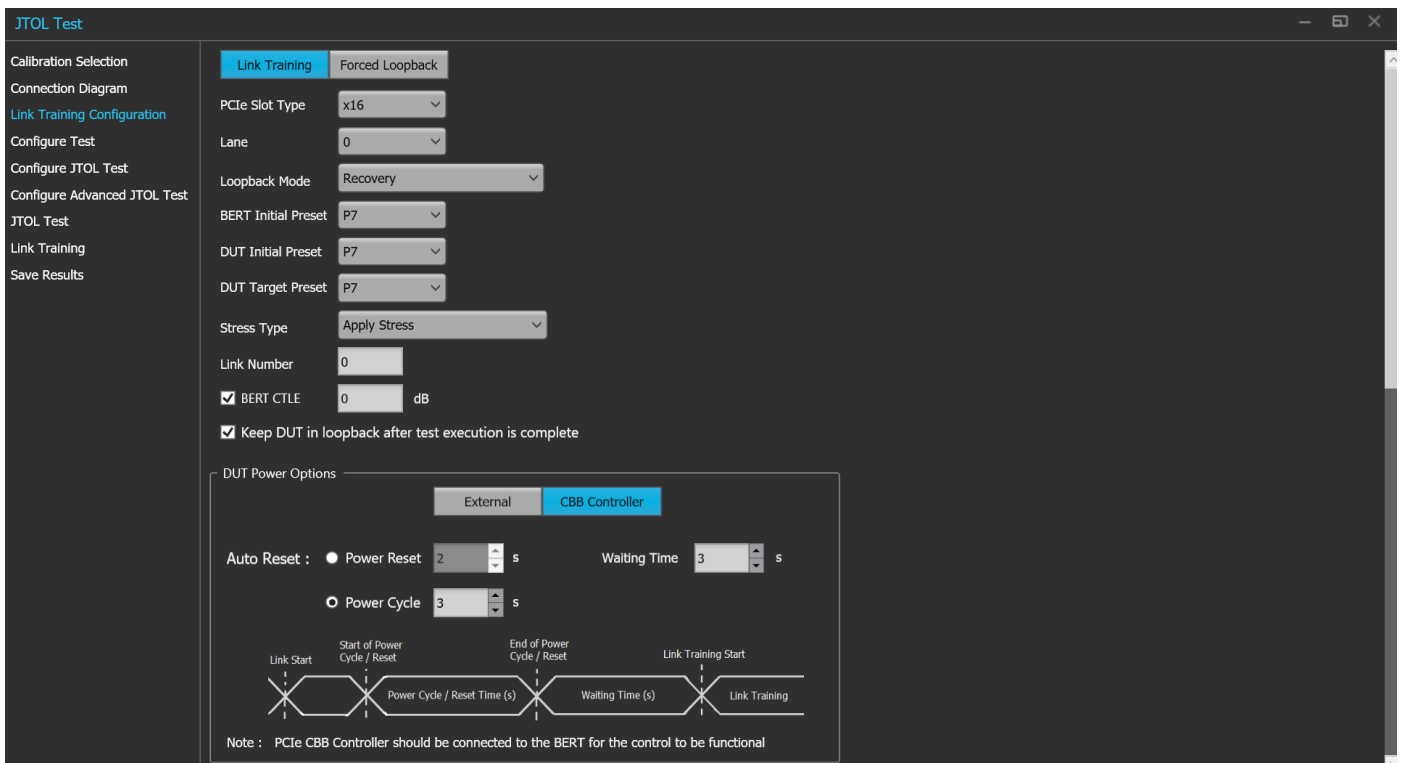

JTOL Test: Link Training Configuration (Link Training - CBB Controller)

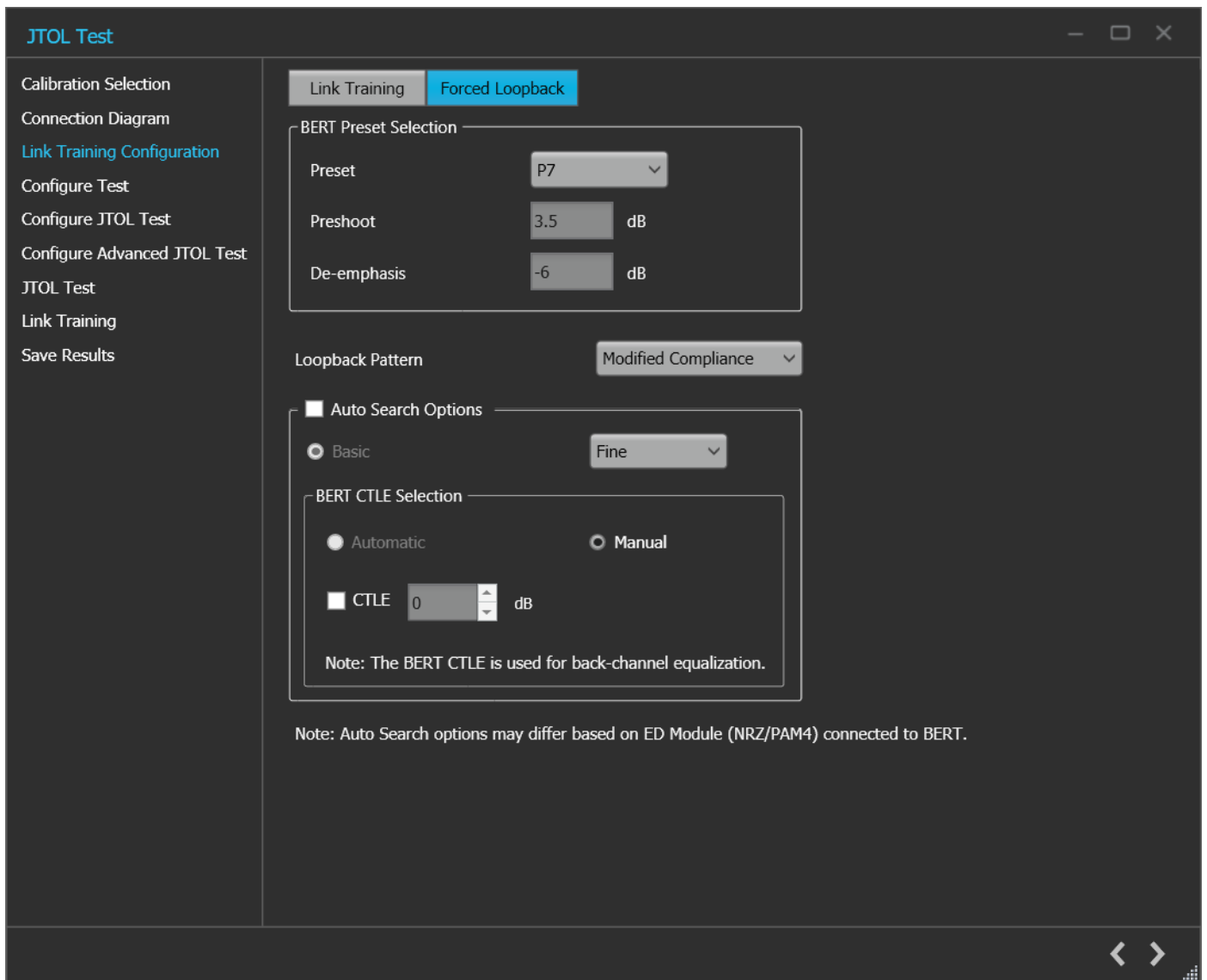

JTOL Test: Link Training Configuration (Forced Loopback)

JTOL Test: Link Training Configuration for Link Training

Parameter	Description
PCIe Slot Type	Select the required PCIe slot from the drop-down list.
Lane	Select the lane to be tested from the drop-down list.
Loopback Mode	Select the required loopback mode from the drop-down list.
BERT Initial Preset	Select the Preset to be set on the BERT PPG during loopback from the drop-down list.
DUT Initial Preset	Select the Preset to be set on the DUT Tx during loopback from the drop-down list.
DUT Target Preset	Select the Preset to be set on the DUT Tx during loopback from the drop-down list.

Stress Type	Select the required stress type from the drop-down list.
Link Number	Enter the link number value.
BERT CTLE	Enable and enter the BERT Error Detector CTLE value in dB.
Keep DUT in loopback after test execution is complete	Select to enable the DUT in the loopback after test execution is complete.
DUT Power Options	Select the required DUT power options. <ul style="list-style-type: none"> • External • CBB Controller
DUT Power ON Type	Select the required DUT power ON type for External option. <ul style="list-style-type: none"> • Manual • Pause For Power Cycle • Automatic
Script File Location	Browse and navigate to the path and select the required script file. Enabled only when Automatic is selected as DUT Power ON Type.
Delay	Enter the delay time in seconds.
Auto Reset	Select the required CBB Controller and enter the values in seconds. <ul style="list-style-type: none"> • Power Cycle • Power Reset • Waiting Time

JTOL Test: Link Training Configuration for Forced Loopback

Parameter	Description
BERT Preset Selection	
Preset	Select the BERT Tx Preset setting from the drop-down list.
Preshoot	Displays the preshoot value corresponding to the choice of preset. Editable for P10 and Custom Preset selection.
De-emphasis	Displays the de-emphasis value corresponding to the choice of preset. Editable for Custom Preset selection.

Loopback Pattern	Select the pattern to be used during loopback from the drop-down list. The drop-down list contains the following elements: <ul style="list-style-type: none"> ▪ Modified Compliance ▪ Compliance ▪ PRBS7 ▪ PRBS9 ▪ PRBS10 ▪ PRBS11 ▪ PRBS15 ▪ PRBS20 ▪ PRBS23 ▪ PRBS31
Auto Search	Select to enable the auto search basic mode and choose from the drop-down. The drop-down contains the following elements: <ul style="list-style-type: none"> ▪ Fine ▪ Coarse
BERT CTLE Selection	
Automatic	Enables automatic CTLE selection for back-channel equalization in the BERT Error Detector.
Manual	Select to manually choose the BERT CTLE selection.
CTLE	Select to enable and enter the BERT Error Detector CTLE value in dB.



Click  to move to the next screen.

3. **Configure Test:** This tab allows you to configure the test settings.

The screenshot shows the 'JTOL Test' configuration window with the 'Basic' tab selected. The window title is 'JTOL Test' and it has standard window controls (minimize, maximize, close) in the top right corner. On the left side, there is a navigation menu with the following items: Calibration Selection, Connection Diagram, Link Training Configuration, Configure Test (highlighted in blue), Configure JTOL Test, Configure Advanced JTOL Test, JTOL Test, Link Training, and Save Results. The main configuration area is divided into several sections:

- Calibration Selection:** Two tabs are visible: 'Basic' (selected) and 'SKP Ordered Set'.
- Apply SSC to Data and Clock output:** A checked checkbox.
- BER Settings:** A box containing 'BER' set to '1 E- 12' and 'Error Limit' set to '1'.
- Test Length:** A box containing 'Duration' set to '125' s and 'Confidence' set to '26.424' % at 1E+12 Bits.
- Stress Configuration:** A box with three tabs: 'Calibrated' (selected), 'Customized', and 'Un-Calibrated'. It contains the following parameters:
 - CMI: 0 mV
 - RJ: 2.75 ps (RMS)
 - DMI: 24.8 mV
 - SJ: 12.5 ps
 - Amplitude: 800 mV (Diff)A 'Load Stresses' button is present, along with a note: 'Note: Use the 'Load Stresses' option exclusively for loading preset and stress parameters in BERT'.
- BER Measurement Pattern:** A dropdown menu currently set to 'Modified Compliance'.

Navigation arrows (left and right) are located in the bottom right corner of the window.

JTOL Test: Configure Test (Basic)

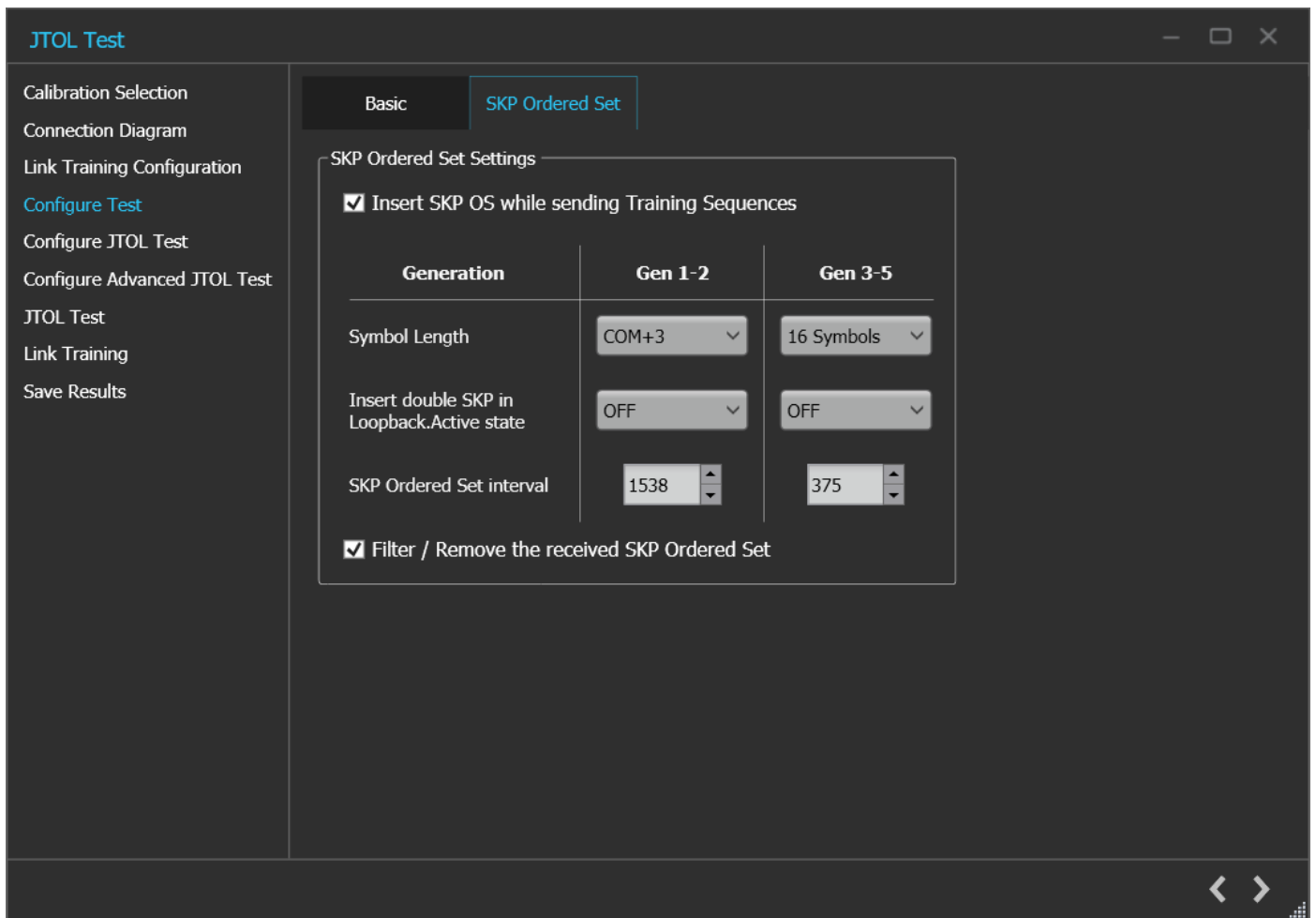

JTOL Test: Configure Test (SKP Orderd Set)

JTOL Test: Configure Test (Basic)

Parameter	Description
Apply SSC to data and clock output	Select to apply SSC to data and clock output.
BER Settings	<ul style="list-style-type: none"> BER - Enter the number of bits in error that can be tolerated. Error Limit - Enter the required error limit. The default value is 1.
Test Length	<ul style="list-style-type: none"> Duration - Enter the test length duration value. Confidence - Displays the test length confidence value.
Stress Configuration	Select the required stress configuration among calibrated, customized, un-calibrated.
Spread Spectrum Clocking (SSC)	Enables SSC for both Data and Clock
CMI	Displays the CMI value in mV. The stress on the waveform is defined by the parameters of CMI.
DMI	Displays the DMI value in mV. The stress on the waveform is defined by the parameters of DMI.
Amplitude	Displays the Amplitude value in mV. The stress on the waveform is defined by the parameters of Amplitude.

RJ	Displays the RJ value in ps or Ulp-p. The stress on the waveform is defined by the parameters of RJ.
SJ	Displays the SJ value in ps or Ulp-p. The stress on the waveform is defined by the parameters of SJ.
Load Stresses	Click Load Stresses to apply all the configured stress parameters CMI, DMI, SJ, and amplitude in the BERT. <hr/> NOTE: Use the Load Stresses option exclusively to load preset and stress parameters into BERT. <hr/>
BER Measurement Pattern	Select the required BER measurement pattern from the drop-down list.

JTOL Test: Configure Test (SKP Order Set)

Parameter	Description
SKP Ordered Set Settings	
Insert SKP OS while sending Training Sequence	Click to insert SKP OS while sending training sequence.
Symbol Length	Select the required symbol length from the drop-down list for the corresponding generation.
Insert double SKP in Loopback.Active state	Select the required option (ON/OFF) from the drop-down list for the corresponding generation.
SKP Ordered Set interval	Select the required interval value from the drop-down list for the corresponding generation.
Filter/Remove the received SKP Order Set	Select to enable the filter or remove the received SKP ordered set.



Click  to move to the next screen.

4. **Configure JTOL Test:** This tab allows you to configure the JTOL test settings.

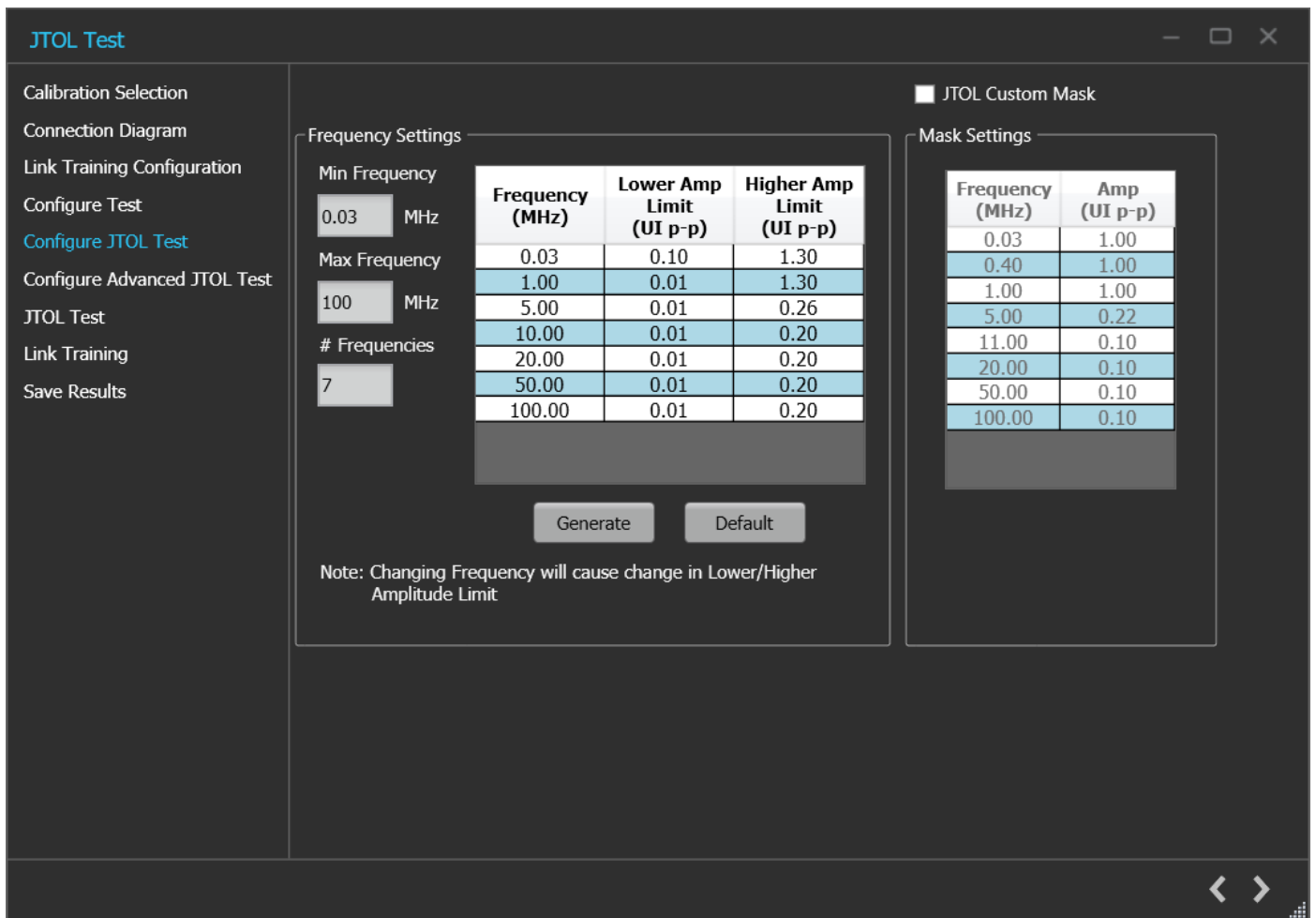

JTOL Test: Configure JTOL Test

JTOL Test: Configure JTOL Test

Parameter	Description
Frequency Settings	
Frequency (MHz)	Displays the table of frequencies in MHz for which JTOL test is to be performed.
Lower Amplitude Limit (UI p-p)	Displays the table of lower amplitude limit values at which JTOL test starts for that frequency.
Higher Amplitude Limit (UI p-p)	Displays the table of higher amplitude limit values at which JTOL test ends for that frequency.
Min Frequency	Enter the minimum frequency value.
Max Frequency	Enter the maximum frequency value.
# Frequencies	Enter the desired number of frequencies within the specified range.
Generate	Click to view the table populated with the frequencies.
Default	Click to view the table populated with default list of frequencies.

JTOL Custom Mask	Select to enable the JTOL Custom mask. On JTOL custom mask selection with the defined mask settings, mask will get generated on the plot.
Mask Settings	
Frequency (MHz)	Displays the table of knee frequencies for the mask.
Amplitude (UI p-p)	Displays the amplitude of SJ at each knee frequency.



Click  to move to the next screen.

5. **Configure Advanced JTOL Test:** This tab allows you to configure the advanced JTOL test settings.

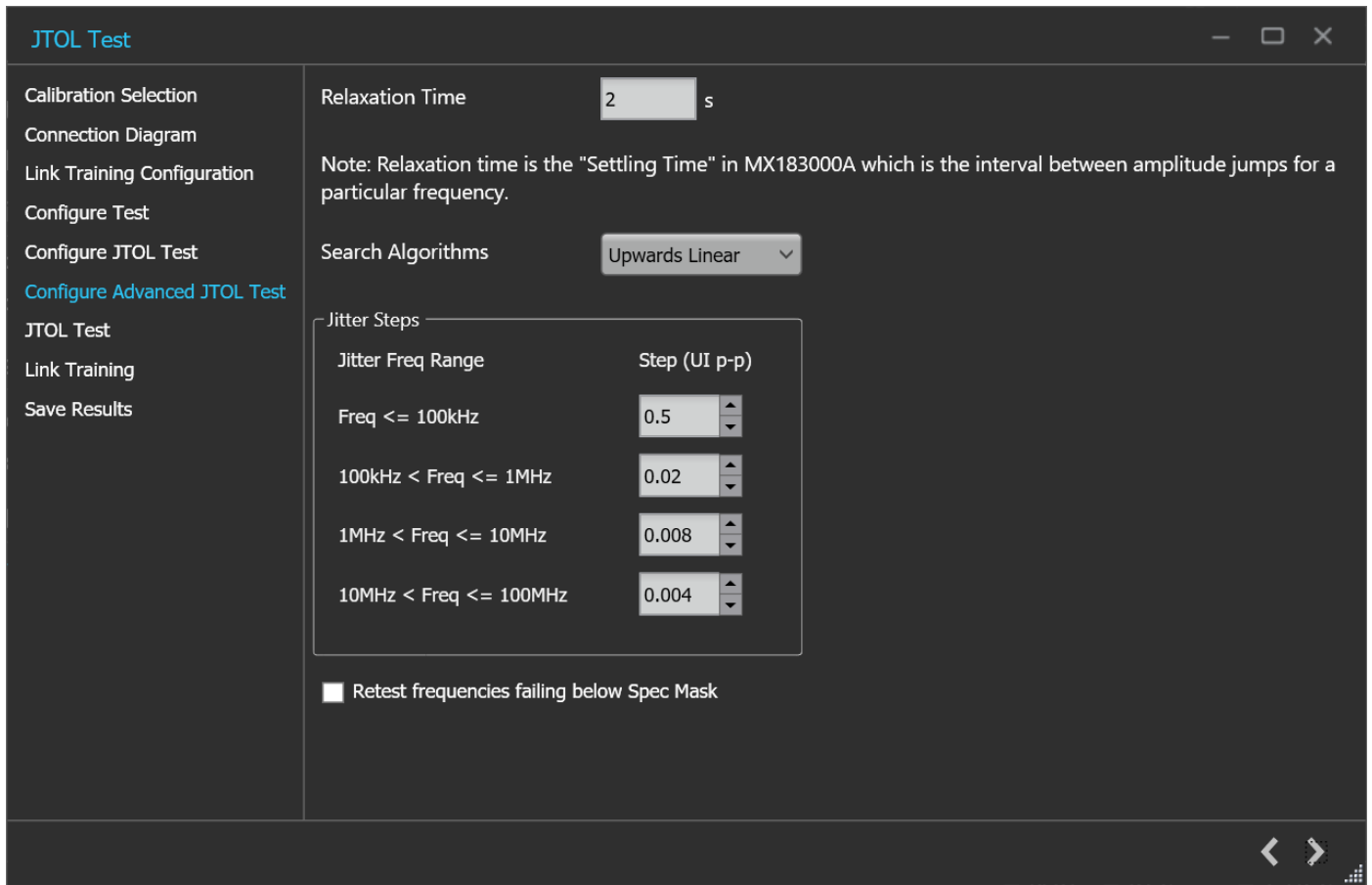

JTOL Test: Configure Advanced JTOL Test

JTOL Test: Configure Advanced JTOL Test

Parameter	Description
Relaxation Time	Enter the amount of time BERT needs to relax before running BER for each amplitude point.

Search Algorithms	Select the required search algorithm from the drop-down for JTOL test. Binary Downwards Linear Downwards Log Upwards Log Upwards Linear Binary + Linear
Jitter Steps	
Jitter Freq Range	The different frequency ranges can have different step size for SJ amplitude sweep. Freq <= 100 KHz 100KHz < Freq <=1 MHz 1 MHz < Freq <=10 MHz 10 MHz <Freq <= 100 MHz
Step (UI p-p)	Sets the SJ amplitude step size for different frequency ranges. Sets the ratios for Downward and Upward-Log search algorithms. No steps size is defined for Binary + Linear search algorithm.
Retest frequencies failing below Spec Mask	In case a user-configured SJ tone fails below the limit as provided by the specification, the TekRxTest application will throw a prompt. In such a scenario, the user can either retest the tone or proceed with the test. We also allow the user to perform auto search before retesting at this point in case retesting the tone alone doesn't help.



Click  to move to the next screen.

6. **JTOL Test:** This tab displays a graphical representation of JTOL test result. It includes the result table tab which displays the JTOL test results in a tabular form.

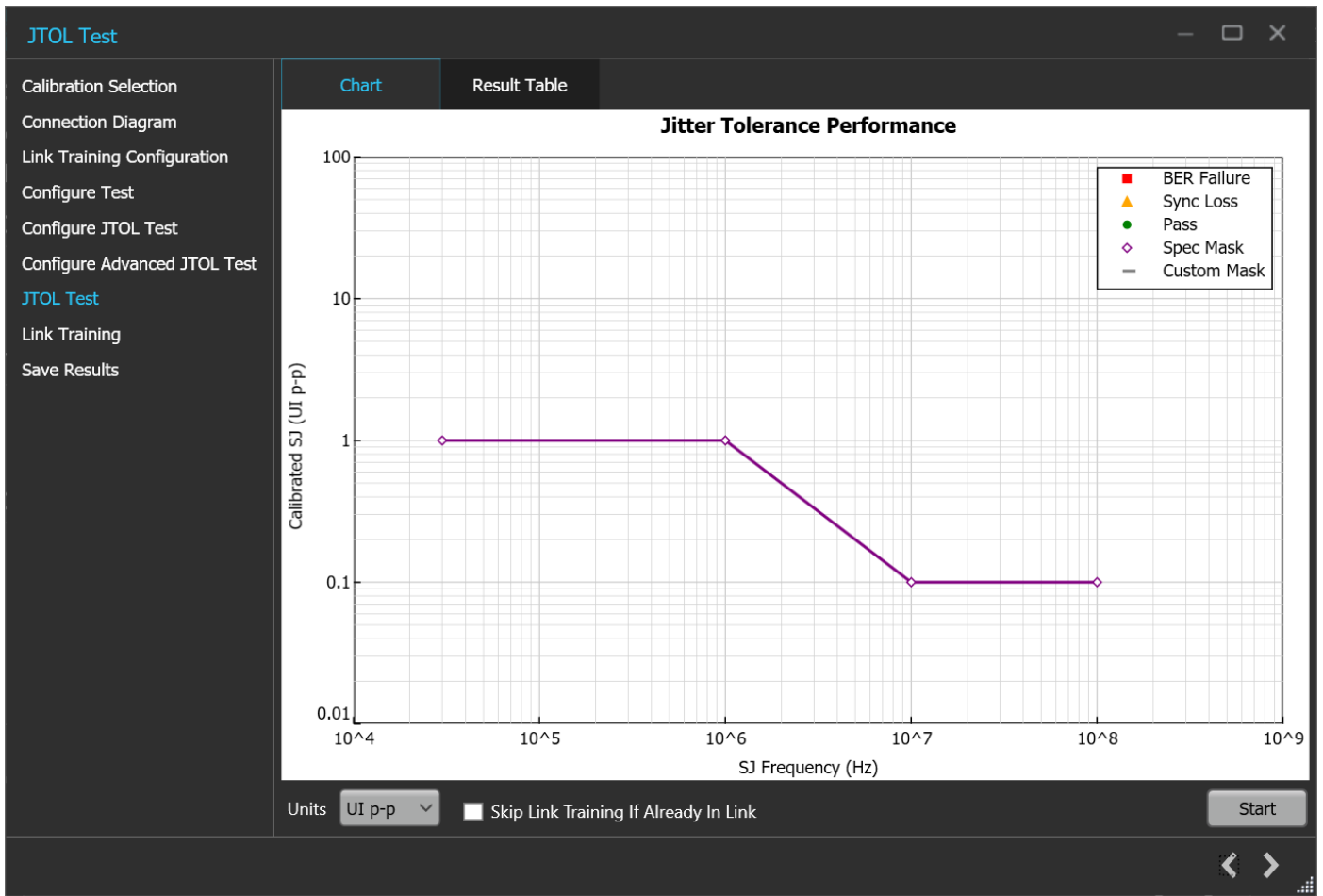

JTOL Test: JTOL Chart

JTOL Test: JTOL Chart

Parameter	Description
Units	Select the required unit from the drop-down list. The list contains the following elements: <ul style="list-style-type: none"> ps UI_{p-p}
Start	Click Start to run the test.
Skip Link Training	Select if DUT is already in link.

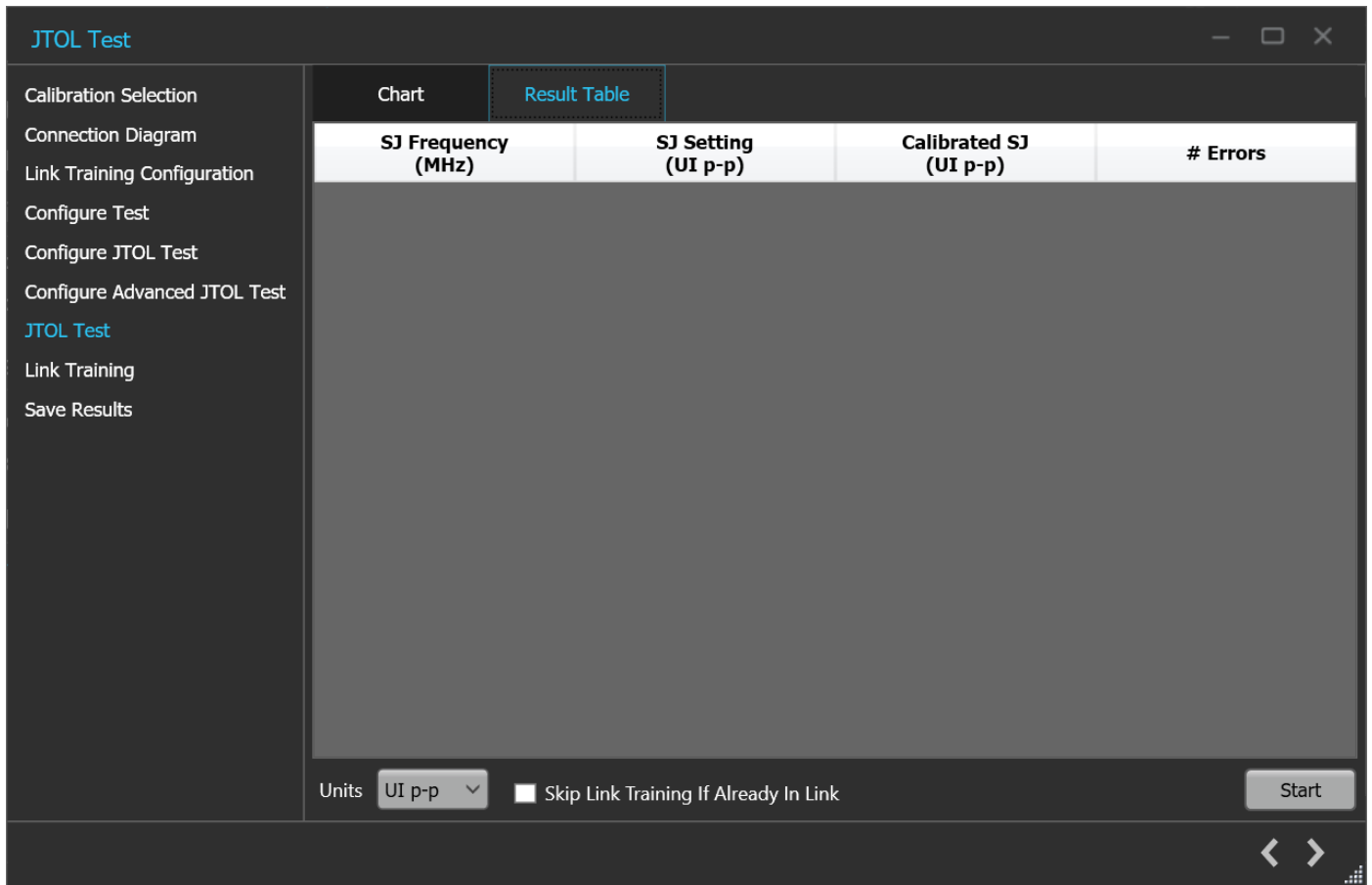

JTOL Test (Result Table)

JTOL Test (Results Table)

Parameter	Description
SJ Frequency (MHz)	Displays the frequencies for which JTOL Test was performed.
SJ Setting (UI _{p-p} / ps)	Displays the SJ Amplitude on the BERT.
Calibrated SJ (UI _{p-p} / ps)	Displays the Calibrated SJ Amplitude.
#Errors	Displays the Error count reported by MX183000A.



Click  to move to the next screen.

7. **Link Training:** This tab displays the loopback steps with its status in a tabular form.

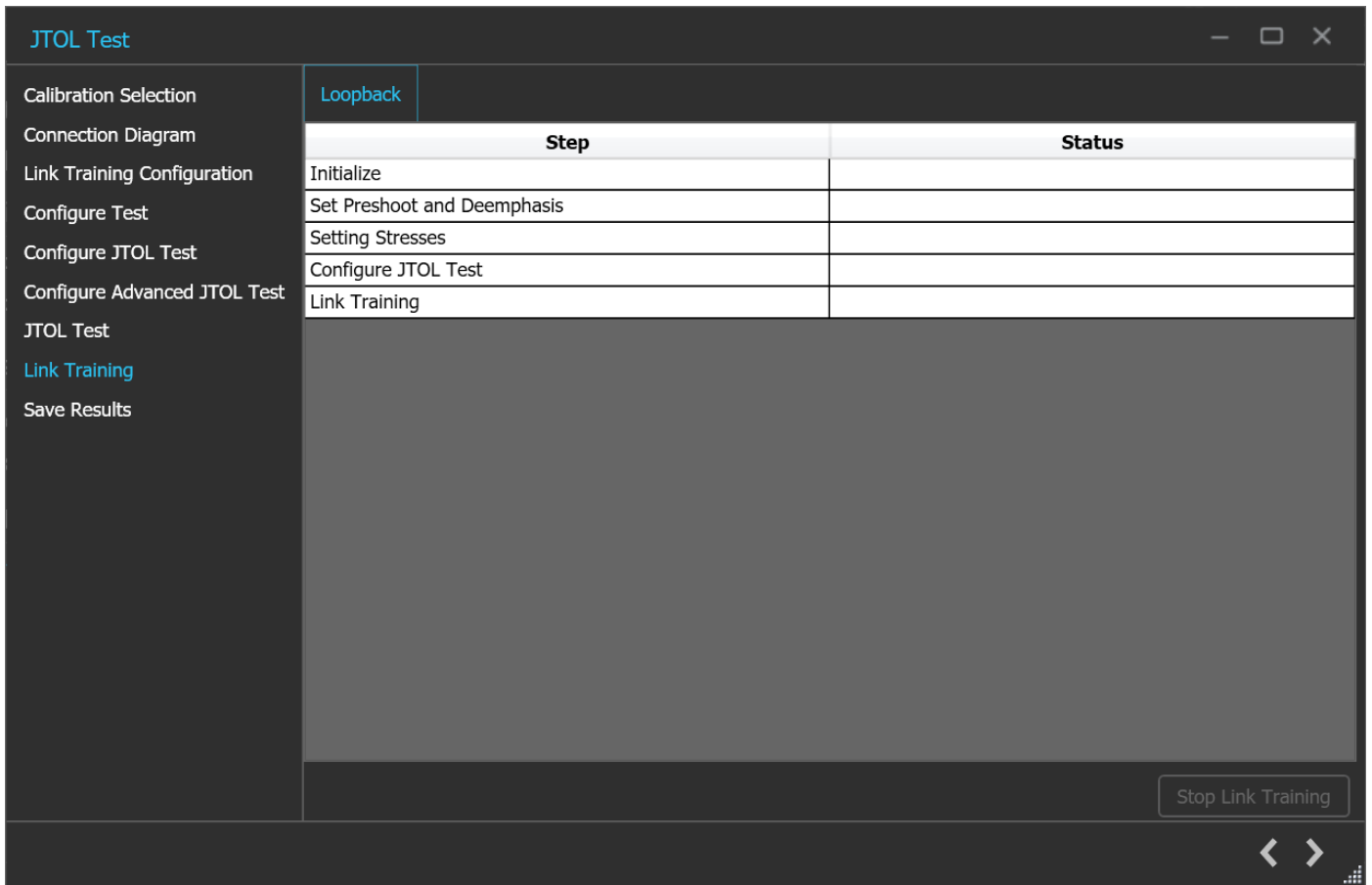

JTOL Test: Link Training

JTOL Test: Link Training

Parameter	Description
Step	Lists the different steps that are prerequisite for initiating link training
Status	Indicates the completion status of each activity
Initialize	Initialize the BERT for performing link training
Set Preshoot and deemphasis	Sets the preset as per BERT Initial Preset in Link Training Configuration wizard It sets all the calibrated Presets on the BERT from P0-P9
Setting Stresses	Sets stresses as per the user selection in Configure Test wizard
Configure JTOL Test	Sets the BERT, DUT initial and Target Presets, Loopback mode (Recovery, Config), Link and Lane number
Link Training	Initiates the link training process in MX 183000A



Click  to move to the next screen.

8. **Save Results:** This tab allows you to save the JTOL test results.

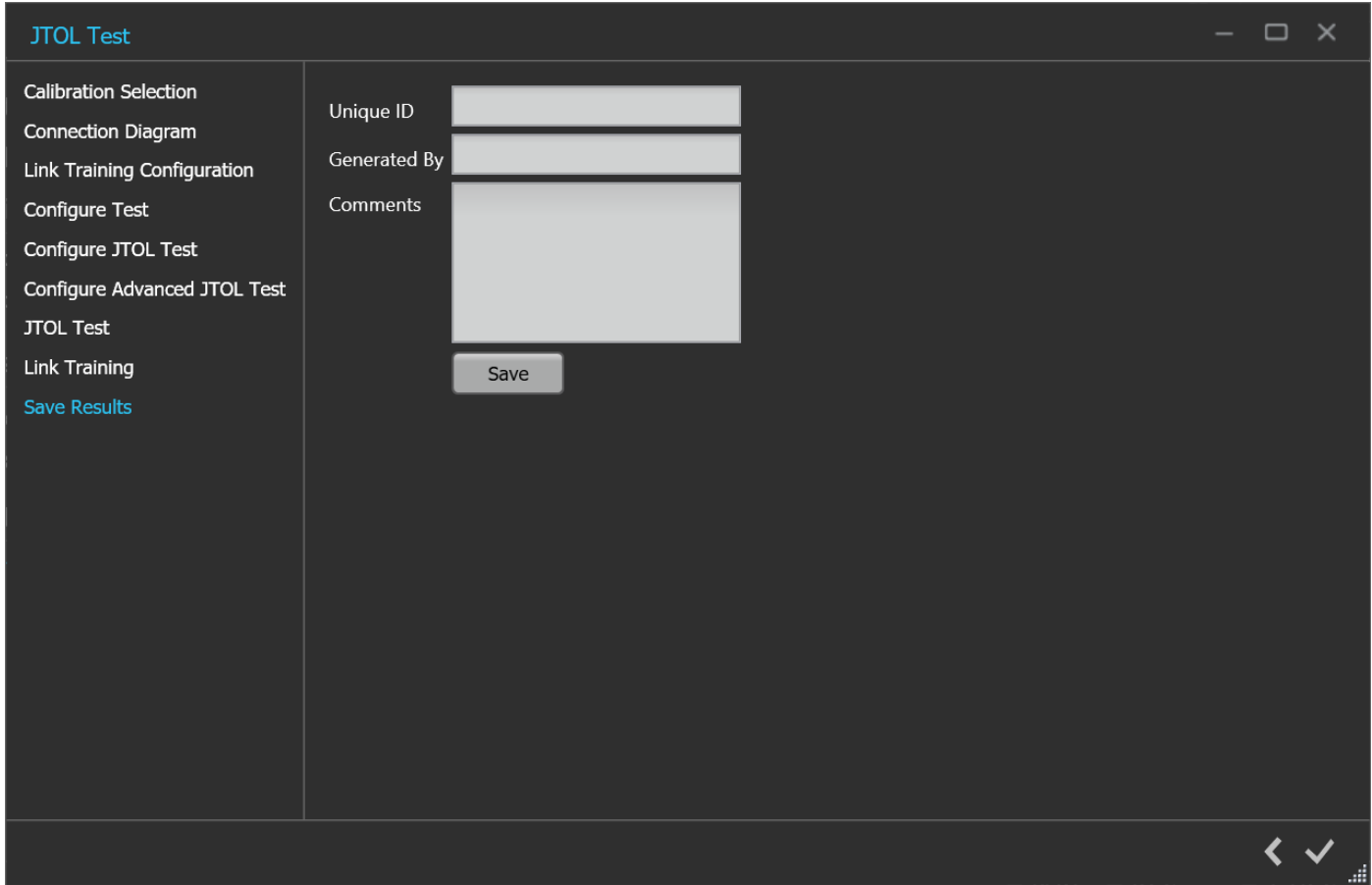

JTOL Test: Save Results

JTOL Test: Save Results

Parameter	Description
Unique ID	Enter the Unique ID of the calibrated equipment in the text box.
Generated By	Enter the user name in the text box.
Comments (Optional)	Enter the required comments in the comment box.
Save	Click to save the results.



Click  to complete the JTOL Test and close the wizard.

Programmatic interface commands

TEKRXTEST:SELECT:HOME

This command selects the home button.

Syntax

TEKRXTEST:SELECT:HOME

Inputs

NA

Outputs

NA

TEKRXTEST:SELECT:PCle1

This command selects the PCIe 1.0 application.

Syntax

TEKRXTEST:SELECT:PCle1

Inputs

NA

Outputs

NA

TEKRXTEST:SELECT:PCle2

This command selects the PCIe 2.0 application.

Syntax

TEKRXTEST:SELECT:PCle2

Inputs

NA

Outputs

NA

TEKRXTEST:SELECT:PCle3

This command selects the PCIe 3.0 application.

Syntax

TEKRXTEST:SELECT:PCIe3

Inputs

NA

Outputs

NA

PREF:BERT:IP

This command sets or returns the IP address of the BERT used to connect with the TekRxTest application.

Syntax

PREF:BERT:IP <IP address>

PREF:BERT:IP?

Inputs

<IP address> = <String>

Outputs

<String>

PREF:RTS:IP

This command sets or returns the IP address of the Real Time Oscilloscope used to connect with the TekRxTest application.

Syntax

PREF:RTS:IP <IP address>

PREF:RTS:IP?

Inputs

<IP address> = <String>

Outputs

<String>

CONN:BERT

This command sets or returns the connection status of the BERT with TekRxTest application.

Syntax

CONN:BERT <0 | 1>

CONN:BERT?

Inputs

<0 | 1>

0 indicates to disconnect the BERT.

1 indicates to connect the BERT.

Outputs

<0 | 1>

CONN:RTS

This command sets or returns the connection status of the Real Time Oscilloscope with PCIe3.0 (BASE / CEM) TekRxTest application.

Syntax

CONN:RTS <0 | 1>

CONN:RTS?

Inputs

<0 | 1>

0 indicates to disconnect the Real Time Oscilloscope.

1 indicates to connect the Real Time Oscilloscope.

Outputs

<0 | 1>

SETTINGS:RTS:POSITIVECHANNEL

This command sets or returns the real time scope channel number for positive channel.

Syntax

SETTINGS:RTS:POSITIVECHANNEL <0 | 1 | 2 | 3>

SETTINGS:RTS:POSITIVECHANNEL?

Inputs

<0 | 1 | 2 | 3>

0 - Indicates the CH1.

1 - Indicates the CH2.

2 - Indicates the CH3.

3 - Indicates the CH4.

Outputs

<0 | 1 | 2 | 3>

SETTINGS:RTS:NEGATIVECHANNEL

This command sets or returns the real time scope channel number for negative channel.

Syntax

```
SETTINGS:RTS:NEGATIVECHANNEL <0 | 1 | 2 | 3>
```

```
SETTINGS:RTS:NEGATIVECHANNEL?
```

Inputs

```
<0 | 1 | 2 | 3>
```

0 - Indicates the CH1.

1 - Indicates the CH2.

2 - Indicates the CH3.

3 - Indicates the CH4.

Outputs

```
<0 | 1 | 2 | 3>
```

SETTINGS:RTS:SAMPLERATE

This command returns the sample rate of Real Time oscilloscope.

Syntax

```
SETTINGS:RTS:SAMPLERATE?
```

Inputs

NA

Outputs

```
<int>
```

SETTINGS:TEKRXSERVICE:ANALYSISTIMEOUT

This command sets or returns TekRxService analysis time out value.

Syntax

```
SETTINGS:TEKRXSERVICE:ANALYSISTIMEOUT<int>
```

```
SETTINGS:TEKRXSERVICE:ANALYSISTIMEOUT?
```

Inputs

```
<int> 15 to 1000
```

Outputs

```
<int>
```

SETTINGS:SIGTEST:VERSION

This command sets or returns the sigtest version number.

Syntax

```
SETTINGS:SIGTEST:VERSION <String>
```

```
SETTINGS:SIGTEST:VERSION?
```

Inputs

<String>

Outputs

<String>

SETTINGS:AMPLITUDE:TARGET

This command returns the nominal amplitude target value.

Syntax

```
SETTINGS:AMPLITUDE:TARGET?
```

Inputs

NA

Outputs

<float>

SETTINGS:RJ:TARGET

This command returns the nominal RJ target value.

Syntax

```
SETTINGS:RJ:TARGET?
```

Inputs

NA

Outputs

<NRf>

SETTINGS:SJAT100MHZ:TARGET

This command returns the nominal SJ target value.

Syntax

```
SETTINGS:SJAT100MHZ:TARGET?
```

Inputs

NA

Outputs

<NRf>

SETTINGS:DMI:TARGET

This command returns the nominal DMI target value.

Syntax

```
SETTINGS:DMI:TARGET?
```

Inputs

NA

Outputs

<NRf>

SETTINGS:CMI:TARGET

This command returns the nominal CMI target value.

Syntax

```
SETTINGS:CMI:TARGET?
```

Inputs

NA

Outputs

<NRf>

SETTINGS:CMICALGEN3:ENABLE

This allows the user to perform or skip CMI calibration as a part of TP2 Calibration

Syntax

```
SETTINGS:CMICALGEN3:ENABLE?
```

```
SETTINGS:CMICALGEN3:ENABLE 0/1
```

Input

<0 | 1>

Output

<0 | 1>

SETTINGS:MULTITONESJCAL:ENABLE

This command sets or returns the enable or disable status of Multi-tone SJ calibration.

Syntax

```
SETTINGS:MULTITONESJCAL:ENABLE {0|1}
```

```
SETTINGS:MULTITONESJCAL:ENABLE?
```

Inputs

{0 | 1}

0 indicates to disable the multi-tone SJ calibration.

1 indicates to enable the multi-tone SJ calibration.

Outputs

{0 | 1}

SETTINGS:MULTITONESJCAL:FREQUENCYCOUNT

This command sets or returns the frequency count value for Multi-tone SJ calibration.

Syntax

```
SETTINGS:MULTITONESJCAL:FREQUENCYCOUNT <NR1>
```

```
SETTINGS:MULTITONESJCAL:FREQUENCYCOUNT?
```

Inputs

<NR1> 1 to 14

Outputs

<NR1>

SETTINGS:MULTITONESJCAL:MAXFREQUENCY

This command sets or returns the maximum frequency value for Multi-tone SJ calibration.

Syntax

```
SETTINGS:MULTITONESJCAL:MAXFREQUENCY <NR1>
```

```
SETTINGS:MULTITONESJCAL:MAXFREQUENCY?
```

Inputs

<NR1> 1 to 100 MHz

Outputs

<NR1>

SETTINGS:MULTITONESJCAL:MINFREQUENCY

This command sets or returns the minimum frequency value for Multi-tone SJ calibration.

Syntax

```
SETTINGS:MULTITONESJCAL:MINFREQUENCY <NR1>
```

```
SETTINGS:MULTITONESJCAL:MINFREQUENCY?
```

Inputs

<NR1> 0.03 to 99 MHz

Outputs

<NR1>

SETTINGS:MULTITONESJCAL:POINTS

This command sets or returns the number of points for Multi-tone SJ calibration.

Syntax

```
SETTINGS:MULTITONESJCAL:POINTS <NR1>
```

```
SETTINGS:MULTITONESJCAL:POINTS?
```

Inputs

<NR1> 2 to 8

Outputs

<NR1>

SETTINGS:EYE:ACQUISITIONS

This command sets or returns the number of acquisitions for stressed eye calibration.

Syntax

```
SETTINGS:EYE:ACQUISITIONS <int>
```

```
SETTINGS:EYE:ACQUISITIONS?
```

Inputs

<int> 1 to 20

Outputs

<int>

SETTINGS:MULTITONESJCAL:DEFAULT

This command sets the SJ Frequencies to its default value for multitone SJ calibration.

Syntax

```
SETTINGS:MULTITONESJCAL:DEFAULT
```

Inputs

NA

Outputs

NA

SETTINGS:MULTITONESJCAL:GENERATE

This command generates the SJ frequencies for multitone SJ calibration.

Syntax

```
SETTINGS: MULTITONESJCAL: GENERATE
```

Inputs

NA

Outputs

NA

SETTINGS: SOCKETSERVER: IP

This command returns the IP address of the socket server.

Syntax

```
SETTINGS: SOCKETSERVER: IP?
```

Inputs

NA

Outputs

<String>

SETTINGS: SOCKETSERVER: LISTENINGPORT

This command returns the listening port of the socket server.

Syntax

```
SETTINGS: SOCKETSERVER: LISTENINGPORT?
```

Inputs

NA

Outputs

<String>

SETTINGS: SOCKETSERVER: TIMEOUT

This command returns the time out value of the socket server.

Syntax

```
SETTINGS: SOCKETSERVER: TIMEOUT?
```

Inputs

NA

Outputs

<int>

SETTINGS:RESTORE

This command resets the application to default settings.

Syntax

```
Settings:Restore
```

Inputs

NA

Outputs

NA

SETTINGS:RECALL

This command recalls the settings as per specified file.

Syntax

```
SETTINGS:RECALL <"File path">
```

Inputs

<"File path"> = <String>

Outputs

NA

SETTINGS:SAVE

This command saves the settings into the specified file.

Syntax

```
Settings:Save <"File path">
```

Inputs

<"File path"> = <String>

Outputs

NA

SETTINGS:RECALL:STATUS

This command returns the status of the recall command execution.

Syntax

```
SETTINGS:RECALL:STATUS?
```

Inputs

NA

Outputs

<String>

SETTINGS:RESTORE:STATUS

This command returns the status of restore command execution.

Syntax

```
SETTINGS:RESTORE:STATUS?
```

Inputs

NA

Outputs

<String>

SETTINGS:SAVE:STATUS

This command returns the status of the save command execution.

Syntax

```
SETTINGS:SAVE:STATUS?
```

Inputs

NA

Outputs

<String>

TP1CAL:OPEN

This command opens the calibration panel.

Syntax

```
TP1CAL:OPEN
```

Inputs

NA

Outputs

NA

TP1CAL:WIZARD:OPEN

This command opens the calibration wizard.

Syntax

TP1CAL:WIZARD:OPEN

Inputs

NA

Outputs

NA

TP1CAL:WIZARD:CLOSE

This command closes the calibration wizard.

Syntax

TP1CAL:WIZARD:CLOSE

Inputs

NA

Outputs

NA

TP1CAL:DELETE

This command deletes the selected calibration file.

Syntax

TP1CAL:DELETE

Inputs

NA

Outputs

NA

TP1CAL:REPORT

This command generates the report for the selected calibration.

Syntax

TP1CAL:REPORT

Inputs

NA

Outputs

NA

TP1CAL:SAVE

This command saves the current Calibration file to the database.

Syntax

```
TP1CAL:SAVE
```

Inputs

NA

Outputs

NA

TP1CAL:EQUIP:INIT

This command sets the equipment initialization run status for calibration.

Syntax

```
TP1CAL:EQUIP:INIT <0 | 1>
```

Inputs

<0 | 1>

0 - Stop the equipment initialization to run.

1 - Start the equipment initialization to run.

Outputs

NA

TP1CAL:EQUIP:SKIPSIGNALVALIDATION

This allows the user to skip signal validation as a part of equipment initialization.

Syntax

```
TP1CAL:EQUIP:SKIPSIGNALVALIDATION <0 | 1>
```

```
TP1CAL:EQUIP:SKIPSIGNALVALIDATION?
```

Input

<0 | 1>

1- Skip signal validation.

0 - Perform signal validation.

Output

<0 | 1>

TP1CAL:AUTOCAL

This command sets the automatic calibration run status.

Syntax

```
TP1CAL:AUTOCAL <0 | 1>
```

Inputs

<0 | 1>

0 - Stop the automatic calibration run.

1 - Start the automatic calibration run.

Outputs

NA

TP1CAL:AMPLITUDE:RUN

This command sets the Amplitude calibration run status.

Syntax

```
TP1CAL:AMPLITUDE:RUN <0 | 1>
```

Inputs

<0 | 1>

0 - Stop the Amplitude calibration run.

1 - Start the Amplitude calibration run.

Outputs

NA

TP1CAL:PRESET:RUN

This command sets the Preset calibration run status.

Syntax

```
TP1CAL:PRESET:RUN <0 | 1>
```

Inputs

<0 | 1>

0 - Stop the the Preset calibration run.

1 - Start the the Preset calibration run.

Outputs

NA

TP1CAL:RJ:RUN

This command sets the RJ calibration run status.

Syntax

```
TP1CAL:RJ:RUN <0 | 1>
```

Inputs

<0 | 1>

0 - Stop the RJ calibration run.

1 - Start the RJ calibration run.

Outputs

NA

TP1CAL:SJ:RUN

This command sets the SJ calibration run status.

Syntax

```
TP1CAL:SJ:RUN <0 | 1>
```

Inputs

<0 | 1>

0 - Stop the SJ calibration run.

1 - Start the SJ calibration run.

Outputs

NA

TP1CAL:MULTITONESJCAL:RUN

This command sets the Multi-tone SJ calibration run status.

Syntax

```
TP1CAL:MULTITONESJCAL:RUN <0|1>
```

Inputs

<0 | 1>

0 - Stop the Multi-tone SJ calibration run.

1 - Start the Multi-tone SJ calibration run.

Outputs

NA

TP1CAL:EQUIP:STATUS

This command returns the equipment initialization run status for TP1 calibration.

Syntax

```
TP1CAL:EQUIP:STATUS?
```

Inputs

NA

Outputs

{InProgress | Done}

TP1CAL:AMPLITUDE:STATUS

This command returns the amplitude calibration run status.

Syntax

TP1CAL:AMPLITUDE:STATUS?

Inputs

NA

Outputs

{InProgress | Done}

TP1CAL:PRESET:STATUS

This command returns the preset calibration run status.

Syntax

TP1CAL:PRESET:STATUS?

Inputs

NA

Outputs

{InProgress | Done}

TP1CAL:RJ:STATUS

This command returns the RJ calibration run status.

Syntax

TP1CAL:RJ:STATUS?

Inputs

NA

Outputs

{InProgress | Done}

TP1CAL:SJ:STATUS

This command returns the SJ calibration run status.

Syntax

```
TP1CAL:SJ:STATUS?
```

Inputs

NA

Outputs

{InProgress | Done}

TP1CAL:MULTITONESJCAL:RUN

This command returns the Multi-tone SJ calibration run status.

Syntax

```
TP1CAL:MULTITONESJCAL:STATUS?
```

Inputs

NA

Outputs

{InProgress | Done}

TP1CAL:AMPLITUDE:SETTING

This command returns the amplitude value for TP1 calibration.

Syntax

```
TP1CAL:AMPLITUDE:SETTING?
```

Inputs

NA

Outputs

<float>

TP1CAL:RJ:SETTING

This command returns the RJ calibrated value for TP1 calibration.

Syntax

```
TP1CAL:RJ:SETTING?
```

Inputs

NA

Outputs

<float>

TP1CAL:SJ:SETTING

This command returns the SJ calibrated value for TP1 calibration.

Syntax

TP1CAL:SJ:SETTING?

Inputs

NA

Outputs

<float>

TP1CAL:SAVE:ID

This command sets or returns the unique identifier used as key to save the report in database for TP1 calibration.

Syntax

TP1CAL:SAVE:ID <String>

TP1CAL:SAVE:ID?

Inputs

<String>

Outputs

<String>

TP1CAL:SAVE:GENERATEDBY

This command sets or returns the creator name who save the report in database for TP1 calibration.

Syntax

TP1CAL:SAVE:GENERATEDBY <String>

TP1CAL:SAVE:GENERATEDBY?

Inputs

<String>

Outputs

<String>

TP1CAL:SAVE:COMMENTS

This command sets or returns the comments given to save the report in database for TP1 calibration.

Syntax

TP1CAL:SAVE:COMMENTS <String>

TP1CAL:SAVE:COMMENTS?

Inputs

<String>

Outputs

<String>

TP1CAL:ACDC:RUN

This command runs the TP1 AC-DC balance calibration process.

Syntax

TP1CAL:ACDC:RUN <0 | 1>

Inputs

<0 | 1>

1 - Start the AC-DC balance calibration run.

0 - Stop the AC-DC balance calibration run.

Outputs

NA

TP1CAL:ACDC:STATUS

This command returns the TP1 AC-DC balance calibration run status.

Syntax

TP1CAL:ACDC:STATUS?

Inputs

NA

Outputs

{InProgress | Done}

TP1CAL:ACDC:SETTING

This command returns the AC-DC balanced value for TP1 calibration.

Syntax

TP1CAL:ACDC:SETTING?

Inputs

NA

Outputs

<float>

TP1CAL:SJ@210MHz:RUN

This command sets the TP1 SJ@210MHz calibration run status.

Syntax

```
TP1CAL:SJ@210MHz:RUN <0 | 1>
```

Inputs

<0 | 1>

1 - Start the SJ@210 MHz calibration run.

0 - Stop the SJ@210 MHz calibration run.

Outputs

NA

TP1CAL:SJ@210MHz:STATUS

This command returns the status of SJ@210 MHz Calibration run status.

Syntax

```
TP1CAL:SJ@210MHz:STATUS?
```

Inputs

NA

Outputs

{InProgress | Done}

TP2CAL:OPEN

This command opens the TP2 calibration panel.

Syntax

```
TP2CAL:OPEN
```

Inputs

NA

Outputs

NA

TP2CAL:WIZARD:OPEN

This command opens the TP2 calibration wizard.

Syntax

```
TP2CAL:WIZARD:OPEN
```

Inputs

NA

Outputs

NA

TP2CAL:WIZARD:CLOSE

This command closes the TP2 calibration wizard.

Syntax

```
TP2CAL:WIZARD:CLOSE
```

Inputs

NA

Outputs

NA

TP2CAL:DUT:TYPE

This command sets or returns the DUT type used for TP2 calibration.

Syntax

```
TP2CAL:DUT:TYPE <0 | 1>
```

```
TP2CAL:DUT:TYPE?
```

Inputs

<0 | 1>

0 - Indicates the DUT type is Non-Root Complex.

1 - Indicates the DUT type is Root Complex.

Outputs

<0 | 1>

TP2CAL:SELECT:TP1

This command sets or returns the selected TP1 calibration file.

Syntax

```
TP2CAL:SELECT:TP1 <String>
```

```
TP2CAL:SELECT:TP1?
```

Inputs

Application Help

<String>

Outputs

<String>

TP2CAL:DELETE

This command deletes the selected TP2 calibration file.

Syntax

```
TP2CAL:DELETE
```

Inputs

NA

Outputs

NA

TP2CAL:REPORT

This command generates the report for selected TP2 calibration.

Syntax

```
TP2CAL:REPORT
```

Inputs

NA

Outputs

NA

TP2CAL:SAVE

This command saves the current TP2 Calibration file to the database.

Syntax

```
TP2CAL:SAVE
```

Inputs

NA

Outputs

NA

TP2CAL:EQUIP:INIT

This command sets the equipment initialization run status for TP2 calibration.

Syntax

```
TP2CAL:EQUIP:INIT <0 | 1>
```

Inputs

<0 | 1>

0 - Stop the equipment initialization run.

1 - Start the equipment initialization run.

Outputs

NA

TP2CAL:EQUIP:SKIPSIGNALVALIDATION

This allows the user to skip signal validation as a part of equipment initialization.

Syntax

```
TP2CAL:EQUIP:SKIPSIGNALVALIDATION <0 | 1 >
```

```
TP2CAL:EQUIP:SKIPSIGNALVALIDATION?
```

Input

<0 | 1>

1- Skip signal validation.

0 - Perform signal validation.

Output

<0 | 1>

TP2CAL:CMI:RUN

This command sets the CMI calibration run status.

Syntax

```
TP2CAL:CMI:RUN <0 | 1>
```

Inputs

<0 | 1>

0 - Stop the CMI calibration run.

1 - Start the CMI calibration run.

Outputs

NA

TP2CAL:STRESSEDEYE:RUN

This command sets the stressed eye calibration run status.

Syntax

```
TP2CAL:STRESSEDEYE:RUN <0 | 1>
```

Inputs

<0 | 1>

0 - Stop the stressed eye calibration run.

1 - Start the stressed eye calibration run.

Outputs

NA

TP2CAL:STRESSEDEYE:MANUALCALRUN

This command sets or returns the enable or disable status of the manual calibration run for stressed eye.

Syntax

```
TP2CAL:STRESSEDEYE:MANUALCALRUN <0 | 1>
```

```
TP2CAL:STRESSEDEYE:MANUALCALRUN?
```

Inputs

<0 | 1>

0 - Indicates to disable the manual calibration run.

1 - Indicates to enable the manual calibration run.

Outputs

<1 | 0>

TP2CAL:EQUIP:STATUS

This command returns the equipment initialization run status for TP2 calibration.

Syntax

```
TP2CAL:EQUIP:STATUS?
```

Inputs

NA

Outputs

{InProgress | Done}

TP2CAL:CMI:STATUS

This command returns the CMI calibration run status for TP2 calibration.

Syntax

```
TP2CAL:CMI:STATUS?
```

Inputs

NA

Outputs

{InProgress | Done}

TP2CAL:STRESSEDEYE:STATUS

This command returns the stressed eye calibration run status for TP2 calibration.

Syntax

TP2CAL:STRESSEDEYE:STATUS?

Inputs

NA

Outputs

{InProgress | Done}

TP2CAL:DMI:SETTING

This command returns the DMI calibrated value for TP2 calibration.

Syntax

TP2CAL:DMI:SETTING?

Inputs

NA

Outputs

<float>

TP2CAL:CMI:SETTING

This command returns the CMI calibrated value for TP2 calibration.

Syntax

TP2CAL:CMI:SETTING?

Inputs

NA

Outputs

<int>

TP2CAL:SAVE:ID

This command sets or returns the unique identifier used as key to save the report in database for TP2 calibration.

Syntax

```
TP2CAL:SAVE:ID <String>
```

```
TP2CAL:SAVE:ID?
```

Inputs

<String>

Outputs

<String>

TP2CAL:SAVE:GENERATEDBY

This command sets or returns the creator name who save the report in database for TP2 calibration.

Syntax

```
TP2CAL:SAVE:GENERATEDBY <String>
```

```
TP2CAL:SAVE:GENERATEDBY?
```

Inputs

<String>

Outputs

<String>

TP2CAL:SAVE:COMMENTS

This command sets or returns the comments given to save the report in database for TP2 calibration.

Syntax

```
TP2CAL:SAVE:COMMENTS <String>
```

```
TP2CAL:SAVE:COMMENTS?
```

Inputs

<String>

Outputs

<String>

TP2CAL:STRESSEDEYE:ACQUISITIONS

This command sets or returns the number of acquisitions value for TP2 stressed eye calibration.

Syntax

```
TP2CAL:STRESSEDEYE:ACQUISITIONS<int>
```

```
TP2CAL:STRESSEDEYE:ACQUISITIONS?
```

Inputs

<int> 1 to 20

Outputs

<int>

TP2CAL:DMI:RUN

This command sets the run status for TP2 DMI calibration.

Syntax

```
TP2CAL:DMI:RUN <0 | 1>
```

Inputs

<0 | 1>

0 - Stop the TP2 DMI calibration.

1 - Start the TP2 DMI calibration.

Outputs

NA

TP2CAL:DMI:STATUS

This command returns the TP2 DMI calibration run status.

Syntax

```
TP2CAL:DMI:STATUS?
```

Inputs

NA

Outputs

{InProgress | Done}

TP2CAL:STRESSEDEYE:RJ

This command sets or returns the RJ stress value for Manual Stressed Eye Calibration run.

Syntax

```
TP2CAL:STRESSEDEYE:RJ <float>
```

```
TP2CAL:STRESSEDEYE:RJ?
```

Inputs

<float>

Outputs

<float>

TP2CAL:STRESSEDEYE:DMI

This command sets or returns the DMI stress value for Manual Stressed Eye Calibration run.

Syntax

```
TP2CAL:STRESSEDEYE:DMI <float>
```

```
TP2CAL:STRESSEDEYE:DMI?
```

Inputs

<float>

Outputs

<float>

TP2CAL:STRESSEDEYE:AMPLITUDE

This command sets or returns the amplitude value for Manual Stressed Eye Calibration run.

Syntax

```
TP2CAL:STRESSEDEYE:AMPLITUDE<int>
```

```
TP2CAL:STRESSEDEYE:AMPLITUDE?
```

Inputs

<int> 720 to 800

Outputs

<int>

TP2CAL:STRESSEDEYE:EXHAUSTIVESWEEP

This command sets or returns the min, max settings for the specified sweep parameter for Exhaustive Sweep.

Syntax

```
TP2CAL:STRESSEDEYE:EXHAUSTIVESWEEP <string> <double/int>
```

```
TP2CAL:STRESSEDEYE:EXHAUSTIVESWEEP? <string>
```

Inputs

<string> (Sweep Parameter) - Indicates the parameter for which min, max value needs to be set. The Sweep parameters can be Amplitude, SJ.

<double/int> (MIN,MAX) - Indicates the min, max settings for the specified sweep parameter.

NOTE: If sweep parameter is amplitude then min, max values should be of type <int> or <double>

The min, max values should be within the below range:

1. 720 – 800 mV for Amplitude.

Example

```
TP2CAL:STRESSEDEYE:EXHAUSTIVESWEEP SJ .
```

Output

<double/int>

Example

```
TP2CAL:STRESSEDEYE:EXHAUSTIVESWEEP SJ?
```

.

TP2CAL:STRESSEDEYE:LINEARSWEEP

This command sets or returns the initial, min, max settings for the specified sweep parameter for Linear Sweep.

Syntax

```
TP2CAL:STRESSEDEYE:LINEARSWEEP <string> <double/int>
```

```
TP2CAL:STRESSEDEYE:LINEARSWEEP? <string>
```

Inputs

<string> (Sweep Parameter) - Indicates the parameter for which initial, min, max value needs to be set. The Sweep parameters can be RJ

<double/int> (Initial,MIN,MAX) - Indicates the Initial, min, max settings for the specified sweep parameter.

NOTE: If sweep parameter is amplitude then initial, min, max values should be of type <int> or <double>

The initial min, max values should be within the below range:

1. ps for RJ.

Example

```
TP2CAL:STRESSEDEYE:LINEARSWEEP RJ.
```

Output

<double/int>

Example

```
TP2CAL:STRESSEDEYE:LINEARSWEEP RJ?
```

.

TP2CAL:STRESSEDEYE:EXHAUSTIVE

This command sets or returns enable or disable status of Exhaustive Sweep for TP2 Stressed Eye Calibration

Syntax

```
TP2CAL:STRESSEDEYE:EXHAUSTIVE <0 / 1>
```

```
TP2CAL:STRESSEDEYE:EXHAUSTIVE?
```

Inputs

<0 / 1>

0 - Indicates the Exhaustive Sweep is disabled.

1 - Indicates the Exhaustive Sweep is enabled.

Output

<0 | 1>

TP2CAL:STRESSEDEYE:STEPSIZE

The Command sets or returns the step size settings for the specified sweep parameter of TP2 Calibration

Syntax

```
TP2CAL:STRESSEDEYE:STEPSIZE <string> <double/int>
```

```
TP2CAL:STRESSEDEYE:STEPSIZE? <string>
```

Inputs

<string> (Sweep Parameter) - Indicates the parameter for which step size value needs to be set. The Sweep parameters can be RJ

<double/int> (Step Size) - Indicates the step size value for the specified sweep parameter

NOTE: If sweep parameter is amplitude then step size value should be of type <int> or <double>

The Step Size values should be within the below range:

1. ps for RJ.

Example

```
TP2CAL:STRESSEDEYE:STEPSIZE RJ.
```

Output

<double/int>

Example

```
TP2CAL:STRESSEDEYE: STEPSIZE RJ?
```

.

TEST:SELECT:TESTDURATION

This command sets or returns the test length duration value.

Syntax

```
TEST:SELECT:TESTDURATION <float>
```

```
TEST:SELECT:TESTDURATION?
```

Inputs

<float> 1 to 1000

Outputs

<float>

TEST:SELECT:STRESSCONFIGTYPE

This command sets or returns the required stress config type.

Syntax

```
TEST:SELECT:STRESSCONFIGTYPE <0 | 1 | 2>
```

```
TEST:SELECT:STRESSCONFIGTYPE?
```

Inputs

0 indicates that stress config type is calibrated.

1 indicates that stress config type is customized

2 indicates that stress config type is un-calibrated.

Outputs

<0 | 1 | 2>

TEST:SELECT:AMP

This command sets or returns the amplitude value used for the test.

Syntax

```
TEST:SELECT:AMP <int>
```

```
TEST:SELECT:AMP?
```

Inputs

<int> 100 to 800 for customized stress selection.

<int> 100 to 650 for un-calibrated stress selection.

Outputs

<int>

TEST:SELECT:DMI

This command sets or returns the DMI value to be used for non-compliance test.

Syntax

```
TEST:SELECT:DMI <float>
```

```
TEST:SELECT:DMI?
```

Inputs

<float> 0 to 200

Outputs

<float>

TEST:SELECT:CMI

This command sets or returns the CMI value to be used for non-compliance test.

Syntax

```
TEST:SELECT:CMI <float>
```

```
TEST:SELECT:CMI?
```

Inputs

<float> 0 to 250

Outputs

<float>

TEST:SELECT:RJ

This command sets or returns the RJ value used for the test.

Syntax

```
TEST:SELECT:RJ <float>
```

```
TEST:SELECT:RJ?
```

Inputs

<float> 0 to 31.25 for customized stress selection.

<float> 0 to 0.5 for un-calibrated stress selection.

Outputs

<float>

TEST:SELECT:SJ

This command sets or returns the SJ value used for the test.

Syntax

```
TEST:SELECT:SJ <float>
```

```
TEST:SELECT:SJ?
```

Inputs

<float> 0 to 31.25 for customized stress selection.

<float> 0 to 0.5 for un-calibrated stress selection.

Outputs

<float>

TEST:SELECT:BER

This command sets or returns the BER value over which the test should be done.

Syntax

```
TEST:SELECT:BER <int>
```

```
TEST:SELECT:BER?
```

Inputs

<int> 3 to 12

Outputs

<int>

TEST:SELECT:ERRORLIMIT

This command sets or returns the maximum errors limit value.

Syntax

```
TEST:SELECT:ERRORLIMIT <int>
```

```
TEST:SELECT:ERRORLIMIT?
```

Inputs

<int> 1 to 1000

Outputs

<int>

LOOPBACK:SELECT:CONFIGURATIONTYPE

This command sets or returns the configuration type for loop back setting.

Syntax

```
LOOPBACK:SELECT:CONFIGURATIONTYPE <0 | 1>
```

```
LOOPBACK:SELECT:CONFIGURATIONTYPE?
```

Inputs

<0 | 1>

0 - Indicates the configuration type is Link training.

1 - Indicates the configuration type is Forced loopback.

Outputs

<0 | 1>

LOOPBACK:SELECT:PRESETSNAME

This command sets or returns the PCIe Preset, controls preshoot and deemphasis values.

Syntax

```
LOOPBACK:SELECT:PRESETSNAME <int>
```

LOOPBACK:SELECT:PRESETSNAME?

Inputs

<int> 0-11; P0-P10 for Corresponding Preset and 11 for Custom Preset

Outputs

<int>

LOOPBACK:SELECT:PRESETSPRESHOOT

This command sets or returns the preshoot value to be applied during loopback training.

Syntax

LOOPBACK:SELECT:PRESETSPRESHOOT <float>

LOOPBACK:SELECT:PRESETSPRESHOOT?

Inputs

<float> 0 to 12

Outputs

<float>

LOOPBACK:SELECT:PRESETSDEEMPHASIS

This command sets or returns the preset deemphasis value to be applied during loopback training.

Syntax

LOOPBACK:SELECT:PRESETSDEEMPHASIS <float>

LOOPBACK:SELECT:PRESETSDEEMPHASIS?

Inputs

<float> -20 to 0

Outputs

<float>

LOOPBACK:SELECT:BERTCTLEMODE

This command sets or returns the BERT CTLE mode.

Syntax

LOOPBACK:SELECT:BERTCTLEMODE <0 | 1>

LOOPBACK:SELECT:BERTCTLEMODE?

Inputs

<0 | 1>

0 - Indicates BERT CTLE mode is Automatic.

1 - Indicates BERT CTLE mode is Manual.

Outputs

<0 | 1>

LOOPBACK:SELECT:BERTCTLETYPE

This command sets or returns the BERT CTLE Type when loopback configuration type selected is forced loopback.

Syntax

```
LOOPBACK:SELECT:BERTCTLETYPE<0 | 1>
```

```
LOOPBACK:SELECT:BERTCTLETYPE?
```

Inputs

<0 | 1>

0 - Indicates the BERT CTLE type is OFF.

1 - Indicates the BERT CTLE type is ON.

Outputs

<0 | 1>

LOOPBACK:SELECT:BERTCTLEVALUE

This command sets or returns the BERT CTLE value.

Syntax

```
LOOPBACK:SELECT:BERTCTLEVALUE <float>
```

```
LOOPBACK:SELECT:BERTCTLEVALUE?
```

Inputs

<float> -30 to 0.

Outputs

<float>

LOOPBACK:SELECT:AUTOSEARCHMODE

This command sets or returns the auto search mode when loopback configuration type selected is forced loopback.

Syntax

```
LOOPBACK:SELECT:AUTOSEARCHMODE <0 | 1>
```

```
LOOPBACK:SELECT:AUTOSEARCHMODE?
```

Inputs

<0 | 1>

0 - Indicates the auto search mode is Fine.

1 - Indicates the auto search mode is Coarse.

Outputs

<0 | 1>

LOOPBACK:SELECT:PATTERN TYPE

This command sets or returns the pattern used for BER Measurement.

Syntax

```
LOOPBACK:SELECT:PatternType <0 | 1 | 3 | 4 | 5 | 6 | 7 | 8 | 9 | 10 >
```

```
LOOPBACK:SELECT:PatternType?
```

Inputs

0 indicates that Pattern type is Modified Compliance

1 indicates that Pattern type is Compliance

3 indicates that Pattern type is PRBS7

4 indicates that Pattern type is PRBS9

5 indicates that Pattern type is PRBS10

6 indicates that Pattern type is PRBS11

7 indicates that Pattern type is PRBS15

8 indicates that Pattern type is PRBS20

9 indicates that Pattern type is PRBS23

10 indicates that Pattern type is PRBS31

Outputs

<0 | 1 | 3 | 4 | 5 | 6 | 7 | 8 | 9 | 10 >

JTOLTEST:OPEN

This command opens the JTOL test panel.

Syntax

```
JTOLTEST:OPEN
```

Inputs

NA

Outputs

NA

JTOLTEST:WIZARD:OPEN

This command opens the JTOL test wizard.

Syntax

Application Help

```
JTOLTEST:WIZARD:OPEN
```

Inputs

NA

Outputs

NA

JTOLTEST:WIZARD:CLOSE

This command closes the JTOL test wizard.

Syntax

```
JTOLTEST:WIZARD:CLOSE
```

Inputs

NA

Outputs

NA

JTOLTEST:SELECT:TP2FILE

This command sets or returns the selected TP2 calibration file for the JTOL test.

Syntax

```
JTOLTEST:SELECT:TP2FILE <String>
```

```
JTOLTEST:SELECT:TP2FILE:FILE?
```

Inputs

<String>

Outputs

<String>

JTOLTEST:SELECT:CUSTOM:MASK

This command sets or returns the enable or disable status of configuring user-defined mask for the JTOL test.

Syntax

```
JTOLTEST:SELECT:CUSTOM:MASK {0 | 1}
```

```
JTOLTEST:SELECT:CUSTOM:MASK?
```

Inputs

{0 | 1}

0 - Indicates that custom mask is disabled.

1 - Indicates that custom mask is enabled.

Outputs

{0 | 1}

JTOLTEST:LOADSTRESS

This command loads stresses to the BERT for the JTOL Test.

Syntax

```
JTOLTEST:LOADSTRESS
```

Input

NA

Output

NA

JTOLTEST:MIN:FREQ

This command sets or returns the minimum frequency value for JTOL test.

Syntax

```
JTOLTEST:MIN:FREQ <float>
```

```
JTOLTEST:MIN:FREQ?
```

Inputs

<float> 0.03 to 99

Outputs

<float>

JTOLTEST:MAX:FREQ

This command sets or returns the maximum frequency value for JTOL test.

Syntax

```
JTOLTEST:MAX:FREQ <float>
```

```
JTOLTEST:MAX:FREQ?
```

Inputs

<float> 1 to 100

Outputs

<float>

JTOLTEST:FREQ:POINTS

This command sets or returns the number of SJ Frequencies for JTOL Test.

Syntax

```
JTOLTEST:FREQ:POINTS <int>
```

```
JTOLTEST:FREQ:POINTS?
```

Inputs

<int> 1 to 14

Outputs

<int>

JTOLTEST:FREQ:GENERATE

This command generates frequency in grid view.

Syntax

```
JTOLTEST:FREQ:GENERATE
```

Inputs

NA

Outputs

NA

JTOLTEST:FREQ:DEFAULT

This command loads the grid with calibrated SJ-tone values.

Syntax

```
JTOLTEST:FREQ:DEFAULT
```

Inputs

NA

Outputs

NA

JTOLTEST:SELECT:RELAXATION

This command sets or returns the relaxation time to ignore the BER bits before running every amplitude points in JTOL test.

Syntax

```
JTOLTEST:SELECT:RELAXATION <int>
```

```
JTOLTEST:SELECT:RELAXATION?
```

Inputs

<int> 1 to 10

Outputs

<int>

JTOLTEST:SEARCH:ALGO

This command sets or returns the selected search algorithm type for JTOL test.

Syntax

```
JTOLTEST:SEARCH:ALGO <0 | 1 | 2 | 3 | 4 | 5>
```

```
JTOLTEST:SEARCH:ALGO?
```

Inputs

0 indicates that search algorithm type is Binary.

1 indicates that search algorithm type is Downwards linear.

2 indicates that search algorithm type is Downwards log.

3 indicates that search algorithm type is Upwards linear.

4 indicates that search algorithm type is Upwards log.

5 indicates that search algorithm type is Binary+Linear.

Outputs

<0 | 1 | 2 | 3 | 4 | 5>

JTOLTEST:RUN

This commands sets the run status of JTOL test.

Syntax

```
JTOLTEST:RUN <0 | 1>
```

Inputs

<0 | 1>

0 - Stop the JTOL test run.

1 - Start the JTOL test run.

Outputs

NA

JTOLTEST:SAVE:ID

This command sets or returns the unique identifier used as key to save the report in database for JTOL test.

Syntax

```
JTOLTEST:SAVE:ID <String>
```

```
JTOLTEST:SAVE:ID?
```

Inputs

Application Help

<String>

Outputs

<String>

JTOLTEST:SAVE:GENERATEDBY

This command sets or returns the creator name who save the report in database for JTOL test.

Syntax

```
JTOLTEST:SAVE:GENERATEDBY <String>
```

```
JTOLTEST:SAVE:GENERATEDBY?
```

Inputs

<String>

Outputs

<String>

JTOLTEST:SAVE:COMMENTS

This command sets or returns the comments given to save the report in database for JTOL test.

Syntax

```
JTOLTEST:SAVE:COMMENTS <String>
```

```
JTOLTEST:SAVE:COMMENTS?
```

Inputs

<String>

Outputs

<String>

JTOLTEST:SAVE

This command saves the current JTOL test file to the database.

Syntax

```
JTOLTEST:SAVE
```

Inputs

NA

Outputs

NA

JTOLTEST:RUNSTATUS

This command returns the JTOL test run status.

Syntax

```
JTOLTEST:RUNSTATUS?
```

Inputs

NA

Outputs

```
{InProgress | Done}
```

JTOLTEST:FREQ

This command returns the JTOL test result for the specified frequency.

Syntax

```
JTOLTEST:FREQ <Freq>?
```

Inputs

<Freq> = <int> Frequency for which JTOL results need to be shown.

Outputs

```
<String>
```

JTOLTEST:PLOT:POINTS

This command returns the number of plotted points in JTOL test plot.

Syntax

```
JTOLTEST:PLOT:POINTS?
```

Inputs

NA

Outputs

```
<int>
```

JTOLTEST:SELECT:SJAMPUNITS

This command sets or returns the SJ Amplitude unit for JTOL test.

Syntax

```
JTOLTEST:SELECT:SJAMPUNITS <0 | 1>
```

```
JTOLTEST:SELECT:SJAMPUNITS?
```

Inputs

<0 | 1>

0 - Indicates the unit is ps.

1 - Indicates the unit is UI p-p.

Outputs

<0 | 1>

JTOLTEST:SELECT:CLOCKTYPE

This command sets or returns the clock type used for JTOL test.

Syntax

```
JTOLTEST:SELECT:CLOCKTYPE <1>
```

```
JTOLTEST:SELECT:CLOCKTYPE?
```

Inputs

<1>

1 - Indicates the clock type is Internal.

Outputs

<1>

JTOLTEST:PLOT

This command displays the JTOL test results plot.

Syntax

```
JTOLTEST:PLOT
```

Inputs

NA

Outputs

NA

JTOLTEST:TABLE

This command displays the JTOL test results table.

Syntax

```
JTOLTEST:TABLE
```

Inputs

NA

Outputs

NA

JTOLTEST:SELECT:DUTTYPE

This command sets or returns the DUT Type used for JTOL test.

Syntax

```
JTOLTEST:SELECT:DUTTYPE <0 | 1>
```

```
JTOLTEST:SELECT:DUTTYPE?
```

Inputs

<0 | 1>

0 - Indicates the DUT type is Non-RootComplex.

1 - Indicates the DUT type is RootComplex.

Outputs

<0 | 1>

JTOLTEST:LINKTRAINING:LOOPBACKMODEGEN3

This command sets or returns the loopback mode in link training for Gen3 in JTOL test.

Syntax

```
JTOLTEST:LINKTRAINING:LOOPBACKMODEGEN3 <0 | 1>
```

```
JTOLTEST:LINKTRAINING:LOOPBACKMODEGEN3?
```

Inputs

<0 | 1>

0 - Indicates the loopback mode is Configuration.

1 - Indicates the loopback mode is Recovery.

Outputs

<0 | 1>

JTOLTEST:LINKTRAINING:BERTINITIALPRESET

This command sets or returns the initial preset set at the BERT in the link training for JTOL test.

Syntax

```
JTOLTEST:LINKTRAINING:BERTINITIALPRESET <0 | 1 | 2 | 3 | 4 | 5 | 6 | 7 | 8 | 9>
```

```
JTOLTEST:LINKTRAINING:BERTINITIALPRESET?
```

Inputs

<0 | 1 | 2 | 3 | 4 | 5 | 6 | 7 | 8 | 9>

0 to 9 indicates P0 to P9.

Outputs

<0 | 1 | 2 | 3 | 4 | 5 | 6 | 7 | 8 | 9>

JTOLTEST:LINKTRAINING:DUTINITIALPRESET

This command sets or returns the initial preset for DUT in the link training for JTOL test.

Syntax

```
JTOLTEST:LINKTRAINING:DUTINITIALPRESET <0 | 1 | 2 | 3 | 4 | 5 | 6 | 7 | 8 | 9>
```

```
JTOLTEST:LINKTRAINING:DUTINITIALPRESET?
```

Inputs

```
<0 | 1 | 2 | 3 | 4 | 5 | 6 | 7 | 8 | 9>
```

0 to 9 indicates P0 to P9.

Outputs

```
<0 | 1 | 2 | 3 | 4 | 5 | 6 | 7 | 8 | 9>
```

JTOLTEST:LINKTRAINING:DUTTARGETPRESET

This command sets or returns the final preset for DUT in the link training for JTOL test.

Syntax

```
JTOLTEST:LINKTRAINING:DUTTARGETPRESET <0 | 1 | 2 | 3 | 4 | 5 | 6 | 7 | 8 | 9>
```

```
JTOLTEST:LINKTRAINING:DUTTARGETPRESET?
```

Inputs

```
<0 | 1 | 2 | 3 | 4 | 5 | 6 | 7 | 8 | 9>
```

0 to 9 indicates P0 to P9.

Outputs

```
<0 | 1 | 2 | 3 | 4 | 5 | 6 | 7 | 8 | 9>
```

JTOLTEST:LINKTRAINING:LANENUMBER

This command sets or returns the lane number for link training in JTOL test.

Syntax

```
JTOLTEST:LINKTRAINING:LANENUMBER <int>
```

```
JTOLTEST:LINKTRAINING:LANENUMBER?
```

Inputs

```
<int> 0 to 15
```

Outputs

```
<int>
```

JTOLTEST:LINKTRAINING:LINKNUMBER

This command sets or returns the link number for link training in JTOL test.

Syntax

```
JTOLTEST:LINKTRAINING:LINKNUMBER <int>
```

```
JTOLTEST:LINKTRAINING:LINKNUMBER?
```

Inputs

<int> 0 to 255

Outputs

<int>

JTOLTEST:LINKTRAINING:STRESSTYPE

This command sets or returns the type of stress to be used during the JTOL test.

Syntax

```
JTOLTEST:LINKTRAINING:STRESSTYPE <0 | 1 | 2>
```

```
JTOLTEST:LINKTRAINING:STRESSTYPE?
```

Inputs

<0 | 1 | 2>

0 - Indicates the stress type is Apply stress.

1 - Indicates the stress type is Inhibit stress during loopback.

2 - Indicates the stress type is Disable stress.

Outputs

<0 | 1 | 2>

JTOLTEST:LINKTRAINING:CTLE

This command sets or returns the CTLE value in link training for JTOL test.

Syntax

```
JTOLTEST:LINKTRAINING:CTLE <float>
```

```
JTOLTEST:LINKTRAINING:CTLE?
```

Inputs

<float> -12 to 0

Outputs

<float>

JTOLTEST:LINKTRAINING:DUTPOWERONTYPE

This command sets or returns the DUT Power ON type in the link training for JTOL test.

Syntax

```
JTOLTEST:LINKTRAINING:DUTPOWERONTYPE <0 | 1 | 2>
```

```
JTOLTEST:LINKTRAINING:DUTPOWERONTYPE?
```

Inputs

```
<0 | 1 | 2>
```

0 - Indicates the DUT Power ON type is Manual.

1 - Indicates the DUT Power ON type is Pause for power cycle.

2 - Indicates the DUT Power ON type is Automatic.

Outputs

```
<0 | 1 | 2>
```

JTOLTEST:LINKTRAINING:SCRIPTLOCATION

This command sets or returns the script file location for the link training in JTOL test.

Syntax

```
JTOLTEST:LINKTRAINING:SCRIPTLOCATION <Filepath>
```

```
JTOLTEST:LINKTRAINING:SCRIPTLOCATION ?
```

Inputs

```
<Filepath> = <String>
```

Outputs

```
<String>
```

JTOLTEST:LINKTRAINING:DUTPOWERDELAY

This command sets or returns the DUT Power ON delay value for link training in JTOL test.

Syntax

```
JTOLTEST:LINKTRAINING:DUTPOWERDELAY <int>
```

```
JTOLTEST:LINKTRAINING:DUTPOWERDELAY?
```

Inputs

```
<int> 0 to 300
```

Outputs

```
<int>
```

JTOLTEST:BERMEASUREMENT:PATTERN

This command sets or returns the BER Measurement patterns in JTOL test.

Syntax

```
JTOLTEST:BERMEASUREMENT:PATTERN <0 | 1 | 2 | 4 | 5 | 6 | 7 | 8 | 9 | 10 | 11 | 12>
```

JTOLTEST:BERMEASUREMENT:PATTERN?

Inputs

0-12

<0 | 1 | 2 | 4 | 5 | 6 | 7 | 8 | 9 | 10 | 11 | 12>

0 - Indicates BER Measurement pattern is Modified compliance.

1 - Indicates BER Measurement pattern is Compliance.

2 - Indicates BER Measurement pattern is Jitter Meas.

4 - Indicates BER Measurement pattern is PRBS7.

5 - Indicates BER Measurement pattern is PRBS9.

6 - Indicates BER Measurement pattern is PRBS10.

7 - Indicates BER Measurement pattern is PRBS11.

8 - Indicates BER Measurement pattern is PRBS15.

9 - Indicates BER Measurement pattern is PRBS20.

10 - Indicates BER Measurement pattern is PRBS23.

11 - Indicates BER Measurement pattern is PRBS31.

12 - Indicates BER Measurement pattern is User.

Outputs

<0-12>

JTOLTEST:LINKTRAINING:STOP

This command stops the link training process in JTOL test.

Syntax

JTOLTEST:LINKTRAINING:STOP

Inputs

NA

Outputs

NA

JTOLTEST:LINKTRAINING:ENABLEDUTLOOPBACKAFTERTEST

This command sets or returns the enable and disable status to keep the DUT in loopback state even after JTOL test execution is complete.

Syntax

JTOLTEST:LINKTRAINING:ENABLEDUTLOOPBACKAFTERTEST {0 | 1}

JTOLTEST:LINKTRAINING:ENABLEDUTLOOPBACKAFTERTEST?

Inputs

{0 | 1}

0 - Indicates to disable the option to keep DUT in loopback state even after JTOL test execution is complete.

1 - Indicates to enable the option to keep DUT in loopback state even after JTOL test execution is complete.

Outputs

{0 | 1}

JTOLTEST:LINKTRAINING:USERPATTERNLOCATION

This command sets or returns the user pattern location file path for the link training in JTOL test.

Syntax

```
JTOLTEST:LINKTRAINING:USERPATTERNLOCATION <"Filepath">
```

```
JTOLTEST:LINKTRAINING:USERPATTERNLOCATION?
```

Inputs

<Filepath> = <String>

Outputs

<String>

JTOLTEST:JITTERSTEP:VERYLOWFREQ

This command sets or returns the jitter step size/ratio (very low frequency) value for linear and log based search algorithms respectively.

Syntax

```
JTOLTEST:JITTERSTEP:VERYLOWFREQ <int>
```

```
JTOLTEST:JITTERSTEP:VERYLOWFREQ?
```

Inputs

<int> = 0.01 to 1 for log algorithms / 0.004 to 1000 for linear algorithms.

Outputs

<int>

JTOLTEST:JITTERSTEP:LOWFREQ

This command sets or returns the jitter step size/ratio (low frequency) value for linear and log based search algorithms respectively.

Syntax

```
JTOLTEST:JITTERSTEP:LOWFREQ <int>
```

```
JTOLTEST:JITTERSTEP:LOWFREQ?
```

Inputs

<int> = 0.01 to 1 for log algorithms / 0.004 to 75 for linear algorithms.

Outputs

<int>

JTOLTEST:JITTERSTEP:MIDDLEFREQ

This command sets or returns the jitter step size/ratio (middle frequency) value for linear and log based search algorithms respectively.

Syntax

```
JTOLTEST:JITTERSTEP:MIDDLEFREQ <int>
```

```
JTOLTEST:JITTERSTEP:MIDDLEFREQ?
```

Inputs

<int> = 0.01 to 1 for log algorithms / 0.004 to 7.5 for linear algorithms.

Outputs

<int>

JTOLTEST:JITTERSTEP:HIGHFREQ

This command sets or returns the jitter step size/ratio (high frequency) value for linear and log based search algorithms respectively.

Syntax

```
JTOLTEST:JITTERSTEP:HIGHFREQ <int>
```

```
JTOLTEST:JITTERSTEP:HIGHFREQ?
```

Inputs

<int> = 0.01 to 1 for log algorithms / 0.004 to 0.5 for linear algorithms.

Outputs

<int>

JTOLTEST:CLOCK:ARCHITECTURE

This command sets or returns the clock architecture type for the JTOL test.

Syntax

```
JTOLTEST:CLOCK:ARCHITECTURE <0 | 1 | 2>
```

```
JTOLTEST:CLOCK:ARCHITECTURE?
```

Inputs

<0 | 1 | 2>

0 - Indicates the clock architecture type is Common.

1 - Indicates the clock architecture type is SRIS.

2 - Indicates the clock architecture type is SRNS.

Outputs

<0 | 1 | 2>

JTOLTEST:INSERT:SKP

This command sets or returns the enable or disable status to insert the SKP OS while sending training sequences in JTOL test.

Syntax

```
JTOLTEST:INSERT:SKP {0 | 1}
```

```
JTOLTEST:INSERT:SKP?
```

Inputs

{0 | 1}

0 - Disables the option to insert the SKP OS while sending training sequences.

1 - Enables the option to insert the SKP OS while sending training sequences.

Outputs

{0 | 1}

JTOLTEST:FILTER:SKP

This command sets or returns the enable or disable status to filter/remove the received SKP ordered set in JTOL test.

Syntax

```
JTOLTEST:FILTER:SKP {0 | 1}
```

```
JTOLTEST:FILTER:SKP?
```

Inputs

{0 | 1}

0 - Disables the option to filter/remove the received SKP ordered set.

1 - Enables the option to filter/remove the received SKP ordered set.

Outputs

{0 | 1}

JTOLTEST:SKP:GEN12:SYMBOLLENGTH

This command sets or returns the symbol length for Gen1 and Gen2 in JTOL test.

Syntax

```
JTOLTEST:SKP:GEN12:SYMBOLLENGTH <0 | 1 | 2 | 3 | 4>
```

```
JTOLTEST:SKP:GEN12:SYMBOLLENGTH?
```

Inputs

<0 | 1 | 2 | 3 | 4>

- 0 - Indicates the symbol length is COM+1.
- 1 - Indicates the symbol length is COM+2.
- 2 - Indicates the symbol length is COM+3.
- 3 - Indicates the symbol length is COM+4.
- 4 - Indicates the symbol length is COM+5.

Outputs

<0 | 1 | 2 | 3 | 4>

JTOLTEST:SKP:GEN345:SYMBOLLENGTH

This command sets or returns the symbol length for Gen3, Gen4 and Gen5 in JTOL test.

Syntax

JTOLTEST:SKP:GEN345:SYMBOLLENGTH <0 | 1 | 2 | 3 | 4>

JTOLTEST:SKP:GEN345:SYMBOLLENGTH?

Inputs

<0 | 1 | 2 | 3 | 4>

- 0 - Indicates the symbol length is 8.
- 1 - Indicates the symbol length is 12.
- 2 - Indicates the symbol length is 16.
- 3 - Indicates the symbol length is 20.
- 4 - Indicates the symbol length is 24.

Outputs

<0 | 1 | 2 | 3 | 4>

JTOLTEST:SKP:GEN12:DOUBLESKP

This command sets or returns the ON or OFF status to insert the double SKP in loopback for Gen1 and Gen2 in JTOL test.

Syntax

JTOLTEST:SKP:GEN12:DOUBLESKP {0 | 1}

JTOLTEST:SKP:GEN12:DOUBLESKP?

Inputs

{0 | 1}

- 0 - Indicates the status is OFF.
- 1 - Indicates the status is ON.

Outputs

{0 | 1}

JTOLTEST:SKP:GEN345:DOUBLESKP

This command sets or returns the ON or OFF status to insert the double SKP in loopback for Gen3, Gen4, and Gen5 in JTOL test.

Syntax

```
JTOLTEST:SKP:GEN345:DOUBLESKP {0 | 1}
```

```
JTOLTEST:SKP:GEN345:DOUBLESKP?
```

Inputs

{0 | 1}

0 - Indicates the status is OFF.

1 - Indicates the status is ON.

Outputs

{0 | 1}

JTOLTEST:SRNS:SKP:GEN12:INTERVAL

This command sets or returns the SRNS SKP ordered set interval value for Gen1 and Gen2 in JTOL test.

Syntax

```
JTOLTEST:SRNS:SKP:GEN12:INTERVAL <int>
```

```
JTOLTEST:SRNS:SKP:GEN12:INTERVAL?
```

Inputs

<int> = 80 to 3076

Outputs

<int>

JTOLTEST:SRNS:SKP:GEN345:INTERVAL

This command sets or returns the SRNS SKP ordered set interval value for Gen3, Gen4, and Gen5 in JTOL test.

Syntax

```
JTOLTEST:SRNS:SKP:GEN345:INTERVAL <int>
```

```
JTOLTEST:SRNS:SKP:GEN345:INTERVAL?
```

Inputs

<int> = 20 to 750

Outputs

<int>

JTOLTEST:SRIS:SKP:GEN12:INTERVAL

This command sets or returns the SRIS SKP ordered set interval value for Gen1 and Gen2 in JTOL test.

Syntax

```
JTOLTEST:SRIS:SKP:GEN12:INTERVAL <int>
```

```
JTOLTEST:SRIS:SKP:GEN12:INTERVAL?
```

Inputs

<int> = 76 to 3076

Outputs

<int>

JTOLTEST:SRIS:SKP:GEN345:INTERVAL

This command sets or returns the SRIS SKP ordered set interval value for Gen3, Gen4, and Gen5 in JTOL test.

Syntax

```
JTOLTEST:SRIS:SKP:GEN345:INTERVAL <int>
```

```
JTOLTEST:SRIS:SKP:GEN345:INTERVAL?
```

Inputs

<int> = 20 to 750

Outputs

<int>

JTOLTEST:SSC:STATE

This command enable or disable applying SSC to data and clock output for JTOL Test.

Syntax

```
JTOLTEST:SSC:STATE <0 | 1>
```

```
JTOLTEST:SSC:STATE?
```

Inputs

<0 | 1>

0 - Disable the option to apply SSC to data and clock output.

1 - Enable the option to apply SSC to data and clock output.

Outputs

<1 | 0>

JTOLTEST:LINKTRAINING:PCIESLOT

This command sets or returns the PCIe slot selected for the JTOL test.

Syntax

```
JTOLTEST:LINKTRAINING:PCIESLOT <0 | 1 | 2 | 3 >
```

```
JTOLTEST:LINKTRAINING:PCIESLOT?
```

Inputs

<0 - x1>

<1 - x4>

<2 - x8>

<3 - x16>

Outputs

<0 | 1 | 2 | 3>

JTOLTEST:COMMONCLOCK:SKP:GEN12:INTERVAL

This command sets or returns the Common Clock SKP ordered set interval value for Gen1 and Gen2 in JTOL test.

Syntax

```
JTOLTEST:COMMONCLOCK:SKP:GEN12:INTERVAL <int>
```

```
JTOLTEST:COMMONCLOCK:SKP:GEN12:INTERVAL?
```

Inputs

<int> = 80 to 3076

Outputs

<int>

JTOLTEST:COMMONCLOCK:SKP:GEN345:INTERVAL

This command sets or returns the Common Clock SKP ordered set interval value for Gen3, Gen4, and Gen5 in JTOL test.

Syntax

```
JTOLTEST:COMMONCLOCK:SKP:GEN345:INTERVAL <int>
```

```
JTOLTEST:COMMONCLOCK:SKP:GEN345:INTERVAL?
```

Inputs

<int> = 20 to 750

Outputs

<int>

JTOLTEST:LINKTRAINING:CTLETYPE

This command sets or returns the enable or disable status of BERT CTLE type during Link training in JTOL test.

Syntax

```
JTOLTEST:LINKTRAINING:CTLETYPE <0 | 1>
```

```
JTOLTEST:LINKTRAINING:CTLETYPE?
```

Inputs

```
<0 | 1>
```

0 - Indicates the BERT CTLE type is disabled.

1 - Indicates the BERT CTLE type is enabled.

Outputs

```
<0 | 1>
```

JTOLTEST:LINKTRAINING:POWEROPTIONTYPE

This command sets or returns the DUT Power Option for Link Training in JTOL test.

Syntax

```
JTOLTEST:LINKTRAINING:POWEROPTIONTYPE <0 | 1>
```

```
JTOLTEST:LINKTRAINING:POWEROPTIONTYPE?
```

Inputs

```
<0 | 1>
```

0 - Indicates the power option is External.

1 - Indicates the power option is CBB Controller.

Outputs

```
<0 | 1>
```

JTOLTEST:LINKTRAINING:CBBAUTORESET

This command sets or returns the CBB auto reset method for Link Training in JTOL test.

Syntax

```
JTOLTEST:LINKTRAINING:CBBAUTORESET <0 | 1>
```

```
JTOLTEST:LINKTRAINING:CBBAUTORESET?
```

Inputs

```
<0 | 1>
```

0 - Indicates the CBB auto reset method is Power Reset.

1 - Indicates the CBB auto reset method is Power Cycle.

Outputs

```
<0 | 1>
```

JTOLTEST:LINKTRAINING:CBBPOWERCYCLE

This command sets or returns the time value to send a Power OFF signal to CBB during the specified time (seconds).

Syntax

```
JTOLTEST:LINKTRAINING:CBBPOWERCYCLE <float>
```

```
JTOLTEST:LINKTRAINING:CBBPOWERCYCLE?
```

Inputs

<float> 0.1 to 20.0 seconds

Outputs

<float>

JTOLTEST:LINKTRAINING:CBBPOWERRESET

This command sets or returns the time value to send a Power Reset signal to CBB during the specified time (seconds).

Syntax

```
JTOLTEST:LINKTRAINING:CBBPOWERRESET <float>
```

```
JTOLTEST:LINKTRAINING:CBBPOWERRESET?
```

Inputs

<float> 0.1 to 20.0 seconds

Outputs

<float>

JTOLTEST:LINKTRAINING:CBBWAITINGTIME

This command sets or returns the waiting time after the DUT is powered ON.

Syntax

```
JTOLTEST:LINKTRAINING:CBBWAITINGTIME <float>
```

```
JTOLTEST:LINKTRAINING:CBBWAITINGTIME?
```

Inputs

<float> 0.1 to 300 seconds

Outputs

<float>

LEQRXTEST:OPEN

This command opens the LEQRx test panel.

Syntax

```
LEQRXTEST:OPEN
```

Inputs

NA

Outputs

NA

LEQRXTEST:WIZARD:OPEN

This command opens the LEQRx test wizard.

Syntax

```
LEQRXTEST:WIZARD:OPEN
```

Inputs

NA

Outputs

NA

LEQRXTEST:WIZARD:CLOSE

This command closes the LEQRx test wizard.

Syntax

```
LEQRXTEST:WIZARD:CLOSE
```

Inputs

NA

Outputs

NA

LEQRXTEST:DUTTYPE

This command selects the DUT Type for LEQRx test.

Syntax

```
LEQRXTEST:DUTTYPE <0 | 1>
```

```
LEQRXTEST:DUTTYPE?
```

Inputs

<0 | 1>

0 indicates the DUT type is Non-Root Complex/AIC.

1 indicates the DUT type is Root Complex/System.

Outputs

<0 | 1>

LEQRXTEST:CLOCKTYPE

This command selects the Clock Type for LEQRx test.

Syntax

```
LEQRXTEST:CLOCKTYPE <0 | 1>
```

```
LEQRXTEST:CLOCKTYPE?
```

Inputs

<0 | 1>

0 indicates the Clock type is 100 MHz External.

1 indicates the Clock type is Internal.

Outputs

<0 | 1>

LEQRXTEST:SELECT:TP2FILE

This command sets or returns the selected TP2 calibration file for LEQRx test.

Syntax

```
LEQRXTEST:SELECT:TP2FILE <String>
```

```
LEQRXTEST:SELECT:TP2FILE?
```

Inputs

<String>

Outputs

<String>

LEQRXTEST:SHOW:CONNECTIONDIAGRAM

This command displays the connection diagram of the LEQRx test.

Syntax

```
LEQRXTEST:SHOW:CONNECTIONDIAGRAM
```

Inputs

NA

Outputs

NA

LEQRXTEST:LINKTRAINING:BERTINITIALPRESET

This command sets or returns the initial preset set at the BERT end for the link training in LEQRx test.

Syntax

```
LEQRXTEST:LINKTRAINING:BERTINITIALPRESET <0 | 1 | 2 | 3 | 4 | 5 | 6 | 7 | 8 | 9>
```

```
LEQRXTEST:LINKTRAINING:BERTINITIALPRESET?
```

Inputs

0 to 9 indicates P0 to P9.

Outputs

```
<0 | 1 | 2 | 3 | 4 | 5 | 6 | 7 | 8 | 9>
```

LEQRXTEST:LINKTRAINING:DUTINITIALPRESET

This command sets or returns the initial preset for the DUT in LEQRx test.

Syntax

```
LEQRXTEST:LINKTRAINING:DUTINITIALPRESET <0 | 1 | 2 | 3 | 4 | 5 | 6 | 7 | 8 | 9>
```

```
LEQRXTEST:LINKTRAINING:DUTINITIALPRESET?
```

Inputs

0 to 9 indicates P0 to P9.

Outputs

```
<0 | 1 | 2 | 3 | 4 | 5 | 6 | 7 | 8 | 9>
```

LEQRXTEST:LINKTRAINING:DUTTARGETPRESET

This command sets or returns the final preset for the DUT in LEQRx test.

Syntax

```
LEQRXTEST:LINKTRAINING:DUTTARGETPRESET <0 | 1 | 2 | 3 | 4 | 5 | 6 | 7 | 8 | 9>
```

```
LEQRXTEST:LINKTRAINING:DUTTARGETPRESET?
```

Inputs

0 to 9 indicates P0 to P9.

Outputs

```
<0 | 1 | 2 | 3 | 4 | 5 | 6 | 7 | 8 | 9>
```

LEQRXTEST:LINKTRAINING:LINKNUMBER

This command sets or returns the link number for link training in the LEQRx test.

Syntax

```
LEQRXTEST:LINKTRAINING:LINKNUMBER <int>
```

```
LEQRXTEST:LINKTRAINING:LINKNUMBER?
```

Inputs

Application Help

<int> 0 to 255

Outputs

<int>

LEQRXTEST:LINKTRAINING:LANENUMBER

This command sets or returns the lane number for link training in the LEQRx test.

Syntax

```
LEQRXTEST:LINKTRAINING:LANENUMBER <int>
```

```
LEQRXTEST:LINKTRAINING:LANENUMBER?
```

Inputs

<int> 0 to 15

Outputs

<int>

LEQRXTEST:LINKTRAINING:LOOPBACKMODEGEN3

This command sets or returns the loopback mode in link training for Gen3 in LEQRx test.

Syntax

```
LEQRXTEST:LINKTRAINING:LOOPBACKMODEGEN3 <0 | 1>
```

```
LEQRXTEST:LINKTRAINING:LOOPBACKMODEGEN3?
```

Inputs

<0 | 1>

0 - Indicates the loopback mode is Configuration.

1 - Indicates the loopback mode is Recovery.

Outputs

<0 | 1>

LEQRXTEST:LINKTRAINING:DUTPOWERONTYPE

This command sets or returns the DUT Power ON type for link training in the LEQRx test.

Syntax

```
LEQRXTEST:LINKTRAINING:DUTPOWERONTYPE <0 | 1 | 2>
```

```
LEQRXTEST:LINKTRAINING:DUTPOWERONTYPE?
```

Inputs

<0 | 1 | 2>

0 indicates the DUT Power On type is Manual.

1 indicates the DUT Power On type is Pause for power cycle.

2 indicates the DUT Power On type is Automatic.

Outputs

<0 | 1 | 2>

LEQRXTEST:LINKTRAINING:DUTPOWERDELAY

This command gets or returns the delay value of the DUT power On for the link training in LEQRx test.

Syntax

```
LEQRXTEST:LINKTRAINING:DUTPOWERDELAY <int>
```

```
LEQRXTEST:LINKTRAINING:DUTPOWERDELAY?
```

Inputs

<int> 0 to 300

Outputs

<int>

LEQRXTEST:LINKTRAINING:SCRIPTLOCATION

This command sets or returns the script file location for the link training in LEQRx test.

Syntax

```
LEQRXTEST:LINKTRAINING:SCRIPTLOCATION <Filepath>
```

```
LEQRXTEST:LINKTRAINING:SCRIPTLOCATION?
```

Inputs

<Filepath> = <string>

Outputs

<string>

LEQRXTEST:BERMEASUREMENT:PATTERN

This command sets or returns the BER measurement patterns selected for the link training in LEQRx test.

Syntax

```
LEQRXTEST:BERMEASUREMENT:PATTERN <0 | 1 | 2 | 3 | 4 | 5 | 6 | 7 | 8 | 9 | 10 | 11>
```

```
LEQRXTEST:BERMEASUREMENT:PATTERN?
```

Inputs

0- 11

<0 | 1 | 2 | 3 | 4 | 5 | 6 | 7 | 8 | 9 | 10 | 11>

0 - Indicates BER Measurement pattern is Modified compliance.

- 1 - Indicates BER Measurement pattern is Jitter Meas.
- 2 - Indicates BER Measurement pattern is Compliance.
- 3 - Indicates BER Measurement pattern is PRBS7.
- 4 - Indicates BER Measurement Pattern is PRBS9.
- 5 - Indicates BER Measurement pattern is PRBS10.
- 6 - Indicates BER Measurement pattern is PRBS11.
- 7 - Indicates BER Measurement pattern is PRBS15.
- 8 - Indicates BER Measurement pattern is PRBS20.
- 9 - Indicates BER Measurement pattern is PRBS23.
- 10 - Indicates BER Measurement pattern is PRBS31.
- 11 - Indicates BER Measurement pattern is User

Outputs

<0 -11>

LEQRXTEST:LINKTRAINING:STRESSTYPE

This command sets or returns the stress type selected for the link training in LEQRx test.

Syntax

```
LEQRXTEST:LINKTRAINING:STRESSTYPE <0 | 1 | 2>
```

```
LEQRXTEST:LINKTRAINING:STRESSTYPE?
```

Inputs

<0 | 1 | 2>

0 indicates the stress type is Apply stress.

1 indicates the stress type is Inhibit stress during loopback.

2 indicates the stress type is Disable stress.

Outputs

<0 | 1 | 2>

LEQRXTEST:LINKTRAINING:CTLE

This command sets or returns the CTLE value for the link training in LEQ Rx test.

Syntax

```
LEQRXTEST:LINKTRAINING:CTLE <float>
```

```
LEQRXTEST:LINKTRAINING:CTLE?
```

Inputs

<float> -12 to 0

Outputs

<float>

LEQRXTEST:LINKTRAINING:ENABLEDUTLOOPBACKAFTERTEST

This command sets or returns the enable and disable status to keep the DUT in loopback state even after LEQRx test execution is complete.

Syntax

```
LEQRXTEST:LINKTRAINING:ENABLEDUTLOOPBACKAFTERTEST {0 | 1}
```

```
LEQRXTEST:LINKTRAINING:ENABLEDUTLOOPBACKAFTERTEST?
```

Inputs

{0 | 1}

0 indicates to disable the option to keep DUT in loopback state even after LEQ Rx Test execution is complete.

1 indicates to enable the option to keep DUT in loopback state even after LEQ Rx Test execution is complete.

Outputs

{0 | 1}

LEQRXTEST:LINKTRAINING:USERPATTERNLOCATION

This command sets or returns the user pattern location file path for the link training in LEQRx test.

Syntax

```
LEQRXTEST:LINKTRAINING:USERPATTERNLOCATION <"Filepath">
```

```
LEQRXTEST:LINKTRAINING:USERPATTERNLOCATION?
```

Inputs

<Filepath> = <String>

Outputs

<String>

LEQRXTEST:SSC:STATE

This command enable or disable applying SSC to data and clock output for LEQ Rx Test.

Syntax

```
LEQRXTEST:SSC:STATE <1 | 0>
```

```
LEQRXTEST:SSC:STATE?
```

Inputs

<0 | 1>

0 - Disable the option to apply SSC to data and clock output.

1 - Enable the option to apply SSC to data and clock output.

Outputs

Application Help

<1 | 0>

LEQRXTEST:LINKTRAINING:AUTOSEARCHANDTUNECDR

This command enable or disable option to perform Auto Search and Tune CDR during LEQ Rx Test.

Syntax

```
LEQRXTEST:LINKTRAINING:AUTOSEARCHANDTUNECDR <1 | 0>
```

```
LEQRXTEST:LINKTRAINING:AUTOSEARCHANDTUNECDR?
```

Inputs

<0 | 1>

0 - Disable the option to perform Auto Search and Tune CDR.

1 - Enable the option to perform Auto Search and Tune CDR.

Outputs

<1 | 0>

LOOPBACK:SELECT:BERTCTLEMODE

This command sets or returns the BERT CTLE mode for LEQ Rx Test.

Syntax

```
LOOPBACK:SELECT:BERTCTLEMODE <0 | 1>
```

```
LOOPBACK:SELECT:BERTCTLEMODE?
```

Inputs

<0 | 1>

0 - Indicates BERT CTLE mode is Automatic.

1 - Indicates BERT CTLE mode is Manual.

Outputs

<1 | 0>

LEQRXTEST:RUN

This command sets the LEQRx test run status.

Syntax

```
LEQRXTEST:RUN <0 | 1>
```

Inputs

<0 | 1>

0 - Stop the LEQRx test run.

1 - Start the LEQRx test run.

Outputs

<0 | 1>

LEQRXTEST:STATUS

This command returns the run status of LEQRx test.

Syntax

```
LEQRXTEST:STATUS?
```

Inputs

NA

Outputs

{Inprogress | Done}

LEQRXTEST:LINKTRAINING:STATUS

This command returns the result status of link training during LEQRx test.

Syntax

```
LEQRXTEST:LINKTRAINING:STATUS?
```

Inputs

NA

Outputs

{Returns | Success | Fail}

LEQRXTEST:LINKTRAINING:STOP

This command stops the link training process during LEQRx test.

Syntax

```
LEQRXTEST:LINKTRAINING:STOP
```

Inputs

NA

Outputs

NA

LEQRXTEST:TEST:ADDERROR

This command manually add errors during BER run during LEQRx test.

Syntax

LEQRXTEST:TEST:ADDEROR

Inputs

NA

Outputs

NA

LEQRXTEST:TEST:CURRENTBER

This command returns the current BER value in the DUT.

Syntax

LEQRXTEST:TEST:CURRENTBER?

Inputs

NA

Outputs

<String>

LEQRXTEST:TEST:CURRENTERRORCOUNT

This command returns the number of errors in the DUT for LEQRx test..

Syntax

LEQRXTEST:TEST:CURRENTERRORCOUNT?

Inputs

NA

Outputs

<int>

LEQRXTEST:TEST:CURRENTTOTALBITS

This command returns the total number of bits transmitted during test execution in LEQRx test.

Syntax

LEQRXTEST:TEST:CURRENTTOTALBITS?

Inputs

NA

Outputs

<float>

LEQRXTEST:TEST:RESULT

This command returns the result status of the LEQRx test.

Syntax

```
LEQRXTEST:TEST:RESULT?
```

Inputs

NA

Outputs

{Pass | Fail}

LEQRXTEST:SAVE:ID

This command sets or returns the unique identifier used as key to save the report in database for LEQRx test.

Syntax

```
LEQRXTEST:SAVE:ID <string>
```

```
LEQRXTEST:SAVE:ID?
```

Inputs

<string>

Outputs

<string>

LEQRXTEST:SAVE:GENERATEDBY

This command sets or returns the creator name who save the report in database for LEQRx test.

Syntax

```
LEQRXTEST:SAVE:GENERATEDBY <string>
```

```
LEQRXTEST:SAVE:GENERATEDBY?
```

Inputs

<string>

Outputs

<string>

LEQRXTEST:SAVE:COMMENTS

This command sets or returns the comments given to save the report in database for LEQRx test.

Syntax

```
LEQRXTEST:SAVE:COMMENTS <String>
```

LEQRXTEST:SAVE:COMMENTS?

Inputs

<string>

Outputs

<string>

LEQRXTEST:SAVE

This command saves the LEQRx test report to the database.

Syntax

LEQRXTEST:SAVE

Inputs

NA

Outputs

NA

LEQRXTEST:CLOCK:ARCHITECTURE

This command sets or returns the clock architecture type for the LEQRx test.

Syntax

LEQRXTEST:CLOCK:ARCHITECTURE <0 | 1 | 2>

LEQRXTEST:CLOCK:ARCHITECTURE?

Inputs

<0 | 1 | 2>

0 - Indicates the clock architecture type is Common.

1 - Indicates the clock architecture type is SRIS.

2 - Indicates the clock architecture type is SRNS.

Outputs

<0 | 1 | 2>

LEQRXTEST:INSERT:SKP

This command sets or returns the enable or disable status to insert the SKP OS while sending training sequences in LEQRx test.

Syntax

LEQRXTEST:INSERT:SKP {0 | 1}

LEQRXTEST:INSERT:SKP?

Inputs

{0 | 1}

0 - Disables the option to insert the SKP OS while sending training sequences.

1 - Enables the option to insert the SKP OS while sending training sequences.

Outputs

{0 | 1}

LEQRXTEST:FILTER:SKP

This command sets or returns the enable or disable status to filter/remove the received SKP ordered set in LEQRx test.

Syntax

```
LEQRXTEST:FILTER:SKP {0 | 1}
```

```
LEQRXTEST:FILTER:SKP?
```

Inputs

{0 | 1}

0 - Disables the option to filter/remove the received SKP ordered set.

1 - Enables the option to filter/remove the received SKP ordered set.

Outputs

{0 | 1}

LEQRXTEST:SKP:GEN12:SYMBOLLENGTH

This command sets or returns the symbol length for Gen1 and Gen2 in LEQRx test.

Syntax

```
LEQRXTEST:SKP:GEN12:SYMBOLLENGTH <0 | 1 | 2 | 3 | 4>
```

```
LEQRXTEST:SKP:GEN12:SYMBOLLENGTH?
```

Inputs

<0 | 1 | 2 | 3 | 4>

0 - Indicates the symbol length is COM+1.

1 - Indicates the symbol length is COM+2.

2 - Indicates the symbol length is COM+3.

3 - Indicates the symbol length is COM+4.

4 - Indicates the symbol length is COM+5.

Outputs

<0 | 1 | 2 | 3 | 4>

LEQRXTEST:SKP:GEN345:SYMBOLLENGTH

This command sets or returns the symbol length for Gen3, Gen4 and Gen5 in LEQRx test.

Syntax

```
LEQRXTEST:SKP:GEN345:SYMBOLLENGTH <0 | 1 | 2 | 3 | 4>
```

```
LEQRXTEST:SKP:GEN345:SYMBOLLENGTH?
```

Inputs

<0 | 1 | 2 | 3 | 4>

0 - Indicates the symbol length is 8.

1 - Indicates the symbol length is 12.

2 - Indicates the symbol length is 16.

3 - Indicates the symbol length is 20.

4 - Indicates the symbol length is 24.

Outputs

<0 | 1 | 2 | 3 | 4>

LEQRXTEST:SKP:GEN12:DOUBLESKP

This command sets or returns the ON or OFF status to insert the double SKP in loopback for Gen1 and Gen2 in LEQRx test.

Syntax

```
LEQRXTEST:SKP:GEN12:DOUBLESKP {0 | 1}
```

```
LEQRXTEST:SKP:GEN12:DOUBLESKP?
```

Inputs

{0 | 1}

0 - Indicates the status is OFF.

1 - Indicates the status is ON.

Outputs

{0 | 1}

LEQRXTEST:SKP:GEN345:DOUBLESKP

This command sets or returns the ON or OFF status to insert the double SKP in loopback for Gen3, Gen4, and Gen5 in LEQRx test.

Syntax

```
LEQRXTEST:SKP:GEN345:DOUBLESKP {0 | 1}
```

```
LEQRXTEST:SKP:GEN345:DOUBLESKP?
```

Inputs

{0 | 1}

0 - Indicates the status is OFF.

1 - Indicates the status is ON.

Outputs

{0 | 1}

LEQRXTEST:SRNS:SKP:GEN12:INTERVAL

This command sets or returns the SRNS SKP ordered set interval value for Gen1 and Gen2 in LEQ Rx test.

Syntax

```
LEQRXTEST:SRNS:SKP:GEN12:INTERVAL <int>
```

```
LEQRXTEST:SRNS:SKP:GEN12:INTERVAL?
```

Inputs

<int> = 80 to 3076

Outputs

<int>

LEQRXTEST:SRNS:SKP:GEN345:INTERVAL

This command sets or returns the SRNS SKP ordered set interval value for Gen3, Gen4, and Gen5 in LEQ Rx test.

Syntax

```
LEQRXTEST:SRNS:SKP:GEN345:INTERVAL <int>
```

```
LEQRXTEST:SRNS:SKP:GEN345:INTERVAL?
```

Inputs

<int> = 20 to 750

Outputs

<int>

LEQRXTEST:SRIS:SKP:GEN12:INTERVAL

This command sets or returns the SRIS SKP ordered set interval value for Gen1 and Gen2 in LEQ Rx test.

Syntax

```
LEQRXTEST:SRIS:SKP:GEN12:INTERVAL <int>
```

```
LEQRXTEST:SRIS:SKP:GEN12:INTERVAL?
```

Inputs

<int> = 76 to 3076

Outputs

<int>

LEQRXTEST:SRIS:SKP:GEN345:INTERVAL

This command sets or returns the SRIS SKP ordered set interval value for Gen3, Gen4, and Gen5 in LEQ Rx test.

Syntax

```
LEQRXTEST:SRIS:SKP:GEN345:INTERVAL <int>
```

```
LEQRXTEST:SRIS:SKP:GEN345:INTERVAL?
```

Inputs

<int> = 20 to 750

Outputs

<int>

LEQRXTEST:COMMONCLOCK:SKP:GEN12:INTERVAL

This command sets or returns the Common Clock SKP ordered set interval value for Gen1 and Gen2 in LEQ Rx test.

Syntax

```
LEQRXTEST:COMMONCLOCK:SKP:GEN12:INTERVAL <int>
```

```
LEQRXTEST:COMMONCLOCK:SKP:GEN12:INTERVAL?
```

Inputs

<int> = 80 to 3076

Outputs

<int>

LEQRXTEST:COMMONCLOCK:SKP:GEN345:INTERVAL

This command sets or returns the Common Clock SKP ordered set interval value for Gen3, Gen4, and Gen5 in LEQ Rx test.

Syntax

```
LEQRXTEST:COMMONCLOCK:SKP:GEN345:INTERVAL <int>
```

```
LEQRXTEST:COMMONCLOCK:SKP:GEN345:INTERVAL?
```

Inputs

<int> = 20 to 750

Outputs

<int>

LEQRXTEST:LINKTRAINING:CTLETYPE

This command sets or returns the enable or disable status of BERT CTLE type during Link training in LEQ Rx test.

Syntax

```
LEQRXTEST:LINKTRAINING:CTLETYPE <0 | 1>
```

```
LEQRXTEST:LINKTRAINING:CTLETYPE?
```

Inputs

<0 | 1>

0 - Indicates the BERT CTLE type is disabled.

1 - Indicates the BERT CTLE type is enabled.

Outputs

<0 | 1>

LEQRXTEST:LINKTRAINING:CBBAUTORESET

This command sets or returns the CBB auto reset method for Link Training in LEQ Rx test.

Syntax

```
LEQRXTEST:LINKTRAINING:CBBAUTORESET <0 | 1>
```

```
LEQRXTEST:LINKTRAINING:CBBAUTORESET?
```

Inputs

<0 | 1>

0 - Indicates the CBB auto reset method is Power Reset.

1 - Indicates the CBB auto reset method is Power Cycle.

Outputs

<0 | 1>

LEQRXTEST:LINKTRAINING:CBBPOWERCYCLE

This command sets or returns the time value to sends a power OFF signal to CBB during the specified time (seconds).

Syntax

```
LEQRXTEST:LINKTRAINING:CBBPOWERCYCLE <float>.
```

```
LEQRXTEST:LINKTRAINING:CBBPOWERCYCLE?
```

Inputs

<float> 0.1 to 20.0 seconds

Outputs

<float>

LEQRXTEST:LINKTRAINING:CBBPOWERRESET

This command sets or returns the time value to send a Power Reset signal to CBB during the specified time (seconds).

Syntax

```
LEQRXTEST:LINKTRAINING:CBBPOWERRESET <float>
```

```
LEQRXTEST:LINKTRAINING:CBBPOWERRESET?
```

Inputs

<float> 0.1 to 20.0 seconds

Outputs

<float>

LEQRXTEST:LINKTRAINING:CBBWAITINGTIME

This command sets or returns the waiting time after the DUT is powered ON.

Syntax

```
LEQRXTEST:LINKTRAINING:CBBWAITINGTIME <float>
```

```
LEQRXTEST:LINKTRAINING:CBBWAITINGTIME?
```

Inputs

<float> 0.1 to 300 seconds

Outputs

<float>

LEQRXTEST:LINKTRAINING:POWEROPTIONTYPE

This command sets or returns the DUT power option for Link Training in LEQ Rx test.

Syntax

```
LEQRXTEST:LINKTRAINING:POWEROPTIONTYPE <0 | 1>
```

```
LEQRXTEST:LINKTRAINING:POWEROPTIONTYPE?
```

Inputs

<0 | 1>

0 - Indicates the power option is External.

1 - Indicates the power option is CBB Controller.

Outputs

<0 | 1>

LEQTXTEST:OPEN

This command opens LEQTx test panel.

Syntax

```
LEQTXTEST:OPEN
```

Inputs

NA

Outputs

NA

LEQTXTEST:WIZARD:OPEN

This command opens LEQTx test wizard.

Syntax

```
LEQTXTEST:WIZARD:OPEN
```

Inputs

NA

Outputs

NA

LEQTXTEST:WIZARD:CLOSE

This command closes LEQTx test wizard.

Syntax

```
LEQTXTEST:WIZARD:CLOSE
```

Inputs

NA

Outputs

NA

LEQTXTEST:SELECT:TP1FILE

This command selects the Calibration file for LEQTx test..

Syntax

```
LEQTXTEST:SELECT:TP1FILE <string>
```

```
LEQTXTEST:SELECT:TP1FILE?
```

Inputs

<string>

Outputs

<string>

LEQTXTEST:DUTTYPE

This command sets or returns the DUT type for LEQTx test.

Syntax

```
LEQTXTEST:DUTTYPE <0 | 1>>
```

```
LEQTXTEST:DUTTYPE?
```

Inputs

<0 | 1>

0 - Indicates the DUT type is Non-Root Complex/AIC.

1 - Indicates the DUT type is Root Complex/System.

Outputs

<0 | 1>

LEQTXTEST:CLOCKTYPE

This command sets or returns the Clock type for LEQTx test..

Syntax

```
LEQTXTEST:CLOCKTYPE <0 | 1>
```

```
LEQTXTEST:CLOCKTYPE?
```

Inputs

<0 | 1>

0 - Indicates the Clock type is 100 MHz External.

1 - Indicates the Clock type is Internal.

Outputs

<0 | 1>

LEQTXTEST:SELECT:TEST

This command sets or returns the LEQTx test selected to be executed.

Syntax

```
LEQTXTEST:SELECT:TEST <0 | 1 | 2>
```

```
LEQTXTEST:SELECT:TEST?
```

Inputs

<0 | 1 | 2>

0 - Indicates the tests are AIC Initial Tx EQ tests.

1 - Indicates the tests is AIC Response Time test.

2 - Indicates the tests is System Response Time test.

Outputs

<0 | 1 | 2>

LEQTXTEST:LINKTRAINING:BERTINITIALPRESET

This command sets or returns the initial preset set at the BERT end for the link training in LEQTx test.

Syntax

```
LEQTXTEST:LINKTRAINING:BERTINITIALPRESET <0 | 1 | 2 | 3 | 4 | 5 | 6 | 7 | 8 | 9>
```

```
LEQTXTEST:LINKTRAINING:BERTINITIALPRESET?
```

Inputs

0 to 9 indicates P0 to P9

Outputs

<0 | 1 | 2 | 3 | 4 | 5 | 6 | 7 | 8 | 9>

LEQTXTEST:LINKTRAINING:LINKNUMBER

This command sets or returns the link number for link training in LEQTx test.

Syntax

```
LEQTXTEST:LINKTRAINING:LINKNUMBER <int>
```

```
LEQTXTEST:LINKTRAINING:LINKNUMBER?
```

Inputs

<int> 0 to 255

Outputs

<int>

LEQTXTEST:LINKTRAINING:LANENUMBER

This command sets or returns the lane number for link training in LEQTx test.

Syntax

```
LEQTXTEST:LINKTRAINING:LANENUMBER <int>
```

```
LEQTXTEST:LINKTRAINING:LANENUMBER?
```

Inputs

<int> 0 to 255

Outputs

<int>

LEQTXTEST:LINKTRAINING:DUTPOWERONTYPE

This command sets or returns the DUT Power ON type for the link training in LEQTx test.

Syntax

```
LEQTXTEST:LINKTRAINING:DUTPOWERONTYPE <0 | 1 | 2>
```

```
LEQTXTEST:LINKTRAINING:DUTPOWERONTYPE?
```

Inputs

<0 | 1 | 2>

0 - Indicates the DUT Power ON type is Manual.

1 - Indicates the DUT Power ON type is Pause for power cycle.

2 - Indicates the DUT Power ON type is Automatic.

Outputs

<0 | 1 | 2>

LEQTXTEST:LINKTRAINING:DUTPOWERDELAY

This command sets or returns the DUT Power On delay value for link training in LEQTx test.

Syntax

```
LEQTXTEST:LINKTRAINING:DUTPOWERDELAY <int>
```

```
LEQTXTEST:LINKTRAINING:DUTPOWERDELAY?
```

Inputs

<int> 0 to 300

Outputs

<int>

LEQTXTEST:LINKTRAINING:SCRIPTLOCATION

This command sets or returns the script file location for the link training in LEQTx test.

Syntax

```
LEQTXTEST:LINKTRAINING:SCRIPTLOCATION <Filepath>
```

```
LEQTXTEST:LINKTRAINING:SCRIPTLOCATION?
```

Inputs

<Filepath> = <string>

Outputs

<string>

LEQTXTEST:LINKTRAINING:CTLE

This command sets or returns the CTLE value for LEQ Tx test.

Syntax

```
LEQTXTEST:LINKTRAINING:CTLE <float>
```

```
LEQTXTEST:LINKTRAINING:CTLE?
```

Inputs

<float> -30 to 0

Outputs

<float>

LEQTXTEST:LINKTRAINING:LOOPBACKMODEGEN3

This command sets or returns the loopback mode in link training for Gen3 in LEQTx test.

Syntax

```
LEQTXTEST:LINKTRAINING:LOOPBACKMODEGEN3 <0 | 1>
```

```
LEQTXTEST:LINKTRAINING:LOOPBACKMODEGEN3?
```

Inputs

<0 | 1>

0 - Indicates the loopback mode is Configuration.

1 - Indicates the loopback mode is Recovery.

Outputs

<0 | 1>

LEQTXTEST:STRESSTYPE

This command sets or returns the Amplitude Configuration type for the LEQTx test.

Syntax

```
LEQTXTEST:STRESSTYPE <0 | 1 | 2>
```

```
LEQTXTEST:STRESSTYPE?
```

Inputs

<0 | 1 | 2>

0 - Indicates the Amplitude Configuration type is Calibrated.

1 - Indicates the Amplitude Configuration type is Customized.

2 - Indicates the Amplitude Configuration type is Un-calibrated.

Outputs

<0 | 1 | 2>

LEQTXTEST:AMPLITUDE

This command sets or returns the amplitude value for LEQTx test.

Syntax

```
LEQTXTEST:AMPLITUDE <int>
```

```
LEQTXTEST:AMPLITUDE?
```

Inputs

<int>

Outputs

<int>

LEQTXTEST:APPLYSOFTEQ

This command sets or returns the enable or disable status to apply software CTLE to the DUT Waveform in LEQTx test.

Syntax

```
LEQTXTEST:APPLYSOFTEQ {0 | 1}
```

```
LEQTXTEST:APPLYSOFTEQ?
```

Inputs

{0 | 1}

0 - Disables the option to apply software CTLE to the DUT Waveform.

1 - Enables the option to apply software CTLE to the DUT Waveform.

Outputs

{0 | 1}

LEQTXTEST:FILTERFILE

This command sets or returns the filter file name for software CTLE in LEQTx test.

Syntax

```
LEQTXTEST:FILTERFILE <string>
```

```
LEQTXTEST:FILTERFILE?
```

Inputs

<String>

Outputs

<String>

LEQTXTEST:DUTWFMSCALE

This command sets or returns the waveform scale value for the DUT waveform in LEQTx test.

Syntax

```
LEQTXTEST:DUTWFMSCALE <float>
```

```
LEQTXTEST:DUTWFMSCALE?
```

Inputs

<float> 20 to 200

Outputs

<float>

LEQTXTEST:LOOPBACKRUN

This command sets or returns the number of retrials when loopback is failed in LEQTx test.

Syntax

```
LEQTXTEST:LOOPBACKRUN <int>
```

```
LEQTXTEST:LOOPBACKRUN?
```

Inputs

<int>

Outputs

<int>

LEQTXTEST:DUTID

This command sets or returns the DUT ID for creating folder to save the waveforms in LEQTx test.

Syntax

```
LEQTXTEST:DUTID <String>
```

```
LEQTXTEST:DUTID?
```

Inputs

<String>

Outputs

<String>

LEQTXTEST:INITIALPRESET

This command sets the DUT Initial preset for AIC response test in LEQTx test.

Syntax

```
LEQTXTEST:INITIALPRESET <Row index> <0 | 1 | 2 | 3 | 4 | 5 | 6 | 7 | 8 | 9>
```

Inputs

<Row index> = <int> 0 to 19

- 0 = Indicates the DUT initial preset is P0.
- 1 = Indicates the DUT initial preset is P1.
- 2 = Indicates the DUT initial preset is P2.
- 3 = Indicates the DUT initial preset is P3.
- 4 = Indicates the DUT initial preset is P4.
- 5 = Indicates the DUT initial preset is P5.
- 6 = Indicates the DUT initial preset is P6.
- 7 = Indicates the DUT initial preset is P7.
- 8 = Indicates the DUT initial preset is P8.
- 9 = Indicates the DUT initial preset is P9.

Outputs

NA

LEQTXTEST:SELECTPRESET

This command sets the preset or coefficients for LEQTx test execution.

Syntax

```
LEQTXTEST:SELECTPRESET <Row index> {0 | 1}
```

Inputs

<Row index> = <int> 0 to 9 for Initial Tx EQ and 0 to 19 for response time.

- 0 = Disables the preset checkbox.
- 1 = Enables the preset checkbox.

Outputs

NA

LEQTXTEST:CLEARALL

This command un-checks all the presets for LEQTx test.

Syntax

```
LEQTXTEST:CLEARALL
```

Inputs

NA

Outputs

NA

LEQTXTEST:CHECKALL

This command checks all the presets for LEQTx test.

Syntax

```
LEQTXTEST:CHECKALL
```

Inputs

NA

Outputs

NA

LEQTXTEST:RUN

This command sets the run status of LEQTx test.

Syntax

```
LEQTXTEST:RUN <0 | 1>
```

```
LEQTXTEST:RUN?
```

Inputs

<0 | 1>

0 - Stops the LEQTx test run.

1 - Starts the LEQTx test run.

Outputs

<0 | 1>

LEQTXTEST:STATUS

This command returns the run status of LEQTx test.

Syntax

```
LEQTXTEST:STATUS?
```

Inputs

NA

Outputs

{InProgress | Done}

LEQTXTEST:LINKTRAINING:STATUS

This command returns the status of linktraining during LEQTx test.

Syntax

```
LEQTXTEST:LINKTRAINING:STATUS?
```

Inputs

NA

Outputs

{Running | Success | Fail}

LEQTXTEST:LINKTRAINING:STOP

This command stops the link training process.

Syntax

```
LEQTXTEST:LINKTRAINING:STOP
```

Inputs

NA

Outputs

NA

LEQTXTEST:SAVE:ID

This command sets or returns the unique identifier used as key to save the report in database for LEQTx test.

Syntax

```
LEQTXTEST:SAVE:ID <String>
```

```
LEQTXTEST:SAVE:ID?
```

Inputs

<String>

Outputs

<String>

LEQTXTEST:SAVE:COMMENTS

This command sets or returns the comments given to save the report in database for LEQTx test.

Syntax

```
LEQTXTEST:SAVE:COMMENTS <string>
```

```
LEQTXTEST:SAVE:COMMENTS ?
```

Inputs

<string>

Outputs

<string>

LEQTXTEST:SAVE:GENERATEDBY

This command sets or returns the creator name who save the report in database for LEQTx test.

Syntax

```
LEQTXTEST:SAVE:GENERATEDBY <String>
```

```
LEQTXTEST:SAVE:GENERATEDBY?
```

Inputs

<String>

Outputs

<String>

LEQTXTEST:SAVE

This command saves the LEQTx test report to the database.

Syntax

```
LEQTXTEST:SAVE
```

Inputs

NA

Outputs

NA

LEQTXTEST:LINKTRAINING:CTLETYPE

This command sets or returns the enable or disable status of BERT CTLE type during Link training in LEQ Tx test.

Syntax

```
LEQTXTEST:LINKTRAINING:CTLETYPE <0 | 1>
```

```
LEQTXTEST:LINKTRAINING:CTLETYPE?
```

Inputs

<0 | 1>

0 - Indicates the BERT CTLE type is disabled.

1 - Indicates the BERT CTLE type is enabled.

Outputs

<0 | 1>

LEQTXTEST:LINKTRAINING:CBBAUTORESET

This command to sets or returns the CBB auto reset method for Link Training in LEQ Tx test.

Syntax

```
LEQTXTEST:LINKTRAINING:CBBAUTORESET <0 | 1>
```

```
LEQTXTEST:LINKTRAINING:CBBAUTORESET?
```

Inputs

<0 | 1>

0 - Indicates the CBB auto reset method is Power Reset.

1 - Indicates the CBB auto reset method is Power Cycle.

Outputs

<0 | 1>

LEQTXTEST:LINKTRAINING:CBBPOWERCYCLE

This command sets or returns the time value to send a power OFF signal to CBB during the specified time (seconds).

Syntax

```
LEQTXTEST:LINKTRAINING:CBBPOWERCYCLE <float>
```

```
LEQTXTEST:LINKTRAINING:CBBPOWERCYCLE?
```

Inputs

<float> 0.1 to 20.0 seconds

Outputs

<float>

LEQTXTEST:LINKTRAINING:CBBPOWERRESET

This command sends a power reset signal to CBB during the specified time (seconds).

Syntax

```
LEQTXTEST:LINKTRAINING:CBBPOWERRESET <float>
```

```
LEQTXTEST:LINKTRAINING:CBBPOWERRESET?
```

Inputs

<float> 0.1 to 20.0 seconds

Outputs

<float>

LEQTXTEST:LINKTRAINING:CBBWAITINGTIME

This command sets or returns the waiting time after the DUT is powered ON.

Syntax

```
LEQTXTEST:LINKTRAINING:CBBWAITINGTIME <float>
```

```
LEQTXTEST:LINKTRAINING:CBBWaitingTime?
```

Inputs

<float> 0.1 to 300 seconds

Outputs

<float>

LEQTXTEST:LINKTRAINING:POWEROPTIONTYPE

This command sets or returns the DUT power option for Link Training in LEQ Tx test.

Syntax

```
LEQTXTEST:LINKTRAINING:POWEROPTIONTYPE <0 | 1>
```

```
LEQTXTEST:LINKTRAINING:POWEROPTIONTYPE?
```

Inputs

<0 | 1>

0 - Indicates the power option is External.

1 - Indicates the power option is CBB Controller.

Outputs

<0 | 1>

LEQTXTEST:SOFTWAREQTYPE <0/1>

This command sets or returns the Software Equalization type.

Syntax

```
LEQTXTEST:SOFTWAREQTYPE <0/1>
```

Inputs

<0 | 1>

0 - Indicates Software Equalization type is Automatic.

1 - Indicates Software Equalization type is Manual.

Outputs

<0 | 1>

LOOPBACK:AAS:DELAYSEARCHTYPE

This command sets or queries the delay search type to be set as a part of JTOL Test

Syntax

```
LOOPBACK:AAS:DELAYSEARCHTYPE <string>
```

```
LOOPBACK:AAS:DELAYSEARCHTYPE?
```

Inputs

<string> Fine, Coarse, OFF

Outputs

<string> Fine, Coarse, OFF

LOOPBACK:AAS:EYETHRESHOLDTYPE

This command sets or queries the eye threshold type to be set as a part of the JTOL test

Syntax

```
LOOPBACK:AAS:EYETHRESHOLDTYPE <string>
```

```
LOOPBACK:AAS:EYETHRESHOLDTYPE?
```

Inputs

<string> Fine, Coarse, OFF

Outputs

<string> Fine, Coarse, OFF

LOOPBACK:SELECT:LFEDFEMODE

This command sets or returns the BERT LFE DFE selection mode.

Syntax

```
LOOPBACK:SELECT:LFEDFEMODE <0 | 1>
```

```
LOOPBACK:SELECT:LFEDFEMODE?
```

Inputs

<0 | 1>

0 - Indicates BERT LFE DFE selection mode is Automatic.

1 - Indicates BERT LFE DFE selection mode is Manual.

Outputs

<0 | 1>

LOOPBACK:SELECT:AUTOSEARCH

This command sets or queries the auto search mode to be performed as a part of JTOL Test

Syntax

```
LOOPBACK:SELECT:AUTOSEARCH <0|1>
```

```
LOOPBACK:SELECT:AUTOSEARCH?
```

Inputs

<0 | 1>

0 - turn OFF the Auto search mode

1 - turn ON the Auto search mode

Outputs

<0 | 1>

LOOPBACK:AUTOSEARCH:TYPE

This command sets or returns the BERT Auto Search Type.

Syntax

```
LOOPBACK:AUTOSEARCH:TYPE <0 | 1>
```

```
LOOPBACK:AUTOSEARCH:TYPE?
```

Inputs

<0 | 1>

0 - Auto search TYPE is Basic

1 - Auto search TYPE is Advanced

Outputs

<0 | 1>

0 - Auto search TYPE is Basic

1 - Auto search TYPE is Advanced