



**PRISM MPX2-10
Media Analysis Platform
Installation and Safety
Instructions**



071-3629-00



**PRISM MPX2-10
Media Analysis Platform
Installation and Safety
Instructions**

This document supports software version 1.7 and above.

Register now!

Click the following link to protect your product.

► www.tek.com/register

www.tek.com

071-3629-00

Copyright © Tektronix. All rights reserved. Licensed software products are owned by Tektronix or its subsidiaries or suppliers, and are protected by national copyright laws and international treaty provisions.

Tektronix products are covered by U.S. and foreign patents, issued and pending. Information in this publication supersedes that in all previously published material. Specifications and price change privileges reserved.

TEKTRONIX and TEK are registered trademarks of Tektronix, Inc.

Contacting Tektronix

Tektronix, Inc.
14150 SW Karl Braun Drive
P.O. Box 500
Beaverton, OR 97077
USA

For product information, sales, service, and technical support:

- In North America, call 1-800-833-9200.
- Worldwide, visit www.tek.com to find contacts in your area.

Warranty

Tektronix warrants that this product will be free from defects in materials and workmanship for a period of one (1) year from the date of shipment. If any such product proves defective during this warranty period, Tektronix, at its option, either will repair the defective product without charge for parts and labor, or will provide a replacement in exchange for the defective product. Parts, modules and replacement products used by Tektronix for warranty work may be new or reconditioned to like new performance. All replaced parts, modules and products become the property of Tektronix.

In order to obtain service under this warranty, Customer must notify Tektronix of the defect before the expiration of the warranty period and make suitable arrangements for the performance of service. Customer shall be responsible for packaging and shipping the defective product to the service center designated by Tektronix, with shipping charges prepaid. Tektronix shall pay for the return of the product to Customer if the shipment is to a location within the country in which the Tektronix service center is located. Customer shall be responsible for paying all shipping charges, duties, taxes, and any other charges for products returned to any other locations.

This warranty shall not apply to any defect, failure or damage caused by improper use or improper or inadequate maintenance and care. Tektronix shall not be obligated to furnish service under this warranty a) to repair damage resulting from attempts by personnel other than Tektronix representatives to install, repair or service the product; b) to repair damage resulting from improper use or connection to incompatible equipment; c) to repair any damage or malfunction caused by the use of non-Tektronix supplies; or d) to service a product that has been modified or integrated with other products when the effect of such modification or integration increases the time or difficulty of servicing the product.

THIS WARRANTY IS GIVEN BY TEKTRONIX WITH RESPECT TO THE PRODUCT IN LIEU OF ANY OTHER WARRANTIES, EXPRESS OR IMPLIED. TEKTRONIX AND ITS VENDORS DISCLAIM ANY IMPLIED WARRANTIES OF MERCHANTABILITY OR FITNESS FOR A PARTICULAR PURPOSE. TEKTRONIX' RESPONSIBILITY TO REPAIR OR REPLACE DEFECTIVE PRODUCTS IS THE SOLE AND EXCLUSIVE REMEDY PROVIDED TO THE CUSTOMER FOR BREACH OF THIS WARRANTY. TEKTRONIX AND ITS VENDORS WILL NOT BE LIABLE FOR ANY INDIRECT, SPECIAL, INCIDENTAL, OR CONSEQUENTIAL DAMAGES IRRESPECTIVE OF WHETHER TEKTRONIX OR THE VENDOR HAS ADVANCE NOTICE OF THE POSSIBILITY OF SUCH DAMAGES.

[W2 – 15AUG04]

TEKTRONIX SOFTWARE LICENSE AGREEMENT

THE PROGRAM, OR PROGRAMS, ENCODED OR INCORPORATED WITHIN EQUIPMENT OR ACCOMPANYING THIS AGREEMENT, IS FURNISHED SUBJECT TO THE TERMS AND CONDITIONS OF THIS AGREEMENT. RETENTION OF THE PROGRAM FOR MORE THAN THIRTY DAYS OR USE OF THE PROGRAM IN ANY MANNER WILL BE CONSIDERED ACCEPTANCE OF THE AGREEMENT TERMS. IF THESE TERMS ARE NOT ACCEPTABLE, THE UNUSED PROGRAM AND ANY ACCOMPANYING DOCUMENTATION SHOULD BE RETURNED PROMPTLY TO TEKTRONIX FOR A FULL REFUND OF THE LICENSE FEE PAID. (FOR INFORMATION REGARDING THE RETURN OF PROGRAMS ENCODED OR INCORPORATED WITHIN EQUIPMENT, CONTACT THE NEAREST TEKTRONIX SALES OFFICE.)

DEFINITIONS.

"Tektronix" means Tektronix, Inc., an Oregon corporation, or local Tektronix' legal entity that is supplying the equipment.

"Program" means the Tektronix software product (executable program and/or data) enclosed with this Agreement or included within the equipment with which this Agreement is packed.

"Customer" means the person or organization in whose name the Program was ordered.

LICENSE.

Customer may:

1. Use the Program on a single machine at any one time; and
2. Copy the Program for archival or backup purposes, provided that no more than one (1) such copy is permitted to exist at any one time.

Each copy of the Program made by Customer must include a reproduction of any copyright notice or restrictive rights legend appearing in or on the copy of the Program as received from Tektronix.

Customer may not:

1. Use the Program on more than one machine at any one time;
2. Transfer the Program to any person or organization outside of Customer or the corporation of which Customer is a part without the prior written consent of Tektronix, except in connection with the transfer of the equipment within which the programs are encoded or incorporated;
3. Export or re-export, directly or indirectly, the program, any associated documentation, or the direct product thereof, to any country to which such export or re-export is restricted by law or regulation of the United States or any foreign government having jurisdiction without the prior authorization, if required, of the Office of Export Administration, Department of Commerce, Washington, D.C. and the corresponding agency of such foreign government;
4. Modify the Program, create derivative works, or merge the Program with another program;
5. Reverse compile or disassemble the Program for any purpose, beyond the extent that such activity is expressly permitted by applicable open source licenses or applicable law notwithstanding this limitation; or
6. Copy the documentation accompanying the Program.

For Programs designed to reside on a single-machine and support one or more additional machines, either locally or remotely, without permitting the Program to be transferred to an additional machine for local execution, the additional machines shall be considered within the definition of "single machine." For programs permitting the Program to be transferred to an additional machine for local execution, a separate license shall be required for each such machine with which the Program may be used.

Title to the Program and all copies thereof, but not the media on which the Program or copies may reside, shall be and remain with Tektronix or others for whom Tektronix has obtained a respective licensing right.

Customer shall pay when due all property taxes that may now or hereafter be imposed, levied or assessed with respect to the possession or use of the Program or this license and shall file all reports required in connection with such taxes.

If the Program or any related documentation is acquired by or for an agency of the U.S. Government, the Program and documentation shall be considered "commercial computer software" or "commercial computer software documentation" respectively, as those terms are used in 48 CFR §12.212, 48 CFR §227.7202, or 48 CFR §252.227-7014, and are licensed with only those rights as are granted to all other licensees as set forth in this Agreement.

THE PROGRAM MAY NOT BE USED, COPIED, MODIFIED, MERGED, OR TRANSFERRED TO ANOTHER EXCEPT AS EXPRESSLY PERMITTED BY THESE TERMS AND CONDITIONS. UPON TRANSFER OF ANY COPY, MODIFICATION, OR MERGED PORTION OF THE PROGRAM, THE LICENSE GRANTED HEREIN IS AUTOMATICALLY TERMINATED WITH RESPECT TO THE PARTY THAT TRANSFERS THE PROGRAM.

TERM.

The license granted herein is effective upon acceptance by Customer, and shall remain in effect until terminated as provided herein. The license may be terminated by Customer at any time upon written notice to Tektronix. The license may be terminated by Tektronix or any third party from whom Tektronix may have obtained a respective licensing right if Customer fails to comply with any term or condition and such failure is not remedied within thirty (30) days after notice hereof from Tektronix or such third party. Upon termination by either party, Customer shall return to Tektronix or destroy, the Program and all associated documentation, together with all copies in any form.

LIMITED WARRANTY.

The Program is provided "as is" without warranty of any kind, either express or implied. Tektronix does not warrant that the functions contained in the Program will meet Customer's requirements or that the operation of the Program will be uninterrupted or error-free.

TEKTRONIX AND ITS VENDORS DISCLAIM ANY IMPLIED WARRANTIES OF MERCHANTABILITY OR FITNESS FOR A PARTICULAR PURPOSE.

LIMITATION OF LIABILITY, IN NO EVENT SHALL TEKTRONIX OR OTHERS FROM WHOM TEKTRONIX HAS OBTAINED A LICENSING RIGHT BE LIABLE FOR ANY INDIRECT, SPECIAL, INCIDENTAL, OR CONSEQUENTIAL DAMAGES ARISING OUT OF OR CONNECTED WITH CUSTOMER'S POSSESSION OR USE OF THE PROGRAM, EVEN IF TEKTRONIX OR SUCH OTHERS HAS ADVANCE NOTICE OF THE POSSIBILITY OF SUCH DAMAGES.

THIRD-PARTY DISCLAIMER.

Except as expressly agreed otherwise, third parties from whom Tektronix may have obtained a licensing right do not warrant the program, do not assume any liability with respect to its use, and do not undertake to furnish any support or information relating thereto.

GENERAL.

This Agreement contains the entire agreement between the parties with respect to the use, reproduction, and transfer of the Program. Neither this Agreement nor the license granted herein is assignable or transferable by Customer without the prior written consent of Tektronix.

This Agreement and the license granted herein shall be governed by the laws of the state of Oregon.

All questions regarding this Agreement or the license granted herein should be directed to the nearest Tektronix Sales Office.

Table of Contents

Important safety information	iii
General safety summary.....	iii
Service safety summary	v
Terms in this manual	v
Symbols and terms on the product.....	v
Preface.....	vi
Product description.....	vi
Documentation	vii
Conventions used in this manual.....	viii
Installation.....	1
Initial product inspection	1
Accessories	3
Operating requirements.....	5
Equipment rack installation	6
Rear panel connectors.....	7
SFP module installation.....	9
Power-on and power-off procedures	10
Operation.....	12
Front panel controls and connectors	12
Display elements	13
Methods of operation	14
Compliance information	19
EMC compliance	19
Safety compliance.....	20
Environmental considerations	22

Important safety information

This manual contains information and warnings that must be followed by the user for safe operation and to keep the product in a safe condition.

To safely perform service on this product, additional information is provided at the end of this section. (See page v, *Service safety summary*.)

General safety summary

Use the product only as specified. Review the following safety precautions to avoid injury and prevent damage to this product or any products connected to it. Carefully read all instructions. Retain these instructions for future reference.

Comply with local and national safety codes.

For correct and safe operation of the product, it is essential that you follow generally accepted safety procedures in addition to the safety precautions specified in this manual.

The product is designed to be used by trained personnel only.

Only qualified personnel who are aware of the hazards involved should remove the cover for repair, maintenance, or adjustment.

Before use, always check the product with a known source to be sure it is operating correctly.

This product is not intended for detection of hazardous voltages.

While using this product, you may need to access other parts of a larger system. Read the safety sections of the other component manuals for warnings and cautions related to operating the system.

When incorporating this equipment into a system, the safety of that system is the responsibility of the assembler of the system.

To avoid fire or personal injury

Use proper power cord. Use only the power cord specified for this product and certified for the country of use.

Do not use the provided power cord for other products.

Ground the product. This product is grounded through the grounding conductor of the power cord. To avoid electric shock, the grounding conductor must be connected to earth ground. Before making connections to the input or output terminals of the product, make sure that the product is properly grounded.

Do not disable the power cord grounding connection.

Power disconnect. The power cord disconnects the product from the power source. See instructions for the location. Do not position the equipment so that it is difficult to operate the power cord; it must remain accessible to the user at all times to allow for quick disconnection if needed.

Observe all terminal ratings. To avoid fire or shock hazard, observe all ratings and markings on the product. Consult the product manual for further ratings information before making connections to the product.

Do not apply a potential to any terminal, including the common terminal, that exceeds the maximum rating of that terminal.

Do not operate without covers. Do not operate this product with covers or panels removed, or with the case open. Hazardous voltage exposure is possible.

Avoid exposed circuitry. Do not touch exposed connections and components when power is present.

Do not operate with suspected failures. If you suspect that there is damage to this product, have it inspected by qualified service personnel.

Disable the product if it is damaged. Do not use the product if it is damaged or operates incorrectly. If in doubt about safety of the product, turn it off and disconnect the power cord. Clearly mark the product to prevent its further operation.

Before use, inspect test leads and accessories for mechanical damage and replace when damaged. Do not use test leads if they are damaged, if there is exposed metal, or if a wear indicator shows.

Examine the exterior of the product before you use it. Look for cracks or missing pieces.

Use only specified replacement parts.

Do not operate in wet/damp conditions. Be aware that condensation may occur if a unit is moved from a cold to a warm environment.

Do not operate in an explosive atmosphere.

Keep product surfaces clean and dry. Remove the input signals before you clean the product.

Provide proper ventilation. Refer to the installation instructions in the manual for details on installing the product so it has proper ventilation.

Slots and openings are provided for ventilation and should never be covered or otherwise obstructed. Do not push objects into any of the openings.

Provide a safe working environment. Always place the product in a location convenient for viewing the display and indicators.

Avoid improper or prolonged use of keyboards, pointers, and button pads. Improper or prolonged keyboard or pointer use may result in serious injury.

Be sure your work area meets applicable ergonomic standards. Consult with an ergonomics professional to avoid stress injuries.

Use only the Tektronix rackmount hardware specified for this product.

Service safety summary

The *Service safety summary* section contains additional information required to safely perform service on the product. Only qualified personnel should perform service procedures. Read this *Service safety summary* and the *General safety summary* before performing any service procedures.

To avoid electric shock. Do not touch exposed connections.

Do not service alone. Do not perform internal service or adjustments of this product unless another person capable of rendering first aid and resuscitation is present.

Disconnect power. To avoid electric shock, switch off the product power and disconnect the power cord from the mains power before removing any covers or panels, or opening the case for servicing.

Use care when servicing with power on. Dangerous voltages or currents may exist in this product. Disconnect power, remove battery (if applicable), and disconnect test leads before removing protective panels, soldering, or replacing components.

Verify safety after repair. Always recheck ground continuity and mains dielectric strength after performing a repair.

Terms in this manual

These terms may appear in this manual:



WARNING. Warning statements identify conditions or practices that could result in injury or loss of life.



CAUTION. Caution statements identify conditions or practices that could result in damage to this product or other property.

Symbols and terms on the product

These terms may appear on the product:

- DANGER indicates an injury hazard immediately accessible as you read the marking.
- WARNING indicates an injury hazard not immediately accessible as you read the marking.
- CAUTION indicates a hazard to property including the product.



When this symbol is marked on the product, be sure to consult the manual to find out the nature of the potential hazards and any actions which have to be taken to avoid them. (This symbol may also be used to refer the user to ratings in the manual.)

The following symbol(s) may appear on the product:



Preface

This manual describes how to install the PRISM Media Analysis Platform and provides basic safety and operating information. Detailed operating information is available in the user manual. A complete list of PRISM documentation is provided in this manual. (See page vii, *Documentation*.)

Product description

The PRISM MPX2-10 Media Analysis Platform provides flexible options and field-installable upgrades to monitor a diverse variety of SDI and IP statistics as well as video and audio content. The comprehensive feature set, along with an intuitive and simplified graphical presentation of IP statistics, including video quality and diagnostic information, enables engineers to ensure the delivery of superior QoS levels in an increasingly complex broadcast environment involving compressed / uncompressed video transmission through SDI/IP signal paths. PRISM is an ideal solution for monitoring SDI/IP hybrid environments including master control rooms, production studios, OB vans, and signal contribution/distribution centers.



Figure i: PRISM MPX2-10 Media Analysis Platform

Features and benefits

- A comprehensive analysis and monitoring tool for a hybrid IP / SDI broadcast systems that provides system evaluation for long term system quality monitoring and reporting
- All-in-one instrument within a 1RU full rack-width platform
- Extensive IP monitoring solution for SMPTE 2022-6, 2110, PTP, and ASPEN streams
- Graphical displays that show the traffic present in the 10G Ethernet link, allowing engineers to understand what is on their network and to easily select the stream of interest
- Select a stream to view and monitor the content using the Picture, Waveform, and Audio applications, and listen to audio with headphones for conformance monitoring

- Detect IP packet errors, monitor the packet inter arrival time (PIT) and time stamped delay factor (TS-DF) to allow engineers to observe issues that may cause intermittent loss of Video, Audio or Data
- Monitor PTP trend graphs to ensure proper IP system setup for robust sync system
- Tektronix patented Timing display showing the relative timing of the input signal and PTP reference that makes facility timing easy
- 1 PPS output when the instrument is locked to a PTP reference
- Seamless switching to ensure proper SMPTE 2022 and 2110 redundant system operation
- API to control PRISM from system management software
- Multipoint or remote site monitoring allowing one engineer to quickly respond to issues from multiple points in the system
- Optional 10GbE line rate packet capture for offline analysis
- Optional SDI and ST2110 IP signal generators for testing new or changing facility configurations
- NMOS IS-04 / IS-05 support for network discovery and connection management

Documentation

Table i: Product documentation

Document	Manual type	Tektronix part number	Description	Availability	
				Print	Web
Installation and Safety Instructions	User	071-3629-xx	Describes how to install the instrument and provides basic safety and operating information	√	√
User Manual	Primary User	077-1522-xx	Provides detailed operating information		√
Specifications and Performance Verification	Performance Verification	077-1523-xx	Lists the product specifications and provides procedures for verifying product performance		√
Release Notes	Release Notes	077-1524-xx	Describes the new features, improvements, and limitations of the instrument firmware		√
Rackmount Slides and Rails Installation Instructions	Field Install Instructions	071-2746-xx	Describes how to install the instrument in a 19" equipment rack	√	√
Field Upgrade Kit Instructions	Field Install Instructions	075-1106-xx	Describes how to install post-purchase field upgrades in the instrument	√	√

Searching for documents on www.tek.com/downloads

The fastest way to find a document on tek.com is through filtering. Using the filtering options on the left side of the Web page will help narrow down your choices until you find the correct documentation.

The following example lists six steps on searching for the latest User Manual:

1. Go to www.tek.com/downloads and search for PRISM.
2. Filter by **Manual** in the **Filter by Type** menu.
3. Filter by **Primary User** in the **Filter by Manual Type** menu.

NOTE. The Manual Type for each document is in the second column of the product documentation table. (See Table i.)

4. Sort by **Date** above the search bar.
5. The first manual in the list should be the latest PRISM User Manual. Click the link to the manual for additional information and to download.
6. To confirm that you have the correct manual, look at the **P/N** and the **Last Update** date. This information is found below the **Download this manual** link. See the image below for an example of the location.

NOTE. The first seven numbers of the P/N are the Tektronix part number from the product documentation table. The last two numbers are the revision level number.

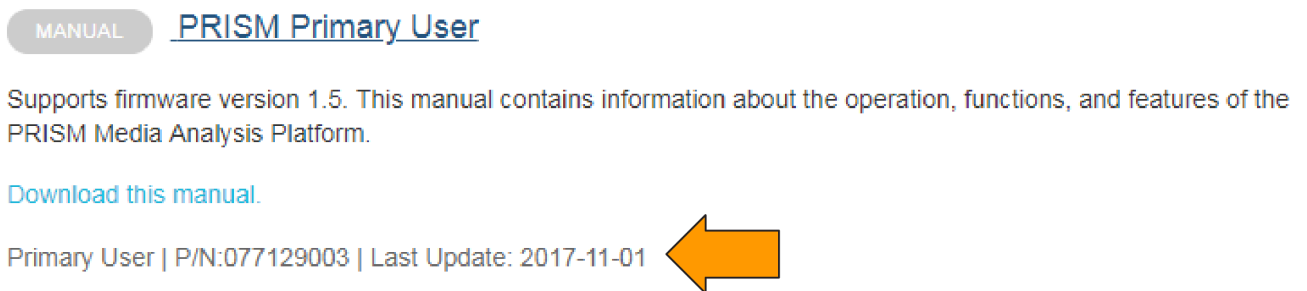
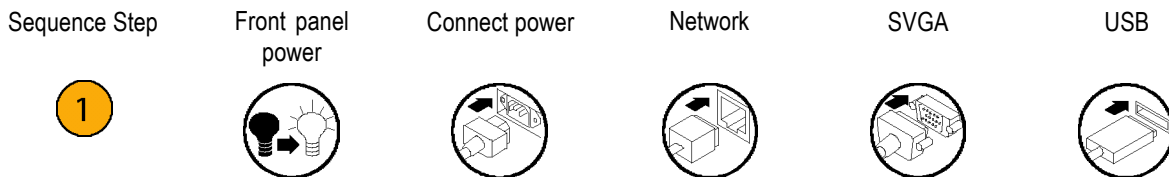

Figure ii: Location of the document part number and the date it was last updated.

Conventions used in this manual

The following icons may be used throughout this manual.



Installation

Initial product inspection

Perform the following product inspection procedure when you receive your instrument:

1. Inspect the shipping carton for external damage, which may indicate damage to the instrument.



WARNING. To prevent injury or damage to the instrument, do not carry the PRISM monitor by the small handles on the front sides of the instrument. These handles are for pulling the instrument out of a rackmount installation and are not intended to be used for carrying the instrument.

2. Remove the PRISM monitor from the shipping carton, and then check that the instrument has not been damaged in transit. Prior to shipment the instrument is thoroughly inspected for mechanical defects. The exterior should not have any scratches or impact marks.

NOTE. Save the shipping carton and packaging materials for instrument repackaging in case shipment becomes necessary.

3. Verify that the shipping carton contains the instrument, the standard accessories, and any optional accessories that you ordered. (See page 3, *Accessories*.)
4. Verify that all of the product options you ordered are installed:
 - a. After you install and power-on the instrument, touch or click the **Settings** icon.
 - b. Touch or click the **Utilities** bar.
 - c. Touch or click the **Options** bar.
 - d. The display will list all installed product options (for example, MP2-IP-MEAS). The display will read “None” if no options are installed.

Exterior cleaning

The instrument exterior was inspected for debris when it was shipped. If necessary, you can clean the exterior of the instrument as follows.



WARNING. *To prevent injury or death, power off the instrument and disconnect it from line voltage before cleaning.*

Clean the exterior surfaces of the chassis with a dry lint-free cloth or a soft-bristle brush. If any dirt remains, use a cloth or swab dipped in a 75% isopropyl alcohol solution. Use a swab to clean narrow spaces around controls and connectors. Do not use abrasive compounds on any part of the instrument that may be damaged by it.



CAUTION. *Avoid the use of chemical cleaning agents that might damage the plastics used in the instrument. Use only deionized water when cleaning the front-panel buttons. For the rest of the instrument, use a 75% isopropyl alcohol solution as a cleaner and rinse with deionized water. Before using any other type of cleaner, consult your Tektronix Service Center or representative.*

Accessories

Table 1: Standard and optional accessories

Accessory	Std.	Opt.	Tektronix part number
PRISM MPX2-10 Installation and Safety Instructions	√		071-3549-xx
Power cord (See page 4, <i>International power cords.</i>)	√		NA
SFP and transceiver modules:			
SD/HD/3G Optical (1310 nm) SDI SFP transmitter module (to be installed into SDI SFP+ cage for optical SDI loop through output)		√	MP-SFP Opt. 3GTO
SD/HD/3G DIN SDI SFP transmitter module (to be installed into SDI SFP+ cage for SDI loop through output with DIN coaxial connector)		√	MP-SFP Opt. 3GTD
SD/HD/3G HDBNC SDI SFP transmitter module (to be installed into SDI SFP+ cage for SDI loop through output with HDBNC coaxial connector)		√	MP-SFP Opt. 3GTH
10G Ethernet short range (850 nm) transceiver module (to be installed into 10GbE SFP+ cage)		√	MP-SFP Opt. 10GESR
10G Ethernet long range (1310 nm) transceiver module (to be installed into 10GbE SFP+ cage)		√	MP-SFP Opt. 10GELR
Rackmount Slides and Rails Kit ¹		√	MPX2-10 RACK

¹ The rackmount kit includes the *Rackmount Slides and Rails Kit Instructions*, Tektronix part number 071-2746-xx.

International power cords. Your instrument was shipped with one of the following power cord options. Power cords for use in North America are UL listed and CSA certified. Cords for use in areas other than North America are approved by at least one authority acceptable in the country to which the product is shipped.

- Opt. A0 – North America power cord
- Opt. A1 – Universal EUR power cord
- Opt. A2 – United Kingdom power cord
- Opt. A3 – Australia power cord
- Opt. A4 – 240 V, North America power cord
- Opt. A5 – Switzerland power cord
- Opt. A6 – Japan power cord
- Opt. A10 – China power cord
- Opt. A11 – India power cord
- Opt. A12 – Brazil power cord
- Opt. A99² – No power cord

² When ordering the A99 option, it is the responsibility of the end user to ensure that a certified power cord, for the country or region it is installed, is used with this instrument.



CAUTION. To reduce risk of fire and shock, use the certified power cord provided with the product.

Operating requirements

This section provides the environmental and power operating requirements for the instrument. See the *PRISM Specifications and Performance Verification Technical Reference* for additional information on product environmental and power specifications.

Environmental operating requirements

Check that the location of your installation has the proper operating environment as listed in the following table.



CAUTION. *Damage to the instrument can occur if this instrument is powered on at temperatures outside the specified temperature range.*

Table 2: Environmental requirements

Parameter		Description
Temperature	Operating	0 °C to +40 °C
	Non Operating	-20 °C to +60 °C
Humidity	Operating	20% to 80% relative humidity (% RH) at up to +40 °C, non-condensing
	Non Operating	5% to 90% relative humidity (% RH) at up to 40 °C and derated linearly to 45% RH at 60 °C, non-condensing
Altitude	Operating	To 3,000 m (10,000 feet) Maximum operating temperature decreases 1 °C each 300 m above 1.5 km
	Non Operating	To 12,000 m (40,000 feet)
Cooling		Internal fans provide forced air circulation. Do not block ventilation openings.
	Bare Instrument	To ensure proper airflow, there must be at least 2 inches of clearance on both sides of the instrument, at least 2 inches of clearance from the rear of the instrument, and at least a 1/2 inch of clearance from the top of the instrument.
	Rackmount Kit	Use only the Tektronix Rackmount Slides and Rails Kit, MPX2-10 RACK, to install this instrument in an equipment rack. To ensure proper airflow when installing the instrument in a closed rack with solid walls, there must be at least 2 inches of clearance from both sides of the instrument chassis to the rack side walls, at least 3 inches of clearance from the rear of the instrument to the rack's back wall, and at least a 1/2 inch of clearance from the top of the instrument to another installed instrument. The rack intake air to the side vents must not exceed 40 °C.

Electrical power requirements

The instrument operates from an AC power input. Check that your location provides the proper electrical power requirements as listed in the following tables.

AC line power. Use the proper power cord with the instrument. (See page 4, *International power cords*.) The following table lists the power requirements for the instrument.

Table 3: AC line power requirements

Parameter	Description
Line voltage range	100 - 240 VAC
	 WARNING. To reduce the risk of fire and shock, ensure that the mains supply voltage fluctuations do not exceed 10% of the operating voltage range.
Line frequency	50/60 Hz
Maximum power	200 W ¹

¹ Typical power 100 W.



WARNING. In the instrument, only the line conductor is fused for over-current protection. The fuse is internal and not user replaceable. Do not attempt to replace the fuse. If you suspect the fuse has blown, return the unit to an authorized service center for repair.

Physical characteristics

The following table lists the physical characteristics of a bare instrument.

Table 4: Physical characteristics

Parameter	Description
Dimensions	
Height	4.45 cm (1.75 in.)
Width	48.26 cm (19.00 in.), includes bezel
Depth	45.72 cm (18.00 in.), includes bezel and connectors
Weight	
Net	3.9 kg (8.7 lbs.)
Shipping	Typically 10.21 kg (22.5 lb.), includes rackmount kit

Equipment rack installation

There is an optional Rackmount Slides and Rails Kit available for the PRISM MPX2-10 monitor (MPX2-10 RACK). The rackmount kit includes the *Rackmount Slides and Rails Kit Installation Instructions* document (Tektronix part number 071-2746-xx).

Rear panel connectors

The following figure shows the external connections to the rear panel of the instrument. A description of each connector is provided in the following table. See *Front panel controls and connectors* for information about the front panel connectors. (See page 12.)

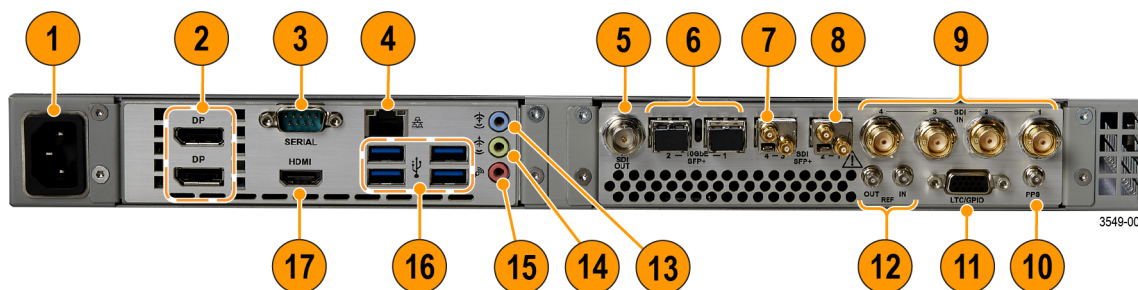
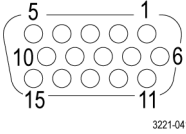

Figure 1: PRISM MPX2-10 rear panel

Item number (See Figure 1.)	Description
1	AC power input. Connector for AC power source.
2	DisplayPort (DP). Two DisplayPort outputs for external monitors. The output video format is 1920×1080. ¹
3	SERIAL. The Serial Interface 9-pin connector is not used.
<p style="text-align: center; font-size: small;">3629-001</p>	
4	Ethernet port. Standard RJ-45 connector for 10/100/1000Base-T Ethernet cable.
5	SDI OUT. SDI output of the selected SDI or ST2022-6 IP input.
6	10 GbE SFP+ 1-2. Two optional SFP+ ports for 10 GbE Ethernet applications.
7	SDI SFP+ 3-4. Two optional SFP+ outputs for SDI signals. SDI SFP+ inputs 3 and 4 support HD/3G signals.
8	SDI SFP+ 1-2. Two optional SFP+ outputs for SDI signals. SDI SFP+ inputs 1 and 2 support HD/3G signals.

Item number (See Figure 1.)	Description
9	<p>SDI IN 1-4. The BNC inputs that can operate in the following modes:</p> <ul style="list-style-type: none"> ■ SDI inputs 1 and 3 support SD/HD/3G/12G signals. SDI inputs 2 and 4 support SD/HD/3G signals. ■ Single SDI link (Option MP-FMT-4K is required for 12G support). When used as a single link, only one of the SDI 1-4 inputs is active at a time. ■ Eye diagram up to 12G on SDI input 1 only for physical layer measurements, including automated measurement of 12G-SDI eye pattern parameters (requires Options MP-FMT-4K and PHY-12G). ■ Quad 4K links when used in conjunction with the SDI 1-4 inputs (Option MP-FMT-4K only). When used as Quad 4K links, all four SDI inputs are active.
10	<p>PPS. The PPS connector outputs a 1 PPS (Pulse Per Second) signal when the instrument is locked to a PTP reference.</p>
11	<p>LTC/GPIO. 15-pin, D-type connector is for future functionality.</p>
	
12	<p>IN – OUT. The REF IN is used for analog reference signals black burst and tri-level sync for locking. REF OUT is a pass through of the REF IN.</p>
13	<p>Audio input. This connector is for future use.</p>
14	<p>Audio output. 3.5 mm line out port for using headphones to listen to the selected audio channel pair.</p>
15	<p>Mic input. This connector is for future use.</p>
16	<p>USB ports. Four USB 3.0 ports for connecting a mouse and keyboard, importing or exporting instrument presets, upgrading the instrument firmware, or saving screen and stream captures.</p>
17	<p>HDMI port. HDMI port output for an external monitor. The output video format is 1920×1080.¹</p>

¹ When connecting to an external monitor, a monitor with a 1920×1080 capable display works best with the instrument.

SFP module installation

There are several types of optional SFP modules available. (See Table 1 on page 3.)

To install the SFP module, you will first need to remove the plug from the SFP connector. Insert the SFP module into the SFP connector as shown below (optical SFP module shown). The module will latch into place when fully inserted.

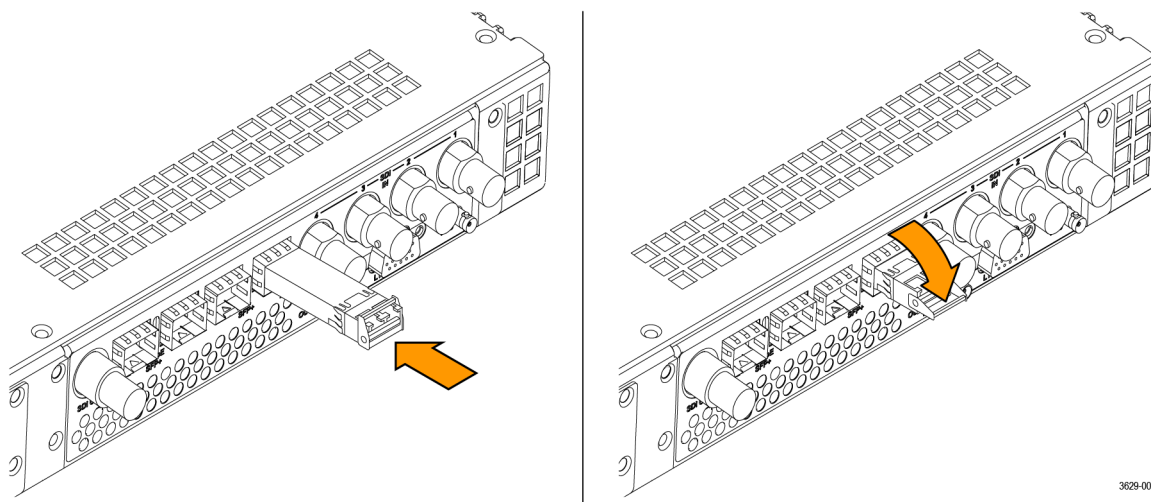

Figure 2: Installing and removing an optical SFP module

To remove the SFP module, pull down on the latch and then pull the module out of the SFP connector as shown above (optical SFP module shown).

NOTE. An optical SFP module is shown above. Other types of SFP modules may have different latching mechanisms.

SFP module transportation



CAUTION. To prevent static damage to the SFP module, if you remove the SFP module from the instrument, always transport the SFP module in a anti-static bag or container.

Power-on and power-off procedures

This section describes how to apply power to the instrument and how to power-on and power-off the instrument.

Power cord installation

This instrument is powered by an AC power source. Connect the power cord to the power connector on the rear panel of the instrument as shown below. The power connector is keyed to be directional, with the flat portion of the power cord housing facing the left of the instrument (as viewed from the rear). When fully inserted, the power cord housing latches onto the instrument power connector.



CAUTION. To minimize the risk of damage to the instrument, it is strongly recommended that the power cord be connected to the instrument before the power cord is connected to the AC power source.

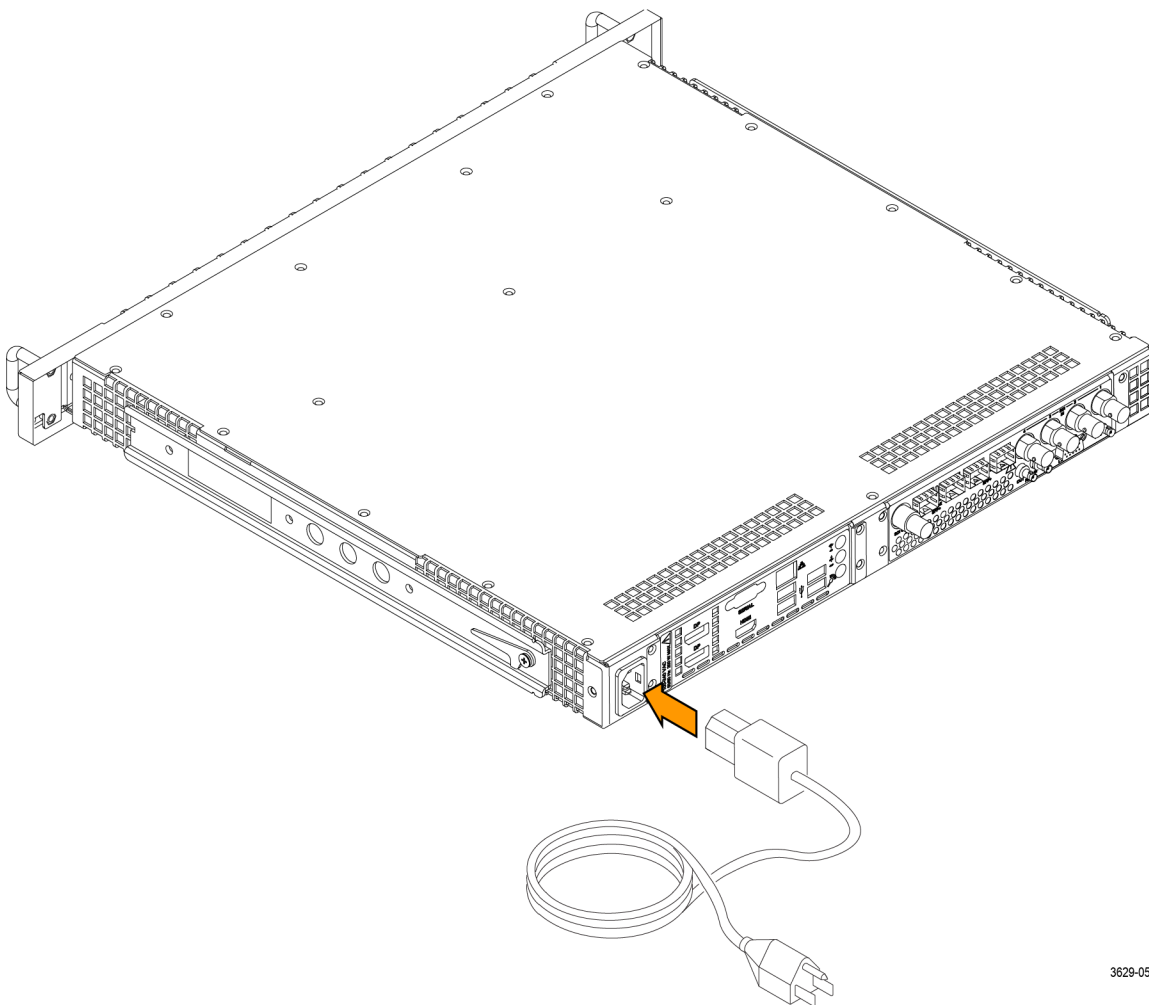

3629-05

Figure 3: Connecting the power cord to the instrument

Power-on procedure

1. Apply power to the instrument. (See page 10, *Power cord installation*.)

NOTE. If the PRISM monitor was previously powered off by a power interruption or by removing the power cord from the rear of the instrument, the instrument will power on when power is reapplied.

2. Press the **Power/Standby** button on the instrument front panel to turn the instrument on.

NOTE. The Power/Standby button illuminates during the power-on sequence and then turns off during normal instrument operation.



Power-off procedure

1. Press the **Power/Standby** button on the instrument front panel to turn the instrument off.



CAUTION. To prevent data loss, it is strongly recommended that you first shut down the instrument using the power button or the *Settings > Utilities > Power* submenu before disconnecting the power cord.

2. To completely remove power from the instrument, disconnect the power cord from the instrument. The power cord has a locking mechanism to keep it attached to the instrument. Push the button on the cord housing to release the locking mechanism.

Operation

Front panel controls and connectors

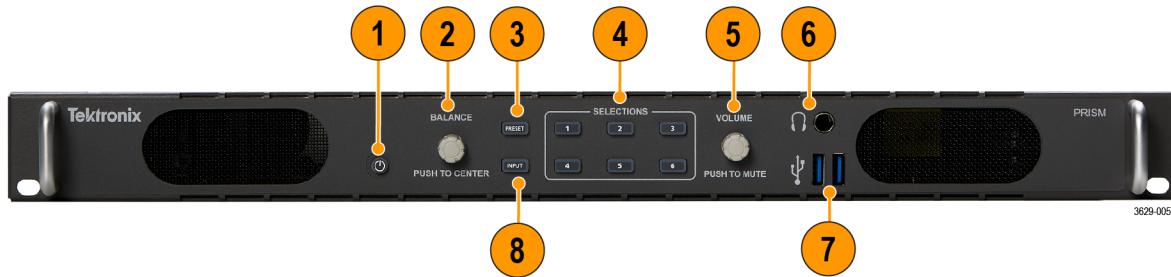

Figure 4: Front panel controls

Item number
(See Figure 4.)

Description

1 **Power / Standby button.** Press the button to turn the instrument on or off. To completely remove power from the instrument, remove the power cord.



CAUTION. To prevent data loss, it is strongly recommended that you first shut down the instrument using the power button or the Settings > Utilities menu before disconnecting the power cord.

2 **PRESET button.** Press the button once to prepare the instrument for a preset selection from preset Group A using the SELECTIONS buttons (1-6). Press the button repeatedly to select preset Group B-F.¹

3 **BALANCE control.** Turn the BALANCE control to re-center the left or right balance.¹

4 **SELECTIONS buttons.** After pressing the PRESET or INPUT button, press one of the SELECTIONS buttons (1-6) to recall an instrument preset or to select an input to monitor.

5 **VOLUME control.** Turn the VOLUME control to adjust the volume on the front and rear-panel headphone outputs. Push the VOLUME control to mute or unmute the audio.¹

6 **Headphone jack.** 1/4 inch headphone jack for listening to the selected audio channel pair.

7 **USB ports.** Two USB 3.0 ports for connecting a mouse and keyboard, importing or exporting instrument presets, upgrading the instrument firmware, or saving screen and stream captures.

8 **INPUT button.** Press the button to prepare the instrument for an input selection using the SELECTIONS buttons (1-6).¹

¹ When you use the PRESET and INPUT buttons, the associated menus appear on the display. The menus close after a short time-out period. Similarly, when you use the VOLUME or BALANCE control, the volume or balance slider and mute controls appear on the display and close after a short time-out period.

Display elements



Figure 5: Elements of the display

Item number (See Figure 5.)	Description
1	Application name. Lists the name of the displayed application.
2	Application tile 1. ¹
3	Application tile 3. ¹
4	Status bar. The right side of the status bar lists instrument status such as the selected input, type of input signal, selected signal reference, video/reference signal status, audio channel status, the real time clock setting, and the message center. The left side of the Status bar has icons with links to various instrument setting menus, presets, audio volume control, and status readouts. Use the Home icon to exit any displayed menus.
5	Application tabs. Some applications have selectable tabs (highlighted readouts) you can use to display additional information.
6	Application tile 4. ¹
7	Application tile 2. ¹

¹ The application panels can be shown in four-tile mode or in full screen mode.

Methods of operation

This section describes the four primary methods of operating the instrument:

- Keyboard and mouse with external display
- Remote control via VNC
- External touchscreen display

Keyboard and mouse with external display operation

You can use a USB keyboard and mouse to operate the instrument when an external display is connected to the instrument. The mouse needs to have a scrolling wheel in order to access all of the menu selections. Click or click and hold on applications to perform actions like you would on the touch panel.

Connect the keyboard, mouse and external display as follows:

- Connect the keyboard and mouse to any of the available front or rear-panel USB ports
- Connect the external monitor to any of the available display outputs, including VGA, DVI, or DisplayPort

Front panel operation

You can use the instrument front panel to perform the following functions:

- Recall instrument presets
- Select an input to monitor
- Control or mute the volume on the headphone outputs
- Connect a mouse and keyboard
- Connect a USB drive to import or export instrument presets, upgrade the instrument firmware, or save screen and stream captures

How to recall instrument presets. Perform the following steps to recall instrument presets using the front panel:

1. Press the **PRESET** button once to prepare the instrument for a preset selection from preset Group A using the **SELECTIONS** buttons (1-6).
2. Press the **PRESET** button repeatedly to select preset Group B-F. The selected preset group will be displayed.
3. After you select the desired preset group, press the **SELECTIONS numbered button** corresponding to the preset in that group you want to recall (1-6).

***NOTE.** When you use the **PRESET** and **INPUT** buttons, the associated menus appear on the display. The menus close after a short time-out period. Similarly, when you use the **VOLUME** control, the volume slider and mute controls appear on the display and close after a short time-out period.*

How to select an input to monitor. Perform the following steps to recall instrument presets using the front panel:

1. Press the **INPUT** button to prepare the instrument for an input selection.
2. Press the **SELECTIONS numbered button** corresponding to the input you want to monitor.

External touchscreen operation

You can use an external touchscreen display to control the instrument. Two connections are required:

- Connect the Display Port output from the PRISM monitor to the input on the external device.
- Connect the output of the external device to one of the USB ports on the PRISM monitor.

NOTE. A monitor with a 1920×1080 capable display works best with the instrument.

The following figure shows the instrument display with the application selection menu open in tile four.

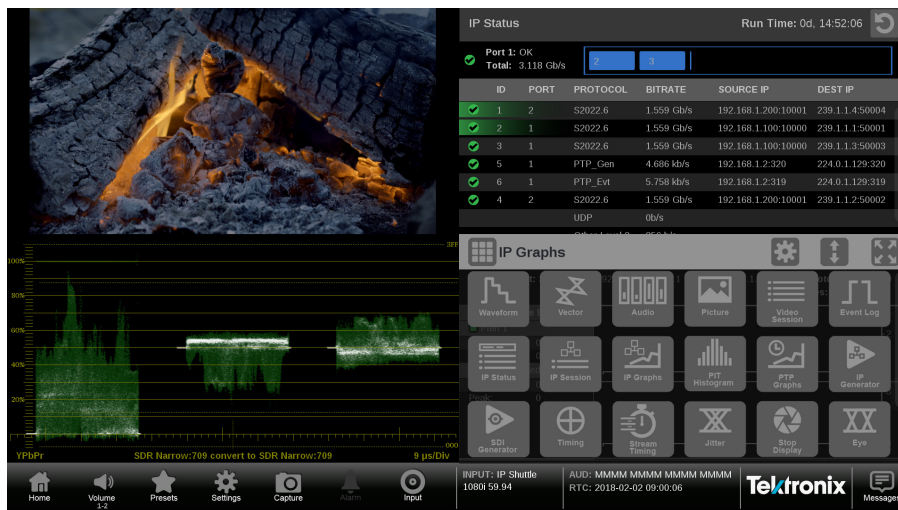







Figure 6: PRISM display in four-tile mode

Supported touchscreen gestures. You can use the following touchscreen gestures to control the instrument:

- Touch or tap the screen to select display elements.
- Press and hold on a tile to open the application banner to access the application controls or switch applications.
- Double tap an application banner to toggle the display between tile and a full-screen display of the selected application.
- Swipe up/down or left/right as necessary to navigate menus and preset listings and to view additional application information.
- Some applications support pinch and zoom.

NOTE. The terms "press and hold", "tap", "swipe", and "pinch" apply to the touchscreen on the instrument. If you are using a mouse and keyboard you must "click and hold", "click", "scroll" and use the scroll wheel on the mouse.

How to select or control an application to display.

1. Press and hold on an open application to open the application menu.
2. If necessary, touch the  icon to open the list of available applications. (See Figure 6 on page 15.)
3. Press, hold, and drag an application icon to reorder the application list to best match your workflow.
4. Touch the desired application icon to display that application.
5. If available, touch or tap the  icon in the menu bar to open the settings menu for the application.
6. Touch or tap the  icon in the menu bar to change the selected application display to full screen.
7. Touch or tap the  icon in the menu bar to change the selected application display to vertical extended mode. The vertical extended mode is useful for when you want to view two application displays side-by-side. When an application display is in vertical extended mode, touch or tap the  icon in the menu bar to return to quarter tile mode.
8. If available, touch or tap the  icon to clear or reset the selected display.

Remote control via VNC operation

When the PRISM monitor is connected to an Ethernet network, you can use a computer connected to the same network to remotely control the instrument in a Web browser or in a VNC client such as VNC Viewer. Use the following steps to connect to the PRISM monitor via VNC:

VNC client. When using VNC for extended periods of time, it is recommended to use a VNC client.

1. On the PRISM monitor, open the **Settings > Network** page to view the **Control IP Port** address of the instrument to which you are going to connect.
2. On your computer, open your VNC client and enter the IP address of the Control IP Port of the instrument in the VNC Server search bar.
3. The VNC client connects to the instrument in a separate window that appears exactly like the instrument display.

Web browser. Use the following steps to connect to the instrument through a Web browser.

1. On the PRISM monitor, open the **Settings > Network** page to view the **Control IP Port** address of the instrument to which you are going to connect.
2. On your computer, enter the following in the URL box of your Web browser, where xxx.xxx.xxx.xxx is the IP address of the Control IP Port of the instrument.

`http://xxx.xxx.xxx.xxx:6080/vnc.html`

3. This opens a login Web page as shown below.



4. In the Control bar, click the **Settings** icon to open the Settings dialog.
5. In the Settings dialog, use the Scaling Mode drop-down list to select **Local Scaling**, and then click **Apply**.

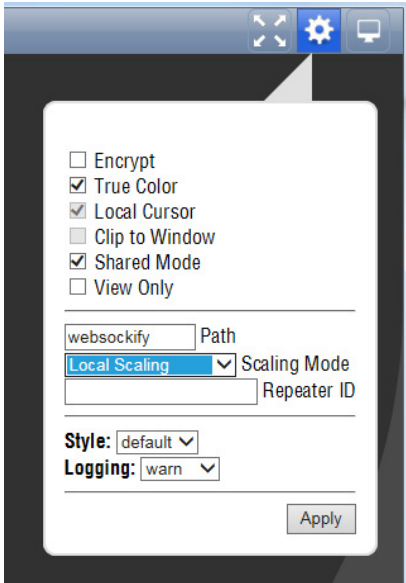

6. In the Control bar, click the **Connect** icon to open the Connect dialog.
7. In the Settings dialog, enter the default password **PRISM**, and then click **Connect**.

NOTE. You can use the **WEB REMOTE** tab of the **PRISM Settings > Network** menu to change the default password for the remote Web connection.

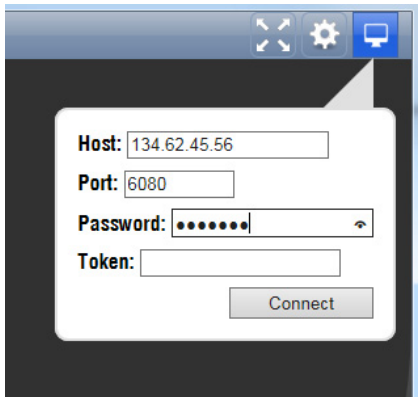

8. The Web browser connects to the instrument with the browser display appearing exactly like the display on the external monitor, but with a slower update rate.

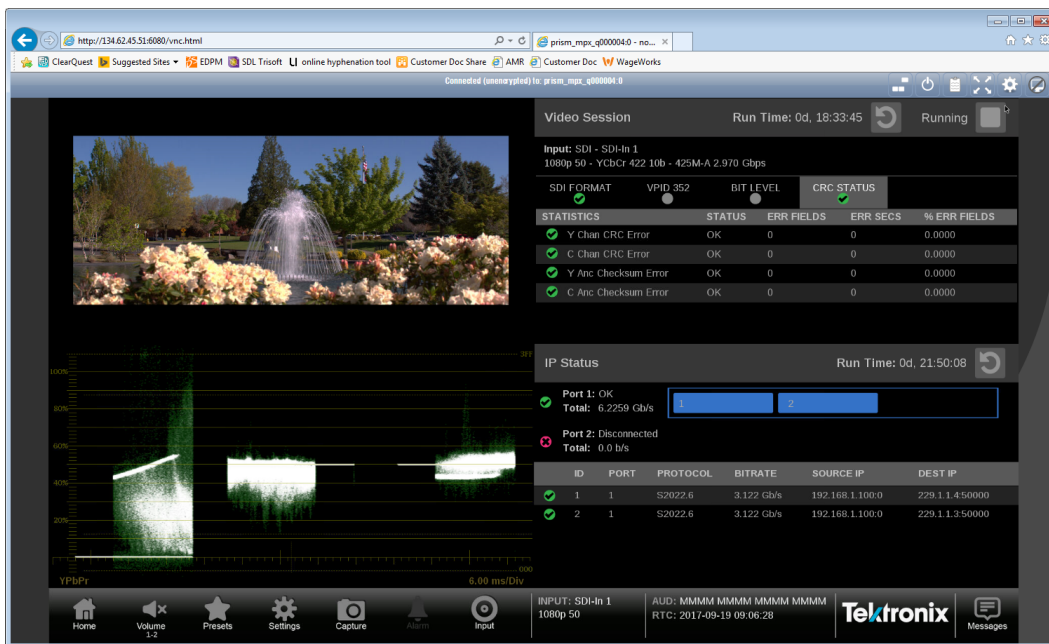

Compliance information

This section lists the EMC (electromagnetic compliance), safety, and environmental standards with which the instrument complies. This product is intended for use by professionals and trained personnel only; it is not designed for use in households or by children.

Questions about the following compliance information may be directed to the following address:

Tektronix, Inc.
PO Box 500, MS 19-045
Beaverton, OR 97077, USA
www.tek.com

EMC compliance

EU EMC Directive

Meets intent of Directive 2014/30/EU for Electromagnetic Compatibility. Compliance was demonstrated to the following specifications as listed in the Official Journal of the European Communities:

EN 55032. Electromagnetic compatibility of multimedia equipment - Emission requirements ^{1 2}

Class A radiated and conducted emissions

EN 55103-2. Product family standard for audio, video, audio-visual and entertainment lighting control apparatus for professional use - Part 2 Immunity. ²

Environment E2 – commercial and light industrial

- IEC 61000-4-2. Electrostatic discharge immunity
- IEC 61000-4-3. RF electromagnetic field immunity
- IEC 61000-4-4. Electrical fast transient / burst immunity
- IEC 61000-4-5. Power line surge immunity
- IEC 61000-4-6. Conducted RF Immunity
- IEC 61000-4-11. Voltage dips and interruptions immunity
- EN 55103-2 Annex A. Radiated magnetic field immunity

EN 61000-3-2. AC power line harmonic emissions

EN 61000-3-3. Voltage changes, fluctuations, and flicker

¹ This product is intended for use in nonresidential areas only. Use in residential areas may cause electromagnetic interference.

² For compliance with the EMC standards listed here, high quality shielded interface cables that incorporate low impedance connection between the cable shield and the connector shell should be used.

Australia / New Zealand EMC

Complies with the EMC provision of the Radiocommunications Act per the following standard, in accordance with ACMA:

- EN 55032. Radiated and conducted emissions, Class A.

Safety compliance

This section lists the safety standards with which the product complies and other safety compliance information.

EU low voltage directive

Compliance was demonstrated to the following specification as listed in the Official Journal of the European Union:

Low Voltage Directive 2014/35/EU.

- EN 61010-1. Safety Requirements for Electrical Equipment for Measurement, Control, and Laboratory Use – Part 1: General Requirements.

U.S. nationally recognized testing laboratory listing

- UL 61010-1. Safety Requirements for Electrical Equipment for Measurement, Control, and Laboratory Use – Part 1: General Requirements.

Canadian certification

- CAN/CSA-C22.2 No. 61010-1. Safety Requirements for Electrical Equipment for Measurement, Control, and Laboratory Use – Part 1: General Requirements.

Additional compliances

- IEC 61010-1. Safety Requirements for Electrical Equipment for Measurement, Control, and Laboratory Use – Part 1: General Requirements.

Equipment type

Test and measuring equipment.

Safety class

Class 1 – grounded product.

Pollution degree descriptions

A measure of the contaminants that could occur in the environment around and within a product. Typically the internal environment inside a product is considered to be the same as the external. Products should be used only in the environment for which they are rated.

- Pollution degree 1. No pollution or only dry, nonconductive pollution occurs. Products in this category are generally encapsulated, hermetically sealed, or located in clean rooms.
- Pollution degree 2. Normally only dry, nonconductive pollution occurs. Occasionally a temporary conductivity that is caused by condensation must be expected. This location is a typical office/home environment. Temporary condensation occurs only when the product is out of service.
- Pollution degree 3. Conductive pollution, or dry, nonconductive pollution that becomes conductive due to condensation. These are sheltered locations where neither temperature nor humidity is controlled. The area is protected from direct sunshine, rain, or direct wind.
- Pollution degree 4. Pollution that generates persistent conductivity through conductive dust, rain, or snow. Typical outdoor locations.

Pollution degree rating

Pollution degree 2 (as defined in IEC 61010-1). Rated for indoor, dry location use only.

IP rating

IP20 (as defined in IEC 60529).

Measurement and overvoltage category descriptions

Measurement terminals on this product may be rated for measuring mains voltages from one or more of the following categories (see specific ratings marked on the product and in the manual).

- Category II. Circuits directly connected to the building wiring at utilization points (socket outlets and similar points).
- Category III. In the building wiring and distribution system.
- Category IV. At the source of the electrical supply to the building.

NOTE. Only mains power supply circuits have an overvoltage category rating. Only measurement circuits have a measurement category rating. Other circuits within the product do not have either rating.

Mains overvoltage category rating

Overvoltage category II (as defined in IEC 61010-1).

Environmental considerations

This section provides information about the environmental impact of the product.

Restriction of hazardous substances

Complies with RoHS2 Directive 2011/65/EU.

Product end-of-life handling

Observe the following guidelines when recycling an instrument or component:

Equipment recycling. Production of this equipment required the extraction and use of natural resources. The equipment may contain substances that could be harmful to the environment or human health if improperly handled at the product's end of life. To avoid release of such substances into the environment and to reduce the use of natural resources, we encourage you to recycle this product in an appropriate system that will ensure that most of the materials are reused or recycled appropriately.



This symbol indicates that this product complies with the applicable European Union requirements according to Directives 2012/19/EU and 2006/66/EC on waste electrical and electronic equipment (WEEE) and batteries. For information about recycling options, check the Tektronix Web site (www.tek.com/productrecycling).

Battery recycling. This product contains a small installed lithium metal button cell. Please properly dispose of or recycle the cell at its end of life according to local government regulations.

Perchlorate materials. This product contains one or more type CR lithium batteries. According to the state of California, CR lithium batteries are classified as perchlorate materials and require special handling. See www.dtsc.ca.gov/hazardouswaste/perchlorate for additional information.

Transporting batteries

The small lithium primary button cell contained in this equipment does not exceed 1 gram of lithium metal content per cell, and the cell type has been shown by the manufacturer to comply with the applicable requirements of the UN Manual of Tests and Criteria Part III, Sub-section 38.3. Consult your carrier to determine which lithium battery transportation requirements are applicable to your configuration, including to its re-packaging and re-labeling, prior to reshipment of the product by any mode of transport.