



**TBS1000B and TBS1000B-EDU Series Oscilloscopes
Specifications and Performance Verification**

Technical Reference



077-1025-01



TBS1000B and TBS1000B-EDU Series Oscilloscopes Specifications and Performance Verification

Technical Reference

Register now!

Click the following link to protect your product.

► www.tektronix.com/register

Revision B

www.tek.com

077-1025-01

Copyright © Tektronix. All rights reserved. Licensed software products are owned by Tektronix or its subsidiaries or suppliers, and are protected by national copyright laws and international treaty provisions.

Tektronix products are covered by U.S. and foreign patents, issued and pending. Information in this publication supersedes that in all previously published material. Specifications and price change privileges reserved.

TEKTRONIX and TEK are registered trademarks of Tektronix, Inc.

Contacting Tektronix

Tektronix, Inc.
14150 SW Karl Braun Drive
P.O. Box 500
Beaverton, OR 97077
USA

For product information, sales, service, and technical support:

- In North America, call 1-800-833-9200.
- Worldwide, visit www.tektronix.com to find contacts in your area.

Table of Contents

Important safety information	iii
General safety summary.....	iii
Service safety summary	vi
Terms in this manual	vii
Symbols and terms on the product.....	vii
Specifications	1
Signal Acquisition System Characteristics	1
Time Base System	7
Triggering System.....	10
Display Specifications.....	14
Interfaces and Output Ports Specifications	14
Data Handling Characteristics	15
Power Distribution System.....	15
Mechanical Characteristics	15
Environmental Performance	16
Data Logging System Characteristics	16
Limit Testing System Characteristics	17
Performance Verification	18
Required Equipment	18
Test Record.....	19
Performance Verification Procedures	19
Self Test.....	20
Self Calibration.....	20
Check DC Gain Accuracy	20
Check Bandwidth	21
Check Sample Rate Accuracy and Delay Time Accuracy	22
Check Edge Trigger Sensitivity	23
Check External Edge Trigger Sensitivity.....	25
Check Vertical Position Accuracy	26
Example of a Vertical Position Accuracy Test Spreadsheet	30
Sample Filled-In Vertical Position Accuracy Test Spreadsheet	30
Index	

Important safety information

This manual contains information and warnings that must be followed by the user for safe operation and to keep the product in a safe condition.

To safely perform service on this product, additional information is provided at the end of this section. (See page vi, *Service safety summary*.)

General safety summary

Use the product only as specified. Review the following safety precautions to avoid injury and prevent damage to this product or any products connected to it. Carefully read all instructions. Retain these instructions for future reference.

Comply with local and national safety codes.

For correct and safe operation of the product, it is essential that you follow generally accepted safety procedures in addition to the safety precautions specified in this manual.

The product is designed to be used by trained personnel only.

Only qualified personnel who are aware of the hazards involved should remove the cover for repair, maintenance, or adjustment.

Before use, always check the product with a known source to be sure it is operating correctly.

This product is not intended for detection of hazardous voltages.

Use personal protective equipment to prevent shock and arc blast injury where hazardous live conductors are exposed.

While using this product, you may need to access other parts of a larger system. Read the safety sections of the other component manuals for warnings and cautions related to operating the system.

When incorporating this equipment into a system, the safety of that system is the responsibility of the assembler of the system.

To avoid fire or personal injury

Use proper power cord. Use only the power cord specified for this product and certified for the country of use.

Do not use the provided power cord for other products.

Ground the product. This product is grounded through the grounding conductor of the power cord. To avoid electric shock, the grounding conductor must be connected to earth ground. Before making connections to the input or output terminals of the product, make sure that the product is properly grounded.

Do not disable the power cord grounding connection.

Power disconnect. The power switch disconnects the product from the power source. See instructions for the location. Do not position the equipment so that it is difficult to disconnect the power switch; it must remain accessible to the user at all times to allow for quick disconnection if needed.

Connect and disconnect properly. Do not connect or disconnect probes or test leads while they are connected to a voltage source.

Use only insulated voltage probes, test leads, and adapters supplied with the product, or indicated by Tektronix to be suitable for the product.

Observe all terminal ratings. To avoid fire or shock hazard, observe all ratings and markings on the product. Consult the product manual for further ratings information before making connections to the product. Do not exceed the Measurement Category (CAT) rating and voltage or current rating of the lowest rated individual component of a product, probe, or accessory. Use caution when using 1:1 test leads because the probe tip voltage is directly transmitted to the product.

Do not apply a potential to any terminal, including the common terminal, that exceeds the maximum rating of that terminal.

Do not float the common terminal above the rated voltage for that terminal.

Do not operate without covers. Do not operate this product with covers or panels removed, or with the case open. Hazardous voltage exposure is possible.

Avoid exposed circuitry. Do not touch exposed connections and components when power is present.

Do not operate with suspected failures. If you suspect that there is damage to this product, have it inspected by qualified service personnel.

Disable the product if it is damaged. Do not use the product if it is damaged or operates incorrectly. If in doubt about safety of the product, turn it off and disconnect the power cord. Clearly mark the product to prevent its further operation.

Before use, inspect voltage probes, test leads, and accessories for mechanical damage and replace when damaged. Do not use probes or test leads if they are damaged, if there is exposed metal, or if a wear indicator shows.

Examine the exterior of the product before you use it. Look for cracks or missing pieces.

Use only specified replacement parts.

Use proper fuse. Use only the fuse type and rating specified for this product.

Wear eye protection. Wear eye protection if exposure to high-intensity rays or laser radiation exists.

Do not operate in wet/damp conditions. Be aware that condensation may occur if a unit is moved from a cold to a warm environment.

Do not operate in an explosive atmosphere.

Keep product surfaces clean and dry. Remove the input signals before you clean the product.

Provide proper ventilation. Refer to the installation instructions in the manual for details on installing the product so it has proper ventilation.

Slots and openings are provided for ventilation and should never be covered or otherwise obstructed. Do not push objects into any of the openings.

Provide a safe working environment. Always place the product in a location convenient for viewing the display and indicators.

Avoid improper or prolonged use of keyboards, pointers, and button pads. Improper or prolonged keyboard or pointer use may result in serious injury.

Be sure your work area meets applicable ergonomic standards. Consult with an ergonomics professional to avoid stress injuries.

Probes and test leads

Before connecting probes or test leads, connect the power cord from the power connector to a properly grounded power outlet.

Keep fingers behind the finger guards on the probes.

Remove all probes, test leads and accessories that are not in use.

Use only correct Measurement Category (CAT), voltage, temperature, altitude, and amperage rated probes, test leads, and adapters for any measurement.

Beware of high voltages. Understand the voltage ratings for the probe you are using and do not exceed those ratings. Two ratings are important to know and understand:

- The maximum measurement voltage from the probe tip to the probe reference lead.
- The maximum floating voltage from the probe reference lead to earth ground

These two voltage ratings depend on the probe and your application. Refer to the Specifications section of the manual for more information.



WARNING. *To prevent electrical shock, do not exceed the maximum measurement or maximum floating voltage for the oscilloscope input BNC connector, probe tip, or probe reference lead.*

Connect and disconnect properly. Connect the probe output to the measurement product before connecting the probe to the circuit under test. Connect the probe reference lead to the circuit under test before connecting the probe input. Disconnect the probe input and the probe reference lead from the circuit under test before disconnecting the probe from the measurement product.

Connect and disconnect properly. De-energize the circuit under test before connecting or disconnecting the current probe.

Connect the probe reference lead to earth ground only.

Do not connect a current probe to any wire that carries voltages above the current probe voltage rating.

Inspect the probe and accessories. Before each use, inspect probe and accessories for damage (cuts, tears, or defects in the probe body, accessories, or cable jacket). Do not use if damaged.

Ground-referenced oscilloscope use. Do not float the reference lead of this probe when using with ground-referenced oscilloscopes. The reference lead must be connected to earth potential (0 V).

Service safety summary

The *Service safety summary* section contains additional information required to safely perform service on the product. Only qualified personnel should perform service procedures. Read this *Service safety summary* and the *General safety summary* before performing any service procedures.

To avoid electric shock. Do not touch exposed connections.

Do not service alone. Do not perform internal service or adjustments of this product unless another person capable of rendering first aid and resuscitation is present.

Disconnect power. To avoid electric shock, switch off the product power and disconnect the power cord from the mains power before removing any covers or panels, or opening the case for servicing.

Use care when servicing with power on. Dangerous voltages or currents may exist in this product. Disconnect power, remove battery (if applicable), and disconnect test leads before removing protective panels, soldering, or replacing components.

Verify safety after repair. Always recheck ground continuity and mains dielectric strength after performing a repair.

Terms in this manual

These terms may appear in this manual:



WARNING. Warning statements identify conditions or practices that could result in injury or loss of life.



CAUTION. Caution statements identify conditions or practices that could result in damage to this product or other property.

Symbols and terms on the product

These terms may appear on the product:

- DANGER indicates an injury hazard immediately accessible as you read the marking.
- WARNING indicates an injury hazard not immediately accessible as you read the marking.
- CAUTION indicates a hazard to property including the product.



When this symbol is marked on the product, be sure to consult the manual to find out the nature of the potential hazards and any actions which have to be taken to avoid them. (This symbol may also be used to refer the user to ratings in the manual.)

The following symbol(s) may appear on the product:

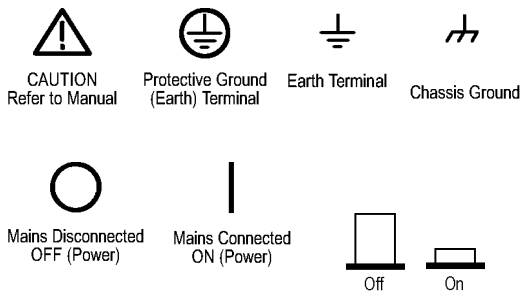

Specifications

These specifications apply to all TBS1000B series oscilloscopes. To verify that an oscilloscope meets specifications, it must first meet the following conditions:

- The oscilloscope must have been operating continuously for twenty minutes within the specified operating temperature.
- You must perform the Do Self Cal operation, accessible through the Utility menu, if the operating temperature has changed by more than 5 °C (9 °F) since the last time the Do Self Cal operation was performed.
- The oscilloscope must be within the factory calibration interval of one year.

Specifications are provided in the following tables. All specifications are guaranteed unless noted "typical." Specifications that are marked with the symbol are checked in the *Performance Verification* section. (See page 18, *Performance Verification*.)

Signal Acquisition System Characteristics

NOTE. All amplitude-related or modified specifications require 1X probe attenuation factors unless otherwise specified. This is due to the way the displayed sensitivity works. This does not affect actual methods of attachment. It only alters the relationship between displayed scale factors and the specifications.

Table 1: Signal acquisition system characteristics

Characteristic	Description
Number of Input Channels	Two
Input Coupling	DC, AC, or GND AC coupling connects a capacitor in series with the input circuitry. The DC input impedance becomes very high, since capacitance is in series with all paths to ground. Ground coupling mode provides a reference waveform derived from the values identified during SPC. This reference waveform shows visually where ground is expected to be.
Input Impedance, DC Coupled	1 M Ω \pm 2% in parallel with 20 pF \pm 3 pF
Maximum Input Voltage	At the front panel connector, 300 V _{RMS} , Installation Category II; derate at 20 dB/decade above 100 kHz to 13 V peak AC at 3 MHz and above. Based on sinusoidal or DC input signal. The maximum viewable signal while DC coupled is \pm 50 V offset \pm 5 V/div at 4 divisions, or 70 V. AC coupling allows measuring signals on a DC level up to 300 V. For nonsinusoidal waveforms, peak value must be less than 450 V. Excursions above 300 V should be less than 100 ms in duration, and the duty factor is limited to \leq 44%. The RMS signal level must be limited to 300 V. If these values are exceeded, damage to the instrument may result.
Number of Digitized Bits	8 bits except at 2 mV/div Displayed vertically with 25 digitization levels per division, 10 divisions dynamic range. 2 mV/div setting is generated by digital multiplication and the resolution is reduced. Given 100 levels available, the resolution is $>$ 6.5 bits.
Sensitivity Range	2 mV/div to 5 V/div in 1-2-5 sequence with the probe attenuation set to 1X.

Table 1: Signal acquisition system characteristics (cont.)

Characteristic	Description
Display Gain Variable	<p>The Display Gain Variable function allows the user to vary the vertical display gain continuously over the full range.</p> <p>Resolution is that of the coarse gain from which these data are constructed. Fine gain values (for instance 120 mV/div) are acquired at the next higher coarse gain setting (in this case 200 mV/div). The Display Gain Variable is achieved by digital multiplication of the data to obtain the settings between the 1-2-5 gain settings.</p> <p>Hard copy outputs to printer will be exactly the same as seen on screen even when the Display Gain Variable is used.</p> <p>However, WAVEFORM DATA obtained through the I/O interface is limited to the 1-2-5 gain settings.</p>
Probe Scale Factors	<p>1X, 10X, 20X, 50X, 100X, 500X, 1000X voltage attenuation. 5, 1, 500 m, 200 m, 100 m, 20 m, 10 m, 1 m V/A current scale factor.</p> <p>This adjusts the display scale factor of the instrument to accommodate various probe types. Accuracy of the probe used must be added to the accuracy specifications of instrument.</p> <p>No automatic probe interface is provided, so you must verify that the settings match the probe characteristics. The probe check function allows setting of the proper attenuation for voltage probes.</p>
Acquisition Modes	<p>Sample, Peak Detect, Average Envelope mode not provided</p>
Retained Front Panel Settings	<p>Front panel settings are retained when the instrument power is turned off and on with the power switch. The settings are retained when the line power is turned off and on.</p> <p>The instrument periodically saves front panel settings after settings are changed. There is a delay of three seconds after the last change and before the storage of the settings in memory.</p>
Math Modes	<p>All Units: Channel 1 – Channel 2 Channel 2 – Channel 1 Channel 1 + Channel 2 Channel 1 * Channel 2</p>
Voltage Measurement Functions	<p>Mean, Cycle Mean, Cursor Mean, Max, Min, RMS, Cycle RMS, Cursor RMS, Peak-to-Peak., Amplitude, Positive Overshoot, Negative Overshoot, High, Low</p>
√ DC Gain Accuracy, Sample or Average Acquisition	<p><i>This is the difference between the measured DC gain and the nominal DC gain, divided by the nominal DC gain and expressed as a percent.</i></p> <p>±3%, 5 V/div through 10 mV/div ±4%, 5 mV/div and 2 mV/div</p>
DC Voltage Measurement Accuracy, Average Acquisition Mode	<p><i>This is the accuracy of DC voltage measurements acquired using Average of > 16 waveforms.</i></p> <p>Vertical position = 0: ±(3% of reading + 0.1 div + 1 mV) Vertical position ≠ 0 and vertical scale = 2 mV/div to 200 mV/div: ±[3% of reading + vertical position + 1% of vertical position + 0.2 div + 7 mV] Vertical position ≠ 0 and vertical scale > 200 mV/div: ±[3% of reading + vertical position + 1% of vertical position + 0.2 div + 175 mV]</p>

Table 1: Signal acquisition system characteristics (cont.)

Characteristic	Description
Delta Volts Measurement Accuracy, Average Acquisition Mode	<i>Delta volts between any two averages of 16 waveforms acquired under the same setup and ambient conditions.</i> (3% of reading + 0.05 div)
Analog Bandwidth	<i>Defined in Section 4.6 of IEEE std 1057. The difference between the upper and lower frequencies, at which the amplitude response, as seen in the data record, is 0.707 (-3 dB) of the response seen in the data record at the specified reference frequency. Specifies only the -3 dB point. It does not include the in-band response.</i>
√ Analog Bandwidth, DC Coupled, Sample or Average	<i>This is analog bandwidth when the instrument is DC coupled in sample or average mode. V/div values are accurate for probe attenuation settings of 1X. No probe should be installed for these measurements. System bandwidth is type tested to be equivalent to this specification with the provided probe in 10X mode. Use Section 4.6.1 of IEEE 1057, with the reference frequency of 1 kHz at an amplitude of 5 divisions, driven from a 50 Ω source with external termination at the input BNC (25 Ω effective source).</i>
	TBS1032B: DC to ≥ 30 MHz for 5 mV/div through 5V/div setting with bandwidth limit at full. < 5 mV/div settings are limited to 20 MHz bandwidth.
	TBS1202B, TBS1202B-EDU: DC to ≥ 200 MHz for 5 mV/div through 5 V/div settings with bandwidth limit at full with temperature between 0° and 35 °C. DC to >160 MHz from 5 mV/div through 5 V/div settings with bandwidth limit at full for temperatures between 0° and 50 °C. < 5 mV/div settings are limited to 20 MHz bandwidth.
	TBS1152B, TBS1152B-EDU: DC to ≥ 150 MHz for 5 mV/div through 5 V/div settings with bandwidth limit at full. < 5 mV/div settings are limited to 20 MHz bandwidth.
	TBS1102B, TBS1102B-EDU: DC to ≥ 100 MHz for 5 mV/div through 5 V/div settings with the bandwidth limit at full. < 5 mV/div settings are limited to 20 MHz bandwidth.
	TBS1072B, TBS1072B-EDU: DC to ≥ 70 MHz for 5 mV/div through 5 V/div settings with the bandwidth limit at full. < 5 mV/div settings are limited to 20 MHz bandwidth.
	TBS1052B, TBS1052B-EDU: DC to ≥ 50 MHz for 5 mV/div through 5 V/div settings with bandwidth limit at full. < 5 mV/div settings are limited to 20 MHz bandwidth.

Table 1: Signal acquisition system characteristics (cont.)

Characteristic	Description														
Analog Bandwidth, DC Coupled, Peak Detect, typical	<p><i>This is the analog bandwidth when the instrument is DC coupled. V/div values are accurate for probe attenuation settings of 1X. No probe should be installed for these measurements.</i></p> <p>TBS1032B: DC to ≥ 25 MHz for 5 mV/div through 5 V/div setting with bandwidth limit at full. Settings less than 5 mV/div are limited to 20 MHz bandwidth.</p> <p>TBS1202B, TBS1202B-EDU, TBS1152B, TBS1152B-EDU, TBS1102B, TBS1102B-EDU: DC to ≥ 75 MHz for 5 mV/div through 5 V/div settings with the bandwidth limit at full. Settings less than 5 mV/div are limited to 20 MHz bandwidth.</p> <p>TBS1072B, TBS1072B-EDU: DC to ≥ 50 MHz for 5 mV/div through 5 V/div settings with the bandwidth limit at full. Settings less than 5 mV/div are limited to 20 MHz bandwidth.</p> <p>TBS1052B, TBS1052B-EDU: DC to ≥ 30 MHz for 5 mV/div through 5 V/div settings with the bandwidth limit at full. Settings less than 5 mV/div are limited to 20 MHz bandwidth.</p>														
Analog Bandwidth Selections	20 MHz bandwidth limit ON/OFF														
Upper-Frequency Limit, 20 MHz Bandwidth Limited, typical	<p><i>This is the upper frequency for Analog Bandwidth when the instrument has 20 MHz bandwidth limiting turned on.</i></p> <p>20 MHz</p> <p>Bandwidth of all trigger paths are similarly limited, except the External Trigger, which is not affected by BW Limit function. Each channel is separately limited, allowing different bandwidths on different channels of the same instrument.</p>														
Lower- Frequency Limit, AC Coupled	<p><i>This is the lower frequency for Analog Bandwidth when the instrument is AC-coupled</i></p> <p>≤ 10 Hz. <1 Hz when 10X, passive probes are used.</p>														
Rise Time, typical	<table border="1"> <thead> <tr> <th>Model</th> <th>Expected full bandwidth rise time</th> </tr> </thead> <tbody> <tr> <td>TBS1032B</td> <td>11.7 ns</td> </tr> <tr> <td>TBS1202B, TBS1202B-EDU</td> <td>2.1 ns</td> </tr> <tr> <td>TBS1152B, TBS1152B-EDU</td> <td>2.4 ns</td> </tr> <tr> <td>TBS1102B, TBS1102B-EDU</td> <td>3.5 ns</td> </tr> <tr> <td>TBS1072B, TBS1072B-EDU</td> <td>5.0 ns</td> </tr> <tr> <td>TBS1052B, TBS1052B-EDU</td> <td>7.0 ns</td> </tr> </tbody> </table> <p>Rise time is generally calculated from the following formula: Rise time in ns = 350 / Bandwidth in MHz</p>	Model	Expected full bandwidth rise time	TBS1032B	11.7 ns	TBS1202B, TBS1202B-EDU	2.1 ns	TBS1152B, TBS1152B-EDU	2.4 ns	TBS1102B, TBS1102B-EDU	3.5 ns	TBS1072B, TBS1072B-EDU	5.0 ns	TBS1052B, TBS1052B-EDU	7.0 ns
Model	Expected full bandwidth rise time														
TBS1032B	11.7 ns														
TBS1202B, TBS1202B-EDU	2.1 ns														
TBS1152B, TBS1152B-EDU	2.4 ns														
TBS1102B, TBS1102B-EDU	3.5 ns														
TBS1072B, TBS1072B-EDU	5.0 ns														
TBS1052B, TBS1052B-EDU	7.0 ns														

Table 1: Signal acquisition system characteristics (cont.)

Peak Detect Mode Pulse Response	<i>This is the capability of the instrument to capture single event pulses using the Peak Detect Acquisition Mode.</i>	
	<i>The minimum single pulse widths for guaranteed 50% or greater amplitude capture are as follows:</i>	
	<i>Model</i>	<i>Sec/Div Setting</i>
	<i>Minimum Pulse Width</i>	
	TBS1032B	50 s/div to 5 μ S/div
	TBS1202B, TBS1202B-EDU, TBS1152B, TBS1152B-EDU, TBS1102B, TBS1102B-EDU, TBS1072B, TBS1072B-EDU	
	TBS1052B, TBS1052B-EDU	
Vertical Position Ranges	<i>These are the ranges of the user-settable input offset voltage.</i>	
	<i>Volts/Div Setting</i>	<i>Position Range</i>
	2 mV/div to 200 mV/div	± 1.8 V
	> 200 mV/div to 5 V/div	± 45 V
√ Vertical Position Accuracy	<i>This is the accuracy of the nominal voltage level represented by the code at the vendor of the A-D converter's dynamic range.</i>	
	<i>Volts/Div Setting</i>	<i>Position Accuracy</i>
	2 mV/div to 200 mV/div	$\pm(1\%$ of selected value + 0.1 div + 5 mV) within the range ± 1.8 V
	> 200 mV/div to 5 V/div	$\pm(1\%$ of selected value + 0.1 div + 125 mV) within the range ± 45 V

Table 1: Signal acquisition system characteristics (cont.)

Common Mode Rejection Ratio (CMRR), typical	<i>With the same signal applied to each channel, CMRR is the ratio of the acquired signal amplitude to the amplitude of the MATH difference waveform, either (Channel 1 - Channel 2), (Channel 2 - Channel 1)</i>	
	<i>Model</i>	<i>Common Mode Rejection Ratio</i>
	TBS1032B, TBS1202B, TBS1202B-EDU, TBS1152B, TBS1152B-EDU, TBS1102B, TBS1102B-EDU	100:1 at 60 Hz, reducing to 10:1 with 50 MHz sine wave, with equal Volts/Div and Coupling settings on each channel.
Crosstalk (Channel Isolation)	<i>Section 4.11.1 of IEEE std. 1057. It is the ratio of the level of a signal input into one channel to that of the same signal present in another channel due to stray coupling.</i>	
	<i>Model</i>	<i>Crosstalk</i>
	TBS1032B	≥ 100:1 with a 10 MHz sine wave and with equal V/div settings on each channel
	TBS1202B, TBS1202B-EDU	≥ 100:1 with a 100 MHz sine wave and with equal V/div settings on each channel
	TBS1152B, TBS1152B-EDU	≥ 100:1 with a 70 MHz sine wave and with equal V/div settings on each channel
	TBS1102B, TBS1102B-EDU	≥ 100:1 with a 50 MHz sine wave and with equal V/div settings on each channel
	TBS1072B, TBS1072B-EDU	≥ 100:1 with a 30 MHz sine wave and with equal V/div settings on each channel
	TBS1052B, TBS1052B-EDU	≥ 100:1 with a 20 MHz sine wave and with equal V/div settings on each channel

Time Base System

Table 2: Time base system

Characteristic	Description	
Sample-Rate Range	<i>This is the range of real-time rates, expressed in samples/second, at which a digitizer samples signals at its inputs and stores the samples in memory to produce a record of time-sequential samples. (IEEE 1057, 2.2.1)</i>	
	<i>Model</i> <i>Sample-rate range</i>	
	TBS1032B	5 S/s to 500 MS/s
	TBS1202B, TBS1202B-EDU, TBS1152B, TBS1152B-EDU, TBS1102B, TBS1102B-EDU	5 S/s to 2000 MS/s Refer to the table for a tabular listing (See Table 3 on page 8.)
	TBS1072B, TBS1072B-EDU, TBS1052B, TBS1052B-EDU	5 S/s to 1000 MS/s Refer to the table for a tabular listing (See Table 3 on page 8.)
Waveform Interpolation	(Sin x)/x interpolation Waveform interpolation is activated for sweep speeds of 100 ns/div and faster.	
Record Length	<i>This is the total number of samples contained in a single acquired waveform record (Memory Length in IEEE 1057.2.2.1).</i> 2,500 samples per record.	
Seconds/Division Range	<i>Sec/Div Variable function is not available for this product.</i>	
	<i>Model</i> <i>Range</i>	
	TBS1032B	10 ns/div to 50 s/div in 1-2.5-5 sequence
	TBS1202B, TBS1202B-EDU, TBS1152B, TBS1152B-EDU, TBS1102B, TBS1102B-EDU	2.5 ns/div to 50 s/div in 1-2.5-5 sequence Refer to the table for a tabular listing (See Table 3 on page 8.)
	TBS1072B, TBS1072B-EDU, TBS1052B, TBS1052B-EDU	5 ns/div to 50 s/div in 1-2.5-5 sequence Refer to the table for a tabular listing (See Table 3 on page 8.)
√ Long-Term Sample Rate and Horizontal Position Time Accuracy	<i>This is the maximum, total, long-term error in sample-rate or horizontal position time accuracy, expressed in parts per million.</i> ±50 ppm over any ≥1 ms interval.	

Table 2: Time base system (cont.)

Characteristic	Description
Horizontal Position	<i>Horizontal scale setting</i>
Time Range	<i>Horizontal position time range</i>
	5 ns/div to 10 ns/div
	25 ns/div to 100 μs/div
	250 μs/div to 10 s/div
	25 s/div to 50 s/div
	–4 div * s/div to 20 ms
	–4 div * s/div to 50 ms
	–4 div * s/div to 50 s
	–4 div * s/div to 250 s
	The user controls the time from the trigger to the center graticule on the display with the Horizontal Position knob.
	The resolution of the Horizontal Position time is 1/25 of a horizontal division.
Zoom	The zoom function enables a user to select a part of the display to be magnified. Both the original waveform and the zoomed waveform are displayed. The user chooses the waveform with the Multipurpose knob.
Delta Time Measurement Accuracy	<i>This is the accuracy of delta time measurements made on any single waveform. The specification is related to the long-term sampling rate.</i>
	<i>The following limits are given for signals having an amplitude ≥ 5 divisions, a slew rate at the measurement points of ≥ 2.0 divisions/ns, and acquired ≥ 10 mV/div.</i>
	<i>Condition</i>
	<i>Time Measurement Accuracy</i>
	Single shot, sample mode, full bandwidth selected
	$\pm(1 \text{ Sample Internal} + 100 \text{ ppm} * \text{reading} + 0.6 \text{ ns})$
	> 16 averages, full bandwidth selected
	$\pm(1 \text{ Sample Internal} + 100 \text{ ppm} * \text{reading} + 0.4 \text{ ns})$
	The Sample Interval is the time between the samples in the waveform record.
Time Measurement Functions	Frequency, Period, Rise, Fall, Pwidth, Nwidth, Pduty, Nduty, DelayRR, DelayRF, DelayFR, DelayFF, Burst width, Phase.
Miscellaneous Measurement Functions	Area, Cycle Area, Rising edge count, Falling edge count, Positive pulse count, Negative pulse count

The following table shows conditions for each Sec/Div. When possible, the input signal is over-sampled. At the fastest Sec/Div settings, the data is interpolated so that the waveform record length stays constant.

Table 3: Table of time base characteristics

Sec/Div	Mode	Sample interval in waveform record	Sampling rate [Sampling rate with interpolation]		Horizontal pixel interval in Display
			1 GS/s max ¹	2 GS/s max ²	
2.5 ns ²	FISO (interpolated)	10 ps	1 GS/s [100 GS/s]	2 GS/s [100 GS/s]	30 ps
5 ns	FISO (interpolated)	20 ps	1 GS/s [50 GS/s]	2 GS/s [50 GS/s]	60 ps
10 ns	FISO (interpolated)	40 ps	1 GS/s [25 GS/s]	2 GS/s [25 GS/s]	120 ps
25 ns	FISO (interpolated)	100 ps	1 GS/s [10 GS/s]	2 GS/s [10 GS/s]	300 ps
50 ns	FISO (interpolated)	200 ps	1 GS/s [5 GS/s]	2 GS/s [5 GS/s]	600 ps
100 ns	FISO (interpolated)	400 ps	1 GS/s [2.5 GS/s]	2 GS/s [2.5 GS/s]	1.2 ns
250 ns	FISO	1 ns	1 GS/s		3 ns

Table 3: Table of time base characteristics (cont.)

Sec/Div	Mode	Sample interval in waveform record	Sampling rate [Sampling rate with interpolation]		Horizontal pixel interval in Display
			1 GS/s max ¹	2 GS/s max ²	
500 ps	FISO	2 ns	500 MS/s		6 ns
1 μs	FISO	4 ns	250 MS/s		12 ns
2.5 μs	FISO	10 ns	100 MS/s		30 ns
5 μs	FISO	20 ns	50 MS/s		60 ns
10 μs	FISO	40 ns	25 MS/s		120 ns
25 μs	FISO	100 ns	10 MS/s		300 ns
50 μs	FISO	200 ns	5 MS/s		600 ns
100 μs	FISO	400 ns	2.5 MS/s		1.2 μs
250 μs	S.P.	1 μs	1 MS/s		3 μs
500 μs	S.P.	2 μs	500 KS/s		6 μs
1 ms	S.P.	4 μs	250 KS/s		12 μs
2.5 ms	S.P.	10 μs	100 KS/s		30 μs
5 ms	S.P.	20 μs	50 KS/s		60 μs
10 ms	S.P.	40 μs	25 KS/s		120 μs
25 ms	S.P.	100 μs	10 KS/s		300 μs
50 ms	S.P.	200 μs	5 KS/s		600 μs
100 ms	S.P. (Scan Mode)	400 μs	2.5 KS/s		1.2 ms
250 ms	S.P. (Scan Mode)	1 ms	1 KS/s		3 ms
500 ms	S.P. (Scan Mode)	2 ms	500 S/s		6 ms
1 s	S.P. (Scan Mode)	4 ms	250 S/s		12 ms
2.5 s	S.P. (Scan Mode)	10 ms	100 S/s		30 ms
5 s	S.P. (Scan Mode)	20 ms	50 S/s		60 ms
10 s	S.P. (Scan Mode)	4 ms	25 S/s		120 ms
25 s	S.P. (Scan Mode)	100 ms	10 S/s		300 ms
50 s	S.P. (Scan Mode)	200 ms	5 S/s		600 ms

¹ TBS1072B, TBS1072B-EDU, TBS1052B, TBS1052B-EDU

² TBS1102B, TBS1102B-EDU, TBS1152B, TBS1152B-EDU, TBS1202B, TBS1202B-EDU

Triggering System

Table 4: Triggering system

Characteristic	Description
Trigger Types	Edge, Video, Pulse Width
Trigger Source Selection	Channel 1, External, External/5, AC Line Channel 2 External/5 selection attenuates the external signal by 5. When Bandwidth Limit is selected for channels, the bandwidth of that channel's trigger path will also be limited. The bandwidth of the External Trigger path is not affected by the bandwidth limit.
Horizontal Trigger Position	The trigger position is set by the Horizontal Position knob.
Trigger Holdoff Range	500 ns minimum to 10 s maximum The ability to set large values of Holdoff is limited by the difficulty in adjusting the Holdoff at seconds/Div settings less than 100 ms/Div. This is because Holdoff cannot be set in Scan Mode, which begins at 100 ms/div when Trigger Mode is AUTO. By adjusting Trigger Mode to NORMAL, the Scan Mode operation is turned off, and Holdoff can be adjusted at larger seconds/Div settings.
External Trigger Input Impedance	1 M \pm 2% in parallel with 20 pF \pm 3 pF
External Trigger Maximum Input Voltage	300 V _{RMS} , Installation Category II; derate at 20 dB/decade above 100 kHz to 13 V peak AC at 3 MHz and above Based on sinusoidal or DC input signal. The maximum viewable signal while DC coupled is \pm 50 V offset \pm 5 V/div at 4 divisions, or 70 V. AC coupling allows measuring signals on a DC level up to 300 V. For nonsinusoidal waveforms, peak value must be less than 450 V. Excursions above 300 V should be less than 100 ms duration and the duty factor is limited to < 44%. RMS signal level must be limited to 300 V. If these values are exceeded, damage to the instrument may result.
Line Trigger Characteristics	Line Trigger mode provides a source to synchronize the trigger with the AC line input. Input Amplitude requirements: 85 V _{AC} - 265 V _{AC} . Input Frequency requirements: 45 Hz - 440 Hz.
Edge Trigger	
Trigger Modes	Auto, Normal
Trigger Coupling	AC, DC, Noise Reject, High Frequency Reject, Low Frequency Reject The External Trigger path does not have a DC blocking capacitor ahead of the trigger input circuit. The roll off associated with AC coupling happens after the input circuit. When attempting to trigger on an AC signal that has a DC offset, use care to avoid overloading the input of the External Trigger circuit. For signals that have a large DC offset, using Channel 1 or Channel 2 with AC coupling is preferred.
Trigger Slope	Rising Edge, Falling Edge

Table 4: Triggering system (cont.)

Characteristic	Description		
√ Sensitivity, Edge-Type Trigger, DC Coupled	<i>Measurement Style A: The minimum signal levels for achieving stable frequency indication on the Trigger Frequency Counter within 1% of correct indication.</i>		
	<i>Measurement Style B: Section 4 10.2 in IEEE Std. #1057. The minimum signal levels required for stable edge triggering of an acquisition when the trigger Source is DC coupled.</i>		
	<i>Trigger Source</i>	<i>Sensitivity (Measurement style A), typical</i>	<i>Sensitivity (Measurement style B)</i>
Channel Inputs	All products	1.5 div from DC to 10 MHz (> 2 mV/div)	0.8 div from DC to 10 MHz > 2 mV/div)
		4 div from DC to 10 MHz (2 mV/Div)	2.5 div from DC to 10 MHz (2 mV/Div)
	TBS1032B	3 div between 10 MHz and 30 MHz	1.5 div between 10 MHz and 30 MHz
	TBS1052B, TBS1052B-EDU	3 div between 10 MHz and 50 MHz	1.5 div between 10 MHz and 50 MHz
	TBS1072B, TBS1072B-EDU	3 div between 10 MHz and 70 MHz	1.5 div between 10 MHz and 70 MHz
	TBS1102B, TBS1102B-EDU	3 div between 10 MHz and 100 MHz	1.5 div between 10 MHz and 100 MHz
	TBS1152B, TBS1152B-EDU	3 div between 10 MHz and 150 MHz	1.5 div from 10 MHz and 100 MHz 2.0 div above 100 MHz to 150 MHz
	TBS1202B, TBS1202B-EDU	3 div between 10 MHz and 200 MHz	1.5 div from 10 MHz and 100 MHz 2.0 div above 100 MHz to 200 MHz
Ext		300 mV from DC to 100 MHz	200 mV from DC to 100 MHz
		500 mV from 100 MHz to 200 MHz	350 mV from 100 MHz to 200 MHz
		(TBS1202B, TBS1202B-EDU, TBS1152B, TBS1152B-EDU)	(TBS1202B, TBS1202B-EDU, TBS1152B, TBS1152B-EDU)
Ext/5		1.5 V from DC to 100 MHz	1 V from DC to 100 MHz
		2.5 V from 100 MHz to 200 MHz	1.75 V from 100 MHz to 200 MHz
		(TBS1202B, TBS1202B-EDU, TBS1152B, TBS1152B-EDU)	(TBS1202B, TBS1202B-EDU, TBS1152B, TBS1152B-EDU)
Trigger Frequency Readout typically stabilizes at 50% more signal than generates a stable visual display.			

Table 4: Triggering system (cont.)

Characteristic	Description	
Sensitivity, Edge-Type Trigger, non-DC Coupled, typical	Trigger Source	Sensitivity
	AC	Same as DC Coupled limits for frequencies 50 Hz and above
	Noise Rej	Effective in Sample or Average Mode, > 10 mV/div to 5 V/div. Reduces DC Coupled trigger sensitivity by 2X.
	HF Rej	Same as DC Coupled limits from DC to 7 kHz.
	LF Ref	Same as DC Coupled limits for frequencies above 300 kHz.
Since AC coupling is not done in the front end, use of a 10 M probe does not affect the low frequency corner.		
Lowest Frequency for Successful Operation of "Set Level to 50%" Function, typical	<i>This is the typical lowest frequency for which the "Set Level to 50%" function will successfully determine the 50% point of the trigger signal.</i>	
	50 Hz.	Using a 10M probe will not affect the operation of this function.
Trigger Level Ranges, typical	<i>Input Channel</i>	± 8 divisions from center screen
	Ext	± 1.6 V
	Ext/5:	± 8 V
	The settable resolution for Trigger Level is 0.02 division for an input channel source, 4 mV for Ext source, and 20 mV for Ext/5 source.	
Trigger Level Accuracy, DC Coupled, typical	<i>This is the amount of deviation allowed between the level on the waveform at which triggering occurs and the level selected for DC-coupled triggering signals. A sine wave with 20 ns rise time corresponds to about 18 MHz.</i>	
	$\pm(0.2 \text{ div} + 5 \text{ mV})$ for signals within ± 4 divisions from the center screen, having rise and fall times of ≥ 20 ns.	
	Ext: $\pm(6\% \text{ of setting} + 40 \text{ mV})$ for signals less than ± 800 mV	
	Ext/5: $\pm(6\% \text{ of setting} + 200 \text{ mV})$ for signals less than ± 4 V	
Video Trigger		
Default Settings for Video Trigger	Trigger Mode: Auto	
	Trigger Coupling: AC	
Video Trigger Source Selection	Same as Source Selections listed above except Line Trigger. Line Trigger source is meaningless in this mode.	
Video Trigger Polarity Selection	Normal (Negative going Sync Signal), Invert (Positive going Sync Signal)	
Video Sync Selection	Line, Line #, Odd Field, Even Field, Field: PAL/SECAM, NTSC formats	
Video Trigger Formats and Field Rates	Field rates: 50 Hz to 60 Hz.	
	Line rates: 15 kHz to 20 kHz (NTSC, PAL, SECAM)	

Table 4: Triggering system (cont.)

Characteristic	Description
Video Trigger Sensitivity, typical	<i>This is the minimum peak-to-peak video signal required for stable Video-Type triggering. A 2 division composite video signal will have 0.6 division sync tip.</i>
	<i>Source</i> <i>Typical sensitivity</i>
	Input Channels 2 divisions of composite video
	Ext 400 mV of composite video
	Ext/5 2 V of composite video
Pulse-Width Trigger	
Pulse-Width Trigger Modes	< (Less than), > (Greater than), = (Equal), ≠ (Not equal)
Pulse Width Trigger Edge	Falling edge for positive polarity pulse. Rising edge for negative polarity pulse.
Pulse Width Range	33 ns ≤ width ≤ 10 seconds
Pulse Width Resolution	16.5 ns or 1 part per thousand, whichever is larger
Equal Guardband	$t > 330 \text{ ns}: \pm 5\% < \text{guardband} < \pm(5.1\% + 16.5 \text{ ns})$ $t \leq 330 \text{ ns}: \text{guardband} = \pm 16.5 \text{ ns}.$ <p>All pulses, even from the most stable sources, have some amount of jitter. To avoid disqualifying pulses that are intended to qualify but are not absolutely correct values, Tektronix provides an arbitrary guardband. Any measured pulse width within the guardband will qualify. If you are looking for pulse width differences that are smaller than the guardband width, offsetting the center should allow discriminating differences down to the guardband accuracy.</p>
Not Equal Guardband	$330 \text{ ns} < 1: \pm 5\% \leq \text{guardband} < \pm(5.1\% + 16.5 \text{ ns})$ $165 \text{ ns} < 1 < 330 \text{ ns}: \text{guardband} = -16.5 \text{ ns}/+33 \text{ ns}$ $t \leq 165 \text{ ns}: \text{guardband} = \pm 16.5 \text{ ns}$ <p>All pulses, even from the most stable sources, have some amount of jitter. To avoid disqualifying pulses that are intended to qualify but are not absolutely correct values, Tektronix provides an arbitrary guardband. Any measured pulse width outside the guardband will qualify. If you are looking for pulse width differences that are smaller than the guardband width, offsetting the center should allow discriminating differences down to the guardband accuracy. Not equal has slightly better ability to deal with small pulse widths than equal. The accuracy is not better.</p>
Pulse-Width Trigger Point	<p><i>Equal:</i> The oscilloscope triggers when the trailing edge of the pulse crosses the trigger level.</p> <p><i>Not Equal:</i> If the pulse is narrower than the specified width, the trigger point is the trailing edge. Otherwise, the oscilloscope triggers when a pulse continues longer than the time specified as the Pulse Width.</p> <p><i>Less than:</i> The trigger point is the trailing edge.</p> <p><i>Greater than</i> (also called the time out trigger): The oscilloscope triggers when a pulse continues longer than the time specified as the Pulse Width.</p>

Display Specifications

Table 5: Display specifications

Characteristic	Description
Display Type	<i>This is the description of the display, including its nominal screen size.</i> 17.0 cm (width) * 11.1 cm (height) * 0.8 cm (depth), 17.78 cm diagonal (7"), WVGA(800(H)X480(V)), active TFT color liquid crystal display (LCD) with color characters/waveforms on a black background.
Display Resolution	<i>This is the number of individually addressable pixels</i> 800 horizontal by 480 vertical pixels The video display contains both the character and waveform displays.
Brightness, typical	<i>This is the light output of the back light.</i> 300 cd/m ² , typical. 250 cd/m ² min. The brightness can be controlled by the PWM signal; a menu for this is provided.
Contrast Ratio and Control, typical	Available black room contrast ratio, full black to full white. 400 minimum, 500 typical.

Interfaces and Output Ports Specifications

Table 6: Interfaces and output ports specifications

Characteristic	Description
USB Device	USB 2.0 High Speed device. 480 Mb/second maximum. Supports PICTBRIDGE compatibility and provides USB-TMC communications with Tektronix extensions. Standard
USB Host	USB 2.0 Full Speed host. 12 Mb/sec maximum. Supports USB Mass Storage Class. Bulk Only Subclass only. Provides full 0.5 A of 5 V. Standard
USB Host Current	Provides full 0.5 A of 5 V. Standard
GPIB Interface	GPIB access via TEK-USB-488 accessory.
Probe Compensator, Output Voltage and Frequency, typical	<i>The Probe Compensator output voltage is in peak-to-peak Volts and frequency is in Hertz.</i> Output voltage: 5.0 V \pm 10% into 1 M Ω load. Frequency: 1 kHz

Data Handling Characteristics

Table 7: Data handling characteristics

Characteristic	Description
Retention of Front Panel Settings	Front panel settings are stored periodically in memory. The settings are not lost when the instrument is turned off or if there is a power failure.
Stored Waveforms and Multiple Front Panel Settings	Two Channel 1, Channel 2, or Math waveforms can be stored in nonvolatile waveform memory A or B. One, both, or neither of A or B waveform memories can be displayed. Ten user setups of the current instrument settings can be saved and restored from nonvolatile memory. Additional storage is available when an appropriate mass storage device is connected via USB.

Power Distribution System

Table 8: Power distribution system

Characteristic	Description
Power Consumption	Less than 30 W at 85 to 275 V _{AC} input.
Source Voltage	Full Range: 100 to 240 V _{ACRMS} ± 10%, Installation Category II (Covers range of 90 to 264 V _{AC})
Source Frequency	360 Hz to 440 Hz from 100 V _{AC} to 120 V _{AC} . 45 Hz to 66 Hz from 100 V _{AC} to 240 V _{AC} .
Fuse Rating	3.15 Amps, T rating, 250 V; IEC and UL approved.

Mechanical Characteristics

Table 9: Mechanical characteristics

Characteristic	Description
Weight	Requirements that follow are nominal: 2.0 kg (4.4 lbs), stand-alone instrument 2.2 kg (4.9 lbs), with accessories 3.6 kg (8 lbs), when packaged for domestic shipment
Size	Height 158 mm (6.22 in)
	Width 326.3 mm (12.85 in)
	Depth 124.1 mm (4.88 in)
Cooling Method	Convection cooled

Environmental Performance

Table 10: Environmental performance

Characteristic	Description	
Temperature	Operating	0° C to +50° C (32 °F to 122 °F)
	Nonoperating	–40° C to +71° C (–40 °F to 159.8 °F), with 5° C/minute maximum gradient
Humidity	Operating and Nonoperating	5% to 90% relative humidity (% RH) at up to +39° C 5% to 45% RH above +40° C up to +50° C, noncondensing, and as limited by a Maximum Wet-Bulb Temperature of +37° C (derates relative humidity to 45 % RH at +50° C)
Altitude	Operating	Up to 3,000 meters (9,842 feet)
	Nonoperating	Up to 12,000 meters (39,370 feet).

Data Logging System Characteristics

NOTE. This software feature directs the oscilloscope to automatically collect data over a period of time. After you configure the trigger conditions to use, you can use the data logging menu to set up the oscilloscope so that it will save all of the triggered waveform to a USB memory device, within a time duration that you have set.

Table 11: Data logging system characteristics

Characteristic	Description
Duration	The time period. 0.5 hour, 1 hour, 1.5 hour, 2 hour, 2.5 hour, 3 hour, 3.5 hour, 4 hour, 4.5 hour, 5 hour, 5.5 hour, 6 hour, 6.5 hour, 7 hour, 7.5 hour, 8 hour, 9 hour, 10 hour, 11 hour, 12 hour, 13 hour, 14 hour, 15 hour, 16 hour, 17 hour, 18 hour, 19 hour, 20 hour, 21 hour, 22 hour, 23 hour, 24 hour, Infinite
Source	The signal source which you want to save the waveform. Channel 1, Channel 2, Math
Select Folder	The file folder where you save the waveform data. You can create the new folder or change the existing folder as the folder where you want to save the waveform data.

Limit Testing System Characteristics

NOTE. This software feature directs the oscilloscope to monitor an active input signal against a template and to output pass or fail results by judging whether the input signal is within the bounds of the template.

Table 12: Limit testing system characteristics

Characteristic	Description
Source	The signal source which you want to do the limit testing. Channel 1, Channel 2, Math
Compare Ref Channel	The reference channel number where the template is saved. RefA, RefB, and DualRef. The limit testing system will compare the source signal with this template.
Run/Stop	To enable or disable the limit testing function. Run, Stop.
Template Setup	Use this menu item to set up a limit test waveform template. The template is the mask signal that you define as the boundary to compare with the input source signal. You can create the template from internal or external waveforms with specific horizontal and vertical tolerances.
Source	The location of the signal source that is used to create the limit test template. Single Ref(CH1, CH2, MATH) Dual Ref(CH1, CH2, MATH)
Vertical Limit	The vertical limit in vertical divisions. 0~1000 mdiv
Horizontal Limit	The horizontal limit in horizontal divisions. 0~500 mdiv.
Destination Ref Channel	The location of the reference memory location that is used to store the limit test template. RefA, RefB.
Display Template	Displays or does not display a stored test template. On, Off.
Action on Violation	Defines the actions the oscilloscope will take after a violation is detected. <i>Save Image:</i> The oscilloscope will automatically save a screen image when a violation is detected. <i>Save Waveform:</i> The oscilloscope will automatically save a digital copy of the source waveform when a violation is detected.
Stop After	Defines the conditions that will cause the oscilloscope to end limit testing. <i>Manual:</i> Lets you stop the test by toggling the "Run/stop" choice. <i>Waveforms:</i> Lets you set the numbers of waveforms to test before stopping limit testing. <i>Violations:</i> Lets you set the numbers of violations to detect before stopping limit testing. <i>Elapsed time:</i> Lets you set the elapsed test time in seconds to pass before stopping limit testing.

Performance Verification

This chapter contains performance verification procedures for the specifications marked with the check mark. The following equipment, or a suitable equivalent, is required to complete these procedures.

Required Equipment

Table 13: Performance verification

Description	Minimum requirements	Examples
DC Voltage Source	17.5 mV to 7 V, $\pm 0.5\%$ accuracy	Wavetek 9100 Universal Calibration System with Oscilloscope Calibration Module (Option 250)
Leveled Sine Wave Generator	50 kHz and 200 MHz, $\pm 3\%$ amplitude accuracy	Fluke 5500A Multi-product Calibrator with Oscilloscope Calibration Option (Option 5500A-SC)
Time Mark Generator	10 ms period, ± 10 ppm accuracy	
50 Ω BNC Cable	BNC male to BNC male, ≈ 1 m (36 in) long	Tektronix part number 012-0482-XX
50 Ω BNC Cable	BNC male to BNC male, ≈ 25 cm (10 in) long	Tektronix part number 012-0208-XX
50 Ω Feedthrough Termination	BNC male and female connectors	Tektronix part number 011-0049-XX
Dual Banana to BNC Adapter	Banana plugs to BNC female	Tektronix part number 103-0090-XX
BNC T Adapter	BNC male to dual BNC female connectors	Tektronix part number 103-0030-XX
Splitter, Power	Frequency range: DC to 4 GHz. Tracking: $>2.0\%$	Tektronix part number 015-0565-XX
Adapter (four required)	Male N-to-female BNC	Tektronix part number 103-045-XX
Adapter	Female N-to-male BNC	Tektronix part number 103-0058-XX
Leads, 3 Black	Stacking Banana Plug Patch Cord, ≈ 45 cm (18 in) long	Pomona #B-18-0
Leads, 2 Red	Stacking Banana Plug Patch Cord, ≈ 45 cm (18 in) long	Pomona #B-18-2

Test Record

Table 14: Test record

Instrument Serial Number:

Certificate Number:

Temperature:

RH %:

Date of Calibration:

Technician:

Instrument performance test	Minimum	Incoming	Outgoing	Maximum
Channel 1	5 mV/div	33.6 mV		36.4 mV
DC Gain Accuracy	200 mV/div	1.358 V		1.442 V
	2 V/div	13.58 V		14.42 V
Channel 2	5 mV/div	33.6 mV		36.4 mV
DC Gain Accuracy	200 mV/div	1.358 V		1.442 V
	2 V/div	13.58 V		14.42 V
Channel 1 Bandwidth		2.12 V		— ¹
Channel 2 Bandwidth		2.12 V		— ¹
Sample Rate and Delay Time Accuracy		-2 divs		+2 divs
Channel 1 Edge Trigger Sensitivity		Stable trigger		— ²
Channel 2 Edge Trigger Sensitivity		Stable trigger		— ²
External Edge Trigger Sensitivity		Stable trigger		— ²
Channel 1 Vertical Position Accuracy, Minimum margin		0		—
Channel 2 Vertical Position Accuracy, Minimum margin		0		—

¹ The bandwidth test does not have a high limit.

² The limits vary by model. Check the procedure for the correct limits.

Performance Verification Procedures

Before beginning these procedures, two conditions must be met:

- The oscilloscope must have been operating continuously for twenty minutes within the operating temperature range specified in the Environmental Performance table. (See Table 10.)
- You must perform the Self Calibration operation described below. If the ambient temperature changes by more than 5 °C, you must perform the Self Calibration operation again.

The time required to complete the entire procedure is approximately one hour.



WARNING. Some procedures use hazardous voltages. To prevent electrical shock, always set voltage source outputs to 0 V before making or changing any interconnections.

Self Test

This internal procedure is automatically performed every time the oscilloscope is powered on. No test equipment or hookups are required. Verify that no error messages are displayed before continuing with this procedure.

Self Calibration

The self calibration routine lets you quickly optimize the oscilloscope signal path for maximum measurement accuracy. You can run the routine at any time, but you should always run the routine if the ambient temperature changes by 5 °C or more.

1. Disconnect all probes and cables from the channel input connectors (channels 1 and 2).
2. Push the **Utility** button and select the **Do Self Cal** option to start the routine. The routine takes approximately one minute to complete.
3. Verify that self calibration passed.

Check DC Gain Accuracy

This test checks the DC gain accuracy of all input channels.

1. Set the DC voltage source output level to **0 V**.
2. Set up the oscilloscope using the following table:

Push menu button	Select menu option	Select setting
Default Setup	—	—
Channel 1	Probe	1X
Acquire	Average	16
Measure	Source	Channel under test
	Measurements	Mean

3. Connect the oscilloscope channel under test to the DC voltage source as shown in the following figure:

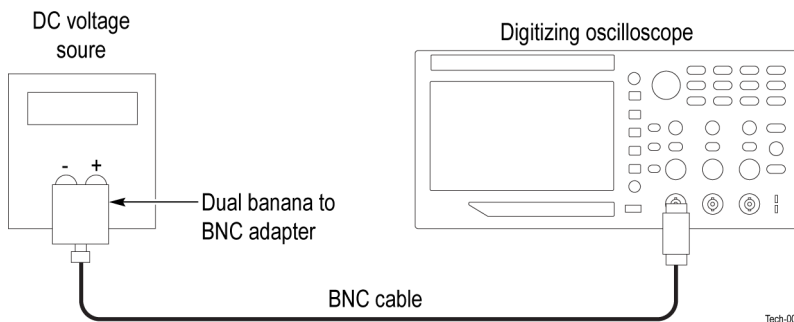

4. For each vertical scale (volts/division) setting in the following table, perform the following steps:
 - a. Set the DC voltage source output level to the positive voltage listed and then record the mean measurement as V_{pos} .
 - b. Reverse the polarity of the DC voltage source and record the mean measurement as V_{neg} .
 - c. Calculate $V_{diff} = V_{pos} - V_{neg}$ and compare V_{diff} to the accuracy limits in the following table:

Vertical Scale (volts/div) setting	DC voltage source output levels	Accuracy limits for V_{diff}
5 mV/div	+17.5 mV, -17.5 mV	33.6 mV to 36.4 mV
200 mV/div	+700 mV, -700 mV	1.358 V to 1.442 V
2 V/div	+7.00 V, -7.00 V	13.58 V to 14.42 V

- Set DC voltage source output level to **0 V**.
- Disconnect the test setup.
- Repeat steps 1 through 6 for all input channels.

Check Bandwidth

This test checks the bandwidth of all input channels.

- Set up the oscilloscope using the following table:

Push menu button	Select menu option	Select setting
Default Setup	—	—
Channel 1	Probe	1X
Acquire	Average	16
Trig Menu	Coupling	Noise Reject
Measure	Source	Channel under test
	Measurements	Peak-Peak

- Connect the oscilloscope channel under test to the leveled sine wave generator as shown in the following figure:

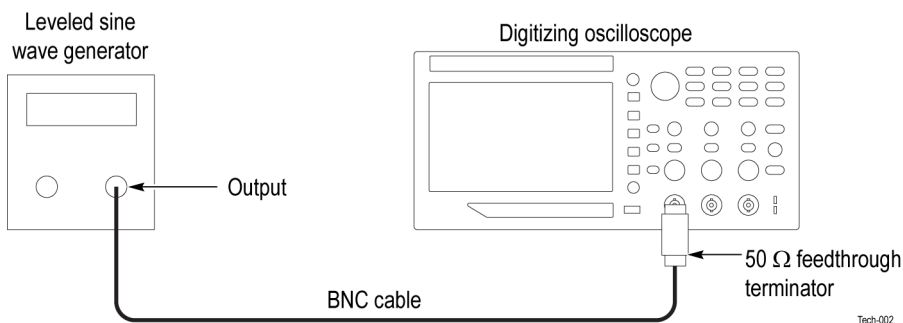

- Set the oscilloscope **Vertical Scale** (volts/division) to **500 mV/div**.
- Set the oscilloscope **Horizontal Scale** (seconds/division) to **10 μs/div**.
- Set the leveled sine wave generator frequency to **50 kHz**.
- Set the leveled sine wave generator output level so the peak-to-peak measurement is between **2.98 V** and **3.02 V**.

7. Set the leveled sine wave generator frequency to:
 - **200 MHz** if you are checking a TBS1202B or TBS1202B-EDU
 - **150 MHz** if you are checking a TBS1152B or TBS1152B-EDU
 - **100 MHz** if you are checking a TBS1102B or TBS1102B-EDU
 - **70 MHz** if you are checking a TBS1072B or TBS1072B-EDU
 - **50 MHz** if you are checking a TBS1052B or TBS1052B-EDU
 - **30 MHz** if you are checking a TBS1032B
8. Set the oscilloscope **Horizontal Scale** (seconds/division) to **10 ns/div**.
9. Check that the peak-to-peak measurement is $\geq 2.12 \text{ V}$.
10. Disconnect the test setup.
11. Repeat steps 1 through 10 for all input channels.

Check Sample Rate Accuracy and Delay Time Accuracy

This test checks the time base accuracy.

1. Set up the oscilloscope using the following table:

Push menu button	Select menu option	Select setting
Default Setup	—	—
Channel 1	Probe	1X

2. Connect the oscilloscope to the time mark generator as shown in the following figure:

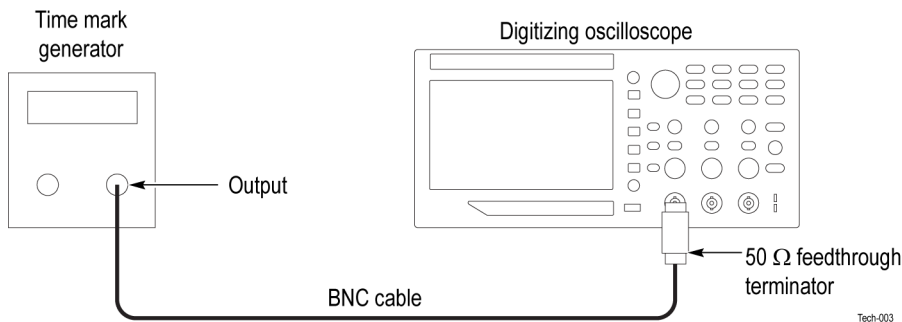

3. Set the time mark generator period to **10 ms**.
4. Set the oscilloscope **Vertical Scale** (volts/division) to **500 mV/div**.
5. Set the oscilloscope Main **Horizontal Scale** (seconds/division) to **1 ms/div**.
6. Push the **Trigger Level** knob to activate the **Set To 50%** feature.
7. Use the **Vertical Position** control to center the test signal on screen.
8. Use the **Horizontal Position** control to set the position to **10.00 ms**.
9. Set the oscilloscope **Horizontal Scale** (seconds/division) to **250 ns/div**.

10. Check that the rising edge of the marker crosses the center horizontal graticule line within ± 2 divisions of the vertical center graticule line, as shown in the following figure:

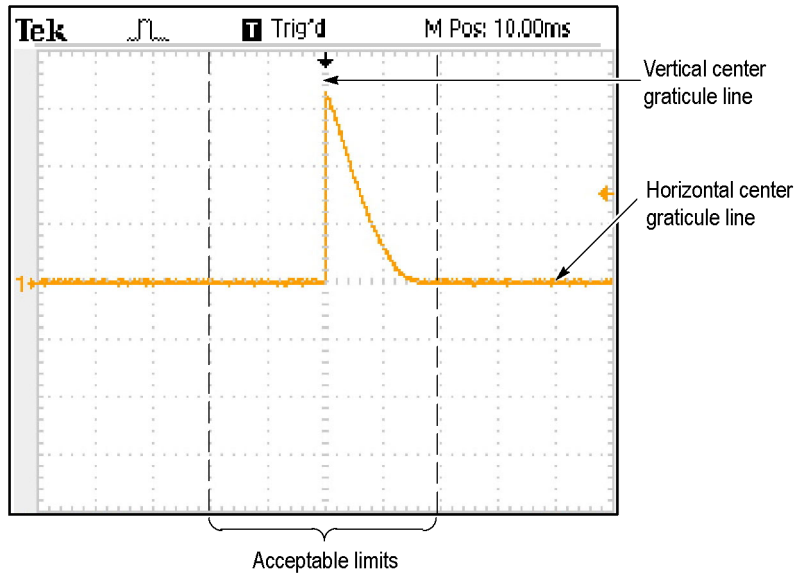

NOTE. One division of displacement from graticule center corresponds to a 25 ppm time base error.

11. Disconnect the test setup.

Check Edge Trigger Sensitivity

This test checks the edge trigger sensitivity for all input channels.

1. Set up the oscilloscope using the following table:

Push menu button	Select menu option	Select setting
Default Setup	—	—
Channel 1	Probe	1X
Trig Menu	Mode	Normal
Acquire	Sample	—
Measure	Source	Channel under test
	Measurements	Peak-Peak

2. Connect the oscilloscope channel under test to the leveled sine wave generator as shown in the following figure:

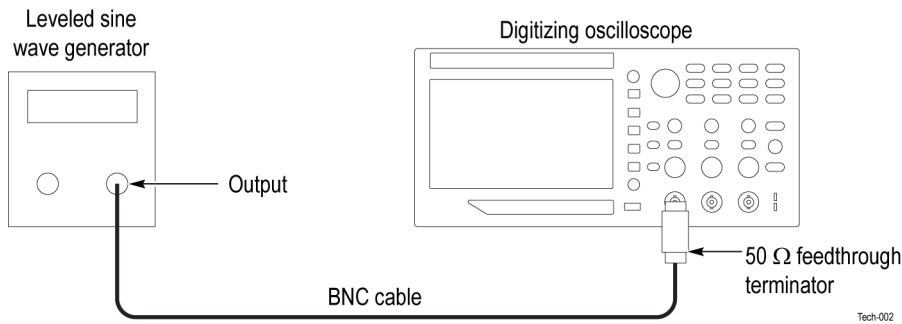

3. Set the oscilloscope **Vertical Scale** (volts/division) to **500 mV/div**.
4. Set the oscilloscope **Horizontal Scale** (seconds/division) to **25 ns/div**.
5. Set the leveled sine wave generator frequency to **10 MHz**.
6. Set the leveled sine wave generator output level to approximately **500 mV_{p-p}** so that the measured amplitude is approximately **500 mV**. (The measured amplitude can fluctuate around 500 mV.)
7. Push the **Trigger Level** knob to activate the **Set To 50%**. Rotate the **Trigger Level** knob to adjust the trigger level as necessary and then check that triggering is stable.
8. Set the leveled sine wave generator frequency to:
 - **200 MHz** if you are checking a TBS1202B or TBS1202B-EDU
 - **150 MHz** if you are checking a TBS1152B or TBS1152B-EDU
 - **100 MHz** if you are checking a TBS1102B or TBS1102B-EDU
 - **70 MHz** if you are checking a TBS1072B or TBS1072B-EDU
 - **50 MHz** if you are checking a TBS1052B or TBS1052B-EDU
 - **30 MHz** if you are checking a TBS1032B
9. Set the oscilloscope **Horizontal Scale** (seconds/division) to **5 ns/div**.
10. Set the leveled sine wave generator output level to approximately **750 mV_{p-p}** so that the measured amplitude is approximately **750 mV**. (The measured amplitude can fluctuate around 750 mV.)
11. Push the **Trigger Level** knob to activate the **Set To 50%** feature. Rotate the **Trigger Level** knob to adjust the trigger level as necessary and then check that triggering is stable.
12. For the TBS1152B, TBS1152B-EDU, TBS1202B, and TBS1202B-EDU models, set the frequency to 150 MHz, and increase the amplitude to 1 V_{p-p}. Verify stable triggering.
13. Set the oscilloscope **Horizontal Scale** (seconds/division) to **2.5 ns/div**.
14. Change the oscilloscope setup using the following table:

Push menu button	Select menu option	Select setting
Trig Menu	Slope	Falling

15. Push the **Trigger Level** knob to activate the **Set To 50%** feature. Rotate the **Trigger Level** knob to adjust the trigger level as necessary and then check that triggering is stable.

16. Disconnect the test setup.
17. Repeat steps 1 through 16 for all input channels.

Check External Edge Trigger Sensitivity

This test checks the edge trigger sensitivity for the external trigger.

1. Set up the oscilloscope using the following table:

Push menu button	Select menu option	Select setting
Default Setup	—	—
Channel 1	Probe	1X
Trig Menu	Source	Ext
	Mode	Normal
Acquire	Sample	—
Measure	Source	CH1
	Measurements	Peak-Peak

2. Connect the oscilloscope to the leveled sine wave generator as shown in the following figure, using channel 1 and **Ext Trig**.

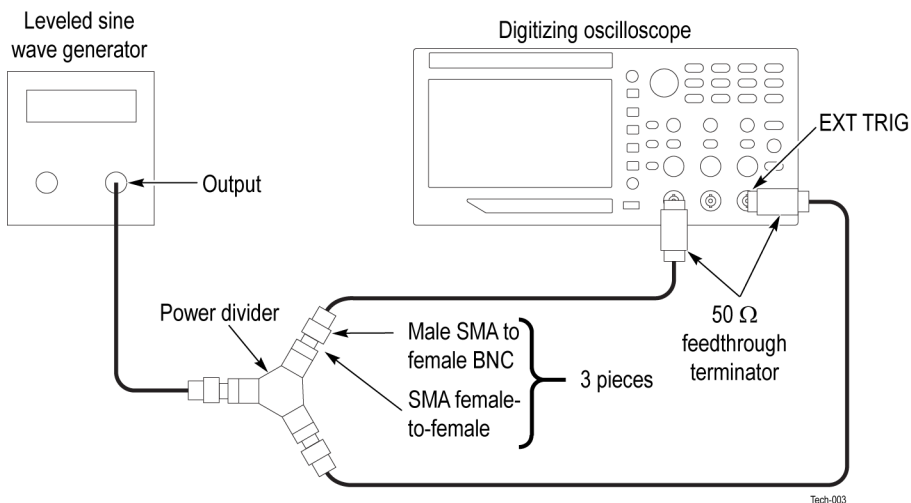

3. Set the oscilloscope **Vertical Scale** (volts/division) to **100 mV/div**.
4. Set the oscilloscope **Horizontal Scale** (seconds/division) to **25 ns/div**.
5. Set the leveled sine wave generator frequency to **10 MHz**.
6. Set the sine wave generator output level to approximately **300 mV_{p-p}** into the power splitter. This is about **200 mV_{p-p}** on channel 1 of the oscilloscope.

The **Ext Trig** input will also be receiving approximately 200 mV_{p-p}. Small deviations from the nominal 200 mV_{p-p} oscilloscope display are acceptable.

7. Set the leveled sine wave generator frequency to:
 - **200 MHz** if you are checking a TBS1202B or TBS1202B-EDU
 - **150 MHz** if you are checking a TBS1152B or TBS1152B-EDU
 - **100 MHz** if you are checking a TBS1102B or TBS1102B-EDU
 - **70 MHz** if you are checking a TBS1072B or TBS1072B-EDU
 - **50 MHz** if you are checking a TBS1052B or TBS1052B-EDU
 - **30 MHz** if you are checking a TBS1032B
8. Set the oscilloscope **Horizontal Scale** (seconds/division) to **5 ns/div**.
9. Push the **Trigger Level** knob to activate the **Set To 50%** feature. Rotate the **Trigger Level** knob to adjust the trigger level as necessary and then check that triggering is stable.
10. Set the oscilloscope **Horizontal Scale** (seconds/division) to **2.5 ns/div**.
11. Push the **Trigger Level** knob to activate the **Set To 50%** feature. Rotate the **Trigger Level** knob to adjust the trigger level as necessary and then check that triggering is stable.
12. Change the oscilloscope setup using the following table:

Push menu button	Select menu option	Select setting
Trig Menu	Slope	Falling

13. Push the **Trigger Level** knob to activate the **Set To 50%** feature. Rotate the **Trigger Level** knob to adjust the trigger level as necessary and then check that triggering is stable.
14. Disconnect the test setup.

Check Vertical Position Accuracy

The results of this test and the DC Gain Accuracy test together define the DC Measurement Accuracy of the oscilloscope. The DC Measurement Accuracy specification encompasses two different ranges of operation over two different attenuator settings.

- **DC Gain Accuracy:** Identifies errors, mostly from the A/D converter, when the vertical position (known as offset in these oscilloscopes) is set to 0 divisions (or a grounded input will show screen center)
- **Vertical Position Accuracy:** Identifies errors, mostly from the position control, made when the vertical position is set to a non-zero value

The two attenuator settings operate identically, so verification of the attenuation range from -1.8 V to 1.8 V also verifies the attenuation range of -45 V to 45 V.

1. Set up the oscilloscope as shown in the following table:

Push menu button	Select menu option	Select setting
Default Setup	—	—
Channels 1, 2,	Probe	1X
Channels 1, 2,	Volts/Div	50 mV/div
Trig Menu	Source	Ext ¹
	Mode	Auto
Acquire	Sample	—
Measure	Source	Channel under test
	Measurements	Mean

- 1 The test operates without a trigger. To maintain uniformity and to avoid false triggering on noise, the Ext trigger is the recommended source.
2. Make a spreadsheet approximately as shown in the example in Appendix A. You only need to enter the values for column A and the equations. The values in columns B, C, D, E, F, and G are examples of the measured or calculated values.

The PDF version of the technical reference manual (which you can download from www.tektronix.com/manuals), includes an empty spreadsheet for your convenience. To access and save the test spreadsheet, see the instructions in *Appendix A: Example of a Vertical Position Accuracy Test Spreadsheet* on page A-1.

3. Connect the oscilloscope, power supply, and voltmeter as shown in the following figure:

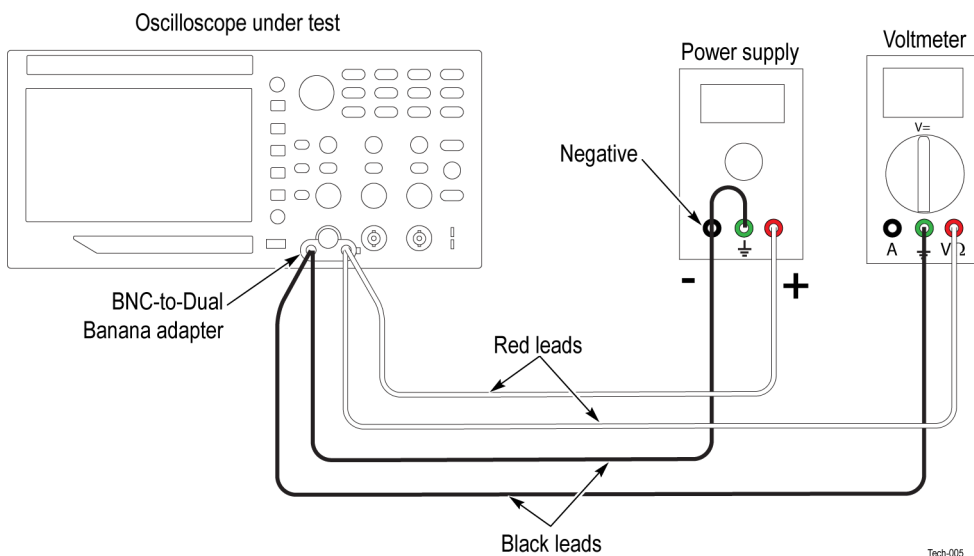

4. Set the power supply to the 1.8 V value shown in column A, the Approximate Test Voltage.
5. Adjust the vertical position knob for the DC line to position the line in the center of the screen.
6. Enter the voltage on the voltmeter and on the oscilloscope into the spreadsheet in the appropriate columns, B and C.
7. Repeat steps 4 through 6 for the values of 1.76 V through 0 V.
8. Swap the connections to the positive terminal of the power supply with those at the negative terminal as shown in the following figure:

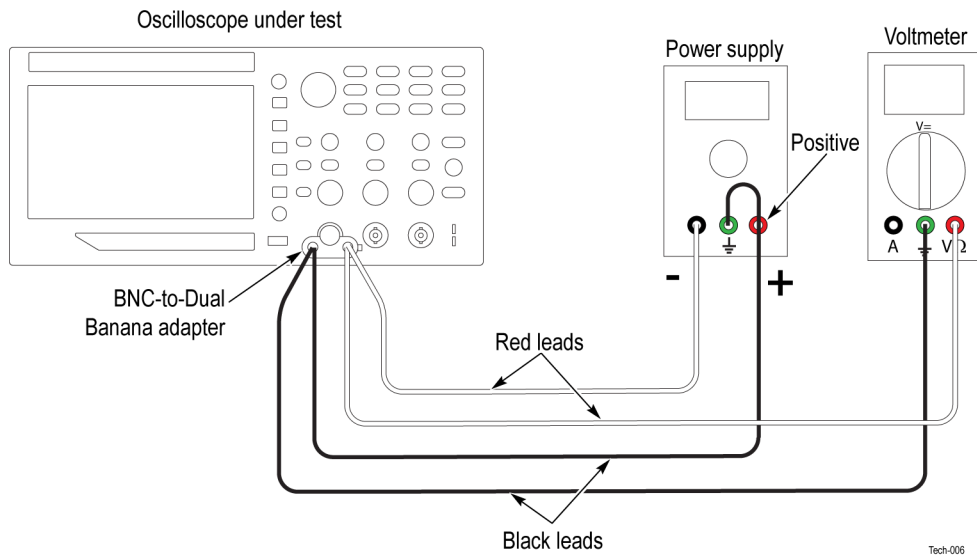

9. Repeat steps 4 through 6 for the values of -0.04 V through -1.8 V.
10. Enter the Minimum Margin number (cell I16) for the channel tested in the test record.
11. Repeat steps 1 through 10 for all input channels.

Data verification. To verify data, set the spreadsheet to present a line graph of columns D, E, and F. Verify that no error values (the blue line in the center) go above the yellow line (upper line), or below the purple line (lower line). For calculations involved in this example, refer to the data in the previous table (see step 1).

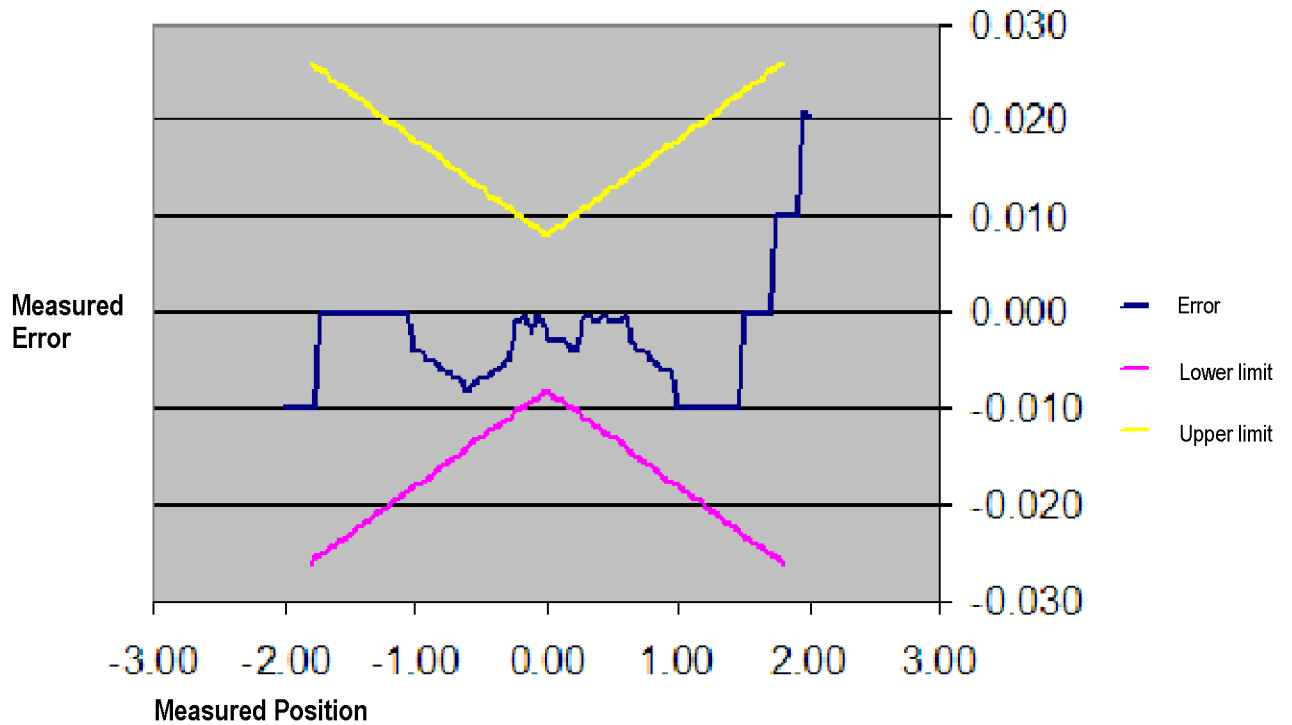

Figure 1: Example of a line graph for the Vertical Position Accuracy test

Example of a Vertical Position Accuracy Test Spreadsheet

This appendix contains a filled-in example of the vertical position accuracy (VPA) test spreadsheet that is used. (See page 26, *Check Vertical Position Accuracy*.)

The PDF version of this technical reference manual (Tektronix part number 077-1025-xx) includes an empty VPA test spreadsheet for your convenience. To access and save the test spreadsheet:

1. Go to the Tektronix manuals Web site, www.tektronix.com/manuals.
2. Enter **077102501** in the **Search Manuals** field and click **Go**.
3. Click **Download** for the TBS1000B and TBS1000B-EDU Series Digital Storage Oscilloscopes Technical Reference Manual (Tektronix part number 077-1025-xx) and follow the instructions to download the file to your PC.
4. Open the PDF file in Adobe Reader (version 7 or later).
5. Click the **Attachments** tab or click **View > Navigation Panels > Attachments** to display the Attachments panel.
6. Double-click the **VPA Test Table.xls** file.
7. Click **OK** in the **Launch Attachment** dialog box. The test spreadsheet opens in your spreadsheet application and shows the **Blank Test Record** spreadsheet tab.
8. Click **File > Save As** to save the file to a name and location that you enter. You can now use the spreadsheet to enter values for the vertical position accuracy test.

Sample Filled-In Vertical Position Accuracy Test Spreadsheet

Table 15: Vertical position accuracy test spreadsheet

	A	B	C	D	E	F	G	H	I
1	Approximate Test Voltage	DVM Measured Voltage	Oscilloscope Measured Voltage	Error	Lower Limit	Upper Limit	Margin		
2	2.00			0.000	‡	‡	‡	Volts/div	0.05
3	1.96			0.000	‡	‡	‡		
4	1.92			0.000	‡	‡	‡	Offset as a fractional division	0.1
5	1.88			0.000	‡	‡	‡	Offset in volts	0.005
6	1.84			0.000	‡	‡	‡	Total voltage offset	0.01=I2* I4+I5
7	1.80	1.80	1.79	0.010	-0.028	0.028	0.018		

Table 15: Vertical position accuracy test spreadsheet (cont.)

8	1.76	1.76	1.75	0.010	-0.02 76	0.027 6	0.018	Gain error	1%
9	1.72	1.72	1.72	0.000	-0.02 72	0.027 2	0.027		
10	1.68	1.68	1.68	0.000	-0.02 68	0.026 8	0.027	Equa- tion for cell D7	=B7-C7
11	1.64	1.64	1.64	0.000	-0.02 64	0.026 4	0.026	Equa- tion for cell E7	=-F7
12	1.60	1.6	1.6	0.000	-0.02 6	0.026	0.026	Equa- tion for cell F7	=(ABS(B7)*\$I\$8 + \$I\$6)
13	1.56	1.56	1.56	0.000	-0.02 56	0.025 6	0.026		
14	1.52	1.52	1.52	0.000	-0.02 52	0.025 2	0.025	Equa- tion for cell G7	=MIN (D7- E7,F7- D7)
15	1.48	1.48	1.49	-0.01 0	-0.02 48	0.024 8	0.015		
16	1.44	1.44	1.45	-0.01 0	-0.02 44	0.024 4	0.014	Mini- mum margin	0.007= MIN (G7:G97)
17	1.40	1.4	1.41	-0.01 0	-0.02 4	0.024	0.014		
18	1.36	1.36	1.37	-0.01 0	-0.02 36	0.023 6	0.014		
19	1.32	1.32	1.33	-0.01 0	-0.02 32	0.023 2	0.013		
20	1.28	1.28	1.29	-0.01 0	-0.02 28	0.022 8	0.013		
21	1.24	1.24	1.25	-0.01 0	-0.02 24	0.022 4	0.012		
22	1.20	1.2	1.21	-0.01 0	-0.02 2	0.022	0.012		
23	1.16	1.16	1.17	-0.01 0	-0.021 6	0.021 6	0.012		
24	1.12	1.12	1.13	-0.01 0	-0.021 2	0.021 2	0.011		
25	1.08	1.08	1.09	-0.01 0	-0.02 08	0.020 8	0.011		
26	1.04	1.04	1.05	-0.01 0	-0.02 04	0.020 4	0.010		

Table 15: Vertical position accuracy test spreadsheet (cont.)

27	1.00	1	1.01	-0.01 0	-0.02	0.02	0.010
28	0.96	0.96	0.966	-0.00 6	-0.01 96	0.019 6	0.014
29	0.92	0.92	0.926	-0.00 6	-0.01 92	0.019 2	0.013
30	0.88	0.88	0.886	-0.00 6	-0.01 88	0.018 8	0.013
31	0.84	0.84	0.845	-0.00 5	-0.01 84	0.018 4	0.013
32	0.80	0.8	0.805	-0.00 5	-0.01 8	0.018	0.013
33	0.76	0.76	0.764	-0.00 4	-0.01 76	0.017 6	0.014
34	0.72	0.72	0.724	-0.00 4	-0.01 72	0.017 2	0.013
35	0.68	0.68	0.683	-0.00 3	-0.01 68	0.016 8	0.014
36	0.64	0.64	0.643	-0.00 3	-0.01 64	0.016 4	0.013
37	0.60	0.6	0.6	0.000	-0.01 6	0.016	0.016
38	0.56	0.56	0.561	-0.00 1	-0.01 56	0.015 6	0.015
39	0.52	0.52	0.521	-0.00 1	-0.01 52	0.015 2	0.014
40	0.48	0.48	0.481	-0.00 1	-0.01 48	0.014 8	0.014
41	0.44	0.44	0.44	0.000	-0.01 44	0.014 4	0.014
42	0.40	0.4	0.401	-0.00 1	-0.01 4	0.014	0.013
43	0.36	0.36	0.361	-0.00 1	-0.01 36	0.013 6	0.013
44	0.32	0.32	0.32	0.000	-0.01 32	0.013 2	0.013
45	0.28	0.28	0.281	-0.00 1	-0.01 28	0.012 8	0.012
46	0.24	0.24	0.244	-0.00 4	-0.01 24	0.012 4	0.008
47	0.20	0.2	0.204	-0.00 4	-0.01 2	0.012	0.008
48	0.16	0.16	0.163	-0.00 3	-0.011 6	0.011 6	0.009

Table 15: Vertical position accuracy test spreadsheet (cont.)

49	0.12	0.12	0.123	-0.00 3	-0.011 2	0.011 2	0.008
50	0.08	0.08	0.083	-0.00 3	-0.01 08	0.010 8	0.008
51	0.04	0.04	0.043	-0.00 3	-0.01 04	0.010 4	0.007
52	0.00	0	0.002	-0.00 2	-0.01	0.01	0.008
53	-0.04	-0.04	-0.039	-0.00 1	-0.01 04	0.010 4	0.009
54	-0.08	-0.079	-0.079	0.000	-0.01 079	0.010 79	0.011
55	-0.12	-0.12	-0.118	-0.00 2	-0.011 2	0.011 2	0.009
56	-0.16	-0.159	-0.159	0.000	-0.011 59	0.011 59	0.012
57	-0.20	-0.199	-0.198	-0.00 1	-0.011 99	0.011 99	0.011
58	-0.24	-0.239	-0.238	-0.00 1	-0.01 239	0.012 39	0.011
59	-0.28	-0.279	-0.274	-0.00 5	-0.01 279	0.012 79	0.008
60	-0.32	-0.319	-0.314	-0.00 5	-0.01 319	0.013 19	0.008
61	-0.36	-0.359	-0.353	-0.00 6	-0.01 359	0.013 59	0.008
62	-0.40	-0.399	-0.393	-0.00 6	-0.01 399	0.013 99	0.008
63	-0.44	-0.439	-0.432	-0.00 7	-0.01 439	0.014 39	0.007
64	-0.48	-0.48	-0.473	-0.00 7	-0.01 48	0.014 8	0.008
65	-0.52	-0.52	-0.513	-0.00 7	-0.01 52	0.015 2	0.008
66	-0.56	-0.56	-0.552	-0.00 8	-0.01 56	0.015 6	0.008
67	-0.6	-0.6	-0.592	-0.00 8	-0.01 6	0.016	0.008
68	-0.64	-0.64	-0.633	-0.00 7	-0.01 64	0.016 4	0.009
69	-0.68	-0.68	-0.673	-0.00 7	-0.01 68	0.016 8	0.010
70	-0.72	-0.72	-0.713	-0.00 7	-0.01 72	0.017 2	0.010

Table 15: Vertical position accuracy test spreadsheet (cont.)

71	-0.76	-0.76	-0.754	-0.00 6	-0.01 76	0.017 6	0.012
72	-0.80	-0.8	-0.794	-0.00 6	-0.01 8	0.018	0.012
73	-0.84	-0.84	-0.835	-0.00 5	-0.01 84	0.018 4	0.013
74	-0.88	-0.88	-0.875	-0.00 5	-0.01 88	0.018 8	0.014
75	-0.92	-0.92	-0.915	-0.00 5	-0.01 92	0.019 2	0.014
76	-0.96	-0.96	-0.956	-0.00 4	-0.01 96	0.019 6	0.016
77	-1.00	-1	-0.996	-0.00 4	-0.02	0.02	0.016
78	-1.04	-1.04	-1.04	0.000	-0.02 04	0.020 4	0.020
79	-1.08	-1.08	-1.08	0.000	-0.02 08	0.020 8	0.021
80	-1.12	-1.12	-1.12	0.000	-0.021 2	0.021 2	0.021
81	-1.16	-1.16	-1.16	0.000	-0.021 6	0.021 6	0.022
82	-1.20	-1.2	-1.2	0.000	-0.02 2	0.022	0.022
83	-1.24	-1.24	-1.24	0.000	-0.02 24	0.022 4	0.022
84	-1.28	-1.28	-1.28	0.000	-0.02 28	0.022 8	0.023
85	-1.32	-1.32	-1.32	0.000	-0.02 32	0.023 2	0.023
86	-1.36	-1.36	-1.36	0.000	-0.02 36	0.023 6	0.024
87	-1.40	-1.4	-1.4	0.000	-0.02 4	0.024	0.024
88	-1.44	-1.44	-1.44	0.000	-0.02 44	0.024 4	0.024
89	-1.48	-1.48	-1.48	0.000	-0.02 48	0.024 8	0.025
90	-1.52	-1.52	-1.52	0.000	-0.02 52	0.025 2	0.025
91	-1.56	-1.56	-1.56	0.000	-0.02 56	0.025 6	0.026
92	-1.60	-1.6	-1.6	0.000	-0.02 6	0.026	0.026

Table 15: Vertical position accuracy test spreadsheet (cont.)

93	-1.64	-1.64	-1.64	0.000	-0.02 64	0.026 4	0.026
94	-1.68	-1.68	-1.68	0.000	-0.02 68	0.026 8	0.027
95	-1.72	-1.72	-1.72	0.000	-0.02 72	0.027 2	0.027
96	-1.76	-1.76	-1.75	-0.01 0	-0.02 76	0.027 6	0.018
97	-1.80	-1.8	-1.79	-0.01 0	-0.02 8	0.028	0.018
98	-1.84				‡	‡	‡
99	-1.88				‡	‡	‡
100	-1.92				‡	‡	‡
101	-1.96				‡	‡	‡
102	-2.00				‡	‡	‡

‡ These test values are outside of the range in the specification.

Index

B

bandwidth test, 21

C

calibration

Do Self Cal, 20

D

DC gain accuracy test, 20

delay time accuracy test, 22

E

edge trigger sensitivity test, 23

equipment required

performance verification, 18

external edge trigger sensitivity
test, 25

P

performance verification, 18

S

sample rate and delay time accuracy
test, 22

self calibration, 20

specifications, 1

V

Vertical position accuracy test, 26

example line graph, 29

example spreadsheet, 30