



**TekExpress® C-PHY  
Automated Test Software  
Application Help (6 Series MSO)**



077-1717-01





**TekExpress® C-PHY**  
**Automated Test Software**  
**Application Help (6 Series MSO)**

**Register now!**  
**Click the following link to protect your product.**  
**[www.tek.com/register](http://www.tek.com/register)**



077-1717-01

Copyright © Tektronix. All rights reserved. Licensed software products are owned by Tektronix or its subsidiaries or suppliers, and are protected by national copyright laws and international treaty provisions. Tektronix products are covered by U.S. and foreign patents, issued and pending. Information in this publication supersedes that in all previously published material. Specifications and price change privileges reserved.

TEKTRONIX and TEK are registered trademarks of Tektronix, Inc.

## **Contacting Tektronix**

Tektronix, Inc.

14150 SW Karl Braun Drive

P.O. Box 500

Beaverton, OR 97077

USA

For product information, sales, service, and technical support:

- In North America, call 1-800-833-9200.
- Worldwide, visit to [www.tek.com](http://www.tek.com) find contacts in your area.

# Table of Contents

Welcome.....	9
C-PHY Tx 2.0 key features.....	10
Getting help and support.....	11
Product documents.....	11
Conventions.....	11
Technical support.....	12
Getting started.....	13
Hardware requirements.....	13
Supported oscilloscopes.....	13
Minimum system requirements.....	13
Instruments and accessories.....	14
Software requirements.....	14
Downloading and installing the software.....	14
Activate the license.....	14
View software version and license key details.....	14
Setting up the test environment.....	16
Installing the software.....	16
About setting up tests.....	16
Instrument connection setup.....	16
Search instruments connected to the application.....	21
Test setup overview.....	22
About running tests.....	23
Before you click start.....	23
Pre-test checklist.....	23
Starting the application.....	25
Application controls.....	25
Options menu functions.....	27
Configure email settings.....	28
TekExpress instrument control settings.....	29
Setup panel: Configure the test setup.....	30
DUT: Set DUT settings.....	31
Multiple-session run .....	34
Test Selection: Select the tests.....	34
Acquisitions: Set waveform acquisition settings.....	35
Configuration: Set measurement limits for tests.....	37
Preferences: Set the test run preferences.....	40
Status panel: View the test execution status.....	42
View test execution status.....	42
View test execution logs.....	43
Results panel: View summary of test results.....	45
Filter the test results.....	45
Reports panel: Configure report generation settings.....	46
Report configuration settings.....	46
Configure report view settings.....	48

View a generated report.....	49
Saving and recalling test setup.....	50
Test setup files overview.....	50
Save the configured test setup.....	50
Load a saved test setup.....	50
Select a pre-run session from the loaded test setup.....	50
Save the test setup with a different name.....	51
Application measurements.....	52
1.1.1 Thevenin Output High Level Voltage (VOH).....	52
1.1.2 LP-TX Thevenin Output Low Level Voltage (VOL).....	52
1.1.3 LP-TX 15%-85% Rise Time (tR <sub>LP</sub> ).....	52
1.1.4 LP-TX 15%-85% Fall Time (t <sub>F</sub> <sub>LP</sub> ).....	52
1.1.5 LP-TX Slew Rate versus C <sub>LOAD</sub> (dV/dt <sub>SR</sub> ).....	53
1.1.6 LP-TX pulse width of Exclusive-OR Clock (t <sub>LP-PULSE-TX</sub> ).....	53
1.1.7 LP-TX Period of Exclusive-OR Clock (t <sub>LP-PER-TX</sub> ).....	53
1.1.8 t <sub>LP-EXIT</sub> value.....	54
1.2.1 tL <sub>PX</sub> Duration.....	54
1.2.2 t3-PREPARE Duration.....	54
1.2.3 t3-PREBEGIN Duration.....	54
1.2.4 t3-PROGSEQ Duration.....	54
1.2.5 t3- PREEND Duration.....	55
1.2.6 t3-SYNC Duration .....	55
1.2.7 HS-TX Differential Voltages (VOD_AB, VOD_BC, VOD_CA).....	55
1.2.8 HS-TX Differential Voltage Mismatch (ΔVOD).....	55
1.2.9 HS-TX Single-Ended Output High Voltages (VOHHS(VA), VOHHS(VB), VOHHS(VC)).....	56
1.2.10 HS-TX Static Common-Point Voltages (VCPTX).....	56
1.2.11 HS-TX Static Common-Point Voltage Mismatch (ΔVCPTX(HS)).....	56
1.2.12 HS-TX Dynamic Common-Point Variations Between 50-450 MHz (ΔVCPTX(LF)).....	56
1.2.13 HS-TX Dynamic Common-Point Variations Above 450 MHz (ΔVCPTX(HF)).....	57
1.2.14 HS-TX Rise Time (tR).....	57
1.2.15 HS-TX Fall Time (tF).....	57
1.2.16 t3-POST Duration.....	57
1.2.17 30%-85% Post-EoT Rise Time (tREOT).....	57
1.2.18 tHS-EXIT Value.....	58
1.2.19 HS Clock Instantaneous UI (UIINST).....	58
1.2.20 HS Clock Delta UI (ΔUI) (OBSOLETE).....	58
1.2.21 HS-TX Eye Diagram.....	58
1.2.22 HS-TX UI Jitter (UI_JitterPEAK_TX).....	59
1.3.1 INIT: LP-TX Initialization Period (t <sub>INIT,MASTER</sub> ).....	59
1.3.2 ULPS Exit: Transmitted t <sub>WAKEUP</sub> Interval.....	59
1.3.3 BTA: TX-Side t <sub>TA-GO</sub> Interval Value.....	59
1.3.4 BTA: RX-Side t <sub>TA-SURE</sub> Interval Value.....	60
1.3.5 BTA: RX-Side t <sub>TA-GET</sub> Interval Value.....	60
1.4.1 HS-TX Differential Voltages Unterminated (V <sub>OD(UT)-AB</sub> , V <sub>OD(UT)-BC</sub> , V <sub>OD(UT)-CA</sub> ).....	60
1.4.2 HS-TX Differential Voltage Mismatch Unterminated (ΔV <sub>OD(UT)</sub> ).....	60
1.4.3 HS-TX Single-Ended Output High Voltages Unterminated (V <sub>OHHS(UT)(VA)</sub> , V <sub>OHHS(UT)(VB)</sub> , V <sub>OHHS(UT)(VC)</sub> ).....	61
1.4.4 HS-TX Static Common-Point Voltages Unterminated (V <sub>CPTX(UT)</sub> ).....	61

1.5.1 t3-CALPREAMBLE Duration (Informative).....	61
1.5.2 t3-ASID Duration (Informative).....	61
1.5.3 t3-CALALTSEQ Duration (Informative).....	61
1.5.4 Calibration Sequence t3-SYNC Duration (Informative).....	62
SCPI Commands.....	63
About SCPI command.....	63
Socket configuration for SCPI commands.....	63
Set or query the device name of application.....	69
Set or query the DUTID of application.....	69
Set or query the suite name of the application.....	70
Set or query the test name of the application.....	70
Set or query the version name of the application.....	74
Set or query the general parameter values.....	74
Set or query the acquire parameter values.....	80
Set or query the analyze parameter values.....	93
Set or query the user defined acquisition values.....	98
Query the available devices in the DUT panel of the application.....	98
Query the available suites for the selected device.....	99
Query the list of available tests of the application.....	99
Query the available version names of the application.....	99
Query the list of available instruments based on the specified instrument type.....	100
Set or query the IP address of the instrument based on the specified instrument type.....	100
Query the information of the generated report file.....	101
Query the information of the generated waveform files.....	101
Query the information of the generated image files.....	101
Query the active TekExpress application name.....	102
Sets or query the acquire mode status.....	102
Set or query the execution mode status.....	102
Generate the report for the current session.....	103
Query the value of specified report header field in the report.....	103
Query the value of specified result detail available in report summary/details table.....	104
Restore the setup to default settings.....	105
Save the settings to a specified session.....	105
Open the setup from a specified session.....	105
Query the current setup file name.....	106
Run/stop/pause/resume the selected measurements execution in the application.....	106
Query the current measurement execution status.....	106
Query whether the current setup is saved or not saved.....	107
Query the status of the previous command execution.....	107
Query the last error occurred.....	107
Set or query the popup details.....	107
Query the enable or disable status of Continuous run function.....	108
Set or query the enable/disable status of Continuous Run function.....	108
Set or query the enable/disable status of Verbose function.....	109
Set or query the continuous run duration time value.....	109
Set or query the session create option in the continuous run function.....	110
Set or query the View report after generating option status.....	111
Sets or query the limit values in the limits editor window.....	111
Set or query the waveform file recalled for the specified test name and acquire type.....	112

---

Set the default session.....	112
Save the run/config sessions.....	112
Load the run/config session.....	113
Delete the run/config session.....	113
Run the run/config saved session.....	113
Query the available list in the run/config session.....	114
Query the current run/config session.....	114
Override the run/config session.....	114
Example.....	115
References.....	118
Application directories.....	118
File name extensions.....	119
View test-related files.....	119
Probe and termination voltage.....	120
Default values.....	122
Index.....	124



# Welcome

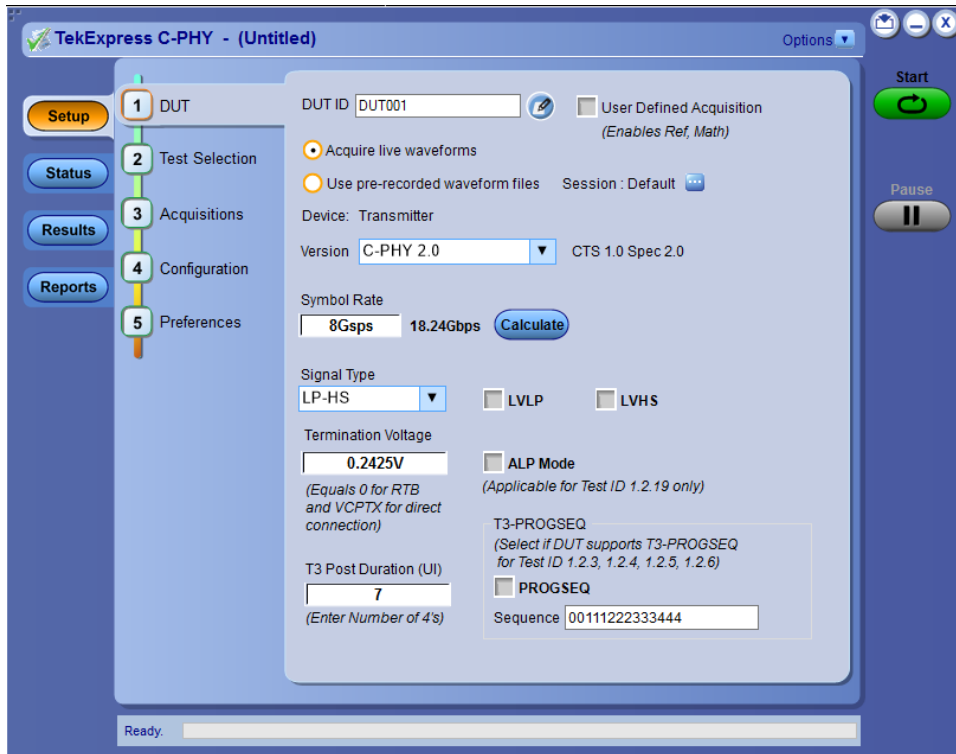

The Tektronix C-PHY Tx 2.0 Automated Test software runs on Tektronix real-time oscilloscopes that are based on Windows 10 computer operating systems. C-PHY Tx 2.0 delivers the TekExpress based C-PHY automation solution with Tx measurement.

---

## C-PHY Tx 2.0 key features

C-PHY Tx 2.0 delivers 100% Automated TekExpress based C-PHY solution for all the Tx measurements.

The TekExpress C-PHY application supports the following key features:

- Supports C-PHY specification version for MIPI C-PHY 1.0, 1.1, and 2.0
- Live and pre-acquired waveform Analysis
- Easily select and configure the desired tests
- Modify limits of test parameters for debug, margin, and characterization testing
- Supports LP-TX and HS-TX signaling tests at highest symbol rate — 8 GS/s
- Supports dynamic data rate updation for the waveform captured
- Options to select LVLP, LVHS, and ALP mode functionality for LP and HS tests
- Supports Eye Diagram Test with CTLE for symbol rates above 3.5 GS/s and without CTLE at symbol rates below 3.5 GS/s
- Supports Hexagonal shaped eye diagram for devices with maximum operating symbol rates  $<1$  GS/s and for devices with maximum operating symbol rates  $\geq 1$  GS/s, a diamond shaped eye diagram is displayed
- Supports horizontal mask movement to a position where there are zero mask hits
- User-defined options to select three reference templates (Short, Standard, and Long) for differential insertion loss that are applicable for all symbol rates
- Provision to run in user-defined mode with user-defined parameters for triggering the LP-HS signals
- Manual Cursor Mode support to enable the user to capture and measure the desired LP-HS regions
- Debug Mode support to load waveforms on Ref and Math channels for Analysis
- Reporting measurement test run details and repeatability with option to save the waveforms only for a fail test run.

# Getting help and support

## Product documents

Use the product documents for more information on the application functions, understand the theory of operation, how to remotely program or operate the application, and do other tasks.

**Table 1: TekExpress Application documents**



To learn about	Use this document
How to use the application	TekExpress <Application Name> Help
How to remotely control the instrument	PDF version of this document can be downloaded from <a href="http://www.tek.com/downloads">www.tek.com/downloads</a> Compiled HTML (CHM) version is integrated with the application. Press <b>F1</b> key from the keyboard to start the help. Tektronix Part Number: 077-xxxx-xx

## Conventions

This application help uses the following conventions:

- The term "Application," and "Software" refers to the TekExpress Application.
- The term "DUT" is an abbreviation for Device Under Test.
- The term "select" is a generic term that applies to the two methods of choosing a screen item (button control, list item): using a mouse or using the touch screen.
- A **Note** identifies important information.

**Table 2: Icons used in the help**

Icon	Description
	This icon identifies important information
	This icon identifies conditions or practices that could result in loss of data.
	This icon identifies additional information that will help you use the application more efficiently.

## Technical support

Tektronix values your feedback on our products. To help us serve you better, please send us your suggestions, ideas, or comments on your application or oscilloscope. Contact Tektronix through mail, telephone, or the Web site. See [Contacting Tektronix](#) at the front of this document for contact information.

When you contact Tektronix Technical Support, please include the following information (be as specific as possible):

### General information

- All instrument model numbers
- Hardware options, if any
- Modules used
- Your name, company, mailing address, phone number, FAX number
- Please indicate if you would like to be contacted by Tektronix about your suggestion or comments.

### Application specific information

- Software version number
- Description of the problem such that technical support can duplicate the problem
- If possible, save the setup files for all the instruments used and the application
- If possible, save the TekExpress setup files, log.xml, \*.TekX (session files and folders), and status messages text file

# Getting started

## Hardware requirements

### Supported oscilloscopes

The C-PHY Tx application runs on the following Tektronix oscilloscopes:

- MSO64
- MSO64B
- MSO66B
- MSO68B

### Minimum system requirements

The following table shows the minimum system requirements for an oscilloscope to run TekExpress.

**Table 3: System requirements**

Component	Requirement
Processor	Same as the oscilloscope
Operating System	Same as the oscilloscope: Win 10 64-bit
Memory	Same as the oscilloscope
Hard Disk	Same as the oscilloscope
Display	Same as the oscilloscope <sup>1</sup>
Firmware	MSO TekScope v1.34.8 or above
Software	<ul style="list-style-type: none"> <li>• IronPython 2.7.3 installed</li> <li>• MATLAB Compiler run time v8.0</li> <li>• PyVisa 1.0.0.25 installed</li> <li>• Microsoft .NET 4.0 Framework</li> <li>• Microsoft Internet Explorer 7.0 SP1 or greater, or other Web browser for viewing reports</li> <li>• Adobe Reader software 7.0 or greater for viewing portable document format (PDF) files</li> </ul>
Other Devices	<ul style="list-style-type: none"> <li>• Matched pair of SMA cables, two-set minimum for single lane</li> <li>• Microsoft compatible mouse or compatible pointing device</li> </ul>



**Note:** If TekExpress is installed on a Tektronix oscilloscope, TekExpress uses a virtual GPIB port to communicate with oscilloscope applications. If external GPIB communication devices such as USB-GPIB-HS or equivalent are used for instrument connectivity, make sure that the Talker Listener utility is enabled in the MSO oscilloscope GPIB menu. For ease of use, connect to an external (secondary) monitor.

<sup>1</sup> If TekExpress is running on an instrument having a video resolution lower than 800x600 (for example, sampling oscilloscope), it is recommended that you connect a secondary monitor. The secondary monitor must be configured and active before starting the application.

## See also

[Supported oscilloscopes and probes](#)

[Instrument connection setup](#)

## Instruments and accessories

The table below lists the instruments and accessories for C-PHY application:

**Table 4: Instruments and accessories**

Component	Description
Oscilloscope	<a href="#">Supported oscilloscopes and probes</a>
Probes	TDP77xx (TDP7704/06/08/10) Series Tri-mode probe with P77STFLXA solder-in tip with TekFlex connector technology (Quantity: 3 number).

## Software requirements

### Downloading and installing the software

Complete the following steps to download and install the latest TekExpress <Application Name> application.

1. Go to [www.tek.com](http://www.tek.com).
2. Click **Downloads**. In the Downloads menu, select DOWNLOAD TYPE as Software and enter the application name in the MODEL OR KEYWORD field and click **SEARCH**.

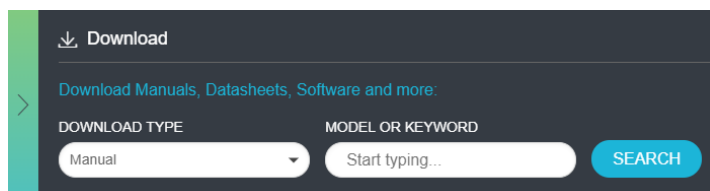

3. Select the latest version of software and follow the instructions to download the software. Copy the executable file into the oscilloscope.
4. Double-click the executable and follow the on-screen instructions.

The software is installed at C:\Program Files\Tektronix\TekExpress\TekExpress <Application Name>.

5. Select **Analyze > TekExpress <Application Name>** from the Oscilloscope menu, to open the application.

### Activate the license

Activate the license using the **Option Installation** wizard in the TekScope application:

1. In the **TekScope** application menu bar, click **Utilities > Option Installation**. The TekScope Option Installation wizard opens.
2. Push the **F1** key on the oscilloscope keyboard to open the Option Installation help topic.
3. Follow the directions in the help topic to activate the license.

### View software version and license key details

To view version information of the application, click **Options > About TekExpress**.



---

# Setting up the test environment

## Installing the software

### About setting up tests

Set up tests using the tabs in the Setup panel. Settings in the DUT tab use a top-down, left-to-right logic flow, so that any parameter that affects or acts as a filter for other parameters appears either to the top of or to the left of the affected parameters.

Tests are saved when you save a test setup. To avoid overwriting test results, remember to assign a unique name to the test either before running it or immediately after.

All listed tests are required for compliance testing.

#### See also

[Test setup overview](#)

[Before you click Start](#)

[About running tests](#)

### Instrument connection setup

The following diagram shows how to connect the DUT to the oscilloscope for all the C-PHY Tx measurements.

Click **Setup** > **Test Selection** > **Schematic** to view the equipment setup diagram(s).



**Note:** For Riddick, these probes can be connected through TDP77XX only.



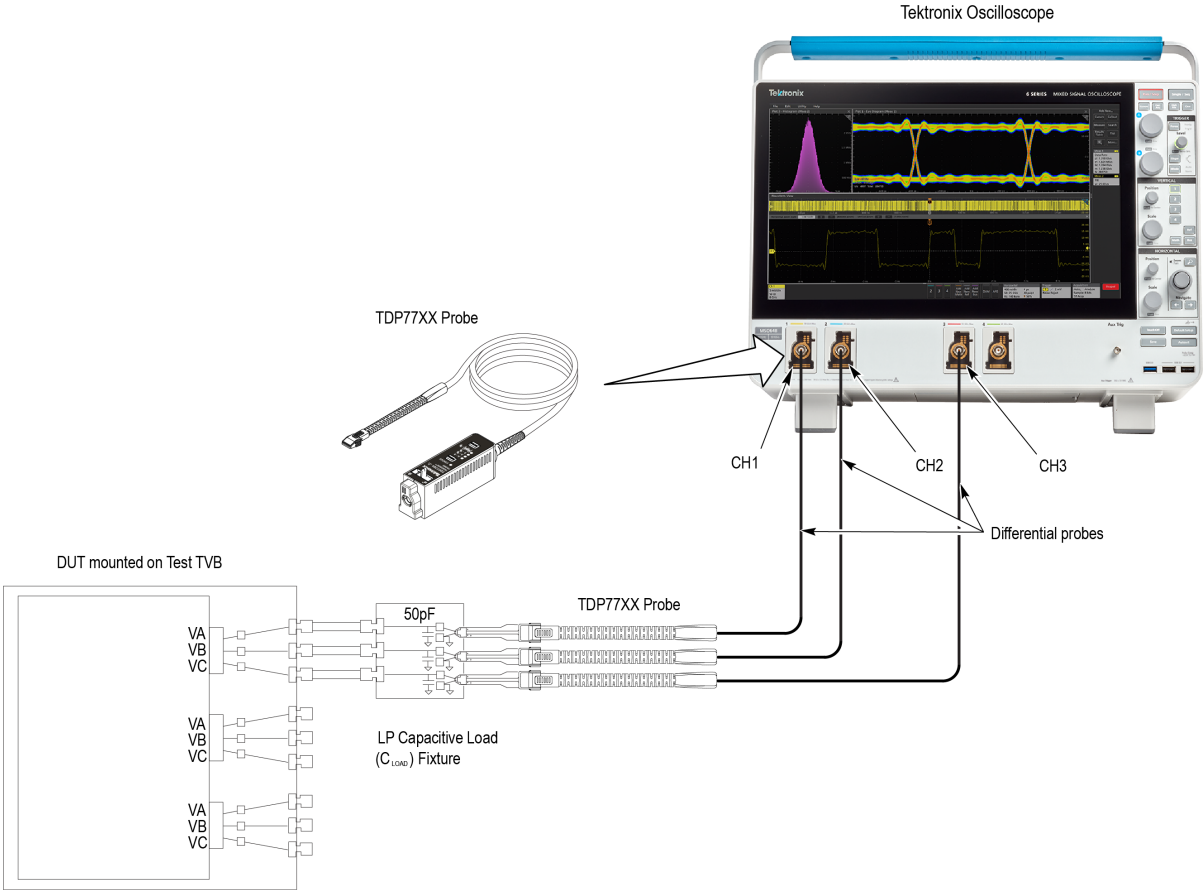

1717-001

Figure 1: LP Transmitter

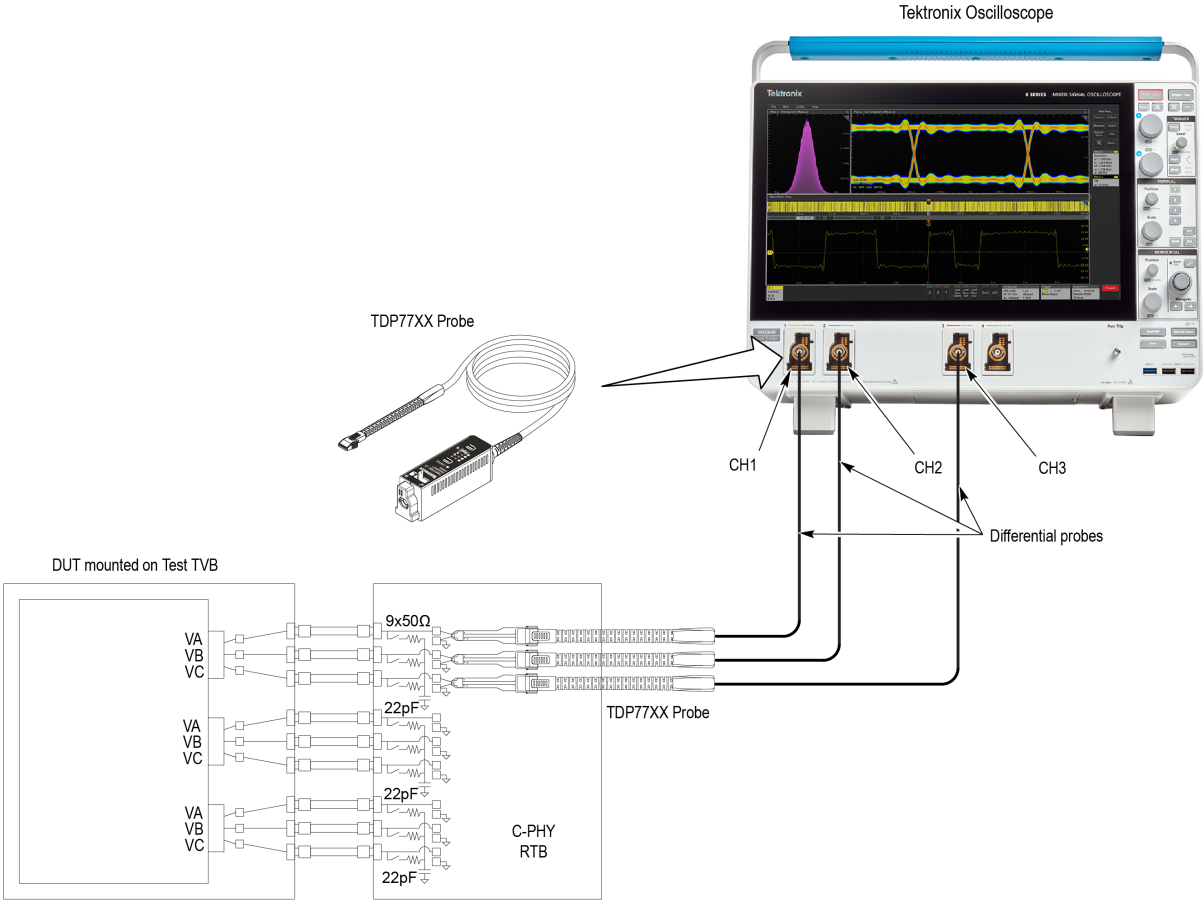

1717-002

Figure 2: LP-HS RTB

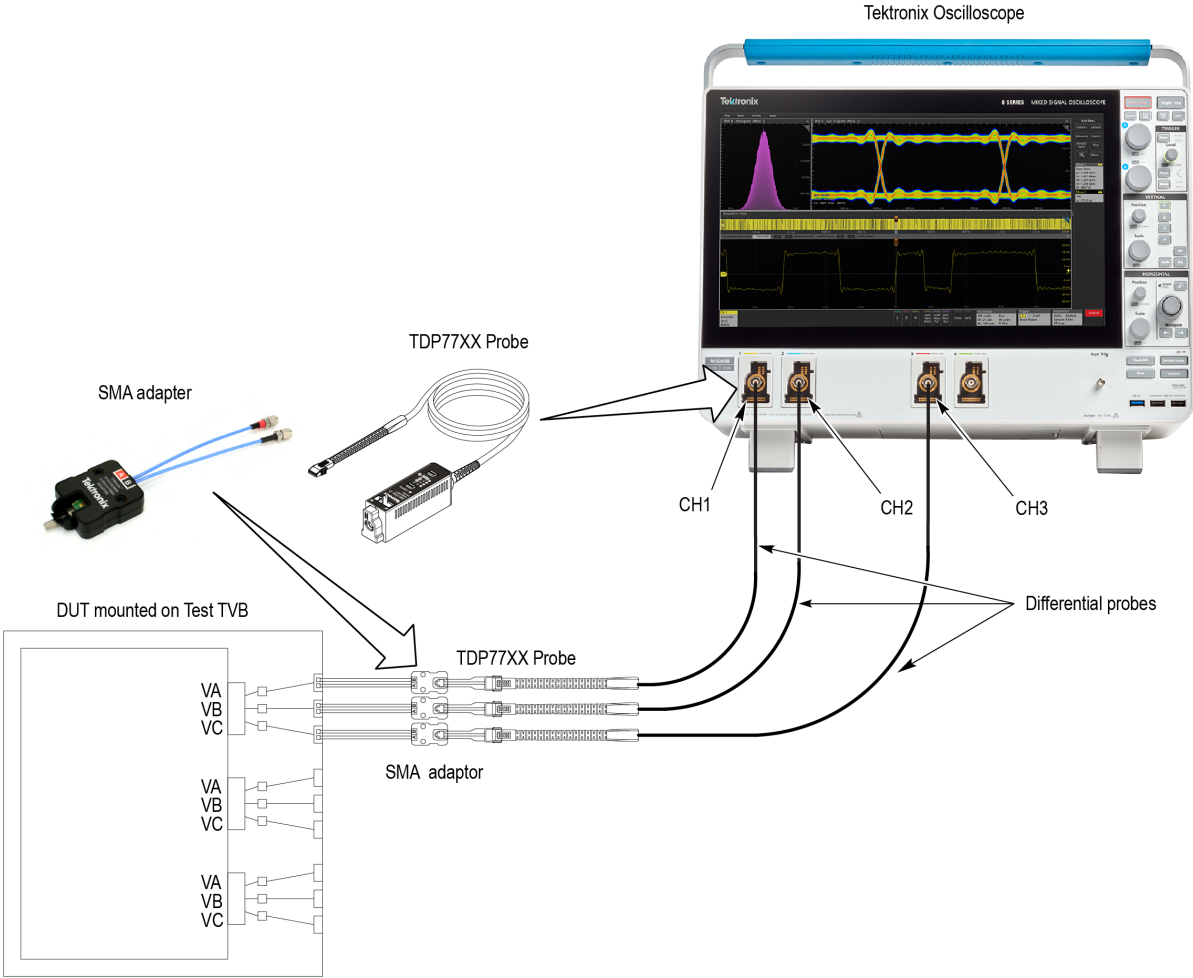

1717-003

Figure 3: HS Transmitter Direct Connection

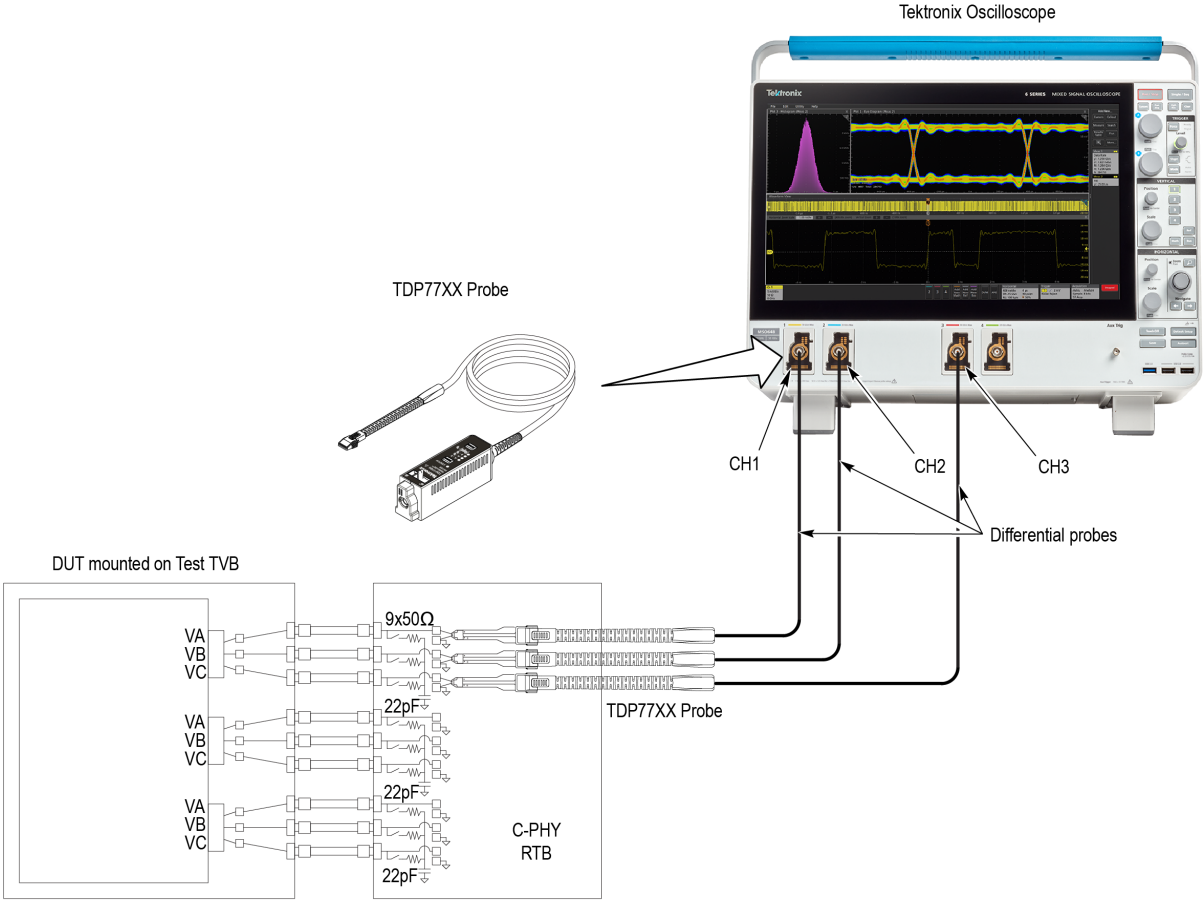

Note: Switch OFF the termination on RTB using dip switch

1717-004

Figure 4: HS Transmitter with RTB

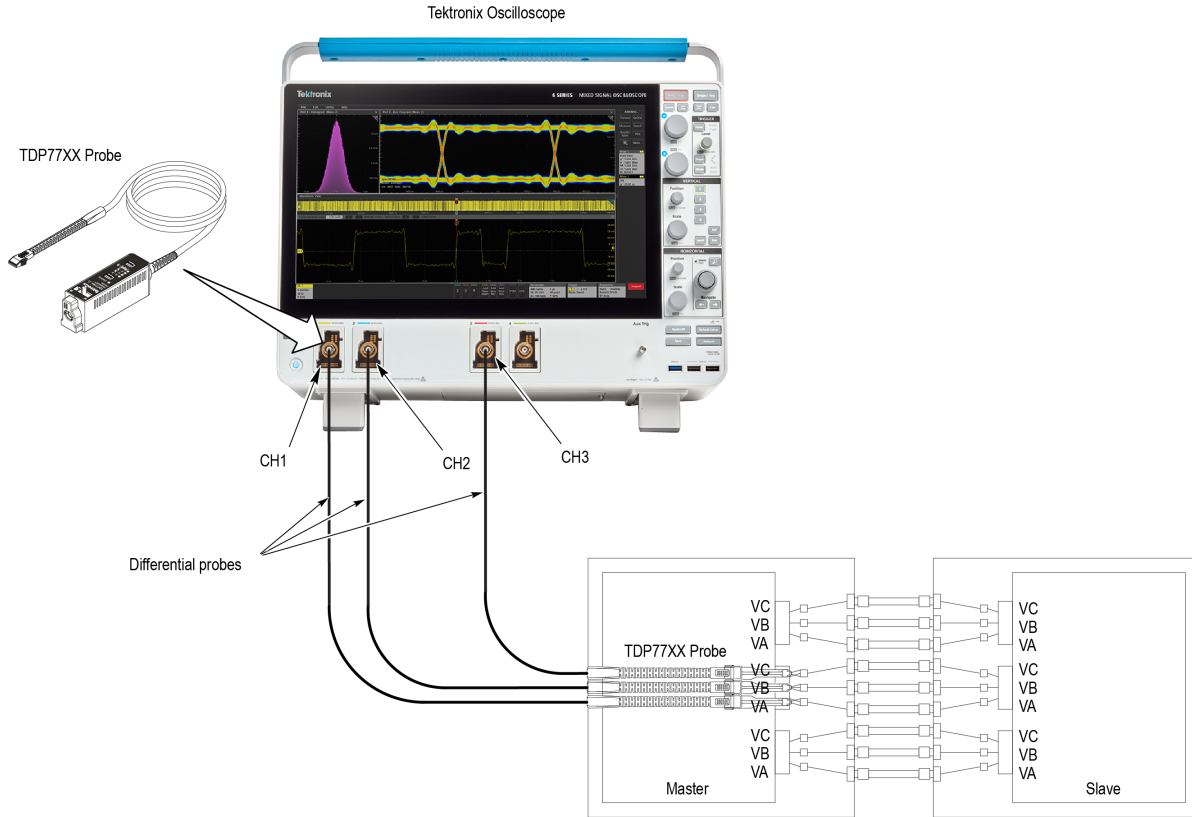

1717-005

Figure 5: LP Bus Turnaround

**See also**[Minimum system requirements](#)[Search instruments connected to the application](#)[About setting up tests](#)**Search instruments connected to the application**

Use the TekExpress Instrument Control Settings dialog box to search the instruments (resources) connected to the application. The application uses TekVISA to discover the connected instruments.



**Note:** The instruments required for the test setup must be connected and detected by the application, before running the test.

To refresh the list of connected instruments:

1. Select **Options > Instrument Control Settings**.
2. In the **Search Criteria** section of the **Instrument Control Settings** dialog box, select the connection types of the instruments to search. Instrument search is based on the VISA layer, but different connections determine the resource type, such as LAN, GPIB, and USB. For example, if you choose LAN, the search will include all the instruments supported by the TekExpress that are communicating over the LAN.
3. Click **Refresh**. The TekExpress application searches for the connected instruments.

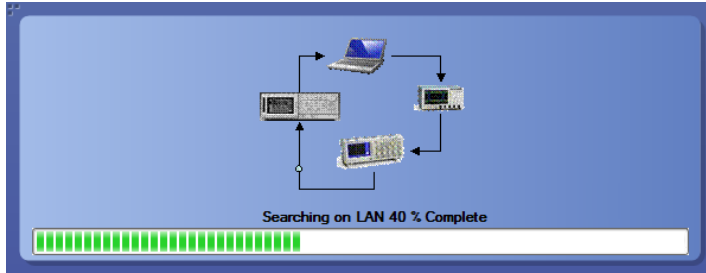

Figure 6: Search status of the instruments connected to LAN

- When the search is complete, a dialog box lists the instrument-related details based on the search criteria. For example, for the Search Criteria as LAN and GPIB, the application displays all the LAN and GPIB instruments connected to the application.

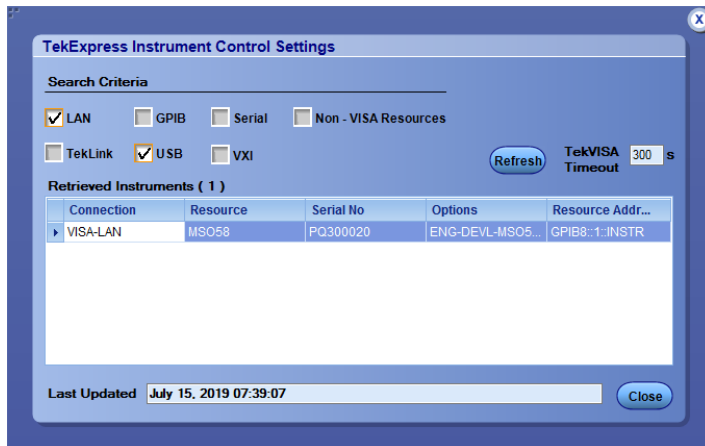

Figure 7: TekExpress Instrument Control Settings window

The details of the instruments are displayed in the Retrieved Instruments table. The time and date of instrument refresh is displayed in the Last Updated field.

## Test setup overview

A test setup includes configuration parameters and report options. Use the options in the [Setup panel](#) and [Reports panel](#) to select and configure tests.

- [Select the DUT parameters.](#)
- [Select one or more tests.](#)
- [Configure test parameters.](#)
- [Select test notification preferences.](#)
- [Select report options.](#)

### See also

[Pre-test checklist](#)

[Before you click Start](#)

[About running tests](#)

## About running tests

After selecting and configuring the test, [review the pre-run checklist](#) and then click **Start** to run the tests. While tests are running, you cannot access the Setup or Reports panels. To monitor the test progress, switch back and forth between the Status panel and the Results panel.

The application displays a report when the tests are complete. While the tests are running, other applications may display windows in the background. The TekScope application takes precedence over other applications, but you can switch to other applications by using the **Alt + Tab** key combination. To keep the TekExpress C-PHY Tx application on top, select **Keep On Top** from the C-PHY Tx Options menu.

### See also

[Configure test parameters](#)

[About setting up tests](#)

[Before you click Start](#)

## Before you click start

Before you run tests for the first time, do the following:

1. Understand where your test files are stored on the instrument.
2. Map my TekExpress folder as X: (X drive) on all instruments used in test setup running Microsoft Windows Operating System.

The `My TekExpress` folder has the shared name format `<domain><user ID>My TekExpress`. Or, if the instrument is not connected to a domain, then the shared name format is `<instrument name><user ID>My TekExpress`. This shared folder is used to save the test session files and is used during any other file transfer operations.



**Note:** If the X: drive is mapped to any other shared folder, the application will display a warning message asking you to disconnect the X: drive manually.

3. Make sure that the My TekExpress folder has read and write access and that the contents are not set to be encrypted:
  - a. Right-click the My TekExpress folder and select **Properties**.
  - b. Select the **General** tab and then click **Advanced**.
  - c. In the Advanced Attributes dialog box, make sure that the option **Encrypt contents to secure data** is NOT selected.
4. Review the [pre-run checklist](#) before you run a test.

### See also

[View test-related files](#)

[Application directories and file types](#)

[File name extensions](#)

## Pre-test checklist

Do the following before you click Start to run a test. If this is the first time you are running a test for a setup, refer to the information in [Before you click Start](#).

On the oscilloscope:

- Make sure that all the required instruments are properly warmed up (approximately 20 minutes).
- Perform Signal Path Compensation (SPC).
- Perform deskew on any cables.

In the C-PHY Tx application:

- Verify that the application is able to find the instrument. If it cannot, [perform a search for connected instruments](#).

**See also**

[Instrument connection setup](#)



## Starting the application

To start the TekExpress C-PHY, select **Analyze > TekExpress C-PHY** from the oscilloscope menu bar.

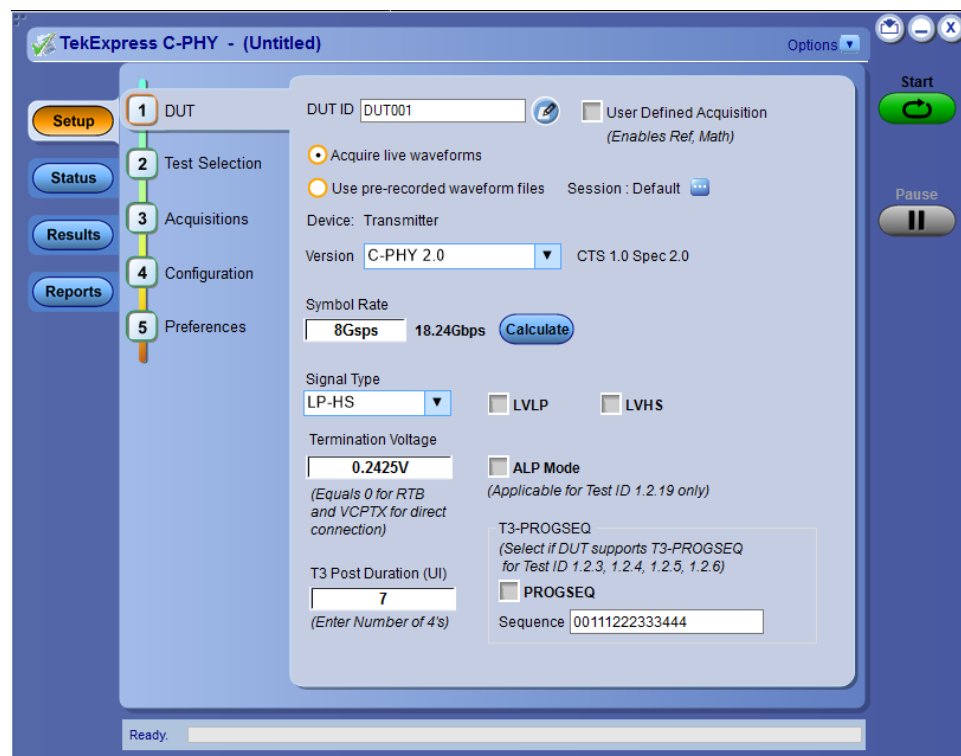

During start, a "My TekExpress" folder is created in the Documents folder of the current user and gets mapped to "X" drive. When the application is closed properly, the "X" drive gets unmapped. Session files are then stored inside the `X:\C-PHY` folder. If this file is not found, the application runs an instrument discovery program to detect connected instruments before starting TekExpress C-PHY.

To keep the TekExpress C-PHY application on top of any application, select **Keep On Top** from the *options menu*. If the application goes behind the oscilloscope application, select **Analyze > TekExpress C-PHY** to bring the application to the front.

## Application controls

This section describes the application controls.

**Table 5: Application control description**









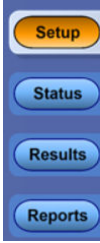

Item	Description
<i>Options menu</i> 	Menu to display global application controls.

Table continued...

Item	Description
Test panel 	Controls that open tabs for configuring test settings and options.
Start / Stop button 	<p>Use the <b>Start</b> button to start the test run of the measurements in the selected order. If prior acquired measurements are not cleared, then new measurements are added to the existing set.</p> <p>The button toggles to the Stop mode while tests are running. Use the <b>Stop</b> button to abort the test.</p>
Pause / Continue button 	Use the <b>Pause</b> button to pause the acquisition. When a test is paused, this button changes as <b>Continue</b> .
Clear button 	<p>Use the <b>Clear</b> button to clear all existing measurement results. Adding or deleting a measurement, or changing a configuration parameter of an existing measurement, also clears measurements. This is to prevent the accumulation of measurement statistics or sets of statistics that are not coherent. This button is available only on <a href="#">Results panel: View summary of test results</a> on page 45.</p> <p> <b>Note:</b> This button is visible only when there are results data on the panel.</p>
Application window move icon 	Place the cursor over the top of the application window to move the application window to the desired location
Minimize icon 	Minimizes the application.
Close icon 	Close the application.
Mini view / Normal view 	<p>Toggles the application between mini view and normal view.</p> <p>Mini view displays the run messages with the time stamp, progress bar, Start / Stop button, and Pause / Continue button.</p> <p>The application moves to mini view when you click the <b>Start</b> button.</p> 

## Options menu functions

To access the **Options** menu, click  in the upper-right corner of the application. It has the following selections:

### Options menu

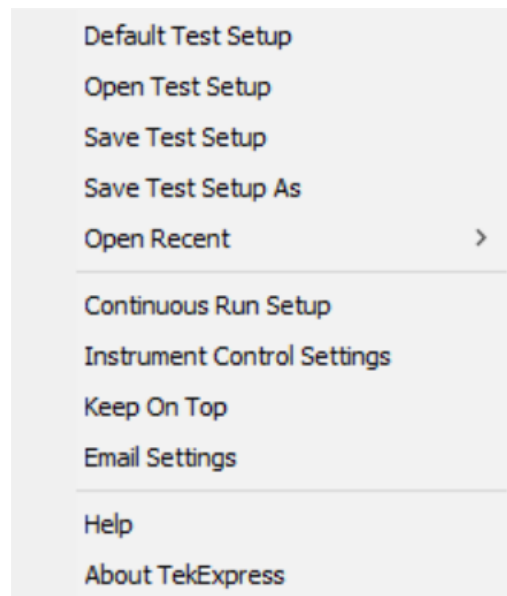

Figure 8: Option menu

Table 6: Options menu settings

Menu	Function
Default Test Setup	Opens a new test setup with default configurations.
Open Test Setup	Opens a previously saved test setup. Displays the list of previously saved test setup file names. Make the selection and click <b>OK</b> to open the test setup.
Save Test Setup	Saves the current test configurations with the specified file name.
Save Test Setup As	Saves the current test setup with a different file name or file type.
Open Recent	Displays the recently opened test setup file names. Make the selection and click <b>OK</b> to open the test setup.
<i>Instrument Control Settings</i>	Detects, lists, and refreshes the connected instruments found on the specified connections (LAN, GPIB, USB, Serial, Non-VISA Resources, TekLink, and VXI).
Keep On Top	Always keeps the TekExpress application on top of all the applications.
<i>Email Settings</i>	Configures email options for test run and result notifications.
Help	Displays the TekExpress help.
About TekExpress	Displays the application name, version, and hyperlink to end the user license agreement.

## Configure email settings

Use the **Email Settings** utility to get notified by email when a measurement completes or produces any error condition. Follow the steps to configure email settings:

Figure 9: Email settings window

1. Select **Options > Email Settings** to open the Email Settings dialog box.
2. (Required) For **Recipient email Address(es)**, enter one or more recipient email addresses. To include multiple addresses, separate the addresses with commas.
3. (Required) For **Sender's Address**, enter the email address used by the instrument. This address consists of the instrument name, followed by an underscore, followed by the instrument serial number, then the @ symbol, and the email server ID. For example: user@yourcompany.com.
4. (Required) In the **Server Configuration** section, type the SMTP Server address of the Mail server configured at the client location, and the SMTP Port number, in the corresponding fields.

If this server requires password authentication, enter a valid login name, password, and host name in the corresponding fields.



**Note:** If any of the above required fields are left blank, the settings will not be saved, and email notifications will not be sent.

5. In the **Email Attachments** section, select from the following options:
  - **Reports:** Select to receive the test report with the notification email.
  - **Status Log:** Select to receive the test status log with the notification email. If you select this option, then also select whether you want to receive the full log or just the last 20 lines.
6. In the **Email Configuration** section:
  - Enter a maximum file size for the email message. Messages with attachments larger than this limit will not be sent. The default is 0 MB.
  - Enter the number in the Number of Attempts to Send field, to limit the number of attempts that the system makes to send a notification. The default is 1. You can also specify a timeout period.
7. Select the **Email Test Results When complete or on error** check box. Use this check box to quickly enable or disable email notifications.
8. To test your email settings, click **Test Email**.
9. To apply your settings, click **Apply**.
10. Click **Close** when finished.

## TekExpress instrument control settings

Use the **TekExpress Instrument Control Settings** dialog box to search the instruments (resources) connected to the application. You can use the **Search Criteria** options to search the connected instruments depending on the connection type. The details of the connected instrument is displayed in the Retrieved Instruments window.

To access, click **Options > Instrument Control Settings**. Select **USB** and **LAN** as search criteria for TekExpress application and click **Refresh**. The connected instruments displayed in the Retrieved Instruments window and can be selected for use under Global Settings in the test configuration section.

Figure 10: TekExpress Instrument Control Settings window

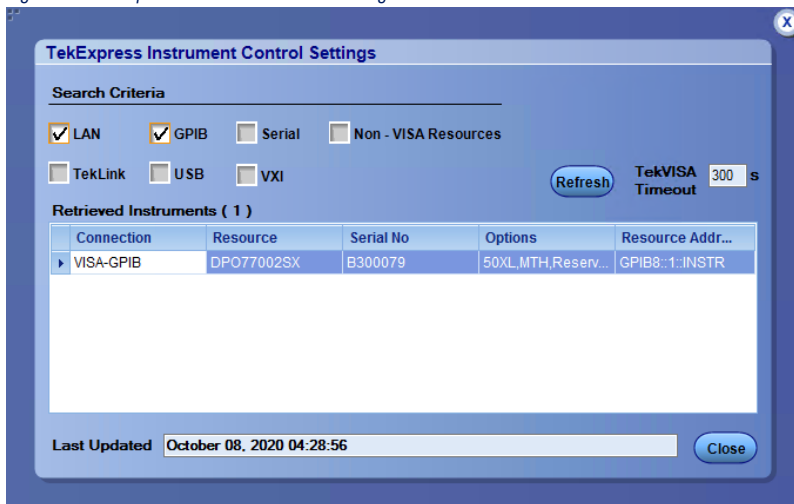

### See also

[Options menu functions](#) on page 27

## Setup panel: Configure the test setup

The Setup panel contains sequentially ordered tabs that help to guide you through a typical test setup process.

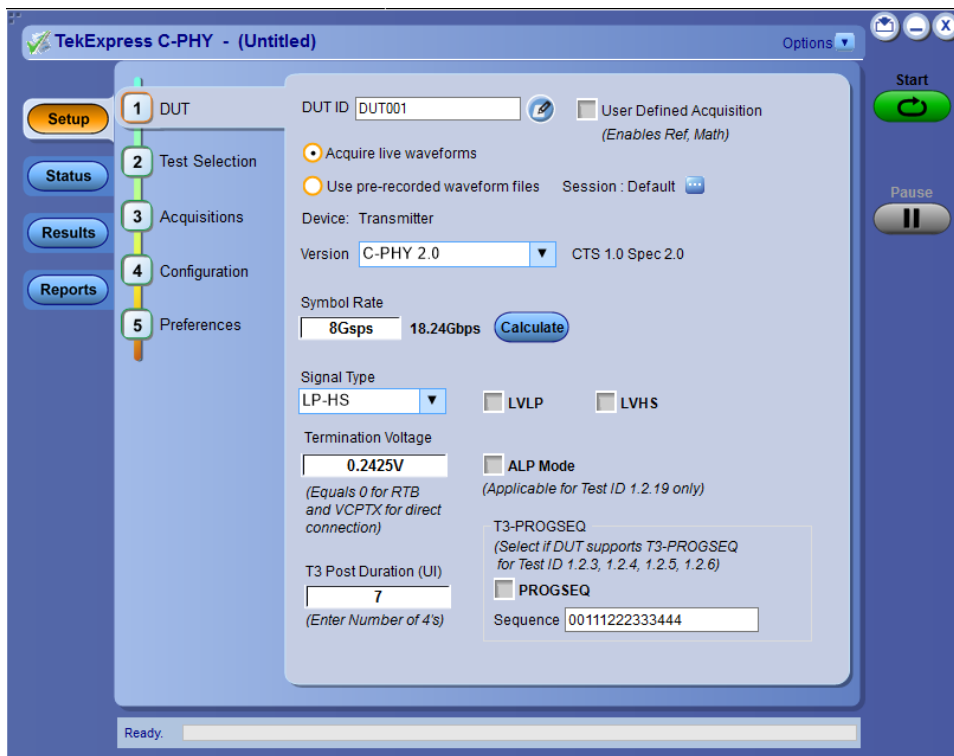

Items selected in one Setup tab may change options available in the other tabs. You can switch between the tabs in any order to modify your test parameters.

### Also refer

[DUT: Set DUT settings](#) on page 31

[Test Selection: Select the tests](#) on page 34

[Acquisitions: Set waveform acquisition settings](#) on page 35

[Configuration: Set measurement limits for tests](#) on page 37

[Preferences: Set the test run preferences](#) on page 40

## DUT: Set DUT settings

Use the Setup panel DUT tab to select parameters for the device under test. The settings are global and apply to all tests for the current session. The DUT settings available and the options in the drop-down list depends on the selections made in the settings. DUT settings also affect the list of available tests in the Test Selection tab.

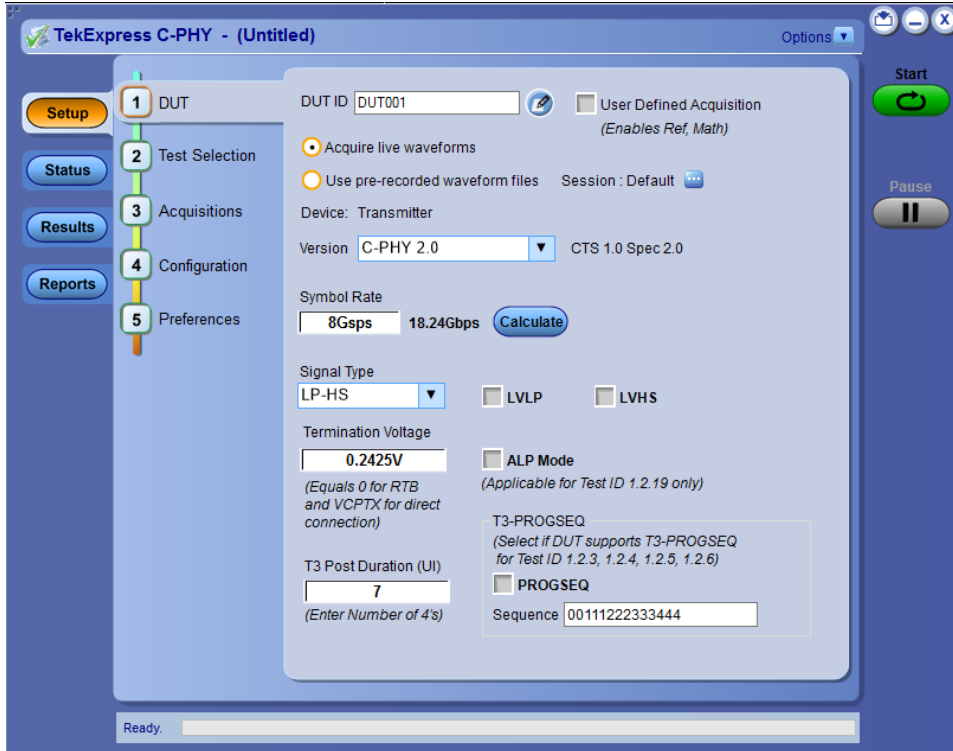

Figure 11: DUT tab settings

Click **Setup> DUT** to access the DUT parameters.

**Table 7: DUT tab parameter settings**

Parameter	Description
DUT ID	Adds an optional text label for the DUT to reports. The default value is DUT001. The maximum number of characters is 32.  You cannot use the following characters in an ID name: (,.,:;.,\,/:?*"< *).
 Comments icon (to the right of the DUT ID field)	Open a Comments dialog box which allows you to enter optional text to add to a report. You can enter a maximum number of 256 characters. Refer <a href="#">Configure report view settings</a> to enable or disable comments which appear on the test report.

Table continued...





Parameter	Description
User Defined Acquisition	Select the check box to enable Ref or Math channel in the Acquisitions tab and run the test.  <b>Prerequisite:</b> <ul style="list-style-type: none"> <li>Ensure waveform is available/recalled on selected source each time before click on "Start".</li> <li>Waveform is saved for the selected source in TekExpress session and the scope settings are overridden during test run in UDA Mode.</li> </ul>
Acquire live waveforms	Acquire active signals from the DUT for measurement and analysis.
Use prerecorded waveform files	Run tests on a saved waveform. Refer <a href="#">Load a saved test setup</a> on page 50 to save the test setup.
Session	Allows you to save multiple config sessions and run multiple config/run sessions together.
Device	Select Device name as Transmitter.
Version	Displays the CTS version. C-PHY application supports CTS 2.0, 1.1, and 1.0 version.  Select the Version from the drop-down: <ul style="list-style-type: none"> <li>C-PHY 2.0 for CTS 1.0 Spec 2.0</li> <li>C-PHY 1.1 for CTS 1.0 Spec 1.1</li> <li>C-PHY 1.0 for CTS 1.0 Spec 1.0</li> </ul>
Device Profile	
Symbol Rate	Select one or multiple data rates for waveform acquisition.
Calculate	Computes Symbol Rate of HS signals.   <b>Note:</b> There will be mis-match in the auto-calculated dynamic data rate value if the LP region is dominant in the captured signal from the DUT.  Auto calculation of Symbol Rate is applicable only for HS Signal Types.
Signal Type	Select the Signal type from the drop-down: <ul style="list-style-type: none"> <li>HS</li> <li>LP</li> <li>LP-HS</li> </ul>  <b>Note:</b> Based on the selection of Signal Type, the list of tests will change in the Test Selection panel.
LVLP	Available only when <b>Version=C-PHY 2.0</b> Select the check box to run the low voltage low power tests.
LVHS	Available only when <b>Version=C-PHY 2.0</b> Select the check box to run the low voltage high speed tests.

Table continued...



Parameter	Description
ALP Mode	Select the check box to run the Alternate Low Power   <b>Note:</b> It is applicable for Test ID 1.2.19 only
Termination Voltage	Enter the Termination Voltage value for the direct connection from DUT to oscilloscope.   <b>Note:</b> Equals 0 for RTB and VCPTX for direct connection.
T3 Post Duration (UI)	Enter T3 Post Duration in terms of number of unit interval.   <b>Note:</b> Enter number of 4's, which should be adjustable at the transmitter from 7 UI minimum to 224 UI maximum in increments of 7 UI.
T3-PROGSEQ	Select if DUT supports T3-PROGSEQ for Test ID 1.2.3, 1.2.4, 1.2.5, 1.2.6
PROGSEQ	When selected, the DUT supports the programmable sequence.
Sequence	Enter the programmable sequence value.

**See also**[About setting up tests](#)



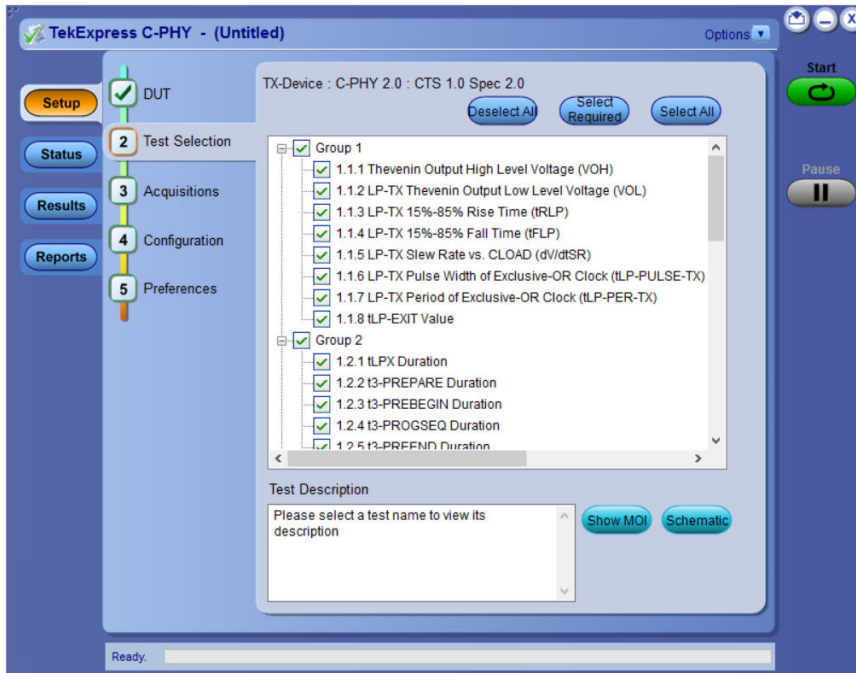

Table 8: Test Selection tab settings

Setting	Description
Deselect All, Select All,	Deselect or selects all tests in the list.
Select Required	Selects the required test in the listed tests.
Tests	Click a test to select or deselect. Selecting a test also show details about the selected test in the Test Description panel. All required tests are selected in the Compliance test mode.
Show MOI	Displays MOI document when you click the button.
Schematic	Displays equipment connection setup for the selected measurements. You need to select at least a measurement before you click the Schematic button.

## See also

[About setting up tests](#)

## Acquisitions: Set waveform acquisition settings

Use Acquisitions tab to view the test acquisition parameters. The contents displayed on this tab depends on the DUT type and the tests selected.

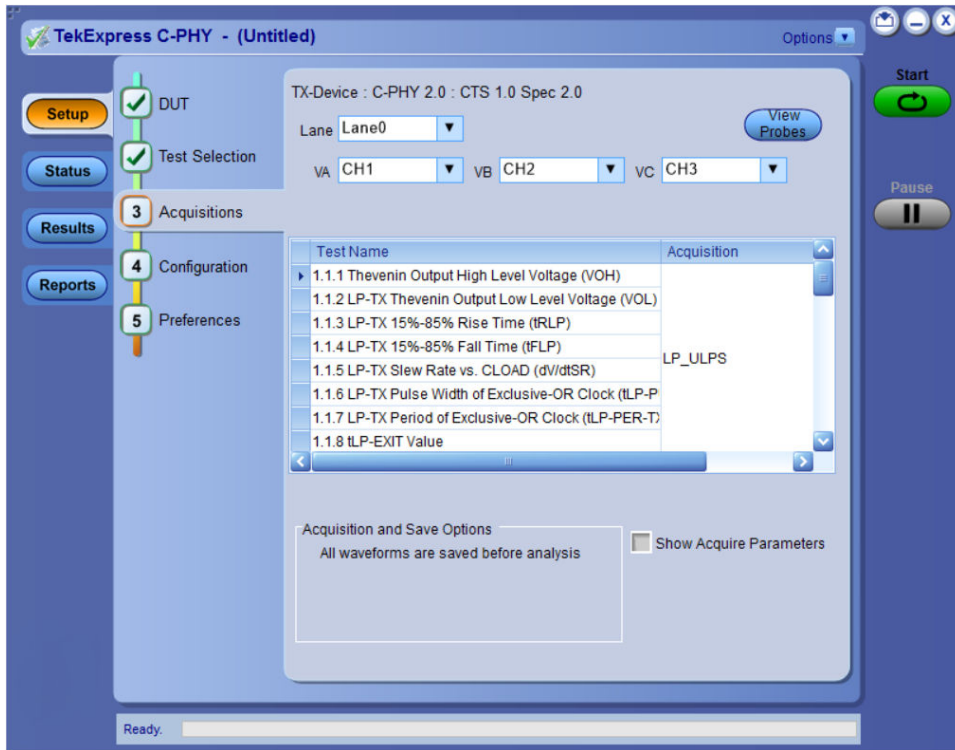

Table 9: Acquisition tab settings

Settings	Description
Lane	Select the lane from the drop-down: <ul style="list-style-type: none"> <li>• Lane0</li> <li>• Lane1</li> <li>• Lane2</li> <li>• Lane3</li> </ul>
View Probes	Displays the list of connected probes. 

Table continued...

Settings	Description
VA, VB, VC	<p>Selects the lane from the drop-down and are based on the selection of User Defined Acquisition in the DUT panel:</p> <ul style="list-style-type: none"> <li>• CH1</li> <li>• CH2</li> <li>• CH3</li> <li>• CH4</li> <li>• REF1</li> <li>• REF2</li> <li>• REF3</li> <li>• REF4</li> <li>• MATH1</li> <li>• MATH2</li> <li>• MATH3</li> <li>• MATH4</li> </ul>
Acquisition and Save Options	All waveforms are saved before analysis
Show Acquire Parameters	When enabled displays the parameter name.

TekExpress C-PHY saves all acquisition waveforms to files by default. Waveforms are saved in a unique folder for each session (a session is started when you click the Start button). The folder path is X:\C-PHY\Untitled Session\

## Configuration: Set measurement limits for tests

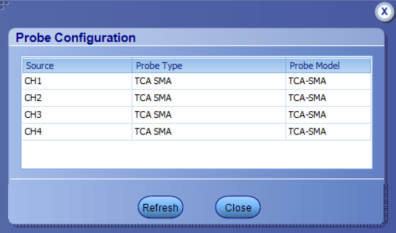
Use Configuration tab to view and configure the Global Settings and the measurement configurations. The measurement specific configurations available in this tab depends on the selections made in the DUT panel and Test Selection panel.

Table 10: Configuration tab: Common parameters

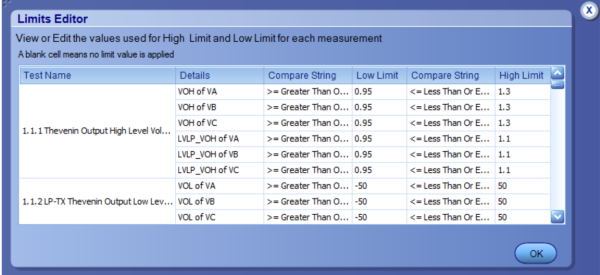
Settings	Description
Limits Editor	<p>Displays the upper and lower limits for the applicable measurement using different types of comparisons.</p> 

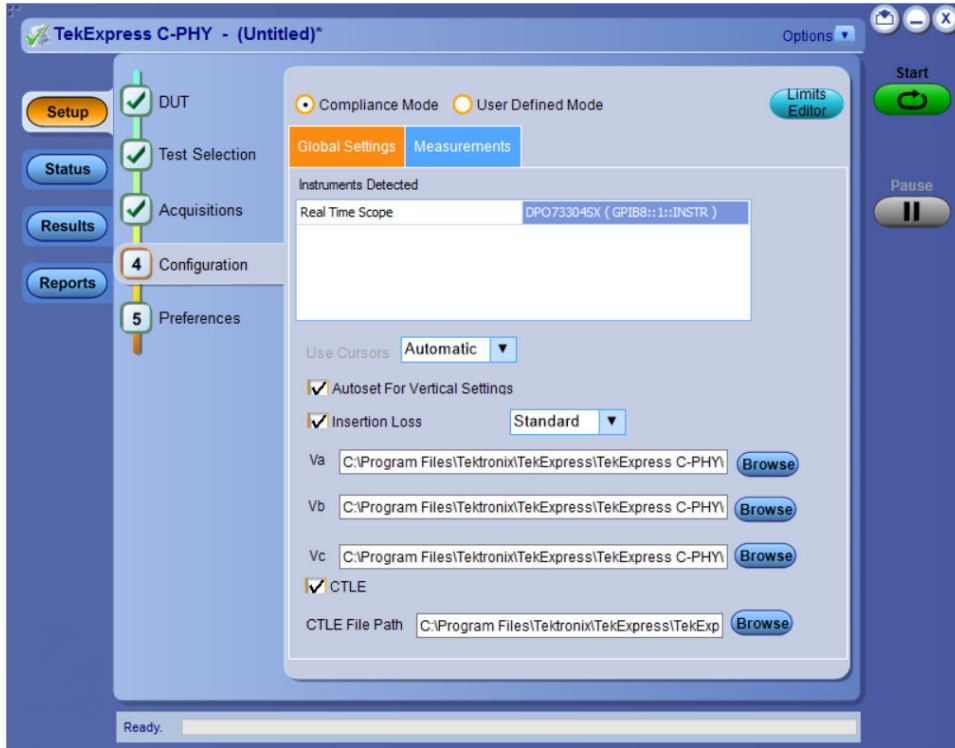

Figure 12: Configuration tab - Global Settings

Table 11: Configuration tab: Global settings



Settings	Description
Instruments Detected	<p>Displays the instruments connected to this application. Click on the instrument name to open a list of available (detected) instruments.</p> <p>Select <b>Options &gt; Instrument Control Settings</b> to refresh the connected instrument list refer <a href="#">TekExpress instrument control settings</a> on page 29</p>
Use Cursors	<p>Select the cursor from the drop-down:</p> <ul style="list-style-type: none"> <li>Automatic: Displays the calculated results automatically.</li> <li>Manual: Application allows you to place the cursor on the desired region of acquired waveform. The cursors are used as the gating criteria for the measurement and provides the report for measured value.</li> </ul> <p> <b>Note:</b> This is not applicable for Test ID 1.2.21, 1.2.22, 1.3.3, 1.3.4, and 1.3.5 measurements.</p>
Autoset For Vertical Settings	
Insertion Loss	<p>Select to browse the filter file for respective Va, Vb, and Vc Sources.</p> <p> <b>Note:</b> This is applicable for Test ID 1.2.21 and 1.2.22</p>

Table continued...

Settings	Description
CTLE	 <b>Note:</b> This is applicable for Test ID 1.2.21 and 1.2.22
CTLE File Path	Select to browse the filter file for Continuous Time Linear Equalizer.

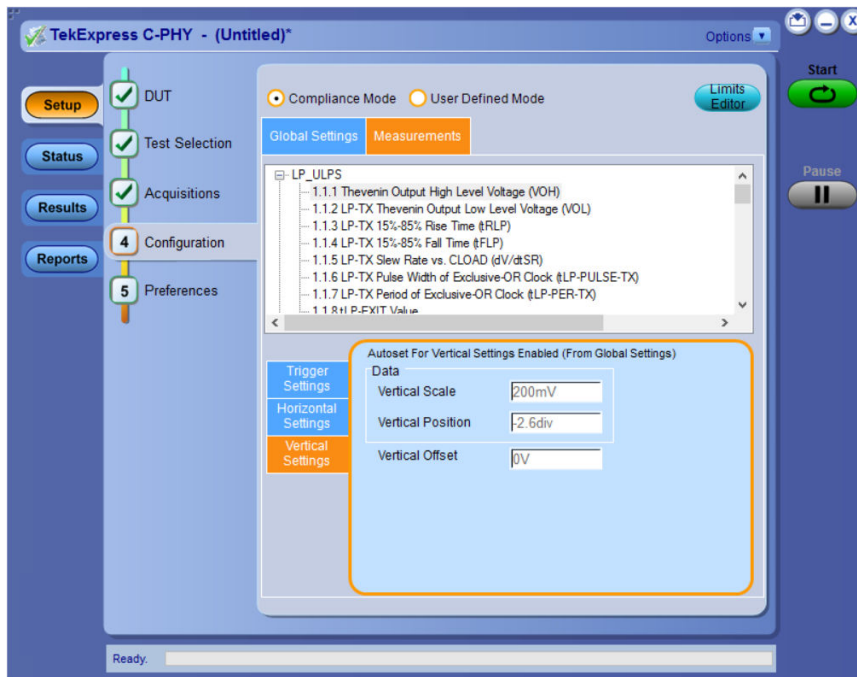



Figure 13: Configuration tab - Measurements

Table 12: Configuration tab: Measurement settings

Settings	Description	
Measurements	Displays the measurement groups, that are selected in the Test Selection tab. Select the respective test group to view or modify the measurement configuration.	
Trigger settings		
Trigger Type	Transition	Transition Time triggering allows you to trigger the time interval from the low-to-high and/or high-to-low thresholds is slower (larger) than, or faster (smaller) than a specified time, with Positive, Negative, or Either polarity selected.
	Edge	Edge triggering is usually an adequate to give you a look at the essential amplitude and timing characteristics of the waveform.
	Width	Width triggering allows you to accept (or reject) triggers, defined by pulse widths that are between two defined time limits.
Source	Source channel or waveform used to trigger or search. Types that require multiple inputs will replace this control with a different source definition control.	

Table continued...

Settings		Description
Slope		The slope controls provide the basic trigger point definition and determine how a waveform is displayed
Level		
Horizontal Settings		 <b>Note:</b> This setting is not applicable for Reference Channels or UDA.
Record Length		Specifies the waveform record length.
Sample Rate (GS/s)		Specifies the oscilloscope's sample rate for all tests.
Vertical Settings		 <b>Note:</b> This setting is not applicable for Reference Channels or UDA.
Data	Vertical Scale (mV)	Sets the Vertical Scale of the signal.
	Vertical Position (div)	Sets the Vertical Position of the signal.
Vertical Offset (V)		Sets the channel signal vertical offset.

## See also

[Configure tests](#)

[About running tests](#)

## Preferences: Set the test run preferences



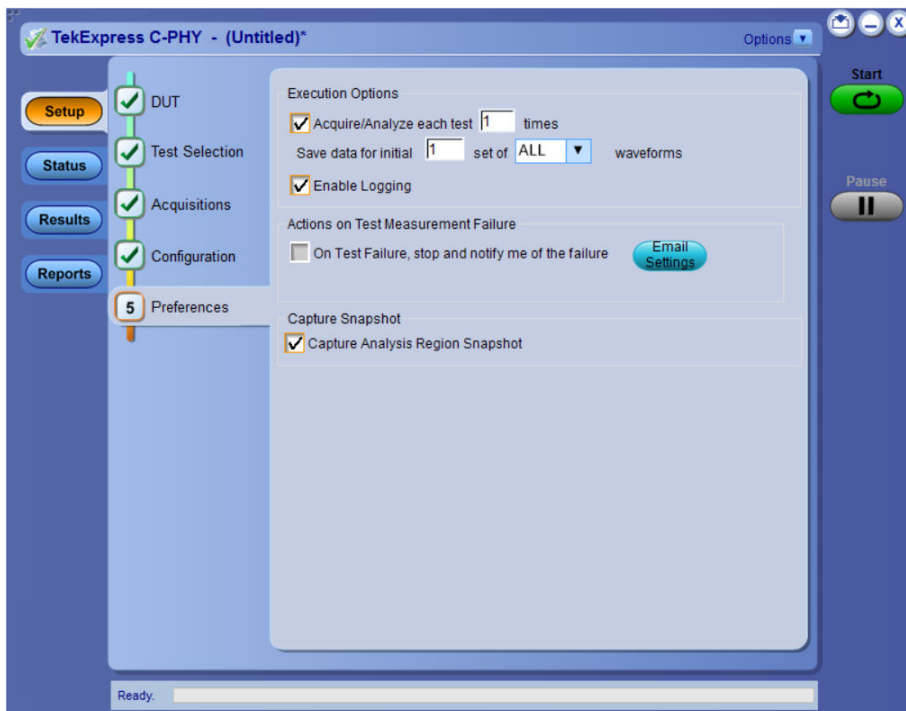

Use **Preferences** tab to set the application action on completion of a measurement. The **Preferences** tab has the feature to enable or disable certain options related to the measurement execution.



Refer the below table for the options available in the **Preferences** tab:



Table 13: Preferences tab settings

Setting	Description
<b>Execution Options</b>	
Acquire/Analyze each test <no> times (not applicable to Custom Tests)	Select to repeat the test run by setting the number of times. By default, the check box is enabled.   <b>Note:</b> This is not applicable for Pre-recorded Mode and User Defined Acquisition.
Save data for initial <no> set of <type> waveforms	Saves the set(s) of Pass/Fail waveforms to the session path.   <b>Note:</b> This is not applicable for Pre-recorded Mode and User Defined Acquisition.
Enable Logging	Select to record the actions of the user by the application. By default, it is selected.   <b>Note:</b> Uncheck and Check this feature for the log to be available in the session folder.
<b>Actions on Test Measurement Failure</b>	
On Test Failure, stop and notify me of the failure	Select to stop the test run on Test Failure, and to get notified via email. By default, it is unselected. Click <b>Email Settings</b> to configure the email settings to receive notifications.
<b>Capture snapshot</b>	
Capture Analysis Region Snapshot	Enables the Analysis region snapshot in the report.   <b>Note:</b> This is not applicable for Test ID 1.2.21, 1.2.22, 1.3.3, 1.3.4, and 1.3.5 measurements.

## Status panel: View the test execution status

The Status panel contains the **Test Status** and **Log View** tabs, which provides status on the test acquisition and analysis (Test Status) and listing of test tasks performed (Log View tab). The application opens the **Test Status** tab when you start to execute the test. Select the **Test Status** or the **Log View** tab to view these items while the test execution is in progress.

### View test execution status

The tests are grouped and displayed based on the Clock and Data lane. It displays the tests along with the acquisition type, acquire, and analysis status of the tests. In pre-recorded mode, **Acquire Status** is not valid.

The **Test Status** tab presents a collapsible table with information about each test as it is running. Use the symbols to expand (+) and collapse (-) the table rows.

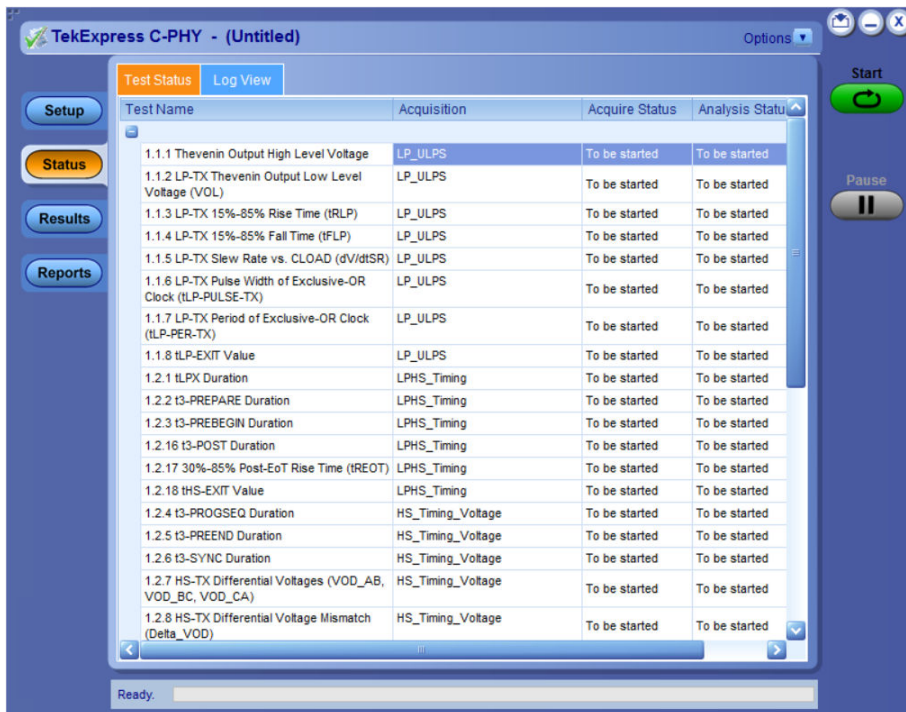

Figure 14: Test execution status view in Status panel

Table 14: Test execution status table headers

Table Header	Description
Test Name	Displays the measurement name.
Acquisition	Describes the type of data being acquired.
Table continued...	

Table Header	Description
Acquire Status	Displays the progress state of the acquisition: <ul style="list-style-type: none"> <li>To be started</li> <li>Inprogress</li> <li>Completed</li> </ul>
Analysis Status	Displays the progress state of the analysis: <ul style="list-style-type: none"> <li>To be started</li> <li>Inprogress</li> <li>Completed</li> </ul>

## View test execution logs

The Test Status tab displays the detailed execution status of the tests. Also, displays each and every execution step in detail with its timestamp information. The log details can be used to troubleshoot and resolve any issue/bug which is blocking the test execution process.

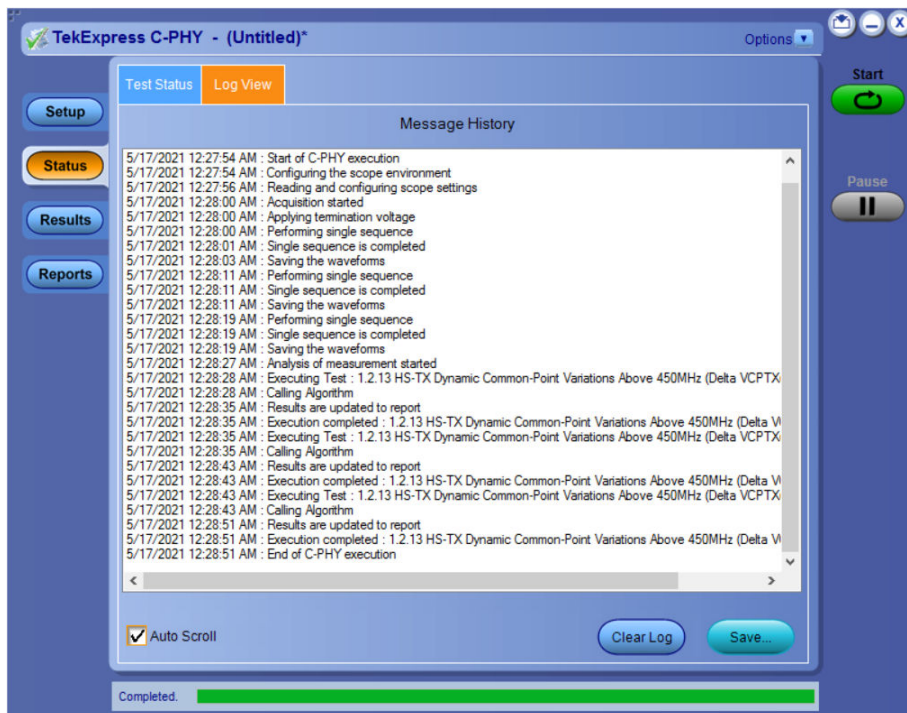

Figure 15: Log view in Status panel

Table 15: Status panel settings

Control	Description
Message History	Lists all the executed test operations and timestamp information.
Auto Scroll	Enables automatic scrolling of the log view as information is added to the log during the test execution.
Clear Log	Clears all the messages from the log view.

Table continued...

---

Control	Description
Save	Saves the log file into a text file format. Use the standard Save File window to navigate to and specify the folder and file name to save the log text.

## Results panel: View summary of test results

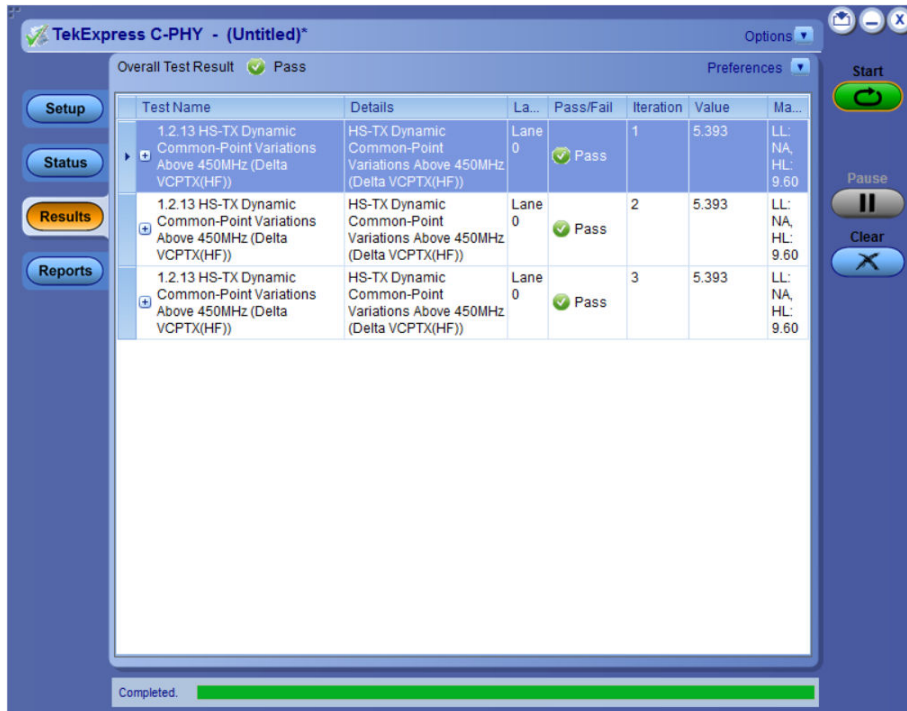

Figure 16: Results panel with measurement results

Click **+** icon on each measurement in the row to expand and to display the minimum and maximum parameter values of the measurement.

## Filter the test results

Each column in the result table can be customized and displayed by enabling or disabling any column as per your requirement. You can change the view in the following ways:

- To remove or restore the Pass/Fail column, select **Preferences > Show Pass/Fail**.
- To collapse all expanded tests, select **Preferences > View Results Summary**.
- To expand all the listed tests, select **View Results Details** from the **Preferences** menu in the upper right corner.
- To enable or disable the wordwrap feature, select **Preferences > Enable Wordwrap**.
- To view the results grouped by lane or test, select the corresponding item from the **Preferences** menu.
- To expand the width of a column, place the cursor over the vertical line that separates the column from the column to the right. When the cursor changes to a double-ended arrow, hold down the mouse button and drag the column to the desired width.
- To clear all test results displayed, click **Clear**.

# Reports panel: Configure report generation settings

Click **Reports** panel to configure the report generation settings and select the test result information to include in the report. You can use the Reports panel to configure report generation settings, select test content to include in reports, generate the report, view the report, browse for reports, name and save reports, and select report viewing options.

## Report configuration settings

The Configuration tab describes the report generation settings to configure the Reports panel. Select report settings before running a test or when creating and saving test setups. Report settings configured are included in saved test setups.

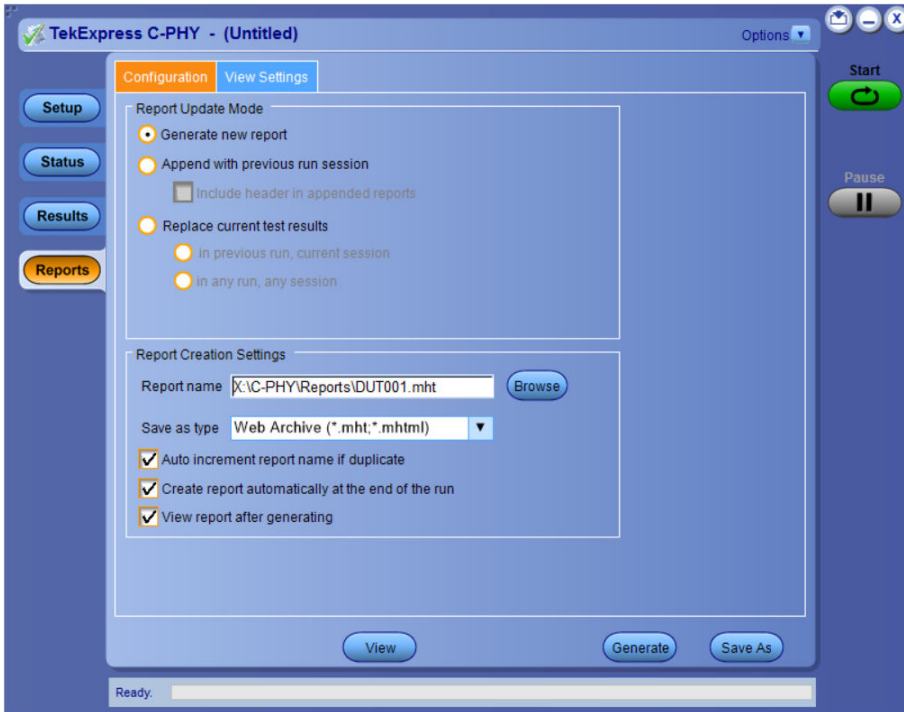



Figure 17: Report panel-Configuration tab details

Table 16: Report configuration panel settings

Control	Description
View	Click to view the most current report.
Generate	Generates a new report based on the current analysis results.
Save As	Specify a name for the report.
<b>Report Update Mode Settings</b>	
Generate new report	Each time when you click <b>Run</b> and when the test execution is complete, it will create a new report. The report can be in either .mht, .pdf, or .csv file formats.
Append with previous run session	Appends the latest test results to the end of the current test results report. Each time when you click this option and run the tests, it will run the previously failed tests and replace the failed test result with the new pass test result in the same report.
Include header in appended reports	Select to include header in appended reports.

Table continued...

Control	Description
Replace current test results	Replaces the previous test results with the latest test results. Results from newly added tests are appended to the end of the report.
In previous run, current session	Select to replace current test results in the report with the test result(s) of previous run in the current session.
In any run, any session	Select to replace current test results in the report with the test result(s) in the selected run session's report. Click and select test result of any other run session.
<b>Report Creation Settings</b>	
Report name	<p>Displays the name and path of the &lt;Application Name&gt; report. The default location is at \My Documents&gt;\My TekExpress\&lt;Application Name&gt;\Reports. The report file in this folder gets overwritten each time you run a test unless you specify a unique name or select to auto increment the report name.</p> <p><b>To change the report name or location, do one of the following:</b></p> <ul style="list-style-type: none"> <li>In the Report Path field, type the current folder path and name.</li> <li>Double-click in the Report Path field and then make selections from the popup keyboard and click <b>Enter</b>.</li> </ul> <p>Be sure to include the entire folder path, the file name, and the file extension.                      For example: C:\Documents and Settings\your user name\My Documents\My TekExpress\&lt;Application Name&gt; \DUT001.mht.</p> <p> <b>Note:</b> You cannot set the file location using the Browse button.</p> <p><b>Open an existing report</b></p> <p>Click <b>Browse</b>, locate and select the report file and then click <b>View</b> at the bottom of the panel.</p>
Save as type	<p>Saves a report in the specified file type, selected from the drop-down list. The report is saved in .csv, .pdf, or .mht.</p> <p> <b>Note:</b> If you select a file type different from the default, be sure to change the report file name extension in the Report Name field to match.</p>
Auto increment report name if duplicate	Sets the application to automatically increment the name of the report file if the application finds a file with the same name as the one being generated. For example: DUT001, DUT002, DUT003. This option is enabled by default.
Create report automatically at the end of the run	Select to create the report with the settings configured, at the end of run.
View report after generating	Automatically opens the report in a Web browser when the test execution is complete. This option is selected by default.

## Configure report view settings

The **View Settings** tab describes the report view settings to configure the Reports panel. Select report view settings before running a test or when creating and saving test setups. Report settings configured are included in saved test setups.

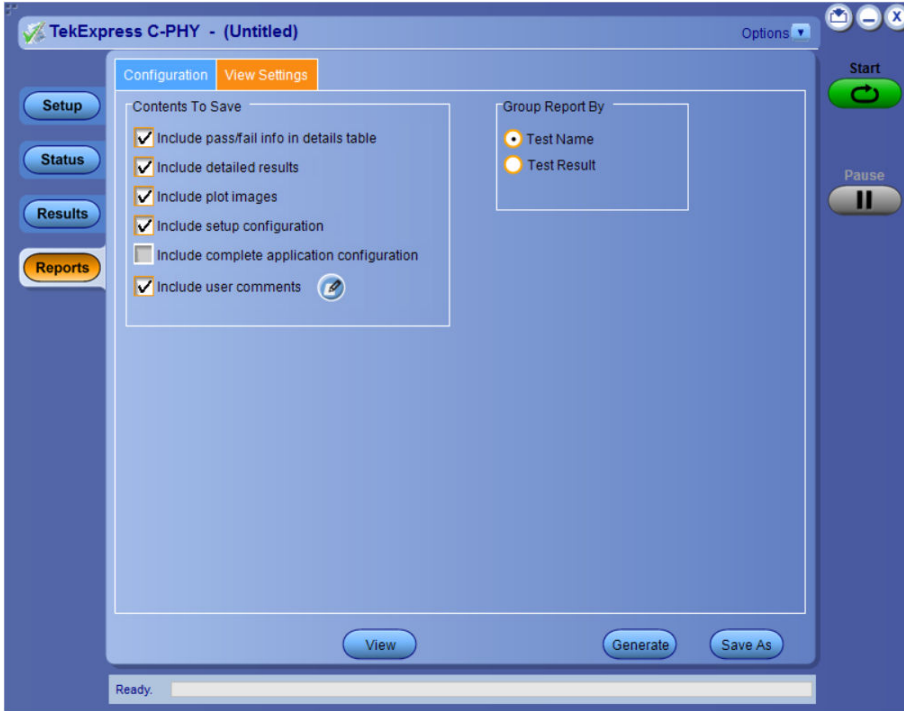

Figure 18: Report panel-View settings tab

Table 17: Report panel view settings

Control	Description
<b>Contents To Save Settings</b>	
Include pass/fail info in details table	Select to include pass/fail information in the details table of the report.
Include detailed results	Select to include detailed results in the report.
Include plot images	Select to include the plot images in the report.
Include setup configuration	Sets the application to include hardware and software information in the summary box at the top of the report. Information includes: the oscilloscope model and serial number, the oscilloscope firmware version, and software versions for applications used in the measurements.
Include complete application configuration	Select to include the complete application configuration in the report.
Include user comments	Select to include any comments about the test that you or another user have added in the DUT tab of the Setup panel. Comments appear in the Comments section, below the summary box at the beginning of each report.
<b>Group Report By</b>	
Test Name	Select to group the test results based on the test name in the report.
Test Result	Select to group the test results based on the test result in the report.



## View a generated report

### Sample report and its contents

A report shows detailed results and plots, as set in the Reports panel.

Setup Information		TekExpress C-PHY Transmitter Test Report	
DUT ID	DUT001	Scope Model	MSO688
Date/Time	7/19/2021 7:10:05 PM	Scope Serial Number	Q000027
Symbol Rate(Gsps)	1	Scope F/W Version	1.36.0.1280
Signal Type	LP-HS	DPOJET Version	N.A
Compliance Mode	Yes	VA: (Source, Probe Model-Serial)	CH1, 1X-N/A
Acquisition Mode	Live	VA: (Deskew(ps))	0
Device Type	TX-Device	VB: (Source, Probe Model-Serial)	CH2, 1X-N/A
TekExpress C-PHY Version	1.0.1.163	VB: (Deskew(ps))	0
TekExpress Framework Version	5.6.0.102	VC: (Source, Probe Model-Serial)	CH3, 1X-N/A
C-PHY version	C-PHY 2.0	VC: (Deskew(ps))	0
Measurement Method	Automatic		
User Defined Acquisition	No		
Overall Test Result	Pass		
Overall Execution Time	00:00:34		
DUT COMMENT:	General Comment - C-PHY		

Test Name Summary Table	
1.1.1 Thevenin Output High Level Voltage (VOH)	Pass

1.1.1 Thevenin Output High Level Voltage (VOH)								
Lane	Measurement Details	Iteration	Measured Value	Units	Test Result	Margin	Low Limit	High Limit
<a href="#">Lane 0</a>	VOH of VA	1	1.076	V	Pass	LL: 0.126, HL: 0.224	0.95	1.3
<a href="#">Lane 0</a>	VOH of VB	1	1.076	V	Pass	LL: 0.126, HL: 0.224	0.95	1.3
<a href="#">Lane 0</a>	VOH of VC	1	1.077	V	Pass	LL: 0.127, HL: 0.223	0.95	1.3
COMMENTS								

[Back to Summary Table](#)

Figure 19: Report of C-PHY

#### Setup Information

The summary box at the beginning of the report lists setup configuration information. This information includes the oscilloscope model and serial number, optical module model and serial number, and software version numbers of all associated applications.

The test summary table lists all the tests which are executed with its result status.

#### Measurement

The measurement table displays the measurement related details with its parameter value.

#### User comments

If you had selected to include comments in the test report, any comments you added in the DUT tab are shown at the top of the report.



**Note:** To navigate to the plot click on the first row in the measurement table for each iteration.

# Saving and recalling test setup

## Test setup files overview

Saved test setup information (such as the selected oscilloscope, general parameters, acquisition parameters, measurement limits, waveforms (if applicable), and other configuration settings) are saved under the setup name at X:\<Application Name>.

Use test setups to:

- Run a new session, acquire live waveforms, using a saved test configuration.
- Create a new test setup using an existing one.
- View all the information associated with a saved test, including the log file, the history of the test status as it executed, and the results summary.
- Run a saved test using saved waveforms.

## Save the configured test setup

You can save a test setup before or after running a test. You can create a test setup from already created test setup or using a default test setup. When you save a setup, all the parameters, measurement limits, waveform files (if applicable), test selections, and other configuration settings are saved under the setup name. When you select the default test setup, the parameters are set to the application's default value.

Select **Options > Save Test Setup** to save the opened setup.

Select **Options > Save Test Setup As** to save the setup with different name.

## Load a saved test setup

To open (load) a saved test setup, do the following:

- Select **Options > Open Test Setup**.
- Select the setup from the list and click **Open**. Setup files are located at X:\<Application Name>.

## Select a pre-run session from the loaded test setup

Complete the following steps to load a test setup from a pre-run session:

1. Select **Options > Open Test Setup**.
2. Select a setup from the list and then click **Open**. Setup files are located at X:\<Application Name>\.
3. Switch the mode to **Pre-recorded waveform files** in the DUT panel.
4. Select the required waveforms from the selected setup in the Acquisition tab and **Run** the required test.

## Save the test setup with a different name

To create a test setup with a different name, follow the steps:

1. Select **Options > Open Test Setup**.
2. Select a setup from the list and then click **Open**.
3. Click application setup and modify the parameters.
4. Click application reports and modify the report options.
5. Select **Options > Save Test Setup As**.
6. Enter the test setup name and click **Save**.

# Application measurements

## 1.1.1 Thevenin Output High Level Voltage (VOH)

CPHY-TX test verifies that Thevenin Output High Level Voltage (VOH) of the DUTs LP transmitter is within the conformance limits as per MIPI CPHY Specification.

### Procedure

1. Using DSO, VA, VB, and VC signals with LP signaling sequence is captured from DUT
2. 400 MHz, 4<sup>th</sup> order Butterworth Lowpass test filter is applied to the acquired waveform.
3. LP-1 states are found and VOH is measured as mode of all samples which are greater than 50% of absolute peak-to-peak of VA.
4. Repeat Step 3 for VB and VC waveform.

## 1.1.2 LP-TX Thevenin Output Low Level Voltage (VOL)

This CPHY-TX test verifies that Thevenin Output High Level Voltage (VOH) of the DUTs LP transmitter is within the conformance limits as per MIPI CPHY Specification.

### Procedures

1. Using DSO, VA, VB, and VC signals with LP signaling sequence is captured from DUT.
2. 400 MHz, 4<sup>th</sup> order Butterworth Lowpass test filter is applied to the acquired waveform.
3. LP-0 states are found and VOH is measured as mode of all samples which are less than 50% of absolute peak-to-peak of VA.
4. Repeat Step 3 for VB and VC waveform.

## 1.1.3 LP-TX 15%-85% Rise Time (tRLP)

This CPHY-TX test verifies that 15%-85% Rise Time (tRLP) of the DUT's LP transmitter is within the conformance limits as per MIPI CPHY Specification.

### Procedures

1. Using DSO, VA, VB, and VC signals with LP signaling sequence is captured from DUT.
2. LP regions are found from the acquired VA,VB, and VC waveform.
3. 400 MHz, 4<sup>th</sup> order Butterworth Lowpass test filter is applied to the acquired waveform.
4. Refer [1.1.1 Thevenin Output High Level Voltage \(VOH\)](#) on page 52 and [1.1.2 LP-TX Thevenin Output Low Level Voltage \(VOL\)](#) on page 52 to calculate VOH and VOL.
5. Repeat Step 4 to Step 5 for VB and VC waveform.

## 1.1.4 LP-TX 15%-85% Fall Time (tFLP)

This CPHY-TX test verifies that 15%-85% Fall Time (tFLP) of the DUT's LP transmitter is within the conformance limits as per MIPI CPHY Specification.

### Procedure

1. Using DSO, VA, VB, and VC signals with LP signaling sequence is captured from DUT.
2. LP regions are found from the acquired VA,VB, and VC waveform.

3. 400 MHz, 4<sup>th</sup> order Butterworth Lowpass test filter is applied to the acquired waveform.
4. Refer [1.1.1 Thevenin Output High Level Voltage \(VOH\)](#) on page 52 and [1.1.2 LP-TX Thevenin Output Low Level Voltage \(VOL\)](#) on page 52 to calculate VOH and VOL.
5. Fall Time ( $t_{FLP}$ ) is measured as mean of 15%-85% fall time for VA across all falling edges of LP region found.
6. Repeat Step 4 to Step 5 for VB and VC waveform.

### 1.1.5 LP-TX Slew Rate versus $C_{LOAD}$ ( $dV/dt_{SR}$ )

This CPHY-TX test verifies that slew rate ( $dV/dt_{SR}$ ) of the DUT's LP transmitter is within the conformance limits as per MIPI CPHY Specification.

#### Procedure

1. Using DSO, VA, VB, and VC signals with LP signaling sequence is captured from DUT.
2. LP regions are found from the acquired VA,VB, and VC waveform.
3. 400 MHz, 4<sup>th</sup> order Butterworth Lowpass test filter is applied to the acquired waveform.
4. The maximum and minimum slew rate ( $dV/dt_{SR}$ ) for falling and rising edge is measured over desired region as per MIPI-CPHY CTS for VA.
5. Repeat Step 4 for VB and VC waveform.

### 1.1.6 LP-TX pulse width of Exclusive-OR Clock ( $t_{LP-PULSE-TX}$ )

This CPHY-TX test verifies that pulse width ( $t_{LP-PULSE-TX}$ ) of the DUT's LP transmitter XOR clock is within the conformance limits as per MIPI CPHY Specification.

#### Procedure

1. Using DSO, VA, VB, and VC signals with LP signaling sequence is captured from DUT.
2. Mark1 and stop state are found from the acquired VA,VB, and VC waveform.
3. 400 MHz, 4<sup>th</sup> order Butterworth Lowpass test filter is applied to the acquired waveform.
4. XOR clock computed from VA and VC waveform.
5. Pulse width is measured for the XOR clock based on minimum and maximum trip level defined in MIPI-CPHY CTS.

### 1.1.7 LP-TX Period of Exclusive-OR Clock ( $t_{LP-PER-TX}$ )

This CPHY-TX test verifies the period ( $t_{LP-PER-TX}$ ) of the DUT's LP transmitter XOR clock is within the conformance limits as per MIPI CPHY Specification.

#### Procedure

1. Using DSO, VA, VB, and VC signals with LP signaling sequence is captured from DUT.
2. Mark1 and stop state are found from the acquired VA,VB and VC waveform.
3. 400 MHz, 4<sup>th</sup> order Butterworth Lowpass test filter is applied to the acquired waveform.
4. XOR clock computed from VA and VC waveform.
5. Period is measured for the XOR clock based on minimum and maximum trip level defined in MIPI-CPHY CTS.

## 1.1.8 $t_{LP-EXIT}$ value

This CPHY-TX test verifies that  $t_{LP-EXIT}$  of the DUT's LP transmitter is within the conformance limits as per MIPI CPHY Specification.

### Procedure

1. Using DSO, VA, VB, and VC signals with LP signaling sequence is captured from DUT.
2.  $t_{LP-EXIT}$  interval is measured when VB rising edge crosses  $V_{IH\_Min}$  until VB falling edge  $V_{IL\_Max}$  up to the next sequence respectively.

## 1.2.1 tLPX Duration

This CPHY-TX test verifies that the duration ( $t_{LPX}$ ) of the final LP-001 state immediately before HS transmission is as per MIPI CPHY Specification.

### Procedure

1. Using DSO, VA, VB, and VC signals with HS burst sequence is captured from DUT.
2. The desired LP region is found from the acquired waveforms.
3.  $t_{LPX}$  duration is measured from the point where VA crosses below  $V_{IL\_MAX}$  till the point where VC crosses below  $V_{IL\_MAX}$  as defined in MIPI CPHY CTS.

## 1.2.2 t3-PREPARE Duration

This CPHY-TX test verifies that the duration of the final LP-000 state immediately before HS transmission ( $t3-PREPARE$ ) is as per MIPI CPHY Specification.

### Procedure

1. Using DSO, VA, VB, and VC signals with HS burst sequence is captured from DUT.
2. The desired LP and HS regions are found from the acquired waveforms.
3.  $t3-PREPARE$  duration is measured from the point where VC crosses below  $V_{IL\_MAX}$  till the point where the VAB, VBC, and VCA differential waveforms all cross above the minimum differential threshold level as defined in MIPI CPHY CTS.

## 1.2.3 t3-PREBEGIN Duration

This CPHY-TX test verifies that duration of  $t3-PREBEGIN$  is within the conformance limits as per MIPI CPHY Specification.

### Procedure

1. Using DSO, VA, VB, and VC signals with HS burst sequence is captured from DUT.
2. The captured signal is decoded.
3. If  $t3-PROGSEQ$  is enabled,  $t3-PREBEGIN$  is measured from the start of HS burst (point where the VAB, VBC, and VCA differential waveforms all cross above the minimum differential threshold level as defined in MIPI CPHY CTS) till start of  $t3-PROGSEQ$ .
4. Else,  $t3-PREBEGIN$  is measured from the start of HS burst (point where the VAB, VBC, and VCA differential waveforms all cross above the minimum differential threshold level as defined in MIPI CPHY CTS) till start of  $t3-PREEND$ .

## 1.2.4 t3-PROGSEQ Duration

This CPHY-TX test verifies that duration of  $t3-PREBEGIN$  is within the conformance limits as per MIPI CPHY Specification.

**Procedure**

1. Using DSO, VA, VB, and VC signals with HS burst sequence is captured from DUT.
2. The captured signal is decoded and t3- PROGSEQ sequence is read as input from user.
3. The given t3-PROGSEQ sequence is searched from the decoded bursts.

**1.2.5 t3- PREEND Duration**

This CPHY-TX test verifies that duration of t3- CALALTSEQ is within the conformance limits as per MIPI CPHY Specification.

**Procedure**

1. Using DSO, VA, VB, and VC signals with HS burst sequence is captured from DUT.
2. The captured signal is decoded, and t3-PREEND, which is “3,3,3,3,3,3” is found from the decoded burst.

**1.2.6 t3-SYNC Duration**

This CPHY-TX test verifies that duration of t3- SYNC is within the conformance limits as per MIPI CPHY Specification.

**Procedure**

1. Using DSO, VA, VB & VC signals with HS burst sequence is captured from DUT.
2. The captured signal is decoded.
3. t3-SYNC Word, which is “3,4,4,4,4,3” is found from the decoded burst.

**1.2.7 HS-TX Differential Voltages (VOD\_AB, VOD\_BC, VOD\_CA)**

This CPHY-TX test verifies that differential voltages (VOD\_AB, VOD\_BC, VOD\_CA) of the DUT HS transmitter are within the conformance limits as per MIPI CPHY Specification.

**Procedure**

1. Using DSO, VA, VB, and VC signals with HS signaling sequence is captured from DUT.
2. Mean value of maximum VOD\_AB for the Strong 1, Weak 0 and mean value of minimum VOD\_AB for the Weak 0, Strong 0 levels of the AB pair are calculated as defined in MIPI-CPHY CTS.
3. Repeat Step 2 for VBC and VCA waveform.

**1.2.8 HS-TX Differential Voltage Mismatch ( $\Delta$ VOD)**

This CPHY-TX test Differential Voltage Mismatch ( $\Delta$ VOD) of the DUT HS transmitter is within the conformance limits per MIPI CPHY Specification.

**Procedure**

1. Using DSO, VA, VB, and VC signals with HS signaling sequence is captured from DUT.
2. Refer [1.2.7 HS-TX Differential Voltages \(VOD\\_AB, VOD\\_BC, VOD\\_CA\)](#) on page 55 to obtain VOD value for VAB, VBC, VCA differential pairs.
3. Differential voltage mismatch,  $\Delta$ VOD is calculated as defined in MIPI-CPHY CTS.

## 1.2.9 HS-TX Single-Ended Output High Voltages (VOHHS(VA), VOHHS(VB), VOHHS(VC))

This CPHY-TX test verifies that single-Ended output high voltages (VOHHS(VA), VOHHS(VB), and VOHHS(VC)) of the DUT HS transmitter are less than the maximum conformance limit as per MIPI CPHY Specification.

### Procedure

1. Using DSO, VA, VB, and VC signals with HS signaling sequence is captured from DUT.
2. Values of VOHHS(VA), VOHHS(VB), and VOHHS(VC) are calculated as defined in MIPI-CPHY CTS similar to the test [1.2.7 HS-TX Differential Voltages \(VOD\\_AB, VOD\\_BC, VOD\\_CA\)](#) on page 55 using VA, VB and VC signals.

## 1.2.10 HS-TX Static Common-Point Voltages (VCPTX)

This CPHY-TX test verifies that Static Common-Point Voltages (VCPTX) of the DUT HS transmitter are within the conformance limits as per MIPI CPHY Specification.

### Procedure

1. Using DSO, VA, VB, and VC signals with HS signaling sequence is captured from DUT.
2. Mean values for VCPTX for each of the +x, +y, +z, -x, -y, and -z states are calculated as defined in MIPI-CPHY CTS.

## 1.2.11 HS-TX Static Common-Point Voltage Mismatch ( $\Delta$ VCPTX(HS))

This CPHY-TX test verifies that Static Common-Point Voltage Mismatch ( $\Delta$ VCPTX(HS)) of the DUT HS transmitter is within the conformance limits as per MIPI CPHY Specification.

### Procedure

1. Using DSO, VA, VB, and VC signals with HS signaling sequence is captured from DUT.
2. Refer [1.2.10 HS-TX Static Common-Point Voltages \(VCPTX\)](#) on page 56 to calculate static common-mode levels for VA, VB and VC signals.
3. Static common-point voltage mismatch is calculated as defined in MIPI CPHY CTS.
4. Repeat Step 2 to Step 3 for all Lanes.

## 1.2.12 HS-TX Dynamic Common-Point Variations Between 50-450 MHz ( $\Delta$ VCPTX(LF))

This CPHY-TX test verifies that AC Common-Point Signal Level Variations between 50 and 450 MHz ( $\Delta$ VCPTX(LF)) of the DUT HS transmitter is within the conformance limits as per MIPI CPHY Specification.

### Procedure

1. Using DSO, VA, VB, and VC signals with HS signaling sequence is captured from DUT.
2. Common-point voltage, VCPTX signal is computed and 8th-order Butterworth IIR bandpass filter with -3 dB cutoff frequencies of 50 MHz and 450 MHz is applied as defined in MIPI CPHY CTS.
3. The peak voltage of the bandpass-filtered VCPTX waveform is measured.
4. Repeat Step 2 to Step 5 for all Lanes.



### 1.2.13 HS-TX Dynamic Common-Point Variations Above 450 MHz ( $\Delta VCPTX(HF)$ )

This CPHY-TX test verifies that AC Common-Mode Signal Level Variations above 450 MHz ( $\Delta VCPTX(HF)$ ) of the DUT HS transmitter is within the conformance limits as per MIPI CPHY Specification.

#### Procedure

1. Using DSO, VA, VB, and VC signals with HS signaling sequence is captured from DUT.
2. Common-point voltage VCPTX signal is computed and 8th-order Butterworth highpass filter with cutoff frequencies of 450 MHz is applied as defined in MIPI CPHY CTS.
3. The RMS value of the filtered VCPTX waveform is measured.

### 1.2.14 HS-TX Rise Time (tR)

This CPHY-TX test verifies that Rise Time (tR) of the DUT HS transmitter is within the conformance limits as per MIPI CPHY Specification.

#### Procedure

1. Using DSO, VA, VB, and VC signals with HS signaling sequence is captured from DUT.
2. The differential waveform is computed as difference of the VA and VB single-ended waveforms (VA-VB).
3. The averaged rise time waveform is computed for the strong zero to weak one transition.
4. Measure the Rise Time (tR) of the averaged reference waveform between the -58 and +58 mV levels.

### 1.2.15 HS-TX Fall Time (tF)

This CPHY-TX test verifies that Fall Time (tF) of the DUT HS transmitter is within the conformance limits as per MIPI CPHY Specification.

#### Procedure

1. Using DSO, VA, VB, and VC signals with HS signaling sequence is captured from DUT.
2. The differential waveform is computed as difference of the VA and VB single-ended waveforms (VA-VB).
3. The averaged Fall Time (tF) is measured for the weak one to strong zero transition.
4. Measure the Fall Time (tF) of the averaged reference waveform between the -58 and +58 mV levels.

### 1.2.16 t3-POST Duration

This CPHY-TX test verifies that duration of HS-TX burst (t3-POST), is within the conformance limits as per MIPI CPHY Specification.

#### Procedure

1. Using DSO, VA, VB, and VC signals with HS signaling sequence is captured from DUT.
2. The captured signal is decoded and length of t3- POST is read as input from user.
3. The t3-POST sequence (all 4's) of given length is searched from the decoded bursts.

### 1.2.17 30%-85% Post-EoT Rise Time (tREOT)

This CPHY-TX test verifies that 30%-85% Post-EoT Rise Time (tREOT)), is within the conformance limits as per MIPI CPHY Specification.

#### Procedure

1. Using DSO, VA, VB, and VC signals with HS signaling sequence is captured from DUT.
2. The differential waveform is computed as difference of single-ended waveforms VA and VC (VC-VA).

3. tREOT Rise Time is measured at the starting point where the differential waveform last crosses below the minimum valid HS-RX differential threshold level ( $\pm 40$  mV), until VA crosses VIH\_MIN as defined in MIPI CPHY CTS.

## 1.2.18 tHS-EXIT Value

This CPHY-TX test verifies that duration of in the LP-111 (Stop) state, is within the conformance limits as per MIPI CPHY Specification.

### Procedure

1. Using DSO, VA, VB, and VC signals with HS signaling sequence is captured from DUT.
2. tHS-EXIT interval for a given Lane is measured at the starting point which is from the end of the t3-POST interval until the VA (LP-001) falling edge crosses VIL\_MAX as defined in MIPI CPHY CTS.

## 1.2.19 HS Clock Instantaneous UI (UIINST)

This CPHY-TX test verifies that Instantaneous Unit Interval values (UIINST), is within the conformance limits as per MIPI CPHY Specification.

### Procedure

1. Using DSO, VA, VB, and VC signals with HS signaling sequence is captured from DUT.
2. Differential waveforms are calculated to observe the zero crossings between each UI.
3. The UIINST values for each UI are measured as the difference between successive 0 V crossing times of the differential waveforms is calculated as mentioned in MIPI CPHY CTS.

## 1.2.20 HS Clock Delta UI ( $\Delta$ UI) (OBSOLETE)

This CPHY-TX test verifies that frequency stability of the DUT HS Clock during a single burst, is within the conformance limits as per MIPI CPHY Specification.

### Procedure

1. Using DSO, VA, VB, and VC signals with HS signaling sequence is captured from DUT.
2. Differential waveforms Vab are calculated to observe the zero crossings between each UI.
3. Butterworth lowpass filter with a -3 dB cutoff frequency of 2.0 MHz is applied.
4. The HS Clock Delta UI ( $\Delta$ UI) values for each UI are measured as The widths for each UI is measured as the difference between successive 0 V crossing times of the differential waveforms.

## 1.2.21 HS-TX Eye Diagram

This CPHY-TX test verifies that Transmitter Eye Diagram, is within the conformance limits as per MIPI CPHY Specification.

### Procedure

1. Using DSO, VA, VB, and VC signals with continuous pseudo random (PRBS9) HS test sequence is captured from DUT.
2. Capture at least 1 million UIs of the differential waveforms Vab from the HS sequence using the DSO
3. Generate RCLK
4. Reference channel and CTLE is applied on the differential waveform computed as required.



**Note:** Devices that operates at Symbol Rate greater than 4.5 Gbps (Short Reference Channel), greater than 3.5 Gbps (Standard Reference Channel), greater than 2.3 Gbps (Long Reference Channel) continuity CTLE should be used.

5. Check for mask hit using Eye Diagram as described in MIPI CPHY CTS.

- Repeat Step 2 to Step 6 for VBC and VCA

## 1.2.22 HS-TX UI Jitter (UI\_JitterPEAK\_TX)

This CPHY-TX test verifies that Transmitter UI Jitter specification, is within the conformance limits as per MIPI CPHY Specification.

### Procedure

- Using DSO, VA, VB, and VC signals with continuous pseudo random (PRBS9) HS sequence is captured from DUT.
- Capture 1000 UIs of the differential waveforms Vab from the HS sequence.
- Generate the RCLK.
- 25 GHz low pass filter applied on RCLK signal before performing measurements.
- Reference channel and CTLE is applied on the differential waveform computed as required.



**Note:** Devices that operates at Symbol Rate greater than 4.5 Gbps (Short Reference Channel), greater than 3.5 Gbps (Standard Reference Channel), greater than 2.3 Gbps (Long Reference Channel) continuity CTLE should be used.

- The peak-to-peak values of the histogram are reported as mentioned in MIPI CPHY CTS.
- Repeat Step 2 to Step 5 for Vbc and Vca.

## 1.3.1 INIT: LP-TX Initialization Period ( $t_{\text{INIT,MASTER}}$ )

This CPHY-TX test verifies that duration of the DUTs transmitted LP Initialization period ( $t_{\text{INIT,MASTER}}$ ) is within the conformance limits as per MIPI CPHY Specification.

### Procedure

- Using DSO, VA, VB, and VC signals with LP signaling sequence is captured from DUT.
- Desired LP region is found from the acquired VA,VB, and VC waveforms.
- LP-111 initialization period is measured from the point where VA first crosses above  $V_{\text{IH\_MIN}}$  till the first point where VA crosses below  $V_{\text{IL\_MAX}}$  as defined in MIPI-CPHY CTS.

## 1.3.2 ULPS Exit: Transmitted $t_{\text{WAKEUP}}$ Interval

This CPHY-TX test verifies that duration of the DUTs transmitted Mark-1 ( $t_{\text{WAKEUP}}$ ) when initiating a ULPS Exit sequence is within the conformance limits as per MIPI CPHY Specification.

### Procedure

- Using DSO, VA, VB, and VC signals with ULPS entry sequence followed by a Mark-1 ULPS Exit sequence is captured from DUT.
- Desired LP region is found from the acquired VA, VB, and VC waveforms.
- The  $t_{\text{WAKEUP}}$  is measured from the point where the VA line of LP-100 transition crosses  $V_{\text{IH\_MIN}}$ , to the point where the VC line of LP-111 transition crosses  $V_{\text{IH\_MIN}}$  as defined in MIPI-CPHY CTS.

## 1.3.3 BTA: TX-Side $t_{\text{TA-GO}}$ Interval Value

This CPHY-TX test verifies that DUT drives the Bridge state (LP-000) for the proper period ( $t_{\text{TA-GO}}$ ) and is within the conformance limits as per MIPI CPHY Specification.

### Procedure

- Using DSO, VA, VB, and VC signals with Turnaround sequence is captured from DUT.

2. The desired Link Turnaround sequence region is identified and recalled on DSO.
3. Measure the required LP-000 duration manually by placing the cursor on appropriate region as defined in MIPI-CPHY CTS.
4. TLPX Duration value is obtained (follow the procedure listed in the [1.2.1 tLPX Duration](#) on page 54) which is updated in report for reference under test comment as part of observable result.

### 1.3.4 BTA: RX-Side $t_{TA-SURE}$ Interval Value

This CPHY-TX test verifies that DUT waits the required period ( $t_{TA-SURE}$ ) while observing the TX-Side Bridge state (LP-000) and is within the conformance limits as per MIPI CPHY Specification.

#### Procedure

1. Using DSO, VA, VB, and VC signals with Turnaround sequence is captured from DUT.
2. The desired Link Turnaround sequence region is identified and recalled on DSO.
3. Measure the required LP-000 duration manually by placing the cursor on appropriate region as defined in MIPI-CPHY CTS.
4. TLPX Duration value is obtained (follow the procedure listed in the [1.2.1 tLPX Duration](#) on page 54) which is updated in report for reference under test comment as part of observable result.

### 1.3.5 BTA: RX-Side $t_{TA-GET}$ Interval Value

This CPHY-TX test verifies that DUT drives the Bridge state (LP-000) for the required period ( $t_{TA-GET}$ ) and is within the conformance limits as per MIPI CPHY Specification.

#### Procedure

1. Using DSO, VA, VB, and VC signals with Turnaround sequence is captured from DUT.
2. The desired Link Turnaround sequence region is identified and recalled on DSO.
3. Measure the required LP-000 duration manually by placing the cursor on appropriate region as defined in MIPI-CPHY CTS.
4. TLPX Duration value is obtained (follow the procedure listed in the [1.2.1 tLPX Duration](#) on page 54) which is updated in report for reference under test comment as part of observable result.

### 1.4.1 HS-TX Differential Voltages Unterminated ( $V_{OD(UT)-AB}$ , $V_{OD(UT)-BC}$ , $V_{OD(UT)-CA}$ )

This CPHY-TX test verifies that Unterminated Differential Voltages ( $V_{OD(UT)-AB}$ ,  $V_{OD(UT)-BC}$ ,  $V_{OD(UT)-CA}$ ) of the DUT HS transmitter is within the conformance limits as per MIPI CPHY Specification.

#### Procedure

1. Using DSO, VA, VB, and VC signals with HS signaling sequence is captured from DUT.
2. Mode value of maximum  $V_{OD(UT)-AB}$  for the Strong 1, Weak 0 and minimum  $V_{OD(UT)-AB}$  for the Weak 0, Strong 0 levels of the AB pair are calculated as defined in MIPI-CPHY CTS.
3. Repeat Step 2 for VBC and VCA waveform.

### 1.4.2 HS-TX Differential Voltage Mismatch Unterminated ( $\Delta V_{OD(UT)}$ )

This CPHY-TX test verifies that Unterminated Differential Voltage Mismatch ( $\Delta V_{OD(UT)}$ ) of DUT HS transmitter is within the conformance limits as per MIPI CPHY Specification.

#### Procedure

1. Using DSO, VA, VB, and VC signals with HS signaling sequence is captured from DUT.

2. Refer [1.4.1 HS-TX Differential Voltages Unterminated \(VOD\(UT\)-AB, VOD\(UT\)-BC, VOD\(UT\)-CA\)](#) on page 60 to obtain the  $V_{ODUT}$  value for VAB, VBC, and VCA differential pairs.
3. Differential voltage mismatch ( $\Delta VOD$ ) is calculated as defined in MIPI-CPHY CTS.

### 1.4.3 HS-TX Single-Ended Output High Voltages Unterminated ( $V_{OHHS(UT)(VA)}$ , $V_{OHHS(UT)(VB)}$ , $V_{OHHS(UT)(VC)}$ )

This CPHY-TX test verifies that Unterminated Single-Ended Output High Voltages ( $V_{OHHS(UT)(VA)}$ ,  $V_{OHHS(UT)(VB)}$ , and  $V_{OHHS(UT)(VC)}$ ) of the DUT HS transmitter is within the conformance limits as per MIPI CPHY Specification.

#### Procedure

1. Using DSO, VA, VB, and VC signals with HS signaling sequence is captured from DUT.
2. Refer [1.4.1 HS-TX Differential Voltages Unterminated \(VOD\(UT\)-AB, VOD\(UT\)-BC, VOD\(UT\)-CA\)](#) on page 60 to calculate the mode value of  $V_{OHHS(UT)(VA)}$ ,  $V_{OHHS(UT)(VB)}$ , and  $V_{OHHS(UT)(VC)}$  as defined in MIPI-CPHY CTS.

### 1.4.4 HS-TX Static Common-Point Voltages Unterminated ( $V_{CPTX(UT)}$ )

This CPHY-TX test verifies that Static Common-Point Voltages ( $V_{CPTX(UT)}$ ) of DUT HS transmitter is within the conformance limits as per MIPI CPHY Specification.

#### Procedure

1. Using DSO, VA, VB, and VC signals with HS signaling sequence is captured from DUT.
2. Mean values for  $V_{CPTX(UT)}$  for each of the +x, +y, +z, -x, -y, and -z states are calculated as defined in MIPI-CPHY CTS.

### 1.5.1 t3-CALPREAMBLE Duration (Informative)

This CPHY-TX test verifies that duration of t3-CALPREAMBLE is within the conformance limits as per MIPI CPHY Specification.

#### Procedure

1. Using DSO, VA, VB, and VC signals with HS burst sequence containing Format 1 Calibration Preamble is captured from DUT.
2. t3-CALPREAMBLE is measured from start of HS Burst (point where all 3 differential signals: VAB, VBC, VCA cross above the minimum threshold  $\pm 40$  mV) till the start of t3-SYNC Word.
3. The captured signal is decoded, and t3-SYNC Word position is found from the decoded burst.
4. t3-CALPREAMBLE duration is measured from start of the HS burst to start of t3-SYNC Word. It is also verified that t3-CALPREAMBLE contains all 1's.

### 1.5.2 t3-ASID Duration (Informative)

This CPHY-TX test verifies that duration of t3-ASID is within the conformance limits as per MIPI CPHY Specification.

#### Procedure

1. Using DSO, VA, VB, and VC signals with HS burst sequence containing Format 2 Calibration Preamble is captured from DUT.
2. The captured signal is decoded, and t3-ASID, which is "3,3,3,3,3,3,3" is found from the decoded burst.

### 1.5.3 t3-CALALTSEQ Duration (Informative)

This CPHY-TX test verifies that duration of t3-CALALTSEQ is within the conformance limits as per MIPI CPHY Specification.

---

**Procedure**

1. Using DSO, VA, VB, and VC signals with HS burst sequence containing Format 2 Calibration Preamble is captured from DUT.
2. The captured signal is decoded.
3. t3-SYNC Word position and t3-ASID position is found from the decoded burst.
4. t3- CALALTSEQ is measured from end of the t3- ASID to start of t3-SYNC Word. It is also verified that t3- CALALTSEQ length is a multiple of 7UI.

**1.5.4 Calibration Sequence t3-SYNC Duration (Informative)**

This CPHY-TX test verifies that duration of t3- SYNC is within the conformance limits as per MIPI CPHY Specification.

**Procedure**

1. Using DSO, VA, VB, and VC signals with HS burst sequence containing Format 1 Calibration Preamble is captured from DUT.
2. The captured signal is decoded.
3. t3-SYNC Word, which is "3,4,4,4,4,4,3" is found from the decoded burst.
4. Repeat the procedure for Format 2 Calibration Preamble.

# SCPI Commands

## About SCPI command

You can use the Standard Commands for Programmable Instruments (SCPI) to communicate remotely with the TekExpress application. Complete the TCPIP socket configuration and the TekVISA configuration in the oscilloscope or in the device where you are executing the script.



**Note:** If you are using an external PC to execute the remote interface commands, then install TekVISA in the PC to make the configurations.

## Socket configuration for SCPI commands

This section describes the steps to configure the TCPIP socket configuration in your script execution device and the steps to configure the TekVISA configuration in the oscilloscope to execute the SCPI commands.

### TCPIP socket configuration

1. Click **Start > Control Panel > System and Security > Windows Firewall > Advanced settings**.

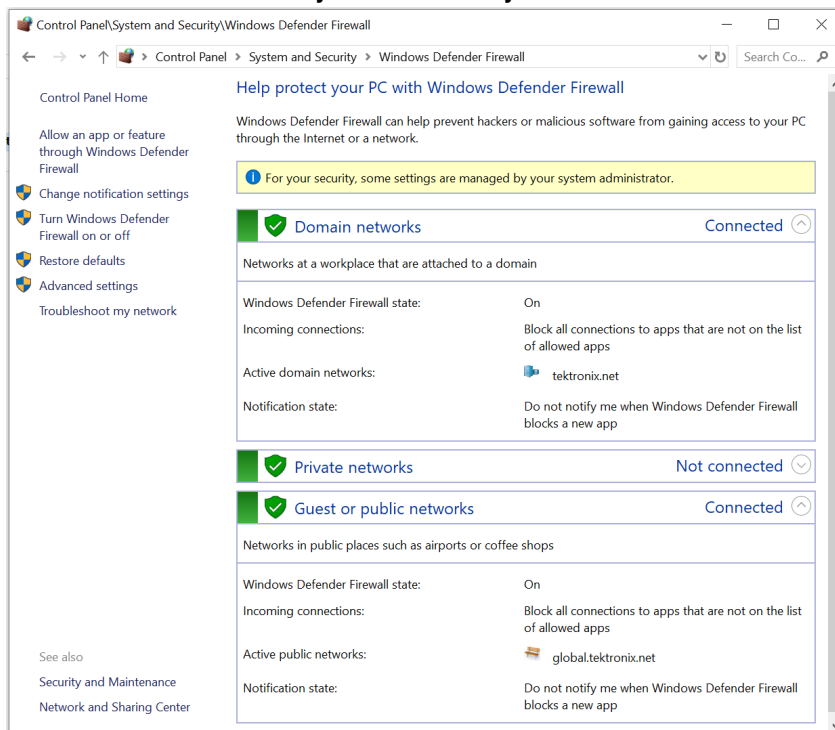

2. In Windows Firewall with Advanced Security menu, select **Windows Firewall with Advanced Security on Local Computer > Inbound Rules** and click **New Rule...**

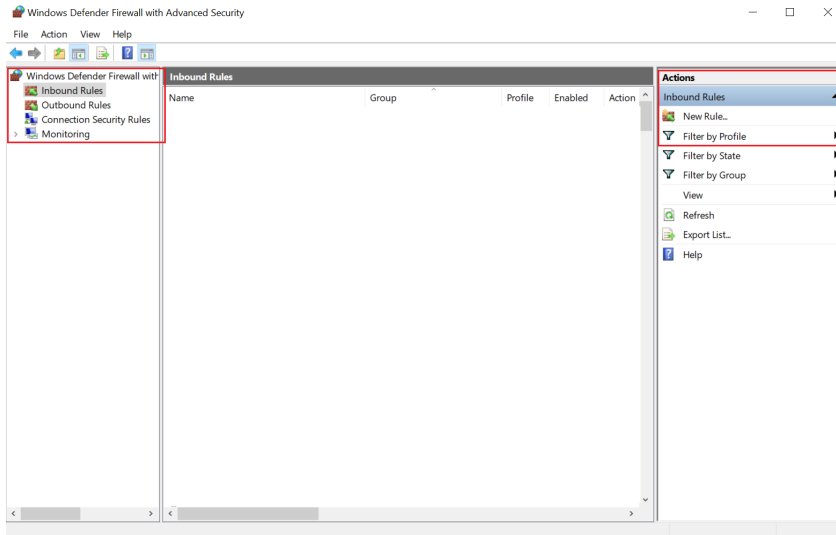

3. In **New Inbound Rule Wizard** menu

- a. Select **Port** and click **Next**.

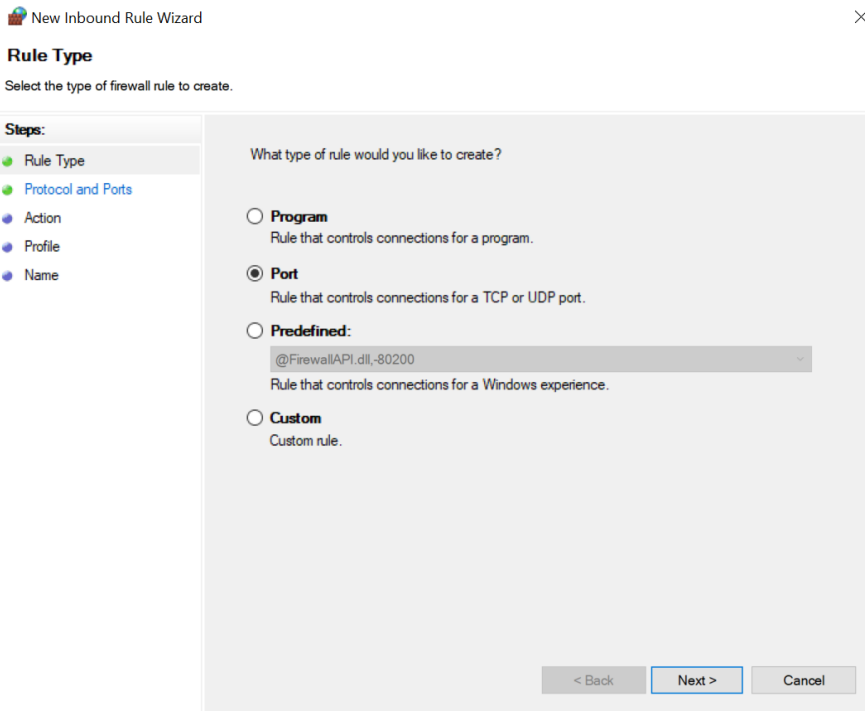

- b. Select **TCP** as rule apply, enter 5000 for **Specific local ports** and click **Next**.



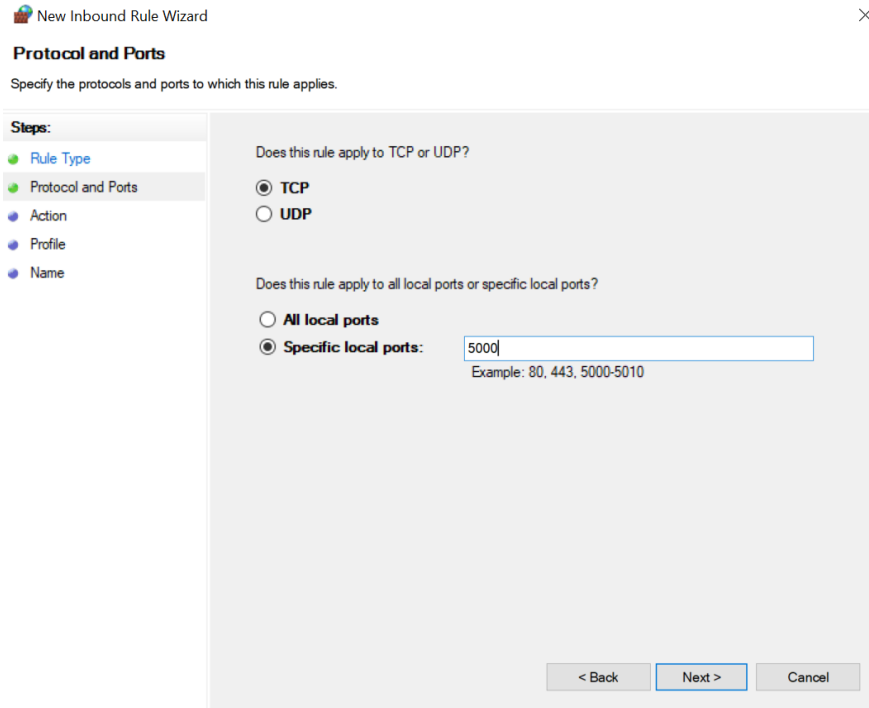

c. Select **Allow the connection** and click **Next**.

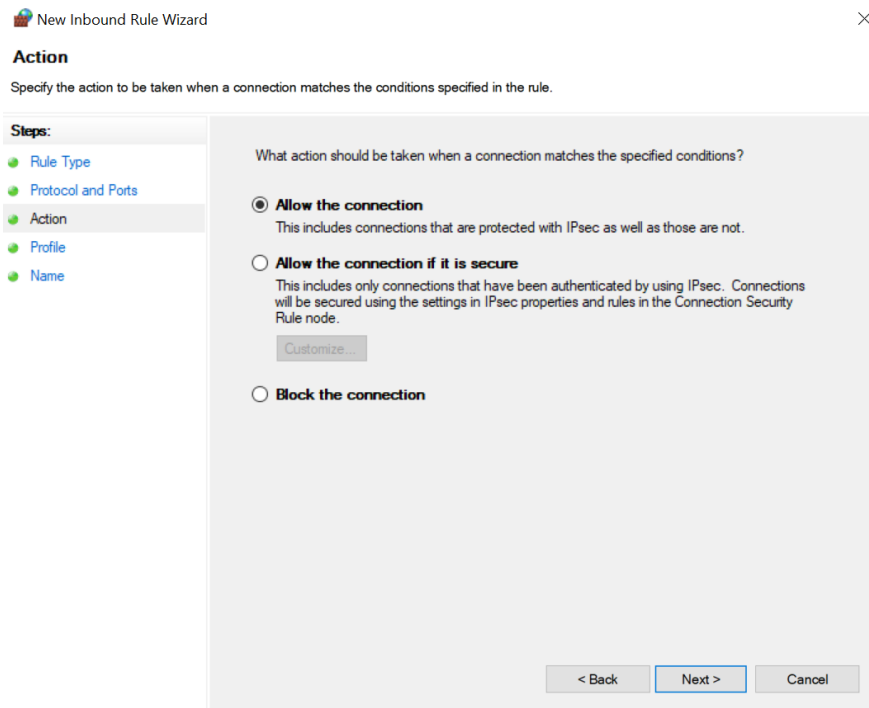

d. Select **Domain, Private, Public** checkbox and click **Next**.

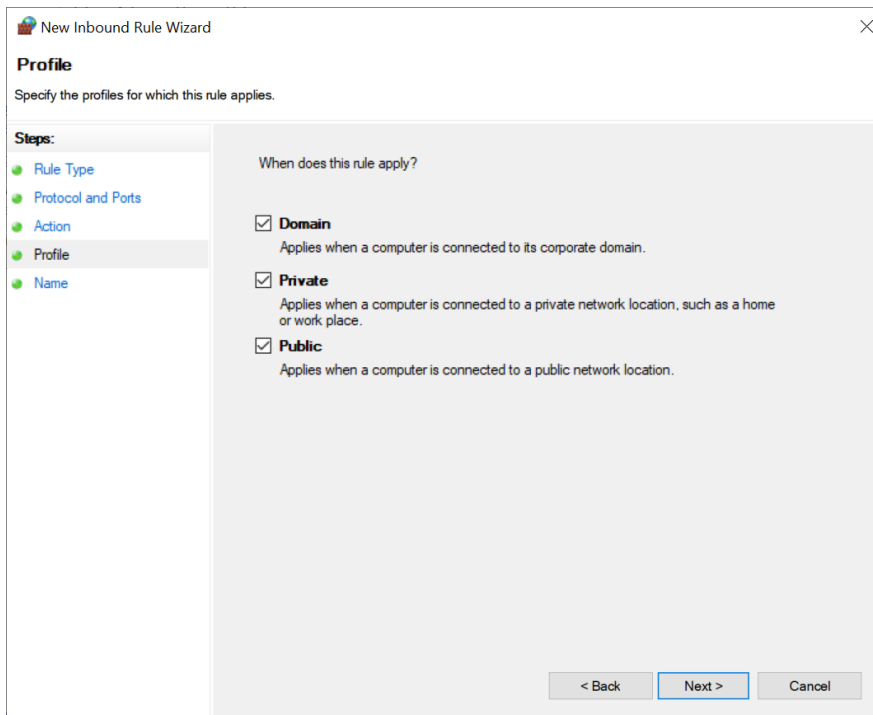

e. Enter **Name**, Description (optional), and click **Finish**.

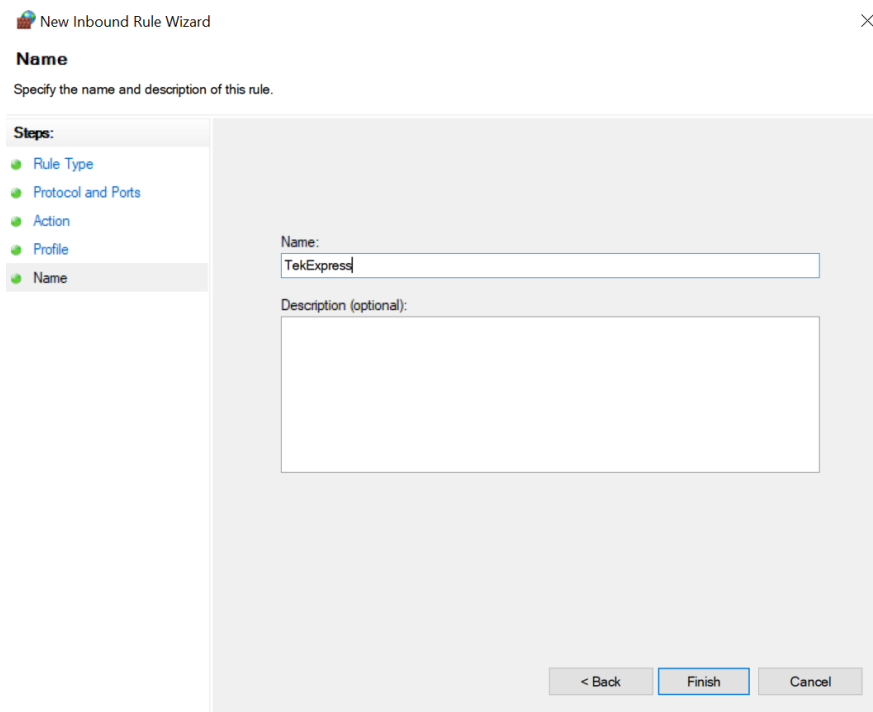

4. Check whether the Rule name is displayed in **Windows Firewall with Advanced Security** menu > **Inbound Rules**.

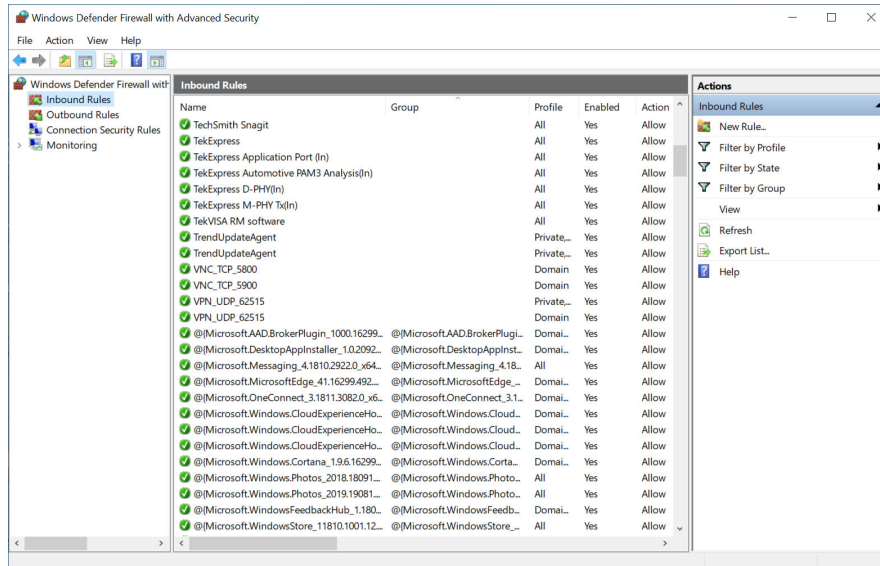

## TekVISA configuration

1. Click **Start > All Programs > TekVISA > OpenChoice Instrument Manager**.

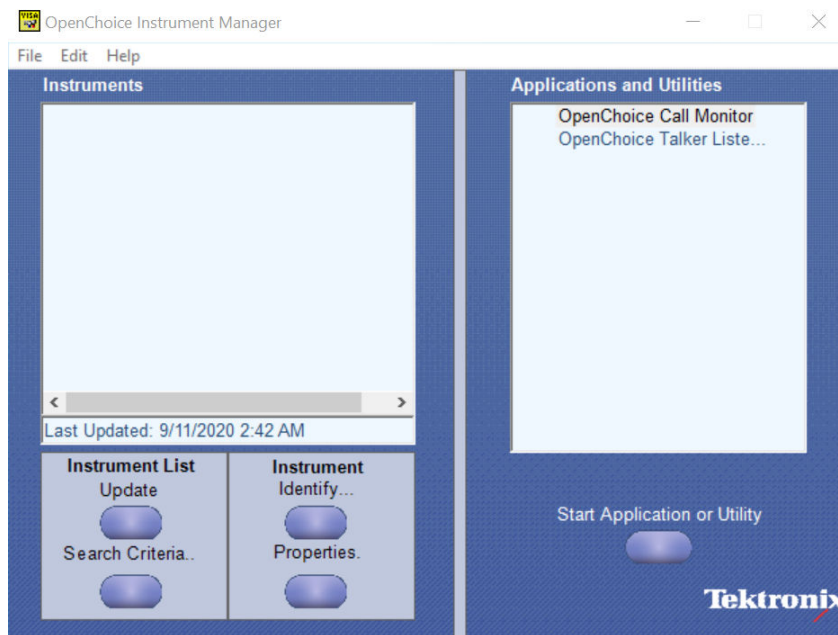

2. Click **Search Criteria**. In **Search Criteria** menu, click **LAN** to Turn-on. Select **Socket** from the drop-down list, enter the IP address of

the TekExpress device in **Hostname** and type **Port** as 5000. Click  to configure the IP address with Port.

Enter the Hostname as 127.0.0.1 if the TekVISA and TekExpress application are in the same system, else enter the IP address of the oscilloscope where the TekExpress application is running.

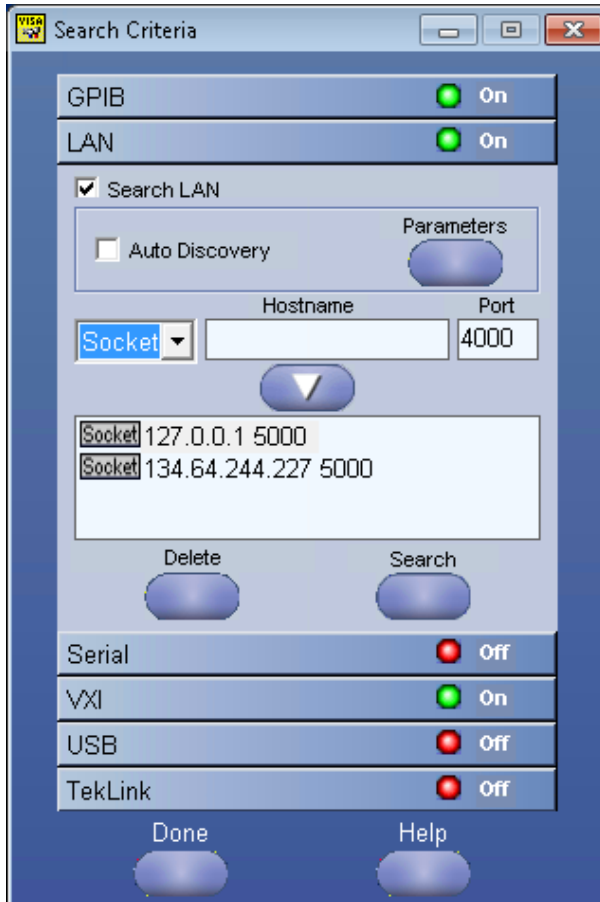

3. Click **Search** to setup the TCPIP connection with the host. Check whether the TCPIP host name is displayed in **OpenChoice Instrument Manager > Instruments**.

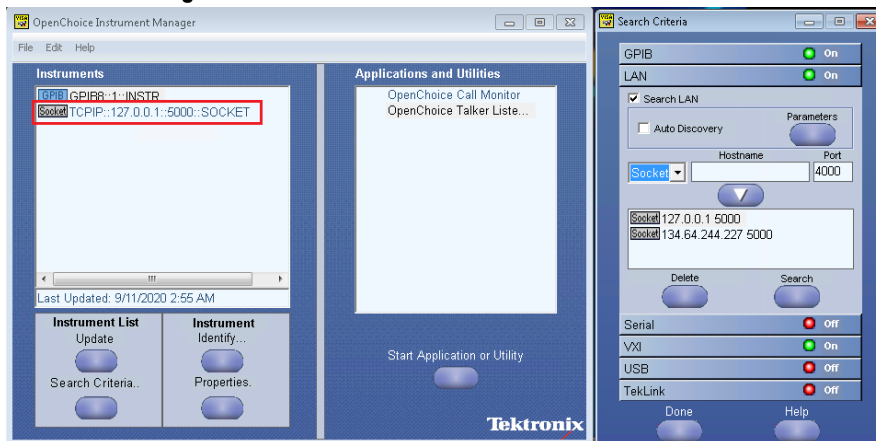

4. Double-click **OpenChoice Talker Listener** and enter the Command **\*IDN?** in command entry field and click **Query**. Check that the Operation is successful and Talker Listener Readout displays the Command / Data.

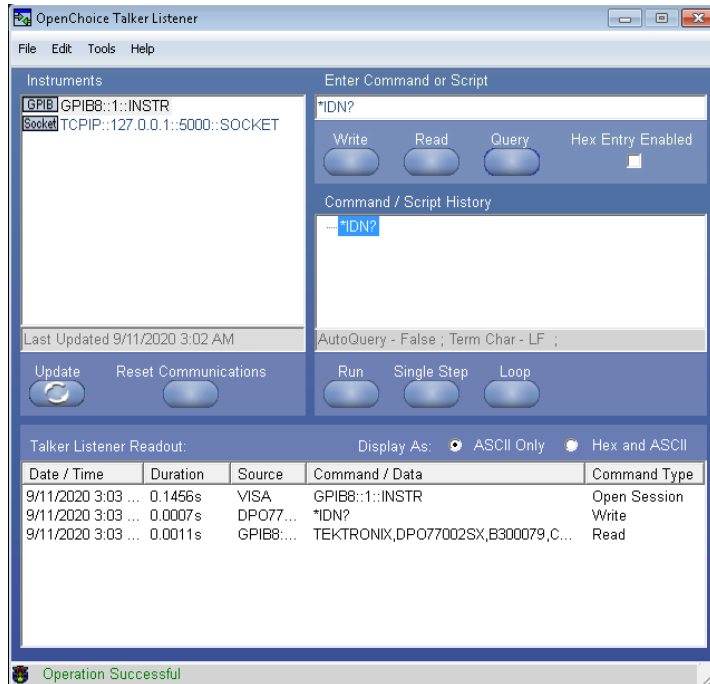

## Set or query the device name of application

This command sets or queries the device name of the application.

### Syntax

TEKEXP:SELECT DEVICE, "<DeviceName>" (Set)

TEKEXP:SELECT? DEVICE (Query)

### Command arguments

Argument Name	Argument Type
<DeviceName>	<String>

### Returns

<String>

### Examples

TEKEXP:SELECT DEVICE, "<DUT001>" command sets the device name of the application to DUT001.

TEKEXP:SELECT? DEVICE command returns the selected device name of the application.

## Set or query the DUTID of application

This command sets or queries the DUTID of the application.

### Syntax

TEKEXP:VALUE DUTID, "<Value>" (Set)

TEKEXP:VALUE? DUTID (Query)

### Command arguments

Argument Name	Argument Type
<Value>	<String>

### Returns

<String>

### Examples

TEKEXP:VALUE DUTID, "DUT001" command sets the DUTID of the application to DUT001.

TEKEXP:VALUE? DUTID command returns the DUTID of the application.

## Set or query the suite name of the application

This command sets or queries the suite name of the application.

### Syntax

TEKEXP:SELECT SUITE, "<SuiteName>" (Set)

TEKEXP:SELECT? SUITE (Query)

### Command arguments

### Returns

<String>

### Examples

TEKEXP:SELECT SUITE, "<SuiteName>" command sets the suite name of the application.

TEKEXP:SELECT? SUITE command returns the selected suite of the application.

## Set or query the test name of the application

This command selects or deselects the specified test name of the application.

### Syntax

TEKEXP:SELECT TEST, "<TestName>", <Value> (Set)

TEKEXP:SELECT TEST, "<ALL>" (Set)

TEKEXP:SELECT? TEST (Query)

### Command arguments

TestName	Value
C-PHY 1.1	{True   False} or {1   0}
<ul style="list-style-type: none"> <li>Test 1.1.1 LP-TX Thevenin Output High Level Voltage (VOH)</li> <li>Test 1.1.2 LP-TX Thevenin Output Low Level Voltage (VOL)</li> <li>Test 1.1.3 LP-TX 15%-85% Rise Time (tRLP)</li> </ul>	It represents selected or unselected. Where, True or 1 - Selected

Table continued...

TestName	Value
<ul style="list-style-type: none"> <li>• Test 1.1.4 LP-TX 15%-85% Fall Time (tFLP)</li> <li>• Test 1.1.5 LP-TX Slew Rate vs. CLOAD (dV_dtSR)</li> <li>• Test 1.1.6 LP-TX Pulse Width of Exclusive-OR Clock (tLP-PULSE-TX)</li> <li>• Test 1.1.7 LP-TX Period of Exclusive-OR Clock (tLP-PER-TX)</li> <li>• Test 1.2.1 LP_TX tLPX Duration</li> <li>• Test 1.2.2 LP_TX t3-PREPARE Duration</li> <li>• Test 1.2.3 LP_TX t3-PREBEGIN Duration</li> <li>• Test 1.2.4 LP_TX t3-PROGSEQ Duration</li> <li>• Test 1.2.5 LP_TX t3-PREEND Duration</li> <li>• Test 1.2.6 LP_TX t3-SYNC Duration</li> <li>• Test 1.2.7 HS-TX Differential Voltages (VOD_AB, VOD_BC, VOD_CA)</li> <li>• Test 1.2.8 HS-TX Differential Voltage Mismatch (Delta_VOD)</li> <li>• Test 1.2.9 HS-TX Single-Ended Output High Voltages (VOHHS(VA),VOHHS(VB),VOHHS(VC))</li> <li>• Test 1.2.10 HS-TX Static Common-Point Voltages (VCPTX)</li> <li>• Test 1.2.11 HS-TX Static Common-Point Voltage Mismatch (Delta VCPTX(HS))</li> <li>• Test 1.2.12 HS-TX Dynamic Common-Point Variations Between 50-450MHz (Delta VCPTX(LF))</li> <li>• Test 1.2.13 HS-TX Dynamic Common-Point Variations Above 450MHz (Delta VCPTX(HF))</li> <li>• Test 1.2.16 HS_TX t3-POST Duration</li> <li>• Test 1.2.17 HS_TX Post-EoT Rise Time(tREOT)</li> <li>• Test 1.2.18 HS_TX tHS-EXIT Value</li> <li>• Test 1.2.19 HS Clock Instantaneous UI (UIINST)</li> <li>• Test 1.2.20 HS Clock Delta UI (Delta_UI)</li> <li>• Test 1.2.21 HS-TX Eye Diagram</li> <li>• Test 1.3.1 INIT LP-TX Initialization Period (tINIT,MASTER)</li> <li>• Test 1.3.2 ULPS Exit Transmitted tWAKEUP Interval</li> <li>• Test 1.3.3 BTA TX-Side tTA-GO Interval Value</li> <li>• Test 1.3.4 BTA RX-Side tTA-SURE Interval Value</li> <li>• Test 1.3.5 BTA RX-Side tTA-GET Interval Value</li> <li>• Test 1.4.1 HS-TX Differential Voltages Unterminated (VOD(UT)-AB, VOD(UT)-BC, VOD(UT)-CA)</li> <li>• Test 1.4.2 HS-TX Differential Voltages Mismatch Unterminated (Delta_VOD(UT))</li> <li>• Test 1.4.3 HS-TX Single-Ended Output High Voltages Unterminated (VOHHS(VA),VOHHS(VB),VOHHS(VC))</li> <li>• Test 1.4.4 HS-TX Static Common-Point Voltages Unterminated (VCPTX(UT))</li> </ul>	<p>False or 0 - Unselected</p>
<p>C-PHY 2.0</p> <ul style="list-style-type: none"> <li>• Test 1.1.1 LP-TX Thevenin Output High Level Voltage (VOH)</li> <li>• Test 1.1.2 LP-TX Thevenin Output Low Level Voltage (VOL)</li> </ul> <p>Table continued...</p>	<p>{True   False} or {1   0}</p> <p>It represents selected or unselected.</p> <p>Where,</p>

TestName	Value
• Test 1.1.3 LP-TX 15%-85% Rise Time (tRLP)	True or 1 - Selected
• Test 1.1.4 LP-TX 15%-85% Fall Time (tFLP)	False or 0 - Unselected
• Test 1.1.5 LP-TX Slew Rate vs. CLOAD (dV_dtSR)	
• Test 1.1.6 LP-TX Pulse Width of Exclusive-OR Clock (tLP-PULSE-TX)	
• Test 1.1.7 LP-TX Period of Exclusive-OR Clock (tLP-PER-TX)	
• Test 1.1.8 LP-TX tLP-EXIT Value	
• Test 1.2.1 LP_TX tLPX Duration	
• Test 1.2.2 LP_TX t3-PREPARE Duration	
• Test 1.2.3 LP_TX t3-PREBEGIN Duration	
• Test 1.2.4 LP_TX t3-PROGSEQ Duration	
• Test 1.2.5 LP_TX t3-PREEND Duration	
• Test 1.2.6 LP_TX t3-SYNC Duration	
• Test 1.2.7 HS-TX Differential Voltages (VOD_AB, VOD_BC, VOD_CA)	
• Test 1.2.8 HS-TX Differential Voltage Mismatch (Delta_VOD)	
• Test 1.2.9 HS-TX Single-Ended Output High Voltages (VOHHS(VA),VOHHS(VB),VOHHS(VC))	
• Test 1.2.10 HS-TX Static Common-Point Voltages (VCPTX)	
• Test 1.2.11 HS-TX Static Common-Point Voltage Mismatch (Delta VCPTX(HS))	
• Test 1.2.12 HS-TX Dynamic Common-Point Variations Between 50-450MHz (Delta VCPTX(LF))	
• Test 1.2.13 HS-TX Dynamic Common-Point Variations Above 450MHz (Delta VCPTX(HF))	
• Test 1.2.16 HS_TX t3-POST Duration	
• Test 1.2.17 HS_TX Post-EoT Rise Time(tREOT)	
• Test 1.2.18 HS_TX tHS-EXIT Value	
• Test 1.2.19 HS Clock Instantaneous UI (UIINST)	
• Test 1.2.21 HS-TX Eye Diagram	
• Test 1.2.22 HS-TX UI Jitter (UI_JitterPEAK_TX)	
• Test 1.3.1 INIT LP-TX Initialization Period (tINIT,MASTER)	
• Test 1.3.2 ULPS Exit Transmitted tWAKEUP Interval	
• Test 1.3.3 BTA TX-Side tTA-GO Interval Value	
• Test 1.3.4 BTA RX-Side tTA-SURE Interval Value	
• Test 1.3.5 BTA RX-Side tTA-GET Interval Value	
• Test 1.4.1 HS-TX Differential Voltages Unterminated (VOD(UT)-AB, VOD(UT)-BC, VOD(UT)-CA)	
• Test 1.4.2 HS-TX Differential Voltages Mismatch Unterminated (Delta_VOD(UT))	
• Test 1.4.3 HS-TX Single-Ended Output High Voltages Unterminated (VOHHS(VA),VOHHS(VB),VOHHS(VC))	
• Test 1.4.4 HS-TX Static Common-Point Voltages Unterminated (VCPTX(UT))	
• Test 1.5.1 t3-CALPREAMBLE Duration	
• Test 1.5.2 t3-ASID Duration	

Table continued...



TestName	Value
<ul style="list-style-type: none"> <li>• Test 1.5.3 t3-CALALTSEQ Duration</li> <li>• Test 1.5.4 Calibration Sequence t3-SYNC Duration</li> </ul>	
<p>C-PHY 1.0</p> <ul style="list-style-type: none"> <li>• Test 1.1.1 LP-TX Thevenin Output High Level Voltage (VOH)</li> <li>• Test 1.1.2 LP-TX Thevenin Output Low Level Voltage (VOL)</li> <li>• Test 1.1.3 LP-TX 15%-85% Rise Time (tRLP)</li> <li>• Test 1.1.4 LP-TX 15%-85% Fall Time (tFLP)</li> <li>• Test 1.1.5 LP-TX Slew Rate vs. CLOAD (dV_dtSR)</li> <li>• Test 1.1.6 LP-TX Pulse Width of Exclusive-OR Clock (tLP-PULSE-TX)</li> <li>• Test 1.1.7 LP-TX Period of Exclusive-OR Clock (tLP-PER-TX)</li> <li>• Test 1.2.1 LP_TX tLPX Duration</li> <li>• Test 1.2.2 LP_TX t3-PREPARE Duration</li> <li>• Test 1.2.3 LP_TX t3-PREBEGIN Duration</li> <li>• Test 1.2.4 LP_TX t3-PROGSEQ Duration</li> <li>• Test 1.2.5 LP_TX t3-PREEND Duration</li> <li>• Test 1.2.6 LP_TX t3-SYNC Duration</li> <li>• Test 1.2.7 HS-TX Differential Voltages (VOD_AB, VOD_BC, VOD_CA)</li> <li>• Test 1.2.8 HS-TX Differential Voltage Mismatch (Delta_VOD)</li> <li>• Test 1.2.9 HS-TX Single-Ended Output High Voltages (VOHHS(VA),VOHHS(VB),VOHHS(VC))</li> <li>• Test 1.2.10 HS-TX Static Common-Point Voltages (VCPTX)</li> <li>• Test 1.2.11 HS-TX Static Common-Point Voltage Mismatch (Delta VCPTX(HS))</li> <li>• Test 1.2.12 HS-TX Dynamic Common-Point Variations Between 50-450MHz (Delta VCPTX(LF))</li> <li>• Test 1.2.13 HS-TX Dynamic Common-Point Variations Above 450MHz (Delta VCPTX(HF))</li> <li>• Test 1.2.14 HS-TX Rise Time (tR)</li> <li>• Test 1.2.15 HS-TX Fall Time (tF)</li> <li>• Test 1.2.16 HS_TX t3-POST Duration</li> <li>• Test 1.2.17 HS_TX Post-EoT Rise Time(tREOT)</li> <li>• Test 1.2.18 HS_TX tHS-EXIT Value</li> <li>• Test 1.2.19 HS Clock Instantaneous UI (UIINST)</li> <li>• Test 1.2.20 HS Clock Delta UI (Delta_UI)</li> <li>• Test 1.3.1 INIT LP-TX Initialization Period (tINIT,MASTER)</li> <li>• Test 1.3.2 ULPS Exit Transmitted tWAKEUP Interval</li> <li>• Test 1.3.3 BTA TX-Side tTA-GO Interval Value</li> <li>• Test 1.3.4 BTA RX-Side tTA-SURE Interval Value</li> <li>• Test 1.3.5 BTA RX-Side tTA-GET Interval Value</li> </ul>	<p>{True   False} or {1   0}</p> <p>It represents selected or unselected.</p> <p>Where,</p> <p>True or 1 - Selected</p> <p>False or 0 - Unselected</p>

## Returns

{True | False} or {1 | 0}

## Examples

TEKEXP:SELECT TEST, "<TestName>", 1 command selects the specified test in the Test Panel.

TEKEXP:SELECT TEST, "<ALL>" command select all the tests in the Test Panel.

TEKEXP:SELECT? TEST command returns the list of selected tests.

## Set or query the version name of the application

This command sets or queries the version name of the application.

### Syntax

TEKEXP:SELECT VERSION, "<VersionName>" (Set)

TEKEXP:SELECT? VERSION (Query)

### Command arguments

Argument Name	Argument Type	Valid Values
<VersionName>	<String>	It is the name of the version on the DUT panel of the application.

VersionName
<ul style="list-style-type: none"> <li>• C-PHY 1.0</li> <li>• C-PHY 1.1</li> <li>• C-PHY 2.0</li> </ul>

### Returns

<String>

### Examples

TEKEXP:SELECT VERSION, "<VersionName>" command sets the version name of application.

TEKEXP:SELECT? VERSION command returns the version name of application.

## Set or query the general parameter values

This command sets or queries the general parameter values of the application.

### Syntax

TEKEXP:VALUE GENERAL, "<ParameterName>", "<Value>" (Set)

TEKEXP:VALUE? GENERAL, "<ParameterName>" (Query)

### Command arguments

**Table 18: General command parameters**

ParameterName	Value
LVHS Mode	<ul style="list-style-type: none"> <li>• TRUE</li> <li>• FALSE</li> </ul>
LVLP Mode	<ul style="list-style-type: none"> <li>• TRUE</li> <li>• FALSE</li> </ul>
Termination Voltage (V)	0 to 5
Cursor Mode	<ul style="list-style-type: none"> <li>• Automatic</li> <li>• Manual</li> </ul>
Data Rate	0.08 to 8
Signal Types	<ul style="list-style-type: none"> <li>• HS</li> <li>• LP</li> <li>• LP-HS</li> </ul>
Insertion Loss Selection	<ul style="list-style-type: none"> <li>• TRUE</li> <li>• FALSE</li> </ul>
CTLE Selection	<ul style="list-style-type: none"> <li>• TRUE</li> <li>• FALSE</li> </ul>
CTLE File PathC-PHY 1.1	<ul style="list-style-type: none"> <li>• For C-PHY 1.1: C:\Program Files\Tektronix\TekExpress\TekExpress C-PHY\Compliance Suites\C-PHY\TX-Device\C-PHY 1.1\CTLE\CTLE_8Gsp.s.ft</li> <li>• C-PHY 2.0 C:\Program Files\Tektronix\TekExpress\TekExpress C-PHY\Compliance Suites\C-PHY\TX-Device\C-PHY 2.0\CTLE\CTLE_8Gsp.s.ft</li> </ul>
Va Filter File Path	<ul style="list-style-type: none"> <li>• C-PHY 1.1 C:\Program Files\Tektronix\TekExpress\TekExpress C-PHY\Compliance Suites\C-PHY\TX-Device\C-PHY 1.1\Standard_VAB.ft</li> <li>• C-PHY 2.0 C:\Program Files\Tektronix\TekExpress\TekExpress C-PHY\Compliance Suites\C-PHY\TX-Device\C-PHY 2.0\Standard_VAB.ft</li> </ul>

Table continued...

ParameterName	Value
Vb Filter File Path	<ul style="list-style-type: none"> <li>• C-PHY 1.1 C:\Program Files\Tektronix\TekExpress\TekExpress C-PHY\Compliance Suites\C-PHY\TX-Device\C-PHY 1.1\Standard_VBC.ftt</li> <li>• C-PHY 2.0 C:\Program Files\Tektronix\TekExpress\TekExpress C-PHY\Compliance Suites\C-PHY\TX-Device\C-PHY 2.0\Standard_VBC.ftt</li> </ul>
Vc Filter File Path	<ul style="list-style-type: none"> <li>• C-PHY 1.1 C:\Program Files\Tektronix\TekExpress\TekExpress C-PHY\Compliance Suites\C-PHY\TX-Device\C-PHY 1.1\Standard_VCA.ftt</li> <li>• C-PHY 2.0 C:\Program Files\Tektronix\TekExpress\TekExpress C-PHY\Compliance Suites\C-PHY\TX-Device\C-PHY 2.0\Standard_VCA.ftt</li> </ul>
Enable Logging	<ul style="list-style-type: none"> <li>• TRUE</li> <li>• FALSE</li> </ul>
Acquisition Save Options	Save All Waveforms Before Analysis
Number Lane	<ul style="list-style-type: none"> <li>• Lane0</li> <li>• Lane1</li> <li>• Lane2</li> <li>• Lane3</li> </ul>
SourceVA	<ul style="list-style-type: none"> <li>• CH1</li> <li>• CH2</li> <li>• CH3</li> <li>• CH4</li> </ul>
SourceVB	<ul style="list-style-type: none"> <li>• CH1</li> <li>• CH2</li> <li>• CH3</li> <li>• CH4</li> </ul>
SourceVC	<ul style="list-style-type: none"> <li>• CH1</li> <li>• CH2</li> <li>• CH3</li> <li>• CH4</li> </ul>
Number of Runs	1 to 1000
Table continued...	

ParameterName	Value
On Failure Stop and Notify	<ul style="list-style-type: none"> <li>• TRUE</li> <li>• FALSE</li> </ul>
Save Number Of Waveform	1 to 30 (Available only when <b>Suite=C-PHY 2.0</b> )
Result Type	(Available only when <b>Suite=C-PHY 2.0</b> ) <ul style="list-style-type: none"> <li>• FAIL</li> <li>• ALL</li> </ul>
Autoset - For Vertical Settings	(Available only when <b>Suite=C-PHY 2.0</b> ) <ul style="list-style-type: none"> <li>• TRUE</li> <li>• FALSE</li> </ul>

**Table 19: Report panel command parameters**

<ParameterName>	<Value>
On Test Failure, stop and notify me of the failure	{True   False} or {1   0} It represents selected or unselected. Where, <ul style="list-style-type: none"> <li>• True or 1 - Selected</li> <li>• False or 0 - Unselected</li> </ul>
Report Update Mode	<ul style="list-style-type: none"> <li>• New</li> <li>• Append</li> <li>• Replace</li> </ul>
Report Path	X:\<application name>\Reports\DUT001.mht
Save As Type	<ul style="list-style-type: none"> <li>• Web Archive (*.mht;*.mhtml)</li> <li>• PDF (*.pdf;)</li> <li>• CSV (*.csv;)</li> </ul>
Auto increment report name if duplicate	{True   False} or {1   0} It represents selected or unselected. Where, <ul style="list-style-type: none"> <li>• True or 1 - Selected</li> <li>• False or 0 - Unselected</li> </ul>

Table continued...

<ParameterName>	<Value>
Create report at the end	{True   False} or {1   0} It represents selected or unselected. Where, <ul style="list-style-type: none"> <li>• True or 1 - Selected</li> <li>• False or 0 - Unselected</li> </ul>
Include Pass/Fail Results Summary	{True   False} or {1   0} It represents selected or unselected. Where, <ul style="list-style-type: none"> <li>• True or 1 - Selected</li> <li>• False or 0 - Unselected</li> </ul>
Include Detailed Results	{True   False} or {1   0} It represents selected or unselected. Where, <ul style="list-style-type: none"> <li>• True or 1 - Selected</li> <li>• False or 0 - Unselected</li> </ul>
Include Plot Images	{True   False} or {1   0} It represents selected or unselected. Where, <ul style="list-style-type: none"> <li>• True or 1 - Selected</li> <li>• False or 0 - Unselected</li> </ul>
Include Setup Configuration	{True   False} or {1   0} It represents selected or unselected. Where, <ul style="list-style-type: none"> <li>• True or 1 - Selected</li> <li>• False or 0 - Unselected</li> </ul>
Include Complete Application Configuration	{True   False} or {1   0} It represents selected or unselected. Where, <ul style="list-style-type: none"> <li>• True or 1 - Selected</li> <li>• False or 0 - Unselected</li> </ul>
Table continued...	

<ParameterName>	<Value>
Include User Comments	{True   False} or {1   0} It represents selected or unselected. Where, <ul style="list-style-type: none"> <li>• True or 1 - Selected</li> <li>• False or 0 - Unselected</li> </ul>
Report Settings:Include Header In Appended Reports	{True   False} or {1   0} It represents selected or unselected. Where, <ul style="list-style-type: none"> <li>• True or 1 - Selected</li> <li>• False or 0 - Unselected</li> </ul>
View Report After Generating	{True   False} or {1   0} It represents selected or unselected. Where, <ul style="list-style-type: none"> <li>• True or 1 - Selected</li> <li>• False or 0 - Unselected</li> </ul>
Report Group Mode	<ul style="list-style-type: none"> <li>• Test Name</li> <li>• Test Result</li> </ul>
Append Report	{True   False} or {1   0} It represents selected or unselected. Where, <ul style="list-style-type: none"> <li>• True or 1 - Selected</li> <li>• False or 0 - Unselected</li> </ul>

## Returns

<NRf> or <String>

## Examples

TEKEXP:VALUE GENERAL, "<ParameterName>", "<Value>" command set the value for the specified general parameter.

TEKEXP:VALUE? GENERAL, "<ParameterName>" command returns the value for the specified general parameter.

---

## Set or query the acquire parameter values

This command sets or queries the acquire parameter values of the application.

### Syntax

TEKEXP:VALUE

ACQUIRE,"<TestName>","<AcquireType>","<ParameterName>","<ParameterValue>" (Set)

TEKEXP:VALUE? ACQUIRE,"<TestName>","<AcquireType>","<ParameterName>" (Query)

### Command arguments



TestName	AcquireType	ParameterName	ParameterValue
1.1.1 Thevenin Output High Level Voltage (VOH) 1.1.2 LP-TX Thevenin Output Low Level Voltage (VOL) 1.1.3 LP-TX 15%-85% Rise Time (tRLP) 1.1.4 LP-TX 15%-85% Fall Time (tFLP) 1.1.5 LP-TX Slew Rate vs. CLOAD (dV/dtSR) 1.1.6 LP-TX Pulse Width of Exclusive-OR Clock (tLP-PULSE-TX) 1.1.7 LP-TX Period of Exclusive-OR Clock (tLP-PER-TX) 1.1.8 tLP-EXIT Value	LP_ULPS	Vertical Scale (mV)	10 to 500
		Vertical Position (div)	-5 to 5
		Vertical Offset (V)	-1.3 to 1.3
		Sample Rate (GS/s)	<ul style="list-style-type: none"> <li>• 6.25</li> <li>• 12.5</li> <li>• 25</li> <li>• 50</li> </ul>
		Record Length	100000 to 10000000
		Trigger Type	<ul style="list-style-type: none"> <li>• Transition</li> <li>• Edge</li> <li>• Width</li> </ul>
		Trigger Source	<ul style="list-style-type: none"> <li>• VA</li> <li>• VB</li> <li>• VC</li> </ul>
		Trigger Upper Level (V)	-5 to 5
		Trigger Lower Level (V)	-6 to 1
		Trigger Upper Limit (us)	
		Trigger Lower Limit (us)	
		Trigger Polarity	<ul style="list-style-type: none"> <li>• Positive</li> <li>• Negative</li> </ul>
		Edge Trigger Level(V)	0 to 1
		Trigger Time (ps)	<ul style="list-style-type: none"> <li>• 250</li> <li>• 500</li> </ul>
		Trigger Transition	<ul style="list-style-type: none"> <li>• Less Than</li> <li>• Greater Than</li> </ul>
		Trigger Slope	<ul style="list-style-type: none"> <li>• Positive</li> <li>• Negative</li> <li>• Either</li> </ul>
		Trigger If Violation	<ul style="list-style-type: none"> <li>• Occurs</li> <li>• Logic</li> </ul>

TestName	AcquireType	ParameterName	ParameterValue
1.2.1 tLPX Duration 1.2.2 t3-PREPARE Duration 1.2.3 t3-PREBEGIN Duration 1.2.16 t3-POST Duration 1.2.17 30%-85% Post-EoT RiseTime (tREOT) 1.2.18 tHS-EXIT Value	LPHS_Timing	Vertical Scale (mV)	10 to 500
		Vertical Position (div)	-5 to 5
		Vertical Offset (V)	-1.3 to 1.3
		Sample Rate (GS/s)	<ul style="list-style-type: none"> <li>• 6.25</li> <li>• 12.5</li> <li>• 25</li> <li>• 50</li> <li>• AUTO</li> </ul>
		Record Length	100000 to 10000000
		Trigger Type	<ul style="list-style-type: none"> <li>• Transition</li> <li>• Edge</li> <li>• Width</li> </ul>
		Trigger Source	<ul style="list-style-type: none"> <li>• VA</li> <li>• VB</li> <li>• VC</li> </ul>
		Trigger Upper Level (V)	-5 to 5
		Trigger Lower Level (V)	-6 to 1
		Trigger Upper Limit (us)	
		Trigger Lower Limit (us)	
		Trigger Polarity	<ul style="list-style-type: none"> <li>• Positive</li> <li>• Negative</li> </ul>
		Edge Trigger Level(V)	0 to 1
		Trigger Time (ps)	<ul style="list-style-type: none"> <li>• 250</li> <li>• 500</li> </ul>
		Trigger Transition	<ul style="list-style-type: none"> <li>• Less Than</li> <li>• Greater Than</li> </ul>
		Trigger Slope	<ul style="list-style-type: none"> <li>• Positive</li> <li>• Negative</li> <li>• Either</li> </ul>
		Trigger If Violation	<ul style="list-style-type: none"> <li>• Occurs</li> <li>• Logic</li> </ul>

Table continued...

TestName	AcquireType	ParameterName	ParameterValue
1.2.4 t3-PROGSEQ Duration	HS_Timing_Voltage	Vertical Scale (mV)	10 to 500
1.2.5 t3-PREEND Duration		Vertical Position (div)	-5 to 5
1.2.6 t3-SYNC Duration		Vertical Offset (V)	-1.3 to 1.3
1.2.7 HS-TX Differential Voltages (VOD_AB, VOD_BC, VOD_CA)		Sample Rate (GS/s)	• 6.25
1.2.8 HS-TX Differential Voltage Mismatch (Delta_VOD)			• 12.5
1.2.9 HS-TX Single-Ended Output High Voltages (VOHHS(VA),VOHHS(VB),VOHHS(VC))			• 25
			• 50
			• AUTO
1.2.10 HS-TX Static Common-Point Voltages (VCPTX)		Record Length	100000 to 10000000
1.2.11 HS-TX Static Common-Point Voltage Mismatch (Delta VCPTX(HS))		Trigger Type	• Transition
1.2.12 HS-TX Dynamic Common-Point Variations Between 50-450MHz (Delta VCPTX(LF))			• Edge
1.2.13 HS-TX Dynamic Common-Point Variations Above 450MHz (Delta VCPTX(HF))			• Width
1.2.14 HS-TX Rise Time (tR)		Trigger Source	• VA
1.2.15 HS-TX Fall Time (tF)			• VB
1.2.19 HS Clock Instantaneous UI (UIINST)			• VC
1.2.20 HS Clock Delta UI (Delta_UI)		Trigger Upper Level (V)	-5 to 5
		Trigger Lower Level (V)	-6 to 1
		Trigger Upper Limit (us)	
		Trigger Lower Limit (us)	
		Trigger Polarity	• Positive
		• Negative	
	Edge Trigger Level(V)	0 to 1	
	Trigger Time (ps)	• 250	
		• 500	
	Trigger Transition	• Less Than	
		• Greater Than	
	Trigger Slope	• Positive	
		• Negative	
		• Either	
	Trigger If Violation	• Occurs	
		• Logic	

Table continued...

TestName	AcquireType	ParameterName	ParameterValue
1.2.21 HS-TX Eye Diagram	HS_EYE	Termination Voltage (V)	0 to 5
		Vertical Scale (mV)	10 to 500
		Vertical Position (div)	-3 to 3
		Vertical Offset (V)	-1.3 to 1.3
		Sample Rate (GS/s)	<ul style="list-style-type: none"> <li>• 6.25</li> <li>• 12.5</li> <li>• 25</li> <li>• 50</li> <li>• AUTO</li> </ul>
		Record Length	100000 to 10000000
		Trigger Type	<ul style="list-style-type: none"> <li>• Transition</li> <li>• Edge</li> <li>• Width</li> </ul>
		Trigger Source	<ul style="list-style-type: none"> <li>• VA</li> <li>• VB</li> <li>• VC</li> </ul>
		Trigger Upper Level (V)	-5 to 5
		Trigger Lower Level (V)	-6 to 1
		Trigger Upper Limit (us)	
		Trigger Lower Limit (us)	
		Trigger Polarity	<ul style="list-style-type: none"> <li>• Positive</li> <li>• Negative</li> </ul>
		Edge Trigger Level(V)	0 to 1
		Trigger Time (ps)	<ul style="list-style-type: none"> <li>• 250</li> <li>• 500</li> </ul>
		Trigger Transition	<ul style="list-style-type: none"> <li>• Less Than</li> <li>• Greater Than</li> </ul>
		Trigger Slope	<ul style="list-style-type: none"> <li>• Positive</li> <li>• Negative</li> <li>• Either</li> </ul>
		Trigger If Violation	<ul style="list-style-type: none"> <li>• Occurs</li> <li>• Logic</li> </ul>
		Number of UI	100 to 2000000

Table continued...

TestName	AcquireType	ParameterName	ParameterValue
1.2.22 HS-TX UI Jitter (UI_JitterPEAK_TX)	HS_JITTER	Termination Voltage (V)	0 to 5
		Vertical Scale (mV)	10 to 500
		Vertical Position (div)	-5 to 5
		Vertical Offset (V)	-1.3 to 1.3
		Sample Rate (GS/s)	<ul style="list-style-type: none"> <li>• 6.25</li> <li>• 12.5</li> <li>• 25</li> <li>• 50</li> <li>• AUTO</li> </ul>
		Record Length	100000 to 10000000
		Trigger Type	<ul style="list-style-type: none"> <li>• Transition</li> <li>• Edge</li> <li>• Width</li> </ul>
		Trigger Source	<ul style="list-style-type: none"> <li>• VA</li> <li>• VB</li> <li>• VC</li> </ul>
		Trigger Upper Level (V)	-5 to 5
		Trigger Lower Level (V)	-6 to 1
		Trigger Upper Limit (us)	
		Trigger Lower Limit (us)	
		Trigger Polarity	<ul style="list-style-type: none"> <li>• Positive</li> <li>• Negative</li> </ul>
		Edge Trigger Level(V)	0 to 1
		Trigger Time (ps)	<ul style="list-style-type: none"> <li>• 250</li> <li>• 500</li> </ul>
		Trigger Transition	<ul style="list-style-type: none"> <li>• Less Than</li> <li>• Greater Than</li> </ul>
		Trigger Slope	<ul style="list-style-type: none"> <li>• Positive</li> <li>• Negative</li> <li>• Either</li> </ul>
		Trigger If Violation	<ul style="list-style-type: none"> <li>• Occurs</li> <li>• Logic</li> </ul>

TestName	AcquireType	ParameterName	ParameterValue
1.3.1 INIT: LP-TX Initialization Period (tINIT,MASTER)	LP_INIT_Period	Vertical Scale (mV)	10 to 500
		Vertical Position (div)	-5 to 5
		Vertical Offset (V)	-1.3 to 1.3
		Sample Rate (GS/s)	<ul style="list-style-type: none"> <li>• 3.125</li> <li>• 6.25</li> <li>• 12.5</li> <li>• 25</li> <li>• 50</li> </ul>
		Record Length	100000 to 50000000
		Trigger Type	<ul style="list-style-type: none"> <li>• Transition</li> <li>• Edge</li> <li>• Width</li> </ul>
		Trigger Source	<ul style="list-style-type: none"> <li>• VA</li> <li>• VB</li> <li>• VC</li> </ul>
		Trigger Upper Level (V)	-5 to 5
		Trigger Lower Level (V)	-6 to 1
		Trigger Upper Limit (us)	
		Trigger Lower Limit (us)	
		Trigger Polarity	<ul style="list-style-type: none"> <li>• Positive</li> <li>• Negative</li> </ul>
		Edge Trigger Level(V)	0 to 1
		Trigger Time (ps)	<ul style="list-style-type: none"> <li>• 250</li> <li>• 500</li> </ul>
		Trigger Transition	<ul style="list-style-type: none"> <li>• Less Than</li> <li>• Greater Than</li> </ul>
		Trigger Slope	<ul style="list-style-type: none"> <li>• Positive</li> <li>• Negative</li> <li>• Either</li> </ul>
		Trigger If Violation	<ul style="list-style-type: none"> <li>• Occurs</li> <li>• Logic</li> </ul>

Table continued...

TestName	AcquireType	ParameterName	ParameterValue
1.3.2 ULPS Exit: Transmitted tWAKEUP Interval	LP_WAKEUP	Vertical Scale (mV)	10 to 500
		Vertical Position (div)	-5 to 5
		Vertical Offset (V)	-1.3 to 1.3
		Sample Rate (GS/s)	<ul style="list-style-type: none"> <li>• 3.125</li> <li>• 6.25</li> <li>• 12.5</li> <li>• 25</li> <li>• 50</li> </ul>
		Record Length	100000 to 50000000
		Trigger Type	<ul style="list-style-type: none"> <li>• Transition</li> <li>• Edge</li> <li>• Width</li> </ul>
		Trigger Source	<ul style="list-style-type: none"> <li>• VA</li> <li>• VB</li> <li>• VC</li> </ul>
		Trigger Upper Level (V)	-5 to 5
		Trigger Lower Level (V)	-6 to 1
		Trigger Upper Limit (us)	
		Trigger Lower Limit (us)	
		Trigger Polarity	<ul style="list-style-type: none"> <li>• Positive</li> <li>• Negative</li> </ul>
		Edge Trigger Level(V)	0 to 1
		Trigger Time (ps)	<ul style="list-style-type: none"> <li>• 250</li> <li>• 500</li> </ul>
		Trigger Transition	<ul style="list-style-type: none"> <li>• Less Than</li> <li>• Greater Than</li> </ul>
		Trigger Slope	<ul style="list-style-type: none"> <li>• Positive</li> <li>• Negative</li> <li>• Either</li> </ul>
		Trigger If Violation	<ul style="list-style-type: none"> <li>• Occurs</li> <li>• Logic</li> </ul>

Table continued...

TestName	AcquireType	ParameterName	ParameterValue
1.3.3 BTA: TX-Side tTA-GO Interval Value 1.3.4 BTA: RX-Side tTA-SURE Interval Value 1.3.5 BTA: RX-Side tTA-GET Interval Value	LP_BTA	Vertical Scale (mV)	10 to 500
		Vertical Position (div)	-5 to 5
		Vertical Offset (V)	-1.3 to 1.3
		Sample Rate (GS/s)	<ul style="list-style-type: none"> <li>• 6.25</li> <li>• 12.5</li> <li>• 25</li> <li>• 50</li> </ul>
		Record Length	100000 to 50000000
		Trigger Type	<ul style="list-style-type: none"> <li>• Transition</li> <li>• Edge</li> <li>• Width</li> </ul>
		Trigger Source	<ul style="list-style-type: none"> <li>• VA</li> <li>• VB</li> <li>• VC</li> </ul>
		Trigger Upper Level (V)	-5 to 5
		Trigger Lower Level (V)	-6 to 1
		Trigger Upper Limit (us)	
		Trigger Lower Limit (us)	
		Trigger Polarity	<ul style="list-style-type: none"> <li>• Positive</li> <li>• Negative</li> </ul>
		Edge Trigger Level(V)	0 to 1
		Trigger Time (ps)	<ul style="list-style-type: none"> <li>• 250</li> <li>• 500</li> </ul>
		Trigger Transition	<ul style="list-style-type: none"> <li>• Less Than</li> <li>• Greater Than</li> </ul>
		Trigger Slope	<ul style="list-style-type: none"> <li>• Positive</li> <li>• Negative</li> <li>• Either</li> </ul>
		Trigger If Violation	<ul style="list-style-type: none"> <li>• Occurs</li> <li>• Logic</li> </ul>



TestName	AcquireType	ParameterName	ParameterValue
1.4.1 HS-TX Differential Voltages Underminated (VOD(UT)-AB, VOD(UT)-BC, VOD(UT)-CA)  1.4.2 HS-TX Differential Voltage Mismatch Underminated (Delta_VOD(UT))  1.4.3 HS-TX Single- Ended Output High Voltages Underminated (VOHHS(UT)(VA),VOHHS(UT) (VB),VOHHS(UT)(VC))  1.4.4 HS-TX Static Common- Point Voltages Underminated (VCPTX(UT))	HS_Underminated	Vertical Scale (mV)	10 to 500
		Vertical Position (div)	-5 to 5
		Vertical Offset (V)	-1.3 to 1.3
		Sample Rate (GS/s)	<ul style="list-style-type: none"> <li>• 6.25</li> <li>• 12.5</li> <li>• 25</li> <li>• 50</li> <li>• AUTO</li> </ul>
		Record Length	100000 to 10000000
		Trigger Type	<ul style="list-style-type: none"> <li>• Transition</li> <li>• Edge</li> <li>• Width</li> </ul>
		Trigger Source	<ul style="list-style-type: none"> <li>• VA</li> <li>• VB</li> <li>• VC</li> </ul>
		Trigger Upper Level (V)	-5 to 5
		Trigger Lower Level (V)	-6 to 1
		Trigger Upper Limit (us)	
		Trigger Lower Limit (us)	
		Trigger Polarity	<ul style="list-style-type: none"> <li>• Positive</li> <li>• Negative</li> </ul>
		Edge Trigger Level(V)	0 to 1
		Trigger Time (ps)	<ul style="list-style-type: none"> <li>• 250</li> <li>• 500</li> </ul>
		Trigger Transition	<ul style="list-style-type: none"> <li>• Less Than</li> <li>• Greater Than</li> </ul>
		Trigger Slope	<ul style="list-style-type: none"> <li>• Positive</li> <li>• Negative</li> <li>• Either</li> </ul>
		Trigger If Violation	<ul style="list-style-type: none"> <li>• Occurs</li> <li>• Logic</li> </ul>

TestName	AcquireType	ParameterName	ParameterValue
1.5.1 t3-CALPREAMBLE Duration	LPHS_Format1_CALPREAMBL E	Vertical Scale (mV)	10 to 500
		Vertical Position (div)	-5 to 5
		Vertical Offset (V)	-1.3 to 1.3
		Sample Rate (GS/s)	<ul style="list-style-type: none"> <li>• 6.25</li> <li>• 12.5</li> <li>• 25</li> <li>• 50</li> <li>• AUTO</li> </ul>
		Record Length	100000 to 10000000
		Trigger Type	<ul style="list-style-type: none"> <li>• Transition</li> <li>• Edge</li> <li>• Width</li> </ul>
		Trigger Source	<ul style="list-style-type: none"> <li>• VA</li> <li>• VB</li> <li>• VC</li> </ul>
		Trigger Upper Level (V)	-5 to 5
		Trigger Lower Level (V)	-6 to 1
		Trigger Upper Limit (us)	
		Trigger Lower Limit (us)	
		Trigger Polarity	<ul style="list-style-type: none"> <li>• Positive</li> <li>• Negative</li> </ul>
		Edge Trigger Level(V)	0 to 1
		Trigger Time (ps)	<ul style="list-style-type: none"> <li>• 250</li> <li>• 500</li> </ul>
		Trigger Transition	<ul style="list-style-type: none"> <li>• Less Than</li> <li>• Greater Than</li> </ul>
		Trigger Slope	<ul style="list-style-type: none"> <li>• Positive</li> <li>• Negative</li> <li>• Either</li> </ul>
		Trigger If Violation	<ul style="list-style-type: none"> <li>• Occurs</li> <li>• Logic</li> </ul>

Table continued...

TestName	AcquireType	ParameterName	ParameterValue
1.5.2 t3-ASID Duration 1.5.3 t3-CALALTSEQ Duration	LPHS_Format2_CALPREAMBLE	Vertical Scale (mV)	10 to 500
		Vertical Position (div)	-5 to 5
		Vertical Offset (V)	-1.3 to 1.3
		Sample Rate (GS/s)	<ul style="list-style-type: none"> <li>• 6.25</li> <li>• 12.5</li> <li>• 25</li> <li>• 50</li> <li>• AUTO</li> </ul>
		Record Length	100000 to 10000000
		Trigger Type	<ul style="list-style-type: none"> <li>• Transition</li> <li>• Edge</li> <li>• Width</li> </ul>
		Trigger Source	<ul style="list-style-type: none"> <li>• VA</li> <li>• VB</li> <li>• VC</li> </ul>
		Trigger Upper Level (V)	-5 to 5
		Trigger Lower Level (V)	-6 to 1
		Trigger Upper Limit (us)	
		Trigger Lower Limit (us)	
		Trigger Polarity	<ul style="list-style-type: none"> <li>• Positive</li> <li>• Negative</li> </ul>
		Edge Trigger Level(V)	0 to 1
		Trigger Time (ps)	<ul style="list-style-type: none"> <li>• 250</li> <li>• 500</li> </ul>
		Trigger Transition	<ul style="list-style-type: none"> <li>• Less Than</li> <li>• Greater Than</li> </ul>
		Trigger Slope	<ul style="list-style-type: none"> <li>• Positive</li> <li>• Negative</li> <li>• Either</li> </ul>
		Trigger If Violation	<ul style="list-style-type: none"> <li>• Occurs</li> <li>• Logic</li> </ul>

Table continued...

TestName	AcquireType	ParameterName	ParameterValue
1.5.4 Calibration Sequence t3-SYNC Duration	LPHS_CALPREAMBLE	Vertical Scale (mV)	10 to 500
		Vertical Position (div)	-5 to 5
		Vertical Offset (V)	-1.3 to 1.3
		Sample Rate (GS/s)	<ul style="list-style-type: none"> <li>• 6.25</li> <li>• 12.5</li> <li>• 25</li> <li>• 50</li> <li>• AUTO</li> </ul>
		Record Length	100000 to 10000000
		Trigger Type	<ul style="list-style-type: none"> <li>• Transition</li> <li>• Edge</li> <li>• Width</li> </ul>
		Trigger Source	<ul style="list-style-type: none"> <li>• VA</li> <li>• VB</li> <li>• VC</li> </ul>
		Trigger Upper Level (V)	-5 to 5
		Trigger Lower Level (V)	-6 to 1
		Trigger Upper Limit (us)	
		Trigger Lower Limit (us)	
		Trigger Polarity	<ul style="list-style-type: none"> <li>• Positive</li> <li>• Negative</li> </ul>
		Edge Trigger Level(V)	0 to 1
		Trigger Time (ps)	<ul style="list-style-type: none"> <li>• 250</li> <li>• 500</li> </ul>
		Trigger Transition	<ul style="list-style-type: none"> <li>• Less Than</li> <li>• Greater Than</li> </ul>
		Trigger Slope	<ul style="list-style-type: none"> <li>• Positive</li> <li>• Negative</li> <li>• Either</li> </ul>
		Trigger If Violation	<ul style="list-style-type: none"> <li>• Occurs</li> <li>• Logic</li> </ul>

## Returns

<Nrf>

## Examples

TEKEXP:VALUE

ACQUIRE, "<TestName>", "<AcquireType>", "<ParameterName>", "<ParameterValue>" command sets the value for the specified test and its acquire parameter.

TEKEXP:VALUE? ACQUIRE, "<TestName>", "<AcquireType>", "<ParameterName>" command returns the value for the specified test and its acquire parameter.

## Set or query the analyze parameter values

This command sets or queries the analyze parameter values of the application.

### Syntax

TEKEXP:VALUE ANALYZE, "<TestName>", "<ParameterName>", "<ParameterValue>" (Set)

TEKEXP:VALUE? ANALYZE, "<TestName>", "<ParameterName>" (Query)

### Command arguments

**Table 20: For C-PHY 1.0**

TestName	ParameterName	ParameterValue
1.1.1 Thevenin Output High Level Voltage (VOH)	Supported Settings	LP Signal Types
1.1.2 LP-TX Thevenin Output Low Level Voltage (VOL)		
1.1.3 LP-TX 15%-85% Rise Time (tRLP)		
1.1.4 LP-TX 15%-85% Fall Time (tFLP)		
1.1.5 LP-TX Slew Rate vs. CLOAD (dV/dtSR)		
1.1.6 LP-TX Pulse Width of Exclusive-OR Clock (tLP-PULSE-TX)		
1.1.7 LP-TX Period of Exclusive-OR Clock (tLP-PER-TX)		
1.3.1 INIT: LP-TX Initialization Period (tINITMASTER)		
1.3.2 ULPS Exit: Transmitted tWAKEUP Interval		
1.3.3 BTA: TX-Side tTA-GO Interval Value		
1.3.4 BTA: RX-Side tTA-SURE Interval Value		
1.3.5 BTA: RX-Side tTA-GET Interval Value		
1.2.1 tLPX Duration		
1.2.2 t3-PREPARE Duration		
1.2.3 t3-PREBEGIN Duration		
1.2.16 t3-POST Duration		
1.2.17 30%-85% Post-EoT Rise Time (tREOT)		
1.2.18 tHS-EXIT Value		
Table continued...		

TestName	ParameterName	ParameterValue
1.2.4 t3-PROGSEQ Duration	Supported Settings	HS Signal Types
1.2.5 t3-PREEND Duration		
1.2.6 t3-SYNC Duration		
1.2.7 HS-TX Differential Voltages (VOD_AB VOD_BC VOD_CA)		
1.2.8 HS-TX Differential Voltage Mismatch (Delta_VOD)		
1.2.9 HS-TX Single-Ended Output High Voltages (VOHHS(VA)VOHHS(VB)VOHHS(VC))		
1.2.10 HS-TX Static Common-Point Voltages (VCPTX)		
1.2.11 HS-TX Static Common-Point Voltage Mismatch (Delta VCPTX(HS))		
1.2.12 HS-TX Dynamic Common-Point Variations Between 50-450MHz (Delta VCPTX(LF))		
1.2.13 HS-TX Dynamic Common-Point Variations Above 450MHz (Delta VCPTX(HF))		
1.2.14 HS-TX Rise Time (tR)		
1.2.15 HS-TX Fall Time (tF)		
1.2.20 HS Clock Delta UI (Delta_UI)		
1.2.19 HS Clock Instantaneous UI (UIINST)	UI INST MIN (ps)	1 to 12500000
	Supported Settings	HS Signal Types

**Table 21: For C-PHY 1.1**

TestName	ParameterName	ParameterValue
1.1.1 Thevenin Output High Level Voltage (VOH)	Supported Settings	LP Signal Types
1.1.2 LP-TX Thevenin Output Low Level Voltage (VOL)		
1.1.3 LP-TX 15%-85% Rise Time (tRLP)		
1.1.4 LP-TX 15%-85% Fall Time (tFLP)		
1.1.5 LP-TX Slew Rate vs. CLOAD (dV/dtSR)		
1.1.6 LP-TX Pulse Width of Exclusive-OR Clock (tLP-PULSE-TX)		
1.1.7 LP-TX Period of Exclusive-OR Clock (tLP-PER-TX)		
1.3.1 INIT: LP-TX Initialization Period (tINITMASTER)		
1.3.2 ULPS Exit: Transmitted tWAKEUP Interval		
1.3.3 BTA: TX-Side tTA-GO Interval Value		
1.3.4 BTA: RX-Side tTA-SURE Interval Value		
1.3.5 BTA: RX-Side tTA-GET Interval Value		

Table continued...

TestName	ParameterName	ParameterValue
1.2.1 tLPX Duration	Supported Settings	LP-HS Signal Types
1.2.2 t3-PREPARE Duration		
1.2.3 t3-PREBEGIN Duration		
1.2.16 t3-POST Duration		
1.2.17 30%-85% Post-EoT Rise Time (tREOT)		
1.2.18 tHS-EXIT Value		
1.2.4 t3-PROGSEQ Duration	Supported Settings	HS Signal Types
1.2.5 t3-PREEND Duration		
1.2.6 t3-SYNC Duration		
1.2.7 HS-TX Differential Voltages (VOD_AB VOD_BC VOD_CA)		
1.2.8 HS-TX Differential Voltage Mismatch (Delta_VOD)		
1.2.9 HS-TX Single-Ended Output High Voltages (VOHHS(VA)VOHHS(VB)VOHHS(VC))		
1.2.10 HS-TX Static Common-Point Voltages (VCPTX)		
1.2.11 HS-TX Static Common-Point Voltage Mismatch (Delta VCPTX(HS))		
1.2.12 HS-TX Dynamic Common-Point Variations Between 50-450MHz (Delta VCPTX(LF))		
1.2.13 HS-TX Dynamic Common-Point Variations Above 450MHz (Delta VCPTX(HF))		
1.2.20 HS Clock Delta UI (Delta_UI)		
1.4.1 HS-TX Differential Voltages Unterminated (VOD(UT)-AB VOD(UT)-BC VOD(UT)-CA)		
1.4.2 HS-TX Differential Voltage Mismatch Unterminated (Delta_VOD(UT))		
1.4.3 HS-TX Single-Ended Output High Voltages Unterminated (VOHHS(UT)(VA)VOHHS(UT)(VB)VOHHS(UT)(VC))		
1.4.4 HS-TX Static Common-Point Voltages Unterminated (VCPTX(UT))		
1.2.19 HS Clock Instantaneous UI (UIINST)	UI INST MIN (ps)	1 to 12500000
	Supported Settings	HS Signal Types

Table continued...

TestName	ParameterName	ParameterValue
1.2.21 HS-TX Eye Diagram	Clock Edge	<ul style="list-style-type: none"> <li>• RISE</li> <li>• FALL</li> <li>• BOTH</li> </ul>
	Clock Recovery Method	<ul style="list-style-type: none"> <li>• EXPEDGE</li> <li>• EXPPLL</li> </ul>
	Signal Type	<ul style="list-style-type: none"> <li>• CLOCK</li> <li>• DATA</li> <li>• AUTO</li> </ul>
	Mask Hit Type	<ul style="list-style-type: none"> <li>• Auto</li> <li>• Manual</li> </ul>
	Loop Bandwidth	1 to 10
	Supported Settings	HS Signal Types

**Table 22: For C-PHY 2.0**

TestName	ParameterName	ParameterValue
1.1.1 Thevenin Output High Level Voltage (VOH)	Supported Settings	LP Signal Types
1.1.2 LP-TX Thevenin Output Low Level Voltage (VOL)		
1.1.3 LP-TX 15%-85% Rise Time (tRLP)		
1.1.4 LP-TX 15%-85% Fall Time (tFLP)		
1.1.5 LP-TX Slew Rate vs. CLOAD (dV/dtSR)		
1.1.6 LP-TX Pulse Width of Exclusive-OR Clock (tLP-PULSE-TX)		
1.1.7 LP-TX Period of Exclusive-OR Clock (tLP-PER-TX)		
1.3.1 INIT: LP-TX Initialization Period (tINITMASTER)		
1.3.2 ULPS Exit: Transmitted tWAKEUP Interval		
1.3.3 BTA: TX-Side tTA-GO Interval Value		
1.3.4 BTA: RX-Side tTA-SURE Interval Value		
1.3.5 BTA: RX-Side tTA-GET Interval Value		
1.1.8 tLP-EXIT Value		

Table continued...



TestName	ParameterName	ParameterValue
1.2.1 tLPX Duration	Supported Settings	LP-HS Signal Types
1.2.2 t3-PREPARE Duration		
1.2.3 t3-PREBEGIN Duration		
1.2.16 t3-POST Duration		
1.2.17 30%-85% Post-EoT Rise Time (tREOT)		
1.2.18 tHS-EXIT Value		
1.5.1 t3-CALPREAMBLE Duration		
1.2.4 t3-PROGSEQ Duration	Supported Settings	HS Signal Types
1.2.5 t3-PREEND Duration		
1.2.6 t3-SYNC Duration		
1.2.7 HS-TX Differential Voltages (VOD_AB VOD_BC VOD_CA)		
1.2.8 HS-TX Differential Voltage Mismatch (Delta_VOD)		
1.2.9 HS-TX Single-Ended Output High Voltages (VOHHS(VA)VOHHS(VB)VOHHS(VC))		
1.2.10 HS-TX Static Common-Point Voltages (VCPTX)		
1.2.11 HS-TX Static Common-Point Voltage Mismatch (Delta VCPTX(HS))		
1.2.12 HS-TX Dynamic Common-Point Variations Between 50-450MHz (Delta VCPTX(LF))		
1.2.13 HS-TX Dynamic Common-Point Variations Above 450MHz (Delta VCPTX(HF))		
1.2.19 HS Clock Instantaneous UI (UIINST)		
1.2.22 HS-TX UI Jitter (UI_JitterPEAK_TX)		
1.4.1 HS-TX Differential Voltages Unterminated (VOD(UT)-AB VOD(UT)-BC VOD(UT)-CA)		
1.4.2 HS-TX Differential Voltage Mismatch Unterminated (Delta_VOD(UT))		
1.4.3 HS-TX Single-Ended Output High Voltages Unterminated (VOHHS(UT)(VA)VOHHS(UT)(VB)VOHHS(UT)(VC))		
1.4.4 HS-TX Static Common-Point Voltages Unterminated (VCPTX(UT))		
1.5.2 t3-ASID Duration		
1.5.3 t3-CALALTSEQ Duration		
1.5.4 Calibration Sequence t3-SYNC Duration		
Table continued...		

TestName	ParameterName	ParameterValue
1.2.21 HS-TX Eye Diagram	Clock Edge	<ul style="list-style-type: none"> <li>• RISE</li> <li>• FALL</li> <li>• BOTH</li> </ul>
	Clock Recovery Method	<ul style="list-style-type: none"> <li>• EXPEDGE</li> <li>• EXPPLL</li> </ul>
	Signal Type	<ul style="list-style-type: none"> <li>• CLOCK</li> <li>• DATA</li> <li>• AUTO</li> </ul>
	Mask Hit Type	<ul style="list-style-type: none"> <li>• Auto</li> <li>• Manual</li> </ul>
	Loop Bandwidth	1 to 10
	Supported Settings	HS Signal Types

## Returns

<Nrf>

## Examples

TEKEXP:VALUE ANALYZE,"<TestName>","<ParameterName>","<ParameterValue>" command set the value for the specified test and its analyze parameter.

TEKEXP:VALUE? ANALYZE,"<TestName>","<ParameterName>" command returns the value for the specified test and its analyze parameter.

## Set or query the user defined acquisition values

This command sets or queries the user defined acquisition values.

### Syntax

TEKEXP:USER\_DEF\_ACQ (Set)

TEKEXP:USER\_DEF\_ACQ? (Query)

### Returns

{0 | 1} or {True | False}

1 or True indicates that the user defined acquisition is enabled.

0 or False indicates that the user defined acquisition is disabled.

### Examples

TEKEXP:USER\_DEF\_ACQ? command returns the enable or disable status of user defined acquisition.

## Query the available devices in the DUT panel of the application

This command queries the list of available devices on the DUT panel as comma separated values.

## Syntax

TEKEXP:LIST? DEVICE (Query)

## Command arguments

Device	Device Type and value	Description
<Device>		It is the name of the device on the DUT panel of the application.

## Returns

<String>

## Examples

TEKEXP:LIST? DEVICE command returns the list of available devices.

## Query the available suites for the selected device

This command queries the list of available suites for the selected device as comma separated values.

## Syntax

TEKEXP:LIST? SUITE (Query)

## Returns

<String>

## Examples

TEKEXP:LIST? SUITE command returns the list of available suites for the selected device.

## Query the list of available tests of the application

This command queries the list of available tests of the application for the selected device as comma separated values.

## Syntax

TEKEXP:LIST? TEST (Query)

## Command arguments

NA

## Returns

<String>

## Examples

TEKEXP:LIST? TEST command returns the list of available tests for the selected device.

## Query the available version names of the application

This command queries the list of available version names of the application for the selected device as comma separated values.

## Syntax

TEKEXP:LIST? VERSION (Query)

**Returns**

&lt;String&gt;

**Examples**

TEKEXP:LIST? VERSION command returns the list of version names for the selected device.

**Query the list of available instruments based on the specified instrument type**

This command queries the list of available instruments based on the specified instrument type.

**Syntax**

TEKEXP:LIST? INSTRUMENT, "<InstrumentType>" (Query)

**Command argument**

Argument Name	Argument value
<InstrumentType>	<String>

**Returns**

&lt;String&gt;

**Examples**

TEKEXP:LIST? INSTRUMENT, "Real Time Scope" command returns the list of available instruments based on the real time scope type.

**Set or query the IP address of the instrument based on the specified instrument type**

This command sets or queries the IP address of the instrument based on the specified instrument type.

**Syntax**

TEKEXP:INSTRUMENT? "<InstrumentType>" (Query)

TEKEXP:INSTRUMENT, "<InstrumentType>", "<Value>" (Set)

**Command argument**

Argument Name	Argument Type
<InstrumentType>	<String>
<Value>	<String> TCPIP::XXX.XX.XXX.XXX::INSTR

**Returns**

&lt;String&gt;

**Examples**

TEKEXP:INSTRUMENT? "<InstrumentType>" command returns the IP address of the oscilloscope.

TEKEXP:INSTRUMENT, "<InstrumentType>", "<value>" command sets the oscilloscope to the specified IP address.

## Query the information of the generated report file

This command queries the information of the generated report file in the format "<FileSize>","<FileName>".

### Pre-requisite

A session should be run earlier and the report should be generated to get the information of the report.

### Syntax

```
TEKEXP:INFO? REPORT (Query)
```

### Returns

<FileSize>:: <String>

<FileName>:: <String>

### Examples

TEKEXP:INFO? REPORT command returns the information of the generated report in the format ("1215","DUT001.mht").

## Query the information of the generated waveform files

This command queries the information of the generated waveform files in the format.

<File1Size,"File1Name">.

If there are more than one waveform, the waveform file names are displayed with the comma separated values in the format

<File1Size,"File1Name">,<File2Size,"File2Name">.

### Syntax

```
TEKEXP:INFO? WFM (Query)
```

### Returns

<FileSize>:: <String>

<FileName>:: <String>

### Examples

TEKEXP:INFO? WFM command returns the information of the generated waveform in the format (20000858,"X:\<Application Name>\Untitled Session\DUT001\20200916\_041609\Iter1\_Short Record-length for SCOPE Period\_NoSSC\_DIFF.wfm").

## Query the information of the generated image files

This command queries the information of the generated image files in the format.

<File1Size,"File1Name">.

If there are more than one image, the image file names are displayed with the comma separated values in the format

<File1Size,"File1Name">,<File2Size,"File2Name">.

### Syntax

```
TEKEXP:INFO? IMAGE (Query)
```

## Returns

<FileSize>: <String>

<FileName>: <String>

## Examples

TEKEXP:INFO? IMAGE command returns the information of the generated image in the format (109058, "X:\<Application Name>\Untitled Session\DUT001\20200916\_041609\Iter1\_Short Record-length for SCOPE Period\_NoSSC\_DIFF.png";22794,"X:\<Application Name>\UntitledSession\DUT001\20200916\_041609\ScopePeriodPlot\_Iteration1WithCursor.png").

## Query the active TekExpress application name

This command queries the active TekExpress application name running on the oscilloscope.

### Syntax

TEKEXP:\*IDN? (Query)

### Returns

<String>

### Examples

TEKEXP:\*IDN? command returns the active TekExpress application name running on the oscilloscope.

## Sets or query the acquire mode status

This command sets or queries the acquire mode status.

### Syntax

TEKEXP:ACQUIRE\_MODE <Mode> (Set)

TEKEXP:ACQUIRE\_MODE? (Query)

### Command arguments

Argument Name	Argument value
<Mode>	<ul style="list-style-type: none"> <li>• LIVE</li> <li>• PRE-RECORDED</li> </ul>

### Returns

LIVE | PRE-RECORDED

### Examples

TEKEXP:ACQUIRE\_MODE LIVE command sets the acquire mode to the Live mode.

TEKEXP:ACQUIRE\_MODE? command returns the current acquire mode.

## Set or query the execution mode status

This command sets or queries the execution mode status.

## Syntax

TEKEXP:MODE <Mode> (Set)

TEKEXP:MODE? (Query)

## Command arguments

Argument Name	Argument value
<Mode>	<ul style="list-style-type: none"> <li>• COMPLIANCE</li> <li>• USER-DEFINED</li> </ul>

## Returns

COMPLIANCE | USER-DEFINED

## Examples

TEKEXP:MODE COMPLIANCE command sets the execution mode to the compliance mode.

TEKEXP:MODE? command returns the current execution mode.

## Generate the report for the current session

This command generates the report for the current session.

## Syntax

TEKEXP:REPORT GENERATE(Set)

## Arguments

N/A

## Examples

TEKEXP:REPORT GENERATE command generates the report for the current session.

## Query the value of specified report header field in the report

This command queries the value of specified report header field in the report.

## Syntax

TEKEXP:REPORT? "<Device Field>" (Query)

## Command arguments

Argument Name	Argument Type																																																								
<p>&lt;Device Field&gt;</p> <p>Device field is the header name of each field in the setup information section of the report.</p> <table border="1"> <thead> <tr> <th colspan="4">Setup Information</th> </tr> </thead> <tbody> <tr> <td>DUT ID</td> <td>DUT001</td> <td>Probe1 Model</td> <td>"1X"</td> </tr> <tr> <td>Date/Time</td> <td>2020-10-22 11:24:39</td> <td>Probe1 Serial Number</td> <td>"N/A"</td> </tr> <tr> <td>Device Type</td> <td>TK-Device</td> <td>Probe2 Model</td> <td>"1X"</td> </tr> <tr> <td>TekExpress App/Emulator Version</td> <td>5.2.999.17 (DAILY)</td> <td>Probe2 Serial Number</td> <td>"N/A"</td> </tr> <tr> <td>TekExpress Framework Version</td> <td>5.2.999.12 (INTERNAL)</td> <td>Probe3 Model</td> <td>"1X"</td> </tr> <tr> <td>Spec Version</td> <td>Spec 1.0</td> <td>Probe3 Serial Number</td> <td>"N/A"</td> </tr> <tr> <td>Overall Compliance Mode</td> <td>Yes</td> <td>Probe4 Model</td> <td>"1X"</td> </tr> <tr> <td>Overall Test Result</td> <td>Pass</td> <td>Probe4 Serial Number</td> <td>"N/A"</td> </tr> <tr> <td></td> <td></td> <td>Scope Model</td> <td>DPO5104</td> </tr> <tr> <td></td> <td></td> <td>Scope Serial Number</td> <td>Not-Set</td> </tr> <tr> <td></td> <td></td> <td>SFC_FactoryCalibration</td> <td>INFUNCTIONAL</td> </tr> <tr> <td></td> <td></td> <td>Scope F/W Version</td> <td>10.0.1 Build 25</td> </tr> <tr> <td></td> <td></td> <td>DPO51 Version</td> <td>10.1.0.64</td> </tr> </tbody> </table>	Setup Information				DUT ID	DUT001	Probe1 Model	"1X"	Date/Time	2020-10-22 11:24:39	Probe1 Serial Number	"N/A"	Device Type	TK-Device	Probe2 Model	"1X"	TekExpress App/Emulator Version	5.2.999.17 (DAILY)	Probe2 Serial Number	"N/A"	TekExpress Framework Version	5.2.999.12 (INTERNAL)	Probe3 Model	"1X"	Spec Version	Spec 1.0	Probe3 Serial Number	"N/A"	Overall Compliance Mode	Yes	Probe4 Model	"1X"	Overall Test Result	Pass	Probe4 Serial Number	"N/A"			Scope Model	DPO5104			Scope Serial Number	Not-Set			SFC_FactoryCalibration	INFUNCTIONAL			Scope F/W Version	10.0.1 Build 25			DPO51 Version	10.1.0.64	<String>
Setup Information																																																									
DUT ID	DUT001	Probe1 Model	"1X"																																																						
Date/Time	2020-10-22 11:24:39	Probe1 Serial Number	"N/A"																																																						
Device Type	TK-Device	Probe2 Model	"1X"																																																						
TekExpress App/Emulator Version	5.2.999.17 (DAILY)	Probe2 Serial Number	"N/A"																																																						
TekExpress Framework Version	5.2.999.12 (INTERNAL)	Probe3 Model	"1X"																																																						
Spec Version	Spec 1.0	Probe3 Serial Number	"N/A"																																																						
Overall Compliance Mode	Yes	Probe4 Model	"1X"																																																						
Overall Test Result	Pass	Probe4 Serial Number	"N/A"																																																						
		Scope Model	DPO5104																																																						
		Scope Serial Number	Not-Set																																																						
		SFC_FactoryCalibration	INFUNCTIONAL																																																						
		Scope F/W Version	10.0.1 Build 25																																																						
		DPO51 Version	10.1.0.64																																																						

## Returns

<String>

## Examples

TEKEXP:REPORT? "DUT ID" command returns the value of DUT ID field in the report.

## Query the value of specified result detail available in report summary/details table

This command queries the value of specified result detail available in report summary/details table.

## Syntax

TEKEXP:RESULT? "<TestName>" (Query)

TEKEXP:RESULT? "<TestName>", "<ColumnName>" (Query)

TEKEXP:RESULT? "<TestName>", "<ColumnName>", <RowNumber> (Query)

## Command arguments

Argument Name	Argument Type
<p>&lt;TestName&gt;</p> <p>It is the test name of which the details are required in the report.</p>	<String>
<p>&lt;ColumnName&gt;</p> <p>It is the column header name of which the details are required in the report.</p>	<String>
<p>&lt;RowNumber&gt;</p> <p>It is the row number of which the details are required in the report.</p>	<String>

## Returns

<String>

## Examples

TEKEXP:RESULT? "<TestName>" will return the pass fail status of test.



TEKEXP:RESULT? "<TestName>", "<ColumnName>" will return all the row values of specific column for the test with comma separated values.

TEKEXP:RESULT? "<TestName>", "<ColumnName>", <RowNumber> will return the column value of specified row number.

## Restore the setup to default settings

This command restores the setup to default settings.

### Syntax

TEKEXP:SETUP Default (Set)

### Arguments

N/A

### Examples

TEKEXP:SETUP Default command restores the setup to default settings.

## Save the settings to a specified session

This command saves the settings to a specified session.

### Syntax

TEKEXP:SETUP Save, "<SessionName>"

### Command arguments

Argument Name	Argument value
<SessionName>	<String>

### Examples

TEKEXP:SETUP Save, "<SessionName>" command saves the settings to a specified session.

## Open the setup from a specified session

This command opens the setup from a specified session.

### Syntax

TEKEXP:SETUP Open, "<SessionName>" (Set)

### Command arguments

Argument Name	Argument value
<SessionName>	<String>

### Examples

TEKEXP:SETUP Open, "<SessionName>" command opens the setup from a specified session.

## Query the current setup file name

This command queries the current setup file name.

### Syntax

TEKEXP:SETUP? CURRENT (Query)

### Returns

<String>

### Examples

TEKEXP:SETUP? CURRENT command returns the current setup file name.

## Run/stop/pause/resume the selected measurements execution in the application

This command run/stop/pause/resume the selected measurements execution in the application.

### Syntax

TEKEXP:STATE <operation mode> (Set)

### Command arguments

Argument Name	Argument value
<operation mode>	<ul style="list-style-type: none"> <li>• RUN</li> <li>• STOP</li> <li>• PAUSE</li> <li>• RESUME</li> </ul>

### Returns

RUN | STOP | PAUSE | RESUME

### Examples

TEKEXP:STATE RUN command runs the execution for the selected measurements.

## Query the current measurement execution status

This command queries the current measurement execution status.

### Syntax

TEKEXP:STATE? (Query)

### Returns

RUNNING | PAUSED | WAIT | ERROR | READY

### Examples

TEKEXP:STATE? command returns the current measurement execution status.

---

## Query whether the current setup is saved or not saved

This command queries whether the current setup is saved or not saved.

### Syntax

```
TEKEXP:STATE? SETUP (Query)
```

### Returns

Saved or Not-Saved

### Examples

TEKEXP:STATE? SETUP command returns whether the current setup is saved or not saved.

## Query the status of the previous command execution

This command queries whether the previous command execution is completed successfully.

### Syntax

```
TEKEXP:*OPC? (Query)
```

### Returns

{0 | 1} or {True | False}

1 or True indicates that command execution is successful.

0 or False indicates that command execution is failed.

### Examples

TEKEXP:\*OPC? command returns whether the previous command operation is completed successfully.

## Query the last error occurred

This command queries the last error occurred.

### Syntax

```
TEKEXP:LASTERROR? (Query)
```

### Returns

<String>

### Examples

TEKEXP:LASTERROR? command returns the last error occurred.

## Set or query the popup details

This command sets or queries the popup details.

### Syntax

```
TEKEXP:POPOP? (Query)
```

```
TEKEXP:POPOP "<PopupResponse>" (Set)
```

## Command arguments

Argument Name	Argument value
<PopupResponse>	<ul style="list-style-type: none"> <li>• Yes</li> <li>• No</li> </ul>

## Returns

The pop-up details return in the following format:

"<Title>",<message>",<response1>,<response2>".

Where,

<Title> :: <String>

<message> :: <String>

<response1>,<response2> :: <String>

## Examples

TEKEXP:POPUP? command returns the popup details in following format ": "Do you really want to exit TekExpress?";Responses: "Yes, No".

TEKEXP:POPUP "Yes" command sets the popup response to Yes.

## Query the enable or disable status of Continuous run function.

This command queries the enable or disable status of Continuous run function.

### Syntax

TEKEXP:VALUE? GENERAL, "Enable Continuous Run" (Query)

### Returns

{True | False} or {0 | 1}

Where,

1 or True indicates that the continuous run function is enabled.

0 or False indicates that the continuous run function is disabled.

### Examples

TEKEXP:VALUE? GENERAL, "Enable Continuous Run" command returns the enable or disable status of continuous run function.

## Set or query the enable/disable status of Continuous Run function

This command sets or queries the enable/disable status of Continuous Run function.

### Syntax

TEKEXP:VALUE ContinuousRun, "<Value>" (Set)

TEKEXP:VALUE? ContinuousRun (Query)

## Arguments

Argument Name	Argument value
<Value>	{True   False} or {1   0} It represents enabled or disabled. Where, <ul style="list-style-type: none"> <li>• True or 1 - enabled</li> <li>• False or 0 - disabled</li> </ul>

## Returns

{True | False} or {0 | 1}

## Examples

TEKEXP:VALUE? ContinuousRun command returns the enable or disable status of Continuous run function.

TEKEXP:VALUE ContinuousRun, "<Value>" command enable or disable the Continuous run function.

## Set or query the enable/disable status of Verbose function

This command sets or queries the enable/disable status of Verbose function.

## Syntax

TEKEXP:VALUE VERBOSE, "<Value>" (Set)

TEKEXP:VALUE? VERBOSE (Query)

## Arguments

Argument Name	Argument value
<Value>	{True   False} or {1   0} It represents enabled or disabled. Where, <ul style="list-style-type: none"> <li>• True or 1 - enabled</li> <li>• False or 0 - disabled</li> </ul>

## Returns

{True | False} or {0 | 1}

## Examples

TEKEXP:VALUE VERBOSE, "<Value>" command enable or disable the Verbose function.

TEKEXP:VALUE? VERBOSE command returns the enable or disable status of Verbose function.

## Set or query the continuous run duration time value

This command sets or queries the continuous run duration time value.

## Syntax

TEKEXP:VALUE? ContinuousRun\_Duration (Query)

TEKEXP:VALUE ContinuousRun\_Duration, "<Value>" (Set)

## Arguments

Argument Name	Argument value
<Value>	Infinite   hh:mm  Infinite sets the radio on button to infinite.  hh:mm sets the continuous run duration to the specified time in hours and minutes. The minimum time duration you can set is 00:30.

## Returns

Infinite | hh:mm

## Examples

TEKEXP:VALUE? ContinuousRun\_Duration command returns the continuous run duration time value.

TEKEXP:VALUE ContinuousRun\_Duration, "<Value>" command sets the continuous run duration time value.

## Set or query the session create option in the continuous run function

This command sets or queries the option for session creation in the continuous run function.

## Syntax

TEKEXP:VALUE? ContinuousRun\_RunSessionOptions (Query)

TEKEXP:VALUE ContinuousRun\_RunSessionOptions, "Value" (Set)

## Arguments

Argument Name	Argument value
<Value>	NewSession   SameSession_ClearResults  NewSession - creates new session for each run.  SameSession_ClearResults - Clears the test results of the current session and starts the test execution. The session results will be added in the same session, by erasing the previous run results.

## Returns

NewSession | SameSession\_ClearResults

## Examples

TEKEXP:VALUE? ContinuousRun\_RunSessionOptions command returns the option for session creation in the continuous run function.

TEKEXP:VALUE ContinuousRun\_RunSessionOptions, "Value" command sets the option for session creation in the continuous run function.

## Set or query the View report after generating option status

This command sets or queries the enable/disable status of the View report after generating function.

### Syntax

TEKEXP:VALUE? GENERAL, "View Report After Generating" (Query)

TEKEXP:VALUE GENERAL, "View Report After Generating", <value> (Set)

### Arguments

Argument Name	Argument value
<Value>	{True   False} or {1   0} It represents enabled or disabled. Where, <ul style="list-style-type: none"> <li>• True or 1 - enabled</li> <li>• False or 0 - disabled</li> </ul>

### Returns

{True | False} or {0 | 1}

### Examples

TEKEXP:VALUE? GENERAL, "View Report After Generating" command returns the enable or disable status of view report after generating option.

TEKEXP:VALUE GENERAL, "View Report After Generating", <value> command enable or disable the view report after generating option.

## Sets or query the limit values in the limits editor window

This command sets or queries the limit values in the limits editor window.

### Syntax

TEKEXP:VALUE LIMIT, <TestName>, <LimitHeader>, <Value1>, <CompareString>, <Value2> (Set)

TEKEXP:VALUE? LIMIT, <TestName>, <LimitHeader> (Query)

### Returns

<String> or <NRf>

### Examples

TEKEXP:VALUE LIMIT, <TestName>, <LimitHeader>, <Value1>, <CompareString>, <Value2> command sets the limits value for the specified testname and limit header.

TEKEXP:VALUE? LIMIT, <TestName>, <LimitHeader> command returns the limits value for the specified testname and limit header.

## Set or query the waveform file recalled for the specified test name and acquire type

This command set or queries the waveform file recalled for the specified test name and acquire type.

If there are more than one waveform, the waveform file names are displayed with the symbol "\$" separated values in the format <WaveformFileName1\$ WaveformFileName2>.

### Syntax

TEKEXP:VALUE WFMFILE,<TestName>,<AcquireType>,<WaveformFileName> (Set)

TEKEXP:VALUE? WFMFILE,<TestName>,<AcquireType> (Query)

### Returns

<String>

### Examples

TEKEXP:VALUE WFMFILE,<TestName>,<AcquireType>,<WaveformFileName> command recalls the specified waveform file for the specified testname and acquire type.

TEKEXP:VALUE? WFMFILE,<TestName>,<AcquireType> command returns the waveform file name recalled for the specified testname and acquire type.

## Set the default session

Sets the application configurations to default value.

### Syntax

TEKEXP:SESSION DEFAULT (set)

### Examples

TEKEXP:SESSION DEFAULT, sets the application configurations to default value.

## Save the run/config sessions

Enter the name to save the run/config session.

### Syntax

TEKEXP:SESSION SAVE,"Session Name" (set)

### Command arguments

Argument Name	Argument value
<Session Name>	<String>

### Examples

TEKEXP:SESSION SAVE,"Session Name" saves the session.



## Load the run/config session

Load the selected config/run session.

### Syntax

TEKEXP:SESSION LOAD, "Session Name" (set)

### Command arguments

Argument Name	Argument value
<Session Name>	<String>

### Examples

TEKEXP:SESSION LOAD, "Session Name", load the selected config/run session.

## Delete the run/config session

Deletes the selected config/run session.

### Syntax

TEKEXP:SESSION DELETE, "Session1, Session2" (set)

### Command arguments

Argument Name	Argument value
<Session Name>	<String>

### Examples

TEKEXP:SESSION DELETE, "Session1, Session2", deletes the selected config/run session.

## Run the run/config saved session

Run the selected config/run session.

### Syntax

TEKEXP:SESSION RUN, "Session Name's separated by comma" (set)

### Command arguments

Argument Name	Argument value
<Session Name>	<String>
Session Name's separated by comma (to run the multiple run sessions)	<String>

### Examples

TEKEXP:SESSION RUN, "Session Name's separated by comma", runs the selected config/run session.

## Query the available list in the run/config session

Returns the list of available config/run session.

### Syntax

```
TEKEXP:SESSION? LIST
```

### Returns

Returns the list of available config/run session.

### Examples

TEKEXP:SESSION? LIST, returns the list of available config/run session.

## Query the current run/config session

Returns the selected config/run session.

### Syntax

```
TEKEXP:SESSION? CURRENT
```

### Returns

Returns the selected config/run session.

### Examples

TEKEXP:SESSION? CURRENT, returns the selected config/run session.

## Override the run/config session

Overrides the selected config/run session.

### Syntax

```
TEKEXP:SESSION SAVE, "SessionName", "True" (set)
```

### Command arguments

Argument Name	Argument Type	Argument Value
<Session Name>	<String>	{True   False} or {1   0} It represents enabled or disabled. Where, <ul style="list-style-type: none"> <li>• True or 1 - enabled</li> <li>• False or 0 - disabled</li> </ul>

### Returns

{True | False} or {0 | 1}

### Examples

TEKEXP:SESSION SAVE, "SessionName", "True", overrides the selected config/run session.

## Example

```
import socket
import time
#Create Socket
skt= socket.socket(socket.AF_INET,socket.SOCK_STREAM)
scopeIpAddress = "localhost"
tekexpressPortNo = 5000
#Connect to TekExpress applicaiton with scope IP address and port no
skt.connect((scopeIpAddress,tekexpressPortNo))
print ""
#Measurement for execution
measurement = "1.2.13 HS-TX Dynamic Common-Point Variations Above 450MHz (Delta VCPTX(HF))"
#Setting the Mode to LIVE
skt.sendall("TEKEXP:ACQUIRE_MODE LIVE\n")
#setting the device
skt.sendall("TEKEXP:SELECT DEVICE,\"TX-Device\"\n")
time.sleep (2)
skt.sendall("TEKEXP:SELECT? DEVICE\n")
time.sleep (2)
status=str(skt.recv(1024))
print "The selected device is : "+status
# Select the Suite
skt.sendall("TEKEXP:SELECT SUITE,\"C-PHY 2.0\"\n")
skt.sendall("TEKEXP:SELECT? SUITE\n")
time.sleep (5)
status=str(skt.recv(1024))
print "The selected Suite is : "+status
#GENERAL Parameters SCPI Commands
print "Started setting the GENERAL parameters"
#Set DUT ID
dutid = "DemoDUTID"
skt.sendall("TEKEXP:VALUE DUTID,\"+dutid+\n")
time.sleep(2)
skt.sendall("TEKEXP:VALUE? DUTID\n")
time.sleep (5)
```

```
status=str(skt.recv(1024))
print "After setting the DUT Id :"+status
skt.sendall("TEKEXP:SELECT TEST,ALL,FALSE\n")
print "Deselect all tests. "
time.sleep (5)
#Select Measurement
skt.sendall("TEKEXP:SELECT TEST,\"1.2.13 HS-TX Dynamic Common-Point Variations Above 450MHz (Delta VCPTX(HF))\")\n")
print "Selected Test : 1.2.13 HS-TX Dynamic Common-Point Variations Above 450MHz (Delta VCPTX(HF)) "
skt.sendall("TEKEXP:STATE RUN\n")
print "Clicked start button."
time.sleep (5)
skt.sendall("TEKEXP:POPUP \"OK\"\n")
time.sleep(10)
skt.sendall("TEKEXP:STATE?\n")
time.sleep (5)
response = str(skt.recv(1024))
response= response.strip()
print "Current Status after clicking on Start: "+response
while (response == "RUNNING" or response == "ERROR" or response=="WAIT"):
print "Running...Inside While"
time.sleep(15)
skt.sendall("TEKEXP:STATE?\n")
time.sleep(3)
response = str(skt.recv(1024))
response = response.strip()
if response == "ERROR" or response=="WAIT":
skt.sendall("TEKEXP:POPUP?\n")
response = str(skt.recv(1024))
print response
skt.sendall("TEKEXP:POPUP \"Continue\"\n")
print "Measurement execution completed."
print "Getting the info of Report file..."
skt.sendall("TEKEXP:INFO? REPORT\n")
response = str(skt.recv(1024))
print "ReportFile Info: "+response
fileInfo= response.split(',')
```

---

```
fileLength = long(fileInfo[0])
destinationPath = "C:\\Python27\\"
print "Exporting report file to client location "+destinationPath+" ..."
skt.sendall("TEKEXP:EXPORT REPORT\n")
#response = str(skt.recv(1024))
while(len(response) < fileLength):
received = skt.recv(fileLength)
response = response + received
fileName = fileInfo[1].strip()
fileName = fileName.strip("\\")
f= open(destinationPath+fileName,'wb')
f.write(response)
f.close()
print "Export completed for "+fileName
print "Querying the result of \\1.2.13 HS-TX Dynamic Common-Point Variations Above 450MHz (Delta VCPTX(HF))" ..."
skt.sendall("TEKEXP:RESULT? \\1.2.13 HS-TX Dynamic Common-Point Variations Above 450MHz (Delta VCPTX(HF))\n")
response = str(skt.recv(1024))
print "The result of \\1.2.13 HS-TX Dynamic Common-Point Variations Above 450MHz (Delta VCPTX(HF))" is "+response
skt.close()
```

# References

## Application directories

You can find the application files at *C:\Program Files\Tektronix\<Application Name>*. The application directory and associated files are organized as follows:

The following table lists the default directory names and their usage:

**Table 23: Application directories and usage**

Directory names	Usage
Bin	Contains application libraries
Compliance Suites	Contains test suite specific files
Examples	Contains various support files
ICP	Contains instrument and application specific interface libraries
Images	Contains images of the application
Lib	Contains utility files specific to the application
Licenses	Contains all the license files
Report Generator	Contains style sheets for report generation
Tools	Contains instrument and application specific files

## File name extensions

The TekExpress <Application Name> software uses the following file name extensions:

**Table 24: File name extension**

File name extension	Description
*.TekX	Application session files (the extensions may not be displayed)
*.py	Python sequence file.
*.xml	Test-specific configuration information (encrypted) files. Application log files
*.csv	Test result reports Plot data
*.mht	Test result reports (default) Test reports can also be saved in HTML format
*.pdf	Test result reports Application help document
*.xslt	Style sheet used to generate reports
*.png	Captured images

## View test-related files

Files related to tests are stored in My Documents\<Application Name>\Untitled session folder. Each test setup in this folder has both a test setup file and a test setup folder, both with the test setup name. The test setup file is preceded by the TekExpress icon.

Inside the test setup folder is another folder named for the DUT ID used in the test sessions. The default is DUT001.

Inside the DUT001 folder are the session folders and files. Each session also has a folder and file pair, both named for the test session using the naming convention (date)\_(time). Each session file is stored outside its matching session folder:

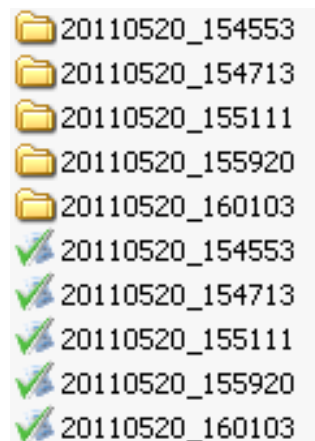

Each session folder contains image files of any plots generated from running the test session. If you selected to save all waveforms or ran tests using prerecorded waveform files, these are included here.

The first time you run a new, unsaved session, the session files are stored in the Untitled Session folder located at X: \<Application Name>. When you name and save the session, the files are placed in a folder with the name that you specify. A copy of the test files stay in the Untitled Session folder until you run a new test or until you close the application.

## Probe and termination voltage

Test Type	CTS 2.0 Test ID	Test Name Connection type	Termination Voltage	Probe Setup
LP Tests	1.1.1	LP-TX Thevenin Output High Level Voltage (VOH)	No	Differential Probe with RTB\Capacitive load
	1.1.2	LP-TX Thevenin Output Low Level Voltage (VOL) ESCAPEMODE		
		LP-TX Thevenin Output Low Level Voltage (VOL)		
	1.1.3	LP-TX 15%-85% Rise Time (TRLP) ESCAPEMODE		
	1.1.4	LP-TX 15%-85% Fall Time (TFLP) ESCAPEMODE		
		LP-TX 15%-85% Fall Time (TFLP)		
	1.1.5	LP-TX Slew Rate vs. CLOAD (RiseEdgeMax)		
		LP-TX Slew Rate vs. CLOAD (RiseEdgeMin)		
		LP-TX Slew Rate vs. CLOAD (RiseEdgeMargin)		
		LP-TX Slew Rate vs. CLOAD (FallEdgeMax)		
		LP-TX Slew Rate vs. CLOAD (FallEdgeMin)		
	1.1.6	LP-TX Pulse Width of Exclusive-OR Clock (TLP-PULSE-TX)		
		LP-TX Pulse Width of Exclusive-OR Clock (TLP-PULSE-TX) [Initial]		
	1.1.7	LP-TX Period of Exclusive-OR Clock (TLP-PER-TX) [Rising-to-Rising]		
LP-TX Period of Exclusive-OR Clock (TLP-PER-TX) [Falling-to-Falling]				
1.1.8	tLP-EXIT Value			
HS Timing Tests	1.2.1	TLPX Duration	No	Differential Probe with RTB
	1.2.2	T3-PREPARE Duration		
	1.2.3	T3-PREBEGIN Duration		
	1.2.4	T3-PROGSEQ Duration		
	1.2.5	T3-PREEND Duration		
	1.2.6	T3-SYNC Duration		

Table continued...



Test Type	CTS 2.0 Test ID	Test Name Connection type	Termination Voltage	Probe Setup
HS Electrical Tests	1.2.7	HS-TX Differential Voltages (VOD-AB-Strong1) [Max]	Yes	Direct DSO Connection with SMA
		HS-TX Differential Voltages (VOD-AB-Weak1) [Min]		
		HS-TX Differential Voltages (VOD-AB-Weak0) [Max]		
		HS-TX Differential Voltages (VOD-AB-Strong0) [Min]		
		HS-TX Differential Voltages (VOD-BC-Strong1) [Max]		
		HS-TX Differential Voltages (VOD-BC-Weak1) [Min]		
		HS-TX Differential Voltages (VOD-BC-Weak0) [Max]		
		HS-TX Differential Voltages (VOD-BC-Strong0) [Min]		
		HS-TX Differential Voltages (VOD-CA-Strong1) [Max]		
		HS-TX Differential Voltages (VOD-CA-Weak1) [Min]		
		HS-TX Differential Voltages (VOD-CA-Weak0) [Max]		
		HS-TX Differential Voltages (VOD-CA-Strong0) [Min]		
		1.2.8		
	1.2.9	HS-TX Single-Ended Output High Voltages (VOHHS(VA))		
		HS-TX Single-Ended Output High Voltages (VOHHS(VB))		
		HS-TX Single-Ended Output High Voltages (VOHHS(VC))		
	1.2.10	HS-TX Static Common-Point Voltages (VCPTX_HS_+X)		
		HS-TX Static Common-Point Voltages (VCPTX_HS_X)		
		HS-TX Static Common-Point Voltages (VCPTX_HS_+Y)		
		HS-TX Static Common-Point Voltages (VCPTX_HS_Y)		
		HS-TX Static Common-Point Voltages (VCPTX_HS_+Z)		
		HS-TX Static Common-Point Voltages (VCPTX_HS_Z)		
	1.2.11	HS-TX Static Common-Point Voltage Mismatch ( $\Delta$ VCPTX(HS))		
	1.2.12	HS-TX Dynamic Common-Point Variations Between 50-450 MHz ( $\Delta$ VCPTX(LF))		
	1.2.13	HS-TX Dynamic Common-Point Variations Above 450 MHz ( $\Delta$ VCPTX(HF))		
	1.2.14	HS-TX Rise Time (tR) [1.5Gbps and below]	Yes	Direct DSO Connection with SMA
		HS-TX Rise Time (tR) [above 1.5Gbps]		
1.2.15	HS-TX Fall Time (tF) [1.5Gbps and below]			
	HS-TX Fall Time (tF) [above 1.5Gbps]			

Table continued...

Test Type	CTS 2.0 Test ID	Test Name Connection type	Termination Voltage	Probe Setup
HS Timing Tests	1.2.16	T3-POST Duration	No	Differential Probe with RTB
	1.2.17	30%-85% Post-EoT Rise Time (TREET)		
	1.2.18	THS-EXIT Value		
HS Electrical Tests	1.2.19	HS Clock Instantaneous UI (UIINST_Max)	Yes	Direct DSO Connection with SMA
	1.2.20	HS Clock Delta UI ( $\Delta$ UI) [1Gbps and below]		
		HS Clock Delta UI ( $\Delta$ UI) [above 1Gbps]		
	1.2.21	HS-TX Eye diagram	Yes	Direct DSO Connection with SMA
1.2.22	HS-TX UI Jitter (UI_JitterPEAK_TX)			
LP Timing Tests manual	1.3.1	INIT: LP-TX Initialization Period (tINIT,MASTER)	No	Differential Probe with Capacitive load\RTB
	1.3.2	ULPS Exit: Transmitted tWAKEUP Interval		
BIDIR Timing Tests	1.3.3	BTA: TX-Side tTA-GO Interval Value	No	Differential Probe with Master\Slave Configuration
	1.3.4	BTA: RX-Side tTA-SURE Interval Value		
	1.3.5	BTA: RX-Side tTA-GET Interval Value		
DC Level Tests	1.4.1	[VOD(UT)]	No	Differential Probe with RTB and dip switch settings in unterminated mode
	1.4.2	[Delta VOD(UT)]		
	1.4.3	VOOHS(UT)]		
	1.4.4	VCPTX(UT)		
CAL PRE Timing Tests	1.5.1	t3-CALPREAMBLE Duration (Informative)	No	Differential Probe with RTB
	1.5.2	t3-ASID Duration (Informative)		
	1.5.3	t3-CALALTSEQ Duration (Informative)		
	1.5.4	Calibration Sequence t3-SYNC Duration (Informative)		

## See also

[Instrument connection setup](#)

## Default values

Parameter Name	HS	LP
SR	AUTO	AUTO
RL	2M Group 2, 4 and 5	1M Group 1 and Group 3 all
Width trigger	0.125ns-12.5ns @ 0.2V	10ns-100us @ 0.55V
Transition trigger	0.1V-0.3V, default delta, LT	0.25V-0.8V, default delta, GT
Edge trigger	0.2	0.55
Vertical Scale	200mV	
Vertical Position	-2.6 div	
Vertical Offset	0V	

## Parameter Name and Value for Width Trigger Range

Parameter Name	Parameter Value
Width Trigger Range	0 to 1000 $\mu$ s (Lower and Upper Limits)

## DUT Panel

Parameter	Description
Version	C-PHY 2.0
Default Symbol Rate	8 Gsps
Termination Voltage	0.2425V
T3 Post Duration (UI)	7
PROGSEQ	00111222333444
Signal Type	LP-HS
LVLP	Unchecked
LVHS	Unchecked
ALP	Unchecked
User Defined Acquisition	Unchecked

## Test Selection Panel

Setting	Description
Tests	Except Group 5 all other tests will be enabled for Signal Type as LP-HS

## Acquisition Panel

Setting	Description
Lane	Lane0
VA	CH1
VB	CH2
VC	CH3
Show Acquire Parameters	Unchecked

## Configuration Panel

Global Settings	Description
Compliance Mode	Selected
User Defined Mode	Selected
Auto set for Vertical Settings	Enabled
Insertion Loss	Unchecked and default is Standard
CTLE	Unchecked

# Index

## Numerics

30%-85% Post-EoT Rise Time (tREOT) [57](#)

## A

About SCPI command [63](#)

Acquisitions tab [35](#)

Activate the license  
license [14](#)

Application directories [118](#)

Application measurements [52](#)

## B

BTA: RX-Side  $t_{TA-GET}$  Interval Value [60](#)

BTA: RX-Side  $t_{TA-SURE}$  Interval Value [60](#)

BTA: TX-Side  $t_{TA-GO}$  Interval Value [59](#)

## C

Calibration Sequence t3-SYNC Duration (Informative) [62](#)

Configure report view settings [48](#)

Configuring tests [37](#)

Connected instruments  
searching for [29](#)

Contacting Tektronix [12](#)

Conventions [11](#)

## D

Delete the run/config session [113](#)

Downloading and installing the software  
Download the software  
Install the software [14](#)

## E

Email notification and setup [28](#)

Example [115](#)

## F

File name extensions [119](#)

Filter the test results [45](#)

## G

Gear selection [31](#)

Getting help and support [11](#)

Getting started [13](#)

Global settings [37](#)

GPIB [29](#)

## H

Hardware requirements

Hardware [13](#)

HS Clock Delta UI ( $\Delta UI$ ) (OBSOLETE) [58](#)

HS Clock Instantaneous UI (UIINST) [58](#)

HS-TX Differential Voltage Mismatch ( $\Delta VOD$ ) [55](#)

HS-TX Differential Voltage Mismatch Unterminated ( $\Delta V_{OD(UT)}$ ) [60](#)

HS-TX Differential Voltages (VOD\_AB, VOD\_BC, VOD\_CA) [55](#)

HS-TX Differential Voltages Unterminated ( $V_{OD(UT)-AB}$ ,  $V_{OD(UT)-BC}$ ,  
 $V_{OD(UT)-CA}$ ) [60](#)

HS-TX Dynamic Common-Point Variations Above 450 MHz  
( $\Delta VCPTX(HF)$ ) [57](#)

HS-TX Dynamic Common-Point Variations Between 50-450 MHz  
( $\Delta VCPTX(LF)$ ) [56](#)

HS-TX Eye Diagram [58](#)

HS-TX Fall Time (tF) [57](#)

HS-TX Rise Time (tR) [57](#)

HS-TX Single-Ended Output High Voltages (VOHHS(VA), VOHHS(VB),  
VOHHS(VC)) [56](#)

HS-TX Single-Ended Output High Voltages Unterminated ( $V_{OHHS(UT)}$   
(VA),  $V_{OHHS(UT)(VB)}$ ,  $V_{OHHS(UT)(VC)}$ ) [61](#)

HS-TX Static Common-Point Voltage Mismatch ( $\Delta VCPTX(HS)$ ) [56](#)

HS-TX Static Common-Point Voltages (VCPTX) [56](#)

HS-TX Static Common-Point Voltages Unterminated ( $V_{CPTX(UT)}$ ) [61](#)

HS-TX UI Jitter (UI\_JitterPEAK\_TX) [59](#)

## I

Icons used

symbols [11](#)

INIT: LP-TX Initialization Period ( $t_{INIT, MASTER}$ ) [59](#)

Instrument Control Settings [21](#)

Instruments

discovering connected [29](#)

Instruments and accessories [14](#)

## L

LAN [29](#)

Launch the application [25](#)

license key [15](#)

Load the run/config session [113](#)

load the saved test setup  
load the test setup [50](#)

Log view [43](#)

Log View [42](#)

LP-TX 15%-85% Fall Time ( $t_{FLP}$ ) [52](#)

LP-TX 15%-85% Rise Time (tRLP) [52](#)  
LP-TX Period of Exclusive-OR Clock (tLP-PER-TX) [53](#)  
LP-TX pulse width of Exclusive-OR Clock (tLP-PULSE-TX) [53](#)  
LP-TX Slew Rate versus C<sub>LOAD</sub> (dV/dt<sub>SR</sub>) [53](#)  
LP-TX Thevenin Output Low Level Voltage (VOL) [52](#)

## M

Minimum system requirements [13](#)  
Multiple-session run [34](#)  
My TekExpress folder  
  locating [23](#)

## N

Non-VISA [29](#)

## O

Options menu  
  Instrument control settings [29](#)  
  Options menu functions [27](#)  
Override the run/config session [114](#)

## P

Pre-run checklist [23](#)  
Preferences menu [45](#)  
Preferences tab  
  Preferences [40](#)  
Product documents  
  TekExpress Application documents [11](#)

## Q

Query the available list in the run/config session [114](#)  
Query the current run/config session [114](#)

## R

recalling test setup [50](#)  
References [118](#)  
Remote commands [63](#)  
Report configuration settings [46](#)  
report generation settings  
  Configure report generation settings [46](#)  
Reports  
  receiving in email notifications [28](#)  
Reports panel [46](#)  
Run the run/config saved session [113](#)  
Running tests [23](#)

## S

Save the configured test setup

Save the configured test setup (*continued*)  
  Save the test setup [50](#)  
Save the run/config sessions [112](#)  
Save the test setup [51](#)  
Save the test setup with a different name [51](#)  
Saving test setup [50](#)  
SCPI command [63](#)  
SCPI Commands  
  SCPI [63](#)  
Search instruments connected  
  instruments connected to the application [21](#)  
Select a loaded test setup [50](#)  
Select a pre-run session loaded test setup [50](#)  
Select Channel [35](#)  
Set DUT parameters [31](#)  
Set the default session [112](#)  
Setting up tests [22](#)  
Setting up the test environment  
  test environment [16](#)  
Setup tabs  
  Acquisitions [35](#)  
Signal Path Compensation (SPC) [23](#)  
Signal source validation  
  setting [35](#)  
Socket configuration for SCPI commands  
  Socket configuration [63](#)  
Software requirements  
  Softwares [14](#)  
software version [15](#)  
Start the application [25](#)  
Status panel [42](#)  
Support [12](#)  
System requirements [13](#)

## T

t3- PREEND Duration [55](#)  
t3-ASID Duration (Informative) [61](#)  
t3-CALALTSEQ Duration (Informative) [61](#)  
t3-CALPREAMBLE Duration (Informative) [61](#)  
t3-POST Duration [57](#)  
t3-PREBEGIN Duration [54](#)  
t3-PREPARE Duration [54](#)  
t3-PROGSEQ Duration [54](#)  
t3-SYNC Duration [55](#)  
Tab  
  Acquisitions [35](#)  
  Configuration [37](#)  
Technical support [12](#)  
Tek Link [29](#)  
TEKEXP:\*IDN? [102](#)  
TEKEXP:\*OPC? [107](#)  
TEKEXP:ACQUIRE\_MODE LIVE [102](#)  
TEKEXP:ACQUIRE\_MODE? [102](#)  
TEKEXP:INFO? IMAGE [101](#)

TEKEXP:INFO? REPORT [101](#)  
 TEKEXP:INFO? WFM [101](#)  
 TEKEXP:INSTRUMENT, "<InstrumentType>","<value>" [100](#)  
 TEKEXP:INSTRUMENT? "<InstrumentType>" [100](#)  
 TEKEXP:LASTERROR? [107](#)  
 TEKEXP:LIST? DEVICE [98](#)  
 TEKEXP:LIST? INSTRUMENT,"<Real Time Scope>" [100](#)  
 TEKEXP:LIST? SUITE [99](#)  
 TEKEXP:LIST? TEST [99](#)  
 TEKEXP:LIST? VERSION [99](#)  
 TEKEXP:MODE COMPLIANCE [102](#)  
 TEKEXP:MODE? [102](#)  
 TEKEXP:POPOPUP "Yes" [107](#)  
 TEKEXP:POPOPUP? [107](#)  
 TEKEXP:REPORT GENERATE [103](#)  
 TEKEXP:REPORT? "<Device Field>" [103](#)  
 TEKEXP:RESULT? "<TestName>" [104](#)  
 TEKEXP:RESULT? "<TestName>","<ColumnName>" [104](#)  
 TEKEXP:RESULT? "<TestName>","<ColumnName>","<RowNumber>" [104](#)  
 TEKEXP:SELECT DEVICE,"DeviceName" [69](#)  
 TEKEXP:SELECT SUITE,"<SuiteName>" [70](#)  
 TEKEXP:SELECT TEST,"<ALL>" [70](#)  
 TEKEXP:SELECT TEST,"<TestName>",1 [70](#)  
 TEKEXP:SELECT VERSION,"<VersionName>" [74](#)  
 TEKEXP:SELECT? DEVICE [69](#)  
 TEKEXP:SELECT? SUITE [70](#)  
 TEKEXP:SELECT? TEST [70](#)  
 TEKEXP:SELECT? VERSION [74](#)  
 TEKEXP:SESSION DEFAULT [112](#)  
 TEKEXP:SESSION DELETE, "Session1, Session2" [113](#)  
 TEKEXP:SESSION LOAD, "Session Name" [113](#)  
 TEKEXP:SESSION RUN, "Session Name's separated by comma" [113](#)  
 TEKEXP:SESSION SAVE,"SessionName", "True" [114](#)  
 TEKEXP:SESSION SAVE,"Session Name" [112](#)  
 TEKEXP:SESSION? CURRENT [114](#)  
 TEKEXP:SESSION? LIST [114](#)  
 TEKEXP:SETUP Default [105](#)  
 TEKEXP:SETUP Open,"<SessionName>" [105](#)  
 TEKEXP:SETUP Save,"<SessionName>" [105](#)  
 TEKEXP:SETUP? CURRENT [106](#)  
 TEKEXP:STATE RUN [106](#)  
 TEKEXP:STATE? [106](#)  
 TEKEXP:STATE? SETUP [107](#)  
 TEKEXP:VALUE  
 ACQUIRE,"<TestName>","<AcquireType>","<ParameterName>","<ParameterValue>" [80](#)  
 TEKEXP:VALUE  
 ANALYZE,"<TestName>","<ParameterName>","<ParameterValue>" [93](#)  
 TEKEXP:VALUE ContinuousRun\_Duration,"<Value>" [109](#)  
 TEKEXP:VALUE ContinuousRun\_RunSessionOptions,"Value" [110](#)  
 TEKEXP:VALUE ContinuousRun,"<Value>" [108](#)  
 TEKEXP:VALUE DUTID,"Value" [69](#)  
 TEKEXP:VALUE GENERAL,"<ParameterName>","<Value>" [74](#)

TEKEXP:VALUE GENERAL,"View Report After Generating",<value> [111](#)  
 TEKEXP:VALUE  
 LIMIT,<TestName>,<LimitHeader>,<Value1>,<CompareString>,<Value2> [111](#)  
 TEKEXP:VALUE VERBOSE,"<Value>" [109](#)  
 TEKEXP:VALUE  
 WFMFILE,<TestName>,<AcquireType>,<WaveformFileName> [112](#)  
 TEKEXP:VALUE?  
 ACQUIRE,"<TestName>" "<AcquireType>","<ParameterName>" [80](#)  
 TEKEXP:VALUE? ANALYZE,"<TestName>","<ParameterName>" [93](#)  
 TEKEXP:VALUE? ContinuousRun [108](#)  
 TEKEXP:VALUE? ContinuousRun\_Duration [109](#)  
 TEKEXP:VALUE? ContinuousRun\_RunSessionOptions [110](#)  
 TEKEXP:VALUE? DUTID [69](#)  
 TEKEXP:VALUE? GENERAL,"<ParameterName>" [74](#)  
 TEKEXP:VALUE? GENERAL,"Enable Continuous Run" [108](#)  
 TEKEXP:VALUE? GENERAL,"View Report After Generating" [111](#)  
 TEKEXP:VALUE? LIMIT,<TestName>,<LimitHeader> [111](#)  
 TEKEXP:VALUE? VERBOSE [109](#)  
 TEKEXP:VALUE? WFMFILE,<TestName>,<AcquireType> [112](#)  
 Test configuration [37](#)  
 test execution status [42](#)  
 Test groups [16](#)  
 Test results  
     send by email [28](#)  
 test run preferences [40](#)  
 Test setup files overview  
     Test setup files [50](#)  
 Test setup overview [16](#)  
 Test setup steps [22](#)  
 Test Status [42](#)  
 tests [52](#)  
 Tests  
     running [23](#)  
     setting up [16](#)  
 Thevenin Output High Level Voltage [52](#)  
 tHS-EXIT Value [58](#)  
 tLP-EXIT value [54](#)  
 tLPX Duration [54](#)

## U

ULPS Exit: Transmitted  $t_{WAKEUP}$  Interval [59](#)  
 Untitled Session folder [23](#)  
 User Comments [31](#)

## V

View a report [49](#)  
 View test execution logs [43](#)  
 View test parameters [37](#)  
 View the test execution status [42](#)