



**TekExpress® D-PHY
Compliance Test
Application Help (70K Series MSO/DPO/DPS)**



077-0514-07



**TekExpress® D-PHY
Compliance Test
Application Help (70K Series MSO/DPO/DPS)**

Register now!
Click the following link to protect your product.
www.tek.com/register



077-0514-07

Copyright © Tektronix. All rights reserved. Licensed software products are owned by Tektronix or its subsidiaries or suppliers, and are protected by national copyright laws and international treaty provisions. Tektronix products are covered by U.S. and foreign patents, issued and pending. Information in this publication supersedes that in all previously published material. Specifications and price change privileges reserved.

TEKTRONIX and TEK are registered trademarks of Tektronix, Inc.

Tektronix, Inc.

14150 SW Karl Braun Drive

P.O. Box 500

Beaverton, OR 97077

USA

For product information, sales, service, and technical support:

- In North America, call 1-800-833-9200.
- Worldwide, visit www.tek.com to find contacts in your area.

Table of Contents

List of Figures.....	7
List of Tables.....	8
Welcome.....	9
Getting help and support	11
Conventions.....	11
Related documentation.....	11
Technical Support.....	11
Getting started.....	13
Supported oscilloscopes.....	13
Recommended accessories.....	13
Recommended probes.....	14
Downloading and installing the software.....	14
Activate the license.....	14
View software version.....	14
Application directories.....	15
File name extensions.....	16
Operating basics	17
Launch the application.....	17
Exit the application.....	18
Application controls.....	18
Global application controls.....	19
Options menu overview.....	19
TekExpress instrument control settings.....	20
View connected instruments.....	20
Configure email settings.....	21
Application panels overview.....	23
Setup panel.....	24
Setup panel overview.....	24
Set DUT parameters.....	24
Select tests.....	27
Set acquisition tab parameters.....	28
Set configuration tab parameters.....	30
Set preferences tab parameters.....	35
Status panel overview.....	37
Results panel.....	38
Results panel overview.....	38
Preferences menu.....	39
View test-related files.....	40
Reports panel.....	40
Report configuration settings.....	40
Configure report view settings.....	43
View a report.....	44
Report content.....	44
Running tests	47

Equipment connection diagram.....	47
Prerequisite.....	50
Running tests.....	51
View test results.....	51
Saving and recalling test setup.....	53
Test setup files overview.....	53
Save a test setup.....	53
Open load a saved test setup.....	53
Create a test setup from default settings.....	53
Create a test setup using an existing one.....	54
SCPI commands.....	55
About SCPI command.....	55
Socket configuration for SCPI commands.....	55
TEKEXP:*IDN?.....	61
TEKEXP:*OPC?.....	61
TEKEXP:ACQUIRE_MODE.....	62
TEKEXP:ACQUIRE_MODE?.....	62
TEKEXP:EXPORT.....	62
TEKEXP:INFO?.....	62
TEKEXP:INSTRUMENT.....	63
TEKEXP:INSTRUMENT?.....	63
TEKEXP:LASTERROR?.....	63
TEKEXP:LIST?.....	64
TEKEXP:POPOP.....	64
TEKEXP:POPOP?.....	64
TEKEXP:REPORT.....	65
TEKEXP:REPORT?.....	65
TEKEXP:RESULT?.....	65
TEKEXP:SELECT.....	66
TEKEXP:SELECT?.....	66
TEKEXP:SETUP.....	66
TEKEXP:STATE.....	67
TEKEXP:STATE?.....	67
TEKEXP:VALUE.....	67
TEKEXP:VALUE?.....	68
Command parameters list.....	68
Examples.....	92
References.....	95
Pre-recorded waveform file names for test measurements.....	95
Manual Deskew Procedure.....	97
D-PHY Measurements and Test Modes.....	99
BTA Test Procedure.....	102
Test 1.6.4 BTA: TX-Side TTA-GO Interval Value.....	102
Test 1.6.5 BTA: RX-Side TTA-SURE Interval Value.....	103
Test 1.6.6 BTA: RX-Side TTA-GET Interval Value.....	104
Index.....	106

List of Figures

Figure 1: Email Settings.....	22
Figure 2: TekExpress D-PHY measurements.....	28
Figure 3: Configuration tab: Global Settings.....	31
Figure 4: Configuration tab: Measurements.....	32
Figure 5: Preferences tab.....	36
Figure 6: Test status view in Status panel.....	37
Figure 7: Log view in Status panel.....	38
Figure 8: Report panel- Configuration tab.....	41
Figure 9: Report panel-View settings tab.....	43

List of Tables

Table 1: Icon descriptions.....	11
Table 2: Product documentation.....	11
Table 3: Application directories and usage.....	15
Table 4: File name extension	16
Table 5: Application control description.....	18
Table 6: Application panels overview.....	23
Table 7: DUT tab settings.....	25
Table 8: Test Selection tab settings.....	28
Table 9: Acquisitions tab settings.....	29
Table 10: Configuration tab: Common parameters.....	30
Table 11: Configuration tab: Global settings.....	31
Table 12: Configuration tab: Measurements settings.....	32
Table 13: Preferences tab settings.....	36
Table 14: Status panel settings.....	38
Table 15: Report configuration panel settings.....	41
Table 16: Report panel view settings.....	43
Table 17: ParameterName and Value for DUT tab.....	68
Table 18: ParameterName and Value for Test Selection tab.....	70
Table 19: ParameterName and Value for Acquisition tab.....	72
Table 20: ParameterName and Value for Preferences tab.....	72
Table 21: ParameterName and Value for Analyze.....	72
Table 22: ParameterName and Value for General.....	73
Table 23: ParameterName and Value for Acquire.....	74

Welcome

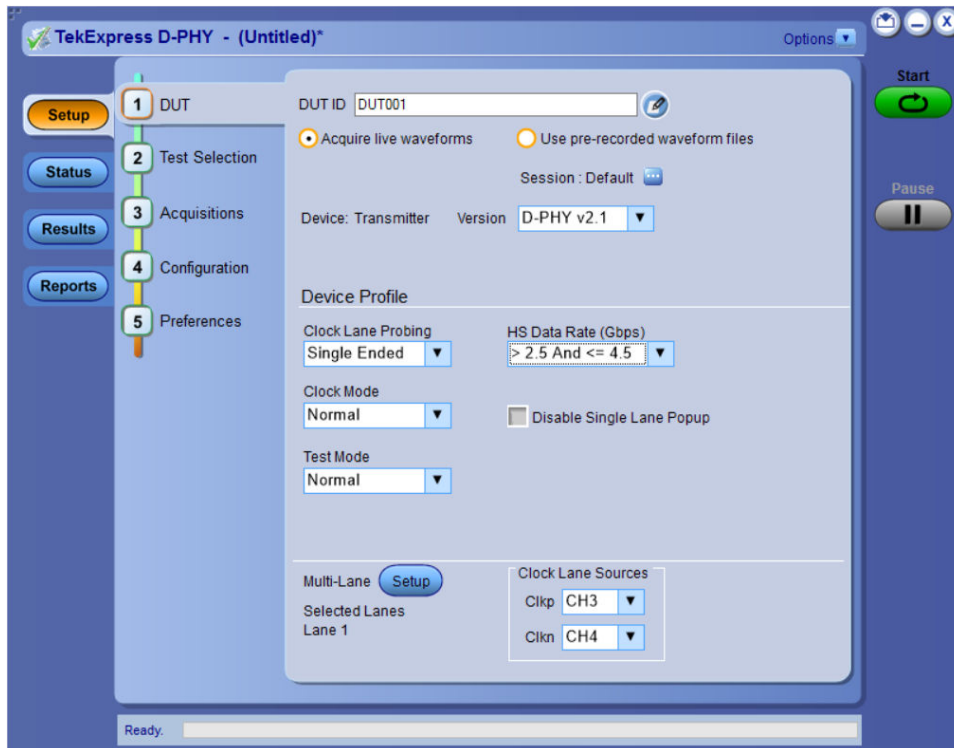

The Tektronix TekExpress D-PHY (DPHY12 / DPHY21) offers a complete physical layer test solution for transmitter conformance and characterization as defined in the MIPI D-PHY v1.2 and v2.1 specifications. The TekExpress D-PHY automated test solution, along with a Tektronix 70K series oscilloscope, provides an easy way to test, debug and characterize the electrical and timing measurements of D-PHY data links.

Key Features

- **Test time**
 - Fully automated solution: Performs D-PHY transmitter test with single-button click across High Speed (HS), Low Power (LP), Low Power-High Speed (LP-HS), and Ultra-Low Power State (ULPS) sequences in the D-PHY signal.
 - Lets you select individual tests or groups of tests.
 - Eye Diagram Capability: Displays the eye diagram of the High Speed signal with option DJA enabled on the oscilloscope for test 1.5.4, Data to clock skew test and test 1.5.7 Data and Clock Eye Diagram.
 - Image Snapshot: Option of including the snapshot of the first reference region of analysis in the captured waveform
- **100% test coverage as per D-PHY v2.1, CTS v1.0**
 - Performs fully-automated tests including Bus Turn Around (BTA) and Ultra-Low Power State (ULPS) measurements, as per D-PHY specifications up to v2.1.
- **Measurement variety**
 - D-PHYTX runs multiple scenarios like Continuous or Burst mode, Termination variations, and varying idle time.
- **Transmitter conformance test and beyond (Debug)**
 - Easily modify limits of test parameters in TekExpress for debug, margin, and characterization testing
 - Performs characterization by running TekExpress application in continuous mode to collect data

- **Signal access**
 - Use the low loading, single-ended or differential Tektronix P7700(70K C/DX/SX) Series High Impedance TriMode probe to measure MIPI signals
 - Supports TekFlex™ accessories for flexible probing
- **Offline and remote analysis**
 - Analyze live or pre-acquired waveforms
 - Allows remote execution of tests



Getting help and support

Conventions

Help uses the following conventions:

- The term "Application," and "Software" refers to the TekExpress D-PHY application.
- The term "DUT" is an abbreviation for Device Under Test.
- The term "select" is a generic term that applies to the two methods of choosing a screen item (button control, list item): using a mouse or using the touch screen.
- A Note identifies important information.

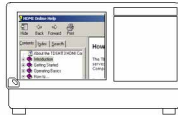

Table 1: Icon descriptions

Icon	Meaning
	This icon identifies important information.
	This icon identifies conditions or practices that could result in loss of data.
	This icon identifies additional information that will help you use the application more efficiently.

Related documentation

The following manuals are available as part of the TekExpress D-PHY Automated Solution documentation set.

Table 2: Product documentation

Item	Purpose	Location
Online Help	In-depth operation and UI help.	
PDF of the Online Help (077-0XXX-XX)	In-depth operation and UI help.	

Technical Support

Tektronix values your feedback on our products. To help us serve you better, please send us your suggestions, ideas, or comments on your application or oscilloscope. Contact Tektronix through mail, telephone, or the Web site. See [Contacting Tektronix](#) at the front of this document for contact information.

When you contact Tektronix Technical Support, please include the following information (be as specific as possible):

General information

- All instrument model numbers
- Hardware options, if any
- Modules used
- Your name, company, mailing address, phone number, FAX number
- Please indicate if you would like to be contacted by Tektronix about your suggestion or comments.

Application specific information

- Software version number
- Description of the problem such that technical support can duplicate the problem
- If possible, save the setup files for all the instruments used and the application
- If possible, save the TekExpress setup files, log.xml, *.TekX (session files and folders), and status messages text file
- If possible, save the waveform on which you are performing the measurement as a .wfm file

Getting started

Supported oscilloscopes

Pre-requisite

Recommended DPOJET version is required to execute v2.1 measurements (Test ids 1.4.18, 1.4.19, 1.4.20, 1.5.7)

Refer ReadMe/Release notes for the latest version details.

Supported oscilloscopes

- MSO/DPO70000 DX Series Oscilloscopes
- DPO70000 SX Series Oscilloscopes (Four channel) with bandwidth upto 33 GHz with Option 20XL
- DPS70000 SX Series Dual Stack Oscilloscopes with 33 GHz bandwidth onwards with Option 20XL

Note:



- D-PHY v1.2 : requires minimum 4 GHz bandwidth as per CTS.
- D-PHY v2.1 : requires minimum 12.5 GHz bandwidth as per CTS.

Recommended accessories

Termination board

UNH-IOL REFERENCE TERMINATION BOARD (RTB) -v3.3 Proto rev.1 Board.

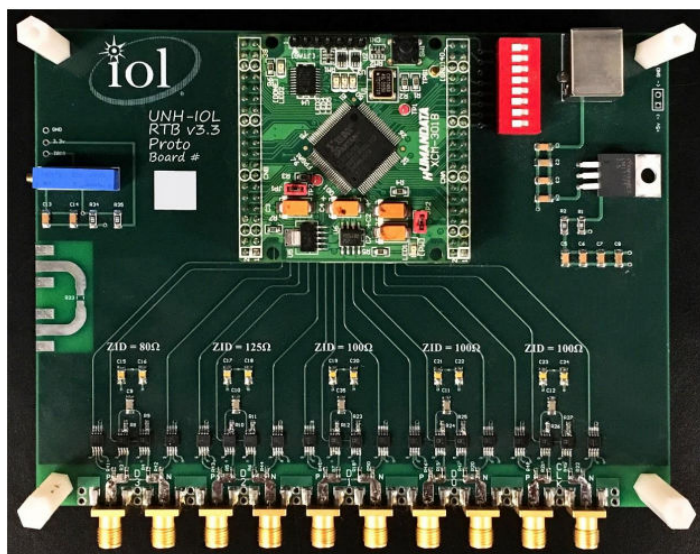

RTB configuration

The dipswitches allow independent control of the Clock Lane and the group of four Data Lanes

- DIPSW8: ON : CLK Lane Termination always ON
- DIPSW7: ON : CLK Lane Termination always OFF

- DIPSW6: ON : DATA0/1/2/3 Lane Termination always ON
- DIPSW5: ON : DATA0/1/2/3 Lane Termination always OFF

Recommended probes

P7700 Series Tri-mode probe with P77STFLXA solder-in tip with TekFlex connector technology (required four numbers)

Downloading and installing the software

Complete the following steps to download and install the latest D-PHY application. See [Supported oscilloscopes](#) on page 13 for compatibility.



Note: Application will install on oscilloscopes with 4 GHz bandwidth onwards.

1. Go to www.tek.com.
2. Click **Downloads**. In the Downloads menu, select DOWNLOAD TYPE as Software and enter *D-PHY* in the MODEL OR KEYWORD field and click **SEARCH**.

3. Select the latest version of the software and follow the instructions to download. Copy the executable file to the oscilloscope.
4. Double-click the executable and follow the on-screen instructions. The software is installed at *C:\Program Files\Tektronix\TekExpress\TekExpress D-PHY*.
5. Select **Analyze > TekExpress D-PHY** from the TekScope menu to launch the application.

Activate the license

Activate the license using the **Option Installation** wizard in the TekScope application:

1. In the TekScope application menu bar, click **Utilities > Option Installation**.
The **TekScope Option Installation** wizard opens.
2. Push the **F1** key on the oscilloscope keyboard to open the Option Installation help topic.
3. Follow the directions in the help topic to activate the license.

See also

[View version and license information](#)

View software version

Use the following instructions to view version information for the application and for the application modules such as the Programmatic Interface and the Programmatic Interface Client.

To view version information for D-PHY, click **Options > About TekExpress**.



Application directories

The TekExpress D-PHY application files are installed at the following location:

C:\Program Files\Tektronix\TekExpress\TekExpress D-PHY

The application directory and associated files are organized as follows:

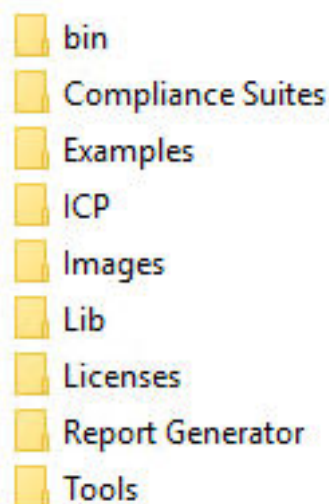

The following table lists the default directory names and their usage:

Table 3: Application directories and usage

Directory names	Usage
Bin	Contains application libraries
Compliance Suites	Contains test suite specific files
Examples	Contains various support files
ICP	Contains instrument and application specific interface libraries
Images	Contains images of the application
Lib	Contains utility files specific to the application

Table continued...

Directory names	Usage
Licenses	Contains all the license files
Report Generator	Contains style sheets for report generation
Tools	Contains instrument and application specific files

File name extensions

The TekExpress D-PHY software uses the following file name extensions:

Table 4: File name extension

File name extension	Description
.TekX	Application session files (the extensions may not be displayed)
.py	Python sequence file
.xml	Test-specific configuration information (encrypted) files Application log files
.csv	Test result reports Plot data
.mht	Test result reports (default) Test reports can also be saved in HTML format
.pdf	Test result reports Application help document
.xslt	Style sheet used to generate reports
.png	Captured images

Operating basics

Launch the application

To launch the TekExpress D-PHY application, select **Analyze > TekExpress D-PHY** from the TekScope menu.

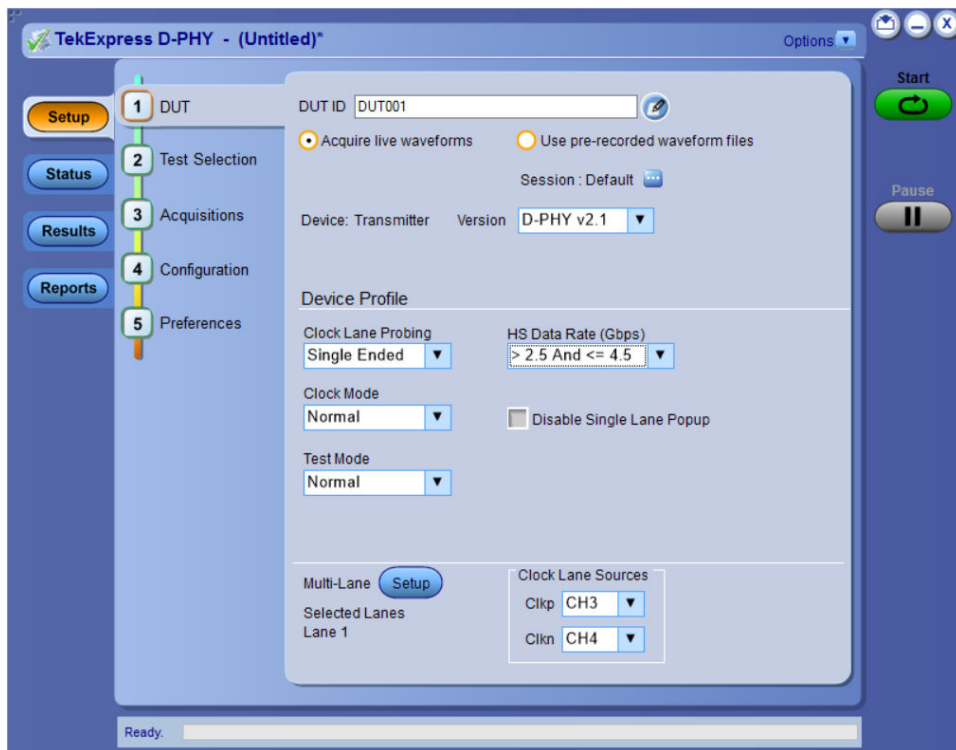

After first launch of Tekexpress D-PHY application following changes take place on the oscilloscope.

During launch, "My TekExpress" folder is created in the Documents folder of the current user and gets mapped to "X" drive. When the application is closed properly, the "X" drive will get unmapped.



Note: If a user with new login ID launches "TekExpress D-PHY.exe", "My TekExpress" folder is created in the Documents folder of the new user.

When you first run the application after installation, the application checks for Resources.xml located in the X:\ folder. The Resources.xml file gets created into X: drive, if the file is not found, then the application creates file with equipment details. Session files are then stored inside the X:\D-PHY folder. If this file is not found, the application runs an instrument discovery program to detect connected instruments before launching TekExpress D-PHY.

To keep the TekExpress D-PHY application window on top, select Keep On Top from the [Options menu](#). If the application goes behind the oscilloscope application, click Application > TekExpress D-PHY to move the application to be in front.



Note: When **Keep on Top** is selected, you cannot access the combo boxes in the application panels.

See also

[Exit the application](#)

Exit the application

To exit the application, click  on the application title bar. Follow on-screen prompts to save any unsaved session, save test setup files, or exit the application.



Note: Using other methods to exit the application can result in abnormal termination of the application.

Application controls

This section describes the application controls.

Table 5: Application control description









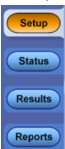

Item	Description
<p><i>Options menu</i></p> 	Menu to display global application controls.
<p><i>Test panel</i></p> 	Controls that open tabs for configuring test settings and options.
<p>Start / Stop button</p>  	<p>Use the Start button to start the test run of the measurements in the selected order. If prior acquired measurements are not cleared, then new measurements are added to the existing set.</p> <p>The button toggles to the Stop mode while tests are running. Use the Stop button to abort the test.</p>
<p>Pause / Continue button</p> 	Use the Pause button to pause the acquisition. When a test is paused, this button changes as Continue .
<p>Clear button</p> 	<p>Use the Clear button to clear all existing measurement results. Adding or deleting a measurement, or changing a configuration parameter of an existing measurement, also clears measurements. This is to prevent the accumulation of measurement statistics or sets of statistics that are not coherent. This button is available only on <i>Results panel</i>.</p> <p> Note: This button is visible only when there are results data on the panel.</p>
<p>Application window move icon</p> 	Place the cursor over the top of the application window to move the application window to the desired location
<p>Minimize icon</p> 	Minimizes the application.
<p>Close icon</p> 	Close the application.

Table continued...

Item	Description
Mini view / Normal view 	Toggles the application between mini view and normal view. Mini view displays the run messages with the time stamp, progress bar, Start / Stop button, and Pause / Continue button. The application moves to mini view when you click the Start button. 

Global application controls

The menus and controls that appear outside the individual tabs are called “Global Controls”. These are used to specify the devices to be tested.

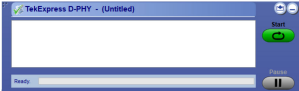
Options menu overview

To access Options menu, click  in the upper-right corner of the application. It has the following selections:

Menu	Function
Default Test Setup	Opens an untitled test setup with defaults selected
Open Test Setup	Opens a saved test setup
Save Test Setup	Saves the current test setup
Save Test Setup As	Saves the current test setup with a different file name or file type
Open Recent	Displays the recently opened test setups to open
<i>Instrument Control Settings</i>	Detects, lists, and refreshes the connected instruments found on specified connections (LAN, GPIB, USB, and so on)
Keep On Top	Keeps the TekExpress D-PHY application on top of all the application  Note: When Keep on Top is selected, you cannot access the combo boxes in the application panels.
<i>Email Settings</i>	Use to configure email options for test run and results notifications
<i>Deskew</i>	Allows to read the deskew, attenuation, and bandwidth values from the TekScope application. Before using this option, manually compensate for skew and attenuations in TekScope application. The values read are stored into a text file in the ICP folder. The stored values can also be set on the TekScope through this option.
Help	Displays the TekExpress D-PHY help

Table continued...

Menu	Function
About TekExpress	<ul style="list-style-type: none"> • Displays application details such as software name, version number, and copyright • Provides a link to the end-user license agreement • Provides a link to the Tektronix Web site

See also

[Application controls](#)

TekExpress instrument control settings

Use **TekExpress Instrument Control Settings** dialog box to search the instruments (resources) connected to the application. You can use the Search Criteria to search the connected instruments depending on the connection type. The details of the connected instrument is displayed in the Retrieved Instruments window.

To access, click **Options > Instrument Control Settings**.

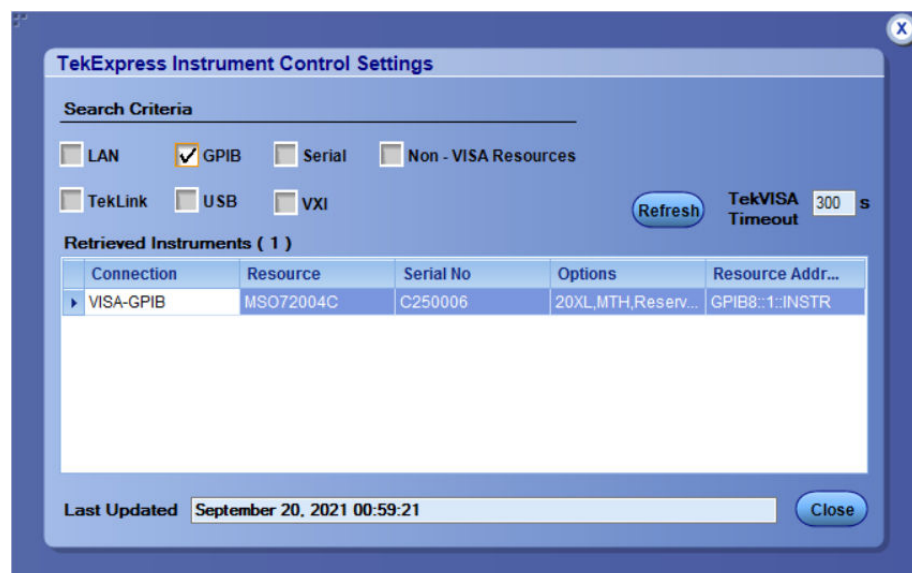

The connected instruments displayed here can be selected for use under Global Settings in the test configuration section.



Note: Select GPIIB (Default) and LAN when using TekExpress D-PHY application on MSO6.

See also

[Options menu overview](#)

View connected instruments

Use TekExpress Instrument Control Settings dialog box to search the instruments (resources) connected to the application. The application uses TekVISA to discover the connected instruments.



Note: The instruments required for the test setup must be connected and it must be recognized by the application before running the test.

To refresh the list of connected instruments:

1. From the Options menu, select **Instrument Control Settings**.
2. In the **Search Criteria** section of the Instrument Control Settings dialog box, select the connection types of the instruments to search.
Instrument search is based on the VISA layer, but different connections determine the resource type, such as LAN, GPIB, and USB. For example, if you choose LAN, the search will include all the instruments supported by TekExpress that are communicating over the LAN.
3. Click **Refresh**. TekExpress searches for connected instruments.

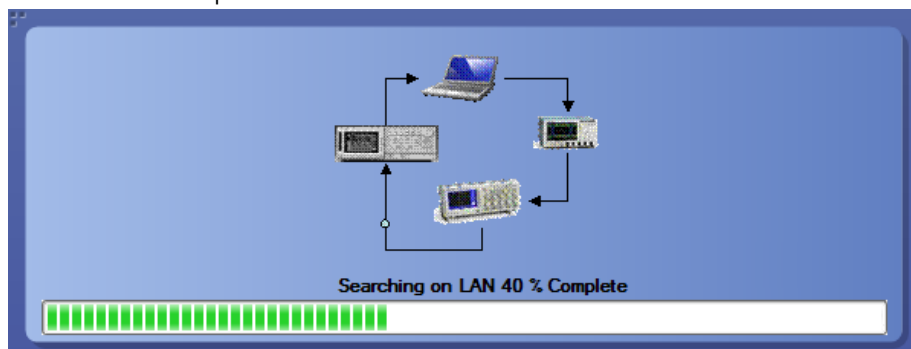

4. After searching, the dialog box lists the instrument-related details based on the search criteria. For example, for the Search Criteria as LAN and GPIB, the application displays all LAN and GPIB instruments connected to the application.

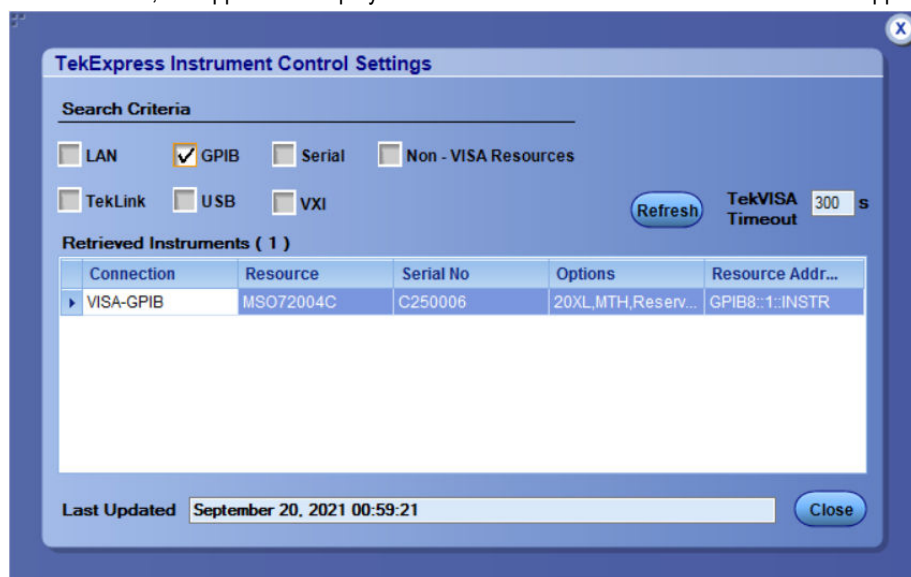

The details of the instruments are displayed in the Retrieved Instruments table. The time and date of instrument refresh is displayed in the Last Updated field.

See also

[Equipment connection diagram](#) on page 47

Configure email settings

Use the Email Settings utility to get notified by email when a measurement completes, or produces any error condition. Follow the steps to configure email settings:

Figure 1: Email Settings

1. Select **Options > Email Settings** to open the Email Settings dialog box.
2. (Required) For **Recipient email Address(es)**, enter one or more recipient email addresses. To include multiple addresses, separate the addresses with commas.
3. (Required) For **Sender's Address**, enter the email address used by the instrument. This address consists of the instrument name, followed by an underscore, followed by the instrument serial number, then the @ symbol, and the email server ID. For example: user@yourcompany.com.
4. (Required) In the **Server Configuration** section, type the SMTP Server address of the Mail server configured at the client location, and the SMTP Port number, in the corresponding fields.

If this server requires password authentication, enter a valid login name, password, and host name in the corresponding fields.



Note: If any of the above required fields are left blank, the settings will not be saved and email notifications will not be sent.

5. In the **Email Attachments** section, select from the following options:
 - **Reports:** Select to receive the test report with the notification email.
 - **Status Log:** Select to receive the test status log with the notification email. If you select this option, then also select whether you want to receive the full log or just the last 20 lines.
6. In the **Email Configuration** section:
 - Enter a maximum file size for the email message. Messages with attachments larger than this limit will not be sent. The default is 0 MB.
 - Enter the number in the Number of Attempts to Send field, to limit the number of attempts that the system makes to send a notification. The default is 1. You can also specify a timeout period.
7. Select the **Email Test Results When complete or on error** check box. Use this check box to quickly enable or disable email notifications.
8. To test your email settings, click **Test Email**.
9. To apply your settings, click **Apply**.
10. Click **Close** when finished.

Application panels overview

TekExpress D-PHY solution uses panels to group Test Setup Configuration, Results, and Reports settings. Click any button to open the associated panel. A panel may have one or more tabs that list the selections available in that panel. Controls in a tab can change depending on settings made in the same tab or another tab.

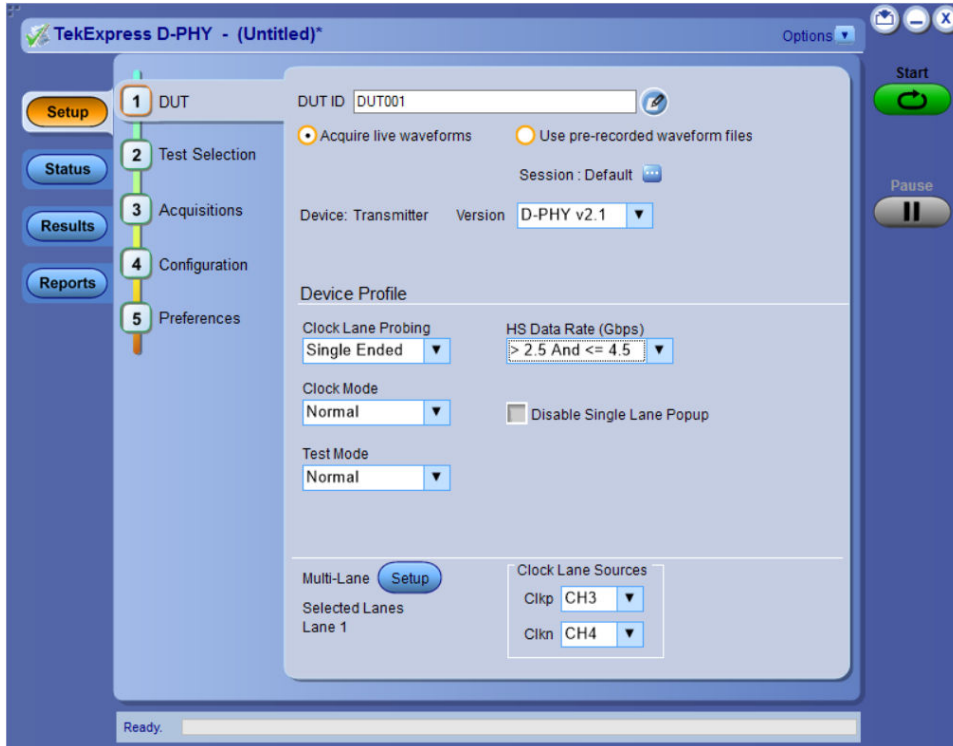

Table 6: Application panels overview

Panel Name	Purpose
Setup panel	The Setup panel shows the test setup controls. Click the Setup button to open this panel. Use this panel to: <ul style="list-style-type: none"> • Set DUT tab parameters • Select tests • Set acquisition tab parameters • Set configuration tab parameters • Set preferences tab parameters
Status panel	View the progress and analysis status of the selected tests, and view test logs.
Results panel	View the summary of test results and select result viewing preferences.
Reports panel	Browse for reports, save reports as specific file types, specify report naming conventions, select report content to include (summary information, detailed information, user comments, setup configuration, application configuration, etc.), and select report viewing options.

See also

[Application controls](#)

Setup panel

Setup panel overview

The Setup panel contains sequentially ordered tabs that help you guide through the test setup and execution process.

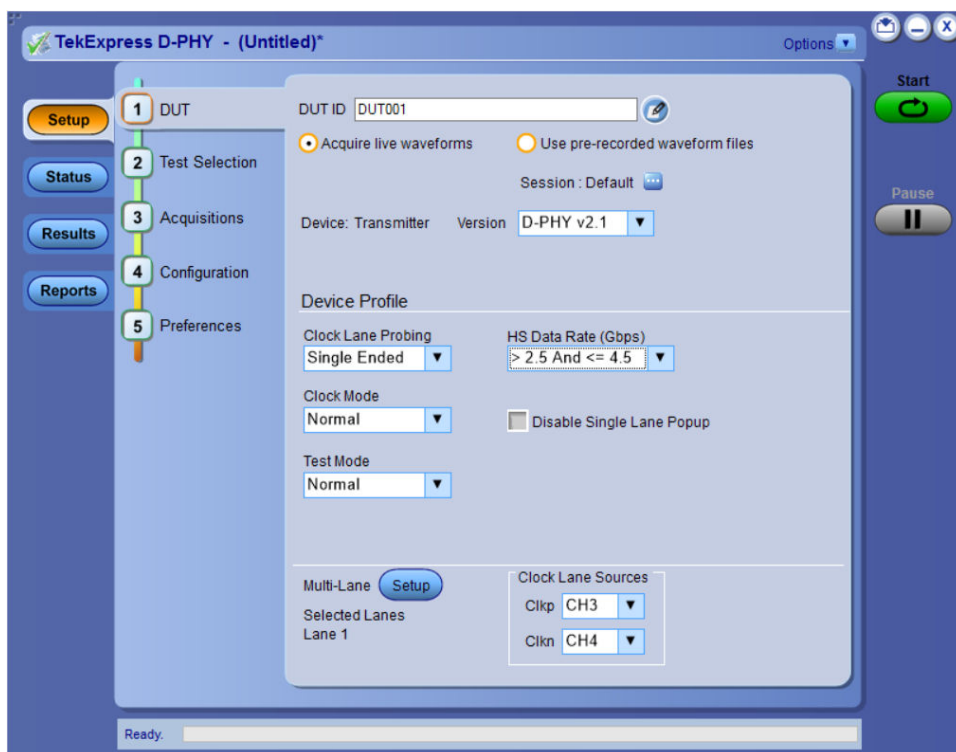

Set DUT parameters

Use the DUT tab to select parameters for the device under test. These settings are global and apply to all tests of current session. DUT settings also affect the list of available tests in the Test Selection tab.









Setting	Description
Clock Lane Probing	Select either single-ended mode or differential mode for clock lane.  Note: When Differential mode is selected, some tests are not available for execution.
Clock Mode	Select the clock mode. The available options are Normal and Continuous. When clock mode is continuous, only normal tests can be performed.  Note: Some tests are not supported in continuous clock mode.
Test Mode	Select the test mode. Based on the selection made, the list of tests in the Test Selection panel will change.
HS Data Rate (Gbps)	Select the HS Data Rate. Available options are For DPHY v1.2: <ul style="list-style-type: none"> • <=1 Gbps • >1 and <=1.5 Gbps • > 1.5 and <= 2.5 Gbps  Note: Default is >1.5 and <=2.5 Gbps For DPHY v2.1: <ul style="list-style-type: none"> • <=1 Gbps • >1 and <=1.5 Gbps • >1.5 and <=2.5 Gbps • >2.5 and <=4.5 Gbps  Note: Default is >2.5 and <=4.5 Gbps The test limits may vary based on the selected data rate. Note: If the selected Version is D-PHY v1.2 and data rate is >1.5 Gbps:  <ul style="list-style-type: none"> • 1.4.18 Clock Lane HS Clock Delta UI is disabled. • 1.5.5 Initial HS Skew Calibration Burst (TSKEWCAL-SYNC, TSKEWCAL) and 1.5.6 Periodic HS Skew Calibration Burst (TSKEWCAL-SYNC, TSKEWCAL) tests are enabled only when the data rate is >1.5 Gbps.
Disable Single Lane Popup	When selected, disables the connection popup.  Note: Before selecting this option ensure that the connections are made as per the selected lane channel configuration.

Table continued...

Setting	Description
<p>Multi-Lane Setup</p> 	<p>Displays the test lanes selected for the test session</p> <p>To change lanes selected for testing, click Setup.</p> <ol style="list-style-type: none"> In the Test Lane Setup dialog box, select the desired number of lanes from the Link Width drop-down list. To select the lanes to use, click the corresponding lane buttons: <ul style="list-style-type: none"> To select all four lanes at once, click Select All. If you select this, select 4 Lanes from the Link Width drop-down list. To deselect all selected lanes, click Deselect All. If you select 1 Lane, only one lane can be used. If you select 2 Lanes, any one lane or two lanes can be used. If you select 4 Lanes, only a lane or two lanes or four lanes can be used. Source selection: Configure the channel sources on which the corresponding data lanes are connected. Click OK. <p>Your selections display in the Lane Setup section of the DUT tab.</p>
<p>Clock Lane Sources</p>	<p>Configure the channel source(s) on which the clock lanes are connected.</p> <p>Note:</p>  <ul style="list-style-type: none"> If the clock probing is differential, only one source need to be configured. The channel sources selected for Data lanes should not be same as the sources selected for Clock lane. If the channels are same, the execution will not proceed.

See also

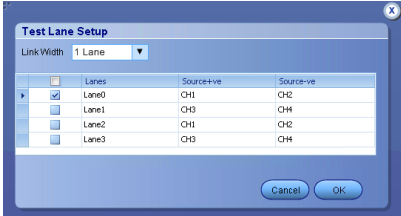
[Select tests](#)

Select tests

Use the Test Selection tab to select the tests. The test measurements available depends on the settings selected in the DUT tab.

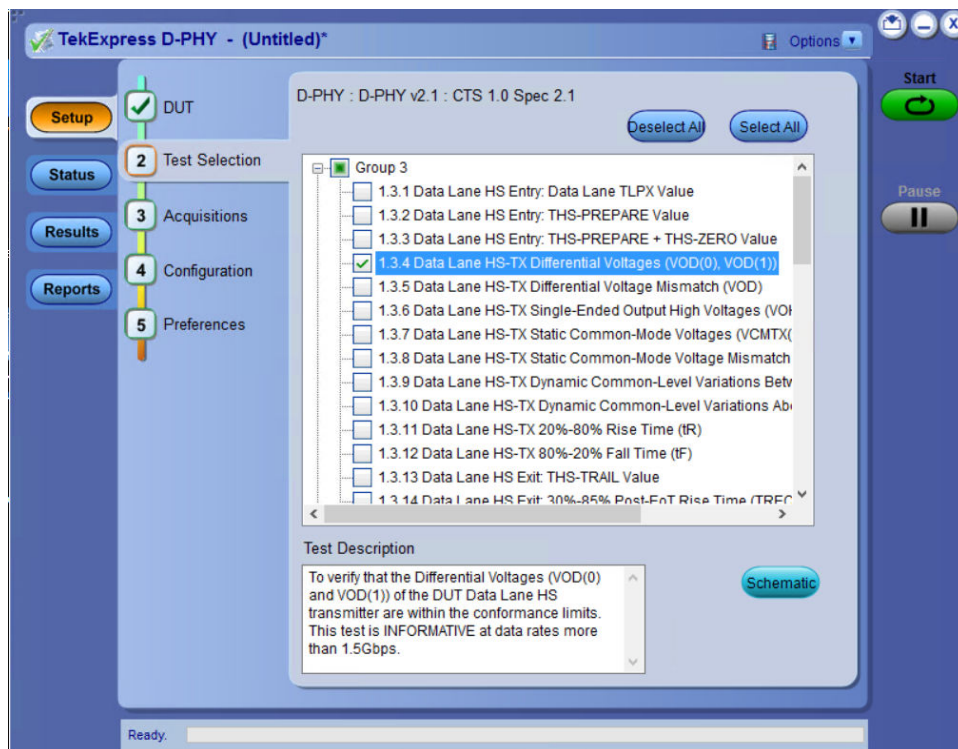

Figure 2: TekExpress D-PHY measurements

Table 8: Test Selection tab settings

Setting	Description
Deselect All	Deselect or select all tests in the list.
Select All	
Tests	Click on a test to select or unselect. Highlight a test to show details in the Test Description pane. The application automatically selects all required tests when in Compliance mode.
Test Description	Shows brief description of the highlighted test in the test tree.
Schematic	Shows an equipment and test fixture setup schematic (connection diagram) for the selected test. Use to set up the equipment and fixtures or to verify the setup before running the test.

See also

[Set acquisition tab parameters](#)

Set acquisition tab parameters

Use Acquisitions tab to view the test acquisition parameters. The contents displayed on this tab depends on the DUT type and the tests selected.

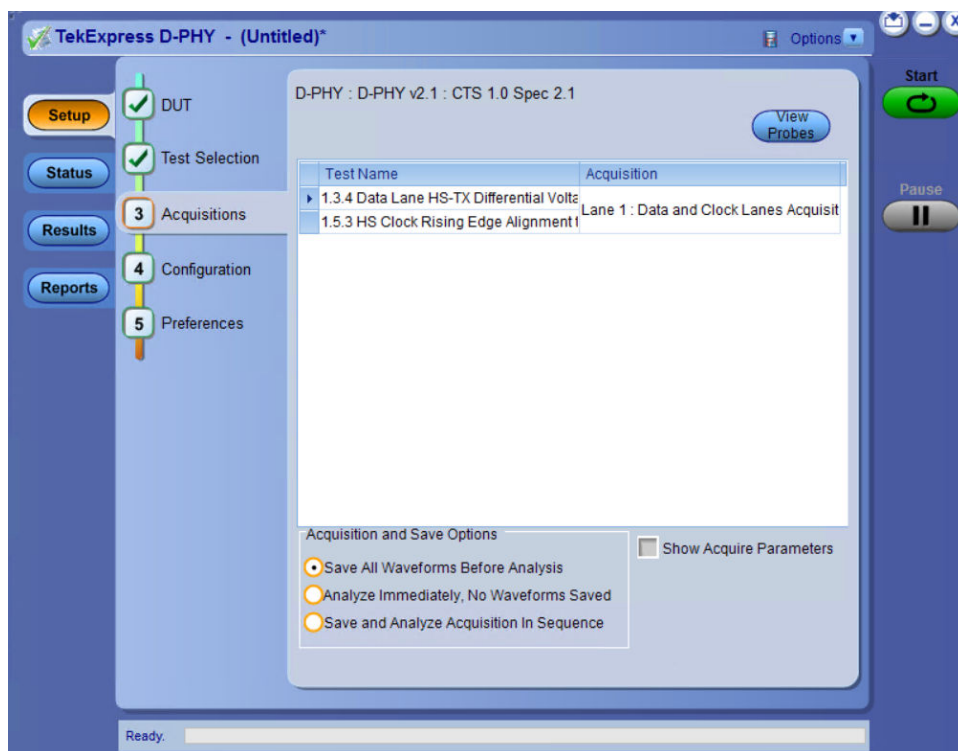



Table 9: Acquisitions tab settings

Settings	Description
View Probes	View the detected probe configuration. Use the View Probes dialog box to view the connected probes.
Acquisition and Save options	
Save All Waveforms Before Analysis	Saves all the waveforms before the analysis.
Analyze Immediately, No Waveforms Saved	Analysis the waveforms and no waveforms are saved.  Note: No .wfm files will not be present in the run folder.
Save and Analyze Acquisition In Sequence	Saves and then analyses the acquisition in sequence.
Show Acquire Parameters	Select to view the acquisition parameters.

TekExpress D-PHY saves all acquisition waveforms to files by default. Waveforms are saved in a unique folder for each session (a session is started when you click the Start button). The folder path is X:\TekExpress D-PHY\Untitled Session\

Saving a session moves the session file contents from the Untitled Session folder to the specified folder name, and changes the session name to the specified name.

See also

[Pre-recorded waveform file names for test measurements](#)

Set configuration tab parameters

Use Configuration tab to view and configure the Global Settings and the measurement configurations. The measurement specific configurations available in this tab depends on the selections made in the DUT panel and Test Selection panel.

Table 10: Configuration tab: Common parameters

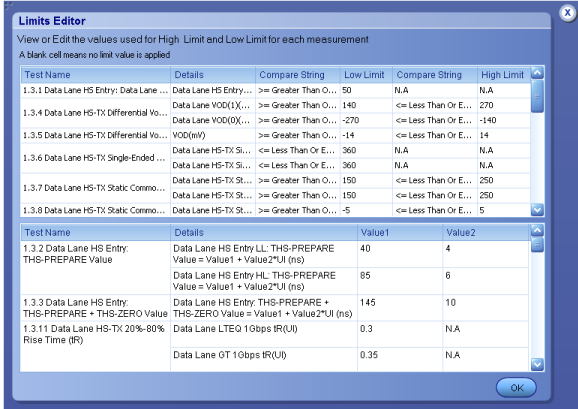
Setting	Description																																																																																				
Mode	<p>Determines whether test parameters are in compliance or can be edited</p> <ul style="list-style-type: none"> Compliance: All the test parameters are editable except Use Cursors in Global Settings. User Defined: All test parameters and global parameters are editable in this mode. 																																																																																				
Limits Editor	<p>Displays the upper and lower limits for the applicable measurement using different types of comparisons. In the Compliance Mode, you can view the measurement high and low limits used for the tests displayed in the tree view of the Measurements tab. When running tests in User Defined Mode, you can edit the limit settings in the Limits Editor.</p> <p>The second table shows the tests with the limits calculated dynamically as per the specification.</p>  <p>The screenshot shows the 'Limits Editor' dialog box with the following data:</p> <table border="1"> <thead> <tr> <th>Test Name</th> <th>Details</th> <th>Compare String</th> <th>Low Limit</th> <th>Compare String</th> <th>High Limit</th> </tr> </thead> <tbody> <tr> <td>1.3.1 Data Lane HS Entry: Data Lane...</td> <td>Data Lane HS Entry...</td> <td>>= Greater Than O...</td> <td>50</td> <td>N/A</td> <td>N/A</td> </tr> <tr> <td>1.3.4 Data Lane HS-TX Differential Vo...</td> <td>Data Lane VOD(I,X,...</td> <td>>= Greater Than O...</td> <td>140</td> <td><= Less Than Or E...</td> <td>270</td> </tr> <tr> <td>1.3.5 Data Lane HS-TX Differential Vo...</td> <td>Data Lane VOD(O,X,...</td> <td>>= Greater Than O...</td> <td>-270</td> <td><= Less Than Or E...</td> <td>-140</td> </tr> <tr> <td>1.3.5 Data Lane HS-TX Differential Vo...</td> <td>VOD(mV)</td> <td>>= Greater Than O...</td> <td>-14</td> <td><= Less Than Or E...</td> <td>14</td> </tr> <tr> <td>1.3.6 Data Lane HS-TX Single-Ended ...</td> <td>Data Lane HS-TX Sl...</td> <td><= Less Than Or E...</td> <td>360</td> <td>N/A</td> <td>N/A</td> </tr> <tr> <td>1.3.6 Data Lane HS-TX Single-Ended ...</td> <td>Data Lane HS-TX Sl...</td> <td><= Less Than Or E...</td> <td>360</td> <td>N/A</td> <td>N/A</td> </tr> <tr> <td>1.3.7 Data Lane HS-TX Static Commo...</td> <td>Data Lane HS-TX St...</td> <td>>= Greater Than O...</td> <td>150</td> <td><= Less Than Or E...</td> <td>250</td> </tr> <tr> <td>1.3.7 Data Lane HS-TX Static Commo...</td> <td>Data Lane HS-TX St...</td> <td>>= Greater Than O...</td> <td>150</td> <td><= Less Than Or E...</td> <td>250</td> </tr> <tr> <td>1.3.8 Data Lane HS-TX Static Commo...</td> <td>Data Lane HS-TX St...</td> <td>>= Greater Than O...</td> <td>-5</td> <td><= Less Than Or E...</td> <td>5</td> </tr> </tbody> </table> <table border="1"> <thead> <tr> <th>Test Name</th> <th>Details</th> <th>Value1</th> <th>Value2</th> </tr> </thead> <tbody> <tr> <td>1.3.2 Data Lane HS Entry: THS-PREPRE Value</td> <td>Data Lane HS Entry:LL THS-PREPRE Value = Value1 + Value2*U (ns)</td> <td>40</td> <td>4</td> </tr> <tr> <td>1.3.2 Data Lane HS Entry: THS-PREPRE Value</td> <td>Data Lane HS Entry:HL THS-PREPRE Value = Value1 + Value2*U (ns)</td> <td>85</td> <td>6</td> </tr> <tr> <td>1.3.3 Data Lane HS Entry: THS-PREPRE + THS-ZERO Value</td> <td>Data Lane HS Entry: THS-PREPRE + THS-ZERO Value = Value1 + Value2*U (ns)</td> <td>145</td> <td>10</td> </tr> <tr> <td>1.3.11 Data Lane HS-TX 20%-80% Rise Time (R)</td> <td>Data Lane LTED 10bps IR(U)</td> <td>0.3</td> <td>N/A</td> </tr> <tr> <td>1.3.11 Data Lane HS-TX 20%-80% Rise Time (R)</td> <td>Data Lane GT 10bps IR(U)</td> <td>0.35</td> <td>N/A</td> </tr> </tbody> </table>	Test Name	Details	Compare String	Low Limit	Compare String	High Limit	1.3.1 Data Lane HS Entry: Data Lane...	Data Lane HS Entry...	>= Greater Than O...	50	N/A	N/A	1.3.4 Data Lane HS-TX Differential Vo...	Data Lane VOD(I,X,...	>= Greater Than O...	140	<= Less Than Or E...	270	1.3.5 Data Lane HS-TX Differential Vo...	Data Lane VOD(O,X,...	>= Greater Than O...	-270	<= Less Than Or E...	-140	1.3.5 Data Lane HS-TX Differential Vo...	VOD(mV)	>= Greater Than O...	-14	<= Less Than Or E...	14	1.3.6 Data Lane HS-TX Single-Ended ...	Data Lane HS-TX Sl...	<= Less Than Or E...	360	N/A	N/A	1.3.6 Data Lane HS-TX Single-Ended ...	Data Lane HS-TX Sl...	<= Less Than Or E...	360	N/A	N/A	1.3.7 Data Lane HS-TX Static Commo...	Data Lane HS-TX St...	>= Greater Than O...	150	<= Less Than Or E...	250	1.3.7 Data Lane HS-TX Static Commo...	Data Lane HS-TX St...	>= Greater Than O...	150	<= Less Than Or E...	250	1.3.8 Data Lane HS-TX Static Commo...	Data Lane HS-TX St...	>= Greater Than O...	-5	<= Less Than Or E...	5	Test Name	Details	Value1	Value2	1.3.2 Data Lane HS Entry: THS-PREPRE Value	Data Lane HS Entry:LL THS-PREPRE Value = Value1 + Value2*U (ns)	40	4	1.3.2 Data Lane HS Entry: THS-PREPRE Value	Data Lane HS Entry:HL THS-PREPRE Value = Value1 + Value2*U (ns)	85	6	1.3.3 Data Lane HS Entry: THS-PREPRE + THS-ZERO Value	Data Lane HS Entry: THS-PREPRE + THS-ZERO Value = Value1 + Value2*U (ns)	145	10	1.3.11 Data Lane HS-TX 20%-80% Rise Time (R)	Data Lane LTED 10bps IR(U)	0.3	N/A	1.3.11 Data Lane HS-TX 20%-80% Rise Time (R)	Data Lane GT 10bps IR(U)	0.35	N/A
Test Name	Details	Compare String	Low Limit	Compare String	High Limit																																																																																
1.3.1 Data Lane HS Entry: Data Lane...	Data Lane HS Entry...	>= Greater Than O...	50	N/A	N/A																																																																																
1.3.4 Data Lane HS-TX Differential Vo...	Data Lane VOD(I,X,...	>= Greater Than O...	140	<= Less Than Or E...	270																																																																																
1.3.5 Data Lane HS-TX Differential Vo...	Data Lane VOD(O,X,...	>= Greater Than O...	-270	<= Less Than Or E...	-140																																																																																
1.3.5 Data Lane HS-TX Differential Vo...	VOD(mV)	>= Greater Than O...	-14	<= Less Than Or E...	14																																																																																
1.3.6 Data Lane HS-TX Single-Ended ...	Data Lane HS-TX Sl...	<= Less Than Or E...	360	N/A	N/A																																																																																
1.3.6 Data Lane HS-TX Single-Ended ...	Data Lane HS-TX Sl...	<= Less Than Or E...	360	N/A	N/A																																																																																
1.3.7 Data Lane HS-TX Static Commo...	Data Lane HS-TX St...	>= Greater Than O...	150	<= Less Than Or E...	250																																																																																
1.3.7 Data Lane HS-TX Static Commo...	Data Lane HS-TX St...	>= Greater Than O...	150	<= Less Than Or E...	250																																																																																
1.3.8 Data Lane HS-TX Static Commo...	Data Lane HS-TX St...	>= Greater Than O...	-5	<= Less Than Or E...	5																																																																																
Test Name	Details	Value1	Value2																																																																																		
1.3.2 Data Lane HS Entry: THS-PREPRE Value	Data Lane HS Entry:LL THS-PREPRE Value = Value1 + Value2*U (ns)	40	4																																																																																		
1.3.2 Data Lane HS Entry: THS-PREPRE Value	Data Lane HS Entry:HL THS-PREPRE Value = Value1 + Value2*U (ns)	85	6																																																																																		
1.3.3 Data Lane HS Entry: THS-PREPRE + THS-ZERO Value	Data Lane HS Entry: THS-PREPRE + THS-ZERO Value = Value1 + Value2*U (ns)	145	10																																																																																		
1.3.11 Data Lane HS-TX 20%-80% Rise Time (R)	Data Lane LTED 10bps IR(U)	0.3	N/A																																																																																		
1.3.11 Data Lane HS-TX 20%-80% Rise Time (R)	Data Lane GT 10bps IR(U)	0.35	N/A																																																																																		

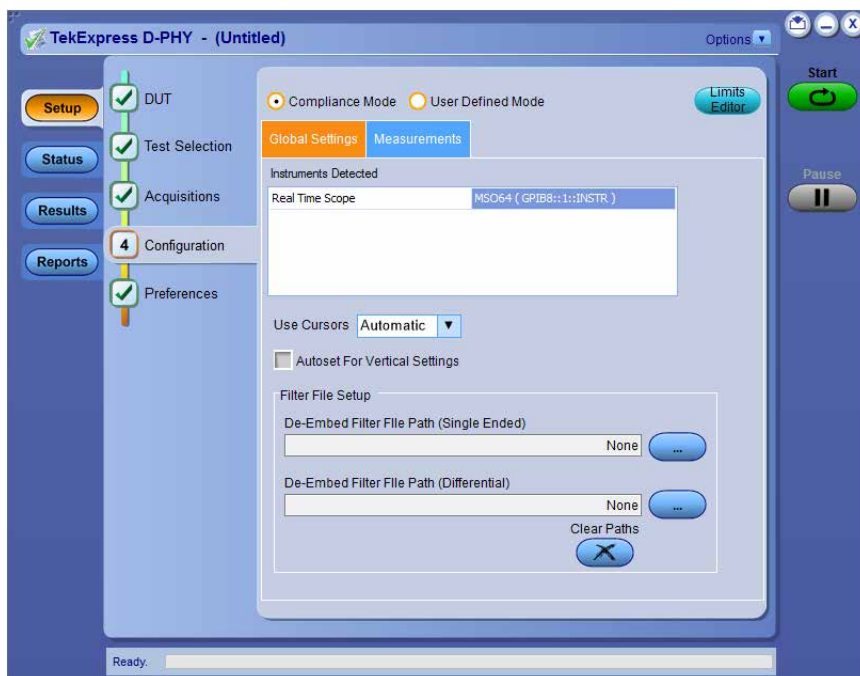

Figure 3: Configuration tab: Global Settings

Table 11: Configuration tab: Global settings



Setting	Description
Global Settings	
Instruments Detected	<p>Displays the instruments connected to this application. Click on the instrument name to open a list of available (detected) instruments.</p> <p>Select Options > Instrument Control Settings and click Refresh to update the instrument list.</p> <p> Note: Verify that the LAN and GPIB search criteria (default setting) in the Instrument Control Settings is selected when using TekExpress D-PHY application.</p>
Use Cursors	<ul style="list-style-type: none"> Automatic mode: the results are computed automatically and are displayed. Manual mode: you will be prompted to place cursors at the desired region in the acquired waveform. The cursors will be used as the gating criteria for the measurement and the measured value will be reported. <p> Note: You can change the settings to Manual mode only if <i>User Defined Mode</i> is selected in the Configuration tab.</p> <p> Note: If the selected version is D-PHY v2.1 then 1.5.7 Data and Clock Eye Diagram, 1.4.19 TX Spread Spectrum Clocking (SSC) Requirements, and 1.4.20 Clock Lane HS-TX Clock Period Jitter are not supported for Manual cursor mode.</p>
Filter File Setup	
De-Embed Filter File Path (Single Ended)	Browse and select the file for de-embedding the single ended signals.
De-Embed Filter File Path (Differential)	Browse and select the file for de-embedding the differential probe.

Table continued...

Setting	Description
Clear Paths	When clicked it resets both the single ended and differential filter file paths.



Note: The selection of the filter file for de-embedding is based on the sample rate selection on the horizontal settings tab in the measurements panel.

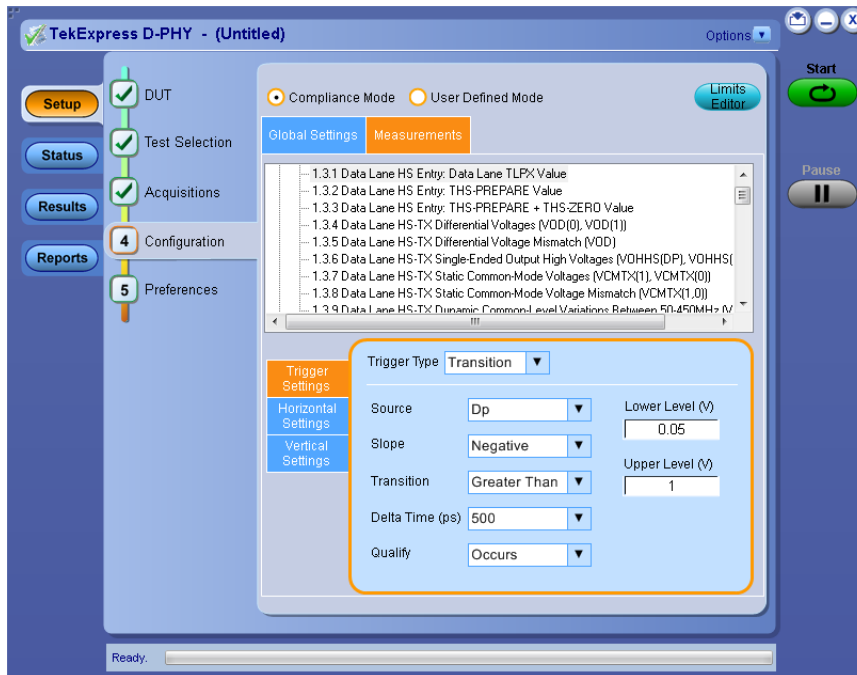

Figure 4: Configuration tab: Measurements

Table 12: Configuration tab: Measurements settings

Setting	Description
Measurements	<p>Displays the measurements which are selected in the Test Selection tab. The tests are grouped with unique acquisition type names.</p> <p>Note:</p> <ul style="list-style-type: none"> When a parent test group is selected and any change is made, the change will be applied to all the tests. Individual test configuration is possible by selecting the test and making the required changes. <p>If changes are made to individual tests, it becomes a separate acquisition during execution of tests. The difference between the acquisitions can be viewed by clicking Acquisitions > Show Acquire Parameter.</p>
Analyze	
<p>Analysis Mode</p> <p>Available for 1.5.3 HS Clock Rising Edge Alignment to First Payload Bit only.</p>	<ul style="list-style-type: none"> Automatic (default) Visual Verification

Table continued...

Setting	Description
<p>Insertion Loss</p> <p>Available for 1.5.7 HS-TX Data and Clock Eye Diagram only</p>	<p>Specify the insertion loss. The default value is Standard.</p>
<p>TX PPI Bus Width (bytes)</p> <p>Available for 1.5.10 Clock and Data Lane TX HS-Idle: THS-IDLE-POST, THS-IDLE-CLKHS0, THS-IDLE-PRE Values</p>	<p>Specify the Bus Width value. The default value is 1 byte.</p>
<p>UI INST MIN (ns)</p> <p>Available for 1.4.17 Clock Lane HS Clock Instantaneous (UIINST) only.</p>	<p>Specify the UI INST MIN. The default value is 1.25 ns.</p>
<p>Signal Type</p> <p>Applicable for 1.4.19 TX Spread Spectrum Clocking (SSC) Requirements for HS data rate > 2.5 And <= 4.5 under version DPHY v2.1</p>	<p>Options > Clock & Data > Default is Clock</p> <p>Note:</p>  <ul style="list-style-type: none"> • When Signal Type is 'Clock', trigger source should be Clkp/Clkn/Clkp-Clkn. • When Signal Type is 'Data', trigger source should be Dp/Dn.
<p>Nominal Frequency Type</p> <p>Applicable for 1.4.19 TX Spread Spectrum Clocking (SSC) Requirements for HS data rate > 2.5 And <= 4.5 under version DPHY v2.1</p>	<p>Options > Auto & Manual > Default is Auto</p>
<p>When 'Manual' is selected Applicable for 1.4.19 TX Spread Spectrum Clocking (SSC) Requirements for HS data rate > 2.5 And <= 4.5 under version DPHY v2.1</p>	<p>Nominal Frequency(GHz) > Default value is 1</p>
<p>Swing Mode</p> <p>Applicable for test 1.3.4 Data Lane HS-TX Differential Voltages (VOD(0), VOD(1)) for version DPHY v2.1</p>	<p>Specify the swing mode > options > Full, Half, Default: Full</p>
<p>Trigger Settings</p>	
<p>Trigger Type</p>	<p>Select the trigger type. The configurations may change depending on the Trigger Type selected.</p> <ul style="list-style-type: none"> • Transition (default) • Edge • Width

Table continued...

Setting	Description
Source	<ul style="list-style-type: none"> • Dp (default) • Dn • Clkp • Clkn
Slope	<ul style="list-style-type: none"> • Positive (default) • Negative • Either <p>Available when Trigger Type = Transition or Edge</p>
Transition	<ul style="list-style-type: none"> • Greater Than (default) • Less Than
Delta Time (ps)	<ul style="list-style-type: none"> • 250 • 500
Quality	<ul style="list-style-type: none"> • Occurs • Logic <p>Available when Trigger Type = Transition.</p>
Lower Level (V)	<p>Specify the lower level in Volts. The default value is 0.05 Volts.</p> <p>Available when Trigger Type = Transition.</p>
Upper Level (V)	<p>Specify the upper level in Volts. The default value is 1 Volts.</p> <p>Available when Trigger Type = Transition.</p>
Edge Trigger Level (V)	<p>Specify the voltage level. The default value is 0.2 V.</p> <p>Available when Trigger Type = Edge.</p>
Clock lane Probing as Differential and Clock Mode as Continuous	<p>Specify the voltage level. The Default value is 0 V</p>
Lower Limit (μs)	<p>The default value is 25.</p> <p>Available when Trigger Type = Width.</p>
Upper Limit (μs)	<p>The default value is 300.</p> <p>Available when Trigger Type = Width.</p>
Polarity	<p>Positive and Negative when Trigger Type = Width</p> <p>Default is Positive</p>
Horizontal Settings	
Table continued...	

Setting	Description
Record Length	<ul style="list-style-type: none"> Specify the record length for the selected measurements. The default value is 1000000. Record length is 2000000 for >2.5 and <=4.5 HS data rate for all DPHY v1.2 compliance tests. Record length is 10000000 for >2.5 and <=4.5 HS data rate and for tests 1.4.19, 1.4.20, 1.5.5, 1.5.6, 1.5.8, 1.5.9, 1.5.10
Sample Rate	<p>Select the sample rate. The default value is 12.5.</p> <p>Sample rate is 25 for >2.5 and <=4.5 HS data rate for all tests</p>
Number of UI	<p>Select the number of UI to be acquired.</p> <p>This is applicable for Test 1.5.7 and 1.4.18.</p> <p>Default value for 1.5.7 test : 3000000</p> <p>Default value for 1.4.18 test : 64000</p>
Vertical Settings	
Vertical Scale (Data)	Specify the vertical scale for data. The default value is 200 mV.
Vertical Position (Data)	Specify the vertical position for data. The default value is -2.6.
Vertical Scale (Clock)	Specify the vertical scale for clock. The default value is 200 mV.
Vertical Position (Clock)	Specify the vertical position for clock. The default value is -2.6.
Vertical Offset	Specify the vertical offset. The default value is 0 V.

Set preferences tab parameters

Use Preferences tab to set the application action on completion of a measurement.

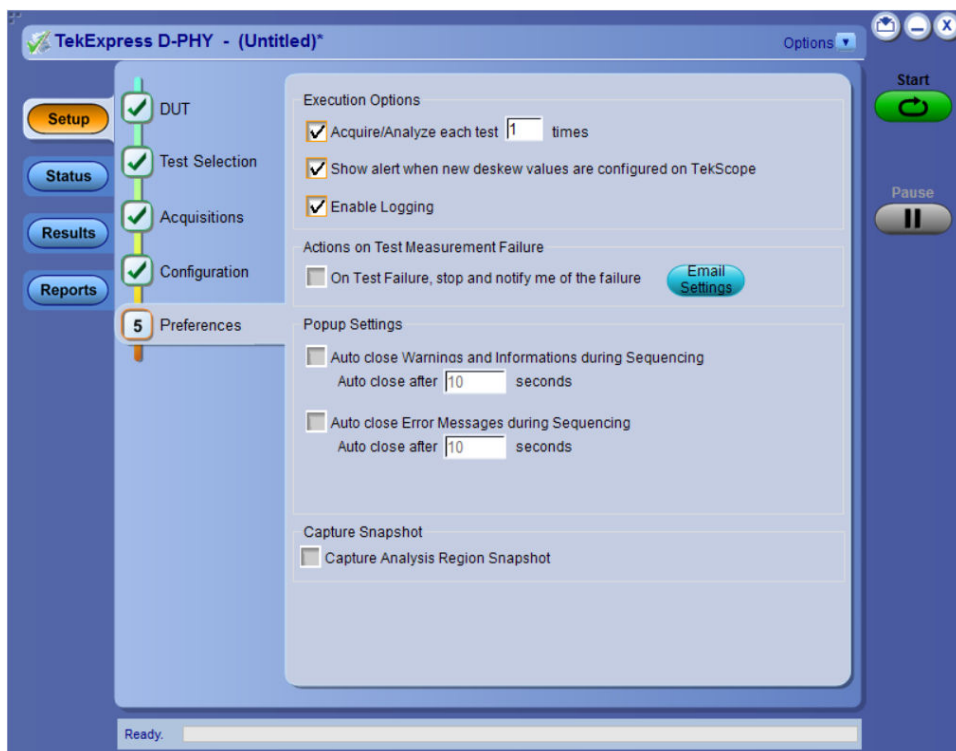



Figure 5: Preferences tab

Table 13: Preferences tab settings

Setting	Description
Execution Options	
Acquire/Analyze each test <no> times (not applicable to Custom Tests)	Select to repeat the test run by setting the number of times. By default, it is selected with 1 run.
Show alert when new deskew values are configured on TekScope	Select to show alert when deskew values are configured on TekScope.  Note: The alert is displayed when the values set on the TekScope is different from the stored values of Deskew or Attenuation.
Enable Logging	Select to see the log messages in the status panel.
Actions on Test Measurement Failure	
On Test Failure, stop and notify me of the failure	Select to stop the test run on Test Failure, and to get notified via email. By default, it is unselected. Click Email Settings to configure.  Note: Ensure that the email settings are configured correctly. If the settings are not done correctly, the test will be stopped and no other notifications will be sent.
Popup Settings	
Table continued...	

Setting	Description
Auto close Warnings and Informations during Sequencing Auto close after <no> Seconds	Select to auto close warnings/informations during sequencing. Set the Auto close time. By default it is unselected.
Auto close Error Messages during Sequencing. Auto close after <no> Seconds	Select to auto close Error Messages during Sequencing. Set the Auto close time. By default it is unselected.
Capture Snapshot	
Capture Analysis Region Snapshot	Select to capture the screenshots of the region of analysis. Select Include plot images in the <i>Reports</i> panel to include the captured screenshots in the reports generated.

Status panel overview

The Status panel accesses the Test Status and Log View tabs, which provide status on test acquisition and analysis (Test Status) and a listing of test tasks performed (Log View tab). The application opens the Test Status tab when you start a test run. You can select the Test Status or the Log View tab to view these items while tests are running.

Test Status: The tests are grouped and displayed based on the Clock and Data lane. It displays the tests along with the Acquisition type, Acquire, and Analysis status of the tests. In pre-recorded mode, Acquire status is not valid.

Log View: It displays the detailed execution status of the tests.

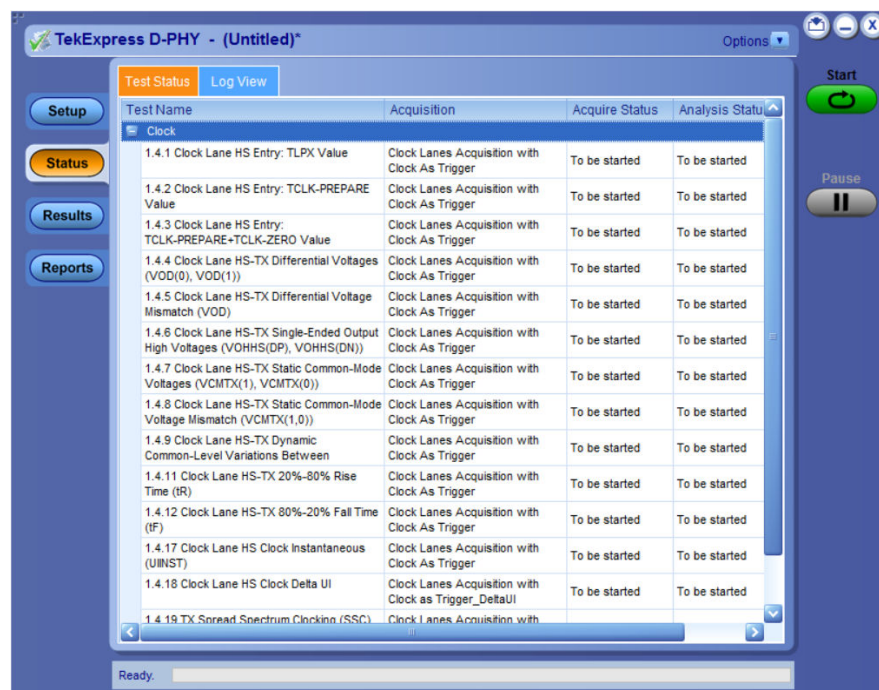

Figure 6: Test status view in Status panel

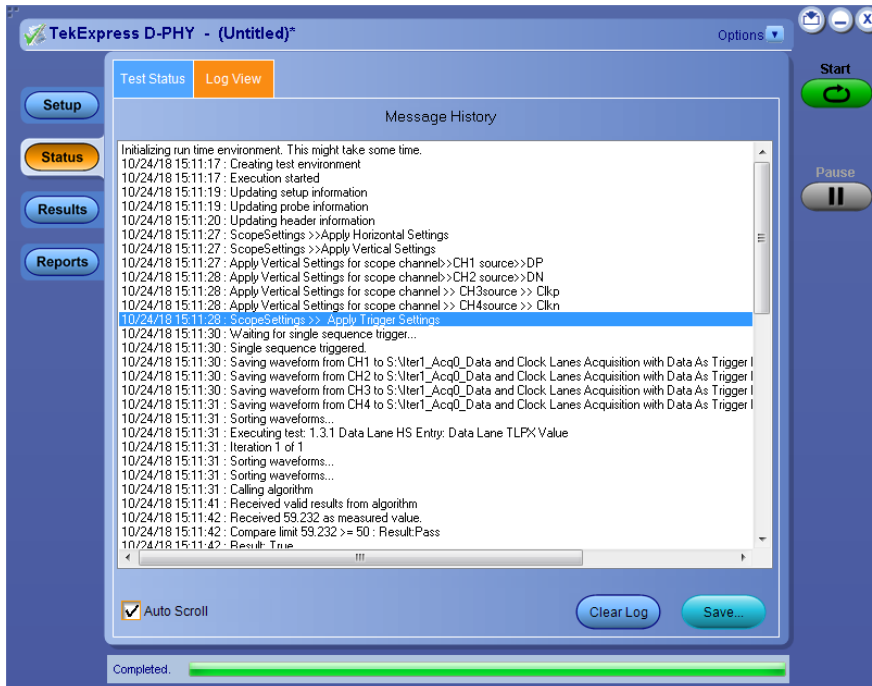

Figure 7: Log view in Status panel

Table 14: Status panel settings

Control	Description
Message History	Lists all executed test operations and timestamp information.
Auto Scroll	Enables automatic scrolling of the log view as information is added to the log during the test execution.
Clear Log	Clears all messages from the log view.
Save	Saves the log file to a text file. Use the standard Save File window to navigate to and specify the folder and file name to which to save the log text.

See also

[Application panel overview](#)

Results panel

Results panel overview

When a test execution is complete, the application automatically opens the **Results** panel to display a summary of test results.

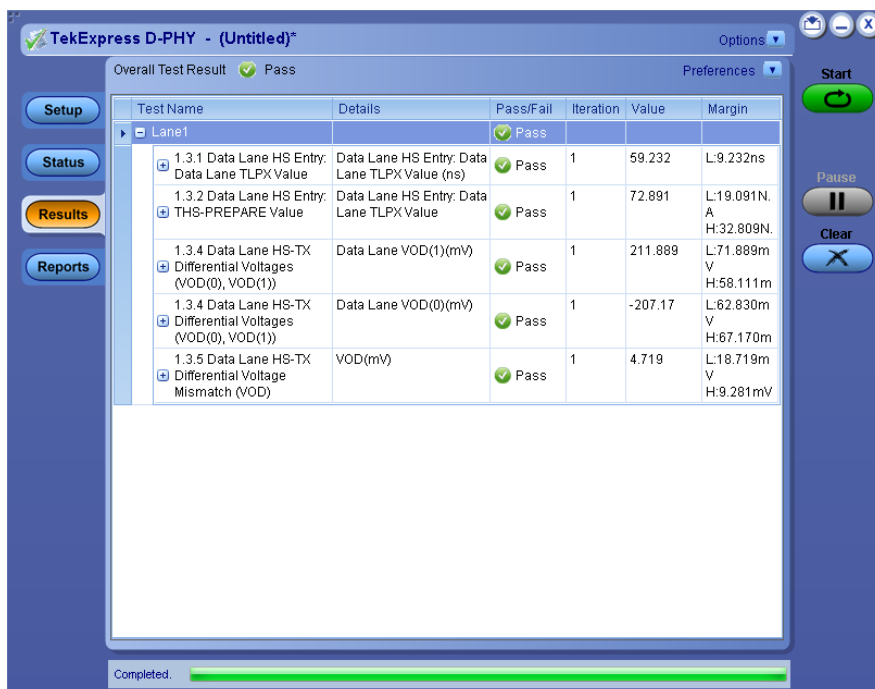

When a test finishes, the application switches to the Results panel, which displays a summary of test results.

Each test result occupies a row in the Results table. By default, results are displayed in summary format with the measurement details collapsed and with the Pass/Fail column visible. Change the view in the following ways:

- To remove or restore the Pass/Fail column, select Preferences > **Show Pass/Fail**.
- To collapse all expanded tests, select Preferences > **View Results Summary**.
- To expand all tests listed, select **View Results Details** from the **Preferences** menu in the upper right corner.
- To enable or disable the wordwrap feature, select Preferences > **Enable Wordwrap**.
- To view the results grouped by lane or test, select the corresponding item from the Preferences menu.
- To expand the width of a column, place the cursor over the vertical line that separates the column from the column to the right. When the cursor changes to a double-ended arrow, hold down the mouse button and drag the column to the desired width.
- To clear all test results displayed, click **Clear**.

See also

[View a report](#)

[Application panel overview](#)

Preferences menu

The Preferences menu is part of the Results panel display. Use the Preferences menu to change how some items display in the Results panel.

- To include pass/fail details info in the details table, select **Show Pass/Fail**.
- To view the results summary, select **View Results Summary**.
- To expand all tests listed, select **View Results Details**
- To enable or disable the wordwrap feature, select **Enable Wordwrap**.
- To group the tests by lane, select **Group by Lane**.
- To group the tests, select **Group by Test**.

See also

[Results panel overview](#)

View test-related files

Files related to tests are stored in `My TekExpress\D-PHY\Untitled session folder`. Each test setup in this folder has both a test setup *file* and a test setup folder, both with the test setup name.

The test setup file is preceded by the TekExpress icon and usually has no visible file name extension.

Inside the test setup folder is another folder named for the DUT ID used in the test sessions. The default is DUT001.

Inside the DUT001 folder are the session folders and files. Each session also has a folder and file pair, both named for the test session using the naming convention (date)_(time). Each session file is stored outside its matching session folder:

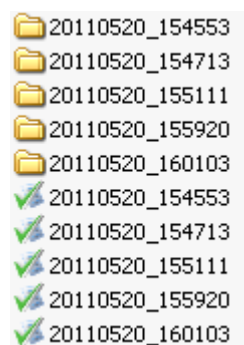

Each session folder contains image files of any plots generated from running the test session. If you selected to save all waveforms or ran tests using prerecorded waveform files, these are included here.

The first time you run a new, unsaved session, the session files are stored in the `Untitled Session` folder located at `X:\D-PHY`. When you name and save the session, the files are placed in a folder with the name that you specify. A copy of the test files stay in the `Untitled Session` folder until you run a new test or until you close the D-PHY application.

See also

[File name extensions](#)

Reports panel

Report configuration settings



The Configuration tab describes the report generation settings to configure the Reports panel. Select report settings before running a test or when creating and saving test setups. Report settings configured are included in saved test setups.



Figure 8: Report panel- Configuration tab

Table 15: Report configuration panel settings

Control	Description
View	Click to view the most current report.
Generate	Generates a new report based on the current analysis results.
Save As	Specify a name for the report.
Report Update Mode Settings	
Generate new report	Each time when you click Run and when the test execution is complete, it will create a new report. The report can be in either .mht, .pdf, or .csv file formats.
Append with previous run session	Appends the latest test results to the end of the current test results report. Each time when you click this option and run the tests, it will run the previously failed tests and replace the failed test result with the new pass test result in the same report.
Include header in appended reports	Select to include header in appended reports.
Replace current test results	Replaces the previous test results with the latest test results. Results from newly added tests are appended to the end of the report.
In previous run, current session	Select to replace current test results in the report with the test result(s) of previous run in the current session.
In any run, any session	Select to replace current test results in the report with the test result(s) in the selected run session's report. Click and select test result of any other run session.
Report Creation Settings	
Table continued...	

Control	Description
Report name	<p>Displays the name and path of the <Application Name> report. The default location is at \My Documents>\My TekExpress\<Application Name>\Reports. The report file in this folder gets overwritten each time you run a test unless you specify a unique name or select to auto increment the report name.</p> <p>To change the report name or location, do one of the following:</p> <ul style="list-style-type: none"> • In the Report Path field, type the current folder path and name. • Double-click in the Report Path field and then make selections from the popup keyboard and click Enter. <p>Be sure to include the entire folder path, the file name, and the file extension. For example: C:\Documents and Settings\your user name\My Documents\My TekExpress\<Application Name> \DUT001.mht.</p> <p> Note: You cannot set the file location using the Browse button.</p> <p>Open an existing report</p> <p>Click Browse, locate and select the report file and then click View at the bottom of the panel.</p>
Save as type	<p>Saves a report in the specified file type, selected from the drop-down list. The report is saved in .csv, .pdf, or .mht.</p> <p>Note:</p> <p> If you select a file type different from the default, be sure to change the report file name extension in the Report Name field to match.</p>
Auto increment report name if duplicate	<p>Sets the application to automatically increment the name of the report file if the application finds a file with the same name as the one being generated. For example: DUT001, DUT002, DUT003. This option is enabled by default.</p>
Create report automatically at the end of the run	<p>Select to create the report with the settings configured, at the end of run.</p>
View report after generating	<p>Automatically opens the report in a Web browser when the test execution is complete. This option is selected by default.</p>

Configure report view settings

The **View Settings** tab describes the report view settings to configure the Reports panel. Select report view settings before running a test or when creating and saving test setups. Report settings configured are included in saved test setups.

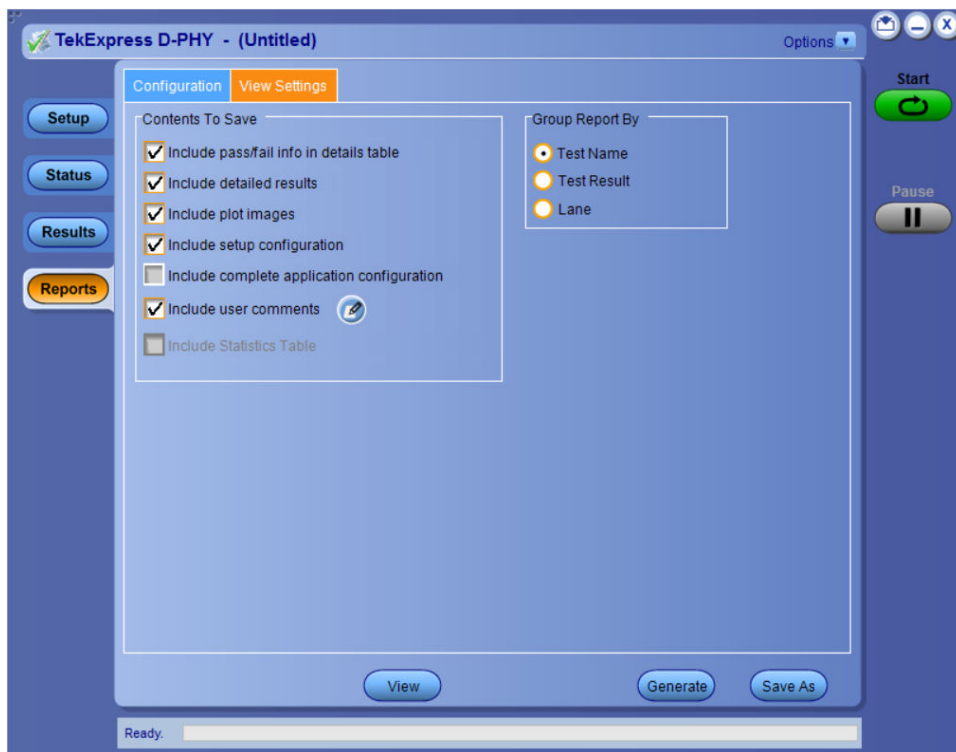

Figure 9: Report panel-View settings tab

Table 16: Report panel view settings

Control	Description
Contents To Save Settings	
Include pass/fail info in details table	Select to include pass/fail information in the details table of the report.
Include detailed results	Select to include detailed results in the report.
Include plot images	Select to include the plot images in the report.
Include setup configuration	Sets the application to include hardware and software information in the summary box at the top of the report. Information includes: the oscilloscope model and serial number, the oscilloscope firmware version, and software versions for applications used in the measurements.
Include complete application configuration	Select to include the complete application configuration in the report.
Include user comments	Select to include any comments about the test that you or another user have added in the DUT tab of the Setup panel. Comments appear in the Comments section, below the summary box at the beginning of each report.
Include statics table	Select to include test run statistics in the report. This is enabled when you run any test for more than once. Set Acquire/Analyze each test in the Preferences tab to more than one, to run any test for multiple times.
Group Report By	

Table continued...

Control	Description
Test Name	Select to group the test results based on the test name in the report..
Lane	Select to display the test results by lane.
Test Result	Select to group the test results based on the test result in the report.

View a report

The application automatically generates a report when test execution is complete and displays the report in your default Web browser (unless you cleared the **View Report After Generating** check box in the Reports panel before running the test). If you cleared this check box, or to view a different test report, do the following:

1. Click the **Reports** button.
2. Click the **Browse** button and locate and select the report file to view.
3. In the Reports panel, click **View**.



Note: Iteration column will be displayed only when more than one test run is selected.

For information on changing the file type, file name, and other report options, see [Report configuration settings](#) on page 40.

Report content

A report shows detailed results and plots, as set in the Reports panel.

Tektronix® TekExpress DPHY-TX Transmitter Test Report

Setup Information			
DUT ID	DUT001	Scope Model Number	MSO72004C
Date/Time	2019-06-03 16:05:38	Scope Serial Number	C250006
Execution Mode	Pre-Recorded	SFC, Factory Calibration	PASS.PASS
HS Data Rate (Gbps)	<= 1	Scope F.W Version	10.8.8 Build 3
TekExpress Framework Version	4.18.0.35	DUT Clock Probing	Single Ended
TekExpress DPHY-TX Version	111.0.0.184	DUT Operation Mode	Normal
CTS Version	CTS 1.2 Base Spec 1.2	ProbModel1	"P775TFLXA;P7720"
Compliance Mode	Yes	ProbModel2	"P775TFLXA;P7720"
Measurement Method	Automatic	ProbModel3	"P775TFLXA;P7720"
Overall Test Result	Pass	ProbModel4	"P775TFLXA;P7720"
Overall Execution Time	0:00:31	ProbeSerial1	"AM68862;B010954"
Measured Data Rate (Gbps)	2.5	ProbeSerial2	"AM68865;B010958"
		ProbeSerial3	"AM70686;B000529"
		ProbeSerial4	"AM70719;P100017"

DUT COMMENT: General Comment - D-PHY

Test Name	Result	Measurement Data
1.5.4 Data to Clock Skew (TSNEWTX)	Pass	<ul style="list-style-type: none"> (HS Data Rate <= 1) Max Data to Clock Skew = (Value1 +/- Value2) * UINST (ns) : 0.222ns (HS Data Rate <= 1) Min Data to Clock Skew = (Value1 +/- Value2) * UINST (ns) : 0.151ns (HS Data Rate <= 1) Mean Data to Clock Skew = (Value1 +/- Value2) * UINST (ns) : 0.188ns

Lane	Measurement Details	Measured Value	Units	Test Result	Margin	Low Limit	High Limit	Additional Information
Lane1	(HS Data Rate <= 1) Max Data to Clock Skew = (Value1 +/- Value2) * UINST (ns)	0.222	ns	Pass	L:0.083ns H:0.037ns	0.14	0.26	Min value = 0.151, Max value = 0.222, Region count = 29256.0
Lane1	(HS Data Rate <= 1) Min Data to Clock Skew = (Value1 +/- Value2) * UINST (ns)	0.151	ns	Pass	L:0.011ns H:0.09ns	0.14	0.26	N.A
Lane1	(HS Data Rate <= 1) Mean Data to Clock Skew = (Value1 +/- Value2) * UINST (ns)	0.188	ns	Pass	L:0.048ns H:0.072ns	0.14	0.26	N.A

COMMENTS: Computed UI value(ns):0.4

*The images shown in this report is an indicator of the region(s) of analysis and is zoomed to show the first region of analysis.

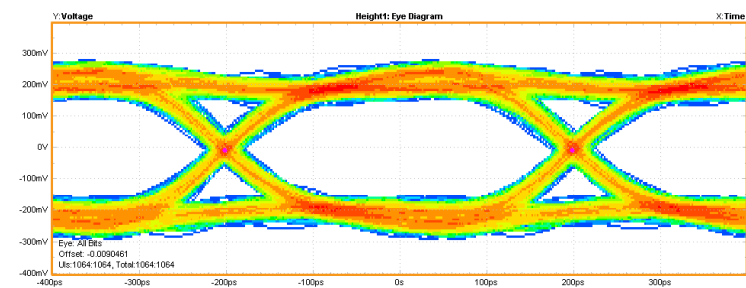
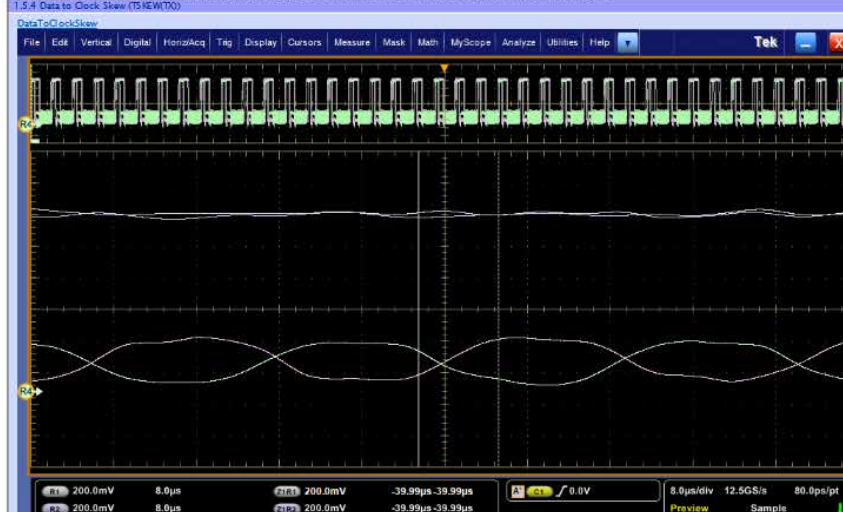

Setup configuration information

The summary box at the beginning of the report lists setup configuration information. This information includes the oscilloscope model and serial number, optical module model and serial number, and software version numbers of all associated applications.

To exclude this information from a report, clear the **Include Setup Configuration** check box in the Reports panel before running the test.

User comments

If you selected to include comments in the test report, any comments you added in the DUT tab are shown at the top of the report.

See also

[Results panel overview](#)

[View test-related files](#)

Running tests

Equipment connection diagram

Single-ended Test

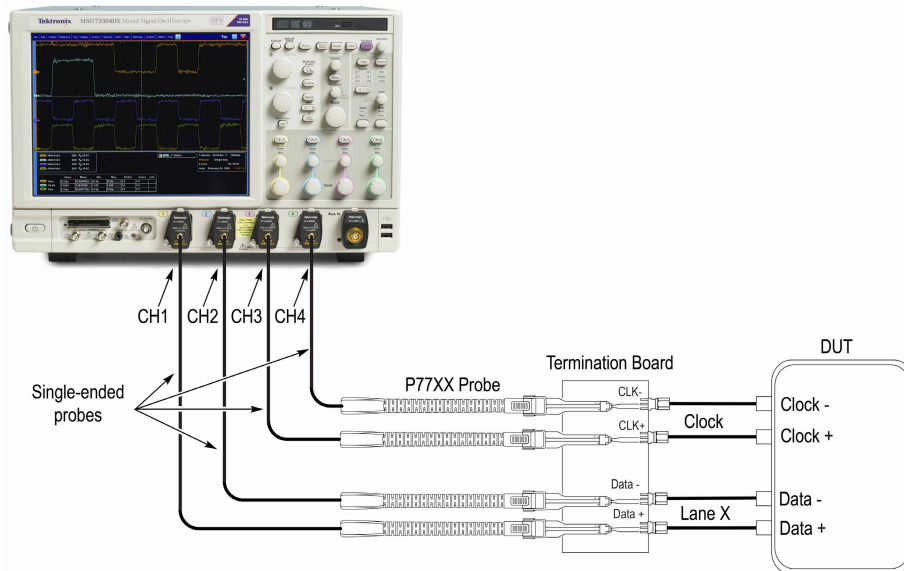

— Indicates connection wire

X- The lane number of the terminator board selected.

Note: If you have a partial setup, such as only Tx and no Rx, then the probing board should be connected to the termination board, which provides proper termination for the LP and HS signals. If you have a full setup, then there is no need for the termination board.

0514-006

Differential Test

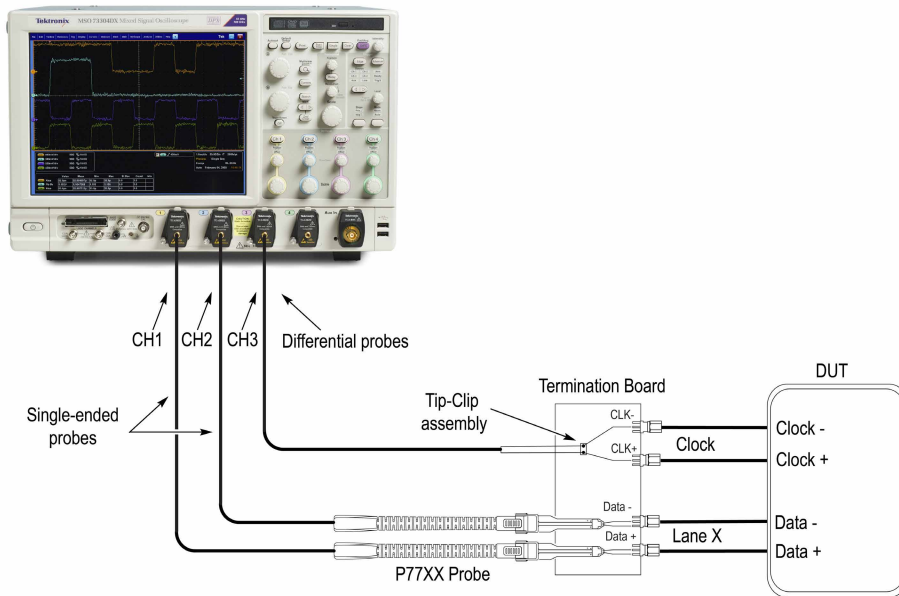

— Indicates connection wire

X- The lane number of the terminator board selected.

Note: If you have a partial setup, such as only Tx and no Rx, then the probing board should be connected to the termination board, which provides proper termination for the LP and HS signals. If you have a full setup, then there is no need for the termination board.

0514-007

Dual Stack Connection Setup - Single Ended Test

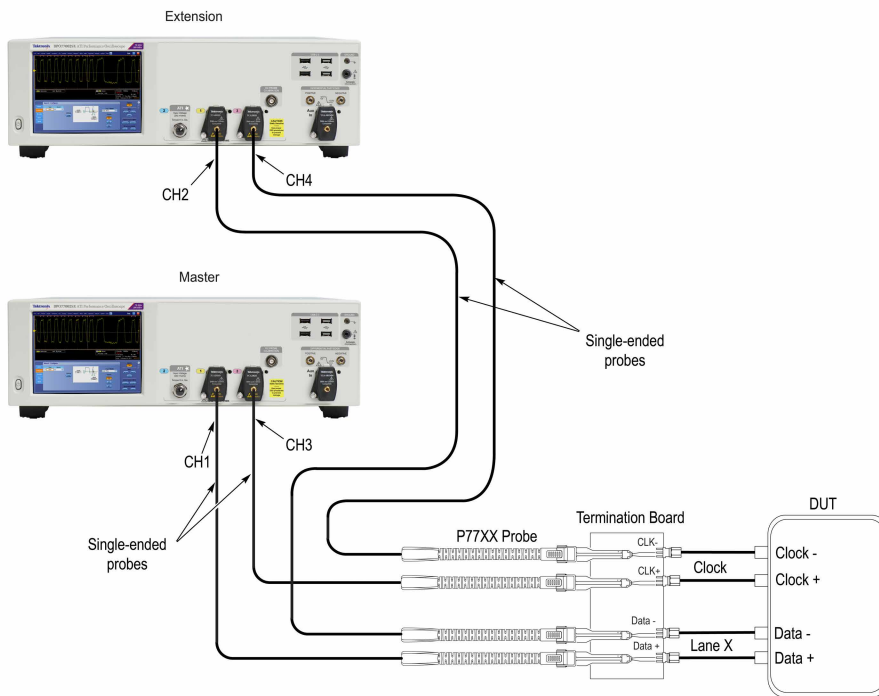

— Indicates connection wire

X - The lane number of the terminator board selected.

Note: If you have a partial setup, such as only Tx and no Rx, then the probing board should be connected to the termination board, which provides proper termination for the LP and HS signals. If you have a full setup, then there is no need for the termination board.

0514-012

Dual Stack Connection Setup - Differential Test

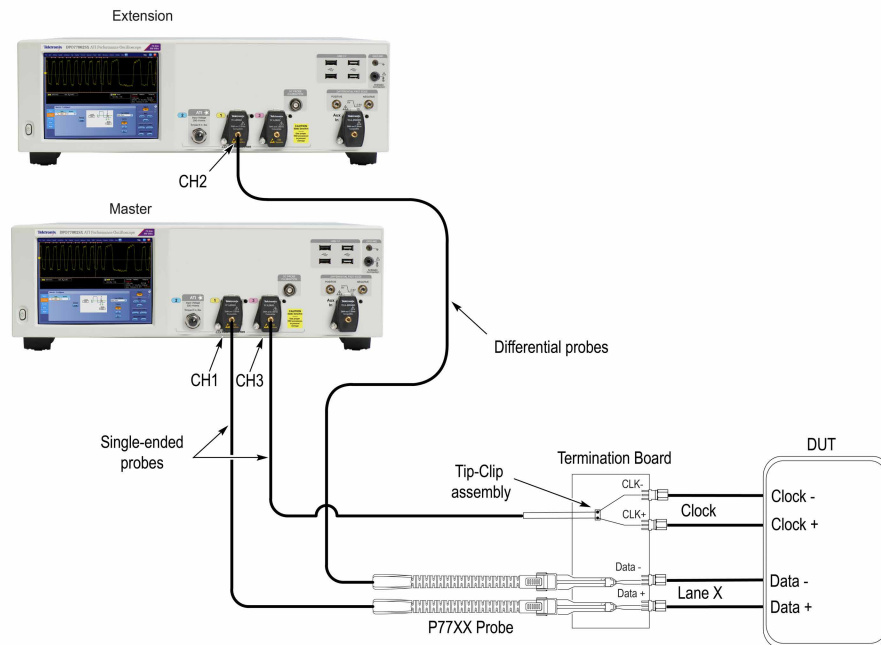

— Indicates connection wire

X - The lane number of the terminator board selected.

Note: If you have a partial setup, such as only Tx and no Rx, then the probing board should be connected to the termination board, which provides proper termination for the LP and HS signals. If you have a full setup, then there is no need for the termination board.

0514-013

Prerequisite

Compensate the signal path

Use the following procedure to compensate the internal signal acquisition path. Perform this procedure if the ambient temperature has changed more than 5 °C (9 °F) since you performed the last signal path compensation. Perform the signal path compensation once a week. Failure to do so may result in the instrument not meeting warranted performance levels.

1. Power on and wait for the instrument to complete its warm up period before continuing with this procedure.
2. Disconnect any probes you have connected to the input channels.
3. Set the instrument to Menu mode.
4. Select Instrument Calibration from the Utilities menu.
5. Note any instructions that appear in the resulting control window.
6. Click Run SPC to begin the procedure. The procedure may take several minutes to complete.
7. Verify that the Status changes to Compensated after the procedure is complete. If the Calibration Status field indicates anything other than Compensated, see Signal Path Compensation Status for information on the readout and recommended action.



Note: When making measurements at vertical scale settings less than or equal to 5 mV, you should perform the signal path compensation at least once a week. Failure to do so may result in the instrument not meeting warranted performance levels at those volts/div settings.

Deskew

If skew is present between positive and negative channels, then the channels need to be deskewed before being used for waveform measurements. TekExpress D-PHY provides support for channel deskew and attenuation using the following method:

1. Determine what the skew is for each channel.
2. From the TekScope menu, select Vertical > Deskew.
3. In the Deskew/Attenuation window, click the channel (1 – 4) button for the first channel to be deskewed.
4. Click in the Ch(x) Deskew Time entry field and enter the skew. The skew can be +ve or –ve.
5. Click the channel button for the next channel and repeat step 1.
6. After entering the skew for all the channels that require it, from the Options menu in TekExpress D-PHY, select Deskew.
7. In the Deskew dialog box, select the desired level (applicable for C series oscilloscopes only):
 - Less than 100 mV signal amplitude: Select this if the signal amplitude is such that the oscilloscope's vertical setting is less than 100 mV/division.
 - 100 mV or greater signal amplitude: Select this if the signal amplitude is such that the oscilloscope's vertical setting is greater than 100 mV/division.
8. Click **Read from Scope**.
9. When the status in the dialog box indicates the deskew is finished, click Close.

Each input channel has its own deskew settings. Deskew compensates individual channels for probes or cables of different lengths. The instrument applies the delay values after each completed acquisition. The deskew values are saved as part of the instrument setup. The deskew values for the selected channel are retained until you change the probe, you restore a saved setup, or you recall the factory setup.

Running tests

[Set DUT parameters](#), [select tests](#), [set acquisition parameters](#), [set configuration parameters](#), [set preferences parameters](#), and click **Start** to run the tests. While tests are running, you cannot access the Setup or Reports panels. To monitor the test progress, switch between the Status panel and the Results panel.

While tests are running, the other applications will be displayed at the background. If you want the TekExpress D-PHY application to run in the foreground select **Keep On Top** from the TekExpress Options menu.

The application displays report when the tests execution is complete.

Prerun checklist

1. Make sure that the instruments are warmed up (approximately 20 minutes) and stabilized.
2. Perform compensation: In the oscilloscope main menu, select **Utilities > Instrument Compensation**. Click **Help** in the compensation window for steps to perform instrument compensation.

View test results

When a test completes, the application switches to the Results panel, which shows a summary of test results.

Each test result occupies a row in the Results table. By default, results are displayed in summary format, with the measurement details collapsed. You can change the view in the following ways:

- To view the results grouped by lane, test, or data rate, select the corresponding item from the Preferences menu.
- To expand all tests listed, select **View Results Details** from the Preferences menu.
- To expand and collapse tests, use the plus and minus buttons to the left of the test rows.
- To collapse all expanded tests, select **Preferences > View Results Summary**.
- To enable or disable the wordwrap feature, select **Preferences > Enable Wordwrap**.

-
- To expand the width of a column, place the cursor over the vertical line that separates the column from the one to the right. When the cursor changes to a double-ended arrow, hold down the mouse button and drag the column to the desired width.
 - To sort the test information by column, click the column head. When sorted in ascending order, a small up arrow is displayed. When sorted in descending order, a small down arrow is displayed.
 - To clear all test results displayed, click **Clear** ()

Saving and recalling test setup

Test setup files overview

Saved test setup information (such as the selected oscilloscope, general parameters, acquisition parameters, measurement limits, waveforms (if applicable), and other configuration settings) are saved under the setup name at **X:\ID-PHY**.

Use test setups to:

- Run a new session, acquiring live waveforms, using a saved test configuration.
- Create a new test setup using an existing one.
- View all the information associated with a saved test, including the log file, the history of the test status as it executed, and the results summary.
- Run a saved test using saved waveforms.

See also

[Save a test setup](#)

[Open \(load\) a saved test setup](#)

Save a test setup

You can save a test setup before or after running a test. You can create a test setup from [already created test setup](#), or using [default test setup](#). When you select the default test setup, the parameters are set to the application's default value.

Select **Options > Save Test Setup** to save the opened setup.

Select **Options > Save Test Setup As** to save the setup with different name.

Open load a saved test setup

To Open (load) a saved test setup, do the following:

1. Select **Options > Open Test Setup**.
2. Select the setup from the list and click **Open**. Setup files are located at **X:\ID-PHY**.

See also

[About test setups](#)

[Create a test setup using an existing one](#)

[Create a test setup from default settings](#)

Create a test setup from default settings

To create a test setup using default settings, follow the steps:

1. Select **Options > Default Test Setup**. For default test setup, the parameters are set to the application's default value.
2. Click application [Setup](#) and set the parameters
3. Click application [Reports](#) and set the report options
4. Optional: Click **Start** to run the test and verify that it runs correctly and captures the specified test information and reports. If it does not, then edit the parameters and repeat this step until the test runs to your satisfaction

5. Select **Options > Save Test Setup**. Enter the file name and click Save. The application saves the file to X:\D-PHY*session_name*

Create a test setup using an existing one

To create a test setup using an existing one, follow the steps:

1. Select **Options > Open Test Setup**
2. Select a setup from the list and then click **Open**
3. Click application setup and modify the parameters
4. Click application reports and modify the report options
5. Select **Options > Save Test Setup As**
6. Enter test setup name, and click **Save**.

SCPI commands

About SCPI command

You can use Standard Commands for Programmable Instruments (SCPI) to communicate with the TekExpress application.

Socket configuration for SCPI commands

This section describes the steps for TCP/IP socket configuration and TekVISA configuration to execute the SCPI commands.

TCP/IP socket configuration

1. Click **Start > Control Panel > System and Security > Windows Firewall > Advanced settings**.

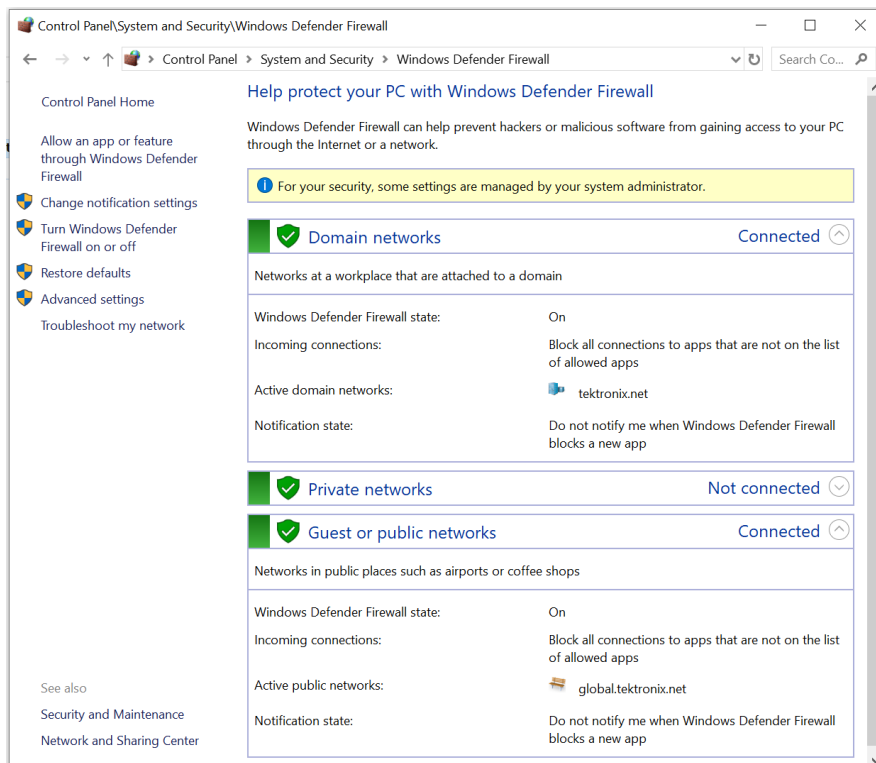

2. In Windows Firewall with Advanced Security menu, select **Windows Firewall with Advanced Security on Local Computer > Inbound Rules** and click **New Rule...**

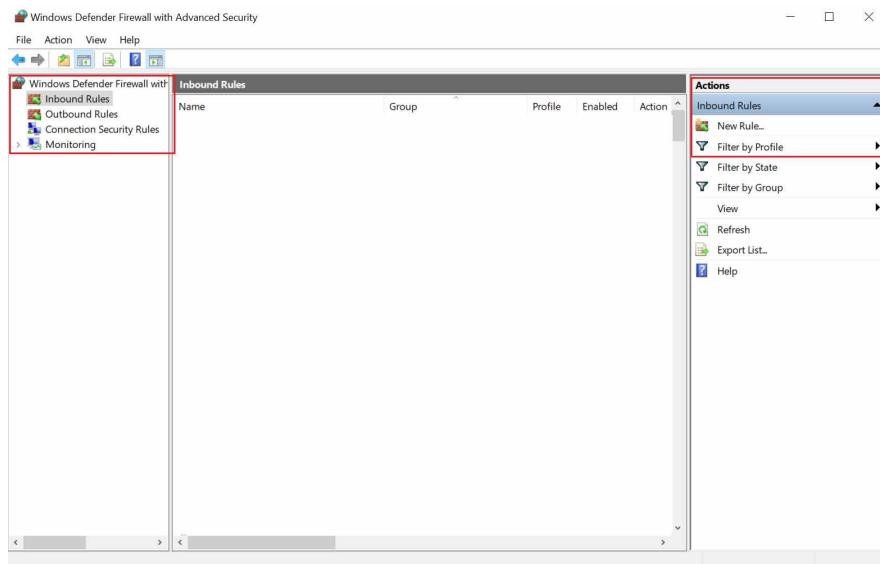

3. In New Inbound Rule Wizard menu
 - a. Select **Port** and click **Next**.

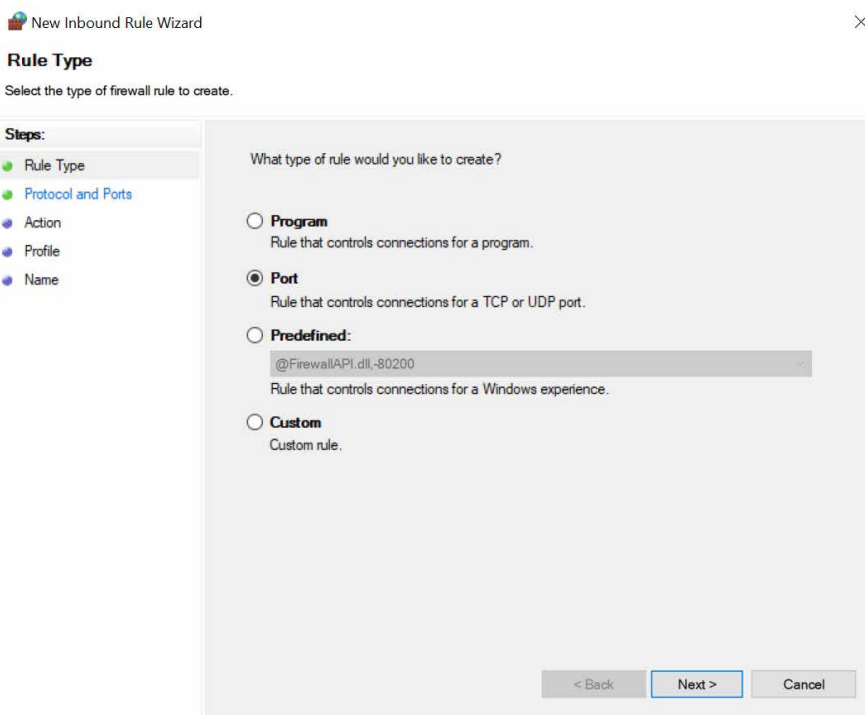

- b. Select **TCP** as rule apply and enter 5000 for **Specific local ports** and click **Next**.

New Inbound Rule Wizard ×

Protocol and Ports

Specify the protocols and ports to which this rule applies.

Steps:

- Rule Type
- Protocol and Ports
- Action
- Profile
- Name

Does this rule apply to TCP or UDP?

TCP
 UDP

Does this rule apply to all local ports or specific local ports?

All local ports
 Specific local ports:
Example: 80, 443, 5000-5010

c. Select **Allow the connection** and click **Next**.

New Inbound Rule Wizard ×

Action

Specify the action to be taken when a connection matches the conditions specified in the rule.

Steps:

- Rule Type
- Protocol and Ports
- Action
- Profile
- Name

What action should be taken when a connection matches the specified conditions?

Allow the connection
This includes connections that are protected with IPsec as well as those are not.

Allow the connection if it is secure
This includes only connections that have been authenticated by using IPsec. Connections will be secured using the settings in IPsec properties and rules in the Connection Security Rule node.

Block the connection

d. Select **Domain, Private, Public** and click **Next**.

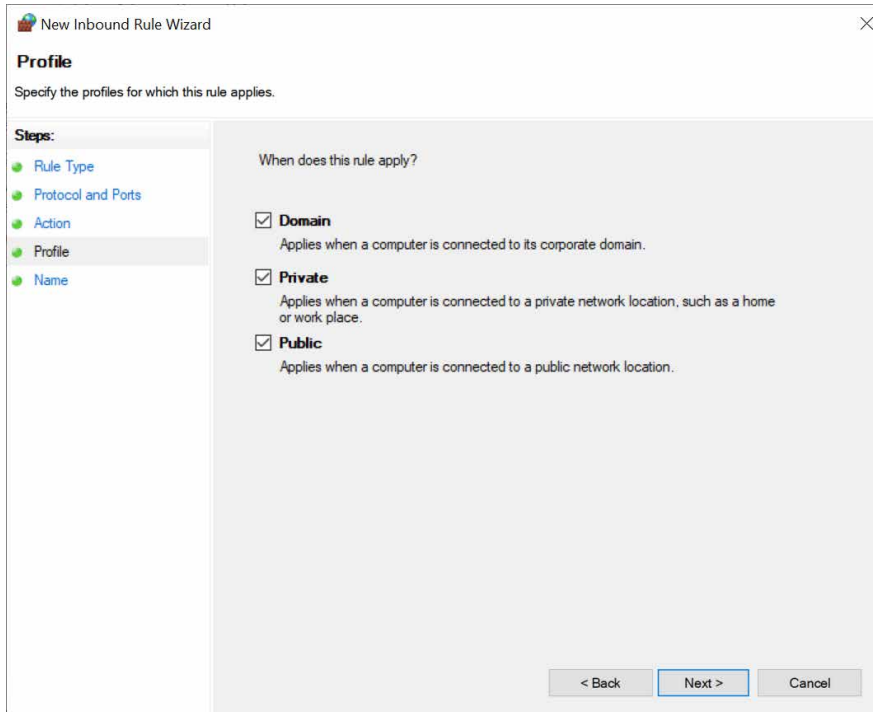

e. Enter **Name**, **Description** (optional), and click **Finish**.

4. Check whether the Rule name is displayed in **Windows Firewall with Advanced Security** menu > **Inbound Rules**.

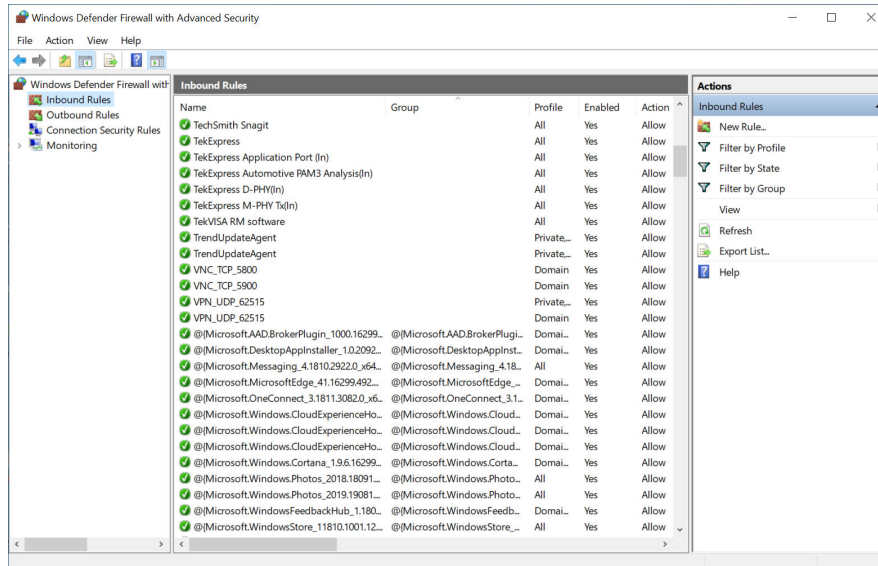

TekVISA configuration

1. Click **Start > All Programs > TekVISA > OpenChoice Instrument Manager**.

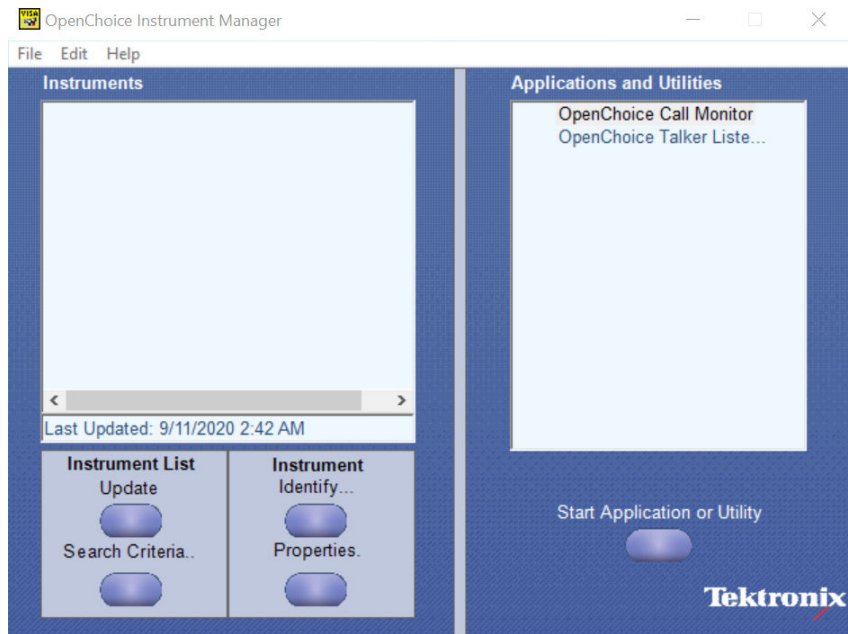

- Click **Search Criteria**. In Search Criteria menu, click **LAN** to Turn-on. Select **Socket** from the drop-down list, enter the IP address of the TekExpress device in **Hostname** and type **Port** as 5000. Click  to configure the IP address with Port. Enter the Hostname as 127.0.0.1 if the TekVISA and TekExpress application are in the same system, else enter the IP address of the TekExpress application system.

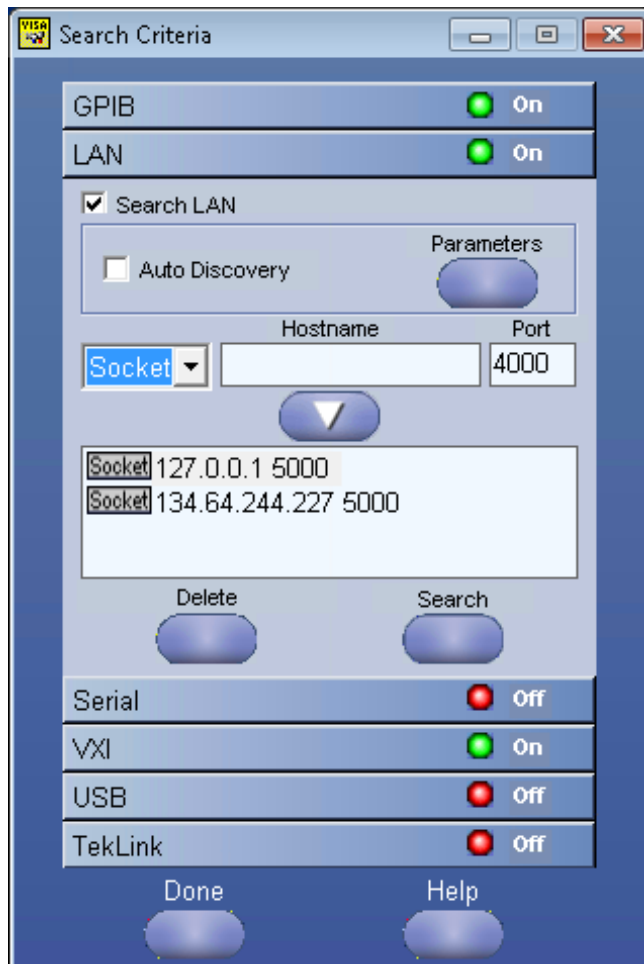

3. Click **Search** to setup the TCPIP connection with the host. Check whether the TCPIP host name is displayed in **OpenChoice Instrument Manager > Instruments**.
4. Double-click **OpenChoice Talker Listener** and enter the Command *IDN? in command entry field and click **Query**. Check that the Operation is successful and Talker Listener Readout displays the Command / Data.

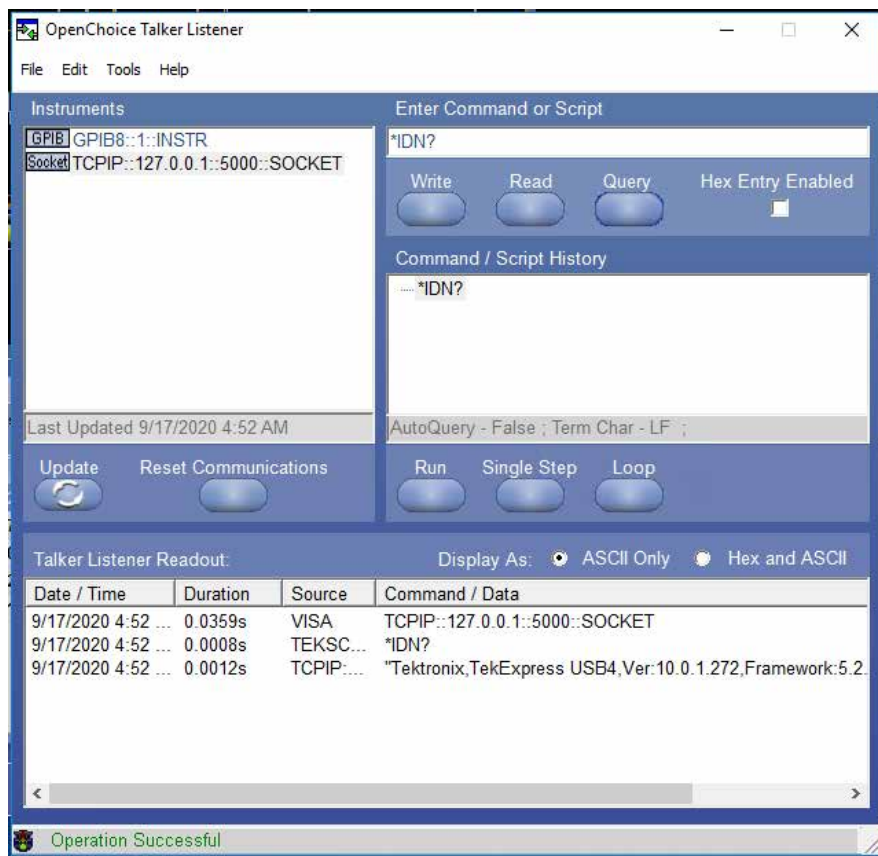

TEKEXP:*IDN?

This command queries the active TekExpress application name running on the oscilloscope.

Syntax

```
TEKEXP : *IDN? \n
```

Inputs

NA

Outputs

Returns active TekExpress application name running on the oscilloscope.

TEKEXP:*OPC?

This command queries the execution status of the last executed command.

Syntax

```
TEKEXP : *OPC? \n
```

Inputs

NA

Outputs

0 - last command execution is not complete

1 - last command execution is complete

TEKEXP:ACQUIRE_MODE

This command sets the acquire mode as live or pre-recorded.

Syntax

```
TEKEXP:ACQUIRE_MODE {LIVE | PRE-RECORDED}\n
```

Inputs

```
{LIVE | PRE-RECORDED}
```

Outputs

NA

TEKEXP:ACQUIRE_MODE?

This command queries the acquire mode type.

Syntax

```
TEKEXP:ACQUIRE_MODE?\n
```

Inputs

NA

Outputs

```
{LIVE | PRE-RECORDED}
```

TEKEXP:EXPORT

This command returns all the bytes of data to the specified file.

Syntax	Outputs
TEKEXP:EXPORT REPORT\n	Returns the report file in bytes
TEKEXP:EXPORT WFM, "<FileName>"\n	Returns the specified waveform file in bytes
TEKEXP:EXPORT IMAGE, "<FileName>"\n	Returns the specified image file in bytes

Inputs

FileName - Specifies the file name

TEKEXP:INFO?

This command queries the information about the file(s).

Syntax	Outputs
TEKEXP:INFO? REPORT\n	<ReportFileSize>,<ReportFileName.mht>
TEKEXP:INFO? WFM\n	<WfmFile1Size>,<WfmFileName1.wfm>;<WfmFile2Size>,<WfmFileName2.wfm>;...
TEKEXP:INFO? IMAGE\n	<Image1FileSize>,<Image1FileName>;<Image2FileSize>,<Image2FileName>;...

TEKEXP:INSTRUMENT

This command sets the value for the selected instrument type.

Syntax

```
TEKEXP:INSTRUMENT "<InstrumentType>",<Value>"\n
```

Inputs

InstrumentType

Value



Tip: Check *Command parameters list* section for InstrumentType and Value parameters.

Outputs

NA

TEKEXP:INSTRUMENT?

This command queries the instrument selected for the specified instrument type.

Syntax

```
TEKEXP:INSTRUMENT? "<InstrumentType>"\n
```

Inputs

InstrumentType



Tip: Check *Command parameters list* section for InstrumentType parameters.

Outputs

Returns the instrument selected for the specified instrument type

TEKEXP:LASTERROR?

This command queries the last error string occurred for the current TCP session. If there are no errors since startup, or since the last call to TEKEXP:LASTERROR?\n, this command returns an empty string.

Syntax

```
TEKEXP:LASTERROR?\n
```

Inputs

NA

Outputs

<string>

TEKEXP:LIST?

This command queries the list of available device, suite, test, version or instrument.

Syntax	Outputs
TEKEXP:LIST? DEVICE\n	Returns the list of available device(s) as comma separated values.
TEKEXP:LIST? SUITE\n	Returns the list of available suite(s) as comma separated values.
TEKEXP:LIST? TEST\n	Returns the list of available test(s) as comma separated values.
TEKEXP:LIST? VERSION\n	Returns the list of available version(s) as comma separated values.
TEKEXP:LIST? INSTRUMENT, "<InstrumentType>"\n	Returns the list of available instruments' for the given Instrument type as comma separated values.



Note: This command returns the list of items within double quotes (""). Iterate the receive procedure until the list ends with double quotes otherwise the next query commands won't work as expected.

Inputs

InstrumentType



Tip: Check *Command parameters list* section for InstrumentType parameters.

TEKEXP:POPUP

This command sets the response to the active popup shown in the application.

Syntax

TEKEXP:POPUP "<PopupResponse>"\n

Inputs

PopupResponse

Outputs

NA

TEKEXP:POPUP?

This command queries the active popup information shown in the application.

Syntax

TEKEXP:POPUP?\n

Inputs

NA

Outputs

Returns the active popup information in the application.

TEKEXP:REPORT

This command generates the report for the current session.

Syntax

```
TEKEXP:REPORT GENERATE\n
```

Inputs

GENERATE

Outputs

NA

TEKEXP:REPORT?

This command queries the queried header field value in the report.

Syntax

```
TEKEXP:REPORT? "<HeaderField>"\n
```

Inputs

HeaderField - Specifies to return the measured value for the indicated test.



Tip: Check **Report** for HeaderField parameters.

Outputs

Returns the queried header field value in the report

TEKEXP:RESULT?

This command queries the result available in report summary/details table.

Syntax	Outputs
TEKEXP:RESULT? "<TestName>"\n	Return Pass/Fail status of the test.
TEKEXP:RESULT? "<TestName>", "<ColumnName>"\n	Returns all the row values of the specified column for the test.
TEKEXP:RESULT? "<TestName>", "<ColumnName>", <RowNumber>\n	Returns the column value for the specified row number

Inputs

TestName - Specifies the name of the test for which to obtain the test result value.

ColumnName - Specifies the column name for the measurement

RowNumber - Specifies the row number of the measurement



Tip: Check **Results** panel for TestName, ColumnName, and RowNumber parameters.

TEKEXP:SELECT

This command selects the device, suite, version, or test.

Syntax

```
TEKEXP:SELECT <string1>,<string2>,<string4>\n
```

```
TEKEXP:SELECT TEST,<string3>,<string4>\n
```

Inputs

<string1> = {DEVICE | SUITE | VERSION}

<string2> = {DeviceName | SuiteName | VersionName}

<string3> = {"<TestName>" | ALL | REQUIRED }

<string4> = {TRUE | FALSE}



Tip: Check *Command parameters list* section for DeviceName, SuiteName, VersionName, and TestName parameters.

Outputs

NA

TEKEXP:SELECT?

This command queries the name of the selected device, suite, version, or test.

Syntax

```
TEKEXP:SELECT? {DEVICE | SUITE | TEST | VERSION}\n
```

Inputs

{DEVICE | SUITE | TEST | VERSION}

Outputs

Returns the name of the selected device, suite, version, or test.

TEKEXP:SETUP

This command sets the value of the current setup.

Syntax	Outputs
TEKEXP:SETUP DEFAULT\n	Restore to default Setup
TEKEXP:SETUP OPEN, "<SessionName>"\n	Open the session
TEKEXP:SETUP SAVE\n	Saves the already existing modified session
TEKEXP:SETUP SAVE, "<SessionName>"\n	Save the session

Inputs

SessionName - The name of the session

TEKEXP:STATE

This command sets the execution state of the application.

Syntax

```
TEKEXP:STATE {RUN | STOP | PAUSE | RESUME}\n
```

Inputs

```
{RUN | STOP | PAUSE | RESUME}
```

Outputs

NA

TEKEXP:STATE?

This command queries the current setup state.

Syntax	Outputs
TEKEXP:STATE?	RUNNING PAUSED WAIT ERROR READY
TEKEXP:STATE? SETUP	SAVED NOT_SAVED

TEKEXP:VALUE

This command sets the value of parameters of type General, Acquire, Analyze, or DUTID.

Syntax

```
TEKEXP:VALUE GENERAL, "<ParameterName>", "<Value>"\n
```

```
TEKEXP:VALUE ACQUIRE, "<TestName>", "<AcquireType>", "<ParameterName>", "<Value>"\n
```

```
TEKEXP:VALUE ANALYZE, "<TestName>", "<ParameterName>." "<Value>"\n
```

```
TEKEXP:VALUE DUTID, "<Value>"\n
```

```
TEKEXP:VALUE VERBOSE, {TRUE | FALSE}\n
```

```
TEKEXP:VALUE WFMFILE, <Test_Name>, <Acquire_Type>, <FileName1$FileName2>\n
```

Inputs

ParameterName - Specifies the parameter name

TestName - Specifies the test name

AcquireType - Specifies the acquire type

Value - Specifies the value to set

FileName1\$FileName2 - Specifies the waveform file name

TRUE - Pop-ups are enabled

FALSE - Pop-ups are disabled



Tip: Check *Command parameters list* section for ParameterName, AcquireType, and Value parameters.

Outputs

NA

TEKEXP:VALUE?

This command queries the value of the parameter for type General, Acquire, Analyze, or DUTID.

Syntax	Outputs
TEKEXP:VALUE? GENERAL, "<ParameterName>"\n	Returns the value of Parameter for type GENERAL
TEKEXP:VALUE? ACQUIRE, "<TestName>", "<AcquireType>", "<ParameterName>"\n	Returns the value of Parameter for type ACQUIRE
TEKEXP:VALUE? ANALYZE, "<TestName>", "<ParameterName>"\n	Returns the value of Parameter for type ANALYZE
TEKEXP:VALUE? DUTID\n	Returns the DUTID value
TEKEXP:VALUE? WFMFILE, <Test_Name>, <Acquire_Type>\n	Returns the waveform file name
TEKEXP:VALUE? VERBOSE	Returns the verbose mode type

Inputs

ParameterName - Specifies the parameter name

TestName - Specifies the test name

AcquireType - Specifies the acquire type

TRUE - Pop-ups are enabled

FALSE - Pop-ups are disabled



Tip: Check *Command parameters list* section for ParameterName and AcquireType parameters.

Outputs

Returns the value of Parameter for type GENERAL | ACQUIRE | ANALYZE | DUTID.

Command parameters list

This section provides the parameters list for the SCPI commands.

TekExpress D-PHY command parameters

ParameterName and Value for DUT, Test selection, Acquisition, Configuration, and Preferences tabs

Specifies the ParameterName and Value for DUT, Test selection, Acquisition, Configuration, and Preferences tabs

Table 17: ParameterName and Value for DUT tab

Parameters	Description
DUT ID	Specifies the value parameters. For DUTID, valid value is: Comment

Table continued...

Parameters	Description
Acquire mode	Specifies the acquire mode parameter: Acquire live waveforms
Use pre-recorded mode	Specifies the pre-recorded parameter: Use pre-recorded waveform files
Version	<ul style="list-style-type: none"> • D-PHY v1.2 • D-PHY v2.1
Test Mode	<p>Specifies the test mode Valid values are:</p> <ul style="list-style-type: none"> • Normal • Escape • Both
Clock Mode	<p>Specifies the clock mode Valid values are:</p> <ul style="list-style-type: none"> • Normal • Continuous
HS Data Rate	<p>D-PHY v1.2</p> <ul style="list-style-type: none"> • <=1 • >1 AND <=1.5 • >1.5 And <=2.5 <p>D-PHY v2.1</p> <ul style="list-style-type: none"> • <=1 • >1 AND <=1.5 • >1.5 And <=2.5 • >2.5 And <=4.5
Multi-Lane	Configures the lanes and channels
Clock-Lane Probing	<p>Specifies the selected source. Valid values are</p> <ul style="list-style-type: none"> • Single-ended • Differential
Disable Single Lane Popup	True or False
Clock Lane Souces	<ul style="list-style-type: none"> • Clkp <ul style="list-style-type: none"> • CH1 • CH2 • CH3 • CH4 • Clkn <ul style="list-style-type: none"> • CH1 • CH2 • CH3 • CH4

Table 18: ParameterName and Value for Test Selection tab

Parameters	Description
Test Name	<p>Specifies the test measurement name. Valid values are:</p> <ul style="list-style-type: none"> • 1.1.1 Data Lane LP-TX Thevenin Output High Level Voltage(VOH) • 1.1.2 Data Lane LP-TX Thevenin Output Low Level Voltage(VOL) • 1.1.3 Data Lane LP-TX 15%-85% Rise Time(TRLP) • 1.1.4 Data Lane LP-TX 15%-85% Fall Time(TFLP) • 1.1.5 Data Lane LP-TX Slew Rate vs.CLOAD • 1.1.6 Data Lane LP-TX Pulse Width of Exclusive-OR Clock(TLP-PULSE-TX) • 1.1.7 Data Lane LP-TX Period of Exclusive-OR Clock(TLP-PER-TX) • 1.2.1 Clock Lane LP-TX Thevenin Output High Level Voltage(VOH) • 1.2.2 Clock Lane LP-TX Thevenin Output Low Level Voltage(VOL) • 1.2.3 Clock Lane LP-TX 15%-85% Rise Time(TRLP) • 1.2.4 Clock Lane LP-TX 15%-85% Fall Time(TFLP) • 1.2.5 Clock Lane LP-TX Slew Rate vs.CLOAD • 1.3.1 Data Lane HS Entry: Data Lane TLPXValue • 1.3.2 Data Lane HS Entry: THS-PREPAREValue • 1.3.3 Data Lane HS Entry: THS-PREPARE + THS-ZEROValue • 1.3.4 Data Lane HS-TX Differential Voltages (VOD(0),VOD(1)) • 1.3.5 Data Lane HS-TX Differential Voltage Mismatch(VOD) • 1.3.6 Data Lane HS-TX Single-Ended Output High Voltages (VOHHS(DP),VOHHS(DN)) • 1.3.7 Data Lane HS-TX Static Common-Mode Voltages (VCMTX(1),VCMTX(0)) • 1.3.8 Data Lane HS-TX Static Common-Mode Voltage Mismatch(VCMTX(1,0)) • 1.3.9 Data Lane HS-TX Dynamic Common-Level Variations Between 50-450MHz (VCMTX(LF)) • 1.3.10 Data Lane HS-TX Dynamic Common-Level Variations Above 450MHz (VCMTX(HF)) • 1.3.11 Data Lane HS-TX 20%-80% Rise Time(tR) • 1.3.12 Data Lane HS-TX 80%-20% Fall Time(tF) • 1.3.13 Data Lane HS Exit: THS-TRAILValue • 1.3.14 Data Lane HS Exit: 30%-85% Post-EoT Rise Time(TREOT) • 1.3.15 Data Lane HS Exit: TEOTValue • 1.3.16 Data Lane HS Exit: THS-EXITValue

Table continued...

Parameters	Description
Test Name	<ul style="list-style-type: none"> • 1.4.1 Clock Lane HS Entry: TLPXValue • 1.4.2 Clock Lane HS Entry: TCLK-PREPAREValue • 1.4.3 Clock Lane HS Entry: TCLK-PREPARE+TCLK-ZEROValue • 1.4.4 Clock Lane HS-TX Differential Voltages (VOD(0),VOD(1)) • 1.4.5 Clock Lane HS-TX Differential Voltage Mismatch(VOD) • 1.4.6 Clock Lane HS-TX Single-Ended Output High Voltages (VOHHS(DP),VOHHS(DN)) • 1.4.7 Clock Lane HS-TX Static Common-Mode Voltages (VCMTX(1),VCMTX(0)) • 1.4.8 Clock Lane HS-TX Static Common-Mode Voltage Mismatch(VCMTX(1,0)) • 1.4.9 Clock Lane HS-TX Dynamic Common-Level Variations Between 50-450MHz (VCMTX(LF)) • 1.4.10 Clock Lane HS-TX Dynamic Common-Level Variations Above 450MHz (VCMTX(HF)) • 1.4.11 Clock Lane HS-TX 20%-80% Rise Time(tR) • 1.4.12 Clock Lane HS-TX 80%-20% Fall Time(tF) • 1.4.13 Clock Lane HS Exit: TCLK-TRAILValue • 1.4.14 Clock Lane HS Exit: 30%-85% Post-EoT Rise Time(TREOT) • 1.4.15 Clock Lane HS Exit: TEOTValue • 1.4.16 Clock Lane HS Exit: THS-EXITValue • 1.4.17 Clock Lane HS Clock Instantaneous(UIINST) • 1.4.18 Clock Lane HS Clock DeltaUI • 1.4.19 TX Spread Spectrum Clocking (SSC) Requirements • 1.4.20 Clock Lane HS Clock Period Jitter • 1.5.1 HS Entry TCLKPREValue • 1.5.2 HS Exit TCLKPOSTValue • 1.5.3 HS Clock Rising Edge Alignment to First PayloadBit • 1.5.4 Data to Clock Skew(TSKEW(TX)) • 1.5.5 Initial HS Skew Calibration Burst (TSKEWCAL-SYNC,TSKEWCAL) • 1.5.6 Periodic HS Skew Calibration Burst (TSKEWCAL-SYNC,TSKEWCAL) • 1.5.7 HS-TX Data and Clock Eye Diagram • 1.5.8 Alternate Calibration Sequence (TALTCAL-SYNC, TALTCAL) • 1.5.9 Preamble Sequence (TPREAMBLE, TEXTSYNC) • 1.5.10 Clock and Data Lane TX HS-Idle: THS-IDLE-POST, THS-IDLE-CLKHS0, THS-IDLE-PRE Values
Test Name	<ul style="list-style-type: none"> • 1.6.1 INIT LP-TX Initialization Period (TINIT,MASTER) • 1.6.2 ULPS Entry Verification of Clock Lane LP-TX ULPS support • 1.6.3 ULPS Exit Transmitted TWAKEUPInterval • 1.6.4 BTA TX-Side TTA-GO IntervalValue • 1.6.5 BTA RX-Side TTA-SURE IntervalValue • 1.6.6 BTA RX-Side TTA-GET IntervalValue

Table 19: ParameterName and Value for Acquisition tab

Parameters	Description
Acquisition and Save Options	Saves the acquisitions and waveforms <ul style="list-style-type: none"> • Save All Waveforms Before Analysis • Analyze immediately, No WaveformsSaved • Save and Analyze Acquisition inSequence
Show Acquire Parameters	<ul style="list-style-type: none"> • True • False

Table 20: ParameterName and Value for Preferences tab

Parameters	Description
Number of Runs	1 to 250
Deskew	True or False
On Test Failure, stop and notify me of the failure	True or False
Email Settings	Recipient e-mail Address Sender's Address
Pop-up Settings	<ul style="list-style-type: none"> • Auto close Warnings and Informations during Sequencing. Auto Close after (1 to 60) seconds • Auto close Error messages during Sequencing. Show in Reports. Auto Close after (1 to 60) seconds
Logging Options: Enable logging	True or False
Capture Snapshot	True or False

Table 21: ParameterName and Value for Analyze

TestName	ParameterName	Value
1.4.17 Clock Lane HS Clock Instantaneous (UIINST)	UI INST Min (ns)	0.01 to 12.5
1.5.7 HS-TX Data and Clock Eye Diagram only - Specify the insertion loss. The default value is 'Standard'	Reference Channel Insertion Loss	Standard, Short, Long
1.5.10 Clock and Data Lane TX HS-Idle: THS-IDLE-POST, THS-IDLE-CLKHS0, THS-IDLE-PRE Values - Specify the Bus Width value. The default value is 1 bytes.	TX PPI Bus Width (bytes)	1 to 64
1.5.3 HS Clock Rising Edge Alignment to First Payload Bit	Analysis Mode	<ul style="list-style-type: none"> • Automatic • Visual Verification
1.3.4 Data Lane HS-TX Differential Voltages (VOD(0), VOD(1)) for version DPHY v2.1	Swing Mode	Full, Half

Table continued...

TestName	ParameterName	Value
1.4.19 TX Spread Spectrum Clocking (SSC) Requirements for HS data rate >2.5 And <= 4.5 under version DPHY v2.1	Signal Type	Clock, Data
1.4.19 TX Spread Spectrum Clocking (SSC) Requirements for HS data rate > 2.5 And <= 4.5 under version DPHY v2.1	Nominal Frequency Type	Auto, Manual
1.4.19 TX Spread Spectrum Clocking (SSC) Requirements for HS data rate > 2.5 And <= 4.5 under version DPHY v2.1, when Manual selected.	Nominal Frequency(GHz)	1 to 100, Default 1

Table 22: ParameterName and Value for General

Parameters	Description
Measurement Method	Automatic Manual
HS Data Rate	D-PHY v1.2 <ul style="list-style-type: none"> • <=1 • >1 AND <=1.5 • >1.5 And <=2.5 D-PHY v2.1 <ul style="list-style-type: none"> • <=1 • >1 AND <=1.5 • >1.5 And <=2.5 • >2.5 And <=4.5
Lane1:Lane 1	Included Excluded
Lane2:Lane 2	Included Excluded
Lane3:Lane 3	Included Excluded
Lane4:Lane 4	Included Excluded

Table 23: ParameterName and Value for Acquire

Test Name	Acquire Type	Parameter Name	Values
1.1.1 Data Lane LP-TX Thevenin Output High Level Voltage (VOH)	Data Lanes Acquisition In Escape Mode with Data As Trigger	Vertical Scale Data (mV)	<ul style="list-style-type: none"> • 10 • 500
1.1.2 Data Lane LP-TX Thevenin Output Low Level Voltage (VOL)		Vertical Scale Clock (mV)	<ul style="list-style-type: none"> • 10 • 500
1.1.3 Data Lane LP-TX 15%-85% Rise Time (TRLP)		Vertical Offset (V)	-1.3 to +1.3
1.1.4 Data Lane LP-TX 15%-85% Fall Time (TFLP)		Sample Rate (Gs/s)	<ul style="list-style-type: none"> • 6.25 • 12.5 • 25 • 50
1.1.5 Data Lane LP-TX Slew Rate vs. CLOAD		Record Length	<ul style="list-style-type: none"> • 100000 • 50000000
1.1.6 Data Lane LP-TX Pulse Width of Exclusive-OR Clock (TLP-PULSE-TX)		Trigger Type: Transition	<ul style="list-style-type: none"> • Source: Dp, Dn • Slope: Positive, Negative, Either • Transition: Greater Than, Less Than • Delta Time: 500, 250 • Qualify: Occurs, Logic • Lower Level: 0.05 • Upper Level: 1
1.1.7 Data Lane LP-TX Period of Exclusive-OR Clock (TLP- PER-TX)		Trigger Type: Edge	<ul style="list-style-type: none"> • Source: Dp, Dn • Slope: Positive, Negative, Either • Level: 0 to 1 V
		Trigger Type: Width	<ul style="list-style-type: none"> • Source: Dp, Dn • Polarity: Positive, Negative • Lower Limit: 25 μs • Upper Limit: 300 μs

Test Name	Acquire Type	Parameter Name	Values
1.2.1 Clock Lane LP-TX Thevenin Output High Level Voltage (VOH) 1.2.2 Clock Lane LP-TX Thevenin Output Low Level Voltage (VOL) 1.2.3 Clock Lane LP-TX 15%-85% Rise Time (TRLP) 1.2.4 Clock Lane LP-TX 15%-85% Fall Time(TFLP) 1.2.5 Clock Lane LP-TX Slew Rate vs.CLOAD	Clock Lanes Acquisition In Escape Mode with Clock As Trigger	Vertical Scale Data (mV)	<ul style="list-style-type: none"> • 10
		Vertical Scale Clock (mV)	<ul style="list-style-type: none"> • 500
		Vertical Offset (V)	-1.3 to +1.3
		Trigger Type: Transition	<ul style="list-style-type: none"> • Source: Clkp, Clkn • Slope: Positive, Negative, Either • Transition: Greater Than, Less Than • Delta Time: 500, 250 • Qualify: Occurs, Logic • Lower Level: 0.05 • Upper Level: 1
		Trigger Type: Edge	<ul style="list-style-type: none"> • Source: Clkp, Clkn • Slope: Positive, Negative, Either • Level: 0 to 1 V
		Trigger Type: Width	<ul style="list-style-type: none"> • Source: Clkp, Clkn • Polarity: Positive, Negative • Lower Limit: 25 μs • Upper Limit: 300 μs
		Sample Rate (GS/s)	<ul style="list-style-type: none"> • 6.25 • 12.5 • 25 • 50
		Record Length	<ul style="list-style-type: none"> • 100000 • 50000000

Test Name	Acquire Type	Parameter Name	Values
1.3.1 Data Lane HS Entry: Data Lane TLPX Value 1.3.2 Data Lane HS Entry: THS-PREPARE Value 1.3.3 Data Lane HS Entry: THS-PREPARE + THS-ZERO Value 1.3.4 Data Lane HS-TX Differential Voltages (VOD(0), VOD(1)) 1.3.5 Data Lane HS-TX Differential Voltage Mismatch (VOD) 1.3.6 Data Lane HS-TX Single-Ended Output High Voltages (VOHHS(DP), VOHHS(DN)) 1.3.7 Data Lane HS-TX Static Common-Mode Voltages (VCMTX(1), VCMTX(0)) 1.3.8 Data Lane HS-TX Static Common-Mode Voltage Mismatch (VCMTX(1,0)) 1.3.9 Data Lane HS-TX Dynamic Common-Level Variations Between 50-450MHz (VCMTX(LF)) 1.3.10 Data Lane HS-TX Dynamic Common-Level Variations Above 450MHz (VCMTX(HF)) 1.3.11 Data Lane HS-TX 20%-80% Rise Time (tR) 1.3.12 Data Lane HS-TX 80%-20% Fall Time (tF) 1.3.13 Data Lane HS Exit: THS-TRAIL Value 1.3.14 Data Lane HS Exit: 30%-85% Post-EoT Rise Time (TREOT) 1.3.15 Data Lane HS Exit: TEOT Value 1.3.16 Data Lane HS Exit: THS-EXIT Value	Data and Clock Lanes Acquisition with Data As Trigger	Vertical Scale Data (mV)	<ul style="list-style-type: none"> • 10
		Vertical Scale Clock (mV)	<ul style="list-style-type: none"> • 500
		Vertical Offset (V)	-1.3 to +1.3
		Sample Rate (GS/s)	<ul style="list-style-type: none"> • 6.25 • 12.5 • 25 • 50
		Record Length	<ul style="list-style-type: none"> • 100000 • 50000000
		Trigger Type: Transition	<ul style="list-style-type: none"> • Source: Dp, Dn, Clkp, Clkn • Slope: Positive, Negative, Either • Transition: Greater Than, Less Than • Delta Time: 500, 250 • Qualify: Occurs, Logic • Lower Level: 0.05 • Upper Level: 1
		Trigger Type: Edge	<ul style="list-style-type: none"> • Source: Dp, Dn, Clkp, Clkn • Slope: Positive, Negative, Either • Level: 0 to 1 V
		Trigger Type: Width	<ul style="list-style-type: none"> • Source: Dp, Dn, Clkp, Clkn • Polarity: Positive, Negative • Lower Limit: 25 μs • Upper Limit: 300 μs

Test Name	Acquire Type	Parameter Name	Values
1.4.1 Clock Lane HS Entry: TLPX Value	Clock Lanes Acquisition with Clock As Trigger	Vertical Scale Data (mV)	<ul style="list-style-type: none"> 10
1.4.2 Clock Lane HS Entry: TCLK-PREPARE Value		Vertical Scale Clock (mV)	<ul style="list-style-type: none"> 500
1.4.3 Clock Lane HS Entry: TCLK-PREPARE+TCLK- ZERO Value		Vertical Offset (V)	-1.3 to +1.3
1.4.4 Clock Lane HS-TX Differential Voltages (VOD(0), VOD(1))		Record Length	<ul style="list-style-type: none"> 100000 50000000
1.4.5 Clock Lane HS-TX Differential Voltage Mismatch (VOD)		Trigger Type: Transition	<ul style="list-style-type: none"> Source: Clkp, Clkn Slope: Positive, Negative, Either Transition: Greater Than, Less Than Delta Time: 500, 250 Qualify: Occurs, Logic Lower Level: 0.05 Upper Level: 1
1.4.6 Clock Lane HS-TX Single-Ended Output High Voltages (VOHHS(DP), VOHHS(DN))		Transition: Edge	<ul style="list-style-type: none"> Source: Clkp, Clkn Slope: Positive, Negative, Either Level: 0 to 1 V
1.4.7 Clock Lane HS-TX Static Common-Mode Voltages (VCMTX(1), VCMTX(0))		Transition: Width	<ul style="list-style-type: none"> Source: Clkp, Clkn Polarity: Positive, Negative Lower Limit: 25 μs Upper Limit: 300 μs
1.4.8 Clock Lane HS-TX Static Common-Mode Voltage Mismatch (VCMTX(1,0))		Sample Rate (GS/s)	<ul style="list-style-type: none"> 6.25 12.5 25 50
1.4.9 Clock Lane HS-TX Dynamic Common-Level Variations Between 50-450MHz (VCMTX(LF))			
1.4.10 Clock Lane HS-TX Dynamic Common-Level			
1.4.11 Clock Lane HS-TX 20%-80% Rise Time (tR)			
1.4.12 Clock Lane HS-TX 80%-20% Fall Time (tF)			
1.4.13 Clock Lane HS Exit: TCLK-TRAIL Value			
1.4.14 Clock Lane HS Exit: 30%-85% Post-EoT Rise Time (TREOT)			
1.4.15 Clock Lane HS Exit: TEOT Value			
1.4.16 Clock Lane HS Exit: THS-EXIT Value			
1.4.17 Clock Lane HS Clock Instantaneous (UIINST)			

Test Name	Acquire Type	Parameter Name	Values
1.4.18 Clock Lane HS Clock Delta UI	Clock Lanes Acquisition with Clock As Trigger_DeltaUI	Vertical Scale Data (mV)	<ul style="list-style-type: none"> 10
		Vertical Scale Clock (mV)	<ul style="list-style-type: none"> 500
		Vertical Offset (V)	-1.3 to +1.3
		Number of UI	<ul style="list-style-type: none"> 10000 1000000 Default is 64000
		Trigger Type: Transition	<ul style="list-style-type: none"> Source: Clkp, Clkn Slope: Positive, Negative, Either Transition: Greater Than, Less Than Delta Time: 500, 250 Qualify: Occurs, Logic Lower Level: 0.05 Upper Level: 1
		Transition: Edge	<ul style="list-style-type: none"> Source: Clkp, Clkn Slope: Positive, Negative, Either Level: 0 to 1 V
		Transition: Width	<ul style="list-style-type: none"> Source: Clkp, Clkn Polarity: Positive, Negative Lower Limit: 25 μs Upper Limit: 300 μs
Sample Rate (GS/s)	<ul style="list-style-type: none"> 6.25 12.5 25 50 		

Test Name	Acquire Type	Parameter Name	Values
1.4.19 TX Spread Spectrum Clocking (SSC) Requirements	Clock Lanes Acquisition with Clock as Trigger and SSC_Enabled	Vertical Scale Data (mV)	10
		Vertical Scale Clock (mV)	500
		Vertical Offset (V)	-1.3 to +1.3
		Record Length	100000 50000000
		Trigger Type: Transition	Source: Dp, Dn, Clkp, Clkn Slope: Positive, Negative, Either Transition: Greater Than, Less Than Delta Time: 500, 250 Qualify: Occurs, Logic Lower Level: 0.05 Upper Level: 1
		Transition: Edge	Source: Dp, Dn, Clkp, Clkn Slope: Positive, Negative, Either Level: 0 to 1 V
		Transition: Width	Source: Dp, Dn, Clkp, Clkn Polarity: Positive, Negative Lower Limit: 25 μ s Upper Limit: 300 μ s
		Sample Rate (GS/s)	6.25 12.5 25 50

Table continued...

Test Name	Acquire Type	Parameter Name	Values
1.4.20 Clock Lane HS Clock Period Jitter	Clock Lanes Acquisition with Clock as Trigger and SSC	Vertical Scale Data (mV)	10
		Vertical Scale Clock (mV)	500
		Vertical Offset (V)	-1.3 to +1.3
		Record Length	100000 50000000
		Trigger Type: Transition	Source: Clkp, Clkn Slope: Positive, Negative, Either Transition: Greater Than, Less Than Delta Time: 500, 250 Qualify: Occurs, Logic Lower Level: 0.05 Upper Level: 1
		Transition: Edge	Source: Clkp, Clkn Slope: Positive, Negative, Either Level: 0 to 1 V
		Transition: Width	Source: Clkp, Clkn Polarity: Positive, Negative Lower Limit: 25 μ s Upper Limit: 300 μ s
		Sample Rate (GS/s)	6.25 12.5 25 50

Test Name	Acquire Type	Parameter Name	Values
1.5.1 HS Entry TCLK PREValue	Data and Clock Lanes Acquisition with Data As Trigger	Vertical Scale Data (mV)	<ul style="list-style-type: none"> • 10
1.5.2 HS Exit TCLKPOSTValue		Vertical Scale Clock (mV)	<ul style="list-style-type: none"> • 500
1.5.4 Data to Clock Skew (TSKEW(TX))		Vertical Offset (V)	-1.3 to +1.3
		Sample Rate (GS/s)	<ul style="list-style-type: none"> • 6.25 • 12.5 • 25 • 50
		Trigger Type: Transition	<ul style="list-style-type: none"> • Source: Dp, Dn, Clkp, Clkn • Slope: Positive, Negative, Either • Transition: Greater Than, Less Than • Delta Time: 500, 250 • Qualify: Occurs, Logic • Lower Level: 0.05 • Upper Level: 1
		Trigger Type: Edge	<ul style="list-style-type: none"> • Source: Dp, Dn, Clkp, Clkn • Slope: Positive, Negative, Either • Level: 0 to 1 V
		Trigger Type: Width	<ul style="list-style-type: none"> • Source: Dp, Dn, Clkp, Clkn • Polarity: Positive, Negative • Lower Limit: 25 μs • Upper Limit: 300 μs
		Record Length	<ul style="list-style-type: none"> • 100000 • 50000000

Test Name	Acquire Type	Parameter Name	Values
1.5.3 HS Clock Rising Edge Alignment to First Payload Bit	Data and Clock Lanes Acquisition with Data As Trigger	Analysis Mode	<ul style="list-style-type: none"> Automatic Visual Verification
		Vertical Scale Data (mV)	<ul style="list-style-type: none"> 10
		Vertical Scale Clock (mV)	<ul style="list-style-type: none"> 500
		Vertical Offset (V)	-1.3 to +1.3
		Sample Rate (GS/s)	<ul style="list-style-type: none"> 6.25 12.5 25 50
		Trigger Type: Transition	<ul style="list-style-type: none"> Source: Dp, Dn, Clkp, Clkn Slope: Positive, Negative, Either Transition: Greater Than, Less Than Delta Time: 500, 250 Qualify: Occurs, Logic Lower Level: 0.05 Upper Level: 1
		Trigger Type: Edge	<ul style="list-style-type: none"> Source: Dp, Dn, Clkp, Clkn Slope: Positive, Negative, Either Level: 0 to 1 V
		Trigger Type: Width	<ul style="list-style-type: none"> Source: Dp, Dn, Clkp, Clkn Polarity: Positive, Negative Lower Limit: 25 μs Upper Limit: 300 μs
Record Length	<ul style="list-style-type: none"> 100000 50000000 		

Test Name	Acquire Type	Parameter Name	Values
1.5.5 Initial HS Skew Calibration Burst (TSKEWCAL- SYNC, TSKEWCAL)	Data and Clock Lanes Acquisition with Data As Trigger Negative Slope_Init	Vertical Scale Data (mV)	<ul style="list-style-type: none"> • 10
		Vertical Scale Clock (mV)	<ul style="list-style-type: none"> • 500
		Vertical Offset (V)	-1.3 to +1.3
		Trigger Type: Transition	<ul style="list-style-type: none"> • Source: Dp, Dn, Clkp, Clkn • Slope: Positive, Negative, Either • Transition: Greater Than, Less Than • Delta Time: 500, 250 • Qualify: Occurs, Logic • Lower Level: 0.05 • Upper Level: 1
		Trigger Type: Edge	<ul style="list-style-type: none"> • Source: Dp, Dn, Clkp, Clkn • Slope: Positive, Negative, Either • Level: 0 to 1 V
		Trigger Type: Width	<ul style="list-style-type: none"> • Source: Dp, Dn, Clkp, Clkn • Polarity: Positive, Negative • Lower Limit: 25 μs • Upper Limit: 300 μs
		Sample Rate (GS/s)	<ul style="list-style-type: none"> • 6.25 • 12.5 • 25 • 50
		Record Length	<ul style="list-style-type: none"> • 100000 • 50000000

Test Name	Acquire Type	Parameter Name	Values
1.5.6 Periodic HS Skew Calibration Burst (TSKEWCAL-SYNC, TSKEWCAL)	Data and Clock Lanes Acquisition with Data As Trigger Negative Slope	Vertical Scale Data (mV)	<ul style="list-style-type: none"> • 10
		Vertical Scale Clock (mV)	<ul style="list-style-type: none"> • 500
		Vertical Offset (V)	-1.3 to +1.3
		Trigger Type: Transition	<ul style="list-style-type: none"> • Source: Dp, Dn, Clkp, Clkn • Slope: Positive, Negative, Either • Transition: Greater Than, Less Than • Delta Time: 500, 250 • Qualify: Occurs, Logic • Lower Level: 0.05 • Upper Level: 1
		Trigger Type: Edge	<ul style="list-style-type: none"> • Source: Dp, Dn, Clkp, Clkn • Slope: Positive, Negative, Either • Level: 0 to 1 V
		Trigger Type: Width	<ul style="list-style-type: none"> • Source: Dp, Dn, Clkp, Clkn • Polarity: Positive, Negative • Lower Limit: 25 μs • Upper Limit: 300 μs
		Sample Rate (GS/s)	<ul style="list-style-type: none"> • 6.25 • 12.5 • 25 • 50
Record Length	<ul style="list-style-type: none"> • 100000 • 50000000 		

Test Name	Acquire Type	Parameter Name	Values
1.5.7 HS-TX Data and Clock Eye Diagram	Data and Clock Lanes Acquisition with Data As Trigger_Eye_Diagram	Vertical Scale Data (mV)	<ul style="list-style-type: none"> • 10
		Vertical Scale Clock (mV)	<ul style="list-style-type: none"> • 500
		Vertical Offset (V)	-1.3 to +1.3
		Sample Rate (GS/s)	<ul style="list-style-type: none"> • 6.25 • 12.5 • 25 • 50
		Trigger Type: Edge	<ul style="list-style-type: none"> • Source: Dp, Dn, Clkp, Clkn • Slope: Positive, Negative, Either • Level: 0 to 1 V
		Trigger Type: Width	<ul style="list-style-type: none"> • Source: Dp, Dn, Clkp, Clkn • Polarity: Positive, Negative • Lower Limit: 25 μs • Upper Limit: 300 μs
		Trigger Type: Transition	<ul style="list-style-type: none"> • Source: Dp, Dn, Clkp, Clkn • Slope: Positive, Negative, Either • Transition: Greater Than, Less Than • Delta Time: 500, 250 • Qualify: Occurs, Logic • Lower Level: 0.05 • Upper Level: 1
		Number of UI	<ul style="list-style-type: none"> • 100000 • 3000000

Test Name	Acquire Type	Parameter Name	Values
1.5.8 Alternate Calibration Sequence (TALTCAL-SYNC, TALTCAL)	Data and Clock Lanes Acquisition with Data As Trigger_ALTCAL	Vertical Scale Data (mV)	<ul style="list-style-type: none"> • 10
		Vertical Scale Clock (mV)	<ul style="list-style-type: none"> • 500
		Vertical Offset (V)	-1.3 to +1.3
		Record Length	<ul style="list-style-type: none"> • 100000 • 50000000
		Trigger Type: Width	<ul style="list-style-type: none"> • Source: Dp, Dn, Clkp, Clkn • Polarity: Positive, Negative • Lower Limit: 25 μs • Upper Limit: 300 μs
		Trigger Type: Transition	<ul style="list-style-type: none"> • Source: Dp, Dn, Clkp, Clkn • Slope: Positive, Negative, Either • Transition: Greater Than, Less Than • Delta Time: 500, 250 • Qualify: Occurs, Logic • Lower Level: 0.05 • Upper Level: 1
		Sample Rate (GS/s)	<ul style="list-style-type: none"> • 6.25 • 12.5 • 25 • 50
		Trigger Type: Edge	<ul style="list-style-type: none"> • Source: Dp, Dn, Clkp, Clkn • Slope: Positive, Negative, Either • Level: 0 to 1 V

Test Name	Acquire Type	Parameter Name	Values
1.5.9 Preamble Sequence (TPREAMBLE, TEXTSYNC)	Data and Clock Lanes Acquisition with Data As Trigger_PREAMBLE	Vertical Scale Data (mV)	<ul style="list-style-type: none"> • 10
		Vertical Scale Clock (mV)	<ul style="list-style-type: none"> • 500
		Vertical Offset (V)	-1.3 to +1.3
		Sample Rate (GS/s)	<ul style="list-style-type: none"> • 6.25 • 12.5 • 25 • 50
		Trigger Type: Width	<ul style="list-style-type: none"> • Source: Dp, Dn, Clkp, Clkn • Polarity: Positive, Negative • Lower Limit: 25 μs • Upper Limit: 300 μs
		Trigger Type: Transition	<ul style="list-style-type: none"> • Source: Dp, Dn, Clkp, Clkn • Slope: Positive, Negative, Either • Transition: Greater Than, Less Than • Delta Time: 500, 250 • Qualify: Occurs, Logic • Lower Level: 0.05 • Upper Level: 1
		Record Length	<ul style="list-style-type: none"> • 100000 • 50000000
		Trigger Type: Edge	<ul style="list-style-type: none"> • Source: Dp, Dn, Clkp, Clkn • Slope: Positive, Negative, Either • Level: 0 to 1 V

Test Name	Acquire Type	Parameter Name	Values
1.5.10 Clock and Data Lane TX HS-Idle: THS-IDLE-POST, THS-IDLE-CLKHS0, THS-IDLE-PRE Values	Data and Clock Lanes Acquisition with Data As Trigger_THS_IDLE	Vertical Scale Data (mV)	<ul style="list-style-type: none"> • 10
		Vertical Scale Clock (mV)	<ul style="list-style-type: none"> • 500
		Vertical Offset (V)	-1.3 to +1.3
		Trigger Type: Edge	<ul style="list-style-type: none"> • Source: Dp, Dn, Clkp, Clkn • Slope: Positive, Negative, Either • Level: 0 to 1 V
		Trigger Type: Width	<ul style="list-style-type: none"> • Source: Dp, Dn, Clkp, Clkn • Polarity: Positive, Negative • Lower Limit: 25 μs • Upper Limit: 300 μs
		Trigger Type: Transition	<ul style="list-style-type: none"> • Source: Dp, Dn, Clkp, Clkn • Slope: Positive, Negative, Either • Transition: Greater Than, Less Than • Delta Time: 500, 250 • Qualify: Occurs, Logic • Lower Level: 0.05 • Upper Level: 1
		Record Length	<ul style="list-style-type: none"> • 100000 • 50000000
Sample Rate (GS/s)	<ul style="list-style-type: none"> • 6.25 • 12.5 • 25 • 50 		

Test Name	Acquire Type	Parameter Name	Values
1.6.1 INIT LP-TX Initialization Period (TINIT,MASTER)	Data and Clock Lanes Acquisition In Escape Mode with Data As Trigger6_1	Vertical Scale Data (mV)	<ul style="list-style-type: none"> • 10
		Vertical Scale Clock (mV)	<ul style="list-style-type: none"> • 500
		Vertical Offset (V)	-1.3 to +1.3
		Sample Rate (GS/s)	<ul style="list-style-type: none"> • 3.125 • 6.25 • 12.5 • 25 • 50
		Trigger Type: Transition	<ul style="list-style-type: none"> • Source: Dp, Dn, Clkp, Clkn • Slope: Positive, Negative, Either • Transition: Greater Than, Less Than • Delta Time: 500, 250 • Qualify: Occurs, Logic • Lower Level: 0.05 • Upper Level: 1
		Trigger Type: Edge	<ul style="list-style-type: none"> • Source: Dp, Dn, Clkp, Clkn • Slope: Positive, Negative, Either • Level: 0 to 1 V
		Trigger Type: Width	<ul style="list-style-type: none"> • Source: Dp, Dn, Clkp, Clkn • Polarity: Positive, Negative • Lower Limit: 25 μs • Upper Limit: 300 μs
		Record Length	<ul style="list-style-type: none"> • 100000 • 50000000

Test Name	Acquire Type	Parameter Name	Values
1.6.2 ULPS Entry Verification of Clock Lane LP-TX ULPS support	Clock Lanes Acquisition In Escape Mode with Clock As Trigger	Vertical Scale Data (mV)	<ul style="list-style-type: none"> • 10
		Vertical Scale Clock (mV)	<ul style="list-style-type: none"> • 500
		Vertical Offset (V)	-1.3 to +1.3
		Trigger Type: Transition	<ul style="list-style-type: none"> • Source: Dp, Dn, Clkp, Clkn • Slope: Positive, Negative, Either • Transition: Greater Than, Less Than • Delta Time: 500, 250 • Qualify: Occurs, Logic • Lower Level: 0.05 • Upper Level: 1
		Trigger Type: Edge	<ul style="list-style-type: none"> • Source: Dp, Dn, Clkp, Clkn • Slope: Positive, Negative, Either • Level: 0 to 1 V
		Trigger Type: Width	<ul style="list-style-type: none"> • Source: Dp, Dn, Clkp, Clkn • Polarity: Positive, Negative • Lower Limit: 25 μs • Upper Limit: 300 μs
		Sample Rate (GS/s)	<ul style="list-style-type: none"> • 3.125 • 6.25 • 12.5 • 25 • 50
		Record Length	<ul style="list-style-type: none"> • 100000 • 50000000

Test Name	Acquire Type	Parameter Name	Values
1.6.3 ULPS Exit Transmitted TWAKEUP Interval	Data and Clock Lanes Acquisition in Escape Mode with Data As Trigger6_3	Vertical Scale Data (mV)	<ul style="list-style-type: none"> • 10
		Vertical Scale Clock (mV)	<ul style="list-style-type: none"> • 500
		Vertical Offset (V)	-1.3 to +1.3
		Trigger Type: Transition	<ul style="list-style-type: none"> • Source: Dp, Dn, Clkp, Clkn • Slope: Positive, Negative, Either • Transition: Greater Than, Less Than • Delta Time: 500, 250 • Qualify: Occurs, Logic • Lower Level: 0.05 • Upper Level: 1
		Trigger Type: Edge	<ul style="list-style-type: none"> • Source: Dp, Dn, Clkp, Clkn • Slope: Positive, Negative, Either • Level: 0 to 1 V
		Trigger Type: Width	<ul style="list-style-type: none"> • Source: Dp, Dn, Clkp, Clkn • Polarity: Positive, Negative • Lower Limit: 25 μs • Upper Limit: 300 μs
		Sample Rate (GS/s)	<ul style="list-style-type: none"> • 3.125 • 6.25 • 12.5 • 25 • 50
		Record Length	<ul style="list-style-type: none"> • 100000 • 50000000

Test Name	Acquire Type	Parameter Name	Values
1.6.4 BTA TX-Side TTA-GO Interval Value 1.6.5 BTA RX-Side TTA-SURE Interval Value 1.6.6 BTA RX-Side TTA-GET Interval Value	Data and Clock Lanes Acquisition in Escape Mode with Data As Trigger6_4to6	Vertical Scale Data (mV)	• 10
		Vertical Scale Clock (mV)	• 500
		Vertical Offset (V)	-1.3 to +1.3
		Sample Rate (GS/s)	• 3.125 • 6.25 • 12.5 • 25 • 50
		Trigger Type: Transition	• Source: Dp, Dn, Clkp, Clkn • Slope: Positive, Negative, Either • Transition: Greater Than, Less Than • Delta Time: 500, 250 • Qualify: Occurs, Logic • Lower Level: 0.05 • Upper Level: 1
		Trigger Type: Edge	• Source: Dp, Dn, Clkp, Clkn • Slope: Positive, Negative, Either • Level: 0 to 1 V
		Trigger Type: Width	• Source: Dp, Dn, Clkp, Clkn • Polarity: Positive, Negative • Lower Limit: 25 μ s • Upper Limit: 300 μ s
		Record Length	• 100000 • 50000000

Examples

This section provides the examples for the SCPI commands.

Example	Description
TEKEXP : *IDN?	It returns the active TekExpress application name running on the oscilloscope.
TEKEXP : *OPC?	It returns the last command execution status, if status is executed it returns "1" else "0".
TEKEXP : ACQUIRE_MODE PRE-RECORDED	It sets the acquire mode as pre-recorded.

Table continued...

Example	Description
TEKEXP:ACQUIRE_MODE?	It returns LIVE when acquire mode is set to live or it returns pre-recorded when acquire mode is set to pre-recorded.
TEKEXP:INFO? REPORT	It returns "100,ReportFileName.mht", when 100 is the file size in bytes for the filename ReportFileName.
TEKEXP:INFO? WFM	It returns "100,"WfmFileName1.wfm";"200,"WfmFileName2.wfm" when 100 is the filesize in bytes for the filename WfmFileName1.wfm and 200 is the file size in bytes for the filename WfmFileName2.wfm.
TEKEXP:INSTRUMENT "Real Time Scope",DPO73304SX (GPIB8::1::INSTR)	It sets the instrument value as DPO73304SX(GPIB8::1::INSTR) for the selected instrument type Real Time Scope.
TEKEXP:INSTRUMENT? "Real Time Scope"	It returns "DPO73304SX(GPIB8::1::INSTR), when DPO73304SX (GPIB8::1::INSTR)" is the selected instrument for the instrument type Real Time Scope.
TEKEXP:LASTERROR?	It returns ERROR: INSTRUMENT_NOT_FOUND, when no instrument is found.
TEKEXP:LIST? DEVICE	It returns "D-PHY".
TEKEXP:LIST? INSTRUMENT,"Real Time Scope"	It returns "DPO73304SX (GPIB8::1::INSTR), DPO73304DX (TCPIP:: 134.64.248.91::INSTR)" when DPO73304SX (GPIB8::1::INSTR), DPO73304DX (TCPIP::134.64.248.91::INSTR) are the list of available instruments.
TEKEXP:MODE COMPLIANCE	It sets the execution mode as compliance or User Defined.
TEKEXP:MODE?	It returns COMPLIANCE when the execution mode is compliance or it returns USER-DEFINED when the execution mode is user defined.
TEKEXP:POPOP OK	It sets OK as the response to active popup in the application.
TEKEXP:POPOP?	It returns "OK", when OK is the active popup information shown in the application.
TEKEXP:REPORT GENERATE	It generates report for the current session.
TEKEXP:REPORT? "Scope Model Number"	Returns "DPO73304SX" when DPO73304SX is the oscilloscope model.
TEKEXP:REPORT? DUT ID	It returns "DUT001" when DUT001 is the DUT ID.
TEKEXP:RESULT? "1.1.1 Data Lane LP-TX Thevenin Output High Level Voltage (VOH) "	It returns Pass when the test result is Pass.
TEKEXP:RESULT? "1.1.1 Data Lane LP-TX Thevenin Output High Level Voltage (VOH) ", "Margin",1	It returns the 2nd Sub measurements Margin L and H values.
TEKEXP:SELECT? DEVICE	It returns "D-PHY" when query.
TEKEXP:SETUP DEFAULT	It restores the application to default setup.
TEKEXP:STATE STOP	It stops the test execution.
TEKEXP:STATE?	It returns as READY when the application is ready to run next measurement.

Table continued...

Example	Description
TEKEXP:STATE? SETUP	It returns as NOT_SAVED when the current setup is not saved else it returns SAVED.
TEKEXP:VALUE GENERAL, "Test Mode", "Escape"	It sets the Test Mode parameter value to Escape .
TEKEXP:VALUE? GENERAL, "Test Mode"	It returns "Escape" when Escape is the Test Mode value.
TEKEXP:SELECT TEST , "1.1.1 Data Lane LP-TX Thevenin Output High Level Voltage (VOH) ", True	Execute this command to select an individual test. This command will select "1.1.1 Data Lane LP-TX Thevenin Output High Level Voltage (VOH)" test in the Signal Test tab.
TEKEXP:VALUE ACQUIRE, "1.1.1 Data Lane LP-TX Thevenin Output High Level Voltage (VOH) ", "Data Lanes Acquisition In Escape Mode with Data As Trigger", "Sample Rate (GS/s) ", 12.5	It sets Sample Rate Parameter value to 12.5.
TEKEXP:VALUE? ACQUIRE, "1.1.1 Data Lane LP-TX Thevenin Output High Level Voltage (VOH) ", "Data Lanes Acquisition In Escape Mode with Data As Trigger", "Sample Rate (GS/s) "	It returns the value of Sample Rate,

References

Pre-recorded waveform file names for test measurements

The following table specifies the waveforms to load for the selected Acquire Type.

Acquire Type	Waveforms to be loaded
Data Lanes Acquisition In Escape Mode with Data As Trigger	DP and DN waveforms captured in escape mode. <ul style="list-style-type: none"> • Lane X..._DP.wfm • Lane X..._DN.wfm
Clock Lanes Acquisition In Escape Mode with Clock As Trigger	Clkp (or CP) and Clkn (or CN) waveforms captured in escape mode. <ul style="list-style-type: none"> • Clock..._Clkp.wfm • Clock..._Clkn.wfm
Data and Clock Lanes Acquisition with Data As Trigger	DP, DN, Clkp (or CP) and Clkn (or CN) waveforms captured in normal mode <ul style="list-style-type: none"> • Lane X..._DP.wfm • Lane X..._DN.wfm • Lane X..._Clkp.wfm • Lane X..._Clkn.wfm
Clock Lanes Acquisition with Clock As Trigger	Clkp (or CP) and Clkn (or CN) waveforms captured in normal mode. <ul style="list-style-type: none"> • Clock..._Clkp.wfm • Clock..._Clkn.wfm
Data and Clock Lanes Acquisition In Escape Mode with Data As Trigger6_1	DP, DN, Clkp (or CP) and Clkn (or CN) waveforms <ul style="list-style-type: none"> • Lane X..._DP.wfm • Lane X..._DN.wfm • Lane X..._Clkp.wfm • Lane X..._Clkn.wfm
Data and Clock Lanes Acquisition in Escape Mode with Data As Trigger6_3	DP, DN, Clkp (or CP) and Clkn (or CN) waveforms <ul style="list-style-type: none"> • Lane X..._DP.wfm • Lane X..._DN.wfm • Lane X..._Clkp.wfm • Lane X..._Clkn.wfm

Table continued...

Acquire Type	Waveforms to be loaded
Data and Clock Lanes Acquisition in Escape Mode with Data As Trigger6_4to6	DP, DN, Clkp (or CP) and Clkn (or CN) waveforms <ul style="list-style-type: none"> • Lane X_..._DP.wfm • Lane X_..._DN.wfm • Lane X_..._Clkp.wfm • Lane X_..._Clkn.wfm
Data and Clock Lanes Acquisition with Data As Trigger Negative_Slope_int	DP, DN, Clkp (or CP) and Clkn (or CN) waveforms <ul style="list-style-type: none"> • Lane X_..._DP.wfm • Lane X_..._DN.wfm • Lane X_..._Clkp.wfm • Lane X_..._Clkn.wfm
Data and Clock Lanes Acquisition with Data As Trigger Negative_Slope	DP, DN, Clkp (or CP) and Clkn (or CN) waveforms <ul style="list-style-type: none"> • Lane X_..._DP.wfm • Lane X_..._DN.wfm • Lane X_..._Clkp.wfm • Lane X_..._Clkn.wfm
Clock Lanes Acquisition with Clock As Trigger and SSC	Clkp (or CP) and Clkn (or CN) waveforms captured in normal mode. <ul style="list-style-type: none"> • Clock_..._Clkp.wfm • Clock_..._Clkn.wfm
Data and Clock Lanes Acquisition with Data As Trigger Eye_Diagram	DP, DN, Clkp (or CP) and Clkn (or CN) waveforms <ul style="list-style-type: none"> • Lane X_..._DP.wfm • Lane X_..._DN.wfm • Lane X_..._Clkp.wfm • Lane X_..._Clkn.wfm
Data and Clock Lanes Acquisition with Data As Trigger_ALTCAL	DP, DN, Clkp (or CP) and Clkn (or CN) waveforms <ul style="list-style-type: none"> • Lane X_..._DP.wfm • Lane X_..._DN.wfm • Lane X_..._Clkp.wfm • Lane X_..._Clkn.wfm
Data and Clock Lanes Acquisition with Data As Trigger_PREAMBLE	DP, DN, Clkp (or CP) and Clkn (or CN) waveforms <ul style="list-style-type: none"> • Lane X_..._DP.wfm • Lane X_..._DN.wfm • Lane X_..._Clkp.wfm • Lane X_..._Clkn.wfm

Table continued...

Acquire Type	Waveforms to be loaded
Data and Clock Lanes Acquisition with Data As Trigger_THS_IDLE	DP, DN, Clkp (or CP) and Clkn (or CN) waveforms <ul style="list-style-type: none"> • Lane X_..._DP.wfm • Lane X_..._DN.wfm • Lane X_..._Clkp.wfm • Lane X_..._Clkn.wfm

Manual Deskew Procedure

Check the calibration status of the oscilloscope before performing the deskew procedure, for better performance. If the oscilloscope requires calibration or the probe requires compensation, perform the below steps before deskewing the probes.

Follow the steps to connect the probes and oscilloscope to the fixture:

1. Perform Signal Path Compensation (SPC) before you connect the probes.
 - a. Touch the Utilities button to display the Instrument Calibration menu.
 - b. Touch the Instrument Calibration menu to display the Calibration Instructions menu.
 - c. Touch Calibrate to perform the Signal Path Compensation.

To check the calibration status of the probe, perform the following steps:

1. Select Probe Calibration from the Vertical menu.
2. Select the channel to which the probe is attached and then check the Probe Status readout. There are three possible values for the status:
 - a. **Initialized.** The probe has not been calibrated on the selected channel perform the DC probe calibration procedure.
 - b. **Compensated.** The probe has been calibrated on the selected channel.
 - c. **Fail.** The probe has not been calibrated; repeat the procedure.

Deskew Function

The deskew function compensates for signal delays that occur between probes due to different tips or cable lengths. The oscilloscope deskew feature applies deskew values after it completes each acquisition. The deskew values do not affect logic triggering.

Steps:

1. From the TekScope menu, select **Vertical > Deskew**.
2. Set the Deskew value to 0.0s for all the channels
3. Make the connection accordingly as shown.

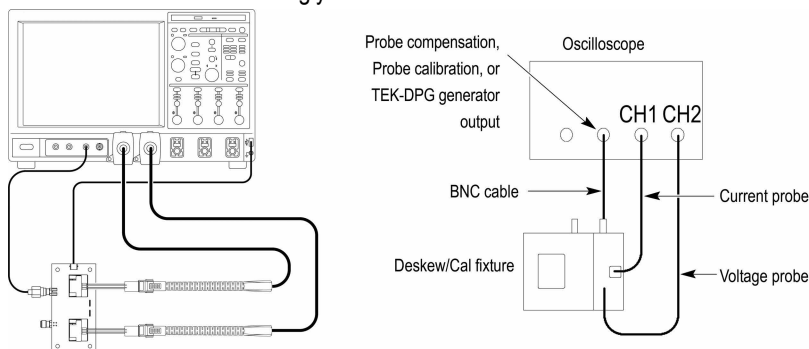

0514-014

4. Turn on the 2 channels on the scope with some signals.
5. Adjust the vertical SCALE, POSITION, and OFFSET for each channel so that signals from the first and second channel overlap and are centred on screen.
6. Adjust the horizontal SCALE and horizontal POSITION so the differences in the channel delays are clearly visible. The waveforms on the screen should look similar to the following figure.



Note: Note the delay between the two edges.



7. Select Deskew from the Vertical menu.
8. Adjust the deskew time for that channel so that its signal aligns with that of the reference channel. When the signals are aligned, they should look like the following figure:

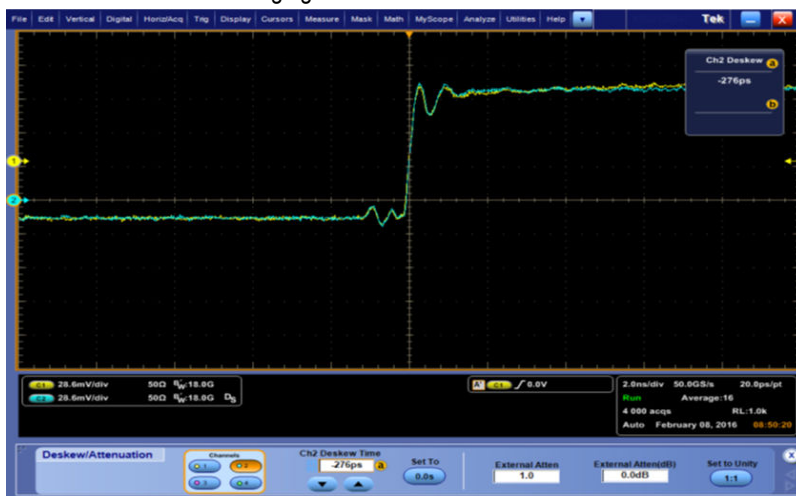

9. Repeat the preceding steps for each additional channel that need to deskew.

TekExpress D-PHY provides support for channel deskew and attenuation using the following method:

- Determine what the skew is for each channel.
- From the TekScope menu, select **Vertical > Deskew**.
- In the Deskew/Attenuation window, click the channel (1 – 4) button for the first channel to be deskewed.
- Click in the Ch(x) Deskew Time entry field and enter the skew. The skew can be +ve or –ve
- Click the channel button for the next channel and repeat step 5 for each input channel.

D-PHY Measurements and Test Modes

The following table specifies the list of data rate, clock lane probing, and clock mode supported for different tests.

Clock Lane Probing	SingleEnded		Differential		Data rate Supported			
	Normal	Continuous	Normal	Continuous	<= 1G	>1 & <= 1.5	>1.5 & < 2.5	> 2.5
Clock Mode	Normal	Continuous	Normal	Continuous	<= 1G	>1 & <= 1.5	>1.5 & < 2.5	> 2.5
Test Name								
Group 1								
Test 1.1.1 – Data Lane LP-TX Thevenin Output High Level Voltage (VOH)	√	x	x	x	√	√	√	√
Test 1.1.2 – Data Lane LP-TX Thevenin Output Low Level Voltage (VOL)	√	x	x	x	√	√	√	√
Test 1.1.3 – Data Lane LP-TX 15%-85% Rise Time (TRLP)	√	x	x	x	√	√	√	√
Test 1.1.4 – Data Lane LP-TX 15%-85% Fall Time (TFLP)	√	x	x	x	√	√	√	√
Test 1.1.5 – Data Lane LP-TX Slew Rate vs. CLOAD ($\delta V/\delta tSR$)	√	x	x	x	√	√	√	√
Test 1.1.6 – Data Lane LP-TX Pulse Width of Exclusive-OR Clock (TLP-PULSE-TX)	√	x	x	x	√	√	√	√
Test 1.1.7 – Data Lane LP-TX Period of Exclusive-OR Clock (TLP-PER-TX)	√	x	x	x	√	√	√	√
Group 2								
Test 1.2.1 – Clock Lane LP-TX Thevenin Output High Level Voltage (VOH)	√	x	x	x	√	√	√	√
Test 1.2.2 – Clock Lane LP-TX Thevenin Output Low Level Voltage (VOL)	√	x	x	x	√	√	√	√
Test 1.2.3 – Clock Lane LP-TX 15%-85% Rise Time (TRLP)	√	x	x	x	√	√	√	√
Test 1.2.4 – Clock Lane LP-TX 15%-85% Fall Time (TFLP)	√	x	x	x	√	√	√	√
Test 1.2.5 – Clock Lane LP-TX Slew Rate vs. CLOAD ($\delta V/\delta tSR$)	√	x	x	x	√	√	√	√
Group 3								
Test 1.3.1 – Data Lane HS Entry: Data Lane TLPX Value	√	√	x	x	√	√	√	√
Test 1.3.2 – Data Lane HS Entry: THS-PREPARE Value	√	√	√	√	√	√	√	√
Test 1.3.3 – Data Lane HS Entry: THS-PREPARE + THS-ZERO Value	√	√	√	√	√	√	√	√
Test 1.3.4 – Data Lane HS-TX Differential Voltages (VOD(0), VOD(1))	√	√	√	√	√	√	√	√
Test 1.3.5 – Data Lane HS-TX Differential Voltage Mismatch (ΔVOD)	√	√	√	√	√	√	√	√

Table continued...

Clock Lane Probing	SingleEnded		Differential		Data rate Supported			
	Normal	Continuous	Normal	Continuous	<= 1G	>1 & <= 1.5	>1.5 & < 2.5	> 2.5
Test 1.3.7 – Data Lane HS-TX Static Common-Mode Voltages (VCMTX(1), VCMTX(0))	√	√	x	x	√	√	√	√
Test 1.3.8 – Data Lane HS-TX Static Common-Mode Voltage Mismatch ($\Delta V_{CMTX(1,0)}$)	√	√	√	√	√	√	√	√
Test 1.3.9 – Data Lane HS-TX Dynamic Common-Level Variations Between 50-450MHz ($\Delta V_{CMTX(LF)}$)	√	√	√	√	√	√	√	√
Test 1.3.10 – Data Lane HS-TX Dynamic Common-Level Variations Above 450MHz ($\Delta V_{CMTX(HF)}$)	√	√	√	√	√	√	√	√
Test 1.3.11 – Data Lane HS-TX 20%-80% Rise Time (t_R)	√	√	√	√	√	√	√	√
Test 1.3.12 – Data Lane HS-TX 80%-20% Fall Time (t_F)	√	√	√	√	√	√	√	√
Test 1.3.13 – Data Lane HS Exit: $T_{HS-TRAIL}$ Value	√	√	√	√	√	√	√	√
Test 1.3.14 – Data Lane HS Exit: 30%-85% Post-EoT Rise Time (T_{REOT})	√	√	√	√	√	√	√	√
Test 1.3.15 – Data Lane HS Exit: T_{EOT} Value	√	√	√	√	√	√	√	√
Test 1.3.16 – Data Lane HS Exit: $T_{HS-EXIT}$ Value	√	√	√	√	√	√	√	√
Group 4								
Test 1.4.1 – Clock Lane HS Entry: T_{LPX} Value	√	x	x	x	√	√	√	√
Test 1.4.2 – Clock Lane HS Entry: $T_{CLK-PREPARE}$ Value	√	x	x	x	√	√	√	√
Test 1.4.3 – Clock Lane HS Entry: $T_{CLK-PREPARE} + T_{CLK-ZERO}$ Value	√	x	x	x	√	√	√	√
Test 1.4.4 – Clock Lane HS-TX Differential Voltages (VOD(0), VOD(1))	√	√	√	√	√	√	√	√
Test 1.4.5 – Clock Lane HS-TX Differential Voltage Mismatch (ΔV_{OD})	√	√	√	√	√	√	√	√
Test 1.4.6 – Clock Lane HS-TX Single-Ended Output High Voltages (VOHHS(DP), VOHHS(DN))	√	√	x	x	√	√	√	√
Test 1.4.7 – Clock Lane HS-TX Static Common-Mode Voltages (VCMTX(1), VCMTX(0))	√	√	x	x	√	√	√	√
Test 1.4.8 – Clock Lane HS-TX Static Common-Mode Voltage Mismatch ($\Delta V_{CMTX(1,0)}$)	√	√	x	x	√	√	√	√
Test 1.4.9 – Clock Lane HS-TX Dynamic Common-Level Variations Between 50-450MHz ($\Delta V_{CMTX(LF)}$)	√	√	x	x	√	√	√	√

Table continued...

Clock Lane Probing	SingleEnded		Differential		Data rate Supported			
	Normal	Continuous	Normal	Continuous	<= 1G	>1 & <= 1.5	>1.5 & < 2.5	> 2.5
Test 1.4.10 – Clock Lane HS-TX Dynamic Common-Level Variations Above 450MHz (Δ VCMX(HF))	√	√	x	x	√	√	√	√
Test 1.4.11 – Clock Lane HS-TX 20%-80% Rise Time (t_R)	√	√	√	√	√	√	√	√
Test 1.4.12 – Clock Lane HS-TX 80%-20% Fall Time (t_F)	√	√	√	√	√	√	√	√
Test 1.4.13 – Clock Lane HS Exit: $T_{CLK-TRAIL}$ Value	√	x	x	x	√	√	√	√
Test 1.4.14 – Clock Lane HS Exit: 30%-85% Post-EoT Rise Time (T_{REOT})	√	x	x	x	√	√	√	√
Test 1.4.15 – Clock Lane HS Exit: TEOT Value	√	x	x	x	√	√	√	√
Test 1.4.16 – Clock Lane HS Exit: THS-EXIT Value	√	x	x	x	√	√	√	√
Test 1.4.17 – Clock Lane HS Clock Instantaneous UI (UIINST)	√	√	√	√	√	√	√	√
Test 1.4.18 – Clock Lane HS Clock Delta UI (Δ UI)	√	√	√	√	√	√	√	√
Test 1.4.19 TX Spread Spectrum Clocking (SSC) Requirements	√	√	√	√	x	x	x	√
Test 1.4.20 Clock Lane HS Clock Period Jitter	√	√	√	√	x	x	x	√
Group 5								
Test 1.5.1 – HS Entry: $T_{CLK-PRE}$ Value	√	x	√	x	√	√	√	√
Test 1.5.2 – HS Exit: $T_{CLK-POST}$ Value	√	x	√	x	√	√	√	√
Test 1.5.3 – HS Clock Rising Edge Alignment to First Payload Bit	√	x	x	x	√	√	√	√
Test 1.5.4 Data-to-Clock Skew (TSKEW[TX])	√	√	√	√	√	√	√	√
Test 1.5.5 – Initial HS Skew Calibration Burst (TSKEWCAL-SYNC, TSKEWCAL)	√	√	√	√	x	x	√	√
Test 1.5.6 – Periodic HS Skew Calibration Burst (TSKEWCAL-SYNC, TSKEWCAL)	√	√	√	√	x	x	√	√
Test 1.5.7 HS -TX Data and Clock Eye Diagram	√	√	√	√	x	x	x	√
Test 1.5.8 - Alternate Calibration Sequence (TALTCAL-SYNC, TALTCAL)	√	√	√	√	x	x	x	√
Test 1.5.9 - Preamble Sequence (TPREAMBLE, TEXTSYNC)	√	√	√	√	x	x	x	√
Test 1.5.10 - TX HS-Idle: THS-IDLE-POST, THS-IDLE-CLKHS0, THS-IDLE-PRE Values	√	√	√	√	x	x	x	√
Group 6								
Table continued...								

Clock Lane Probing	SingleEnded		Differential		Data rate Supported			
	Normal	Continuous	Normal	Continuous	<= 1G	>1 & <= 1.5	>1.5 & < 2.5	> 2.5
Test 1.6.1 – INIT: LP-TX Initialization Period ($T_{INIT,MASTER}$)	√	x	x	x	√	√	√	√
Test 1.6.2 – ULPS Entry: Verification of Clock Lane LP-TX ULPS support	√	x	x	x	√	√	√	√
Test 1.6.3 – ULPS Exit: Transmitted T_{WAKEUP} Interval	√	x	x	x	√	√	√	√
Test 1.6.4 – BTA: TX-Side T_{TA-GO} Interval Value	√	x	x	x	√	√	√	√
Test 1.6.5 – BTA: RX-Side $T_{TA-SURE}$ Interval Value	√	x	x	x	√	√	√	√
Test 1.6.6 – BTA: RX-Side T_{TA-GET} Interval Value	√	x	x	x	√	√	√	√

BTA Test Procedure

Test 1.6.4 BTA: TX-Side TTA-GO Interval Value

To verify that the DUT drives the Bridge state (LP-00) for the proper period (TTA-GO) when handing off control of the Link during a Link Turnaround procedure.

The following figure from the MIPI Alliance D-PHY is reproduced here for reference.

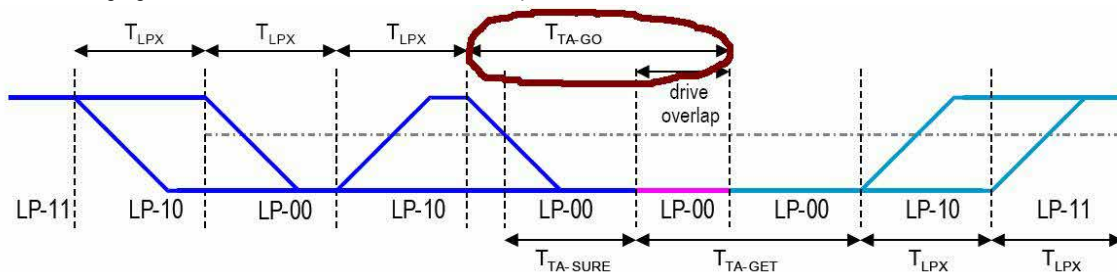

Procedure

1. Using DSO, Dp, Dn, Clkp, and Clkn signals with Turnaround sequence is captured from DUT.
2. The desired Link Turnaround sequence region is identified and recalled on DSO.
3. Place cursors on the required LP-00 region (tTA-GO) as specified in MIPI-DPHY CTS. The delta value between the cursors is reported as tTA-GO Interval.
4. TLPX Duration value is obtained which is updated in the report for reference under test comment as part of the observable result.

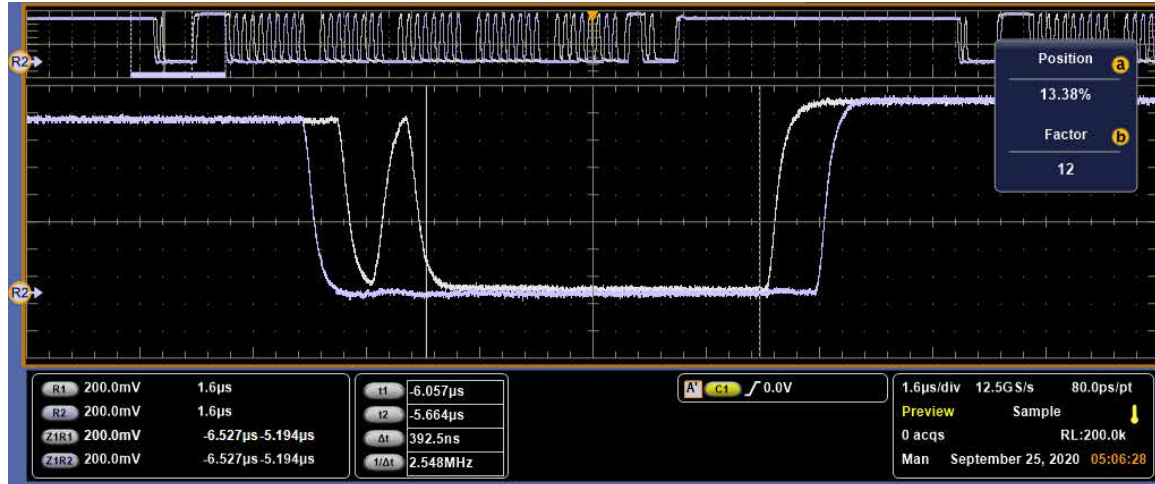

Observable Results

- Verify that the DUT's TTA-GO interval is greater than or equal to $4 \cdot T_{LPX}$ ns.

1.6.4 BTA TX-Side TTA-GO Interval Value								
Lane	Measurement Details	Measured Value	Units	Test Result	Margin	Low Limit	High Limit	Additional Information
Lane1	BTA TX-Side TTA-GO Interval = value1 * TLPX (ns)	392.5	ns	Pass	L:186.868ns	205.632	N.A	N.A
COMMENTS		TLPX Value: 51.408 ns						

Test 1.6.5 BTA: RX-Side TTA-SURE Interval Value

To verify that the DUT waits the required period (TTA-SURE) while observing the TX-Side Bridge state (LP-00) when receiving control of the Link during a Link Turnaround procedure.

The following figure from the MIPI Alliance D-PHY is reproduced here for reference.

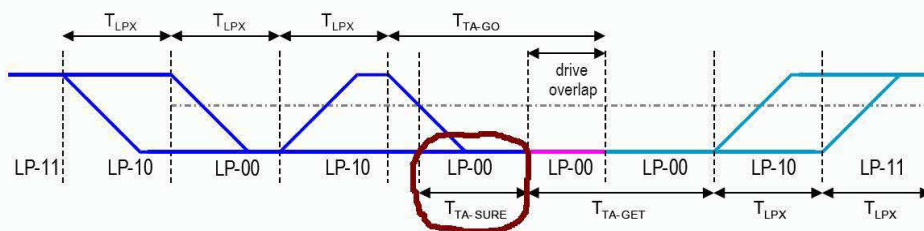

Procedure

- Using DSO, Dp, Dn, Clkp, and Clkn signals with Turnaround sequence is captured from DUT.
- The desired Link Turnaround sequence region is identified and recalled on DSO.
- Place cursors on the required LP-00 region ($t_{TA-SURE}$) as specified in MIPI-DPHY CTS. The delta value between the cursors is reported as $t_{TA-SURE}$ Interval.
- T_{LPX} Duration value is obtained which is updated in the report for reference under test comment as part of the observable result.

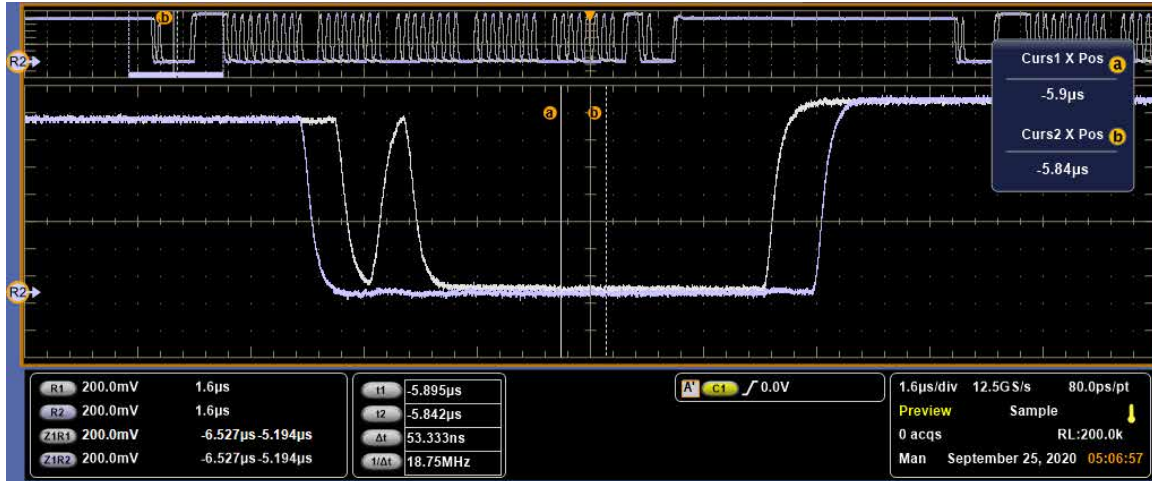

Observable Results

Verify that the TTA-SURE interval is between $1 \cdot T_{LPX}$ and $2 \cdot T_{LPX}$ ns.

Lane	Measurement Details	Measured Value	Units	Test Result	Margin	Low Limit	High Limit	Additional Information
Lane1	BTA RX-Side TTA-SURE Interval = (value1 +/- value2)*TLPX (ns)	53.3	ns	Pass	L:1.892ns H:49.516ns	51.408	102.816	N.A

COMMENTS: TLPX Value: 51.408 ns

Test 1.6.6 BTA: RX-Side TTA-GET Interval Value

To verify that the DUT drives the Bridge state (LP-00) for the required period (TTA-GET) when receiving control of the link during a Link Turnaround procedure.

The following figure from the MIPI Alliance D-PHY is reproduced here for reference

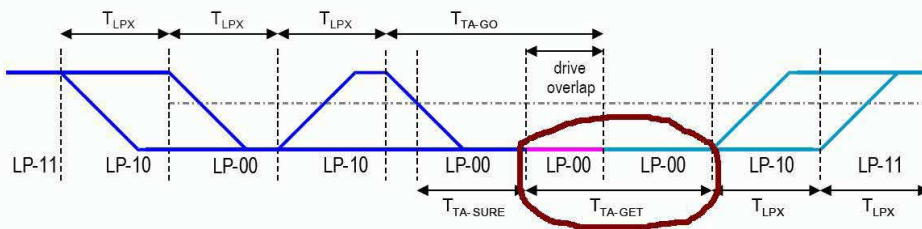

Procedure

- Using DSO, Dp, Dn, Clkp, and Clkn signals with Turnaround sequence is captured from DUT.
- The desired Link Turnaround sequence region is identified and recalled on DSO.
- Place cursors on the required LP-00 region (t_{TA-GET}) as specified in MIPI-DPHY CTS. The delta value between the cursors is reported as t_{TA-GET} Interval.
- T_{LPX} Duration value is obtained which is updated in the report for reference under test comment as part of the observable result.

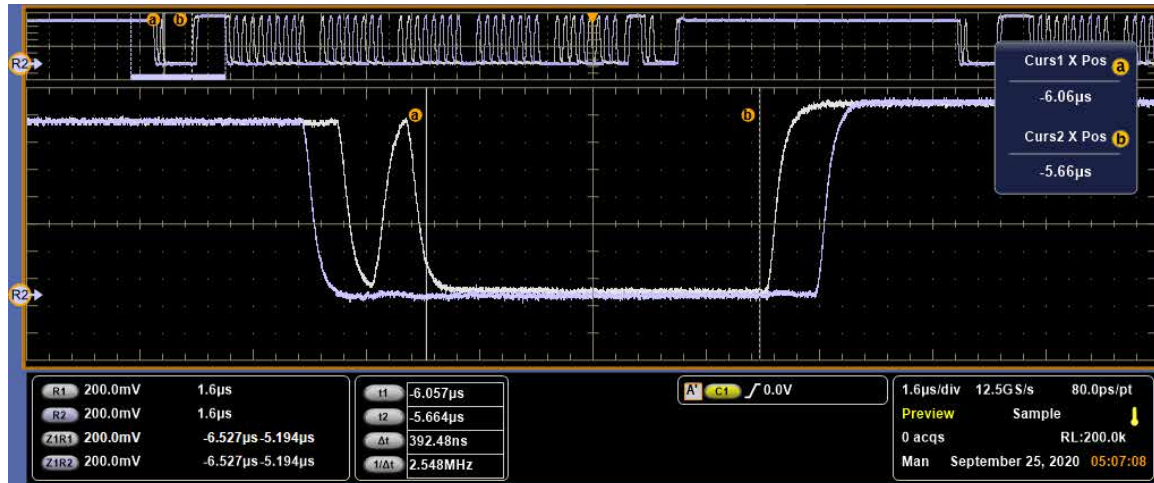

Observable Results

Verify that the TTA-GET interval is greater than or equal to $5 \cdot \text{TLPX}$ ns.

1.6.6 BTA RX-Side TTA-GET Interval Value								
Lane	Measurement Details	Measured Value	Units	Test Result	Margin	Low Limit	High Limit	Additional Information
Lane1	BTA RX-Side TTA-GET Interval = value1*TLPX (ns)	392.5	ns	Pass	L:135.460ns	257.04	N.A	N.A
COMMENTS		TLPX Value: 51.408 ns						

Index

A

- Acquire parameters
 - viewing in reports [44](#)
- Acquire Step by Step [28](#)
- Acquisition tab [28](#)
- Activate the TekExpress D-PHY license [14](#)
- Analysis options [35](#)
- Application panels overview [23](#)

B

- Bandwidth Limit
 - clock channels [25](#)
 - data channels [25](#)
- Button
 - clear log [37](#)
 - Email settings [35](#)
 - save [37](#)

C

- Clearing test results [51](#)
- Compensate the signal path [50](#)
- Configuration tab parameter
 - instruments detected [30](#)
- Configuration tab parameters
 - global settings [30](#)
- Configure report view settings [43](#)
- Connected instruments
 - searching for [20](#)
- Contacting Tektronix [11](#)
- Conventions [11](#)
- Create a test setup from default settings [53](#)
- Create a test setup using an existing one [54](#)

D

- Default directory usage [15](#)
- Directories and usage [15](#)
- DUT ID [25](#)
- DUT parameter
 - device [25](#)
 - device profile [25](#)
- DUT type
 - device [25](#)

E

- Email notification and setup [21](#)
- Exiting the application [18](#)

F

- File name extensions [16](#)

G

- Global controls [19](#)
- GPIO [20](#)

I

- Installing the software
 - switch matrix application [14](#)
- Instruments
 - discovering connected [20](#)
 - viewing connected [20](#)
- Instruments detected [30](#)

L

- LAN [20](#)
- Link Lane Setup [27](#)
- Live waveforms [25](#)
- Loading a test setup [53](#)
- Log view
 - save file [37](#)

M

- Menus
 - Options [19](#)
 - Preferences [51](#)
- My TekExpress folder
 - files stored in [40](#)

N

- Non-VISA [20](#)

O

- Opening a saved test setup [53](#)
- Option Installation wizard [14](#)
- Options menu
 - Instrument control settings [20](#)
- Oscilloscope compensation [50](#)

P

- Panels [23](#)
- Pattern [25](#)

- Pattern type [25](#)
- Pre-recorded waveform file names for test measurements [95](#)
- Preferences menu [38](#)
- Preferences tab
 - send an Email [35](#)
 - setup panel [35](#)

R

- Reactivate the TekExpress D-PHY license [14](#)
- Recalling a test setup [53](#)
- Recommended accessories [13](#)
- Recommended probes [14](#)
- Related Documentation [11](#)
- Report configuration settings [40](#)
- Report contents [44](#)
- Report sections [44](#)
- Reports
 - receiving in email notifications [21](#)
- Reports panel [23](#)
- Results panel
 - summary of test results [38](#)
 - test name [38](#)
- Results Panel [51](#)
- Run button [19](#)
- Running tests [51](#)

S

- Save log file [37](#)
- Saving tests [40](#)
- SCPI commands
 - Examples [92](#)
 - TEKEXP:*IDN? [61](#)
 - TEKEXP:*OPC? [61](#)
 - TEKEXP:ACQUIRE_MODE [62](#)
 - TEKEXP:ACQUIRE_MODE? [62](#)
 - TEKEXP:EXPORT [62](#)
 - TEKEXP:INFO? [62](#)
 - TEKEXP:INSTRUMENT [63](#)
 - TEKEXP:INSTRUMENT? [63](#)
 - TEKEXP:LASTERROR? [63](#)
 - TEKEXP:LIST? [64](#)
 - TEKEXP:POPUP [64](#)
 - TEKEXP:POPUP? [64](#)
 - TEKEXP:REPORT [65](#)
 - TEKEXP:REPORT? [65](#)
 - TEKEXP:RESULT? [65](#)
 - TEKEXP:SELECT [66](#)
 - TEKEXP:SELECT? [66](#)
 - TEKEXP:SETUP [66](#)
 - TEKEXP:STATE [67](#)
 - TEKEXP:STATE? [67](#)
 - TEKEXP:VALUE [67](#)
 - TEKEXP:VALUE? [68](#)

- Search for connected instruments [20](#)
- Selecting tests [27](#)
- Session folders and files [40](#)
- Setup
 - acquisition tab [28](#)
- Setup files [53](#)
- Setup panel [23](#)
- Show acquire parameters [28](#)
- Software installation
 - activate TekExpress D-PHY license [14](#)
 - switch matrix application [14](#)
- Source [25](#)
- Status panel
 - log view [37](#)
 - message history [37](#)
 - test status tab [37](#)
- Support [11](#)
- Supported oscilloscopes [13](#)

T

- Technical support [11](#)
- Tek Link [20](#)
- TekExpress D-PHY license activation [14](#)
- Test Name [28](#)
- Test reports [44](#)
- Test results
 - send by email [21](#)
- Test Results
 - clearing displayed [51](#)
- Test selection
 - TekExpress D-PHY [27](#)
 - test description [27](#)
- Test selection controls [27](#)
- Test setup files [40](#), [53](#)
- Test setups
 - load [53](#)
 - open [53](#)
 - recalling [53](#)
- Test status
 - acquire status [37](#)
 - analysis status [37](#)
 - auto scroll [37](#)
- Test-related files [40](#)
- Tests
 - running [51](#)
 - selecting [27](#)

V

- View a report [44](#)

W

- Waveform files

Waveform files (*continued*)
locating and storing [40](#)
Wavelength [25](#)