



**TekScope**  
**Programmer Manual**



077-1779-04





**TekScope**  
**Programmer Manual**

2024 Copyright © Tektronix. All rights reserved. Licensed software products are owned by Tektronix or its subsidiaries or suppliers, and are protected by national copyright laws and international treaty provisions.

Tektronix products are covered by U.S. and foreign patents, issued and pending. Information in this publication supersedes that in all previously published material. Specifications and price change privileges reserved.

TEKTRONIX and TEK are registered trademarks of Tektronix, Inc.

FlexChannel, FastFrame, OpenChoice, iView, Pinpoint, RT-Eye, TekVPI, FastAcq, and e\*Scope are registered trademarks of Tektronix, Inc.

TekSecure is a trademark of Tektronix, Inc.

Released 2024.

## **Contacting Tektronix**

Tektronix, Inc.  
14150 SW Karl Braun Drive  
P.O. Box 500  
Beaverton, OR 97077  
USA

For product information, sales, service, and technical support:

- In North America, call 1-800-833-9200.
- Worldwide, visit [www.tek.com](http://www.tek.com) to find contacts in your area.

---

# Table of Contents

Preface .....	iii
Getting Started .....	1-1
Setting Up Remote Communications Hardware .....	1-1
Ethernet .....	1-1
USB.....	1-2
Setting Up Remote Communications Software .....	1-3
Using VISA.....	1-3
Using the LXI Web Page and e*Scope .....	1-4
Using a Socket Server .....	1-5
Documentation .....	1-7
Dynamic programmatic interface .....	1-7
Implicit activation .....	1-7
Creating, deleting, and listing dynamic instances.....	1-8
Backwards Compatibility .....	1-8
Command Syntax.....	2-1
Command and Query Structure .....	2-1
Clearing the instrument output queue .....	2-3
Command Entry.....	2-3
Constructed Mnemonics .....	2-5
Argument Types.....	2-7
Command groups.....	2-11
Acquisition command group .....	2-11
Act On Event command group.....	2-11
Alias command group .....	2-13
Bus command group.....	2-14
Callouts command group .....	2-24
Cursor command group .....	2-25
Digital command group .....	2-32
Digital Power Management (DPM) Group .....	2-33
Display control command group.....	2-35
File system command group.....	2-39
Histogram Group .....	2-40
Horizontal command group.....	2-42
Inverter Motors and Drive Analysis (IMDA) Group .....	2-42
Mask command group.....	2-46
Math command group .....	2-48
Measurement command group .....	2-52
Miscellaneous command group .....	2-69
Plot command group .....	2-71

Power command group .....	2-72
Remote Scope command group .....	2-85
Save and Recall command group .....	2-87
Search and Mark command group .....	2-89
Spectrum View command group .....	2-122
Status and Error command group .....	2-125
Trigger command group .....	2-126
Vertical command group .....	2-128
Waveform Transfer command group .....	2-131
Zoom command group .....	2-135
Commands listed in alphabetical order.....	2-137
Status and Events .....	3-1
Registers .....	3-1
Queues .....	3-4
Event Handling Sequence.....	3-5
Synchronization Methods.....	3-7
Appendix A: Character Set .....	A-1
Appendix B: Reserved Words.....	B-1
Appendix C: Factory Defaults .....	C-1
Default Setup.....	C-1
Appendix D: Waveform Transfer (WFMOutpre and CURVe Query) Examples .....	D-1
Example 1: Analog Waveform (Channels 1–4) .....	D-1
Example 2: Digital Waveform .....	D-3
Example 3: Digital with 4 Bytes Per Point and Zoom Off.....	D-5
Example 4: Digital with 8 Bytes Per Point and Zoom Off.....	D-7
Example 5: Digital with 4 Bytes Per Point and Zoom On .....	D-10
Example 6: RF Frequency Domain Waveform.....	D-12
Example 7: Baseband IQ Waveform .....	D-14
Appendix E: Search and Trigger Command Sequence Examples.....	E-1
Example 1: Single Threshold Edge Search .....	E-1
Example 2: Single Threshold Edge Trigger .....	E-1
Example 3: Dual Threshold Runt Search .....	E-2
Example 4: Single Threshold Logic Search on Three Waveforms.....	E-3
Appendix F: Remote Scope Command Examples .....	F-1
Acquire single acquisition .....	F-1
Save Remote channel to ref.....	F-2
Continuous Acquisition .....	F-3
Act on Timer event (DataLogging) .....	F-4
Waveform Transfer .....	F-5
Glossary	
Index	

---

# Preface

This programmer guide provides you with the information required to use Programmable Interface commands to remotely control your instrument.

The programmer manual is divided into the following major topics:

- **Getting started.** This topic introduces you to the programming information and provides basic information about setting up your instrument for remote control.
- **Command syntax.** This topic provides an overview of the command syntax that you use to communicate with the instrument and other general information about commands, such as how commands and queries are constructed, how to enter commands, constructed mnemonics, and argument types.
- **Command groups.** This topic contains all the commands listed in functional groups. Each group consists of an overview of the commands in that group and a table that lists all the commands and queries for that group. You can click a command in the listing to display a detailed description of the command.
- **Commands listed in alphabetical order.** This topic contains all commands listed in alphabetical order. Command details, syntax, and examples are provided.
- **Status and events.** This topic discusses the status and event reporting system for the programming interfaces. This system informs you of certain significant events that occur within the instrument. Topics that are discussed include registers, queues, event handling sequences, synchronization methods, and messages that the instrument might return, including error messages.
- **Appendices.** These topics contain miscellaneous information, such as a list of reserved words, a table of the factory initialization (default) settings, and interface specifications that can be helpful when using commands to remotely control the instrument.





# Getting Started

This manual explains the use of commands to remotely control your instrument. With this information, you can write computer programs to perform functions, such as setting the front-panel controls, taking measurements, performing statistical calculations, and exporting data for use in other programs.

Familiarity with the User Manual for your instrument is assumed. You can download the User Manual from the Tektronix website at [www.tek.com](http://www.tek.com).

---

**NOTE.** Most examples in this document assume that both *HEADer* and *VERBose* are set to ON.

---

## Setting Up Remote Communications Hardware

You can remotely control communications between your instrument and a PC via Ethernet or USB cables.

**Ethernet** If you are using Ethernet, start by connecting an appropriate Ethernet cable to the Ethernet port (RJ-45 connector) on the rear panel of your instrument. This connects the instrument to a 10BASE-T/100BASE-T/1000BASE-T local area network.

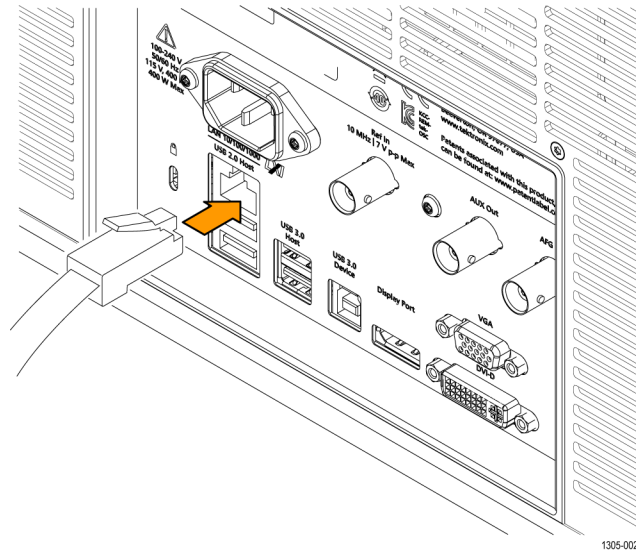

To change the Ethernet settings on your instrument, do the following:

1. Select the **Utility** drop-down menu.
2. Select the **I/O** menu.
3. Select the **LAN** panel.
4. In the menu, if you are on a DHCP Ethernet network that supplies the IP address automatically by a DHCP, tap **Auto**.
5. In the menu, if you want to supply your own network settings, tap **Manual** to set a hard coded TCP/IP address.

**USB** If you are using USB, start by connecting the appropriate USB cable to the USB 3.0 super-speed (SS) Device port on the rear panel of your instrument. This port requires that the cable connected from the port to the host computer meets the USB 3.0 specification for super speed connections. Typically, such cables should be 3 feet or shorter in length, but this is determined by the quality of the cable and, with higher quality cables, this length can be extended. (It is also dependent upon the drive capability of the host USB port to which the instrument is connected.) The use of high quality short cables is recommended to avoid USB connection problems.

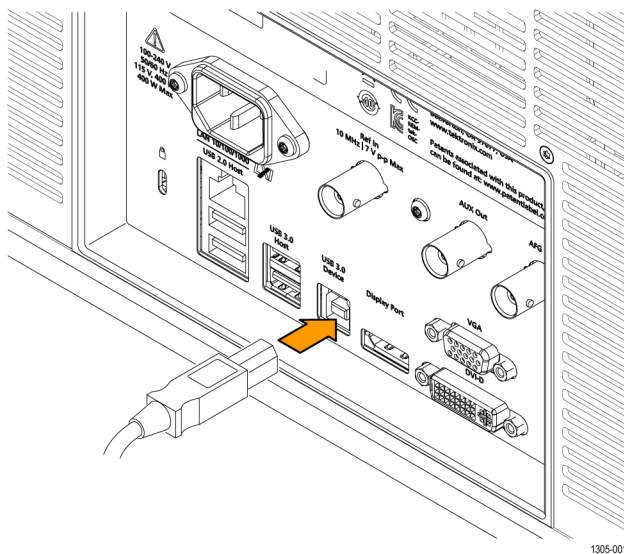

With USB, the system automatically configures itself. To verify that the USB is enabled:

1. Select the **Utility** drop-down menu.
2. Select the **I/O** menu.
3. Touch **USB Device Port** to open the USB Device Port configuration menu.
4. If USB is disabled, tap **USB Device Port** to enable the USB Device port.

After connection, the host, with appropriate software, can list the instrument as a USB device with the following parameters: (See Table 1-1.)

**Table 1-1: USB Device Parameters**

Parameter	Value
Manufacturer ID	0x0699 (decimal 1689)
Product ID	0x0522 (You can send the USBTMC:PRODUCTID:HEXadecimal? query to read the value)
Serial number	Serial number
Manufacturer description	"Tektronix"
Interface description	"USBTMC-USB488"

## Setting Up Remote Communications Software

Connect your instrument directly to a computer to let the PC analyze your data, collect screen images, or to control the instrument using a program of your own creation. Three ways to connect your instrument to a computer are through the VISA drivers, the e\*Scope Web-enabled tools, or via a socket server.

**Using VISA** VISA lets you use your MS-Windows computer to acquire data from your instrument for use in an analysis package that runs on your PC, such as Microsoft Excel, National Instruments LabVIEW, Tektronix OpenChoice Desktop software, or your own custom software. You can use a common communications connection, such as USB or Ethernet, to connect the computer to the instrument.

To set up VISA communications between your instrument and a computer:

1. Load the VISA drivers on your computer. Also, load your application, such as OpenChoice Desktop. You will find the drivers and OpenChoice Desktop software on the appropriate CD that comes with your instrument or at the Tektronix software finder Web page ([www.tektronix.com/downloads](http://www.tektronix.com/downloads)).
2. Connect the instrument to your computer with the appropriate USB or Ethernet cable. Cycle the power on the instrument.
3. Select the **Utility** drop-down menu
4. Select **I/O** menu.
5. If you are using USB, the system sets itself up automatically for you, if USB is enabled. Check **USB DEVICE PORT** panel to be sure that USB is enabled. If it is not enabled, toggle the On/Off button to On.
6. To use Ethernet, select the **LAN** panel. Use the controls to adjust your network settings, as needed. For more information, see the e\*Scope setup information below.
7. If you want to change socket server parameters, select the **Socket Server** panel and enter new values through the resulting panel controls.
8. Run your application software on your computer.

**Quick Tips**

- The USB 3.0 super-speed (SS) device port is the correct USB port for computer connectivity. Use the rear- and front-panel USB 2.0 or 3.0 host ports to connect your instrument to USB flash drives, hard drives, keyboards or mice. Use the USB Device port to connect your instrument to a PC.

There are both USB 2.0 and 3.0 host ports on the instrument. The device port is USB 3.0. Printers are not supported on host ports. PictBridge printers are not supported on the device port.

**Using the LXI Web Page and e\*Scope**

With e\*Scope, you can access your Internet-connected instrument from a web browser.

---

**NOTE.** *This procedure presumes that you have connected the instrument to a network and configures the instrument to work on your network. See the instrument Installation and Safety instructions, or the embedded Help on the instrument, for instructions on how to configure the instrument for network use.*

---

To set up e\*Scope communications between your instrument and a web browser running on a remote computer:

1. Connect the instrument to your computer network with an appropriate Ethernet cable.
2. Select the **Utility** drop-down menu.
3. Select the **I/O** menu.
4. Select the **LAN** panel.
5. At the top left of the panel, there is an indicator light which turns red if the device detects a fault.
6. Tap **Test Connection** to check if your instrument can find an attached network.
7. Record the IP address shown on your instrument.
8. Start a Web browser on a PC that has access to the same network to which the instrument is attached.
9. Enter the IP address of the instrument in the browser address line. You should then see the LXI Welcome page on your Web browser on your computer screen.
10. For e\*Scope, click the Instrument Control (e\*Scope) link on the left side of the LXI Welcome page. You should then see a new tab (or window) open in your browser, showing the instrument screen. You can use the PC mouse to interact with the e\*Scope screen and controls.

### Using a Socket Server

A socket server provides two-way communication over an Internet Protocol-based computer network. You can use your instrument's socket server feature to let your instrument talk to a remote-terminal device or computer.

To set up and use a socket server between your instrument and a remote terminal or computer:

1. Connect the instrument to your computer network with an appropriate Ethernet cable.
2. Select the **Utility** drop-down menu.
3. Select the **I/O** menu.
4. Tap **Socket Server**.
5. On the resulting Socket Server panel, tap the top entry to toggle the Socket Server On.
6. Choose whether the protocol should be **None** or **Terminal**. A communication session run by a human at a keyboard typically uses a terminal protocol. An automated session might handle its own communications without using such a protocol.
7. If required, change the port number by rotating multipurpose knob **a**.
8. If required, press **OK** to set the new port number.

9. After setting up the socket server parameters, you can now have the computer “talk” to the instrument. If you are running an MS Windows PC, you could run its default client with its command-like interface. One way to do this is by typing “Telnet” in the Run window. The Telnet window will open on the PC.

---

**NOTE.** *On MS Windows 7, you must first enable Telnet in order for it to work.*

---

10. Start a terminal session between your computer and your instrument by typing in an open command with the instrument LAN address and port #. You can obtain the LAN address by pushing the LAN panel to view the resulting LAN setting panel. You can obtain the port # by tapping the **Socket Server** panel and viewing the **Port** item.

For example, if the instrument IP address was 123.45.67.89 and the port # was the default of 4000, you could open a session by writing into the MS Windows Telnet screen:

```
open 123.45.67.89 4000
```

The instrument will send a help screen to the computer when it is done connecting.

11. You can now type in a standard query, as found in the programmer manual, such as \*i dn?

The Telnet session window will respond by displaying a character string describing your instrument. You can type in more queries and view more results on this Telnet session window. You can find the syntax for relevant queries and related status codes in other sections of this manual.

---

**NOTE.** *Do not use the computer's backspace key during an MS Windows' Telnet session with the instrument.*

---

**Socket Server Terminal Protocol Mode Commands.** Following are Tektronix Instrument Control Terminal Session Control commands:

!t <timeout> : set the response timeout in milliseconds.

!d : send device clear to the instrument.

!r : read response from instrument.

!h : print this usage info.

---

**NOTE.** *Commands containing a ? are treated as queries, and the responses are read automatically.*

---

**Documentation** Documentation for your instrument is available for download at [www.tek.com](http://www.tek.com).

## Dynamic programmatic interface

This programmatic interface is dynamic. This means the instrument will not recognize certain commands until the objects referenced by those commands actually exist. For example, commands related to measurements are not recognized until measurements are added. Therefore, the response to a `*LRN?` query will not normally include the instrument's complete command set.

The following command groups are not available when the instrument is in its default state:

- Measurement
- Math
- Bus
- Search and Mark
- Plot

Adding an instance of one of those components will cause all commands related to that component to be recognized. For example, sending the [MEASUREMENT:ADDNew](#) command adds a measurement at which point the measurement commands will be recognized. Conversely, once all instances of a component have been deleted, the commands related to that component will no longer be recognized.

## Implicit activation

When you send a command or query related to a dynamic object (such as `Math1`, `Bus3`, or `Meas2`) to the instrument and that instance does not yet exist, the instrument:

- creates a default instance with the name you specified
- adds all relevant commands and queries to the set of recognized commands
- responds to the command or query

**Example 1** `*RST` followed by a `*LRN?` will not return any `MATH<x>` commands because in the default state, the instrument does not have any math waveforms. However querying `:MATH:MATH1:DEFinition?` will add `MATH1` with the default math expression `Ch1 - Ch2`. Then the query will return the expected result. Note that if `Ch1` or `Ch2` is not active, they will be activated as part of this action. A `*LRN?` issued after this will return `MATH` commands in addition to other available commands.

**Example 2** \*RST followed by :MEASUREMENT:MEAS3:TYPE? creates a measurement named MEAS3 and returns its type. Since the default type is Period, you will get Period as the response. A \*LRN issued after this will return all MEASUREMENT:MEAS3 commands in addition to other available commands.

Not all commands in these groups start implicit activation. ADDNew, DELEte, and LIST commands do not result in implicit activation.

## Creating, deleting, and listing dynamic instances

You can create a new default instance of a dynamic feature by using the ADDNew command. For example, :MEASUREMENT:ADDNew "Meas1" will create a new measurement named Meas1. Meas1 will be a Period measurement since the default type for measurements is Period. Note that you can change Meas1 type to any other supported type using :MEASUREMENT:MEAS1:TYPE command. The DELEte command deletes the named dynamic instance. For example :BUS:DELEte "B2" will delete a bus named B2 if it exists. You can delete only one instance at a time. The LIST command returns a list of all dynamic instances currently in existence. For example, if you have added three measurements named Meas1, Meas2 and Meas3, :MEASUREMENT:LIST? returns MEAS1, MEAS2, MEAS3.

## Backwards Compatibility

4, 5, and 6/6B Series MSO instruments have implicit backwards compatibility built into the command set. Many commands from previous scope generations can be successfully processed by modern scopes. In particular, the MSO/DPO5000/7000/70000 command set has been partially migrated to the new generation. Use the following table to check if a legacy command is supported and how it will be interpreted by a 4/5/6 Series MSO.

The left column indicates the legacy command and the right column indicates the command that will be executed on a 4/5/6 Series MSO. Some functions on the scope have been simplified, so multiple legacy commands are mapped to a single modern command.

In addition to these implicit aliases, the 4/5/6 Series MSO also contain a PI Translator feature. This allows users to define custom command processing to improve compatibility with legacy automation code. Please refer to the Programming Interface Translator Technical Brief on tek.com for more information.

Legacy oscilloscope command	4/5/6 Series MSO command alias
:SV:SV<n>:UNIts	:SV:CH<n>:UNIts
:BUS:B<n>:AUDio:FRAMESync:SOURce	:BUS:B<n>:AUDio:WORDSel:SOURce



:BUS:B<n>:AUDIO:FRAMESync:POLarity	:BUS:B<n>:AUDIO:WORDSel:POLarity
:BUS:B<n>:AUTOETHERnet:SOURce:DIFFerential	:BUS:B<n>:AUTOETHERnet:SOURce
:BUS:B<n>:AUTOETHERnet:LOWerthreshold	:BUS:B<n>:AUTOETHERnet:LOWTHRESHold
:BUS:B<n>:CAN:BITRate:VALue	:BUS:B<n>:CAN:BITRate:CUSTom
:BUS:B<n>:CAN:FD:BITRate:VALue	:BUS:B<n>:CAN:FD:BITRate:CUSTom
:MEASUrement:MEAS<n>:EDGEQUALifier	:MEASUrement:MEAS<n>:SOURce<n>
:MEASUrement:MEAS<n>:ACQTime	:MEASUrement:MEAS<n>:WAITTime
:BUS:B<n>:ETHERnet:SOURce:DIFFerential	:BUS:B<n>:ETHERnet:SOURce
:BUS:B<n>:ETHERnet:LOWerthreshold	:BUS:B<n>:ETHERnet:LOWTHRESHold
:BUS:B<n>:THReshold	:BUS:B<n>:FLEXray:THRESHold
:BUS:B<n>:LOWerthreshold	:BUS:B<n>:FLEXray:LOWTHRESHold
:DPOJET:GATing	:MEASUrement:MEAS<n>:GATing
:BUS:B<n>:I2C:SCLk:SOURce	:BUS:B<n>:I2C:CLOCK:SOURce
:BUS:B<n>:I2C:ADDRess:RWINClude	:BUS:B<n>:I2C:DATA:SOURce
:BUS:B<n>:I3C:SCLk:SOURce	:BUS:B<n>:I3C:CLOCK:SOURce
:BUS:B<n>:I3C:SDAta:SOURce	:BUS:B<n>:I3C:DATA:SOURce
:MEASUrement:MEAS<n>:FUNDAMENTALFreq	:MEASUrement:MEAS<n>:FREQ
:BUS:B<n>:LIN:VALue	:BUS:B<n>:LIN:BITRate:CUSTom
:MATH:MATH<n>:SPECTral:UNWRap	:MATH:MATH<n>:SPECTral:WRAP:STATE
:MATH:MATH<n>:SPECTral:UNWRap:DEGrees	:MATH:MATH<n>:SPECTral:WRAP:DEGrees
:BUS:B<n>:MDIO:SCLOCK:SOURce	:BUS:B<n>:MDIO:CLOCK:SOURce
:BUS:B<n>:MDIO:SDATA:SOURce	:BUS:B<n>:MDIO:DATA:SOURce
:DPOJET:DIRacmodel	:MEASUrement:DIRacmodel
:DPOJET:JITTermodel	:MEASUrement:JITTermodel
:DPOJET:MINBUJUI	:MEASUrement:MINUI
:DPOJET:INTERp	:MEASUrement:INTERp
:BUS:B<n>:MIL1553B:LOWerthreshold	:BUS:B<n>:MIL1553B:LOWTHRESHold
:DPOJET:PLOT<n>:SPECTrum:HORizontal:SCALE	:PLOT:PLOT<n>:SPECTrum:HORizontal:SCALE
:DPOJET:PLOT<n>:SPECTrum:BASE	:PLOT:PLOT<n>:SPECTrum:BASE
:DPOJET:PLOT<n>:BATHtub:BER	:PLOT:PLOT<n>:BATHtub:BER
:BUS:B<n>:RS232C:TX:SOURce	:BUS:B<n>:RS232C:SOURce
:BUS:B<n>:RS232C:TX:SOURce:THReshold	:BUS:B<n>:RS232C:SOURce:THReshold
:SEARCH:SEARCH<n>:TRIGger:A:WINDow:POLarity	:SEARCH:SEARCH<n>:TRIGger:A:WINDow:CROSSIng
:BUS:B<n>:SPACEWIRe:SDAta:SOURce	:BUS:B<n>:SPACEWIRe:DATA:SOURce

:BUS:B<n>:SPACEWIRE:SSTRobe:SOURce	:BUS:B<n>:SPACEWIRE:STRobe:SOURce
:BUS:B<n>:SPI:SCLk:SOURce	:BUS:B<n>:SPI:CLOCK:SOURce
:BUS:B<n>:SPI:MOSi:INPut	:BUS:B<n>:SPI:DATA:SOURce
:BUS:B<n>:SPI:SS:SOURce	:BUS:B<n>:SPI:SELEct:SOURce
:BUS:B<n>:SPI:MOSi:THReshold	:BUS:B<n>:SPI:DATA:THReshold
:BUS:B<n>:SPI:SCLk:POLarity	:BUS:B<n>:SPI:CLOCK:POLarity
:BUS:B<n>:SPI:MOSi:DATA:POLarity	:BUS:B<n>:SPI:DATA:POLarity
:BUS:B<n>:SPI:SS:POLarity	:BUS:B<n>:SPI:SELEct:POLarity
:TRIGger:A B:BUS:B<n>:SPI:DATA:IN:VALue	:TRIGger:A B:BUS:B<n>:SPI:DATA:VALue
:TRIGger:A B:BUS:B<n>:SPI:DATA:MISO:VALue	
:TRIGger:A B:BUS:B<n>:SPI:DATA:OUT:VALue	
:TRIGger:A B:BUS:B<n>:SPI:DATA:MOSI:VALue"	
:BUS:B<n>:SPMI:SCLk:SOURce	:BUS:B<n>:SPMI:SCLk:SOURce
:BUS:B<n>:SPMI:SDAta:SOURce	:BUS:B<n>:SPMI:SDAta:SOURce
:BUS:B<n>:SVID:SCLOCK:SOURce	:BUS:B<n>:SVID:CLOCK:SOURce
:BUS:B<n>:SVID:SDATA:SOURce	:BUS:B<n>:SVID:DATA:SOURce
:MEASUrement:MEAS<n>:DELay:DIREction	:MEASUrement:MEAS<n>:TOEDGESEARCHDIRec
:BUS:B<n>:USB:SOURce:DIFFerential	:BUS:B<n>:USB:SOURce
:BUS:B<n>:USB:LOWerthreshold	:BUS:B<n>:USB:LOWTHRESHold
:TRIGger:A B:BUS:B<n>:USB:QUALifier	:TRIGger:A B:BUS:B<n>:USB:DATA:QUALifier
:MATH:MATH<n>:POSITION	:DISplay:WAVEView<n>:MATH:MATH<n>:VERTical:POSition
:MATH:MATH<n>:SCALE	:DISplay:WAVEView<n>:MATH:MATH<n>:VERTical:SCALE
:REF:REF<n>:POSITION	:DISplay:WAVEView<n>:REF:REF<n>:VERTical:POSition
:REF:REF<n>:SCALE	:DISplay:WAVEView<n>:REF:REF<n>:VERTical:SCALE
:HORizontal:FASTframe:SELECTED:REF<n>	:DISplay:WAVEView<n>:REF:REF<n>:FRAME
:CURSor:VBArS:POSITIONA	:DISplay:WAVEView<n>:CURSor:CURSOR:VBArS:APOSition
:CURSor:VBArS:POSA"	
:CURSor:VBArS:POSITIONB	:DISplay:WAVEView<n>:CURSor:CURSOR:VBArS:BPOSition
:CURSor:VBArS:POSB"	
:CURSor:HBArS:POSITIONA	:DISplay:WAVEView<n>:CURSor:CURSOR:HBArS:APOSition
:CURSor:HBArS:POSITIONB	:DISplay:WAVEView<n>:CURSor:CURSOR:HBArS:BPOSition
:CURSor:SCREEN:XPOSITIONA	:DISplay:WAVEView<n>:CURSor:CURSOR:SCREEN:AXPOSition
:CURSor:SCREEN:XPOSITIONB	:DISplay:WAVEView<n>:CURSor:CURSOR:SCREEN:BXPOSition
:CURSor:SCREEN:YPOSITIONA	:DISplay:WAVEView<n>:CURSor:CURSOR:SCREEN:AYPOSition

:CURSor:SCREEN:YPOSITIONB	:DISplay:WAVEView<n>:CURSor:CURSOR:SCREEN:BYPOSITION
:CURSor:WAVEform:POSITIONA	:DISplay:WAVEView<n>:CURSor:CURSOR:WAVEform:APOSITION
:CURSor:WAVEform:POSITIONB	:DISplay:WAVEView<n>:CURSor:CURSOR:WAVEform:BPOSITION
:CURSor:SOURCEA	:DISplay:WAVEView<n>:CURSor:CURSOR:ASOURCE
:CURSor:SOURCEB	:DISplay:WAVEView<n>:CURSor:CURSOR:BSOURCE
:CURSor:VBArS:UNItS	:DISplay:WAVEView<n>:CURSor:CURSOR:VBArS:UNItS
:CURSor:HBArS:UNItA	:DISplay:WAVEView<n>:CURSor:CURSOR:HBArS:AUNItS
:CURSor:HBArS:UNItA	:DISplay:WAVEView<n>:CURSor:CURSOR:HBArS:AUNItS
:CURSor:HBArS:UNItS	
:CURSor:HBArS:UNItB	:DISplay:WAVEView<n>:CURSor:CURSOR:HBArS:BUNItS
:CURSor:VBArS:ALTErNATEA	:DISplay:WAVEView<n>:CURSor:CURSOR:VBArS:ALTErNATEA
:CURSor:VBArS:ALTErNATEB	:DISplay:WAVEView<n>:CURSor:CURSOR:VBArS:ALTErNATEB
:CURSor:VBArS:DELTA	:DISplay:WAVEView<n>:CURSor:CURSOR:VBArS:DELTA
:CURSor:WAVEform:HDELTA"	:DISplay:WAVEView<n>:CURSor:CURSOR:HBArS:DELTA
:CURSor:HBArS:DELTA	
:CURSor:WAVEform:VDELTA"	:DISplay:WAVEView<n>:CURSor:CURSOR:VBArS:DELTA
:CURSor:VBArS:DELTA	
:CURSor:DDT	:DISplay:WAVEView<n>:CURSor:CURSOR:DDT
:CURSor:ONEOVERDELTAVALUE	:DISplay:WAVEView<n>:CURSor:CURSOR:ONEOVERDELTAVALUE
:CURSor:FUNCTion	:DISplay:WAVEView<n>:CURSor:CURSOR:FUNCTion
:CURSor:STATE	:DISplay:WAVEView<n>:CURSor:CURSOR:STATE
:CURSor:CURSOR:STATE"	
:CURSor:MODE	:DISplay:WAVEView<n>:CURSor:CURSOR:MODE
:BUS:B<n>:POSITION	:DISplay:WAVEView<n>:BUS:B<n>:VERTical:POSITION
:ZOOM:HORIZontal:POSITION	:DISplay:WAVEView<n>:ZOOM:ZOOM<n>:HORIZontal:POSITION
:ZOOM:ZOOM<n>:HORIZontal:POSITION"	
:ZOOM:HORIZontal:SCALE	:DISplay:WAVEView<n>:ZOOM:ZOOM<n>:HORIZontal:SCALE
:ZOOM:ZOOM<n>:HORIZontal:SCALE"	
:ZOOM:VERTical:POSITION	:DISplay:WAVEView<n>:ZOOM:ZOOM<n>:VERTical:POSITION
:ZOOM:ZOOM<n>:VERTical:POSITION"	
:ZOOM:VERTical:SCALE	:DISplay:WAVEView<n>:ZOOM:ZOOM<n>:VERTical:SCALE
:ZOOM:ZOOM<n>:VERTical:SCALE"	
:ZOOM:STATE	:DISplay:WAVEView<n>:ZOOM:ZOOM<n>:STATE
:ZOOM:ZOOM<n>:STATE"	

:FASTAcq:PALEtte	:ACQUIRE:FASTAcq:PALEtte
:BUS:B<n>:STATE	:DISPLAY:GLOBAL:B<n>:STATE
CH1:STATE	DISPLAY:GLOBAL:CH1:STATE
:MATH:MATH<n>:STATE	:DISPLAY:GLOBAL:MATH<n>:STATE
:REF:REF<n>:STATE	:DISPLAY:GLOBAL:REF<n>:STATE
:REM:REM<n>:STATE	:DISPLAY:GLOBAL:REM<n>:STATE
:PLOT:PLOT<n>:STATE	:DISPLAY:GLOBAL:PLOT<n>:STATE
:DISPLAY:INTENSITY:WAVEform(:ANALYSIS :FASTAcq)	:DISPLAY:WAVEView<n>:INTENSITY:WAVEform
:DISPLAY:INTENSITY:GRATICule	:DISPLAY:WAVEView<n>:INTENSITY:GRATICule
:DISPLAY:STYLE	:DISPLAY:WAVEView<n>:STYLE
:DISPLAY:GRATICule	:DISPLAY:WAVEView<n>:GRATICule
:DISPLAY:FILTer	:DISPLAY:WAVEView<n>:FILTer
:DISPLAY:VIEWStyle	:DISPLAY:WAVEView<n>:VIEWStyle
:HORIZONTAL:DELAy:POSITION	:HORIZONTAL:POSITION
:HORIZONTAL:MAIn:POSITION"	
:HORIZONTAL:DELAy:POSITION	
:HORIZONTAL:MODE:SCALE	:HORIZONTAL:SCALE
:HORIZONTAL:SECdiv	
:HORIZONTAL:MAIn:SCALE	
:HORIZONTAL:MAIn:SECdiv	
:HORIZONTAL:DELAy:SCALE	
:HORIZONTAL:DELAy:SECdiv"	
:HORIZONTAL:MAIn:UNIts:STRing	
:HORIZONTAL:DELAy:STATE	:HORIZONTAL:DELAy:MODE
:HORIZONTAL:MAIn:DELAy:MODE"	
:HORIZONTAL:DELAy:TIME(:RUNSAfter :TRIGAAfter)	:HORIZONTAL:DELAy:TIME
:HORIZONTAL:MAIn:DELAy:TIME"	
:CH1:VOLTS	CH1:SCALE
:HORIZONTAL:MODE:SAMPLERate	:HORIZONTAL:SAMPLERate
:HORIZONTAL:MAIn:SAMPLERate	
:HORIZONTAL:DIGital:SAMPLERate	
:HORIZONTAL:DIGital:SAMPLERate:MAIn"	

:HORizontal:MODE:RECOrdlength	:HORizontal:RECOrdlengt
:HORizontal:RESOLution	
:HORizontal:DIgital:RECOrdlength	
:HORizontal:DIgital:RECOrdlength:MAIn	
:HORizontal:ACQLENGTH"	
:FASTAcq:STATE	:ACQuire:FASTAcq:STATE
:SAVEON:WAVEform:FILEFormat	:SAVEONEVent:WAVEform:FILEFormat
:SAVEON:WAVEform:SOURce	:SAVEONEVent:WAVEform:SOURce
:SAVEON:IMAGe:FILEFormat	:SAVEONEVent:IMAGe:FILEFormat
:SAVEON:FILE:NAME	:SAVEONEVent:FILEName
:SAVEON:FILE:NAME	:SAVEONEVent:FILEName
:TRIGger:A B:PULse:WIDth:WHEn	:TRIGger:A B:PULSEWidth:WHEn
:TRIGger:A B:PULse:WIDth:POLarity	:TRIGger:A B:PULSEWidth:POLarity
:TRIGger:A B:PULse:WIDth:HIGHLimit	:TRIGger:A B:PULSEWidth:HIGHLimit
:TRIGger:A B:PULse:WIDth:LOWLimit	:TRIGger:A B:PULSEWidth:LOWLimit
:TRIGger:A B:PULSEWidth:WIDth"	
:TRIGger:A B:VIDeo:SYNC	:TRIGger:A B:VIDeo:FIELD
:TRIGger:A B:PULse:RUNT:WHEn	:TRIGger:A B:RUNT:WHEn
:TRIGger:A B:PULse:RUNT:POLarity	:TRIGger:A B:RUNT:POLarity
:TRIGger:A B:PULse:RUNT:WIDth	:TRIGger:A B:RUNT:WIDth
:TRIGger:A B:PULse:TIMEOut:POLarity	:TRIGger:A B:TIMEOut:POLarity
:TRIGger:A B:PULse:TIMEOut:TIME	:TRIGger:A B:TIMEOut:TIME
:TRIGger:A B:RISEFall:SOURce	:TRIGger:A B:TRANSition:SOURce
:TRIGger:A B:RISEFall:WHEn	:TRIGger:A B:TRANSition:WHEn
:TRIGger:A B:PULse:TRANSition:WHEn"	
:TRIGger:A B:RISEFall:WHEn	:TRIGger:A B:TRANSition:WHEn
:TRIGger:A B:PULse:TRANSition:WHEn"	
:TRIGger:A B:RISEFall:POLarity	:TRIGger:A B:TRANSition:POLarity
:TRIGger:A B:PULse:TRANSition:POLarity"	
:TRIGger:A B:RISEFall:POLarity	:TRIGger:A B:TRANSition:POLarity
:TRIGger:A B:PULse:TRANSition:POLarity"	
:TRIGger:A B:RISEFall:DELTatime	:TRIGger:A B:TRANSition:DELTatime
:TRIGger:A B:PULse:TRANSition:DELTatime"	

:TRIGger:A B:RISEFall:DELtAtime	:TRIGger:A B:TRANSition:DELtAtime
:TRIGger:A B:PULse:TRANSition:DELtAtime"	
:TRIGger:A B:WINDow:POLarity	:TRIGger:A B:WINDow:CROSSIng
:TRIGger:A B:PULse:WINDow:POLarity"	
:TRIGger:A B:PULse:WINDow:WIDth	:TRIGger:A B:WINDow:WIDth
:TRIGger:A B:LOGIc:SETHold:CLOCK:SOURce	:TRIGger:A B:SETHold:CLOCK:SOURce
:TRIGger:A B:LOGIc:SETHold:CLOCK:EDGE	:TRIGger:A B:SETHold:CLOCK:EDGE
:TRIGger:A B:LOGIc:SETHold:SETTime	:TRIGger:A B:SETHold:SETTime
:TRIGger:A B:LOGIc:SETHold:HOLDTime	:TRIGger:A B:SETHold:HOLDTime
:TRIGger:A B:LOGIc:PATtern:WHEn	:TRIGger:A B:LOGIc:WHEn
:TRIGger:A B:LOGIc:PATtern:DELtAtime	:TRIGger:A B:LOGIc:DELtAtime
:TRIGger:A B:LOGIc:STATE:CLOCK:SOURce	:TRIGger:A B:LOGIc:INPut:CLOCK:SOURce
:TRIGger:A B:LOGIc:INPut:CLOCK:EDGE	:TRIGger:A B:LOGIc:POLarity
:TRIGger:B:RESET:SOURce	:TRIGger:B:RESET:EDGE:SOURce
:TRIGger:B:RESET:TIMEOut:TIME	:TRIGger:B:RESET:EDGE:LEVel
:TRIGger:B:RESET:TIMEOut	:TRIGger:B:RESET:TIMEOut:TIME
:TRIGger:A B:BUS:B<n>:AUTOETHERnet:QUALifier	:TRIGger:A B:BUS:B<n>:AUTOETHERnet:QUALifier
:TRIGger:A B:BUS:B<n>:AUTOETHERnet:MAC:TYPe:VALue	:TRIGger:A B:BUS:B<n>:AUTOETHERnet:MAC:LENGth:VALue
:TRIGger:A B:BUS:B<n>:AUTOETHERnet:MAC:TYPe:HIVALue	:TRIGger:A B:BUS:B<n>:AUTOETHERnet:MAC:LENGth:HIVALue
:TRIGger:A B:BUS:B<n>:CAN:ADDRess:MODE	:TRIGger:A B:BUS:B<n>:CAN:IDentifier:MODE
:TRIGger:A B:BUS:B<n>:CAN:ADDRess:VALue	:TRIGger:A B:BUS:B<n>:CAN:IDentifier:VALue
:TRIGger:A B:BUS:B<n>:ETHERnet:QUALifier	:TRIGger:A B:BUS:B<n>:ETHERnet:DATA:QUALifie
:TRIGger:A B:BUS:B<n>:ETHERnet:MAC:TYPe:VALue	:TRIGger:A B:BUS:B<n>:ETHERnet:MAC:LENGth:VALue
:TRIGger:A B:BUS:B<n>:ETHERnet:MAC:TYPe:HIVALue	:TRIGger:A B:BUS:B<n>:ETHERnet:MAC:LENGth:HIVALue
:TRIGger:A B:BUS:B<n>:EUSB:QUALifier	:TRIGger:A B:BUS:B<n>:EUSB:DATA:QUALifier
:TRIGger:A B:BUS:B<n>:EUSB:EOP:QUALifier	:TRIGger:A B:BUS:B<n>:EUSB:EOP:QUALifier
:TRIGger:A B:BUS:B<n>:EUSB:SYNC:QUALifier	:TRIGger:A B:BUS:B<n>:EUSB:SYNC:QUALifier
:TRIGger:A B:BUS:B<n>:PARAllel:VALue	:TRIGger:A B:BUS:B<n>:PARAllel:DATA:VALue
:TRIGger:A B:BUS:B<n>:RS232C:RX:DATA:VALue	:TRIGger:A B:BUS:B<n>:RS232C:DATA:VALue
:TRIGger:A B:BUS:B<n>:RS232C:RX:DATA:VALue	:TRIGger:A B:BUS:B<n>:RS232C:DATA:VALue
:TRIGger:A B:BUS:B<n>:RS232C:RX:DATA:SIZE	:TRIGger:A B:BUS:B<n>:RS232C:DATA:SIZE

# Command Syntax

You can control the operations and functions of the instrument through the Ethernet port or the USB 3.0 super speed (SS) device port using commands and queries. The related topics listed below describe the syntax of these commands and queries. The topics also describe the conventions that the instrument uses to process them. See the *Command Groups* topic in the table of contents for a listing of the commands by command group, or use the index to locate a specific command.

## Backus-Naur Form Notation

This documentation describes the commands and queries using Backus-Naur Form (BNF) notation. Refer to the following table for the symbols that are used.

Table 2-1: Symbols for Backus-Naur Form

Symbol	Meaning
< >	Defined element
=	Is defined as
	Exclusive OR
{ }	Group; one element is required
[ ]	Optional; can be omitted
. . .	Previous element(s) may be repeated

## Command and Query Structure

Commands consist of set commands and query commands (usually called commands and queries). Commands modify instrument settings or tell the instrument to perform a specific action. Queries cause the instrument to return data and status information.

Most commands have both a set form and a query form. The query form of the command differs from the set form by its question mark at the end. For example, the set command `ACQuire:MODE` has a query form `ACQuire:MODE?`. Not all commands have both a set and a query form. Some commands have set only and some have query only.

## Messages

A command message is a command or query name followed by any information the instrument needs to execute the command or query. Command messages may contain five element types, defined in the following table.

**Table 2-2: Command Message Elements**

<b>Symbol</b>	<b>Meaning</b>
<Header>	This is the basic command name. If the header ends with a question mark, the command is a query. The header may begin with a colon (:) character. If the command is concatenated with other commands, the beginning colon is required. Never use the beginning colon with command headers beginning with a star (*).
<Mnemonic>	This is a header subfunction. Some command headers have only one mnemonic. If a command header has multiple mnemonics, a colon (:) character always separates them from each other.
<Argument>	This is a quantity, quality, restriction, or limit associated with the header. Some commands have no arguments while others have multiple arguments. A <space> separates arguments from the header. A <comma> separates arguments from each other.
<Comma>	A single comma is used between arguments of multiple-argument commands. Optionally, there may be white space characters before and after the comma.
<Space>	A white space character is used between a command header and the related argument. Optionally, a white space may consist of multiple white space characters.

**Commands**

Commands cause the instrument to perform a specific function or change one of the settings. Commands have the structure:

[ : ] <Header> [ <Space> <Argument> [ <Comma> <Argument> ] . . . ]

A command header consists of one or more mnemonics arranged in a hierarchical or tree structure. The first mnemonic is the base or root of the tree and each subsequent mnemonic is a level or branch off the previous one. Commands at a higher level in the tree may affect those at a lower level. The leading colon (:) always returns you to the base of the command tree.



**Queries** Queries cause the instrument to return status or setting information. Queries have the structure:

- [ : ] <Header>
- [ : ] <Header> [ <Space> <Argument> [ <Comma> <Argument> ] . . . ]

You can specify a query command at any level within the command tree unless otherwise noted. These branch queries return information about all the mnemonics below the specified branch or level.

**Headers** Use the HEADER command to control whether the instrument returns headers as part of the query response. If header is on, the query response returns command headers, then formats itself as a valid set command. When header is off, the response includes only the values. This may make it easier to parse and extract the information from the response. The table below shows the difference in responses.

**Table 2-3: Comparison of Header Off and Header On Responses**

Query	Header Off	Header On
TIME?	"14:30:00"	:TIME "14:30:00"
ACQUIRE:NUMAVG?	100	:ACQUIRE:NUMAVG 100

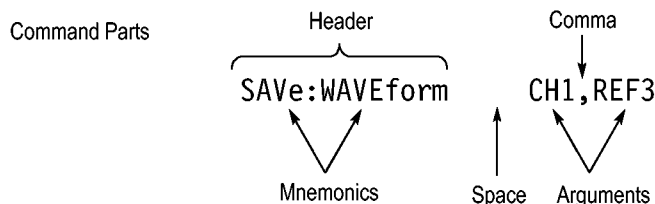

## Clearing the instrument output queue

You can clear the Output Queue and reset the instrument a new command or query by using the selected Device Clear (DCL) function.

## Command Entry

The following rules apply when entering commands:

- You can enter commands in upper or lower case.
- You can precede any command with white space characters. White space characters include any combination of the ASCII control characters 00 through 09 and 0B through 20 hexadecimal (0 through 9 and 11 through 32 decimal).
- The instrument ignores commands consisting of any combination of white space characters and line feeds.

### Abbreviating

You can abbreviate many instrument commands. Each command in this documentation shows the minimum acceptable abbreviations in capitals. For example, you can enter the command `ACQuire:NUMAVg` simply as `ACQ:NUMA` or `acq:numa`.

Abbreviation rules may change over time as new instrument models are introduced. Thus, for the most robust code, use the full spelling.

If you use the `HEADer` command to have command headers included as part of query responses, you can further control whether the returned headers are abbreviated or are full-length with the `VERBoSe` command.

### Concatenating

You can concatenate any combination of set commands and queries using a semicolon (;). The instrument executes concatenated commands in the order received.

When concatenating commands and queries, you must follow these rules:

1. Separate completely different headers by a semicolon and by the beginning colon on all commands except the first one. For example, the commands `TRIGger:MODE NORMAl` and `ACQuire:NUMAVg 8`, can be concatenated into the following single command:

```
TRIGger:MODE NORMAl;:ACQuire:NUMAVg 8
```

2. If concatenated commands have headers that differ by only the last mnemonic, you can abbreviate the second command and eliminate the beginning colon. For example, you can concatenate the commands `ACQuire:MODE ENVeLope` and `ACQuire:NUMAVg 8` into a single command:

```
ACQuire:MODE ENVeLope; NUMAVg 8
```

The longer version works equally well:

```
ACQuire:MODE ENVeLope;:ACQuire:NUMAVg 8
```

3. Never precede a star (\*) command with a colon:

```
ACQuire:STATE 1;*OPC
```

Any commands that follow will be processed as if the star command was not there so the commands, `ACQuire:MODE ENVeLope;*OPC;NUMAVg 8` will set the acquisition mode to envelope and set the number of acquisitions for averaging to 8.

4. When you concatenate queries, the responses to all the queries are concatenated into a single response message. For example, if the display graticule is set to Full and the display style is set to dotsonly, the concatenated query `DISPlay:GRAtiCuLe?;STYLe?` will return the following.

If the header is on:

```
DISPLAY:GRATICULE FULL;:DISPLAY:STYLE DOTSONLY
```

If the header is off:

FULL;DOTSONLY

1. Set commands and queries may be concatenated in the same message. For example,

ACQuire:MODE SAMple;NUMAVg?;STATE?

is a valid message that sets the acquisition mode to sample. The message then queries the number of acquisitions for averaging and the acquisition state. Concatenated commands and queries are executed in the order received.

Here are some invalid concatenations:

DISPlay:STYle DOTsonly OFF;ACQuire:NUMAVg 8 (no colon before ACQuire)

DISPlay:GRAticule FULL;:STYle DOTSONLY OFF (extra colon before STYle.

DISPlay:GRAticule FULL;:\*TRG (colon before a star (\*) command)

ACQUIRE:FASTACQ:PALETTE TEMPerature;FASTAcq:STATE ON (levels of the mnemonics are different; either remove the second use of FASTACQ: or place :ACQUIRE in front of FASTAcq:STATE)

**Terminating** This documentation uses <EOM> (End of Message) to represent a message terminator.

**Table 2-4: End of Message Terminator**

Symbol	Meaning
<EOM>	Message terminator

The end-of-message terminator must be the END message (EOI asserted concurrently with the last data byte). The last data byte may be an ASCII line feed (LF) character.

This instrument does not support ASCII LF only message termination. The instrument always terminates outgoing messages with LF and EOI.

## Constructed Mnemonics

Some header mnemonics specify one of a range of mnemonics. For example, a channel mnemonic can be CH1, CH2, CH3, CH4, CH5, CH6, CH7, or CH8 depending on the number of FlexChannels in your instrument. You use these mnemonics in the command just as you do any other mnemonic. For example, there is a CH1:POSition command, and there is also a CH2:POSition command. In the command descriptions, this list of choices is abbreviated as CH<x>.

**Bus Mnemonics** Commands specify the bus to use as a mnemonic in the header.

**Table 2-5: Bus Mnemonics**

Symbol	Meaning
B<x>	A bus specifier; <x> is ≥1.

**Channel Mnemonics** Commands specify the channel to use as a mnemonic in the header.

**Table 2-6: Channel Mnemonics**

Symbol	Meaning
CH<x>	A channel specifier; <x> is 1 through 8 and is limited by the number of FlexChannels in your instrument.
CH<x>_D<x>	A digital channel specifier; <x> in CH<x> is 1 through 8 and is limited by the number of FlexChannels in your instrument. <x> in D<x> is 0 through 7. Together they define a FlexChannel digital input.

**Cursor Position Mnemonics** When cursors are displayed, commands may specify which cursor of the pair to use.

**Table 2-7: Cursor Mnemonics**

Symbol	Meaning
CURSOR<x>	A cursor selector; <x> is must be 1 or 2.

**Math Specifier Mnemonics** Commands can specify the mathematical waveform to use as a mnemonic in the header.

**Table 2-8: Math Specifier Mnemonics**

Symbol	Meaning
MATH<x>	A math waveform specifier; <x> is ≥1.

**Measurement Specifier Mnemonics** Commands can specify which measurement to set or query as a mnemonic in the header.

**Table 2-9: Measurement Specifier Mnemonics**

Symbol	Meaning
MEAS<x>	A measurement specifier; <x> is ≥1.

**Reference Waveform Mnemonics** Commands can specify the reference waveform to use as a mnemonic in the header.

**Table 2-10: Reference Waveform Mnemonics**

Symbol	Meaning
REF<x>	A reference waveform specifier; <x> is $\geq 1$ .
REF<x>_D<x>	A digital reference waveform specifier; <x> is $\geq 1$ .

**View Mnemonics** Commands can specify the view to use as a mnemonic in the header.

**Table 2-11: Waveview Mnemonics**

Symbol	Meaning
WAVEView<x>	A waveview specifier; <x> must be equal to 1.
PLOTView<x>	A plotview specifier; <x> must be equal to 1.
MATHFFTView<x>	A mathfftview specifier; <x> must be equal to 1.

**Search Mnemonics** Commands can specify a search to use as a mnemonic in the header.

**Table 2-12: Search Mnemonics**

Symbol	Meaning
SEARCH<x>	A Search specifier; <x> is $\geq 1$ .

**Zoom Mnemonics** Commands can specify a zoom to use as a mnemonic in the header.

**Table 2-13: Zoom Mnemonics**

Symbol	Meaning
ZOOM<x>	A zoom specifier; <x> must be equal to 1.

## Argument Types

Commands use arguments such as enumeration, numeric, quoted string and block. Each of these arguments are listed in detail below.

**Enumeration** Enter these arguments as unquoted text words. Like key words, enumeration arguments follow the same convention where the portion indicated in uppercase is required and that in lowercase is optional.

For example: ACQuire:MODe SAMPlE

**Numeric** Many instrument commands require numeric arguments. The syntax shows the format that the instrument returns in response to a query. This is also the preferred format when sending the command to the instrument, though any of the formats will be accepted. This documentation represents these arguments as described below.

**Table 2-14: Numeric Arguments**

Symbol	Meaning
<NR1>	Signed integer value
<NR2>	Floating point value without an exponent
<NR3>	Floating point value with an exponent
<bin>	Signed or unsigned integer in binary format

Most numeric arguments will be automatically forced to a valid setting, by either rounding or truncating, when an invalid number is input, unless otherwise noted in the command description.

**Quoted String** Some commands accept or return data in the form of a quoted string, which is simply a group of ASCII characters enclosed by a single quote (') or double quote ("). The following is an example of a quoted string: "This is a quoted string". This documentation represents these arguments as follows:

**Table 2-15: Quoted String Argument**

Symbol	Meaning
<QString>	Quoted string of ASCII text

A quoted string can include any character defined in the 7-bit ASCII character set. Follow these rules when you use quoted strings:

1. Use the same type of quote character to open and close the string. For example: "this is a valid string".
2. You can mix quotation marks within a string as long as you follow the previous rule. For example: "this is an 'acceptable' string".
3. You can include a quote character within a string by repeating the quote. For example: "here is a "" mark".
4. Strings can have upper or lower case characters.
5. A carriage return or line feed embedded in a quoted string does not terminate the string. The return is treated as another character in the string.
6. The maximum length of a quoted string returned from a query is 1000 characters.

Here are some invalid strings:

- "Invalid string argument" (quotes are not of the same type)
- "test<EOI>" (termination character is embedded in the string)

**Block** Some commands use a block argument form to define a range or type of value, as defined in the table below.

**Table 2-16: Block Argument**

Symbol	Meaning
<NZDig>	A nonzero digit character in the range of 1–9
<Dig>	A digit character, in the range of 0–9
<DChar>	A character with the hexadecimal equivalent of 00 through FF (0 through 255 decimal)
<Block>	A block of data bytes defined as: <Block> ::= {#<NZDig><Dig>[<Dig>...][<DChar>...]}#0[<DChar>...]<terminator>

<NZDig> specifies the number of <Dig> elements that follow. Taken together, the <NZDig> and <Dig> elements form a decimal integer that specifies how many <DChar> elements follow.





# Command groups

The programmable interface conforms to Tektronix standard codes and formats except where noted. The interface also conforms to IEEE Std 488.2-1987 except where noted.

## Acquisition command group

Acquisition commands set up the modes and functions that control how the instrument acquires signals and processes them into waveforms. Using these commands for acquiring waveforms, you can do the following:

- Start and stop acquisitions.
- Control whether each waveform is simply acquired, averaged, or enveloped over successive acquisitions of that waveform.
- Set the controls or conditions that start and stop acquisitions.
- Control acquisition of acquired channel waveforms.
- Set acquisition parameters.

Table 2-17: Acquisition commands

Command	Description
<a href="#">REMOTE:ACQMethod</a>	Sets or queries whether the instrument continually acquires acquisitions or acquires a single sequence.
<a href="#">REMOTE:NUMAcq?</a>	In single sequence acquisition mode, specify the number of acquisitions or measurements that comprise the sequence.
<a href="#">REMOTE:SEquence:CURrent?</a>	In single sequence acquisition mode, this query returns the number of acquisitions or measurements in the sequence completed so far.
<a href="#">REMOTE:SEquence:NUMSEquence</a>	Returns the number of waveform acquisitions that have occurred since the last time acquisitions were stopped.

## Act On Event command group

Use this group of commands to program the instrument to perform an action on trigger, search, measurement limit, and mask test events.

Table 2-18: Act On Event commands

Command	Description
<a href="#">ACTONEVent:ENable</a>	Enables or disables actions on event (AOE).
<a href="#">ACTONEVent:NUMSAVES?</a>	Returns the number of saves completed for save on event timer type.
<a href="#">ACTONEVent:TIMER:ACTION:SAVEIMAGE:STATE</a>	Saves a screen capture when :ACTONEVent:TIMERInterval expires.

**Table 2-18: Act On Event commands (cont.)**

<b>Command</b>	<b>Description</b>
<a href="#">ACTONEvent:TIMER:ACTION:SAVETable:STATE</a>	Saves a measurement results when :ACTONEvent:TIMERInterval expires.
<a href="#">ACTONEvent:TIMER:ACTION:SAVEWAVEform:STATE</a>	Saves the user set source waveform(s) when :ACTONEvent:TIMERInterval expires.
<a href="#">ACTONEvent:TIMERCount</a>	Sets or queries the save on event timer count. The ACTONEvent:ENable must be enabled.
<a href="#">ACTONEvent:TIMERInterval</a>	Sets or queries the amount of time, in seconds, to wait for act on event timer event to trigger.
<a href="#">ACTONEvent:Type?</a>	Returns the act on event type.
<a href="#">REMOTE:LOGGING</a>	Sets or queries the act on event data logging feature.
<a href="#">SAVEONEvent:FILEDest</a>	Sets or queries the file path.
<a href="#">SAVEONEvent:FILENAME</a>	Sets or queries the file name without the extension.
<a href="#">SAVEONEvent:IMAGE:FILEFormat</a>	Sets or returns the file extension (png, jpg, bmp).
<a href="#">SAVEONEvent:WAVEform:FILEFormat</a>	Sets or returns the file extension (csv, wfm, mat).
<a href="#">SAVEONEvent:WAVEform:SOURce</a>	Sets or returns the sources for saving waveforms when an event occurs.

## Alias command group

Alias commands allow you to define new commands as a sequence of standard commands. You might find this useful when repeatedly using the same commands to perform certain tasks like setting up measurements.

Aliases are similar to macros but do not include the capability to substitute parameters into alias bodies. The alias mechanism obeys the following rules:

- The alias name must consist of a valid IEEE 488.2 message unit, which may not appear in a message preceded by a colon, comma, or a command or query program header.
- The alias name may not appear in a message followed by program date, a colon, comma, or question mark.
- An alias name must be distinct from any keyword or keyword short form.
- An alias name cannot be redefined without first being deleted using one of the alias deletion functions.
- Alias names do not appear in response messages.
- The Alias commands are defined in Tektronix Standard Codes and Formats. Deviations between that standard and what is specified here will be considered errors unless specifically noted in the command description in this document.

Table 2-19: Alias commands

Command	Description
<a href="#">ALias</a>	Sets or queries the alias state.
<a href="#">ALias:CATalog?</a>	Returns a list of the currently defined alias labels.
<a href="#">ALias:DEFine</a>	Assigns a sequence of program messages to an alias label.
<a href="#">ALias:DELEte</a>	Removes a specified alias.
<a href="#">ALias:DELEte:ALL</a>	Deletes all existing aliases.
<a href="#">ALias:DELEte:NAME</a>	Removes a specified alias.
<a href="#">ALias:STATE</a>	Sets or queries the alias state.

## Bus command group

Use the commands in the Bus Command Group to configure a bus. These commands let you:

- Specify the bus type.
- Specify the signals to be used in the bus.
- Specify its display style.

---

**NOTE.** *Bus commands are present once a bus has been added.*

---

**Bus Mnemonics**      Commands specify the bus to use as a mnemonic in the header.

**Table 2-20: Bus mnemonics**

Symbol	Meaning
B<x>	A bus specifier; <x> is ≥1.

**Table 2-21: Bus commands**

Command	Description
<a href="#">BUS:ADDNew</a>	Adds the specified bus.
<a href="#">BUS:B&lt;x&gt;:ARINC429A:SOUrce</a>	Sets or queries the source for the specified ARINC429 bus.
<a href="#">BUS:B&lt;x&gt;:ARINC429A:THRESHold</a>	Sets or queries the ARINC429 upper threshold for the specified bus.
<a href="#">BUS:B&lt;x&gt;:ARINC429A:POLARITY</a>	Sets or queries the source polarity for the specified ARINC429 bus.
<a href="#">BUS:B&lt;x&gt;:ARINC429A:DATAFORmat</a>	Sets or queries the format of the DATA field for the specified ARINC429 bus.
<a href="#">BUS:B&lt;x&gt;:ARINC429A:BITRate</a>	Sets or queries the ARINC429 bit rate for the specified bus.
<a href="#">BUS:B&lt;x&gt;:ARINC429A:BITRate:CUSTom</a>	Sets or queries the ARINC429 custom bit rate for the specified bus.
<a href="#">BUS:B&lt;x&gt;:AUDio:BITDelay</a>	Sets or queries the number of delay bits for the specified AUDIO bus.
<a href="#">BUS:B&lt;x&gt;:AUDio:BITOrder</a>	Specifies the bit order for the specified AUDIO bus.
<a href="#">BUS:B&lt;x&gt;:AUDio:CLOCK:POLarity</a>	Sets or queries the clock polarity for the specified AUDIO bus.
<a href="#">BUS:B&lt;x&gt;:AUDio:CLOCK:SOUrce</a>	Sets or queries the clock source waveform for the specified AUDIO bus.
<a href="#">BUS:B&lt;x&gt;:AUDio:CLOCK:THReshold</a>	Sets or queries the Audio Clock source threshold for the specified bus.
<a href="#">BUS:B&lt;x&gt;:AUDio:DATA:POLarity</a>	Specifies the data polarity for the specified AUDIO bus.
<a href="#">BUS:B&lt;x&gt;:AUDio:DATA:SIZE</a>	Specifies the number of bits per word for the specified AUDIO bus.
<a href="#">BUS:B&lt;x&gt;:AUDio:DATA:SOUrce</a>	Specifies the audio data source waveform for the specified AUDIO bus.
<a href="#">BUS:B&lt;x&gt;:AUDio:DATA:THReshold</a>	Sets or queries the Audio Data source threshold for the specified bus.
<a href="#">BUS:B&lt;x&gt;:AUDio:DATA:WORDSize</a>	Sets or queries the Audio bits per word for the specified bus.
<a href="#">BUS:B&lt;x&gt;:AUDio:FRAME:CLOCKBITSPERCHANNEL</a>	Sets or queries the Audio bits of sync width for the specified bus.
<a href="#">BUS:B&lt;x&gt;:AUDio:FRAME:SIZE</a>	Specifies the number of channels in each frame for the specified AUDIO bus.
<a href="#">BUS:B&lt;x&gt;:AUDio:TYPE</a>	Specifies the audio format (type) for the specified AUDIO bus.

Table 2-21: Bus commands (cont.)

Command	Description
BUS:B<x>:AUDio:WORDSel:POLarity	Sets or queries the word select polarity for the specified AUDIO bus.
BUS:B<x>:AUDio:WORDSel:SOUrce	Specifies the word select source waveform for the AUDIO bus.
BUS:B<x>:AUDio:WORDSel:THReshold	Sets or queries the Audio Word Select source threshold for the specified bus.
BUS:B<x>:AUTOETHERnet: DATAMINUSTHRESHOLD	Sets or queries the AutoEthernet D- source threshold level for the specified bus.
BUS:B<x>:AUTOETHERnet: DATAPLUSTHRESHold	Sets or queries the AutoEthernet D+ source threshold level for the specified bus.
BUS:B<x>:AUTOETHERnet:LOWDATAMINus	Sets or queries the AutoEthernet D- source low threshold level for the specified bus.
BUS:B<x>:AUTOETHERnet:LOWDATAPLUS	Sets or queries the AutoEthernet D+ source low threshold level for the specified bus.
BUS:B<x>:AUTOETHERnet:LOWTHRESHold	Sets or queries the AutoEthernet Data source Low threshold level for the specified bus.
BUS:B<x>:AUTOETHERnet:SIGNALType	Sets or queries the AutoEthernet signal type for the specified bus.
BUS:B<x>:AUTOETHERnet:SOUrce	Sets or queries the AutoEthernet data (SDATA) source for the specified bus.
BUS:B<x>:AUTOETHERnet:SOUrce:DMINus	Sets or queries the AutoEthernet D- source for the specified bus.
BUS:B<x>:AUTOETHERnet:SOUrce:DPLUs	Sets or queries the AutoEthernet D+ source for the specified bus.
BUS:B<x>:AUTOETHERnet:THRESHold	Sets or queries the AutoEthernet DATA source High threshold level for the specified bus.
BUS:B<x>:AUTOETHERnet:TYPE	Sets or queries the AutoEthernet standard speed.
BUS:B<x>:CAN:BITRate	Sets or queries the CAN bit rate.
BUS:B<x>:CAN:BITRate:VALue	Sets or queries CAN bit rate.
BUS:B<x>:CAN:FD:BITRate	Sets or queries the increased data phase bit rate used by CAN FD packets on the specified CAN bus.
BUS:B<x>:CAN:FD:BITRate:CUSTom	Sets or queries the custom bit rate for the increased data phase of CAN FD packets on the specified CAN bus.
BUS:B<x>:CAN:SAMPLEpoint	Sets or queries the sample point for the specified CAN bus.
BUS:B<x>:CAN:SIGNAL	Sets or queries the signal type for the specified CAN bus.
BUS:B<x>:CAN:SOUrce	Sets or queries the CAN source channel.
BUS:B<x>:CAN:STANDard	Sets or queries which CAN standard specification to analyze the specified CAN bus with.
BUS:B<x>:CAN:THReshold	Sets or queries the source channel threshold for the specified CAN bus.
BUS:B<x>:CPHY:A:DATA:THRESHold	Sets or queries the CPHY Single Ended A source threshold for the specified bus.
BUS:B<x>:CPHY:A:LP:THRESHold	Sets or queries the CPHY Single Ended A LP threshold for the specified bus.
BUS:B<x>:CPHY:A:SOUrce	Sets or queries the CPHY Single Ended A source for the specified bus line.
BUS:B<x>:CPHY:AB:SOUrce	Sets or queries the CPHY differential AB source for the specified bus line.
BUS:B<x>:CPHY:AB:THReshold	Sets or queries the CPHY differential AB source threshold for the specified bus.
BUS:B<x>:CPHY:AGND:SOUrce	Sets or queries the CPHY differential AGND source for the specified bus line.

Table 2-21: Bus commands (cont.)

Command	Description
BUS:B<x>:CPHY:AGND:THRShold	Sets or queries the CPHY differential AGND source threshold for the specified bus.
BUS:B<x>:CPHY:B:DATA:THREShold	Sets or queries the CPHY Single Ended B source threshold for the specified bus.
BUS:B<x>:CPHY:B:SOUrce	Sets or queries the CPHY Single Ended B source for the specified bus line.
BUS:B<x>:CPHY:BC:SOUrce	Sets or queries the CPHY differential BC source for the specified bus line.
BUS:B<x>:CPHY:BC:THRShold	Sets or queries the CPHY differential BC source threshold for the specified bus.
BUS:B<x>:CPHY:BITRate	Sets or queries the bit rate for the specified CPHY bus.
BUS:B<x>:CPHY:C:DATA:THREShold	Sets or queries the CPHY Single Ended C source threshold for the specified bus.
BUS:B<x>:CPHY:C:LP:THREShold	Sets or queries the CPHY Single Ended C LP threshold for the specified bus.
BUS:B<x>:CPHY:C:SOUrce	Sets or queries the CPHY Single Ended C source for the specified bus line.
BUS:B<x>:CPHY:CA:SOUrce	Sets or queries the CPHY differential CA source for the specified bus line.
BUS:B<x>:CPHY:CA:THRShold	Sets or queries the CPHY differential CA source threshold for the specified bus.
BUS:B<x>:CPHY:CGND:SOUrce	Sets or queries the CPHY differential CGND source for the specified bus line.
BUS:B<x>:CPHY:CGND:THRShold	Sets or queries the CPHY differential CGND source threshold for the specified bus.
BUS:B<x>:CPHY:LP:DIRectioN	Sets or queries the CPHY bus direction in low power.
BUS:B<x>:CPHY:SIGNALTYpe	Sets or queries the signal type for CPHY bus decode.
BUS:B<x>:CPHY:SUBTYpe	Sets or queries the sub type for CPHY bus decode.
BUS:B<x>:CXPI:BITRate	Sets or queries the bit rate for the specified CXPI bus.
BUS:B<x>:CXPI:REC:THRShold	Sets or queries the source channel recessive threshold for the specified CXPI bus.
BUS:B<x>:CXPI:SOUrce	Sets or queries the source channel for the specified CXPI bus.
BUS:B<x>:DISPlay:FORMat	Sets or queries how the data is represented in the busform for the specified bus.
BUS:B<x>:DISPlay:LAYout	This command sets or queries the format a bus layer should use.
BUS:B<x>:DPHY:CLOCK:SOUrce	Sets or queries the DPHY Clock source for the specified bus line.
BUS:B<x>:DPHY:CLOCK:THREShold	Sets or queries the DPHY Clock source threshold for the specified bus.
BUS:B<x>:DPHY:DMINus:DATATHREShold	Sets or queries the DPHY D- source data threshold for the specified bus.
BUS:B<x>:DPHY:DMINus:LPTHREShold	Sets or queries the DPHY D- source low power threshold for the specified bus.
BUS:B<x>:DPHY:DMINus:SOUrce	Sets or queries the DPHY D- source for the specified bus line.
BUS:B<x>:DPHY:DPlus:DATATHREShold	Sets or queries the D+ source data threshold for the specified bus.
BUS:B<x>:DPHY:DPlus:LPTHREShold	Sets or queries the DPHY D+ source low power threshold for the specified bus.
BUS:B<x>:DPHY:DPlus:SOUrce	Sets or queries the DPHY D+ source for the specified bus line.
BUS:B<x>:DPHY:LP:DIRectioN	Sets or queries the DPHY bus direction in low power.
BUS:B<x>:DPHY:PROTOcol:TYpe	Sets or queries the protocol type for DPHY bus decode.
BUS:B<x>:DPHY:SIGNal:ENCoding	Sets or queries the 8b9b encoding for DPHY bus decode.
BUS:B<x>:ESPI:ALERT:POLarity	Sets or queries the ESPI alert polarity for the specified bus.

Table 2-21: Bus commands (cont.)

Command	Description
BUS:B<x>:ESPI:ALERT:SOURce	Sets or queries the alert source for the specified bus.
BUS:B<x>:ESPI:ALERT:THReshold	Sets or queries the alert source threshold for the specified bus.
BUS:B<x>:ESPI:ALERTVIEW	Sets or queries the ESPI alert view for the specified bus.
BUS:B<x>:ESPI:CHIPSElect:POLarity	Sets or queries the ESPI chip select polarity for the specified bus.
BUS:B<x>:ESPI:CHIPSElect:SOURce	Sets or queries the chip select source for the specified bus.
BUS:B<x>:ESPI:CHIPSElect:THReshold	Sets or queries the chip select source threshold for the specified bus.
BUS:B<x>:ESPI:CLOCK:POLarity	Sets or queries the ESPI Clock (SCLK) source polarity for the specified bus.
BUS:B<x>:ESPI:CLOCK:SOURce	Sets or queries the clock source for the specified bus.
BUS:B<x>:ESPI:CLOCK:THReshold	Sets or queries the clock source threshold for the specified bus.
BUS:B<x>:ESPI:DATAONE:POLarity	Sets or queries the ESPI command (single mode)/ IO[0] (dual mode) Data polarity for the specified bus.
BUS:B<x>:ESPI:CLOCK:SOURce	Sets or queries the command (single mode)/ IO[0] (dual mode) Clock source for the specified bus.
BUS:B<x>:ESPI:DATAONE:THReshold	Sets or queries the command (single mode)/ IO[0] (dual mode) Data source threshold for the specified bus.
BUS:B<x>:ESPI:DATATWO:POLarity	Sets or queries the ESPI response (single mode)/ IO[1] (dual mode) polarity for the specified bus.
BUS:B<x>:ESPI:DATATWO:SOURce	Sets or queries the response (single mode)/ IO[1] (dual mode) Data source for the specified bus.
BUS:B<x>:ESPI:DATATWO:THReshold	Sets or queries the response (single mode)/ IO[1] (dual mode) Data source threshold for the specified bus.
BUS:B<x>:ESPI:IOMODE	Sets or queries the ESPI Input/Output mode for the specified bus.
BUS:B<x>:ETHERCAT:DATAMINUSTHRESHold	Sets or queries the DATA Minus source threshold for the specified EtherCAT bus.
BUS:B<x>:ETHERCAT:DATAPLUSTHRESHold	Sets or queries the DATA Plus source threshold for the specified EtherCAT bus.
BUS:B<x>:ETHERCAT:SIGNALTYpe	Sets or queries the signal type for the specified EtherCAT bus.
BUS:B<x>:ETHERCAT:SOURce:DIFF	Sets or queries the differential source for the specified EtherCAT bus.
BUS:B<x>:ETHERCAT:SOURce:DMINus	Sets or queries the DataMinus (SDATAMINUS) source for the specified EtherCAT bus.
BUS:B<x>:ETHERCAT:SOURce:DPLUS	Sets or queries the DataPlus (SDATAPLUS) source for the specified EtherCAT bus.
BUS:B<x>:ETHERCAT:THRESHold	Sets or queries the EtherCAT Differential source threshold for the specified EtherCAT bus
BUS:B<x>:ETHERnet:DATAMINUSTHRESHold	Sets or queries the Ethernet DATA Minus source threshold for the specified bus.
BUS:B<x>:ETHERnet:DATAPLUSTHRESHold	Sets or queries the Ethernet DATA Plus source threshold for the specified bus.
BUS:B<x>:ETHERnet:IPVFOUR	Sets or queries whether IPV4 packets are available for triggering on Ethernet.
BUS:B<x>:ETHERnet:LOWTHRESHold	Sets or queries the Ethernet DATA source Low threshold for the specified bus.
BUS:B<x>:ETHERnet:QTAGGING	Sets or queries whether Q-Tagging packets are available for triggering on Ethernet.

Table 2-21: Bus commands (cont.)

Command	Description
<a href="#">BUS:B&lt;x&gt;:ETHERnet:SIGNALType</a>	Sets or queries the Ethernet signal type for the specified bus.
<a href="#">BUS:B&lt;x&gt;:ETHERnet:SOURce</a>	Specifies the Ethernet data source for differential input.
<a href="#">BUS:B&lt;x&gt;:ETHERnet:SOURce:DMINus</a>	Sets or queries the Ethernet DMINus source.
<a href="#">BUS:B&lt;x&gt;:ETHERnet:SOURce:DPLUs</a>	Sets or queries the Ethernet DPLUs source.
<a href="#">BUS:B&lt;x&gt;:ETHERnet:THRESHold</a>	Sets or queries the Ethernet DATA source High threshold for the specified bus.
<a href="#">BUS:B&lt;x&gt;:ETHERnet:TYPE</a>	Specifies the Ethernet standard type: 10Base-T or 100Base-T.
<a href="#">BUS:B&lt;x&gt;:EUSB:BITRate</a>	Sets or queries the eUSB data rate for the specified bus.
<a href="#">BUS:B&lt;x&gt;:EUSB:DATAMINUS:DATA:THRESHold</a>	Sets or queries the eUSB D- Input Source Data Threshold for Data line decode for specified bus.
<a href="#">BUS:B&lt;x&gt;:EUSB:DATAMINUSTHRESHold</a>	Sets or queries the eUSB DATA Minus source threshold for the specified bus.
<a href="#">BUS:B&lt;x&gt;:EUSB:DATAPLUS:DATA:THRESHold</a>	Sets or queries the eUSB D+ Input Source Data Threshold for Data line decode for specified bus.
<a href="#">BUS:B&lt;x&gt;:EUSB:DATAPLUSTHRESHold</a>	Sets or queries the eUSB DATA Plus source threshold for the specified bus.
<a href="#">BUS:B&lt;x&gt;:EUSB:LOWTHRESHold</a>	Sets or queries the eUSB source Low threshold for the specified bus when signal type is Differential.
<a href="#">BUS:B&lt;x&gt;:EUSB:OPERating:MODE</a>	Sets or queries the eUSB mode for the specified bus.
<a href="#">BUS:B&lt;x&gt;:EUSB:SIGNALType</a>	Sets or queries the eUSB signal type for the specified bus.
<a href="#">BUS:B&lt;x&gt;:EUSB:SOURce:DIFF</a>	Sets or queries the eUSB Diff source for the specified bus when signal type is Diff.
<a href="#">BUS:B&lt;x&gt;:EUSB:SOURce:DMINus</a>	Sets or queries the eUSB DataMinus (SDATAMINUS) source for the specified bus.
<a href="#">BUS:B&lt;x&gt;:EUSB:SOURce:DPLUs</a>	Sets or queries the eUSB dataPlus (SDATAPLUS) source for the Specified bus.
<a href="#">BUS:B&lt;x&gt;:EUSB:THRESHold</a>	Sets or queries the eUSB source High threshold for the specified bus when signal type is Diff.
<a href="#">BUS:B&lt;x&gt;:FLEXray:BITRate</a>	Sets or queries the FlexRay bus bit rate.
<a href="#">BUS:B&lt;x&gt;:FLEXray:BITRate:CUSTom</a>	Sets or queries the FlexRay custom bit rate for the specified bus.
<a href="#">BUS:B&lt;x&gt;:FLEXray:CHannel</a>	Sets or queries the FlexRay bus channel.
<a href="#">BUS:B&lt;x&gt;:FLEXray:LOWTHRESHold</a>	Sets or queries the FlexRay data source low threshold for the specified bus.
<a href="#">BUS:B&lt;x&gt;:FLEXray:SIGnal</a>	Sets or queries the FlexRay probe.
<a href="#">BUS:B&lt;x&gt;:FLEXray:SOURce</a>	Sets or queries the FlexRay bus source.
<a href="#">BUS:B&lt;x&gt;:FLEXray:SOURce:TXRX</a>	Sets or queries the FlexRay TxRx data source for the specified bus.
<a href="#">BUS:B&lt;x&gt;:FLEXray:THRESHold</a>	Sets or queries the FlexRay data source threshold for the specified bus.
<a href="#">BUS:B&lt;x&gt;:FLEXray:TXRXTHRESHold</a>	Sets or queries the FlexRay data source TxRx threshold for the specified bus.
<a href="#">BUS:B&lt;x&gt;:I2C:CLOCK:SOURce</a>	Sets or queries the I2C clock (SCLK) source for the specified bus.
<a href="#">BUS:B&lt;x&gt;:I2C:CLOCK:THReshold</a>	Sets or queries the I2C Clock (SCLK) source threshold for the specified bus.
<a href="#">BUS:B&lt;x&gt;:I2C:DATA:SOURce</a>	Sets or queries the I2C data (SDA) source for the specified bus.
<a href="#">BUS:B&lt;x&gt;:I2C:DATA:THReshold</a>	Sets or queries the I2C Data (SDA) source threshold for the specified bus.



Table 2-21: Bus commands (cont.)

Command	Description
BUS:B<x>:I2C:RWINADDR	Determines whether decoded I2C slave addresses are pure seven-bit values, or have the R/W* combined with them.
BUS:B<x>:I3C:CLOCK:SOURce	Sets or queries the I3C clock (SCLK) source for the specified bus.
BUS:B<x>:I3C:CLOCK:THReshold	Sets or queries the I3C clock (SCLK) source threshold level for the specified bus.
BUS:B<x>:I3C:DATA:SOURce	Sets or queries the I3C data clock (SDA) source for the specified bus.
BUS:B<x>:I3C:DATA:THReshold	Sets or queries the I3C clock (SDA) data threshold level for the specified bus.
BUS:B<x>:LABel:COLor	Sets or queries the color of the specified bus label.
BUS:B<x>:LABel:FONT:BOLD	Sets or queries the bold state of the specified bus label.
BUS:B<x>:LABel:FONT:ITALic	Sets or queries the italic state of the specified bus label.
BUS:B<x>:LABel:FONT:SIZE	Sets or queries the font size of the specified bus label.
BUS:B<x>:LABel:FONT:TYPE	Sets or queries the font type of the specified bus label, such as Arial or Times New Roman.
BUS:B<x>:LABel:FONT:UNDERline	Sets or queries the underline state of the specified bus label.
BUS:B<x>:LABel:name	Sets or queries the waveform label for the specified bus.
BUS:B<x>:LABel:XPOS	Sets or queries the x-position of the specified bus' label.
BUS:B<x>:LABel:YPOS	Sets or queries the y-position of the specified bus' label.
BUS:B<x>:LIN:BITRate	Sets or queries the LIN bus bit rate.
BUS:B<x>:LIN:IDFORmat	Sets or queries LIN bus id format.
BUS:B<x>:LIN:POLarity	Sets or queries the LIN bus polarity.
BUS:B<x>:LIN:SAMPLEpoint	Specifies the point to sample during each bit period, as a percent, for the specified LIN bus.
BUS:B<x>:LIN:SOURce	Sets or queries sets the LIN bus source.
BUS:B<x>:LIN:SOURce:THReshold	Sets or queries the LIN source threshold for the specified bus.
BUS:B<x>:LIN:STANDard	Sets or queries the LIN bus standard.
BUS:B<x>:LIN:BITRate:CUSTom	Sets or queries LIN custom bit rate for the specified bus.
BUS:B<x>:MANChester:BITORDER	Sets or queries the Manchester bus Bit Order.
BUS:B<x>:MANChester:BITRate	Sets or queries the Manchester bus bit rate.
BUS:B<x>:MANChester:DISPlaymode	Sets or queries the Manchester bus Packet View.
BUS:B<x>:MANChester:HEADer:LENGth	Sets or queries the Manchester header length in bits.
BUS:B<x>:MANChester:IDLE:BITS	Sets or queries the Manchester idle bit size in bits.
BUS:B<x>:MANChester:parity	Sets or queries the Manchester bus Parity.
BUS:B<x>:MANChester:SOURce	Sets or queries the Manchester source for the specified bus.
BUS:B<x>:MANChester:START:INDEX	Sets or queries the Manchester start Index in bits.
BUS:B<x>:MANChester:SYNC:SIZE	Sets or queries the Manchester sync Bit Size in bits.
BUS:B<x>:MANChester:THReshold	Sets or queries the Manchester threshold for the specified bus.
BUS:B<x>:MANChester:TOLerance	Sets or queries the Tolerance bus parameter.
BUS:B<x>:MANChester:TRAIler:LENGth	Sets or queries the Manchester trailer length in bits.

Table 2-21: Bus commands (cont.)

Command	Description
BUS:B<x>:MANchester:TRANsition:ZERo	Sets or queries the Manchester bus for zero falling or rising.
BUS:B<x>:MANchester:WORD:COUNT	Sets or queries the Manchester word count in bits.
BUS:B<x>:MANchester:WORDSIZe	Sets or queries the Manchester word size in bits.
BUS:B<x>:MDIO:CLOCK:SOURce	Sets or queries the MDIO Clock source for the specified bus.
BUS:B<x>:MDIO:CLOCK:THReshold	Sets or queries the MDIO Clock source threshold for the specified bus.
BUS:B<x>:MDIO:DATA:SOURce	Sets or queries the MDIO Data source for the specified bus.
BUS:B<x>:MDIO:DATA:THReshold	Sets or queries the MDIO Data source threshold for the specified bus.
BUS:B<x>:MIL1553B:SOURce	Sets or queries the source for the specified MIL-STD-1553 bus.
BUS:B<x>:MIL1553B:THRESHold	Sets or queries the MIL-STD-1553 upper threshold for the specified bus.
BUS:B<x>:MIL1553B:LOWTHRESHold	Sets or queries the MIL-STD-1553 lower threshold for the specified bus.
BUS:B<x>:MIL1553B:POLarity	Sets or queries the source polarity for the specified MIL-STD-1553 bus.
BUS:B<x>:MIL1553B:RESPonsetime:MINimum	Sets or queries the minimum response time to a valid command issued for the specified MIL-STD-1553 bus.
BUS:B<x>:MIL1553B:RESPonsetime:MAXimum	Sets or queries the maximum response time to a valid command issued for the specified MIL-STD-1553 bus.
BUS:B<x>:NRZ:BITOrder	Sets or queries the NRZ bit order for the specified bus.
BUS:B<x>:NRZ:BITRate	Sets or queries the NRZ bus bit rate.
BUS:B<x>:NRZ:POLarity	Sets or queries the NRZ source polarity for the specified bus.
BUS:B<x>:NRZ:SOURce	Sets or queries the NRZ source for the specified bus.
BUS:B<x>:NRZ:SPMI:VERsion	Sets or queries the Version for the specified bus.
BUS:B<x>:NRZ:THReshold	Sets or queries the NRZ threshold for the specified bus.
BUS:B<x>:ONEWIRE:DATA:SOURce	Sets or queries the source for the specified ONEWIRE bus.
BUS:B<x>:ONEWIRE:DATA:THReshold	Sets or queries the ONEWIRE data source threshold for the specified bus.
BUS:B<x>:ONEWIRE:MODE	Sets or queries the mode for the specified ONEWIRE bus.
BUS:B<x>:PARAllel:ALLTHResholds	Sets or queries the threshold for all sources for the parallel bus.
BUS:B<x>:PARAllel:ALLTHResholds:APPLY	Sets all of the data source thresholds to the value of the allMRefs parameter for the parallel bus.
BUS:B<x>:PARAllel:BIT<n>SOURce	Sets or queries the specified bit source for specified parallel bus.
BUS:B<x>:PARAllel:BIT<n>SOURce:THReshold	Sets or queries the specified bit source threshold for the specified parallel bus.
BUS:B<x>:PARAllel:CLOCK:EDGE	Determines which edges of its clock signal cause a clocked parallel bus to sample new states.
BUS:B<x>:PARAllel:CLOCK:ISCLOCKED	Determines whether the bus operates in a clocked or asynchronous fashion.
BUS:B<x>:PARAllel:CLOCKSOURce	Sets or queries the Parallel clock source for the specified bus.
BUS:B<x>:PARAllel:CLOCKSOURce:THReshold	Sets or queries the bit source threshold for the parallel bus.
BUS:B<x>:PSIFIVE:BITPERiod	Sets or queries the PS15 Bit period bus parameter.
BUS:B<x>:PSIFIVE:BITRate	Sets or queries the PS15 bitrate.
BUS:B<x>:PSIFIVE:COMM:DIRection	Sets or queries the PS15 bus communication direction.
BUS:B<x>:PSIFIVE:DATAA	Sets or queries the PS15 frame mandatory data region A.

Table 2-21: Bus commands (cont.)

Command	Description
BUS:B<x>:PSIFive:DATAB	Sets or queries the PSI5 frame optional bits of data region B.
BUS:B<x>:PSIFive:DATAFORMat	Sets or queries the data format in PSI5 Frame2 packet.
BUS:B<x>:PSIFive:ECUSOURce	Sets or queries the ECU to sensor source channel for the specified Bus.
BUS:B<x>:PSIFive:FRAMECONTRol	Sets or queries the PSI5 frame optional control bits.
BUS:B<x>:PSIFive:MESSaging	Sets or queries the PSI5 optional messaging bits.
BUS:B<x>:PSIFive:SOURce	Sets or queries serial channel on or off.
BUS:B<x>:PSIFive:STATus	Sets or queries the optional status bits of PSI5.
BUS:B<x>:PSIFive:SYNcMODE	Sets or queries the PSI5 Sync Mode.
BUS:B<x>:PSIFive:SYNcTHRESHold	Sets or queries the PSI5 threshold for the ECU To Sensor specified bus.
BUS:B<x>:PSIFive:THRESHold	Sets or queries the PSI5 threshold for the Sensor To ECU specified bus.
BUS:B<x>:RS232C:BITRate	Sets or queries the RS-232 bit rate for the specified bus.
BUS:B<x>:RS232C:BITRate:CUStom	Sets or queries the RS232 custom bit rate for the specified bus.
BUS:B<x>:RS232C:DATABits	Sets or queries the number of RS-232 data bits for the specified bus.
BUS:B<x>:RS232C:DELIMiter	Sets or queries the RS-232 delimiting value for a packet on the specified bus.
BUS:B<x>:RS232C:DISplaymode	Sets or queries the display mode for the specified bus.
BUS:B<x>:RS232C:PARity	Sets or queries the RS-232 parity for the specified bus.
BUS:B<x>:RS232C:POLarity	Sets or queries the RS-232 polarity for the specified bus.
BUS:B<x>:RS232C:SOURce	Sets or queries the RS-232 polarity for the specified bus.
BUS:B<x>:RS232C:SOURce:THReshold	Sets or queries the RS232 source threshold for the specified bus.
BUS:B<x>:S8B10B:BITRate	Sets or queries the 8B10B bit rate for the specified bus.
BUS:B<x>:S8B10B:SOURce	Sets or queries the 8B10B source for the specified bus. Specifies the source channel.
BUS:B<x>:S8B10B:THReshold	Sets or queries the 8B10B threshold for the specified bus.
BUS:B<x>:SDLC:BITRate	Sets or queries the bit rate for the specified SDLC bus.
BUS:B<x>:SDLC:DATA:SOURce	Sets or queries the source for the specified bus.
BUS:B<x>:SDLC:DATA:THReshold	Sets or queries the SDLC data source threshold for the specified bus.
BUS:B<x>:SDLC:ENCoding	Sets or queries the SDLC Bus Encoding.
BUS:B<x>:SDLC:MODulo	Sets or queries the SDLC Bus Modulo.
BUS:B<x>:SENT:CHANWidth	Sets or queries SENT fast channel bit widths for the specified bus.
BUS:B<x>:SENT:NIBBLECount	Sets or queries SENT data nibbles for the specified bus.
BUS:B<x>:SENT:NUMCHANnel	Sets or queries SENT fast data channels for the specified bus.
BUS:B<x>:SENT:PAUSEPULSe	Sets or queries SENT pause pulse for the specified bus.
BUS:B<x>:SENT:POLARITY	Sets or queries SENT Idle State signal polarity for the specified bus.
BUS:B<x>:SENT:SLOW	Sets or queries the SENT slow channel configuration for the specified bus.
BUS:B<x>:SENT:SOURce	Sets or queries the SENT DATA source for the specified bus.
BUS:B<x>:SENT:THRESHold	Sets or queries the SENT DATA source threshold for the specified bus.
BUS:B<x>:SENT:TICKTIME	Sets or queries the SENT bus Clock Tick parameter for the specified bus.

Table 2-21: Bus commands (cont.)

Command	Description
BUS:B<x>:SENT:TICKTOLerance	Sets or queries the SENT bus Tick Tolerance percent parameter for the specified bus.
BUS:B<x>:SMBUS:CLOCK:SOUrce	Sets or queries the clock source for the specified bus.
BUS:B<x>:SMBUS:CLOCK:THReshold	Sets or queries the SMBUS clock source threshold for the specified bus.
BUS:B<x>:SMBUS:DATA:SOUrce	Sets or queries the data source for the specified bus.
BUS:B<x>:SMBUS:DATA:THReshold	Sets or queries the SMBUS data source threshold for the specified bus.
BUS:B<x>:SMBUS:PEC:VALUe	Sets or queries the SMBUS PEC selection for the specified bus.
BUS:B<x>:SPACEWIRe:BITRate	Sets or queries the SpaceWire bit rate.
BUS:B<x>:SPACEWIRe:DATa:SOUrce	Sets or queries the source of the SpaceWire Data signal for the specified bus.
BUS:B<x>:SPACEWIRe:DATa:THReshold	Sets or queries the threshold of the SpaceWire Data signal for the specified bus.
BUS:B<x>:SPACEWIRe:DECode:TYPE	Sets or queries the decode type for SpaceWire bus decode.
BUS:B<x>:SPACEWIRe:STRobe:SOUrce	Sets or queries the source of the SpaceWire Strobe signal for the specified bus.
BUS:B<x>:SPACEWIRe:STRobe:THReshold	Sets or queries the threshold level of the SpaceWire Strobe signal for the specified bus.
BUS:B<x>:SPACEWIRe:SYNC	Sets or queries sync for SpaceWire decoding.
BUS:B<x>:SPACEWIRe:SYNC:COUnt	Sets or queries the length of the data string in bytes to be used for an SpaceWire sync bytes.
BUS:B<x>:SPACEWIRe:SYNC:PATtern	Sets or queries sync pattern for SpaceWire decoding.
BUS:B<x>:SPACEWIRe:SYNC:VALUe	Sets or queries sync value for sync option data.
BUS:B<x>:SPI:BITOrder	Sets or queries the shift direction used to de-serialize data for the SPI mode of the bus.
BUS:B<x>:SPI:CLOCK:POLarity	Sets or queries the SPI clock (SCLK) polarity for the specified bus.
BUS:B<x>:SPI:CLOCK:SOUrce	Sets or queries the SPI clock (SCLK) source for the specified bus.
BUS:B<x>:SPI:CLOCK:THReshold	Sets or queries the SPI Clock (SCLK) source threshold for the specified bus.
BUS:B<x>:SPI:DATa:POLarity	Sets or queries the SPI data (DATA) polarity for the specified bus.
BUS:B<x>:SPI:DATa:SIZE	Sets or queries the number of bits per word for the specified bus.
BUS:B<x>:SPI:DATa:SOUrce	Sets or queries the SPI data (DATA) source for the specified bus.
BUS:B<x>:SPI:DATa:THReshold	Sets or queries the SPI Data (DATA) source threshold for the specified bus.
BUS:B<x>:SPI:FRAMING	Sets or queries the SPI bus framing.
BUS:B<x>:SPI:IDLETime	Sets or queries the SPI bus idle time.
BUS:B<x>:SPI:MISo:DATa:POLarity	Sets or queries the SPI MISo Data source polarity for the specified bus.
BUS:B<x>:SPI:MISo:INPut	Sets or queries the SPI MISo source for the specified bus.
BUS:B<x>:SPI:MISo:THReshold	Sets or queries the SPI MISo Data source threshold for the specified bus.
BUS:B<x>:SPI:MOSI:DATa:POLarity	Sets or queries the SPI MOSI source polarity for the specified bus.
BUS:B<x>:SPI:MOSI:INPut	Sets or queries the SPI MOSI source for the specified bus.
BUS:B<x>:SPI:MOSI:THReshold	Sets or queries the SPI MOSI source threshold for the specified bus.
BUS:B<x>:SPI:NUMBer:INputs	Sets or queries the number of inputs for the specified bus.
BUS:B<x>:SPI:SELect:POLarity	Sets or queries the SPI Slave Select (SS) polarity for the specified bus.

Table 2-21: Bus commands (cont.)

Command	Description
BUS:B<x>:SPI:SElect:SOUrce	Sets or queries the SPI Slave Select (SS) source for the specified bus.
BUS:B<x>:SPI:SElect:THReshold	Sets or queries the SPI Select (SS) source threshold for the specified bus.
BUS:B<x>:SPMI:SCLk:SOUrce	This command sets or queries the SPMI Clock (SCLK) source for the specified bus.
BUS:B<x>:SPMI:SCLk:THReshold	This command sets or queries the SPMI Clock (SCLK) source threshold for the specified bus.
BUS:B<x>:SPMI:SDATa:SOUrce	This command sets or queries the SPMI Data (SDATA) source for the specified bus.
BUS:B<x>:SPMI:SDATa:THReshold	This command sets or queries the SPMI Data (SDATA) source threshold for the specified bus.
BUS:B<x>:SVID:ALERT:SOUrce	Sets or queries alert source channel for the specified SVID bus.
BUS:B<x>:SVID:ALERT:THReshold	Sets or queries the alert threshold for the specified SVID bus.
BUS:B<x>:SVID:CLOCK:SOUrce	Sets or queries clock source channel for the specified SVID bus.
BUS:B<x>:SVID:CLOCK:THReshold	Sets or queries the clock threshold for the specified SVID bus.
BUS:B<x>:SVID:DATA:SOUrce	Sets or queries data source channel for the specified SVID bus.
BUS:B<x>:SVID:DATA:THReshold	Sets or queries the data threshold for the specified SVID bus.
BUS:B<x>:TYPE	Sets or queries the bus type specified.
BUS:B<x>:USB:BITRate	Sets or queries the USB bit rate for the specified bus.
BUS:B<x>:USB:SOUrce	Sets or queries the USB Data Source for the specified bus.
BUS:B<x>:USB:SOUrce:DMINus	Sets or queries the USB Data Source for D- input for the specified bus.
BUS:B<x>:USB:SOUrce:DPLUs	Sets or queries the USB Data Source for D+ input for the specified bus.
BUS:B<x>:USB:DATAMINUSTHRESHold	Sets or queries the USB DATA Minus source threshold for the specified bus.
BUS:B<x>:USB:DATAPLUSTHRESHold	Sets or queries the USB DATA Plus source threshold for the specified bus.
BUS:B<x>:USB:LOWTHRESHold	Sets or queries the USB DATA source Low threshold for the specified bus.
BUS:B<x>:USB:SIGNALTYpe	Sets or queries the USB signal type for the specified bus.
BUS:B<x>:USB:THRESHold	Sets or queries the USB DATA source High threshold for the specified bus.
BUS:DELeTe	Deletes the specified bus.
BUS:LIST?	Lists all currently defined bus.
BUSTABLE:ADDNew	Adds the specified bus table.
BUSTABLE:DELeTe	Deletes the specified bus table.
BUSTABLE:LIST?	Lists all currently defined bus tables.
DISPlay:WAVEView<x>:BUS:B<x>:STATE	Sets or queries the state of the specified bus in the specified Waveform View.
DISPlay:WAVEView<x>:BUS:B<x>:VERTical:POStion	Sets or queries the vertical position of the specified bus in the specified Waveform View.

## Callouts command group

The Callout commands creates custom callouts to document specific details of your test results.

Table 2-22: Callout commands

Command	Description
<code>CALLOUTS:CALLOUT&lt;x&gt;</code>	Creates a new note.
<code>CALLOUTS:CALLOUT&lt;x&gt;:BOOKMark:SOURCE</code>	Sets or queries the source of the Bookmark callout type.
<code>CALLOUTS:CALLOUT&lt;x&gt;:BOOKMark:XPOS</code>	Sets or queries the X-Position of the Bookmark callout type.
<code>CALLOUTS:CALLOUT&lt;x&gt;:COLOR</code>	Sets or queries the text color of the callout.
<code>CALLOUTS:CALLOUT&lt;x&gt;:DISPLAYPOSITION:X</code>	Sets or queries horizontal display position of the callout text
<code>CALLOUTS:CALLOUT&lt;x&gt;:DISPLAYPOSITION:Y</code>	Sets or queries vertical display position of the callout text
<code>CALLOUTS:CALLOUT&lt;x&gt;:FONT:BOLD</code>	Sets or queries the bold state of the callout text.
<code>CALLOUTS:CALLOUT&lt;x&gt;:FONT:ITALIC</code>	Sets or queries the italic state of the callout text.
<code>CALLOUTS:CALLOUT&lt;x&gt;:FONT:SIZE</code>	Sets or queries the font size of the callout text.
<code>CALLOUTS:CALLOUT&lt;x&gt;:FONT:TYPE</code>	Sets or queries the font type of the callout.
<code>CALLOUTS:CALLOUT&lt;x&gt;:FONT:UNDERLine</code>	Sets or queries the underline state of the callout text.
<code>CALLOUTS:CALLOUT&lt;x&gt;:TEXT</code>	Sets or queries the callout text.
<code>CALLOUTS:CALLOUT&lt;x&gt;:TYPE</code>	Sets or queries type of the callout

## Cursor command group

Use the commands in the Cursor Command Group to control the cursor display and readout. You can use these commands to control the setups for each cursor, such as waveform source, and cursor position.

You can also use the commands to select one of the following cursor functions:

- **Off.** Shuts off the display of all cursors.
- **Vertical bars.** Displays vertical bar cursors, which provide traditional horizontal unit readouts for Cursor 1 (bar1), Cursor 2 (bar2), the delta between them, and 1/delta (results in frequency when the horizontal unit is time). Vertical bars are another name for vertical screen cursors.
- **Horizontal bars.** Displays horizontal bar cursors, which provide traditional vertical unit readouts for Cursor 1 (bar1), Cursor 2 (bar2), and the delta between them. Horizontal bars are another name for horizontal screen cursors.
- **Waveform cursors.** Consists of two cursors you can independently assign to a waveform. Waveform cursors enable you to conveniently measure waveform amplitude and time at specific points on the waveform. In XY or XYZ format, waveform cursors indicate the amplitude position of an XY pair (Ch1 vs Ch2 voltage, where Ch1 is the X axis and Ch2 is the Y axis) relative to the trigger.
- **Screen cursors.** Consist of two pairs of horizontal and vertical bar cursors. You can use these cursors to indicate an arbitrary position within the waveform display area. Screen cursors are basically just turning on horizontal bars and vertical bars at the same time. These cursors have no association with any waveform, except that they inherit the color of the waveform they are assigned to.

---

**NOTE.** *Cursor commands are available once a view has been added.*

---

Table 2-23: Cursor commands

Command	Description
<code>DISplay:MATHFFTView&lt;x&gt;:CURSor:ASOUrce?</code>	Queries the cursor source for cursor A in the specified Math-FFT waveform.
<code>DISplay:MATHFFTView&lt;x&gt;:CURSor:BSOUrce?</code>	Queries the cursor source for cursor B in the specified Math-FFT waveform.
<code>DISplay:MATHFFTView&lt;x&gt;:CURSor:DDT?</code>	Queries the delta V over delta T cursor readout value in the specified Math-FFT waveform.
<code>DISplay:MATHFFTView&lt;x&gt;:CURSor:FUNCTION</code>	Sets or queries the cursor type in the specified Math-FFT waveform.
<code>DISplay:MATHFFTView&lt;x&gt;:CURSor:HBArs:APOsition</code>	Sets or returns the horizontal cursor A position in the specified Math-FFT waveform.

Table 2-23: Cursor commands (cont.)

Command	Description
DISplay:MATHFFTView<x>:CURSor:HBArs:AUNIts?	Queries cursor A vertical units of the specified cursor in the specified view.
DISplay:MATHFFTView<x>:CURSor:HBArs:BPOsition	Sets or returns the vertical cursor B position in the specified Math-FFT waveform.
DISplay:MATHFFTView<x>:CURSor:HBArs:BUNIts?	Queries the cursor B vertical units in the specified Math-FFT waveform.
DISplay:MATHFFTView<x>:CURSor:HBArs:DELTA?	Queries the delta V cursor readout value of the specified cursor in the specified view.
DISplay:MATHFFTView<x>:CURSor:MODe	Sets or returns the cursor tracking mode in the specified Math-FFT waveform.
DISplay:MATHFFTView<x>:CURSor:ONEOVERDELTAVALUE?	Queries the one over delta T cursor readout value in the specified Math-FFT waveform.
DISplay:MATHFFTView<n>:CURSor:ROLOCATION	Sets or queries the location to display the specified Math FFT plot cursor readouts (in the plot graticule or in a badge in the Results Bar).
DISplay:MATHFFTView<x>:CURSor:SCREEN:AXPOsition	Sets or returns the horizontal cursor A position in the specified Math-FFT waveform.
DISplay:MATHFFTView<x>:CURSor:SCREEN:AYPOsition	Sets or returns the vertical cursor A position in the specified Math-FFT waveform.
DISplay:MATHFFTView<x>:CURSor:SCREEN:BXPOsition	Sets or returns the horizontal cursor B position of the specified cursor in the specified view.
DISplay:MATHFFTView<x>:CURSor:SCREEN:BYPOsition	Sets or returns the vertical cursor B position in the specified Math-FFT waveform.
DISplay:MATHFFTView<x>:CURSor:STATE	Sets or queries the visible state of cursors in the specified Math-FFT waveform.
DISplay:MATHFFTView<x>:CURSor:VBArS:APOsition	Sets or queries the horizontal cursor A position in the specified Math-FFT waveform.
DISplay:MATHFFTView<x>:CURSor:VBArS:AUNIts?	Queries the vertical cursor A measurement units for the specified Math-FFT view.
DISplay:MATHFFTView<x>:CURSor:VBArS:BPOsition	Sets or queries the horizontal cursor B position in the specified Math-FFT waveform.
DISplay:MATHFFTView<x>:CURSor:VBArS:BUNIts?	Queries the vertical cursor B measurement units for the specified Math-FFT view.
DISplay:MATHFFTView<x>:CURSor:VBArS:DELTA?	Queries the delta T cursor readout value of the specified cursor in the specified Math-FFT waveform.
DISplay:MATHFFTView<x>:CURSor:WAVEform:APOsition	Sets or queries the waveform cursor A position in the specified plot view.
DISplay:MATHFFTView<x>:CURSor:WAVEform:BPOsition	Sets or queries the waveform cursor B position in the specified plot view.
DISplay:PLOTView<x>:CURSor:ASOURce?	Queries the cursor source for plot cursor A.
DISplay:PLOTView<x>:CURSor:BSOURce?	Queries the cursor source for plot cursor B.
DISplay:PLOTView<x>:CURSor:DDT?	Queries the delta V over delta T cursor readout value of the specified cursor in the specified view.
DISplay:PLOTView<x>:CURSor:FUNcTion	Sets or queries the cursor mode of the specified cursor in the specified view.



Table 2-23: Cursor commands (cont.)

Command	Description
DISplay:PLOTView<x>:CURSor:HBArS:APOsition	Sets or queries the vertical cursor A position of the specified cursor in the specified view.
DISplay:PLOTView<x>:CURSor:HBArS:AUNIts?	Sets or queries the cursor A vertical units of the specified cursor in the specified view.
DISplay:PLOTView<x>:CURSor:HBArS:BPOsition	Sets or queries the vertical cursor B position of the specified cursor in the specified view.
DISplay:PLOTView<x>:CURSor:HBArS:BUNIts?	Sets or queries the cursor B vertical units of the specified cursor in the specified view.
DISplay:PLOTView<x>:CURSor:HBArS:DELTA?	Sets or queries the delta V cursor readout value of the specified cursor in the specified view.
DISplay:PLOTView<x>:CURSor:MODE	Sets or queries the cursor tracking mode of the specified cursor in the specified view.
DISplay:PLOTView<x>:CURSor:ONEOVERDELTAVALUE?	Sets or queries the one over delta T cursor readout value of the specified cursor in the specified view.
DISplay:PLOTView<n>:CURSor:ROLOCATION	Sets or queries the location to display the specified Plot cursor readouts (in the plot graticule or in a badge in the Results Bar).
DISplay:PLOTView<x>:CURSor:SCREEN:AXPOsition	Sets or queries the horizontal cursor A position of the specified cursor in the specified view.
DISplay:PLOTView<x>:CURSor:SCREEN:AYPOsition	Sets or queries the vertical cursor A position of the specified cursor in the specified view.
DISplay:PLOTView<x>:CURSor:SCREEN:BXPOsition	Sets or queries the horizontal cursor B position of the specified cursor in the specified view.
DISplay:PLOTView<x>:CURSor:SCREEN:BYPOsition	Sets or queries the vertical cursor B position of the specified cursor in the specified view.
DISplay:PLOTView<x>:CURSor:SPLITMODE	Sets or queries the cursor source mode in the specified view.
DISplay:PLOTView<x>:CURSor:STATE	Sets or queries the visible state of the cursor of the specified cursor in the specified view.
DISplay:PLOTView<x>:CURSor:VBArS:APOsition	Sets or queries the horizontal cursor A position of the specified cursor in the specified view.
DISplay:PLOTView<x>:CURSor:VBArS:BPOsition	Sets or queries the horizontal cursor B position of the specified cursor in the specified view.
DISplay:PLOTView<x>:CURSor:VBArS:DELTA?	Queries the delta T cursor readout value of the specified cursor in the specified view.
DISplay:PLOTView<x>:CURSor:VBArS:UNIts?	Queries the VBArS cursor readout units of the specified cursor in the specified view.
DISplay:PLOTView<x>:CURSor:WAVEform:APOsition	Sets or queries the horizontal cursor A position of the specified cursor in the specified view.
DISplay:PLOTView<x>:CURSor:WAVEform:BPOsition	Sets or queries the horizontal cursor B position of the specified cursor in the specified view.
DISplay:REFFFTView<x>:CURSor:ASOURce?	Queries the cursor source for plot cursor A

Table 2-23: Cursor commands (cont.)

Command	Description
DISplay:REFFFTView<x>:CURSor:BSOURce?	Queries the cursor source for plot cursor B.
DISplay:REFFFTView<x>:CURSor:DDT?	Queries the delta V over delta T cursor readout value of the specified cursor in the specified view.
DISplay:REFFFTView<x>:CURSor:FUNCTion	Sets or queries the cursor type of the specified cursor in the specified view.
DISplay:REFFFTView<x>:CURSor:HBArs:APOSition	Sets or queries the vertical cursor A position of the specified cursor in the specified view.
DISplay:REFFFTView<x>:CURSor:HBArs:AUNIts?	Queries cursor A vertical units of the specified cursor in the specified view.
DISplay:REFFFTView<x>:CURSor:HBArs:BPOSition	Sets or queries the vertical cursor B position of the specified cursor in the specified view.
DISplay:REFFFTView<x>:CURSor:HBArs:BUNIts?	Queries the cursor B vertical units of the specified cursor in the specified view.
DISplay:REFFFTView<x>:CURSor:HBArs:DELTA?	Queries the delta V cursor readout value of the specified cursor in the specified view.
DISplay:REFFFTView<x>:CURSor:MODE	Sets or queries the cursor tracking mode of the specified cursor in the specified view.
DISplay:REFFFTView<x>:CURSor:ONEOVERDELTAVALUE?	Queries the one over delta T cursor readout value of the specified cursor in the specified view.
DISplay:REFFFTView<x>:CURSor:ROLOCATION	Sets or queries the location to display the specified Reference FFT plot cursor readouts (in the plot graticule or in a badge in the Results Bar).
DISplay:REFFFTView<x>:CURSor:SCREEN:AXPOSition	Sets or queries the horizontal cursor A position of the specified cursor in the specified view.
DISplay:REFFFTView<x>:CURSor:SCREEN:AYPOSition	Sets or queries the vertical cursor A position of the specified cursor in the specified view.
DISplay:REFFFTView<x>:CURSor:SCREEN:BXPOSition	Sets or queries the horizontal cursor B position of the specified cursor in the specified view.
DISplay:REFFFTView<x>:CURSor:SCREEN:BYPOSition	Sets or queries the vertical cursor B position of the specified cursor in the specified view.
DISplay:REFFFTView<x>:CURSor:SPLITMODE	Sets or queries whether both cursors have same or different source.
DISplay:REFFFTView<x>:CURSor:STATE	Sets or queries the visible state of the cursor of the specified cursor n the specified view.
DISplay:REFFFTView<x>:CURSor:VBArs:APOSition	Sets or queries the horizontal cursor A position of the specified cursor in the specified view.
DISplay:REFFFTView<x>:CURSor:VBArs:BPOSition	Sets or queries the horizontal cursor B position of the specified cursor in the specified view.
DISplay:REFFFTView<x>:CURSor:VBArs:DELTA?	Queries the delta T cursor readout value of the specified cursor in the specified view.
DISplay:REFFFTView<x>:CURSor:VBArs:UNIts?	Queries cursor A vertical units of the specified cursor in the specified view.
DISplay:REFFFTView<x>:CURSor:WAVEform:AHPOSition?	Queries the value of the cursor A horizontal position.

Table 2-23: Cursor commands (cont.)

Command	Description
DISplay:REFFFTView<x>:CURSor:WAVEform:APOSition	Sets or returns the waveform cursor A position in the specified plot view.
DISplay:REFFFTView<x>:CURSor:WAVEform:AVPOSition?	Queries the value of the cursor A vertical position.
DISplay:REFFFTView<x>:CURSor:WAVEform:BHPOSition?	Queries the value of the cursor B horizontal position.
DISplay:REFFFTView<x>:CURSor:WAVEform:BPOSition	Sets or returns the waveform cursor B position in the specified plot view.
DISplay:REFFFTView<x>:CURSor:WAVEform:BVPOSition?	Queries the value of the cursor B vertical position.
DISplay:SPECView<x>:CURSor:CURSOR:ANOISEDensity?	Returns the noise density of the selected RF trace at the Cursor A position
DISplay:SPECView<x>:CURSor:CURSOR:ASOURce	Sets or queries the Cursor A source in the Spectrum View.
DISplay:SPECView<x>:CURSor:CURSOR:BNOISE?	Returns the noise density of the selected RF trace at the Cursor B position when in Absolute mode, or the phase noise when in Delta mode.
DISplay:SPECView<x>:CURSor:CURSOR:BSOURce	Sets or queries the Cursor B source in the Spectrum View.
DISplay:SPECView<x>:CURSor:CURSOR:HBArs:APOSition	Queries the horizontal bar Cursor A vertical position (where it crosses the spectrum signal) in the Spectrum View.
DISplay:SPECView<x>:CURSor:CURSOR:HBArs:AUNIts?	Queries the horizontal bar Cursor A amplitude units in the Spectrum View.
DISplay:SPECView<x>:CURSor:CURSOR:HBArs:BPOSition	Queries the horizontal bar Cursor B vertical position (where it crosses the spectrum signal) in the Spectrum View.
DISplay:SPECView<x>:CURSor:CURSOR:HBArs:BUNIts?	Queries the horizontal bar Cursor B amplitude units in the Spectrum View.
DISplay:SPECView<x>:CURSor:CURSOR:READout	Sets or queries the Cursor B readout type in the Spectrum View.
DISplay:SPECView<x>:CURSor:CURSOR:SPLITMODE	Sets or queries whether both Spectrum View cursors have the same or different sources.
DISplay:SPECView<x>:CURSor:CURSOR:STATE	Sets or queries the visibility state of the cursors in the Spectrum View.
DISplay:SPECView<x>:CURSor:CURSOR:VBArs:APOSition	Sets or queries the Cursor A vertical position in the Spectrum View.
DISplay:SPECView<x>:CURSor:CURSOR:VBArs:BPOSition	Sets or queries the Cursor B horizontal position in the Spectrum View.
DISplay:SPECView<x>:CURSor:CURSOR:VBArs:UNIts?	Queries the cursor horizontal units in the Spectrum View.
DISplay:SPECView<x>:CURSor:CURSOR:WAVEform:APOSition	Sets or queries the Cursor A vertical position in the Spectrum View.
DISplay:SPECView<x>:CURSor:CURSOR:WAVEform:BPOSition	Sets or queries the Cursor B vertical position in the Spectrum View.

Table 2-23: Cursor commands (cont.)

Command	Description
DISplay:WAVEView<x>:CURSor?	Queries the cursor parameters for the specified Waveform View.
DISplay:WAVEView<x>:CURSor:CURSOR<x>?	Queries the cursor parameters for the specified cursor in the specified Waveform View.
DISplay:WAVEView<x>:CURSor:CURSOR<x>:ASOURce	Sets or queries the cursor A source of the specified cursor in the specified Waveform View.
DISplay:WAVEView<x>:CURSor:CURSOR<x>:BSOURce	Sets or queries the cursor B source of the specified cursor in the specified Waveform View.
DISplay:WAVEView<x>:CURSor:CURSOR<x>:DDT?	Returns the delta V over delta T cursor readout value of the specified cursor in the specified Waveform View.
DISplay:WAVEView<x>:CURSor:CURSOR<x>:FUNctIon	Sets or queries the cursor mode (SCREEN or DATA) of the specified cursor in the specified Waveform View.
DISplay:WAVEView<x>:CURSor:CURSOR<x>:HBArS:APOSition	Sets or queries the vertical cursor A position of the specified cursor in the specified Waveform View.
DISplay:WAVEView<x>:CURSor:CURSOR<x>:HBArS:AUNIts?	Queries the cursor A vertical units of the specified cursor in the specified Waveform View.
DISplay:WAVEView<x>:CURSor:CURSOR<x>:HBArS:BPOSition	Sets or queries the vertical cursor B position of the specified cursor in the specified Waveform View.
DISplay:WAVEView<x>:CURSor:CURSOR<x>:HBArS:BUNIts?	Queries the cursor B vertical units of the specified cursor in the specified Waveform View.
DISplay:WAVEView<x>:CURSor:CURSOR<x>:HBArS:DELTA?	Sets or queries the delta V cursor readout value over the history period.
DISplay:WAVEView<x>:CURSor:CURSOR<x>:MODE	Sets or queries the cursor tracking mode of the specified cursor in the specified Waveform View.
DISplay:WAVEView<x>:CURSor:CURSOR<x>:ONEOVERDELTAVALUE?	Sets or queries the one over delta T cursor readout value of the specified cursor in the specified Waveform View.
DISplay:WAVEView:CURSor:CURSOR1:ROLOCATION	Sets or queries the location to display the Waveform View cursor readouts (in the Waveform View graticule or in a badge in the Results Bar).
DISplay:WAVEView<x>:CURSor:CURSOR<x>:SCREEN:AXPOSition	Sets or queries the horizontal cursor A position of the specified cursor in the specified Waveform View.
DISplay:WAVEView<x>:CURSor:CURSOR<x>:SCREEN:AYPOSition	Sets or queries the vertical cursor A position of the specified cursor in the specified Waveform View.
DISplay:WAVEView<x>:CURSor:CURSOR<x>:SCREEN:BXPOSition	Sets or queries the horizontal cursor B position of the specified cursor in the specified Waveform View.
DISplay:WAVEView<x>:CURSor:CURSOR<x>:SCREEN:BYPOSition	Sets or queries the vertical cursor B position of the specified cursor in the specified Waveform View.
DISplay:WAVEView<x>:CURSor:CURSOR<x>:SPLITMODE	Sets or queries the cursor source mode in the specified view.
DISplay:WAVEView<x>:CURSor:CURSOR<x>:STATE	Sets or queries the visible state of the cursor of the specified cursor in the specified Waveform View.
DISplay:WAVEView<x>:CURSor:CURSOR<x>:VBArS:APOSition	Sets or queries the horizontal cursor A position of the specified cursor in the specified Waveform View.

Table 2-23: Cursor commands (cont.)

Command	Description
DISplay:WAVEView<x>:CURSor: CURSOR<x>:VBArS:BPOStion	Sets or queries the horizontal cursor B position of the specified cursor in the specified Waveform View.
DISplay:WAVEView<x>:CURSor: CURSOR<x>:VBArS:DELTA?	Sets or queries the delta T cursor readout value of the specified cursor in the specified Waveform View.
DISplay:WAVEView<x>:CURSor: CURSOR<x>:VBArS:UNItS?	Queries cursor A vertical units of the specified cursor in the specified Waveform View.
DISplay:WAVEView<x>:CURSor:CURSOR: WAVEform:ALL:ValueS?	Returns all values (Time, Voltage, Delta) associated with all the active sources in the Waveform View.
DISplay:WAVEView<x>:CURSor: CURSOR<x>:WAVEform:APOStion	Sets or queries the horizontal cursor A position of the specified cursor in the specified Waveform View.
DISplay:WAVEView<x>:CURSor:CURSOR: WAVEform:AVPOStion?	Queries the vertical waveform value at the cursor A position in the specified Waveform View.
DISplay:WAVEView<x>:CURSor: CURSOR<x>:WAVEform:BPOStion	Sets or queries the horizontal cursor B position of the specified cursor in the specified Waveform View.
DISplay:WAVEView<x>:CURSor:CURSOR: WAVEform:BVPOStion?	Queries the vertical waveform value at the cursor B position in the specified Waveform View.

## Digital command group

Use the commands in the Digital Command Group to acquire up to 64 digital signals and analyze them. Digital channels are only available when a digital probe is attached to the super channel.

Table 2-24: Digital commands

Command	Description
CH<x>_DALL:LABel:COLor	Sets or queries the color of the specified digital group label.
CH<x>_DALL:LABel:FONT:BOLD	Sets or queries the bold state of the specified digital group.
CH<x>_DALL:LABel:FONT:ITALic	Sets or queries the italic state of the specified digital group.
CH<x>_DALL:LABel:FONT:SIZE	Sets or queries the font size of the specified digital group.
CH<x>_DALL:LABel:FONT:TYPE	Sets or queries the font type of the specified digital group, such as Arial or Times New Roman.
CH<x>_DALL:LABel:FONT:UNDERline	Sets or queries the underline state of the specified digital group.
CH<x>_DALL:LABel:NAME	Sets or queries the label of the specified digital group.
CH<x>_D<x>:LABel:COLor	Sets or queries the color of the label of the specified digital bit.
CH<x>_D<x>:LABel:FONT:BOLD	Sets or queries the bold state of the label of the specified digital bit.
CH<x>_D<x>:LABel:FONT:ITALic	Sets or queries the italic state of the label of the specified digital bit.
CH<x>_D<x>:LABel:FONT:SIZE	Sets or queries the font size of the label of the specified digital bit.
CH<x>_D<x>:LABel:FONT:TYPE	Sets or queries the font type of the label of the specified digital bit.
CH<x>_D<x>:LABel:FONT:UNDERline	Sets or queries the underline state of the label of the specified digital bit.
CH<x>_D<x>:LABel:NAME	Sets or queries the label of the specified digital bit.
REF<x>_DALL:LABel:COLor	Sets or queries the color of the specified digital group.
REF<x>_DALL:LABel:FONT:BOLD	Sets or queries the bold state of the specified digital group.
REF<x>_DALL:LABel:FONT:ITALic	Sets or queries the italic state of the specified digital group.
REF<x>_DALL:LABel:FONT:SIZE	Sets or queries the font size of the specified digital group.
REF<x>_DALL:LABel:FONT:TYPE	Sets or queries the font type of the specified digital group.
REF<x>_DALL:LABel:FONT:UNDERline	Sets or queries the underline state of the specified digital group.
REF<x>_DALL:LABel:NAME	Sets or queries the label of the specified digital group.
REF<x>_DALL:LABel:XPOS	Sets or queries the x-position of the label of the specified digital group.
REF<x>_DALL:LABel:YPOS	Sets or queries the y-position of the label of the specified digital group.
REF<x>_D<x>:LABel:COLor	Sets or queries the color of the label of the specified digital channel.
REF<x>_D<x>:LABel:FONT:BOLD	Sets or queries the bold state of the label of the specified digital bit.
REF<x>_D<x>:LABel:FONT:ITALic	Sets or queries the italic state of the label of the specified digital bit.
REF<x>_D<x>:LABel:FONT:SIZE	Sets or queries the font size of the label of the specified digital bit.
REF<x>_D<x>:LABel:FONT:TYPE	Sets or queries the font type of the label of the specified digital bit.
REF<x>_D<x>:LABel:FONT:UNDERline	Sets or queries the underline state of the label of the specified digital bit.
REF<x>_D<x>:LABel:NAME	Sets or queries the label of the specified digital bit.
REF<x>_D<x>:LABel:XPOS	Sets or queries the x-position of the label of the specified digital bit.

Table 2-24: Digital commands (cont.)

Command	Description
REF<x>_D<x>:LABel:YPOS	Sets or queries the y-position of the label of the specified digital channel.
REMOTE:S<x>_CH<x>:DIGGRP:D<x>:THRshold	Sets or queries the threshold level in volts for the specified remote scope digital channel.
REMOTE:S<x>_CH<x>:DIGGRP:THRshold	Sets or queries the threshold level in volts for the specified remote scope channel.
REMOTE:S<x>_CH<x>:SELEct:DIGGRP:Dall	Sets or queries the display state of the specified digital channel in the specified Waveform View.
REMOTE:S<x>_DCH<x>:D<x>:THRshold	Sets or queries the threshold level in volts for the specified digital channel.
REMOTE:S<x>_DCH<x>:GROUP<x>THRshold	Sets or queries the digital threshold of all bits in digital group 0 (D0-D7) or group 1 (D8-D15) on specified digital channel.
REMOTE:S<x>_DCH<x>:SELEct:DAll	Turns on or off all constituent digital channels (D0 through D15) of the specified source channel.

## Digital Power Management (DPM) Group

Use the commands in the DPM command group for Digital Power Management functionality. Requires option 5-DPM (5 Series MSO instruments) or 6-DPM (6 Series MSO instrument).

Table 2-25: DPM Command Group

Command	Description
MEASU:MEAS1:SUBGROUP:RESUIts:ALLAcqs:MAXimum?	Returns the maximum value of the measurement specified by the string, for all acquisitions.
MEASU:MEAS1:SUBGROUP:RESUIts:ALLAcqs:MEAN?	Returns the mean value of the measurement specified by the string, for all acquisitions.
MEASU:MEAS1:SUBGROUP:RESUIts:ALLAcqs:MINimum?	Returns the minimum value of the measurement specified by the string, for all acquisitions.
MEASU:MEAS1:SUBGROUP:RESUIts:ALLAcqs:PK2PK?	Returns the peak-to-peak value of the measurement specified by the string, for all acquisitions.
MEASU:MEAS1:SUBGROUP:RESUIts:ALLAcqs:POPulation?	Returns the population value of the measurement specified by the string, for all acquisitions.
MEASU:MEAS1:SUBGROUP:RESUIts:ALLAcqs:STDDev?	Returns the standard deviation value of the measurement specified by the string, for all acquisitions.
MEASU:MEAS1:SUBGROUP:RESUIts:CURRentacq:MAXimum?	Returns the maximum value of the measurement specified by the string, for the current acquisition.
MEASU:MEAS1:SUBGROUP:RESUIts:CURRentacq:MEAN?	Returns the mean value of the measurement specified by the string, for the current acquisition.
MEASU:MEAS1:SUBGROUP:RESUIts:CURRentacq:MINimum?	Returns the minimum value of the measurement specified by the string, for the current acquisition.
MEASU:MEAS1:SUBGROUP:RESUIts:CURRentacq:PK2PK?	Returns the peak-to-peak value of the measurement specified by the string, for the current acquisition.

Table 2-25: DPM Command Group (cont.)

Command	Description
MEASU:MEAS1:SUBGROUP:RESUlts:CURRentacq:POPULation?	Returns the population value of the measurement specified by the string, for the current acquisition.
MEASU:MEAS1:SUBGROUP:RESUlts:CURRentacq:STDDev?	Returns the standard deviation value of the measurement specified by the string, for the current acquisition.
MEASUrement:MEAS<x>:EDGEQUALifier	Sets or queries the edge qualifier source.
MEASUrement:MEAS<x>:INPUTLEVel	Sets or queries the input trigger voltage level.
MEASUrement:MEAS<x>:MAXVoltage	Sets or queries the maximum input voltage.
MEASUrement:MEAS<x>:OUTPUT<n>VOLTagE	Sets or queries the voltage level for the specified output voltage source n.
MEASUrement:MEAS<x>:REFVOLTAGE<n>Val	Sets or queries the reference voltage per rail of Overshoot and Undershoot measurements.
MEASUrement:MEAS<x>:RIPPLEFREQ<n>Val	Sets or queries the ripple frequency per specified rail for Ripple measurement.
MEASUrement:MEAS<x>:WAITTime	Sets or queries the wait time.
PLOT:PLOT<x>:RAILNUM	Sets the DPM histogram source.



## Display control command group

Display commands can be found in this section as well as the sections of related components. These commands control general instrument settings, such as the intensity of the graticule, stacked or overlay display mode, and the fastacq color palette. Display commands also control how and where waveforms are shown, their position on screen, and zoom settings applied to the view. For example, display commands can turn on or off the display of channels or set the selected source.

Some actions can create a new view which can have its own settings. For example, adding a histogram will create a new view where the Histogram plot is displayed. Each view acts as a separate window within the instrument application and can be rearranged or annotated as desired.

A WaveView is the primary view used for viewing inputs and time-domain signals. Buses, non-FFT maths, refs, analog and digital channels, and time-trends are displayed in the WaveView.

A PlotView is used for viewing measurement results and other plotted data. Histograms, eye diagrams, XY/XYZ plots, FFTs, and other plots are shown in individual PlotViews.

Each of these views can have separate settings, zoom, cursors, and annotations. Display commands which are view specific have a view parameter in the programmable interface, such as `DISPLAY:WAVEView<x>: ...` or `DISPLAY:PLOTView<x>: ...`. Selected source can also be specified on a per-view basis. The overall selected source is determined by the selected view and the selected source within that view.

PlotViews and WaveViews have some differences in command syntax due to differences in view functionality. For example, WaveViews and PlotViews have a different zoom model. The commands for specifying the zoom reflects these differences, and different command syntax is available depending on the view.

Table 2-26: Display control commands

Command	Description
<code>DISplay?</code>	Returns current display settings.
<code>DISplay:{CH&lt;x&gt; Math&lt;x&gt; REF&lt;x&gt;}: INVERTColor</code>	Sets or queries the Inverted mode color of the specified input source to the specified color.
<code>DISplay:{CH&lt;x&gt; Math&lt;x&gt; REF&lt;x&gt;}: NORMALColor</code>	Sets or queries the Inverted mode color of the specified input source to the specified color.
<code>DISplay:COLors</code>	Sets or queries the color mode for the graticule and waveform display.
<code>DISplay:GLObal:B&lt;x&gt;:STATE</code>	Sets or queries the display mode (on or off) of the specified bus.
<code>DISplay:GLObal:CH&lt;x&gt;:STATE</code>	Sets or queries the display mode (on or off) of the specified channel (both analog and digital).
<code>DISplay:GLObal:MATH&lt;x&gt;:STATE</code>	Sets or queries the display mode (on or off) of the specified math.
<code>DISplay:GLObal:PLOT&lt;x&gt;:STATE</code>	Sets or queries the display mode (on or off) of the specified time trend plot.

Table 2-26: Display control commands (cont.)

Command	Description
DISplay:GLObal:REF<x>:STATE	Sets or queries the display mode (on or off) of the specified reference.
DISplay:INTENSITY?	Returns the waveform and graticule saturation levels.
DISplay:INTENSITY:BACKLight	Sets or queries the waveform backlight intensity settings.
DISplay:INTENSITY:BACKLight:AUTODim:ENABle	Sets or queries the state of the display auto-dim feature.
DISplay:INTENSITY:BACKLight:AUTODim:TIME	Sets or queries the amount of time, in minutes, to wait for no user interface activity before automatically dimming the display.
DISplay:MATHFFTView<x>:AUTOScale	Sets or returns the enabled state of autoscale for plots.
DISplay:MATHFFTView<x>:GRIDlines	Sets or queries the grid lines setting of the plot.
DISplay:MATHFFTView<x>:MATH:MATH<x>:STATE	Sets or queries the state of the specified math waveform in the specified Waveform View.
DISplay:MATHFFTView<x>:XAXIS:SCALE	Sets or queries the x-axis scale setting for FFT Math waveforms.
DISplay:MATHFFTView<x>:YAXIS:SCALE	Sets or queries the vertical scale setting for FFT Maths.
DISplay:PERsistence	Sets or queries display persistence setting.
DISplay:PERsistence:RESET	Clears the persistence data.
DISplay:PLOTView<x>:AUTOScale	Sets or queries the enabled state of autoscale for plots.
DISplay:PLOTView<x>:GRIDlines	Sets or queries the Grid lines setting of the specified plot.
DISplay:PLOTVIEW<x>:XAXIS:SCALE	Sets or queries the horizontal scale setting for applicable plot.
DISplay:PLOTVIEW<x>:YAXIS:SCALE	Sets or queries the vertical scale setting for applicable plots.
DISplay:REFFFTView<x>:AUTOScale	Sets or queries the enabled state of auto-scale for plots.
DISplay:REFFFTView<x>:GRIDlines	Sets or returns the grid lines setting of the plot.
DISplay:REFFFTView<x>:REF:REF<x>:STATE	Sets or queries the state of the specified reference waveform in the specified Waveform View.
DISplay:REFFFTView<x>:XAXIS:SCALE	Sets or queries the x-axis scale setting for REFFFT.
DISplay:SElect:BUS	Sets or queries the overall selected bus.
DISplay:SElect:MATH	Sets or queries the overall selected math.
DISplay:SElect:REFerence	Sets or queries the overall selected reference waveform.
DISplay:SElect:SOUrce	Sets or queries the overall selected source.
DISplay:SElect:SPECView<x>:SOUrce	Sets or queries the spectrum trace (source channel) to select in the Spectrum View window.
DISplay:SPECView<x>:GRATICule	Sets or queries the type of graticule that is displayed.
DISplay:SPECView<x>:HORZ	Sets or queries the horizontal display scaling of the Spectrum View window.
DISplay:SPECView<x>:INTENSITY:GRATICule	Sets or queries the graticule saturation level
DISplay:SPECView<x>:INTENSITY:WAVEform	Sets or queries the waveform saturation level.
DISplay:SPECView<x>:VIEWStyle	Sets or queries the waveform layout style used by the display.
DISplay:SElect:VIEW	Sets or queries the selected view.

Table 2-26: Display control commands (cont.)

Command	Description
DISplay:SElect:WAVEView<x>:SOUrce	Sets or queries the selected source in the given waveview.
DISplay:VARpersist	Sets or queries the persistence decay time.
DISplay:WAVEform	Globally enables or disables the waveform display.
DISplay:WAVEView<x>:BUS:B<x>:STATE	Sets or queries the state of the specified bus in the specified Waveform View.
DISplay:WAVEView<x>:BUS:B<x>:VERTical:POSition	Sets or queries the vertical position of the specified bus in the specified Waveform View.
DISplay:WAVEView<x>:CH<x>:STATE	Sets or queries the state of the specified channel in the specified Waveform View.
DISplay:WAVEView<x>:CH<x>:VERTical:POSition	Sets or queries the vertical position of the specified channel in the specified Waveform View in divisions.
DISplay:WAVEView<x>:CH<x>:VERTical:SCALE	Sets or queries the vertical scale of the specified channel in volts per division within the specified Waveform View.
DISplay:WAVEView<x>:CH<x>_DALL:STATE	Sets or queries the display state of the specified digital channels in the specified Waveform View.
DISplay:WAVEView<x>:CH<x>_DALL:VERTical:POSition	Sets or queries the vertical position of the specified digital channel in the specified Waveform View in divisions.
DISplay:WAVEView<x>:CH<x>_D<x>:STATE	Sets or queries the display state of the specified digital channel in the specified Waveform View.
DISplay:WAVEView<x>:FILTer	Sets or queries the type of interpolation filter for the display.
DISplay:WAVEView<x>:GRATicule	Selects or queries the type of graticule that is displayed.
DISplay:WAVEView<x>:INTENSITY:GRATicule	Sets or queries the graticule saturation level.
DISplay:WAVEView<x>:INTENSITY:WAVEform	Sets or queries the waveform saturation level.
DISplay:WAVEView<x>:MATH:MATH<x>:AUTOScale	Sets or queries whether the specified math gets auto-scaled when the math equation changes within the specified Waveform View.
DISplay:WAVEView<x>:MATH:MATH<x>:STATE	Sets or queries the state of the specified math waveform in the specified Waveform View.
DISplay:WAVEView<x>:MATH:MATH<x>:VERTical:POSition	Sets or queries the vertical position in divisions of the specified math waveform.
DISplay:WAVEView<x>:MATH:MATH<x>:VERTical:SCALE	Sets or queries the vertical scale of the specified math waveform.
DISplay:WAVEView<x>:PLOT:PLOT<x>:AUTOScale	Sets or queries whether the specified math gets auto-scaled when the math equation changes within the specified Waveform View.
DISplay:WAVEView<x>:PLOT:PLOT<x>:STATE	Sets or queries the state of the specified trend waveform in the specified Waveform View.
DISplay:WAVEView<x>:PLOT:PLOT<x>:VERTical:POSition	Sets or queries the vertical position of the specified time trend in the specified Waveform View in divisions.
DISplay:WAVEView<x>:PLOT:PLOT<x>:VERTical:SCALE	Sets or queries the vertical scale of the specified time trend in volts per division in the specified Waveform View.
DISplay:WAVEView<y>:REF<x>_DALL:FRAME	Sets or returns the selected frame of the specified digital ref.

Table 2-26: Display control commands (cont.)

Command	Description
DISplay:WAVEView<x>:REF:REF<x>: FRAME	sets or returns the selected frame of the specified analog ref.
DISplay:WAVEView<x>:REF:REF<x>:STATE	Sets or queries the state of the specified reference waveform in the specified Waveform View.
DISplay:WAVEView<x>:REF:REF<x>: VERTical:POSition	Sets or queries the vertical position in divisions of the specified reference waveform.
DISplay:WAVEView<x>:REF:REF<x>: VERTical:SCALE	Sets or queries the vertical scale of the specified reference waveform.
DISplay:WAVEView<x>:RF_FREQuency<x>: VERTical:POSition	Sets or queries the vertical position of the specified Frequency vs. Time trace in the Waveform View, in divisions.
DISplay:WAVEView<x>:RF_FREQuency<x>: VERTical:SCALE	Sets or queries the vertical scale of the specified Frequency vs. Time trace in the Waveform View, in divisions.
DISplay:WAVEView<x>:RF_MAGNitude<x>: VERTical:POSition	Sets or queries the vertical position of the specified Magnitude vs. Time trace in the Waveform View, in divisions.
DISplay:WAVEView<x>:RF_MAGNitude<x>: VERTical:SCALE	Sets or queries the vertical scale of the specified Magnitude vs. Time trace in the specified Waveform View in Volts, Watts, or dB per division.
DISplay:WAVEView<x>:RF_PHASe<x>: VERTical:POSition	Sets or queries the vertical position of the specified Phase vs. Time trace in the Waveform View, in divisions.
DISplay:WAVEView<x>:RF_PHASe<x>: VERTical:SCALE	Sets or queries the vertical scale of the specified Phase vs. Time trace in the specified Waveform View in degrees per division.
DISplay:WAVEView<x>:STYLE	Sets or queries the waveforms are displayed for analysis mode.
DISplay:WAVEView<x>:VIEWStyle	Sets or queries the waveform layout style used by the display.
DISplay:WAVEView:GRIDTYPE	Sets or queries the Waveform View Graticule mode (Fixed or Moveable).
DISplay:PLOTVIEW<x>:XAXIS:SCALE	Sets or queries the horizontal scale setting for applicable plots, either Linear or Log.
DISplay:PLOTVIEW<x>:YAXIS:SCALE	Sets or queries the vertical scale setting for applicable plots, either Linear or Log.

## File system command group

Use the commands in the File System Command Group to help you use the built-in hard disk drive. You can use the commands to do the following:

- List the contents of the current directory
- Create and delete directories
- Create, copy, read, rename, or delete a file

When using these commands, keep the following points in mind:

- File arguments are always enclosed within double quotes:  
“C:\MYDIR\TEK00001.SET”
- File names follow the MS-DOS format: [DRIVE:][\PATH\]filename
- Path separators can be either forward slashes (/) or back slashes (\)

---

**NOTE.** *Using a back slash as a path separator can produce some unexpected results, depending on how your controller application treats escaped characters. Many applications recognize the sequence of a back slash followed by an alphabetic character as an escaped character, and, as such, interpret that alphabetic character as a control character. For example, the sequence “\n” might be interpreted as a newline character; “\t” might be interpreted as a tab character. To ensure that this interpretation does not occur, you can use double back slashes. For example, “C:\\testfile.txt”.*

---

- Some FILESystem commands can fail because a file has read-only attributes. You will not be able to delete or replace such files until this attribute is removed. Refer to the operating system help on file properties for further information.

Table 2-27: File system commands

Command	Description
FILESystem?	Returns the file system state.
FILESystem:COPY	Copies one or more files to a new file.
FILESystem:CWD	Sets or queries the current working directory for FILESystem commands.
FILESystem:DELEte	Deletes a named file or directory.
FILESystem:DIR?	Returns a list of directory contents.
FILESystem:HOMEDir?	Returns the current user's home directory.
FILESystem:LDIR?	Returns a list of directory contents.
FILESystem:MKDir	Makes a new directory.
FILESystem:MOUNT:DRIVE	Mounts a network drive or queries if a network drive is currently mounted.
FILESystem:MOUNT:TEKDrive	Mounts the TekDrive specified by the quoted string arguments.

Table 2-27: File system commands (cont.)

Command	Description
FILESystem:READFile	Copies the named file to the interface.
FILESystem:REName	Assigns a new name to an existing file.
FILESystem:RMDir	Deletes the named directory.
FILESystem:TEKDrive:CODE?	Returns short code in string format.
FILESystem:TEKDrive:CODE:EXPIrytime?	Returns expiry time of short code.
FILESystem:TEKDrive:CODE:STATus?	Returns status of short code.
FILESystem:UNMOUNT:DRive	Unmount the USB drive.
FILESystem:UNMOUNT:TEKDrive	Unmounts the TekDrive specified by the quoted string argument and the drive name is case insensitive.
FILESystem:WRITEFile	Copies the block data to a named file.

## Histogram Group

Use the commands in the Histogram command group for Histogram functionality.

Table 2-28: Histogram Command Group

Command	Description
HISTogram:ADDNew	Adds the specified waveform histogram
HISTogram:DELeTe	Deletes the specified histogram.
HISTogram:DELETEALL	Deletes all the active instances of histograms defined in the scope application.
HISTogram:HISTogram<x>:BOX	Sets or queries the top, left, bottom and right positions of the histogram box in source waveform coordinates.
HISTogram:HISTogram<x>:BSTate	Sets or queries whether the histogram badge is displayed.
HISTogram:HISTogram<x>:DATA?	Returns a comma separated list of numbers representing the histogram bin data.
HISTogram:HISTogram<x>:DISPlay	Sets or queries the histogram scaling display setting.
HISTogram:HISTogram<x>:FUNCTion	Sets or queries the histogram mode.
HISTogram:HISTogram<x>:MEASurement: COUNT	Sets or queries whether the waveform count measurement is enabled on the histogram.
HISTogram:HISTogram<x>:MEASurement: HITS	Sets or queries whether the Hits in Box measurement is enabled on the histogram.
HISTogram:HISTogram<x>:MEASurement: MAX	Sets or queries whether the Max measurement is enabled on the histogram.
HISTogram:HISTogram<x>:MEASurement: MEAN	Sets or queries whether the Mean measurement is enabled on the histogram.
HISTogram:HISTogram<x>:MEASurement: MEDian	Sets or queries whether the Median measurement is enabled on the histogram.
HISTogram:HISTogram<x>:MEASurement: MIN	Sets or queries whether the Min measurement is enabled on the histogram.

Table 2-28: Histogram Command Group (cont.)

Command	Description
HISTogram:HISTogram<x>:MEASurement:MODE	Sets or queries whether the Mode measurement is enabled on the histogram.
HISTogram:HISTogram<x>:MEASurement:ONESigma	Sets or queries whether the $\mu \pm 1\sigma$ measurement is enabled on the histogram.
HISTogram:HISTogram<x>:MEASurement:PHITs	Sets or queries whether the Peak Hits measurement is enabled on the histogram.
HISTogram:HISTogram<x>:MEASurement:PK2PK	Sets or queries whether the Peak-to-peak measurement is enabled on the histogram.
HISTogram:HISTogram<x>:MEASurement:RESULTS?	Returns the measurement results from the specified histogram.
HISTogram:HISTogram<x>:MEASurement:STDDev	Sets or queries whether the Standard Deviation measurement is enabled on the histogram.
HISTogram:HISTogram<x>:MEASurement:THRSigma	Sets or queries whether the $\mu \pm 3\sigma$ measurement is enabled on the histogram.
HISTogram:HISTogram<x>:MEASurement:TWOSigma	Sets or queries whether the $\mu \pm 2\sigma$ measurement is enabled on the histogram.
HISTogram:HISTogram<x>:SAVE	Saves the specified histograms data as a comma separated list of values.
HISTogram:HISTogram<x>:SIZE	Sets or queries the height or width of the specified histogram bins in divisions.
HISTogram:HISTogram<x>:SOURCE	Sets or queries which source waveform will be compared against the histogram box when the histogram testing is enabled.
HISTogram:HISTogram<x>:STATE	Sets or queries whether histogram calculations are enabled for the specified histogram.
HISTogram:HISTogram<x>:TRANSparency	Sets or queries the transparency of the histogram bins.
HISTogram:LIST?	Returns a comma separated list of all currently defined histograms.

## Horizontal command group

Horizontal commands control the time base of the instrument. You can set the time per division (or time per point) of the main time base. You can use the Horizontal commands to do the following:

- Set the scale, horizontal position and reference, and units of the time base
- Get the screen resolution, time of first point and time of last point, or get all the horizontal settings
- Enable or disable the display of the time base

Table 2-29: Horizontal commands

Command	Description
<a href="#">HORizontal:DELay:MODE</a>	Sets or queries the horizontal delay mode.
<a href="#">HORizontal:DELay:TIME</a>	Sets or queries the horizontal delay time (position) that is used when delay is on.
<a href="#">HORizontal:MODE</a>	Sets or queries the horizontal mode.
<a href="#">HORizontal:MODE:MANual:CONFIgure</a>	Sets or queries which horizontal control (scale or record length) will also change when the sample rate is adjusted.
<a href="#">HORizontal:POSition</a>	Sets or queries the waveform horizontal position, in percent, that is used when delay is off.
<a href="#">HORizontal:SAMPLERate</a>	Sets or queries the horizontal sample rate.
<a href="#">HORizontal:SCALE</a>	Sets or queries the horizontal scale.

## Inverter Motors and Drive Analysis (IMDA) Group

Use the commands in the IMDA group for input analysis, output analysis, ripple analysis measurements.

Table 2-30: IMDA Command Group

Command	Description
<a href="#">CUSTOMTABLE:ADDNew</a>	Adds a new custom results table.
<a href="#">CUSTOMTABLE:DELete</a>	Deletes the custom result(s) table..
<a href="#">CUSTOMTABLE:LIST?</a>	Queries the list of custom result tables have been added.
<a href="#">MEASU:MEAS1:SUBGROUP:RESUlts:CURRentacq:MEAN?</a>	Query the mean value of the measurement for current acquisition
<a href="#">MEASUrement:ADDMEAS</a>	Adds a measurement.
<a href="#">MEASUrement:AUTOset</a>	Sets or queries 3 phase autosest for the measurement.
<a href="#">MEASUrement:HIGHLVEl:CONFIguration</a>	Sets or queries the global input and output configuration.
<a href="#">MEASUrement:HIGHLVEl:EDGEQUALifier</a>	Sets or queries global input edge qualifier source.
<a href="#">MEASUrement:HIGHLVEl:INLOWPass:FREQ</a>	Sets or queries global input low pass filter frequency.



Table 2-30: IMDA Command Group (cont.)

Command	Description
MEASUrement:HIGHLEVel:INLOWPass:SPEC	Sets or queries global input low pass filter order.
MEASUrement:HIGHLEVel:L2LTOL2N	Enables the Line-to-Line to Line-to-Neutral Conversion.
MEASUrement:HIGHLEVel:LINESelected	Sets or queries global input select lines.
MEASUrement:HIGHLEVel:OUTEDGEQUALifier	Sets or queries global output edge qualifier source.
MEASUrement:HIGHLEVel:OUTLOWPass:FREQ	Sets or queries global output low pass filter frequency.
MEASUrement:HIGHLEVel:OUTLOWPass:SPEC	Sets or queries global output low pass filter order.
MEASUrement:HIGHLEVel:OUTL2LTOL2N	Sets or queries global output Line-to-Line to Line-to-Neutral Conversion.
MEASUrement:HIGHLEVel:OUTLINESelected	Sets or queries global output select lines.
MEASUrement:HIGHLEVel:OUTSOURCE	Sets or queries global output source.
MEASUrement:HIGHLEVel:OUTWIRing	Sets or queries the global output wiring.
MEASUrement:HIGHLEVel:SOURCE	Sets or queries global input source.
MEASUrement:HIGHLEVel:WIRing	Sets or queries the wiring configuration for the measurement.
MEASUrement:MEAS<x>:COVer	Sets or queries the Calculate Over for the Power Quality measurement.
MEASUrement:MEAS<x>:CUSTOMLIMITSFile	Sets or queries the custom limits file path for custom harmonics standard.
MEASUrement:MEAS<x>:CYCLEmode	Sets or queries cycle mode.
MEASUrement:MEAS<x>:EDGEQUALifier	Sets or queries the Edge Qualifier source.
MEASUrement:MEAS<x>:EDGEQUALONE	Sets or queries the measurement 1 input edge qualifier one source for Efficiency measurement.
MEASUrement:MEAS<x>:EDGEQUALTWO	Sets or queries the measurement 1 output edge qualifier two source for Efficiency measurement.
MEASUrement:MEAS<x>:FILTERRANGEFROM	Sets or queries harmonics filter from order.
MEASUrement:MEAS<x>:FILTERRANGETO	Sets or queries harmonics filter to order.
MEASUrement:MEAS<x>:FILTERs:LOWPass:FREQ	Sets or queries local input low pass filter frequency.
MEASUrement:MEAS<x>:FILTERs:LOWPass:SPEC	Sets or queries local input low pass filter order.
MEASUrement:MEAS<x>:FREQ	Sets or queries switching frequency for Switching Ripple measurement.
MEASUrement:MEAS<x>:FUNDCURRENT	Sets or queries the fundamental current value for IEC-Class C type harmonics standard.
MEASUrement:MEAS<x>:HARMONICSClass	Sets or queries the class type for the harmonics measurement.
MEASUrement:MEAS<x>:HARMONICSSOURCce	Sets or queries harmonics source.

Table 2-30: IMDA Command Group (cont.)

Command	Description
MEASUrement:MEAS<x>:HARMONICSSStd	Sets or queries harmonics standard.
MEASUrement:MEAS<x>:HARMONICSUNits	Sets or queries harmonics units.
MEASUrement:MEAS<x>:HIGHLEVel: CONFIguration	Sets or queries the local input and output configuration.
MEASUrement:MEAS<x>:HIGHLEVel: L2LTOL2N	Sets or queries local input Line-to-Line to Line-to-Neutral Conversion.
MEASUrement:MEAS<x>:HIGHLEVel: LINESelected	Sets or queries local input select lines.
MEASUrement:MEAS<x>:HIGHLEVel: OUTL2LTOL2N	Sets or queries local output Line-to-Line to Line-to-Neutral Conversion.
MEASUrement:MEAS<x>:HIGHLEVel: OUTLINESelected	Sets or queries local output select lines.
MEASUrement:MEAS<x>:HIGHLEVel: OUTWIRing	Sets or queries the local output wiring.
MEASUrement:MEAS<x>:HIGHLEVel: USEGLOBAL	Sets or queries the IMDA source settings as global or local.
MEASUrement:MEAS<x>:HIGHLEVel: WIRing	Sets or queries the local Input wiring.
MEASUrement:MEAS<x>:HTORque	Sets or queries the measurement High Torque value.
MEASUrement:MEAS<x>:HVOLTage	Sets or queries the measurement Torque High Voltage value.
MEASUrement:MEAS<x>:INPUTPOwer	Sets or queries the input power value for IEC-Class C and Class D harmonics standard.
MEASUrement:MEAS<x>:LINESelected	Sets or queries selected lines for the measurement.
MEASUrement:MEAS<x>:LTORque	Sets or queries the measurement Low Torque value.
MEASUrement:MEAS<x>:LVOLTage	Sets or queries the measurement Torque Low Voltage value.
MEASUrement:MEAS<x>:MECH:EINDexz	Sets or queries the specified mechanical Index Z source.
MEASUrement:MEAS<x>:MECH:GRATio	Sets or queries the gear ratio for the specific measurement.
MEASUrement:MEAS<x>:MECH:MUNits	Sets or queries the specified mechanical measurement results units.
MEASUrement:MEAS<x>:MECH:PPAirs	Sets or queries the number of pole pairs for the specific measurement.
MEASUrement:MEAS<x>:MECH:PPRotation	Sets or queries the specified pulses per rotation of the measurement.
MEASUrement:MEAS<x>:MECH:STYPE	Sets or queries the local measurement sensor type.
MEASUrement:MEAS<x>:ODDEVen	Sets or queries harmonics oddeven.
MEASUrement:MEAS<x>:OFILters: LOWPass:FREQ	Sets or returns the cut-off frequency value for a measurement.
MEASUrement:MEAS<x>:OUTFILters: LOWPass:SPEC	Sets or returns low pass filter specification for a measurement.
MEASUrement:MEAS<x>:OSANgle	Sets or queries the specified measurement Offset angle.
MEASUrement:MEAS<x>: OUTEDGEQUALifier	Sets or queries local output edge qualifier source.

Table 2-30: IMDA Command Group (cont.)

Command	Description
MEASUrement:MEAS<x>:OUTFILTerS: LOWPass:FREQ	Sets or queries the measurement output low pass filter frequency.
MEASUrement:MEAS<x>:OUTFILTerS: LOWPass:SPEC	Sets or queries the measurement output low pass filter specification.
MEASUrement:MEAS<x>:POWERFACTOR	Sets or queries the power factor value for IEC-Class C type harmonics standard.
MEASUrement:MEAS<x>:SEQUence	Sets or queries the sequence of hall edges.
MEASUrement:MEAS<x>: SIGNALFREQUency	Sets or queries line frequency for Harmonics and Line Ripple frequency.
MEASUrement:MEAS<x>:SOURCE	Sets or queries local input source.
MEASUrement:MEAS<x>:STYPe	Sets or queries the source type.
MEASUrement:MEAS<x>:SUNits	Sets or queries the speed units for the specific measurement.
MEASUrement:MEAS<x>:TCONstant	Sets or queries the measurement Torque Constant.
MEASUrement:MEAS<x>:TMETHod	Sets or queries the measurement Torque Method.
MEASUrement:MEAS<x>:TYPe	Sets or queries the measurement type for the measurement.
MEASUrement:MECH:EINDEXz	Sets or queries the global mechanical Index Z source.
MEASUrement:MECH:GRATio	Sets or queries the measurement gear ratio.
MEASUrement:MECH:MUNits	Sets or queries the global mechanical measurement results units.
MEASUrement:MECH:PPAIRs	Sets or queries the measurement number of pole pairs.
MEASUrement:MECH:PPROTation	Sets or queries the global pulses per rotation of the measurement.
MEASUrement:MECH:SOURce<x>	Sets or queries the global mechanical source of the specified source number.
MEASUrement:MECH:STYPe	Sets or queries the measurement sensor type.

## Mask command group

Mask commands compare incoming waveforms to standard or user-defined masks. A mask is a set of polygonal regions on the screen. Unlike limit testing, the inside of a mask is the region where waveform data would not normally fall. Standards with eye patterns usually have three masks, but some have four.

Table 2-31: Mask commands

Command	Description
EYEMASK:MASK<x>:COUNT:HITS?	Returns the total number of hit violations for all segments in the specified eye diagram mask test.
EYEMASK:MASK<x>:COUNT:SEG<y>:HITS?	Returns the number of hit violations for the specified segment (area) in the specified eye diagram mask test.
EYEMASK:MASK<x>:CREATor?	Returns the name of the eye diagram plot that created the mask.
EYEMASK:MASK<x>:ENabled	Enables or disables eye mask testing in the specified plot.
EYEMASK:MASK<x>:MASKfile	Sets or queries the current mask definition file name for the specified mask test.
EYEMASK:MASK<x>:MASKOffset:HORizontal:AUTOfit?	Returns the mask offset value in the specified mask in seconds.
EYEMASK:MASK<x>:TEST:SAMple:THReshold	Sets or queries the total number of hit violations that will cause a mask test failure.
EYEMASK:MASK<x>:TEST:STATUS?	Returns the mask hit test status for the specified mask test.
MASK:DELete	Deletes all mask segments of the specified mask test.
MASK:MASK<x>:COUNT?	Returns the total number of mask hits in all segments and the number of mask hits in each individual mask segment for the specified mask test.
MASK:MASK<x>:COUNT:HITS?	Returns the total number of mask hits in all mask segments for the specified mask test.
MASK:MASK<x>:DEFInedby	Sets or queries whether the specified mask is defined by segments or tolerances.
MASK:MASK<x>:DISplay	Sets or queries the display state of the mask used for the specified mask test.
MASK:MASK<x>:LIST?	Queries the list of segments in the mask used by the specified mask test.
MASK:MASK<x>:SEG<x>:POINTS	Sets or queries the X/Y coordinates of all points in the designated mask segment.
MASK:MASK<x>:SEG<x>:COUNT:HITS?	Returns the total number of mask hits in the specified mask segment of the specified mask test.
MASK:MASK<x>:SOUrce	Sets or queries analog source for the specified mask test.
MASK:MASK<x>:TEST:CTHReshold	Sets or queries the number of consecutive waveform violations needed for the specified mask test to change from PASS to FAIL.
MASK:MASK<x>:TEST:STATE	Sets or queries state of the specified mask test.
MASK:MASK<x>:TEST:STATUS?	Queries the status of the specified mask test.
MASK:MASK<x>:TEST:THReshold	Sets or queries the number of waveform violations needed for the specified mask test to change from PASS to FAIL.
MASK:MASK<x>:TOLerance:HABSolute	Sets or queries the mask horizontal tolerance in absolute units of seconds.
MASK:MASK<x>:TOLerance:HORIZontal	Sets or queries the mask horizontal tolerance.

Table 2-31: Mask commands (cont.)

Command	Description
<a href="#">MASK:MASK&lt;x&gt;:TOLerance:UPDateNow</a>	Causes the tolerance mask to be recalculated with the current horizontal and vertical tolerances.
<a href="#">MASK:MASK&lt;x&gt;:TOLerance:VABSolute</a>	Sets or queries the mask vertical tolerance in absolute units of the mask source.
<a href="#">MASK:MASK&lt;x&gt;:TOLerance:VERTical</a>	Sets or queries the mask vertical tolerance.
<a href="#">MASK:MASK&lt;x&gt;:TTYPe</a>	Sets or queries the type of tolerance values used when defining a tolerance mask.
<a href="#">MASK:TEST:WAVEforms</a>	Sets or queries the number of waveform acquisitions to test during mask testing.
<a href="#">RECALL:MASK</a>	Recalls a saved mask definition from a Mask File.

## Math command group

Use the commands in the Math Command Group to create and define math waveforms. Use the available math functions to define your math waveform.

The math waveform you create depends on sources listed in the math expression. If you change these sources, the math waveforms you previously defined will be affected.

Math expressions can be simple, containing no mathematical computation, such as CH1, which specifies that a waveform shows the signal source of channel 1. Math expressions can also be complex, consisting of 100 plus characters and comprising many sources, functions, and operands.

The acquisition of a live waveform can stop for several reasons: You can turn off the channel, stop the waveform (via Run/Stop from the Horiz/Acq menu), or stop the trigger (via Run/Stop from the Trig menu). When you turn off the channel, math continues and data is acquired but is not displayed. When you stop either the waveform or the trigger, the math calculation stops, and the last math calculation performed is displayed.

When a live waveform updates or a reference waveform is altered, math waveforms containing those waveforms as sources are also updated to reflect the changes. Also, sources must exist but do not need to be displayed to be used in and to update math waveforms.

---

**NOTE.** *Math commands are present once a math has been added.*

---

Table 2-32: Math commands

Command	Description
<code>DISplay:GLObal:MATH&lt;x&gt;:STATE</code>	Sets or queries the global state of the specified math.
<code>DISplay:SElect:MATH</code>	Sets or queries the overall selected math.
<code>DISplay:WAVEView&lt;x&gt;:MATH:MATH&lt;x&gt;:STATE</code>	Sets or queries the state of the specified math waveform in the specified Waveform View.
<code>DISplay:WAVEView&lt;x&gt;:MATH:MATH&lt;x&gt;:VERTical:POSition</code>	Sets or queries the vertical position in divisions of the specified math waveform.
<code>DISplay:WAVEView&lt;x&gt;:MATH:MATH&lt;x&gt;:VERTical:SCAle</code>	Sets or queries the vertical scale of the specified math waveform.
<code>MATH:ADDNew</code>	Adds the specified math.
<code>MATHArbflt&lt;x&gt;:FILEpath</code>	Sets the file path for a file of filter coefficients and reads the file.
<code>MATH:DELete</code>	Deletes the specified math.
<code>MATH:LIST?</code>	Lists all currently defined math waveforms.
<code>MATH:MATH&lt;x&gt;:ARINC429A:SUPPortedfields</code>	Sets or queries the field type for the math for the bus source for ARINC429A bus.
<code>MATH:MATH&lt;x&gt;:AUDIO:SUPPortedfields</code>	Sets or queries the field type for the math for the bus source for Audio bus.

Table 2-32: Math commands (cont.)

Command	Description
MATH:MATH<x>:AUTOETHERnet:SUPPortedfields	Sets or queries the field type for the math for the bus source for AUTOETHERnet bus.
MATH:MATH<x>:AVG:MODE	Sets or queries the math average mode flag.
MATH:MATH<x>:AVG:WEIGHT	Sets or queries the number of acquisitions at which the averaging algorithm will begin exponential averaging.
MATH:MATH<x>:CAN:SUPPortedfields	Sets or queries the field type for the math for the bus source for CAN bus.
MATH:MATH<x>:CXPI:SUPPortedfields	Sets or queries the field type for the math for the bus source for CXPI bus.
MATH:MATH<x>:ESPI:SUPPortedfields	Sets or queries the field type for the math for the bus source for ESPI bus.
MATH:MATH<x>:ETHERCAT:SUPPortedfields	Sets or queries the field type for the math for the bus source for ETHERCAT bus.
MATH:MATH<x>:ETHERnet:SUPPortedfields	Sets or queries the field type for the math for the bus source for ETHERnet bus.
MATH:MATH<x>:EUSB:SUPPortedfields	Sets or queries the field type for the math for the bus source for EUSB bus.
MATH:MATH<x>:FILTer:CFReq	Sets or queries the filter cutoff frequency.
MATH:MATH<x>:FILTer:DELay	Sets or queries the delay for all pass filter.
MATH:MATH<x>:FILTer:DESIgn	Performs filter specific Apply, Abort, and Generate operations.
MATH:MATH<x>:FILTer:HCFReq	Sets or queries the high cutoff frequency for bandpass or band stop filter.
MATH:MATH<x>:FILTer:INFo?	Returns filter information output once user created filter.
MATH:MATH<x>:FILTer:LCFReq	Sets or queries the low cutoff frequency for bandpass or band stop filter.
MATH:MATH<x>:FILTer:LOAD	Loads the filter file.
MATH:MATH<x>:FILTer:LOAD:RESPonse	Loads the filter responses and automatically apply filter option.
MATH:MATH<x>:FILTer:ORDER	Sets or queries the filter order.
MATH:MATH<x>:FILTer:PRIPple	Sets or queries the pass band ripple in the filter response.
MATH:MATH<x>:FILTer:RESPonse	Specifies or returns the filter response.
MATH:MATH<x>:FILTer:ROFactor	Sets or queries roll off factor for raised cosine or root raised cosine filter.
MATH:MATH<x>:FILTer:SATTenuation	Sets or queries the stop band attenuation in the filter response.
MATH:MATH<x>:FILTer:SAVe	Saves the filter file.
MATH:MATH<x>:FILTer:SAVe:RESPonse	Sets the filter response images to be saved while saving the filter file.
MATH:MATH<x>:FILTer:SDEViation	Sets or queries the standard deviation in Gaussian filter.
MATH:MATH<x>:FILTer:SDURation	Sets or queries the symbol duration for raised cosine or root raised cosine filter.
MATH:MATH<x>:FILTer:SOURce	Sets or queries color of the specified math filter source.
MATH:MATH<x>:FILTer:SYMBOLs	Sets or queries the symbol for raised cosine or root raised cosine filter.
MATH:MATH<x>:FILTer:TWIDTH	Sets or queries the filter transition width for Custom filter response
MATH:MATH<x>:FILTer:TYPE	Specifies or returns the filter type.
MATH:MATH<x>:FLEXray:SUPPortedfields	Sets or queries the field type for the math for the bus source for FLEXray bus.
MATH:MATH<x>:FUNCTION	Sets or queries the basic math arithmetic function.
MATH:MATH<x>:I2C:SUPPortedfields	Sets or queries the field type for the math for the bus source for I2C bus.
MATH:MATH<x>:I3C:SUPPortedfields	Sets or queries the field type for the math for the bus source for I3C bus

Table 2-32: Math commands (cont.)

Command	Description
MATH:MATH<x>:INTERpolation	Sets or queries whether sinc interpolation is enabled for math on bus source.
MATH:MATH<x>:LABel:COLor	Sets or queries color of the specified math's label.
MATH:MATH<x>:LABel:FONT:BOld	Sets or queries bold state of the specified math label.
MATH:MATH<x>:LABel:FONT:ITALic	Sets or queries italic state of the specified math label.
MATH:MATH<x>:LABel:FONT:SIZE	Sets or queries font size of the specified math label.
MATH:MATH<x>:LABel:FONT:TYPE	Sets or queries font type of the specified math label.
MATH:MATH<x>:LABel:FONT:UNDERline	Sets or queries the underline state of the specified math label.
MATH:MATH<x>:LABel:XPOS	Sets or queries the X screen offset where the math waveform label is displayed.
MATH:MATH<x>:LABel:YPOS	Sets or queries the Y screen offset where the math waveform label is displayed.
MATH:MATH<x>:DEFine	Defines new waveforms using mathematical expressions.
MATH:MATH<x>:GATing	Specifies or returns the gating setting.
MATH:MATH<x>:LABel:NAME	Sets or queries the label string.
MATH:MATH<x>:LIN:SUPPortedfields	Sets or queries the field type for the math for the bus source for LIN bus.
MATH:MATH<x>:MDIO:SUPPortedfields	Sets or queries the field type for the math for the bus source for MDIO bus.
MATH:MATH<x>:MIL 1553B:SUPPortedfields	Sets or queries the field type for the math for the bus source for MIL 1553B bus.
MATH:MATH<x>:ONEWIRe:SUPPortedfields	Sets or queries the field type for the math for the bus source for ONEWIRe bus.
MATH:MATH<x>:PARAllel:SUPPortedfields	Sets or queries the field type for the math for the bus source for PARAllel bus.
MATH:MATH<x>:PSIFIVe:SUPPortedfields	Sets or queries the field type for the math for the bus source for PSIFIVe bus.
MATH:MATH<x>:RS232C:SUPPortedfields	Sets or queries the field type for the math for the bus source for RS232C bus.
MATH:MATH<x>:SDLC:SUPPortedfields	Sets or queries the field type for the math for the bus source for SDLC bus.
MATH:MATH<x>:SENT:SUPPortedfields	Sets or queries the field type for the math for the bus source for SENT bus.
MATH:MATH<x>:SIGNeddata	Sets or queries value to denote that bus field is decoded as signed/unsigned data for math on bus source.
MATH:MATH<x>:SMBUS:SUPPortedfields	Sets or queries the field type for the math for the bus source for SMBUS bus.
MATH:MATH<x>:SOUrce<x>	Sets or queries the specified math source.
MATH:MATH<x>:SPACEWIRe: SUPPortedfields	Sets or queries the field type for the math for the bus source for SPACEWIRe bus.
MATH:MATH<x>:SPECTral:HORZ	Sets or queries the horizontal display scale of the spectral math waveform.
MATH:MATH<x>:SPECTral:MAG	Sets or queries the units of the SpectralMag function in the specified math definition string.
MATH:MATH<x>:SPECTral:PHASE	Sets or queries the units of a SpectralPhase function in the specified math definition string.
MATH:MATH<x>:SPECTral:SOUrce	Sets or queries the specified spectral math source.
MATH:MATH<x>:SPECTral:SUPPress	Sets or queries whether suppression threshold for the specified math waveform is enabled.
MATH:MATH<x>:SPECTral:SUPPress:VALue	Sets or queries in volts the value of suppression threshold of the specified math waveform.
MATH:MATH<x>:SPECTral:TYPE	Sets or queries the FFT type selected for spectral analysis.



Table 2-32: Math commands (cont.)

Command	Description
<a href="#">MATH:MATH&lt;x&gt;:SPECTral:UNWRap</a>	Sets or queries whether phase unwrap of the spectral analyzer output data is enabled.
<a href="#">MATH:MATH&lt;x&gt;:SPECTral:UNWRap:DEGrees</a>	Sets or queries in degrees the value of unwrap phase.
<a href="#">MATH:MATH&lt;x&gt;:SPECTral:WINDow</a>	Sets or queries the window function used to multiply the spectral analyzer input data for the specified math waveform.
<a href="#">MATH:MATH&lt;x&gt;:SPI:SUPPortedfields</a>	Sets or queries the field type for the math for the bus source for SPI bus.
<a href="#">MATH:MATH&lt;x&gt;:SPMI:SUPPortedfields</a>	Sets or queries the field type for the math for the bus source for SPMI bus.
<a href="#">MATH:MATH&lt;x&gt;:SVID:SUPPortedfields</a>	Sets or queries the field type for the math for the bus source for SVID bus.
<a href="#">MATH:MATH&lt;x&gt;:TYPE</a>	Sets or queries the math type.
<a href="#">MATH:MATH&lt;x&gt;:USB:SUPPortedfields</a>	Sets or queries the field type for the math for the bus source for USB bus.
<a href="#">MATH:MATH&lt;x&gt;:VUNIT</a>	Sets or queries the math custom vertical units.

## Measurement command group

Use the commands in the Measurement Command Group to control the automated measurement system.

Measurement commands can set and query measurement parameters. You can assign parameters, such as waveform sources and reference levels, differently for each measurement.

Clock recovery, edge, filter, gating, population and range measurement commands can be either global or per-measurement.

Global clock recovery commands are of the form

```
:MEASUREMENT:CLOCKRECOVERY:XXXX
```

Global edge commands are of the form :MEASUREMENT:XXXX

Global filter commands are of the form :MEASUREMENT:FILTERS:XXXX

Global gating commands are of the form :MEASUREMENT:GATING:XXXX

Global population commands are of the form

```
:MEASUREMENT:POPULATION:XXXX
```

Global range commands are of the form :MEASUREMENT:MEASRANGE:XXXX

Reference levels for measurements can be global, per-measurement or per-source. The default is global. Per-measurement settings are used when local reference levels are enabled for the measurement with the command :MEASUREMENT:MEAS?:GLOBALREF 0. Per-source settings are used when per-source settings are enabled with the command :MEASUREMENT:REFLEVELS:TYPE PerSource and per-source settings are selected for the measurement with the command :MEASUREMENT:MEAS?:GLOBALREF 0.

Global reference level commands are of the form

```
:MEASUREMENT:REFLEVELS:XXXX
```

Per-source reference level commands are of the form

```
:MEASUREMENT:CH1:REFLEVELS:XXXX
```

```
:MEASUREMENT:MATH1:REFLEVELS:XXXX
```

When there is a change in source type then the measurements should be re-added to get valid results.

```
/* Add a reference slot on which to measure */
```

```
:REF:ADDNEW "REF1"
```

```
/* Set up the measurement parameters on the reference */
```

```
:MEASUREMENT:MEAS1:TYPE AMPLITUDE
```

```
:MEASUREMENT:MEAS1:SOURCE REF1
```

```
/* Load the new waveform file */
```

```
:RECALL:WAVEFORM "E:\waveform.wfm",REF1
```

```
*OPC?
```

```
/* wait for read from Output Queue. */
```

```
/* Take amplitude measurement */
```

```
:MEASUREMENT:MEAS1:RESULTS:CURRENTACQ:MEAN?
```

```
/* change analog to digital waveform file */
```

```

:RECALL:WAVEFORM "E:\digital8.wfm",REF1
*OPC?
/* Set up the measurement parameters on the reference
again*/
:MEASUREMENT:MEAS1:TYPE AMPLITUDE
/* Take amplitude measurement */
:MEASUREMENT:MEAS1:RESULTS:CURRENtAcq:MEAN?

```

Table 2-33: Measurement commands

Command	Description
CUSTOMTABLE:ADDNew	This command adds new custom results table.
CUSTOMTABLE:DELete	This command deletes the custom result(s) table that was added.
CUSTOMTABLE:LIST?	This command queries the list of custom result tables has been added.
MEASTABLE:ADDNew	Adds a new measurement results view table to the scope application.
MEASTABLE:DELETE	Removes the requested measurement results view table from the scope application.
MEASU:MEAS1:SUBGROUP:RESUlts: CURRentAcq:MEAN?	This query returns the mean value of the measurement represented by the string, for the current acquisition.
MEASUrement?	This command returns all measurement parameters.
MEASUrement:ADDMEAS	This command adds a measurement.
MEASUrement:ADDNew	Adds the specified measurement.
MEASUrement:ANNOtate	This command sets or queries the annotation state for measurements.
MEASUrement:AUTOset	Performs an analysis jitter autoset.
MEASUrement:CH<x>:REFLevels:ABSolute: FALLHigh	This command sets or queries the value used as the high reference level of the falling edge when the source ref level method is set to absolute.
MEASUrement:CH<x>:REFLevels:ABSolute: FALLLow	This command sets or queries the value used as the low reference level of the falling edge when the source ref level method is set to absolute.
MEASUrement:CH<x>:REFLevels:ABSolute: FALLMid	This command sets or queries the value used as the mid reference level of the falling edge when the source ref level method is set to absolute.
MEASUrement:CH<x>:REFLevels:ABSolute: HYSTeresis	This command sets or queries the value of the hysteresis of the reference level when the source ref level method is set to absolute.
MEASUrement:CH<x>:REFLevels:ABSolute: RISEHigh	This command sets or queries the value used as the high reference level of the rising edge when the source ref level method is set to absolute.
MEASUrement:CH<x>:REFLevels:ABSolute: RISELow	This command sets or queries the value used as the low reference level of the rising edge when the source ref level method is set to absolute.
MEASUrement:CH<x>:REFLevels:ABSolute: RISEMid	This command sets or queries the value used as the mid reference level of the rising edge when the source ref level method is set to absolute.
MEASUrement:CH<x>:REFLevels:ABSolute: TYPE	This command sets or queries the reference level type for the source.
MEASUrement:CH<x>:REFLevels:BASETop	This command sets or queries the method used to calculate the TOP and BASE, used to calculate reference levels for the measurement.

Table 2-33: Measurement commands (cont.)

Command	Description
MEASUrement:CH<x>:REFLevels:METhod	This command sets or queries the method used to calculate reference levels for the source.
MEASUrement:CH<x>:REFLevels:PERCent:FALLHigh	This command sets or queries the percentage (where 100% is equal to TOP and 0% is equal to BASE) used to calculate the high reference level of the falling edge when the source ref level method is set to percent.
MEASUrement:CH<x>:REFLevels:PERCent:FALLLow	This command sets or queries the percentage (where 100% is equal to TOP and 0% is equal to BASE) used to calculate the mid reference level of the falling edge when the source ref level method is set to percent.
MEASUrement:CH<x>:REFLevels:PERCent:FALLMid	This command sets or queries the percentage (where 100% is equal to TOP and 0% is equal to BASE) used to calculate the mid reference level of the falling edge when the source ref level method is set to percent.
MEASUrement:CH<x>:REFLevels:PERCent:HYSteresis	This command sets or queries the percentage (where 100% is equal to MAX and 0% is equal to MIN) used to calculate the hysteresis of the reference level when the source ref level method is set to percent.
MEASUrement:CH<x>:REFLevels:PERCent:RISEHigh	This command sets or queries the percentage (where 100% is equal to TOP and 0% is equal to BASE) used to calculate the high reference level of the rising edge when the source ref level method is set to percent.
MEASUrement:CH<x>:REFLevels:PERCent:RISELow	This command sets or queries the percentage (where 100% is equal to TOP and 0% is equal to BASE) used to calculate the low reference level of the rising edge when the source ref level method is set to percent.
MEASUrement:CH<x>:REFLevels:PERCent:RISEMid	This command sets or queries the percentage (where 100% is equal to TOP and 0% is equal to BASE) used to calculate the mid reference level of the rising edge when the source ref level method is set to percent.
MEASUrement:CH<x>:REFLevels:PERCent:TYPE	This command specifies or queries the reference level percent type for the source.
MEASUrement:CLOCKRecovery:ADVanced:METhod	This command sets or queries the global advanced clock recovery method.
MEASUrement:CLOCKRecovery:CLOCKFrequency	This command sets or queries the global clock frequency used for fixed constant clock recovery.
MEASUrement:CLOCKRecovery:CLOCKMultiplier	This command sets or queries the global clock multiplier used for explicit clock recovery.
MEASUrement:CLOCKRecovery:CONSTCLOCKMODE	This command sets or queries the global constant clock mode used for constant clock recovery.
MEASUrement:CLOCKRecovery:DAMPing	This command sets or queries the global damping value used for PLL clock recovery.
MEASUrement:CLOCKRecovery:DATAPath	This command sets or queries the global file containing the data pattern used for known data pattern clock recovery.
MEASUrement:CLOCKRecovery:DATARate	This command sets or queries the global nominal data bit rate used for nominal data rate clock recovery.
MEASUrement:CLOCKRecovery:EXPLICITCLOCKMODE	This command sets or queries the global explicit clock mode used for explicit clock recovery.

Table 2-33: Measurement commands (cont.)

Command	Description
MEASUrement:CLOCKRecovery:JTFBandwidth	This command sets or queries the global JTF bandwidth used for PLL clock recovery.
MEASUrement:CLOCKRecovery:LOOPBandwidth	This command sets or queries the global loop bandwidth used for PLL clock recovery.
MEASUrement:CLOCKRecovery:MEANAUTOCalculate	This command sets or queries how often the clock is calculated for constant clock recovery.
MEASUrement:CLOCKRecovery:METHod	This command sets or queries the global clock recovery method.
MEASUrement:CLOCKRecovery:MODEl	This command sets or queries the global PLL clock recovery model used for PLL clock recovery.
MEASUrement:CLOCKRecovery:NOMINALOFFset	This command sets or queries the global offset value used for explicit clock recovery.
MEASUrement:CLOCKRecovery:NOMINALOFFset:SELECTIONtype	This command sets or queries the global offset type used for explicit clock recovery.
MEASUrement:CLOCKRecovery:STAndard	This command sets or queries the global communications standard used for PLL clock recovery.
MEASUrement:DELeTe	The command deletes the specified measurement.
MEASUrement:DELETEALL	Deletes all the active instances of measurements defined in the scope application.
MEASUrement:DIRAcmodel	This command sets or queries the dirac model used to separate random from deterministic jitter for jitter measurements.
MEASUrement:DISPLAYUnits	This command sets or queries the display units used for jitter summary measurements.
MEASUrement:EDGE<x>	Sets or queries the type of the edge for the measurement.
MEASUrement:EYERENDER	This command sets or queries the state of high-performance eye rendering for an eye diagram.
MEASUrement:FILTerS:BLANKingtime	This command sets or queries the global filter blanking time.
MEASUrement:FILTerS:HIGHPass:FREQ	This command sets or queries the global high pass filter frequency.
MEASUrement:FILTerS:HIGHPass:SPEC	This command sets or queries the global high pass filter order.
MEASUrement:FILTerS:LOWPass:FREQ	This command sets or queries the global low pass filter cutoff frequency.
MEASUrement:FILTerS:LOWPass:SPEC	This command sets or queries the global low pass filter order.
MEASUrement:FILTerS:RAMPTime	This command sets or queries the global filter ramp time.
MEASUrement:GATing	This command sets or queries the global gating type.
MEASUrement:GATing:ACTive	This command sets or queries the global gating active level used for logic gating.
MEASUrement:GATing:ENDtime	Sets or queries the end gate time for all measurements that use Global gating.
MEASUrement:GATing:HYSTeresis	This command sets or queries the global gating hysteresis value used for logic gating.
MEASUrement:GATing:LOGICSource	This command sets or queries the gating data source used for logic gating.
MEASUrement:GATing:MIDRef	This command sets or queries the global gating mid ref value used for logic gating.
MEASUrement:GATing:SEARCHSource	This command sets or queries the global gating search source used for logic gating.

Table 2-33: Measurement commands (cont.)

Command	Description
MEASUrement:GATing:STARTtime	Sets or queries the start gate time for all measurements that use Global gating.
MEASUrement:HIGHLEVel:L2LTOL2N	Enables the Line-to-Line to Line-to-Neutral Conversion.
MEASUrement:HIGHLEVel:WIRing	Sets or queries the wiring configuration for the measurement.
MEASUrement:INTERp	This command sets or queries the interpolation mode used to locate edge crossings.
MEASUrement:JITTermodel	This command sets or queries the model used to separate random from deterministic jitter for jitter measurements.
MEASUrement:LIST?	Lists all currently defined measurements.
MEASUrement:LOCKRJ	Sets or queries the state of RJ locking.
MEASUrement:LOCKRJValue	Sets or queries the RJ lock value.
MEASUrement:MATH<x>:REFLevels:ABSolute:FALLHigh	This command sets or queries the value used as the high reference level of the falling edge when the source ref level method is set to absolute.
MEASUrement:MATH<x>:REFLevels:ABSolute:FALLLow	This command sets or queries the value used as the low reference level of the falling edge when the source ref level method is set to absolute.
MEASUrement:MATH<x>:REFLevels:ABSolute:FALLMid	This command sets or queries the value used as the mid reference level of the falling edge when the source ref level method is set to absolute.
MEASUrement:MATH<x>:REFLevels:ABSolute:HYSTeresis	This command sets or queries the value of the hysteresis of the reference level when the source ref level method is set to absolute.
MEASUrement:MATH<x>:REFLevels:ABSolute:RISEHigh	This command sets or queries the value used as the high reference level of the rising edge when the source ref level method is set to absolute.
MEASUrement:MATH<x>:REFLevels:ABSolute:RISELow	This command sets or queries the value used as the low reference level of the rising edge when the source ref level method is set to absolute.
MEASUrement:MATH<x>:REFLevels:ABSolute:RISEMid	This command sets or queries the value used as the mid reference level of the rising edge when the source ref level method is set to absolute.
MEASUrement:MATH<x>:REFLevels:ABSolute:TYPE	This command sets or queries the reference level type for the source.
MEASUrement:MATH<x>:REFLevels:BASETop	This command sets or queries the method used to calculate the TOP and BASE used to calculate reference levels for the source.
MEASUrement:MATH<x>:REFLevels:METHod	This command sets or queries the method used to calculate reference levels for the source.
MEASUrement:MATH<x>:REFLevels:PERCent:FALLHigh	This command sets or queries the percentage (where 100% is equal to TOP and 0% is equal to BASE) used to calculate the high reference level of the falling edge when the source ref level method is set to percent.
MEASUrement:MATH<x>:REFLevels:PERCent:FALLLow	This command sets or queries the percentage (where 100% is equal to TOP and 0% is equal to BASE) used to calculate the mid reference level of the falling edge when the source ref level method is set to percent.
MEASUrement:MATH<x>:REFLevels:PERCent:FALLMid	This command sets or queries the percentage (where 100% is equal to TOP and 0% is equal to BASE) used to calculate the mid reference level of the falling edge when the source ref level method is set to percent.

Table 2-33: Measurement commands (cont.)

Command	Description
MEASUrement:MATH<x>:REFLevels:PERCent:HYSTeresis	This command sets or queries the percentage (where 100% is equal to MAX and 0% is equal to MIN) used to calculate the hysteresis of the reference level when the source ref level method is set to percent.
MEASUrement:MATH<x>:REFLevels:PERCent:RISEHigh	This command sets or queries the percentage (where 100% is equal to TOP and 0% is equal to BASE) used to calculate the high reference level of the rising edge when the source ref level method is set to percent.
MEASUrement:MATH<x>:REFLevels:PERCent:RISELow	This command sets or queries the percentage (where 100% is equal to TOP and 0% is equal to BASE) used to calculate the low reference level of the rising edge when the source ref level method is set to percent.
MEASUrement:MATH<x>:REFLevels:PERCent:RISEMid	This command sets or queries the percentage (where 100% is equal to TOP and 0% is equal to BASE) used to calculate the mid reference level of the rising edge when the source ref level method is set to percent.
MEASUrement:MATH<x>:REFLevels:PERCent:TYPE	This command specifies or queries the reference level percent type for the source.
MEASUrement:MEAS<x>:BER	This command sets or queries the BER value for the measurement.
MEASUrement:MEAS<x>:BER:TARGETBER	This command sets or queries the target BER value for the measurement.
MEASUrement:MEAS<x>:BIN	This command sets or queries the bin count for the measurement.
MEASUrement:MEAS<x>:BITCfmode	This command sets or queries whether the measurement returns the mean or mode statistic result when the measurement type is bit amplitude/high/low.
MEASUrement:MEAS<x>:BITEnd	This command sets or queries the bit end as a percentage of the unit interval.
MEASUrement:MEAS<x>:BITPcnt	This command sets or queries the bit center as a percentage of the unit interval.
MEASUrement:MEAS<x>:BITStart	This command sets or queries the bit start as a percentage of the unit interval.
MEASUrement:MEAS<x>:BITType	This command sets or queries the bit type for the measurement.
MEASUrement:MEAS<x>:BURSTEDGTYPe	This command sets or queries the burst edge type for the measurement.
MEASUrement:MEAS<x>:CCRESUIts:ALLAcqs:MAXimum?	This query-only command returns the maximum cycle-cycle value for the specified measurement for all acquisitions.
MEASUrement:MEAS<x>:CCRESUIts:ALLAcqs:MEAN?	This query-only command returns the mean cycle-cycle value for the specified measurement for all acquisitions.
MEASUrement:MEAS<x>:CCRESUIts:ALLAcqs:MINimum?	This query-only command returns the minimum cycle-cycle value for the specified measurement for all acquisitions.
MEASUrement:MEAS<x>:CCRESUIts:ALLAcqs:PK2PK?	This query-only command returns the peak to peak cycle-cycle statistic for the specified measurement for all acquisitions.
MEASUrement:MEAS<x>:CCRESUIts:ALLAcqs:POPulation?	This query-only command returns the population of all cycle-cycle statistics for the specified measurement for all acquisitions accumulated since statistics were last reset.
MEASUrement:MEAS<x>:CCRESUIts:ALLAcqs:STDDDev?	This query-only command returns the standard deviation cycle-cycle for the specified measurement for all acquisitions.
MEASUrement:MEAS<x>:CCRESUIts:CURRentacq:MAXimum?	This query-only command returns the maximum cycle-cycle value for the specified measurement for the current acquisition.

Table 2-33: Measurement commands (cont.)

Command	Description
MEASUrement:MEAS<x>:CCRESUlts:CURRentacq:MEAN?	This query-only command returns the mean cycle-cycle value for the specified measurement for the current acquisition.
MEASUrement:MEAS<x>:CCRESUlts:CURRentacq:MINimum?	This query-only command returns the minimum cycle-cycle value for the specified measurement for the current acquisition.
MEASUrement:MEAS<x>:CCRESUlts:CURRentacq:PK2PK?	This query-only command returns the peak to peak cycle-cycle statistic for the specified measurement for the current acquisition.
MEASUrement:MEAS<x>:CCRESUlts:CURRentacq:POPulation?	This query-only command returns the population of the cycle-cycle statistics for the specified measurement for the current acquisition.
MEASUrement:MEAS<x>:CCRESUlts:CURRentacq:STDDev?	This query-only command returns the standard deviation cycle-cycle for the specified measurement for the current acquisition.
MEASUrement:MEAS<x>:CLOCKRecovery:ADVanced:METHod	This command sets or queries the advanced clock recovery method when advanced clock recovery is used for the measurement.
MEASUrement:MEAS<x>:CLOCKRecovery:CLOCKFrequency	This command sets or queries the clock frequency used when fixed constant clock recovery is used for the measurement.
MEASUrement:MEAS<x>:CLOCKRecovery:CLOCKMultiplier	This command sets or queries the clock multiplier used when explicit clock recovery is used for the measurement.
MEASUrement:MEAS<x>:CLOCKRecovery:CONSTCLOCKMODE	This command sets or queries the constant clock mode used when constant clock recovery is used for the measurement.
MEASUrement:MEAS<x>:CLOCKRecovery:DAMPing	This command sets or queries the damping value used when PLL clock recovery is used for the measurement.
MEASUrement:MEAS<x>:CLOCKRecovery:DATAPath	This command sets or queries the file containing the data pattern used when known data pattern clock recovery is used for the measurement.
MEASUrement:MEAS<x>:CLOCKRecovery:DATARate	This command sets or queries the nominal data bit rate when nominal data rate clock recovery is used for the measurement.
MEASUrement:MEAS<x>:CLOCKRecovery:EXPLICITCLOCKMODE	This command sets or queries the explicit clock mode used when explicit clock recovery is used for the measurement.
MEASUrement:MEAS<x>:CLOCKRecovery:GLOBal	This command sets or queries the clock recovery settings global flag for the measurement.
MEASUrement:MEAS<x>:CLOCKRecovery:JTFBandwidth	This command sets or queries the JTF bandwidth used when PLL clock recovery is used for the measurement.
MEASUrement:MEAS<x>:CLOCKRecovery:LOOPBandwidth	This command sets or queries the loop bandwidth used when PLL clock recovery is used for the measurement.
MEASUrement:MEAS<x>:CLOCKRecovery:MEANAUTOCalculate	This command sets or queries how often the clock is calculated when constant clock recovery is used for the measurement.
MEASUrement:MEAS<x>:CLOCKRecovery:METHod	This command sets or queries the clock recovery method for the measurement.
MEASUrement:MEAS<x>:CLOCKRecovery:MODEl	This command sets or queries the PLL clock recovery model used when PLL clock recovery is used for the measurement.



Table 2-33: Measurement commands (cont.)

Command	Description
MEASUrement:MEAS<x>:CLOCKRecovery:NOMINALOFFset	This command sets or queries the offset value used when explicit clock recovery is used for the measurement.
MEASUrement:MEAS<x>:CLOCKRecovery:NOMINALOFFset:SELECTIONtype	This command sets or queries the offset type used when explicit clock recovery is used for the measurement.
MEASUrement:MEAS<x>:CLOCKRecovery:STAndard	This command sets or queries the communications standard when PLL clock recovery is used for the measurement.
MEASUrement:MEAS<x>:COMMONMode:FILTers:STATE	This command sets or queries whether a filter is used for the measurement when the measurement type is AC common mode.
MEASUrement:MEAS<x>:COMMONMode:SOURCEs	Sets or queries the number of sources for the measurement when the measurement type is AC common mode.
MEASUrement:MEAS<x>:COVer	Sets or queries the Calculate Over for the Power Quality measurement.
MEASUrement:MEAS<x>:CUSTOMLIMITSFile	Sets and queries the custom limits file path for custom harmonics standard.
MEASUrement:MEAS<x>:CYCLemode	This command sets or queries the cycle mode for the measurement.
MEASUrement:MEAS<x>:DELay:EDGE<x>	This command sets or queries the 'to edge' type when EDGE? is EDGE1 and the 'from edge' type when EDGE? is EDG2, for the measurement when the measurement type is DELAY.
MEASUrement:MEAS<x>:DISPlaystat:ENABLE	Turns on and off the display of statistics in measurement badges.
MEASUrement:MEAS<x>:EDGE<x>	This command sets or queries the type of the specified edge, rise or fall, for the measurement.
MEASUrement:MEAS<x>:EDGEIncre	This command sets or queries the edge increment value for the measurement.
MEASUrement:MEAS<x>:EDGEQUALifier	Sets and queries the Edge Qualifier source.
MEASUrement:MEAS<x>:EDGEQUALONE	Set and queries the measurement 1 input edge qualifier one source for Efficiency measurement.
MEASUrement:MEAS<x>:EDGEQUALTWO	Sets and queries the measurement 1 output edge qualifier two source for Efficiency measurement.
MEASUrement:MEAS<x>:EDGES:FROMLevel	This command sets or queries the 'from level' edge for the measurement.
MEASUrement:MEAS<x>:EDGES:LEVel	This sets or queries the level type for the 'time outside level' measurement.
MEASUrement:MEAS<x>:EDGES:LOWERFREQuency	This command sets or queries the lower frequency for the measurement when the measurement type is phase noise. Lower frequencies are ignored.
MEASUrement:MEAS<x>:EDGES:N	The command sets or queries the number of accumulation cycles for the measurement when the measurement type is nperiod.
MEASUrement:MEAS<x>:EDGES:SLEWRATEMethod	This command sets or queries the slew rate method for the measurement.
MEASUrement:MEAS<x>:EDGES:TOLevel	This command sets or queries the 'to level' edge for the measurement.
MEASUrement:MEAS<x>:EDGES:UPPERFREQuency	This command sets or queries the upper frequency for the measurement when the measurement type is phase noise. Higher frequencies are ignored.
MEASUrement:MEAS<x>:EEQUal	Turns on or off the edge qualifier settings as input waveform to measurement.

Table 2-33: Measurement commands (cont.)

Command	Description
MEASUrement:MEAS<x>:FAILCount?	Returns the number of measurement failures, if applicable, for the selected measurement.
MEASUrement:MEAS<x>:FILTERRANGEFROM	This command sets or queries harmonics filter from order.
MEASUrement:MEAS<x>:FILTERRANGETO	This command sets or queries harmonics filter to order.
MEASUrement:MEAS<x>:FILTers:BLANKingtime	This command sets or queries the filter blanking time for the measurement.
MEASUrement:MEAS<x>:FILTers:GLOBal	This command sets or queries the global flag for filter settings for the measurement.
MEASUrement:MEAS<x>:FILTers:HIGHPass:FREQ	This command sets or queries the high pass filter frequency for the measurement.
MEASUrement:MEAS<x>:FILTers:HIGHPass:SPEC	This command sets or queries the high pass filter order for the measurement.
MEASUrement:MEAS<x>:FILTers:LOWPass:FREQ	This command sets or queries the low pass filter cutoff frequency for the measurement.
MEASUrement:MEAS<x>:FILTers:LOWPass:SPEC	This command sets or queries the low pass filter order for the measurement.
MEASUrement:MEAS<x>:FILTers:RAMptime	This command sets or queries the filter ramp time for the measurement.
MEASUrement:MEAS<x>:FREQ	Sets or queries switching frequency for Switching Ripple measurement.
MEASUrement:MEAS<x>:FROMedge	This command sets or queries the 'from edge' type for the measurement.
MEASUrement:MEAS<x>:FROMEDGESEARCHDIRect	This command sets or queries the 'from edge' search direction for the measurement.
MEASUrement:MEAS<x>:FROMSymbol:LOGIC2SOUrce	This command sets or queries the DDR digital measurement logic 1 source From symbol.
MEASUrement:MEAS<x>:FROMSymbol:LOGIC3SOUrce	This command sets or queries the DDR digital measurement logic 2 source From symbol.
MEASUrement:MEAS<x>:FROMSymbol:LOGIC4SOUrce	This command sets or queries the DDR digital measurement logic 3 source From symbol.
MEASUrement:MEAS<x>:FROMSymbol:LOGIC5SOUrce	This command sets or queries the DDR digital measurement logic 4 source From symbol.
MEASUrement:MEAS<x>:FROMSymbol:MEASUREAT	This command sets or queries the DDR digital measurement From Symbol MeasureAT value.
MEASUrement:MEAS<x>:FUNDCURRent	Sets and queries the fundamental current value for IEC-Class C type harmonics standard.
MEASUrement:MEAS<x>:GATing	This command sets or queries the gating type for the measurement.
MEASUrement:MEAS<x>:GATing:ACTive	This command sets or queries the gating active level when the gating type is logic.
MEASUrement:MEAS<x>:GATing:ENDtime	Sets or queries the end gate time for the measurement when using Local gating.
MEASUrement:MEAS<x>:GATing:GLOBal	This command sets or queries the gating settings global flag.

Table 2-33: Measurement commands (cont.)

Command	Description
MEASUrement:MEAS<x>:GATing:HYSTeresis	This command sets or queries the gating hysteresis value when the gating type is logic.
MEASUrement:MEAS<x>:GATing:LOGICSource	This command sets or queries the gating data source when the gating type is logic.
MEASUrement:MEAS<x>:GATing:MIDRef	This command sets or queries the gating mid ref value when the gating type is logic.
MEASUrement:MEAS<x>:GATing:SEARCHSource	This command sets or queries the gating search source when the gating type is search.
MEASUrement:MEAS<x>:GATing:STARTtime	Sets or queries the start gate time for the measurement when using Local gating.
MEASUrement:MEAS<x>:GLOBalref	This command sets or queries the reference levels global flag for the measurement.
MEASUrement:MEAS<x>:HARMONICSClass	Sets and queries the class type for the harmonics measurement.
MEASUrement:MEAS<x>:HARMONICSSOURce	Sets or queries harmonics source.
MEASUrement:MEAS<x>:HARMONICSStd	Sets or queries harmonics standard.
MEASUrement:MEAS<x>:HARMONICSUNits	Sets or queries harmonics units.
MEASUrement:MEAS<x>:HIGHREFVoltage	Sets or queries the high reference voltage value for the 'time outside level' measurement.
MEASUrement:MEAS<x>:HLEVEL:OUTPut:UGLobal	Turns on or off output global settings for measurement
MEASUrement:MEAS<x>:IDLETime	Sets or queries the idle time for the measurement when the measurement type is burst width.
MEASUrement:MEAS<x>:FILTERs:LOWPass:FREQ	Sets and queries the measurement input low pass filter frequency cutoff frequency on the scope.
MEASUrement:MEAS<x>:FILTERs:LOWPass:SPEC	Sets and queries the measurement input low pass filter specification filter order on the scope
MEASUrement:MEAS<x>:INPUTPower	Sets and queries the input power value for IEC-Class C and Class D harmonics standard.
MEASUrement:MEAS<x>:JITTERSummary:DCD	This command sets or queries whether DCD is included in the jitter summary for the measurement.
MEASUrement:MEAS<x>:JITTERSummary:DDJ	This command sets or queries whether DDJ is included in the jitter summary for the measurement.
MEASUrement:MEAS<x>:JITTERSummary:DJDD	This command sets or queries whether DJ-dd is included in the jitter summary for the measurement.
MEASUrement:MEAS<x>:JITTERSummary:EYEWIDTHBER	This command sets or queries whether EyeWidth@BER is included in the jitter summary for the measurement.
MEASUrement:MEAS<x>:JITTERSummary:NPJ	This command sets or queries whether NPJ is included in the jitter summary for the measurement.
MEASUrement:MEAS<x>:JITTERSummary:PJ	This command sets or queries whether PJ is included in the jitter summary for the measurement.

Table 2-33: Measurement commands (cont.)

Command	Description
MEASUrement:MEAS<x>:JITTERSummary:RJDD	This command sets or queries whether RJ-dd is included in the jitter summary for the measurement.
MEASUrement:MEAS<x>:JITTERSummary:TIE	This command sets or queries whether TIE is included in the jitter summary for the measurement.
MEASUrement:MEAS<x>:JITTERSummary:TJBER	This command sets or queries whether TJ@BER is included in the jitter summary for the measurement.
MEASUrement:MEAS<x>:LABel	This command sets or queries the label for the measurement.
MEASUrement:MEAS<x>:LINESelected	Sets or queries selected lines for the measurement.
MEASUrement:MEAS<x>:LOWREFVoltage	This command sets or queries the low reference voltage value for the 'time outside level' measurement.
MEASUrement:MEAS<x>:LTYPe	Sets or returns the value for the level type as auto or custom.
MEASUrement:MEAS<x>:LUNITs	Sets or returns the value for the level units as percentage or absolute.
MEASUrement:MEAS<x>:MAXCurrenT	Sets or returns the maximum current.
MEASUrement:MEAS<x>:MAXCycle	Sets or queries the maximum cycle value for the DDRTERRN and DDRTERRMN measurements.
MEASUrement:MEAS<x>:MAXGVoltage	Sets or returns the maximum gate voltage.
MEASUrement:MEAS<x>:MEASRange:GLOBal	Sets or queries the range settings global flag for the measurement.
MEASUrement:MEAS<x>:MEASRange:MAX	Sets or queries the range maximum value for the measurement.
MEASUrement:MEAS<x>:MEASRange:MIN	Sets or queries the range minimum value for the measurement.
MEASUrement:MEAS<x>:MEASRange:STATE	Sets or queries the range state for the measurement.
MEASUrement:MEAS<x>:MECH:GRATio	Sets or queries the gear ratio for the specific measurement
MEASUrement:MEAS<x>:MECH:PPAirs	Sets or queries the number of pole pairs for the specific measurement.
MEASUrement:MEAS<x>:MECH:STYPe	Sets or queries the local measurement sensor type.
MEASUrement:MEAS<x>:MINCycle	Sets or queries the minimum cycle value for the DDRTERRN and DDRTERRMN measurements.
MEASUrement:MEAS<x>:ODDEVen	Sets or queries harmonics oddeven.
MEASUrement:MEAS<x>:OUTFILTer:LOWPass:FREQ	Sets and queries the measurement output low pass filter frequency cutoff frequency on the scope.
MEASUrement:MEAS<x>:OUTFILTer:LOWPass:SPEC	Sets and queries the measurement output low pass filter specification filter order on the scope.
MEASUrement:MEAS<x>:PASSFAILEnabled	Sets or returns the pass/fail test enable status.
MEASUrement:MEAS<x>:PASSFAILHIGHlimit	Sets or returns the high limit for a measurement test.
MEASUrement:MEAS<x>:PASSFAILLIMIT	Sets or returns the limit for a measurement test.
MEASUrement:MEAS<x>:PASSFAILLOWlimit	Sets or returns the low limit for a measurement test.

Table 2-33: Measurement commands (cont.)

Command	Description
MEASUrement:MEAS<x>:PASSFAILMARGin	Sets or returns the allowed margin for limit comparisons for all pass/fail checks
MEASUrement:MEAS<x>:PASSFAILWHEN	Sets or returns the condition on which a measurement test fails.
MEASUrement:MEAS<x>: PATTERNDETECTION	This command sets or queries the pattern detection type for the measurement.
MEASUrement:MEAS<x>:PATTERNLENgth	This command sets or queries the pattern length for the measurement.
MEASUrement:MEAS<x>:PATTERNTYPE	This command sets or queries the pattern type for the measurement.
MEASUrement:MEAS<x>:PCOUNT	Sets or returns number of pulses.
MEASUrement:MEAS<x>:PERFREQ:EDGE	This command sets or queries the edge type of a Period/Frequency measurement.
MEASUrement:MEAS<x>:POLarity	This command sets or queries the polarity for the measurement when the measurement type is burst width.
MEASUrement:MEAS<x>:POPulation:GLOBal	This command sets or queries the population settings global flag.
MEASUrement:MEAS<x>:POPulation:LIMIT: STATE	This command sets or queries the population limit state for the measurement.
MEASUrement:MEAS<x>:POPulation:LIMIT: VALue	This command sets or queries the population limit value for the measurement.
MEASUrement:MEAS<x>:POWERFACTOR	Set and queries the power factor value for IEC-Class C type harmonics standard.
MEASUrement:MEAS<x>:PREGion	Sets or returns pulse region for measurement.
MEASUrement:MEAS<x>:PWIDth	Sets or returns pulse width.
MEASUrement:MEAS<x>:REDGe	Turns on or off the Refine edge on qualifier.
MEASUrement:MEAS<x>:REFLevels: ABSolute:FALLHigh	This command sets or queries the value used as the high reference level of the falling edge when the measurement's ref level method is set to absolute.
MEASUrement:MEAS<x>:REFLevels<x>: ABSolute:FALLLow	This command sets or queries the value used as the low reference level of the falling edge when the measurement's ref level method is set to absolute.
MEASUrement:MEAS<x>:REFLevels<x>: ABSolute:FALLMid	This command sets or queries the value used as the mid reference level of the falling edge when the measurement's ref level method is set to absolute.
MEASUrement:MEAS<x>:REFLevels<x>: ABSolute:HYSTeresis	This command sets or queries the value of the hysteresis of the reference level when the measurement's ref level method is set to absolute.
MEASUrement:MEAS<x>:REFLevels<x>: ABSolute:RISEHigh	This command sets or queries the value used as the high reference level of the rising edge when the measurement's ref level method is set to absolute.
MEASUrement:MEAS<x>:REFLevels<x>: ABSolute:RISELow	This command sets or queries the value used as the low reference level of the rising edge when the measurement's ref level method is set to absolute.
MEASUrement:MEAS<x>:REFLevels<x>: ABSolute:RISEMid	This command sets or queries the value used as the mid reference level of the rising edge when the measurement's ref level method is set to absolute.
MEASUrement:MEAS<x>:REFLevels<x>: ABSolute:TYPE	This command sets or queries the reference level type for the measurement.
MEASUrement:MEAS<x>:REFLevels<x>: BASETop	This command sets or queries the method used to calculate the TOP and BASE used to calculate reference levels for the measurement.

Table 2-33: Measurement commands (cont.)

Command	Description
MEASUrement:MEAS<x>:REFLevels<x>:METHod	This command sets or queries the method used to calculate reference levels for the measurement.
MEASUrement:MEAS<x>:REFLevels<x>:PERCent:FALLHigh	This command sets or queries the percentage (where 100% is equal to TOP and 0% is equal to BASE) used to calculate the high reference level of the falling edge when the measurement's ref level method is set to percent.
MEASUrement:MEAS<x>:REFLevels<x>:PERCent:FALLLow	This command sets or queries the percentage (where 100% is equal to TOP and 0% is equal to BASE) used to calculate the low reference level of the falling edge when the measurement's ref level method is set to percent.
MEASUrement:MEAS<x>:REFLevels<x>:PERCent:FALLMid	This command sets or queries the percentage (where 100% is equal to TOP and 0% is equal to BASE) used to calculate the mid reference level of the falling edge when the measurement's ref level method is set to percent.
MEASUrement:MEAS<x>:REFLevels<x>:PERCent:HYSteresis	This command sets or queries the percentage (where 100% is equal to MAX and 0% is equal to MIN) used to calculate the hysteresis of the reference level when the measurement's ref level method is set to percent.
MEASUrement:MEAS<x>:REFLevels<x>:PERCent:RISEHigh	This command sets or queries the percentage (where 100% is equal to TOP and 0% is equal to BASE) used to calculate the high reference level of the rising edge when the measurement's ref level method is set to percent.
MEASUrement:MEAS<x>:REFLevels<x>:PERCent:RISELow	This command sets or queries the percentage (where 100% is equal to TOP and 0% is equal to BASE) used to calculate the low reference level of the rising edge when the measurement's ref level method is set to percent.
MEASUrement:MEAS<x>:REFLevels<x>:PERCent:RISEMid	This command sets or queries the percentage (where 100% is equal to TOP and 0% is equal to BASE) used to calculate the mid reference level of the rising edge when the measurement's ref level method is set to percent.
MEASUrement:MEAS<x>:REFLevels<x>:PERCent:TYPE	This command specifies or queries the reference level percent type for the measurement.
MEASUrement:MEAS<x>:REFMode	This command sets or queries the reference level mode for the measurement.
MEASUrement:MEAS<x>:REFVoltage	This command sets or queries the reference voltage value for the measurement.
MEASUrement:MEAS<x>:RESUlts:ALLAcqs:MAXimum?	This command is identical to that described in the DPOJet programmer manual.
MEASUrement:MEAS<x>:RESUlts:ALLAcqs:MEAN?	This command is identical to that described in the DPOJet programmer manual.
MEASUrement:MEAS<x>:RESUlts:ALLAcqs:MINimum?	This command is identical to that described in the DPOJet programmer manual.
MEASUrement:MEAS<x>:RESUlts:ALLAcqs:PK2PK?	This command is identical to that described in the DPOJet programmer manual.
MEASUrement:MEAS<x>:RESUlts:ALLAcqs:POPulation?	This command is identical to that described in the DPOJet programmer manual.
MEASUrement:MEAS<x>:RESUlts:ALLAcqs:STDDev?	This command is identical to that described in the DPOJet programmer manual.

Table 2-33: Measurement commands (cont.)

Command	Description
MEASUrement:MEAS<x>:RESUlts:CURRentacq:MAXimum?	This query-only command returns the maximum value found for the specified measurement since the last statistical reset.
MEASUrement:MEAS<x>:RESUlts:CURRentacq:MEAN?	This query-only command returns the mean value for the measurement for the current acquisition.
MEASUrement:MEAS<x>:RESUlts:CURRentacq:MINimum?	This query-only command returns the minimum value found for the specified measurement since the last statistical reset.
MEASUrement:MEAS<x>:RESUlts:CURRentacq:PK2PK?	This query-only command returns the peak-to-peak value for the specified measurement for the current acquisition.
MEASUrement:MEAS<x>:RESUlts:CURRentacq:POPulation?	This query-only command returns the population for the specified measurement for the current acquisition.
MEASUrement:MEAS<x>:RESUlts:CURRentacq:STDDev?	This query-only command returns the standard deviation for the specified measurement for all acquisitions accumulated since statistics were last reset.
MEASUrement:MEAS<x>:RESUlts:HISTory:MAXimum?	Returns the maximum value for the specified measurement for each acquisition in the history.
MEASUrement:MEAS<x>:RESUlts:HISTory:MEAN?	Returns the mean value for the specified measurement for each acquisition in the history
MEASUrement:MEAS<x>:RESUlts:HISTory:MINimum?	Returns the minimum value for the specified measurement for each acquisition in the history.
MEASUrement:MEAS<x>:RESUlts:HISTory:PK2PK?	Returns the peak-to-peak value for the specified measurement for each acquisition in the history.
MEASUrement:MEAS<x>:RESUlts:HISTory:POPulation?	Returns the population value for the specified measurement for each acquisition in the history.
MEASUrement:MEAS<x>:RESUlts:HISTory:STDDev?	Returns the standard deviation value for the specified measurement for each acquisition in the history.
MEASUrement:MEAS<x>:SEQUence	Sets or queries the sequence of hall edges
MEASUrement:MEAS<x>:SIGNALFREQUEncy	Sets or queries line frequency for Harmonics and Line Ripple frequency.
MEASUrement:MEAS<x>:SIGNALType	Sets or queries the signal type of source 1 for the measurement.
MEASUrement:MEAS<x>:SLABs	Sets or returns the value for the start level in absolute.
MEASUrement:MEAS<x>:SLPct	Sets or returns the value for the start level in percentage.
MEASUrement:MEAS<x>:SLType	Sets or returns the start level source type.
MEASUrement:MEAS<x>:SMOOTHINGFILTER	Sets and queries the status of smoothing filter.
MEASUrement:MEAS<x>:SOUrce<x>	This command sets or queries the measurement source.
MEASUrement:MEAS<x>:SSC:NOMinalfreq	This command sets or queries the user-defined frequency for the measurement when the measurement type is SSC.
MEASUrement:MEAS<x>:SSC:NOMinalfreq:SELECTIONtype	This command sets or queries the frequency detection type for the measurement when the measurement type is SSC.
MEASUrement:MEAS<x>:STATUS?	Returns the pass fail status, if applicable, for the selected measurement

Table 2-33: Measurement commands (cont.)

Command	Description
MEASUrement:MEAS<x>:STLABs	Sets or returns the value for the stop level in absolute.
MEASUrement:MEAS<x>:STLPct	Sets or returns the value for the stop level in percentage.
MEASUrement:MEAS<x>:STYPe	Sets or returns the stop level source type.
MEASUrement:MEAS<x>:SUNits	Sets or queries the speed units for the specific measurement.
MEASUrement:MEAS<x>:TCKAVG	This command sets or queries the average clock period value used in DDR measurements.
MEASUrement:MEAS<x>:TIMINGMode	This command sets or queries the Timing mode for the specified DDR measurement.
MEASUrement:MEAS<x>:TOEdge	This command sets or queries the 'to edge' type for the measurement.
MEASUrement:MEAS<x>:TOEDGESEARCHDIRect	This command sets or queries the 'to edge' search direction for the measurement.
MEASUrement:MEAS<x>:TOSYmbol:LOGIC2SOUrce	This command sets or queries the DDR digital measurement logic 1 source To Symbol.
MEASUrement:MEAS<x>:TOSYmbol:LOGIC3SOUrce	This command sets or queries the DDR digital measurement logic 2 source To Symbol.
MEASUrement:MEAS<x>:TOSYmbol:LOGIC4SOUrce	This command sets or queries the DDR digital measurement logic 3 source To Symbol.
MEASUrement:MEAS<x>:TOSYmbol:LOGIC5SOUrce	This command sets or queries the DDR digital measurement logic 4 source To Symbol.
MEASUrement:MEAS<x>:TOSYmbol:MEASUREAT	This command sets or queries the DDR digital measurement ToSymbol MeasureAT value.
MEASUrement:MEAS<x>:TRANSition	This command sets or queries the transition edges flag for the measurement.
MEASUrement:MEAS<x>:TYPe	This command sets or queries the measurement type.
MEASUrement:MEAS<x>:WINDOWLENgth	This command sets or queries the window length for the measurement.
MEASUrement:MEAS<x>:XUNIT?	Returns the horizontal scale units of the specified measurement.
MEASUrement:MEAS<x>:YUNIT?	Returns the vertical scale units of the specified measurement.
MEASUrement:MEASRange:MAX	This command sets or queries the global range maximum value.
MEASUrement:MEASRange:MIN	This command sets or queries the global range minimum value.
MEASUrement:MEASRange:STATE	Sets or queries the global range state.
MEASUrement:MECH:GRATio	Sets or queries the measurement gear ratio.
MEASUrement:MECH:PPAirs	Sets or queries the measurement number of pole pairs.
MEASUrement:MECH:SOUrce<x>	Sets or queries the global mechanical source of the specified source number.
MEASUrement:MECH:STYPe	Sets or queries the measurement sensor type.
MEASUrement:MINUI	This command sets or queries the minimum number of unit intervals required for BUJ analysis.
MEASUrement:POPULation:LIMIT:STATE	This command sets or queries the global population limit state.



Table 2-33: Measurement commands (cont.)

Command	Description
MEASUrement:POPULATION:LIMIT:VALue	This command sets or queries the global population limit value.
MEASUrement:REFLevels:ABSolute:FALLHigh	Sets or queries the value used as the high reference level of the falling edge.
MEASUrement:REFLevels:ABSolute:FALLLow	Sets or queries the value used as the low reference level of the falling edge.
MEASUrement:REFLevels:ABSolute:FALLMid	Sets or queries the value used as the mid reference level of the falling edge.
MEASUrement:REFLevels:ABSolute:HYSTeresis	Sets or queries the value of the hysteresis of the reference level.
MEASUrement:REFLevels:ABSolute:RISEHigh	Sets or queries the value used as the high reference level of the rising edge.
MEASUrement:REFLevels:ABSolute:RISELow	Sets or queries the value used as the low reference level of the rising edge.
MEASUrement:REFLevels:ABSolute:RISEMid	Sets or queries the value used as the mid reference level of the rising edge.
MEASUrement:REFLevels:ABSolute:TYPE	Sets or queries the reference level type.
MEASUrement:REFLevels:BASETop	Sets or queries the method used to calculate the TOP and BASE, used to calculate reference levels.
MEASUrement:REFLevels:JITTERMODE	Sets or queries how often reference levels are calculated on Jitter measurements.
MEASUrement:REFLevels:METHod	Sets or queries the method used to calculate reference levels.
MEASUrement:REFLevels:MODE	This command sets or queries how often reference levels are calculated.
MEASUrement:REFLevels:PERCent:FALLHigh	Sets or queries the percentage used to calculate the high reference level of the falling edge.
MEASUrement:REFLevels:PERCent:FALLLow	Sets or queries the percentage used to calculate the mid reference level of the falling edge.
MEASUrement:REFLevels:PERCent:FALLMid	Sets or queries the percentage used to calculate the mid reference level of the falling edge.
MEASUrement:REFLevels:PERCent:HYSTeresis	Sets or queries the percentage used to calculate the hysteresis of the reference level.
MEASUrement:REFLevels:PERCent:RISEHigh	Sets or queries the percentage used to calculate the high reference level of the rising edge.
MEASUrement:REFLevels:PERCent:RISELow	Sets or queries the percentage used to calculate the low reference level of the rising edge.
MEASUrement:REFLevels:PERCent:RISEMid	Sets or queries the percentage used to calculate the mid reference level of the rising edge.
MEASUrement:REFLevels:PERCent:TYPE	Sets or queries the reference level percent type.
MEASUrement:REFLevels:TYPE	This command sets or queries the shared reference level method used for sources of measurement calculations.
MEASUrement:REF<x>:REFLevels:ABSolute:FALLHigh	Sets or queries the value used as the high reference level of the falling edge.
MEASUrement:REF<x>:REFLevels:ABSolute:FALLLow	Sets or queries the value used as the low reference level of the falling edge.

Table 2-33: Measurement commands (cont.)

Command	Description
MEASUrement:REF<x>:REFLevels:ABSolute:FALLMid	Sets or queries the value used as the mid reference level of the falling edge.
MEASUrement:REF<x>:REFLevels:ABSolute:HYSteresis	Sets or queries the value of the hysteresis of the reference level.
MEASUrement:REF<x>:REFLevels:ABSolute:RISEHigh	Sets or queries the value used as the high reference level of the rising edge.
MEASUrement:REF<x>:REFLevels:ABSolute:RISELow	Sets or queries the value used as the low reference level of the rising edge.
MEASUrement:REF<x>:REFLevels:ABSolute:RISEMid	Sets or queries the value used as the mid reference level of the rising edge.
MEASUrement:REF<x>:REFLevels:ABSolute:TYPE	Sets or queries the reference level type.
MEASUrement:REF<x>:REFLevels:BASETop	Sets or queries the method used to calculate the TOP and BASE, used to calculate reference levels.
MEASUrement:REF<x>:REFLevels:METHod	Sets or queries the method used to calculate reference levels.
MEASUrement:REF<x>:REFLevels:PERCent:FALLHigh	Sets or queries the percentage used to calculate the high reference level of the falling edge.
MEASUrement:REF<x>:REFLevels:PERCent:FALLLow	Sets or queries the percentage used to calculate the low reference level of the falling edge.
MEASUrement:REF<x>:REFLevels:PERCent:FALLMid	Sets or queries the percentage used to calculate the mid reference level of the falling edge.
MEASUrement:REF<x>:REFLevels:PERCent:HYSteresis	Sets or queries the percentage used to calculate the hysteresis of the reference level.
MEASUrement:REF<x>:REFLevels:PERCent:RISEHigh	Sets or queries the percentage used to calculate the high reference level of the rising edge.
MEASUrement:REF<x>:REFLevels:PERCent:RISELow	Sets or queries the percentage used to calculate the low reference level of the rising edge.
MEASUrement:REF<x>:REFLevels:PERCent:RISEMid	Sets or queries the percentage used to calculate the mid reference level of the rising edge.
MEASUrement:REF<x>:REFLevels:PERCent:TYPE	Sets or queries the reference level percent type.
MEASUrement:RESUlts:HISTory:START	Sets or queries the starting acquisition number for transferring measurement history results.
MEASUrement:RESUlts:HISTory:STOP	Sets or queries the last acquisition number that will be transferred for measurement history results
MEASUrement:STATIstics:CYCLEMode	This command sets or queries whether cycle-cycle statistics are calculated for all measurements.
MEASUrement:WBG:PDEVice	This command sets or returns the type of the Power device.

## Miscellaneous command group

Miscellaneous commands do not fit into other categories.

Several commands and queries are common to all devices. The 488.2-1987 standard defines these commands. The common commands begin with an asterisk (\*) character.

Table 2-34: Miscellaneous commands

Command	Description
AUTOSAVEPITIMEOUT	Sets or queries the idle time from the programmable interface before auto-save occurs.
AUTOSAVEUITIMEOUT	Sets or queries the idle time from the user interface before auto-save occurs.
DATE?	Queries the date that the instrument displays.
HEADER	Sets or queries the Response Header Enable State.
ID?	Returns identifying information about the instrument and its firmware.
*IDN?	Returns the instrument identification code.
LICense?	Queries all license parameters.
LICense:APPID?	Returns a comma-separated list of the active application IDs.
LICense:COUNt?	Returns a count of the number of active licenses installed.
LICense:ERRor?	This query-only command prompts the instrument to return all events and their messages (delimited by commas), and removes the returned events from the Event Queue (alias for ALLEV?).
LICense:GMT?	Returns the GMT time in ISO 8601 format, the local date, 24 hour time and time-zone offset.
LICense:HID?	Returns the instrument HostID unique identifier.
LICense:INSTall	Accepts a <block data> license and installs it on the instrument.
LICense:ITEM?	Returns the details pertaining to a specific license.
LICense:LIST?	Returns the active license nomenclatures as a comma-separated list of strings.
LICense:VALidate?	Accepts a license nomenclature as an argument and returns the status of the license.
LICense:UNINSTALL?	Returns the exit license information for the user to return to their TekAMS account.
*LRN?	Returns a listing of instrument settings.
MAINWindow:BADGe:BRINGtovieW	Makes a specified badge visible.
MAINWindow:FONTSize	Sets the font size for UI text elements.
MAINWindow:RRBDisplaystate	Sets the display state of the Results readout bar to ON (displayed) or OFF (not displayed).
PAUSe	Causes the interface to pause the specified number of seconds before processing any other commands.
REM	Specifies a comment which is ignored by the instrument.
SCOPEApp REBOOT	Reboots the scope.
SET?	Returns a listing of instrument settings.

**Table 2-34: Miscellaneous commands (cont.)**

<b>Command</b>	<b>Description</b>
<a href="#">SOCKETServer:ENable</a>	Enables or disables the socket server which supports a telnet or other TCPIP socket connection to send commands and queries to the instrument.
<a href="#">SOCKETServer:PORT</a>	Sets the TCPIP port for the socket server connection.
<a href="#">SOCKETServer:PROTOCOL</a>	Sets or queries the protocol for the socket server.
<a href="#">TIME</a>	Queries the time displayed by the instrument.
<a href="#">TIME:ZONE</a>	Sets the time zone to the one specified.
<a href="#">TIME:ZONE:UTCDELTA</a>	Sets or queries the time zone using the difference between the desired time zone and UTC.
<a href="#">TOTALuptime?</a>	Returns the total number of hours the instrument has been turned on since the NV memory was last programmed.
<a href="#">*TST?</a>	Tests the interface and returns status.
<a href="#">UNDO</a>	Reverts the scope settings to a state before the previous command or user interface action.
<a href="#">VERBose</a>	Sets or queries the verbose state.

## Plot command group

Plot commands let you select the type and control the appearance of your plots.

Table 2-35: Plot commands

Command	Description
PLOT:ADDNew	Adds the specified plot.
PLOT:DELeTe	Deletes the specified plot.
PLOT:LIST?	Lists all currently defined plots.
PLOT:PLOT<x>:BAThtub:BER	Sets or queries the bathtub BER value.
PLOT:PLOT<x>:BAThtub:XAXISUnits	Sets or queries the X-Axis unit, either unit intervals or seconds.
PLOT:PLOT<x>:BITType	Sets or queries the bit type to display for the specified eye diagram plot.
PLOT:PLOT<x>:EXPORTRaw?	Returns a binary stream of double values containing the x,y and hits value.
PLOT:PLOT<x>:EXTENDuis	Sets or queries number of UIs surrounding the eye boundary UIs that are used for fast eye rendering.
PLOT:PLOT<x>:EYERender	Sets or queries the eye rendering method for the specified plot.
PLOT:PLOT<x>:IMDA:MEAS	Sets or returns the measurement selection of trend plot and acq trend plot.
PLOT:PLOT<x>:IMDAPLOTDisplay	Sets or returns the IMDA time trend and acq trend plot display configuration.
PLOT:PLOT<x>:LABel:COLor	Sets or queries the color of the specified trend label.
PLOT:PLOT<x>:LABel:FONT:BOLD	Sets or queries the bold state of the specified trend label.
PLOT:PLOT<x>:LABel:FONT:ITALic	Sets or queries the italic state of the specified trend label.
PLOT:PLOT<x>:LABel:FONT:SIZE	Sets or queries the font size of the specified trend label.
PLOT:PLOT<x>:LABel:FONT:TYPE	Sets or queries the font type of the specified trend label.
PLOT:PLOT<x>:LABel:FONT:UNDERline	Sets or queries the underline state of the specified trend label.
PLOT:PLOT<x>:LABel:NAME	Sets or queries the specified trend's label.
PLOT:PLOT<x>:LABel:XPOS	Sets or queries the x-position of the specified trend label.
PLOT:PLOT<x>:LABel:YPOS	Sets or queries the y-position of the specified trend label.
PLOT:PLOT<x>:MASK?	Returns the name of the mask test associated with the specified eye diagram plot.
PLOT:PLOT<x>:MASKOffset:HORizontal: AUTOfit	Enables or disables eye mask autofit in the specified plot.
PLOT:PLOT<x>:NUMBins	Sets or queries the current histogram resolution.
	Sets or queries the allowed range for the mask to move in the left direction.
	Sets or queries the allowed range for the mask to move in the right direction.
PLOT:PLOT<x>:PTYPe	Sets or returns the phasor type of the phasor diagram plot.
PLOT:PLOT<x>:SOURce<x>	Sets or queries the measurement source.
PLOT:PLOT<x>:SPECTrum:BASE	Sets or queries the spectrum base. Undefined for non-spectrum plots.
PLOT:PLOT<x>:SPECTrum:DYNRange	Sets or queries the dynamic range value.
PLOT:PLOT<x>:TYPe	Sets or queries the current plot type for the selected plot.

## Power command group

Table 2-36: Power commands

Command	Description
POWER:ADDNew	Adds the specified power measurement badge.
POWER:DELEte	Deletes the specified power measurement badge.
POWER:POWER<x>:AUTOSet	Executes power autosest for the specified power measurement badge.
POWER:POWER<x>:CLRESPONSE:AMP[1-10]Val	Sets or queries the generator amplitude value of the specified configuration step for the Control Loop Response power measurement.
POWER:POWER<x>:CLRESPONSE:AMPMode	Sets or queries the amplitude mode for the Control Loop Response power measurement.
POWER:POWER<x>:CLRESPONSE:ANALYSISMethod	Sets or queries the Analysis Method for Control Loop Response measurement.
POWER:POWER<x>:CLRESPONSE:AUTORbw	Enables Auto RBW computation.
POWER:POWER<x>:CLRESPONSE:CONNECTSTATus?	Queries connection status to the external generator used with the specified Control Loop Response power measurement.
POWER:POWER<x>:CLRESPONSE:CONSTAMPLitude	Sets or queries the constant amplitude voltage for the Control Loop Response power measurement.
POWER:POWER<x>:CLRESPONSE:FREQ[1-11]Val	Sets or queries the generator frequency value of the specified configuration step for the Control Loop Response power measurement.
POWER:POWER<x>:CLRESPONSE:GENerator	Sets or queries the generator source used to send stimulus signals to the DUT, for the Control Loop Response power measurement.
POWER:POWER<x>:CLRESPONSE:GENerator	Sets or queries the generator source for the specified Control Loop Response power measurement.
POWER:POWER<x>:CLRESPONSE:GENIPADDRESS	Sets or queries the IP address of the external generator to be used with the specified Control Loop Response measurement.
POWER:POWER<x>:CLRESPONSE:IMPEDance	Sets or queries the vertical termination impedance for the Control Loop Response power measurement.
POWER:POWER<x>:CLRESPONSE:INPUTSOurce	Sets or queries the input source for the Control Loop Response power measurement.
POWER:POWER<x>:CLRESPONSE:MON	Sets or returns the measure on for the control loop response, PSRR or impedance measurement.
POWER:POWER<x>:CLRESPONSE:OUTPUTSOurce	Sets or queries the output source for the Control Loop Response power measurement.
POWER:POWER<x>:CLRESPONSE:PPD	Sets or queries the points per decade (PPD) value for the Control Loop Response power measurement.
POWER:POWER<x>:CLRESPONSE:STARTFREQuency	Sets or queries the start frequency value for the Control Loop Response power measurement.
POWER:POWER<x>:CLRESPONSE:STOPFREQuency	Sets or queries the stop frequency value for the Control Loop Response power measurement.

Table 2-36: Power commands (cont.)

Command	Description
POWer:POWer<x>:CLRESPONSE:TESTCONNecion	Tests the connection to the external generator used with the specified Control Loop Response power measurement.
POWer:POWer<x>:CYCLEAmp:INPUTSOurce	Sets or queries the input source for cycle amplitude measurement of the specified power measurement number.
POWer:POWer<x>:CYCLEBase:INPUTSOurce	Sets or queries the input source for cycle base measurement of the specified power measurement number.
POWer:POWer<x>:CYCLEMAX:INPUTSOurce	Sets or queries the input source for cycle maximum measurement of the specified power measurement number.
POWer:POWer<x>:CYCLEMin:INPUTSOurce	Sets or queries the input source for cycle minimum measurement of the specified power measurement number.
POWer:POWer<x>:CYCLEPKPK:INPUTSOurce	Sets or queries the input source for cycle peak-to-peak measurement of the specified power measurement number.
POWer:POWer<x>:CYCLETop:INPUTSOurce	Sets or queries the input source for cycle top measurement of the specified power measurement number.
POWer:POWer<x>:DIDT:INPUTSOurce	Sets or queries the input source for di/dt measurement of the specified power measurement number.
POWer:POWer<x>:DIDT:SOURCEEDGEType	Sets or queries the edge type for di/dt measurement of the specified power measurement number.
POWer:POWer<x>:DVDT:INPUTSOurce	Sets or queries the input source for dv/dt measurement of the specified power measurement number.
POWer:POWer<x>:DVDT:SOURCEEDGEType	Sets or queries the edge type for dv/dt measurement of the specified power measurement number.
POWer:POWer<x>:EFFICIENCY:INPUTType	Sets or queries the input type (AC or DC) for efficiency measurement of the specified power measurement number.
POWer:POWer<x>:EFFICIENCY:IOUT1SOurce	Sets or queries the output 1 current source for efficiency measurement of the specified power measurement number.
POWer:POWer<x>:EFFICIENCY:IOUT2SOurce	Sets or queries the output 2 current source for efficiency measurement of the specified power measurement number.
POWer:POWer<x>:EFFICIENCY:IOUT3SOurce	Sets or queries the output 3 current source for efficiency measurement of the specified power measurement number.
POWer:POWer<x>:EFFICIENCY:ISOurce	Sets or queries the current source for efficiency measurement of the specified power measurement number.
POWer:POWer<x>:EFFICIENCY:NUMOFOutputs	Sets or queries the number of outputs for efficiency measurement of the specified power measurement number.
POWer:POWer<x>:EFFICIENCY:OUTPUT1Type	Sets or queries the Output1 type for efficiency measurement of the specified power measurement number.
POWer:POWer<x>:EFFICIENCY:OUTPUT2Type	Sets or queries the Output2 type for efficiency measurement of the specified power measurement number.

Table 2-36: Power commands (cont.)

Command	Description
POWER:POWer<x>:EFFICIENCY:OUTPUT3Type	Sets or queries the Output3 type for efficiency measurement of the specified power measurement number.
POWER:POWer<x>:EFFICIENCY:OUTPUTType	Sets or queries the Output type for efficiency measurement of the specified power measurement number.
POWER:POWer<x>:EFFICIENCY:VOUT1SOUrce	Sets or queries the output 1 voltage source for efficiency measurement of the specified power measurement number.
POWER:POWer<x>:EFFICIENCY:VOUT2SOUrce	Sets or queries the output 2 voltage source for efficiency measurement of the specified power measurement number.
POWER:POWer<x>:EFFICIENCY:VOUT3SOUrce	Sets or queries the output 3 voltage source for efficiency measurement of the specified power measurement number.
POWER:POWer<x>:EFFICIENCY:VSOUrce	Sets or queries the voltage source for efficiency measurement of the specified power measurement number.
POWER:POWer<x>:FREQUENCY:EDGE	Sets or queries the edge type for frequency measurement of the specified power measurement number.
POWER:POWer<x>:FREQUENCY:INPUTSOUrce	Sets or queries the input source for frequency measurement of the specified power measurement number.
POWER:POWer<x>:GATing	Sets or queries the gating type for the specified power measurement badge.
POWER:POWer<x>:GATing:GLOBal	Sets or queries the gating settings for the specified power measurement badge.
POWER:POWer<x>:HARMONICS:CLASs	Sets or queries the class type for the harmonics measurement of the specified power measurement number.
POWER:POWer<x>:HARMONICS:CLFile	Sets or queries the custom limits file path for the harmonics measurement.
POWER:POWer<x>:HARMONICS:CMETHod	Sets or queries the fundamental current method for the harmonics measurement of the specified power measurement number.
POWER:POWer<x>:HARMONICS:FUNDCURRent	Sets or queries the fundamental current value for the harmonics measurement of the specified power measurement number.
POWER:POWer<x>:HARMONICS:HORDER	Sets or queries the order value for the harmonics measurement of the specified power measurement number.
POWER:POWer<x>:HARMONICS:HSOUrce	Sets or queries the source type for the harmonics measurement of the specified power measurement number.
POWER:POWer<x>:HARMONICS:IPOWer	Sets or queries the input power value for the harmonics measurement of the specified power measurement number.
POWER:POWer<x>:HARMONICS:ISOUrce	Sets or queries the current source for SOA measurement of the specified power measurement number.
POWER:POWer<x>:HARMONICS:LINEFREQUency	Sets or queries the value for the line frequency for the power Harmonics measurement.
POWER:POWer<x>:HARMONICS:ODDEVen	Sets or queries the harmonics value analysis format of the specified power measurement number.



Table 2-36: Power commands (cont.)

Command	Description
POWER:POWER<x>:HARMONICS:PFACtor	Sets or queries the value of power factor for the harmonics measurement of the specified power measurement number.
POWER:POWER<x>:HARMONICS:POWERRating	Sets or queries the power level for the harmonics measurement of the specified power measurement number.
POWER:POWER<x>:HARMONICS:RCURRent	Sets or queries the rated current for the harmonics measurement of the specified power measurement number.
POWER:POWER<x>:HARMONICS:STANDard	Sets or queries the test mode for harmonics measurement of the specified power measurement number.
POWER:POWER<x>:HARMONICS:STARTFREQUency	Sets or queries the value for the start frequency for the power Harmonics measurement. in the range of 1 Hz to 1 GHz.
POWER:POWER<x>:HARMONICS:UNITs	Sets or queries the harmonics results units of the specified power measurement number.
POWER:POWER<x>:HARMONICS:VSOURce	Sets or queries the voltage source for SOA measurement of the specified power measurement number.
POWER:POWER<x>:IMPEDANCE:AMP[1-10]Val	Sets or queries the signal generator amplitude setting of the specified profile step, for the specified Impedance measurement.
POWER:POWER<x>:IMPEDANCE:AMPMode	Sets or queries the power amplitude mode for the Impedance measurement.
POWER:POWER<x>:IMPEDANCE:ANALYSISMethod	Sets or queries the Analysis Method for Impedance measurements.
POWER:POWER<x>:IMPEDANCE:AUTORbw	Enables Auto RBW computation
POWER:POWER<x>:IMPEDANCE:CONNECTSTATus?	Queries the instrument's connection status to the external generator, for the specified Impedance measurement.
POWER:POWER<x>:IMPEDANCE:CONSTAMPLitude	Sets or queries the constant amplitude value for the specified Impedance measurement.
POWER:POWER<x>:IMPEDANCE:FREQ[1-10]Val	Sets or queries the signal generator start frequency of the specified profile step, for the specified Impedance measurement.
POWER:POWER<x>:IMPEDANCE:GENERator	Sets or queries the generator source for the Impedance power measurement.
POWER:POWER<x>:IMPEDANCE:GENIPADdress	Sets or queries the external generator IP Address associated with the specified Impedance measurement.
POWER:POWER<x>:IMPEDANCE:IMPEDANCE	Sets or queries the output impedance of the generator for the specified Impedance power measurement.
POWER:POWER<x>:IMPEDANCE:INPUTSOurce	Sets or queries the source for the Impedance input measurement.
POWER:POWER<x>:IMPEDANCE:OUTPUTSOurce	Sets or queries the source for the Impedance output measurement.

Table 2-36: Power commands (cont.)

Command	Description
POWER:POWER<x>:IMPEDANCE:PPD	Sets or queries the value for points per decade for the specified Impedance measurement.
POWER:POWER<x>:IMPEDANCE:STARTFREQuency	Sets or queries the value for the start frequency of the specified Impedance measurement.
POWER:POWER<x>:IMPEDANCE:STOPFREQuency	Sets or queries the value of the specified Impedance measurement.
POWER:POWER<x>:IMPEDANCE:TESTCONNection	This command tests the connection with the external instrument for the specified Impedance measurement.
POWER:POWER<x>:INDUCTANCE:EDGESource	Sets or queries the edge source for inductance measurement of the specified power measurement number.
POWER:POWER<x>:INDUCTANCE:ISOURce	Sets or queries the current source for inductance measurement of the specified power measurement number.
POWER:POWER<x>:INDUCTANCE:VSOURce	Sets or queries the voltage source for inductance measurement of the specified power measurement number.
POWER:POWER<x>:INPUTCAP:ISOURce	Sets or queries the inrush current input source of the specified Input Capacitance measurement.
POWER:POWER<x>:INPUTCAP:PEAKCURRent	Sets or queries the peak current value of the specified Input Capacitance measurement.
POWER:POWER<x>:INPUTCAP:PEAKVOLTag	Sets or queries the peak voltage value of the specified Input Capacitance measurement.
POWER:POWER<x>:INPUTCAP:VSOURce	Sets or queries the input voltage source of the specified Input Capacitance measurement.
POWER:POWER<x>:INRUSHcurrent:INPUTSOurce	Sets or queries the input source of the specified Inrush Current measurement.
POWER:POWER<x>:INRUSHcurrent:PEAKCURRent	Sets or queries the peak current value of the specified Inrush Current measurement.
POWER:POWER<x>:IVSINTEGRALV:ISOURce	Sets or queries the current source for I vs Integral V measurement of the specified power measurement number.
POWER:POWER<x>:IVSINTEGRALV:VSOURce	Sets or queries the voltage source for I vs Integral V measurement of the specified power measurement number.
POWER:POWER<x>:LABel	Sets or queries the custom name for the specified power measurement badge.
POWER:POWER<x>:LINERIPPLE:INPUTSOurce	Sets or queries the input source for line ripple measurement of the specified power measurement number.
POWER:POWER<x>:LINERIPPLE:LFREQuency	Sets or queries the frequency present for line ripple measurement of the specified power measurement number.
POWER:POWER<x>:MAGNETICLOSS:ISOURce	Sets or queries the current source for magnetic measurement of the specified power measurement number.
POWER:POWER<x>:MAGNETICLOSS:VSOURce	Sets or queries the voltage source for magnetic measurement of the specified power measurement number.

Table 2-36: Power commands (cont.)

Command	Description
<code>POWer:POWer&lt;x&gt;</code> : <code>MAGPROPERTY:</code> <code>AREAOfcrosssection</code>	Sets or queries the coil cross section area for magnetic measurement of the specified power measurement number.
<code>POWer:POWer&lt;x&gt;</code> : <code>MAGPROPERTY:</code> <code>EDGESOURce</code>	Sets or queries the edge signal source for magnetic measurement of the specified power measurement number.
<code>POWer:POWer&lt;x&gt;</code> : <code>MAGPROPERTY:</code> <code>ISOURce</code>	Sets or queries the current source for magnetic measurement of the specified power measurement number.
<code>POWer:POWer&lt;x&gt;</code> : <code>MAGPROPERTY:</code> <code>LENgth</code>	Sets or queries the conductor length for magnetic measurement of the specified power measurement number.
<code>POWer:POWer&lt;x&gt;</code> : <code>MAGPROPERTY:</code> <code>PRIMARYTURNs</code>	Sets or queries the number of primary turns for magnetic measurement of the specified power measurement number.
<code>POWer:POWer&lt;x&gt;</code> : <code>MAGPROPERTY:</code> <code>SEC1SOURce</code>	Sets or queries the current source for secondary winding 1 for magnetic measurement of the specified power measurement number.
<code>POWer:POWer&lt;x&gt;</code> : <code>MAGPROPERTY:</code> <code>SEC1TURNs</code>	Sets or queries the number of turns of secondary winding 1 for magnetic measurement in the specified power measurement badge
<code>POWer:POWer&lt;x&gt;</code> : <code>MAGPROPERTY:</code> <code>SEC2SOURce</code>	Sets or queries the current source for secondary winding 2 for magnetic measurement of the specified power measurement number.
<code>POWer:POWer&lt;x&gt;</code> : <code>MAGPROPERTY:</code> <code>SEC2TURNs</code>	Sets or queries the number of turns of secondary winding 2 for magnetic measurement of the specified power measurement number.
<code>POWer:POWer&lt;x&gt;</code> : <code>MAGPROPERTY:</code> <code>SEC3SOURce</code>	Sets or queries the current source for secondary winding 3 for magnetic measurement of the specified power measurement number.
<code>POWer:POWer&lt;x&gt;</code> : <code>MAGPROPERTY:</code> <code>SEC3TURNs</code>	Sets or queries the number of turns of secondary winding 3 for magnetic measurement of the specified power measurement number.
<code>POWer:POWer&lt;x&gt;</code> : <code>MAGPROPERTY:</code> <code>SEC4SOURce</code>	Sets or queries the current source for secondary winding 4 for magnetic measurement of the specified power measurement number.
<code>POWer:POWer&lt;x&gt;</code> : <code>MAGPROPERTY:</code> <code>SEC4TURNs</code>	Sets or queries the number of turns of secondary winding 4 for magnetic measurement of the specified power measurement number.
<code>POWer:POWer&lt;x&gt;</code> : <code>MAGPROPERTY:</code> <code>SEC5SOURce</code>	Sets or queries the current source for secondary winding 5 for magnetic measurement of the specified power measurement number.
<code>POWer:POWer&lt;x&gt;</code> : <code>MAGPROPERTY:</code> <code>SEC5TURNs</code>	Sets or queries the number of turns of secondary winding 5 for magnetic measurement of the specified power measurement number.
<code>POWer:POWer&lt;x&gt;</code> : <code>MAGPROPERTY:</code> <code>SEC6SOURce</code>	Sets or queries the current source for secondary winding 6 for magnetic measurement of the specified power measurement number.
<code>POWer:POWer&lt;x&gt;</code> : <code>MAGPROPERTY:</code> <code>SEC6TURNs</code>	Sets or queries the number of turns of secondary winding 6 for magnetic measurement of the specified power measurement number.
<code>POWer:POWer&lt;x&gt;</code> : <code>MAGPROPERTY:</code> <code>SECPhase</code>	Sets or returns the value for the phase difference between secondary and primary voltage.
<code>POWer:POWer&lt;x&gt;</code> : <code>MAGPROPERTY:</code> <code>SECVolt</code>	Enables or disables secondary voltage input for measurement.

Table 2-36: Power commands (cont.)

Command	Description
POWER:POWER<x>: MAGPROPERTY:SECWINDings	Sets or queries the number of secondary windings for magnetic measurement of the specified power measurement number.
POWER:POWER<x>: MAGPROPERTY:UNITS	Sets or queries the units for magnetic measurement of the specified power measurement number.
POWER:POWER<x>: MAGPROPERTY:VSOURce	Sets or queries the voltage source for magnetic measurement of the specified power measurement number.
POWER:POWER<x>:NDUTYCYCLE: EDGEType	Sets or queries the clock edge type for negative duty cycle measurement of the specified power measurement number.
POWER:POWER<x>:NDUTYCYCLE: INPUTSOurce	Sets or queries the input source for negative duty cycle measurement of the specified power measurement number.
POWER:POWER<x>:NPULSEWIDTH: INPUTSOurce	Sets or queries the input source for negative pulse width measurement of the specified power measurement number.
POWER:POWER<x>:PDUTYCYCLE: EDGEType	Sets or queries the clock edge type for positive duty cycle measurement of the specified power measurement number.
POWER:POWER<x>:PDUTYCYCLE: INPUTSOurce	Sets or queries the input source for positive duty cycle measurement of the specified power measurement number.
POWER:POWER<x>:PERIOD:EDGE	Sets or queries the edge type for period measurement of the specified power measurement number.
POWER:POWER<x>:PERIOD: INPUTSOurce	Sets or queries the input source for period measurement of the specified power measurement number.
POWER:POWER<x>: POWERQUALITY:CCYCles	Sets or queries the calculate cycles over full cycles settings for the specified power quality measurement badge.
POWER:POWER<x>: POWERQUALITY:FREFerence	Sets or queries the frequency reference type for power quality measurement of the specified power measurement number.
POWER:POWER<x>: POWERQUALITY:ISOURce	Sets or queries the current source for power quality measurement of the specified power measurement number.
POWER:POWER<x>: POWERQUALITY:STYPe	Sets or queries the source type.
POWER:POWER<x>: POWERQUALITY:VSOURce	Sets or queries the voltage source for power quality measurement of the specified power measurement number.
POWER:POWER<x>:PPULSEWIDTH: INPUTSOurce	Sets or queries the input source for positive pulse width measurement in the specified power measurement number.
POWER:POWER<x>:PRESET	Sets or queries the input source for positive pulse width measurement of the specified power measurement number.
POWER:POWER<x>:PSRR: AMP[1-10]Val	Sets or queries the generator amplitude value of the specified configuration step for the Power Supply Rejection Ratio (PSRR) power measurement.
POWER:POWER<x>:PSRR: AMPMode	Sets or queries the amplitude mode for the Power Supply Rejection Ratio (PSRR) power measurement.

Table 2-36: Power commands (cont.)

Command	Description
POWer:POWer<x>:PSRR:ANALYSISMethod	Sets or queries the Analysis Method for PSRR measurements.
POWer:POWer<x>:PSRR:AUTORbw	Enables Auto RBW computation.
POWer:POWer<x>:PSRR:CONNECTSTATus?	Queries the external instrument's connection status for the specified Power Supply Rejection Ratio (PSRR) measurement.
POWer:POWer<x>:PSRR:CONSTAMplitude	Sets or queries the constant amplitude voltage for the Power Supply Rejection Ratio (PSRR) power measurement.
POWer:POWer<x>:PSRR:FREQ[1-11]Val	Sets or queries the generator frequency value of the specified configuration step for the Power Supply Rejection Ratio (PSRR) power measurement.
POWer:POWer<x>:PSRR:GENERator	Sets or queries the generator source used to send stimulus signals to the DUT for the Power Supply Rejection Ratio (PSRR) power measurement.
POWer:POWer<x>:PSRR:GENERator	Sets or queries the generator source for the Power Supply Rejection Ratio (PSRR) power measurement.
POWer:POWer<x>:PSRR:GENIPADdress	Sets or queries the instrument's IP Address associated with the specified Power Supply Rejection Ratio (PSRR) measurement.
POWer:POWer<x>:PSRR:IMPEDance	Sets or queries the vertical termination impedance for the Power Supply Rejection Ratio (PSRR) power measurement.
POWer:POWer<x>:PSRR:INPUTSource	Sets or queries the input source for the Power Supply Rejection Ratio (PSRR) power measurement.
POWer:POWer<x>:PSRR:OUTPUTSource	Sets or queries the output source for the Power Supply Rejection Ratio (PSRR) power measurement.
POWer:POWer<x>:PSRR:PPD	Sets or queries the points per decade (PPD) value for the Power Supply Rejection Ratio (PSRR) power measurement.
POWer:POWer<x>:PSRR:STARTFREquency	Sets or queries the start frequency value for the Power Supply Rejection Ratio (PSRR) power measurement.
POWer:POWer<x>:PSRR:STOPFREquency	Sets or queries the stop frequency value for the Power Supply Rejection Ratio (PSRR) power measurement.
POWer:POWer<x>:PSRR:TESTCONNecion	This command tests the connection with the external instrument for the specified Power Supply Rejection Ratio (PSRR) measurement.
POWer:POWer<x>:RDSON:DEVICEType	Sets or queries the device type for the power drain source on resistance measurement for RDSON measurement of the specified power measurement number.
POWer:POWer<x>:RDSON:ISOURce	Sets or queries the current source for RDSON measurement of the specified power measurement number.
POWer:POWer<x>:RDSON:VSOURce	Sets or queries the voltage source for RDSON measurement of the specified power measurement number.
POWer:POWer<x>:REFLevels:ABSolute:FALLHigh	Sets or queries the falling edge for high reference level in absolute units for the specified power measurement badge.

Table 2-36: Power commands (cont.)

Command	Description
POWer:POWer<x>:REFLevels:ABSolute:FALLLow	Sets or queries the falling edge for low reference level in absolute units for the specified power measurement badge.
POWer:POWer<x>:REFLevels:ABSolute:FALLMid	Sets or queries the falling edge for mid reference level in absolute units for the specified power measurement badge.
POWer:POWer<x>:REFLevels:ABSolute:HYSteresis	Sets or queries the absolute hysteresis value for the specified power measurement badge.
POWer:POWer<x>:REFLevels:ABSolute:RISEHigh	Sets or queries the rising edge for high reference level in absolute units for the specified power measurement badge.
POWer:POWer<x>:REFLevels:ABSolute:RISELow	Sets or queries the rising edge for low reference level in absolute units for the specified power measurement badge.
POWer:POWer<x>:REFLevels:ABSolute:RISEMid	Sets or queries the rising edge for mid reference level in absolute units for the specified power measurement badge.
POWer:POWer<x>:REFLevels:ABSolute:TYPE	Sets or queries the type of measurement levels when reference level is set to absolute for the specified power measurement badge.
POWer:POWer<x>:REFLevels:BASETop	Sets or queries the reference level base top method for the specified power measurement badge.
POWer:POWer<x>:REFLevels:METHod	Sets or queries the method to configure reference level values for the specified power measurement badge.
POWer:POWer<x>:REFLevels:PERCent:FALLHigh	Sets or queries the falling edge for high reference level in percentage for the specified power measurement badge.
POWer:POWer<x>:REFLevels:PERCent:FALLLow	Sets or queries the falling edge for low reference level in percentage for the specified power measurement badge.
POWer:POWer<x>:REFLevels:PERCent:FALLMid	Sets or queries the falling edge for mid reference level in percentage for the specified power measurement badge.
POWer:POWer<x>:REFLevels:PERCent:HYSteresis	Sets or queries the hysteresis in percentage for the specified power measurement badge.
POWer:POWer<x>:REFLevels:PERCent:RISEHigh	Sets or queries the rising edge for high reference level in percentage for the specified power measurement badge.
POWer:POWer<x>:REFLevels:PERCent:RISELow	Sets or queries the rising edge for low reference level in percentage for the specified power measurement badge.
POWer:POWer<x>:REFLevels:PERCent:RISEMid	Sets or queries the rising edge for mid reference level in percentage for the specified power measurement badge.
POWer:POWer<x>:REFLevels:PERCent:TYPE	Sets or queries the reference levels for the specified power measurement badge.
POWer:POWer<x>:RESUltS:ALLAcqs:MAXimum?	Queries the maximum value of all acquisitions for the measurement parameter of the specified power measurement number.
POWer:POWer<x>:RESUltS:ALLAcqs:MEAN?	Queries the mean value of all acquisitions for the measurement parameter of the specified power measurement number.

Table 2-36: Power commands (cont.)

Command	Description
POWER:POWER<x>:RESULTS:ALLAcqs:MINimum?	Queries the minimum value of all acquisitions for the measurement parameter of the specified power measurement number.
POWER:POWER<x>:RESULTS:ALLAcqs:PK2PK?	Queries the peak-to-peak value of all acquisitions for the measurement parameter of the specified power measurement number.
POWER:POWER<x>:RESULTS:ALLAcqs:POPulation?	Queries the population (number of complete cycles) of all acquisitions for the measurement parameter of the specified power measurement number.
POWER:POWER<x>:RESULTS:ALLAcqs:STDDev?	Queries the standard deviation value of all acquisitions for the measurement parameter of the specified power measurement number.
POWER:POWER<x>:RESULTS:CURRentacq:F1MAG?	Queries the first harmonics magnitude value for the specified power measurement badge.
POWER:POWER<x>:RESULTS:CURRentacq:F3MAG?	Queries the third harmonics magnitude value for the specified power measurement badge.
POWER:POWER<x>:RESULTS:CURRentacq:FREQUENCY?	Queries the fundamental frequency for the specified power measurement badge.
POWER:POWER<x>:RESULTS:CURRentacq:IRMS?	Queries the RMS current value for the specified power measurement badge.
POWER:POWER<x>:RESULTS:CURRentacq:MAXimum?	Queries the maximum value of the current acquisition for the measurement parameter of the specified power measurement number.
POWER:POWER<x>:RESULTS:CURRentacq:MEAN?	Queries the mean value of the current acquisition for the measurement parameter of the specified power measurement number.
POWER:POWER<x>:RESULTS:CURRentacq:MINimum?	Queries the minimum value of the current acquisition for the measurement parameter of the specified power measurement number.
POWER:POWER<x>:RESULTS:CURRentacq:PK2PK?	Queries the peak-to-peak value of the current acquisition for the measurement parameter of the specified power measurement number.
POWER:POWER<x>:RESULTS:CURRentacq:POHCL?	Queries the limit of partial odd harmonic current for the specified power measurement badge.
POWER:POWER<x>:RESULTS:CURRentacq:POHCM?	Queries the measured value of partial odd harmonic current for the specified power measurement badge.
POWER:POWER<x>:RESULTS:CURRentacq:POHCS?	Queries the status of partial odd harmonic current for the specified power measurement badge.
POWER:POWER<x>:RESULTS:CURRentacq:POPulation?	Queries the population (number of complete cycles) of the current acquisition for the measurement parameter of the specified power measurement number.
POWER:POWER<x>:RESULTS:CURRentacq:RMS?	Queries the RMS value of the source selected for the specified power measurement badge.
POWER:POWER<x>:RESULTS:CURRentacq:STATUS?	Queries the status of the measurement for the specified power measurement badge.
POWER:POWER<x>:RESULTS:CURRentacq:STDDev?	Queries the standard deviation value of the current acquisition for the measurement parameter of the specified power measurement number.

Table 2-36: Power commands (cont.)

Command	Description
POWer:POWer<x>:RESUlts:CURRentacq:THDF?	Queries the total harmonic distortion (fundamental) value for the specified power measurement badge.
POWer:POWer<x>:RESUlts:CURRentacq:THDR?	Queries the total harmonic distortion (RMS) value for the specified power measurement badge.
POWer:POWer<x>:RESUlts:CURRentacq:TRPWR?	Queries the true power value for the specified power measurement badge.
POWer:POWer<x>:RESUlts:CURRentacq:VRMS?	Queries the RMS voltage value for the specified power measurement badge.
POWer:POWer<x>:SEQSEtup	Runs the power measurement sequence setup.
POWer:POWer<x>:SEQuence	Sets or queries the run state of a single sequence power measurement.
POWer:POWer<x>:SOA:ISOURce	Sets or queries the current source for SOA measurement of the specified power measurement number.
POWer:POWer<x>:SOA:POINT	Sets or queries the X or Y coordinate value for a specified SOA mask point.
POWer:POWer<x>:SOA:RECALLmask	Recalls or queries the recall mask file name of the specified power measurement number.
POWer:POWer<x>:SOA:RECALLmask:FILENAME	Sets or queries the file name for saving SOA mask file name of the specified power measurement number.
POWer:POWer<x>:SOA:SAVemask	Saves the mask file as per the name configured and at the configured path or queries the mask file name, path, and file type for the SOA measurement of the specified power measurement number.
POWer:POWer<x>:SOA:SAVemask:AUTOINCrement	Sets or queries the state of auto-increment for saved SOA mask file names of the specified power measurement number.
POWer:POWer<x>:SOA:SAVemask:FILENAME	Sets or queries the mask file name for SOA measurement of the specified power measurement number.
POWer:POWer<x>:SOA:SAVemask:FOLDer	Sets or queries the mask file folder path for SOA measurement of the specified power measurement number.
POWer:POWer<x>:SOA:VSOURce	Sets or queries the voltage source for SOA measurement of the specified power measurement number.
POWer:POWer<x>:SWITCHINGLOSS:DEVICEType	Sets or queries the conduction calculation method for switching loss measurement of the specified power measurement number.
POWer:POWer<x>:SWITCHINGLOSS:GATESOURce	Sets or queries the gate voltage ( $V_g$ ) for the switching loss measurement of the specified power measurement number.
POWer:POWer<x>:SWITCHINGLOSS:ILEVELAbs	Sets or queries the current level (Ton-Start & Stop) in absolute units for switching loss measurement of the specified power measurement number.
POWer:POWer<x>:SWITCHINGLOSS:ILEVELPct	Sets or queries the current level (Ton-Start & Stop) in percentage for switching loss measurement of the specified power measurement number.
POWer:POWer<x>:SWITCHINGLOSS:ISOURce	Sets or queries the current source for the switching loss measurement of the specified power measurement number.



Table 2-36: Power commands (cont.)

Command	Description
POWer:POWer<x>: SWITCHINGLOSS:LEVELUNIts	Sets or queries the level units for switching loss measurement of the specified power measurement number.
POWer:POWer<x>: SWITCHINGLOSS:RDSOn	Sets or queries the RDS(on) value for switching loss measurement of the specified power measurement number.
POWer:POWer<x>: SWITCHINGLOSS: SWLCONFIgType	Sets or queries the configuration type for the switching loss measurement of the specified power measurement number.
POWer:POWer<x>: SWITCHINGLOSS:VCEsat	Sets or queries the value for the VCE(sat) value for switching loss measurement of the specified power measurement number.
POWer:POWer<x>: SWITCHINGLOSS:VGLLevel	Sets or queries the gate voltage value ( $V_g$ Level Ton-Start) for the switching loss measurement of the specified power measurement number.
POWer:POWer<x>: SWITCHINGLOSS:VLEVELAbs	Sets or queries the voltage level (Ton-Start & Stop) in absolute units for switching loss measurement of the specified power measurement number.
POWer:POWer<x>: SWITCHINGLOSS:VLEVELPct	Sets or queries the voltage level (Ton-Start & Stop) in percentage for switching loss measurement of the specified power measurement number.
POWer:POWer<x>: SWITCHINGLOSS:VSOURce	Sets or queries the voltage source for the switching loss measurement of the specified power measurement number.
POWer:POWer<x>: SWITCHINGRIPPLE:INPUTSOurce	Sets or queries the input source for switching ripple measurement of the specified power measurement number.
POWer:POWer<x>: SWITCHINGRIPPLE:LFREQuency	Sets or queries the switching frequency for switching ripple measurement of the specified power measurement number.
POWer:POWer<x>:TURNOFFtime: FREQuency	Sets or queries the input frequency used by the AC or DC converter of the specified Turn Off Time measurement.
POWer:POWer<x>:TURNOFFtime: INPUTLEVel	Sets or returns the input frequency used by the AC or DC converter of the specified Turn Off Time measurement.
POWer:POWer<x>:TURNOFFtime: INPUTSOurce	Sets or queries the input source of the specified Turn Off Time measurement.
POWer:POWer<x>:TURNOFFtime: MAXTime	Sets or queries the maximum turn off time of the specified Turn Off Time measurement.
POWer:POWer<x>:TURNOFFtime: MAXVoltage	Sets or queries the maximum voltage of the specified Turn OffTime measurement.
POWer:POWer<x>:TURNOFFtime: NUMOUTputs	Sets or queries the number of outputs of the specified Turn Off Time power measurement.
POWer:POWer<x>:TURNOFFtime: OUTPUT1SOURce	Sets or queries the output 1 source of the specified Turn Off Time measurement.
POWer:POWer<x>:TURNOFFtime: OUTPUT1VOLTage	Sets or queries the output 1 voltage level of the of the specified Turn Off Time power measurement.
POWer:POWer<x>:TURNOFFtime: OUTPUT2SOURce	Sets or queries the output 2 source of the specified Turn Off Time measurement.

Table 2-36: Power commands (cont.)

Command	Description
POWer:POWer<x>:TURNOFFtime:OUTPUT2VOLTage	Sets or queries the output 2 voltage level of the specified Turn Off Time power measurement.
POWer:POWer<x>:TURNOFFtime:OUTPUT3SOURce	Sets or queries the output 3 source of the specified Turn Off Time measurement.
POWer:POWer<x>:TURNOFFtime:OUTPUT3VOLTage	Sets or queries the output 3 voltage level of the specified Turn Off Time power measurement.
POWer:POWer<x>:TURNOFFtime:OUTPUT4SOURce	Sets or queries the output 4 source of the specified Turn Off Time measurement.
POWer:POWer<x>:TURNOFFtime:OUTPUT4VOLTage	Sets or queries the output 4 voltage level of the specified Turn Off Time power measurement.
POWer:POWer<x>:TURNOFFtime:OUTPUT5SOURce	Sets or queries the output 5 source of the specified Turn Off Time measurement.
POWer:POWer<x>:TURNOFFtime:OUTPUT5VOLTage	Sets or queries the output 5 voltage level of the specified Turn Off Time power measurement.
POWer:POWer<x>:TURNOFFtime:OUTPUT6SOURce	Sets or queries the output 6 source of the specified Turn Off Time measurement.
POWer:POWer<x>:TURNOFFtime:OUTPUT6VOLTage	Sets or queries the output 6 voltage level of the specified Turn Off Time power measurement.
POWer:POWer<x>:TURNOFFtime:OUTPUT7SOURce	Sets or queries the output 7 source of the specified Turn Off Time measurement.
POWer:POWer<x>:TURNOFFtime:OUTPUT7VOLTage	Sets or queries the output 7 voltage level of the specified Turn Off Time power measurement.
POWer:POWer<x>:TURNOFFtime:TYPE	Sets or queries the type of AC/DC converter used in the specified Turn Off Time power measurement.
POWer:POWer<x>:TURNONtime:FREQuency	Sets or queries the input frequency used by the AC or DC converter of the specified Turn On Time measurement.
POWer:POWer<x>:TURNONtime:INPUTLEVel	Sets or queries the input voltage level of the specified Turn On Time measurement.
POWer:POWer<x>:TURNONtime:INPUTSOurce	Sets or queries the input source of the specified Turn On Time measurement.
POWer:POWer<x>:TURNONtime:MAXTIME	Sets or queries the maximum turn on time of the specified Turn On Time measurement.
POWer:POWer<x>:TURNONtime:MAXVoltage	Sets or queries the maximum voltage setting of the specified Turn On Time measurement.
POWer:POWer<x>:TURNONtime:NUMOUTputs	Sets or queries the number of outputs for the specified Turn On Time power measurement.
POWer:POWer<x>:TURNONtime:OUTPUT1SOURce	Sets or queries the output 1 source of the specified Turn On Time measurement.

Table 2-36: Power commands (cont.)

Command	Description
POWER:POWer<x>:TURNONtime:OUTPUT1VOLTage	Sets or queries the output 1 voltage level of the specified Turn On Time power measurement.
POWER:POWer<x>:TURNONtime:OUTPUT2SOURce	Sets or queries the output 2 source of the specified Turn On Time measurement.
POWER:POWer<x>:TURNONtime:OUTPUT2VOLTage	Sets or queries the output 2 voltage level of the specified Turn On Time power measurement.
POWER:POWer<x>:TURNONtime:OUTPUT3SOURce	Sets or queries the output 3 source of the specified Turn On Time measurement.
POWER:POWer<x>:TURNONtime:OUTPUT3VOLTage	Sets or queries the output 3 voltage level of the specified Turn On Time power measurement.
POWER:POWer<x>:TURNONtime:OUTPUT4SOURce	Sets or queries the output 4 source of the specified Turn On Time measurement.
POWER:POWer<x>:TURNONtime:OUTPUT4VOLTage	Sets or queries the output 4 voltage level of the specified Turn On Time power measurement.
POWER:POWer<x>:TURNONtime:OUTPUT5SOURce	Sets or queries the output 5 source of the specified Turn On Time measurement.
POWER:POWer<x>:TURNONtime:OUTPUT5VOLTage	Sets or queries the output 5 voltage level of the specified Turn On Time power measurement.
POWER:POWer<x>:TURNONtime:OUTPUT6SOURce	Sets or queries the output 6 source of the specified Turn On Time measurement.
POWER:POWer<x>:TURNONtime:OUTPUT6VOLTage	Sets or queries the output 6 voltage level of the specified Turn On Time power measurement.
POWER:POWer<x>:TURNONtime:OUTPUT7SOURce	Sets or queries the output 7 source of the specified Turn On Time measurement.
POWER:POWer<x>:TURNONtime:OUTPUT7VOLTage	Sets or queries the output 7 voltage level of the specified Turn On Time power measurement.
POWER:POWer<x>:TURNONtime:TYPE	Sets or queries the type of AC/DC converter used in the specified Turn On Time power measurement.
POWER:POWer<x>:TYPE	Sets or queries the measurement type for the specified power measurement badge.

## Remote Scope command group

Table 2-37: Remote Scope commands

Command	Description
REMOTE:ACQStatus?	Returns the maximum licensed bandwidth of the specified remote scope.
REMOTE:ACQUIRE	Acquires a single sequence on the specified remote scope.
REMOTE:ADDNew	Adds the specified remote scope.

Table 2-37: Remote Scope commands (cont.)

Command	Description
REMOTE:COMMInter	Sets or queries communication Interface for remote connection.
REMOTE:CONTROL	Sets or queries Control the settings on remote scope.
REMOTE:DELEte	Delete the specified remote scope.
REMOTE:S<x>_CH<x>:State	Sets or queries the state of the specified remote channel in the specified Waveform View.
REMOTE:SCOPE<x>:BANDWidth?	Returns the maximum licensed bandwidth of the specified remote scope
REMOTE:SCOPE<x>:CONNECT	Connects the specified Remote Scope.
REMOTE:SCOPE<x>: CONNECTIONMessage?	Returns the connection status message for the specified remote scope.
REMOTE:SCOPE<x>:CONNECTIONState?	Returns the connected state for the specified remote scope.
REMOTE:SCOPE<x>:DISCONNECT	Disconnects the specified Remote Scope.
REMOTE:SCOPE<x>:HORizontal: FASTframe:COUNT?	Returns the number of frames.
REMOTE:SCOPE<x>:HORizontal: FASTframe:MAXFrames?	Returns the maximum number of frames.
REMOTE:SCOPE<x>:HORizontal: FASTframe:SELECTED?	Returns the selected frame number for acquired frames.
REMOTE:SCOPE<x>:HORizontal: FASTframe:STATE?	Returns the state of FastFrame.
REMOTE:SCOPE<x>:HORizontal: FASTframe:SUMFrame?	Returns the summary frame type.
REMOTE:SCOPE<x>:HORizontal: FASTframe:SUMFrame:STATE?	Returns the state of FastFrame summary frame.
REMOTE:SCOPE<x>:IPADdress	Sets or queries the IP Address or host name for the specified remote scope.
REMOTE:SCOPE<x>:MODELname?	Returns the model name of the specified remote scope.
REMOTE:SCOPE<x>:PORT	Sets or queries the port number for the specified remote scope.
REMOTE:SCOPE<x>:SCREen:CAPTure	Saves a capture of the Remote Scope screen contents to the specified image file.
REMOTE:SCOPE<x>:State?	Returns the connected state for the specified remote scope.
REMOTE:SCOPE<x>:SYNC	Refreshes the channel data from the specified remote Scope.
REMOTE:SCOPE<x>:VISACONNectiotype	Sets or queries VISA connection type for remote scope connection.
REMOTE:USBDEscriptors	Sets or queries the USB descriptors available for remote connection.
SV:S<x>_CH<x>:SELEct:SPECTrogram	Sets or queries whether the spectrogram plot for the specified channel is displayed in the Spectrum View.

## Save and Recall command group

Use the commands in the Save and Recall Command Group to store and retrieve internal waveforms and settings. When you save a setup, you save all the settings of the instrument. When you recall a setup, the instrument restores itself to the state that it was in when you originally saved that setting.

Table 2-38: Save and Recall commands

Command	Description
<a href="#">FACTory</a>	Resets the instrument to factory default settings.
<a href="#">FILESYS:COLLECTLOGFILES</a>	Copies the internal log files to the local, USB or network drive specified by the quoted string argument.
<a href="#">RECALL:SESSion</a>	Restores the state of the instrument from a saved session file.
<a href="#">RECALL:SETUp</a>	Recalls saved instrument settings.
<a href="#">RECALL:WAVEform</a>	Recalls a stored waveform to a reference memory location.
<a href="#">SAVE:EVENTtable:BUS</a>	Saves bus results table to the specified file.
<a href="#">SAVE:EVENTtable:CUSTom</a>	Saves the results table to the specified file path and name.
<a href="#">SAVE:EVENTtable:CUSTom:COMMeNts</a>	Sets or queries comments to be included in saved results table files.
<a href="#">SAVE:EVENTtable:CUSTom:DATAFormat</a>	Sets or queries the data format to use for saving results table data.
<a href="#">SAVE:EVENTtable:CUSTom:INCLUDEREFs</a>	Sets or queries whether to include displayed reference waveforms with saved results table files.
<a href="#">SAVE:EVENTtable:MEASUrement</a>	Saves data (measurement) results to the specified file.
<a href="#">SAVE:EVENTtable:PEAKS</a>	Saves peak markers results table to the specified file.
<a href="#">SAVE:EVENTtable:SEARCHTable</a>	Saves a search results table to the specified file.
<a href="#">SAVE:IMAGe</a>	Saves a capture of the screen contents to the specified image file.
<a href="#">SAVE:IMAGe:COMPosition</a>	Sets or queries the color mode for saved images (normal or inverted).
<a href="#">SAVE:IMAGe:VIEWTYpe</a>	Sets or queries the view type for saved images. Currently only FULLScreen is supported.
<a href="#">SAVE:PLOTData</a>	Saves the plot data of the currently selected plot in a specified file. Supported file format is CSV.
<a href="#">SAVE:REPOrt</a>	Saves a report to the specified file or, if no argument is specified, uses the folder and file name specified by the related commands.
<a href="#">SAVE:REPOrt:COMMeNts</a>	Sets or queries the comments to be included in saved report files.
<a href="#">SAVE:SESSion</a>	Saves the state of the instrument, including reference waveforms, to a saved session file.
<a href="#">SAVE:SETUp</a>	Saves the current instrument state to the specified file.
<a href="#">SAVE:SETUp:INCLUDEREFs</a>	Sets or queries whether displayed reference waveforms are to be included in saved setups.
<a href="#">SAVE:WAVEform</a>	Saves the specified waveform(s) to the specified destination file(s).
<a href="#">SAVE:WAVEform:GATing</a>	Sets the method to save a specified part of the waveform data.

Table 2-38: Save and Recall commands (cont.)

Command	Description
<a href="#">SAVe:WAVEform:GATing:RESAMPLERate</a>	Saves the waveform data at a sample interval.
<a href="#">SAVe:WAVEform:SOURCEList?</a>	Returns a list of the available waveforms that can be specified as the source for the SAvE:WAVEform command.

## Search and Mark command group

Use search and mark commands to seek out and identify information in waveform records that warrant further investigation.

Table 2-39: Search and Mark commands

Command	Description
SEARCH:ADDNew	Adds the specified search.
SEARCH:DELeTe	Deletes the specified search.
SEARCH:DELETEALL	Deletes all the active instances of measurements defined in the scope application.
SEARCH:LIST?	Lists all currently defined searches.
SEARCH:SEARCH<x>:COpy	Copies the search criteria to or from the trigger.
SEARCH:SEARCH<x>:NAVigate	Sets the navigation action for search marks.
SEARCH:SEARCH<x>:TOTAL?	Queries the total number of found search marks for this search.
SEARCH:SEARCH<x>:TRIGger:A:BUS:ARINC429A:CONDition	Specifies a field or condition for an ARINC429 bus to search on.
SEARCH:SEARCH<x>:TRIGger:A:BUS:ARINC429A:ERRTYPe	Sets or queries the error type when searching on an ARINC429 bus signal.
SEARCH:SEARCH<x>:TRIGger:A:BUS:ARINC429A:LABel:QUALifier	Sets or queries the qualifier to be used when searching on label data for an ARINC429 bus signal.
SEARCH:SEARCH<x>:TRIGger:A:BUS:ARINC429A:LABel:VALue	Sets or queries the low value when searching on an ARINC429 label field.
SEARCH:SEARCH<x>:TRIGger:A:BUS:ARINC429A:LABel:HIVALue	Sets or queries the high value when searching on an ARINC429 label field.
SEARCH:SEARCH<x>:TRIGger:A:BUS:ARINC429A:SDI:VALue	Sets or queries the when searching on an ARINC429 SDI field.
SEARCH:SEARCH<x>:TRIGger:A:BUS:ARINC429A:SSM:VALue	Sets or queries the when searching on an ARINC429 SSM field.
SEARCH:SEARCH<x>:TRIGger:A:BUS:ARINC429A:DATA:QUALifier	Sets or queries the qualifier to be used when searching on data in the DATA field for an ARINC429 bus signal.
SEARCH:SEARCH<x>:TRIGger:A:BUS:ARINC429A:DATA:VALue	Sets or queries the low value when searching on an ARINC429 data field.
SEARCH:SEARCH<x>:TRIGger:A:BUS:ARINC429A:DATA:HIVALue	Sets or queries the high value when searching on an ARINC429 data field.
SEARCH:SEARCH<x>:TRIGger:A:BUS:AUDio:CONDition	Sets or queries the condition (word select / frame sync, or matching data) to be used when searching on an audio bus signal.
SEARCH:SEARCH<x>:TRIGger:A:BUS:AUDio:DATA:HITDMVALue	Sets or queries the binary data string for the high data word to be used when searching on an TDM audio bus signal.
SEARCH:SEARCH<x>:TRIGger:A:BUS:AUDio:DATA:HIVALue	Sets or queries the binary data string for the high data word to be used when searching on an audio bus signal.

Table 2-39: Search and Mark commands (cont.)

Command	Description
SEARCH:SEARCH<x>:TRIGger:A:BUS:AUDio:DATA:OFFSet	Sets or queries the data offset value (TDM channel) to be used when searching on a TDM type audio bus signal.
SEARCH:SEARCH<x>:TRIGger:A:BUS:AUDio:DATA:QUALifier	Sets or queries the qualifier to be used when searching on an audio bus signal.
SEARCH:SEARCH<x>:TRIGger:A:BUS:AUDio:DATA:TDMVALue	Sets or queries the binary data string for the single or low data word to be used when searching on an TDM audio bus signal
SEARCH:SEARCH<x>:TRIGger:A:BUS:AUDio:DATA:VALue	Sets or queries the binary data string for the single or low data word to be used when searching on an audio bus signal.
SEARCH:SEARCH<x>:TRIGger:A:BUS:AUDio:DATA:WORD	Sets or queries the alignment of the data (left, right or either) to be used when searching on a non-TDM type audio bus signal.
SEARCH:SEARCH<x>:TRIGger:A:BUS:AUTOETHERnet:CONDition	Sets or queries the field or condition for which to search an AutoEthernet.
SEARCH:SEARCH<x>:TRIGger:A:BUS:AUTOETHERnet:DATA:HIVALue	Sets or queries the binary data value to be used when searching on an AutoEthernet bus signal.
SEARCH:SEARCH<x>:TRIGger:A:BUS:AUTOETHERnet:DATA:OFFSet	Sets or queries the data offset value, in bytes, to use when searching on the AutoEthernet data field.
SEARCH:SEARCH<x>:TRIGger:A:BUS:AUTOETHERnet:DATA:SIZE	Sets or queries the length of the data string, in bytes, to use when searching on the AutoEthernet bus signal.
SEARCH:SEARCH<x>:TRIGger:A:BUS:AUTOETHERnet:DATA:VALue	Sets or queries the binary value to use when searching on the AutoEthernet bus signal.
SEARCH:SEARCH<x>:TRIGger:A:BUS:AUTOETHERnet:IPHeader:DESTinationaddr:VALue	Sets or queries the binary destination address value to use when searching on an AutoEthernet bus signal.
SEARCH:SEARCH<x>:TRIGger:A:BUS:AUTOETHERnet:IPHeader:PROTOcol:VALue	Sets or queries the binary protocol value to use when searching on the Ethernet bus signal.
SEARCH:SEARCH<x>:TRIGger:A:BUS:AUTOETHERnet:IPHeader:SOURceaddr:VALue	Sets or queries the binary source address value to use when searching on an AutoEthernet bus signal.
SEARCH:SEARCH<x>:TRIGger:A:BUS:AUTOETHERnet:MAC:ADDRess:DESTination:VALue	Sets or queries the binary MAC address destination value to use when searching on an AutoEthernet bus signal.
SEARCH:SEARCH<x>:TRIGger:A:BUS:AUTOETHERnet:MAC:ADDRess:SOURce:VALue	Sets or queries the binary MAC address source value to use when searching on an AutoEthernet bus signal.
SEARCH:SEARCH<x>:TRIGger:A:BUS:AUTOETHERnet:MAC:LENGth:HIVALue	Sets or queries the binary MAC length high value to use when searching on an AutoEthernet bus signal.
SEARCH:SEARCH<x>:TRIGger:A:BUS:AUTOETHERnet:MAC:LENGth:VALue	Sets or queries the MAC length value to use when searching on an Ethernet bus signal.
SEARCH:SEARCH<x>:TRIGger:A:BUS:AUTOETHERnet:QTAG:VALue	Sets or queries the binary Q-tag information to use when searching on an AutoEthernet bus signal.



Table 2-39: Search and Mark commands (cont.)

Command	Description
SEARCH:SEARCH<x>:TRIGger:A:BUS:AUTOETHERnet:QUALifier	Sets or queries the qualifier to be used when searching on an AutoEthernet bus signal.
SEARCH:SEARCH<x>:TRIGger:A:BUS:AUTOETHERnet:TCPHeader:ACKnum:VALue	Sets or queries the binary ack number value to use when searching on an AutoEthernet bus signal.
SEARCH:SEARCH<x>:TRIGger:A:BUS:AUTOETHERnet:TCPHeader:DESTinationport:VALue	Sets or queries the binary destination port value to use when searching on the AutoEthernet TCP header destination port number.
SEARCH:SEARCH<x>:TRIGger:A:BUS:AUTOETHERnet:TCPHeader:SEQnum:VALue	Sets or queries the TCP header sequence number value to use when searching on the AutoEthernet TCP header destination port number.
SEARCH:SEARCH<x>:TRIGger:A:BUS:AUTOETHERnet:TCPHeader:SOURceport:VALue	Sets or queries the binary source port value to use when searching on an AutoEthernet bus signal.
SEARCH:SEARCH<x>:TRIGger:A:BUS:CAN:CONDition	Sets or queries the CAN bus trigger condition.
SEARCH:SEARCH<x>:TRIGger:A:BUS:CAN:DATA:DIRection	Sets the CAN search type.
SEARCH:SEARCH<x>:TRIGger:A:BUS:CAN:DATA:OFFSet	Sets or queries the data offset value, in bytes, to use when searching on the CAN data field.
SEARCH:SEARCH<x>:TRIGger:A:BUS:CAN:DATA:QUALifier	Sets or queries the CAN bus trigger data qualifier.
SEARCH:SEARCH<x>:TRIGger:A:BUS:CAN:DATA:SIZE	Sets or queries the CAN bus trigger data size.
SEARCH:SEARCH<x>:TRIGger:A:BUS:CAN:DATA:VALue	Sets or queries the binary data value to be used when searching on a CAN bus signal.
SEARCH:SEARCH<x>:TRIGger:A:BUS:CAN:ERRType	Sets or queries the type of error condition for a CAN bus to search on.
SEARCH:SEARCH<x>:TRIGger:A:BUS:CAN:FD:BRSBit	Sets or queries the value of the bit rate switch bit (BRS bit) for a CAN bus to search on.
SEARCH:SEARCH<x>:TRIGger:A:BUS:CAN:FD:ESIBit	Sets or queries the value of the error state indicator bit (ESI bit) for a CAN bus to search on.
SEARCH:SEARCH<x>:TRIGger:A:BUS:CAN:FRAMetype	Sets or queries CAN bus trigger frame type.
SEARCH:SEARCH<x>:TRIGger:A:BUS:CAN:IDentifier:MODE	Sets or queries the CAN bus trigger identifier mode.
SEARCH:SEARCH<x>:TRIGger:A:BUS:CAN:IDentifier:VALue	Sets or queries CAN bus trigger identifier value.
SEARCH:SEARCH<x>:TRIGger:A:BUS:CPHY:BLUE:VALue	Specifies the blue data string used for CPHY triggering if the trigger condition is on RGB packet.

Table 2-39: Search and Mark commands (cont.)

Command	Description
SEARCH:SEARCH<x>:TRIGger:A:BUS:CPHY:CONDition	Sets or queries the trigger condition for an CPHY bus.
SEARCH:SEARCH<x>:TRIGger:A:BUS:CPHY:DATA:SIZE	Specifies the length of the data string in bytes to be used for an CPHY trigger if the trigger condition is DATA.
SEARCH:SEARCH<x>:TRIGger:A:BUS:CPHY:DATA:VALue	Specifies the binary data string used for CPHY triggering if the trigger condition is DATA.
SEARCH:SEARCH<x>:TRIGger:A:BUS:CPHY:ERRor:TYPE	Sets or queries the error type for CPHY bus.
SEARCH:SEARCH<x>:TRIGger:A:BUS:CPHY:ESCAPEMODE:COMManD	Sets or queries the escape mode command type for CPHY bus.
SEARCH:SEARCH<x>:TRIGger:A:BUS:CPHY:GREEN:VALue	Specifies the green data string used for CPHY triggering if the trigger condition is on RGB packet.
SEARCH:SEARCH<x>:TRIGger:A:BUS:CPHY:MODE:TYPE	Sets or queries the mode type for CPHY bus.
SEARCH:SEARCH<x>:TRIGger:A:BUS:CPHY:PACKets:LIST	Sets or queries the packet list for CPHY bus.
SEARCH:SEARCH<x>:TRIGger:A:BUS:CPHY:PACKets:TYPE	Sets or queries the packet type for an CPHY bus.
SEARCH:SEARCH<x>:TRIGger:A:BUS:CPHY:PIXel:NUMBER	Specifies the pixel number to be used for CPHY triggering if the trigger condition is on pixel number pattern.
SEARCH:SEARCH<x>:TRIGger:A:BUS:CPHY:PIXel:SEARCHOPTion	Sets or queries the search pattern type for CPHY bus.
SEARCH:SEARCH<x>:TRIGger:A:BUS:CPHY:RED:VALue	Specifies the red data string used for CPHY triggering if the trigger condition is on RGB packet.
SEARCH:SEARCH<x>:TRIGger:A:BUS:CPHY:SYMBOL:SIZE	Specifies the length of the data string in bytes to be used for an CPHY trigger if the trigger condition is SYMBOL.
SEARCH:SEARCH<x>:TRIGger:A:BUS:CPHY:SYMBOL:VALue	Specifies the binary data string used for CPHY triggering if the trigger condition is Symbol.
SEARCH:SEARCH<x>:TRIGger:A:BUS:CPHY:WORD:SIZE	Specifies the length of the word string in bytes to be used for an CPHY trigger if the trigger condition is WORD.
SEARCH:SEARCH<x>:TRIGger:A:BUS:CPHY:WORD:VALue	Specifies the binary data string used for CPHY triggering if the trigger condition is WORD.
SEARCH:SEARCH<x>:TRIGger:A:BUS:CPHY:WORDCOUNT:VALue	Specifies the word count data string used for CPHY triggering if the trigger condition is on any rgb/ycbcr/yuv packet.
SEARCH:SEARCH<x>:TRIGger:A:BUS:CPHY:YCBCR:CB	Specifies the Cb data string used for CPHY triggering if the trigger condition is on YCbCr packet.
SEARCH:SEARCH<x>:TRIGger:A:BUS:CPHY:YCBCR:CR	Specifies the Cr data string used for CPHY triggering if the trigger condition is on YCbCr packet.

Table 2-39: Search and Mark commands (cont.)

Command	Description
SEARCH:SEARCH<x>:TRIGger:A:BUS:CPHY:YCbCr:Y	Specifies the Y data string used for CPHY triggering if the trigger condition is on YCbCr packet.
SEARCH:SEARCH<x>:TRIGger:A:BUS:CPHY:YUV:U	Specifies the U data string used for CPHY triggering if the trigger condition is on YUV packet.
SEARCH:SEARCH<x>:TRIGger:A:BUS:CPHY:YUV:V	Specifies the V data string used for CPHY triggering if the trigger condition is on YUV packet.
SEARCH:SEARCH<x>:TRIGger:A:BUS:CPHY:YUV:Y	Specifies the Y data string used for CPHY triggering if the trigger condition is on YUV packet.
SEARCH:SEARCH<x>:TRIGger:A:BUS:CXPI:CONDition	Sets or queries the trigger condition for a CXPI bus.
SEARCH:SEARCH<x>:TRIGger:A:BUS:CXPI:COUNter:VALue	Specifies the binary counter string used for CXPI triggering if the trigger condition is COUNTER.
SEARCH:SEARCH<x>:TRIGger:A:BUS:CXPI:DATA:SIZE	Specifies the length of the data string in bytes to be used for CXPI triggering if the trigger condition is DATA.
SEARCH:SEARCH<x>:TRIGger:A:BUS:CXPI:DATA:VALue	Specifies the binary data string used for CXPI triggering if the trigger condition is DATA.
SEARCH:SEARCH<x>:TRIGger:A:BUS:CXPI:DLC:VALue	Specifies the binary dlc string used for CXPI triggering if the trigger condition is DLC.
SEARCH:SEARCH<x>:TRIGger:A:BUS:CXPI:ERROR:TYPE	Sets or queries the Error Type in CXPI bus.
SEARCH:SEARCH<x>:TRIGger:A:BUS:CXPI:EXTDLC:VALue	Specifies the binary dlc string used for CXPI triggering if the trigger condition is Ext DLC.
SEARCH:SEARCH<x>:TRIGger:A:BUS:CXPI:FRAME:TYPE	Sets or queries the frame type in CXPI bus.
SEARCH:SEARCH<x>:TRIGger:A:BUS:CXPI:FRAMEID:VALue	Specifies the binary frameld string used for CXPI triggering if the trigger condition is FRAMEID.
SEARCH:SEARCH<x>:TRIGger:A:BUS:CXPI:NETMN:SLEEPIND	Sets or queries the Sleep Status in CXPI bus.
SEARCH:SEARCH<x>:TRIGger:A:BUS:CXPI:NETMN:WAKEUPIND	Sets or queries the Wakeup Status in CXPI bus.
SEARCH:SEARCH<x>:TRIGger:A:BUS:DPHY:BLUe:VALue	Specifies the blue data string used for DPHY triggering if the trigger condition is on RGB packet.
SEARCH:SEARCH<x>:TRIGger:A:BUS:DPHY:CONDition	Sets or queries the trigger condition for an DPHY bus.
SEARCH:SEARCH<x>:TRIGger:A:BUS:DPHY:DATA:SIZE	Specifies the length of the data string in bytes to be used for an DPHY trigger if the trigger condition is DATA.
SEARCH:SEARCH<x>:TRIGger:A:BUS:DPHY:DATA:VALue	Specifies the binary data string used for DPHY triggering if the trigger condition is DATA.

**Table 2-39: Search and Mark commands (cont.)**

<b>Command</b>	<b>Description</b>
SEARCH:SEARCH<x>:TRIGger:A:BUS:DPHY:ERRor:TYPe	Sets or queries the error type for DPHY bus.
SEARCH:SEARCH<x>:TRIGger:A:BUS:DPHY:ESCAPEMODe:COMMand	Sets or queries the escape mode command type for DPHY bus.
SEARCH:SEARCH<x>:TRIGger:A:BUS:DPHY:GREen:VALue	Specifies the green data string used for DPHY triggering if the trigger condition is on RGB packet.
SEARCH:SEARCH<x>:TRIGger:A:BUS:DPHY:MODe:TYPe	Sets or queries the mode type for DPHY bus.
SEARCH:SEARCH<x>:TRIGger:A:BUS:DPHY:PACKets:LIST	Sets or queries the packet list for DPHY bus.
SEARCH:SEARCH<x>:TRIGger:A:BUS:DPHY:PACKets:TYPe	Sets or queries the packet type for DPHY bus.
SEARCH:SEARCH<x>:TRIGger:A:BUS:DPHY:PIXel:NUMBer	Specifies the pixel number to be used for DPHY triggering if the trigger condition is on pixel number pattern.
SEARCH:SEARCH<x>:TRIGger:A:BUS:DPHY:PIXel:SEARCHOPTion	Sets or queries the search pattern type for DPHY bus.
SEARCH:SEARCH<x>:TRIGger:A:BUS:DPHY:RED:VALue	Specifies the red data string used for DPHY triggering if the trigger condition is on RGB packet.
SEARCH:SEARCH<x>:TRIGger:A:BUS:DPHY:WORDCOUNT:VALue	Specifies the word count data string used for DPHY triggering if the trigger condition is set on any pixel packet.
SEARCH:SEARCH<x>:TRIGger:A:BUS:DPHY:YCBCR:CB	Specifies the Cb data string used for DPHY triggering if the trigger condition is on YCbCr packet.
SEARCH:SEARCH<x>:TRIGger:A:BUS:DPHY:YCBCR:CR	Specifies the Cr data string used for DPHY triggering if the trigger condition is on YCbCr packet.
SEARCH:SEARCH<x>:TRIGger:A:BUS:DPHY:YCBCR:Y	Specifies the Y data string used for DPHY triggering if the trigger condition is on YCbCr packet.
SEARCH:SEARCH<x>:TRIGger:A:BUS:DPHY:YUV:U	Specifies the U data string used for DPHY triggering if the trigger condition is on YUV packet.
SEARCH:SEARCH<x>:TRIGger:A:BUS:DPHY:YUV:V	Specifies the V data string used for DPHY triggering if the trigger condition is on YUV packet.
SEARCH:SEARCH<x>:TRIGger:A:BUS:DPHY:YUV:Y	Specifies the Y data string used for DPHY triggering if the trigger condition is on YUV packet.
SEARCH:SEARCH<x>:TRIGger:A:BUS:ESPI:ADDRess:VALue	Specifies the binary data string used for ESPI triggering if the trigger condition is Address.
SEARCH:SEARCH<x>:TRIGger:A:BUS:ESPI:COMMAND:OPCode	Sets or queries the command opcode in ESPI bus.
SEARCH:SEARCH<x>:TRIGger:A:BUS:ESPI:CONDition	Sets or queries the trigger condition for a ESPI bus.

Table 2-39: Search and Mark commands (cont.)

Command	Description
SEARCH:SEARCH<x>:TRIGger:A:BUS:ESPI:CYCLETYPE	Sets or queries the cycle type on command in ESPI bus.
SEARCH:SEARCH<x>:TRIGger:A:BUS:ESPI:DATA:SIZE	Specifies the length of the data string in bytes to be used for ESPI triggering if the trigger condition is DATA.
SEARCH:SEARCH<x>:TRIGger:A:BUS:ESPI:DATA:VALue	Specifies the binary data string used for ESPI triggering if the trigger condition is Data.
SEARCH:SEARCH<x>:TRIGger:A:BUS:ESPI:ERRor:TYPE	Sets or queries the error type on command or response in ESPI bus.
SEARCH:SEARCH<x>:TRIGger:A:BUS:ESPI:LENGth:VALue	Specifies the binary data string used for ESPI triggering if the trigger condition is Length.
SEARCH:SEARCH<x>:TRIGger:A:BUS:ESPI:PHASe	Sets or queries the phase in ESPI bus.
SEARCH:SEARCH<x>:TRIGger:A:BUS:ESPI:RESPCYCLE:TYPE	Sets or queries the response cycle type on command in ESPI bus.
SEARCH:SEARCH<x>:TRIGger:A:BUS:ESPI:SMBUS:DESTination:ADDRess	Specifies the binary data string used for ESPI triggering if the trigger condition is SMBus Source/Destination Address.
SEARCH:SEARCH<x>:TRIGger:A:BUS:ESPI:SMBUS:SLAVe:ADDRess	Specifies the binary data string used for ESPI triggering if the trigger condition is SMBus Slave Address.
SEARCH:SEARCH<x>:TRIGger:A:BUS:ESPI:TAG:VALue	Specifies the binary data string used for ESPI triggering if the trigger condition is Tag.
SEARCH:SEARCH<x>:TRIGger:A:BUS:ESPI:VIRTUALWIRe:COUNT:VALue	Specifies the binary data string used for ESPI triggering if the trigger condition is Virtual wire count.
SEARCH:SEARCH<x>:TRIGger:A:BUS:ESPI:VIRTUALWIRe:COUNT:VALue	Specifies the binary data string used for ESPI triggering if the trigger condition is Virtual wire Data.
SEARCH:SEARCH<x>:TRIGger:A:BUS:ESPI:VIRTUALWIRe:INDex:VALue	Specifies the binary data string used for ESPI triggering if the trigger condition is Virtual wire Index.
SEARCH:SEARCH<x>:TRIGger:A:BUS:ESPI:VIRTUALWIRe:RESPonse:VALue	Specifies the binary data string used for ESPI triggering if the trigger condition is Virtual wire Response.
SEARCH:SEARCH<x>:TRIGger:A:BUS:ESPI:STATus:VALue	Specifies the binary data string used for ESPI triggering if the trigger condition is Virtual wire Status.
SEARCH:SEARCH<x>:TRIGger:A:BUS:ETHERCAT:ADDRESSMODE	Sets or queries the Address Mode in EtherCAT bus.
SEARCH:SEARCH<x>:TRIGger:A:BUS:ETHERCAT:CNTNV:VALue	Sets or queries the binary Network Variable Count to be used for EtherCAT bus.
SEARCH:SEARCH<x>:TRIGger:A:BUS:ETHERCAT:COMMANDTYPE	Sets or queries the Command Type in EtherCAT bus.
SEARCH:SEARCH<x>:TRIGger:A:BUS:ETHERCAT:CONDition	Sets or queries the trigger condition for a EtherCAT bus.

Table 2-39: Search and Mark commands (cont.)

Command	Description
SEARCH:SEARCH<x>:TRIGger:A:BUS:ETHERCAT:CYC:VALue	Sets or queries the binary Cycle Number to be used for EtherCAT bus.
SEARCH:SEARCH<x>:TRIGger:A:BUS:ETHERCAT:DATA:SIZE	Specifies the length of the data string in bytes to be used for EtherCAT bus.
SEARCH:SEARCH<x>:TRIGger:A:BUS:ETHERCAT:DATA:VALue	Specifies the binary data string used for EtherCAT bus.
SEARCH:SEARCH<x>:TRIGger:A:BUS:ETHERCAT:DATAGRAM	Sets or queries the Datagram fields in EtherCAT bus.
SEARCH:SEARCH<x>:TRIGger:A:BUS:ETHERCAT:DATAGRAMHEADer	Sets or queries the Datagram Header fields in EtherCAT bus.
SEARCH:SEARCH<x>:TRIGger:A:BUS:ETHERCAT:DATAGRAMHEADer:LENGth	Sets or queries the binary Datagram length information to be used for EtherCAT bus.
SEARCH:SEARCH<x>:TRIGger:A:BUS:ETHERCAT:DESTINATIONADDRess:VALue	Sets or queries the binary MAC destination address value to be used for EtherCAT bus.
SEARCH:SEARCH<x>:TRIGger:A:BUS:ETHERCAT:DEVICEADDRess	Sets or queries the Device Address in EtherCAT bus.
SEARCH:SEARCH<x>:TRIGger:A:BUS:ETHERCAT:ERRor:REPLy:SERVice:DATA	Sets or queries the error reply service data fields in EtherCAT bus.
SEARCH:SEARCH<x>:TRIGger:A:BUS:ETHERCAT:FRAMETYPe	Sets or queries the Frame Type in EtherCAT bus.
SEARCH:SEARCH<x>:TRIGger:A:BUS:ETHERCAT:HASH:VALue	Sets or queries the binary HASH to be used for EtherCAT bus.
SEARCH:SEARCH<x>:TRIGger:A:BUS:ETHERCAT:HEADer:LENGth	Sets or queries the binary EtherCAT header length to be used for EtherCAT bus.
SEARCH:SEARCH<x>:TRIGger:A:BUS:ETHERCAT:IDENtification:VALue	Sets or queries the IP Identification to be used for EtherCAT bus.
SEARCH:SEARCH<x>:TRIGger:A:BUS:ETHERCAT:IDX:VALue	Sets or queries the binary Indexing information to be used for EtherCAT bus.
SEARCH:SEARCH<x>:TRIGger:A:BUS:ETHERCAT:INDex:VALue	Sets or queries the binary Index to be used for EtherCAT bus.
SEARCH:SEARCH<x>:TRIGger:A:BUS:ETHERCAT:IPDESTination:ADDRess:VALue	Sets or queries the Destination IP Address to be used for EtherCAT bus.
SEARCH:SEARCH<x>:TRIGger:A:BUS:ETHERCAT:IPSOURce:ADDRess:VALue	Sets or queries the Source IP Address to be used for EtherCAT bus.
SEARCH:SEARCH<x>:TRIGger:A:BUS:ETHERCAT:IRQ:VALue	Sets or queries the binary interrupt request information to be used for EtherCAT bus.
SEARCH:SEARCH<x>:TRIGger:A:BUS:ETHERCAT:LEN:VALue	Sets or queries the binary Length to be used for EtherCAT bus.

Table 2-39: Search and Mark commands (cont.)

Command	Description
SEARCH:SEARCH<x>:TRIGger:A:BUS:ETHERCAT:LOGICALADDRess:VALue	Sets or queries the binary logical address information to be used for EtherCAT bus.
SEARCH:SEARCH<x>:TRIGger:A:BUS:ETHERCAT:MAILbox	Sets or queries the Mailbox fields in EtherCAT bus.
SEARCH:SEARCH<x>:TRIGger:A:BUS:ETHERCAT:MAILbox:ADDRess:VALue	Sets or queries the binary Mailbox Address to be used for EtherCAT bus.
SEARCH:SEARCH<x>:TRIGger:A:BUS:ETHERCAT:MAILbox:CNT:VALue	Sets or queries the binary counter of the mailbox services to be used for EtherCAT bus.
SEARCH:SEARCH<x>:TRIGger:A:BUS:ETHERCAT:MAILbox:DETail	Sets or queries the Error Reply Service Data Details in EtherCAT bus.
SEARCH:SEARCH<x>:TRIGger:A:BUS:ETHERCAT:MAILbox:HEADer	Sets or queries the Mailbox Header fields in EtherCAT bus.
SEARCH:SEARCH<x>:TRIGger:A:BUS:ETHERCAT:MAILBOXTYPe	Sets or queries the Mailbox Type in EtherCAT bus.
SEARCH:SEARCH<x>:TRIGger:A:BUS:ETHERCAT:NETWork:VARiable	Sets or queries the Network Variable fields in EtherCAT bus.
SEARCH:SEARCH<x>:TRIGger:A:BUS:ETHERCAT:NETWork:VARiable:HEADer	Sets or queries the Network Variable Header fields in EtherCAT bus.
SEARCH:SEARCH<x>:TRIGger:A:BUS:ETHERCAT:NETWorkVARIable:DATA:SIZE	Specifies the length of the network variable data string in bytes to be used for EtherCAT bus.
SEARCH:SEARCH<x>:TRIGger:A:BUS:ETHERCAT:NETWorkVARIable:DATA:VALue	Specifies the binary network variable data string used for EtherCAT bus.
SEARCH:SEARCH<x>:TRIGger:A:BUS:ETHERCAT:OFFSet:VALue	Sets or queries the binary address offset information to be used for EtherCAT bus.
SEARCH:SEARCH<x>:TRIGger:A:BUS:ETHERCAT:POSition:VALue	Sets or queries the binary address position information to be used for EtherCAT bus.
SEARCH:SEARCH<x>:TRIGger:A:BUS:ETHERCAT:PROTOCOLTYPe	Sets or queries the EtherCAT Protocol Type in EtherCAT bus.
SEARCH:SEARCH<x>:TRIGger:A:BUS:ETHERCAT:PUBID:VALue	Sets or queries the binary Publisher ID to be used for EtherCAT bus.
SEARCH:SEARCH<x>:TRIGger:A:BUS:ETHERCAT:QUALity:VALue	Sets or queries the binary quality to be used for EtherCAT bus.
SEARCH:SEARCH<x>:TRIGger:A:BUS:ETHERCAT:SERvice:DATA:LENGth	Sets or queries the binary service data length to be used for EtherCAT bus.
SEARCH:SEARCH<x>:TRIGger:A:BUS:ETHERCAT:SERvice:DATA:SIZE	Specifies the length of the service data string in bytes to be used for EtherCAT bus.
SEARCH:SEARCH<x>:TRIGger:A:BUS:ETHERCAT:SERvice:DATA:VALue	Specifies the length of the service data string in bytes to be used for EtherCAT bus.

Table 2-39: Search and Mark commands (cont.)

Command	Description
SEARCH:SEARCH<x>:TRIGger:A:BUS:ETHERCAT:SOURCEADDRess:VALue	Sets or queries the binary MAC source address value to be used for EtherCAT bus.
SEARCH:SEARCH<x>:TRIGger:A:BUS:ETHERCAT:SRC:PORT:VALue	Sets or queries the UDP Source port to be used for EtherCAT bus.
SEARCH:SEARCH<x>:TRIGger:A:BUS:ETHERCAT:TCI:VALue	Sets or queries the binary Tag control Information to be used for EtherCAT bus.
SEARCH:SEARCH<x>:TRIGger:A:BUS:ETHERCAT:WKC:VALue	Sets or queries the binary Working Counter information to be used for EtherCAT bus.
SEARCH:SEARCH<x>:TRIGger:A:BUS:ETHERnet:CONDition	Specifies a field or condition within an Ethernet frame to search on.
SEARCH:SEARCH<x>:TRIGger:A:BUS:ETHERnet:DATA:HIVALue	Sets or queries the binary data value to be used when searching on an Ethernet bus signal.
SEARCH:SEARCH<x>:TRIGger:A:BUS:ETHERnet:DATA:OFFSet	Specifies the data offset value, in bytes, to use when searching on the Ethernet data field.
SEARCH:SEARCH<x>:TRIGger:A:BUS:ETHERnet:DATA:QUALifier	Sets the qualifier to be used when searching on an Ethernet bus signal.
SEARCH:SEARCH<x>:TRIGger:A:BUS:ETHERnet:DATA:SIZE	Specifies the number of contiguous TCP/IPv4/MAC client bytes to use when searching on the Ethernet data field.
SEARCH:SEARCH<x>:TRIGger:A:BUS:ETHERnet:DATA:VALue	Specifies the binary value to use when searching on the Ethernet data field.
SEARCH:SEARCH<x>:TRIGger:A:BUS:ETHERnet:IPHeader:DESTinationaddr:VALue	Specifies the 32-bit value to use when searching on the Ethernet IPv4 header address destination field.
SEARCH:SEARCH<x>:TRIGger:A:BUS:ETHERnet:IPHeader:PROTOcol:VALue	Specifies the 8-bit value to use when searching on the Ethernet IPv4 header protocol field.
SEARCH:SEARCH<x>:TRIGger:A:BUS:ETHERnet:IPHeader:SOURceaddr:VALue	Specifies the 32-bit value to use when searching on the Ethernet IPv4 header address source field.
SEARCH:SEARCH<x>:TRIGger:A:BUS:ETHERnet:MAC:ADDRess:DESTination:VALue	Specifies the 48-bit value to use when searching on the Ethernet MAC address destination field.
SEARCH:SEARCH<x>:TRIGger:A:BUS:ETHERnet:MAC:ADDRess:SOURce:VALue	Specifies the 48-bit value to use when searching on the Ethernet MAC address source field.
SEARCH:SEARCH<x>:TRIGger:A:BUS:ETHERnet:MAC:LENGth:HIVALue	Specifies the 16-bit high value to use when searching on the Ethernet MAC length/type.
SEARCH:SEARCH<x>:TRIGger:A:BUS:ETHERnet:MAC:LENGth:VALue	Specifies the 16-bit value to use when searching on the Ethernet MAC length/type.
SEARCH:SEARCH<x>:TRIGger:A:BUS:ETHERnet:QTAG:VALue	Specifies the 32-bit value to use when searching on the Ethernet Q-Tag field.
SEARCH:SEARCH<x>:TRIGger:A:BUS:ETHERnet:TCPHeader:ACKnum:VALue	Specifies the 32-bit value to use when searching on the Ethernet TCP header acknowledgement number.



Table 2-39: Search and Mark commands (cont.)

Command	Description
SEARCH:SEARCH<x>:TRIGger:A:BUS:ETHERnet:TCPHeader:DESTinationport:VALue	Specifies the 16-bit value to use when searching on the Ethernet TCP header destination port number.
SEARCH:SEARCH<x>:TRIGger:A:BUS:ETHERnet:TCPHeader:SEQnum:VALue	Specifies the 32-bit value to use when searching on the Ethernet TCP header sequence number.
SEARCH:SEARCH<x>:TRIGger:A:BUS:ETHERnet:TCPHeader:SOURceport:VALue	Specifies the 16-bit value to use when searching on the Ethernet TCP header source port number.
SEARCH:SEARCH<x>:TRIGger:A:BUS:EUSB:ADDress:HIVALue	Sets the high binary address value to be used when triggering on a eUSB bus signal.
SEARCH:SEARCH<x>:TRIGger:A:BUS:EUSB:ADDress:VALue	Sets the binary address value to be used when triggering on a eUSB bus signal.
SEARCH:SEARCH<x>:TRIGger:A:BUS:EUSB:CONDition	Sets or queries the search type for the specified search.
SEARCH:SEARCH<x>:TRIGger:A:BUS:EUSB:DATA:HIVALue	Sets the high binary data value to be used when triggering on a eUSB bus signal.
SEARCH:SEARCH<x>:TRIGger:A:BUS:EUSB:DATA:OFFSet	Sets the byte offset to look for a data pattern at, in bytes, to be used when triggering on a eUSB bus signal.
SEARCH:SEARCH<x>:TRIGger:A:BUS:EUSB:DATA:QUALifier	Sets the qualifier to be used when triggering on a eUSB bus signal.
SEARCH:SEARCH<x>:TRIGger:A:BUS:EUSB:DATA:SIZE	Sets the length of the data string, in bytes, to be used when triggering on a eUSB bus signal.
SEARCH:SEARCH<x>:TRIGger:A:BUS:EUSB:DATA:TYPE	Specifies the eUSB trigger type to be valid on any, data0, data1, data2, or mdata condition.
SEARCH:SEARCH<x>:TRIGger:A:BUS:EUSB:DATA:VALue	Sets the binary data value to be used when triggering on a eUSB bus signal.
SEARCH:SEARCH<x>:TRIGger:A:BUS:EUSB:DATABITS:SIZE	Sets the number of Sync bits, in bytes, to be used when triggering on a eUSB bus signal.
SEARCH:SEARCH<x>:TRIGger:A:BUS:EUSB:ENDPoint:VALue	Sets the endpoint binary value to be used when triggering on a eUSB bus signal.
SEARCH:SEARCH<x>:TRIGger:A:BUS:EUSB:ENDSEARch	Specifies eUSB Search EOP Bits to be On and Off.
SEARCH:SEARCH<x>:TRIGger:A:BUS:EUSB:EOP:DATABITS:SIZE	Sets the number of EOP bits, in bytes, to be used when triggering on a eUSB bus signal.
SEARCH:SEARCH<x>:TRIGger:A:BUS:EUSB:EOP:QUALifier	Sets the qualifier to be used when triggering on a eUSB bus signal.
SEARCH:SEARCH<x>:TRIGger:A:BUS:EUSB:EOPBITS:MAX:SIZE	Sets the number of EOP bits, in bits, to be used when triggering on a eUSB bus signal.
SEARCH:SEARCH<x>:TRIGger:A:BUS:EUSB:EOPBITS:MIN:SIZE	Sets the number of EOP bits, in bits, to be used when triggering on a eUSB bus signal.

Table 2-39: Search and Mark commands (cont.)

Command	Description
SEARCH:SEARCH<x>:TRIGger:A:BUS:EUSB:ERRType	Specifies the eUSB trigger type to be valid on a PID, Token CRC5, Data CRC16, or Bit stuffing condition.
SEARCH:SEARCH<x>:TRIGger:A:BUS:EUSB:HANDSHAKType	Specifies the eUSB trigger type to be valid on any, ack, nak, stall, or nyet condition.
SEARCH:SEARCH<x>:TRIGger:A:BUS:EUSB:RAP:ADDress:VALue	Sets the binary Register Access Protocol address value to be used when triggering on a eUSB bus signal.
SEARCH:SEARCH<x>:TRIGger:A:BUS:EUSB:RAP:COMMand	Specifies the eUSB Register Access Protocol search option
SEARCH:SEARCH<x>:TRIGger:A:BUS:EUSB:RAP:DATa:VALue	Sets the binary Register Access Protocol data value to be used when triggering on a eUSB bus signal.
SEARCH:SEARCH<x>:TRIGger:A:BUS:EUSB:RAP:OPTion	Specifies the eUSB Register Access Protocol search option.
SEARCH:SEARCH<x>:TRIGger:A:BUS:EUSB:SOFFRAMENUMber	Sets the binary frame number to be used when triggering on a eUSB bus signal.
SEARCH:SEARCH<x>:TRIGger:A:BUS:EUSB:SPECIALType	Specifies the eUSB trigger type to be valid on any, err, split, ping, or reserved condition.
SEARCH:SEARCH<x>:TRIGger:A:BUS:EUSB:SPLit:ET:VALue	Specifies the eUSB trigger type endpoint condition.
SEARCH:SEARCH<x>:TRIGger:A:BUS:EUSB:SPLit:HUB:VALue	Sets the binary hub address value to be used when triggering on a eUSB bus signal.
SEARCH:SEARCH<x>:TRIGger:A:BUS:EUSB:SPLit:PORT:VALue	Sets the binary port address value to be used when triggering on a eUSB bus signal.
SEARCH:SEARCH<x>:TRIGger:A:BUS:EUSB:SPLit:SC:VALue	Specifies the eUSB trigger type start/complete condition.
SEARCH:SEARCH<x>:TRIGger:A:BUS:EUSB:SPLit:SE:VALue	Specifies the eUSB trigger type start/complete condition.
SEARCH:SEARCH<x>:TRIGger:A:BUS:EUSB:SYNC:QUAlifier	Sets the qualifier to be used when triggering on a eUSB bus signal.
SEARCH:SEARCH<x>:TRIGger:A:BUS:EUSB:SYNCBITS:MAX:SIZE	Sets the number of sync bits, in bits, to be used when triggering on a eUSB bus signal.
SEARCH:SEARCH<x>:TRIGger:A:BUS:EUSB:SYNCBITS:MIN:SIZE	Sets the number of sync bits, in bits, to be used when triggering on a eUSB bus signal.
SEARCH:SEARCH<x>:TRIGger:A:BUS:EUSB:SYNCSEARCh	Specifies eUSB Search Sync Bits to be On and Off.
SEARCH:SEARCH<x>:TRIGger:A:BUS:EUSB:TOKENType	Specifies the eUSB trigger type to be valid on any, sof, out, in, or setup condition.
SEARCH:SEARCH<x>:TRIGger:A:BUS:FLEXRAY:CONDition	Sets or queries FlexRay bus search trigger condition.

Table 2-39: Search and Mark commands (cont.)

Command	Description
SEARCH:SEARCH<x>:TRIGger:A:BUS:FLEXRAY:CYCLEcount:VALue	Sets or queries the FlexRay bus search cycle count value.
SEARCH:SEARCH<x>:TRIGger:A:BUS:FLEXRAY:DATA:VALue	Sets or queries the FlexRay bus search cycle count value.
SEARCH:SEARCH<x>:TRIGger:A:BUS:FLEXRAY:CYCLEcount:HIVALue	Sets or queries the FlexRay bus search cycle count value.
SEARCH:SEARCH<x>:TRIGger:A:BUS:FLEXRAY:CYCLEcount:QUALifier	Sets or queries the FlexRay bus search trigger cycle count qualifier.
SEARCH:SEARCH<x>:TRIGger:A:BUS:FLEXRAY:DATA:HIVALue	Sets or queries the FlexRay bus search trigger data value.
SEARCH:SEARCH<x>:TRIGger:A:BUS:FLEXRAY:DATA:OFFSet	Sets or queries the FlexRay bus search trigger data offset.
SEARCH:SEARCH<x>:TRIGger:A:BUS:FLEXRAY:DATA:QUALifier	Sets or queries the FlexRay bus search trigger data qualifier.
SEARCH:SEARCH<x>:TRIGger:A:BUS:FLEXRAY:DATA:SIZE	Sets or queries the FlexRay bus search trigger data size.
SEARCH:SEARCH<x>:TRIGger:A:BUS:FLEXRAY:EOFTYPE	Sets or queries the FlexRay bus search trigger end of file type.
SEARCH:SEARCH<x>:TRIGger:A:BUS:FLEXRAY:ERRTYPE	Sets or queries the FlexRay bus search trigger error type.
SEARCH:SEARCH<x>:TRIGger:A:BUS:FLEXRAY:FRAMEID:HIVALue	Sets or queries the high value when searching on a FlexRay bus frame id field.
SEARCH:SEARCH<x>:TRIGger:A:BUS:FLEXRAY:FRAMEID:QUALifier	Sets the qualifier to be used when searching on a FlexRay bus signal.
SEARCH:SEARCH<x>:TRIGger:A:BUS:FLEXRAY:FRAMEID:VALue	Sets the low value when searching on a FlexRay bus id field.
SEARCH:SEARCH<x>:TRIGger:A:BUS:FLEXRAY:FRAMEType	Sets or queries the FlexRay bus search trigger frame type.
SEARCH:SEARCH<x>:TRIGger:A:BUS:FLEXRAY:HEADER:CRC	Sets or queries the FlexRay bus search trigger header CRC.
SEARCH:SEARCH<x>:TRIGger:A:BUS:FLEXRAY:HEADER:CYCLECount	Sets or queries the FlexRay bus search trigger header cycle count.
SEARCH:SEARCH<x>:TRIGger:A:BUS:FLEXRAY:HEADER:FRAMEID	Sets or queries the FlexRay bus search trigger header frame id.
SEARCH:SEARCH<x>:TRIGger:A:BUS:FLEXRAY:HEADER:INDBits	Sets or queries the FlexRay bus search header Indicator Bits.
SEARCH:SEARCH<x>:TRIGger:A:BUS:FLEXRAY:HEADER:PAYLENgth	Sets or queries the FlexRay bus search trigger header payload length.

Table 2-39: Search and Mark commands (cont.)

Command	Description
SEARCH:SEARCH<x>:TRIGger:A:BUS:I2C:ADDRess:MODE	Sets or queries the address mode for the specified I2C bus trigger search to determine where to place a mark.
SEARCH:SEARCH<x>:TRIGger:A:BUS:I2C:ADDRess:VALue	Sets or queries the address string when the search condition for the specified search is Address or AddressData, to determine where to place a mark.
SEARCH:SEARCH<x>:TRIGger:A:BUS:I2C:CONDition	Sets or queries the trigger condition for the specified I2C bus trigger search to determine where to place a mark.
SEARCH:SEARCH<x>:TRIGger:A:BUS:I2C:DATA:DIRection	Sets or queries the direction of the data for the I2C bus trigger search to determine where to place a mark.
SEARCH:SEARCH<x>:TRIGger:A:BUS:I2C:DATA:SIZE	Sets or queries the length of the data string in bytes used for the specified I2C bus trigger search to determine where to place a mark.
SEARCH:SEARCH<x>:TRIGger:A:BUS:I2C:DATA:VALue	Sets or queries the data value of the data token for the specified I2C bus trigger search to determine where to place a mark.
SEARCH:SEARCH<x>:TRIGger:A:BUS:I3C:ADDRess:MODE	Sets or queries the address mode for the specified I3C bus trigger search to determine where to place a search mark.
SEARCH:SEARCH<x>:TRIGger:A:BUS:I3C:ADDRess:VALue	Sets or queries the I3C address value for which to search, to determine where to place a search mark.
SEARCH:SEARCH<x>:TRIGger:A:BUS:I3C:BCR:VALue	Sets or queries the binary field string used for the I3C search if the trigger condition is BCR.
SEARCH:SEARCH<x>:TRIGger:A:BUS:I3C:BCRType:VALue	Sets or queries the binary field string used for the I3C bus search if the trigger condition is BCRTYPE.
SEARCH:SEARCH<x>:TRIGger:A:BUS:I3C:BPACKets	Sets or queries the I3C Broadcast Packets search to Broadcast or Response.
SEARCH:SEARCH<x>:TRIGger:A:BUS:I3C:BRGTID:VALue	Sets or queries the binary field string used for the I3C trigger if the trigger condition is SETBRGTGT packet ID.
SEARCH:SEARCH<x>:TRIGger:A:BUS:I3C:CCODE:VALue	Sets or queries the binary field string used for the I3C trigger if the trigger condition is SETBRGTGT packet ID.
SEARCH:SEARCH<x>:TRIGger:A:BUS:I3C:CONDition	Sets or queries the trigger condition for the specified I3C bus trigger search to determine where to place a mark.
SEARCH:SEARCH<x>:TRIGger:A:BUS:I3C:DATA:DIRection	Sets or queries the direction of the data for the I3C bus trigger search to determine where to place a mark.
SEARCH:SEARCH<x>:TRIGger:A:BUS:I3C:DATA:SIZE	Sets or queries the length of the data string in bytes used for the specified I3C bus trigger search to determine where to place a mark.
SEARCH:SEARCH<x>:TRIGger:A:BUS:I3C:DATA:VALue	Sets or queries the data value of the data token for the specified I3C bus trigger search to determine where to place a mark.
SEARCH:SEARCH<x>:TRIGger:A:BUS:I3C:DCR:VALue	Sets or queries the binary field string used for the I3C bus search if the trigger condition is DCR.
SEARCH:SEARCH<x>:TRIGger:A:BUS:I3C:DCRType:VALue	Sets or queries the binary field string used for the I3C bus search if the trigger condition is DCRTYPE.

Table 2-39: Search and Mark commands (cont.)

Command	Description
SEARCH:SEARCH<x>:TRIGger:A:BUS:I3C:DWORd:VALue	Sets or queries the binary field string used for the I3C trigger if the trigger condition is DATAWORDS.
SEARCH:SEARCH<x>:TRIGger:A:BUS:I3C:ERRORTYPe	Sets or queries the error type condition for the specified I3C bus search to determine where to place a mark.
SEARCH:SEARCH<x>:TRIGger:A:BUS:I3C:EVENTBYTe:VALue	Sets or queries the binary field string used for the I3C trigger if the trigger condition is FREQUENCYBYTE.
SEARCH:SEARCH<x>:TRIGger:A:BUS:I3C:FREQBYTe:VALue	Sets or queries the binary field string used for the I3C trigger if the trigger condition is GETSTATUSLSB.
SEARCH:SEARCH<x>:TRIGger:A:BUS:I3C:GSLSB:VALue	Sets or queries the binary field string used for the I3C trigger if the trigger condition is GETSTATUSLSB.
SEARCH:SEARCH<x>:TRIGger:A:BUS:I3C:GMSB:VALue	Sets or queries the binary field string used for the I3C trigger if the trigger condition is GETSTATUSMSB.
SEARCH:SEARCH<x>:TRIGger:A:BUS:I3C:ID:VALue	Sets or queries the binary field string used for the I3C search if the trigger condition is ENTDA packet ID.
SEARCH:SEARCH<x>:TRIGger:A:BUS:I3C:INACCBYTe:VALue	Sets or queries the binary field string used for the I3C search if the trigger condition is INACCURACYBYTE.
SEARCH:SEARCH<x>:TRIGger:A:BUS:I3C:MAXREAD:VALue	Sets or queries the binary field string used for the I3C trigger if the trigger condition is MAXREAD.
SEARCH:SEARCH<x>:TRIGger:A:BUS:I3C:MAXRTURN:VALue	Sets or queries the binary field string used for the I3C trigger if the trigger condition is MAXREADTURN.
SEARCH:SEARCH<x>:TRIGger:A:BUS:I3C:MAXWRITe:VALue	Sets or queries the binary field string used for the I3C trigger if the trigger condition is MAXWRITE.
SEARCH:SEARCH<x>:TRIGger:A:BUS:I3C:PACKets	Sets or queries the I3C Direct Packets to Direct or Response.
SEARCH:SEARCH<x>:TRIGger:A:BUS:I3C:SADDrESS:VALue	Sets or queries the binary field string used for the I3C bus search if the trigger condition is SLAVEADDRESS.
SEARCH:SEARCH<x>:TRIGger:A:BUS:I3C:SDR:BROADCASTPacket	Sets or queries the SDR broadcast packets for the specified I3C bus trigger search to determine where to place a mark.
SEARCH:SEARCH<x>:TRIGger:A:BUS:I3C:SDR:DIRECTPacket	Sets or queries the SDR direct packet types for the specified I3C bus trigger search to determine where to place a mark.
SEARCH:SEARCH<x>:TRIGger:A:BUS:I3C:STATEBYTe:VALue	Sets or queries the binary field string used for the I3C trigger if the trigger condition is STATEBYTE.
SEARCH:SEARCH<x>:TRIGger:A:BUS:I3C:STATic:ADDrESS	Sets or queries the binary field string used for the I3C search if the trigger condition is STATICADDRESS.
SEARCH:SEARCH<x>:TRIGger:A:BUS:I3C:SUPPORTBYTe:VALue	Sets or queries the binary field string used for the I3C trigger if the trigger condition is SUPPORTEDBYTE.
SEARCH:SEARCH<x>:TRIGger:A:BUS:I3C:TESTMODe:VALue	Sets or queries the binary field string used for the I3C trigger if the trigger condition is TESTMODE.

Table 2-39: Search and Mark commands (cont.)

Command	Description
SEARCH:SEARCH<x>:TRIGger:A:BUS:LIN:DATA:HIVALue	Specifies the high data value to be used in a LIN search.
SEARCH:SEARCH<x>:TRIGger:A:BUS:LIN:DATA:QUALifier	Sets or queries the LIN bus search trigger data qualifier.
SEARCH:SEARCH<x>:TRIGger:A:BUS:LIN:DATA:SIZE	Sets or queries the LIN bus search trigger data size.
SEARCH:SEARCH<x>:TRIGger:A:BUS:LIN:DATA:VALue	Sets or queries the LIN bus search trigger data value.
SEARCH:SEARCH<x>:TRIGger:A:BUS:LIN:ERRTYPE	Sets or queries the LIN bus search trigger error type.
SEARCH:SEARCH<x>:TRIGger:A:BUS:LIN:IDentifier:VALue	Sets or queries the LIN bus search trigger identifier value.
SEARCH:SEARCH<x>:TRIGger:A:BUS:MANChester:CONDition	Specifies a field or condition for an Manchester bus to search on.
SEARCH:SEARCH<x>:TRIGger:A:BUS:MANChester:DATA:SIZE	Specifies the number of bits per word for the specified Manchester bus.
SEARCH:SEARCH<x>:TRIGger:A:BUS:MANChester:DATA:VALue	Specifies the binary string used for Manchester triggering if the trigger condition is data when searching on a Manchester signal.
SEARCH:SEARCH<x>:TRIGger:A:BUS:MANChester:ERRor:TYPE	Sets or queries the error to be used when searching on a Manchester signal.
SEARCH:SEARCH<x>:TRIGger:A:BUS:MANChester:HEADER:VALue	Specifies the binary string used for Manchester triggering if the trigger condition is header when searching on a Manchester signal.
SEARCH:SEARCH<x>:TRIGger:A:BUS:MANChester:packetOffData:VALue	Specifies the binary string used for Manchester triggering if the trigger condition is DATA.
SEARCH:SEARCH<x>:TRIGger:A:BUS:MANChester:SYNC:VALue	Specifies the binary string used for Manchester triggering if the trigger condition is Sync when searching on a Manchester signal.
SEARCH:SEARCH<x>:TRIGger:A:BUS:MANChester:TRAILER:VALue	Specifies the binary string used for Manchester triggering if the trigger condition is Trailer when searching on a Manchester signal.
SEARCH:SEARCH<x>:TRIGger:A:BUS:MDIO:ADDRESS:VALue	Specifies the binary address string used for MDIO triggering if the trigger condition is address.
SEARCH:SEARCH<x>:TRIGger:A:BUS:MDIO:CONDition	Sets or queries the trigger condition for MDIO bus.
SEARCH:SEARCH<x>:TRIGger:A:BUS:MDIO:DATA:VALue	Specifies the binary data string used for MDIO triggering if the trigger condition is DATA.
SEARCH:SEARCH<x>:TRIGger:A:BUS:MDIO:DEVicetype:VALue	Specifies the binary device type string used for MDIO triggering if the trigger condition is Device type.
SEARCH:SEARCH<x>:TRIGger:A:BUS:MDIO:ERRType	Sets or queries the error type to be used when triggering on MDIO data. This applies when the MDIO bus trigger condition is set to ERROR.

Table 2-39: Search and Mark commands (cont.)

Command	Description
SEARCH:SEARCH<x>:TRIGger:A:BUS:MDIO:OPCode:VALue	Specifies the binary op-code string used for MDIO triggering if the trigger condition is op-code .
SEARCH:SEARCH<x>:TRIGger:A:BUS:MDIO:PHYSicaladdress:VALue	Specifies the binary physical address string used for MDIO triggering if the trigger condition is physical address.
SEARCH:SEARCH<x>:TRIGger:A:BUS:MDIO:REGisteraddress:VALue	Specifies the binary register address string used for MDIO triggering if the trigger condition is register address.
SEARCH:SEARCH<x>:TRIGger:A:BUS:MIL1553B:CONDition	Sets or queries the field or condition for a MIL-STD-1553 bus to search on.
SEARCH:SEARCH<x>:TRIGger:A:BUS:MIL1553B:ERRTYPE	Sets or queries the type of error condition for a MIL-STD-1553 bus to search on.
SEARCH:SEARCH<x>:TRIGger:A:BUS:MIL1553B:COMMAND:TRBit	Sets or queries the value of the command word Transmit / Receive bit for a MIL-STD-1553 bus to search on.
SEARCH:SEARCH<x>:TRIGger:A:BUS:MIL1553B:COMMAND:PARity	Sets or queries the value of the command word parity bit for a MIL-STD-1553 bus to search on.
SEARCH:SEARCH<x>:TRIGger:A:BUS:MIL1553B:COMMAND:COUNT	Sets or queries the value of the command word "word count" field for a MIL-STD-1553 bus to search on.
SEARCH:SEARCH<x>:TRIGger:A:BUS:MIL1553B:COMMAND:SUBADdress	Sets or queries the value of the command word subaddress field for a MIL-STD-1553 bus to search on.
SEARCH:SEARCH<x>:TRIGger:A:BUS:MIL1553B:COMMAND:ADDRess:QUALifier	Sets or queries the qualifier to be used when searching on command word addresses for a MIL-STD-1553 bus.
SEARCH:SEARCH<x>:TRIGger:A:BUS:MIL1553B:COMMAND:ADDRess:VALue	Sets or queries the low value when searching on command word addresses for a MIL-STD-1553 bus.
SEARCH:SEARCH<x>:TRIGger:A:BUS:MIL1553B:COMMAND:ADDRess:HIVALue	Sets or queries the high value when searching on command word addresses for a MIL-STD-1553 bus.
SEARCH:SEARCH<x>:TRIGger:A:BUS:MIL1553B:DATA:PARity	Sets or queries the value of the command word parity bit for a MIL-STD-1553 bus to search on.
SEARCH:SEARCH<x>:TRIGger:A:BUS:MIL1553B:DATA:VALue	Sets or queries the value when searching on data words for a MIL-STD-1553 bus.
SEARCH:SEARCH<x>:TRIGger:A:BUS:MIL1553B:STATus:PARity	Sets or queries the value of the status word parity bit for a MIL-STD-1553 bus to search on.
SEARCH:SEARCH<x>:TRIGger:A:BUS:MIL1553B:STATus:ADDRess:QUALifier	Sets or queries the qualifier to be used when searching on status word addresses for a MIL-STD-1553 bus.
SEARCH:SEARCH<x>:TRIGger:A:BUS:MIL1553B:STATus:ADDRess:VALue	Sets or queries the low value when searching on status word addresses for a MIL-STD-1553 bus.
SEARCH:SEARCH<x>:TRIGger:A:BUS:MIL1553B:STATus:ADDRess:HIVALue	Sets or queries the high value when searching on status word addresses for a MIL-STD-1553 bus.
SEARCH:SEARCH<x>:TRIGger:A:BUS:MIL1553B:STATus:BIT:ME	Sets or queries the value of the message error bit (ME bit, bit 9) in a status word for a MIL-STD-1553 bus to search on.

Table 2-39: Search and Mark commands (cont.)

Command	Description
SEARCH:SEARCH<x>:TRIGger:A:BUS:MIL1553B:STATus:BIT:INSTR	Sets or queries the value of the instrumentation bit (INSTR bit, bit 10) in a status word for a MIL-STD-1553 bus to search on.
SEARCH:SEARCH<x>:TRIGger:A:BUS:MIL1553B:STATus:BIT:SRQ	Sets or queries the value of the status word service request bit (SRQ bit, bit 11) in a status word for a MIL-STD-1553 bus to search on.
SEARCH:SEARCH<x>:TRIGger:A:BUS:MIL1553B:STATus:BIT:BCR	Sets or queries the value of the broadcast command received bit (BCR bit, bit 15) in a status word for a MIL-STD-1553 bus to search on.
SEARCH:SEARCH<x>:TRIGger:A:BUS:MIL1553B:STATus:BIT:BUSY	Sets or queries the value of the busy bit (BUSY bit, bit 16) in a status word for a MIL-STD-1553 bus to search on.
SEARCH:SEARCH<x>:TRIGger:A:BUS:MIL1553B:STATus:BIT:SUBSF	Ssets or queries the value of the subsystem flag bit (SUBSF bit, bit 17) in a status word for a MIL-STD-1553 bus to search on.
SEARCH:SEARCH<x>:TRIGger:A:BUS:MIL1553B:STATus:BIT:DBCA	Sets or queries the value of the dynamic bus control acceptance bit (DBCA bit, bit 18) in a status word for a MIL-STD-1553 bus to search on.
SEARCH:SEARCH<x>:TRIGger:A:BUS:MIL1553B:STATus:BIT:TF	Sets or queries the value of the terminal flag bit (TF bit, bit 19) in a status word for a MIL-STD-1553 bus to search on.
SEARCH:SEARCH<x>:TRIGger:A:BUS:B:NRZ:CONDition	Specifies a field or condition for an NRZ bus to search on.
SEARCH:SEARCH<x>:TRIGger:A:BUS:NRZ:DATa:SIZE	Specifies the length of the data string, in bytes, to use when searching on the NRZ signal.
SEARCH:SEARCH<x>:TRIGger:A:BUS:NRZ:DATa:VALue	Sets or queries the binary data value to be used when searching on a NRZ signal.
SEARCH:SEARCH<x>:TRIGger:A:BUS:ONEWIRE:COMMand:VALue	This command specifies the binary data string used for ONEWIRE triggering if the trigger condition is COMMAND.
SEARCH:SEARCH<x>:TRIGger:A:BUS:ONEWIRE:CONDition	This command sets or queries the trigger condition for a ONEWIRE bus.
SEARCH:SEARCH<x>:TRIGger:A:BUS:ONEWIRE:DATa:SIZE	This command specifies the length of the data string in bytes to be used for ONEWIRE triggering if the trigger condition is DATA.
SEARCH:SEARCH<x>:TRIGger:A:BUS:ONEWIRE:DATa:VALue	This command specifies the binary data string used for ONEWIRE triggering if the trigger condition is DATA.
SEARCH:SEARCH<x>:TRIGger:A:BUS:ONEWIRE:MATCHROM:FAMILYCODE	This command sets or queries the family code for Match ROM in ONEWIRE bus.
SEARCH:SEARCH<x>:TRIGger:A:BUS:ONEWIRE:MATCHROM:SERIALNUMBer	This command sets or queries the serial number for Match ROM in ONEWIRE bus.
SEARCH:SEARCH<x>:TRIGger:A:BUS:ONEWIRE:OVERDRIVE:FAMILYCODE	This command sets or queries the Family Code for Overdrive match ROM in ONEWIRE bus.
SEARCH:SEARCH<x>:TRIGger:A:BUS:ONEWIRE:OVERDRIVE:SERIALNUMBer	This command sets or queries the serial number for Overdrive match ROM in ONEWIRE bus.
SEARCH:SEARCH<x>:TRIGger:A:BUS:ONEWIRE:READROM:FAMILYCODE	This command sets or queries the family code for Read ROM in ONEWIRE bus.



Table 2-39: Search and Mark commands (cont.)

Command	Description
SEARCH:SEARCH<x>:TRIGger:A:BUS:ONEWIRe:READROM:SERIALNUMBer	This command sets or queries the serial number for Read ROM in ONEWIRE bus.
SEARCH:SEARCH<x>:TRIGger:A:BUS:ONEWIRe:SEARCHROM:ROMCODE	This command sets or queries the ROM code for Search ROM in ONEWIRE bus.
SEARCH:SEARCH<x>:TRIGger:A:BUS:PARAllel:DATa:VALue	Sets or queries the data value for a parallel bus trigger search to determine where to place a mark.
SEARCH:SEARCH<x>:TRIGger:A:BUS:PSIFIVe:BLOCKDATa:VALue	Sets or queries the binary block data string used for PSI5 triggering if the trigger condition is block ID.
SEARCH:SEARCH<x>:TRIGger:A:BUS:PSIFIVe:CONDition	Sets or queries the trigger condition for an PSI5 bus.
SEARCH:SEARCH<x>:TRIGger:A:BUS:PSIFIVe:DATa:ECU:SENSor:VALue	Sets or queries the binary data string used for PSI5 triggering if the trigger condition is Data in ECU to Sensor communication mode.
SEARCH:SEARCH<x>:TRIGger:A:BUS:PSIFIVe:DATa:REGion:A:VALue	Sets or queries the binary data string used for PSI5 triggering if the trigger condition is data region A.
SEARCH:SEARCH<x>:TRIGger:A:BUS:PSIFIVe:DATa:REGion:B:VALue	Sets or queries the length of the data string in bytes to be used for an PSI5 trigger if the trigger condition is data region B.
SEARCH:SEARCH<x>:TRIGger:A:BUS:PSIFIVe:DATABITs	Sets or queries the binary register address string used for PSI5 triggering if the trigger condition is data in ECU to Sensor communication mode.
SEARCH:SEARCH<x>:TRIGger:A:BUS:PSIFIVe:ERRORTYPE	Sets or queries the error type for an PSI5 bus.
SEARCH:SEARCH<x>:TRIGger:A:BUS:PSIFIVe:FUNCTIONCODETYPE	Sets or queries the binary data string used for PSI5 triggering if the trigger condition is a Function Code.
SEARCH:SEARCH<x>:TRIGger:A:BUS:PSIFIVe:REGister:ADDRess:VALue	Sets or queries the binary register address string used for PSI5 triggering if the trigger condition is Register Address.
SEARCH:SEARCH<x>:TRIGger:A:BUS:PSIFIVe:REGISTERADDRess	Sets or queries the register address for PSI5 bus.
SEARCH:SEARCH<x>:TRIGger:A:BUS:PSIFIVe:SENSor:ADDRess:VALue	Sets or queries the binary sensor address string used for PSI5 triggering if the trigger condition is Sensor Address.
SEARCH:SEARCH<x>:TRIGger:A:BUS:PSIFIVe:SENSORSTATus:TYPE	Sets or queries the sensor status for PSI5 bus.
SEARCH:SEARCH<x>:TRIGger:A:BUS:PSIFIVe:STATus:VALue	Sets or queries the binary status string used for PSI5 triggering if the trigger condition is status.
SEARCH:SEARCH<x>:TRIGger:A:BUS:RS232C:DATa:VALue	Sets or queries the data string value for the specified RS232c bus trigger search to determine where to place a mark.
SEARCH:SEARCH<x>:TRIGger:A:BUS:RS232C:CONDition	Sets or queries the condition for an RS232C bus search to determine where to place a mark.
SEARCH:SEARCH<x>:TRIGger:A:BUS:RS232C:DATa:SIZE	Sets or queries the length of the data string in bytes to be used for an RS232 bus search to determine where to place a mark when the search condition is Data.

**Table 2-39: Search and Mark commands (cont.)**

<b>Command</b>	<b>Description</b>
SEARCH:SEARCH<x>:TRIGger:A:BUS:S8B10B:CONDition	Sets or queries the type of data search for an 8B10b bus.
SEARCH:SEARCH<x>:TRIGger:A:BUS:S8B10B:DISParity	Sets or queries the disparity to be used when searching on a 8B10b signal.
SEARCH:SEARCH<x>:TRIGger:A:BUS:S8B10B:ERRor	Sets or queries the error type to be used when searching on a 8B10b signal.
SEARCH:SEARCH<x>:TRIGger:A:BUS:S8B10B:SYMbol:CSYMVALue	Sets or queries the control symbol value to be used when searching on 8b10b signal.
SEARCH:SEARCH<x>:TRIGger:A:BUS:S8B10B:SYMbol:EBITVALue	Specifies the 8 bit value to be used when searching on an 8b10b signal.
SEARCH:SEARCH<x>:TRIGger:A:BUS:S8B10B:SYMbol:TBITVALue	Specifies the 10 bit value to be used when searching on an 8b10b signal.
SEARCH:SEARCH<x>:TRIGger:A:BUS:S8B10B:SYMbol:MODE	Sets or queries the mode of data search to be used when searching on 8b10b signal.
SEARCH:SEARCH<x>:TRIGger:A:BUS:S8B10B:SYMbol:TBITRDNeg	Specifies the 10 bit RD positive value to be used when searching on an 8b10b signal
SEARCH:SEARCH<x>:TRIGger:A:BUS:S8B10B:SYMbol:TBITRDPos	Specifies the 10 bit RD negative value to be used when searching on an 8b10b signal
SEARCH:SEARCH<x>:TRIGger:A:BUS:S8B10B:SYMbol:TYPe	Sets or queries the type of symbol when searching on 8b10b signal.
SEARCH:SEARCH<x>:TRIGger:A:BUS:SDLC:ADDRess:TYPe	Sets or queries the Address in SDLC bus.
SEARCH:SEARCH<x>:TRIGger:A:BUS:SDLC:CONDition	Sets or queries the trigger condition for a SDLC bus.
SEARCH:SEARCH<x>:TRIGger:A:BUS:SDLC:DATA:SIZE	Specifies the length of the data string in bytes to be used for SDLC triggering if the trigger condition is DATA.
SEARCH:SEARCH<x>:TRIGger:A:BUS:SDLC:DATA:VALue	Specifies the binary data string used for SDLC triggering if the trigger condition is DATA.
SEARCH:SEARCH<x>:TRIGger:A:BUS:SDLC:ERROR:TYPe	Sets or queries the Error Type in SDLC bus.
SEARCH:SEARCH<x>:TRIGger:A:BUS:SDLC:FRAMe:TYPe	Sets or queries the Frame Type in SDLC bus.
SEARCH:SEARCH<x>:TRIGger:A:BUS:SDLC:STADDRess:VALue	Specifies the binary Station Address string used for SDLC triggering if the trigger condition is Address.
SEARCH:SEARCH<x>:TRIGger:A:BUS:SDLC:SUPervisory:FRAMETYPE	Sets or queries the Supervisory Frame Type in SDLC bus.
SEARCH:SEARCH<x>:TRIGger:A:BUS:SDLC:UNNumbered:FRAMETYPE	Sets or queries the Unnumbered Frame Type in SDLC bus.

Table 2-39: Search and Mark commands (cont.)

Command	Description
SEARCH:SEARCH<x>:TRIGger:A:BUS:SENT:CONDition	Sets or queries the search condition for a SENT bus.
SEARCH:SEARCH<x>:TRIGger:A:BUS:SENT:ERRType	Sets or queries the error type to be used when searching on SENT data.
SEARCH:SEARCH<x>:TRIGger:A:BUS:SENT:ERRType:CRC	Sets or queries the CRC error type to be used when searching on SENT data.
SEARCH:SEARCH<x>:TRIGger:A:BUS:SENT:FAST:CHAN1A:HIVALue	Sets or queries the high binary fast channel 1 value to use when searching on a SENT bus signal.
SEARCH:SEARCH<x>:TRIGger:A:BUS:SENT:FAST:CHAN1A:QUALifier	Sets or queries the qualifier to be used when searching on SENT fast packet bus data for device channel 1.
SEARCH:SEARCH<x>:TRIGger:A:BUS:SENT:FAST:CHAN1A:VALue	Sets or queries the binary fast channel 1 value to be used when searching on a SENT bus signal.
SEARCH:SEARCH<x>:TRIGger:A:BUS:SENT:FAST:CHAN2B:HIVALue	Sets or queries the high binary fast channel 2 value to use when searching on a SENT bus signal.
SEARCH:SEARCH<x>:TRIGger:A:BUS:SENT:FAST:CHAN2B:QUALifier	Sets or queries the qualifier to be used when searching on SENT fast packet bus data for device channel 2.
SEARCH:SEARCH<x>:TRIGger:A:BUS:SENT:FAST:CHAN2B:VALue	Sets or queries the binary fast channel 2 value to be used when searching on a SENT bus signal.
SEARCH:SEARCH<x>:TRIGger:A:BUS:SENT:FAST:COUNTER:HIVALue	Sets or queries the high binary fast message counter value to use when searching on a SENT bus signal.
SEARCH:SEARCH<x>:TRIGger:A:BUS:SENT:FAST:COUNTER:QUALifier	Sets or queries the qualifier to be used when searching on SENT fast packet bus data for the secure format counter.
SEARCH:SEARCH<x>:TRIGger:A:BUS:SENT:FAST:COUNTER:VALue	Sets or queries the binary fast message counter value to be used when searching on a SENT bus signal.
SEARCH:SEARCH<x>:TRIGger:A:BUS:SENT:FAST:INVERTNIBble:VALue	Sets or queries the binary fast message inverted nibble value to be used when searching on a SENT bus signal.
SEARCH:SEARCH<x>:TRIGger:A:BUS:SENT:FAST:STATUS:VALue	Sets or queries the binary status value to be used when searching on a SENT bus signal.
SEARCH:SEARCH<x>:TRIGger:A:BUS:SENT:PAUSE:QUALifier	Sets or queries the qualifier to be used when searching on SENT pause pulses.
SEARCH:SEARCH<x>:TRIGger:A:BUS:SENT:PAUSE:TICKs:HIVALue	Sets or queries the maximum number of pause clock ticks to be used when searching on a SENT bus signal.
SEARCH:SEARCH<x>:TRIGger:A:BUS:SENT:PAUSE:TICKs:VALue	Sets or queries the minimum number of pause clock ticks to be used when searching on a SENT bus signal.
SEARCH:SEARCH<x>:TRIGger:A:BUS:SENT:SLOW:DATA:HIVALue	Sets or queries the high binary Slow channel data value to use when searching on SENT Slow packet bus data.
SEARCH:SEARCH<x>:TRIGger:A:BUS:SENT:SLOW:DATA:QUALifier	Sets or queries the qualifier to be used when searching on SENT Slow packet bus data.

Table 2-39: Search and Mark commands (cont.)

Command	Description
SEARCH:SEARCH<x>:TRIGger:A:BUS:SENT:SLOW:DATA:VALue	Sets or queries the binary slow channel data value to be used when searching on SENT Slow packet bus data.
SEARCH:SEARCH<x>:TRIGger:A:BUS:SENT:SLOW:IDentifier:VALue	Sets or queries the binary Slow identifier value to be used when searching on SENT Slow packet bus data.
SEARCH:SEARCH<x>:TRIGger:A:BUS:SMBUS:ADDReSS:VALue	Sets or queries the binary physical address string used for SMBUS triggering if the trigger condition is address.
SEARCH:SEARCH<x>:TRIGger:A:BUS:SMBUS:COMMand:VALue	Sets or queries the binary command code string used for SMBUS triggering if the trigger condition is command code.
SEARCH:SEARCH<x>:TRIGger:A:BUS:SMBUS:CONDition	Sets or queries the trigger condition for a SMBUS bus.
SEARCH:SEARCH<x>:TRIGger:A:BUS:SMBUS:DATA:SIZE	Sets or queries the length of the data string in bytes to be used for an SMBus trigger if the trigger condition is DATA.
SEARCH:SEARCH<x>:TRIGger:A:BUS:SMBUS:DATA:VALue	Sets or queries the binary data string used for SMBus triggering if the trigger condition is DATA.
SEARCH:SEARCH<x>:TRIGger:A:BUS:SMBUS:DEVICEADDR:VALue	Sets or queries the binary physical address string used for SMBUS triggering if the trigger condition is Device address.
SEARCH:SEARCH<x>:TRIGger:A:BUS:SMBUS:ERROR:TYPE	Sets or queries the Error type for a SMBus.
SEARCH:SEARCH<x>:TRIGger:A:BUS:SMBUS:FIELDBYTE	Sets or queries the field byte for a SMBUS bus if trigger condition is UDID data.
SEARCH:SEARCH<x>:TRIGger:A:BUS:SMBUS:UDIDDATA:VALue	Sets or queries the binary data string used for SMBus triggering if the trigger condition is UDID DATA.
SEARCH:SEARCH<x>:TRIGger:A:BUS:SOURce	Sets or queries the bus source for the specified bus trigger search to determine where to place a mark.
SEARCH:SEARCH<x>:TRIGger:A:BUS:SPACEWIRe:CONDition	S
SEARCH:SEARCH<x>:TRIGger:A:BUS:SPACEWIRe:CONTROLCHARTYPE	Sets or queries the control character type to use when searching on a SpaceWire bus signal.
SEARCH:SEARCH<x>:TRIGger:A:BUS:SPACEWIRe:CONTROLCODETYPE	Sets or queries the control code type to use when searching on a SpaceWire bus signal.
SEARCH:SEARCH<x>:TRIGger:A:BUS:SPACEWIRe:DATA:SIZE	Sets or queries the length of the data string, in bytes, to use when searching on a SpaceWire bus signal.
SEARCH:SEARCH<x>:TRIGger:A:BUS:SPACEWIRe:DATA:VALue	Sets or queries the binary data value to be used when searching on an SpaceWire bus signal.
SEARCH:SEARCH<x>:TRIGger:A:BUS:SPACEWIRe:ERRORTYPE	Sets or queries the error type for which to search on the SpaceWire bus signal.
SEARCH:SEARCH<x>:TRIGger:A:BUS:SPACEWIRe:TIMECode:VALue	Sets or queries the binary data string used for SpaceWire search if the search condition is Time Code.

Table 2-39: Search and Mark commands (cont.)

Command	Description
SEARCH:SEARCH<x>:TRIGger:A:BUS:SPI:CONDition	Sets or queries the trigger condition for the specified SPI bus trigger search to determine where to place a mark.
SEARCH:SEARCH<x>:TRIGger:A:BUS:SPI:DATa:SIZE	Sets or queries the length of the data string in bytes used for the specified SPI bus trigger search to determine where to place a mark.
SEARCH:SEARCH<x>:TRIGger:A:BUS:SPI:DATa:VALue	Sets or queries the data value of the data token for the specified SPI bus trigger search to determine where to place a mark.
SEARCH:SEARCH<x>:TRIGger:A:BUS:SPI:SOURCEType	Sets or queries trigger Source for SPI bus.
SEARCH:SEARCH<x>:TRIGger:A:BUS:SPMI:CONDition	This command sets or queries the search condition for an SPMI bus.
SEARCH:SEARCH<x>:TRIGger:A:BUS:SPMI:DATa:VALue	This command specifies the binary data string used for SPMI when the search condition is MASTERREAd, MASTERWRite, REGREAd, REGWRite, EXTREGREAd, EXTREGWRite, LONGEXTREGREAd, LONGEXTREGWRite, or REGOWRite.
SEARCH:SEARCH<x>:TRIGger:A:BUS:SPMI:MASTERADDRess:VALue	This command sets or queries the binary data string that identifies the master address used in SPMI search.
SEARCH:SEARCH<x>:TRIGger:A:BUS:SPMI:NORESPonse	This command sets or queries whether or not to search for No Response frames.
SEARCH:SEARCH<x>:TRIGger:A:BUS:SPMI:REGISTERADDRess:VALue	This command sets or queries the binary data string that identifies the register address used in SPMI triggering.
SEARCH:SEARCH<x>:TRIGger:A:BUS:SPMI:SLAVEADDRess:VALue	This command sets or queries the binary data string that identifies the slave address used in SPMI.
SEARCH:SEARCH<x>:TRIGger:A:BUS:SVID:COMManD:RESPonse	Sets or queries the command response of respective command type for SVID bus.
SEARCH:SEARCH<x>:TRIGger:A:BUS:SVID:COMManD:TYPE	Sets or queries the command type for SVID bus.
SEARCH:SEARCH<x>:TRIGger:A:BUS:SVID:CONDition	Sets or queries the trigger condition for SVID bus.
SEARCH:SEARCH<x>:TRIGger:A:BUS:SVID:ERRor:TYPE	Sets or queries the error type for SVID bus.
SEARCH:SEARCH<x>:TRIGger:A:BUS:SVID:PAYLoad:TYPE	Sets or queries the payload type for SVID bus.
SEARCH:SEARCH<x>:TRIGger:A:BUS:SVID:PAYLoad:VALue	Sets or queries the payload value to be used when search is on SVID bus.
SEARCH:SEARCH<x>:TRIGger:A:BUS:SVID:SLAVE:ADDRESS	Sets or queries the slave address to be used when search is on SVID bus.
SEARCH:SEARCH<x>:TRIGger:A:BUS:USB:ADDRess:HIVALue	Sets or queries the address value for normal token to be used with In Range and Out of Range qualifiers for the specified USB bus trigger search to determine where to place a mark.

Table 2-39: Search and Mark commands (cont.)

Command	Description
SEARCH:SEARCH<x>:TRIGger:A:BUS:USB:ADDRESS:VALue	Sets or queries the address value for normal token for the specified USB bus trigger search to determine where to place a mark.
SEARCH:SEARCH<x>:TRIGger:A:BUS:USB:CONDition	Sets or queries the search condition for the specified USB bus trigger search to determine where to place a mark.
SEARCH:SEARCH<x>:TRIGger:A:BUS:USB:DATA:HIVALue	Sets or queries the data value for data token used with In Range and Out of Range qualifiers for the specified USB bus trigger search to determine where to place a mark.
SEARCH:SEARCH<x>:TRIGger:A:BUS:USB:DATA:OFFSet	Sets or queries data offset for the specified USB bus trigger search to determine where to place a mark.
SEARCH:SEARCH<x>:TRIGger:A:BUS:USB:DATA:SIZE	Sets or queries the length of the data string in bytes for the specified USB bus trigger search to determine where to place a mark.
SEARCH:SEARCH<x>:TRIGger:A:BUS:USB:DATA:TYPE	Sets or queries the data packet type for the specified USB bus trigger search to determine where to place a mark.
SEARCH:SEARCH<x>:TRIGger:A:BUS:USB:DATA:VALue	Sets or queries the data value for data token for the specified bus trigger search to determine where to place a mark.
SEARCH:SEARCH<x>:TRIGger:A:BUS:USB:ENDPoint:VALue	Sets or queries the endpoint value for normal token for the specified USB bus trigger search to determine where to place a mark.
SEARCH:SEARCH<x>:TRIGger:A:BUS:USB:ERRType	Sets or queries the error type for the specified USB bus trigger search to determine where to place a mark.
SEARCH:SEARCH<x>:TRIGger:A:BUS:USB:HANDSHAKType	Sets or queries the handshake type for the specified USB bus trigger search to determine where to place a mark.
SEARCH:SEARCH<x>:TRIGger:A:BUS:USB:SOFFRAMENUMber	Sets or queries the frame number string to use for the Start of Frame for the specified USB bus trigger search to determine where to place a mark.
SEARCH:SEARCH<x>:TRIGger:A:BUS:USB:SPECIALType	Sets or queries the PID value for the USB bus trigger search to determine where to place a mark.
SEARCH:SEARCH<x>:TRIGger:A:BUS:USB:SPLIT:ET:VALue	Sets or queries the Endpoint Type value for the specified USB bus trigger split token field search to determine where to place a mark.
SEARCH:SEARCH<x>:TRIGger:A:BUS:USB:SPLIT:HUB:VALue	Sets or queries the hub address of the specified USB bus trigger on split token field search to determine where to place a mark.
SEARCH:SEARCH<x>:TRIGger:A:BUS:USB:SPLIT:PORT:VALue	Sets or queries the port address for the specified USB bus trigger on split token field search to determine where to place a mark.
SEARCH:SEARCH<x>:TRIGger:A:BUS:USB:SPLIT:SC:VALue	Sets or queries the Start/Complete value for the specified USB bus trigger on split token field search to determine where to place a mark.
SEARCH:SEARCH<x>:TRIGger:A:BUS:USB:SPLIT:SE:VALue	Sets or queries the Start/End value for the specified USB bus trigger on split token field search to determine where to place a mark.
SEARCH:SEARCH<x>:TRIGger:A:BUS:USB:TOKENType	Sets or queries the token type when the specified USB bus trigger search to determine where to place a mark.
SEARCH:SEARCH<x>:TRIGger:A:EDGE:SLOpe	Sets or queries the slope for an edge trigger search to determine where to place a mark.

Table 2-39: Search and Mark commands (cont.)

Command	Description
SEARCH:SEARCH<x>:TRIGger:A:DDRREAD: BURSTDETECTmethod	This command sets or queries the DDRRead search burst detection method.
SEARCH:SEARCH<x>:TRIGger:A:DDRREAD: BURSTLatency	This command sets or queries the DDR read logic state burst latency value.
SEARCH:SEARCH<x>:TRIGger:A:DDRREAD: BURSTLENGTH	This command sets or queries the DDR read logic state burst length value.
SEARCH:SEARCH<x>:TRIGger:A:DDRREAD: CSActive	This command sets or queries the DDR Read chip select active state.
SEARCH:SEARCH<x>:TRIGger:A:DDRREAD: CSLevel	This command sets or queries the DDR Read chip select level value.
SEARCH:SEARCH<x>:TRIGger:A:DDRREAD: CSMode	This command sets or queries the DDR Read chip select mode.
SEARCH:SEARCH<x>:TRIGger:A:DDRREAD: CSSource	This command sets or queries the DDR Read search chip select source.
SEARCH:SEARCH<x>:TRIGger:A:DDRREAD: DATARate	Sets or queries the DDR read search data rate for DDR3 and LPDDR3 standards of the specified search.
SEARCH:SEARCH<x>:TRIGger:A:DDRREAD: DATASource	Sets or queries the DDR read data source when the search type is DDR READ.
SEARCH:SEARCH<x>:TRIGger:A:DDRREAD: HYSteresis	Sets or queries the DDR read hysteresis reference level value, when the search type is DDR READ.
SEARCH:SEARCH<x>:TRIGger:A:DDRREAD: LOGIC1SOURCE:SYMBOL	This command sets or queries the DDR read logic source 1 symbol.
SEARCH:SEARCH<x>:TRIGger:A:DDRREAD: LOGIC2SOURCE:SYMBOL	This command sets or queries the DDR read logic source 2 symbol.
SEARCH:SEARCH<x>:TRIGger:A:DDRREAD: LOGIC3SOURCE:SYMBOL	This command sets or queries the DDR read logic source 3 symbol.
SEARCH:SEARCH<x>:TRIGger:A:DDRREAD: LOGIC4SOURCE:SYMBOL	This command sets or queries the DDR read logic source 4 symbol.
SEARCH:SEARCH<x>:TRIGger:A:DDRREAD: MARGin	Sets or queries the DDR read margin reference level value, when the search type is DDR READ.
SEARCH:SEARCH<x>:TRIGger:A:DDRREAD: MAXCAS	This command sets or queries the DDR read chip maximum Column Access Strobe (CAS) value.
SEARCH:SEARCH<x>:TRIGger:A:DDRREAD: MINCas	This command sets or queries the DDR read chip minimum Column Access Strobe (CAS) value.
SEARCH:SEARCH<x>:TRIGger:A:DDRREAD: POSTAMBLE:LENGTH	Sets or queries the DDR read postamble length when the search type is DDR READ.
SEARCH:SEARCH<x>:TRIGger:A:DDRREAD: PREAMBLE:TYPE	Sets or queries the DDR read preamble type when the search type is DDR READ.

Table 2-39: Search and Mark commands (cont.)

Command	Description
SEARCH:SEARCH<x>:TRIGger:A:DDRREAD:REFLevel:DATA:HIGh	Sets or queries the DDR read data high reference level value, when the search type is DDR READ.
SEARCH:SEARCH<x>:TRIGger:A:DDRREAD:REFLevel:DATA:LOW	Sets or queries the DDR read data low reference level value, when the search type is DDR READ.
SEARCH:SEARCH<x>:TRIGger:A:DDRREAD:REFLevel:DATA:MID	Sets or queries the DDR read data mid reference level value, when the search type is DDR READ.
SEARCH:SEARCH<x>:TRIGger:A:DDRREAD:REFLevel:STROBE:HIGh	Sets or queries the DDR read reference level strobe high value, when the search type is DDR READ.
SEARCH:SEARCH<x>:TRIGger:A:DDRREAD:REFLevel:STROBE:LOW	Sets or queries the DDR read reference level strobe low value, when the search type is DDR READ.
SEARCH:SEARCH<x>:TRIGger:A:DDRREAD:REFLevel:STROBE:MID	Sets or queries the DDR read reference level strobe mid value, when the search type is DDR READ.
SEARCH:SEARCH<x>:TRIGger:A:DDRREAD:REFLEVELMode	Sets or queries the DDR read reference level mode to auto or manual, when the search type is DDR READ.
SEARCH:SEARCH<x>:TRIGger:A:DDRREAD:STANdard	Sets or queries the DDR read search standard as DDR3 or LPDDR3.
SEARCH:SEARCH<x>:TRIGger:A:DDRREAD:STROBESource	Sets or queries the DDR read strobe source when the search type is DDR READ.
SEARCH:SEARCH<x>:TRIGger:A:DDRREAD:TOLERance	This command sets or queries the DDR read logic state tolerance value.
SEARCH:SEARCH<x>:TRIGger:A:DDRREADWRITE:BURSTDETECTmethod	This command sets or queries the DDR Read/Write search burst detection method
SEARCH:SEARCH<x>:TRIGger:A:DDRREADWRITE:BURSTLatency	This command sets or queries the DDR read/write logic state burst latency value.
SEARCH:SEARCH<x>:TRIGger:A:DDRREADWRITE:BURSTLENGTH	This command sets or queries the DDR read/write logic state burst length value.
SEARCH:SEARCH<x>:TRIGger:A:DDRREADWRITE:CSActive	This command sets or queries the DDR Read/Write chip select active state.
SEARCH:SEARCH<x>:TRIGger:A:DDRREADWRITE:CSLevel	This command sets or queries the DDR Read/Write chip select level value.
SEARCH:SEARCH<x>:TRIGger:A:DDRREADWRITE:CSMode	This command sets or queries the DDR read/write chip select mode.
SEARCH:SEARCH<x>:TRIGger:A:DDRREADWRITE:CSSource	This command sets or queries the DDR Read/Write search chip select source.
SEARCH:SEARCH<x>:TRIGger:A:DDRREADWRITE:DATARate	Sets or queries the DDR read/write data rate for DDR3 and LPDDR3 standards of the specified search.
SEARCH:SEARCH<x>:TRIGger:A:DDRREADWRITE:DATASource	Sets or queries the DDR read/write data source when the search type is DDR READWRITE.



Table 2-39: Search and Mark commands (cont.)

Command	Description
SEARCH:SEARCH<x>:TRIGger:A:DDRREADWRITE:HYSteresis	Sets or queries the DDR read/write hysteresis reference level value, when the search type is DDR READWRITE.
SEARCH:SEARCH<x>:TRIGger:A:DDRREADWRITE:LOGIC1SOUrce:SYMBOL	This command sets or queries the DDR read/write logic source 1 symbol.
SEARCH:SEARCH<x>:TRIGger:A:DDRREADWRITE:LOGIC2SOUrce:SYMBOL	This command sets or queries the DDR read/write logic source 2 symbol.
SEARCH:SEARCH<x>:TRIGger:A:DDRREADWRITE:LOGIC3SOUrce:SYMBOL	This command sets or queries the DDR read/write logic source 3 symbol.
SEARCH:SEARCH<x>:TRIGger:A:DDRREADWRITE:LOGIC4SOUrce:SYMBOL	This command sets or queries the DDR read/write logic source 4 symbol.
SEARCH:SEARCH<x>:TRIGger:A:DDRREADWRITE:MARgin	Sets or queries the DDR read/write margin reference level value, when the search type is DDR READWRITE.
SEARCH:SEARCH<x>:TRIGger:A:DDRREADWRITE:MAXCAS	This command sets or queries the DDR read/write chip maximum Column Access Strobe (CAS) value.
SEARCH:SEARCH<x>:TRIGger:A:DDRREADWRITE:MINCas	This command sets or queries the DDR read/write chip minimum Column Access Strobe (CAS) value.
SEARCH:SEARCH<x>:TRIGger:A:DDRREADWRITE:POSTAMBLE:LENGth	Sets or queries the DDR read/write postamble length when the search type is DDR READWRITE.
SEARCH:SEARCH<x>:TRIGger:A:DDRREADWRITE:PREAMBLE:TYPE	Sets or queries the DDR read/write preamble type when the search type is DDR READWRITE.
SEARCH:SEARCH<x>:TRIGger:A:DDRREADWRITE:REFLevel:DATA:HIGH	Sets or queries the DDR read/write data high reference level value, when the search type is DDR READWRITE.
SEARCH:SEARCH<x>:TRIGger:A:DDRREADWRITE:REFLevel:DATA:LOW	Sets or queries the DDR read/write data low reference level value, when the search type is DDR READWRITE.
SEARCH:SEARCH<x>:TRIGger:A:DDRREADWRITE:REFLevel:DATA:MID	Sets or queries the DDR read/write data mid reference level value, when the search type is DDR READWRITE.
SEARCH:SEARCH<x>:TRIGger:A:DDRREADWRITE:REFLevel:STROBE:HIGH	Sets or queries the DDR read/write reference level strobe high value, when the search type is DDR READWRITE.
SEARCH:SEARCH<x>:TRIGger:A:DDRREADWRITE:REFLevel:STROBE:LOW	Sets or queries the DDR read/write reference level strobe low value, when the search type is DDR READWRITE.
SEARCH:SEARCH<x>:TRIGger:A:DDRREADWRITE:REFLevel:STROBE:MID	Sets or queries the DDR read/write reference level strobe mid value, when the search type is DDR READWRITE.
SEARCH:SEARCH<x>:TRIGger:A:DDRREADWRITE:REFLEVELMode	Sets or queries the DDR read/write reference level mode to auto or manual, when the search type is DDR READWRITE.
SEARCH:SEARCH<x>:TRIGger:A:DDRREADWRITE:STANdard	Sets or queries the DDR read/write search standard as DDR3 or LPDDR3.
SEARCH:SEARCH<x>:TRIGger:A:DDRREADWRITE:STROBESource	Sets or queries the DDR read/write strobe source when the search type is DDR READWRITE.

Table 2-39: Search and Mark commands (cont.)

Command	Description
SEARCH:SEARCH<x>:TRIGger:A:DDRREADWRITE:TOLERance	This command sets or queries the DDR read/write logic state tolerance value.
SEARCH:SEARCH<x>:TRIGger:A:DDRWRITE:BURSTDETECTmethod	This command sets or queries the DDRWRITE search burst detection method.
SEARCH:SEARCH<x>:TRIGger:A:DDRWRITE:BURSTLatency	This command sets or queries the DDR write logic state burst latency value.
SEARCH:SEARCH<x>:TRIGger:A:DDRWRITE:BURSTLENGTH	This command sets or queries the DDR write logic state burst length value.
SEARCH:SEARCH<x>:TRIGger:A:DDRWRITE:CSActive	This command sets or queries the DDR write chip select active state.
SEARCH:SEARCH<x>:TRIGger:A:DDRWRITE:CSLevel	This command sets or queries the DDR Write chip select level value.
SEARCH:SEARCH<x>:TRIGger:A:DDRWRITE:CSMode	This command sets or queries the DDR Write chip select mode.
SEARCH:SEARCH<x>:TRIGger:A:DDRWRITE:CSSource	This command sets or queries the DDR Write search chip select source.
SEARCH:SEARCH<x>:TRIGger:A:DDRWRITE:DATARate	Sets or queries the DDR write search data rate for DDR3 and LPDDR3 standards of the specified search.
SEARCH:SEARCH<x>:TRIGger:A:DDRWRITE:DATASource	Sets or queries the DDR write data source when the search type is DDR Write.
SEARCH:SEARCH<x>:TRIGger:A:DDRWRITE:HYSTeresis	Sets or queries the DDR write hysteresis reference level value when the search type is DDR WRITE.
SEARCH:SEARCH<x>:TRIGger:A:DDRWRITE:LOGIC1SOURCE:SYMBOL	This command sets or queries the DDR write logic source 1 symbol.
SEARCH:SEARCH<x>:TRIGger:A:DDRWRITE:LOGIC2SOURCE:SYMBOL	This command sets or queries the DDR write logic source 2 symbol.
SEARCH:SEARCH<x>:TRIGger:A:DDRWRITE:LOGIC3SOURCE:SYMBOL	This command sets or queries the DDR write logic source 3 symbol.
SEARCH:SEARCH<x>:TRIGger:A:DDRWRITE:LOGIC4SOURCE:SYMBOL	This command sets or queries the DDR write logic source 4 symbol.
SEARCH:SEARCH<x>:TRIGger:A:DDRWRITE:MARGIN	Sets or queries the DDR write margin reference level value, when the search type is DDR WRITE.
SEARCH:SEARCH<x>:TRIGger:A:DDRWRITE:MAXCAS	This command sets or queries the DDR write chip select maximum Column Access Strobe (CAS) value.
SEARCH:SEARCH<x>:TRIGger:A:DDRWRITE:MINCas	This command sets or queries the DDR write chip select minimum Column Access Strobe (CAS) value.
SEARCH:SEARCH<x>:TRIGger:A:DDRWRITE:POSTAMBLE:LENGTH	Sets or queries the DDR write postamble length when the search type is DDR WRITE.

Table 2-39: Search and Mark commands (cont.)

Command	Description
SEARCH:SEARCH<x>:TRIGger:A:DDRWRITE: PREAMBLE:TYPE	Sets or queries the DDR write preamble type when the search type is DDR WRITE.
SEARCH:SEARCH<x>:TRIGger:A:DDRWRITE: REFLevel:DATA:HIGH	Sets or queries the DDR write data high reference level value, when the search type is DDR WRITE.
SEARCH:SEARCH<x>:TRIGger:A:DDRWRITE: REFLevel:DATA:LOW	Sets or queries the DDR write data low reference level value, when the search type is DDR WRITE.
SEARCH:SEARCH<x>:TRIGger:A:DDRWRITE: REFLevel:DATA:MID	Sets or queries the DDR write data mid reference level value, when the search type is DDR WRITE.
SEARCH:SEARCH<x>:TRIGger:A:DDRWRITE: REFLevel:STROBE:HIGH	Sets or queries the DDR write reference level strobe high value, when the search type is DDR WRITE.
SEARCH:SEARCH<x>:TRIGger:A:DDRWRITE: REFLevel:STROBE:LOW	Sets or queries the DDR write reference level strobe low value, when the search type is DDR WRITE.
SEARCH:SEARCH<x>:TRIGger:A:DDRWRITE: REFLevel:STROBE:MID	Sets or queries the DDR write reference level strobe mid value, when the search type is DDR WRITE.
SEARCH:SEARCH<x>:TRIGger:A:DDRWRITE: REFLEVELMode	Sets or queries the DDR write reference level mode to auto or manual, when the search type is DDR WRITE.
SEARCH:SEARCH<x>:TRIGger:A:DDRWRITE: STANdard	Sets or queries the DDR write search standard as DDR3 or LPDDR3.
SEARCH:SEARCH<x>:TRIGger:A:DDRWRITE: STROBESource	Sets or queries the DDR write strobe source when the search type is DDR Write.
SEARCH:SEARCH<x>:TRIGger:A:DDRWRITE: TOLERance	This command sets or queries the DDR write logic state tolerance value.
SEARCH:SEARCH<x>:TRIGger:A:EDGE: SLOpe	Sets or queries the slope for an edge trigger search to determine where to place a mark.
SEARCH:SEARCH<x>:TRIGger:A:EDGE: SOUrce	Sets or queries the source waveform for an edge trigger search to determine where to place a mark.
SEARCH:SEARCH<x>:TRIGger:A:LOGIc: FUNCtion	Sets or queries the logic operator for a pattern or state trigger search to determine where to place a mark.
SEARCH:SEARCH<x>:TRIGger:A:LOGIc: USEClockedge	Sets whether or not Logic search uses a clock source.
SEARCH:SEARCH<x>:TRIGger:A:RUNT: WHEn	Sets or queries the condition setting for a runt trigger search to determine where to place a mark.
SEARCH:SEARCH<x>:TRIGger:A:RUNT:WIDth	Sets or queries the width setting for a runt trigger search to determine where to place a mark.
SEARCH:SEARCH<x>:TRIGger:A:SETHold: CLOck:EDGE	Sets or queries the clock slope setting for a setup/hold trigger search to determine where to place a mark.
SEARCH:SEARCH<x>:TRIGger:A:SETHold: CLOck:SOUrce	Sets or queries the clock source setting for a setup/hold trigger search to determine where to place a mark.

Table 2-39: Search and Mark commands (cont.)

Command	Description
SEARCH:SEARCH<x>:TRIGger:A:SETHold:HOLDTime	Sets or queries the hold time setting for a setup/hold trigger search to determine where to place a mark.
SEARCH:SEARCH<x>:TRIGger:A:SETHold:SETTime	Sets or queries the setup time setting for a setup/hold trigger search to determine where to place a mark.
SEARCH:SEARCH<x>:TRIGger:A:TIMEOut:TIME	Sets or queries the time setting for a timeout trigger search to determine where to place a mark.
SEARCH:SEARCH<x>:TRIGger:A:TRANSition:DELTATime	Sets or queries the transition time setting for a transition trigger search to determine where to place a mark.
SEARCH:SEARCH<x>:TRIGger:A:TRANSition:WHEN	Sets or queries the condition setting for a transition trigger search to determine where to place a mark.
SEARCH:SEARCH<x>:TRIGger:A:TYPE	Sets or queries the trigger type setting for a search to determine where to place a mark.
SEARCH:SEARCH<x>:TRIGger:A:WINDOW:WIDTH	Sets or queries the width setting for a window search to determine where to place a mark.
SEARCH:SEARCH<x>:TRIGger:A:BUS:LIN:CONDition	Sets or queries the LIN bus search trigger condition.
SEARCH:SEARCH<x>:TRIGger:A:BUS:USB:DATA:QUALifier	Sets or queries the qualifier to be used when searching on a USB bus signal.
SEARCH:SEARCH<x>:TRIGger:A:EDGE:THRESHold	Sets or queries the source threshold level for an edge trigger search to determine where to place a mark.
SEARCH:SEARCH<x>:TRIGger:A:LOGic:CLOCK:THRESHold	Sets or queries the logic clock threshold for a logic trigger search to determine where to place a mark.
SEARCH:SEARCH<x>:TRIGger:A:LOGic:DELTAtime	Specifies the Logic search delta time value.
SEARCH:SEARCH<x>:TRIGger:A:LOGic:INPUT:CLOCK:SOURce	Sets or queries the channel to use as the clock source for logic trigger.
SEARCH:SEARCH<x>:TRIGger:A:LOGic:LEVEL:CH<x>	Sets or queries the voltage level to use for logic trigger search.
SEARCH:SEARCH<x>:TRIGger:A:LOGic:LEVEL:MATH<x>	Sets the voltage level to use for logic trigger search.
SEARCH:SEARCH<x>:TRIGger:A:LOGic:LEVEL:REF<x>	Sets the voltage level to use for logic trigger search.
SEARCH:SEARCH<x>:TRIGger:A:LOGic:LOGICPattern:CH<x>	Sets or queries the conditions used for generating an A logic pattern.
SEARCH:SEARCH<x>:TRIGger:A:LOGic:LOGICPattern:CH<x>_D<x>	Sets or queries the conditions used for generating an A logic pattern.
SEARCH:SEARCH<x>:TRIGger:A:LOGic:LOGICPattern:MATH<x>	Sets or queries the conditions used for generating an A logic pattern.

Table 2-39: Search and Mark commands (cont.)

Command	Description
SEARCH:SEARCH<x>:TRIGger:A:LOGic:LOGICPattern:REF<x>	Sets or queries the conditions used for generating an A logic pattern.
SEARCH:SEARCH<x>:TRIGger:A:LOGic:POLarity	Sets or queries the polarity for the clock channel when Use Clock Edge is set to Yes for Logic search type.
SEARCH:SEARCH<x>:TRIGger:A:LOGic:WHEn	Sets or queries the condition for generating an A or B logic search with respect to the defined input pattern.
SEARCH:SEARCH<x>:TRIGger:A:PULSEWidth:HIGHLimit	Specifies the upper limit to use, in seconds, when searching for a pulse whose duration is inside or outside a range of two values.
SEARCH:SEARCH<x>:TRIGger:A:PULSEWidth:LOGICQUALification	Specifies whether or not to use logic qualification for a pulse width search.
SEARCH:SEARCH<x>:TRIGger:A:PULSEWidth:LOWLimit	Specifies the lower limit to use, in seconds, when searching for a pulse whose duration is inside or outside a range of two values.
SEARCH:SEARCH<x>:TRIGger:A:PULSEWidth:POLarity	Specifies the polarity for a pulse width search.
SEARCH:SEARCH<x>:TRIGger:A:PULSEWidth:SOUrce	Sets and queries the source for the pulsewidth search input.
SEARCH:SEARCH<x>:TRIGger:A:PULSEWidth:THReshold	Sets or queries the source threshold level for a pulse width trigger search to determine where to place a mark.
SEARCH:SEARCH<x>:TRIGger:A:PULSEWidth:WHEn	Specifies to search for a pulse with a specified width.
SEARCH:SEARCH<x>:TRIGger:A:RUNT:LOGICQUALification	Specifies whether or not to use logic qualification for a runt search.
SEARCH:SEARCH<x>:TRIGger:A:RUNT:POLarity	Specifies the polarity for the runt search.
SEARCH:SEARCH<x>:TRIGger:A:RUNT:SOUrce	Sets and queries the source for the Runt search input.
SEARCH:SEARCH<x>:TRIGger:A:RUNT:THReshold:HIGH	Sets or queries the source threshold HIGH level for a runt trigger search to determine where to place a mark.
SEARCH:SEARCH<x>:TRIGger:A:RUNT:THReshold:LOW	Sets or queries the source threshold LOW level for a runt trigger search to determine where to place a mark.
SEARCH:SEARCH<x>:TRIGger:A:SETHold:CLOCK:THReshold	Sets or queries the clock threshold setting for a setup/hold trigger search to determine where to place a mark.
SEARCH:SEARCH<x>:TRIGger:A:SETHold:LEVel:CH<x>	Sets or queries the voltage level to use for setup & hold trigger search.
SEARCH:SEARCH<x>:TRIGger:A:SETHold:LEVel:MATH<x>	Sets or queries the voltage level to use for setup & hold trigger search.
SEARCH:SEARCH<x>:TRIGger:A:SETHold:LEVel:REF<x>	Sets or queries the voltage level to use for setup & hold trigger search.

**Table 2-39: Search and Mark commands (cont.)**

<b>Command</b>	<b>Description</b>
SEARCH:SEARCH<x>:TRIGger:A:SETHold: LOGICPattern:CH<x>	Sets or queries the conditions used for generating an A logic pattern.
SEARCH:SEARCH<x>:TRIGger:A:SETHold: LOGICPattern:CH<x>_D<x>	Sets or queries the conditions used for generating an A logic pattern.
SEARCH:SEARCH<x>:TRIGger:A:SETHold: LOGICPattern:MATH<x>	Sets or queries the conditions used for generating an A logic pattern.
SEARCH:SEARCH<x>:TRIGger:A:SETHold: LOGICPattern:REF<x>	Sets and returns the conditions used for generating an A logic pattern.
SEARCH:SEARCH<x>:TRIGger:A:STATE	Sets or queries the enabled state of the search.
SEARCH:SEARCH<x>:TRIGger:A:STOPAcq	Sets or queries whether acquisitions are stopped when a search hit is found.
SEARCH:SEARCH<x>:TRIGger:A:TIMEOut: LOGICQUALification	Sets whether or not to use logic qualification for a timeout search.
SEARCH:SEARCH<x>:TRIGger:A:TIMEOut: POLarity	Sets or queries the polarity to be used for a Timeout search.
SEARCH:SEARCH<x>:TRIGger:A:TIMEOut: SOUrce	Sets and queries the source for timeout search input.
SEARCH:SEARCH<x>:TRIGger:A:TIMEOut: THReshold	Sets or queries the source threshold level for a timeout trigger search to determine where to place a mark.
SEARCH:SEARCH<x>:TRIGger:A:TRANSition: LOGICQUALification	Specifies whether or not to use logic qualification for a transition search.
SEARCH:SEARCH<x>:TRIGger:A:TRANSition: POLarity	Specifies the polarity for the transition search.
SEARCH:SEARCH<x>:TRIGger:A:TRANSition: SOUrce	Sets and queries the source for the transition search input.
SEARCH:SEARCH<x>:TRIGger:A:TRANSition: THReshold:HIGH	Sets or queries the source threshold HIGH level for a transition trigger search to determine where to place a mark.
SEARCH:SEARCH<x>:TRIGger:A:TRANSition: THReshold:LOW	Sets or queries the source threshold LOW level for a transition trigger search to determine where to place a mark.
SEARCH:SEARCH<x>:TRIGger:A:WINdow: CROSSIng	Sets or queries the window trigger threshold crossing of the selected trigger Source.
SEARCH:SEARCH<x>:TRIGger:A:WINdow: LOGICQUALification	Specifies or queries whether or not to use logic qualification for a window search.
SEARCH:SEARCH<x>:TRIGger:A:WINdow: POLarity	Sets or queries the window trigger threshold crossing of the selected trigger Source.
SEARCH:SEARCH<x>:TRIGger:A:WINdow: SOUrce	Sets and queries the source for the window search input.
SEARCH:SEARCH<x>:TRIGger:A:WINdow: THReshold:HIGH	Sets or queries the source threshold HIGH level for a transition trigger search to determine where to place a mark.

Table 2-39: Search and Mark commands (cont.)

Command	Description
<code>SEARCH:SEARCH&lt;x&gt;:TRIGger:A:WINDow:THReshold:LOW</code>	Sets or queries the source threshold LOW level for a transition trigger search to determine where to place a mark.
<code>SEARCH:SEARCH&lt;x&gt;:TRIGger:A:WINDow:WHEn</code>	Sets or queries the window search event.
<code>SEARCH:SELEcted</code>	Sets or queries the selected search.
<code>SEARCHTABLE</code>	This command adds or deletes a new search event table in an Option 5-WIN (Microsoft Windows 10 OS) TekExpress compliance testing application.

## Spectrum View command group

The Spectrum View commands control the selection and execution of spectrum commands. These commands apply to 4, 5, 6 Series MSO instruments and requires the RF vs. time option on the oscilloscope.

Table 2-40: Spectrum View commands

Command	Description
CH<x>:SV:SPANABovebw?	Queries whether the stop frequency for the specified spectrum trace channel is above the scope input bandwidth.
CH<x>:SV:SPANBELowdc?	Queries whether the start frequency for the specified spectrum trace channel is below 0 Hz.
PEAKSTABLE:ADDNew	Adds the specified peak markers table.
PEAKSTABLE:DELEte	Deletes the specified peak markers table.
PEAKSTABLE:LIST?	Lists all currently defined peak markers tables.
PEAKSTABLE:TABLE<x>:FRESolution	Sets or queries the Frequency Resolution state for peak markers table.
REMOTE:S<x>_CH<x>:SV:CENTERFrequency	Sets or queries the center frequency of the specified spectrum trace channel for Spectrum View.
REMOTE:S<x>_CH<x>:SV:POSition	Sets or queries the Spectrum Time setting of the specified spectrum trace channel in the Spectrum View.
REMOTE:S<x>_CH<x>:SV:STATE	Sets or queries the on/off setting of data acquisition for the specified spectrum trace channel.
REMOTE:S<x>_CH<x>:SV:STARTFrequency?	Queries the start frequency for the specified spectrum trace channel in Spectrum View
REMOTE:S<x>_CH<x>:SV:STOPFrequency?	Queries the stop frequency of the specified spectrum trace channel for Spectrum View
REMOTE:SV:RBW	Sets or queries the resolution bandwidth (RBW) when the RBW mode has been set to Manual.
REMOTE:SV:RBWMode	Sets or queries the resolution bandwidth (RBW) mode, either Automatic or Manual.
REMOTE:SV:SPAN	Sets or queries the span setting for all channels in the Spectrum View.
REMOTE:SV:SPANRBWRatio	This command specifies the ratio of the span to the resolution bandwidth (RBW) that will be used when the RBW Mode is set to AUTO.
REMOTE:SV:WINDOW	Sets or queries the window type used by the windowing function of the Spectrum View.
SV:CH<x>:SELEct:SPECtrogram	Sets or queries whether the spectrogram plot for the specified channel is displayed in the Spectrum View.
SV:LOCKCenter	Sets or queries whether the Center Frequency value is locked across all channels in the Spectrum View.
SV:LOCKpectrum	Sets or queries whether the Spectrum Time value is locked across all spectrum trace channels in the Spectrum View.
SV:MARKER:PEAK:EXCURsion	Sets or queries the minimum peak excursion value, in dB, for the Spectrum View trace peak markers.
SV:MARKER:PEAK:MAXimum	Sets or queries the maximum number of Spectrum View trace peaks that can have automatic markers placed on them.



Command	Description
SV:MARKER:PEAK:STATE	Sets or queries the visibility of peak markers for Spectrum View traces.
SV:MARKER:PEAK:THReshold	Sets or queries the threshold value of the peak markers available for frequency domain traces.
SV:MARKER:PEAKS:AMPLITUDE?	Queries the peak amplitudes for the Spectrum View trace peak markers.
SV:MARKER:PEAKS:FREQuency?	Queries the peak frequencies for the Spectrum View trace peak markers.
SV:MARKER:REFERence	Sets the Center Frequency of the currently selected Spectrum View channel to the frequency indicated by the Reference Marker
SV:MARKER:REFERence:AMPLITUDE?	Queries the actual amplitude (vertical) value of the Reference Marker in user-set units.
SV:MARKER:REFERence:FREQuency?	Queries the frequency of the Reference Marker, in Hz, when the Spectrum View trace markers are on.
SV:MARKER:TYPE	Sets or queries the peak marker type (either DELTA or ABSolute).
SV:RF_PHASe:REFERence:MASTer	Sets or queries the channel used as the Master Phase Reference.
SV:S<x>_CH<x>:RF_AVErage:NUMAVg	Sets or queries the number of acquisitions to be used when creating the Average trace for the specified spectrum trace channel in the Spectrum View.
SV:S<x>_CH<x>:RF_MAGNitude:FORMat	Sets or queries the format of the Magnitude vs. Time trace for the specified channel.
SV:S<x>_CH<x>:RF_PHASe:REFERence:DEGrees	Sets or queries the channel Phase Reference value in degrees.
SV:S<x>_CH<x>:RF_PHASe:REFERence:POSITION	Sets or queries whether the channel Phase Reference is located at the Trigger position or at the Cursor A position.
SV:S<x>_CH<x>:RF_PHASe:REFERence:TIME	Sets or queries the channel Phase Reference time in seconds.
SV:S<x>_CH<x>:RF_PHASe:WRAP:DEGrees	Sets or queries the Phase Wrap limit for the Phase vs. Time trace for the specified channel.
SV:S<x>_CH<x>:RF_PHASe:WRAP:STATE	Sets or queries whether Phase Wrap is applied to the Phase vs. Time trace for the specified channel.
SV:S<x>_CH<x>:SELEct:RF_AVErage	Sets or queries whether the Average trace is displayed for the specified spectrum trace channel in the Spectrum View.
SV:S<x>_CH<x>:SELEct:RF_FREQuency	Sets or queries whether the Frequency vs. Time trace for the specified channel is displayed in the Waveform View.
SV:S<x>_CH<x>:SELEct:RF_MAGNitude	Sets or queries whether the Magnitude vs. Time trace for the specified channel is displayed in the Waveform View.
SV:S<x>_CH<x>:SELEct:RF_MAXHold	Sets or queries whether the Max Hold trace is displayed for the specified spectrum trace channel in the Spectrum View.
SV:S<x>_CH<x>:SELEct:RF_MINHold	Sets or queries whether the Min Hold trace is displayed for the specified spectrum trace channel in the Spectrum View.
SV:S<x>_CH<x>:SELEct:RF_NORMal	Sets or queries whether the Normal trace is displayed for the specified spectrum trace channel in the Spectrum View.
SV:S<x>_CH<x>:SELEct:RF_PHASe	Sets or queries whether the Phase vs. Time trace for the specified channel is displayed in the Waveform View.
SV:S<x>_CH<x>:SELTrace	Sets or queries the spectrum trace type to show for the specified channel in the Spectrum View.

Command	Description
<a href="#">SV:S&lt;x&gt;_CH&lt;x&gt;:SQUELCH:STATE</a>	Sets or queries whether Squelch is enabled for the RF vs Time traces for the specified channel.
<a href="#">SV:S&lt;x&gt;_CH&lt;x&gt;:SQUELCH:THReshold</a>	Sets or queries the Squelch threshold value for the RF vs Time traces for the specified channel.
<a href="#">SV:S&lt;x&gt;_CH&lt;x&gt;:UNIts</a>	Sets or queries the vertical units to be used in the Spectrum View for the specified channel for absolute logarithmic amplitudes.
<a href="#">SV:SPECTrogram:CSCale:MAX</a>	Sets or queries the maximum color scale value.
<a href="#">SV:SPECTrogram:CSCale:MIN</a>	Sets or queries the minimum color scale value.
<a href="#">SV:SPECTrogram:CURSor:A</a>	Sets or queries whether the spectrum trace at cursor A position is selected or not.
<a href="#">SV:SPECTrogram:CURSor:B</a>	Sets or queries whether the spectrum trace at cursor B position is selected or not.

## Status and Error command group

Use the commands in the Status and Error command Group to determine the status of the instrument and control events.

Several commands and queries used with the instrument are common to all devices. The IEEE Std 488.2-1987 defines these commands and queries. The common commands begin with an asterisk (\*) character.

Table 2-41: Status and Error commands

Command	Description
ALLEV?	Returns all events and their messages.
BUSY?	Returns instrument status.
*CLS	Clears status.
DESE	Sets or queries the bits in the Device Event Status Enable Register.
*ESE	Sets or queries the bits in the Event Status Enable Register.
*ESR?	Returns the contents of the Standard Event Status Register.
EVENT?	Returns event code from the event queue.
EVMsg?	Returns event code, message from the event queue.
EVQty?	Returns number of events that are enabled in the queue.
*OPC	Generates the operation complete message in the standard event status register when all pending operations are finished Or returns "1" when all current operations are finished.
*OPT?	Returns a comma separated list of installed options as an arbitrary ASCII string (no quotes).
*PSC	Sets or queries the power on status flag.
*PUD	Sets or queries a string of protected user data.
*RST	Resets the instrument to factory default settings.
*SRE	Sets or queries the bits in the Service Request Enable Register.
*STB?	Returns the contents of the Status Byte Register.
*WAI	Prevents the instrument from executing further commands until all pending operations finish.

## Trigger command group

Use the commands in the Trigger Command Group to control all aspects of triggering for the instrument.

There are two triggers: A and B. Where appropriate, the command set has parallel constructions for each trigger.

You can set the A or B triggers to edge mode. Edge triggering lets you display a waveform at or near the point where the signal passes through a voltage level of your choosing.

You can also set A or B triggers to pulse or logic modes. With pulse triggering, the instrument triggers whenever it detects a pulse of a certain width or height. Logic triggering lets you logically combine the signals on one or more channels. The instrument then triggers when it detects a certain combination of signal levels. The trigger types of Pulse Width, Timeout, Runt, Window, and Rise/Fall Time can be further qualified by a logic pattern. This is referred to as logic qualification.

**Table 2-42: Trigger commands**

Command	Description
TRIGger:{A B}:EDGE:COUPling	Sets or queries the type of coupling for the edge trigger.
TRIGger:{A B}:EDGE:SLOpe	Sets or queries the slope for the edge trigger.
TRIGger:{A B}:EDGE:SOUrce	Sets or queries the source for the edge trigger.
TRIGger:{A B}:LEVel:CH<x>	Sets or queries the level for the trigger for the channel.
TRIGger:{A B}:TYPE	Sets or queries the type of A or B trigger.
VISual:AREA<x>:ASPEctratio	Sets or queries whether the aspect ratio of the specified Visual Trigger area is locked.
VISual:AREA<x>:FLIP:HORIZontal	Flips the specified Visual Trigger area horizontally around its center point.
VISual:AREA<x>:FLIP:VERTical	Flips the specified Visual Trigger area vertically around its center point.
VISual:AREA<x>:HEIGHt	Sets or queries the height of the specified Visual Trigger area.
VISual:AREA<x>:HITType	Sets or queries the area hit logic true condition for the specified Visual Trigger area.
VISual:AREA<x>:RESET	Sets the specified Visual Trigger area shape to a default-sized triangle.
VISual:AREA<x>:ROTAtion	Sets or queries the rotation angle of the specified Visual Trigger area.
VISual:AREA<x>:SHAPE	Sets or queries the current shape of the area.
VISual:AREA<x>:SOUrce	Sets or queries the signal source for the specified Visual Trigger area.
VISual:AREA<x>:VERTICES	Sets or queries the X and Y vertex coordinate values for all vertices of the specified Visual Trigger area.
VISual:AREA<x>:WIDTH	Sets or queries the width of the specified Visual Trigger area.
VISual:AREA<x>:XPOSition	Sets or queries the horizontal (X-axis) center position of the specified Visual Trigger area.
VISual:AREA<x>:YPOSition	Sets or queries the vertical (Y-axis) center position of the specified Visual Trigger area.
VISual:DELETEALL	Deletes all Visual Trigger areas.
VISual:ENable	Sets or queries the status (on or off) of the Visual Trigger mode.

Table 2-42: Trigger commands (cont.)

Command	Description
<a href="#">VISual:EQuation</a>	Sets or queries the Visual Trigger area combination logic equation.
<a href="#">VISual:SHOWAReas</a>	Shows or hides all Visual Trigger areas.
<a href="#">VISual:SHOWCRiteria</a>	Sets or queries display of the area names and hit criteria for all visual trigger areas.
<a href="#">VISual:SHOWEQuation</a>	Shows or hides the Visual Trigger area combination logic equation.

## Vertical command group

Use the commands in the Vertical Command Group to control the vertical setup of all live (channel) waveforms for acquisition and to control the display of channel, reference, and math waveforms. Analog channels are available when analog probes are attached to FlexChannel inputs.

You can replace VOLts with SCAle in the vertical commands. This provides program compatibility with earlier models of Tektronix instruments.

Table 2-43: Vertical commands

Command	Description
CH<x>?	Returns vertical parameters for the specified channel.
CH<x>:BANdwidth	Sets or queries the bandwidth of the specified channel.
CH<x>:BANdwidth:FILTer:OPTIMIZatiOn	Sets or queries the channel filter shape.
CH<x>:DITHERrange	Sets or queries the amount of dithering for the specified analog channel.
CH<x>:INVert	Sets or queries invert state of the specified channel.
CH<x>:PRObe?	Returns all information concerning the probe that is attached to the specified channel.
CH<x>:PRObe:AUTOZero	Autozeros the probe attached to the specified channel.
CH<x>:PRObe:COMPensate	Starts the compensation procedure for passive probes (TPP).
CH<x>:PRObe:DEGAUSS	Starts a degauss cycle of the probe attached to the specified channel.
CH<x>:PRObe:DEGAUSS:STATE?	Queries whether the probe attached to the specified channel requires a degauss operation.
CH<x>:PRObe:FORCEDRange	Sets the attached probe to its default range, or it queries the default range of the probe.
CH<x>:PRObe:GAIN?	Returns the gain of the probe that is attached to the specified channel.
CH<x>:PRObe:ID?	Returns the type and serial number of the probe that is attached to the specified channel.
CH<x>:PRObe:ID:SERnumber?	Returns the serial number of the probe that is attached to the specified channel.
CH<x>:PRObe:ID:TYPE?	Returns the type of probe that is attached to the specified channel.
CH<x>:PRObe:INPUTMode	Sets or queries the input mode of the probe that is attached to the specified channel.
CH<x>:PRObe:INPUTMode:AOFFSet	Sets or queries the A mode offset value of the probe that is attached to the specified channel.
CH<x>:PRObe:INPUTMode:BOFFSet	Sets or queries the B mode offset value of the probe that is attached to the specified channel.
CH<x>:PRObe:INPUTMode:COFFSet	Sets or queries the common mode offset value of the probe that is attached to the specified channel.
CH<x>:PRObe:INPUTMode:DOFFSet	Sets or queries the differential mode offset value of the probe that is attached to the specified channel.
CH<x>:PRObe:RESistance?	Queries the resistance of the probe that is attached to the specified channel.
CH<x>:PRObe:SELFCal	Initiates self-calibration on the probe.

Table 2-43: Vertical commands (cont.)

Command	Description
CH<x>:PRObe:SELFCal:State?	Queries the self-calibration state.
CH<x>:PRObe:SET	Sets or queries aspects of probe accessory user interfaces, for example probe attenuation factors.
CH<x>:PRObe:STATus?	Queries the probe unsigned integer error value.
CH<x>:PRObe:UNIts?	Returns the units of the probe that is attached to the specified channel.
CH<x>:PROBECal?	Returns the probe calibration status.
CH<x>:PROBECOntrol	Sets or queries the probe range.
CH<x>:PROBEFunc:EXTAtten	Sets the attenuation value for the specified channel to the specified scale factor. Or queries the user-specified attenuation.
CH<x>:PROBEFunc:EXTDBatten	Sets the attenuation value for the specified channel to the specified value in decibels. Or queries the user-specified attenuation in decibels.
CH<x>:PROBEFunc:EXTUnits	Sets or queries the alternate unit for the external attenuator of the specified channel.
CH<x>:PROBEFunc:EXTUnits:STATE	Sets or queries the custom units enable state for the specified channel.
CH<x>:SCALERATIo	Sets or returns the scale ratio for the specified analog channel.
CH<x>:TERmination	Sets channel input termination.
CH<x>:VTERm:BIAS	Sets or queries the termination voltage for the specified channel (if control is available).
CONFIguration:ANALOG:BAWIDth?	Queries the maximum licensed bandwidth of the instrument.
REF:ADDNew	Adds the specified reference. Argument is of the form "REF<NR1> ", where NR1 ≥ 1.
REF:DELeTe	Deletes the specified reference.
REF:REF<x>:DESKew	Sets or queries the deskew time for the specified reference.
REF:REF<x>:LABel:COLor	Sets or queries the color of the specified ref label.
REF:REF<x>:LABel:FONT:BOLD	Sets or queries the bold state of the specified reference label.
REF:REF<x>:LABel:FONT:ITALic	Sets or queries the italic state of the specified reference label.
REF:REF<x>:LABel:FONT:SIZE	Sets or queries the font size of the specified reference label.
REF:REF<x>:LABel:FONT:TYPE	Sets or queries the font type of the specified reference label.
REF:REF<x>:LABel:FONT:UNDERline	Sets or queries the underline state of the specified reference label.
REF:REF<x>:LABel:NAME	Sets or queries the label of the designated waveform.
REF:REF<x>:LABel:XPOS	Sets or queries the position of the reference waveform label on the X axis.
REF:REF<x>:LABel:YPOS	Sets or queries the position of the reference waveform label on the Y axis.
REF:LIST?	Lists all currently defined references.
REF:REF<x>:SOUrce	Sets or queries the filename used by the given reference.
REMOTE:S<x>_CH<x>:PROBETYPE?	Queries the probe type connected to a specified channel
S<x>_CH<x>:BANdwidth:ACTUal?	Queries whether the actual bandwidth of the specified remote scope channel.

Table 2-43: Vertical commands (cont.)

Command	Description
S<x>_CH<x>:CLIPping?	Queries whether the specified remote scope channel's input signal is clipping (exceeding) the channel A/D converter range.
S<x>_CH<x>:COUPLing	Sets or returns the vertical scale for the specified remote scope analog channel.
S<x>_CH<x>:DESKew	Sets or queries the horizontal deskew time for the remote scope specified channel.
S<x>_CH<x>:LABel:COLor	Sets or queries the color of the specified remote scope channel label.
S<x>_CH<x>:LABel:FONT:BOLD	Sets or queries the bold state of the specified remote scope channel label.
S<x>_CH<x>:LABel:FONT:ITALic	Sets or queries the italic state of the specified remote scope channel label.
S<x>_CH<x>:LABel:FONT:SIZE	Sets or queries the font size of the specified channel label.
S<x>_CH<x>:LABel:FONT:TYPE	Sets or queries the font type of the specified remote scope channel label.
S<x>_CH<x>:LABel:FONT:UNDERline	Sets or queries the underline state of the specified remote scope channel label.
S<x>_CH<x>:LABel:NAME	Sets or queries the label attached to the displayed waveform for the specified remote scope channel.
S<x>_CH<x>:LABel:XPOS	Sets or queries the X-position of the specified remote scope channel
S<x>_CH<x>:LABel:YPOS	Sets or queries the Y-position of the specified remote scope channel.
S<x>_CH<x>:OFFSet	Sets or queries the channel offset.
S<x>_CH<x>:POSition	Sets or queries the vertical position for the specified analog channel.
S<x>_CH<x>:SCALE	Sets or returns the vertical scale for the specified remote scope analog channel.
VERTical:DESKew:FROM:CUSTOMPROPAGation	Sets or queries a target (FROM) delay that you can specify when the propagation delay of the target (FROM) probe used for deskew cannot be detected automatically.
VERTical:DESKew:STATIC	Sets or queries the target channel for performing channel-to-channel deskew adjustment.
VERTical:DESKew:TO:CUSTOMPROPAGation	Sets or queries a target (TO) delay that can be specified by the user when the propagation delay of the target (TO) probe used for deskew cannot be detected automatically.
VERTical:DESKew:FROM:SOUrce	Sets or queries the source channel for performing channel-to-channel deskew adjustment.
VERTical:DESKew:TO:SOUrce	Sets or queries the target channel for performing channel-to-channel deskew adjustment.



## Waveform Transfer command group

Use the commands in the Waveform Transfer Command Group to transfer waveform data points from the instrument. Waveform data points are a collection of values that define a waveform. One data value usually represents one data point in the waveform record. When working with envelope waveforms, each data value is either the minimum or maximum of a min/max pair.

Before you transfer waveform data, you must specify the data format, record length, and waveform source.

**Data formats.** Acquired waveform data uses eight or more bits to represent each data point. The number of bits used depends on the acquisition mode specified when you acquired the data. Data acquired in SAMple or ENvelope mode uses eight bits per waveform data point. Data acquired in AVERage mode uses up to 14 bits per point.

The instrument can transfer waveform data in either ASCII or binary format. You specify the format with the DATA:ENCdg command. The instrument uses signed, 4 byte integers and floating point values; it does not support unsigned floating point values.

**ASCII data** is represented by signed integer or floating point values. An example ASCII waveform data string can look like this:

```
CURVE<space>-110,-109,-110,-110,-109,-107,  
-109,-107,-106,-105,-103,-100,-97,-90,-84,-80
```

Use ASCII to obtain more readable and easier to format output than binary. However, ASCII can require more bytes to send the same values than it does with binary. This can reduce transmission speeds.

**Binary data** can be represented by signed integer or floating point values. The range of the values depends on the byte width specified. When the byte width is one, signed integer data ranges from -128 to 127, and positive integer values range from 0 to 255. When the byte width is two, the values range from -32768 to 32767. When a MATH (or REF that came from a MATH) is used, 32-bit floating point values are used that are four bytes in width.

The defined binary formats specify the order in which the bytes are transferred. The following are the four binary formats:

- **RIBinary** specifies signed integer data-point representation with the most significant byte transferred first.
- **SRIBinary** is the same as RIBinary except that the byte order is swapped, meaning that the least significant byte is transferred first. This format is useful when transferring data to PCs.
- **RFBinary** specifies floating point data-point representation with the most significant byte transferred first.
- **SRFBinary** is the same as RFBinary except that the byte order is swapped, meaning that the least significant byte is transferred first. This format is useful when transferring data to PCs.

**Waveform data and record lengths.** You can transfer multiple points for each waveform record. You can transfer a portion of the waveform or you can transfer the entire record. You can use the `DATA:START` and `DATA:STOP` commands to specify the first and last data points of the waveform record.

When transferring data from the instrument, you must specify the first and last data points in the waveform record. Setting `DATA:START` to 1 and `DATA:STOP` to the record length will always return the entire waveform.

**Waveform data locations and memory allocation.** The `DATA:SOURce` command specifies the waveform source when transferring a waveform from the instrument.

**Waveform preamble.** Each waveform that you transfer has an associated waveform preamble that contains information such as the horizontal scale, the vertical scale, and other settings in effect when the waveform was created. Refer to the individual `WFMOutpre?` commands for more information.

**Scaling waveform data.** Once you transfer the waveform data to the controller, you can convert the data points into voltage values for analysis using information from the waveform preamble.

**Transferring waveform data from the instrument.**

You can transfer waveforms from the instrument to an external controller using the following sequence:

1. Select the waveform source(s) using `DATA:SOURCE`.
2. Specify the waveform data format using `DATA:ENCdg`.
3. Specify the number of bytes per data point using `WFMOuTpre:BYT_Nr`.

---

**NOTE.** *MATH waveforms (and REF waveforms that came from a MATH) are always set to four bytes.*

---

4. Specify the portion of the waveform that you want to transfer using `DATA:START` and `DATA:STOP`.
5. Transfer waveform preamble information using `WFMOuTpre`.
6. Transfer waveform data from the instrument using `CURVe?`.

**Table 2-44: Waveform Transfer commands**

Command	Description
<a href="#">CURVe?</a>	The query format transfers waveform data from instrument specified by the <code>DATA:SOURCE</code> command.
<a href="#">CURVEStream?</a>	Continuously transfers waveform data from the instrument as it is acquired.
<a href="#">DATA</a>	Sets the format and location of the waveform data that is transferred with the <code>CURVE</code> Command. Or queries the format and location of the waveform data that is transferred with the <code>CURVe?</code> command.
<a href="#">DATA:ENCdg</a>	Sets or queries the format of outgoing waveform data.
<a href="#">DATA:FRAMESTART</a>	Sets or queries the starting acquisition for waveform transfer using the <code>CURVE?</code> query.
<a href="#">DATA:FRAMESTOP</a>	Sets or queries the last acquisition for waveform transfer using the <code>CURVE?</code> query.
<a href="#">DATA:MODE</a>	Sets or returns the mode for waveform data.
<a href="#">DATA:RESample</a>	Sets or queries the resampling of outgoing waveform data.
<a href="#">DATA:SOURce</a>	Sets or queries the location of waveform data transferred from the instrument.
<a href="#">DATA:SOURce:AVAILable?</a>	Returns a list of enumerations representing the source waveforms that are currently available for <code>:CURVe?</code> queries.
<a href="#">DATA:START</a>	Sets or queries the starting point in waveform transfer.
<a href="#">DATA:STOP</a>	Sets or queries the ending data point in waveform transfer.
<a href="#">DATA:WIDth</a>	Specifies the width, in bytes per point, for waveform data transferred from the instrument via the <code>CURVe?</code> query.
<a href="#">WAVFrm?</a>	Returns <code>WFMOuTpre?</code> and <code>CURVe?</code> data for the waveform as specified by the <code>DATA:SOURCE</code> command.

Table 2-44: Waveform Transfer commands (cont.)

Command	Description
WFMOutpre?	Returns the waveform formatting data for the waveform specified by the DATA:SOURCE command.
WFMOutpre:ASC_Fmt?	Returns the format for ASCII data transferred from the instrument.
WFMOutpre:BIT_Nr	Sets or queries the number of bits per waveform point that outgoing waveforms contain.
WFMOutpre:BN_Fmt	Sets or queries the format of binary data for the waveform.
WFMOutpre:BYT_Nr	Sets or queries the data width for the waveform.
WFMOutpre:BYT_Or	Sets or queries the byte order of waveform points.
WFMOutpre:CENTERFREQuency?	Returns the center frequency of the outgoing waveform.
WFMOutpre:DOMain?	Returns the domain of the outgoing waveform.
WFMOutpre:ENCdg	Sets or queries the type of encoding for outgoing waveforms.
WFMOutpre:NR_Pt?	Returns the number of points for the waveform transmitted in response to a CURVe? query.
WFMOutpre:PT_Fmt?	Returns the point format for the waveform.
WFMOutpre:PT_Off?	Returns the trigger point relative to DATA:START for the waveform.
WFMOutpre:PT_ORder?	Returns whether the source waveform is Fast Acquisition.
WFMOutpre:RESample	Sets or queries the resampling of outgoing waveform data.
WFMOutpre:SPAN?	Returns the frequency span of the outgoing waveform.
WFMOutpre:WFId?	Returns a string describing the acquisition parameters for the waveform.
WFMOutpre:WFMTYPE?	Returns the type of the outgoing waveform.
WFMOutpre:XINcr?	Returns the horizontal sampling interval.
WFMOutpre:XUNit?	Returns the horizontal units for the waveform.
WFMOutpre:XZEro?	Returns the (sub-sample) time between the trigger sample and the occurrence of the actual waveform trigger.
WFMOutpre:YOFf?	Returns the vertical offset in digitizing levels for the waveform.
WFMOutpre:YUNit?	Returns the vertical units for the waveform.
WFMOutpre:YZEro?	Returns the vertical offset for the waveform.

## Zoom command group

Zoom commands let you expand and position the waveform display horizontally and vertically, without changing the time base or vertical settings.

**NOTE.** *Zoom commands are available once a view has been added.*

Table 2-45: Zoom commands

Command	Description
DISplay:MATHFFTView<x>:ZOOM:XAXIS:FROM	Sets or queries the start of the zoom x axis in the specified plot view.
DISplay:MATHFFTView<x>:ZOOM:XAXIS:TO	Sets or queries the end of the zoom x axis in the specified plot view.
DISplay:MATHFFTView<x>:ZOOM:YAXIS:FROM	Sets or queries the start of the zoom y axis in the specified plot view.
DISplay:MATHFFTView<x>:ZOOM:YAXIS:TO	Sets or queries the end of the zoom y axis in the specified plot view.
DISplay:PLOTView<x>:ZOOM:XAXIS:FROM	Sets or queries the start of the zoom x-axis in the specified plot view.
DISplay:PLOTView<x>:ZOOM:XAXIS:TO	Sets or queries the end of the zoom x-axis in the specified plot view.
DISplay:PLOTView<x>:ZOOM:YAXIS:FROM	Sets or queries the start of the zoom y-axis in the specified plot view.
DISplay:PLOTView<x>:ZOOM:YAXIS:TO	Sets or queries the end of the zoom y-axis in the specified plot view.
DISplay:REFFFTView<x>:ZOOM:XAXIS:FROM	Sets or returns the left edge of the zoom x-axis in the specified plot view.
DISplay:REFFFTView<x>:ZOOM:XAXIS:TO	Sets or queries the right edge of the zoom x-axis in the specified plot view.
DISplay:REFFFTView<x>:ZOOM:YAXIS:FROM	Sets or queries the bottom value of the zoom y-axis in the specified plot view.
DISplay:REFFFTView<x>:ZOOM:YAXIS:TO	Sets or queries the top value of the zoom y-axis in the specified plot view.
DISplay:WAVEView<x>:ZOOM:ZOOM<x>:HORizontal:POSition	Sets or queries the horizontal zoom position (of the specified zoom in the specified Waveform View) of the zoomed waveform or zoom waveform in the display, around which the zoom waveform displays.
DISplay:WAVEView<x>:ZOOM:ZOOM<x>:HORizontal:SCALE	Sets or queries the zoom horizontal scale factor, of the specified zoom in the specified Waveform View, in which the zoom waveform is displayed.
DISplay:WAVEView<x>:ZOOM:ZOOM<x>:HORizontal:WINSCALE	Sets or queries the zoom window horizontal scale in the specified Waveform View.
DISplay:WAVEView<x>:ZOOM:ZOOM<x>:STATE	Sets or queries the specified zoom in the specified Waveform View on or off.
DISplay:WAVEView<x>:ZOOM:ZOOM<x>:VERTical:POSition	Sets or queries the vertical position of the specified zoom in the specified Waveform View, in which the zoom waveform is displayed.
DISplay:WAVEView<x>:ZOOM:ZOOM<x>:VERTical:SCALE	Sets or queries the zoom vertical scale factor of the specified waveform for the specified zoom in the specified Waveform View.
DISplay:WAVEView<x>:ZOOM?	Queries the zoom parameters of the specified Waveform View.
DISplay:WAVEView<x>:ZOOM:ZOOM<x>?	Queries the zoom parameters of the specified zoom in the specified Waveform View.



---

## Commands listed in alphabetical order

---

*NOTE. Some of the following commands may not be available on your instrument model. Also, some of the following commands are only available if your instrument has the associated option installed.*

---

### ACTONEvent:ENable

This command enables or disables actions on event (AOE). If AOE saves are limited and the limit has been reached, the command will return an error.

**Group** Act On Event

**Syntax** ACTONEvent:ENable <NR1>  
ACTONEvent:ENable?

**Arguments** <NR1> is a number that enables or disables actions on event. The number zero disables the feature and the number one enables the feature.

**Examples** ACTONEvent:ENable 1 enables actions on event.  
ACTONEvent:ENable? might return :ACTONEvent:ENable 0, indicating the actions on event feature is disabled.

### ACTONEvent:NUMSAVEs? (Query Only)

This command returns the number of saves completed for save on event timer type.

**Group** Act On Event

**Syntax** ACTONEvent:NUMSAVEs?

**Examples** ACTONEvent:NUMSAVEs? might return 10, indicating that 10 iterations have completed since executing an REMOTE:LOGGING Start command.

### ACTONEvent:TIMER:ACTION:SAVEIMAGE:STATE

This command saves a screen capture when :ACTONEvent:TIMERInterval expires.

<b>Group</b>	Act On Event
<b>Syntax</b>	ACTONEvent:TIMER:ACTION:SAVEIMAGE:STATE {ON OFF <NR1>} ACTONEvent:TIMER:ACTION:SAVEIMAGE:STATE?
<b>Arguments</b>	ON enables the save screen capture when :ACTONEvent:TIMERInterval expires.  OFF disables the save screen capture when :ACTONEvent:TIMERInterval expires.  <NR1> is a number that enables or disables the save screen capture :ACTONEvent:TIMERInterval expires. The number zero disables the feature, all other numbers enable the feature.
<b>Examples</b>	ACTONEvent:TIMER:ACTION:SAVEIMAGE:STATE ON sets the state of the save screen capture feature to on.  ACTONEvent:TIMER:ACTION:SAVEIMAGE:STATE? might return :ACTONEvent:TIMER:ACTION:SAVEIMAGE:STATE OFF, indicating the state of the save screen capture feature is set to off.

## ACTONEvent:TIMER:ACTION:SAVETable:STATE

This command saves a measurement results when :ACTONEvent:TIMERInterval expires.

<b>Group</b>	Act On Event
<b>Syntax</b>	ACTONEvent:TIMER:ACTION:SAVETable:STATE {ON OFF <NR1>} ACTONEvent:TIMER:ACTION:SAVETable:STATE?
<b>Arguments</b>	ON enables the save measurement results when :ACTONEvent:TIMERInterval expires.  OFF disables the save measurement results when :ACTONEvent:TIMERInterval expires.  <NR1> is a number that enables or disables the save measurement results :ACTONEvent:TIMERInterval expires. The number zero disables the feature, all other numbers enable the feature.
<b>Examples</b>	ACTONEvent:TIMER:ACTION:SAVEIMAGE:STATE ON sets the state of the measurement results feature to on.



`ACTONEvent:TIMER:ACTION:SAVEIMAGE:STATE?` might return  
`:ACTONEvent:TIMER:ACTION:SAVEIMAGE:STATE OFF`, indicating the state  
of the save measurement results feature is set to off.

## ACTONEvent:TIMER:ACTION:SAVEWAVEform:STATE

This command saves the user set source waveform(s) when  
`:ACTONEvent:TIMERInterval` expires.

<b>Group</b>	Act On Event
<b>Syntax</b>	<code>ACTONEvent:TIMER:ACTION:SAVEWAVEform:STATE {ON OFF &lt;NR1&gt;}</code> <code>ACTONEvent:TIMER:ACTION:SAVEWAVEform:STATE?</code>
<b>Arguments</b>	<p><code>ON</code> enables the save source waveform(s) when <code>:ACTONEvent:TIMERInterval</code> expires.</p> <p><code>OFF</code> disables the save source waveform(s) when <code>:ACTONEvent:TIMERInterval</code> expires.</p> <p><code>&lt;NR1&gt;</code> is a number that enables or disables the user set source waveform(s) when <code>:ACTONEvent:TIMERInterval</code> expires. The number zero disables the feature, all other numbers enable the feature.</p>
<b>Examples</b>	<p><code>ACTONEvent:TIMER:ACTION:SAVEWAVEform:STATE ON</code> sets the state of the save source waveform feature to on.</p> <p><code>ACTONEvent:TIMER:ACTION:SAVEWAVEform:STATE?</code> might return  <code>:ACTONEvent:TIMER:ACTION:SAVEWAVEform:STATE OFF</code>, indicating the state of the save source waveform feature is set to off.</p>

## ACTONEvent:TIMERCount

This command sets or queries the save on event timer count. The  
`ACTONEvent:ENable` must be enabled.

<b>Group</b>	Act On Event
<b>Syntax</b>	<code>ACTONEvent:TIMERCount &lt;NR1&gt;</code> <code>ACTONEvent:TIMERCount?</code>

**Arguments** <NR1> sets the number of allowed saves for the act on event feature. The number must be a positive integer.

**Examples** ACTONEvent:TIMERCount 2 sets the number of saves to 2.  
ACTONEvent:TIMERCount? might return :ACTONEvent:TIMERCount 4, indicating the limit of act on event saves is 4.

## ACTONEvent:TIMERInterval

This command sets or queries the amount of time, in seconds, to wait for act on event timer event to trigger. The time can range from a minimum of 10 seconds to a maximum of 100 seconds. The default is 30 seconds

**Group** Act On Event

**Syntax** ACTONEvent:TIMERInterval <NR1>  
ACTONEvent:TIMERInterval?

**Arguments** <NR1> is the amount of time, in seconds, to wait for act on event timer event to trigger.

**Examples** ACTONEvent:TIMERInterval 20 sets the timer interval to 20 seconds.  
ACTONEvent:TIMERInterval? might return :ACTONEvent:TIMERInterval 60, indicating the timer interval is 60 seconds (1 minute).

## ACTONEvent:Type? (Query Only)

This command returns the act on event type.

**Group** Act On Event

**Syntax** ACTONEvent:Type?

**Examples** ACTONEvent:Type? might return Timer, indicating the act on event type is timer.

## ALias

This command sets or queries the state of alias functionality, and it is identical to the ALIAS:STATE command.

**Group** Alias

**Syntax** ALIAS {OFF|ON|<NR1>}  
ALIAS?

**Related Commands** [ALIAS:STATE](#)

**Arguments** OFF turns Alias expansion off.

ON turns Alias expansion on. When a defined alias is received, the specified command sequence is substituted for the alias and executed.

<NR1> = 0 disables Alias mode; any other value enables Alias mode.

**Examples** ALIAS ON turns the alias feature on. When a defined alias is received, the specified command sequence is substituted for the alias and executed.

ALIAS? might return :ALIAS:STATE 1, indicating that the alias feature is on.

## ALias:CATalog? (Query Only)

This query-only command returns a list of the currently defined alias labels, separated by commas. If no aliases are defined, the query returns the string "".

**Group** Alias

**Syntax** ALIAS:CATalog?

**Examples** ALIAS:CATALOG? might return the string :ALIAS:CATALOG "SETUP1", "TESTMENU1", "DEFAULT" showing that there are three aliases named SETUP1, TESTMENU1, and DEFAULT.

## ALias:DEFine

This command assigns a sequence of program messages to an alias label. These messages are then substituted for the alias whenever it is received as a command

or query, provided that `ALIAS:STATE` is turned on. The query form of this command returns the definitions of a selected alias.

---

**NOTE.** *Attempting to give two aliases the same name causes an error. To give a new alias the name of an existing alias, the existing alias must first be deleted.*

---

**Group** Alias

**Syntax** `ALIAS:DEFINE <QString><,>{<QString>|<Block>}`  
`ALIAS:DEFINE?`

**Related Commands** [ALIAS:STATE](#)

**Arguments** The first `<QString>` is the alias label.  
 This label cannot be a command name. Labels must start with a letter and can contain only letters, numbers, and underscores; other characters are not allowed. The label must be less than or equal to 12 characters.  
 The second `<QString>` or `<Block>` is a complete sequence of program messages.  
 The messages can contain only valid commands that must be separated by semicolons and must follow all rules for concatenating commands. The sequence must be less than or equal to 256 characters.

**Examples** `ALIAS:DEFINE "ST1",":RECALL:SETUP 'C:/mySetup.set';:AUTOSET EXECUTE"` defines an alias named "ST1" that recalls a previously saved setup and performs an autoset.

`ALIAS:DEFINE? "ST1"` returns `:ALIAS:DEFINE "ST1",#247 :RECALL:SETUP 'C:/mySetup.set';:AUTOSET EXECUTE.`

## ALIAS:DELETE (No Query Form)

This command removes a specified alias and is identical to `ALIAS:DELETE:NAME`. An error message is generated if the named alias does not exist.

**Group** Alias

**Syntax** `ALIAS:DELETE <QString>`

**Related Commands**[\\*ESR?](#)[ALias:DELEte:ALL](#)**Arguments**

<QString> is the name of the alias to be removed. Using `ALias:DELEte` without specifying an alias causes an execution error. <QString> must be a previously defined value.

**Examples**

`ALIAS:DELETE "SETUP1"` deletes the alias named SETUP1.

## ALias:DELEte:ALL (No Query Form)

This command deletes all existing aliases.

**Group** Alias**Syntax** `ALias:DELEte:ALL`**Related Commands**[ALias:DELEte](#)[ALias:DELEte:NAME](#)**Examples**

`ALIAS:DELETE:ALL` deletes all existing aliases.

## ALias:DELEte:NAME (No Query Form)

This command removes a specified alias. An error message is generated if the named alias does not exist. This command is identical to `ALias:DELEte`.

**Group** Alias**Syntax** `ALias:DELEte:NAME <QString>`**Arguments**

<QString> is the name of the alias to remove. Using `ALias:DELEte:NAME` without specifying an alias causes an exception error.<QString> must be a previously defined alias.

**Examples**

`ALIAS:DELETE:NAME "STARTUP"` deletes the alias named STARTUP.

## ALIAS:STATE

This command turns aliases on or off and is identical to the [ALIAS](#) command. The query form of this command returns the state of the aliases.

<b>Group</b>	Alias
<b>Syntax</b>	ALIAS:STATE {<NR1> OFF ON} ALIAS:STATE?
<b>Arguments</b>	<NR1> = 0 turns off aliases; any other value turns on aliases.  OFF turns alias expansion off.  ON turns alias expansion on. When a defined alias is received, the specified command sequence is substituted for the alias and executed.
<b>Examples</b>	ALIAS:STATE OFF turns off the alias feature.  ALIAS:STATE? might return :ALIAS:STATE ON, indicating that alias expansion is currently turned on.

## ALLEV? (Query Only)

This query-only command prompts the instrument to return all events and their messages (delimited by commas), and removes the returned events from the Event Queue. Use the [\\*ESR?](#) query to enable the events to be returned. This command is similar to repeatedly sending [\\*EVMsg?](#) queries to the instrument.

<b>Group</b>	Status and Error
<b>Syntax</b>	ALLEV?
<b>Related Commands</b>	<a href="#">*ESR?</a> <a href="#">EVMsg?</a>
<b>Examples</b>	ALLEV? might return :ALLEV 2225,"Measurement error, No waveform to measure; "420,"Query UNTERMINATED;".

## AUTOSAVEPITIMEOUT

This command sets or queries the idle time from the programmable interface before auto-save occurs.

**Group** Miscellaneous

**Syntax** AUTOSAVEPITIMEOUT <NR1>  
AUTOSAVEPITIMEOUT?

**Arguments** <NR1>

**Examples** AUTOSAVEPITIMEOUT 100000 sets the timeout to 100 seconds.

AUTOSAVEPITIMEOUT? might return :AUTOSAVEPITIMEOUT 180000 indicating the time out value is 180 seconds.

## AUTOSAVEUITIMEOUT

This command sets or queries the idle time from the user interface before auto-save occurs.

**Group** Miscellaneous

**Syntax** AUTOSAVEUITIMEOUT <NR1>  
AUTOSAVEUITIMEOUT?

**Arguments** <NR1>

**Examples** AUTOSAVEUITIMEOUT 4000 sets the timeout to 4 seconds.

AUTOSAVEUITIMEOUT? might return :AUTOSAVEUITIMEOUT 3000 indicating the time out value is 3 seconds.

## BUS:ADDNew (No Query Form)

This command adds the specified bus. This command creates/adds the bus but does not display it (turn it on). In order to enable bus decoding and see the bus display on screen, send the [DISplay:WAVEView<x>:BUS:B<x>:STATE ON](#) command.

<b>Group</b>	Bus
<b>Syntax</b>	<code>BUS:ADDNew &lt;QString&gt;</code>
<b>Related Commands</b>	<a href="#">BUS:B&lt;x&gt;:TYPE</a> <a href="#">DISplay:WAVEView&lt;x&gt;:BUS:B&lt;x&gt;:STATE</a>
<b>Arguments</b>	<QString> is a quoted string of the form "B<NR1>" where NR1 is ≥1.
<b>Examples</b>	<code>BUS:ADDNEW "B5";:display:waveview1:bus:b5:state</code> on creates bus 3 with the default type of Parallel, and then turns it on.

## BUS:B<x>:ARINC429A:BITRate

This command sets or queries the ARINC429 bit rate for the specified bus. The bus number is specified by x. If you select Custom, use `BUS:B<x>:ARINC429A:BITRate:CUSTOM` to set the bit rate.

<b>Conditions</b>	Requires option SR-AERO.
<b>Group</b>	Bus
<b>Syntax</b>	<code>BUS:B&lt;x&gt;:ARINC429A:BITRate {LOW HI CUSTOM}</code> <code>BUS:B&lt;x&gt;:ARINC429A:BITRate?</code>
<b>Related Commands</b>	B<x> is the number of the bus. <a href="#">BUS:B&lt;x&gt;:ARINC429A:BITRate:CUSTOM</a>
<b>Arguments</b>	Arguments specify the bit rate.
<b>Examples</b>	<code>BUS:B1:ARINC429A:BITRATE LOW</code> sets the bit rate to handle low speed signals. <code>BUS:B1:ARINC429A:BITRATE?</code> might return <code>:BUS:B1:ARINC429A:BITRATE HI</code> , indicating the bit rate is set to handle high speed signals.



## BUS:B<x>:ARINC429A:BITRate:CUSTom

This command sets or queries the ARINC429 custom bit rate for the specified bus. The bus is specified by x.

**Conditions** Requires option SR-AERO.

**Group** Bus

**Syntax** BUS:B<x>:ARINC429A:BITRate:CUSTom <NR1>  
BUS:B<x>:ARINC429A:BITRate:CUSTom?

**Related Commands** [BUS:B<x>:ARINC429A:BITRate](#)

**Arguments** B<x> is the number of the bus.  
<NR1> is the ARINC429 custom bit rate for the specified bus.

**Examples** BUS:B1:ARINC429A:BITRATE:CUSTOM 12500 sets the bit rate to 12,500.  
BUS:B1:ARINC429A:BITRATE:CUSTOM? might return  
:BUS:B1:ARINC429A:BITRATE:CUSTOM 100000, indicating the bit rate is set to 100,000.

## BUS:B<x>:ARINC429A:DATAFORmat

This command sets or queries the format of the DATA field for the specified ARINC429 bus. The bus is specified by x.

**Conditions** Requires option SR-AERO.

**Group** Bus

**Syntax** BUS:B<x>:ARINC429A:DATAFORmat {DATA|SDIDATA|SDIDATASSM}  
BUS:B<x>:ARINC429A:DATAFORmat?

**Arguments** B<x> is the number of the bus.  
DATA specifies a DATA field width of 19 bits (covering bits 11 through 29 of the 32 bit packet)

SDIDATA specifies a DATA field width of 21 bits (covering bits 9 through 29 of the 32 bit packet)

SDIDATASSM specifies a DATA field width of 23 bits (covering bits 9 through 31 of the 32 bit packet)

**Examples**    `BUS:B1:ARINC429A:DATAFORMAT SDIDATASSM` sets Bus 1 ARINC429 DATA field width to 23 bits.

`BUS:B1:ARINC429A:DATAFORMAT?` might return  
`:BUS:B1:ARINC429A:DATAFORMAT DATA`, indicating a DATA field width of 19 bits.

## **BUS:B<x>:ARINC429A:POLARITY**

This command sets or queries the source polarity for the specified ARINC429 bus. The bus is specified by x.

**Conditions**    Requires option SR-AERO.

**Group**        Bus

**Syntax**       `BUS:B<x>:ARINC429A:POLARITY {NORMa1 | INVERTed}`  
`BUS:B<x>:ARINC429A:POLARITY?`

**Arguments**    B<x> is the number of the bus.  
  
NORMa1 specifies normal polarity.  
  
INVERTed specifies inverted polarity.

**Examples**    `BUS:B3:ARINC429A:POLARITY INVERTed` sets Bus 3 ARINC429 polarity to inverted.  
  
`BUS:B2:ARINC429A:POLARITY?` might return  
`:BUS:B2:ARINC429A:POLARITY NORMAL`, indicating that the Bus 2 ARINC429 polarity is set to normal.

## **BUS:B<x>:ARINC429A:SOUrce**

This command sets or queries the source for the specified ARINC429 bus. The bus is specified by x.

<b>Conditions</b>	Requires option SR-AERO.
<b>Group</b>	Bus
<b>Syntax</b>	<code>BUS:B&lt;x&gt;:ARINC429A:SOURce {S&lt;x&gt;_Ch&lt;x&gt; CH&lt;x&gt; Math&lt;x&gt; REF&lt;x&gt;}</code> <code>BUS:B&lt;x&gt;:ARINC429A:SOURce?</code>
<b>Arguments</b>	<p><code>S&lt;x&gt;_Ch&lt;x&gt;</code> specifies the remote scope number and the analog channel.</p> <p><code>CH&lt;x&gt;</code> specifies an analog channel as the source waveform for the ARINC429 bus.</p> <p><code>Math&lt;x&gt;</code> specifies a math waveform as the source waveform for the ARINC429 bus.</p> <p><code>REF&lt;x&gt;</code> specifies a reference waveform as the source waveform for the ARINC429 bus.</p>
<b>Examples</b>	<p><code>BUS:B1:ARINC429A:SOURCE CH1</code> sets channel 1 as the source for the ARINC429 bus.</p> <p><code>BUS:B1:ARINC429A:SOURCE?</code> might return <code>:BUS:B1:ARINC429A:SOURCE MATH2</code> indicating that the source is set to MATH2.</p>

## BUS:B<x>:ARINC429A:THRESHold

This command sets or queries the ARINC429 upper threshold for the specified bus. The bus is specified by x.

<b>Conditions</b>	Requires option SR-AERO.
<b>Group</b>	Bus
<b>Syntax</b>	<code>BUS:B&lt;x&gt;:ARINC429A:THRESHold &lt;NR3&gt;</code> <code>BUS:B&lt;x&gt;:ARINC429A:THRESHold?</code>
<b>Related Commands</b>	<a href="#">BUS:B&lt;x&gt;:ARINC429A:SOURce</a>
<b>Arguments</b>	<p><code>B&lt;x&gt;</code> is the number of the bus.</p> <p><code>&lt;NR3&gt;</code> is the ARINC429 lower threshold for the specified bus.</p>

**Examples**    `BUS:B3:ARINC429A:THRESHOLD -200e-3` sets the Bus 3 ARINC429 upper threshold to -200 mV.

`BUS:B2:ARINC429A:THRESHOLD?` might return  
`:BUS:B2:ARINC429A:THRESHOLD -500.0000E-3` indicating the Bus 2 ARINC429 upper threshold is set to -500 mV.

## **BUS:B<x>:AUDIO:BITDelay**

This command sets or queries the number of delay bits for the specified AUDIO bus. The bus is specified by x.

---

**NOTE.** *This command only applies to the TDM Audio type.*

---

**Conditions**    Requires option SR-AUDIO.

**Group**        Bus

**Syntax**        `BUS:B<x>:AUDIO:BITDelay <NR1>`  
`BUS:B<x>:AUDIO:BITDelay?`

**Arguments**    `B<x>` is the number of the bus.  
`<NR1>` specifies the number of delay bits.

**Examples**        `BUS:B1:AUDIO:BITDELAY 2` sets the bit delay to 2.  
`BUS:B1:AUDIO:BITDELAY?` might return `:BUS:B1:AUDIO:BITDELAY 1`  
indicating that the number of delay bits is 1.

## **BUS:B<x>:AUDIO:BITOrder**

Specifies the bit order for the specified AUDIO bus. The bus is specified by x.

**Conditions**    Requires option SR-AUDIO.

**Group**        Bus

**Syntax**        `BUS:B<x>:AUDIO:BITOrder {MSB|LSB}`  
`BUS:B<x>:AUDIO:BITOrder?`

**Arguments** B<x> is the number of the bus.  
 MSB specifies that the most significant bit will be expected first in the order.  
 LSB specifies that the least significant bit will be expected first in the order.

**Examples** BUS:B1:AUDIO:BITORDER LSB sets the bit order to LSB.  
 BUS:B1:AUDIO:BITORDER? might return :BUS:B1:AUDIO:BITORDER MSB indicating that the MSB is first in the bit order.

## BUS:B<x>:AUDio:CLOCK:POLarity

This command sets or queries the clock source polarity for the specified AUDIO bus. The bus is specified by x.

**Conditions** Requires option SR-AUDIO.

**Group** Bus

**Syntax** BUS:B<x>:AUDio:CLOCK:POLarity {FALL|RISE}  
 BUS:B<x>:AUDio:CLOCK:POLarity?

**Arguments** B<x> is the number of the bus.  
 FALL sets falling edge as the clock polarity.  
 RISE sets rising edge as the clock polarity.

**Examples** BUS:B1:AUDIO:CLOCK:POLARITY FALL sets the clock polarity to Fall.  
 BUS:B1:AUDIO:CLOCK:POLARITY? might return :BUS:B1:AUDIO:CLOCK:POLARITY RISE indicating that the clock polarity is set to Rise.

## BUS:B<x>:AUDio:CLOCK:SOUrce

This command sets or queries the clock source waveform for the specified AUDIO bus. The bus is specified by x.

**Conditions** Requires option SR-AUDIO.

<b>Group</b>	Bus
<b>Syntax</b>	<pre>BUS:B&lt;x&gt;:AUDio:CLOCK:SOURce {S&lt;x&gt;_Ch&lt;x&gt;_D&lt;x&gt; CH&lt;x&gt; CH&lt;x&gt;_D&lt;x&gt; Math&lt;x&gt; REF&lt;x&gt; REF&lt;x&gt;_D&lt;x&gt;} BUS:B&lt;x&gt;:AUDio:CLOCK:SOURce?</pre>
<b>Arguments</b>	<p>B&lt;x&gt; is the number of the bus.</p> <p>S&lt;x&gt;_Ch&lt;x&gt;_D&lt;x&gt; specifies is the remote scope number, the analog channel and the digital channel.</p> <p>CH&lt;x&gt; specifies an analog channel as the clock source waveform for the audio bus.</p> <p>CH&lt;x&gt;_D&lt;x&gt; specifies a digital channel as the clock source waveform for the specified audio bus.</p> <p>Math&lt;x&gt; specifies a math waveform as the clock source waveform for the audio bus.</p> <p>REF&lt;x&gt; specifies a reference waveform as the clock source waveform for the audio bus.</p> <p>REF&lt;x&gt;_D&lt;x&gt; specifies a digital reference waveform as the clock source waveform for the specified audio bus.</p>
<b>Examples</b>	<pre>BUS:B1:AUDIO:CLOCK:SOURCE CH1_D1 sets D1 of channel 1 as the clock source for the audio bus.  BUS:B1:AUDIO:CLOCK:SOURCE? might return :BUS:B1:AUDIO:CLOCK:SOURCE CH1 indicating that the clock source is set to channel 1.</pre>

## BUS:B<x>:AUDio:CLOCK:THReshold

This command sets or queries the audio clock source threshold for the specified bus. The bus is specified by x.

<b>Conditions</b>	Requires option SR-AUDIO.
<b>Group</b>	Bus
<b>Syntax</b>	<pre>BUS:B&lt;x&gt;:AUDio:CLOCK:THReshold &lt;NR3&gt; BUS:B&lt;x&gt;:AUDio:CLOCK:THReshold?</pre>

**Related Commands** [BUS:B<x>:AUDio:CLOCK:SOUrce](#)

**Arguments** B<x> is the number of the bus.  
 <NR3> is the audio clock source threshold for the specified bus.

**Examples** BUS:B3:AUDIO:CLOCK:THRESHOLD 500.0E-3 sets the Bus 3 audio Cclock source threshold to 500.0 mV.  
 BUS:B2:AUDIO:CLOCK:THRESHOLD? might return  
 :BUS:B2:AUDIO:CLOCK:THRESHOLD 1.0 indicates the Bus 2 audio clock source threshold is set to 1.0 V.

## BUS:B<x>:AUDio:DATA:POLarity

This command sets or queries the audio data source polarity for the specified audio bus. The bus is specified by x.

**Conditions** Requires option SR-AUDIO.

**Group** Bus

**Syntax** BUS:B<x>:AUDio:DATA:POLarity {HIGH|LOW}  
 BUS:B<x>:AUDio:DATA:POLarity?

**Arguments** B<x> is the number of the bus.  
 HIGH specifies positive data polarity for the audio bus.  
 LOW specifies negative data polarity for the audio bus.

**Examples** BUS:B1:AUDIO:DATA:POLARITY LOW sets the data polarity to LOW.  
 BUS:B1:AUDIO:DATA:POLARITY? might return  
 :BUS:B1:AUDIO:DATA:POLARITY HIGH indicating that the data polarity is set to HIGH.

## BUS:B<x>:AUDio:DATA:SIZE

This command sets or queries the number of bits per channel for the specified audio bus. The bus is specified by x.

---

**NOTE.** *This command only applies to the TDM Audio type.*

---

<b>Conditions</b>	Requires option SR-AUDIO.
<b>Group</b>	Bus
<b>Syntax</b>	BUS:B<x>:AUDio:DATA:SIZE <NR1> BUS:B<x>:AUDio:DATA:SIZE?
<b>Arguments</b>	B<x> is the number of the bus.  NR1 specifies the number of bits per word.
<b>Examples</b>	BUS:B1:AUDIO:DATA:SIZE 8 sets the number of bits per word to 8.  BUS:B1:AUDIO:DATA:SIZE? might return :BUS:B1:AUDIO:DATA:SIZE 24 indicating that the number of bits per word is set to 24.

## BUS:B<x>:AUDio:DATA:SOUrce

This command sets or queries the audio data source for the specified audio bus. The bus is specified by x.

<b>Conditions</b>	Requires option SR-AUDIO.
<b>Group</b>	Bus
<b>Syntax</b>	BUS:B<x>:AUDio:DATA:SOUrce {S<x>_Ch<x>_D<x> CH<x> CH<x>_D<x> MATH<x> REF<x> REF<x>_D<x>} BUS:B<x>:AUDio:DATA:SOUrce?
<b>Arguments</b>	B<x> is the number of the bus.  S<x>_Ch<x>_D<x> specifies is the remote scope number, the analog channel and the digital channel.  CH<x> specifies an analog channel as the data source waveform for the audio bus.  CH<x>_D<x> specifies a digital channel as the data source waveform for the audio bus.



MATH<x> specifies an math waveform as the data source waveform for the audio bus.

REF<x> specifies an reference waveform as the data source waveform for the audio bus.

REF<x>\_D<x> specifies a digital reference waveform as the data source waveform for the specified audio bus.

**Examples**    `BUS:B1:AUDIO:DATA:SOURCE CH1_D1` sets the data source to D1 of FlexChannel 1.

`BUS:B1:AUDIO:DATA:SOURCE?` might return `:BUS:B1:AUDIO:DATA:SOURCE CH3` indicating that the data source is set to CH3.

## BUS:B<x>:AUDio:DATA:THReshold

This command sets or queries the audio data source threshold for the specified bus. The bus is specified by x.

**Conditions**    Requires option SR-AUDIO.

**Group**        Bus

**Syntax**        `BUS:B<x>:AUDio:DATA:THReshold <NR3>`  
`BUS:B<x>:AUDio:DATA:THReshold?`

**Related Commands**    [BUS:B<x>:AUDio:DATA:SOUrce](#)

**Arguments**    `B<x>` is the number of the bus.  
`<NR3>` is the audio data source threshold for the specified bus.

**Examples**        `BUS:B3:AUDIO:DATA:THRESHOLD 1.5` sets the Bus 3 audio clock source threshold to 500.0 mV.  
`BUS:B2:AUDIO:DATA:THRESHOLD?` might return `:BUS:B2:AUDIO:DATA:THRESHOLD 500.0000E-3` indicates the Bus 2 audio data source threshold is set to 500 mV.

## BUS:B<x>:AUDio:DATA:WORDSize

This command sets or queries the audio bits per word for the specified bus. The bus is specified by x.

<b>Group</b>	Bus
<b>Syntax</b>	BUS:B<x>:AUDio:DATA:WORDSize <NR1> BUS:B<x>:AUDio:DATA:WORDSize?
<b>Arguments</b>	B<x> is the number of the bus.  <NR1> is the audio bits per word for the specified bus.
<b>Examples</b>	BUS:B1:AUDio:DATA:WORDSize 24 sets the audio bits per word to 24 bits.  BUS:B1:AUDio:DATA:WORDSize? might return :BUS:B1:AUDIO:DATA:WORDSIZE 24 indicating the bits per word is 24.

## BUS:B<x>:AUDio:FRAME:CLOCKBITSPERCHANNEL

This command sets or queries the audio bits of sync width for the specified bus. The bus is specified by x.

---

**NOTE.** *This command only applies to the TDM Audio type.*

---

<b>Conditions</b>	Requires option SR-AUDIO.
<b>Group</b>	Bus
<b>Syntax</b>	BUS:B<x>:AUDio:FRAME:CLOCKBITSPERCHANNEL <NR1> BUS:B<x>:AUDio:FRAME:CLOCKBITSPERCHANNEL?
<b>Arguments</b>	B<x> is the number of the bus.  <NR1> is the audio bits of sync width for the specified bus.
<b>Examples</b>	BUS:B1:AUDio:FRAME:CLOCKBITSPERCHANNEL 32 sets the number of bits to 32.

`BUS:B1:Audio:FRAME:CLOCKBITSPERCHANNEL?` might return  
`:BUS:B1:Audio:FRAME:CLOCKBITSPERCHANNEL 24` indicating there are 24 bits of sync width for the bus.

## BUS:B<x>:Audio:FRAME:SIZE

This command sets or queries the number of audio channels in each frame for the specified AUDIO bus. The bus is specified by x.

---

**NOTE.** *This command only applies to the TDM Audio type.*

---

**Conditions** Requires option SR-AUDIO.

**Group** Bus

**Syntax** `BUS:B<x>:Audio:FRAME:SIZE <NR1>`  
`BUS:B<x>:Audio:FRAME:SIZE?`

**Arguments** B<x> is the number of the bus.  
<NR1> specifies the number of channels in each frame.

**Examples** `BUS:B1:Audio:FRAME:SIZE 2` sets the frame size to 2.  
`BUS:B1:Audio:FRAME:SIZE?` might return `:BUS:B1:Audio:FRAME:SIZE 8` indicating that the number of channels in each frame is set to 8.

## BUS:B<x>:Audio:TYPE

This command sets or queries the audio format (type) for the specified audio bus. The bus is specified by x.

**Conditions** Requires option SR-AUDIO.

**Group** Bus

**Syntax** `BUS:B<x>:Audio:TYPE {I2S|LJ|RJ|TDM}`  
`BUS:B<x>:Audio:TYPE?`

<b>Arguments</b>	<p>B&lt;x&gt; is the number of the bus.</p> <p>I2S specifies the I<sup>2</sup>S audio format.</p> <p>LJ specifies the left-justified audio format.</p> <p>RJ specifies the right-justified audio format.</p> <p>TDM specifies the time-division multiplexing audio format.</p>
<b>Examples</b>	<p>BUS:B1:AUDIO:TYPE RJ sets right-justified as the audio format.</p> <p>BUS:B1:AUDIO:TYPE? might return :BUS:B1:AUDIO:TYPE I2S indicating that the audio format is set to I<sup>2</sup>S.</p>

## BUS:B<x>:AUDIO:WORDSel:POLarity

This command sets or queries the word select source polarity for the specified audio bus. The bus is specified by x.

<b>Conditions</b>	Requires option SR-AUDIO.
<b>Group</b>	Bus
<b>Syntax</b>	<pre>BUS:B&lt;x&gt;:AUDIO:WORDSel:POLarity {NORMal INVERTed} BUS:B&lt;x&gt;:AUDIO:WORDSel:POLarity?</pre>
<b>Arguments</b>	<p>B&lt;x&gt; is the number of the bus.</p> <p>NORMal specifies positive polarity.</p> <p>INVERTed specifies negative polarity.</p>
<b>Examples</b>	<p>BUS:B1:AUDIO:WORDSEL:POLARITY NORMal sets normal as the word select polarity.</p> <p>BUS:B1:AUDIO:WORDSEL:POLARITY? might return :BUS:B1:AUDIO:WORDSEL:POLARITY NORMAL indicating that the word select polarity is set to normal.</p>

## BUS:B<x>:AUDIO:WORDSel:SOUrce

This command sets or queries the audio word select source waveform for the specified audio bus. The bus is specified by x.

<b>Conditions</b>	Requires option SR-AUDIO.
<b>Group</b>	Bus
<b>Syntax</b>	BUS:B<x>:AUDIO:WORDSEL:SOURCE {S<x>_Ch<x>_D<x>   CH<x>   CH<x>_D<x>   MATH<x>   REF<x>   REF<x>_D<x>} BUS:B<x>:AUDIO:WORDSEL:SOURCE?
<b>Arguments</b>	B<x> is the number of the bus.  S<x>_Ch<x>_D<x> specifies is the remote scope number, the analog channel and the digital channel.  CH<x> specifies an analog channel as the word select source waveform.  CH<x>_D<x> specifies a digital channel as the word select source waveform.  MATH<x> specifies an math waveform as the word select source waveform.  REF<x> specifies an reference waveform as the word select source waveform.  REF<x>_D<x> specifies a digital reference waveform as the word select source waveform for the specified audio bus.
<b>Examples</b>	BUS:B1:AUDIO:WORDSEL:SOURCE CH1 sets CH1 as the word select source.  BUS:B1:AUDIO:WORDSEL:SOURCE CH2_D3 sets D3 of FlexChannel 2 as the word select source.  BUS:B1:AUDIO:WORDSEL:SOURCE? might return :BUS:B1:AUDIO:WORDSEL:SOURCE CH2 indicating that the word select source is set to CH2.

## BUS:B<x>:AUDIO:WORDSEL:THRESHOLD

This command sets or queries the audio word select source threshold for the specified bus. The bus is specified by x.

<b>Conditions</b>	Requires option SR-AUDIO.
<b>Group</b>	Bus
<b>Syntax</b>	BUS:B<x>:AUDIO:WORDSEL:THRESHOLD <NR3> BUS:B<x>:AUDIO:WORDSEL:THRESHOLD?

<b>Arguments</b>	<p>B&lt;x&gt; is the number of the bus.</p> <p>&lt;NR3&gt; is the audio word select source threshold for the specified bus.</p>
<b>Examples</b>	<p><code>BUS:B4:AUDIO:WORDSEL:THRESHOLD 300.0E-3</code> sets the Bus 4 audio word select source threshold to 300 mV.</p> <p><code>BUS:B1:AUDIO:WORDSEL:THRESHOLD?</code> might return <code>:BUS:B1:AUDIO:WORDSEL:THRESHOLD 1.25</code> indicates the Bus 1 audio word select source threshold is set to 1.25 V.</p>

## **BUS:B<x>:AUTOETHERnet:DATAMINUSTHRESHOLD**

This command sets or queries the AutoEthernet D– source threshold level for the specified bus. This threshold only applies when the AutoEthernet signal type is single ended.

<b>Conditions</b>	<p>Requires option SR-AUTOENET</p> <p>The AutoEthernet signal type is single ended.</p>
<b>Group</b>	Bus
<b>Syntax</b>	<p><code>BUS:B&lt;x&gt;:AUTOETHERnet:DATAMINUSTHRESHOLD &lt;NR3&gt;</code> <code>BUS:B&lt;x&gt;:AUTOETHERnet:DATAMINUSTHRESHOLD?</code></p>
<b>Arguments</b>	<p>Bus&lt;x&gt; is the Bus number.</p> <p>NR3 specifies the AutoEthernet D– source threshold level for the specified bus, in volts. This threshold only applies when the AutoEthernet signal type is single ended.</p>
<b>Examples</b>	<p><code>BUS:B3:AUTOETHERnet:DATAMINUSTHRESHOLD 250.0E-3</code> sets the Bus 3 AutoEthernet D– source threshold level to 250.0000 mV.</p> <p><code>BUS:B2:AUTOETHERnet:DATAMINUSTHRESHOLD?</code> might return <code>BUS:B2:AUTOETHERnet:DATAMINUSTHRESHOLD 1.0</code>, indicating the Bus 2 AutoEthernet D– source threshold level is set to 1.0 V.</p>

## BUS:B<x>:AUTOETHERnet:DATAPLUSTHRESHold

This command sets or queries the AutoEthernet D+ source threshold level for the specified bus. This threshold only applies when the AutoEthernet signal type is single ended.

<b>Conditions</b>	Requires option SR-AUTOENET The AutoEthernet signal type is single ended.
<b>Group</b>	Bus
<b>Syntax</b>	BUS:B<x>:AUTOETHERnet:DATAPLUSTHRESHold <NR3> BUS:B<x>:AUTOETHERnet:DATAPLUSTHRESHold?
<b>Arguments</b>	Bus<x> is the Bus number.  NR3 specifies the AutoEthernet D+ source threshold for the specified bus, in volts. This threshold only applies when the AutoEthernet signal type is single ended.
<b>Examples</b>	BUS:B3:AUTOETHERnet:DATAPLUSTHRESHOLD 250.0E-3 sets the Bus 3 AutoEthernet D+ source threshold level to 250.0000 mV.  BUS:B2:AUTOETHERnet:DATAPLUSTHRESHOLD? might return BUS:B2:AUTOETHERnet:DATAPLUSTHRESHOLD 1.0, indicating the Bus 2 AutoEthernet D+ source threshold level is set to 1.0 V.

## BUS:B<x>:AUTOETHERnet:LOWDATAMINus

This command sets or queries the AutoEthernet D– source low threshold level for the specified bus. This threshold only applies when the AutoEthernet signal type is single ended.

<b>Conditions</b>	Requires option SR-AUTOENET The AutoEthernet signal type is single ended.
<b>Group</b>	Bus
<b>Syntax</b>	BUS:B<x>:AUTOETHERnet:LOWDATAMINus <NR3> BUS:B<x>:AUTOETHERnet:LOWDATAMINus?

**Arguments** Bus<x> is the Bus number.

NR3 specifies the AutoEthernet D– source low threshold level for the specified bus, in volts. This threshold only applies when the AutoEthernet signal type is single ended.

**Examples** BUS:B1:AUTOETHERnet:LOWDATAMINus 250.0E-3 sets the Bus 1 AutoEthernet D– source low threshold level to 250.0000 mV.

BUS:B2:AUTOETHERnet:LOWDATAMINus? might return  
 BUS:B2:AUTOETHERnet:LOWDATAMINus 1.0, indicating the Bus 2 AutoEthernet D– source threshold level is set to 1.0 V.

## BUS:B<x>:AUTOETHERnet:LOWDATAPLUS

This command sets or queries the AutoEthernet D+ source low threshold level for the specified bus. This threshold only applies when the AutoEthernet signal type is single ended.

**Conditions** Requires option SR-AUTOENET

The AutoEthernet signal type is single ended.

**Group** Bus

**Syntax** BUS:B<x>:AUTOETHERnet:LOWDATAPLUS <NR3>  
 BUS:B<x>:AUTOETHERnet:LOWDATAPLUS?

**Arguments** Bus<x> is the Bus number.

NR3 specifies the AutoEthernet D+ source low threshold level for the specified bus, in volts. This threshold only applies when the AutoEthernet signal type is single ended.

**Examples** BUS:B3:AUTOETHERnet:LOWDATAPLUS 250.0E-3 sets the Bus 3 AutoEthernet D+ source low threshold level to 250.0000 mV.

BUS:B2:AUTOETHERnet:LOWDATAPLUS? might return  
 BUS:B2:AUTOETHERnet:LOWDATAPLUS 1.0, indicating the Bus 2 AutoEthernet D+ source low threshold level is set to 1.0 V.



## BUS:B<x>:AUTOETHERnet:LOWTHRESHold

This command sets or queries the AutoEthernet Data source Low threshold level for the specified bus. This threshold only applies when the AutoEthernet signal type is differential.

**Conditions** Requires option SR-AUTOENET  
The AutoEthernet signal type is differential.

**Group** Bus

**Syntax** BUS:B<x>:AUTOETHERnet:LOWTHRESHold <NR3>  
BUS:B<x>:AUTOETHERnet:LOWTHRESHold?

**Related Commands** [BUS:B<x>:AUTOETHERnet:SIGNALTYpe](#)

**Arguments** Bus<x> is the Bus number.  
NR3 specifies the AutoEthernet DATA source Low threshold level for the specified bus, in volts. This threshold only applies when the AutoEthernet signal type is differential.

**Examples** BUS:B1:AUTOETHERnet:LOWTHRESHold -200e-3 sets the bus 1 low threshold to -200 mV.  
BUS:B3:AUTOETHERnet:LOWTHRESHold? might return  
BUS:B3:AUTOETHERnet:LOWTHRESHOLD -500.0000E-3, indicating the threshold is set to -500 mV for bus 3.

## BUS:B<x>:AUTOETHERnet:SIGNALTYpe

This command sets or queries the AutoEthernet signal type for the specified bus.

**Conditions** Requires option SR-AUTOENET  
The AutoEthernet signal type is single ended.

**Group** Bus

**Syntax** BUS:B<x>:AUTOETHERnet:SIGNALTYpe {SINGLE|DIFF}  
BUS:B<x>:AUTOETHERnet:SIGNALTYpe?

<b>Arguments</b>	<p><b>BUS&lt;x&gt;</b> is the Bus number.</p> <p><b>SINGLE</b> specifies single-ended signals.</p> <p><b>DIFF</b> specifies differential signals.</p>
<b>Examples</b>	<p><b>BUS:B4:AUTOETHERnet:SIGNALType SINGLE</b> specifies the AutoEthernet signal type as single-ended for Bus B4.</p> <p><b>BUS:B3:AUTOETHERnet:SIGNALType?</b> might return <b>BUS:B3:AUTOETHERnet:SIGNALType DIFF</b>, indicating that the AutoEthernet signal type is differential for Bus 3.</p>

## BUS:B<x>:AUTOETHERnet:SOURce

This command sets or queries the AutoEthernet data (SDATA) source for the specified bus. This command controls the source channel when the signal type is differential.

<b>Conditions</b>	Requires option SR-AUTOENET
<b>Group</b>	Bus
<b>Syntax</b>	<p><b>BUS:B&lt;x&gt;:AUTOETHERnet:SOURce</b> {S&lt;x&gt;_Ch&lt;x&gt;   CH&lt;x&gt;   MATH&lt;x&gt;   REF&lt;x&lt;&gt;&gt;}</p> <p><b>BUS:B&lt;x&gt;:AUTOETHERnet:SOURce?</b></p>
<b>Related Commands</b>	<a href="#">BUS:B&lt;x&gt;:AUTOETHERnet:THRESHold</a>
<b>Arguments</b>	<p><b>BUS&lt;x&gt;</b> is the Bus number.</p> <p><b>CH&lt;x&gt;</b> specifies an analog channel as the AutoEthernet data source for differential input, where &lt;x&gt; is the channel number.</p> <p><b>MATH&lt;x&gt;</b> specifies a math channel as the AutoEthernet data source for differential input, where &lt;x&gt; is the math waveform number.</p> <p><b>REF&lt;x&gt;</b> specifies a reference waveform as the AutoEthernet data source for differential input, where &lt;x&gt; is the reference waveform number.</p> <p><b>S&lt;x&gt;_Ch&lt;x&gt;</b> specifies the remote scope number and the analog channel as the source.</p>
<b>Examples</b>	<p><b>BUS:B5:AUTOETHERnet:SOURce CH4</b> specifies to use the channel 4 waveform as the source for AutoEthernet data on bus 5.</p>

`BUS:B1:AUTOETHERnet:SOURCE?` might return  
`BUS:B1:AUTOETHERnet:SOURCE? CH2`, indicating that channel 2 is the currently specified source for AutoEthernet data on bus 1.

## **BUS:B<x>:AUTOETHERnet:SOUrcE:DMINus**

This command sets or queries the AutoEthernet D– source for the specified bus. This command specifies the source channel to use when the signal type is single ended.

<b>Conditions</b>	Requires option SR-AUTOENET
<b>Group</b>	Bus
<b>Syntax</b>	<code>BUS:B&lt;x&gt;:AUTOETHERnet:SOUrcE:DMINus</code> <code>{S&lt;x&gt;_Ch&lt;x&gt; CH&lt;x&gt; MATH&lt;x&gt; REF&lt;x&gt;&lt;&gt;}</code> <code>BUS:B&lt;x&gt;:AUTOETHERnet:SOUrcE:DMINus?</code>
<b>Arguments</b>	<code>Bus&lt;x&gt;</code> is the Bus number.  <code>S&lt;x&gt;_Ch&lt;x&gt;</code> specifies the remote scope number and the analog channel.  <code>CH&lt;x&gt;</code> specifies an analog channel as the source for the D– signal, where <code>&lt;x&gt;</code> is the channel number.  <code>MATH&lt;x&gt;</code> specifies a math channel as the source for the D– signal, where <code>&lt;x&gt;</code> is the math waveform number.  <code>REF&lt;x&gt;</code> specifies a reference waveform as the source for the D– signal, where <code>&lt;x&gt;</code> is the reference waveform number.
<b>Examples</b>	<code>BUS:B2:AUTOETHERnet:SOUrcE:DMINus CH5</code> sets the D– source to channel 5 for bus 2.  <code>BUS:B1:AUTOETHERnet:SOUrcE:DMINus?</code> might return <code>BUS:B1:AUTOETHERnet:SOUrcE:DMINus CH6</code> , indicating the D– source is set to channel 6 for bus 1.

## **BUS:B<x>:AUTOETHERnet:SOUrcE:DPLUs**

This command sets or queries the AutoEthernet D+ source for the specified bus. This command specifies the source channel to use when the signal type is single ended.

<b>Conditions</b>	Requires option SR-AUTOENET
<b>Group</b>	Bus
<b>Syntax</b>	BUS:B<x>:AUTOETHERnet:SOURce:DPLUS {S<x>_Ch<x> CH<x> MATH<x> REF<x>} BUS:B<x>:AUTOETHERnet:SOURce:DPLUS?
<b>Arguments</b>	<p>Bus&lt;x&gt; is the Bus number.</p> <p>S&lt;x&gt;_Ch&lt;x&gt; specifies the remote scope number and the analog channel as the source.</p> <p>CH&lt;x&gt; specifies an analog channel as the source for the D+ signal, where &lt;x&gt; is the channel number.</p> <p>MATH&lt;x&gt; specifies a math channel as the source for the D+ signal, where &lt;x&gt; is the math waveform number.</p> <p>REF&lt;x&gt; specifies a reference waveform as the source for the D+ signal, where &lt;x&gt; is the reference waveform number.</p>
<b>Examples</b>	<p>BUS:B2:AUTOETHERnet:SOURce:DPLUS CH5 sets the D+ source to channel 5 for bus 2.</p> <p>BUS:B1:AUTOETHERnet:SOURce:DPLUS? might return BUS:B1:AUTOETHERnet:SOURce:DPLUS CH8, indicating the D+ source is set to channel 8 for bus 1.</p>

## BUS:B<x>:AUTOETHERnet:THRESHold

This command sets or queries the AutoEthernet DATA source High threshold level for the specified bus.

<b>Conditions</b>	Requires option SR-AUTOENET
<b>Group</b>	Bus
<b>Syntax</b>	BUS:B<x>:AUTOETHERnet:THRESHold <NR3> BUS:B<x>:AUTOETHERnet:THRESHold?
<b>Related Commands</b>	<a href="#">BUS:B&lt;x&gt;:AUTOETHERnet:SOURce</a>

<b>Arguments</b>	<p><code>BUS&lt;x&gt;</code> is the Bus number.</p> <p><code>NR3</code> specifies the AutoEthernet DATA source High threshold level for the specified bus, in volts.</p>
<b>Examples</b>	<p><code>BUS:B4:AUTOETHERnet:THRESHOLD 1.0</code> sets the Bus 4 AutoEthernet Data source High threshold level to 1.0 V.</p> <p><code>BUS:B3:AUTOETHERnet:THRESHOLD?</code> might return  <code>BUS:B3:AUTOETHERnet:THRESHOLD 225.00000E-3</code>, indicating the Bus 3 AutoEthernet Data source High threshold level is set to 225.0 mV.</p>

## BUS:B<x>:AUTOETHERnet:TYPE

This command sets or queries the AutoEthernet standard speed.

<b>Conditions</b>	<p>Requires option SR-AUTOENET</p> <p>The AutoEthernet signal type is single ended.</p>
<b>Group</b>	Bus
<b>Syntax</b>	<p><code>BUS:B&lt;x&gt;:AUTOETHERnet:TYPE {HUNDRDBASET1}</code>  <code>BUS:B&lt;x&gt;:AUTOETHERnet:TYPE?</code></p>
<b>Arguments</b>	<p><code>Bus&lt;x&gt;</code> is the Bus number.</p> <p><code>HUNDRDBASET1</code> specifies the AutoEthernet speed as 100Base-T1.</p>
<b>Examples</b>	<p><code>BUS:B1:AUTOETHERnet:TYPE HUNDRDBASET1</code> specifies the AutoEthernet speed as 100Base-T1.</p> <p><code>BUS:B3:AUTOETHERnet:TYPE?</code> might return <code>BUS:B3:AUTOETHERnet:TYPE HUNDRDBASET1</code>, indicating that the AutoEthernet speed is 100Base-T1 for Bus 3.</p>

## BUS:B<x>:CAN:BITRate

This command sets or queries the CAN bit rate. The bus number is specified by x. If you select Custom, use [BUS:B<x>:CAN:BITRate:VALue](#) to set the bit rate.

<b>Conditions</b>	Requires option SR-AUTO.
-------------------	--------------------------

<b>Group</b>	Bus
<b>Syntax</b>	BUS:B<x>:CAN:BITRate {RATE10K RATE100K RATE1M RATE125K RATE153K  RATE20K RATE25K RATE250K RATE31K RATE33K RATE400K RATE50K  RATE500K RATE62K  RATE68K RATE800K RATE83K RATE92K CUSTOM} BUS:B<x>:CAN:BITRate?
<b>Related Commands</b>	<a href="#">BUS:B&lt;x&gt;:CAN:BITRate:VALue</a>
<b>Arguments</b>	B<x> is the number of the bus. Arguments specify the bit rate.
<b>Examples</b>	BUS:B1:CAN:BITRate RATE1M sets the CAN bit rate to 1 Mb. BUS:B1:CAN:BITRate? might return :BUS:B1:CAN:BITRATE RATE500K, indicating the CAN bit rate is set to 500 k.

## BUS:B<x>:CAN:BITRate:VALue

This command sets or queries CAN bit rate when Custom is selected by [BUS:B<x>:CAN:BITRate](#). The bus number is specified by x.

<b>Conditions</b>	Requires option SR-AUTO.
<b>Group</b>	Bus
<b>Syntax</b>	BUS:B<x>:CAN:BITRate:VALue <NR3> BUS:B<x>:CAN:BITRate:VALue?
<b>Related Commands</b>	<a href="#">BUS:B&lt;x&gt;:CAN:BITRate</a>
<b>Arguments</b>	B<x> is the number of the bus. <NR3> specifies the CAN bit rate.
<b>Returns</b>	<NR1> is the bit rate.

**Examples** `BUS:B1:CAN:BITRate:VALue 400.0E+3` sets the bit rate to 400 k.

`BUS:B1:CAN:BITRate:VALue?` might return `:BUS:B1:CAN:BITRATE:VALUE 500000`, indicating that the bit rate is set to 500,000.

## BUS:B<x>:CAN:FD:BITRate

This command sets or queries the increased data phase bit rate used by CAN FD packets on the specified CAN bus. The bus is specified by x. If you select Custom, use `BUS:B<x>:CAN:FD:BITRate:CUSTom` to set the bit rate.

**Conditions** Requires option SR-AUTO.

**Group** Bus

**Syntax** `BUS:B<x>:CAN:FD:BITRate`  
`{RATE1M|RATE2M|RATE3M|RATE4M|RATE5M|RATE6M|`  
`RATE7M|RATE8M|RATE9M|RATE10M|RATE11M|RATE12M|RATE13M|`  
`RATE14M|RATE15M|RATE16M|CUSTom}`  
`BUS:B<x>:CAN:FD:BITRate?`

**Related Commands** [BUS:B<x>:CAN:FD:BITRate:CUSTom](#)

**Arguments** B<x> is the number of the bus.  
 Arguments specify the bit rate.

**Examples** `BUS:B1:CAN:BITRATE RATE1M` sets the CAN FD bit rate to 1 Mbps.

`BUS:B1:CAN:BITRATE?` might return `:BUS:B1:CAN:BITRATE RATE4M`, indicating that the CAN FD bit rate is 4 Mbps.

## BUS:B<x>:CAN:FD:BITRate:CUSTom

This command sets or queries the custom bit rate for the increased data phase of CAN FD packets on the specified CAN bus. The bus is specified by x.

**Conditions** Requires option SR-AUTO.

**Group** Bus

**Syntax**     **BUS:B<x>:CAN:FD:BITRate:CUSTOM <NR1>**  
**BUS:B<x>:CAN:FD:BITRate:CUSTOM?**

**Related Commands**   [BUS:B<x>:CAN:BITRate](#)

**Arguments**     **B<x>** is the number of the bus.  
**<NR1>** is the custom FD bit rate for the specified bus.

**Examples**     **BUS:B1:CAN:FD:BITRATE:CUSTOM 1000000** sets the bit rate to 1,000,000.  
**BUS:B1:CAN:FD:BITRATE:CUSTOM?** might return  
**:BUS:B1:CAN:FD:BITRATE:CUSTOM 4000000**, indicating the bit rate is set to 4,000,000.

## **BUS:B<x>:CAN:SAMPLEpoint**

This command sets or queries the sample point for the specified CAN bus. The bus is specified by x.

**Conditions**     Requires option SR-AUTO.

**Group**         Bus

**Syntax**       **BUS:B<x>:CAN:SAMPLEpoint <NR1>**  
**BUS:B<x>:CAN:SAMPLEpoint?**

**Arguments**     **B<x>** is the number of the bus.  
**<NR1>** is the sample point, in percent, for the specified CAN bus.

**Examples**     **BUS:B1:CAN:SAMPLEpoint 40** sets the sample point to 40%.  
**BUS:B1:CAN:SAMPLEpoint?** might return **:BUS:B1:CAN:SAMPLEPOINT 50** indicating the sample point is at 50%.

## **BUS:B<x>:CAN:SIGNAL**

This command sets or queries the signal type for the specified CAN bus. The bus is specified by x.



<b>Conditions</b>	Requires option SR-AUTO.
<b>Group</b>	Bus
<b>Syntax</b>	BUS:B<x>:CAN:SIGna1 {DIFFerentia1 CANH CANL RX TX} BUS:B<x>:CAN:SIGna1?
<b>Arguments</b>	B<x> is the number of the bus.  Arguments are the CAN bus signal types.
<b>Examples</b>	BUS:B1:CAN:SIGna1 CANL sets the signal type to CANL.  BUS:B1:CAN:SIGna1? might return :BUS:B1:CAN:SIGNAL CANH indicating the signal type is CANH.

## BUS:B<x>:CAN:SOUrce

This command sets or queries the CAN source channel for the specified CAN bus. The bus number is specified by x.

<b>Conditions</b>	Requires option SR-AUTO.
<b>Group</b>	Bus
<b>Syntax</b>	BUS:B<x>:CAN:SOUrce {S<x>_Ch<x>_D<x> CH<x> CH<x>_D<x> MATH<x> REF<x> REF<x>_D<x>} BUS:B<x>:CAN:SOUrce?
<b>Arguments</b>	B<x> is the number of the bus.  S<x>_Ch<x>_D<x> specifies the remote scope number, the analog channel, and the digital channel.  CH<x>_D<x> specifies an analog channel and the digital channel as the source.  REF<x>_D<x> specifies a reference waveform and digital channel as the source.  CH<x> specifies an analog channel as the source.  Math<x> specifies a math waveform as the source  REF<x> specifies a reference waveform as the source.

**Examples** `BUS:B1:CAN:SOURce MATH6` sets the source channel to MATH6.  
`BUS:B1:CAN:SOURce?` might return `:BUS:B1:CAN:SOURce CH1`, indicating that the CAN source channel is CH1.

## **BUS:B<x>:CAN:STANDARD**

This command sets or queries which CAN standard specification to analyze the specified CAN bus with. The bus is specified by x.

**Conditions** Requires option SR-AERO.

**Group** Bus

**Syntax** `BUS:B<x>:CAN:STANDARD {CAN2X|FDISO|FDNONISO}`  
`BUS:B<x>:CAN:STANDARD?`

**Arguments** B<x> is the number of the bus.  
CAN2X sets the CAN bus standard to CAN 2.0.  
FDISO sets the CAN bus standard to ISO CAN FD (11898-1:2015).  
FDNONISO sets the CAN bus standard to non-ISO CAN FD (Bosch:2012).

**Examples** `BUS:B1:CAN:STANDARD FDISO` sets the CAN standard to ISO CAN FD.  
`BUS:B1:CAN:STANDARD?` might return `:BUS:B1:CAN:STANDARD CAN2X`, indicating that the CAN standard is CAN 2.0.

## **BUS:B<x>:CAN:THRESHOLD**

This command sets or queries the source channel threshold for the specified CAN bus. The bus is specified by x.

**Conditions** Requires option SR-AUTO.

**Group** Bus

**Syntax** `BUS:B<x>:CAN:THRESHOLD <NR3>`  
`BUS:B<x>:CAN:THRESHOLD?`

**Arguments** B<x> is the number of the bus.  
 <NR3> is the source channel threshold for the specified CAN bus.

**Examples** BUS:B1:CAN:THRESHold 5 sets the threshold to 5 V.  
 BUS:B1:CAN:THRESHold? might return :BUS:B1:CAN:THRESHOLD 0.0E+0 indicating the threshold is set to 0.0 V.

## BUS:B<x>:CPHY:A:DATA:THRESHold

This command sets or queries the CPHY Single Ended A source threshold for the specified bus. The bus is specified by x.

**Conditions** Requires option SR-CPHY.

**Group** Bus

**Syntax** BUS:B<x>:CPHY:A:DATA:THRESHold <NR3>  
 BUS:B<x>:CPHY:A:DATA:THRESHold?

**Arguments** B<x> is the number of the bus.  
 <NR3> is the CPHY Single Ended A threshold in Volts for the specified bus. The argument range is -8 V to +8 V.

**Examples** BUS:B4:CPHY:A:DATA:THRESHold 1.0 sets the Bus 4 CPHY threshold to 1.0 V.  
 BUS:B3:CPHY:A:DATA:THRESHold? might return :BUS:B3:CPHY:A:DATA:THRESHold 100.00000E-3 indicating the Bus 3 CPHY threshold is set to 100.0 mV.

## BUS:B<x>:CPHY:A:LP:THRESHold

This command sets or queries the CPHY Single Ended A LP threshold for the specified bus. The bus is specified by x.

**Conditions** Requires option SR-CPHY.

**Group** Bus

**Syntax**    `BUS:B<x>:CPHY:A:LP:THRESHo1d <NR3>`  
`BUS:B<x>:CPHY:A:LP:THRESHo1d?`

**Arguments**    `B<x>` is the number of the bus.  
  
`<NR3>` is the CPHY Single Ended A LP threshold in Volts for the specified bus.  
The argument range is -8 V to +8 V.

**Examples**    `BUS:B4:CPHY:A:LP:THRESHo1d 1.0` sets the Bus 4 CPHY threshold to 1.0 V.  
  
`BUS:B3:CPHY:A:LP:THRESHo1d?` might return  
`:BUS:B3:CPHY:A:LP:THRESHo1d 100.00000E-3` indicating the Bus 3  
CPHY threshold is set to 100.0 mV.

## BUS:B<x>:CPHY:A:SOUrce

This command sets or queries the CPHY Single Ended A source for the specified bus line. The bus number is specified by x.

**Conditions**    Requires option SR-CPHY.

**Group**    Bus

**Syntax**    `BUS:B<x>:CPHY:A:SOUrce {S<x>_Ch<x> | CH<x> | MATH<x> | REF<x>}`  
`BUS:B<x>:CPHY:A:SOUrce?`

**Arguments**    `B<x>` is the number of the bus.  
  
`S<x>_Ch<x>` specifies the remote scope number and the analog channel.  
  
`CH<x>` specifies an analog channel as the source.  
  
`MATH<x>` specifies a math channel as the source.  
  
`REF<x>` specifies an analog reference waveform as the source.

**Examples**    `BUS:B1:CPHY:A:SOUrce Ch1` sets the source to channel 1.  
  
`BUS:B1:CPHY:A:SOUrce?` might return `:BUS:B1:CPHY:A:SOUrce CH1`,  
indicating the source is set to channel 1.

## BUS:B<x>:CPHY:AB:SOURce

This command sets or queries the CPHY differential AB source for the specified bus line. The bus number is specified by x.

**Conditions** Requires option SR-CPHY.

**Group** Bus

**Syntax** BUS:B<x>:CPHY:AB:SOURce {S<x>\_Ch<x>|CH<x>|MATH<x>|REF<x>}  
BUS:B<x>:CPHY:AB:SOURce?

**Arguments** B<x> is the number of the bus.

S<x>\_Ch<x> specifies the remote scope number and the analog channel.

CH<x> specifies an analog/digital channel as the source.

MATH<x> specifies a math channel as the source.

REF<x> specifies an analog/digital reference waveform as the source.

**Examples** BUS:B1:CPHY:AB:SOURce Ch1 sets the source to channel 1.

BUS:B1:CPHY:AB:SOURce? might return :BUS:B1:CPHY:AB:SOURce CH1, indicating the source is set to channel 1.

## BUS:B<x>:CPHY:AB:THReshold

This command sets or queries the CPHY differential AB source threshold for the specified bus. The bus is specified by x.

**Conditions** Requires option SR-CPHY.

**Group** Bus

**Syntax** BUS:B<x>:CPHY:AB:THReshold <NR3>  
BUS:B<x>:CPHY:AB:THReshold?

<b>Arguments</b>	<p>B&lt;x&gt; is the number of the bus.</p> <p>&lt;NR3&gt; is the CPHY differential AB threshold for the specified bus. The argument range is -8 V to +8 V.</p>
<b>Examples</b>	<p>BUS:B4:CPHY:AB:THResho1d 1.0 sets the Bus 4 CPHY threshold to 1.0 V.</p> <p>BUS:B4:CPHY:AB:THResho1d? might return :BUS:B4:CPHY:AB:THResho1d 100.00000E-3 indicating the Bus 4 CPHY clock threshold is set to 100.0 mV.</p>

## BUS:B<x>:CPHY:AGND:SOUrce

This command sets or queries the CPHY differential AGND source for the specified bus line. The bus number is specified by x.

<b>Conditions</b>	Requires option SR-CPHY.
<b>Group</b>	Bus
<b>Syntax</b>	BUS:B<x>:CPHY:AGND:SOUrce {S<x>_Ch<x> CH<x> MATH<x> REF<x>} BUS:B<x>:CPHY:AGND:SOUrce?
<b>Arguments</b>	<p>B&lt;x&gt; is the number of the bus.</p> <p>S&lt;x&gt;_Ch&lt;x&gt; specifies the remote scope number and the analog channel.</p> <p>CH&lt;x&gt; specifies an analog/digital channel as the source.</p> <p>MATH&lt;x&gt; specifies a math channel as the source.</p> <p>REF&lt;x&gt; specifies an analog/digital reference waveform as the source.</p>
<b>Examples</b>	<p>BUS:B1:CPHY:AGND:SOUrce Ch1 sets the source to channel 1.</p> <p>BUS:B1:CPHY:AGND:SOUrce? might return :BUS:B1:CPHY:AGND:SOUrce CH1, indicating the source is set to channel 1.</p>

## BUS:B<x>:CPHY:AGND:THReshold

This command sets or queries the CPHY differential AGND source threshold for the specified bus. The bus is specified by x.

<b>Conditions</b>	Requires option SR-CPHY.
-------------------	--------------------------

<b>Group</b>	Bus
<b>Syntax</b>	<code>BUS:B&lt;x&gt;:CPHY:AGND:THResho1d &lt;NR3&gt;</code> <code>BUS:B&lt;x&gt;:CPHY:AGND:THResho1d?</code>
<b>Arguments</b>	<code>B&lt;x&gt;</code> is the number of the bus.  <code>&lt;NR3&gt;</code> is the CPHY differential A GND threshold for the specified bus. The argument range is -8 V to +8 V.
<b>Examples</b>	<code>BUS:B4:CPHY:AGND:THResho1d 1.0</code> sets the Bus 4 CPHY threshold to 1.0 V.  <code>BUS:B4:CPHY:AGND:THResho1d?</code> might return <code>:BUS:B4:CPHY:AGND:THResho1d 100.00000E-3</code> indicating the Bus 4 CPHY threshold is set to 100.0 mV.

## BUS:B<x>:CPHY:B:DATA:THRESHold

This command sets or queries the CPHY Single Ended B source threshold for the specified bus. The bus is specified by x.

<b>Conditions</b>	Requires option SR-CPHY.
<b>Group</b>	Bus
<b>Syntax</b>	<code>BUS:B&lt;x&gt;:CPHY:B:DATA:THRESHold &lt;NR3&gt;</code> <code>BUS:B&lt;x&gt;:CPHY:B:DATA:THRESHold?</code>
<b>Arguments</b>	<code>B&lt;x&gt;</code> is the number of the bus.  <code>&lt;NR3&gt;</code> is the CPHY Single Ended B threshold for the specified bus. The argument range is -8 V to +8 V.
<b>Examples</b>	<code>BUS:B4:CPHY:B:DATA:THRESHold 1.0</code> sets the Bus 4 CPHY threshold to 1.0 V.  <code>BUS:B4:CPHY:B:DATA:THRESHold?</code> might return <code>:BUS:B4:CPHY:B:DATA:THRESHold 100.00000E-3</code> indicating the Bus 4 CPHY threshold is set to 100.0 mV.

## BUS:B<x>:CPHY:B:SOURce

This command sets or queries the CPHY Single Ended B source for the specified bus line. The bus number is specified by x.

<b>Conditions</b>	Requires option SR-CPHY.
<b>Group</b>	Bus
<b>Syntax</b>	BUS:B<x>:CPHY:B:SOURce {S<x>_Ch<x> CH<x> MATH<x> REF<x>} BUS:B<x>:CPHY:B:SOURce?
<b>Arguments</b>	B<x> is the number of the bus. S<x>_Ch<x> specifies the remote scope number and the analog channel. CH<x> specifies an analog channel as the source. MATH<x> specifies a math channel as the source. REF<x> specifies an analog reference waveform as the source.
<b>Examples</b>	BUS:B1:CPHY:B:SOURce Ch1 sets the source to channel 1. BUS:B1:CPHY:B:SOURce? might return :BUS:B1:CPHY:B:SOURce CH1, indicating the source is set to channel 1.

## BUS:B<x>:CPHY:BC:SOURce

This command sets or queries the CPHY differential BC source for the specified bus line. The bus number is specified by x.

<b>Conditions</b>	Requires option SR-CPHY.
<b>Group</b>	Bus
<b>Syntax</b>	BUS:B<x>:CPHY:BC:SOURce {S<x>_Ch<x> CH<x> MATH<x> REF<x>} BUS:B<x>:CPHY:BC:SOURce?
<b>Arguments</b>	B<x> is the number of the bus. S<x>_Ch<x> specifies the remote scope number and the analog channel.



CH<x> specifies an analog/digital channel as the source.

MATH<x> specifies a math channel as the source.

REF<x> specifies an analog/digital reference waveform as the source.

**Examples** `BUS:B1:CPHY:BC:SOURce Ch1` sets the source to channel 1.

`BUS:B1:CPHY:BC:SOURce?` might return `:BUS:B1:CPHY:BC:SOURce CH1`, indicating the source is set to channel 1.

## BUS:B<x>:CPHY:BC:THReshold

This command sets or queries the CPHY differential BC source threshold for the specified bus. The bus is specified by x.

**Conditions** Requires option SR-CPHY.

**Group** Bus

**Syntax** `BUS:B<x>:CPHY:BC:THReshold <NR3>`  
`BUS:B<x>:CPHY:BC:THReshold?`

**Arguments** B<x> is the number of the bus.  
 <NR3> is the CPHY differential BC threshold for the specified bus. The argument range is -8 V to +8 V.

**Examples** `BUS:B4:CPHY:BC:THReshold 1.0` sets the Bus 4 CPHY threshold to 1.0 V.

`BUS:B4:CPHY:BC:THReshold?` might return `:BUS:B4:CPHY:BC:THReshold 100.00000E-3` indicating the Bus 4 CPHY threshold is set to 100.0 mV.

## BUS:B<x>:CPHY:BITRate

This command sets or queries the bit rate for the specified CPHY bus. The bus is specified by x.

**Conditions** Requires option SR-CPHY.

**Group** Bus

**Syntax**    `BUS:B<x>:CPHY:BITRate <NR1>`  
`BUS:B<x>:CPHY:BITRate?`

**Arguments**    `B<x>` is the number of the bus.  
  
`<NR1>` specifies the bit rate. The default bit rate is 1 Gbps and varies 4 Mbps ~ 10Gps

**Examples**    `BUS:B1:CPHY:BITRate 8000000` sets the bit rate as 80 Mbps.  
  
`BUS:B1:CPHY:BITRate?` might return `:BUS:B1:CPHY:BITRate 80000000`, indicating that the bit rate is 80 Mbps.

## **BUS:B<x>:CPHY:C:DATA:THRESHold**

This command sets or queries the CPHY Single Ended C source threshold for the specified bus. The bus is specified by x.

**Conditions**    Requires option SR-CPHY.

**Group**    Bus

**Syntax**    `BUS:B<x>:CPHY:C:DATA:THRESHold <NR3>`  
`BUS:B<x>:CPHY:C:DATA:THRESHold?`

**Arguments**    `B<x>` is the number of the bus.  
  
`<NR3>` is the CPHY Single Ended C threshold for the specified bus. The argument range is -8 V to +8 V.

**Examples**    `BUS:B4:CPHY:C:DATA:THRESHold 1.0` sets the Bus 4 CPHY threshold to 1.0 V.  
  
`BUS:B4:CPHY:C:DATA:THRESHold?` might return `:BUS:B4:CPHY:C:DATA:THRESHold 100.00000E-3` indicating the Bus 4 CPHY threshold is set to 100.0 mV.

## **BUS:B<x>:CPHY:C:LP:THRESHold**

This command sets or queries the CPHY Single Ended C LP threshold for the specified bus. The bus is specified by x.

<b>Conditions</b>	Requires option SR-CPHY.
<b>Group</b>	Bus
<b>Syntax</b>	<code>BUS:B&lt;x&gt;:CPHY:C:LP:THRESHo1d &lt;NR3&gt;</code> <code>BUS:B&lt;x&gt;:CPHY:C:LP:THRESHo1d?</code>
<b>Arguments</b>	<code>B&lt;x&gt;</code> is the number of the bus.  <code>&lt;NR3&gt;</code> is the CPHY Single Ended C LP threshold for the specified bus. The argument range is -8 V to +8 V.
<b>Examples</b>	<code>BUS:B4:CPHY:C:LP:THRESHo1d 1.0</code> sets the Bus 4 CPHY threshold to 1.0 V. <code>BUS:B4:CPHY:C:LP:THRESHo1d?</code> might return <code>:BUS:B4:CPHY:C:LP:THRESHo1d 100.00000E-3</code> indicating the Bus 4 CPHY threshold is set to 100.0 mV.

## BUS:B<x>:CPHY:C:SOUrce

This command sets or queries the CPHY Single Ended C source for the specified bus line. The bus number is specified by x.

<b>Conditions</b>	Requires option SR-CPHY.
<b>Group</b>	Bus
<b>Syntax</b>	<code>BUS:B&lt;x&gt;:CPHY:C:SOUrce {S&lt;x&gt;_Ch&lt;x&gt; CH&lt;x&gt; MATH&lt;x&gt; REF&lt;x&gt;}</code> <code>BUS:B&lt;x&gt;:CPHY:C:SOUrce?</code>
<b>Arguments</b>	<code>B&lt;x&gt;</code> is the number of the bus.  <code>S&lt;x&gt;_Ch&lt;x&gt;</code> specifies the remote scope number and the analog channel.  <code>CH&lt;x&gt;</code> specifies an analog channel as the source.  <code>MATH&lt;x&gt;</code> specifies a math channel as the source.  <code>REF&lt;x&gt;</code> specifies an analog reference waveform as the source.

**Examples**    `BUS:B1:CPHY:C:SOURce Ch1` sets the source to channel 1.  
`BUS:B1:CPHY:C:SOURce?` might return `:BUS:B1:CPHY:C:SOURce CH1`, indicating the source is set to channel 1.

## **BUS:B<x>:CPHY:CA:SOURce**

This command sets or queries the CPHY differential CA source for the specified bus line. The bus number is specified by x.

**Conditions**    Requires option SR-CPHY.

**Group**        Bus

**Syntax**        `BUS:B<x>:CPHY:CA:SOURce {S<x>_Ch<x>|CH<x>|MATH<x>|REF<x>}`  
`BUS:B<x>:CPHY:CA:SOURce?`

**Arguments**    `B<x>` is the number of the bus.  
`S<x>_Ch<x>` specifies the remote scope number and the analog channel.  
`CH<x>` specifies an analog/digital channel as the source.  
`MATH<x>` specifies a math channel as the source.  
`REF<x>` specifies an analog/digital reference waveform as the source.

**Examples**    `BUS:B1:CPHY:CA:SOURce Ch1` sets the source to channel 1.  
`BUS:B1:CPHY:CA:SOURce?` might return `:BUS:B1:CPHY:CA:SOURce CH1`, indicating the source is set to channel 1.

## **BUS:B<x>:CPHY:CA:THReshold**

This command sets or queries the CPHY differential CA source threshold for the specified bus. The bus is specified by x.

**Conditions**    Requires option SR-CPHY.

**Group**        Bus

**Syntax**    `BUS:B<x>:CPHY:CA:THResho1d <NR3>`  
`BUS:B<x>:CPHY:CA:THResho1d?`

**Arguments**    `B<x>` is the number of the bus.  
  
`<NR3>` is the CPHY differential CA threshold for the specified bus. The argument range is -8 V to +8 V.

**Examples**    `BUS:B4:CPHY:CA:THResho1d 1.0` sets the Bus 4 CPHY threshold to 1.0 V.  
  
`BUS:B4:CPHY:CA:THResho1d?` might return `:BUS:B4:CPHY:CA:THResho1d 100.00000E-3` indicating the Bus 4 CPHY threshold is set to 100.0 mV.

## **BUS:B<x>:CPHY:CGND:SOUrce**

This command sets or queries the CPHY differential CGND source for the specified bus line. The bus number is specified by `x`.

**Conditions**    Requires option SR-CPHY.

**Group**    Bus

**Syntax**    `BUS:B<x>:CPHY:CGND:SOUrce {S<x>_Ch<x>|CH<x>|MATH<x>|REF<x>}`  
`BUS:B<x>:CPHY:CGND:SOUrce?`

**Arguments**    `B<x>` is the number of the bus.  
  
`S<x>_Ch<x>` specifies the remote scope number and the analog channel.  
  
`CH<x>` specifies an analog/digital channel as the source.  
  
`MATH<x>` specifies a math channel as the source.  
  
`REF<x>` specifies an analog/digital reference waveform as the source.

**Examples**    `BUS:B1:CPHY:CGND:SOUrce Ch1` sets the source to channel 1.  
  
`BUS:B1:CPHY:CGND:SOUrce?` might return `:BUS:B1:CPHY:CGND:SOUrce CH1`, indicating the source is set to channel 1.

## BUS:B<x>:CPHY:CGND:THReshold

This command sets or queries the CPHY differential CGND source threshold for the specified bus. The bus is specified by x.

<b>Conditions</b>	Requires option SR-CPHY.
<b>Group</b>	Bus
<b>Syntax</b>	BUS:B<x>:CPHY:CGND:THReshold <NR3> BUS:B<x>:CPHY:CGND:THReshold?
<b>Arguments</b>	B<x> is the number of the bus.  <NR3> is the CPHY differential C GND threshold for the specified bus. The argument range is -8 V to +8 V.
<b>Examples</b>	BUS:B4:CPHY:CGND:THReshold 1.0 sets the Bus 4 CPHY threshold to 1.0 V.  BUS:B4:CPHY:CGND:THReshold? might return :BUS:B4:CPHY:CGND:THReshold 100.00000E-3 indicating the Bus 4 CPHY clock threshold is set to 100.0 mV.

## BUS:B<x>:CPHY:LP:DIRection

This command sets or queries the CPHY bus direction in low power. The bus is specified by x.

<b>Conditions</b>	Requires option SR-CPHY.
<b>Group</b>	Bus
<b>Syntax</b>	BUS:B<x>:CPHY:LP:DIRection {forward reverse} BUS:B<x>:CPHY:LP:DIRection?
<b>Arguments</b>	B<x> is the number of the bus.  forward specifies the direction in low power to forward. The default direction is forward.  reverse specifies the direction in low power to reverse.

**Examples** `BUS:B1:CPHY:LP:DIRection reverse` sets the Bus 1 CPHY bus direction in low power to reverse.

`BUS:B2:CPHY:LP:DIRection?` might return `:BUS:B2:CPHY:LP:DIRection forward`, indicating the Bus 2 CPHY direction in low power is forward.

## BUS:B<x>:CPHY:SIGNALTYpe

This command sets or queries the signal type for CPHY bus decode. The bus is specified by x.

**Conditions** Requires option SR-CPHY.

**Group** Bus

**Syntax** `BUS:B<x>:CPHY:SIGNALTYpe {SINGLE|DIFF}`  
`BUS:B<x>:CPHY:SIGNALTYpe?`

**Arguments** B<x> is the number of the bus.  
 SINGLE specifies the signal type to single ended.  
 DIFF specifies the signal type to differential. The default type is differential.

**Examples** `BUS:B1:CPHY:SIGNALTYpe DIFF` sets the Bus 1 CPHY to differential.

`BUS:B2:CPHY:SIGNALTYpe?` might return `:BUS:B2:CPHY:SIGNALTYpe DIFF`, indicating the Bus 2 CPHY signal type is set to differential.

## BUS:B<x>:CPHY:SUBTYPe

This command sets or queries the sub type for CPHY bus decode. The bus is specified by x.

**Conditions** Requires option SR-CPHY.

**Group** Bus

**Syntax** `BUS:B<x>:CPHY:SUBTYPe {CSI|DSI|word|Symbo[]}`  
`BUS:B<x>:CPHY:SUBTYPe?`

**Arguments**    **B<x>** is the number of the bus.  
                   **CSI** specifies the protocol type to CSI. The default type is CSI.  
                   **DSI** specifies the protocol type to DSI.  
                   **word** specifies the protocol type to word.  
                   **Symbol** specifies the protocol type to symbol.

**Examples**    **BUS:B1:CPHY:SUBTYPE DSI** sets the Bus 1 CPHY protocol type to DSI.  
**BUS:B2:CPHY:SUBTYPE?** might return **:BUS:B2:CPHY:SUBTYPE CSI**,  
 indicating the Bus 2 CPHY protocol type is set to CSI.

## **BUS:B<x>:CXPI:BITRate**

This command sets or queries the bit rate for the specified CXPI bus. The bus is specified by x.

**Conditions**    Requires option SR-CXPI.

**Group**        Bus

**Syntax**       **BUS:B<x>:CXPI:BITRate <NR1>**  
**BUS:B<x>:CXPI:BITRate?**

**Arguments**    **<NR1>** sets the CXPI Source bit rate for the specified bus. The default value is 19.2 kbps and the valid range is 1 bps to 20 kbps.

**Examples**    **BUS:B1:CXPI:BITRate 100** sets the Bus 1 CXPI Source bit rate to 100 bps.  
**BUS:B1:CXPI:BITRate?** might return **:BUS:B1:CXPI:BITRate 100**,  
 indicating the Bus 1 CXPI Source bit rate is set to 100 bps.

## **BUS:B<x>:CXPI:REC:THReshold**

This command sets or queries the source channel recessive threshold for the specified CXPI bus. The bus is specified by x.

**Conditions**    Requires option SR-CXPI.



<b>Group</b>	Bus
<b>Syntax</b>	<code>BUS:B&lt;x&gt;:CXPI:REC:THResho1d &lt;NR3&gt;</code> <code>BUS:B&lt;x&gt;:CXPI:REC:THResho1d?</code>
<b>Arguments</b>	<NR3> sets the CXPI Source recessive threshold for the specified bus. The default value is 0 V and the valid range is -12 V to +12 V.
<b>Examples</b>	<code>BUS:B1:CXPI:REC:THResho1d 1.0</code> sets the Bus 1 CXPI Source threshold to 1 V.  <code>BUS:B1:CXPI:REC:THResho1d?</code> might return <code>:BUS:B1:CXPI:REC:THResho1d 1.0</code> , indicating the Bus 1 CXPI Source threshold is set to 1 V.

## BUS:B<x>:CXPI:SOUrce

This command sets or queries the source channel for the specified CXPI bus. The bus is specified by x.

<b>Conditions</b>	Requires option SR-CXPI.
<b>Group</b>	Bus
<b>Syntax</b>	<code>BUS:B&lt;x&gt;:CXPI:SOUrce {S&lt;x&gt;_Ch&lt;x&gt; CH&lt;x&gt; MATH&lt;x&gt; REF&lt;x&gt;}</code> <code>BUS:B&lt;x&gt;:CXPI:SOUrce?</code>
<b>Arguments</b>	<code>S&lt;x&gt;_Ch&lt;x&gt;</code> specifies the remote scope number and the analog channel.  <code>CH&lt;x&gt;</code> specifies an analog channel as the source, where <x> is the channel number.  <code>MATH&lt;x&gt;</code> specifies a math channel as the source, where <x> is the math waveform number.  <code>REF&lt;x&gt;</code> specifies a digital reference waveform as the source, where <x> is the reference waveform number.
<b>Examples</b>	<code>BUS:B1:CXPI:SOUrce Ch5</code> sets the source to channel 5.  <code>BUS:B1:CXPI:SOUrce?</code> might return <code>:BUS:B1:CXPI:SOUrce Ch5</code> , indicating the source is set to channel 5.

## BUS:B<x>:DISPlay:FORMat

This command sets or queries how the data is represented in the bus form for the specified bus. The bus is specified by x.

**Group** Bus

**Syntax** BUS:B<x>:DISPlay:FORMat  
 {HEX|BINARY|MIXEDASCII|MIXEDHEX|ASCII|DECIMAL|MIXED}  
 BUS:B<x>:DISPlay:FORMat?

**Arguments** B<x> is the number of the bus.

---

**NOTE.** *Different bus types support only a subset of these arguments.*

---

HEX specifies hexadecimal format.

BINARY specifies binary format.

MIXEDASCII specifies mixed ASCII format.

MIXEDHEX specifies mixed hexadecimal format.

ASCII specifies ASCII format.

DECIMAL specifies decimal format.

MIXED specifies mixed format.

**Examples** BUS:B1:DISPlay:FORMat BINARY sets the format to binary.

BUS:B1:DISPlay:FORMat? might return :BUS:B1:DISPLAY:FORMAT HEX indicating the format is set to hexadecimal.

## BUS:B<x>:DISPlay:LAYout

This command sets or queries what to display for the specified bus. The bus is specified by x.

**Group** Bus

**Syntax** BUS:B<x>:DISPlay:LAYout {BUS|BUSANDWAVEFORM}  
 BUS:B<x>:DISPlay:LAYout?

**Arguments** B<x> is the number of the bus.  
 BUS specifies displaying the bus form only.  
 BUSANDWAVEFORM specifies displaying the bus form and the constituent source waveform(s). This argument is not available for some bus types and some bus configurations

**Examples** BUS:B1:DISPlay:LAYout BUS specifies displaying the bus form only.  
 BUS:B1:DISPlay:LAYout? might return :BUS:B1:DISPLAY:LAYOUT BUS indicating the bus will be displayed without displaying its constituent source waveform(s).

## BUS:B<x>:DPHY:CLOCK:SOURce

This command sets or queries the DPHY Clock source for the specified bus line. The bus is specified by x.

**Conditions** Requires option SR-DPHY

**Group** Bus

**Syntax** BUS:B<x>:DPHY:CLOCK:SOURce {S<x>\_Ch<x>|CH<x>|MATH<x>|REF<x>}  
 BUS:B<x>:DPHY:CLOCK:SOURce?

**Arguments** Bus<x> is the Bus number.  
 S<x>\_Ch<x> specifies the remote scope number and the analog channel as the source.  
 CH<x> specifies an analog channel as the source, where <x> is the channel number.  
 MATH<x> specifies a math channel as the source, where <x> is the math waveform number.  
 REF<x> specifies a reference waveform as the source, where <x> is the reference waveform number.

**Examples** BUS:B1:DPHY:CLOCK:SOURce Ch1 sets the source to channel 1 for bus 1.  
 BUS:B1:DPHY:CLOCK:SOURce? might return :BUS:B1:DPHY:CLOCK:SOURce Ch1, indicating the source is set to channel 1 for bus 1.

## BUS:B<x>:DPHY:CLOCK:THRESHold

This command sets or queries the DPHY Clock source threshold for the specified bus. The bus is specified by x.

**Conditions** Requires option SR-DPHY.

**Group** Bus

**Syntax** BUS:B<x>:DPHY:CLOCK:THRESHold <NR3>  
BUS:B<x>:DPHY:CLOCK:THRESHold?

**Arguments** B<x> is the number of the bus.  
  
<NR3> is the DPHY clock high threshold for the specified bus. The argument range is -8V to +8V.

**Examples** BUS:B4:DPHY:CLOCK:THRESHold 1.0 sets the Bus 4 DPHY threshold to 1.0 V.  
  
BUS:B3:DPHY:CLOCK:THRESHold? might return  
:BUS:B3:DPHY:CLOCK:THRESHold 100.00000E-3, indicating the Bus 3 DPHY clock threshold is set to 100.0 mV.

## BUS:B<x>:DPHY:DMINus:DATATHRESHold

This command sets or queries the DPHY D- source data threshold for the specified bus. The bus is specified by x.

**Conditions** Requires option SR-DPHY.

**Group** Bus

**Syntax** BUS:B<x>:DPHY:DMINus:DATATHRESHold <NR3>  
BUS:B<x>:DPHY:DMINus:DATATHRESHold?

**Arguments** B<x> is the number of the bus.  
  
<NR3> is the DPHY D- source data threshold for the specified bus. The argument range is -8V to +8V.

**Examples** `BUS:B1:DPHY:DMINus:DATATHRESHold -160.00000E-3` sets the Bus 3 DPHY D- source data threshold to 160.0 mV.

`BUS:B3:DPHY:DMINus:DATATHRESHold?` might return  
`:BUS:B3:DPHY:DMINus:DATATHRESHold 150.00000E-3,`  
 indicating the Bus 1 DPHY D- source data threshold is set to 150.0 mV.

## BUS:B<x>:DPHY:DMINus:LPTHRESHold

This command sets or queries the DPHY D- source low power threshold for the specified bus. The bus is specified by x.

**Conditions** Requires option SR-DPHY.

**Group** Bus

**Syntax** `BUS:B<x>:DPHY:DMINus:LPTHRESHold <NR3>`  
`BUS:B<x>:DPHY:DMINus:LPTHRESHold?`

**Arguments** B<x> is the number of the bus.

<NR3> is the DPHY D- source low power threshold for the specified bus. The argument range is -8V to +8V.

**Examples** `BUS:B3:DPHY:DMINus:LPTHRESHold -2.5` sets the Bus 3 DPHY D- source low power threshold to -2.5 V.

`BUS:B2:DPHY:DMINus:LPTHRESHold?` might return  
`:BUS:B2:DPHY:DMINus:LPTHRESHold -1.2,` indicating the Bus 1 DPHY D- source low power threshold is set to -1.2 V.

## BUS:B<x>:DPHY:DMINus:SOUrce

This command sets or queries the DPHY D- source for the specified bus line. The bus is specified by x.

**Conditions** Requires option SR-DPHY

**Group** Bus

**Syntax** `BUS:B<x>:DPHY:DMINus:SOURce {S<x>_Ch<x>|CH<x>|MATH<x>|REF<x>}`  
`BUS:B<x>:DPHY:DMINus:SOURce?`

**Arguments** `Bus<x>` is the Bus number.

`S<x>_Ch<x>` specifies the remote scope number and the analog channel as the source.

`CH<x>` specifies an analog channel as the source, where `<x>` is the channel number.

`MATH<x>` specifies a math channel as the source, where `<x>` is the math waveform number.

`REF<x>` specifies a reference waveform as the source, where `<x>` is the reference waveform number.

**Examples** `BUS:B1:DPHY:DMINus:SOURce Ch3` sets the source to channel 3 for bus 1.

`BUS:B1:DPHY:DMINus:SOURce?` might return  
`:BUS:B1:DPHY:DMINus:SOURce Ch3`, indicating the source is set to channel 3 for bus 1.

## **BUS:B<x>:DPHY:DPPlus:DATATHRESHold**

This command sets or queries the D+ source data threshold for the specified bus. The bus is specified by `x`.

**Conditions** Requires option SR-DPHY.

**Group** Bus

**Syntax** `BUS:B<x>:DPHY:DPPlus:DATATHRESHold <NR3>`  
`BUS:B<x>:DPHY:DPPlus:DATATHRESHold?`

**Arguments** `B<x>` is the number of the bus.

`<NR3>` is the DPHY D+ source data threshold for the specified bus. The argument range is -8V to +8V.

**Examples** `BUS:B2:DPHY:DPPlus:DATATHRESHold 100.00000E-3` sets the Bus 2 DPHY D+ source data threshold to 100.0 mV.

`BUS:B1:DPHY:DPlus:DATATHRESHold?` might return  
`:BUS:B1:DPHY:DPlus:DATATHRESHold 150.00000E-3`, indicating the Bus  
 1 DPHY D+ source data threshold is set to 150.0 mV.

## BUS:B<x>:DPHY:DPlus:LPTHRESHold

This command sets or queries the DPHY D+ source low power threshold for the specified bus. The bus is specified by x.

<b>Conditions</b>	Requires option SR-DPHY.
<b>Group</b>	Bus
<b>Syntax</b>	<code>BUS:B&lt;x&gt;:DPHY:DPlus:LPTHRESHold &lt;NR3&gt;</code> <code>BUS:B&lt;x&gt;:DPHY:DPlus:LPTHRESHold?</code>
<b>Arguments</b>	<code>B&lt;x&gt;</code> is the number of the bus.  <code>&lt;NR3&gt;</code> is the DPHY D+ source low power threshold for the specified bus. The argument range is -8V to +8V.
<b>Examples</b>	<code>BUS:B3:DPHY:DPlus:LPTHRESHold 1.2</code> sets the Bus 3 DPHY D+ source low power threshold to 1.2 V.  <code>BUS:B2:DPHY:DPlus:LPTHRESHold?</code> might return <code>:BUS:B2:DPHY:DPlus:LPTHRESHold 1.2</code> , indicating the Bus 1 DPHY D+ source low power threshold is set to 1.2 V.

## BUS:B<x>:DPHY:DPlus:SOUrce

This command sets or queries the DPHY D+ source for the specified bus line. The bus is specified by x.

<b>Conditions</b>	Requires option SR-DPHY
<b>Group</b>	Bus
<b>Syntax</b>	<code>BUS:B&lt;x&gt;:DPHY:DPlus:SOUrce {S&lt;x&gt;_Ch&lt;x&gt; CH&lt;x&gt; MATH&lt;x&gt; REF&lt;x&gt;&lt;&gt;}</code> <code>BUS:B&lt;x&gt;:DPHY:DPlus:SOUrce?</code>

**Arguments**    **BUS<x>** is the Bus number.

**S<x>\_Ch<x>** specifies the remote scope number and the analog channel as the source.

**CH<x>** specifies an analog channel as the source, where <x> is the channel number.

**MATH<x>** specifies a math channel as the source, where <x> is the math waveform number.

**REF<x>** specifies a reference waveform as the source, where <x> is the reference waveform number.

**Examples**    **BUS:B1:DPHY:DPUs:SOURCE Ch2** sets the source to channel 2 for bus 1.

**BUS:B1:DPHY:DPUs:SOURCE?** might return **:BUS:B1:DPHY:DPUs:SOURCE CH2**, indicating the source is set to channel 2 for bus 1.

## **BUS:B<x>:DPHY:LP:DIRection**

This command sets or queries the DPHY bus direction in low power. By default lp direction is set to forward. The bus is specified by x.

**Conditions**    Requires option SR-DPHY

**Group**    Bus

**Syntax**    **BUS:B<x>:DPHY:LP:DIRection {forward|reverse}**  
**BUS:B<x>:DPHY:LP:DIRection?**

**Arguments**    **BUS<x>** is the Bus number.

**forward** specifies the direction as forward.

**reverse** specifies the direction as reverse.

**Examples**    **BUS:B1:DPHY:LP:DIRection reverse** sets the Bus 1 DPHY bus direction in low power to reverse.

**BUS:B2:DPHY:LP:DIRection?** might return **:BUS:B2:DPHY:LP:DIRection forward**, indicating the Bus 2 DPHY direction in low power is forward.



## BUS:B<x>:DPHY:PROTOcol:TYPE

This command sets or queries the protocol type for DPHY bus decode. The default type is CSI. The bus is specified by x.

<b>Conditions</b>	Requires option SR-DPHY
<b>Group</b>	Bus
<b>Syntax</b>	BUS:B<x>:DPHY:PROTOcol:TYPE {CSI DSI} BUS:B<x>:DPHY:PROTOcol:TYPE?
<b>Arguments</b>	Bus<x> is the Bus number.  CSI specifies the protocol type as CSI.  DSI specifies the protocol type as DSI.
<b>Examples</b>	BUS:B1:DPHY:PROTOcol:TYPE DSI sets the Bus 1 DPHY protocol type to DSI.  BUS:B2:DPHY:PROTOcol:TYPE? might return :BUS:B2:DPHY:PROTOcol:TYPE CSI, indicating the Bus 2 DPHY protocol type is set to CSI.

## BUS:B<x>:DPHY:SIGNAL:ENCoding

This command sets or queries the 8b9b encoding for DPHY bus decode. By default 8b9b encoding is set to false. The bus is specified by x.

<b>Conditions</b>	Requires option SR-DPHY
<b>Group</b>	Bus
<b>Syntax</b>	BUS:B<x>:DPHY:SIGNAL:ENCoding {false true} BUS:B<x>:DPHY:SIGNAL:ENCoding?
<b>Arguments</b>	Bus<x> is the Bus number.  false specifies the 8b9b encoding disabled.  true specifies 8b9b encoding disabled.

**Examples** `BUS:B1:DPHY:SIGNal:ENCoding true` sets the Bus 1 DPHY 8b9b encoding to true.

`BUS:B2:DPHY:SIGNal:ENCoding?` might return `::BUS:B2:DPHY:SIGNal:ENCoding true`, indicating the Bus 2 DPHY 8b9b encoding is set to true.

## BUS:B<x>:ESPI:ALERT:POLarity

This command sets or queries the ESPI alert polarity for the specified bus. The bus is specified by x.

**Conditions** Requires option SR-ESPI.

**Group** Bus

**Syntax** `BUS:B<x>:ESPI:ALERT:POLarity {HIGH|LOW}`  
`BUS:B<x>:ESPI:ALERT:POLarity?`

**Arguments** HIGH sets the ESPI alert polarity to active high.  
 LOW sets the ESPI alert polarity to active low.

**Examples** `BUS:B1:ESPI:ALERT:POLarity LOW` sets the Bus 1 alert polarity to active low.

`BUS:B1:ESPI:ALERT:POLarity?` might return `::BUS:B1:ESPI:ALERT:POLarity LOW` indicating the Bus 1 alert polarity is set to active low.

## BUS:B<x>:ESPI:ALERT:SOURce

This command sets or queries the alert source for the specified bus. The bus is specified by x.

**Conditions** Requires option SR-ESPI.

**Group** Bus

**Syntax** `BUS:B<x>:ESPI:ALERT:SOURce {S<x>_Ch<x>|CH<x>|MATH<x>|REF<x<>`  
`BUS:B<x>:ESPI:ALERT:SOURce?`

**Arguments** S<x>\_Ch<x> specifies the remote scope number and the analog channel as the source.  
 CH<x> specifies an analog channel as the source.  
 Math<x> specifies a math waveform as the source.  
 REF<x> specifies a reference waveform as the source.

**Examples** BUS:B1:ESPI:ALERT:SOURce Ch5 sets the alert source to channel 5.  
 BUS:B1:ESPI:ALERT:SOURce? might return :BUS:B1:ESPI:ALERT:SOURce CH5, indicating the alert source is set to channel 5.

## BUS:B<x>:ESPI:ALERT:THReshold

This command sets or queries the alert source threshold for the specified bus. The bus is specified by x.

**Conditions** Requires option SR-ESPI.

**Group** Bus

**Syntax** BUS:B<x>:ESPI:ALERT:THReshold <NR3>  
 BUS:B<x>:ESPI:ALERT:THReshold?

**Arguments** <NR3> sets the alert threshold for the specified bus. The valid range is -8V to +8V.

**Examples** BUS:B1:ESPI:ALERT:THReshold 1.0 sets the Bus 1 alert threshold to 1.0 V.  
 BUS:B1:ESPI:ALERT:THReshold? might return  
 BUS:B1:ESPI:ALERT:THReshold 225.00000E-3 indicating the Bus 1 alert threshold is set to 225.0 mV.

## BUS:B<x>:ESPI:ALERTVIEW

This command sets or queries the ESPI alert view for the specified bus. The bus is specified by x.

**Conditions** Requires option SR-ESPI.

**Group** Bus

**Syntax**    `BUS:B<x>:ESPI:ALERTVIEW {ON|OFF}`  
`BUS:B<x>:ESPI:ALERTVIEW?`

**Arguments**    `ON` turns the alert source on.  
`OFF` turns the alert source on.

**Examples**    `BUS:B1:ESPI:ALERTVIEW ON` sets the Bus 1 alert view to on.  
`BUS:B1:ESPI:ALERTVIEW?` might return `:BUS:B1:ESPI:ALERTVIEW ON` indicating the Bus 1 alert view is on.

## **BUS:B<x>:ESPI:CHIPSElect:POLarity**

This command sets or queries the ESPI chip select polarity for the specified bus. The bus is specified by x.

**Conditions**    Requires option SR-ESPI.

**Group**    Bus

**Syntax**    `BUS:B<x>:ESPI:CHIPSElect:POLarity {HIGH|LOW}`  
`BUS:B<x>:ESPI:CHIPSElect:POLarity?`

**Arguments**    `HIGH` sets the ESPI chip select polarity to active high.  
`LOW` sets the ESPI chip select polarity to active low.

**Examples**    `BUS:B1:ESPI:CHIPSElect:POLarity LOW` sets the Bus 1 chip select polarity to active low.  
`BUS:B1:ESPI:CHIPSElect:POLarity?` might return `:BUS:B1:ESPI:CHIPSElect:POLarity LOW`, indicating the Bus 1 chip select polarity is set to active low.

## **BUS:B<x>:ESPI:CHIPSElect:SOURce**

This command sets or queries the chip select source for the specified bus. The bus is specified by x.

**Conditions**    Requires option SR-ESPI.

<b>Group</b>	Bus
<b>Syntax</b>	<code>BUS:B&lt;x&gt;:ESPI:CHIPSElect:SOURCE</code> <code>{S&lt;x&gt;_Ch&lt;x&gt; CH&lt;x&gt; MATH&lt;x&gt; REF&lt;x&lt;&gt;&gt;}</code> <code>BUS:B&lt;x&gt;:ESPI:CHIPSElect:SOURCE?</code>
<b>Arguments</b>	<code>S&lt;x&gt;_Ch&lt;x&gt;</code> specifies the remote scope number and the analog channel as the source.  <code>CH&lt;x&gt;</code> specifies an analog channel as the source.  <code>Math&lt;x&gt;</code> specifies a math waveform as the source.  <code>REF&lt;x&gt;</code> specifies a reference waveform as the source.
<b>Examples</b>	<code>BUS:B1:ESPI:CHIPSElect:SOURCE Ch5</code> sets the chip select source to channel 5.  <code>BUS:B1:ESPI:CHIPSElect:SOURCE?</code> might return <code>:BUS:B1:ESPI:CHIPSElect:SOURCE Ch5</code> , indicating the chip select source is set to channel 5.

## BUS:B<x>:ESPI:CHIPSElect:THReshold

This command sets or queries the chip select source threshold for the specified bus. The bus is specified by x.

<b>Conditions</b>	Requires option SR-ESPI.
<b>Group</b>	Bus
<b>Syntax</b>	<code>BUS:B&lt;x&gt;:ESPI:CHIPSElect:THReshold &lt;NR3&gt;</code> <code>BUS:B&lt;x&gt;:ESPI:CHIPSElect:THReshold?</code>
<b>Arguments</b>	<code>&lt;NR3&gt;</code> sets the chip select threshold for the specified bus. The valid range is -8V to +8V.
<b>Examples</b>	<code>BUS:B1:ESPI:CHIPSElect:THReshold 1.0</code> sets the Bus 1 chip select threshold to 1.0 V.  <code>BUS:B1:ESPI:CHIPSElect:THReshold?</code> might return <code>BUS:B1:ESPI:CHIPSElect:THReshold 225.00000E-3</code> , indicating the Bus 1 chip select threshold is set to 225.0 mV.

## BUS:B<x>:ESPI:CLOCK:POLarity

This command sets or queries the ESPI Clock (SCLK) source polarity for the specified bus. The bus is specified by x.

<b>Conditions</b>	Requires option SR-ESPI.
<b>Group</b>	Bus
<b>Syntax</b>	BUS:B<x>:ESPI:CLOCK:POLarity {FALL RISE} BUS:B<x>:ESPI:CLOCK:POLarity?
<b>Arguments</b>	FALL sets the ESPI clock polarity to fall. RISE sets the ESPI clock polarity to rise.
<b>Examples</b>	BUS:B1:ESPI:CLOCK:POLarity FALL sets the Bus 1 clock polarity to fall. BUS:B1:ESPI:CLOCK:POLarity? might return :BUS:B1:ESPI:CLOCK:POLarity FALL, indicating the Bus 1 clock polarity is set to fall.

## BUS:B<x>:ESPI:CLOCK:SOURce

This command sets or queries the Clock source for the specified bus. The bus is specified by x.

<b>Conditions</b>	Requires option SR-ESPI.
<b>Group</b>	Bus
<b>Syntax</b>	BUS:B<x>:ESPI:CLOCK:SOURce {S<x>_Ch<x> CH<x> MATH<x> REF<x<>>} BUS:B<x>:ESPI:CLOCK:SOURce?
<b>Arguments</b>	S<x>_Ch<x> specifies the remote scope number and the analog channel as the source. CH<x> specifies an analog channel as the source. Math<x> specifies a math waveform as the source. REF<x> specifies a reference waveform as the source.

**Examples** `BUS:B1:ESPI:CLOCK:SOURce Ch5` sets the clock source to channel 5.  
`BUS:B1:ESPI:CLOCK:SOURce?` might return `:BUS:B1:ESPI:CLOCK:SOURce Ch5`, indicating the clock source is set to channel 5.

## BUS:B<x>:ESPI:CLOCK:THReshold

This command sets or queries the Clock source threshold for the specified bus. The bus is specified by x.

**Conditions** Requires option SR-ESPI.

**Group** Bus

**Syntax** `BUS:B<x>:ESPI:CLOCK:THReshold <NR3>`  
`BUS:B<x>:ESPI:CLOCK:THReshold?`

**Arguments** <NR3> sets the clock threshold for the specified bus. The valid range is -8V to +8V.

**Examples** `BUS:B1:ESPI:CLOCK:THReshold 1.0` sets the Bus 1 clock threshold to 1.0 V.  
`BUS:B1:ESPI:CLOCK:THReshold?` might return  
`BUS:B1:ESPI:CLOCK:THReshold 225.00000E-3`, indicating the Bus 1 clock threshold is set to 225.0 mV.

## BUS:B<x>:ESPI:DATAONE:POLarity

This command sets or queries the ESPI command (single mode)/ IO[0] (dual mode) polarity for the specified bus. The bus is specified by x.

**Conditions** Requires option SR-ESPI.

**Group** Bus

**Syntax** `BUS:B<x>:ESPI:DATAONE:POLarity {HIGH|LOW}`  
`BUS:B<x>:ESPI:DATAONE:POLarity?`

**Arguments** HIGH sets the ESPI data polarity to active high.  
 LOW sets the ESPI data polarity to active low.

**Examples**    `BUS:B1:ESPI:DATAONE:POLarity LOW` sets the Bus 1 data polarity to active low.

`BUS:B1:ESPI:DATAONE:POLarity?` might return  
                 `:BUS:B1:ESPI:DATAONE:POLarity LOW`, indicating the Bus 1 data polarity is set to active low.

## **BUS:B<x>:ESPI:DATAONE:SOURce**

This command sets or queries the command (single mode)/ IO[0] (dual mode) Data source for the specified bus. The bus is specified by x.

**Conditions**    Requires option SR-ESPI.

**Group**        Bus

**Syntax**        `BUS:B<x>:ESPI:DATAONE:SOURce {S<x>_Ch<x>|CH<x>|MATH<x>|REF<x>}`  
`BUS:B<x>:ESPI:DATAONE:SOURce?`

**Arguments**    `S<x>_Ch<x>` specifies the remote scope number and the analog channel as the source.

`CH<x>` specifies an analog channel as the source.

`Math<x>` specifies a math waveform as the source.

`REF<x>` specifies a reference waveform as the source.

**Examples**    `BUS:B1:ESPI:DATAONE:SOURce Ch5` sets the data source to channel 5.

`BUS:B1:ESPI:DATAONE:SOURce?` might return  
                 `:BUS:B1:ESPI:DATAONE:SOURce Ch5`, indicating the data source is set to channel 5.

## **BUS:B<x>:ESPI:DATAONE:THReshold**

This command sets or queries the command (single mode)/ IO[0] (dual mode) Data source threshold for the specified bus. The bus is specified by x.

**Conditions**    Requires option SR-ESPI.

**Group**        Bus



<b>Syntax</b>	<code>BUS:B&lt;x&gt;:ESPI:DATAONE:THreshold &lt;NR3&gt;</code> <code>BUS:B&lt;x&gt;:ESPI:DATAONE:THreshold?</code>
<b>Arguments</b>	<code>&lt;NR3&gt;</code> sets the command/data threshold for the specified bus. The valid range is -8V to +8V.
<b>Examples</b>	<code>BUS:B1:ESPI:DATAONE:THreshold 1.0</code> sets the Bus 1 data threshold to 1.0 V. <code>BUS:B1:ESPI:DATAONE:THreshold?</code> might return <code>BUS:B1:ESPI:DATAONE:THreshold 225.00000E-3</code> , indicating the Bus 1 data threshold is set to 225.0 mV.

## BUS:B<x>:ESPI:DATATWO:POLarity

This command sets or queries the ESPI response (single mode)/ IO[1] (dual mode) polarity for the specified bus. The bus is specified by x.

<b>Conditions</b>	Requires option SR-ESPI.
<b>Group</b>	Bus
<b>Syntax</b>	<code>BUS:B&lt;x&gt;:ESPI:DATATWO:POLarity {HIGH LOW}</code> <code>BUS:B&lt;x&gt;:ESPI:DATATWO:POLarity?</code>
<b>Arguments</b>	<code>HIGH</code> sets the ESPI data polarity to active high. <code>LOW</code> sets the ESPI data polarity to active low.
<b>Examples</b>	<code>BUS:B1:ESPI:DATATWO:POLarity LOW</code> sets the Bus 1 data polarity to active low. <code>BUS:B1:ESPI:DATATWO:POLarity?</code> might return <code>:BUS:B1:ESPI:DATATWO:POLarity LOW</code> , indicating the Bus 1 data polarity is set to active low.

## BUS:B<x>:ESPI:DATATWO:SOUrce

This command sets or queries the response (single mode)/ IO[1] (dual mode) Data source for the specified bus. The bus is specified by x.

<b>Conditions</b>	Requires option SR-ESPI.
-------------------	--------------------------

<b>Group</b>	Bus
<b>Syntax</b>	BUS:B<x>:ESPI:DATATWO:SOURce {S<x>_Ch<x> CH<x> MATH<x> REF<x<>>} BUS:B<x>:ESPI:DATATWO:SOURce?
<b>Arguments</b>	S<x>_Ch<x> specifies the remote scope number and the analog channel as the source.  CH<x> specifies an analog channel as the source.  Math<x> specifies a math waveform as the source.  REF<x> specifies a reference waveform as the source.
<b>Examples</b>	BUS:B1:ESPI:DATATWO:SOURce Ch5 sets the data source to channel 5.  BUS:B1:ESPI:DATATWO:SOURce? might return :BUS:B1:ESPI:DATATWO:SOURce Ch5, indicating the data source is set to channel 5.

## BUS:B<x>:ESPI:DATATWO:THReshold

This command sets or queries the response (single mode)/ IO[1] (dual mode) Data source threshold for the specified bus. The bus is specified by x.

<b>Conditions</b>	Requires option SR-ESPI.
<b>Group</b>	Bus
<b>Syntax</b>	BUS:B<x>:ESPI:DATATWO:THReshold <NR3> BUS:B<x>:ESPI:DATATWO:THReshold?
<b>Arguments</b>	<NR3> sets the command/data threshold for the specified bus. The valid range is -8V to +8V.
<b>Examples</b>	BUS:B1:ESPI:DATATWO:THReshold 1.0 sets the Bus 1 data threshold to 1.0 V.  BUS:B1:ESPI:DATATWO:THReshold? might return BUS:B1:ESPI:DATATWO:THReshold 225.00000E-3, indicating the Bus 1 data threshold is set to 225.0 mV.

## BUS:B<x>:ESPI:IOMODE

This command sets or queries the ESPI Input/Output mode for the specified bus. The bus is specified by x.

<b>Conditions</b>	Requires option SR-ESPI.
<b>Group</b>	Bus
<b>Syntax</b>	BUS:B<x>:ESPI:IOMODE {SINGle DUAL} BUS:B<x>:ESPI:IOMODE?
<b>Arguments</b>	SINGle displays the command and response decode in two lanes. DUAL displays the decode in a single data lane.
<b>Examples</b>	BUS:B1:ESPI:IOMODE DUAL sets the Bus 1 mode to dual. BUS:B1:ESPI:IOMODE? might return :BUS:B1:ESPI:IOMODE DUAL, indicating the Bus 1 mode is set to dual.

## BUS:B<x>:ETHERCAT:DATAMINUSTHRESHold

This command sets or queries the DATA Minus source threshold for the specified EtherCAT bus.

<b>Conditions</b>	Requires option SR-ETHERCAT.
<b>Group</b>	Bus
<b>Syntax</b>	BUS:B<x>:ETHERCAT:DATAMINUSTHRESHold <NR3> BUS:B<x>:ETHERCAT:DATAMINUSTHRESHold?
<b>Arguments</b>	B<x> is the number of the bus.  <NR3> is the EtherCAT DataMinus source threshold for the specified bus. The valid range is -8V to +8V. The default value is 0 V.
<b>Examples</b>	BUS:B1:ETHERCAT:DATAMINUSTHRESHold 1.0 sets the EtherCAT DataMinus source threshold to 1.0 V.

`BUS:B1:ETHERCAT:DATAMINUSTHRESHold?` might return  
`:BUS:B1:ETHERCAT:DATAMINUSTHRESHold 1.0`, indicates the EtherCAT  
DataMinus source threshold is set to 1.0 V.

## **BUS:B<x>:ETHERCAT:DATAPLUSTHRESHold**

This command sets or queries the DATA Plus source threshold for the specified EtherCAT bus.

<b>Conditions</b>	Requires option SR-ETHERCAT.
<b>Group</b>	Bus
<b>Syntax</b>	<code>BUS:B&lt;x&gt;:ETHERCAT:DATAPLUSTHRESHold &lt;NR3&gt;</code> <code>BUS:B&lt;x&gt;:ETHERCAT:DATAPLUSTHRESHold?</code>
<b>Arguments</b>	<code>B&lt;x&gt;</code> is the number of the bus.  <code>&lt;NR3&gt;</code> is the EtherCAT DataPinus source threshold for the specified bus. The valid range is -8V to +8V. The default value is 0 V.
<b>Examples</b>	<code>BUS:B1:ETHERCAT:DATAPLUSTHRESHold 1.0</code> sets the EtherCAT DataPlus source threshold to 1.0 V.  <code>BUS:B1:ETHERCAT:DATAPLUSTHRESHold?</code> might return <code>:BUS:B1:ETHERCAT:DATAPLUSTHRESHold 1.0</code> , indicates the EtherCAT DataPlus source threshold is set to 1.0 V.

## **BUS:B<x>:ETHERCAT:SIGNALTYpe**

This command sets or queries the signal type for the specified EtherCAT bus.

<b>Conditions</b>	Requires option SR-ETHERCAT.
<b>Group</b>	Bus
<b>Syntax</b>	<code>BUS:B&lt;x&gt;:ETHERCAT:SIGNALTYpe {SINGLE DIFF}</code> <code>BUS:B&lt;x&gt;:ETHERCAT:SIGNALTYpe?</code>

<b>Arguments</b>	<p>B&lt;x&gt; is the number of the bus.</p> <p>SINGLE specifies single-ended signals.</p> <p>DIFF specifies differential signals.</p>
<b>Examples</b>	<p>BUS:B1:ETHERCAT:SIGNALType SINGLE sets the Signal Type to single-ended signals.</p> <p>BUS:B1:ETHERCAT:SIGNALType? might return :BUS:B1:ETHERCAT:SIGNALType SINGLE, indicates the Signal Type is set to single-ended signals.</p>

## BUS:B<x>:ETHERCAT:SOURce:DIFF

This command sets or queries the differential source for the specified EtherCAT bus.

<b>Conditions</b>	Requires option SR-ETHERCAT.
<b>Group</b>	Bus
<b>Syntax</b>	<pre>BUS:B&lt;x&gt;:ETHERCAT:SOURce:DIFF {S&lt;x&gt;_Ch&lt;x&gt; CH&lt;x&gt; MATH&lt;x&gt; REF&lt;x&gt;} BUS:B&lt;x&gt;:ETHERCAT:SOURce:DIFF?</pre>
<b>Arguments</b>	<p>B&lt;x&gt; is the number of the bus.</p> <p>S&lt;x&gt;_Ch&lt;x&gt; specifies the remote scope number and the analog channel.</p> <p>CH&lt;x&gt; specifies to use one of the analog channels as the differential source.</p> <p>MATH&lt;x&gt; specifies to use a math waveform as the differential source.</p> <p>REF&lt;x&gt; specifies to use one of the reference waveforms as the differential source.</p>
<b>Examples</b>	<p>BUS:B1:ETHERCAT:SOURce:DIFF CH4 specifies to use the channel 4 waveform as the differential source.</p> <p>BUS:B1:ETHERCAT:SOURce:DIFF? might return :BUS:B1:ETHERCAT:SOURce:DIFF CH4, indicating that channel 4 is the currently specified differential source.</p>

## **BUS:B<x>:ETHERCAT:SOURce:DMINus**

This command sets or queries the DataMinus (SDATAMINUS) source for the specified EtherCAT bus.

**Conditions** Requires option SR-ETHERCAT.

**Group** Bus

**Syntax** `BUS:B<x>:ETHERCAT:SOURce:DMINus`  
`{S<x>_Ch<x>|CH<x>|MATH<x>|REF<x>}`  
`BUS:B<x>:ETHERCAT:SOURce:DMINus?`

**Arguments** B<x> is the number of the bus.  
S<x>\_Ch<x> specifies the remote scope number and the analog channel.  
CH<x> specifies to use one of the analog channels as the DataMinus source.  
MATH<x> specifies to use a math waveform as the DataMinus source.  
REF<x> specifies to use one of the reference waveforms as the DataMinus source.

**Examples** `BUS:B1:ETHERCAT:SOURce:DMINus CH4` specifies to use the channel 4 waveform as the DataMinus source.  
`BUS:B1:ETHERCAT:SOURce:DMINus?` might return  
`:BUS:B1:ETHERCAT:SOURce:DMINus CH4`, indicating that channel 4 is the currently specified DataMinus source.

## **BUS:B<x>:ETHERCAT:SOURce:DPLUS**

This command sets or queries the DataPlus (SDATAPLUS) source for the specified EtherCAT bus.

**Conditions** Requires option SR-ETHERCAT.

**Group** Bus

**Syntax** `BUS:B<x>:ETHERCAT:SOURce:DPLUS`  
`{S<x>_Ch<x>|CH<x>|MATH<x>|REF<x>}`  
`BUS:B<x>:ETHERCAT:SOURce:DPLUS?`

**Arguments** B<x> is the number of the bus.

S<x>\_Ch<x> specifies the remote scope number and the analog channel.

CH<x> specifies to use one of the analog channels as the DataPlus source.

MATH<x> specifies to use a math waveform as the DataPlus source.

REF<x> specifies to use one of the reference waveforms as the DataPlus source.

**Examples** BUS:B1:ETHERCAT:SOURce:DPLUS CH4 specifies to use the channel 4 waveform as the DataPlus source.

BUS:B1:ETHERCAT:SOURce:DPLUS? might return  
:BUS:B1:ETHERCAT:SOURce:DPLUS CH4, indicating that channel 4 is the currently specified DataPlus source.

## BUS:B<x>:ETHERCAT:THRESHold

This command sets or queries the differential source threshold for the specified EtherCAT bus.

**Conditions** Requires option SR-ETHERCAT.

**Group** Bus

**Syntax** BUS:B<x>:ETHERCAT:THRESHold <NR3>  
BUS:B<x>:ETHERCAT:THRESHold?

**Arguments** B<x> is the number of the bus.

<NR3> specifies the EtherCAT differential Source threshold for the specified bus. The default value is 0 V. The valid range is -8 V to +8 V.

**Examples** BUS:B1:ETHERCAT:THRESHold 1.0 sets the EtherCAT differential source threshold to 1.0 V.

BUS:B1:ETHERCAT:THRESHold? might return  
:BUS:B1:ETHERCAT:THRESHold 1.0, indicating the EtherCAT differential source threshold is set to 1.0 V.

## BUS:B<x>:ETHERnet:DATAMINUSTHRESHold

This command sets or queries the Ethernet D- source threshold for the specified bus. This threshold only applies when the Ethernet signal type is single ended. The bus is specified by x.

<b>Conditions</b>	Requires option SR-ENET.
<b>Group</b>	Bus
<b>Syntax</b>	BUS:B<x>:ETHERnet:DATAMINUSTHRESHold <NR3> BUS:B<x>:ETHERnet:DATAMINUSTHRESHold?
<b>Related Commands</b>	<a href="#">BUS:B&lt;x&gt;:ETHERnet:SOURce:DMINus</a> <a href="#">BUS:B&lt;x&gt;:ETHERnet:SOURce:DPLUs</a> <a href="#">BUS:B&lt;x&gt;:ETHERnet:SIGNALTYpe</a>
<b>Arguments</b>	B<x> is the number of the bus.  <NR3> is the Ethernet D- source threshold for the specified bus.
<b>Examples</b>	BUS:B3:ETHERNET:DATAMINUSTHRESHOLD 250.0E-3 sets the Bus 3 Ethernet DATA Minus source threshold to 250.0000 mV.  BUS:B2:ETHERNET:DATAMINUSTHRESHOLD? might return BUS:B2:ETHERNET:DATAMINUSTHRESHOLD 1.0 indicates the Bus 2 Ethernet D- source threshold is set to 1.0 V.

## BUS:B<x>:ETHERnet:DATAPLUSTHRESHold

This command sets or queries the Ethernet D+ source threshold for the specified bus. This threshold only applies when the Ethernet signal type is single ended. The bus is specified by x.

<b>Conditions</b>	Requires option SR-ENET.
<b>Group</b>	Bus
<b>Syntax</b>	BUS:B<x>:ETHERnet:DATAPLUSTHRESHold <NR3> BUS:B<x>:ETHERnet:DATAPLUSTHRESHold?



<b>Related Commands</b>	<p>B&lt;x&gt; is the number of the bus.</p> <p><a href="#">BUS:B&lt;x&gt;:ETHERnet:SOUrce:DMINus</a></p> <p><a href="#">BUS:B&lt;x&gt;:ETHERnet:SOUrce:DPLUs</a></p> <p><a href="#">BUS:B&lt;x&gt;:ETHERnet:SIGNALTYpe</a></p>
<b>Arguments</b>	<NR3> is the Ethernet D+ source threshold for the specified bus.
<b>Examples</b>	<p><code>BUS:B3:ETHERNET:DATAPLUSTHRESHOLD 250.0E-3</code> sets the Bus 3 Ethernet D+ source threshold to 250.0000 mV.</p> <p><code>BUS:B2:ETHERNET:DATAMINUSTHRESHOLD?</code> might return  <code>:BUS:B2:ETHERNET:DATAPLUSTHRESHOLD 1.0</code> indicating the Bus 2 Ethernet D+ source threshold is set to 1.0 V.</p>

## BUS:B<x>:ETHERnet:IPVFOUR

This command sets or queries whether IPV4 packets are available for triggering on Ethernet. The bus is specified by x.

<b>Conditions</b>	Requires option SR-ENET.
<b>Group</b>	Bus
<b>Syntax</b>	<p><code>BUS:B&lt;x&gt;:ETHERnet:IPVFOUR {YES NO}</code></p> <p><code>BUS:B&lt;x&gt;:ETHERnet:IPVFOUR?</code></p>
<b>Arguments</b>	<p>B&lt;x&gt; is the number of the bus.</p> <p>YES specifies that IPV4 packets are available.</p> <p>NO specifies that IPV4 packets are not available.</p>
<b>Examples</b>	<p><code>BUS:B1:ETHERNET:IPVFOUR NO</code> will specify that Bus 1 does not have IPV4 packets available.</p> <p><code>BUS:B3:ETHERNET:IPVFOUR?</code> might return <code>:BUS:B3:ETHERNET:IPVFOUR YES</code> indicating that Bus 3 has IPV4 packets available.</p>

## BUS:B<x>:ETHERnet:LOWTHRESHold

This command sets or queries the Ethernet source Low threshold for the specified bus. This threshold only applies when the Ethernet signal type is differential. The bus is specified by x.

<b>Conditions</b>	Requires option SR-ENET.
<b>Group</b>	Bus
<b>Syntax</b>	BUS:B<x>:ETHERnet:LOWTHRESHold <NR3> BUS:B<x>:ETHERnet:LOWTHRESHold?
<b>Related Commands</b>	<a href="#">BUS:B&lt;x&gt;:ETHERnet:SIGNALTYpe</a>
<b>Arguments</b>	B<x> is the number of the bus.  <NR3> is the Ethernet source Low threshold for the specified bus.
<b>Examples</b>	BUS:B1:ETHERnet:LOWTHRESHold -200e-3 sets the threshold to -200 mV.  BUS:B1:ETHERnet:LOWTHRESHold? might return :BUS:B1:ETHERnet:LOWTHRESHold -500.0000E-3 indicating the threshold is set to -500 mV.

## BUS:B<x>:ETHERnet:QTAGGING

This command sets or queries whether Q-Tagging packets are available for triggering on Ethernet. The bus is specified by x.

<b>Conditions</b>	Requires option SR-ENET.
<b>Group</b>	Bus
<b>Syntax</b>	BUS:B<x>:ETHERnet:QTAGGING {YES NO} BUS:B<x>:ETHERnet:QTAGGING?
<b>Arguments</b>	B<x> is the number of the bus.  YES specifies that Q-Tagging packets are available.

NO specifies that Q-Tagging packets are not available.

**Examples** `BUS:B1:ETHERnet:QTAGGING YES` turns on Q-Tagging.

`BUS:B1:ETHERnet:QTAGGING?` might return `:BUS:B1:ETHERNET:QTAGGING YES` indicating that Q-tagging packets are available.

## BUS:B<x>:ETHERnet:SIGNALTYpe

This command sets or queries the Ethernet signal type for the specified bus. The bus is specified by x.

**Conditions** Requires option SR-ENET.

**Group** Bus

**Syntax** `BUS:B<x>:ETHERnet:SIGNALTYpe {SINGLE|DIFF}`  
`BUS:B<x>:ETHERnet:SIGNALTYpe?`

**Arguments** B<x> is the number of the bus.  
 SINGLE specifies single-ended signals.  
 DIFF specifies differential signals.

**Examples** `BUS:B1:ETHERnet:SIGNALTYpe SINGLE` specifies single-ended signals.

`BUS:B1:ETHERnet:SIGNALTYpe?` might return `:BUS:B1:ETHERNET:SIGNALTYpe DIFF` indicating differential signals are specified.

## BUS:B<x>:ETHERnet:SOUrce

This command sets or queries the Ethernet data (SDATA) source for the specified bus. This command controls the source channel when the signal type is differential. The bus number is specified by x.

**Conditions** Requires option SR-ENET.

**Group** Bus

**Syntax**    `BUS:B<x>:ETHERnet:SOURce {S<x>_Ch<x>|CH<x>|MATH<x>|REF<x>}`  
`BUS:B<x>:ETHERnet:SOURce?`

**Related Commands**    [BUS:B<x>:ETHERnet:THRESHold](#)

**Arguments**    `B<x>` is the number of the bus.  
`S<x>_Ch<x>` specifies the remote scope number and the analog channel.  
`CH<x>` specifies to use one of the analog channels as the Ethernet data source for differential input.  
`MATH<x>` specifies to use a math waveform as the source for Ethernet data differential input  
`REF<x>` specifies to use one of the reference waveforms as the Ethernet data source for differential input.

**Examples**    `BUS:B1:ETHERNET:SOURCE CH4` specifies to use the channel 4 waveform as the source for Ethernet data.  
`BUS:B1:ETHERNET:SOURCE?` might return `CH2`, indicating that channel 2 is the currently specified source for Ethernet data.

## BUS:B<x>:ETHERnet:SOURce:DMINus

This command sets or queries the Ethernet D- source for the specified bus. this command specifies the source channel to use when the signal type is single ended. The bus is specified by x.

**Group**    Bus

**Syntax**    `BUS:B<x>:ETHERnet:SOURce:DMINus`  
`{S<x>_Ch<x>|CH<x>|MATH<x>|REF<x>}`  
`BUS:B<x>:ETHERnet:SOURce:DMINus?`

**Arguments**    `B<x>` is the number of the bus.  
`S<x>_Ch<x>` specifies the remote scope number and the analog channel as the source.  
`CH<x>` specifies an analog channel as the source.  
`Math<x>` specifies a math waveform as the source.

REF<x> specifies a reference waveform as the source.

**Examples**    `BUS:B1:ETHERnet:SOURce:DMINus CH1` sets the D- source to channel 1.  
`BUS:B1:ETHERnet:SOURce:DMINus?` might return  
`:BUS:B1:ETHERnet:SOURce:DMINUS CH2` indicating the D- source is set to channel 2.

## BUS:B<x>:ETHERnet:SOURce:DPLUs

This command sets or queries the Ethernet D+ source for the specified bus. this command specifies the source channel to use when the signal type is single ended. The bus is specified by x.

**Group**    Bus

**Syntax**    `BUS:B<x>:ETHERnet:SOURce:DPLUs`  
`{S<x>_Ch<x> | CH<x> | MATH<x> | REF<x>}`  
`BUS:B<x>:ETHERnet:SOURce:DPLUs?`

**Arguments**    B<x> is the number of the bus.  
  
S<x>\_Ch<x> specifies the remote scope number and the analog channel as the source.  
  
CH<x> specifies an analog channel as the source.  
  
Math<x> specifies a math waveform as the source.  
  
REF<x> specifies a reference waveform as the source.

**Examples**    `BUS:B1:ETHERnet:SOURce:DPLUs Ch5` sets the D+ source to channel 5.  
`BUS:B1:ETHERnet:SOURce:DPLUs?` might return  
`:BUS:B1:ETHERnet:SOURce:DPLUS CH5` indicating the D+ source is set to channel 5.

## BUS:B<x>:ETHERnet:THRESHold

This command sets or queries the Ethernet DATA source High threshold for the specified bus. The bus is specified by x.

**Conditions**    Requires option SR-ENET.

<b>Group</b>	Bus
<b>Syntax</b>	BUS:B<x>:ETHERnet:THRESHo1d <NR3> BUS:B<x>:ETHERnet:THRESHo1d?
<b>Related Commands</b>	<a href="#">BUS:B&lt;x&gt;:ETHERnet:SOUrce</a>
<b>Arguments</b>	B<x> is the number of the bus.  <NR3> is the Ethernet DATA source High threshold for the specified bus.
<b>Examples</b>	BUS:B4:ETHERNET:THRESHOLD 1.0 sets the Bus 4 Ethernet DATA source High threshold to 1.0 V.  BUS:B3:ETHERNET:THRESHOLD? might return BUS:B3:ETHERNET:THRESHOLD 225.00000E-3 indicates the Bus 3 Ethernet DATA source High threshold is set to 225.0 mV.

## BUS:B<x>:ETHERnet:TYPE

This command specifies the Ethernet standard speed. The bus number is specified by x.

<b>Conditions</b>	Requires option SR-ENET.
<b>Group</b>	Bus
<b>Syntax</b>	BUS:B<x>:ETHERnet:TYPE {TENBASET HUNDREDBASETX} BUS:B<x>:ETHERnet:TYPE?
<b>Arguments</b>	B<x> is the number of the bus.  TENBASET specifies the Ethernet speed as 10Base-T.  HUNDREDBASETX specifies the Ethernet speed as 100Base-T.
<b>Examples</b>	BUS:B1:ETHERNET:TYPE HUNDREDBASETX specifies the Ethernet speed as 100Base-T.  BUS:B1:ETHERNET:TYPE? might return TENBASET, indicating that 10Base-T is the currently specified Ethernet speed.

## BUS:B<x>:EUSB:BITRate

This command sets or queries the eUSB data rate for the specified bus.

**Conditions** Requires option SR-EUSB2.

**Group** Bus

**Syntax** BUS:B<x>:EUSB:BITRate {HIGH|FULL|LOW}  
BUS:B<x>:EUSB:BITRate?

**Arguments** B<x> is the number of the bus.  
HIGH sets the bit rate to Bit Rate to 480 Mbps.  
FULL sets the bit rate to Bit Rate to 12 Mbps.  
LOW sets the bit rate to Bit Rate to 1.5 Mbps.

**Examples** BUS:B1:EUSB:BITRate HIGH sets the bit rate to 480 Mbps.  
BUS:B1:EUSB:BITRate? might return :BUS:B1:EUSB:BITRate FULL,  
indicating the bit rate is set to 12 Mbps.

## BUS:B<x>:EUSB:DATAMINUS:DATA:THRESHold

This command sets or queries the eUSB D- Input Source Data Threshold for Data line decode for specified bus.

**Conditions** Requires option SR-EUSB2.

**Group** Bus

**Syntax** BUS:B<x>:EUSB:DATAMINUS:DATA:THRESHold <NR3>  
BUS:B<x>:EUSB:DATAMINUS:DATA:THRESHold?

**Arguments** B<x> is the number of the bus.  
<NR3> is the EUSB Strobe threshold for the specified bus. The argument range is -8 V to +8 V.

**Examples**    `BUS:B1:EUSB:DATAMINUS:DATA:THRESHold 1.0` sets the bus 1 eUSB threshold to 1.0 V.

`BUS:B1:EUSB:DATAMINUS:DATA:THRESHold?` might return  
`:BUS:B1:EUSB:DATAMINUS:DATA:THRESHold -8.0`, indicating the bus 1 eUSB threshold is set to -8.0V.

## **BUS:B<x>:EUSB:DATAMINUSTHRESHold**

This command sets or queries the eUSB D- Input Source Data Threshold for Data line decode for specified bus.

**Conditions**    Requires option SR-EUSB2.

**Group**        Bus

**Syntax**        `BUS:B<x>:EUSB:DATAMINUSTHRESHold <NR3>`  
`BUS:B<x>:EUSB:DATAMINUSTHRESHold?`

**Arguments**    `B<x>` is the number of the bus.

`<NR3>` is the eUSB DATA Minus source threshold. The argument range is -8 V to +8 V.

**Examples**    `BUS:B1:EUSB:DATAMINUSTHRESHold 0.0` sets the bus 1 eUSB threshold to 0.0 V.

`BUS:B1:EUSB:DATAMINUSTHRESHold?` might return  
`:BUS:B1:EUSB:DATAMINUSTHRESHold -8.0`, indicating the bus 1 eUSB threshold is set to -8.0 V.

## **BUS:B<x>:EUSB:DATAPLUS:DATA:THRESHold**

This command sets or queries the eUSB D+ Input Source Data Threshold for Data line decode for specified bus.

**Conditions**    Requires option SR-EUSB2.

**Group**        Bus



<b>Syntax</b>	<code>BUS:B&lt;x&gt;:EUSB:DATAPLUS:DATA:THRESHo1d &lt;NR3&gt;</code> <code>BUS:B&lt;x&gt;:EUSB:DATAPLUS:DATA:THRESHo1d?</code>
<b>Arguments</b>	<code>B&lt;x&gt;</code> is the number of the bus.  <code>&lt;NR3&gt;</code> is the eUSB Strobe threshold for the specified bus. The argument range is -8 V to +8 V.
<b>Examples</b>	<code>BUS:B1:EUSB:DATAPLUS:DATA:THRESHo1d 1.0</code> sets the bus 1 eUSB threshold to 1.0 V.  <code>BUS:B1:EUSB:DATAPLUS:DATA:THRESHo1d?</code> might return <code>:BUS:B1:EUSB:DATAPLUS:DATA:THRESHo1d -8.0</code> , indicating the bus 1 eUSB threshold is set to -8.0V.

## BUS:B<x>:EUSB:DATAPLUSTHRESHo1d

This command sets or queries the eUSB DATA Plus source threshold for the specified bus.

<b>Conditions</b>	Requires option SR-EUSB2.
<b>Group</b>	Bus
<b>Syntax</b>	<code>BUS:B&lt;x&gt;:EUSB:DATAPLUSTHRESHo1d &lt;NR3&gt;</code> <code>BUS:B&lt;x&gt;:EUSB:DATAPLUSTHRESHo1d?</code>
<b>Arguments</b>	<code>B&lt;x&gt;</code> is the number of the bus.  <code>&lt;NR3&gt;</code> is the eUSB DATA Plus source threshold. The argument range is -8 V to +8 V.
<b>Examples</b>	<code>BUS:B1:EUSB:DATAPLUSTHRESHo1d 0.0</code> sets the bus 1 eUSB threshold to 0.0 V.  <code>BUS:B1:EUSB:DATAPLUSTHRESHo1d?</code> might return <code>:BUS:B1:EUSB:DATAPLUSTHRESHo1d -8.0V</code> , indicating the bus 1 eUSB threshold is set to -8.0 V.

## BUS:B<x>:EUSB:LOWTHRESHold

This command sets or queries the eUSB source Low threshold for the specified bus when signal type is Differential.

<b>Conditions</b>	Requires option SR-EUSB2.
<b>Group</b>	Bus
<b>Syntax</b>	BUS:B<x>:EUSB:LOWTHRESHold <NR3> BUS:B<x>:EUSB:LOWTHRESHold?
<b>Arguments</b>	B<x> is the number of the bus.  <NR3> is the eUSB Strobe threshold for the specified bus. The argument range is -8 V to +8 V.
<b>Examples</b>	BUS:B1:EUSB:LOWTHRESHold 1.0 sets the bus 1 eUSB threshold to 1.0 V.  BUS:B1:EUSB:LOWTHRESHold? might return :BUS:B1:EUSB:LOWTHRESHold -8.0V, indicating the bus 1 eUSB threshold is set to -8.0V

## BUS:B<x>:EUSB:OPERating:MODE

This command sets or queries the eUSB mode for the specified bus.

<b>Conditions</b>	Requires option SR-EUSB2.
<b>Group</b>	Bus
<b>Syntax</b>	BUS:B<x>:EUSB:OPERating:MODE {NATive REPEATERHOST REPEATERPERIPHERAL} BUS:B<x>:EUSB:OPERating:MODE?
<b>Arguments</b>	B<x> is the number of the bus.  NATive sets the operating mode as native.  REPEATERHOST sets the operating mode as repeater host.  REPEATERPERIPHERAL sets the operating mode as repeater peripheral.

**Examples** `BUS:B1:EUSB:OPERating:MODE NATive` sets the operating mode as native.  
`BUS:B1:EUSB:OPERating:MODE?` might return  
`:BUS:B1:EUSB:OPERating:MODE NATive`, indicating that operating mode is native.

## **BUS:B<x>:EUSB:SIGNALTYpe**

This command sets or queries the eUSB signal type for the specified bus.

**Conditions** Requires option SR-EUSB2.

**Group** Bus

**Syntax** `BUS:B<x>:EUSB:SIGNALTYpe {SINGLE|DIFF}`  
`BUS:B<x>:EUSB:SIGNALTYpe?`

**Arguments** B<x> is the number of the bus.  
 Arguments are the available eUSB signal types.

**Examples** `BUS:B1:EUSB:SIGNALTYpe SINGLE` sets the eUSB signal type to single for bus 1.  
`BUS:B1:EUSB:SIGNALTYpe?` might return `:BUS:B1:EUSB:SIGNALTYpe SINGLE`, indicating the eUSB signal type is single for bus 1.

## **BUS:B<x>:EUSB:SOURce:DIFF**

This command sets or queries the eUSB Diff source for the specified bus when signal type is Diff.

**Conditions** Requires option SR-EUSB2.

**Group** Bus

**Syntax** `BUS:B<x>:EUSB:SOURce:DIFF {S<x>_Ch<x>|CH<x>|MATH<x>|REF<x>}`  
`BUS:B<x>:EUSB:SOURce:DIFF?`

**Arguments**    **B<x>** is the number of the bus.

**S<x>\_Ch<x>** specifies the remote scope number and the analog channel as the source.

**CH<x>** specifies an analog channel as the source.

**Math<x>** specifies a math waveform as the source.

**REF<x>** specifies a reference waveform as the source.

**Examples**     **BUS:B1:EUSB:SOURce:DIFF Ch1** sets the channel to 1.

**BUS:B1:EUSB:SOURce:DIFF?** might return **:BUS:B1:EUSB:SOURce:DIFF CH1**, indicating channel 1 is the source.

## **BUS:B<x>:EUSB:SOURce:DMINus**

This command sets or queries the eUSB DataMinus (SDATAMINUS) source for the specified bus.

**Conditions**    Requires option SR-EUSB2.

**Group**         Bus

**Syntax**        **BUS:B<x>:EUSB:SOURce:DMINus**  
                  **{S<x>\_Ch<x>|CH<x>|MATH<x>|REF<x>}**  
                  **BUS:B<x>:EUSB:SOURce:DMINus?**

**Arguments**    **B<x>** is the number of the bus.

**S<x>\_Ch<x>** specifies the remote scope number and the analog channel as the source.

**CH<x>** specifies an analog channel as the source.

**Math<x>** specifies a math waveform as the source.

**REF<x>** specifies a reference waveform as the source.

**Examples**     **BUS:B1:EUSB:SOURce:DMINus CH1** sets the channel to 1.

**BUS:B1:EUSB:SOURce:DMINus?** might return **:BUS:B1:EUSB:SOURce:DMINus CH1**, indicating channel 1 is the source.

## BUS:B<x>:EUSB:SOURce:DPLUS

This command sets or queries the eUSB dataPlus (SDATAPLUS) source for the specified bus.

<b>Conditions</b>	Requires option SR-EUSB2.
<b>Group</b>	Bus
<b>Syntax</b>	BUS:B<x>:EUSB:SOURce:DPLUS {S<x>_Ch<x> CH<x> MATH<x> REF<x>} BUS:B<x>:EUSB:SOURce:DPLUS?
<b>Arguments</b>	B<x> is the number of the bus.  S<x>_Ch<x> specifies the remote scope number and the analog channel as the source.  CH<x> specifies an analog channel as the source.  Math<x> specifies a math waveform as the source.  REF<x> specifies a reference waveform as the source.
<b>Examples</b>	BUS:B1:EUSB:SOURce:DPLUS CH1 sets the channel to 1.  BUS:B1:EUSB:SOURce:DPLUS? might return :BUS:B1:EUSB:SOURce:DPLUS CH1, indicating channel 1 is the source.

## BUS:B<x>:EUSB:THRESHold

This command sets or queries the eUSB source High threshold for the specified bus when signal type is Diff.

<b>Conditions</b>	Requires option SR-EUSB2.
<b>Group</b>	Bus
<b>Syntax</b>	BUS:B<x>:EUSB:THRESHold <NR3> BUS:B<x>:EUSB:THRESHold ?

**Arguments** B<x> is the number of the bus.  
  
<NR3> is the eUSB Strobe threshold for the specified bus. The argument range is -8 V to +8 V.

**Examples** BUS:B1:EUSB:THRESHo1d 1.0 sets the bus 1 eUSB threshold to 1.0 V.  
  
BUS:B1:EUSB:THRESHo1d? might return :BUS:B1:EUSB:THRESHo1d -8.0V, indicating the bus 1 eUSB threshold is set to -8.0V

## BUS:B<x>:FLEXray:BITRate

This command sets or queries the FlexRay bus bit rate. The bus is specified by x. If you select Custom, use [BUS:B<x>:FLEXray:BITRate:CUSTom](#) to set the bit rate.

**Conditions** Requires option SR-AUTO.

**Group** Bus

**Syntax** BUS:B<x>:FLEXray:BITRate {CUSTOM|RATE2M|RATE5M|RATE10M}  
BUS:B<x>:FLEXray:BITRate?

**Arguments** B<x> is the number of the bus.  
  
Arguments specify the bit rate.

**Examples** BUS:B1:FLEXRAY:BITRate RATE2M sets the bit rate to 2 Mb.  
  
BUS:B1:FLEXRAY:BITRate? might return :BUS:B1:FLEXRAY:BITRATE RATE10M, indicating the bit rate is 10 Mb.

## BUS:B<x>:FLEXray:BITRate:CUSTom

This command sets or queries the FlexRay custom bit rate for the specified bus. The bus is specified by x.

**Conditions** Requires option SR-AUTO.

**Group** Bus

<b>Syntax</b>	<code>BUS:B&lt;x&gt;:FLEXray:BITRate:CUSTom &lt;NR1&gt;</code> <code>BUS:B&lt;x&gt;:FLEXray:BITRate:CUSTom?</code>
<b>Arguments</b>	<code>B&lt;x&gt;</code> is the number of the bus. <code>&lt;NR1&gt;</code> is the FlexRay custom bit rate for the specified bus.
<b>Examples</b>	<code>BUS:B1:FLEXray:BITRate:CUSTom 10000000</code> sets the bit rate to 10,000,000. <code>BUS:B1:FLEXray:BITRate:CUSTom?</code> might return <code>:BUS:B1:FLEXRAY:BITRATE:CUSTOM 10000000</code> indicating the bit rate is set to 10,000,000.

## BUS:B<x>:FLEXray:CHannel

This command sets or queries the FlexRay channel type for the specified bus. The bus number is specified by `x`.

<b>Conditions</b>	Requires option SR-AUTO.
<b>Group</b>	Bus
<b>Syntax</b>	<code>BUS:B&lt;x&gt;:FLEXray:CHannel {A B}</code> <code>BUS:B&lt;x&gt;:FLEXray:CHannel?</code>
<b>Arguments</b>	<code>B&lt;x&gt;</code> is the number of the bus. <code>A</code> specifies the A channel. <code>B</code> specifies the B channel.
<b>Examples</b>	<code>BUS:B1:FLEXRAY:CHANNEL B</code> sets the FlexRay channel to B. <code>BUS:B1:FLEXRAY:CHANNEL?</code> might return <code>:BUS:B1:FLEXRAY:CHANNEL A</code> , indicating the channel is set to A.

## BUS:B<x>:FLEXray:LOWTHRESHold

This command sets or queries the FlexRay data source low threshold for the specified bus. The bus is specified by `x`.

<b>Conditions</b>	Requires option SR-AUTO.
-------------------	--------------------------

<b>Group</b>	Bus
<b>Syntax</b>	<code>BUS:B&lt;x&gt;:FLEXray:LOWTHRESHold &lt;NR3&gt;</code> <code>BUS:B&lt;x&gt;:FLEXray:LOWTHRESHold?</code>
<b>Arguments</b>	<NR3> is the FlexRay data source low threshold for the specified bus. B<x> is the number of the bus.
<b>Examples</b>	<code>BUS:B1:FLEXray:LOWTHRESHold 50.0e-3</code> sets the threshold to 50 mV. <code>BUS:B1:FLEXray:LOWTHRESHold?</code> might <code>:BUS:B1:FLEXray:LOWTHRESHold 0.0E+0</code> indicating the threshold is set to 0.0 V.

## BUS:B<x>:FLEXray:SIGnal

This command sets or queries the FlexRay signal type for the specified bus. The bus number is specified by x.

<b>Conditions</b>	Requires option SR-AUTO.
<b>Group</b>	Bus
<b>Syntax</b>	<code>BUS:B&lt;x&gt;:FLEXray:SIGnal {BDIFFBP BM TXRX}</code> <code>BUS:B&lt;x&gt;:FLEXray:SIGnal?</code>
<b>Arguments</b>	B<x> is the number of the bus. BDIFFBP sets the FlexRay signal type to BDIFFBP. BM sets the FlexRay signal type to BM. TXRX sets the FlexRay signal type to TXRX.
<b>Examples</b>	<code>BUS:B1:FLEXRAY:SIGNAL BM</code> sets the FlexRay channel type to BM. <code>BUS:B1:FLEXRAY:SIGNAL?</code> might return <code>:BUS:B1:FLEXRAY:SIGNAL BDIFFBP</code> , indicating the FlexRay channel type is set to BDIFFBP.



## BUS:B<x>:FLEXray:SOURce

This command sets or queries the Flexray bus data source for the specified bus when the signal type is BDIFFBP or BM. The bus number is specified by x.

**Conditions** Requires option SR-AUTO.

**Group** Bus

**Syntax** BUS:B<x>:FLEXray:SOURce {S<x>\_Ch<x>|CH<x>|MATH<x>|REF<x>}  
BUS:B<x>:FLEXray:SOURce?

**Arguments** B<x> is the number of the bus.

S<x>\_Ch<x> specifies the remote scope number and the analog channel as the source.

CH<x> specifies an analog channel as the source.

Math<x> specifies a math waveform as the source.

REF<x> specifies a reference waveform as the source.

**Examples** BUS:B1:FLEXRAY:SOURce MATH4 sets the FlexRay source to Math 4.

BUS:B1:FLEXRAY:SOURce? might return :BUS:B1:FLEXRAY:SOURce CH1, indicating the source is channel 1.

## BUS:B<x>:FLEXray:SOURce:TXRX

This command sets or queries the FlexRay TxRx data source for the specified bus when the signal type is TXRX. The bus is specified by x.

**Conditions** Requires option SR-AUTO.

**Group** Bus

**Syntax** BUS:B<x>:FLEXray:SOURce:TXRX  
{S<x>\_Ch<x>\_D<x>|CH<x>|CH<x>\_D<x>|MATH<x>|REF<x>|REF<x>\_D<x>}  
BUS:B<x>:FLEXray:SOURce:TXRX?

**Arguments**    **B<x>** is the number of the bus.

**S<x>\_Ch<x>\_D<x>** specifies the remote scope number, the analog channel and the digital channel as the source.

**CH<x>\_D<x>** specifies an analog channel and the digital channel as the source.

**REF<x>\_D<x>** specifies a reference waveform and the digital channel as the source.

**CH<x>** specifies an analog channel as the source.

**Math<x>** specifies a math waveform as the source.

**REF<x>** specifies a reference waveform as the source.

**Examples**    **BUS:B1:FLEXray:SOURce:TXRX CH1** sets the TXRX source the channel 1.

**BUS:B1:FLEXray:SOURce:TXRX?** might return  
**:BUS:B1:FLEXRAY:SOURCE:TXRX CH1\_D0** indicating the TXRX source is set to CH1\_D0.

## **BUS:B<x>:FLEXray:THRESHold**

This command sets or queries the FlexRay data source high threshold for the specified bus. The bus is specified by x.

**Conditions**    Requires option SR-AUTO.

**Group**    Bus

**Syntax**    **BUS:B<x>:FLEXray:THRESHold <NR3>**  
**BUS:B<x>:FLEXray:THRESHold?**

**Arguments**    **B<x>** is the number of the bus.

**<NR3>** is the FlexRay data source high threshold for the specified bus.

**Examples**    **BUS:B1:FLEXray:THRESHold 50.0-3** sets the high threshold to 50 mV.

**BUS:B1:FLEXray:THRESHold?** might return **:BUS:B1:FLEXRAY:THRESHOLD 0.0E+0** indicating the high threshold is set to 0.0 V.

## BUS:B<x>:FLEXray:TXRXTHRESHold

This command sets or queries the FlexRay data source TxRx threshold for the specified bus. The bus is specified by x.

**Conditions** Requires option 5-SREMBD or SUP5-SREMBD.

**Group** Bus

**Syntax** BUS:B<x>:FLEXray:TXRXTHRESHold <NR3>  
BUS:B<x>:FLEXray:TXRXTHRESHold?

**Arguments** B<x> is the number of the bus.  
<NR3> is the TxRx threshold.

**Examples** BUS:B1:FLEXray:TXRXTHRESHold 50.0e-3 sets the threshold to 50 mV.  
BUS:B1:FLEXray:TXRXTHRESHold? might return  
:BUS:B1:FLEXRAY:TXRXTHRESHOLD 0.0E+0 indicating the threshold is set to 0.0 V.

## BUS:B<x>:I2C:CLOCK:SOURce

This command sets or queries the I2C clock (SCLK) source for the specified bus. The bus is specified by x.

**Conditions** Requires option 5-SREMBD or SUP5-SREMBD.

**Group** Bus

**Syntax** BUS:B<x>:I2C:CLOCK:SOURce  
{S<x>\_Ch<x>\_D<x> | CH<x> | CH<x>\_D<x> | MATH<x> | REF<x> | REF<x>\_D<x>}  
BUS:B<x>:I2C:CLOCK:SOURce?

**Related Commands** [BUS:B<x>:I2C:DATA:SOURce](#)  
[BUS:B<x>:I2C:RWINADDR](#)

**Arguments**    **B<x>** is the number of the bus.

**S<x>\_Ch<x>\_D<x>** specifies is the remote scope number, the analog channel and the digital channel.

**CH<x>** specifies an analog channel to use as the I2C SCLK source.

**CH<x>\_D<x>** specifies a digital channel to use as the I2C SCLK source.

**MATH<x>** specifies a math waveform to use as the I2C SCLK source.

**REF<x>** specifies a reference waveform to use as the I2C SCLK source.

**REF<x>\_D<x>** specifies a digital reference waveform as the clock source waveform for the specified I2C bus.

**Examples**    **BUS:B1:I2C:CLOCK:SOURCE CH1** sets the I2C SCLK source to CH1.

**BUS:B1:I2C:CLOCK:SOURCE?** might return **:BUS:B1:I2C:CLOCK:SOURCE CH4\_D5**, indicating that the I2C SCLK source is set to D5 of FlexChannel 4.

## BUS:B<x>:I2C:CLOCK:THReshold

This command sets or queries the I2C Clock (SCLK) source threshold for the specified bus. The bus is specified by x.

**Conditions**    Requires option 5-SREMBD or SUP5-SREMBD.

**Group**    Bus

**Syntax**    **BUS:B<x>:I2C:CLOCK:THReshold <NR3>**  
**BUS:B<x>:I2C:CLOCK:THReshold?**

**Arguments**    **B<x>** is the number of the bus.

**<NR3>** is the I2C Clock (SCLK) source threshold for the specified bus.

**Examples**    **BUS:B1:I2C:CLOCK:THReshold 50.0e-3** sets the threshold to 50 mV.

**BUS:B1:I2C:CLOCK:THReshold?** might return **:BUS:B1:I2C:CLOCK:THRESHOLD 0.0E+0** indicating the threshold is set to 0 V.

## BUS:B<x>:I2C:DATA:SOURce

This command sets or queries the I2C data (SDA) source for the specified I2C bus. The bus is specified by x.

**Conditions** Requires option 5-SREMBD or SUP5-SREMBD.

**Group** Bus

**Syntax** `BUS:B<x>:I2C:DATA:SOURce`  
`{S<x>_Ch<x>_D<x> | CH<x> | CH<x>_D<x> | MATH<x> | REF<x> | REF<x>_D<x>}`  
`BUS:B<x>:I2C:DATA:SOURce?`

**Related Commands** [BUS:B<x>:I2C:CLOCK:SOURce](#)  
[BUS:B<x>:I2C:RWINADDR](#)

**Arguments** `S<x>_Ch<x>_D<x>` specifies is the remote scope number, the analog channel and the digital channel.

`CH<x>` specifies an analog channel to use as the I2C SDA source.

`CH<x>_D<x>` specifies a digital channel to use as the I2C SDA source.

`MATH<x>` specifies a math waveform to use as the I2C SDA source.

`REF<x>` specifies a reference waveform to use as the I2C SDA source.

`REF<x>_D<x>` specifies a digital reference waveform as the data source waveform for the specified I2C bus.

**Examples** `BUS:B1:I2C:DATA:SOURCE CH1_D5` sets the I2C SDA source to CH1\_D5.

`BUS:B1:I2C:DATA:SOURCE?` might return `:BUS:B1:I2C:DATA:SOURCE MATH1`, indicating that the I2C SDA source is set to MATH1.

## BUS:B<x>:I2C:DATA:THReshold

This command sets or queries the I2C Data (SDA) source threshold for the specified bus. The bus is specified by x.

**Conditions** Requires option 5-SREMBD or SUP5-SREMBD.

**Group** Bus

**Syntax** `BUS:B<x>:I2C:DATA:THResho1d <NR3>`  
`BUS:B<x>:I2C:DATA:THResho1d?`

**Arguments** `B<x>` is the number of the bus.  
`<NR3>` is the I2C Data (SDA) source threshold for the specified bus.

**Examples** `BUS:B1:I2C:DATA:THResho1d 50.0e-3` sets the threshold to 50 mV.  
`BUS:B1:I2C:DATA:THResho1d?` might return  
`:BUS:B1:I2C:DATA:THRESHOLD 0.0E+0` indicating the threshold is set to 0 V.

## BUS:B<x>:I2C:RWINADDR

This command sets or queries the manner in which seven-bit I2C addresses are represented in the busform display of the specified bus. The bus is specified by x.

**Conditions** Requires option 5-SREMBD or SUP5-SREMBD.

**Group** Bus

**Syntax** `BUS:B<x>:I2C:RWINADDR {0|1}`  
`BUS:B<x>:I2C:RWINADDR?`

**Related Commands** [BUS:B<x>:I2C:CLOCK:SOUrce](#)  
[BUS:B<x>:I2C:DATA:SOUrce](#)

**Arguments** `B<x>` is the number of the bus.

0 displays seven-bit slave addresses as integers in the range of 0 to 127, with the state of the R/W\* bit from the LSB of the slave address byte. For example, the slave address byte of 0b10100101 is displayed as the value 0x52 R.

1 displays the entire slave address byte as a number, with the R/W\* signal as its LSB (bit 0) and the slave address in bits 7..1. For example, the slave address byte of 0b10100101 is displayed as the value 0xA5 R.

**Examples** `BUS:B1:I2C:RWINADDR 0` displays seven-bit slave addresses as integers in the range of 0 to 127.

`BUS:B1:I2C:RWINADDR?` might return `:BUS:B1:I2C:RWINADDR 1`, indicating that the entire slave address byte is displayed as a number, with the R/W\* signal as its LSB (bit 0) and the slave address in bits 7..1.

## BUS:B<x>:I3C:CLOCK:SOURce

This command sets or queries the I3C clock (SCLK) source for the specified bus.

Requires purchase and installation of option SRI3C.

<b>Group</b>	Bus
<b>Syntax</b>	<code>BUS:B&lt;x&gt;:I3C:CLOCK:SOURce</code> <code>{S&lt;x&gt;_Ch&lt;x&gt;_D&lt;x&gt;   CH&lt;x&gt;   CH&lt;x&gt;_D&lt;x&gt;   MATH&lt;x&gt;   REF&lt;x&gt;   REF&lt;x&gt;_D&lt;x&gt;}</code> <code>BUS:B&lt;x&gt;:I3C:CLOCK:SOURce?</code>

**Related Commands** [BUS:B<x>:I3C:CLOCK:THReshold](#)

<b>Arguments</b>	<p><code>B&lt;x&gt;</code> specifies the bus number.</p> <p><code>S&lt;x&gt;_Ch&lt;x&gt;_D&lt;x&gt;</code> specifies is the remote scope number, the analog channel and the digital channel.</p> <p><code>CH&lt;x&gt;</code> specifies the analog channel to use as the I3C SCLK source.</p> <p><code>CH&lt;x&gt;_D&lt;x&gt;</code> specifies the digital channel to use as the I3C SCLK source.</p> <p><code>Math&lt;x&gt;</code> specifies the math waveform to use as the I3C SCLK source.</p> <p><code>REF&lt;x&gt;</code> specifies the reference waveform to use as the I3C SCLK source.</p> <p><code>REF&lt;x&gt;_D&lt;x&gt;</code> specifies the digital reference waveform to use as the I3C SCLK source.</p>
------------------	------------------------------------------------------------------------------------------------------------------------------------------------------------------------------------------------------------------------------------------------------------------------------------------------------------------------------------------------------------------------------------------------------------------------------------------------------------------------------------------------------------------------------------------------------------------------------------------------------------------------------------------------------------------------------------------------------------------------

**Examples** `BUS:B5:I3C:CLOCK:SOURCE CH1` sets the Bus 5 I3C SCLK source to Channel 1.

`BUS:B2:I3C:CLOCK:SOURCE?` might return `BUS:B2:I3C:CLOCK:SOURCE CH4_D5`, indicating that the Bus 2 I3C SCLK source is set to Digital signal 5 of Channel 4.

## BUS:B<x>:I3C:CLOCK:THReshold

This command sets or queries the I3C clock (SCLK) source threshold level for the specified bus.

Requires purchase and installation of option SRI3C.

**Group** Bus

**Syntax** `BUS:B<x>:I3C:CLOCK:THResho1d <NR3>`  
`BUS:B<x>:I3C:CLOCK:THResho1d?`

**Related Commands** [BUS:B<x>:I3C:CLOCK:SOUrce](#)

**Arguments** `B<x>` specifies the bus number.  
`<NR3>` is the threshold value for I3C Clock (SCLK) source of the specified bus.

**Examples** `BUS:B3:I3C:CLOCK:THResho1d 50.0e-3` sets the I3C clock threshold to 50 mV for Bus 3.  
`BUS:B3:I3C:CLOCK:THResho1d?` might return  
`BUS:B1:I3C:CLOCK:THRESHOLD 0.0E+0`, indicating the threshold is set to 0 V.

## BUS:B<x>:I3C:DATA:SOUrce

This command sets or queries the I3C data clock (SDA) source for the specified bus.

Requires purchase and installation of option SRI3C.

**Group** Bus

**Syntax** `BUS:B<x>:I3C:DATA:SOUrce`  
`{S<x>_Ch<x>_D<x> | CH<x> | CH<x>_D<x> | MATH<x> | REF<x> | REF<x>_D<x>}`  
`BUS:B<x>:I3C:DATA:SOUrce?`

**Related Commands** [BUS:B<x>:I3C:DATA:THReshold](#)

**Arguments** `B<x>` specifies the bus number.  
`S<x>_Ch<x>_D<x>` specifies is the remote scope number, the analog channel and the digital channel.  
`CH<x>` specifies the analog channel to use as the I3C SDA source.  
`CH<x>_D<x>` specifies the digital channel to use as the I3C SDA source.



Math<x> specifies the math waveform to use as the I3C SDA source.

REF<x> specifies the reference waveform to use as the I3C SDA source.

REF<x>\_D<x> specifies the digital reference waveform to use as the I3C SDA source.

**Examples** `BUS:B5:I3C:DATA:SOURCE CH1` sets the Bus 5 I3C SDA clock source to Channel 1.

`BUS:B2:I3C:DATA:SOURCE?` might return `BUS:B2:I3C:DATA:SOURCE MATH1`, indicating that the Bus 2 I3C SDA source is set to Math waveform 1.

## BUS:B<x>:I3C:DATA:THReshold

This command sets or queries the I3C clock (SDA) data threshold level for the specified bus.

Requires purchase and installation of option SRI3C.

**Group** Bus

**Syntax** `BUS:B<x>:I3C:DATA:THReshold`  
`{S<x>_Ch<x>_D<x> | CH<x> | CH<x>_D<x> | MATH<x> | REF<x> | REF<x>_D<x>}`  
`BUS:B<x>:I3C:DATA:THReshold?`

**Related Commands** [BUS:B<x>:I3C:DATA:SOUrce](#)

**Arguments** B<x> specifies the bus number.

<NR3> is the threshold value for I3C Data Clock (SDA) source of the specified bus.

**Examples** `BUS:B3:I3C:DATA:THReshold 50.0e-2` sets the I3C data threshold to 500 mV for Bus 3.

`BUS:B3:I3C:DATA:THReshold?` might return `BUS:B1:I3C:DATA:THRESHOLD 0.0E+0`, indicating the Bus 1 I3C SDA threshold is set to 0 V.

## BUS:B<x>:LABel:COLor

This command sets or queries the color of the specified bus label. The bus is specified by x.

<b>Group</b>	Bus
<b>Syntax</b>	<code>BUS:B&lt;x&gt;:LABe1:COLor &lt;QString&gt;</code> <code>BUS:B&lt;x&gt;:LABe1:COLor?</code>
<b>Arguments</b>	<code>B&lt;x&gt;</code> is the number of the bus.  <code>&lt;QString&gt;</code> is the bus label color. To return the color to the default color, send an empty string as in this example: <code>:BUS:B1:LABEL:COLOR ""</code> .
<b>Examples</b>	<code>BUS:B1:LABe1:COLor "#FF0000"</code> sets the label color to red.  <code>BUS:B1:LABe1:COLor?</code> might return <code>:BUS:B1:LABEL:COLOR "#FF0000"</code> indicating the color is red.

## BUS:B<x>:LABe1:FONT:BOLD

This command sets or queries the bold state of the specified bus label. The bus is specified by x.

<b>Group</b>	Bus
<b>Syntax</b>	<code>BUS:B&lt;x&gt;:LABe1:FONT:BOLD {ON OFF 1 0}</code> <code>BUS:B&lt;x&gt;:LABe1:FONT:BOLD?</code>
<b>Arguments</b>	<code>B&lt;x&gt;</code> is the number of the bus.  <code>ON</code> displays the label in bold font.  <code>OFF</code> does not display the label in bold font.  <code>1</code> displays the label in bold font.  <code>0</code> does not display the label in bold font.
<b>Examples</b>	<code>BUS:B1:LABe1:FONT:BOLD OFF</code> turns off bold font.  <code>BUS:B1:LABe1:FONT:BOLD?</code> might return <code>:BUS:B1:LABEL:FONT:BOLD 1</code> indicating a bold font.

**BUS:B<x>:LABel:FONT:ITALic**

This command sets or queries the italic state of the specified bus label. The bus is specified by x.

<b>Group</b>	Bus
<b>Syntax</b>	<code>BUS:B&lt;x&gt;:LABel:FONT:ITALic {ON OFF 1 0}</code> <code>BUS:B&lt;x&gt;:LABel:FONT:ITALic?</code>
<b>Arguments</b>	<p>B&lt;x&gt; is the number of the bus.</p> <p>ON displays the label in italic font.</p> <p>OFF does not display the label in italic font.</p> <p>1 displays the label in italic font.</p> <p>0 does not display the label in italic font.</p>
<b>Examples</b>	<p><code>BUS:B1LABel:FONT:ITALic OFF</code> turns off italic font.</p> <p><code>BUS:B1LABel:FONT:ITALic?</code> might return <code>:BUS:B1:LABEL:FONT:ITALIC 1</code> indicating the font is italic.</p>

**BUS:B<x>:LABel:FONT:SIZE**

This command sets or queries the font size of the specified bus label. The bus is specified by x.

<b>Group</b>	Bus
<b>Syntax</b>	<code>BUS:B&lt;x&gt;:LABel:FONT:SIZE &lt;NR1&gt;</code> <code>BUS:B&lt;x&gt;:LABel:FONT:SIZE?</code>
<b>Arguments</b>	<p>B&lt;x&gt; is the number of the bus.</p> <p>&lt;NR1&gt; is the font size.</p>
<b>Examples</b>	<p><code>BUS:B1:LABel:FONT:SIZE 10</code> sets the font size to 10 points.</p> <p><code>BUS:B1:LABel:FONT:SIZE?</code> might return <code>:BUS:B1:LABEL:FONT:SIZE 20</code> indicating the font size is 20 points.</p>

## BUS:B<x>:LABel:FONT:TYPE

This command sets or queries the font type of the specified bus label, such as Arial or Times New Roman. The bus is specified by x.

**Group** Bus

**Syntax** BUS:B<x>:LABel:FONT:TYPE <QString>  
BUS:B<x>:LABel:FONT:TYPE?

**Arguments** B<x> is the number of the bus.  
  
<QString> is the specified font type. Available fonts include: DejaVu Sans, DejaVu Sans Mono, DejaVu Serif, Frutiger LT Std, Monospace, Sans Serif, Serif, Ubuntu, Ubuntu Condensed, and Ubuntu Mono.

**Examples** BUS:B1:LABel:FONT:TYPE Monospace selects a monospace font.  
  
BUS:B1:LABel:FONT:TYPE? might return :BUS:B1:LABel:FONT:TYPE "Frutiger LT Std 55 Roman" indicating the font type is Frutiger LT Std.

## BUS:B<x>:LABel:FONT:UNDERline

This command sets or queries the underline state of the specified bus label. The bus is specified by x.

**Group** Bus

**Syntax** BUS:B<x>:LABel:FONT:UNDERline {ON|OFF|1|0}  
BUS:B<x>:LABel:FONT:UNDERline?

**Arguments** B<x> is the number of the bus.  
  
ON displays the label in underlined font.  
  
OFF does not display the label in underlined font.  
  
1 displays the label in underlined font.  
  
0 does not display the label in underlined font.

**Examples** `BUS:B:LABel:FONT:UNDERline ON` turns on underline font.  
`BUS:B:LABel:FONT:UNDERline?` might return  
`:BUS:B1:LABEL:FONT:UNDERLINE 0` indicating underline is off.

## BUS:B<x>:LABel:name

This command sets or queries the label for the specified bus. The bus is specified by x.

**Group** Bus

**Syntax** `BUS:B<x>:LABel:name <QString>`  
`BUS:B<x>:LABel:name?`

**Related Commands** [BUS:B<x>:TYPE](#)

**Arguments** B<x> is the number of the bus.  
<QString> is an alphanumeric string of text enclosed in quotes. The text string is limited to 30 characters. It contains the text label information for the bus.

**Examples** `BUS:B1:LABEL:NAME "TEST"` sets the waveform label for the bus B1 to Test.  
`BUS:B1:LABEL:NAME?` might return `:BUS:B1:LABEL:NAME "BUS 1"`, indicating that the waveform label for the bus B1 is set to "Bus 1".

## BUS:B<x>:LABel:XPOS

This command sets or queries the x-position of the specified bus label. The bus is specified by x.

**Group** Bus

**Syntax** `BUS:B<x>:LABel:XPOS <NR3>`  
`BUS:B<x>:LABel:XPOS?`

**Arguments** B<x> is the number of the bus.  
<NR3> is the x-position, in pixels relative to the left edge of the screen of the specified bus label.

**Examples** `BUS:B1:LABEL:XPOS 90` set the x position to 90.  
`BUS:B1:LABEL:XPOS?` might return `:BUS:B1:LABEL:XPOS 45.0000` indicating the x position is 45.0 pixels to the right of the left edge of the display.

## BUS:B<x>:LABEL:YPOS

This command sets or queries the y-position of the specified bus label. The bus is specified by x.

**Group** Bus

**Syntax** `BUS:B<x>:LABEL:YPOS <NR3>`  
`BUS:B<x>:LABEL:YPOS?`

**Arguments** `B<x>` is the number of the bus.  
`<NR3>` is the y-position, in pixels relative to the baseline of the waveform, of the specified bus label.

**Examples** `BUS:B1:LABEL:YPOS 1.0e1` set the y position to 10.0.  
`BUS:B1:LABEL:YPOS?` might return `:BUS:B1:LABEL:YPOS 0.0E+0` indicating the y position is 0.0 pixels from the baseline of the waveform.

## BUS:B<x>:LIN:BITRate

This command sets or queries the LIN bus bit rate. The bus number is specified by x. If you select Custom, use `BUS:B<x>:LIN:BITRate:CUSTom` to set the bit rate.

**Conditions** Requires option SR-AUTO.

**Group** Bus

**Syntax** `BUS:B<x>:LIN:BITRate`  
`{RATE10K|RATE1K|RATE19K|RATE2K|RATE4K|RATE9K|CUSTom}`  
`BUS:B<x>:LIN:BITRate?`

**Related Commands** [BUS:B<x>:LIN:BITRate:CUSTom](#)

**Arguments** B<x> is the number of the bus.  
Arguments are the available bit rates.

**Examples** BUS:B1:LIN:BITRate Rate4k sets the bit rate to 4 kb.  
BUS:B1:LIN:BITRate? might return :BUS:B1:LIN:BITRATE RATE19K, indicating that the bit rate is set to 19 kb.

## BUS:B<x>:LIN:BITRate:CUSTom

This command sets or queries LIN custom bit rate for the specified bus. The bus is specified by x.

**Conditions** Requires option SR-AUTO.

**Group** Bus

**Syntax** BUS:B<x>:LIN:BITRate:CUSTom <NR1>  
BUS:B<x>:LIN:BITRate:CUSTom?

**Related Commands** [BUS:B<x>:LIN:BITRate](#)

**Arguments** B<x> is the number of the bus.  
<NR1> is the LIN custom bit rate for the specified bus.

**Examples** BUS:B1:LIN:BITRate:CUSTom 9000 sets the bit rate to 9,000.  
BUS:B1:LIN:BITRate:CUSTom? might return :BUS:B1:LIN:BITRate:CUSTom 10000 indicating the bit rate is set to 10,000.

## BUS:B<x>:LIN:IDFORmat

This command sets or queries LIN bus identifier format for the specified bus. The bus number is specified by x.

**Conditions** Requires option SR-AUTO.

**Group** Bus

**Syntax**    `BUS:B<x>:LIN:IDFormat {NOPARity|PARity}`  
`BUS:B<x>:LIN:IDFormat?`

**Arguments**    `B<x>` is the number of the bus.  
  
    `NOPARity` specifies an id format that includes parity.  
  
    `PARity` specifies an id format that separates parity.

**Examples**    `BUS:B1:LIN:IDFormat PARITY` set the id format to parity.  
  
    `BUS:B1:LIN:IDFormat?` might return `:BUS:B1:LIN:IDFORMAT NOPARITY`,  
    indicating the id format is set to no parity.

## **BUS:B<x>:LIN:POLarity**

This command sets or queries the LIN source polarity for the specified bus. The bus number is specified by x.

**Conditions**    Requires option SR-AUTO.

**Group**        Bus

**Syntax**       `BUS:B<x>:LIN:POLarity {INVerted|NORmal}`  
`BUS:B<x>:LIN:POLarity?`

**Arguments**    `B<x>` is the number of the bus.  
  
    `INVerted` specifies inverted polarity.  
  
    `NORmal` specifies normal polarity.

**Examples**    `BUS:B1:LIN:POLarity INverted` sets the polarity to inverted.  
  
    `BUS:B1:LIN:POLarity?` might return `:BUS:B1:LIN:POLARITY NORMAL`,  
    indicating the bus polarity is set to normal.

## **BUS:B<x>:LIN:SAMPLEpoint**

Specifies the LIN sample point, for the specified LIN bus. The bus is specified by x.



<b>Conditions</b>	Requires option SR-AUTO.
<b>Group</b>	Bus
<b>Syntax</b>	<code>BUS:B&lt;x&gt;:LIN:SAMPLEpoint &lt;NR1&gt;</code> <code>BUS:B&lt;x&gt;:LIN:SAMPLEpoint?</code>
<b>Arguments</b>	<code>B&lt;x&gt;</code> is the number of the bus.  <NR1> is a percentage that represents the point at which to sample during each bit period.
<b>Examples</b>	<code>BUS:B1:LIN:SAMPLEPOINT 10</code> sets the sample point to 10% of the bit period <code>BUS:B1:LIN:SAMPLEPOINT?</code> might return <code>BUS:B1:LIN:SAMPLEPOINT 50</code> indicating that the sample point is set to 50% of the bit period

## BUS:B<x>:LIN:SOURce

This command sets or queries the LIN data source for the specified bus. The bus number is specified by x.

<b>Conditions</b>	Requires option SR-AUTO.
<b>Group</b>	Bus
<b>Syntax</b>	<code>BUS:B&lt;x&gt;:LIN:SOURce</code> { <code>S&lt;x&gt;_Ch&lt;x&gt;_D&lt;x&gt;</code>   <code>CH&lt;x&gt;</code>   <code>CH&lt;x&gt;_D&lt;x&gt;</code>   <code>MATH&lt;x&gt;</code>   <code>REF&lt;x&gt;</code>   <code>REF&lt;x&gt;_D&lt;x&gt;</code> } <code>BUS:B&lt;x&gt;:LIN:SOURce?</code>
<b>Arguments</b>	<code>B&lt;x&gt;</code> is the number of the bus.  Arguments specify the available sources.
<b>Examples</b>	<code>BUS:B1:LIN:SOURce MATH4</code> sets the source to MATH 4 <code>BUS:B1:LIN:SOURce?</code> might return <code>:BUS:B1:LIN:SOURce CH1</code> , indicating the source is set to channel 1.

## BUS:B<x>:LIN:SOURce:THReshold

This command sets or queries the LIN source threshold for the specified bus. The bus is specified by x.

**Conditions** Requires option SR-AUTO.

**Group** Bus

**Syntax** BUS:B<x>:LIN:SOURce:THReshold <NR3>  
BUS:B<x>:LIN:SOURce:THReshold?

**Arguments** B<x> is the number of the bus.  
<NR3> the LIN source threshold for the specified bus.

**Examples** BUS:B1:LIN:SOURce:THReshold 50.0e-3 sets the threshold to 50 mV.  
BUS:B1:LIN:SOURce:THReshold? might return  
:BUS:B1:LIN:SOURce:THRESHOLD 0.0E+0 indicating the threshold is 0.0 V.

## BUS:B<x>:LIN:STANDard

This command sets or queries the LIN bus standard for the specified bus. The bus number is specified by x.

**Conditions** Requires option SR-AUTO.

**Group** Bus

**Syntax** BUS:B<x>:LIN:STANDard {MIXed|V1X|V2X}  
BUS:B<x>:LIN:STANDard?

**Arguments** B<x> is the number of the bus.  
MIXed specifies both versions 1.x and 2.x of the LIN standard.  
V1X specifies version 1.x of the LIN standard.  
V2X specifies version 2.x of the LIN standard.

**Examples** `BUS:B1:LIN:STANDARD V1X` sets the standard to version 1.x.  
`BUS:B1:LIN:STANDARD?` might return `:BUS:B1:LIN:STANDARD V2X`,  
 indicating the standard is set to version 2.x for bus B1.

## **BUS:B<x>:MANchester:BITORDER**

This command sets or queries the Manchester bus Bit Order. The bus is specified by x.

**Conditions** Requires option SR-MANCH.

**Group** Bus

**Syntax** `BUS:B<x>:MANchester:BITORDER {LSB|MSB}`  
`BUS:B<x>:MANchester:BITORDER?`

**Related Commands** [BUS:B<x>:MANchester:DISplaymode](#)

**Arguments** B<x> is the number of the bus.  
 LSB arranges the bits in LSB format, least significant bits first.  
 MSB arranges the bits in MSB format, most significant bits first.

**Examples** `BUS:B1:MANchester:BITORDER LSB` arranges the bits in LSB format for bus 1.  
`BUS:B1:MANchester:BITORDER?` might return  
`:BUS:B1:MANchester:BITORDER MSB`, indicating that bus 1 bits are arranged  
 in MSB format.

## **BUS:B<x>:MANchester:BITRate**

This command sets or queries the Manchester bus bit rate. The bus number is specified by x.

**Conditions** Requires option SR-MANCH.

**Group** Bus

**Syntax**    `BUS:B<x>:MANchester:BITRate <NR1>`  
`BUS:B<x>:MANchester:BITRate?`

**Arguments**    `B<x>` is the number of the bus.  
`<NR1>` sets the bit rate up to 1 Gbps.

**Examples**    `BUS:B1:MANchester:BITRate 125000` sets the bit rate to 125 kb.  
`BUS:B1:MANchester:BITRate?` might return  
`:BUS:B1:MANchester:BITRATE 19000`, indicating that the bit rate is set to 19 kb.

## **BUS:B<x>:MANchester:DISplaymode**

This command sets or queries the Manchester bus Packet View. The bus number is specified by x.

**Conditions**    Requires option SR-MANCH.

**Group**    Bus

**Syntax**    `BUS:B<x>:MANchester:DISplaymode {BITS|PACKET}`  
`BUS:B<x>:MANchester:DISplaymode?`

**Arguments**    `B<x>` is the number of the bus.  
`BITS` sets the PacketView to off and the data to be seen as single bits formats.  
`PACKET` sets the PacketView to on and the data to be seen in the form of fields.

**Examples**    `BUS:B1:MANchester:DISplaymode PACKET` sets the PacketView to off and the data to be seen as single bits formats.  
`BUS:B1:MANchester:DISplaymode?` might return  
`:BUS:B1:MANchester:DISplaymode BITS`, indicating the PacketView is on and the data can be seen in the form of fields.

## **BUS:B<x>:MANchester:HEADer:LENGth**

This command sets or queries the Manchester header length in bits. The bus number is specified by x.

<b>Conditions</b>	Requires option SR-MANCH.
<b>Group</b>	Bus
<b>Syntax</b>	BUS:B<x>:MANchester:HEADer:LENGth <NR1> BUS:B<x>:MANchester:HEADer:LENGth?
<b>Related Commands</b>	<a href="#">BUS:B&lt;x&gt;:MANchester:DISplaymode</a>
<b>Arguments</b>	B<x> is the number of the bus. <NR1> sets the header length in bits.
<b>Examples</b>	BUS:B1:MANchester:HEADer:LENGth 2 sets the header length to 2 bits. BUS:B1:MANchester:HEADer:LENGth? might return :BUS:B1:MANchester:HEADer:LENGth 2, indicating the header length is 2 bits.

## BUS:B<x>:MANchester:IDLE:BITS

This command sets or queries the Manchester idle bit size in bits. The bus number is specified by x.

<b>Conditions</b>	Requires option SR-MANCH.
<b>Group</b>	Bus
<b>Syntax</b>	BUS:B<x>:MANchester:IDLE:BITS <NR1> BUS:B<x>:MANchester:IDLE:BITS?
<b>Arguments</b>	B<x> is the number of the bus. <NR1> sets the idle bit size.
<b>Examples</b>	BUS:B1:MANchester:IDLE:BITS 2 sets the idle bit size to 2 bits. BUS:B1:MANchester:IDLE:BITS? might return :BUS:B1:MANchester:IDLE:BITS 2, indicating the idle bit size is 2 bits.

## BUS:B<x>:MANChester:parity

This command sets or queries the Manchester bus Parity. The bus number is specified by x.

**Conditions** Requires option SR-MANCH.

**Group** Bus

**Syntax** BUS:B<x>:MANChester:parity {ODD|EVEN|NONE}  
BUS:B<x>:MANChester:parity?

**Related Commands** [BUS:B<x>:MANChester:DISplaymode](#)

**Arguments** ODD sets the number of 1's to odd.  
EVEN sets the number of 1's to even.  
NONE specifies that Parity is not considered.

**Examples** BUS:B1:MANChester:parity ODD sets the number of 1's to odd.  
BUS:B1:MANChester:parity? might return :BUS:B1:MANChester:parity  
EVEN, indicating the number of 1's are even.

## BUS:B<x>:MANChester:SOUrce

This command sets or queries the Manchester source for the specified bus. The bus is specified by x.

**Conditions** Requires option SR-MANCH.

**Group** Bus

**Syntax** BUS:B<x>:MANChester:SOUrce {S<x>\_Ch<x>|CH<x>|MATH<x>|REF<x>}  
BUS:B<x>:MANChester:SOUrce?

**Related Commands** [BUS:B<x>:MANChester:THReshold](#)

**Arguments** B<x> is the number of the bus.  
 S<x>\_Ch<x> specifies the remote scope number and the analog channel.  
 CH<x> specifies an analog channel as the source.  
 Math<x> specifies a math waveform as the source.  
 REF<x> specifies a reference waveform as the source.

**Examples** BUS:B1:MANchester:SOURCE CH1 sets the source to channel 5.  
 BUS:B1:MANchester:SOURCE? might return :BUS:B1:MANchester:SOURCE CH5, indicating the source is set to channel 5.

## BUS:B<x>:MANchester:START:INDEX

This command sets or queries the Manchester start Index in bits. The bus is specified by x.

**Conditions** Requires option SR-MANCH.

**Group** Bus

**Syntax** BUS:B<x>:MANchester:START:INDEX <NR1>  
 BUS:B<x>:MANchester:START:INDEX?

**Arguments** B<x> is the number of the bus.  
 <NR1> sets the start Index in bits.

**Examples** BUS:B1:MANchester:START:INDEX 2 sets the start Index to 2 bits.  
 BUS:B1:MANchester:START:INDEX? might return :BUS:B1:MANchester:START:INDEX 2, indicating the start Index is 2 bits.

## BUS:B<x>:MANchester:SYNC:SIZE

This command sets or queries the Manchester sync Bit Size in bits. The bus is specified by x.

**Conditions** Requires option SR-MANCH.

<b>Group</b>	Bus
<b>Syntax</b>	<code>BUS:B&lt;x&gt;:MANchester:SYNC:SIZE &lt;NR1&gt;</code> <code>BUS:B&lt;x&gt;:MANchester:SYNC:SIZE?</code>
<b>Related Commands</b>	<a href="#">BUS:B&lt;x&gt;:MANchester:DISplaymode</a>
<b>Arguments</b>	<code>B&lt;x&gt;</code> is the number of the bus. <code>&lt;NR1&gt;</code> sets the Bit Size in bits.
<b>Examples</b>	<code>BUS:B1:MANchester:SYNC:SIZE 2</code> sets the sync Bit Size to 2 bits. <code>BUS:B1:MANchester:SYNC:SIZE?</code> might return <code>:BUS:B1:MANchester:SYNC:SIZE 2</code> , indicating the sync Bit Size is 2 bits.

## BUS:B<x>:MANchester:THReshold

This command sets or queries the Manchester threshold for the specified bus. The bus is specified by `x`.

<b>Conditions</b>	Requires option SR-MANCH.
<b>Group</b>	Bus
<b>Syntax</b>	<code>BUS:B&lt;x&gt;:MANchester:THReshold &lt;NR3&gt;</code> <code>BUS:B&lt;x&gt;:MANchester:THReshold?</code>
<b>Related Commands</b>	<a href="#">BUS:B&lt;x&gt;:MANchester:SOUrce</a>
<b>Arguments</b>	<code>B&lt;x&gt;</code> is the number of the bus. <code>&lt;NR3&gt;</code> sets the Manchester Strobe threshold for the specified bus in Volts. The argument range is -8V to +8V
<b>Examples</b>	<code>BUS:B4:MANchester:THReshold 1.0</code> sets the Bus 4 Manchester threshold to 1.0 V. <code>BUS:B4:MANchester:THReshold?</code> might return <code>:BUS:B4:MANchester:THReshold 225.00000E-3</code> , indicates the Bus 4 Manchester threshold is set to 225.0 mV.



## BUS:B<x>:MANChester:TOLerance

This command sets or queries the Tolerance bus parameter. The bus is specified by x.

**Conditions** Requires option SR-MANCH.

**Group** Bus

**Syntax** `BUS:B<x>:MANChester:TOLerance <NR3>`  
`BUS:B<x>:MANChester:TOLerance?`

**Arguments** B<x> is the number of the bus.  
<NR3> sets the Tolerance bus parameter.

**Examples** `BUS:B1:MANChester:TOLerance 20` sets the Tolerance bus parameter to 20 for bus 1.  
`BUS:B1:MANChester:TOLerance?` might return  
`:BUS:B1:MANChester:TOLerance 20`, indicates the Tolerance bus parameter is 20 for bus 1.

## BUS:B<x>:MANChester:TRAIler:LENGth

This command sets or queries the Manchester trailer length in bits. The bus is specified by x.

**Conditions** Requires option SR-MANCH.

**Group** Bus

**Syntax** `BUS:B<x>:MANChester:TRAIler:LENGth <NR1>`  
`BUS:B<x>:MANChester:TRAIler:LENGth?`

**Related Commands** [BUS:B<x>:MANChester:DISplaymode](#)

**Arguments** B<x> is the number of the bus.  
<NR1> sets the trailer length in bits.

**Examples**    `BUS:B1:MANchester:TRAIler:LENGth 2` sets the trailer length to 2 bits for bus 1.

`BUS:B1:MANchester:TRAIler:LENGth?` might return  
                 `:BUS:B1:MANchester:TRAIler:LENGth 2`, indicates the trailer length is 2 bits for bus 1.

## **BUS:B<x>:MANchester:TRANstion:ZERo**

This command sets or queries the Manchester bus for zero falling or rising. Manchester bit are defined by transition in the middle of the bit. Depending on the transition, conventions are defined. The bus is specified by x.

**Conditions**    Requires option SR-MANCH.

**Group**        Bus

**Syntax**       `BUS:B<x>:MANchester:TRANstion:ZERo {FALLing|RISing}`  
                 `BUS:B<x>:MANchester:TRANstion:ZERo?`

**Arguments**    `B<x>` is the number of the bus.

`FALLing` sets Falling as 0.

`RISing` sets Rising as 0.

**Examples**     `BUS:B1:MANchester:TRANstion:ZERo FALLing` sets Falling as 0 for bus 1.

`BUS:B1:MANchester:TRANstion:ZERo?` might return  
                 `:BUS:B1:MANchester:TRANstion:ZERo RISing`, indicates that transition of 0 is Rising.

## **BUS:B<x>:MANchester:WORD:COUNT**

This command sets or queries the Manchester word count in bits. The bus is specified by x.

**Conditions**    Requires option SR-MANCH.

**Group**        Bus

**Syntax**     `BUS:B<x>:MANChester:WORD:COUNT <NR1>`  
                  `BUS:B<x>:MANChester:WORD:COUNT?`

**Related Commands**     [BUS:B<x>:MANChester:DISplaymode](#)

**Arguments**     `B<x>` is the number of the bus.  
                      `<NR1>` sets the word count in bits.

**Examples**     `BUS:B1:MANChester:WORD:COUNT 2` sets the word count to 2 bits for bus 1.  
                      `BUS:B1:MANChester:WORD:COUNT?` might return  
                      `:BUS:B1:MANChester:WORD:COUNT 2`, indicates the word count is 2 bits  
                      for bus 1.

## **BUS:B<x>:MANChester:WORDSIZE**

This command sets or queries the Manchester word size in bits. The bus is specified by x.

**Conditions**     Requires option SR-MANCH.

**Group**     Bus

**Syntax**     `BUS:B<x>:MANChester:WORDSIZE <NR1>`  
                  `BUS:B<x>:MANChester:WORDSIZE?`

**Related Commands**     [BUS:B<x>:MANChester:DISplaymode](#)

**Arguments**     `B<x>` is the number of the bus.  
                      `<NR1>` sets the word size in bits.

**Examples**     `BUS:B1:MANChester:WORDSIZE 12` sets the word size to 2 bits for bus 1.  
                      `BUS:B1:MANChester:WORDSIZE?` might return  
                      `:BUS:B1:MANChester:WORDSIZE 12`, indicates the word size is 2 bits  
                      for bus 1.

## **BUS:B<x>:MDIO:CLOCK:SOURce**

This command sets or queries the MDIO Clock source for the specified bus. The bus is specified by x.

**Conditions** Requires option SR-MDIO.

**Group** Bus

**Syntax** `BUS:B<x>:MDIO:CLOCK:SOURce {S<x>_Ch<x>|CH<x>|MATH<x>|REF<x>}`  
`BUS:B<x>:MDIO:CLOCK:SOURce?`

**Arguments** B<x> is the number of the bus.

S<x>\_Ch<x> specifies the remote scope number and the analog channel.

CH<x> specifies an analog channel as the Clock source.

Math<x> specifies a math waveform as the Clock source.

REF<x> specifies a reference waveform as the Clock source.

**Examples** `BUS:B1:MDIO:CLOCK:SOURce CH1` sets the channel to 1 to clock.

`BUS:B1:MDIO:CLOCK:SOURce?` might return `:BUS:B1:MDIO:CLOCK:SOURce CH1`, indicating that channel 1 is set to clock.

## **BUS:B<x>:MDIO:CLOCK:THReshold**

This command sets or queries the MDIO clock source threshold for the specified bus. The bus is specified by x.

**Conditions** Requires option SR-MDIO.

**Group** Bus

**Syntax** `BUS:B<x>:MDIO:CLOCK:THReshold <NR3>`  
`BUS:B<x>:MDIO:CLOCK:THReshold?`

<b>Arguments</b>	B<x> is the number of the bus.  <NR3> is the clock source threshold for the specified bus. The argument range is -8V to +8V.
<b>Examples</b>	BUS:B1:MDIO:CLOCK:THResho1d 0.0 sets the Bus 1 MDIO clock threshold to 0.0V.  BUS:B1:MDIO:CLOCK:THResho1d? might return :BUS:B2:MDIO:CLOCK:THResho1d -8.0, indicating the Bus 1 MDIO clock threshold is set to -8.0V.

## BUS:B<x>:MDIO:DATA:SOUrce

This command sets or queries the data for the specified bus. The bus is specified by x.

<b>Conditions</b>	Requires option SR-MDIO.
<b>Group</b>	Bus
<b>Syntax</b>	BUS:B<x>:MDIO:DATA:SOUrce {S<x>_Ch<x> CH<x> MATH<x> REF<x>} BUS:B<x>:MDIO:DATA:SOUrce?
<b>Arguments</b>	B<x> is the number of the bus.  S<x>_Ch<x> specifies the remote scope number and the analog channel.  CH<x> specifies an analog channel as the data source.  Math<x> specifies a math waveform as the data source.  REF<x> specifies a reference waveform as the data source.
<b>Examples</b>	BUS:B1:MDIO:DATA:SOUrce CH2 sets the data source to channel 2.  BUS:B1:MDIO:DATA:SOUrce? might return :BUS:B1:MDIO:DATA:SOUrce CH1, indicating the data source is set to channel 1.

## BUS:B<x>:MDIO:DATA:THReshold

This command sets or queries the MDIO Data source threshold for the specified bus. The bus is specified by x.

<b>Conditions</b>	Requires option SR-MDIO.
<b>Group</b>	Bus
<b>Syntax</b>	BUS:B<x>:MDIO:DATA:THRESHoId <NR3> BUS:B<x>:MDIO:DATA:THRESHoId?
<b>Arguments</b>	B<x> is the number of the bus.  <NR3> is the data source threshold for the specified bus. The argument range is -8V to +8V.
<b>Examples</b>	BUS:B1:MDIO:DATA:THRESHoId 0.0 sets the Bus 1 MDIO data threshold to 0.0V.  BUS:B1:MDIO:DATA:THRESHoId? might return :BUS:B2:MDIO:DATA:THRESHoId -8.0, indicating the Bus 1 MDIO data threshold is set to -8.0V.

## BUS:B<x>:MIL1553B:LOWTHRESHoId

This command sets or queries the MIL-STD-1553 lower threshold for the specified bus. The bus is specified by x.

<b>Conditions</b>	Requires option SR-AERO.
<b>Group</b>	Bus
<b>Syntax</b>	BUS:B<x>:MIL1553B:LOWTHRESHoId <NR3> BUS:B<x>:MIL1553B:LOWTHRESHoId?
<b>Related Commands</b>	<a href="#">BUS:B&lt;x&gt;:MIL1553B:SOUrce</a>
<b>Arguments</b>	B<x> is the number of the bus.  <NR3> is the MIL-STD-1553 lower threshold for the specified bus.
<b>Examples</b>	BUS:B3:MIL1553B:LOWTHRESHoId -200e-3 sets the Bus 3 MIL-STD-1553 lower threshold to -200 mV.

`BUS:B2:MIL1553B:LOWTHRESHOLD?` might return  
`:BUS:B2:MIL1553B:LOWTHRESHOLD -500.0000E-3` indicating the Bus 2  
MIL-STD-1553 lower threshold is set to -500 mV.

## **BUS:B<x>:MIL1553B:POLarity**

This command sets or queries the source polarity for the specified MIL-STD-1553 bus. The bus is specified by x.

<b>Conditions</b>	Requires option SR-AERO.
<b>Group</b>	Bus
<b>Syntax</b>	<code>BUS:B&lt;x&gt;:MIL1553B:POLarity {NORMal INVERTed}</code> <code>BUS:B&lt;x&gt;:MIL1553B:POLarity?</code>
<b>Arguments</b>	B<x> is the number of the bus.  NORMal specifies normal polarity.  INVERTed specifies inverted polarity.
<b>Examples</b>	<code>BUS:B3:MIL1553B:POLARITY INVERTED</code> sets Bus 3 MIL-STD-1553 polarity to inverted.  <code>BUS:B2:MIL1553B:POLARITY?</code> might return <code>:BUS:B2:MIL1553B:POLARITY NORMAL</code> , indicating that the Bus 2 MIL-STD-1553 polarity is set to normal.

## **BUS:B<x>:MIL1553B:RESPonsetime:MAXimum**

This command sets or queries the maximum response time to a valid command issued for the specified MIL-STD-1553 bus. The bus is specified by x.

<b>Conditions</b>	Requires option SR-AERO.
<b>Group</b>	Bus
<b>Syntax</b>	<code>BUS:B&lt;x&gt;:MIL1553B:RESPonsetime:MAXimum &lt;NR3&gt;</code> <code>BUS:B&lt;x&gt;:MIL1553B:RESPonsetime:MAXimum?</code>

**Related Commands**    [BUS:B<x>:MIL1553B:RESPonsetime:MINimum](#)

**Arguments**    B<x> is the number of the bus.  
  
<NR3> is a floating point number that specifies the maximum response time, in seconds.

**Examples**    `BUS:B1:MIL1553B:RESPONSETIME:MAXIMUM 15.0E-6` specifies the maximum response time to a valid command received to be 15.0 microseconds.  
  
`BUS:B1:MIL1553B:RESPONSETIME:MAXIMUM?` might return  
`:BUS:B1:MIL1553B:RESPONSETIME:MAXIMUM 12.000E-6`, indicating a maximum response time of 12 microseconds.

## **BUS:B<x>:MIL1553B:RESPonsetime:MINimum**

This command sets or queries the minimum response time to a valid command issued for the specified MIL-STD-1553 bus. The bus is specified by x.

**Conditions**    Requires option SR-AERO.

**Group**    Bus

**Syntax**    `BUS:B<x>:MIL1553B:RESPonsetime:MINimum <NR3>`  
`BUS:B<x>:MIL1553B:RESPonsetime:MINimum?`

**Related Commands**    [BUS:B<x>:MIL1553B:RESPonsetime:MAXimum](#)

**Arguments**    <NR3> is a floating point number that specifies the minimum response time, in seconds.

**Examples**    `BUS:B1:MIL1553B:RESPONSETIME:MINIMUM 5.0E-6` specifies the minimum response time to a valid command received to be 5.0 microseconds.  
  
`BUS:B1:MIL1553B:RESPONSETIME:MINIMUM?` might return  
`:BUS:B1:MIL1553B:RESPONSETIME:MINIMUM 4.000E-6`, indicating a minimum response time of 4 microseconds.



## BUS:B<x>:MIL1553B:SOURce

This command sets or queries the source for the specified MIL-STD-1553 bus. The bus is specified by x.

**Conditions** Requires option SR-AERO.

**Group** Bus

**Syntax** BUS:B<x>:MIL1553B:SOURce {S<x>\_Ch<x>|CH<x>|MATH<x>|REF<x>}  
BUS:B<x>:MIL1553B:SOURce?

**Arguments** B<x> is the number of the bus.

S<x>\_Ch<x> specifies the remote scope number and the analog channel.

CH<x> specifies an analog channel as the source waveform for the MIL-STD-1553 bus.

Math<x> specifies a math waveform as the source waveform for the MIL-STD-1553 bus.

REF<x> specifies a reference waveform as the source waveform for the MIL-STD-1553 bus.

**Examples** BUS:B1:MIL1553B:SOURCE CH1 sets channel 1 as the source for the MIL-STD-1553 bus.

BUS:B1:MIL1553B:SOURCE? might return :BUS:B1:MIL1553B:SOURCE MATH2 indicating that the source is set to MATH2.

## BUS:B<x>:MIL1553B:THRESHold

This command sets or queries the MIL-STD-1553 upper threshold for the specified bus. The bus is specified by x.

**Conditions** Requires option SR-AERO.

**Group** Bus

**Syntax** BUS:B<x>:MIL1553B:THRESHold <NR3>  
BUS:B<x>:MIL1553B:THRESHold?

**Related Commands**    [BUS:B<x>:MIL1553B:SOUrce](#)

**Arguments**    B<x> is the number of the bus.  
                   <NR3> is the MIL-STD-1553 upper threshold for the specified bus.

**Examples**    BUS:B3:MIL1553B:THRESHOLD 2.5 sets the Bus 3 MIL-STD-1553 upper threshold to 2.5 V.  
                   BUS:B2:MIL1553B:THRESHOLD? might return  
                   :BUS:B2:MIL1553B:THRESHOLD 500.0000E-3 indicating the Bus 2 MIL-STD-1553 upper threshold is set to 500 mV.

## BUS:B<x>:NRZ:BITOrder

This command sets or queries the NRZ bit order for the specified bus. The bus is specified by x.

**Conditions**    Requires option SRNRZ.

**Group**    Bus

**Syntax**    BUS:B<x>:NRZ:BITOrder {LSB|MSB}  
               BUS:B<x>:NRZ:BITOrder?

**Arguments**    B<x> is the number of the bus.  
                   LSB specifies that each bit becomes the recovered value's new LSB, after shifting previously recovered bits one place to the left. The decoding happens right to left.  
                   MSB specifies that each successive bit from the bus's data line becomes the new MSB of the recovered value, shifting any previously recovered bits one place to the right. The decoding happens left to right.

**Examples**    BUS:B1:NRZ:BITORDER LSB sets each bit order for the NRZ bus B1 to LSB.  
                   BUS:B1:NRZ:BITORDER? might return :BUS:B1:NRZ:BITORDER MSB, indicating that the bit order for the NRZ bus B1 is set to MSB.

## BUS:B<x>:NRZ:BITRate

This command sets or queries the NRZ bus bit rate. The bus number is specified by <x>.

**Conditions** Requires option SRNRZ.

**Group** Bus

**Syntax** `BUS:B<x>:NRZ:BITRate <NR1>`  
`BUS:B<x>:NRZ:BITRate?`

**Arguments** B<x> is the number of the bus.

<NR1> specifies the bit rate for the NRZ bus. Arguments are the available bit rates up to 1 G

Arguments are the available bit rates up to 1 G.

**Examples** `BUS:B1:NRZ:BITRate 4000` sets the bit rate to 4 kb.

`BUS:B1:NRZ:BITRate?` might return `:BUS:B1:NRZ:BITRate 19000`, indicating that the bit rate is set to 19 kb.

## BUS:B<x>:NRZ:POLarity

This command sets or queries the NRZ source polarity for the specified bus. The bus number is specified by x.

**Conditions** Requires option SRNRZ.

**Group** Bus

**Syntax** `BUS:B<x>:NRZ:POLarity {INVerted|NORMal}`  
`BUS:B<x>:NRZ:POLarity?`

**Arguments** B<x> is the number of the bus.

INVerted specifies inverted polarity.

NORMal specifies normal polarity.

**Examples**    `BUS:B1:NRZ:POLarity` Inverted sets the polarity to inverted.  
`BUS:B1:NRZ:POLarity?` might return `:BUS:B1:NRZ:POLARITY NORMAL`, indicating the bus polarity is set to normal.

## **BUS:B<x>:NRZ:SOURce**

This command sets or queries the NRZ source for the specified bus. This command specifies the source channel. The bus is specified by x.

**Conditions**    Requires option SRNRZ.

**Group**        Bus

**Syntax**       `BUS:B<x>:NRZ:SOURce` {`S<x>_Ch<x>` | `CH<x>` | `MATH<x>` | `REF<x>`]  
`BUS:B<x>:NRZ:SOURce?`

**Related Commands**    [BUS:B<x>:NRZ:THReshold](#)

**Arguments**    `B<x>` is the number of the bus.  
`S<x>_Ch<x>` specifies the remote scope number and the analog channel as the source.  
`CH<x>` specifies an analog channel as the source.  
`MATH<x>` specifies a math waveform as the source.  
`REF<x>` specifies a digital reference waveform as the source.

**Examples**    `BUS:B1:NRZ:SOURce` Ch5 sets the source to channel 5.  
`BUS:B1:NRZ:SOURce?` might return `:BUS:B1:NRZ:SOURce CH5`, indicating the source is set to channel 5.

## **BUS:B<x>:NRZ:SPMI:VERsion**

This command sets or queries the Version for the specified bus. The bus number is specified by x.

**Conditions**    Requires option SRPM.

<b>Group</b>	Bus
<b>Syntax</b>	<code>BUS:B&lt;x&gt;:NRZ:SPMI:VERSION {v1 v2}</code> <code>BUS:B&lt;x&gt;:NRZ:SPMI:VERSION?</code>
<b>Arguments</b>	<code>B&lt;x&gt;</code> is the number of the bus. <code>v1</code> specifies version 1. <code>v2</code> specifies version 2.
<b>Examples</b>	<code>BUS:B1:SPMI:VERSION v2</code> sets to version 2. <code>BUS:B1:SPMI:VERSION?</code> might return <code>:BUS:B1:SPMI:VERSION v2</code> , indicating version 2 is set.

## BUS:B<x>:NRZ:THReshold

This command sets or queries the NRZ threshold for the specified bus. The bus number is specified by `x`.

<b>Conditions</b>	Requires option SRNRZ.
<b>Group</b>	Bus
<b>Syntax</b>	<code>BUS:B&lt;x&gt;:NRZ:THReshold &lt;NR3&gt;</code> <code>BUS:B&lt;x&gt;:NRZ:THReshold?</code>
<b>Related Commands</b>	<a href="#">BUS:B&lt;x&gt;:NRZ:SOUrce</a>
<b>Arguments</b>	<code>B&lt;x&gt;</code> is the number of the bus. <code>&lt;NR3&gt;</code> is the NRZ Strobe threshold for the specified bus in volts. The valid range is -8 V to +8 V.
<b>Examples</b>	<code>BUS:B4:NRZ:THReshold 1.0</code> sets the Bus 4 NRZ threshold to 1.0 V. <code>BUS:B3:NRZ:THReshold?</code> might return <code>:BUS:B4:NRZ:THReshold 225.00000E-3</code> , indicating the Bus 3 NRZ threshold is set to 225.0 mV.

## BUS:B<x>:ONEWIRE:DATA:SOURce

This command sets or queries the ONEWIRE source for the specified bus. This command specifies the source channel. The bus is specified by x.

<b>Conditions</b>	Requires option SR-ONEWIRE.
<b>Group</b>	Bus
<b>Syntax</b>	BUS:B<x>:ONEWIRE:DATA:SOURce {S<x>_Ch<x> CH<x> MATH<x> REF<x>} BUS:B<x>:ONEWIRE:DATA:SOURce?
<b>Related Commands</b>	<a href="#">BUS:B&lt;x&gt;:NRZ:THReshold</a>
<b>Arguments</b>	B<x> is the number of the bus.  S<x>_Ch<x> specifies the remote scope number and the analog channel as the source.  CH<x> specifies an analog channel as the source.  MATH<x> specifies a math waveform as the source.  REF<x> specifies a digital reference waveform as the source.
<b>Examples</b>	BUS:B1:ONEWIRE:DATA:SOURce Ch5 sets the source to channel 5.  BUS:B1:ONEWIRE:DATA:SOURce? might return :ONEWIRE:DATA:SOURce CH5, indicating the source is set to channel 5.

## BUS:B<x>:ONEWIRE:DATA:THReshold

This command sets or queries the ONEWIRE data source threshold for the specified bus. The bus number is specified by x.

<b>Conditions</b>	Requires option SR-ONEWIRE.
<b>Group</b>	Bus
<b>Syntax</b>	BUS:B<x>:ONEWIRE:DATA:THReshold <NR3> BUS:B<x>:ONEWIRE:DATA:THReshold?

**Related Commands** [BUS:B<x>:NRZ:SOUrce](#)

**Arguments** B<x> is the number of the bus.  
 <NR3> is the ONEWIRE Strobe threshold for the specified bus in volts. The valid range is -8 V to +8 V. The default value is 1.25 V.

**Examples** `BUS:B4:ONEWIRE:DATA:THResho1d 1.0` sets the Bus 4 ONEWIRE threshold to 1.0 V.  
`BUS:B3:ONEWIRE:DATA:THResho1d?` might return `:BUS:B4:ONEWIRE:DATA:THResho1d 225.00000E-3`, indicating the Bus 3 ONEWIRE threshold is set to 225.0 mV.

## BUS:B<x>:ONEWIRE:MODE

This command sets or queries the mode for the specified ONEWIRE bus. The bus number is specified by x.

**Conditions** Requires option SR-ONEWIRE.

**Group** Bus

**Syntax** `BUS:B<x>:ONEWIRE:MODE {STANDARD|OVERdrive}`  
`BUS:B<x>:ONEWIRE:MODE?`

**Arguments** B<x> is the number of the bus.  
 STANDARD specifies the mode as standard. Standard is the default mode whose value is 15.4 kbs.  
 OVERdrive specifies the mode as overdrive.

**Examples** `BUS:B1:ONEWIRE:MODE OVERdrive` sets the mode to 125 kbps.  
`BUS:B1:ONEWIRE:MODE?` might return `:BUS:B1:ONEWIRE:MODE OVERdrive`, indicating that the mode is 125 kbps.

## BUS:B<x>:PARAllel:ALLTHResholds

This command sets or queries a threshold value for sources for the parallel bus. Use the [BUS:B<x>:PARAllel:ALLTHResholds:APPLY](#) command to set the thresholds to this value. The bus is specified by x.

**Group** Bus

**Syntax** `BUS:B<x>:PARAllel:ALLTHResholds <NR3>`

**Related Commands** [BUS:B<x>:PARAllel:ALLTHResholds:APPLY](#)

**Arguments** B<x> is the number of the bus.  
<NR3> is the source threshold.

**Examples** `BUS:B4:PARALLEL:ALLTHRESHOLDS 1.0` sets the threshold of all the sources in parallel Bus 4 to 1.0 V.  
`BUS:B3:PARALLEL:ALLTHRESHOLDS?` might return  
`BUS:B3:PARALLEL:ALLTHRESHOLDS 500.00000E-3` indicates the threshold for all sources in parallel Bus 3 is currently set to 500.0 mV.

## BUS:B<x>:PARAllel:ALLTHResholds:APPLY (No Query Form)

This command sets all of the data source thresholds to the value set by [BUS:B<x>:PARAllel:ALLTHResholds](#) for the parallel bus. The bus is specified by x.

**Group** Bus

**Syntax** `BUS:B<x>:PARAllel:ALLTHResholds:APPLY`

**Related Commands** [BUS:B<x>:PARAllel:ALLTHResholds](#)

**Examples** `BUS:B1:PARAllel:ALLTHResholds:APPLY` sets all data source thresholds to the value set by [BUS:B<x>:PARAllel:ALLTHResholds](#).



## BUS:B<x>:PARAllel:BIT<n>SOURce

This command sets or queries the specified bit source for specified parallel bus. The bus is specified by x. The bit is specified by n and is an integer in the range of 1 to 64.

**Group** Bus

**Syntax** `BUS:B<x>:PARAllel:BIT<n>SOURce`  
`{S<x>_Ch<x>_D<x>|CH<x>|CH<x>_D<x>|MATH<x>|REF<x>|REF<x>_D<x>|NONE}`

**Related Commands** [BUS:B<x>:PARAllel:BIT<n>SOURce:THReshold](#)

**Arguments** B<x> is the number of the bus.

S<x>\_Ch<x>\_D<x> specifies the remote scope number, the analog channel and the digital channel as the source.

CH<x> is the specified bit source.

CH<x>\_D<x> is the specified bit source.

MATH<x> is the specified bit source.

REF<x> is the specified bit source.

REF<x>\_D<x> specifies a digital reference waveform as the bit<x> source waveform for the specified parallel bus.

NONE disables the bit source.

**Examples** `BUS:B1:PARAllel:BIT1SOURce CH1` sets the bit 1 source to channel 1.

`BUS:B1:PARAllel:BIT1SOURce?` might return  
`:BUS:B1:PARALLEL:BIT1SOURCE CH1_D0` indicating the bit1 source is CH1\_D0.

## BUS:B<x>:PARAllel:BIT<n>SOURce:THReshold

This command sets or queries the specified bit source threshold for the specified parallel bus. The bus is specified by x. The bit is specified by n and is an integer in the range of 1 to 64.

**Group** Bus

<b>Syntax</b>	<code>BUS:B&lt;x&gt;:PARAllel:BIT&lt;n&gt;SOURce:THResho1d &lt;NR3&gt;</code>
<b>Related Commands</b>	<a href="#">BUS:B&lt;x&gt;:PARAllel:BIT&lt;n&gt;SOURce</a>
<b>Arguments</b>	<p><code>B&lt;x&gt;</code> is the number of the bus.</p> <p><code>&lt;NR3&gt;</code> is the specified bit source threshold for the specified parallel bus.</p>
<b>Examples</b>	<p><code>BUS:B3:PARALLEL:BIT2SOURCE:THRESHOLD 1.0</code> sets the threshold of bit source 2 of parallel Bus 3 to 1.0 V.</p> <p><code>BUS:B1:PARALLEL:BIT4SOURCE:THRESHOLD?</code> might return  <code>:BUS:B1:PARALLEL:BIT4SOURCE:THRESHOLD 250.00000E-3</code> indicates the threshold of bit source 4 of parallel Bus 1 is currently set to 250.0 mV.</p>

## BUS:B<x>:PARAllel:CLOCK:EDGE

This command sets or queries the clock edge for the parallel bus. The bus is specified by x.

<b>Group</b>	Bus
<b>Syntax</b>	<code>BUS:B&lt;x&gt;:PARAllel:CLOCK:EDGE {FALLING RISING EITHER}</code> <code>BUS:B&lt;x&gt;:PARAllel:CLOCK:EDGE?</code>
<b>Related Commands</b>	<a href="#">BUS:B&lt;x&gt;:PARAllel:CLOCK:SOURce</a>
<b>Arguments</b>	<p><code>B&lt;x&gt;</code> is the number of the bus.</p> <p><code>FALLING</code> decodes on the falling edge of the clocked parallel bus signal.</p> <p><code>RISING</code> decodes on the rising edge of the clocked parallel bus signal.</p> <p><code>EITHER</code> decodes on the rising or falling edge of the clocked parallel bus signal.</p>
<b>Examples</b>	<p><code>BUS:B1:PARALLEL:CLOCK:EDGE FALLING</code> sets the decoding to happen on the falling edge of its clocked parallel bus B1.</p> <p><code>BUS:B1:PARALLEL:CLOCK:EDGE?</code> might return  <code>:BUS:B1:PARALLEL:CLOCK:EDGE RISING</code>, indicating that when bus B1 operates in Clocked Parallel mode, it samples new data values on the rising edge of its clock source signal.</p>

## BUS:B<x>:PARAllel:CLOCK:ISCLOCKED

This command determines whether the bus operates in a clocked or asynchronous fashion. The bus is specified by x.

<b>Group</b>	Bus
<b>Syntax</b>	BUS:B<x>:PARAllel:CLOCK:ISCLOCKED {OFF ON NR1} BUS:B<x>:PARAllel:CLOCK:ISCLOCKED?
<b>Arguments</b>	B<x> is the number of the bus.  OFF argument specifies an asynchronous bus.  ON argument specifies a clocked bus.  <NR1> = 0 specifies an asynchronous bus; any other value specifies a clocked bus.
<b>Examples</b>	BUS:B1:PARAllel:CLOCK:ISCLOCKED 0 sets the bus to operate asynchronously.  BUS:B1:PARAllel:CLOCK:ISCLOCKED? might return :BUS:B1:PARALLEL:CLOCK:ISCLOCKED 1 indicating the bus is clocked.

## BUS:B<x>:PARAllel:CLOCKSOURCE

This command sets or queries the Parallel clock bit source for the specified bus. The bus is specified by x.

<b>Group</b>	Bus
<b>Syntax</b>	BUS:B<x>:PARAllel:CLOCKSOURCE {S<x>_Ch<x>_D<x> CH<x> CH<x>_D<x> MATH<x> REF<x> REF<x>_D<x> NONE} BUS:B<x>:PARAllel:CLOCKSOURCE?
<b>Related Commands</b>	<a href="#">BUS:B&lt;x&gt;:PARAllel:CLOCK:ISCLOCKED</a>
<b>Arguments</b>	B<x> is the number of the bus.  S<x>_Ch<x>_D<x> specifies the remote scope number, the analog channel and the digital channel as the source.

CH<x> specifies an analog FlexChannel to use as the bus clock source.

CH<x>\_D<x> specifies a digital channel on a specified FlexChannel to use as the bus clock source.

MATH<x> specifies the math channel to use as the bus clock source.

REF<x> specifies the reference channel to use as the bus clock source.

REF<x>\_D<x> specifies a digital reference waveform as the clock source waveform for the specified parallel bus.

NONE specifies the reference channel to use as the bus clock source.

**Examples**    `BUS:B1:PARALLEL:CLOCK:SOURCE CH3_D6` sets the Parallel clock source for the bus B1 to D6 of FlexChannel 3.

`BUS:B1:PARALLEL:CLOCK:SOURCE?` might return  
`:BUS:B1:PARALLEL:CLOCK:SOURCE CH8_D9`, indicating that the Parallel clock source for the bus B1 is set to D9 of FlexChannel 8.

## BUS:B<x>:PARALLEL:CLOCKSOURCE:THRESHOLD

This command sets or queries the clock source threshold for the parallel bus. The bus is specified by x.

**Group**    Bus

**Syntax**    `BUS:B<x>:PARALLEL:CLOCKSOURCE:THRESHOLD <NR3>`  
`BUS:B<x>:PARALLEL:CLOCKSOURCE:THRESHOLD?`

**Related Commands**    [BUS:B<x>:PARALLEL:CLOCK:ISCLOCKED](#)

**Arguments**    <NR3> is the clock bit source threshold for the parallel bus.

**Examples**    `BUS:B4:PARALLEL:CLOCKSOURCE:THRESHOLD 1.5` sets the threshold of the clock source of parallel Bus 4 to 1.5 V.

`BUS:B3:PARALLEL:CLOCKSOURCE:THRESHOLD?` might return  
`:BUS:B3:PARALLEL:CLOCKSOURCE:THRESHOLD 750.00000E-3` indicates the threshold of the clock source of parallel Bus 3 is currently set to 750.0 mV.

## BUS:B<x>:PSIFIVE:BITPERiod

This command sets or queries the PSI5 Bit period bus parameter.

<b>Conditions</b>	Requires option SR-PSI5
<b>Group</b>	Bus
<b>Syntax</b>	BUS:B<x>:PSIFIVE:BITPERiod <NR1> BUS:B<x>:PSIFIVE:BITPERiod?
<b>Arguments</b>	B<x> is the number of the bus.  <NR1> specifies the bit period. The default bit period is 60 Micro seconds.
<b>Examples</b>	BUS:B1:PSIFIVE:BITPERiod 0.000060 sets the bit period to 60 $\mu$ s.  BUS:B1:PSIFIVE:BITPERiod? might return :BUS:B1:PSIFIVE:BITPERiod 0.000120, indicating that the bit rate is set to 120 $\mu$ s.

## BUS:B<x>:PSIFIVE:BITRate

This command sets or queries the PSI5 bitrate.

<b>Conditions</b>	Requires option SR-PSI5
<b>Group</b>	Bus
<b>Syntax</b>	BUS:B<x>:PSIFIVE:BITRate {RATE125K RATE189K RATE83K} BUS:B<x>:PSIFIVE:BITRate?
<b>Arguments</b>	B<x> is the number of the bus.  Arguments are the available bit rates.
<b>Examples</b>	BUS:B1:PSIFIVE:BITRate RATE125k sets the bit rate to 125 kb.  BUS:B1:PSIFIVE:BITRate? might return :BUS:B1:PSIFIVE:BITRATE RATE189K, indicating that the bit rate is set to 189 kb.

## BUS:B<x>:PSIFIVE:COMM:DIRection

This command sets or queries the PSI5 bus communication direction. Communication direction by default is set to Sensor to ECU.

<b>Conditions</b>	Requires option SR-PSI5
<b>Group</b>	Bus
<b>Syntax</b>	BUS:B<x>:PSIFIVE:COMM:DIRection {SENSORECU ECUSENSor} BUS:B<x>:PSIFIVE:COMM:DIRection?
<b>Arguments</b>	B<x> is the number of the bus.  SENSORECU specifies the communication direction to Sensor to ECU. This is the default value.  ECUSENSor specifies the communication direction to ECU to Sensor.
<b>Examples</b>	BUS:B1:PSIFIVE:COMM:DIRection SENSORECU sets the communication direction to Sensor to ECU.  BUS:B1:PSIFIVE:COMM:DIRection? might return :BUS:B1:PSIFIVE:COMM:DIRection ECUSENSor, indicating that the communication direction is ECU to Sensor .

## BUS:B<x>:PSIFIVE:DATAA

This command sets or queries the PSI5 frame mandatory data region A.

<b>Conditions</b>	Requires option SR-PSI5
<b>Group</b>	Bus
<b>Syntax</b>	BUS:B<x>:PSIFIVE:DATAA <NR1> BUS:B<x>:PSIFIVE:DATAA?
<b>Arguments</b>	B<x> is the number of the bus.  <NR1> specifies the dataA value in bits. The default dataA value is 10 bits, otherwise it ranges between 10 to 24 bits.

**Examples**    `BUS:B1:PSIFIVE:DATAA 17` sets the dataA as 17 bits.  
                   `BUS:B1:PSIFIVE:DATAA?` might return `:BUS:B1:PSIFIVE:DATAA 10`,  
                   indicating that the dataA is 10 bits.

## **BUS:B<x>:PSIFIVE:DATAB**

This command sets or queries the PSI5 frame optional bits of data region B.

**Conditions**    Requires option SR-PSI5

**Group**        Bus

**Syntax**        `BUS:B<x>:PSIFIVE:DATAB <NR1>`  
                   `BUS:B<x>:PSIFIVE:DATAB?`

**Arguments**    `B<x>` is the number of the bus.  
                   `<NR1>` specifies the dataA value in bits. The default dataB value is 0 bits,  
                   otherwise it ranges between 0 to 12 bits.

**Examples**        `BUS:B1:PSIFIVE:DATAB 7` sets the dataB as 7 bits.  
                   `BUS:B1:PSIFIVE:DATAB?` might return `:BUS:B1:PSIFIVE:DATAB 0`,  
                   indicating that the dataB is 0 bits.

## **BUS:B<x>:PSIFIVE:DATAFORMat**

This command sets or queries the data format in PSI5 Frame2 packet.

**Conditions**    Requires option SR-PSI5

**Group**        Bus

**Syntax**        `BUS:B<x>:PSIFIVE:DATAFORMat {NIBBLE|BYTE}`  
                   `BUS:B<x>:PSIFIVE:DATAFORMat?`

**Arguments**    `B<x>` is the number of the bus.  
                   `NIBBLE` specifies the data format as Nibble.

BYTe specifies the data format as Byte.

**Examples**    `BUS:B1:PSIFIVE:DATAFORMat NIBBLE` sets the data format to Nibble.  
`BUS:B1:PSIFIVE:DATAFORMat?` might return  
`:BUS:B1:PSIFIVE:DATAFORMat BYTE`, indicating that the data format is Byte.

## **BUS:B<x>:PSIFIVE:ECUSOURce**

This command sets or queries the ECU to sensor source channel for the specified Bus.

**Conditions**    Requires option SR-PSI5

**Group**        Bus

**Syntax**        `BUS:B<x>:PSIFIVE:ECUSOURce {S<x>_Ch<x>|CH<x>|MATH<x>|REF<x>}`  
`BUS:B<x>:PSIFIVE:ECUSOURce?`

**Arguments**    `B<x>` is the number of the bus.  
`S<x>_Ch<x>` specifies the remote scope number and the analog channel.  
`CH<x>` specifies an analog channel as the source.  
`MATH<x>` specifies a math waveform as the source.  
`REF<x>` specifies a digital reference waveform as the source.

**Examples**        `BUS:B1:PSIFIVE:ECUSOURce CH5` sets the source to channel 5.  
`BUS:B1:PSIFIVE:ECUSOURce?` might return `:BUS:B1:PSIFIVE:ECUSOURce CH5`, indicating the source is set to channel 5.

## **BUS:B<x>:PSIFIVE:FRAMECONTRol**

This command sets or queries the PSI5 frame optional control bits.

**Conditions**    Requires option SR-PSI5

**Group**        Bus



<b>Syntax</b>	<code>BUS:B&lt;x&gt;:PSIFIVE:FRAMECONTRol &lt;NR1&gt;</code> <code>BUS:B&lt;x&gt;:PSIFIVE:FRAMECONTRol?</code>
<b>Arguments</b>	<code>B&lt;x&gt;</code> is the number of the bus.  <code>&lt;NR1&gt;</code> specifies the frame control value in bits. The default frame control value is 0 bits, otherwise it ranges between 0 to 4 bits.
<b>Examples</b>	<code>BUS:B1:PSIFIVE:FRAMECONTRol 2</code> sets the frame control as 2 bits.  <code>BUS:B1:PSIFIVE:FRAMECONTRol?</code> might return <code>:BUS:B1:PSIFIVE:FRAMECONTRol 3</code> , indicating that the frame control is 3 bits.

## BUS:B<x>:PSIFIVE:MESSaging

This command sets or queries the PSI5 optional messaging bits.

<b>Conditions</b>	Requires option SR-PSI5
<b>Group</b>	Bus
<b>Syntax</b>	<code>BUS:B&lt;x&gt;:PSIFIVE:MESSaging {OFF ON}</code> <code>BUS:B&lt;x&gt;:PSIFIVE:MESSaging?</code>
<b>Arguments</b>	<code>B&lt;x&gt;</code> is the number of the bus.  OFF specifies the messaging bits as the default value of 0.  ON specifies the messaging bits as 2.
<b>Examples</b>	<code>BUS:B1:PSIFIVE:MESSaging OFF</code> sets the messaging bits as 0.  <code>BUS:B1:PSIFIVE:MESSaging?</code> might return <code>:BUS:B1:PSIFIVE:MESSaging ON</code> , indicating that the messaging bits are 2.

## BUS:B<x>:PSIFIVE:SOUrce

This command sets or queries serial channel on or off.

<b>Conditions</b>	Requires option SR-PSI5
-------------------	-------------------------

<b>Group</b>	Bus
<b>Syntax</b>	BUS:B<x>:PSIFIVE:SOURce {S<x>_Ch<x> CH<x> MATH<x> REF<x>} BUS:B<x>:PSIFIVE:SOURce?
<b>Arguments</b>	B<x> is the number of the bus. S<x>_Ch<x> specifies the remote scope number and the analog channel. CH<x> specifies an analog channel as the source. MATH<x> specifies a math waveform as the source. REF<x> specifies a digital reference waveform as the source.
<b>Examples</b>	BUS:B1:PSIFIVE:SOURce CH5 sets the source to channel 5. BUS:B1:PSIFIVE:SOURce? might return :BUS:B1:PSIFIVE:SOURce CH5, indicating the source is set to channel 5.

## BUS:B<x>:PSIFIVE:STATUs

This command sets or queries the optional status bits of PSI5.

<b>Conditions</b>	Requires option SR-PSI5
<b>Group</b>	Bus
<b>Syntax</b>	BUS:B<x>:PSIFIVE:STATUs <NR1> BUS:B<x>:PSIFIVE:STATUs?
<b>Arguments</b>	B<x> is the number of the bus. <NR1> specifies the status value in bits. The default status value is 0 bits, otherwise it ranges between 0 to 2 bits.
<b>Examples</b>	BUS:B1:PSIFIVE:STATUs 2 sets the status as 2 bits. BUS:B1:PSIFIVE:STATUs? might return :BUS:B1:PSIFIVE:STATUs 0, indicating that the status is 0 bits.

**BUS:B<x>:PSIFIVE:SYNCMODE**

This command sets or queries the PSI5 Sync Mode.

<b>Conditions</b>	Requires option SR-PSI5
<b>Group</b>	Bus
<b>Syntax</b>	<code>BUS:B&lt;x&gt;:PSIFIVE:SYNCMODE {PULSEWIDTH TOOTHGAP}</code> <code>BUS:B&lt;x&gt;:PSIFIVE:SYNCMODE?</code>
<b>Arguments</b>	<code>B&lt;x&gt;</code> is the number of the bus.  <code>PULSEWIDTH</code> specifies the Sync Mode as Pulse Width.  <code>TOOTHGAP</code> specifies the Sync Mode as Tooth Gap.
<b>Examples</b>	<code>BUS:B1:PSIFIVE:SYNCMODE PULSEWIDTH</code> sets the Sync Mode to Pulse Width.  <code>BUS:B1:PSIFIVE:SYNCMODE?</code> might return <code>:BUS:B1:PSIFIVE:SYNCMODE TOOTHGAP</code> , indicating that the Sync Mode is Tooth Gap.

**BUS:B<x>:PSIFIVE:SYNCTHRESHold**

This command sets or queries the PSI5 threshold for the ECU To Sensor specified bus.

<b>Conditions</b>	Requires option SR-PSI5
<b>Group</b>	Bus
<b>Syntax</b>	<code>BUS:B&lt;x&gt;:PSIFIVE:SYNCTHRESHold &lt;NR3&gt;</code> <code>BUS:B&lt;x&gt;:PSIFIVE:SYNCTHRESHold?</code>
<b>Arguments</b>	<code>B&lt;x&gt;</code> is the number of the bus.  <code>&lt;NR3&gt;</code> specifies the PSI5 Strobe threshold for the specified bus. The threshold range is -8 V to +8 V.

**Examples**    `BUS:B1:PSIFIVE:SYNCTHRESHo1d 1.0` sets the bus 4 PSI5 threshold to 1.0 V.  
`BUS:B1:PSIFIVE:SYNCTHRESHo1d?` might return  
`:BUS:B1:PSIFIVE:SYNCTHRESHo1d 225.00000E-3`, indicating the bus 3  
PSIFIVE threshold is set to 225.0 mV.

## **BUS:B<x>:PSIFIVE:THRESHo1d**

This command sets or queries the PSI5 threshold for the Sensor To ECU specified bus.

**Conditions**    Requires option SR-PSI5

**Group**        Bus

**Syntax**        `BUS:B<x>:PSIFIVE:THRESHo1d <NR3>`  
`BUS:B<x>:PSIFIVE:THRESHo1d?`

**Arguments**    `B<x>` is the number of the bus.  
  
`<NR3>` specifies the PSI5 Strobe threshold for the specified bus. The threshold range is -8 V to +8 V.

**Examples**    `BUS:B1:PSIFIVE:THRESHo1d 1.0` sets the bus 4 PSI5 threshold to 1.0 V.  
`BUS:B1:PSIFIVE:THRESHo1d?` might return `:BUS:B1:PSIFIVE:THRESHo1d 225.00000E-3`, indicating the bus 4 PSI5 threshold is set to 225.0 mV.

## **BUS:B<x>:RS232C:BITRate**

This command sets or queries the RS-232C bit rate for bus<x>, where the bus number is specified by x. If you select Custom, use [BUS:B<x>:RS232C:BITRate:CUSTom](#) to set the bit rate.

**Conditions**    Requires option SR-COMP.

**Group**        Bus

**Syntax**        `BUS:B<x>:RS232C:BITRate`  
`{CUSTOM|RATE300|RATE1K|RATE2K|RATE9K|`  
`RATE19K|RATE38K|RATE115K|RATE921K}`

**BUS:B<x>:RS232C:BITRate?**

- Arguments** B<x> is the number of the bus.  
Arguments are the available bit rates.
- Examples** **BUS:B1:RS232C:BITRATE RATE9K** sets the bit rate for the RS-232C bus B1 to 9000 bits-per-second.  
**BUS:B1:RS232C:BITRATE?** might return **:BUS:B1:RS232C:BITRATE 9000**, indicating that the bit rate for the RS-232C bus B1 is set to 9000 bits-per-second.

## **BUS:B<x>:RS232C:BITRate:CUSTom**

This command sets or queries the RS-232C custom bit rate for the specified bus. The bus is specified by x.

- Conditions** Requires option SR-COMP.
- Group** Bus
- Syntax** **BUS:B<x>:RS232C:BITRate:CUSTom <NR1>**  
**BUS:B<x>:RS232C:BITRate:CUSTom?**

**Related Commands** [BUS:B<x>:RS232C:BITRate](#)

- Arguments** B<x> is the number of the bus.  
<NR1> is the custom bit rate.
- Examples** **BUS:B1:RS232C:BITRATE:CUSTOM 9500** sets the bit rate for the RS-232C bus B1 to 9500 bits-per-second.  
**BUS:B1:RS232C:BITRATE:CUSTOM?** might return **:BUS:B1:RS232C:BITRATE:CUSTOM 9500**, indicating that the bit rate for the RS-232C bus B1 is set to 9500 bits-per-second.

## **BUS:B<x>:RS232C:DATABits**

This command sets or queries the RS-232C data width for bus<x>, where the bus number is specified by x.

<b>Conditions</b>	Requires option SR-COMP.
<b>Group</b>	Bus
<b>Syntax</b>	BUS:B<x>:RS232C:DATAbits {7 8 9} BUS:B<x>:RS232C:DATAbits?
<b>Arguments</b>	B<x> is the number of the bus.  <NR1> specifies the number of bits in the RS-232C data frame.
<b>Examples</b>	BUS:B1:RS232C:DATABITS 8 sets the data bits to 8 for the RS-232C bus B1.  BUS:B5:RS232C:DATABITS? might return :BUS:B1:RS232C:DATABITS 7, indicating that the data bits is set to 7 for the RS-232C bus B5.

## BUS:B<x>:RS232C:DELIMiter

This command sets or queries the RS-232C string delimiter on bus <x>, where the bus number is specified by x. This command only applies when Packet view is turned On.

<b>Conditions</b>	Requires option SR-COMP.
<b>Group</b>	Bus
<b>Syntax</b>	BUS:B<x>:RS232C:DELIMiter {NUL CR LF SPace XFF} BUS:B<x>:RS232C:DELIMiter?
<b>Related Commands</b>	<a href="#">BUS:B&lt;x&gt;:RS232C:DISplaymode</a>
<b>Arguments</b>	B<x> is the number of the bus.  NUL specifies NULL (0x00 ) delimiting value for a packet.  CR specifies CR (0x0D) delimiting value for a packet.  LF specifies LF (0x0A) delimiting value for a packet.  XFF specifies XFF (0xFF) delimiting value for a packet.  SPace specifies SPace delimiting value for a packet.

**Examples** `BUS:B1:RS232C:DELIMITER LF` sets the delimiter to 0x0A for the RS-232C bus B1.

`BUS:B1:RS232C:DELIMITER?` might return `:BUS:B1:RS232C:DELIMITER NULL`, indicating that the delimiter is 0x00 for the RS-232C bus B1.

## BUS:B<x>:RS232C:DISplaymode

This command sets or queries the RS-232C display mode for the specified bus. The bus is specified by x.

**Conditions** Requires option SR-COMP.

**Group** Bus

**Syntax** `BUS:B<x>:RS232C:DISplaymode {FRame|PACKET}`  
`BUS:B<x>:RS232C:DISplaymode?`

**Related Commands** [BUS:B<x>:RS232C:DELIMiter](#)

**Arguments** B<x> is the number of the bus.

FRame displays each frame as a single entity.

PACKET displays a group of frames terminated with a single frame defined by the `BUS:B<x>:RS232C:DELIMiter` command.

**Examples** `BUS:B1:RS232C:DISPLAYMODE FRAME` sets the display mode for the RS-232C bus B1 to Frame.

`BUS:B1:RS232C:DISPLAYMODE?` might return `:BUS:B1:RS232C:DISPLAYMODE PACKET`, indicating that the display mode for the RS-232C bus B1 is set to Packet.

## BUS:B<x>:RS232C:PARity

This command sets or queries the RS-232C parity for bus <x>, where the bus number is specified by x.

**Conditions** Requires option SR-COMP.

<b>Group</b>	Bus
<b>Syntax</b>	<code>BUS:B&lt;x&gt;:RS232C:PARity {NONE EVEN ODD}</code> <code>BUS:B&lt;x&gt;:RS232C:PARity?</code>
<b>Arguments</b>	<p><code>B&lt;x&gt;</code> is the number of the bus.</p> <p><code>NONE</code> specifies no parity.</p> <p><code>EVEN</code> specifies even parity.</p> <p><code>ODD</code> specifies odd parity.</p>
<b>Examples</b>	<p><code>BUS:B1:RS232C:PARITY ODD</code> sets the parity for the RS-232C bus B1 to odd.</p> <p><code>BUS:B1:RS232C:PARITY?</code> might return <code>:BUS:B1:RS232C:PARITY NONE</code>, indicating that the display mode for the RS-232C bus B1 is set to none.</p>

## **BUS:B<x>:RS232C:POLarity**

This command sets or queries the RS-232C source polarity for bus <x>, where the bus number is specified by x.

<b>Conditions</b>	Requires option SR-COMP.
<b>Group</b>	Bus
<b>Syntax</b>	<code>BUS:B&lt;x&gt;:RS232C:POLarity {NORma1 INVERTed}</code> <code>BUS:B&lt;x&gt;:RS232C:POLarity?</code>
<b>Arguments</b>	<p><code>B&lt;x&gt;</code> is the number of the bus.</p> <p><code>NORma1</code> sets the RS-232C bus polarity to positive.</p> <p><code>INVERTed</code> sets the RS-232C bus polarity to negative.</p>
<b>Examples</b>	<p><code>BUS:B1:RS232C:POLARITY INVERTed</code> sets the polarity for the RS-232C bus B1 to Inverted.</p> <p><code>BUS:B1:RS232C:POLARITY?</code> might return <code>:BUS:B1:RS232C:POLARITY NORMAL</code>, indicating that the polarity for the RS-232C bus B1 is set to Normal.</p>



## BUS:B<x>:RS232C:SOURce

This command sets or queries the RS-232C source for bus <x>, where the bus number is specified by x.

<b>Conditions</b>	Requires option SR-COMP.
<b>Group</b>	Bus
<b>Syntax</b>	<pre>BUS:B&lt;x&gt;:RS232C:SOURce {S&lt;x&gt;_Ch&lt;x&gt;_D&lt;x&gt; CH&lt;x&gt; CH&lt;x&gt;_D&lt;x&gt; REF&lt;x&gt; MATH&lt;x&gt; REF&lt;x&gt;_D&lt;x&gt;} BUS:B&lt;x&gt;:RS232C:SOURce?</pre>
<b>Arguments</b>	<p>B&lt;x&gt; is the number of the bus.</p> <p>S&lt;x&gt;_Ch&lt;x&gt;_D&lt;x&gt; specifies the remote scope number, the analog channel and the digital channel as the source.</p> <p>CH&lt;x&gt; specifies an analog channel to use as the RS-232C source.</p> <p>CH&lt;x&gt;_D&lt;x&gt; specifies a digital channel of a specified FlexChannel to use for the RS-232C source.</p> <p>MATH&lt;x&gt; specifies a math channel to use for the RS-232C source.</p> <p>REF&lt;x&gt; specifies a reference channel to use for the RS-232C source.</p> <p>REF&lt;x&gt;_D&lt;x&gt; specifies a digital reference waveform as the source waveform for the specified RS-232C bus.</p>
<b>Examples</b>	<pre>BUS:B1:RS232C:SOURCE CH1_D0</pre> sets the source for the RS-232C bus B1 to D0 of FlexChannel 1. <p><pre>BUS:B1:RS232C:SOURCE?</pre> might return <pre>:BUS:B1:RS232C:SOURCE CH1</pre>, indicating that the source for the RS-232C bus B1 is CH1.</p>

## BUS:B<x>:RS232C:SOURce:THReshold

This command sets or queries the RS-232C source threshold for the specified bus. The bus is specified by x.

<b>Conditions</b>	Requires option SR-COMP.
<b>Group</b>	Bus

**Syntax**    `BUS:B<x>:RS232C:SOURce:THResho1d <NR3>`  
`BUS:B<x>:RS232C:SOURce:THResho1d?`

**Arguments**    `B<x>` is the number of the bus.  
  
`<NR3>` is the RS-232C source threshold for the specified bus.

**Examples**    `BUS:B1:RS232C:SOURCE:THRESHOLD 50.0e-3` sets the threshold to 50 mV.  
  
`BUS:B1:RS232C:SOURCE:THRESHOLD?` might return  
`:BUS:B1:RS232C:SOURCE:THRESHOLD 0.0E+0` indicating the threshold  
is set to 0.0 V.

## **BUS:B<x>:S8B10B:BITRate**

This command sets or queries the 8B10b bit rate for the specified bus, where the bus is specified by x.

**Conditions**    Requires option SR8B10b.

**Group**    Bus

**Syntax**    `BUS:B<x>:S8B10B:BITRate <NR1>`  
`BUS:B<x>:S8B10B:BITRate?`

**Arguments**    `B<x>` is the number of the bus.  
  
`<NR1>` sets the bit rate for the specified bus. Arguments are the available bit rates up to 1 Tbps.

**Examples**    `BUS:B1:S8B10B:BITRate 4000` sets the bit rate to 4 kb.  
  
`BUS:B1:S8B10B:BITRate?` might return `:BUS:B1:S8B10B:BITRATE 19000`,  
which indicates that the bit rate is set to 19 kb.

## **BUS:B<x>:S8B10B:SOURce**

This command sets or queries the 8B10b source for the specified bus, where the bus is specified by x. This command specifies the source channel.

**Conditions**    Requires option SR8B10b.

<b>Group</b>	Bus
<b>Syntax</b>	<code>BUS:B&lt;x&gt;:S8B10B:SOURce {S&lt;x&gt;_Ch&lt;x&gt; CH&lt;x&gt; MATH&lt;x&gt; REF&lt;x&gt;}</code> <code>BUS:B&lt;x&gt;:S8B10B:SOURce?</code>
<b>Related Commands</b>	<a href="#">BUS:B&lt;x&gt;:S8B10B:THReshold</a>
<b>Arguments</b>	<p>B&lt;x&gt; is the number of the bus.</p> <p>S&lt;x&gt;_Ch&lt;x&gt; specifies the remote scope number and the analog channel.</p> <p>CH&lt;x&gt; specifies an analog channel as the source.</p> <p>MATH&lt;x&gt; specifies a math waveform as the source.</p> <p>REF&lt;x&gt; specifies a digital reference waveform as the source.</p>
<b>Examples</b>	<p><code>BUS:B1:S8B10B:SOURce Ch5</code> sets the source to channel 5.</p> <p><code>BUS:B1:S8B10B:SOURce?</code> might return <code>:BUS:B1:S8B10B:SOURce CH5</code>, indicating the source is set to channel 5.</p>

## BUS:B<x>:S8B10B:THReshold

This command sets or queries the 8B10b threshold for the specified bus, where the bus is specified by x.

<b>Conditions</b>	Requires option SR8B10b.
<b>Group</b>	Bus
<b>Syntax</b>	<code>BUS:B&lt;x&gt;:S8B10B:THReshold &lt;NR3&gt;</code> <code>BUS:B&lt;x&gt;:S8B10B:THReshold?</code>
<b>Related Commands</b>	<a href="#">BUS:B&lt;x&gt;:S8B10B:SOURce</a>
<b>Arguments</b>	<p>B&lt;x&gt; is the number of the bus.</p> <p>&lt;NR3&gt; is the 8B10b Strobe threshold for the specified bus in volts. The valid range is -8V to +8V.</p>

**Examples** `BUS:B4:S8B10B:THResho1d 1.0` sets Bus 4 8B10b threshold to 1.0 V.  
`BUS:B3:S8B10B:THResho1d?` might return `:BUS:B3:S8B10B:THResho1d 225.00000E-3` indicates the Bus 3 8B10b threshold is set to 225.0 mV.

## **BUS:B<x>:SDLC:BITRate**

This command sets or queries the bit rate for the specified SDLC bus. The bus is specified by x.

**Conditions** Requires option SR-SDLC.

**Group** Bus

**Syntax** `BUS:B<x>:SDLC:BITRate <NR1>`  
`BUS:B<x>:SDLC:BITRate?`

**Arguments** B<x> is the number of the bus.  
<NR1> specifies the bit rate. The default bit rate is 10 kbs and varies 300 ~ 1000000000.

**Examples** `BUS:B1:SDLC:BITRate 80000` sets the bit rate as 80 Kbps.  
`BUS:B1:SDLC:BITRate?` might return `:BUS:B1:SDLC:BITRate 80000`, indicating that the bit rate is 80 Kbps.

## **BUS:B<x>:SDLC:DATA:SOURce**

This command sets or queries the source for the specified bus. The bus is specified by x.

**Conditions** Requires option SR-SDLC.

**Group** Bus

**Syntax** `BUS:B<x>:SDLC:DATA:SOURce {S<x>_Ch<x>|CH<x>|MATH<x>|REF<x>}`  
`BUS:B<x>:SDLC:DATA:SOURce?`

**Arguments** B<x> is the number of the bus.  
 S<x>\_Ch<x> specifies the remote scope number and the analog channel.  
 CH<x> specifies an analog channel as the source.  
 MATH<x> specifies a math waveform as the source.  
 REF<x> specifies a digital reference waveform as the source.

**Examples** BUS:B1:SDLC:DATA:SOURce Ch5 sets the source to channel 5.  
 BUS:B1:SDLC:DATA:SOURce? might return :BUS:B1:SDLC:DATA:SOURce CH5, indicating the source is set to channel 5.

## BUS:B<x>:SDLC:DATA:THReshold

This command sets or queries the SDLC data source threshold for the specified bus. The bus is specified by x.

**Conditions** Requires option SR-SDLC.

**Group** Bus

**Syntax** BUS:B<x>:SDLC:DATA:THReshold <NR3>  
 BUS:B<x>:SDLC:DATA:THReshold?

**Arguments** B<x> is the number of the bus.  
 <NR3> is the SDLC Strobe threshold for the specified bus. The valid range is -8V to +8V.

**Examples** BUS:B1:SDLC:DATA:THReshold 1.0 sets the bus 1 SDLC threshold to 1.0 V.  
 BUS:B1:SDLC:DATA:THReshold? might return :BUS:B1:SDLC:DATA:THReshold 225.00000E-3 indicates the bus 1 SDLC threshold is set to 225.0 mV.

## BUS:B<x>:SDLC:ENCoding

This command sets or queries the SDLC Bus Encoding. The bus is specified by x.

**Conditions** Requires option SR-SDLC.

<b>Group</b>	Bus
<b>Syntax</b>	<code>BUS:B&lt;x&gt;:SDLC:ENCoding {DISCcrete INVert}</code> <code>BUS:B&lt;x&gt;:SDLC:ENCoding?</code>
<b>Arguments</b>	<code>B&lt;x&gt;</code> is the number of the bus waveform.  <code>DISCcrete</code> specifies the encoding mechanism is Discrete Transmission (NRZ).  <code>INVert</code> specifies that encoding mechanism is Invert On Zero i.e. NRZI.
<b>Examples</b>	<code>BUS:B1:SDLC:ENCoding DISCcrete</code> sets the encoding method to discrete transmission.  <code>BUS:B1:SDLC:ENCoding?</code> might return <code>:BUS:B1:SDLC:ENCoding DISCcrete</code> , indicating that the encoding type is Discrete Transmission.

## BUS:B<x>:SDLC:MODulo

This command sets or queries the SDLC Bus Modulo. The bus is specified by x.

<b>Conditions</b>	Requires option SR-SDLC.
<b>Group</b>	Bus
<b>Syntax</b>	<code>BUS:B&lt;x&gt;:SDLC:MODulo {8 128}</code> <code>BUS:B&lt;x&gt;:SDLC:MODulo?</code>
<b>Arguments</b>	<code>B&lt;x&gt;</code> is the number of the bus waveform.  8 specifies the C-Field size is 8 bit in SDLC frame.  128 specifies the C-Field size is 16 bit in SDLC frame.
<b>Examples</b>	<code>BUS:B1:SDLC:MODulo 128</code> sets the modulo to 128.  <code>BUS:B1:SDLC:MODulo?</code> might return <code>:BUS:B1:SDLC:MODulo 128</code> , indicating that the modulo is 128.

## BUS:B<x>:SENT:CHANWidth

This command sets or queries SENT fast channel bit widths for the specified bus.

<b>Conditions</b>	Requires option SRAUTOSEN.
<b>Group</b>	Bus
<b>Syntax</b>	BUS:B<x>:SENT:CHANwidth {TWELVETwelve FOURTEENTen SIXTEENeight} BUS:B<x>:SENT:CHANwidth?
<b>Related Commands</b>	<a href="#">BUS:B&lt;x&gt;:SENT:NUMCHANnel</a>
<b>Arguments</b>	B<x> is the number of the bus waveform.  TWELVETwelve sets both Fast Channel 1 and Fast Channel 2 to 12 bits wide. FOURTEENTen sets Fast Channel 1 to 14 bits and Fast Channel 2 to 10 bits. SIXTEENeight sets Fast Channel 1 to 16 bits and Fast Channel 2 to eight bits.
<b>Examples</b>	BUS:B1:SENT:CHANWIDTH TWELVETWELVE sets the channel width of both Fast Channel 1 and Fast Channel 2 to twelve bits.  BUS:B1:SENT:CHANWIDTH? might return :BUS:B1:SENT:CHANWIDTH SIXTEENEIGHT, which indicates that the Fast Channel 1 width is 16 and the Fast Channel 2 width is eight.

## BUS:B<x>:SENT:NIBBLECount

This command sets or queries SENT data nibbles for the specified bus.

<b>Conditions</b>	Requires option SRAUTOSEN.
<b>Group</b>	Bus
<b>Syntax</b>	BUS:B<x>:SENT:NIBBLECount {THREE FOUR SIX} BUS:B<x>:SENT:NIBBLECount?
<b>Arguments</b>	B<x> is the number of the bus waveform.  THREE specifies regular data with 3 nibbles  FOUR specifies regular data with 4 nibbles  SIX specifies regular data with 6 nibbles

**Examples** `BUS:B1:SENT:NIBBLECOUNT THREE` sets the data nibble count to three.  
`BUS:B1:SENT:NIBBLECOUNT?` might return `:BUS:B1:SENT:NIBBLECOUNT SIX`, which indicates the nibble count is set to six.

## **BUS:B<x>:SENT:NUMCHANnel**

This command sets or queries SENT fast data channels for the specified bus.

**Conditions** Requires option SRAUTOSEN.

**Group** Bus

**Syntax** `BUS:B<x>:SENT:NUMCHANnel {ONE|TWO}`  
`BUS:B<x>:SENT:NUMCHANnel?`

**Arguments** `B<x>` is the number of the bus waveform.  
`ONE` specifies a SENT bus with one fast channel.  
`TWO` specifies a SENT bus with two fast channels.

**Examples** `BUS:B1:SENT:NUMCHANnel TWO` sets the number of SENT channels to two.  
`BUS:B1:SENT:NUMCHANNEL?` might return `:BUS:B1:SENT:NUMCHANNEL ONE` to indicate that the number of channels is set to one.

## **BUS:B<x>:SENT:PAUSEPULSe**

This command sets or queries SENT pause pulse for the specified bus.

**Conditions** Requires option SRAUTOSEN.

**Group** Bus

**Syntax** `BUS:B<x>:SENT:PAUSEPULSe {NO|YES}`  
`BUS:B<x>:SENT:PAUSEPULSe?`

**Arguments** `B<x>` is the number of the bus waveform.  
`NO` specifies no pause pulse.



YES specifies a pause pulse is used.

**Examples** `BUS:B1:SENT:PAUSEPULSE NO` sets the pause pulse value to indicate no pause pulse.  
`BUS:B1:SENT:PAUSEPULSE?` might return `:BUS:B1:SENT:PAUSEPULSE YES`, which indicates the SENT bus is set to use pause pulses.

## BUS:B<x>:SENT:POLARITY

This command sets or queries SENT Idle State signal polarity for the specified bus.

**Conditions** Requires option SRAUTOSEN.

**Group** Bus

**Syntax** `BUS:B<x>:SENT:POLARITY {INverted|NORMAL}`  
`BUS:B<x>:SENT:POLARITY?`

**Arguments** B<x> is the number of the bus waveform.  
 INverted specifies inverted polarity.  
 NORMAL specifies normal polarity.

**Examples** `BUS:B1:SENT:POLARITY INVERTED` sets the idle state of the bus to inverted polarity.  
`BUS:B1:SENT:POLARITY?` might return `:BUS:B1:SENT:POLARITY NORMAL` to indicate the bus idle state polarity is set to normal

## BUS:B<x>:SENT:SLOW

This command sets or queries the SENT slow channel configuration for the specified bus.

**Conditions** Requires option SRAUTOSEN.

**Group** Bus

**Syntax**     `BUS:B<x>:SENT:SLOW {None|ENHANCED4|ENHANCED8|SHORT}`  
`BUS:B<x>:SENT:SLOW?`

**Arguments**     `B<x>` is the number of the bus waveform.

`None` specifies no slow channel configured.

`ENHANCED4` specifies Enhanced 4 slow channel configuration.

`ENHANCED8` specifies Enhanced 8 slow channel configuration.

`SHORT` specifies short slow channel configuration.

**Examples**     `BUS:B1:SENT:SLOW SHORT` sets the SENT bus to use the short slow channel configuration.

`BUS:B1:SENT:SLOW?` might return `:BUS:B1:SENT:SLOW NONE` to indicate that the SENT bus is set to have no slow channel.

## **BUS:B<x>:SENT:SOURce**

This command sets or queries the SENT DATA source for the specified bus.

**Conditions**     Requires option SRAUTOSEN.

**Group**     Bus

**Syntax**     `BUS:B<x>:SENT:SOURce`  
`{S<x>_Ch<x>_D<x>|CH<x>|CH<x>_D<x>|Math<x>|REF<x>|REF<x>_D<x>}`  
`BUS:B<x>:SENT:SOURce?`

**Arguments**     `B<x>` is the number of the bus waveform.

`S<x>_Ch<x>_D<x>` specifies is the remote scope number, the analog channel and the digital channel.

`CH<x>` specifies an analog channel as the clock source waveform for the audio bus.

`CH<x>_D<x>` specifies a digital channel as the clock source waveform for the specified audio bus.

`Math<x>` specifies a math waveform as the clock source waveform for the audio bus.

`REF<x>` specifies a reference waveform as the clock source waveform for the audio bus

REF<x>\_D<x> specifies a digital reference waveform as the clock source waveform for the specified audio bus.

**Examples**    `BUS:B1:SENT:SOURCE CH1_D1` sets D1 of channel 1 as the source for the SENT bus.

`BUS:B1:SENT:SOURCE?` might return `:BUS:B1:SENT:SOURCE CH1` indicating that the source is set to channel 1

## BUS:B<x>:SENT:THRESHold

This command sets or queries the SENT DATA source threshold for the specified bus.

**Conditions**    Requires option SRAUTOSEN.

**Group**        Bus

**Syntax**       `BUS:B<x>:SENT:THRESHold <NR3>`  
`BUS:B<x>:SENT:THRESHold?`

**Arguments**    `B<x>` is the number of the bus waveform.  
`<NR3>` sets the data source threshold value in volts.

**Examples**     `BUS:B1:SENT:THRESHOLD 500.0E-3` sets the Bus 1 source threshold to 500.0 mV.

`BUS:B1:SENT:THRESHOLD?` might return `:BUS:B1:SENT:THRESHOLD 2.5000` to indicate the Bus 1 source threshold is 2.5 V.

## BUS:B<x>:SENT:TICKTIME

This command sets or queries the SENT bus Clock Tick parameter for the specified bus.

**Conditions**    Requires option SRAUTOSEN.

**Group**        Bus

**Syntax**    `BUS:B<x>:SENT:TICKTIME <NR3>`  
`BUS:B<x>:SENT:TICKTIME?`

**Arguments**    `B<x>` is the number of the bus waveform.  
`<NR3>` is the SENT clock tick time, in seconds.

**Examples**    `BUS:B1:SENT:TICKTIME 3.0E-6` sets the SENT bus to clock tick to 3 microseconds.  
`BUS:B1:SENT:TICKTIME?` might return `:BUS:B1:SENT:TICKTIME 10.0000E-6` to indicate the clock tick is set to 10 microseconds.

## **BUS:B<x>:SENT:TICKTOLerance**

This command sets or queries the SENT bus Tick Tolerance percent parameter for the specified bus.

**Conditions**    Requires option SRAUTOSEN.

**Group**    Bus

**Syntax**    `BUS:B<x>:SENT:TICKTOLerance <NR3>`  
`BUS:B<x>:SENT:TICKTOLerance?`

**Arguments**    `B<x>` is the number of the bus waveform.  
`<NR3>` is the tick tolerance percentage.

**Examples**    `BUS:B1:SENT:TICKTOLERANCE 20.0` sets the tick tolerance to 20%.  
`US:B1:SENT:TICKTOLERANCE?` might return `:BUS:B1:SENT:TICKTOLERANCE 22.5` to indicate the tolerance is set to 22.5%.

## **BUS:B<x>:SMBUS:CLOCK:SOUrce**

This command sets or queries the clock source for the specified bus.

**Conditions**    Requires option SR-SMBUS

<b>Group</b>	Bus
<b>Syntax</b>	BUS:B<x>:SMBUS:CLOCK:SOURCE {S<x>_Ch<x> CH<x> MATH<x> REF<x>} BUS:B<x>:SMBUS:CLOCK:SOURCE?
<b>Arguments</b>	B<x> is the bus number.  S<x>_Ch<x> specifies the remote scope number and the analog channel.  CH<x> specifies an analog channel as the source for the data signal, where <x> is the channel number.  MATH<x> specifies a math channel as the source for the data signal, where <x> is the math waveform number.  REF<x> specifies a reference waveform as the source for the data signal, where <x> is the reference waveform number.
<b>Examples</b>	BUS:B1:SMBUS:CLOCK:SOURCE CH5 sets the Bus 1 clock source to channel 5.  BUS:B1:SMBUS:CLOCK:SOURCE? might return :BUS:B1:SMBUS:CLOCK:SOURCE CH5, indicating the Bus 1 clock source is channel 5.

## BUS:B<x>:SMBUS:CLOCK:THReshold

This command sets or queries the SMBUS clock source threshold for the specified bus.

<b>Conditions</b>	Requires option SR-SMBUS
<b>Group</b>	Bus
<b>Syntax</b>	BUS:B<x>:SMBUS:CLOCK:THReshold <NR3> BUS:B<x>:SMBUS:CLOCK:THReshold?
<b>Arguments</b>	B<x> is the bus number.  <NR3> specifies the SMBUS clock threshold for the specified bus. The valid range is -8V to +8V.

**Examples**    `BUS:B1:SMBUS:CLOCK:THResho1d 1.0` sets the Bus 1 SMBUS clock threshold to 1.0 V.

`BUS:B1:SMBUS:CLOCK:THResho1d?` might return `:BUS:B1:SMBUS:CLOCK:THResho1d 1.0`, indicating the Bus 1 SMBUS clock threshold is 1.0 V.

## **BUS:B<x>:SMBUS:DATA:SOURce**

This command sets or queries the data source for the specified bus.

**Conditions**    Requires option SR-SMBUS

**Group**        Bus

**Syntax**        `BUS:B<x>:SMBUS:DATA:SOURce {S<x>_Ch<x>|CH<x>|MATH<x>|REF<x>}`  
`BUS:B<x>:SMBUS:DATA:SOURce?`

**Arguments**    `B<x>` is the bus number.

`S<x>_Ch<x>` specifies the remote scope number and the analog channel.

`CH<x>` specifies an analog channel as the source for the data signal, where `<x>` is the channel number.

`MATH<x>` specifies a math channel as the source for the data signal, where `<x>` is the math waveform number.

`REF<x>` specifies a reference waveform as the source for the data signal, where `<x>` is the reference waveform number.

**Examples**        `BUS:B1:SMBUS:DATA:SOURce CH5` sets the Bus 1 data source to channel 5.

`BUS:B1:SMBUS:DATA:SOURce?` might return `:BUS:B1:SMBUS:DATA:SOURce CH5`, indicating the Bus 1 data source is channel 5.

## **BUS:B<x>:SMBUS:DATA:THReshold**

This command sets or queries the SMBUS data source threshold for the specified bus.

**Conditions**    Requires option SR-SMBUS

<b>Group</b>	Bus
<b>Syntax</b>	<code>BUS:B&lt;x&gt;:SMBUS:DATA:THResho1d &lt;NR3&gt;</code> <code>BUS:B&lt;x&gt;:SMBUS:DATA:THResho1d?</code>
<b>Arguments</b>	<code>B&lt;x&gt;</code> is the bus number.  <code>&lt;NR3&gt;</code> specifies the SMBUS data threshold for the specified bus. The valid range is -8V to +8V.
<b>Examples</b>	<code>BUS:B1:SMBUS:DATA:THResho1d 1.0</code> sets the Bus 1 SMBUS data threshold to 1.0 V.  <code>BUS:B1:SMBUS:DATA:THResho1d?</code> might return <code>:BUS:B1:SMBUS:DATA:THResho1d 1.0</code> , indicating the Bus 1 SMBUS data threshold is 1.0 V.

## **BUS:B<x>:SMBUS:PEC:VALUe**

This command sets or queries the SMBus PEC selection for the specified bus.

<b>Conditions</b>	Requires option SR-SMBUS
<b>Group</b>	Bus
<b>Syntax</b>	<code>BUS:B&lt;x&gt;:SMBUS:PEC:VALUe {TRUE FALSE}</code> <code>BUS:B&lt;x&gt;:SMBUS:PEC:VALUe?</code>
<b>Arguments</b>	<code>B&lt;x&gt;</code> is the bus number.  TRUE specifies the SMBus PEC selection as true.  FALSE specifies the SMBus PEC selection as false.
<b>Examples</b>	<code>BUS:B1:SMBUS:PEC:VALUe TRUE</code> sets the PEC checkbox selection to true.  <code>BUS:B1:SMBUS:PEC:VALUe?</code> might return <code>:BUS:B1:SMBUS:PEC:VALUe TRUE</code> , indicating the PEC checkbox selection is true.

## BUS:B<x>:SPACEWIRE:BITRate

This command sets or queries the SpaceWire bit rate.

**Conditions** Requires option SR-SPACEWIRE

**Group** Bus

**Syntax** BUS:B<x>:SPACEWIRE:BITRate <NR3>  
BUS:B<x>:SPACEWIRE:BITRate?

**Arguments** B<x> is the bus number.  
NR3 specifies the SpaceWire bit rate for the specified bus. The valid bit rate range is 2 Mbps to 200 Mbps. The default value is 10 Mbps.

**Examples** BUS:B1:SPACEWIRE:BITRate 10000000 sets the bit rate to 10 Mbps.  
BUS:B1:SPACEWIRE:BITRate? might return :BUS:B1:SPACEWIRE:BITRate RATE189K, indicating that the bit rate is set to 10 Mbps.

## BUS:B<x>:SPACEWIRE:DATA:SOURce

This command sets or queries the source of the SpaceWire Data signal for the specified bus.

**Conditions** Requires option SR-SPACEWIRE

**Group** Bus

**Syntax** BUS:B<x>:SPACEWIRE:DATA:SOURce  
{S<x>\_Ch<x>|CH<x>|MATH<x>|REF<x>}  
BUS:B<x>:SPACEWIRE:DATA:SOURce?

**Related Commands** [BUS:B<x>:SPACEWIRE:DATA:THReshold](#)

**Arguments** B<x> is the bus number.  
S<x>\_Ch<x> specifies the remote scope number and the analog channel.



CH<x> specifies an analog channel as the source for the data signal, where <x> is the channel number.

MATH<x> specifies a math channel as the source for the data signal, where <x> is the math waveform number.

REF<x> specifies a reference waveform as the source for the data signal, where <x> is the reference waveform number.

**Examples** `BUS:B1:SPACEWIRE:DATA:SOURce Ch5` sets the Bus 1 DATA source to channel 5.

`BUS:B3:SPACEWIRE:DATA:SOURce?` might return  
`BUS:B3:SPACEWIRE:DATA:SOURce MATH2`, indicating the DATA source for Bus 3 is set to Math waveform 2.

## BUS:B<x>:SPACEWIRE:DATA:THReshold

This command sets or queries the threshold of the SpaceWire Data signal for the specified bus.

**Conditions** Requires option SR-SPACEWIRE

**Group** Bus

**Syntax** `BUS:B<x>:SPACEWIRE:DATA:THReshold <NR3>`  
`BUS:B<x>:SPACEWIRE:DATA:THReshold?`

**Related Commands** [BUS:B<x>:SPACEWIRE:DATA:SOURce](#)

**Arguments** B<x> is the bus number.  
 NR3 specifies the SpaceWire Data threshold level for the specified bus, in volts.

**Examples** `BUS:B1:SPACEWIRE:DATA:THReshold 2.0` sets the Bus 1 DATA source threshold to 2.0 V.

`BUS:B3:SPACEWIRE:DATA:THReshold?` might return  
`BUS:B3:SPACEWIRE:DATA:THReshold 978.00000E-3`, indicating the DATA source threshold level for Bus 3 is set to 978.0 mV.

## BUS:B<x>:SPACEWIRE:DECode:TYPe

This command sets or queries the decode type for SpaceWire bus decode.

**Conditions** Requires option SR-SPACEWIRE

**Group** Bus

**Syntax** BUS:B<x>:SPACEWIRE:DECode:TYPe {STRObe|DATARate}  
BUS:B<x>:SPACEWIRE:DECode:TYPe?

**Arguments** B<x> is the bus number.  
STRObe specifies the decode type as strobe.  
DATARate specifies the decode type as data rate.

**Examples** BUS:B1:SPACEWIRE:DECode:TYPe STRObe sets the decode type as strobe.  
BUS:B1:SPACEWIRE:DECode:TYPe? might return  
:BUS:B1:SPACEWIRE:DECode:TYPe Strobe, indicating the decode type  
is strobe.

## BUS:B<x>:SPACEWIRE:STRobe:SOUrce

This command sets or queries the source of the SpaceWire Strobe signal for the specified bus.

**Conditions** Requires option SR-SPACEWIRE

**Group** Bus

**Syntax** BUS:B<x>:SPACEWIRE:STRobe:SOUrce  
{S<x>\_Ch<x>|CH<x>|MATH<x>|REF<x>}  
BUS:B<x>:SPACEWIRE:STRobe:SOUrce?

**Related Commands** [BUS:B<x>:SPACEWIRE:STRobe:THReshold](#)

**Arguments** B<x> is the bus number.  
S<x>\_Ch<x> specifies the remote scope number and the analog channel.

CH<x> specifies an analog channel as the source for the strobe signal, where <x> is the channel number.

MATH<x> specifies a math channel as the source for the strobe signal, where <x> is the math waveform number.

REF<x> specifies a reference waveform as the source for the strobe signal, where <x> is the reference waveform number.

**Examples** `BUS:B1:SPACEWIRE:STRObe:SOUrce Ch5` sets the Bus 1 Strobe source to channel 5.

`BUS:B3:SPACEWIRE:STRObe:SOUrce?` might return  
`BUS:B3:SPACEWIRE:STRObe:SOUrce MATH2`, indicating the Strobe source for Bus 3 is set to Math waveform 2.

## BUS:B<x>:SPACEWIRE:STRObe:THReshold

This command sets or queries the threshold level of the SpaceWire Strobe signal for the specified bus.

**Conditions** Requires option SR-SPACEWIRE

**Group** Bus

**Syntax** `BUS:B<x>:SPACEWIRE:STRObe:THResho1d <NR3>`  
`BUS:B<x>:SPACEWIRE:STRObe:THResho1d?`

**Related Commands** [BUS:B<x>:SPACEWIRE:STRObe:SOUrce](#)

**Arguments** B<x> is the bus number.  
 NR3 specifies the SpaceWire Strobe signal threshold level for the specified bus, in volts.

**Examples** `BUS:B4:SPACEWIRE:STRObe:THResho1d 1.2` sets the Bus 4 Strobe source threshold to 1.2 V.

`BUS:B1:SPACEWIRE:STRObe:THResho1d?` might return  
`BUS:B1:SPACEWIRE:STRObe:THResho1d 950.00000E-3`, indicating the Strobe source threshold level for bus 1 is set to 950.0 mV.

## **BUS:B<x>:SPACEWIRE:SYNC**

This command sets or queries sync for SpaceWire decoding.

<b>Conditions</b>	Requires option SR-SPACEWIRE
<b>Group</b>	Bus
<b>Syntax</b>	BUS:B<x>:SPACEWIRE:SYNC {DATA NULL AUTO CUSTOM} BUS:B<x>:SPACEWIRE:SYNC?
<b>Arguments</b>	B<x> is the bus number.  DATA specifies sync as data.  NULL specifies sync as null.  AUTO specifies sync as auto.  CUSTOM specifies sync as custom.
<b>Examples</b>	BUS:B1:SPACEWIRE:SYNC NULL sets the sync to null.  BUS:B1:SPACEWIRE:SYNC? might return :BUS:B1:SPACEWIRE:SYNC NULL, indicating the sync is set to null.

## **BUS:B<x>:SPACEWIRE:SYNC:COUnt**

This command sets or queries the length of the data string in bytes to be used for a SpaceWire sync bytes.

<b>Conditions</b>	Requires option SR-SPACEWIRE
<b>Group</b>	Bus
<b>Syntax</b>	BUS:B<x>:SPACEWIRE:SYNC:COUnt <NR1> BUS:B<x>:SPACEWIRE:SYNC:COUnt?
<b>Arguments</b>	B<x> is the bus number.  NR1 specifies the length of the data string in bytes. The minimum is 2 and the maximum is 10. The default is 2 bytes.

**Examples**    `BUS:B1:SPACEWIRE:SYNC:COUnT 3` sets the count to 3.  
                   `BUS:B1:SPACEWIRE:SYNC:COUnT?` might return  
                   `:BUS:B1:SPACEWIRE:SYNC:COUnT 3`, indicating the count is 3.

## **BUS:B<x>:SPACEWIRE:SYNC:PATtern**

This command sets or queries sync pattern for SpaceWire decoding.

**Conditions**    Requires option SR-SPACEWIRE

**Group**        Bus

**Syntax**        `BUS:B<x>:SPACEWIRE:SYNC:PATtern <NR3>`  
                   `BUS:B<x>:SPACEWIRE:SYNC:PATtern?`

**Arguments**    `B<x>` is the bus number.  
                   `NR3` specifies the sync pattern.

**Examples**    `BUS:B1:SPACEWIRE:SYNC:PATtern N N` sets the sync pattern to N N.  
                   `BUS:B1:SPACEWIRE:SYNC:PATtern?` might return  
                   `:BUS:B1:SPACEWIRE:SYNC:PATtern N N`, indicating the Bus 1 SpaceWire  
                   pattern to be N N.

## **BUS:B<x>:SPACEWIRE:SYNC:VALUe**

This command sets or queries sync value for sync option data.

**Conditions**    Requires option SR-SPACEWIRE

**Group**        Bus

**Syntax**        `BUS:B<x>:SPACEWIRE:SYNC:VALUe <NR3>`  
                   `BUS:B<x>:SPACEWIRE:SYNC:VALUe?`

**Arguments**    `B<x>` is the bus number.  
                   `NR3` specifies the sync value for sync option data.

**Examples** `BUS:B1:SPACEWIRE:SYNC:VALUE D-00 D-00` sets the sync value to D-00 D-00.

`BUS:B1:SPACEWIRE:SYNC:VALUE?` might return `:BUS:B1:SPACEWIRE:SYNC:VALUE D-00 D-00`, indicating the Bus 1 SpaceWire sync value is D-00 D-00.

## **BUS:B<x>:SPI:BITOrder**

This command sets or queries the SPI bit order for the specified bus. The bus is specified by x.

**Conditions** Requires option 5-SREMBD or SUP5-SREMBD.

**Group** Bus

**Syntax** `BUS:B<x>:SPI:BITOrder {LSB|MSB}`  
`BUS:B<x>:SPI:BITOrder?`

**Related Commands** [BUS:B<x>:SPI:DATA:SIZE](#)

**Arguments** B<x> is the number of the bus waveform.

LSB specifies that each bit becomes the recovered value's new LSB, after shifting previously recovered bits one place to the left. The decoding happens right to left.

MSB specifies that each successive bit from the bus's data line becomes the new MSB of the recovered value, shifting any previously recovered bits one place to the right. The decoding happens left to right.

**Examples** `BUS:B1:SPI:BITORDER LSB` sets each bit order for the SPI Bus 1 to LSB.

`BUS:B1:SPI:BITORDER?` might return `BUS:B1:SPI:BITORDER MSB`, indicating that the bit order for the SPI Bus 1 is set to MSB.

## **BUS:B<x>:SPI:CLOCK:POLarity**

This command sets or queries the SPI clock (SCLK) source polarity for the specified bus. The bus is specified by x.

**Conditions** Requires option 5-SREMBD or SUP5-SREMBD.

<b>Group</b>	Bus
<b>Syntax</b>	BUS:B<x>:SPI:CLOCK:POLARity {FALL RISE} BUS:B<x>:SPI:CLOCK:POLARity?
<b>Related Commands</b>	<a href="#">BUS:B&lt;x&gt;:SPI:CLOCK:SOURce</a>
<b>Arguments</b>	B<x> is the number of the bus waveform.  FALL sets the clock to the falling edge of the signal.  RISE sets the clock to the rising edge of the signal.
<b>Examples</b>	BUS:B1:SPI:CLOCK:POLARITY FALL sets the SPI clock polarity to the falling edge for the Bus 1.  BUS:B1:SPI:CLOCK:POLARITY? might return BUS:B1:SPI:CLOCK:POLARITY RISE, indicating that the SPI clock polarity for the Bus 1 is set to the rising edge.

## BUS:B<x>:SPI:CLOCK:SOURce

This command sets or queries the SPI clock (SCLK) source for the specified bus. The bus is specified by x.

<b>Conditions</b>	Requires option 5-SREMBD or SUP5-SREMBD.
<b>Group</b>	Bus
<b>Syntax</b>	BUS:B<x>:SPI:CLOCK:SOURce {S<x>_Ch<x>_D<x> CH<x> CH<x>_D<x> MATH<x> REF<x> REF<x>_D<x>} BUS:B<x>:SPI:CLOCK:SOURce?
<b>Related Commands</b>	<a href="#">BUS:B&lt;x&gt;:SPI:CLOCK:POLarity</a>
<b>Arguments</b>	B<x> is the number of the bus waveform.  S<x>_Ch<x>_D<x> specifies is the remote scope number, the analog channel and the digital channel.  CH<x> designates an analog channel as the bus SPI clock source.

CH<x>\_D<x> designates an digital channel as the bus SPI clock source.

MATH<x> designates a math waveform as the clock source.

REF<x> designates a reference waveform as the clock source.

REF<x>\_D<x> specifies a digital reference waveform as the clock source waveform for the specified SPI bus.

**Examples**    `BUS:B1:SPI:CLOCK:SOURCE CH5` sets the SPI clock source for the Bus 1 to CH5.

`BUS:B1:SPI:CLOCK:SOURCE?` might return `BUS:B1:SPI:CLOCK:SOURCE MATH1`, indicating that the SPI clock source for the Bus 1 is set to MATH1.

## BUS:B<x>:SPI:CLOCK:THReshold

This command sets or queries the SPI Clock (SCLK) source threshold for the specified bus. The bus is specified by x.

**Conditions**    Requires option 5-SREMBD or SUP5-SREMBD.

**Group**        Bus

**Syntax**       `BUS:B<x>:SPI:CLOCK:THReshold <NR3>`  
`BUS:B<x>:SPI:CLOCK:THReshold?`

**Arguments**    B<x> is the number of the bus waveform.  
  
                  <NR3> is the SPI Clock (SCLK) source threshold for the specified bus.

**Examples**    `BUS:B1:SPI:CLOCK:THReshold 50.0e-3` sets the threshold to 50.0 mV.  
  
`BUS:B1:SPI:CLOCK:THReshold?` might return  
`BUS:B1:SPI:CLOCK:THRESHOLD 0.0E+0`, indicating the threshold is set to 0.0 V.

## BUS:B<x>:SPI:DATA:POLarity

This command sets or queries the SPI Data (Data) source polarity for the bus number specified by x.

**Conditions**    Requires option 5-SREMBD or SUP5-SREMBD.



<b>Group</b>	Bus
<b>Syntax</b>	BUS:B<x>:SPI:DATA:POLARity {HIGH LOW} BUS:B<x>:SPI:DATA:POLARity?
<b>Arguments</b>	B<x> is the number of the bus waveform.  HIGH sets the SPI data polarity to active high.  LOW sets the SPI data polarity to active low.
<b>Examples</b>	BUS:B4:SPI:DATA:POLARITY HIGH sets the SPI data polarity for the Bus 4 to active high.  BUS:B1:SPI:DATA:POLARITY? might return BUS:B1:SPI:DATA:POLARITY LOW, indicating that the SPI SDA polarity for the Bus 1 is set to active low.

## BUS:B<x>:SPI:DATA:SIZE

This command sets or queries the number of bits per word for the specified SPI bus. The bus is specified by x.

<b>Conditions</b>	Requires option 5-SREMBD or SUP5-SREMBD.
<b>Group</b>	Bus
<b>Syntax</b>	BUS:B<x>:SPI:DATA:SIZE <NR1> BUS:B<x>:SPI:DATA:SIZE?
<b>Arguments</b>	B<x> is the number of the bus waveform.  <NR1> is the data size for the specified bus. The minimum value is 2 and maximum is 32.
<b>Examples</b>	BUS:B1:SPI:DATA:SIZE 7 sets the data size for SPI Bus 1 to seven bits per word.  BUS:B1:SPI:DATA:SIZE? might return BUS:B1:SPI:DATA:SIZE 8, indicating that the data size for SPI Bus 1 is set to eight bits per word.

## BUS:B<x>:SPI:DATA:SOURce

This command sets or queries the SPI Data (Data) source for the bus number specified by x.

**Conditions** Requires option 5-SREMBD or SUP5-SREMBD.

**Group** Bus

**Syntax** BUS:B<x>:SPI:DATA:SOURce  
{S<x>\_Ch<x>\_D<x>|CH<x>|CH<x>\_D<x>|MATH<x>|REF<x>|REF<x>\_D<x>}  
BUS:B<x>:SPI:DATA:SOURce?

**Arguments** B<x> is the number of the bus waveform.

S<x>\_Ch<x>\_D<x> specifies is the remote scope number, the analog channel and the digital channel.

CH<x> designates an analog channel as the data source for the specified SPI bus.

CH<x>\_D<x> designates an digital channel as the bus SPI clock source.

MATH<x> designates a math waveform as the data source.

REF<x> designates a reference waveform as the data source.

REF<x>\_D<x> specifies a digital reference waveform as the data source waveform for the specified SPI bus.

**Examples** BUS:B1:SPI:DATA:SOURCE CH2 sets the SPI data source for the Bus 1 to CH2.

BUS:B3:SPI:DATA:SOURCE? might return BUS:B3:SPI:DATA:SOURCE CH3, indicating that the SPI data source for the Bus 3 is set to CH3.

## BUS:B<x>:SPI:DATA:THReshold

This command sets or queries the SPI Data (Data) source threshold for the specified bus. The bus is specified by x.

**Conditions** Requires option 5-SREMBD or SUP5-SREMBD.

**Group** Bus

<b>Syntax</b>	<code>BUS:B&lt;x&gt;:SPI:DATA:THResho1d &lt;NR3&gt;</code> <code>BUS:B&lt;x&gt;:SPI:DATA:THResho1d?</code>
<b>Arguments</b>	<code>B&lt;x&gt;</code> is the number of the bus waveform. <code>&lt;NR3&gt;</code> is the SPI Data (SDA) source threshold for the specified bus.
<b>Examples</b>	<code>BUS:B1:SPI:DATA:THResho1d 50.0e-3</code> sets the threshold to 50.0 mV. <code>BUS:B1:SPI:DATA:THResho1d?</code> might return <code>BUS:B1:SPI:DATA:THRESHOLD 0.0E+0</code> indicating the threshold is set to 0.0 V.

## BUS:B<x>:SPI:FRAMING

This command sets or queries the SPI framing setting for the specified bus. The bus number is specified by `x`.

<b>Conditions</b>	Requires option 5-SREMBD or SUP5-SREMBD.
<b>Group</b>	Bus
<b>Syntax</b>	<code>BUS:B&lt;x&gt;:SPI:FRAMING {IDLE SS}</code> <code>BUS:B&lt;x&gt;:SPI:FRAMING?</code>
<b>Arguments</b>	<code>B&lt;x&gt;</code> is the number of the bus waveform. IDLE specifies IDLE SPI framing. SS specifies SS SPI framing.
<b>Examples</b>	<code>BUS:B1:SPI:FRAMING IDLE</code> sets the SPI framing to IDLE. <code>BUS:B1:SPI:FRAMING?</code> might return <code>BUS:B1:SPI:FRAMING SS</code> , indicating that the SPI framing is set to SS.

## BUS:B<x>:SPI:IDLETime

This command sets or queries the SPI idle time for the specified bus. The bus is specified by `x`.

<b>Conditions</b>	Requires option 5-SREMBD or SUP5-SREMBD.
-------------------	------------------------------------------

<b>Group</b>	Bus
<b>Syntax</b>	<code>BUS:B&lt;x&gt;:SPI:IDLEtime &lt;NR3&gt;</code> <code>BUS:B&lt;x&gt;:SPI:IDLEtime?</code>
<b>Arguments</b>	<code>B&lt;x&gt;</code> is the number of the bus waveform. <code>&lt;NR3&gt;</code> specifies the SPI idle time.
<b>Examples</b>	<code>BUS:B1:SPI:IDLEtime 0.000004</code> sets the idle time to 4 $\mu$ s. <code>BUS:B1:SPI:IDLEtime?</code> might return <code>BUS:B1:SPI:IDLETIME 5.0000E-6</code> , indicating that the idle time is set to 5 $\mu$ s.

## **BUS:B<x>:SPI:MISo:DATA:POLarity**

This command sets or queries the SPI MISo Data source polarity for the specified bus. The bus is specified by x.

<b>Conditions</b>	Requires option SR-SPI.
<b>Group</b>	Bus
<b>Syntax</b>	<code>BUS:B&lt;x&gt;:SPI:MISo:DATA:POLarity {HIGH LOW}</code> <code>BUS:B&lt;x&gt;:SPI:MISo:DATA:POLarity?</code>
<b>Arguments</b>	<code>B&lt;x&gt;</code> is the number of the bus waveform. HIGH sets the polarity to high. LOW sets the polarity to low.
<b>Examples</b>	<code>BUS:B1:SPI:MISo:DATA:POLarity HIGH</code> sets the SPI MISo data polarity to high. <code>BUS:B1:SPI:MISo:DATA:POLarity?</code> might return <code>BUS:B1:SPI:MISo:DATA:POLarity HIGH</code> , indicating that the SPI MISo data polarity is high.

## BUS:B<x>:SPI:MISo:INPut

This command sets or queries the SPI MISo source for the specified bus. The bus is specified by x.

<b>Conditions</b>	Requires option SR-SPI.
<b>Group</b>	Bus
<b>Syntax</b>	BUS:B<x>:SPI:MISo:INPut {S<x>_Ch<x> CH<x> MATH<x> REF<x>} BUS:B<x>:SPI:MISo:INPut?
<b>Arguments</b>	B<x> is the number of the bus waveform. S<x>_Ch<x> specifies the remote scope number and the analog channel. CH<x> designates an analog channel as the source. MATH<x> designates a math waveform as the source. REF<x> designates a reference waveform as the source.
<b>Examples</b>	BUS:B1:SPI:MISo:INPut Ch5 sets the source to channel 5. BUS:B1:SPI:MISo:INPut? might return BUS:B1:SPI:MISo:INPut HIGH, indicating the source is set to channel 5.

## BUS:B<x>:SPI:MISo:THReshold

This command sets or queries the SPI MISo Data source threshold for the specified bus. The bus is specified by x.

<b>Conditions</b>	Requires option SR-SPI.
<b>Group</b>	Bus
<b>Syntax</b>	BUS:B<x>:SPI:MISo:THReshold <NR3> BUS:B<x>:SPI:MISo:THReshold?
<b>Arguments</b>	B<x> is the number of the bus waveform. <NR3> is the SPI MISo Data source threshold for the specified bus.

**Examples**    `BUS:B1:SPI:MISO:THRESHOLD 1.0` sets the Bus 1 SPI MISO threshold to 1.0 V.

`BUS:B1:SPI:MISO:THRESHOLD?` might return  
                 `:BUS:B1:SPI:MISO:THRESHOLD 225.00000E-3`, indicates the Bus 1 SPI MISO threshold is set to 225.0 mV.

## **BUS:B<x>:SPI:MOSi:DATA:POLarity**

This command sets or queries the SPI MOSI source polarity for the specified bus. The bus is specified by x.

**Conditions**    Requires option SR-SPI.

**Group**        Bus

**Syntax**       `BUS:B<x>:SPI:MOSi:DATA:POLarity {HIGH|LOW}`  
                 `BUS:B<x>:SPI:MOSi:DATA:POLarity?`

**Arguments**    `B<x>` is the number of the bus waveform.

                 HIGH sets the polarity to high.

                 LOW sets the polarity to low.

**Examples**     `BUS:B1:SPI:MOSi:DATA:POLarity HIGH` sets the SPI MOSI data polarity to high.

`BUS:B1:SPI:MOSi:DATA:POLarity?` might return  
                 `:BUS:B1:SPI:MOSi:DATA:POLarity HIGH`, indicating that the SPI MOSI data polarity is high.

## **BUS:B<x>:SPI:MOSi:INPut**

This command sets or queries the SPI MOSI source for the specified bus. The bus is specified by x.

**Conditions**    Requires option SR-SPI.

**Group**        Bus

**Syntax** `BUS:B<x>:SPI:MOSi:INPut {S<x>_Ch<x>|CH<x>|MATH<x>|REF<x>}`  
`BUS:B<x>:SPI:MOSi:INPut?`

**Arguments** `B<x>` is the number of the bus waveform.  
`S<x>_Ch<x>` specifies the remote scope number and the analog channel.  
`CH<x>` designates an analog channel as the source.  
`MATH<x>` designates a math waveform as the source.  
`REF<x>` designates a reference waveform as the source.

**Examples** `BUS:B1:SPI:MOSi:INPut Ch5` sets the source to channel 5.  
`BUS:B1:SPI:MOSi:INPut?` might return `:BUS:B1:SPI:MOSi:INPut HIGH`, indicating the source is set to channel 5.

## BUS:B<x>:SPI:MOSi:THReshold

This command sets or queries the SPI MOSI source threshold for the specified bus. The bus is specified by `x`.

**Conditions** Requires option SR-SPI.

**Group** Bus

**Syntax** `BUS:B<x>:SPI:MOSi:THReshold <NR3>`  
`BUS:B<x>:SPI:MOSi:THReshold?`

**Arguments** `B<x>` is the number of the bus waveform.  
`<NR3>` is the SPI MOSI Data source threshold for the specified bus.

**Examples** `BUS:B1:SPI:MOSi:THReshold 1.0` sets the Bus 1 SPI MOSI threshold to 1.0 V.  
`BUS:B1:SPI:MOSi:THReshold?` might return `:BUS:B1:SPI:MOSi:THReshold 225.00000E-3`, indicates the Bus 1 SPI MOSI threshold is set to 225.0 mV.

## BUS:B<x>:SPI:NUMBer:INputs

This command sets or queries the number of inputs for the specified bus. The bus is specified by x.

**Conditions** Requires option SR-SPI.

**Group** Bus

**Syntax** BUS:B<x>:SPI:NUMBer:INputs {ONE|TWO}  
BUS:B<x>:SPI:NUMBer:INputs?

**Arguments** B<x> is the number of the bus waveform.  
ONE sets the Data Inputs as one.  
TWO sets the Data Inputs as two.

**Examples** BUS:B1:SPI:NUMBer:INputs TWO sets the Data Inputs as two.  
BUS:B1:SPI:NUMBer:INputs? might return :BUS:B1:SPI:NUMBer:INputs  
TWO, indicating that the Data Inputs is two.

## BUS:B<x>:SPI:SElect:POLarity

This command sets or queries the SPI Slave Select (SS) polarity for the specified bus. The bus is specified by x.

**Conditions** Requires option 5-SREMBD or SUP5-SREMBD.

**Group** Bus

**Syntax** BUS:B<x>:SPI:SElect:POLarity {LOW|HIGH}  
BUS:B<x>:SPI:SElect:POLarity?

**Related Commands** [BUS:B<x>:SPI:SElect:SOUrce](#)

**Arguments** B<x> is the number of the bus waveform.  
LOW sets an active low polarity.



HIGH sets an active high polarity.

**Examples** `BUS:B1:SPI:SELECT:POLARITY HIGH` sets the SPI Slave Select polarity for the bus B1 to active high.

`BUS:B1:SPI:SELECT:POLARITY?` might return `BUS:B1:SPI:SELECT:POLARITY HIGH`, indicating that the SPI Slave Select polarity for the bus B1 is set to active high.

## BUS:B<x>:SPI:SElect:SOUrce

This command sets or queries the SPI Slave Select (SS) source for the specified bus. The bus is specified by x.

**Conditions** Requires option 5-SREMBD or SUP5-SREMBD.

**Group** Bus

**Syntax** `BUS:B<x>:SPI:SElect:SOUrce`  
`{S<x>_Ch<x>_D<x> | CH<x> | CH<x>_D<x> | MATH<x> | REF<x> | REF<x>_D<x>}`  
`BUS:B<x>:SPI:SElect:SOUrce?`

**Related Commands** [BUS:B<x>:SPI:SElect:POLarity](#)

**Arguments** B<x> is the number of the bus waveform.

S<x>\_Ch<x>\_D<x> specifies is the remote scope number, the analog channel and the digital channel.

CH<x> designates an analog channel as the buses' SPI Slave Select source.

CH<x>\_D<x> designates a digital channel as the buses' SPI Slave Select source.

MATH<x> designates a math waveform as the Slave Select source.

REF<x> designates a reference waveform as the Slave Select source.

REF<x>\_D<x> specifies a digital reference waveform as the clock source waveform for the specified SPI bus.

**Examples** `BUS:B1:SPI:SELECT:SOURCE MATH3` sets the SPI Slave Select source for the bus B1 to MATH3.

`BUS:B1:SPI:SELECT:SOURCE?` might return `BUS:B1:SPI:SELECT:SOURCE CH3`, indicating that the SPI Slave Select source for the bus B1 is set to CH3.

## BUS:B<x>:SPI:SElect:THReshold

This command sets or queries the SPI Select (SS) source threshold for the specified bus. The bus is specified by x.

**Conditions** Requires option 5-SREMBD or SUP5-SREMBD.

**Group** Bus

**Syntax** `BUS:B<x>:SPI:SElect:THReshold <NR3>`  
`BUS:B<x>:SPI:SElect:THReshold?`

**Arguments** B<x> is the number of the bus waveform.  
 <NR3> is the SPI Select (SS) source threshold for the specified bus.

**Examples** `BUS:B1:SPI:SElect:THReshold 50.0e-3` sets the threshold to 50.0 mV.  
`BUS:B1:SPI:SElect:THReshold?` might return  
`BUS:B1:SPI:SELECT:THRESHOLD 0.0E+0`, indicating the threshold is set to 0.0 V.

## BUS:B<x>:SPMI:SCLk:SOUrce

This command sets or queries the SPMI Clock (SCLK) source for the specified bus.

**Conditions** Requires option SRPM

**Group** Bus

**Syntax** `BUS:B<x>:SPMI:SCLk:SOUrce {CH<x>|CH<x>_D<x>|`  
`Math<x>|REF<x>|REF<x>_D<x>}`  
`BUS:B<x>:SPMI:SCLk:SOUrce?`

**Related Commands** [BUS:B<x>:SPMI:SDATa:SOUrce](#)

**Arguments** B<x> is the number of the bus waveform.  
 CH<x> specifies an analog channel as the clock source waveform for the SPMI bus.

CH<x>\_Dx> specifies a digital channel and bit as the clock source waveform for the specified SPMI bus.

Math<x> specifies a math waveform as the clock source waveform for the specified SPMI bus.

REF<x> specifies a reference waveform as the clock source waveform for the specified SPMI bus.

REF<x>\_D<x> specifies a digital reference waveform and bit as the clock source waveform for the specified SPMI bus.

**Examples**    `BUS:B1:SPMI:SCLk:SOURCE CH1_D1` sets D1 of channel 1 as the clock source for the SPMI bus B1.

`BUS:B1:SPMI:SCLk:SOURCE?` might return `BUS:B3:SPMI:SCLk:SOURCE CH3`, indicating that the data source for bus B3 is set to channel 3.

## BUS:B<x>:SPMI:SCLk:THReshold

This command sets or queries the SPMI Clock (SCLK) source threshold for the specified bus.

**Conditions**    Requires option SRPM

**Group**    Bus

**Syntax**    `BUS:B<x>:SPMI:SCLk:THReshold <NR3>`  
`BUS:B<x>:SPMI:SCLk:THReshold?`

**Arguments**    B<x> is the number of the bus waveform.  
 <NR3> is the clock (SCLK) source threshold value for the specified SPMI bus.

**Examples**    `BUS:B3:SPMI:SCLk:THRESHOLD 500.0E-3` sets the Bus3 clock source threshold to 500.0 mV.

`BUS:B1:SPMI:SCLk:THRESHOLD?` might return  
`BUS:B1:SPMI:SCLk:THRESHOLD 250.0E-3` to indicate Bus1 clock threshold is set to 250.0 mV.

## BUS:B<x>:SPMI:SDATa:SOUrce

This command sets or queries the SPMI Data (SDATA) source for the specified bus.

**Conditions** Requires option SRPM

**Group** Bus

**Syntax** `BUS:B<x>:SPMI:SDATa:SOUrce {CH<x>|CH<x>_D<x>|Math<x>|REF<x>|REF<x>_D<x>}`  
`BUS:B<x>:SPMI:SDATa:SOUrce?`

**Related Commands** [BUS:B<x>:SPMI:SCLk:SOUrce](#)

**Arguments** `B<x>` is the number of the bus waveform.

`CH<x>` specifies an analog channel as the data source waveform for the SPMI bus.

`CH<x>_D<x>` specifies a digital channel and bit as the data source waveform for the specified SPMI bus.

`Math<x>` specifies a math waveform as the data source waveform for the specified SPMI bus.

`REF<x>` specifies a reference waveform as the data source waveform for the specified SPMI bus.

`REF<x>_D<x>` specifies a digital reference waveform and bit as the data source waveform for the specified SPMI bus.

**Examples** `BUS:B4:SPMI:SDATa:SOUrce CH1_D2` sets bit D2 of digital channel 1 as the data source for the SPMI bus B4.

`BUS:B1:SPMI:SCLk:SOUrce?` might return `BUS:B3:SPMI:SCLk:SOUrce CH5` indicating that the data source is set to channel 5 for bus B3.

## BUS:B<x>:SPMI:SDATa:THReshold

This command sets or queries the SPMI Data (SDATA) source threshold for the specified bus.

**Conditions** Requires option SRPM

<b>Group</b>	Bus
<b>Syntax</b>	BUS:B<x>:SPMI:SDATA:THRESHOLD <NR3> BUS:B<x>:SPMI:SDATA:THRESHOLD?
<b>Arguments</b>	B<x> is the number of the bus waveform.  <NR3> is the data (SDATA) source threshold value for the specified SPMI bus.
<b>Examples</b>	BUS:B2:SPMI:SDATA:THRESHOLD 400.0E-3 sets Bus2 data source threshold to 400.0 mV.  BUS:B1:SPMI:SDATA:THRESHOLD? might return BUS:B1:SPMI:SDATA:THRESHOLD 220.0E-3 to indicate that Bus1 data source threshold is set to 220.0 mV

## BUS:B<x>:SVID:ALERT:SOURce

This command sets or queries alert source channel for the specified SVID bus. The bus is specified by x.

<b>Conditions</b>	Requires option SR-SVID
<b>Group</b>	Bus
<b>Syntax</b>	BUS:B<x>:SVID:ALERT:SOURce {S<x>_Ch<x> CH<x> MATH<x> REF<x>} BUS:B<x>:SVID:ALERT:SOURce?
<b>Arguments</b>	B<x> is the number of the bus waveform.  S<x>_Ch<x> specifies the remote scope number and the analog channel.  CH<x> specifies an analog channel as the data source.  MATH<x> specifies a math channel as the data source.  REF<x> specifies a digital reference waveform as the data source.
<b>Examples</b>	BUS:B1:SVID:ALERT:SOURce CH5 sets the source to channel 5.  BUS:B1:SVID:ALERT:SOURce? might return :BUS:B1:SVID:ALERT:SOURce CH5, indicating the source is set to channel 5.

## BUS:B<x>:SVID:ALERT:THReshold

This command sets or queries the alert threshold for the specified SVID bus. The bus is specified by x.

<b>Conditions</b>	Requires option SR-SVID
<b>Group</b>	Bus
<b>Syntax</b>	BUS:B<x>:SVID:ALERT:THReshold <NR3> BUS:B<x>:SVID:ALERT:THReshold?
<b>Arguments</b>	B<x> is the number of the bus waveform.  <NR3> is the SVID Strobe threshold for the specified bus. The argument range is -8V to +8V
<b>Examples</b>	BUS:B1:SVID:ALERT:THReshold 0.6 sets the Bus 1 SVID threshold to 600 mV.  BUS:B1:SVID:ALERT:THReshold? might return :BUS:B1:SVID:ALERT:THReshold 600.00000E-3, indicates the Bus 1 SVID threshold is set to 600 mV.

## BUS:B<x>:SVID:CLOCK:SOURce

This command sets or queries clock source channel for the specified SVID bus. The bus is specified by x.

<b>Conditions</b>	Requires option SR-SVID
<b>Group</b>	Bus
<b>Syntax</b>	BUS:B<x>:SVID:CLOCK:SOURce {S<x>_Ch<x> CH<x> MATH<x> REF<x>} BUS:B<x>:SVID:CLOCK:SOURce?
<b>Arguments</b>	B<x> is the number of the bus waveform.  S<x>_Ch<x> specifies the remote scope number and the analog channel.  CH<x> specifies an analog channel as the source.

MATH<x> specifies a math channel as the source.

REF<x> specifies a digital reference waveform as the source.

**Examples** `BUS:B1:SVID:CLOCK:SOURce CH3` sets the source to channel 3.

`BUS:B1:SVID:CLOCK:SOURce?` might return `:BUS:B1:SVID:CLOCK:SOURce CH3`, indicating the source is set to channel 3.

## BUS:B<x>:SVID:CLOCK:THReshold

This command sets or queries the clock threshold for the specified SVID bus. The bus is specified by x.

**Conditions** Requires option SR-SVID

**Group** Bus

**Syntax** `BUS:B<x>:SVID:CLOCK:THReshold <NR3>`  
`BUS:B<x>:SVID:CLOCK:THReshold?`

**Arguments** B<x> is the number of the bus waveform.  
 <NR3> is the SVID Strobe threshold for the specified bus. The argument range is -8V to +8V

**Examples** `BUS:B1:SVID:CLOCK:THReshold 1.0` sets the Bus 1 SVID threshold to 1.0 V.

`BUS:B1:SVID:CLOCK:THReshold?` might return `:BUS:B1:SVID:CLOCK:THReshold 1.0000`, indicates the Bus 1 SVID threshold is set to 1V.

## BUS:B<x>:SVID:DATA:SOURce

This command sets or queries data source channel for the specified SVID bus. The bus is specified by x.

**Conditions** Requires option SR-SVID

**Group** Bus

**Syntax**    `BUS:B<x>:SVID:DATA:SOURce {S<x>_Ch<x>|CH<x>|MATH<x>|REF<x>}`  
`BUS:B<x>:SVID:DATA:SOURce?`

**Arguments**    `B<x>` is the number of the bus waveform.  
`S<x>_Ch<x>` specifies the remote scope number and the analog channel.  
`CH<x>` specifies an analog channel as the source.  
`MATH<x>` specifies a math channel as the source.  
`REF<x>` specifies a digital reference waveform as the source.

**Examples**    `BUS:B1:SVID:DATA:SOURce CH4` sets the source to channel 4.  
`BUS:B1:SVID:DATA:SOURce?` might return `:BUS:B1:SVID:DATA:SOURce CH4`, indicating the source is set to channel 4.

## **BUS:B<x>:SVID:DATA:THReshold**

This command sets or queries the data threshold for the specified SVID bus. The bus is specified by x.

**Conditions**    Requires option SR-SVID

**Group**    Bus

**Syntax**    `BUS:B<x>:SVID:DATA:THResho1d <NR3>`  
`BUS:B<x>:SVID:DATA:THResho1d?`

**Arguments**    `B<x>` is the number of the bus waveform.  
`<NR3>` is the SVID Strobe threshold for the specified bus. The argument range is -8V to +8V

**Examples**    `BUS:B1:SVID:DATA:THResho1d 0.25` sets the Bus 1 SVID threshold to 250 mV.  
`BUS:B1:SVID:DATA:THResho1d?` might return `:BUS:B1:SVID:DATA:THResho1d 250.00000E-3`, indicates the Bus 1 SVID threshold is set to 250 mV.



## BUS:B<x>:TYPE

This command sets or queries the bus type or standard for the specified bus. The bus is specified by x. Arguments for a bus type are only available when the required serial bus option is installed.

<b>Group</b>	Bus
<b>Syntax</b>	BUS:B<x>:TYPE {ARINC429  AUDio  CAN  ETHernet  EUSB  FLEXRAY  I2C  I3C  LIN  MDIO  MIL1553B  PARAllel  RS232C  SENT  SPI  SPMI  SVID  USB} BUS:B<x>:TYPE?
<b>Arguments</b>	<p>B&lt;x&gt; is the number of the bus waveform.</p> <p>ARINC429 specifies the ARINC 429 avionics serial bus.</p> <p>AUDio specifies an audio bus.</p> <p>CAN specifies a Controller Area Network bus.</p> <p>ETHernet specifies the Ethernet bus.</p> <p>EUSB specifies a eUSB bus. Requires option SR-EUSB2.</p> <p>FLEXRAY specifies a FlexRay bus.</p> <p>I2C specifies the Inter-IC bus.</p> <p>I3C specifies the MIPI Improved Inter Integrated Circuit (I3C) bus.</p> <p>LIN specifies a Local Interconnect Network bus.</p> <p>MDIO specifies a MDIO bus.</p> <p>MIL1553B specifies the MIL-STD-1553 avionics serial bus.</p> <p>PARAllel specifies a parallel bus.</p> <p>RS232C specifies the RS-232 Serial bus.</p> <p>SENT specifies the Single Edge Nibble Transmission (SENT) automotive serial bus.</p> <p>SPI specifies the Serial Peripheral Interface bus.</p> <p>SPMI Specifies a System Power Management Interface bus</p> <p>SVID Specifies a Serial VID bus</p> <p>USB specifies the Universal Serial bus.</p>

**Examples** `BUS:B1:TYPE I2C` sets the bus B1 type to I2C.  
`BUS:B1:TYPE?` might return `BUS:B1:TYPE SPI`, indicating that the bus B1 type is set to SPI and that the bus behavior is governed by the `BUS:B1:SPI:xxxx` commands.

## **BUS:B<x>:USB:BITRate**

This command sets or queries the USB data rate for bus <x>, where the bus number is specified by x.

**Conditions** Requires option SR-USB2.

**Group** Bus

**Syntax** `BUS:B<x>:USB:BITRate {FULL|HIGH|LOW}`  
`BUS:B<x>:USB:BITRate?`

**Arguments** B<x> is the number of the bus waveform.  
FULL indicates the bit rate is 12 Mbps.  
HIGH indicates the bit rate is 480 Mbps.  
LOW indicates the bit rate is 1.5 Mbps.

**Examples** `BUS:B1:USB:BITRATE FULL` sets the bit rate to 12 Mbps.  
`BUS:B1:USB:BITRATE?` might return `BUS:B1:USB:BITRATE LOW`, indicating that the bit rate is 1.5 Mbps.

## **BUS:B<x>:USB:DATAMINUSTHRESHold**

This command sets or queries the USB D- source threshold for the specified bus. The bus is specified by x.

**Conditions** Requires option SR-USB2.

**Group** Bus

**Syntax** `BUS:B<x>:USB:DATAMINUSTHRESHold <NR3>`  
`BUS:B<x>:USB:DATAMINUSTHRESHold?`

<b>Arguments</b>	B<x> is the number of the bus waveform. <NR3> is the Minus threshold.
<b>Examples</b>	BUS:B1:USB:DATAMINUSTHRESHo1d 50.0e-3 sets the threshold to 50.0 mV. BUS:B1:USB:DATAMINUSTHRESHo1d? might return BUS:B1:USB:DATAMINUSTHRESHOLD 0.0E+0 indicating the threshold is set to 0.0 V.

## BUS:B<x>:USB:DATAPLUSTHRESHo1d

This command sets or queries the USB D+ source threshold for the specified bus. The bus is specified by x.

<b>Conditions</b>	Requires option SR-USB2.
<b>Group</b>	Bus
<b>Syntax</b>	BUS:B<x>:USB:DATAPLUSTHRESHo1d <NR3> BUS:B<x>:USB:DATAPLUSTHRESHo1d?
<b>Arguments</b>	B<x> is the number of the bus waveform. <NR3> is the Plus threshold.
<b>Examples</b>	BUS:B1:USB:DATAPLUSTHRESHo1d 50.0e-3 sets the threshold to 50.0 mV. BUS:B1:USB:DATAPLUSTHRESHo1d? might return BUS:B1:USB:DATAPLUSTHRESHOLD 0.0E+0 indicating the threshold is set to 0.0 V.

## BUS:B<x>:USB:LOWTHRESHo1d

This command sets or queries the USB data source threshold for the specified bus when the signal type is differential. The bus is specified by x.

<b>Conditions</b>	Requires option SR-USB2.
<b>Group</b>	Bus

**Syntax**    `BUS:B<x>:USB:LOWTHRESHo1d <NR3>`  
`BUS:B<x>:USB:LOWTHRESHo1d?`

**Arguments**    `B<x>` is the number of the bus waveform.  
`<NR3>` is the Low threshold.

**Examples**    `BUS:B1:USB:LOWTHRESHo1d 50.0e-3` sets the threshold to 50.0 mV.  
`BUS:B1:USB:LOWTHRESHo1d?` might return `BUS:B1:USB:LOWTHRESHOLD 0.0E+0` indicating the threshold is set to 0.0 V.

## **BUS:B<x>:USB:SIGNALTYpe**

This command sets or queries the USB signal type for the specified bus. The bus is specified by x.

**Conditions**    Requires option SR-USB2.

**Group**    Bus

**Syntax**    `BUS:B<x>:USB:SIGNALTYpe {SINGLE|DIFF}`  
`BUS:B<x>:USB:SIGNALTYpe?`

**Arguments**    `B<x>` is the number of the bus waveform.  
`SINGLE` specifies single-ended signals.  
`DIFF` specifies differential signals.

**Examples**    `BUS:B1:USB:SIGNALTYpe SINGLE` specifies single-ended signals.  
`BUS:B1:USB:SIGNALTYpe?` might return `BUS:B1:USB:SIGNALTYpe DIFF` indicating the signal type is differential.

## **BUS:B<x>:USB:SOUrce**

This command sets or queries the USB data source when the signal type is differential for bus <x>. The bus number is specified by x.

**Conditions**    Requires option SR-USB2.

<b>Group</b>	Bus
<b>Syntax</b>	<code>BUS:B&lt;x&gt;:USB:SOURce {S&lt;x&gt;_Ch&lt;x&gt;   CH&lt;x&gt;   MATH&lt;x&gt;   REF&lt;x&gt;}</code> <code>BUS:B&lt;x&gt;:USB:SOURce?</code>
<b>Related Commands</b>	<a href="#">BUS:B&lt;x&gt;:USB:SOURce:DMINus</a> <a href="#">BUS:B&lt;x&gt;:USB:SOURce:DPLUs</a>
<b>Arguments</b>	<code>B&lt;x&gt;</code> is the number of the bus waveform. <code>S&lt;x&gt;_Ch&lt;x&gt;</code> specifies the remote scope number and the analog channel. <code>CH&lt;x&gt;</code> specifies an analog channel as the data source for the specified USB bus. <code>MATH&lt;x&gt;</code> specifies a math channel as the data source for the specified USB bus. <code>REF&lt;x&gt;</code> specifies a reference waveform as the data source.
<b>Examples</b>	<code>BUS:B1:USB:SOURCE D2</code> sets the USB data source for bus B1 to D2. <code>BUS:B1:USB:SOURCE?</code> might return <code>BUS:B1:USB:SOURCE D3</code> , indicating that the USB data source for bus B1 is D3.

## BUS:B<x>:USB:SOURce:DMINus

This command sets or queries the USB D- (SDATAMINUS) source for bus <x> when the signal type is single ended. The bus number is specified by x.

<b>Conditions</b>	Requires option SR-USB2.
<b>Group</b>	Bus
<b>Syntax</b>	<code>BUS:B&lt;x&gt;:USB:SOURce:DMINus</code> <code>{S&lt;x&gt;_Ch&lt;x&gt;_D&lt;x&gt;   CH&lt;x&gt;   CH&lt;x&gt;_D&lt;x&gt;   MATH&lt;x&gt;   REF&lt;x&gt;   REF&lt;x&gt;_D&lt;x&gt;}</code> <code>BUS:B&lt;x&gt;:USB:SOURce:DMINus?</code>
<b>Related Commands</b>	<a href="#">BUS:B&lt;x&gt;:USB:SOURce</a> <a href="#">BUS:B&lt;x&gt;:USB:SOURce:DPLUs</a> <a href="#">BUS:B&lt;x&gt;:USB:SIGNALTYpe</a>

<b>Arguments</b>	<p><b>B&lt;x&gt;</b> is the number of the bus waveform.</p> <p><b>S&lt;x&gt;_Ch&lt;x&gt;_D&lt;x&gt;</b> specifies is the remote scope number, the analog channel and the digital channel.</p> <p><b>CH&lt;x&gt;</b> specifies an analog channel as the D- source for the specified USB bus.</p> <p><b>CH&lt;x&gt;_D&lt;x&gt;</b> specifies a digital channel as the D- source for the specified USB bus.</p> <p><b>MATH&lt;x&gt;</b> specifies a math channel as the D- source for the specified USB bus.</p> <p><b>REF&lt;x&gt;</b> specifies a reference waveform as the source</p> <p><b>REF&lt;x&gt;_D&lt;x&gt;</b> specifies a digital reference waveform as the clock source waveform for the specified USB bus.</p>
<b>Examples</b>	<p><b>BUS:B1:USB:SOURCE:DMINUS CH2</b> sets the USB Data Source for D- input to CH2.</p> <p><b>BUS:B1:USB:SOURCE:DMINUS?</b> might return <b>BUS:B1:USB:SOURCE:DMINUS CH4</b>, indicating that CH4 is set to be the D- input for USB data.</p>

## BUS:B<x>:USB:SOURce:DPLUs

This command sets or queries the USB dataPlus (SDATAPLUS) source for the specified bus when the signal type is single ended. The bus is specified by x.

<b>Conditions</b>	Requires option SR-USB2.
<b>Group</b>	Bus
<b>Syntax</b>	<p><b>BUS:B&lt;x&gt;:USB:SOURce:DPLUS</b>  <b>{S&lt;x&gt;_Ch&lt;x&gt;_D&lt;x&gt; CH&lt;x&gt; CH&lt;x&gt;_D&lt;x&gt; MATH&lt;x&gt; REF&lt;x&gt; REF&lt;x&gt;_D&lt;x&gt;}</b>  <b>BUS:B&lt;x&gt;:USB:SOURce:DPLUS?</b></p>
<b>Related Commands</b>	<p><a href="#">BUS:B&lt;x&gt;:USB:SOURce</a></p> <p><a href="#">BUS:B&lt;x&gt;:USB:SOURce:DMINus</a></p> <p><a href="#">BUS:B&lt;x&gt;:USB:SIGNALTYpe</a></p>
<b>Arguments</b>	<p><b>B&lt;x&gt;</b> is the number of the bus waveform.</p> <p><b>S&lt;x&gt;_Ch&lt;x&gt;_D&lt;x&gt;</b> specifies is the remote scope number, the analog channel and the digital channel.</p>

CH<x> specifies an analog channel as the D+ source for the specified USB bus

CH<x>\_D<x> specifies a digital channel as the D+ source for the specified USB bus

MATH<x> specifies a math channel as the D+ source for the specified USB bus.

REF<x> specifies a reference waveform as the source.

REF<x>\_D<x> specifies a digital reference waveform as the clock source waveform for the specified USB bus.

**Examples**    `BUS:B1:USB:SOURCE:DPLUS CH2` sets the USB Data Source for D+ input to CH2.

`BUS:B1:USB:SOURCE:DPLUS?` might return `BUS:B1:USB:SOURCE:DPLUS CH3`, indicating that CH3 is set to be the D+ input for USB data.

## BUS:B<x>:USB:THRESHold

This command sets or queries the USB DATA source High threshold for the specified bus when the signal source is differential. The bus is specified by x.

**Conditions**    Requires option SR-USB2.

**Group**        Bus

**Syntax**       `BUS:B<x>:USB:THRESHold <NR3>`  
`BUS:B<x>:USB:THRESHold?`

**Arguments**    `B<x>` is the number of the bus waveform.

`<NR3>` is the USB DATA source High threshold for the specified bus.

**Examples**     `BUS:B1:USB:THRESHold 50.0e-3` sets the threshold to 50.0 mV.

`BUS:B1:USB:THRESHold?` might return `BUS:B1:USB:THRESHOLD 0.0E+0` indicating the threshold is set to 0.0 V.

## BUS:DELeTe (No Query Form)

This command deletes the specified bus.

<b>Group</b>	Bus
<b>Syntax</b>	BUS:DELeTe <QString>
<b>Arguments</b>	<QString> specifies the bus to delete and is of the form "B<NR1>", where <NR1> is $\geq 1$ .
<b>Examples</b>	BUS:DELETE B1 deletes bus B1.

## BUS:LIST? (Query Only)

This query returns a comma separated list of all currently defined buses.

<b>Group</b>	Bus
<b>Syntax</b>	BUS:LIST?
<b>Returns</b>	Returns all currently defined buses.
<b>Examples</b>	BUS:LIST? might return BUS:LIST B1,B4 indicating the bus 1 and bus 4 are defined.

## BUSTABLE:ADDNew (No Query Form)

Adds the specified bus table. Argument is of the form "TABLE<NR1>", where <NR1> is  $\geq 1$ ).

<b>Group</b>	Bus
<b>Syntax</b>	BUSTABLE:ADDNew <QString>
<b>Arguments</b>	<QString> is a quoted string that is the name of the new bus table.
<b>Examples</b>	BUSTABLE:ADDNEW "Table1" adds bus table Table1.



## BUSTABLE:DELEte (No Query Form)

Deletes the specified bus table. Argument is of the form "TABLE<NR1>", where <NR1> is  $\geq 1$ ).

**Group** Bus

**Syntax** BUSTABLE:DELEte <QString>

**Arguments** <QString> is a quoted string that is the name of the bus table to delete.

**Examples** BUSTABLE:DELETE "Table1" deletes bus table Table1.

## BUSTABLE:LIST? (Query Only)

This query lists all currently defined bus tables.

**Group** Bus

**Syntax** BUSTABLE:LIST?

**Returns** Returns a list of all currently defined bus tables.

**Examples** BUSTABLE:LIST? might return BUSTABLE:LIST TABLE1 indicating TABLE1 is currently the only defined bus table.

## BUSY? (Query Only)

This query-only command returns the status of the instrument. This command allows you to synchronize the operation of the instrument with your application program.

**Group** Status and Error

**Syntax** BUSY?

**Related Commands**    [\\*OPC](#)  
                              [\\*WAI](#)

**Returns**            <NR1> = 0 means that the instrument is not busy processing a command whose execution time is extensive.  
  
                          <NR1> = 1 means that the instrument is busy processing Commands that Generate an OPC Message(See Table 3-3.).

**Examples**            BUSY? might return BUSY 1, indicating that the instrument is currently busy.

## CALLOUTS:CALLOUT<x> (No Query Form)

This command creates a new note. A Note is the default callout value. The callout number is specified by x.

**Group**              Callouts

**Syntax**             CALLOUTS:CALLOUT<x>

**Examples**            CALLOUTS:CALLOUT1 creates a new Note callout specified as callout1.

## CALLOUTS:CALLOUT<x>:BOOKMark:SOURCE

This command sets or queries the source of the Bookmark callout type.

**Group**              Callouts

**Syntax**             CALLOUTS:CALLOUT<x>:BOOKMark:SOURCE {CH1|CH2|CH3|CH4}  
                          CALLOUTS:CALLOUT<x>:BOOKMark:SOURCE?

**Arguments**        CH1 specifies the bookmark callout source as Ch1.  
                          CH2 specifies the bookmark callout source as Ch2.  
                          CH3 specifies the bookmark callout source as Ch3.  
                          CH4 specifies the bookmark callout source as Ch4.

- Examples** `CALLOUTS:CALLOUT1:BOOKMark:SOURCE CH2` sets the bookmark callout source as Ch2 for callout1.
- `CALLOUTS:CALLOUT1:BOOKMark:SOURCE?`, might return "CH1", indicating that the bookmark callout source is Ch1.

## CALLOUTS:CALLOUT<x>:BOOKMark:XPOS

This command sets or queries the X-Position of the Bookmark callout type.

- Group** Callouts
- Syntax** `CALLOUTS:CALLOUT<x>:BOOKMark:XPOS <NR1>`  
`CALLOUTS:CALLOUT<x>:BOOKMark:XPOS?`
- Arguments** <NR1> specifies the location of the bookmark linked to the source waveform in X-axis.
- Examples** `CALLOUTS:CALLOUT1:BOOKMark:XPOS 9.28µs` sets the bookmark callout X-Position to 9.28 µs for callout1.
- `CALLOUTS:CALLOUT1:BOOKMark:XPOS?`, might return "9.28 µs", indicating the bookmark callout X-Position is 9.28 µs.

## CALLOUTS:CALLOUT<x>:COLOR

This command sets or queries the text color of the callout.

- Group** Callouts
- Syntax** `CALLOUTS:CALLOUT<x>:COLOR <QString>`  
`CALLOUTS:CALLOUT<x>:COLOR?`
- Arguments** <QString> specifies the callout text color using hexadecimal color values.
- Examples** `CALLOUTS:CALLOUT1:COLOR "#FF0000"` sets the text color of callout 1 to red.
- `CALLOUTS:CALLOUT1:COLOR?`, might return "#FF0000", indicating the text color is red.

## CALLOUTS:CALLOUT<x>:DISPLAYPOSITION:X

This command sets or queries horizontal display position of the callout text.

<b>Group</b>	Callouts
<b>Syntax</b>	CALLOUTS:CALLOUT<x>:DISPLAYPOSITION:X <NR1> CALLOUTS:CALLOUT<x>:DISPLAYPOSITION:X?
<b>Arguments</b>	<NR1> specifies the callout horizontal display position.
<b>Examples</b>	CALLOUTS:CALLOUT1:DISPLAYPOSITION:X 50 sets the callout text in the center on the horizontal axis of the display on the scopeapp.  CALLOUTS:CALLOUT1:DISPLAYPOSITION:X?, might return "50", indicating the callout text is in the center on the horizontal axis of the display on the scopeapp

## CALLOUTS:CALLOUT<x>:DISPLAYPOSITION:Y

This command sets or queries vertical display position of the callout text.

<b>Group</b>	Callouts
<b>Syntax</b>	CALLOUTS:CALLOUT<x>:DISPLAYPOSITION:Y <NR1> CALLOUTS:CALLOUT<x>:DISPLAYPOSITION:Y?
<b>Arguments</b>	<NR1> specifies the callout vertical display position.
<b>Examples</b>	CALLOUTS:CALLOUT1:DISPLAYPOSITION:Y 50 sets the callout text in the center on the vertical axis of the display on the scopeapp.  CALLOUTS:CALLOUT1:DISPLAYPOSITION:Y?, might return "50", indicating the callout text is in the center on the vertical axis of the display on the scopeapp

## CALLOUTS:CALLOUT<x>:FONT:BOLD

This command sets or queries the bold state of the callout text.

<b>Group</b>	Callouts
--------------	----------

<b>Syntax</b>	CALLOUTS:CALLOUT<x>:FONT:BOLD {1 0} CALLOUTS:CALLOUT<x>:FONT:BOLD?
<b>Arguments</b>	1 specifies the callout font weight as bold. 0 specifies the callout font weight as normal.
<b>Examples</b>	CALLOUTS:CALLOUT1:FONT:BOLD 1 sets the font weight of callout1 to bold. CALLOUTS:CALLOUT1:FONT:BOLD?, might return "0", indicating the font weight is set to normal.

## CALLOUTS:CALLOUT<x>:FONT:ITALIC

This command sets or queries the italic state of the callout text.

<b>Group</b>	Callouts
<b>Syntax</b>	CALLOUTS:CALLOUT<x>:FONT:ITALIC {1 0} CALLOUTS:CALLOUT<x>:FONT:ITALIC?
<b>Arguments</b>	1 specifies the callout font style as italic. 0 does not specify the font style as italic.
<b>Examples</b>	CALLOUTS:CALLOUT1:FONT:ITALIC 1 sets the font style of callout1 to italic. CALLOUTS:CALLOUT1:FONT:ITALIC?, might return "0", indicating the font style is not italic.

## CALLOUTS:CALLOUT<x>:FONT:SIZE

This command sets or queries the font size of the callout text.

<b>Group</b>	Callouts
<b>Syntax</b>	CALLOUTS:CALLOUT<x>:FONT:SIZE <NR1> CALLOUTS:CALLOUT<x>:FONT:SIZE?
<b>Arguments</b>	<NR1> specifies the font size in points.

**Examples**    `CALLOUTS:CALLOUT1:FONT:SIZE 11` sets the font size of callout1 to 11 points.  
`CALLOUTS:CALLOUT1:FONT:SIZE?`, might return "14", indicating the font size is 14 points.

## **CALLOUTS:CALLOUT<x>:FONT:TYPE**

This command sets or queries type of the callout.

**Group**    Callouts

**Syntax**    `CALLOUTS:CALLOUT<x>:FONT:TYPE <QString>`  
`CALLOUTS:CALLOUT<x>:FONT:TYPE?`

**Arguments**    `<QString>` specifies the type of font for the callout text. The available font types include: DejaVu Sans, DejaVu Sans Mono, DejaVu Serif, Frutiger LT Std, Monospace, Sans Serif, Serif, Ubuntu, Ubuntu Condensed, and Ubuntu Mono.

**Examples**    `CALLOUTS:CALLOUT1:FONT:TYPE "Serif"` sets the font type of callout1 to serif.  
`CALLOUTS:CALLOUT1:FONT:TYPE?`, might return "Monospace", indicating the font type is monospace.

## **CALLOUTS:CALLOUT<x>:FONT:UNDERLine**

This command sets or queries the underline state of the callout text.

**Group**    Callouts

**Syntax**    `CALLOUTS:CALLOUT<x>:FONT:UNDERLine {1|0}`  
`CALLOUTS:CALLOUT<x>:FONT:UNDERLine?`

**Arguments**    1 underlines the callout text.  
0 does not underline the callout text.

**Examples**    `CALLOUTS:CALLOUT1:FONT:UNDERLine 1` displays the text of callout 1 as underlined.

CALLOUTS:CALLOUT1:FONT:UNDERLINE?, might return "0", indicating the callout text is not underlined.

## CALLOUTS:CALLOUT<x>:TEXT

This command sets or queries the callout text.

<b>Group</b>	Callouts
<b>Syntax</b>	CALLOUTS:CALLOUT<x>:TEXT <QString> CALLOUTS:CALLOUT<x>:TEXT?
<b>Arguments</b>	<QString> specifies the callout text.
<b>Examples</b>	CALLOUTS:CALLOUT1:TEXT "Review measurements" sets the text for callout 1 as "Review measurements".  CALLOUTS:CALLOUT1:TEXT?, might return "Review measurements", indicating the text for callout 1 is "Review measurements".

## CALLOUTS:CALLOUT<x>:TYPE

This command sets or queries type of the callout.

<b>Group</b>	Callouts
<b>Syntax</b>	CALLOUTS:CALLOUT<x>:TYPE {NOTE ARROW RECTANGLE BOOKMARK} CALLOUTS:CALLOUT<x>:TYPE?
<b>Arguments</b>	NOTE specifies callout type as note.  ARROW specifies callout type as arrow.  RECTANGLE specifies callout type as rectangle.  BOOKMARK specifies callout type as bookmark.
<b>Examples</b>	CALLOUTS:CALLOUT1:TYPE NOTE sets the callout type of callout1 to note.  CALLOUTS:CALLOUT1:TYPE?, might return "ARROW", indicating the callout type is arrow.

## CH<x>? (Query Only)

This query-only command returns the vertical parameters for the specified channel. The channel is specified by x.

<b>Group</b>	Vertical
<b>Syntax</b>	CH<x>?
<b>Examples</b>	<p>CH1? might return the following vertical parameters for channel 1:</p> <pre>CH1:BANDWIDTH 1.0000E+09;COUPLING DC;DESKEW0.0000E+00;OFFSET 0.0000E+00;POSITION 0.0000E+00;SCALE 5.0000E-01;PROBCAL INIT;PROBE:GAIN 1.0000E+00;RESISTANCE 1.0000E+06;UNITS "V";ID:TYPE "1X";SERNUMBER "N/A";:CH1:PROBEFUNC:EXTATTEN 1.0000E+00;EXTUNITS "None";:CH1:LABEL:NAME "";XPOS 5;YPOS 5.</pre>

## CH<x>:BANDwidth

This command sets or queries the selectable low-pass bandwidth limit filter of the specified channel. The channel is specified by x.

The query form of this command always returns the approximate realized bandwidth of the channel.

Available arguments depend upon the instrument and the attached accessories.

<b>Group</b>	Vertical
<b>Syntax</b>	<pre>CH&lt;x&gt;:BANDwidth {&lt;NR3&gt; FUL1} CH&lt;x&gt;:BANDwidth?</pre>
<b>Arguments</b>	<p>CH&lt;x&gt; is the channel number.</p> <p>&lt;NR3&gt; is the desired bandwidth. The instrument rounds this value to an available bandwidth using geometric rounding and then uses this value to set the upper bandwidth.</p> <p>FUL1 disables any optional bandwidth limiting. The specified channel operates at its maximum bandwidth.</p>



**Examples** CH1: BANDWIDTH 20 sets the bandwidth of Channel 1 to 20 MHz.  
 CH2: BANDWIDTH?, might return :CH2: BANDWIDTH 500.0000E+06, indicating that there is bandwidth limiting on Channel 2.

## CH<x>:BANDwidth:FILTer:OPTIMIZatiOn

This command sets or queries the channel filter shape. The channel is specified by x.

**Conditions** Only available on 6 Series MSO instruments.

**Group** Vertical

**Syntax** CH<x>:BANDwidth:FILTer:OPTIMIZatiOn {STEPRESPONSE|FLATNESS}  
 CH<x>:BANDwidth:FILTer:OPTIMIZatiOn?

**Arguments** CH<x> is the channel number.  
 STEPRESPONSE sets a Bessel-Thompson filter that minimizes overshoot with a gradual rolloff.  
 FLATNESS sets selects a brick-wall filter optimized for flatness within band with a sharp rolloff. Flatness filtering is not compatible with Peak Detect and Envelope acquisition modes..

**Examples** CH1: BANDwidth:FILTer:OPTIMIZatiOn FLATNESS sets channel 1 filter shape to Flatness.  
 CH1: BANDwidth:FILTer:OPTIMIZatiOn?, might return :CH1: BANDwidth:FILTer:OPTIMIZatiOn FLATNESS, indicating that the filter shape is Flatness for channel 2.

## CH<x>:DITHErRange

This command sets or returns the amount of dithering for the specified analog channel. The channel is specified by x. The amount of dithering is a percentage of full scale (10 times volts/division).

Note: Setting this value to 0.0 for any unused channels may slightly improve performance.

**Group** Vertical

**Syntax** CH<x>:DITHerRange <NR3>  
CH<x>:DITHerRange?

**Arguments** <NR3> is the amount of dithering as a percentage of full scale. Must be between 0.0 and 100.0 and 0.0 disables dithering.

**Examples** CH1:DITHerRange 10 sets the amount of dithering as a percentage of full scale to 10.

CH1:DITHerRange? might return CH1:DITHerRange 10, which if vertical scale is 1V/div then the dithering amplitude will be 1 Vpk-pk.

## CH<x>:INVert

This command sets or queries invert state of the specified channel. The channel is specified by x.

**Group** Vertical

**Syntax** CH<x>:INVert {ON|OFF|<NR1>}  
CH<x>:INVert?

**Arguments** OFF turns off the channel invert.  
ON turns on the channel invert.  
<NR1> 0 turns off the channel invert; any other value turns on the channel invert.

**Examples** CH2:INVert OFF turns off the invert on channel 2.

CH2:INVert? might return CH2:INVert 1, indicating channel 2 is inverted.

## CH<x>:PRObe? (Query Only)

This query-only command returns all information concerning the probe that is attached to the specified channel. The channel is specified by x.

**Group** Vertical

**Syntax** CH<x>:PRObe?

**Related Commands** [CH<x>:PROBECal?](#)

**Examples** CH2:PROBE? might return CH2:PROBE:GAIN 1.0000E-01; RESISTANCE 1.0000E+07;UNITS "V";ID:TYPE "10X" 'SERNUMBER "N/A" for a 10X probe, indicating that (among other parameters) the attenuation factor for the probe attached to Channel 2 is 100.0 mV (assuming that probe units are set to volts).

## CH<x>:PRObe:AUTOZero (No Query Form)

This command executes the attached probe's Auto Zero function, for probes that support this feature. See your probe documentation for more details. The channel is specified by x.

**Group** Vertical

**Syntax** CH<x>:PRObe:AUTOZero EXECute

**Arguments** CH<x> is the channel number.  
EXECute sets the probe attached to the specified channel to autozero.

**Examples** CH1:PROBE:AUTOZERO EXECUTE sets the probe attached to the Channel 1 to autozero.

## CH<x>:PRObe:COMPensate (No Query Form)

This command starts the probe compensation procedure for passive probes. The channel is specified by x.

**Group** Vertical

**Syntax** CH<x>:PRObe:COMPensate

**Examples** CH1:PRObe:COMPensate starts probe compensation for passive probes (TPP).

## CH<x>:PRObe:DEGAUSS (No Query Form)

This command starts a degauss cycle of the TekVPI probe attached to the specified channel. The channel is specified by x.

<b>Group</b>	Vertical
<b>Syntax</b>	CH<x>:PRObe:DEGAUSS EXECute
<b>Arguments</b>	CH<x> is the channel number. EXECute starts the degauss cycle.
<b>Examples</b>	CH1:PROBE:DEGAUSS EXECUTE causes the probe attached to Channel 1 to degauss.

## CH<x>:PRObe:DEGAUSS:STATE? (Query Only)

This command queries whether the probe attached to the specified channel requires a degauss operation. The channel is specified by x.

<b>Group</b>	Vertical
<b>Syntax</b>	CH<x>:PRObe:DEGAUSS:STATE?
<b>Returns</b>	Required indicates the probe should be degaussed before taking measurements. Recommended indicates the measurement accuracy might be improved by degaussing the probe. Passed indicates the probe is degaussed. Failed indicates the degauss operation failed. Inprocess indicates the probe degauss operation is currently in progress.
<b>Examples</b>	CH2:PROBE:DEGAUSS:STATE? might return CH2:PROBE:DEGAUSS:STATE PASSED, indicating that the probe attached to the Channel 2 is degaussed.

## CH<x>:PRObe:FORCEDRange

This command sets the attached TekVPI probe to the specified range, or it queries the range of the probe attached to the specified channel. The channel is specified by x.

<b>Group</b>	Vertical
<b>Syntax</b>	CH<x>:PRObe:FORCEDRange <NR3> CH<x>:PRObe:FORCEDRange?
<b>Arguments</b>	CH<x> is the channel number.  <NR3> specifies the probe dynamic range.
<b>Examples</b>	If a TCP0030 current probe is attached to the Channel 1 input, CH1:PROBE:FORCEDRANGE 5.0 sets the attached probe to its 5 Ampere range.  CH3:PROBE:FORCEDRANGE? might return CH1:PROBE:FORCEDRANGE 30.0000, indicating that the range of the probe attached to the Channel 3 is set to 30 Amperes.

## CH<x>:PRObe:GAIN? (Query Only)

This query-only command returns the gain factor of the probe that is attached to the specified channel. The channel is specified by x. The gain of a probe is the output divided by the input transfer ratio. For example, a common 10x probe has a gain of 0.1.

<b>Group</b>	Vertical
<b>Syntax</b>	CH<x>:PRObe:GAIN?
<b>Examples</b>	CH2:PROBE:GAIN? might return CH2:PROBE:GAIN 100.0000E-3, indicating that the attached 10X probe delivers 0.1 V to the Channel 2 BNC for every 1.0 V applied to the probe input.

## CH<x>:PRObe:ID? (Query Only)

This query-only command returns the type and serial number of the probe that is attached to the specified channel. The channel is specified by x.

<b>Group</b>	Vertical
<b>Syntax</b>	CH<x>:PRObe:ID?
<b>Examples</b>	CH2:PROBE:ID? might return CH2:PROBE:ID:TYPE "10X";SERNUMBER "N/A", indicating that a passive 10X probe of unknown serial number is attached to Channel 2.

## CH<x>:PRObe:ID:SERnumber? (Query Only)

This query-only command returns the serial number of the probe that is attached to the specified channel. The channel is specified by x.

---

**NOTE.** For Level 0 and 1 probes, the serial number will be "N/A".

---

<b>Group</b>	Vertical
<b>Syntax</b>	CH<x>:PRObe:ID:SERnumber?
<b>Examples</b>	CH1:PROBE:ID:SERNUMBER? might return CH1:PROBE:ID:SERNUMBER "B010289", indicating that the serial number of the probe attached to Channel 1 is B010289.

## CH<x>:PRObe:ID:TYPE? (Query Only)

This query-only command returns the type of probe that is attached to the specified channel. The channel is specified by x.

<b>Group</b>	Vertical
<b>Syntax</b>	CH<x>:PRObe:ID:TYPE?
<b>Examples</b>	CH1:PROBE:ID:TYPE? might return CH1:PROBE:ID:TYPE "TCP0030", indicating that a TCP0030 current probe is attached to Channel 1.

## CH<x>:PRObe:INPUTMode

Sets or queries the input mode of the probe that is attached to the specified channel.

**Conditions** Requires a probe with dual inputs.

**Group** Vertical

**Syntax** CH<x>:PRObe:INPUTMode {A|B|C|D}  
CH<x>:PRObe:INPUTMode?

**Arguments** CH<x> is the channel number.

A sets the probe to send single-ended A signals to the instrument.

B sets the probe to send single-ended B signals to the instrument.

COMMONMODE sets the probe to send common-mode signals to the instrument.

DIFFERENTIAL sets the probe to send differential signals to the instrument.

**Examples** CH8:PROBE:INPUTMODE COMMONMODE sets the probe input type to send common mode signals to channel 8.

CH6:PROBE:INPUTMODE? might return CH6:PROBE:INPUTMODE A, indicating that the input mode of the probe that is attached to the Channel 6 is set to single ended A signals.

## CH<x>:PRObe:INPUTMode:AOffset

Sets or queries the A mode offset control of the probe that is attached to the specified channel.

**Conditions** Requires a probe with dual inputs.

**Group** Vertical

**Syntax** CH<x>:PRObe:INPUTMode:AOffset <NR3>  
CH<x>:PRObe:INPUTMode:AOffset?

<b>Arguments</b>	CH<x> is the channel number.  <NR3> sets the A mode offset value, in vertical units (V or A).
<b>Examples</b>	CH2:PROBE:INPUTMODE:AOFFSET 5.0 sets the A mode offset control value of the probe that is attached to the Channel 2 to 5.  CH1:PROBE:INPUTMODE:AOFFSET? might return CH1:PROBE:INPUTMODE:AOFFSET? 0.0000, indicating that the A mode offset value of the probe that is attached to the channel 1 is set to 0.0.

## CH<x>:PRObe:INPUTMode:BOFFSet

Sets or queries the B mode offset control of the probe that is attached to the specified channel.

<b>Conditions</b>	Requires a probe with dual inputs.
<b>Group</b>	Vertical
<b>Syntax</b>	CH<x>:PRObe:INPUTMode:BOFFSet <NR3> CH<x>:PRObe:INPUTMode:BOFFSet?
<b>Arguments</b>	CH<x> is the channel number.  <NR3> sets the B mode offset value, in vertical units (V or A).
<b>Examples</b>	CH2:PROBE:INPUTMODE:BOFFSET 5.0 sets the B mode offset value of the probe that is attached to the Channel 2 to 5.  CH5:PROBE:INPUTMODE:BOFFSET? might return CH5:PROBE:INPUTMODE:BOFFSET? 1.2500, indicating that the B mode offset value of the probe that is attached to the channel 5 is set to 1.25.

## CH<x>:PRObe:INPUTMode:COFFSet

Sets or queries the common mode offset value of the probe that is attached to the specified channel.

<b>Conditions</b>	Requires a probe with dual inputs.
-------------------	------------------------------------



<b>Group</b>	Vertical
<b>Syntax</b>	CH<x>:PRObe:INPUTMode:COFFSet <NR3> CH<x>:PRObe:INPUTMode:COFFSet?
<b>Arguments</b>	CH<x> is the channel number.  <NR3> sets the C (common) mode offset value, in vertical units (V or A).
<b>Examples</b>	CH7:PROBE:INPUTMODE:COFFSET 3.2 sets the C mode offset value of the probe that is attached to the Channel 7 to 3.2.  CH5:PROBE:INPUTMODE:COFFSET? might return CH5:PROBE:INPUTMODE:COFFSET? 1.0250, indicating that the C mode offset value of the probe that is attached to the channel 5 is set to 1.025.

## CH<x>:PRObe:INPUTMode:DOFFSet

Sets or queries the differential offset value of the probe that is attached to the specified channel.

<b>Conditions</b>	Requires a probe with dual inputs.
<b>Group</b>	Vertical
<b>Syntax</b>	CH<x>:PRObe:INPUTMode:DOFFSet <NR3> CH<x>:PRObe:INPUTMode:DOFFSet?
<b>Arguments</b>	CH<x> is the channel number.  <NR3> sets the D (differential) mode offset value, in vertical units (V or A).
<b>Examples</b>	CH7:PROBE:INPUTMODE:DOFFSET 3.2 sets the D mode offset value of the probe that is attached to the Channel 7 to 3.2.  CH5:PROBE:INPUTMODE:DOFFSET? might return CH5:PROBE:INPUTMODE:DOFFSET? 1.0250, indicating that the D mode offset value of the probe that is attached to the channel 5 is set to 1.025.

## CH<x>:PRObe:RESistance? (Query Only)

This query-only command returns the resistance of the probe that is attached to the specified channel. The channel is specified by x.

**Group** Vertical

**Syntax** CH<x>:PRObe:RESistance?

**Examples** CH2:PROBE:RESISTANCE? might return :CH2:PROBE:RESISTANCE  
1.0000E+06, indicating that the input resistance of the probe attached to Channel 2 is 1 M $\Omega$ .

## CH<x>:PRObe:SELFCal (No Query Form)

This command initiates self-calibration on the probe. The channel is specified by x.

**Group** Vertical

**Syntax** CH<x>:PRObe:SELFCal EXECUTE

**Examples** CH1:PRObe:SELFCal EXECUTE runs self-calibration on the Channel 1 probe.

## CH<x>:PRObe:SELFCal:State? (Query Only)

This query-only command returns the self-calibration state. The channel is specified by x.

**Group** Vertical

**Syntax** CH<x>:PRObe:SELFCal:State? EXECUTE

**Returns** This query returns the self-calibration state of RECOMMENDED, RUNNING, or PASSED.

**Examples** CH1:PRObe:SELFCal:State? might return :CH1:PRObe:SELFCal:State RUNNING, indicating that the Channel 1 probe is currently running a self-calibration.

## CH<x>:PRObe:SET

This command sets or queries aspects of probe accessory user interfaces, for example probe attenuation factors or probe audible over range. The available arguments for this command will vary depending on the accessory you attach to the instrument. The channel is specified by x.

**Group** Vertical

**Syntax** CH<x>:PRObe:SET <QString>  
CH<x>:PRObe:SET?

**Arguments** CH<x> is the channel number.  
  
<QString> is a quoted string representing a settable aspect of the attached accessory.

**Examples** CH6:PRObe:SET "ATTENUATION 10X" sets the probe to 10X attenuation.  
  
CH6:PRObe:SET? might return CH6:PROBE:SET "ATTENUATION 25X" indicating that the probe is set to the selection for 25X attenuation.

## CH<x>:PRObe:STATUs? (Query Only)

Queries the probe unsigned integer error value.

**Conditions** Requires a probe that supports the relevant error messages.

**Group** Vertical

**Syntax** CH<x>:PRObe:STATUs?x

**Returns** Returns an integer number that represents the sum total of binary error bits B0 – B15. The error bits are not displayed; they are concatenated into the integer value. The following is a list of the error for each bit.

- B0 – Probe disabled
- B1 – Jaws open
- B2 – Over range
- B3 – Probe temperature out of limits
- B4 – Degauss needed
- B5 – Probe tip missing
- B6 – Probe tip failed
- B7 – Probe tip not supported
- B8 through B15 – Reserved

**Examples** CH4:PROBE:STATUS? might return CH4:PROBE:STATUS 0, indicating that the probe is not reporting any errors.

CH4:PROBE:STATUS? might return CH4:PROBE:STATUS 20, indicating that the probe is reporting an over range error and a Degauss needed error.

CH4:PROBE:STATUS? might return CH4:PROBE:STATUS 2, indicating that the probe is reporting an open jaws error.

## CH<x>:PROBe:UNIts? (Query Only)

This query-only command returns a string describing the units of measure for the probe attached to the specified channel. The channel is specified by x.

**Group** Vertical

**Syntax** CH<x>:PROBe:UNIts?

**Related Commands** [CH<x>:PROBEFunc:EXTUnits](#)

**Examples** CH4:PROBE:UNITS? might return :CH4:PROBE:UNITS "V", indicating that the units of measure for the probe attached to Channel 4 are volts.

## CH<x>:PROBECal? (Query Only)

This query-only command returns the probe calibration state for the specified channel. The channel is specified by x.

<b>Group</b>	Vertical
<b>Syntax</b>	CH<x>:PROBECAL?
<b>Returns</b>	This query will return one of the following: <ul style="list-style-type: none"> <li>■ <b>Failed</b> signifies that the probe calibration has failed for the selected channel.</li> <li>■ <b>Default</b> signifies that the probe calibration has not yet been run for the selected channel.</li> <li>■ <b>Passed</b> signifies the probe calibration has passed for the selected channel.</li> <li>■ <b>Running</b> signifies the probe calibration is running.</li> </ul>
<b>Examples</b>	CH2:PROBECAL? might return CH2:PROBECAL PASSED indicating that the probe calibration has passed for Channel 2.

## CH<x>:PROBECOntrOl

This command sets or queries multirange probe range-control policy preference of the probe that is attached to CH<x>. The channel number is specified by x.

<b>Group</b>	Vertical
<b>Syntax</b>	CH<x>:PROBECOntrOl {AUTO MANuaL} CH<x>:PROBECOntrOl?
<b>Arguments</b>	CH<x> is the channel number.  AUTO sets the values. The probe range is automatically calculated.  MANuaL allows you to select various valid values for the probe connected to a particular channel.
<b>Examples</b>	CH2:PROBECOntrOl AUTO sets the values and the probe range is automatically calculated.  CH2:PROBECOntrOl? might return CH2:PROBECOntrOl MANuaL indicating that you can select various valid values for the probe connected to channel 2.

## CH<x>:PROBEFunc:EXTAtten

This command is used to specify the attenuation value as a multiplier to the given scale factor on the specified channel. The channel is specified by x.

The query form of this command returns the user-specified attenuation.

**Group** Vertical

**Syntax** CH<x>:PROBEFunc:EXTAtten <NR3>  
CH<x>:PROBEFunc:EXTAtten?

**Related Commands** [CH<x>:PROBEFunc:EXTDBatten](#)

**Arguments** CH<x> is the channel number.  
  
<NR3> is the attenuation value, which is specified as a multiplier in the range from 1.00E-10 to 1.00E+10.

**Examples** CH1:PROBEFunc:EXTATTEN 167.00E-3 specifies an external attenuation, which is connected between the your input signal and the input of the probe attached to Channel 1.  
  
CH2:PROBEFunc:EXTATTEN? might return CH2:PROBEFunc:EXTATTEN 1.0000E+00, indicating that the probe attached to Channel 2 is connected directly to the user's signal.

## CH<x>:PROBEFunc:EXTDBatten

This command sets or queries the input-output ratio (expressed in decibel units) of external attenuation or gain between the signal and the instrument input channels. The channel is specified by x.

The query form of this command returns the user-specified attenuation in decibels.

**Group** Vertical

**Syntax** CH<x>:PROBEFunc:EXTDBatten <NR3>  
CH<x>:PROBEFunc:EXTDBatten?

**Related Commands** [CH<x>:PROBEFunc:EXTAtten](#)

<b>Arguments</b>	CH<x> is the channel number.  <NR3> is the attenuation value, which is specified in the range from -200.00 dB to 200.00 dB.
<b>Examples</b>	CH3:PROBEFUNC:EXTDBATTEN 2.5 specifies an external 2.5 dB attenuator on Channel 3.  CH1:PROBEFUNC:EXTDBATTEN? might return CH1:PROBEFUNC:EXTDBATTEEN 2.5000E+00, indicating that the attenuation for Channel 1 is 2.5 dB.

## CH<x>:PROBEFunc:EXTUnits

This command sets the unit of measurement for the external attenuator of the specified channel. The channel is specified by x. The alternate units are used if they are enabled. Use the [CH<x>:PROBEFunc:EXTUnits:STATE](#) command to enable or disable the alternate units.

<b>Group</b>	Vertical
<b>Syntax</b>	CH<x>:PROBEFunc:EXTUnits <QString> CH<x>:PROBEFunc:EXTUnits?
<b>Related Commands</b>	<a href="#">CH&lt;x&gt;:PROBe:UNIts?</a>
<b>Arguments</b>	CH<x> is the channel number.  <QString> indicates the attenuation unit of measurement for the specified channel.
<b>Examples</b>	CH4:PROBEFUNC:EXTUNITS "Pascals" sets the unit of measurement for the Channel 4 external attenuator.  CH2:PROBEFUNC:EXTUNITS? might return :CH2:PROBEFUNC:EXTUNITS "Pascals", indicating that the Channel 2 external attenuator units of measurement are Pascals.

## CH<x>:PROBEFunc:EXTUnits:STATE

This command sets or queries the custom units enable state for the specified channel. The channel is specified by x.

<b>Group</b>	Vertical
<b>Syntax</b>	CH<x>:PROBEFunc:EXTUnits:STATE {ON OFF <NR1>} CH<x>:PROBEFunc:EXTUnits:STATE?
<b>Arguments</b>	CH<x> is the channel number.  OFF argument turns off external units.  ON argument turns on external units.  <NR1> = 0 turns off external units; any other value turns on external units.
<b>Examples</b>	CH2:PROBEFunc:EXTUnits:STATE ON turns on external units.  CH2:PROBEFunc:EXTUnits:STATE? might return CH2:PROBEFunc:EXTUnits:STATE 0 indicating that external units are off for the specified channel.

## CH<x>:SCALERATIo

This command sets or returns the scale ratio for the specified analog channel.

<b>Group</b>	Vertical
<b>Syntax</b>	CH<x>:SCALERATIo <NR2> CH<x>:SCALERATIo?
<b>Arguments</b>	CH<x> is the channel number.  <NR2> is the scale ratio for the specified analog channel.
<b>Examples</b>	CH2:SCALERATIo 2.0 sets the scale ratio to 2.0.  CH2:SCALERATIo? might return CH2:SCALERATIO 1.0000 indicating the scale ratio is 1.0.

## CH<x>:SV:SPANABovebw? (Query Only)

This command queries whether the stop frequency for the specified spectrum trace channel is above the scope input bandwidth.



<b>Group</b>	Spectrum View
<b>Syntax</b>	CH<x>:SV:SPANABovebw?
<b>Arguments</b>	CH<x> specifies the spectrum trace channel source.
<b>Returns</b>	0 specifies the stop frequency is not above the scope bandwidth. 1 specifies the stop frequency is above the scope bandwidth.
<b>Examples</b>	CH3:SV:SPANABovebw? might return 0, indicating the stop frequency is not above the scope bandwidth.

### CH<x>:SV:SPANBELowdc? (Query Only)

This command queries whether the start frequency for the specified spectrum trace channel is below 0 Hz.

<b>Group</b>	Spectrum View
<b>Syntax</b>	CH<x>:SV:SPANBELowdc?
<b>Arguments</b>	CH<x> specifies the spectrum trace channel source.
<b>Returns</b>	0 specifies the start frequency is not below 0 Hz. 1 specifies the start frequency is below 0 Hz.
<b>Examples</b>	CH<x>:SV:SPANBELowdc? might return 0, indicating the start frequency is not below 0 Hz.

### CH<x>:TERmination

This command sets or queries the vertical termination for the specified analog channel. The channel is specified by x.

---

**NOTE.** *The available arguments depend on the instrument model and the attached accessories.*

---

<b>Group</b>	Vertical
<b>Syntax</b>	CH<x>:TERmination <NR3> CH<x>:TERmination?
<b>Arguments</b>	CH<x> is the channel number.  <NR3> specifies the channel input resistance, which can be specified as 50 $\Omega$ or 1,000,000 $\Omega$ .
<b>Examples</b>	CH4:TERMINATION 50.0E+0 establishes 50 $\Omega$ impedance on Channel 1.  CH2:TERMINATION? might return CH2:TERMINATION 50.0E+0, indicating that Channel 2 is set to 50 $\Omega$ impedance.

## CH<x>:VTERm:BIAS

Sets or queries the termination bias voltage for the specified channel (if control is available).

<b>Conditions</b>	Requires a probe with dual inputs.
<b>Group</b>	Vertical
<b>Syntax</b>	CH<x>:VTERm:BIAS <NR3> CH<x>:VTERm:BIAS?
<b>Arguments</b>	CH<x> is the channel number.  <NR> is the termination voltage.
<b>Examples</b>	CH1:VTERm:BIAS 1.5 sets the termination bias voltage on channel 1 to 1.5 Volts  CH2:VTERm:BIAS? might return CH2:VTERm:BIAS 0.0000, indicating that the termination bias voltage for channel 2 is set to 0 volts.

## CH<x>\_DALL:LABel:COLor

This command sets or queries the color of the specified digital group label. The channel is specified by x.

<b>Group</b>	Digital
<b>Syntax</b>	CH<x>_DALL:LABel:COLor <QString> CH<x>_DALL:LABel:COLor?
<b>Arguments</b>	CH<x> is the channel number.  <QString> is the color of the digital group label. To return the color to the default color, send an empty string as in this example: :CH5_DALL:LABel:COLOR "".
<b>Examples</b>	CH1_DALL:LABel:COLor "#FF0000" sets the font color to red. CH1_DALL:LABel:COLor? might return CH1_DALL:LABel:COLOR "#FFFF00" indicating the font color is yellow.

## CH<x>\_DALL:LABel:FONT:BOLD

This command sets or queries the bold state of the specified digital group. The channel is specified by x.

<b>Group</b>	Digital
<b>Syntax</b>	CH<x>_DALL:LABel:FONT:BOLD {ON OFF <NR1>} CH<x>_DALL:LABel:FONT:BOLD?
<b>Arguments</b>	CH<x> is the channel number.  OFF argument turns off bold font.  ON argument turns on bold font.  <NR1> = 0 turns off bold font; any other value turns on bold font.
<b>Examples</b>	CH1_DALL:LABel:FONT:BOLD ON sets the font to bold. CH1_DALL:LABel:FONT:BOLD? might return CH1_DALL:LABel:FONT:BOLD 0 indicating the font is not bold.

## CH<x>\_DALL:LABel:FONT:ITALic

This command sets or queries the italic state of the specified digital group. The channel is specified by x.

<b>Group</b>	Digital
<b>Syntax</b>	CH<x>_DALL:LABe1:FONT:ITALiC {ON OFF <NR1>} CH<x>_DALL:LABe1:FONT:ITALiC?
<b>Arguments</b>	CH<x> is the channel number.  OFF argument turns off italic font.  ON argument turns on italic font.  <NR1> = 0 turns off italic font; any other value turns on italic font.
<b>Examples</b>	CH1_DALL:LABe1:FONT:ITALiC 1 turns on italic font.  CH1_DALL:LABe1:FONT:ITALiC? might return CH1_DALL:LABEL:FONT:ITALIC 0 indicating the font is not italic.

## CH<x>\_DALL:LABe1:FONT:SIZE

This command sets or queries the font size of the specified digital group. The channel is specified by x.

<b>Group</b>	Digital
<b>Syntax</b>	CH<x>_DALL:LABe1:FONT:SIZE <NR1> CH<x>_DALL:LABe1:FONT:SIZE?
<b>Arguments</b>	CH<x> is the channel number.  <NR1> is the font size.
<b>Examples</b>	CH1_DALL:LABe1:FONT:SIZE 16 sets the font size to 16 points.  CH1_DALL:LABe1:FONT:SIZE? might return CH1_DALL:LABEL:FONT:SIZE 20 indicating the font size is 20 points.

## CH<x>\_DALL:LABe1:FONT:TYPE

This command sets or queries the font type of the specified digital group, such as Arial or Times New Roman. The channel is specified by x.

<b>Group</b>	Digital
<b>Syntax</b>	CH<x>_DALL:LABel:FONT:TYPE <QString> CH<x>_DALL:LABel:FONT:TYPE?
<b>Arguments</b>	CH<x> is the channel number. <QString> is the font type.
<b>Examples</b>	CH1_DALL:LABel:FONT:TYPE "Monospace" sets the font to a monospace font. CH1_DALL:LABel:FONT:TYPE? might return CH1_DALL:LABEL:FONT:TYPE "Frutiger LT Std 55 Roman".

## CH<x>\_DALL:LABel:FONT:UNDERline

This command sets or queries the underline state of the specified digital group. The channel is specified by x.

<b>Group</b>	Digital
<b>Syntax</b>	CH<x>_DALL:LABel:FONT:UNDERline {ON OFF <NR1>} CH<x>_DALL:LABel:FONT:UNDERline?
<b>Arguments</b>	CH<x> is the channel number. OFF argument turns off underline font. ON argument turns on underline font. <NR1> = 0 turns off underline font; any other value turns on underline font.
<b>Examples</b>	CH1_DALL:LABel:FONT:UNDERline ON specifies an underlined font. CH1_DALL:LABel:FONT:UNDERline? might return CH1_DALL:LABEL:FONT:UNDERLINE 0 indicating underline is off.

## CH<x>\_DALL:LABel:NAME

This command sets or queries the label of the specified digital group. The channel is specified by x.

<b>Group</b>	Digital
<b>Syntax</b>	CH<x>_DALL:LABeL:NAME <QString> CH<x>_DALL:LABeL:NAME?
<b>Arguments</b>	CH<x> is the channel number.  <QString> is the name of the group.
<b>Examples</b>	CH1_DALL:LABeL:NAME "Clock Out" sets the label name to Clock Out.  CH1_DALL:LABeL:NAME? might return CH1_DALL:LABEL:NAME "This is the digital name".

## CH<x>\_D<x>:LABeL:COLoR

This command sets or queries the color of the label of the specified digital bit. The channel is specified by x.

<b>Group</b>	Digital
<b>Syntax</b>	CH<x>_D<x>:LABeL:COLoR <QString> CH<x>_D<x>:LABeL:COLoR?
<b>Arguments</b>	CH<x> is the channel number.  <QString> is the label color. To return the color to the default color, send an empty string as in this example: :CH5_D1:LABEL:COLOR "".
<b>Examples</b>	CH1_D1:LABeL:COLoR "#FF0000" sets the color to red.  CH1_D1:LABeL:COLoR? might return CH1_D1:LABEL:COLOR "#FFFF00" indicating the color is yellow.

## CH<x>\_D<x>:LABeL:FONT:BOLD

This command sets or queries the bold state of the label of the specified digital bit. The channel is specified by x.

<b>Group</b>	Digital
--------------	---------

<b>Syntax</b>	CH<x>_D<x>:LABe1:FONT:BOLD {ON OFF <NR1>} CH<x>_D<x>:LABe1:FONT:BOLD?
<b>Arguments</b>	CH<x> is the channel number. OFF argument turns off bold font. ON argument turns on bold font. <NR1> = 0 turns off bold font; any other value turns on bold font.
<b>Examples</b>	CH1_D1:LABe1:FONT:BOLD ON sets the font to bold. CH1_D1:LABe1:FONT:BOLD? might return CH1_D1:LABEL:FONT:BOLD 0 indicating the font is not bold.

## CH<x>\_D<x>:LABe1:FONT:ITALic

This command sets or queries the italic state of the label of the specified digital bit. The channel is specified by x.

<b>Group</b>	Digital
<b>Syntax</b>	CH<x>_D<x>:LABe1:FONT:ITALic {ON OFF <NR1>} CH<x>_D<x>:LABe1:FONT:ITALic?
<b>Arguments</b>	CH<x> is the channel number. OFF argument turns off italic font. ON argument turns on italic font. <NR1> = 0 turns off italic font; any other value turns on italic font.
<b>Examples</b>	CH1_D1:LABe1:FONT:ITALic OFF turns off italic font. CH1_D1:LABe1:FONT:ITALic? might return CH1_D1:LABEL:FONT:ITALIC 1 indicating the font is italic.

## CH<x>\_D<x>:LABe1:FONT:SIZE

This command sets or queries the font size of the label of the specified digital bit. The channel is specified by x.

<b>Group</b>	Digital
<b>Syntax</b>	CH<x>_D<x>:LABeł : FONT : SIZE <NR1> CH<x>_D<x>:LABeł : FONT : SIZE?
<b>Arguments</b>	CH<x> is the channel number. <NR1> is the font size.
<b>Examples</b>	CH1_D1:LABeł : FONT : SIZE 16 sets the font size to 16 points. CH1_D1:LABeł : FONT : SIZE? might return CH1_D1:LABEL : FONT : SIZE 20 indicating the font size is 20 points.

## CH<x>\_D<x>:LABeł:FONT:TYPE

This command sets or queries the font type of the label of the specified digital bit, such as Arial or Times New Roman. The channel is specified by x.

<b>Group</b>	Digital
<b>Syntax</b>	CH<x>_D<x>:LABeł : FONT : TYPE <QString> CH<x>_D<x>:LABeł : FONT : TYPE?
<b>Arguments</b>	CH<x> is the channel number. <QString> is the font type of the label.
<b>Examples</b>	CH1_D1:LABeł : FONT : TYPE "Monospace" sets the font to Monospace. CH1_D1:LABeł : FONT : TYPE? might return CH1_D1:LABEL : FONT : TYPE "Frutiger LT Std 55 Roman".

## CH<x>\_D<x>:LABeł:FONT:UNDERline

This command sets or queries the underline state of the label of the specified digital bit. The channel is specified by x.

<b>Group</b>	Digital
--------------	---------



<b>Syntax</b>	CH<x>_D<x>:LABel:FONT:UNDERline {ON OFF <NR1>} CH<x>_D<x>:LABel:FONT:UNDERline?
<b>Arguments</b>	CH<x> is the channel number. OFF argument turns off underline font. ON argument turns on underline font. <NR1> = 0 turns off underline font; any other value turns on underline font.
<b>Examples</b>	CH1_D1:LABel:FONT:UNDERline ON turns on underline font. CH1_D1:LABel:FONT:UNDERline? might return CH1_D1:LABel:FONT:UNDERLINE 0 indicating the underline font is off.

## CH<x>\_D<x>:LABel:NAME

Sets or queries the label of the specified digital bit. The channel is specified by x.

<b>Group</b>	Digital
<b>Syntax</b>	CH<x>_D<x>:LABel:NAME <QString> CH<x>_D<x>:LABel:NAME?
<b>Arguments</b>	CH<x> is the channel number. <QString> is the label.
<b>Examples</b>	CH1_D1:LABel:NAME "Clock in" sets the name to Clock in. CH1_D1:LABel:NAME? might return CH1_D1:LABel:NAME "Digital 1".

## \*CLS (No Query Form)

This command (no query form) clears the following:

- Event Queue
- Standard Event Status Register
- Status Byte Register (except the MAV bit)

If the \*CLS command immediately follows an <EOI>, the Output Queue and MAV bit (Status Byte Register bit 4) are also cleared. MAV indicates that

information is in the output queue. The device clear (DCL) control message will clear the output queue and thus MAV. \*CLS does not clear the output queue or MAV.

\*CLS can suppress a Service Request that is to be generated by an \*OPC. This will happen if a single sequence acquisition operation is still being processed when the \*CLS command is executed.

<b>Group</b>	Status and Error
<b>Syntax</b>	*CLS
<b>Related Commands</b>	<a href="#">DESE</a> <a href="#">*ESE</a> <a href="#">*ESR?</a> <a href="#">EVENT?</a> <a href="#">EVMsg?</a> <a href="#">*SRE</a> <a href="#">*STB?</a>
<b>Examples</b>	*CLS clears the instrument status data structures.

## CONFIGuration:ANALog:BANDWidth? (Query Only)

This command queries the maximum licensed bandwidth of the instrument.

<b>Group</b>	Vertical
<b>Syntax</b>	CONFIGuration:ANALog:BANDwidth?
<b>Returns</b>	The maximum licensed bandwidth of the instrument is returned.
<b>Examples</b>	CONFIGuration:ANALog:BANDwidth? might return CONFIGURATION:ANALOG:BANDWIDTH 2.0000E+9 indicating the bandwidth is 2.0 GHz.

## CURVe? (Query Only)

This command transfers waveform data from the instrument. Each waveform that is transferred has an associated waveform preamble that contains information such as data format and scale.

The CURVe? query transfers data from the instrument. The data source is specified by the **DATA:SOURce** command. The first and last data points are specified by the **DATA:START** and **DATA:STOP** commands.

For digital sources, CH<x>\_D<n> or CH<x>\_DALL, when the :DATA:WIDth is 1, the returned data is state only. When the :DATA:WIDth is 2, the returned data is transition data with 2 bits per digital channel representing the transition information as follows:

- 0 0 low
- 0 1 high
- 1 1 multiple transitions in interval ending with high
- 1 0 multiple transitions in interval ending with low

For individual digital channels (such as CH<x>\_D<n>), :DATA:WIDth 2 provides the 2-bit transition data with the upper 14 bits zero. :DATA:WIDth 1 provides only the state in the LSB with the upper 7 bits all zero.

For CH<x>\_DAll sources, :DATA:WIDth 2 provides the 2-bit transition data for each of the 8 constituent channels with the D7 bit represented in the 2 most significant bits, D6 in the next 2, and so on. :DATA:WIDth 1 provides the states of each of the 8 constituent channels with D7 represented in the most significant bit and D0 in the least significant bit.

Depending on the sample rate, multi-transition data may not be available and :CURVe? queries for digital channels with :DATA:WIDth 2 may result in a warning event "Execution warning: Multi-transition data not available". In this case, the transition data returned will be 0 0 or 0 1.

For MATH sources, only 8-byte double precision floating point data is returned in :CURVe? queries.

A Fast Acquisition waveform Pixmap data is a 500 (vertical) by 1000 (horizontal) point bitmap. Each point represents display intensity for that screen location. 500 (vertical) which is the row count in the bitmap, might vary based on how many channels enabled from same FastAcq group. To query and get the Fast Acq Pixel Map data, the following command set should be sent:

- ACQuire:FASTAcq:STATE ON
- DATA:MODE PIXmap

When the FastAcq is on, Curve? on Ch<x> will return pixmap data (if DATA:MODE is PIXmap). The number of rows in the pixmap will vary based on how many ch<x> sources are turned on and how they are grouped in acquisition

HW. The grouping can vary from model to model. The number of columns in pixmap data is fixed to 1000. For example, on a MSO58 instrument, Ch1 to Ch4 is “group1” and Ch5 to Ch8 is “group2”. If Ch1 is turned on (in group1) then Ch1 rows will be 500. If Ch2 and Ch3 are turned on (in group1) then Ch2 and Ch3 rows will be 250 each. When all Ch1/2/3/4 are turned on (in group1) then 125 rows per channel. If Ch1 (in group1) and Ch8 (in group2) are turned on then 500 rows will be returned for each channel. To calculate the number of rows, you can use- (number of bytes from curve header/BYT\_NR)/1000.

**Group**      Waveform Transfer

**Syntax**     CURVE?

**Related Commands**    [DATA:SOURce](#)

[DATA:START](#)

[DATA:STOP](#)

[SAVE:WAVEform](#)

[WFMOutpre?](#)

**Returns**      CH<x>\_SV\_NORMal, CH<x>\_SV\_AVErage, CH<x>\_SV\_MAXHOld, CH<x>\_SV\_MINHOld: When DATA:SOURce is set to one of these traces, the data points represent the amplitude of the Spectrum View frequency domain traces in the current units, and are floating point values. The frequency domain trace data is returned as 8-byte floating point values.

CH<x>\_SV\_AMPliitude, CH<x>\_SV\_FREQUency, CH<x>\_SV\_PHASE: When DATA:SOURce is set to one of these traces, the data points are the Magnitude vs. Time, Frequency vs. Time, or Phase vs. Time representations of the RF input signal (Spectrum View) time domain traces. The RF time domain traces are returned as floating point values.

CH<x>\_FREQ\_vs\_time is the frequency in Hz.

CH<x>\_PHASE\_vs\_time is the phase in degrees.

CH<x>\_MAG\_vs\_time is the magnitude in Volts.

CH<x>\_SV\_BASEband\_IQ is the Spectrum View RF baseband IQ traces. When DATA:SOURce is set to one of these traces, the data points represent the digitizing levels of the IQ data. The IQ data is formatted as pairs of integer values (i.e. <I>,<Q>,<I>,<Q>,...)

**Examples**      CURVE? with ASCII encoding, start and stop of 1 and 10 respectively, and a width set to 1 might return :CURVE 61,62,61,60,60,-59,-59,-58,-58,-59

**NOTE.** *Curve data is transferred from the instrument asynchronously and, depending upon the length of the curve record, such transfers can require several seconds to complete. During this time, the instrument will not respond to user controls. You can interrupt these asynchronous data transfers by sending a device clear message to the instrument or by interrupting the query with another command or query. Verify that curve data is completely transferred.*

*It is recommended that you follow such queries with an **\*ESR?** query and verify that the error bit returned and, if set, check the event queue to ascertain the reason for the error. If the error was caused by an interrupted query, then the asynchronous data transfer had not completed when the **\*ESR?** query was sent. In this case, you might need increase your program's time-out value to ensure that all data is transferred and read.*

---

## **CURVEStream? (Query Only)**

This query-only command continuously transfers waveform data from the instrument as it is acquired.

This command puts the instrument into a streaming data mode, allowing the controller to receive waveform records as fast as they are acquired. Use the [DATA:SOURce](#) command to specify the waveform sources. The command supports all the same data formatting options as the [CURVe?](#) command.

- Control of the instrument through the user interface or other external clients is not allowed while in streaming data mode.
- The GPIB controller must take the instrument out of this streaming data mode to terminate the query and allow other input sources to resume communication with the instrument. The following options are available to transition out of streaming data mode:
  - Send a device clear over the bus
  - Send another command or query to the instrument
- Turning the waveform screen display mode off (:DISPlay:WAVEform OFF) may increase waveform throughput during streaming mode.
- Using a data encoding of SRIBinary (DATA:ENCdg SRIBinary) may also increase the waveform throughput since that is the raw native data format of the oscilloscope.
- While in streaming data mode, two extreme conditions can occur.
  - If the waveform records are being acquired slowly (high resolution), configure the controller for a long time-out threshold, as the data is not sent out until each complete record is acquired.
  - If the waveform records are being acquired rapidly (low resolution), and the controller is not reading the data off the bus fast enough, the trigger rate is slowed to allow each waveform to be sent sequentially.

**Group** Waveform Transfer

**Syntax** CURVEStream?

**Related Commands** [CURVe?](#)  
[DATA:SOURce](#)  
[DATA:START](#)  
[DATA:STOP](#)  
[DATA:ENCdg](#)  
[DATA:WIDTH](#)  
[WFMOutpre?](#)

**Returns** Formatted waveform data, once per acquisition.

**Examples** CURVESTREAM? with ASCII encoding, start and stop of 1 and 10 respectively, and a width set to 1 might return :CURVESTREAM 61,62,61,60,60,-59,-59,-58,-58,-59

---

**NOTE.** Curve data is transferred from the instrument asynchronously and, depending upon the length of the curve record, such transfers can require several seconds to complete. During this time, the instrument will not respond to user controls. You can interrupt these asynchronous data transfers by sending a device clear message to the instrument or by interrupting the query with another command or query. Verify that curve data is completely transferred.

It is recommended that you follow such queries with an *\*ESR?* query and verify that the error bit returned and, if set, check the event queue to ascertain the reason for the error. If the error was caused by an interrupted query, then the asynchronous data transfer had not completed when the *\*ESR?* query was sent. In this case, you might need increase your program's time-out value to ensure that all data is transferred and read.

---

## CUSTOMTABLE:ADDNew (No Query Form)

This command adds new custom results table.

**Group** Measurement, IMDA

**Syntax** CUSTOMTABLE:ADDNew <Qstring>

**Arguments** <Qstring> specifies the custom results table name.

**Examples** CUSTOMTABLE:ADDNEW"TABLE1" adds a new custom table named TABLE1.

## CUSTOMTABLE:DELeTe (No Query Form)

This command deletes the custom result(s) table that was added.

**Group** Measurement, IMDA

**Syntax** CUSTOMTABLE:DELeTe <Qstring>

**Arguments** <Qstring> specifies the custom results table name.

**Examples**     `CUSTOMTABLE:DELETE"TABLE1"` deletes the new custom table named TABLE1.

## CUSTOMTABLE:LIST? (Query Only)

This command queries the list of custom result tables has been added.

**Group**     Measurement, IMDA

**Syntax**     `CUSTOMTABLE:LIST? <Qstring>`

**Arguments**     `<Qstring>` specifies the custom results table name.

**Examples**     `CUSTOMTABLE:LIST?` might return `:CUSTOMTABLE:LIST TABLE1, TABLE2`, indicating there are two custom result tables.

## DATA

This command sets or queries the format and location of the waveform data that is transferred with the [CURVe?](#) command.

**Group**     Waveform Transfer

**Syntax**     `DATA {INIT|SNAP}`  
`DATA?`

**Related Commands**     [CURVe?](#)  
[DATA:START](#)  
[DATA:STOP](#)  
[DATA:ENCdg](#)  
[WFMOutpre:NR\\_Pt?](#)

**Arguments**     `INIT` initializes the waveform data parameters to their factory defaults except for `DATA:STOP`, which is set to the current acquisition record length.

`SNAP` Sets `DATA:START` and `DATA:STOP` to match the current waveform cursor positions of `WAVEVIEW1 CURSOR1` if these waveform cursors are currently on. If these waveform cursors are not on when the `DATA SNAP` command is sent, it is silently ignored and `DATA:START` and `:STOP` remain unchanged.



If either of the cursors is outside the record, DATA:START and :STOP are set to nearest values within the record. This will cause DATA:START and/or :STOP to snap to the beginning or end of the record whichever is nearest, and the following event is set: 500, "Execution warning", "One or both cursors outside of waveform record".

If there is no acquired waveform for the cursor source, then DATA:START and :STOP remain unchanged and the following event is set: 500, "Execution warning", "No acquired waveform record".

If DATA:START is greater than :STOP, the values of DATA:START and STOP are swapped and the following event is set: 530, "Data start > stop, Values swapped internally".

**Examples** DATA INIT initializes the waveform data parameters to their factory defaults.  
 DATA? might return DATA:ENCDG RIBINARY;SOURCE CH1;START 1;STOP 1000;FRAMESTART 1;FRAMESTOP 1000.

## DATA:ENCdg

This command sets or queries the format of outgoing waveform data. This command is equivalent to setting [WFMOupre:ENCdg](#), [WFMOupre:BN\\_Fmt](#), and [WFMOupre:BYT\\_Or](#). Setting the DATA:ENCdg value causes the corresponding WFMOupre values to be updated and vice versa.

---

**NOTE.** Values are constrained (for outbound data) to the format of the data specified by DATA:SOURce.

---

**Group** Waveform Transfer

**Syntax** DATA:ENCdg {ASCIi| RIBinary| RPBinary| FPBinary| SRIBinary| SRPbinary| SFPbinary}  
 DATA:ENCdg?

**Related Commands** [WFMOupre:ENCdg](#)  
[WFMOupre:BN\\_Fmt](#)  
[WFMOupre:BYT\\_Or](#)

- Arguments**
- **ASCIi** specifies the ASCII representation of signed INT, FLOAT. If ASCII is the value, then :BN\_Fmt and :BYT\_Or are ignored.
  - **RIBinary** specifies the positive integer data-point representation, with the most significant byte transferred first.  
 When :BYT\_Nr is 1, the range from 0 through 255. When :BYT\_Nr is 2, the range is from 0 to 65,535. When :BYT\_Nr is 4, then the waveform being queried would return Fast Acquisition Pixmap data (if fast acq is turned on and data mode is set to pixmap).
  - **RPBinary** specifies the positive integer data-point representation, with the most significant byte transferred first.  
 When :BYT\_Nr is 1, the range from 0 through 255. When :BYT\_Nr is 2, the range is from 0 to 65,535.
  - **FPBinary** specifies the floating point (width = 4) data.  
 The range is from  $-3.4 \times 10^{38}$  to  $3.4 \times 10^{38}$ . The center of the screen is 0. The upper limit is the top of the screen and the lower limit is the bottom of the screen.  
 The **FPBinary** argument is only applicable to math waveforms or ref waveforms saved from math waveforms.
  - **SRIbinary** is the same as **RIBinary** except that the byte order is swapped, meaning that the least significant byte is transferred first. This format is useful when transferring data to IBM compatible PCs.
  - **SRPbinary** is the same as **RPBinary** except that the byte order is swapped, meaning that the least significant byte is transferred first. This format is useful when transferring data to PCs.
  - **SFPbinary** specifies floating point data in IBM PC format. The **SFPbinary** argument only works on math waveforms or ref waveforms saved from math waveforms.

**Table 2-46: DATA and WFMOutpre Parameter Settings**

DATA:ENCdg Setting	WFMOutpre Settings			
	:ENCdg	:BN_Fmt	:BYT_Or	:BYT_NR
ASCIi	ASC	N/A	N/A	1,2,4
RIBinary	BIN	RI	MSB	1,2
RPBinary	ASC	RP	MSB	1,2
FPBinary	BIN	FP	MSB	4
SRIbinary	BIN	RI	LSB	1,2
SRPbinary	BIN	RP	LSB	1,2
SFPbinary	BIN	FP	LSB	4

- Examples** DATA:ENCDG RPBinary sets the data encoding format to be a positive integer data-point representation, where the most significant byte is transferred first.
- DATA:ENCDG? might return DATA:ENCDG SRPBINARY for the format of the outgoing waveform data.

## DATA:FRAMESTART

This command sets or queries the starting acquisition for waveform transfer using the CURVE? query. This is only relevant when History or FastFrame acquisition modes are enabled.

**Group** Waveform Transfer

**Syntax** DATA:FRAMESTART <NR1>  
DATA:FRAMESTART?

**Arguments** <NR1> is the first acquisition that will be transferred, which ranges from 1 to the number of History or FastFrame acquisitions. Results are transferred from acquisition <NR1> to DATA:FRAMESTOP or the total number of acquisitions, whichever is less. If <NR1> is greater than the number of acquisitions, then only the last acquisition is transferred. If DATA:FRAMESTART is greater than DATA:FRAMESTOP, then only a single acquisition at <NR1> is transferred.

- Examples** DATA:FRAMESTART 10 specifies that the waveform transfer will begin with the 10th acquisition.
- DATA:FRAMESTART? might return :DATA:FRAMESTART 25, indicating that acquisition 25 is the first one that will be transferred.

## DATA:FRAMESTOP

This command sets or queries the last acquisition for waveform transfer using the CURVE? query. This is only relevant when History or FastFrame acquisition modes are enabled.

**Group** Waveform Transfer

**Syntax** DATA:FRAMESTOP {<NR1>|MAX}  
DATA:FRAMESTOP?

<b>Arguments</b>	<p>&lt;NR1&gt; is the last acquisition that will be transferred, which ranges from 1 to the number of History or FastFrame acquisitions. Results will be transferred from acquisitions DATA:FRAMESTART to &lt;NR1&gt;. If &lt;NR1&gt; is greater than the number of acquisitions, then data will be transferred up to the last acquisition. If DATA:FRAMESTOP is less than DATA:FRAMESTART, then only a single acquisition at DATA:FRAMESTART is transferred.</p> <p>MAX indicates that data is always transferred up to the last acquisition.</p>
<b>Examples</b>	<p>DATA:FRAMESTOP 100 specifies that the waveform transfer will stop with the 100th acquisition.</p> <p>DATA:FRAMESTOP? might return :DATA:FRAMESTOP 250, indicating that acquisition 250 is the last one that will be transferred.</p>

## DATA:MODE

This command sets or queries the mode for waveform data sent to returned by CURVE?. When FastAcq mode is ON, and the value is PIXmap, it returns Fast Acquisition pixmap data or the vector data is returned. When the data mode is set as VECtor then you get the waveform sampled data. The Data width is reset to 1 or 2 instead of 4.

<b>Group</b>	Waveform Transfer
<b>Syntax</b>	DATA:MODE {VECTor PIXmap} DATA:MODE ?
<b>Arguments</b>	<p>VECTor sets the mode for waveform data to vector.</p> <p>PIXmap sets the mode for waveform data to pixmap.</p>
<b>Examples</b>	<p>DATA:MODE VECTor sets the mode for waveform data to vector.</p> <p>DATA:MODE ? might return :DATA:MODE VECTor, indicating that the mode for waveform data is set to vector.</p>

## DATA:RESample

This command sets or queries the resampling of outgoing waveform data. This command is equivalent to setting WFMOuppre:RESampLe. Setting the DATA:RESampLe value causes the corresponding WFMOuppre value to be updated and vice versa.

<b>Group</b>	Waveform Transfer
<b>Syntax</b>	DATA:RESample <NR1> DATA:RESample?
<b>Related Commands</b>	<a href="#">WFMOutpre:RESample</a>
<b>Arguments</b>	<NR1> is the resampling rate. The default value is 1, which means every sample is returned. A value of 2 returns every other sample, while a value of 3 returns every third sample, and so on.
<b>Examples</b>	DATA:RESAMPLE 1 sets the resampling to return all waveform data samples.  DATA:RESAMPLE? might return :DATA:RESAMPLE 4, indicating that every fourth sample of the waveform data is returned.

## DATA:SOURce

This command sets or queries the location of waveform data that is transferred from the instrument by the [CURVe??](#) Query.

<b>Group</b>	Waveform Transfer
<b>Syntax</b>	DATA:SOURce <wfm> [<,><wfm>] DATA:SOURce?
<b>Related Commands</b>	<a href="#">CURVe?</a>  <a href="#">DATA</a>
<b>Arguments</b>	<wfm> is the location of the waveform data that will be transferred from the instrument to the controller. It can consist of CH<x>, MATH<x>, REF<x>, DIGITALALL. Note that digital data is transferred as 16-bit data, with the least-significant bit representing D0, and the most-significant bit representing D15.  <wfm> can consist of the following:  CH<x> selects the specified analog channel as the source.  MATH<x> selects the specified reference waveform as the source. The reference number is specified by x, which ranges from 1 through 4.

REF<x> selects the specified reference waveform as the source. The reference number is specified by x, which ranges from 1 through 8.

CH<x>\_D<x> selects the specified digital channel.

CH<x>\_DA11 selects the specified channel group of digital channels.

DIGITALALL selects digital waveforms as the source. The Digital data is transferred as 16-bit data, with the least-significant bit representing D0, and the most-significant bit representing D15. The LSB always contains D0-D7 and MSB always contains D8-D15 data.

CH<x>\_SV\_NORMa1, CH<x>\_SV\_AVErage, CH<x>\_SV\_MAXHo1d, CH<x>\_SV\_MINHo1d selects the specified Spectrum View waveform.

CH<x>\_MAG\_VS\_TIME, CH<x>\_FREQ\_VS\_TIME, CH<x>\_PHASE\_VS\_TIME selects the specified RF vs. Time waveform.

CH<x>\_SV\_BASEBAND\_IQ selects the specified RF baseband IQ data.

**Examples** DATA:SOURCE CH1 specifies that the CH1 waveforms will be transferred in the next CURVe? query.

DATA:SOURCE? might return DATA:SOURCE REF3, indicating that the source for the waveform data which is transferred using a CURVe? query is reference 3.

## DATA:SOURCE:AVAILABLE? (Query Only)

This query returns a list of enumerations representing the source waveforms that are currently available for :CURVe? queries. This means that the waveforms have been acquired. If there are none, NONE is returned.

**Group** Waveform Transfer

**Syntax** DATA:SOURCE:AVAILABLE?

**Related Commands** [CURVe?](#)

**Returns** Returns a list of source waveforms that are currently available for :CURVe? queries.

**Examples** DATA:SOURCE:AVAILABLE? might return DATA:SOURCE:AVAILABLE CH2, CH3, CH6, CH7, MATH1, REF1 indicating that CH2, CH3, CH6, CH7, MATH1, and REF1 are available.

## DATA:START

This command sets or queries the starting data point for waveform transfer. This command allows for the transfer of partial waveforms to and from the instrument.

**Group** Waveform Transfer

**Syntax** DATA:START <NR1>  
DATA:START?

**Related Commands** [CURVe?](#)  
[DATA](#)  
[DATA:STOP](#)  
[WFMOutpre:NR\\_Pt?](#)

**Arguments** <NR1> is the first data point that will be transferred, which ranges from 1 to the record length. Data will be transferred from <NR1> to DATA:STOP or the record length, whichever is less. If <NR1> is greater than the record length, the last data point in the record is transferred.

DATA:START and DATA:STOP are order independent. When DATA:STOP is greater than DATA:START, the values will be swapped internally for the CURVE? query.

**Examples** DATA:START 10 specifies that the waveform transfer will begin with data point 10.

DATA:START? might return DATA:START 214, indicating that data point 214 is the first waveform data point that will be transferred.

## DATA:STOP

This command sets or queries the last data point that will be transferred when using the [CURVe??](#) query. This command allows for the transfer of partial waveforms to the controller.

Changes to the record length value are not automatically reflected in the data:stop value. As record length is varied, the DATA:STOP value must be explicitly changed to ensure the entire record is transmitted. In other words, curve results will not automatically and correctly reflect increases in record length if the distance from DATA:START to DATA:STOP stays smaller than the increased record length.

---

**NOTE.** When using the [CURVe?](#) command, DATA:STOP is ignored.

---

<b>Group</b>	Waveform Transfer
<b>Syntax</b>	DATA:STOP <NR1> DATA:STOP?
<b>Related Commands</b>	<a href="#">CURVe?</a> <a href="#">DATA</a> <a href="#">DATA:START</a> <a href="#">WFMOutpre:NR_Pt?</a>
<b>Arguments</b>	<p>&lt;NR1&gt; is the last data point that will be transferred, which ranges from 1 to the record length. If &lt;NR1&gt; is greater than the record length, then data will be transferred up to the record length. If both DATA:START and DATA:STOP are greater than the record length, the last data point in the record is returned.</p> <p>DATA:START and DATA:STOP are order independent. When DATA:STOP is less than DATA:START, the values will be swapped internally for the CURVE? query.</p> <p>If you always want to transfer complete waveforms, set DATA:START to 1 and DATA:STOP to the maximum record length, or larger.</p>
<b>Examples</b>	<p>DATA:STOP 15000 specifies that the waveform transfer will stop at data point 15000.</p> <p>DATA:STOP? might return DATA:STOP 14900, indicating that 14900 is the last waveform data point that will be transferred.</p>

## DATA:WIDTH

This command specifies the width, in bytes per point, for waveform data transferred from the instrument via the CURVE? query. (This command is synonymous with WFMOutpre:BYT\_Nr.)

<b>Group</b>	Waveform Transfer
<b>Syntax</b>	DATA:WIDTH <NR1> DATA:WIDTH?
<b>Related Commands</b>	<a href="#">WFMOutpre:BYT_Nr</a>



- Arguments** <NR1> is an integer that indicates the number of bytes per point for the outgoing waveform data when queried using the CURVe? command.
- For analog channels, NR1 can be 1 or 2.
  - For digital channels, NR1 can be 1 or 2.
  - For the digital collection, NR1 can be 4 or 8.
  - For CH<x>\_SV\_NORMal, CH<x>\_SV\_AVErage, CH<x>\_SV\_MAXHold, CH<x>\_SV\_MINHold, CH<x>\_MAG\_VS\_TIME, CH<x>\_FREQ\_VS\_TIME, and CH<x>\_PHASE\_VS\_TIME, NR1 can only be 8.
  - For CH<x>\_SV\_BASEBAND\_IQ, NR1 can be 1 or 2.

- Examples** DATA:WIDTH 1 sets the data width to 1 byte.
- DATA:WIDTH? might return DATA:WIDTH 1 indicating the width, in bytes per point, for waveform data transferred by the CURVE? query is 1 byte.

## DATE? (Query Only)

This command queries the date that the instrument displays.

**Group** Miscellaneous

**Syntax** DATE?

**Related Commands** [TIMe](#)

**Returns** <QString> is a date in the form “yyyy-mm-dd” where yyyy refers to a four-digit year number, mm refers to a two-digit month number from 01 to 12, and dd refers to a two-digit day number in the month.

**Examples** DATE? might return DATE 2000-01-24, indicating the current date is set to January 24, 2000.

## DESE

This command sets and queries the bits in the Device Event Status Enable Register (DESER). The DESER is the mask that determines whether events are reported to

the Standard Event Status Register (SESR), and entered into the Event Queue. For a more detailed discussion of the use of these registers, see Registers.

**Group** Status and Error

**Syntax** DESE <NR1>  
DESE?

**Related Commands** [\\*CLS](#)  
[\\*ESE](#)  
[\\*ESR?](#)  
[EVENT?](#)  
[EVMsg?](#)  
[\\*SRE](#)  
[\\*STB?](#)

**Arguments** <NR1> The binary bits of the DESER are set according to this value, which ranges from 1 through 255. For example, DESE 209 sets the DESER to the binary value 11010001 (that is, the most significant bit in the register is set to 1, the next most significant bit to 1, the next bit to 0, etc.).

The power-on default for DESER is all bits set if \*PSC is 1. If \*PSC is 0, the DESER maintains the previous power cycle value through the current power cycle.

---

**NOTE.** Setting the DESER and ESER to the same value allows only those codes to be entered into the Event Queue and summarized on the ESB bit (bit 5) of the Status Byte Register. Use the [\\*ESE](#) command to set the ESER.

---

**Examples** DESE 209 sets the DESER to binary 11010001, which enables the PON, URQ, EXE and OPC bits.

DESE? might return DESE 186, showing that the DESER contains the binary value 10111010.

## DISplay? (Query Only)

This query-only command returns the current Display settings.

**Group** Display Control

**Syntax** DISplay?

**Examples** DISPLAY? might return DISPLAY:CLOCK 1;COLOR:PALETTE:IMAGEVIEW  
 MONOGREEN; RECORDVIEW TEMPERATURE;USER:GRATICULE  
 165,50,15;CH1 180,50,100; CH2 300,50,100;CH3  
 60,50,100;CH4 240,50,100;REF1 0,90,0; REF2  
 0,90,100;REF3 60,90,100;REF4 240,90,100;MATH1  
 160,50,100; MATH2 40,60,100;MATH3 120,60,100;MATH4  
 195,50,100; HISTOGRAM 320,50,100;CARET 150,50,100;MASK  
 0,25,75;MASKHIGHLIGHT 140,50,100;:DISPLAY:COLOR:MATHCOLOR  
 DEFAULT;REFCOLOR DEFAULT; :DISPLAY:FILTER SINX;FORMAT  
 YT;GRATICULE IRE;INTENSITY :WAVEFORM:IMAGEVIEW  
 81.0000;RECORDVIEW 81.0000;:DISPLAY :INTENSITY:AUTOBRIGHT  
 0; :DISPLAY:PERSISTENCE OFF;STYLE DOTS;TRIGBAR OFF;TRIGT  
 1; CURSORTICK LONG;VARPERSIST 2.6000;SCREENTEXT:STATE  
 1; LABEL1:NAME "";XPOS 100;YPOS 5;:DISPLAY:SCREENTEXT  
 :LABEL2:NAME "THIS IS SCREEN TEXT";XPOS 100;YPOS 20;  
 :DISPLAY:SCREENTEXT:LABEL3:NAME "";XPOS 100;YPOS 35;  
 :DISPLAY:SCREENTEXT:LABEL4:NAME "";XPOS 100;YPOS 50;  
 :DISPLAY:SCREENTEXT:LABEL5:NAME "";XPOS 100;YPOS 343;  
 :DISPLAY:SCREENTEXT:LABEL6:NAME "";XPOS 100;YPOS 80;  
 :DISPLAY:SCREENTEXT:LABEL7:NAME "";XPOS 100;YPOS 95;  
 :DISPLAY:SCREENTEXT:LABEL8:NAME "";XPOS 100;YPOS 110;  
 :DISPLAY:WAVEFORM 1.

## DISplay:{CH<x>|Math<x>|REF<x>}:INVERTColor

This command sets or queries the Inverted mode color of the specified input source to the specified color. You can assign one of 48 unique colors to any channel, math, or reference waveform. These colors replace the default Inverted colors and remain in effect until you reset the colors.

**Group** Display

**Syntax** DISplay:{CH<x>|Math<x>|REF<x>}:INVERTColor COLOR<y>  
 DISplay:{CH<x>|Math<x>|REF<x>}:INVERTColor?

**Arguments** CH<x> specifies the input channel for which you want to change the waveform color, where <x> is the channel number.

Math<x> specifies the math waveform for which you want to change the waveform color, where <x> is the math waveform number.

REF<x> specifies the reference waveform for which you want to change the waveform color, where <x> is the reference waveform number.

COLOR<y> specifies the color to assign to the specified waveform, where <y> = 0 to 47.

**Examples**    `DISplay:Ch1:INVERTColor COLOR23` sets the channel 2 Inverted waveform color to the value 23.

`DISplay:REF3:INVERTColor?` might return `COLOR2`, indicating that the Inverted waveform color setting for reference waveform 3 is 2.

## DISplay:{CH<x>|Math<x>|REF<x>}:NORMALColor

This command sets or queries the normal mode color of the specified input source to the specified color. You can assign one of 48 unique colors to any channel, math, or reference waveform. These colors replace the default normal colors and remain in effect until you reset the colors.

**Group**    Display

**Syntax**    `DISplay:{CH<x>|Math<x>|REF<x>}:NORMALColor COLOR<y>`  
`DISplay:{CH<x>|Math<x>|REF<x>}:NORMALColor?`

**Arguments**    `CH<x>` specifies the input channel for which you want to change the waveform color, where <x> is the channel number.

`Math<x>` specifies the math waveform for which you want to change the waveform color, where <x> is the math waveform number.

`REF<x>` specifies the reference waveform for which you want to change the waveform color, where <x> is the reference waveform number.

`COLOR<y>` specifies the color to assign to the specified waveform, where <y> = 0 to 47.

**Examples**    `DISplay:Ch1:NORMALColor COLOR13` sets the channel 2 normal waveform color to the value 13.

`DISplay:REF3:NORMALColor?` might return `COLOR12`, indicating that the normal waveform color setting for reference waveform 3 is 12.

## DISplay:COLors

Sets or queries the color mode for the graticule and waveform display.

<b>Group</b>	Display Control
<b>Syntax</b>	DISPlay:COLors {NORMal INVERTed} DISPlay:COLors?
<b>Arguments</b>	NORMal specifies normal color mode. INVERTed specifies inverted color mode.
<b>Examples</b>	DISPLAY:COLORS NORMAL sets the display colors to normal. DISPLAY:COLORS? might return DISPLAY:COLORS INVERTED indicating the display colors are inverted.

## DISPlay:GLObal:B<x>:STATE

This command sets or queries the global state (display mode On or Off) of the specified bus. Setting this value true (On or NR1  $\neq$  0 ) turns on the source in the waveform view. Setting this value false (Off or NR1 = 0 ) turns off the source in the waveform view. This command only works if the specified bus is added already.

<b>Group</b>	Display Control
<b>Syntax</b>	DISPlay:GLObal:B<x>:STATE {<NR1> OFF ON} DISPlay:GLObal:B<x>:STATE?
<b>Arguments</b>	<NR1> = 0 disables the display of the specified bus; any other value enables display of the bus. ON enables display of the specified bus. OFF disables display of the specified bus.
<b>Examples</b>	DISPlay:GLObal:B1:STATE OFF turns off the display of bus 1. DISPlay:GLObal:B1:STATE? might return DISPLAY:GLOBAL:B1:STATE 1 indicating the bus is displayed.

## DISPlay:GLObal:CH<x>:STATE

This command sets or queries the global state (display mode On or Off) of the specified channel (both analog and digital). Setting this value true (On or NR1

$\neq 0$ ) turns on the source in the waveform view. Setting this value false (Off or  $\text{NR1} = 0$ ) turns off the source in the waveform view. This command only works if the specified channel is added already.

**Group** Display Control

**Syntax** `DISPlay:GLObal:CH<x>:STATE {<NR1>|OFF|ON}`  
`DISPlay:GLObal:CH<x>:STATE?`

**Arguments**  $\text{<NR1>} = 0$  disables the display of the specified channel; any other value enables display of the channel.

ON enables display of the specified channel.

OFF disables display of the specified channel.

**Examples** `DISPlay:GLObal:CH1:STATE OFF` turns off the display of channel 1.

`DISPlay:GLObal:CH1:STATE?` might return `:DISPLAY:GLOBAL:CH1:STATE 0` indicating that channel 1 is not displayed.

## DISPlay:GLObal:MATH<x>:STATE

This command sets or queries the global state (display mode On or Off) of the specified math. Setting this value true (On or  $\text{NR1} \neq 0$ ) turns on the source in the waveform view. Setting this value false (Off or  $\text{NR1} = 0$ ) turns off the source in the waveform view. This command only works if the specified math waveform is added already.

**Group** Display Control

**Syntax** `DISPlay:GLObal:MATH<x>:STATE {<NR1>|OFF|ON}`  
`DISPlay:GLObal:MATH<x>:STATE?`

**Arguments**  $\text{<NR1>} = 0$  disables the display of the specified math; any other value enables display of the math.

ON enables display of the specified math.

OFF disables display of the specified math.

**Examples**    `DISPlay:GLObal:MATH1:STATE 1` displays math 1.  
`DISPlay:GLObal:MATH1:STATE?` might return  
`:DISPLAY:GLOBAL:MATH1:STATE 1` indicating that math1 is displayed.

## DISPlay:GLObal:PLOT<x>:STATE

This command sets or queries the global state (display mode On or Off) of the specified time trend plot. Setting this value true (On or  $\text{NR1} \neq 0$ ) turns on the source in the waveform view. Setting this value false (Off or  $\text{NR1} = 0$ ) turns off the source in the waveform view. This command only works if the specified plot is added already.

**Group**    Display Control

**Syntax**    `DISPlay:GLObal:PLOT<x>:STATE {<NR1>|OFF|ON}`  
`DISPlay:GLObal:PLOT<x>:STATE?`

**Arguments**    `PLOT<x>` is the plot number.  
 $\text{NR1} = 0$  disables the display of the specified plot; any other value enables display of the plot.  
 ON enables display of the specified plot.  
 OFF disables display of the specified plot.

**Examples**    `DISPlay:GLObal:PLOT1:STATE ON` displays plot 1.  
`DISPlay:GLObal:PLOT1:STATE?` might return  
`:DISPLAY:GLOBAL:PLOT1:STATE 1` indicating plot 1 is displayed.

## DISPlay:GLObal:REF<x>:STATE

this command sets or queries the global state (display mode On or Off) of the specified reference waveform. Setting this value true (On or  $\text{NR1} \neq 0$ ) turns on the source in the waveform view. Setting this value false (Off or  $\text{NR1} = 0$ ) turns off the source in the waveform view. This command only works if the specified reference waveform is added already.

**Group**    Display Control

**Syntax**    `DISplay:GLObal:REF<x>:STATE {<NR1>|OFF|ON}`  
`DISplay:GLObal:REF<x>:STATE?`

**Arguments**    `REF<x>` is the Reference waveform number.

`<NR1> = 0` disables the display of the specified reference; any other value enables display of the reference.

`ON` enables display of the specified reference.

`OFF` disables display of the specified reference.

**Examples**    `DISplay:GLObal:REF1:STATE 1` displays reference 1.

`DISplay:GLObal:REF1:STATE?` might return  
`:DISplay:GLObal:REF1:STATE 1` indicating that reference 1 is displayed.

## DISplay:INTENSITY? (Query Only)

This query-only command returns the waveform saturation level and screen saver settings.

**Group**    Display Control

**Syntax**    `DISplay:INTENSITY?`

### Related Commands

**Arguments**    None

**Examples**    `DISPLAY:INTENSITY?` might return `:DISPLAY:INTENSITY:BACKLIGHT 1`, indicating the intensity is set to 1.

## DISplay:INTENSITY:BACKLight

This command sets or queries the display backlight intensity setting.

**Group**    Display Control

**Syntax**    `DISplay:INTENSITY:BACKLight {LOW|MEDIum|HIGH}`  
`DISplay:INTENSITY:BACKLight?`



<b>Arguments</b>	<p>LOW selects a low brightness level.</p> <p>MEDIUM selects a moderate brightness level.</p> <p>HIGH selects a full brightness level.</p>
<b>Examples</b>	<p>DISPLAY:INTENSITY:BACKLIGHT LOW sets the display backlight to low brightness level.</p> <p>DISPLAY:INTENSITY:BACKLIGHT? might return DISPLAY:INTENSITY:BACKLIGHT HIGH, indicating that the display backlight is set to full brightness level.</p>

## DISplay:INTENSITy:BACKLight:AUTODim:ENABle

Sets or queries the state of the display auto-dim feature. The default is enabled. Once the backlight has dimmed, any button push, knob turn or mouse movement returns the backlight value to the value set by :DISplay:INTENSITy:BACKLight.

<b>Group</b>	Display Control
<b>Syntax</b>	DISplay:INTENSITy:BACKLight:AUTODim:ENABle {ON OFF} DISplay:INTENSITy:BACKLight:AUTODim:ENABle?
<b>Related Commands</b>	<a href="#">DISplay:INTENSITy:BACKLight</a>
<b>Arguments</b>	<p>ON enables the display auto-dim feature.</p> <p>OFF disables the display auto-dim feature.</p>
<b>Examples</b>	<p>DISPLAY:INTENSITY:BACKLIGHT:AUTODIM:ENABLE ON enables auto-dimming of the backlight.</p> <p>DISPLAY:INTENSITY:BACKLIGHT:AUTODIM:ENABLE? might return DISPLAY:INTENSITY:BACKLIGHT:AUTODIM:ENABLE ON, indicating that auto-dimming of the backlight is enabled.</p>

## DISplay:INTENSITy:BACKLight:AUTODim:TIME

Sets or queries the amount of time, in minutes, to wait for no user interface activity before automatically dimming the display. The time can range from a minimum of 10 minutes to a maximum of 1440 minutes (24 hours). The default is 10 minutes.

<b>Group</b>	Display Control
<b>Syntax</b>	DISplay:INTENSITY:BACKLight:AUTODim:TIME <NR1> DISplay:INTENSITY:BACKLight:AUTODim:TIME?
<b>Arguments</b>	<NR1> is the amount of time, in minutes, to wait for no user interface activity before automatically dimming the display.
<b>Examples</b>	DISPLAY:INTENSITY:BACKLIGHT:AUTODIM:TIME 30 sets the backlight to autodim in 30 minutes.  DISPLAY:INTENSITY:BACKLIGHT:AUTODIM:TIME? might return DISPLAY:INTENSITY:BACKLIGHT:AUTODIM:TIME 60, indicating the backlight will auto-dim in 60 minutes.

## DISplay:MATHFFTView<n>:CURSor:ROLOCATION

This command sets or queries the location to display the specified Math FFT plot cursor readouts (in the plot graticule or in a badge in the Results Bar).

<b>Group</b>	Cursor
<b>Syntax</b>	DISplay:MATHFFTView<n>:CURSor:ROLOCATION {GRATICULE BADGE} DISplay:MATHFFTView<n>:CURSor:ROLOCATION?
<b>Arguments</b>	MATHFFTView<x> is the Math FFT plot number.  GRATICULE sets the Math FFT plot cursor readouts to display as part of the cursors in the plot view.  BADGE removes the Math FFT plot cursor readouts from the cursors in the graticule and displays the cursor information as a badge in the Results Bar.
<b>Examples</b>	DISplay:MATHFFTView4:CURSor:ROLOCATION GRATICULE sets the cursor readout information for Math FFT plot 4 to display in the plot graticule.  DISplay:MATHFFTView2:CURSor:ROLOCATION? might return DISplay:MATHFFTView2:CURSor:ROLOCATION BADGE, indicating that cursor readout information for Math FFT plot 2 is set to display as a badge in the Results Bar.

## DISplay:MATHFFTView<x>:AUTOScale

This command sets or returns the enabled state of autoscale for Math/FFT waveforms.

<b>Group</b>	Display Control
<b>Syntax</b>	DISplay:MATHFFTView<x>:AUTOScale {OFF ON <NR1> DISplay:MATHFFTView<x>:AUTOScale?
<b>Arguments</b>	MATHFFTView<x> is the Math-FFT waveform number.  OFF disables the autoscale feature.  ON enables the autoscale feature.  <NR1> = 0 disables the autoscale feature; any other value enables the autoscale feature.
<b>Examples</b>	DISplay:MATHFFTView1:AUTOScale OFF disables the autoscale feature.  DISplay:MATHFFTView3:AUTOScale? might return DISPLAY:MATHFFTVIEW3:AUTOSCALE 1, indicating that autoscale is on for the Math3 FFT waveform.

## DISplay:MATHFFTView<x>:CURSor:ASOURce? (Query Only)

This command queries the Math-FFT waveform view source for cursor A.

<b>Group</b>	Cursor
<b>Syntax</b>	DISplay:MATHFFTView<x>:CURSor:ASOURce?
<b>Arguments</b>	MATHFFTView<x> is the Math-FFT waveform number.
<b>Examples</b>	DISplay:MATHFFTView1:CURSor:ASOURce? might return DISPLAY:MATHFFTVIEW1:CURSOR:ASOURCE MATH1, indicating the source is MATH 1.

## DISplay:MATHFFTView<x>:CURSor:BSOURce? (Query Only)

This command queries the Math-FFT waveform view source for cursor B.

<b>Group</b>	Cursor
<b>Syntax</b>	DISplay:MATHFFTView<x>:CURSor:BSOURce?
<b>Arguments</b>	MATHFFTView<x> is the Math-FFT waveform number.
<b>Examples</b>	DISplay:MATHFFTView5:CURSor:BSOURce? might return DISPLAY:MATHFFTVIEW5:CURSOR:BSOURCE MATH5, indicating the source is Math waveform MATH 5.

## DISplay:MATHFFTView<x>:CURSor:DDT? (Query Only)

This command queries the delta Y over delta X ( $\Delta Y/\Delta X$ ) cursor readout value of the specified cursor in the specified Math-FFT view.

---

**NOTE.** *If the current cursor is set to horizontal mode, this command will time out.*

---

<b>Group</b>	Cursor
<b>Syntax</b>	DISplay:MATHFFTView<x>:CURSor:DDT?
<b>Arguments</b>	MATHFFTView<x> is the Math-FFT waveform number.
<b>Examples</b>	DISplay:MATHFFTView<x>:CURSor:DDT? might return DISPLAY:MATHFFTVIEW1:CURSOR:DDT 14.0056E-9, indicating the $\Delta Y/\Delta X$ cursor readout value is 14.0056E-9.

## DISplay:MATHFFTView<x>:CURSor:FUNCtion

This command sets or queries the cursor type for the specified Math-FFT view.

<b>Group</b>	Cursor
--------------	--------

<b>Syntax</b>	<p>DISplay:MATHFFTView&lt;x&gt;:CURSor:FUNctIon          {WAVEform VBArS HBArS SCREEN}          DISplay:MATHFFTView&lt;x&gt;:CURSor:FUNctIon?</p>
<b>Arguments</b>	<p>MATHFFTView&lt;x&gt; is the Math-FFT waveform number.</p> <p>WAVEFORM specifies to display the paired vertical cursors in YT display format for measuring waveform amplitude and time. Measurements are taken at where the cursor intersects the waveform, and tracks waveform changes.</p> <p>VBArS specifies vertical bar cursors, which measure in horizontal units.</p> <p>HBArS specifies horizontal bar cursors, which measure in vertical units.</p> <p>SCREEN specifies to display both horizontal and vertical bar cursors, which display the horizontal and vertical positions of the cursors, not waveform levels. Use these cursors to measure anywhere in the waveform display area.</p>
<b>Examples</b>	<p>DISplay:MATHFFTView5:CURSor:FUNctIon HBArS sets Math-FFT waveform 5 to use horizontal bar cursors.</p> <p>DISplay:MATHFFTView1:CURSor:FUNctIon? might return          DISplay:MATHFFTView1:CURSor:FUNctIon? SCREEN, indicating that Math-FFT waveform 2 is set to use both horizontal and vertical cursors.</p>

## DISplay:MATHFFTView<x>:CURSor:HBArS:APOsition

This command sets or returns the position of horizontal cursor A for the specified Math-FFT view.

<b>Group</b>	Cursor
<b>Syntax</b>	<p>DISplay:MATHFFTView&lt;x&gt;:CURSor:HBArS:APOsition &lt;NR3&gt;          DISplay:MATHFFTView&lt;x&gt;:CURSor:HBArS:APOsition?</p>
<b>Arguments</b>	<p>MATHFFTView&lt;x&gt; is the Math-FFT waveform number.</p> <p>&lt;NR3&gt; is the cursor position of the specified cursor in the specified view.</p>
<b>Examples</b>	<p>DISplay:MATHFFTView1:CURSor:HBArS:APOsition 50.0e-3 sets the position to 50 mV.</p> <p>DISplay:MATHFFTView4:CURSor:HBArS:APOsition? might return          DISPLAY:MATHFFTVIEW4:CURSOR:HBARS:APOSITION -274.2247E-3,          indicating the A cursor position is -274.2247E-3.</p>

## DISplay:MATHFFTView<x>:CURSor:HBArS:AUNIts? (Query Only)

This command queries the vertical units of horizontal cursor A for the specified Math-FFT view.

<b>Group</b>	Cursor
<b>Syntax</b>	DISplay:MATHFFTView<x>:CURSor:HBArS:AUNIts?
<b>Arguments</b>	MATHFFTView<x> is the Math-FFT waveform number.
<b>Examples</b>	DISplay:MATHFFTView1:CURSor:HBArS:AUNIts? might return DISPLAY:MATHFFTVIEW1:CURSOR:HBARS:AUNITS "dBm", indicating the vertical units are dBm.

## DISplay:MATHFFTView<x>:CURSor:HBArS:BPOsition

This command sets or returns the position of horizontal cursor B for the specified Math-FFT view.

<b>Group</b>	Cursor
<b>Syntax</b>	DISplay:MATHFFTView<x>:CURSor:HBArS:BPOsition <NR3> DISplay:MATHFFTView<x>:CURSor:HBArS:BPOsition?
<b>Arguments</b>	MATHFFTView<x> is the Math-FFT waveform number.  <NR3> is the vertical cursor B position for the specified Math-FFT view.
<b>Examples</b>	DISplay:MATHFFTView1:CURSor:HBArS:BPOsition 50e-3 sets the position to 0.005 vertical units.  DISplay:MATHFFTView1:CURSor:HBArS:BPOsition? might return DISPLAY:MATHFFTVIEW1:CURSOR:HBARS:BPOSITION -40.4061, indicating the position is -40.4061 vertical units.

## DISplay:MATHFFTView<x>:CURSor:HBArS:BUNIts? (Query Only)

This command queries the vertical units of horizontal cursor B for the specified Math-FFT view.

<b>Group</b>	Cursor
<b>Syntax</b>	DISPlay:MATHFFTView<x>:CURSOR:HbARS:BUNITS?
<b>Arguments</b>	MATHFFTView<x> is the Math-FFT waveform number.
<b>Examples</b>	DISPlay:MATHFFTView3:CURSOR:HbARS:BUNITS? might return DISPLAY:MATHFFTVIEW3:CURSOR:HbARS:BUNITS "dBm", indicating the cursor units are dBm.

## DISPlay:MATHFFTView<x>:CURSOR:HbARS:DELTA? (Query Only)

This command queries the horizontal cursor's delta value of the specified Math-FFT view.

<b>Group</b>	Cursor
<b>Syntax</b>	DISPlay:MATHFFTView<x>:CURSOR:HbARS:DELTA?
<b>Arguments</b>	MATHFFTView<x> is the Math-FFT waveform number.
<b>Examples</b>	DISPlay:MATHFFTView1:CURSOR:HbARS:DELTA? might return DISPLAY:MATHFFTVIEW1:CURSOR:HbARS:DELTA 30.61448, indicating the cursor readout is 30.61488 units.

## DISPlay:MATHFFTView<x>:CURSOR:MODE

This command sets or queries the cursor tracking mode of the specified Math-FFT view.

<b>Group</b>	Cursor
<b>Syntax</b>	DISPlay:MATHFFTView<x>:CURSOR:MODE {INDEPENDENT TRACK} DISPlay:MATHFFTView<x>:CURSOR:MODE?
<b>Arguments</b>	MATHFFTView<x> is the Math-FFT waveform number.  INDEPENDENT allows independent adjustment of the two cursors.

TRACK ties the navigational functionality of the two cursors together. For cursor 1 adjustments, this ties the movement of the two cursors together; however, cursor 2 continues to move independently of cursor 1.

**Examples**    `DISPlay:MATHFFTView1:CURSOR:MODE INDEPENDENT` allows independent adjustment of the two cursors.

`DISPlay:MATHFFTView1:CURSOR:MODE?` might return  
`:DISPLAY:MATHFFTVIEW1:CURSOR:MODE INDEPENDENT`, indicating the mode is set to independent.

## **DISPlay:MATHFFTView<x>:CURSOR:ONEOVERDELTAVALUE? (Query Only)**

This command queries the one over delta cursor readout value of the specified Math-FFT view.

**Group**    Cursor

**Syntax**    `DISPlay:MATHFFTView<x>:CURSOR:ONEOVERDELTAVALUE?`

**Arguments**    `MATHFFTView<x>` is the Math-FFT waveform number.

**Examples**    `DISPlay:MATHFFTView1:CURSOR:ONEOVERDELTAVALUE?` might return  
`DISPLAY:MATHFFTVIEW1:CURSOR:ONEOVERDELTAVALUE 2.6005E-9`,  
indicating the one over delta time value is 2.6005 nanoseconds.

## **DISPlay:MATHFFTView<x>:CURSOR:SCREEN:AXPOSITION**

This command sets or returns the vertical cursor A x-axis waveform measurement position of the specified Math-FFT view.

**Group**    Cursor

**Syntax**    `DISPlay:MATHFFTView<x>:CURSOR:SCREEN:AXPOSITION <NR3>`  
`DISPlay:MATHFFTView<x>:CURSOR:SCREEN:AXPOSITION?`

**Arguments**    `MATHFFTView<x>` is the Math-FFT waveform number.  
`<NR3>` is the cursor position in MHz.



**Examples** `DISPLAY:MATHFFTVIEW1:CURSOR:SCREEN:AXPOSITION 700.000E+6` sets the cursor position to 700 MHz.

`DISPLAY:MATHFFTVIEW3:CURSOR:SCREEN:AXPOSITION?` might return `DISPLAY:MATHFFTVIEW3:CURSOR:SCREEN:AXPOSITION 125.000E+6`, indicating the x-axis value of cursor A is 125 MHz.

## DISplay:MATHFFTView<x>:CURSor:SCREEN:AYPOsition

This command sets or returns the vertical cursor A y-axis amplitude measurement value of the specified Math-FFT view.

**Group** Cursor

**Syntax** `DISplay:MATHFFTView<x>:CURSor:SCREEN:AYPOsition <NR3>`  
`DISplay:MATHFFTView<x>:CURSor:SCREEN:AYPOsition?`

**Arguments** `MATHFFTView<x>` is the Math-FFT waveform number.  
`<NR3>` is the cursor A position of the specified cursor in the specified view.

**Examples** `DISplay:MATHFFTView2:CURSor:SCREEN:AYPOsition 1.0e0` sets the cursor position to 1.0 dBm.

`DISplay:MATHFFTView5:CURSor:SCREEN:AYPOsition?` might return `DISPLAY:MATHFFTVIEW5:CURSOR:SCREEN:AYPOSITION 1.1741714106633`, indicating the cursor position is 1.174 vertical units (such as dBm).

## DISplay:MATHFFTView<x>:CURSor:SCREEN:BXPOsition

This command sets or returns the vertical cursor Bx-axis waveform time measurement position of the specified Math-FFT view.

**Group** Cursor

**Syntax** `DISplay:MATHFFTView<x>:CURSor:SCREEN:BXPOsition <NR3>`  
`DISplay:MATHFFTView<x>:CURSor:SCREEN:BXPOsition?`

<b>Arguments</b>	MATHFFTView<x> is the Math-FFT waveform number.  <NR3> is the horizontal cursor B position of the specified cursor in the specified view.
<b>Examples</b>	DISplay:MATHFFTView1:CURSor:SCREEN:BXPOSITION 3.5e9 sets the cursor position to 3.5 GHz.  DISplay:MATHFFTView1:CURSor:SCREEN:BXPOSITION? might return DISPLAY:MATHFFTVIEW1:CURSOR:SCREEN:BXPOSITION 2.50E+9, indicating the cursor position is 2.5 GHz.

## DISplay:MATHFFTView<x>:CURSor:SCREEN:BYPOSITION

This command sets or returns the vertical cursor B y-axis amplitude measurement value of the specified Math-FFT view.

<b>Group</b>	Cursor
<b>Syntax</b>	DISplay:MATHFFTView<x>:CURSor:SCREEN:BYPOSITION <NR3> DISplay:MATHFFTView<x>:CURSor:SCREEN:BYPOSITION?
<b>Arguments</b>	MATHFFTView<x> is the Math-FFT waveform number.  <NR3> is the vertical cursor B position of the specified cursor in the specified view.
<b>Examples</b>	DISplay:MATHFFTView1:CURSor:SCREEN:BYPOSITION -50.0e0 sets the cursor position to -50.0.  DISplay:MATHFFTView4:CURSor:SCREEN:BYPOSITION? might return DISPLAY:MATHFFTVIEW4:CURSOR:SCREEN:BYPOSITION -59.0460929065173, indicating the cursor position is at -59.0 dBm.

## DISplay:MATHFFTView<x>:CURSor:STATE

This command sets or queries the visible state of cursors for the specified Math-FFT view.

<b>Group</b>	Cursor
<b>Syntax</b>	DISplay:MATHFFTView<x>:CURSor:STATE {ON OFF <NR1>} DISplay:MATHFFTView<x>:CURSor:STATE?

<b>Arguments</b>	<p>MATHFFTView&lt;x&gt; is the Math-FFT waveform number.</p> <p>1 or ON enables the cursors.</p> <p>0 or OFF disables the cursors.</p> <p>&lt;NR1&gt; = 0 turns off cursors; any other value displays cursors.</p>
<b>Examples</b>	<p>DISPlay:MATHFFTView2:CURSOR:STATE OFF turns off the cursors for Math-FFT waveform 2.</p> <p>DISPlay:MATHFFTView1:CURSOR:STATE? might return DISPLAY:MATHFFTVIEW1:CURSOR:STATE 1 indicating the cursors are enabled.</p>

## DISPlay:MATHFFTView<x>:CURSOR:VBARS:APOSITION

This command sets or queries the horizontal cursor A position for the specified Math-FFT view.

<b>Group</b>	Cursor
<b>Syntax</b>	<p>DISPlay:MATHFFTView&lt;x&gt;:CURSOR:VBARS:APOSITION &lt;NR3&gt;</p> <p>DISPlay:MATHFFTView&lt;x&gt;:CURSOR:VBARS:APOSITION?</p>
<b>Arguments</b>	<p>MATHFFTView&lt;x&gt; is the Math-FFT waveform number.</p> <p>&lt;NR3&gt; sets the vertical cursor A position in the specified view.</p>
<b>Examples</b>	<p>DISPlay:MATHFFTView1:CURSOR:VBARS:APOSITION 500.0e6 sets the cursor A position to 500 MHz.</p> <p>DISPlay:MATHFFTView1:CURSOR:VBARS:APOSITION? might return DISPLAY:MATHFFTVIEW1:CURSOR:VBARS:APOSITION 585.533869115958E+6, indicating cursor position is 585.5 MHz.</p>

## DISPlay:MATHFFTView<x>:CURSOR:VBARS:AUNITS? (Query Only)

This command queries the vertical cursor A measurement units for the specified Math-FFT view.

<b>Group</b>	Cursor
--------------	--------

**Syntax** `DISPlay:MATHFFTView<x>:CURSor:VBArS:AUNItS?`

**Arguments** `MATHFFTView<x>` is the Math-FFT waveform number.

**Examples** `DISPlay:MATHFFTView1:CURSor:VBArS:AUNItS?` might return `:DISPLAY:MATHFFTVIEW1:CURSOR:VBARS:UNITS "dBm"`, indicating the cursor units are dBm.

## **DISPlay:MATHFFTView<x>:CURSor:VBArS:BPOStion**

This command sets or queries the vertical cursor B position for the specified Math-FFT view.

**Group** Cursor

**Syntax** `DISPlay:MATHFFTView<x>:CURSor:VBArS:BPOStion <NR3>`  
`DISPlay:MATHFFTView<x>:CURSor:VBArS:BPOStion?`

**Arguments** `MATHFFTView<x>` is the Math-FFT waveform number.  
`<NR3>` sets the vertical cursor B position in the specified view.

**Examples** `DISPlay:MATHFFTView1:CURSor:VBArS:BPOStion 2.0e9` sets the cursor B position to 2.0 GHz.  
`DISPlay:MATHFFTView1:CURSor:VBArS:BPOStion?` might return `DISPLAY:MATHFFTVIEW1:CURSOR:VBARS:BPOSITION 2.50E+9`, indicating the cursor position is at 2.5 GHz.

## **DISPlay:MATHFFTView<x>:CURSor:VBArS:BUNItS? (Query Only)**

This command queries the vertical cursor B measurement units for the specified Math-FFT view.

**Group** Cursor

**Syntax** `DISPlay:MATHFFTView<x>:CURSor:VBArS:BUNItS?`

**Arguments** `MATHFFTView<x>` is the Math-FFT waveform number.

**Examples** `DISPlay:MATHFFTView1:CURSOR:VBARS:BUNITs?` might return  
`:DISPLAY:MATHFFTVIEW1:CURSOR:VBARS:BUNITS "Hz"` indicating the  
 cursor units are Hz.

## `DISPlay:MATHFFTView<x>:CURSOR:VBARS:DELTA?` (Query Only)

This command queries the vertical cursor's delta T readout value for the specified Math-FFT view.

**Group** Cursor

**Syntax** `DISPlay:MATHFFTView<x>:CURSOR:VBARS:DELTA?`

**Arguments** `MATHFFTView<x>` is the Math-FFT waveform number.

**Examples** `DISPlay:MATHFFTView1:CURSOR:VBARS:DELTA?` might return  
`DISPLAY:MATHFFTVIEW1:CURSOR:VBARS:DELTA 1.9144661308840E+9,`  
 indicating the delta T cursor value is 1.9 GHz.

## `DISPlay:MATHFFTView<x>:CURSOR:WAVEform:APOSITION`

This command sets or queries the waveform cursor A position for the specified Math-FFT view.

**Group** Cursor

**Syntax** `DISPlay:MATHFFTView<x>:CURSOR:WAVEform:APOSITION <NR3>`  
`DISPlay:MATHFFTView<x>:CURSOR:WAVEform:APOSITION?`

**Arguments** `MATHFFTView<x>` is the Math-FFT waveform number.  
`<NR3>` is the waveform cursor A position in the specified plot view.

**Examples** `DISPlay:MATHFFTView1:CURSOR:WAVEform:APOSITION 600.0e6` sets the  
 position to 600 MHz.

`DISPlay:MATHFFTView1:CURSOR:WAVEform:APOSITION?` might return  
`DISPLAY:MATHFFTVIEW1:CURSOR:WAVEFORM:APOSITION 25.000E+6,`  
 indicating the cursor position is 25 MHz.

## DISplay:MATHFFTView<x>:CURSor:WAVEform:BPOSition

This command sets or queries the waveform cursor B position for the specified Math-FFT view.

<b>Group</b>	Cursor
<b>Syntax</b>	DISplay:MATHFFTView<x>:CURSor:WAVEform:BPOSition <NR3> DISplay:MATHFFTView<x>:CURSor:WAVEform:BPOSition?
<b>Arguments</b>	MATHFFTView<x> is the Math-FFT waveform number.  <NR3> is the waveform cursor B position in the specified plot view.
<b>Examples</b>	DISplay:MATHFFTView1:CURSor:WAVEform:BPOSition 2.0E+9 sets the cursor position to 2.0 GHz.  DISplay:MATHFFTView1:CURSor:WAVEform:BPOSition? might return DISPLAY:MATHFFTVIEW1:CURSOR:WAVEFORM:BPOSITION 250.0E+6, indicating the waveform cursor B position is 250 MHz.

## DISplay:MATHFFTView<x>:GRIDlines

This command sets or queries the grid lines setting for the specified Math-FFT view.

<b>Group</b>	Display Control
<b>Syntax</b>	DISplay:MATHFFTView<x>:GRIDlines {HORIZONTAL VERTICAL BOTH} DISplay:MATHFFTView<x>:GRIDlines?
<b>Arguments</b>	MATHFFTView<x> is the Math-FFT waveform number.  HORIZONTAL specifies horizontal grid lines.  VERTICAL specifies vertical grid lines.  BOTH specifies both vertical and horizontal grid lines.

**Examples**    `DISPlay:MATHFFTView1:GRIDlines VERTICAL` specifies vertical grid lines.

`DISPlay:MATHFFTView1:GRIDlines?` might return  
`:DISPLAY:MATHFFTVIEW1:GRIDLINES BOTH` indicating both  
horizontal and vertical grid lines are displayed.

## DISPlay:MATHFFTView<x>:MATH:MATH<x>:STATE

This command sets or queries the display state of the specified math waveform for the specified Math-FFT view.

**Group**    Display Control

**Syntax**    `DISPlay:MATHFFTView<x>:MATH:MATH<x>:STATE {OFF|ON|<NR1>}`  
`DISPlay:MATHFFTView<x>:MATH:MATH<x>:STATE?`

**Arguments**    `MATHFFTView<x>` is the Math-FFT waveform number.

`OFF` disables displaying the specified Math-FFT view.

`ON` enables displaying the specified Math-FFT view.

`<NR1> = 0` disables the specified Math-FFT view; any other value enables the specified Math-FFT view.

**Examples**    `DISPlay:MATHFFTView1:MATH:MATH1:STATE ON` enables the specified Math-FFT view.

`DISPlay:MATHFFTView4:MATH:MATH4:STATE?` might return  
`:DISPLAY:MATHFFTVIEW1:MATH:MATH1:STATE 1`, indicating the waveform  
Math-FFT 1 is displayed.

## DISPlay:MATHFFTView<x>:XAXIS:SCALE

This command sets or queries the x-axis scale (Linear or Log) for the specified Math-FFT view.

**Group**    Display Control

**Syntax**    `DISPlay:MATHFFTView<x>:XAXIS:SCALE {LINEAR|LOG}`  
`DISPlay:MATHFFTView<x>:XAXIS:SCALE?`

- Arguments**    `MATHFFTView<x>` is the Math-FFT waveform number.
- `LINEAR` specifies a linear scale.
- `LOG` specifies a logarithmic scale.
- Examples**     `DISPlay:MATHFFTView1:XAXIS:SCALE LOG` specifies a logarithmic scale.
- `DISPlay:MATHFFTView1:XAXIS:SCALE?` might return  
`DISPLAY:MATHFFTVIEW1:XAXIS:SCALE LINEAR`, indicating that  
the scale setting is linear.

## **DISPlay:MATHFFTView<x>:YAXIS:SCALE**

This command sets or queries the vertical scale setting (Linear or dBm) for the specified Math-FFT view.

- Group**        `Display Control`
- Syntax**       `DISPlay:MATHFFTView<x>:YAXIS:SCALE {LINEAR|DBM}`  
`DISPlay:MATHFFTView<x>:YAXIS:SCALE?`
- Arguments**    `MATHFFTView<x>` is the Math-FFT waveform number.
- `LINEAR` specifies a linear scale.
- `DBM` specifies a dBm scale.
- Examples**     `DISPlay:MATHFFTView1:YAXIS:SCALE LINEAR` specifies a linear scale.
- `DISPlay:MATHFFTView1:YAXIS:SCALE?` might return  
`DISPLAY:MATHFFTVIEW1:YAXIS:SCALE DBM`, indicating that the  
scale is dBm.

## **DISPlay:MATHFFTView<x>:ZOOM:XAXIS:FROM**

This command sets or queries the value of the left edge of the zoom area for the specified Math-FFT view.

- Group**        `Zoom`
- Syntax**       `DISPlay:MATHFFTView<x>:ZOOM:XAXIS:FROM <NR3>`  
`DISPlay:MATHFFTView<x>:ZOOM:XAXIS:FROM?`



- Arguments**    `MATHFFTView<x>` is the Math-FFT waveform number.  
                   `<NR3>` is the value of the left edge of the zoom x axis in the specified plot view.
- Examples**     `DISPlay:MATHFFTView1:ZOOM:XAXIS:FROM 800.e6` sets the x axis value of the left edge of the plot view to 800 MHz.  
                   `DISPlay:MATHFFTView1:ZOOM:XAXIS:FROM?` might return  
`DISPLAY:MATHFFTVIEW1:ZOOM:XAXIS:FROM 781.0E+6`, indicating the x axis value of the left edge of the plot view is at 781 MHz.

## **DISPlay:MATHFFTView<x>:ZOOM:XAXIS:TO**

This command sets or queries the value of the right edge value of the zoom area for the specified Math-FFT view.

- Group**        Zoom
- Syntax**      `DISPlay:MATHFFTView<x>:ZOOM:XAXIS:TO <NR3>`
- Arguments**    `MATHFFTView<x>` is the Math-FFT waveform number.  
                   `<NR3>` is the value of the right edge of the zoom x axis in the specified plot view.
- Examples**     `DISPlay:MATHFFTView1:ZOOM:XAXIS:TO 2.3E+9` sets the value of the right edge of the x axis to 2.3 GHz.  
                   `DISPlay:MATHFFTView1:ZOOM:XAXIS:TO?` might return  
`:DISPLAY:MATHFFTVIEW1:ZOOM:XAXIS:TO 2.343750E+9`,  
                   indicating the value of the right edge of the zoom x axis is 2.34 GHz.

## **DISPlay:MATHFFTView<x>:ZOOM:YAXIS:FROM**

This command sets or queries the bottom edge value of the zoom y-axis area for the specified Math-FFT view.

- Group**        Zoom
- Syntax**      `DISPlay:MATHFFTView<x>:ZOOM:YAXIS:FROM <NR3>`  
`DISPlay:MATHFFTView<x>:ZOOM:YAXIS:FROM?`

- Arguments**    `MATHFFTView<x>` is the Math-FFT waveform number.  
                   `<NR3>` is the bottom value of the zoom y axis in the specified plot view.
- Examples**     `DISPlay:MATHFFTView1:ZOOM:YAXIS:FROM -75.0e0` sets the bottom value of the y axis to -75 dBm.  
                   `DISPlay:MATHFFTView1:ZOOM:YAXIS:FROM?` might return  
                   `DISPLAY:MATHFFTVIEW1:ZOOM:YAXIS:FROM -78.8258285893367`  
                   indicating the bottom value of the y axis is -78.8 dBm.

## **DISPlay:MATHFFTView<x>:ZOOM:YAXIS:TO**

This command sets or queries the top edge value of the zoom y-axis area for the specified Math-FFT view.

- Group**         Zoom
- Syntax**       `DISPlay:MATHFFTView<x>:ZOOM:YAXIS:TO <NR3>`  
                   `DISPlay:MATHFFTView<x>:ZOOM:YAXIS:TO?`
- Arguments**    `MATHFFTView<x>` is the Math-FFT waveform number.  
                   `<NR3>` is the top value of the zoom y axis in the specified plot view.
- Examples**     `DISPlay:MATHFFTView1:ZOOM:YAXIS:TO 21.0E0` sets the top value of the zoom y axis in the specified plot view to 21 dBm.  
                   `DISPlay:MATHFFTView1:ZOOM:YAXIS:TO?` might return  
                   `DISPLAY:MATHFFTVIEW1:ZOOM:YAXIS:TO 21.1741714106633,`  
                   indicating the top value of the zoom y axis in the specified plot view is 21.17 dBm.

## **DISPlay:PERSistence**

This command sets or queries the display persistence for analog waveforms. Persistence is valid for wave views only.

- Group**         Display Control
- Syntax**       `DISPlay:PERSistence`  
                   `{OFF|AUTO|INFPersist|INFINite|VARpersist|CLEAR}`  
                   `DISPlay:PERSistence?`

**Related Commands**    [DISplay:VARpersist](#)

**Arguments**

OFF disables the persistence aspect of the display.

AUTO automatically set the persistence.

INFPersist sets a display mode where any pixels, once touched by samples, remain set until cleared by a mode change.

INFINite sets a display mode where any pixels, once touched by samples, remain set until cleared by a mode change.

VARPersist sets a display mode where set pixels are gradually dimmed.

CLEAR resets the persist time count down and clears the display of acquired points.

**Examples**

DISPLAY: PERSISTENCE VARPERSIST sets the persistence aspect of the display to fade set pixels according to the time set in the [DISplay:VARpersist](#) command.

DISPLAY: PERSISTENCE? might return :DISPLAY: PERSISTENCE OFF, indicating that the persistence aspect of the display is disabled.

## DISplay:PERStence:RESEt (No Query Form)

This command controls the clearing of persistence data that has been built up over time. Persistence is valid for wave views only.

**Group**    Display Control

**Syntax**    DISplay:PERStence:RESEt

**Related Commands**    [DISplay:PERStence](#)  
                                   [DISplay:VARpersist](#)

**Examples**    DISPLAY: PERSISTENCE: RESEt clears the display of persistence data.

## DISplay:PLOTView<n>:CURSor:ROLOCAtION

This command sets or queries the location to display the specified plot cursor readouts (in the plot graticule or in a badge in the Results Bar).

**Group**    Cursor

**Syntax**    `DISPlay:PLOTView<n>:CURSOR:ROLOCATION {GRATICULE|BADGE}`  
`DISPlay:PLOTView<n>:CURSOR:ROLOCATION?`

**Arguments**    `PLOTView<x>` is the waveform plot number.

`GRATICULE` sets the plot cursor readouts to display as part of the cursors in the plot view.

`BADGE` removes the plot cursor readouts from the cursors in the graticule and displays the cursor information as a badge in the Results Bar.

**Examples**    `DISPlay:PLOTView1:CURSOR:ROLOCATION GRATICULE` sets the cursor readout information for plot 1 to display in the plot graticule.

`DISPlay:PLOTView2:CURSOR:ROLOCATION?` might return  
`DISPlay:PLOTView2:CURSOR:ROLOCATION BADGE`, indicating that cursor readout information for plot 2 is set to display as a badge in the Results Bar.

## **DISPlay:PLOTView<x>:AUTOScale**

This command sets or queries the enabled state of autoscale for the specified plot.

**Group**    Display Control

**Syntax**    `DISPlay:PLOTView<x>:AUTOScale {OFF|ON|<NR1>}`  
`DISPlay:PLOTView<x>:AUTOScale?`

**Arguments**    `PLOTView<x>` is the Plot waveform number.

`OFF` disables the autoscale feature.

`ON` enables the autoscale feature.

`<NR1> = 0` disables the autoscale feature; any other value enables the autoscale feature.

**Examples**    `DISPlay:PLOTView1:AUTOScale OFF` turns off plot autoscale.

`DISPlay:PLOTView3:AUTOScale?` might return  
`:DISPLAY:PLOTVIEW3:AUTOSCALE 0`, indicating the plot autoscale is off for plot 3.

## DISplay:PLOTView<x>:CURSor:ASOURce? (Query Only)

This command queries the cursor source for plot cursor A.

<b>Group</b>	Cursor
<b>Syntax</b>	DISplay:PLOTView<x>:CURSor:ASOURce?
<b>Arguments</b>	PLOTView<x> is the Plot waveform number.
<b>Examples</b>	DISplay:PLOTView1:CURSor:ASOURce? might return DISPLAY:PLOTVIEW1:CURSOR:ASOURCE PLOT1 indicating the source of the cursor is plot 1.

## DISplay:PLOTView<x>:CURSor:BSOURce? (Query Only)

This command queries the cursor source for plot cursor B.

<b>Group</b>	Cursor
<b>Syntax</b>	DISplay:PLOTView<x>:CURSor:BSOURce?
<b>Arguments</b>	PLOTView<x> is the Plot waveform number.
<b>Examples</b>	DISplay:PLOTView1:CURSor:BSOURce? might return :DISPLAY:PLOTVIEW1:CURSOR:BSOURCE PLOT1 indicating the B cursor source is plot 1.

## DISplay:PLOTView<x>:CURSor:DDT? (Query Only)

This command returns the delta V over delta T cursor readout value for the specified Plot view.

<b>Group</b>	Cursor
<b>Syntax</b>	DISplay:PLOTView<x>:CURSor:DDT?

**Arguments** PlotView<x> is the Plot waveform number.

**Examples** DISplay:PLOTview1:CURSor:DDT? might return  
:DISPLAY:PLOTVIEW1:CURSOR:DDT 131.0470E+6 indicating the cursor  
readout value is 131.0470E+6.

## DISplay:PLOTView<x>:CURSor:FUNctIon

This command sets or queries the cursor mode for the specified Plot view.

**Group** Cursor

**Syntax** DISplay:PLOTview<x>:CURSor:FUNctIon  
{WAVEFORM|VBARS|HBARS|SCREEN}  
DISplay:PLOTview<x>:CURSor:FUNctIon?

**Arguments** PLOTview<x> is the Plot waveform number.

WAVEFORM specifies to display the paired cursors in YT display format for measuring waveform amplitude and time.

VBARS specifies vertical bar cursors, which measure in horizontal units.

HBARS specifies horizontal bar cursors, which measure in vertical units.

SCREEN specifies to display both horizontal and vertical bar cursors, which measure the selected waveform in horizontal and vertical units. Use these cursors to measure anywhere in the waveform display area.

**Examples** DISplay:PLOTview1:CURSor:FUNctIon VBARS displays vertical bar cursors.

DISplay:PLOTview1:CURSor:FUNctIon? might return  
:DISPLAY:PLOTVIEW1:CURSOR:FUNCTION SCREEN indicating that  
both horizontal and vertical bar cursors are displayed.

## DISplay:PLOTView<x>:CURSor:HBARS:APOSition

This command sets or queries the horizontal cursor A position for the specified Plot view.

**Group** Cursor

<b>Syntax</b>	<code>DISplay:PLOTView&lt;x&gt;:CURSor:HBARS:APOSition &lt;NR3&gt;</code> <code>DISplay:PLOTView&lt;x&gt;:CURSor:HBARS:APOSition?</code>
<b>Arguments</b>	<code>PLOTView&lt;x&gt;</code> is the Plot waveform number. <code>&lt;NR3&gt;</code> is the cursor position.
<b>Examples</b>	<code>DISplay:PLOTView&lt;x&gt;:CURSor:HBARS:APOSition 2.0</code> sets the cursor to 2 Volts. <code>DISplay:PLOTView&lt;x&gt;:CURSor:HBARS:APOSition?</code> might return <code>:DISPLAY:PLOTVIEW1:CURSOR:HBARS:APOSITION 2.2186</code> indicating the HBARS cursors are at 2.2186 Volts.

## `DISplay:PLOTView<x>:CURSor:HBARS:AUNIts? (Query Only)`

This command queries the horizontal cursor A vertical units for the specified Plot view.

<b>Group</b>	Cursor
<b>Syntax</b>	<code>DISplay:PLOTView&lt;x&gt;:CURSor:HBARS:AUNIts?</code>
<b>Returns</b>	<code>PLOTView&lt;x&gt;</code> is the Plot waveform number.
<b>Examples</b>	<code>DISplay:PLOTView1:CURSor:HBARS:AUNIts?</code> might return <code>:DISPLAY:PLOTVIEW1:CURSOR:HBARS:AUNITS "V"</code> , indicating the A units are volts.

## `DISplay:PLOTView<x>:CURSor:HBARS:BPOSition`

This command sets or queries the horizontal cursor B position for the specified Plot view.

<b>Group</b>	Cursor
<b>Syntax</b>	<code>DISplay:PLOTView&lt;x&gt;:CURSor:HBARS:BPOSition &lt;NR3&gt;</code> <code>DISplay:PLOTView&lt;x&gt;:CURSor:HBARS:BPOSition?</code>

- Arguments** PLOTview<x> is the Plot waveform number.  
<NR3> is the HBArS vertical position.
- Examples** DISplay:PLOTView<x>:CURSor:HBArS:BPOsition 2.0 sets the cursor to 2 Volts.  
DISplay:PLOTView<x>:CURSor:HBArS:BPOsition? might return :DISPLAY:PLOTVIEW1:CURSOR:HBARS:BPOSITION 2.2186 indicating the HBArS cursors are at 2.2186 Volts.

### DISplay:PLOTView<x>:CURSor:HBArS:BUNIts? (Query Only)

This command queries the cursor B vertical units for the specified Plot view.

- Group** Cursor
- Syntax** DISplay:PLOTView<x>:CURSor:HBArS:BUNIts?
- Arguments** PLOTView<x> is the Plot waveform number.
- Examples** DISplay:PLOTView1:CURSor:HBArS:BUNIts? might return :DISPLAY:PLOTVIEW1:CURSOR:HBARS:BUNITS "V" indicating the units are Volts.

### DISplay:PLOTView<x>:CURSor:HBArS:DELTA? (Query Only)

This command queries the delta V cursor readout value for the specified Plot view.

- Group** Cursor
- Syntax** DISplay:PLOTView<x>:CURSor:HBArS:DELTA?
- Arguments** PLOTView<x> is the Plot waveform number.
- Returns** Returns an <NR3> that is the delta V cursor value.



**Examples** `DISPlay:PLOTView1:CURSOR:HBARS:DELTA?` might return  
`:DISPLAY:PLOTVIEW1:CURSOR:HBARS:DELTA 1.2543`, indicating the delta  
value is 1.2543 V.

## DISPlay:PLOTView<x>:CURSOR:MODE

This command sets or queries the cursor tracking mode for the specified Plot view.

**Group** Cursor

**Syntax** `DISPlay:PLOTView<x>:CURSOR:MODE {INDEPENDENT|TRACK}`  
`DISPlay:PLOTView<x>:CURSOR:MODE?`

**Arguments** `PLOTView<x>` is the Plot waveform number.

`INDEPENDENT` allows independent adjustment of the two cursors.

`TRACK` ties the navigational functionality of the two cursors together. For cursor A adjustments, this ties the movement of the two cursors together; however, cursor B continues to move independently of cursor A.

**Examples** `DISPlay:PLOTView1:CURSOR:MODE TRACK` sets the cursor to track together.  
`DISPlay:PLOTView1:CURSOR:MODE?` might return  
`:DISPLAY:PLOTVIEW1:CURSOR:MODE INDEPENDENT`, indicating independent  
adjustment of the cursors is allowed.

## DISPlay:PLOTView<x>:CURSOR:ONEOVERDELTAVALUE? (Query Only)

This command sets or queries the one over delta T cursor readout value for the specified Plot view.

**Group** Cursor

**Syntax** `DISPlay:PLOTView<x>:CURSOR:ONEOVERDELTAVALUE?`

**Arguments** `PLOTView<x>` is the Plot waveform number.

**Returns** Returns an `<NR3>` that is the one over delta T cursor readout value (it may not be delta T, depending on the plot units).

**Examples**    `DISPlay:PLOTView<x>:CURSor:ONEOVERDELTAVALUE?` might return  
                  `:DISPLAY:PLOTVIEW1:CURSOR:ONEOVERDELTAVALUE 88.2295E+6`  
                  indicating the 1 over delta time value is 88.2295 MHz.

## **DISPlay:PLOTView<x>:CURSor:SCREEN:AXPOSITION**

This command sets or queries the horizontal cursor A position of the specified cursor in the specified view.

**Group**        Cursor

**Syntax**       `DISPlay:PLOTView<x>:CURSor:SCREEN:AXPOSITION <NR3>`  
                  `DISPlay:PLOTView<x>:CURSor:SCREEN:AXPOSITION?`

**Arguments**   `PLOTView<x>` is the Plot waveform number.  
                  `<NR3>` is the horizontal cursor A position.

**Examples**     `DISPlay:PLOTView1:CURSor:SCREEN:AXPOSITION -5.0` sets the A X  
                  cursor position to —5.0 ns.  
  
                  `DISPlay:PLOTView1:CURSor:SCREEN:AXPOSITION?` might return  
                  `:DISPLAY:PLOTVIEW1:CURSOR:SCREEN:AXPOSITION -5.5460E-9`  
                  indication the cursor A X position is -5.546 ns.

## **DISPlay:PLOTView<x>:CURSor:SCREEN:AYPOSITION**

This command sets or queries the vertical cursor A position of the specified cursor in the specified view.

**Group**        Cursor

**Syntax**       `DISPlay:PLOTView<x>:CURSor:SCREEN:AYPOSITION <NR3>`  
                  `DISPlay:PLOTView<x>:CURSor:SCREEN:AYPOSITION?`

**Arguments**   `PLOTView<x>` is the Plot waveform number.  
                  `<NR3>` is the vertical cursor A position.

**Examples**     `DISPlay:PLOTView1:CURSor:SCREEN:AYPOSITION 2.0` set the A cursor  
                  Y position to 2.0 Volts.

DISplay:PLOTView1:CURSor:SCREEN:AYPOSITION? might return  
:DISPLAY:PLOTVIEW1:CURSOR:SCREEN:AYPOSITION 1.9035 indicating  
the A cursor Y position is 1.9035 V.

## DISplay:PLOTView<x>:CURSor:SCREEN:BXPOSITION

This command sets or queries the horizontal cursor B position of the specified cursor in the specified view.

<b>Group</b>	Cursor
<b>Syntax</b>	DISplay:PLOTView<x>:CURSor:SCREEN:BXPOSITION <NR3> DISplay:PLOTView<x>:CURSor:SCREEN:BXPOSITION?
<b>Arguments</b>	PLOTView<x> is the Plot waveform number. <NR3> is the horizontal cursor B position.
<b>Examples</b>	DISplay:PLOTView1:CURSor:SCREEN:BXPOSITION 59.0E-9 sets the B cursor X position to 59.0 ns.  DISplay:PLOTView1:CURSor:SCREEN:BXPOSITION? might return :DISPLAY:PLOTVIEW1:CURSOR:SCREEN:BXPOSITION 59.6802E-9 indicating the B cursor X position is 59.6802 ns.

## DISplay:PLOTView<x>:CURSor:SCREEN:BYPOSITION

This command sets or queries the vertical cursor B position of the specified cursor in the specified view.

<b>Group</b>	Cursor
<b>Syntax</b>	DISplay:PLOTView<x>:CURSor:SCREEN:BYPOSITION <NR3> DISplay:PLOTView<x>:CURSor:SCREEN:BYPOSITION?
<b>Arguments</b>	PLOTView<x> is the Plot waveform number. <NR3> is the vertical cursor B position.
<b>Examples</b>	DISplay:PLOTView1:CURSor:SCREEN:BYPOSITION 0.589 sets the B cursor Y position to 589 mV.

DISplay:PLOTView1:CURSor:SCREEN:BYPOSITION? might return  
:DISPLAY:PLOTVIEW1:CURSOR:SCREEN:BYPOSITION 589.0696E-3  
indicating the B cursor Y position is 589.0696 mV.

## DISplay:PLOTView<x>:CURSor:SPLITMODE

This command sets or queries the cursor source mode in the specified view.

<b>Group</b>	Cursor
<b>Syntax</b>	DISplay:PLOTView<x>:CURSor:SPLITMODE {SAME SPLIT} DISplay:PLOTView<x>:CURSor:SPLITMODE?
<b>Arguments</b>	PLOTView<x> is the Plot waveform number.  SAME specifies that both cursors are on the same waveform.  SPLIT specifies that the cursors can be on different waveforms.
<b>Examples</b>	DISplay:PLOTView1:CURSor:SPLITMODE SAME sets the cursors to be on the same waveform.  DISplay:PLOTView1:CURSor:SPLITMODE? might return :DISPLAY:PLOTVIEW1:CURSOR:SPLITMODE SAME indicating both cursors are on the same waveform.

## DISplay:PLOTView<x>:CURSor:STATE

This command sets or queries the visible state of the cursor of the specified cursor in the specified view.

<b>Group</b>	Cursor
<b>Syntax</b>	DISplay:PLOTView<x>:CURSor:STATE {OFF ON <NR1>} DISplay:PLOTView<x>:CURSor:STATE?
<b>Arguments</b>	PLOTView<x> is the Plot waveform number.  OFF disables the specified cursor.  ON enables the specified cursor.

<NR1> = 0 disables the specified cursor; any other value enables the specified cursor.

**Examples**    `DISplay:PLOTView1:CURSor:STATE OFF` disables the specified cursor.  
`DISplay:PLOTView5:CURSor:STATE?` might return  
`:DISPLAY:PLOTVIEW5:CURSOR:STATE 1` indicating cursors are on.

## DISplay:PLOTView<x>:CURSor:VBArS:APOSition

This command sets or queries the vertical cursor A position of the specified cursor in the specified view.

**Group**    Cursor

**Syntax**    `DISplay:PLOTView<x>:CURSor:VBArS:APOSition <NR3>`  
`DISplay:PLOTView<x>:CURSor:VBArS:APOSition?`

**Arguments**    `PLOTView<x>` is the Plot waveform number.  
<NR3> is the vertical cursor A position.

**Examples**    `DISplay:PLOTView1:CURSor:VBArS:APOSition 50.0E-9` sets the VBARS APOSITION to 50 ns.  
`DISplay:PLOTView1:CURSor:VBArS:APOSition?` might return  
`:DISPLAY:PLOTVIEW1:CURSOR:VBARS:APOSITION -60.0796E-9`  
indicating the VBARS APOSITION is set to -60.08 ns.

## DISplay:PLOTView<x>:CURSor:VBArS:BPOSition

This command sets or queries the vertical cursor B position of the specified cursor in the specified view.

**Group**    Cursor

**Syntax**    `DISplay:PLOTView<x>:CURSor:VBArS:BPOSition <NR3>`  
`DISplay:PLOTView<x>:CURSor:VBArS:BPOSition?`

<b>Arguments</b>	PLOTView<x> is the Plot waveform number.  <NR3> is the vertical cursor B position.
<b>Examples</b>	:DISPLAY:PLOTVIEW1:CURSOR:VBARS:BPOSITION 50.0E-9 sets the VBARS BPOSITION to 50 ns.  :DISPLAY:PLOTVIEW1:CURSOR:VBARS:BPOSITION? might return :DISPLAY:PLOTVIEW1:CURSOR:VBARS:BPOSITION -60.0796E-9 indicating the VBARS BPOSITION is set to 60.08 ns.

### DISplay:PLOTView<x>:CURSor:VBArS:DELTA? (Query Only)

This command queries the delta T cursor readout value of the specified cursor in the specified view.

<b>Group</b>	Cursor
<b>Syntax</b>	DISplay:PLOTView<x>:CURSor:VBArS:DELTA?
<b>Arguments</b>	PLOTView<x> is the Plot waveform number.
<b>Returns</b>	The delta T cursor readout value is returned.
<b>Examples</b>	DISplay:PLOTView1:CURSor:VBArS:DELTA? might return :DISPLAY:PLOTVIEW1:CURSOR:VBARS:DELTA 119.7593E-9 indicating the VBARS DELTA is set to 119.76 ns.

### DISplay:PLOTView<x>:CURSor:VBArS:UNItS? (Query Only)

This command queries the VBARS cursor readout units of the specified cursor in the specified view.

<b>Group</b>	Cursor
<b>Syntax</b>	DISplay:PLOTView<x>:CURSor:VBArS:UNItS?
<b>Arguments</b>	PLOTView<x> is the Plot waveform number.

**Returns** The VBArS cursor readout units are returned.

**Examples** `DISPlay:PLOTView<x>:CURSOR:VBARS:UNITS?` might return  
`:DISPLAY:PLOTVIEW5:CURSOR:VBARS:UNITS "V"` indicating the units are  
 Volts.

## DISPlay:PLOTView<x>:CURSOR:WAVEform:APOSITION

This command sets or queries the waveform cursor A horizontal position of the specified cursor in the specified view.

---

**NOTE.** *In case of XY plot, this command has no effect when used to set the value. In case of bathtub plot, this command sets or returns the cursor A vertical position. For all other plots, this command sets or returns the cursor A horizontal position.*

---

**Group** Cursor

**Syntax** `DISPlay:PLOTView<x>:CURSOR:WAVEform:APOSITION <NR3>`  
`DISPlay:PLOTView<x>:CURSOR:WAVEform:APOSITION?`

**Arguments** `PLOTView<x>` is the Plot waveform number.  
`<NR3>` is the horizontal cursor A position.

**Examples** `DISPlay:PLOTView1:CURSOR:WAVEform:APOSITION -50.0E-9` sets the  
 waveform APOSITION to -50.0 ns.

`DISPlay:PLOTView1:CURSOR:WAVEform:APOSITION?` might return  
`:DISPLAY:PLOTVIEW1:CURSOR:WAVEFORM:APOSITION -60.0796E-9`  
 indicating the waveform APOSITION is set to -60.08 ns.

## DISPlay:PLOTView<x>:CURSOR:WAVEform:BPOSITION

This command sets or queries the waveform cursor B horizontal position of the specified cursor in the specified view.

---

**NOTE.** *In case of XY plot, this command has no effect when used to set the value. In case of bathtub plot, this command has no effect. Query returns invalid values. For all other plots, this command sets or returns the cursor B horizontal position.*

---

<b>Group</b>	Cursor
<b>Syntax</b>	DISplay:PLOTView<x>:CURSor:WAVEform:BPOsition <NR3> DISplay:PLOTView<x>:CURSor:WAVEform:BPOsition?
<b>Arguments</b>	PLOTView<x> is the Plot waveform number.  <NR3> is the horizontal cursor B position.
<b>Examples</b>	DISplay:PLOTView1:CURSor:WAVEform:BPOsition 3.0 sets the position to 3.0 V.  DISplay:PLOTView5:CURSor:WAVEform:BPOsition? might return :DISPLAY:PLOTVIEW5:CURSOR:WAVEFORM:BPOSITION 2.600517840 indicating the position is 2.5 V.

## DISplay:PLOTView<x>:GRIDlines

This command sets or queries the Grid (graticule) lines setting of the specified plot. This command works for plots that have vertical and horizontal units associated with the graticule. For example, this command does not work for XY or XYZ plots.

<b>Group</b>	Display Control
<b>Syntax</b>	DISplay:PLOTView<x>:GRIDlines {HORizontal VERTical BOTH} DISplay:PLOTView<x>:GRIDlines?
<b>Arguments</b>	PLOTView<x> is the Plot waveform number.  HORizontal specifies horizontal grid lines.  VERTical specifies vertical grid lines.  BOTH specifies both vertical and horizontal grid lines.
<b>Examples</b>	DISplay:PLOTView1:GRIDlines vertical sets the vertical grid lines to display.  DISplay:PLOTView1:GRIDlines? might return :DISPLAY:PLOTVIEW1:GRIDLINES BOTH indicating that both vertical and horizontal grid lines are displayed.



## DISplay:PLOTVIEW<x>:XAXIS:SCALE

This command sets or queries the horizontal scale setting for applicable plots (Linear or Log) for the specified plot view.

<b>Group</b>	Display
<b>Syntax</b>	DISplay:PLOTVIEW<x>:XAXIS:SCALE {LINEAR LOG} DISplay:PLOTVIEW<x>:XAXIS:SCALE?
<b>Arguments</b>	PLOTview<x> is the Plot waveform number.  LINEAR creates a plot with linear scales.  LOG creates a plot with logarithmic scales.
<b>Examples</b>	DISplay:PLOTVIEW1:XAXIS:SCALE LOG creates a plot with a logarithmic horizontal scale.  DISplay:PLOTVIEW1:XAXIS:SCALE? might return :DISplay:PLOTVIEW1:XAXIS:SCALE LINEAR indicating plots will have linear scales.

## DISplay:PLOTVIEW<x>:YAXIS:SCALE

This command sets or queries the vertical scale setting for applicable plots (Linear or Log) in the specified plot view.

<b>Group</b>	Display
<b>Syntax</b>	DISplay:PLOTVIEW<x>:YAXIS:SCALE {LINEAR LOG} DISplay:PLOTVIEW<x>:YAXIS:SCALE?
<b>Arguments</b>	PLOTview<x> is the Plot waveform number.  LINEAR specifies a linear vertical scale.  LOG specifies a logarithmic vertical scale.
<b>Examples</b>	DISplay:PLOTVIEW1:YAXIS:SCALE LINEAR sets the plot to use a linear vertical scale.

DISplay:PLOTVIEW1:YAXIS:SCALE? might return  
:DISplay:PLOTVIEW1:YAXIS:SCALE LOG indicating a logarithmic vertical  
scale is used.

## DISplay:PLOTView<x>:ZOOM:XAXIS:FROM

This command sets or queries the value of the left edge of the specified plot.

<b>Group</b>	Zoom
<b>Syntax</b>	DISplay:PLOTView<x>:ZOOM:XAXIS:FROM <NR3> DISplay:PLOTView<x>:ZOOM:XAXIS:FROM?
<b>Arguments</b>	PLOTView<x> is the Plot waveform number.  <NR3> is start of the zoom x-axis.
<b>Examples</b>	DISplay:PLOTView1:ZOOM:XAXIS:FROM 2.0 sets the start of the zoom x-axis to 2.0 V.  DISplay:PLOTView3:ZOOM:XAXIS:FROM? might return DISplay:PLOTVIEW3:ZOOM:XAXIS:FROM 1.9844803459459 indicating the start of the zoom x-axis is 1.9845 V.

## DISplay:PLOTView<x>:ZOOM:XAXIS:TO

This command sets or queries the value of the right edge of the specified plot.

<b>Group</b>	Zoom
<b>Syntax</b>	DISplay:PLOTView<x>:ZOOM:XAXIS:TO <NR3> DISplay:PLOTView<x>:ZOOM:XAXIS:TO?
<b>Arguments</b>	PLOTView<x> is the Plot waveform number.  <NR3> is the end of the zoom x-axis.
<b>Examples</b>	DISplay:PLOTView1:ZOOM:XAXIS:TO 2.5 sets the end of the zoom x-axis to 2.5 V.

DISplay:PLOTView3:ZOOM:XAXIS:TO? might return  
 DISPLAY:PLOTVIEW3:ZOOM:XAXIS:TO 2.2144883507508  
 indicating the end of the zoom x-axis is 2.21 V.

## DISplay:PLOTView<x>:ZOOM:YAXIS:FROM

This command sets or queries the bottom value of the zoom y-axis in the specified plot view.

<b>Group</b>	Zoom
<b>Syntax</b>	DISplay:PLOTView<x>:ZOOM:YAXIS:FROM <NR3> DISplay:PLOTView<x>:ZOOM:YAXIS:FROM?
<b>Arguments</b>	PLOTView<x> is the Plot waveform number. <NR3> is the bottom value of the zoom y-axis.
<b>Examples</b>	DISplay:PLOTView1:ZOOM:YAXIS:FROM -1.0E+20 sets the bottom value of the zoom y-axis to -1E+20. DISplay:PLOTView1:ZOOM:YAXIS:FROM? might return :DISPLAY:PLOTVIEW1:ZOOM:YAXIS:FROM -1.0E+21 indicating the bottom value of the zoom y-axis is -1E+21.

## DISplay:PLOTView<x>:ZOOM:YAXIS:TO

This command sets or queries the top value of the zoom y-axis in the specified plot view.

<b>Group</b>	Zoom
<b>Syntax</b>	DISplay:PLOTView<x>:ZOOM:YAXIS:TO <NR3> DISplay:PLOTView<x>:ZOOM:YAXIS:TO?
<b>Arguments</b>	PLOTView<x> is the Plot waveform number. <NR3> is the top value of the zoom y-axis.
<b>Examples</b>	DISplay:PLOTView1:ZOOM:YAXIS:TO 100 sets the top value of the zoom y-axis to 100.

DISplay:PLOTView1:ZOOM:YAXIS:TO? might return  
:DISPLAY:PLOTVIEW3:ZOOM:YAXIS:FROM 0.0E+0 indicating the  
top value of the zoom y-axis is 0.0 hits (for a histogram plot, or it could be Volts  
for an XY plot).

## DISplay:REFFFTView<x>:AUTOScale

This command sets or queries the enabled state of auto-scale for plots.

<b>Group</b>	Display Control
<b>Syntax</b>	DISplay:REFFFTView<x>:AUTOScale {OFF ON 0 1} DISplay:REFFFTView<x>:AUTOScale?
<b>Arguments</b>	REFFFTView<x> is the plot number.  <NR1> = 0 disables auto-scale on the specified reffftview; any other value turns this feature on.  OFF disables auto-scale on the specified reffftview.  ON enables the specified channel on the specified Waveform View.
<b>Examples</b>	DISplay:REFFFTView1:AUTOScale 1 enables auto-scale on the specified view.  DISplay:REFFFTView5:AUTOScale? might return :DISPLAY:REFFFTVIEW5:AUTOSCALE 1 indicating auto-scale is on.

## DISplay:REFFFTView<x>:CURSor:ASOURce? (Query Only)

This command returns the cursor source for plot cursor A

<b>Group</b>	Cursor
<b>Syntax</b>	DISplay:REFFFTView<x>:CURSor:ASOURce?
<b>Arguments</b>	PLOTView<x> is the Plot waveform number.
<b>Returns</b>	Returns the cursor source for plot cursor A.

**Examples** `DISPlay:REFFFTView5:CURSor:ASOURce?` might return  
`:DISPLAY:REFFFTVIEW5:CURSOR:ASOURCE REF5` indicating the A cursor  
source is reference 5.

## **DISPlay:REFFFTView<x>:CURSor:BSOURce? (Query Only)**

This command returns the cursor source for plot cursor B.

**Group** Cursor

**Syntax** `DISPlay:REFFFTView<x>:CURSor:BSOURce?`

**Returns** Returns the cursor source for plot cursor B.

**Examples** `DISPlay:REFFFTView5:CURSor:BSOURce?` might return  
`:DISPLAY:REFFFTVIEW5:CURSOR:BSOURCE REF5` indicating the source of the  
B cursor is reference 5.

## **DISPlay:REFFFTView<x>:CURSor:DDT? (Query Only)**

This command returns the delta V over delta T cursor readout value of the  
specified cursor in the specified view.

**Group** Cursor

**Syntax** `DISPlay:REFFFTView<x>:CURSor:DDT?`

**Returns** Returns the delta V over delta T cursor readout value

**Examples** `DISPlay:REFFFTView5:CURSor:DDT?` might return  
`:DISPLAY:REFFFTVIEW5:CURSOR:DDT 9.91E+37` indicating the delta V over  
delta T cursor readout value is 9.91E+37.

## **DISPlay:REFFFTView<x>:CURSor:FUNCtion**

This command sets or queries the cursor type of the specified cursor in the  
specified view.

<b>Group</b>	Cursor
<b>Syntax</b>	<pre>DISPlay:REFFFTView&lt;x&gt;:CURSor:FUNctIon {WAVEform VBArS HBArS SCReEN} DISPlay:REFFFTView&lt;x&gt;:CURSor:FUNctIon?</pre>
<b>Arguments</b>	<p>HBArS specifies horizontal bar cursors, which measure in vertical units.</p> <p>VBArS specifies vertical bar cursors, which measure in horizontal units.</p> <p>SCReEN specifies both horizontal and vertical bar cursors, which measure in horizontal and vertical units specified by the cursor sources. Use these cursors to measure anywhere in the waveform display area.</p> <p>WAVEform specifies paired or split cursors in YT display format for measuring waveform amplitude and time. In XY and XYZ format, these cursors indicate the amplitude positions of an XY pair (Ch1 vs Ch2 voltage, where Ch1 is the X axis and Ch2 is the Y axis) relative to the trigger.</p>
<b>Examples</b>	<p>DISPlay:REFFFTView5:CURSor:FUNctIon screen sets the cursor function to screen.</p> <p>DISPlay:REFFFTView5:CURSor:FUNctIon? might return :DISPlay:REFFFTVIEW5:CURSOR:FUNCTION WAVEFORM indicating the cursor function is set to waveform.</p>

## DISPlay:REFFFTView<x>:CURSor:HBArS:APOsition

This command sets or queries the vertical cursor A position of the specified cursor in the specified view.

<b>Group</b>	Cursor
<b>Syntax</b>	<pre>DISPlay:REFFFTView&lt;x&gt;:CURSor:HBArS:APOsition &lt;NR3&gt; DISPlay:REFFFTView&lt;x&gt;:CURSor:HBArS:APOsition?</pre>
<b>Arguments</b>	<NR3> is the vertical cursor A position of the specified cursor in the specified view.
<b>Examples</b>	<p>DISPlay:REFFFTView5:CURSor:HBArS:APOsition -20 sets the A cursor position to -20.</p> <p>DISPlay:REFFFTView5:CURSor:HBArS:APOsition? might return :DISPlay:REFFFTVIEW5:CURSOR:HBARS:APOSITION -14.4762489421361 indicating the A cursor position is -14.48 dBm.</p>

## DISplay:REFFFTView<x>:CURSOR:HBARS:AUNIts? (Query Only)

This command returns cursor A vertical units of the specified cursor in the specified view.

<b>Group</b>	Cursor
<b>Syntax</b>	DISplay:REFFFTView<x>:CURSOR:HBARS:AUNIts?
<b>Returns</b>	Returns the cursor A vertical units of the specified cursor in the specified view.
<b>Examples</b>	DISplay:REFFFTView5:CURSOR:HBARS:AUNIts? might return :DISPLAY:REFFFTVIEW5:CURSOR:HBARS:AUNITS "dBm" indicating the A cursor units are dBm.

## DISplay:REFFFTView<x>:CURSOR:HBARS:BPOSITION

This command sets or queries the vertical cursor B position of the specified cursor in the specified view.

<b>Group</b>	Cursor
<b>Syntax</b>	DISplay:REFFFTView<x>:CURSOR:HBARS:BPOSITION <NR3> DISplay:REFFFTView<x>:CURSOR:HBARS:BPOSITION?
<b>Arguments</b>	<NR3> is the vertical cursor B position of the specified cursor in the specified view.
<b>Examples</b>	DISplay:REFFFTView5:CURSOR:HBARS:BPOSITION -90 sets the B cursor position to -90.  DISplay:REFFFTView5:CURSOR:HBARS:BPOSITION? might return :DISPLAY:REFFFTVIEW5:CURSOR:HBARS:BPOSITION -100.6262359333038 indicating the B cursor position is -100.6.

## DISplay:REFFFTView<x>:CURSOR:HBARS:BUNIts? (Query Only)

This command returns the cursor B vertical units of the specified cursor in the specified view.

<b>Group</b>	Cursor
<b>Syntax</b>	<code>DISPlay:REFFFTView&lt;x&gt;:CURSOR:HBARS:BUNITS?</code>
<b>Returns</b>	Returns the cursor B vertical units of the specified cursor in the specified view.
<b>Examples</b>	<code>DISPlay:REFFFTView5:CURSOR:HBARS:BUNITS?</code> might return <code>:DISPLAY:REFFFTVIEW5:CURSOR:HBARS:BUNITS "dBm"</code> indicating the units are dBm.

### **DISPlay:REFFFTView<x>:CURSOR:HBARS:DELTA? (Query Only)**

This command returns the delta V cursor readout value of the specified cursor in the specified view.

<b>Group</b>	Cursor
<b>Syntax</b>	<code>DISPlay:REFFFTView&lt;x&gt;:CURSOR:HBARS:DELTA?</code>
<b>Returns</b>	Returns the delta V cursor readout value of the specified cursor in the specified view.
<b>Examples</b>	<code>DISPlay:REFFFTView5:CURSOR:HBARS:DELTA?</code> might return <code>:DISPLAY:REFFFTVIEW5:CURSOR:HBARS:DELTA 59.9867396737569</code> indicating the delta V cursor readout value is 59.99.

### **DISPlay:REFFFTView<x>:CURSOR:MODE**

This command sets or queries the cursor tracking mode of the specified cursor in the specified view.

<b>Group</b>	Cursor
<b>Syntax</b>	<code>DISPlay:REFFFTView&lt;x&gt;:CURSOR:MODE {INDEPENDENT TRACK}</code> <code>DISPlay:REFFFTView&lt;x&gt;:CURSOR:MODE?</code>



**Arguments** TRACK ties the navigational functionality of the two cursors together. For cursor A adjustments, this ties the movement of the two cursors together; however, cursor B continues to move independently of cursor A.

INDEPENDENT allows independent adjustment of the two cursors.

**Examples** `DISPlay:REFFFTView5:CURSOR:MODE TRACK` sets the cursors to track together.

`DISPlay:REFFFTView5:CURSOR:MODE?` might return `:DISPLAY:REFFFTVIEW5:CURSOR:MODE INDEPENDENT` indicating the cursors move independently.

## DISPlay:REFFFTView<x>:CURSOR:ONEOVERDELTAVALUE? (Query Only)

This command returns the one over delta T cursor readout value of the specified cursor in the specified view.

**Group** Cursor

**Syntax** `DISPlay:REFFFTView<x>:CURSOR:ONEOVERDELTAVALUE?`

**Examples** `DISPlay:REFFFTView5:CURSOR:ONEOVERDELTAVALUE?` might return `:DISPLAY:REFFFTVIEW5:CURSOR:ONEOVERDELTAVALUE 2.540935140340E-9` indicating the one over delta T cursor readout value is 2.54 ns.

## DISPlay:REFFFTView<x>:CURSOR:ROLOCATION

This command sets or queries the location to display the specified Reference FFT plot cursor readouts (in the plot graticule or in a badge in the Results Bar).

**Group** Cursor

**Syntax** `DISPlay:REFFFTView<x>:CURSOR:ROLOCATION {GRATICULE|BADGE}`  
`DISPlay:REFFFTView<x>:CURSOR:ROLOCATION?`

**Arguments** `REFFFTView<x>` is the Reference FFT plot number.

`GRATICULE` sets the Reference FFT plot cursor readouts to display as part of the cursors in the plot view.

BADGE removes the Reference FFT plot cursor readouts from the cursors in the graticule and displays the cursor information as a badge in the Results Bar.

**Examples**    `DISPlay:REFFFTView1:CURSor:ROLOCATION GRATICULE` sets the cursor readout information for Reference FFT plot 1 to display in the plot graticule.

`DISPlay:REFFFTView2:CURSor:ROLOCATION?` might return `DISPlay:REFFFTView2:CURSor:ROLOCATION BADGE`, indicating that cursor readout information for Reference FFT plot 2 is set to display as a badge in the Results Bar.

## DISPlay:REFFFTView<x>:CURSor:SCREEN:AXPOSITION

This command sets or queries the horizontal cursor A position of the specified cursor in the specified view.

**Group**    Cursor

**Syntax**    `DISPlay:REFFFTView<x>:CURSor:SCREEN:AXPOSITION <NR3>`  
`DISPlay:REFFFTView<x>:CURSor:SCREEN:AXPOSITION?`

**Arguments**    <NR3> is the horizontal cursor A position of the specified cursor in the specified view.

**Examples**    `DISPlay:REFFFTView5:CURSor:SCREEN:AXPOSITION 1.0E+6` sets the cursor position to 1.0 MHz.

`DISPlay:REFFFTView5:CURSor:SCREEN:AXPOSITION?` might return `:DISPLAY:REFFFTVIEW5:CURSOR:SCREEN:AXPOSITION 792.4465962305570E+3` indicating the A cursor horizontal position is 792.447 kHz.

## DISPlay:REFFFTView<x>:CURSor:SCREEN:AYPOSITION

This command sets or queries the vertical cursor A position of the specified cursor in the specified view.

**Group**    Cursor

**Syntax**    `DISPlay:REFFFTView<x>:CURSor:SCREEN:AYPOSITION <NR3>`  
`DISPlay:REFFFTView<x>:CURSor:SCREEN:AYPOSITION?`

**Arguments** <NR3> is the vertical cursor A position of the specified cursor in the specified view.

**Examples** `DISPlay:REFFFTView5:CURSor:SCREEN:AYPOSITION -20.9` sets the position to -20 dBm.

`DISPlay:REFFFTView5:CURSor:SCREEN:AYPOSITION?` might return `:DISPLAY:REFFFTVIEW5:CURSOR:SCREEN:AYPOSITION -30.0132603262431` indicating the A cursor vertical position is -30.01 dBm.

## DISPlay:REFFFTView<x>:CURSor:SCREEN:BXPOSITION

This command sets or queries the horizontal cursor B position of the specified cursor in the specified view.

**Group** Cursor

**Syntax** `DISPlay:REFFFTView<x>:CURSor:SCREEN:BXPOSITION <NR3>`  
`DISPlay:REFFFTView<x>:CURSor:SCREEN:BXPOSITION?`

**Arguments** <NR3> is the horizontal cursor B position of the specified cursor in the specified view.

**Examples** `DISPlay:REFFFTView5:CURSor:SCREEN:BXPOSITION 300` sets the position to 300 MHz.

`DISPlay:REFFFTView5:CURSor:SCREEN:BXPOSITION?` might return `:DISPLAY:REFFFTVIEW5:CURSOR:SCREEN:BXPOSITION 394.3483403001212E+6` indicating the B cursor horizontal position is 394.348 MHz.

## DISPlay:REFFFTView<x>:CURSor:SCREEN:BYPOSITION

This command sets or queries the vertical cursor B position of the specified cursor in the specified view.

**Group** Cursor

**Syntax** `DISPlay:REFFFTView<x>:CURSor:SCREEN:BYPOSITION <NR3>`  
`DISPlay:REFFFTView<x>:CURSor:SCREEN:BYPOSITION?`

**Arguments** <NR3> is the vertical cursor B position of the specified cursor in the specified view.

**Examples** `DISPlay:REFFFTView5:CURSOR:SCREEN:BYPOSITION -80` sets the cursor position to -90 dBm.

`DISPlay:REFFFTView5:CURSOR:SCREEN:BYPOSITION?` might return `:DISPLAY:REFFFTVIEW5:CURSOR:SCREEN:BYPOSITION -90.0` indicating the B cursor vertical position is -90 dBm.

## DISPlay:REFFFTView<x>:CURSOR:SPLITMODE

This command sets or queries whether both cursors have same or different source.

**Group** Cursor

**Syntax** `DISPlay:REFFFTView<x>:CURSOR:SPLITMODE {SAME|SPLIT}`  
`DISPlay:REFFFTView<x>:CURSOR:SPLITMODE?`

**Arguments** SAME specifies both cursors have the same sources.

SPLIT specifies both cursors have different sources.

**Examples** `DISPlay:REFFFTView5:CURSOR:SPLITMODE SPLIT` specified that the cursors have different sources.

`DISPlay:REFFFTView5:CURSOR:SPLITMODE?` might return `:DISPLAY:REFFFTVIEW5:CURSOR:SPLITMODE SAME` indicating both cursors have the same source.

## DISPlay:REFFFTView<x>:CURSOR:STATE

This command sets or queries the visible state of the cursor of the specified cursor n the specified view.

**Group** Cursor

**Syntax** `DISPlay:REFFFTView<x>:CURSOR:STATE {OFF|ON|0|1}`  
`DISPlay:REFFFTView<x>:CURSOR:STATE?`

**Arguments** <NR1> = 0 specifies the cursor is not visible; any other value displays the cursor.  
 OFF specifies the cursor is not visible.  
 ON displays the cursor.

**Examples** `DISPlay:REFFFTView5:CURSor:STATE ON` specifies the cursor is visible.  
`DISPlay:REFFFTView5:CURSor:STATE?` might return  
`:DISPLAY:REFFFTVIEW5:CURSOR:STATE 1` indicating the cursor is visible.

## DISPlay:REFFFTView<x>:CURSor:VBARS:APOSition

This command sets or queries the horizontal cursor A position of the specified cursor in the specified view.

**Group** Cursor

**Syntax** `DISPlay:REFFFTView<x>:CURSor:VBARS:APOSition <NR3>`  
`DISPlay:REFFFTView<x>:CURSor:VBARS:APOSition?`

**Arguments** <NR3> is the horizontal cursor A position of the specified cursor in the specified view.

**Examples** `DISPlay:REFFFTView5:CURSor:VBARS:APOSition 1.0E+6` sets the cursor to 1 MHz.  
`DISPlay:REFFFTView5:CURSor:VBARS:APOSition?` might return  
`:DISPLAY:REFFFTVIEW5:CURSOR:VBARS:APOSITION 792.4465962305570E+3` indicating the cursor position is 792.447 kHz.

## DISPlay:REFFFTView<x>:CURSor:VBARS:BPOSition

This command sets or queries the horizontal cursor B position of the specified cursor in the specified view.

**Group** Cursor

**Syntax** `DISPlay:REFFFTView<x>:CURSor:VBARS:BPOSition <NR3>`  
`DISPlay:REFFFTView<x>:CURSor:VBARS:BPOSition?`

**Arguments** <NR3> is the horizontal cursor B position of the specified cursor in the specified view.

**Examples** `DISPlay:REFFFTView5:CURSor:VBArS:BPOsition 300.0E+6` sets the cursor position to 300 MHz.

```
DISPlay:REFFFTView5:CURSor:VBArS:BPOsition? might
return :DISPLAY:REFFFTVIEW5:CURSOR:VBARS:BPOSITION
394.3483403001212E+6 indicating the B cursor horizontal position is
394.348 MHz.
```

## **DISPlay:REFFFTView<x>:CURSor:VBArS:DELTA? (Query Only)**

This command returns the delta T cursor readout value of the specified cursor in the specified view.

**Group** Cursor

**Syntax** `DISPlay:REFFFTView<x>:CURSor:VBArS:DELTA?`

**Returns** Returns the delta T cursor readout value of the specified cursor in the specified view.

**Examples** `DISPlay:REFFFTView5:CURSor:VBArS:DELTA?` might return  
`:DISPLAY:REFFFTVIEW5:CURSOR:VBARS:DELTA 393.5558937038906E+6`  
indicating the delta T cursor readout value is 393.556 MHz.

## **DISPlay:REFFFTView<x>:CURSor:VBArS:UNIts? (Query Only)**

This command returns cursor A vertical units of the specified cursor in the specified view.

**Group** Cursor

**Syntax** `DISPlay:REFFFTView<x>:CURSor:VBArS:UNIts?`

**Returns** Returns cursor A vertical units of the specified cursor in the specified view.

**Examples**    `DISPlay:REFFFTView5:CURSor:VBARs:UNITs?` might return  
`:DISPLAY:REFFFTVIEW5:CURSOR:VBARS:UNITS "Hz"` indicating the A  
cursor vertical units are Hz.

## `DISPlay:REFFFTView<x>:CURSor:WAVEform:AHPOSITION?` (Query Only)

This query-only command returns the value of the cursor A horizontal position.

**Group**    Cursor

**Syntax**    `DISPlay:REFFFTView<x>:CURSor:WAVEform:AHPOSITION?`

**Examples**    `DISPlay:REFFFTView1:CURSor:WAVEform:AHPOSITION?` might return  
`:DISPLAY:REFFFTVIEW1:CURSOR:WAVEFORM:AHPOSITION 9.91E+37.`

## `DISPlay:REFFFTView<x>:CURSor:WAVEform:APOSITION`

Sets or returns the waveform cursor A position in the specified plot view.

---

**NOTE.** *In case of an XY plot, this command has no effect when used to set the value. In the case of a bathtub plot, this command sets or queries the cursor A vertical position. For all other plots, this command sets or queries the cursor A horizontal position.*

---

**Group**    Cursor

**Syntax**    `DISPlay:REFFFTView<x>:CURSor:WAVEform:APOSITION <NR3>`  
`DISPlay:REFFFTView<x>:CURSor:WAVEform:APOSITION?`

**Arguments**    <NR3> is the waveform cursor A position in the specified plot view.

**Examples**    `DISPlay:REFFFTView5:CURSor:WAVEform:APOSITION 7E+5` sets the  
position to 700 kHz.

`DISPlay:REFFFTView5:CURSor:WAVEform:APOSITION?` might  
return `:DISPLAY:REFFFTVIEW5:CURSOR:WAVEFORM:APOSITION`  
`792.4465962305570E+3` indicating the A cursor waveform position is  
792.4 kHz.

## DISplay:REFFFTView<x>:CURSor:WAVEform:AVPOSition? (Query Only)

This query-only command returns the value of the cursor A vertical position.

<b>Group</b>	Cursor
<b>Syntax</b>	DISplay:REFFFTView<x>:CURSor:WAVEform:AVPOSition?
<b>Examples</b>	DISplay:REFFFTView<x>:CURSor:WAVEform:AVPOSition? might return :DISplay:REFFFTView1:CURSor:WAVEform:AVPOSition 1.605E+0 indicating the cursor vertical position is 1.6 dBm.

## DISplay:REFFFTView<x>:CURSor:WAVEform:BHPOSition? (Query Only)

This query-only command returns the value of the cursor B horizontal position.

<b>Group</b>	Cursor
<b>Syntax</b>	DISplay:REFFFTView<x>:CURSor:WAVEform:BHPOSition?
<b>Examples</b>	DISplay:REFFFTView<x>:CURSor:WAVEform:BHPOSition? might return :DISPLAY:REFFFTVIEW1:CURSOR:WAVEFORM:BHPOSITION 9.91E+37.

## DISplay:REFFFTView<x>:CURSor:WAVEform:BPOSition

Sets or returns the waveform cursor B position in the specified plot view.

---

**NOTE.** In case of an XY plot, this command has no effect when used to set the value. In the case of a bathtub plot, this command has no effect. Queries return invalid values. For all other plots, this command sets or queries the cursor B horizontal position.

---

<b>Group</b>	Cursor
<b>Syntax</b>	DISplay:REFFFTView<x>:CURSor:WAVEform:BPOSition <NR3> DISplay:REFFFTView<x>:CURSor:WAVEform:BPOSition?
<b>Arguments</b>	<NR3> is the waveform cursor B position in the specified plot view.



**Examples**    `DISPlay:REFFFTView5:CURSor:WAVEform:BPOsition 4E+8` sets the cursor position to 400 MHz.

`DISPlay:REFFFTView5:CURSor:WAVEform:BPOsition?` might return `:DISPlay:REFFFTVIEW5:CURSOR:WAVEFORM:BPOSITION 394.3483403001212E+6` indicating the B waveform cursor position is 394.35 MHz.

## `DISPlay:REFFFTView<x>:CURSor:WAVEform:BVPOsition? (Query Only)`

This query-only command returns the value of the cursor B vertical position.

**Group**    Cursor

**Syntax**    `DISPlay:REFFFTView<x>:CURSor:WAVEform:BVPOsition?`

**Examples**    `DISPlay:REFFFTView1:CURSor:WAVEform:BVPOsition?` might return `:DISPlay:REFFFTView<x>:CURSor:WAVEform:BVPOsition -119.866E+0` indicating the cursor vertical position is -119.9 dBm.

## `DISPlay:REFFFTView<x>:GRIDLINES`

This command sets or returns the grid lines setting of the plot.

**Group**    Display Control

**Syntax**    `DISPlay:REFFFTView<x>:GRIDLINES {HORizontal|VERTical|BOTH}`  
`DISPlay:REFFFTView<x>:GRIDLINES?`

**Arguments**    `HORizontal` specifies horizontal grid lines.  
`VERTical` specifies vertical grid lines.  
`BOTH` specifies both horizontal and vertical grid lines.

**Examples**    `DISPlay:REFFFTView5:GRIDLINES hhorizontal` specifies horizontal grid lines.

`DISPlay:REFFFTView5:GRIDLINES?` might return `:DISPlay:REFFFTVIEW5:GRIDLINES BOTH` indicating that both vertical and horizontal grid lines are displayed

## DISplay:REFFFTView<x>:REF:REF<x>:STATE

This command sets or queries the state of the specified reference waveform in the specified Waveform View.

**Group** Display Control

**Syntax** DISplay:REFFFTView<x>:REF:REF<x>:STATE boolean  
DISplay:REFFFTView<x>:REF:REF<x>:STATE?

**Arguments** <NR1> = 0 disables the specified reference; any other value turns this feature on.  
OFF disables the display the specified reference.  
ON enables the specified reference.

**Examples** DISplay:REFFFTView5:REF:REF5:STATE 0 turns display of the reference off.  
DISplay:REFFFTView5:REF:REF5:STATE? might return  
:DISPLAY:REFFFTVIEW5:REF:REF5:STATE 1 indicating the reference is displayed.

## DISplay:REFFFTView<x>:XAXIS:SCALE

This command sets or queries the x-axis scale setting for Ref FFT.

**Group** Display Control

**Syntax** DISplay:REFFFTView<x>:XAXIS:SCALE {LINEAR|LOG}  
DISplay:REFFFTView<x>:XAXIS:SCALE?

**Arguments** LINEAR specifies a linear scale.  
LOG specifies a logarithmic scale.

**Examples** DISplay:REFFFTView5:XAXIS:SCALE linear sets the x-axis scale to linear.  
DISplay:REFFFTView5:XAXIS:SCALE? might return  
:DISPLAY:REFFFTVIEW5:XAXIS:SCALE LOG indicating x-axis scale for the specified reference view is logarithmic.

**DISplay:REFFFTView<x>:ZOOM:XAXIS:FROM**

This command sets or returns the left edge of the zoom x-axis in the specified plot view.

<b>Group</b>	Zoom
<b>Syntax</b>	DISplay:REFFFTView<x>:ZOOM:XAXIS:FROM <NR3> DISplay:REFFFTView<x>:ZOOM:XAXIS:FROM?
<b>Arguments</b>	<NR3> is the left edge of the zoom x-axis in the specified plot view.
<b>Examples</b>	DISplay:REFFFTView5:ZOOM:XAXIS:FROM 2.0E+6 sets the left edge of the specified view to 2.0 MHz.  DISplay:REFFFTView5:ZOOM:XAXIS:FROM? might return :DISPLAY:REFFFTVIEW5:ZOOM:XAXIS:FROM 1.3295739742362E+6 indicating the left edge of the specified view is 1.33 MHz.

**DISplay:REFFFTView<x>:ZOOM:XAXIS:TO**

This command sets or queries the right edge of the zoom x-axis in the specified plot view.

<b>Group</b>	Zoom
<b>Syntax</b>	DISplay:REFFFTView<x>:ZOOM:XAXIS:TO <NR3> DISplay:REFFFTView<x>:ZOOM:XAXIS:TO?
<b>Arguments</b>	<NR3> is the right edge of the zoom x-axis in the specified plot view.
<b>Examples</b>	DISplay:REFFFTView5:ZOOM:XAXIS:TO 2.0E+8 sets the right edge of the zoom x-axis to 200 MHz.  DISplay:REFFFTView5:ZOOM:XAXIS:TO? might return :DISPLAY:REFFFTVIEW5:ZOOM:XAXIS:TO 235.0376933178995E+6 indicating the right edge of the zoom x-axis is 235.0 MHz.

## DISplay:REFFFTView<x>:ZOOM:YAXIS:FROM

This command sets or queries the bottom value of the zoom y-axis in the specified plot view.

**Group** Zoom

**Syntax** DISplay:REFFFTView<x>:ZOOM:YAXIS:FROM <NR3>  
DISplay:REFFFTView<x>:ZOOM:YAXIS:FROM?

**Arguments** <NR3> is the bottom value of the zoom y-axis in the specified plot view.

**Examples** DISplay:REFFFTView5:ZOOM:YAXIS:FROM -120.0 sets the bottom value of the zoom y-axis to -120.0 dBm.

DISplay:REFFFTView5:ZOOM:YAXIS:FROM? might return  
:DISPLAY:REFFFTVIEW5:ZOOM:YAXIS:FROM -129.7533120632172  
indicating the bottom value of the zoom y-axis is -129.8 dBm.

## DISplay:REFFFTView<x>:ZOOM:YAXIS:TO

This command sets or queries the top value of the zoom y-axis in the specified plot view.

**Group** Zoom

**Syntax** DISplay:REFFFTView<x>:ZOOM:YAXIS:TO <NR3>  
DISplay:REFFFTView<x>:ZOOM:YAXIS:TO?

**Arguments** <NR3> is the top value of the zoom y-axis in the specified plot view.

**Examples** DISplay:REFFFTView5:ZOOM:YAXIS:TO 0.0 sets the top value of the zoom y-axis to 0.0 dBm.

DISplay:REFFFTView5:ZOOM:YAXIS:TO? might return  
:DISPLAY:REFFFTVIEW5:ZOOM:YAXIS:TO 15.8820685863495  
indicating the top value of the zoom y-axis is 15.9 dBm.

## DISplay:SElect:BUS

This command sets or queries the overall selected bus. Sets are applied to all views that contain the source and the selected view is changed. When multiple buses are open, querying the command gives the correct result, but the bus cannot set.

**Group** Display Control

**Syntax** DISplay:SElect:BUS BUS<x>  
DISplay:SElect:BUS?

**Arguments** BUS<x> is the selected bus.

**Examples** DISplay:SElect:BUS Bus2 sets Bus 2 as the selected bus.  
DISplay:SElect:BUS? might return :DISPLAY:SELECT:BUS BUS1  
indicating Bus 1 is the selected bus.

## DISplay:SElect:MATH

This command sets or queries the overall selected math. Sets are applied to all views that contain the source and the selected view is changed. When multiple Math are open, querying the command gives the correct result, but the required Math cannot be set.

**Group** Display Control

**Syntax** DISplay:SElect:MATH MATH<x>  
DISplay:SElect:MATH?

**Arguments** MATH<x> is the selected math.

**Examples** DISplay:SElect:MATH MATH1 selects Math 1.  
DISplay:SElect:MATH? might display :DISPLAY:SELECT:MATH MATH2  
indicating that Math 2 is selected.

## DISplay:SElect:REFerence

This command sets or queries the overall selected reference waveform. Sets are applied to all views that contain the source and the selected view is changed.

<b>Group</b>	Display Control
<b>Syntax</b>	DISplay:SElect:REFerence {NONE REF<x>} DISplay:SElect:REFerence?
<b>Arguments</b>	Arguments are the selected reference.
<b>Examples</b>	DISplay:SElect:REFerence REF2 selects reference 2.  DISplay:SElect:REFERENCE? might return DISPLAY:SELECT:REFERENCE NONE indicating no reference is selected.

## DISplay:SElect:SOUrce

This command sets or queries the overall selected source. Sets are applied to all views that contain the source and the selected view is changed.

<b>Group</b>	Display Control
<b>Syntax</b>	DISplay:SElect:SOUrce {NONE CH<x> BUS<x> MATH<x> PLOT<x> REF<x>} DISplay:SElect:SOUrce?
<b>Arguments</b>	PLOT<x> specifies the plot as the source.  CH<x> specifies an analog channel as the source.  Math<x> specifies a math waveform as the source.  REF<x> specifies a reference waveform as the source.  NONE specifies nothing as the source.
<b>Examples</b>	DISplay:SElect:SOUrce Bus1 selects Bus1 as the selected source.  DISplay:SElect:SOUrce? might return :DISPLAY:SELECT:SOURCE MATH1 indicating Math 1 is the selected source.

## DISplay:SElect:SPECView<x>:SOUrce

This command sets or queries the spectrum trace (source channel) to select in the Spectrum View window.

<b>Group</b>	Display
<b>Syntax</b>	DISplay:SElect:SPECView<x>:SOUrce {CH<x>} DISplay:SElect:SPECView<x>:SOUrce?
<b>Arguments</b>	SPECView<x> specifies the Spectrum View number. <x> is always 1.  CH<x> specifies the spectrum trace (source channel) to select (make active) in the Spectrum View.
<b>Examples</b>	DISplay:SElect:SPECView1:SOUrce CH1 sets the spectrum trace associated with channel 1 as the selected trace.  DISplay:SElect:SPECView1:SOUrce? might return CH3, indicating that the spectrum trace associated with channel 3 is selected in the Spectrum View.

## DISplay:SElect:VIEW

This command sets or queries the selected view.

<b>Group</b>	Display Control
<b>Syntax</b>	DISplay:SElect:VIEW {WAVEVIEW1 MATHFFT<x> PLOTVIEW<x> REFFT<x>} DISplay:SElect:VIEW?
<b>Arguments</b>	Arguments are the selected view.
<b>Examples</b>	DISplay:SElect:VIEW PLOTVIEW1 selects PLOTVIEW1 as the selected view.  DISplay:SElect:VIEW? might return :DISPLAY:SELECT:VIEW MATHFFT1 indicating MATHFFT1 is the selected view.

## DISplay:SElect:WAVEView<x>:SOUrce

This command sets or queries the selected source in the given waveview.

<b>Group</b>	Display Control
<b>Syntax</b>	<pre>DISPlay:SElect:WAVEView&lt;x&gt;:SOURCE {S&lt;x&gt;_Ch&lt;x&gt; CH&lt;x&gt; MATH&lt;x&gt; BUS&lt;x&gt; REF&lt;x&gt; PLOT&lt;x&gt;} DISPlay:SElect:WAVEView&lt;x&gt;:SOURCE?</pre>
<b>Arguments</b>	<p>S&lt;x&gt;_Ch&lt;x&gt; specifies the remote scope number and the analog channel as the source.</p> <p>CH&lt;x&gt; specifies an analog channel as the source.</p> <p>Math&lt;x&gt; specifies a math waveform as the source.</p> <p>REF&lt;x&gt; specifies a reference waveform as the source.</p> <p>PLOT&lt;x&gt; specifies a plot as the source.</p>
<b>Examples</b>	<p>DISPlay:SElect:WAVEView1:SOURCE MATH1 sets MATH1 as the selected source.</p> <p>DISPlay:SElect:WAVEView1:SOURCE? might return :DISPLAY:SELECT:WAVEVIEW1:SOURCE CH2 indicating CH2 is the selected source.</p>

## DISPlay:SPECView<x>:CURSOR:CURSOR:ANOISEDensity? (Query Only)

Returns the noise density of the selected RF trace at the Cursor A position

<b>Group</b>	Cursor
<b>Syntax</b>	DISPlay:SPECView<x>:CURSOR:CURSOR:ANOISEDensity?
<b>Related Commands</b>	<a href="#">DISPlay:SPECView&lt;x&gt;:CURSOR:CURSOR:BNOISE?</a>
<b>Arguments</b>	SPECView<x> is the specified Spectrum View and must be SPECView1.
<b>Returns</b>	The noise density of the selected RF trace at the horizontal position of Cursor A in <RF Units>/Hz units, where <RF Units> are the vertical units of the RF trace.
<b>Examples</b>	DISPlay:SPECView1:CURSOR:CURSOR:ANOISEDensity? might return -133.2350, indicating a noise density of -133.2350 dBm/Hz at the Cursor A position.



**DISplay:SPECView<x>:CURSor:CURSOR:ASOURce**

This command sets or queries the Cursor A source in the Spectrum View.

<b>Group</b>	Cursor
<b>Syntax</b>	DISplay:SPECView<x>:CURSor:CURSOR:ASOURce {AUTO CH<x>} DISplay:SPECView<x>:CURSor:CURSOR:ASOURce?
<b>Arguments</b>	SPECView<x> specifies the Spectrum View number. <x> is always 1. AUTO specifies to use the selected analog channel as the Spectrum View source. CH<x> specifies the analog channel to use as the Spectrum View source.
<b>Examples</b>	DISplay:SPECView2:CURSor:CURSOR:ASOURce CH1 sets the Cursor A source of Spectrum View 2 to Channel 1.  DISplay:SPECView1:CURSor:CURSOR:ASOURce? might return DISplay:SPECView1:CURSor:CURSOR:ASOURce AUTO, indicating the Cursor A source of Spectrum View 1 is the selected source.

**DISplay:SPECView<x>:CURSor:CURSOR:BNOISE? (Query Only)**

Returns the noise density of the selected RF trace at the Cursor B position when in Absolute mode, or the phase noise when in Delta mode.

<b>Group</b>	Cursor
<b>Syntax</b>	DISplay:SPECView<x>:CURSor:CURSOR:BNOISE?
<b>Related Commands</b>	<a href="#">DISplay:SPECView&lt;x&gt;:CURSor:CURSOR:ANOISEDensity?</a> <a href="#">DISplay:SPECView&lt;x&gt;:CURSor:CURSOR:READout</a>
<b>Arguments</b>	SPECView<x> is the specified Spectrum View and must be SPECView1.
<b>Returns</b>	In Absolute mode: The noise density of the selected RF trace at the horizontal position of Cursor B in <RF Units>/Hz units, where <RF Units> are the vertical units of the RF trace.

In Delta mode: The phase noise of the selected RF trace at the horizontal position of Cursor B in dBc/Hz units.

- Examples**    `DISPlay:SPECView1:CURSor:CURSOR:BNOISE?` might return `-60.1289`, indicating a phase noise of `-60.1289` dBc/Hz at the Cursor B position in Delta mode.
- `DISPlay:SPECView1:CURSor:CURSOR:BNOISE?` might return `-47.922`, indicating a phase noise of `-47.922` dBm/Hz at the Cursor B position in Absolute mode.

## DISPlay:SPECView<x>:CURSor:CURSOR:BSOURce

This command sets or queries the Cursor B source in the Spectrum View.

- Group**        Cursor
- Syntax**        `DISPlay:SPECView<x>:CURSor:CURSOR:BSOURce {AUTO|CH<x>}`  
`DISPlay:SPECView<x>:CURSor:CURSOR:BSOURce?`
- Arguments**    `SPECView<x>` specifies the Spectrum View number. `<x>` is always 1.  
`AUTO` specifies to use the selected analog channel as the Spectrum View source.  
`CH<x>` specifies the analog channel to use as the Spectrum View source.
- Examples**        `DISPlay:SPECView1:CURSor:CURSOR:ASOURce CH1` sets the Cursor A source of Spectrum View 1 to Channel 1.
- `DISPlay:SPECView1:CURSor:CURSOR:ASOURce?` might return  
`DISPlay:SPECView1:CURSor:CURSOR:ASOURce AUTO`, indicating the Cursor A source of Spectrum View 1 is the selected source.

## DISPlay:SPECView<x>:CURSor:CURSOR:HBArs:APOSition

This command queries the Cursor A horizontal bar's vertical position (where it crosses the spectrum signal) in the Spectrum View.

- Group**        Cursor
- Syntax**        `DISPlay:SPECView<x>:CURSor:CURSOR:HBArs:APOSition?`

<b>Related Commands</b>	<a href="#">DISplay:SPECView&lt;x&gt;:CURSor:CURSOR:HBArs:AUNIts?</a>
<b>Arguments</b>	SPECview<x> specifies the Spectrum View number. <x> is always 1.
<b>Returns</b>	The vertical position of Cursor A in the vertical units of the cursor source.
<b>Examples</b>	DISplay:SPECview1:CURSor:CURSOR:HBArs:APOSITION? might return DISplay:SPECview1:CURSor:CURSOR:HBArs:APOSITION -40.0 indicating the Cursor A vertical position is -40.0 units (such as dBm).

## DISplay:SPECView<x>:CURSor:CURSOR:HBArs:AUNIts? (Query Only)

This command queries the horizontal bar Cursor A horizontal bar's amplitude units in the Spectrum View.

<b>Group</b>	Cursor
<b>Syntax</b>	DISplay:SPECview<x>:CURSor:CURSOR:HBArs:AUNIts?
<b>Related Commands</b>	<a href="#">DISplay:SPECView&lt;x&gt;:CURSor:CURSOR:HBArs:APOSITION</a>
<b>Arguments</b>	SPECview<x> specifies the Spectrum View number. <x> is always 1.
<b>Returns</b>	The vertical units of the Spectrum View Cursor A as a Qstring.
<b>Examples</b>	DISplay:SPECview1:CURSor:CURSOR:HBArs:AUNIts? might return DISplay:SPECview1:CURSor:CURSOR:HBArs:AUNIts "dBmV", indicating the Cursor A vertical units are decibel millivolts.

## DISplay:SPECView<x>:CURSor:CURSOR:HBArs:BPOSITION

This command queries the horizontal bar Cursor B horizontal bar's vertical position (where it crosses the spectrum signal) in the Spectrum View.

<b>Group</b>	Cursor
<b>Syntax</b>	DISplay:SPECview<x>:CURSor:CURSOR:HBArs:BPOSITION?

<b>Related Commands</b>	<a href="#">DISplay:SPECView&lt;x&gt;:CURSor:CURSOR:HBArs:BUNIts?</a>
<b>Arguments</b>	SPECview<x> specifies the Spectrum View number. <x> is always 1.
<b>Returns</b>	The vertical position of Cursor B in the vertical units of the cursor source.
<b>Examples</b>	DISplay:SPECview1:CURSor:CURSOR:HBArs:BPOSITION? might return DISplay:SPECview1:CURSor:CURSOR:HBArs:BPOSITION -67.8 indicating the Cursor A vertical position is -67.8 units (such as dBm).

## DISplay:SPECView<x>:CURSor:CURSOR:HBArs:BUNIts? (Query Only)

This command queries the Cursor B horizontal bar's amplitude units in the Spectrum View.

<b>Group</b>	Cursor
<b>Syntax</b>	DISplay:SPECview<x>:CURSor:CURSOR:HBArs:BUNIts?
<b>Related Commands</b>	<a href="#">DISplay:SPECView&lt;x&gt;:CURSor:CURSOR:HBArs:BPOSITION</a>
<b>Arguments</b>	SPECview<x> specifies the Spectrum View number. <x> is always 1.
<b>Returns</b>	The vertical units of the Spectrum View Cursor B as a Qstring.
<b>Examples</b>	DISplay:SPECview1:CURSor:CURSOR:HBArs:BUNIts? might return DISplay:SPECview1:CURSor:CURSOR:HBArs:BUNIts "dBmV", indicating the Cursor A vertical units are decibel millivolts.

## DISplay:SPECView<x>:CURSor:CURSOR:READOut

This command sets or queries the Cursor B readout type in the Spectrum View.

<b>Group</b>	Cursor
<b>Syntax</b>	DISplay:SPECview<x>:CURSor:CURSOR:READout {ABSOLUTE DELTA} DISplay:SPECview<x>:CURSor:CURSOR:READout?

**Arguments**    `SPECview<x>` specifies the Spectrum View number. `<x>` is always 1.  
                   `ABSOLUTE` specifies the Cursor B readout displays absolute frequency and amplitude.  
                   `DELTA` specifies the Cursor B readout displays delta frequency and amplitude from Cursor A.

**Examples**     `DISplay:SPECview1:CURSor:CURSOR:READout ABSOLUTE` sets the readout type to Absolute for Cursor B.  
                   `DISplay:SPECview1:CURSor:CURSOR:READout?` might return  
                   `DISplay:SPECview1:CURSor:CURSOR:READout DELTA`, indicating the readout type is Delta between Cursor A and B.

## **DISplay:SPECView<x>:CURSor:CURSOR:SPLITMODE**

This command sets or queries whether both Spectrum View cursors have the same or different sources.

**Group**        Cursor

**Syntax**       `DISplay:SPECview<x>:CURSor:CURSOR:SPLITMODE {SAME|SPLIT}`  
                   `DISplay:SPECview<x>:CURSor:CURSOR:SPLITMODE?`

**Arguments**    `SPECview<x>` specifies the Spectrum View number. `<x>` is always 1.  
                   `SAME` specifies that both Spectrum View cursors have the same source  
                   `SPLIT` specifies that both Spectrum View cursors have independent sources.

**Examples**     `DISplay:SPECview1:CURSor:CURSOR:SPLITMODE SPLIT` sets the Spectrum View cursors have independent sources.  
                   `DISplay:SPECview1:CURSor:CURSOR:SPLITMODE?` might return  
                   `DISplay:SPECview1:CURSor:CURSOR:SPLITMODE SAME`, indicating the Spectrum View cursors have the same source.

## **DISplay:SPECView<x>:CURSor:CURSOR:STATE**

This command sets or queries the visibility state of the cursors in the Spectrum View.

**Group**        Cursor

**Syntax**     `DISPlay:SPECView<x>:CURSor:CURSOR:STATE {ON|OFF}`  
`DISPlay:SPECView<x>:CURSor:CURSOR:STATE?`

**Arguments**     `SPECView<x>` specifies the Spectrum View number. `<x>` is always 1.  
`ON` enables viewing cursors in the Spectrum View.  
`OFF` disables viewing cursors in the Spectrum View.

**Examples**     `DISPlay:SPECView1:CURSor:CURSOR:STATE OFF` enables (displays) cursors in the Spectrum View.  
`DISPlay:SPECView1:CURSor:CURSOR:STATE?` might return  
`DISPlay:SPECView1:CURSor:CURSOR:STATE ON`, indicating the Spectrum View cursors are enabled (being displayed).

## **DISPlay:SPECView<x>:CURSor:CURSOR:VBArS:APOsition**

This command sets or queries the Cursor A vertical bar's horizontal position in the Spectrum View.

**Group**     Cursor

**Syntax**     `DISPlay:SPECView<x>:CURSor:CURSOR:VBArS:APOsition <NR3>`  
`DISPlay:SPECView<x>:CURSor:CURSOR:VBArS:APOsition?`

**Arguments**     `SPECView<x>` specifies the Spectrum View number. `<x>` is always 1.  
`<NR3>` specifies the horizontal position of Cursor A in Hz. The available frequency range is set by the frequencies at the left and right edges of the Spectrum View for the cursor source.

**Examples**     `DISPlay:SPECView1:CURSor:CURSOR:VBArS:APOsition 50E+6` sets the Spectrum View Cursor B position to 50 MHz.  
`DISPlay:SPECView1:CURSor:CURSOR:VBArS:APOsition?` might return  
`DISPlay:SPECView1:CURSor:CURSOR:VBArS:APOsition 48.5E+6`, indicating the Spectrum View Cursor B position is 48.5 MHz.

## **DISPlay:SPECView<x>:CURSor:CURSOR:VBArS:BPOsition**

This command sets or queries the Cursor B vertical bar's horizontal position in the Spectrum View.

<b>Group</b>	Cursor
<b>Syntax</b>	DISPlay:SPECView<x>:CURSOR:CURSOR:VBARS:BPOSITION <NR3> DISPlay:SPECView<x>:CURSOR:CURSOR:VBARS:BPOSITION?
<b>Arguments</b>	SPECView<x> specifies the Spectrum View number. <x> is always 1.  <NR3> specifies the horizontal position of Cursor B in Hz. The available frequency range is set by the frequencies at the left and right edges of the Spectrum View for the cursor source.
<b>Examples</b>	DISPlay:SPECView1:CURSOR:CURSOR:VBARS:BPOSITION 55E+6 sets the Spectrum View Cursor B position to 55 MHz.  DISPlay:SPECView1:CURSOR:CURSOR:VBARS:APOSITION? might return DISPlay:SPECView1:CURSOR:CURSOR:VBARS:APOSITION 482.5E+6, indicating the Spectrum View Cursor B position is 42.5 MHz.

## DISPlay:SPECView<x>:CURSOR:CURSOR:VBARS:UNITS? (Query Only)

This command queries the cursor horizontal units in the Spectrum View.

<b>Group</b>	Cursor
<b>Syntax</b>	DISPlay:SPECView<x>:CURSOR:CURSOR:VBARS:UNITS?
<b>Arguments</b>	SPECView<x> specifies the Spectrum View number. <x> is always 1.
<b>Returns</b>	The horizontal units of the Spectrum View as a Qstring.
<b>Examples</b>	DISPlay:SPECView1:CURSOR:CURSOR:VBARS:UNITS? might return DISPlay:SPECView1:CURSOR:CURSOR:VBARS:UNITS "Hz", indicating the cursor horizontal units are Hertz.

## DISPlay:SPECView<x>:CURSOR:CURSOR:WAVEform:APOSITION

This command sets or queries the Cursor A horizontal position in the Spectrum View.

<b>Group</b>	Cursor
<b>Syntax</b>	DISplay:SPECview<x>:CURSor:CURSOR:WAVEform:APOSition <NR3> DISplay:SPECview<x>:CURSor:CURSOR:WAVEform:APOSition?
<b>Arguments</b>	SPECview<x> specifies the Spectrum View number. <x> is always 1.  <NR3> specifies the horizontal position of Spectrum View Cursor A in Hz. The range of values is the frequencies at the left and right edges of the Spectrum View for the cursor source
<b>Examples</b>	DISplay:SPECview1:CURSor:CURSOR:WAVEform:APOSition 22E+6 sets the Spectrum View Cursor B position to 22 MHz.  DISplay:SPECview1:CURSor:CURSOR:WAVEform:APOSition? might return DISplay:SPECview1:CURSor:CURSOR:WAVEform:APOSition 48.5E+6, indicating the Spectrum View Cursor A position is 48.5 MHz.

## DISplay:SPECView<x>:CURSor:CURSOR:WAVEform:BPOStion

This command sets or queries the Cursor B horizontal position in the Spectrum View.

<b>Group</b>	Cursor
<b>Syntax</b>	DISplay:SPECview<x>:CURSor:CURSOR:WAVEform:BPOStion <NR3> DISplay:SPECview<x>:CURSor:CURSOR:WAVEform:BPOStion?
<b>Arguments</b>	SPECview<x> specifies the Spectrum View number. <x> is always 1.  <NR3> specifies the horizontal position of Spectrum View Cursor B in Hz. The range of values is the frequencies at the left and right edges of the Spectrum View for the cursor source
<b>Examples</b>	DISplay:SPECview1:CURSor:CURSOR:WAVEform:BPOStion 22E+6 sets the Spectrum View Cursor B position to 22 MHz.  DISplay:SPECview1:CURSor:CURSOR:WAVEform:BPOStion? might return DISplay:SPECview1:CURSor:CURSOR:WAVEform:BPOStion 48.5E+6, indicating the Spectrum View Cursor B position is 48.5 MHz.



## DISplay:SPECView<x>:HORZ

This command sets or queries the horizontal display scaling of the Spectrum View window.

<b>Group</b>	Display
<b>Syntax</b>	DISplay:SPECView<x>:HORZ {LOG LINEAR} DISplay:SPECView<x>:HORZ?
<b>Arguments</b>	SPECView<x> specifies the Spectrum View number. <x> is always 1.  LINEAR sets the Spectrum View horizontal scaling to linear.  LOG sets the Spectrum View horizontal scaling to log.
<b>Examples</b>	DISplay:SPECView1:HORZ LOG sets the horizontal display scaling in the Spectrum View window to log.  DISplay:SPECView1:HORZ? might return :DISplay:SPECView1:HORZ LOG, indicating that the horizontal display scaling in the Spectrum View window is set to log.

## DISplay:SPECView<x>:GRAticule

This command sets or queries the type of graticule shown in the Spectrum View window. The same grid is used for all spectrum traces.

<b>Group</b>	Display
<b>Syntax</b>	DISplay:SPECView<x>:GRAticule {GRID TIME FULL NONE} DISplay:SPECView<x>:GRAticule?
<b>Arguments</b>	SPECView<x> specifies the Spectrum View number. <x> is always 1.  GRID specifies to show the Grid graticule (frame and grid) in the Spectrum View window.  TIME specifies to show the Time graticule in the Spectrum View window.  FULL specifies to show the Full graticule (frame, a grid and cross hairs) in the Spectrum View window.  NONE specifies to show no graticule in the Spectrum View window.

**Examples**    `DISplay:SPECview1:GRATICule TIME` sets the Spectrum View window to show a Time graticule.

`DISplay:SPECview1:GRATICule?` might return `GRID`, indicating that the Spectrum View is showing a Grid graticule.

## **DISplay:SPECView<x>:INTENSITY:GRATICule**

This command sets or queries the graticule saturation (brightness) level in the Spectrum View window.

---

***NOTE.** This command also changes the intensity of the vertical scale values on the graticule.*

---

**Group**    Display

**Syntax**    `DISplay:SPECview<x>:INTENSITY:GRATICule <NR2>`  
`DISplay:SPECview<x>:INTENSITY:GRATICule?`

**Arguments**    `SPECview<x>` specifies the Spectrum View number. `<x>` is always 1.  
`<NR2>` specifies the Spectrum View graticule intensity lever as a percent between 0% and 100%.

**Examples**    `DISplay:SPECview1:INTENSITY:GRATICule 75` sets the Spectrum View graticule saturation level to 75%.  
`DISplay:SPECview1:INTENSITY:GRATICule?` might return `66.0`, indicating the Spectrum View graticule saturation level is at 66%.

## **DISplay:SPECView<x>:INTENSITY:WAVEform**

This command sets or queries the spectrum trace saturation (brightness) level in the Spectrum View window.

**Group**    Display

**Syntax**    `DISplay:SPECview<x>:INTENSITY:WAVEform <NR2>`  
`DISplay:SPECview<x>:INTENSITY:WAVEform?`

- Arguments**    `SPECview<x>` specifies the Spectrum View number. `<x>` is always 1.  
                   `<NR2>` specifies the spectrum trace intensity lever as a percent between 1% and 100%.
- Examples**     `DISplay:SPECview1:INTENSITY:WAVEform 75` sets the spectrum trace saturation level to 75%.  
                   `DISplay:SPECview1:INTENSITY:WAVEform?` might return `80.0`, indicating the spectrum trace saturation level is at 80%.

## DISplay:SPECView<x>:VIEWStyle

This command sets or queries the spectrum trace layout style used by the Spectrum View window.

- Group**        Display
- Syntax**       `DISplay:SPECview<x>:VIEWStyle {OVERlay|STACKed}`  
                   `DISplay:SPECview<x>:VIEWStyle?`
- Arguments**    `SPECview<x>` specifies the Spectrum View number. `<x>` is always 1.  
                   `OVERlay` specifies the Spectrum View window to show all spectrum traces drawn on top of each other.  
                   `STACKed` specifies the Spectrum View window to show each spectrum trace in a separate horizontal slice.
- Examples**     `DISplay:SPECview1:VIEWStyle OVERlay` sets the view style to overlay.  
                   `DISplay:SPECview1:VIEWStyle?` might return `STACKED`, indicating the Spectrum View window is showing spectrum traces in stacked mode.

## DISplay:VARpersist

This command sets or queries display persistence decay time, which is the approximate decay time for a freshly struck persistence sample.

- Group**        Display Control
- Syntax**       `DISplay:VARpersist <NR3>`  
                   `DISplay:VARpersist?`

**Related Commands**    [DISplay:PERSistence](#)

**Arguments**    <NR3> indicates the persistence decay time and ranges from 0.5 to 100.

**Examples**    DISPLAY:VARPERSIST 5 sets the persistence decay time to 5.  
 DISPLAY:VARPERSIST? might return :DISPLAY:VARPERSIST 3.0000E-01, indicating that persistence decay time is currently set to 0.300.

## DISplay:WAVEform

This command globally enables or disables the waveform display. When disabled, the waveform is still acquired and held in memory, but it is not drawn to the screen. Disabling the waveform display may improve processing speed.

**Group**    Cursor

**Syntax**    DISplay:WAVEform {<NR1>|OFF|ON}  
 DISplay:WAVEform?

**Arguments**    <NR1> enables or disables the waveform display. 0 disables the waveform display; any other value enables the waveform display.  
 ON enables the waveform display.  
 OFF disables the waveform display.

**Examples**    DISplay:WAVEform OFF disables the waveform display.  
 DISplay:WAVEform? might return DISplay:WAVEform 1, indicating that the waveform display is enabled.

## DISplay:WAVEView:CURSor:CURSOR1:ROLOCATION

This command sets or queries the location to display the Waveform View cursor readouts (in the Waveform View graticule or in a badge in the Results Bar).

**Group**    Cursor

**Syntax**    DISplay:WAVEview:CURSor:CURSOR1:ROLOCATION {GRATICULE|BADGE}  
 DISplay:WAVEview:CURSor:CURSOR1:ROLOCATION?

<b>Arguments</b>	<p>GRATICULE sets the Waveform View cursor readouts to display as part of the cursors in the plot view.</p> <p>BADGE removes the Waveform View cursor readouts from the cursors in the graticule and displays the cursor information as a badge in the Results Bar.</p>
<b>Examples</b>	<p>DISplay:WAVEview:CURSor:CURSOR1:ROLOCATION GRATICULE sets the cursor readout information for the Waveform View to display in the Waveform View graticule.</p> <p>DISplay:WAVEview:CURSor:CURSOR1:ROLOCATION? might return DISplay:WAVEview:CURSor:CURSOR1:ROLOCATION BADGE, indicating that cursor readout information for the Waveform View is set to display as a badge in the Results Bar.</p>

## DISplay:WAVEView:GRIDTYPE

This command sets or queries the Waveform View Graticule type.

<b>Group</b>	Display
<b>Syntax</b>	<p>DISplay:WAVEview:GRIDTYPE {MOVEABLE FIXED}</p> <p>DISplay:WAVEview:GRIDTYPE?</p>
<b>Arguments</b>	<p>MOVEABLE sets the Waveform View so that both the waveform and the grid (graticule) move together when moving the waveform horizontally</p> <p>FIXED sets the Waveform View so that the grid does not move when moving the waveform horizontally.</p>
<b>Examples</b>	<p>DISplay:WAVEview:GRIDTYPE MOVEABLE sets the Waveform View to enable both the graticule and the waveform to move together.</p> <p>DISplay:WAVEview:GRIDTYPE? might return FIXED, indicating that the graticule will not change positions if the waveform moves horizontally.</p>

## DISplay:WAVEView<x>:BUS:B<x>:STATE

Sets or queries the state of the specified bus in the specified Waveform View.

---

**NOTE.** *WAVEView<x>* is the specified Waveform View and must be *WAVEView1*.

---

<b>Group</b>	Display Control
<b>Syntax</b>	DISplay:WAVEview<x>:BUS:B<x>:STATE {OFF ON 0 1} DISplay:WAVEview<x>:BUS:B<x>:STATE?
<b>Arguments</b>	0 turns specified bus off. 1 turns the specified bus on. ON turns the specified bus on. OFF turns specified bus off.
<b>Examples</b>	DISplay:WAVEview1:BUS:B1:STATE OFF turns specified bus off. DISplay:WAVEview1:BUS:B1:STATE? might return :DISPLAY:WAVEVIEW1:BUS:B1:STATE 1 indicating the specified bus is on.

## DISplay:WAVEView<x>:BUS:B<x>:VERTical:POSition

Sets or queries the vertical position of the specified bus in the specified Waveform View.

---

**NOTE.** *WAVEview<x> is the specified Waveform View and must be WAVEview1.*

---

<b>Group</b>	Display Control
<b>Syntax</b>	DISplay:WAVEview<x>:BUS:B<x>:VERTical:POSition <NR3> DISplay:WAVEview<x>:BUS:B<x>:VERTical:POSition?
<b>Arguments</b>	<NR3> is the vertical position of the specified bus.
<b>Examples</b>	DISplay:WAVEview1:BUS:B1:VERTical:POSition 1.0e0 sets the position to 1 division. DISplay:WAVEview1:BUS:B1:VERTical:POSition? might return :DISPLAY:WAVEVIEW1:BUS:B1:VERTICAL:POSITION 0.0E+0 indicating the position is 0.0 divisions.

## DISplay:WAVEView<x>:CH<x>:STATE

Sets or queries the state of the specified channel in the specified Waveform View.

---

**NOTE.** *WAVEView<x> is the specified Waveform View and must be WAVEView1.*

---

<b>Group</b>	Display Control
<b>Syntax</b>	DISplay:WAVEView<x>:CH<x>:STATE {<NR1> OFF ON} DISplay:WAVEView<x>:CH<x>:STATE?
<b>Arguments</b>	<NR1> = 0 disables the specified channel on the specified Waveform View; any other value turns this feature on.  OFF disables the display the specified channel on the specified Waveform View.  ON enables the specified channel on the specified Waveform View.
<b>Examples</b>	DISplay:WAVEView1:CH1:STATE ON turns on channel 1.  DISplay:WAVEView1:CH1:STATE? might return :DISPLAY:WAVEVIEW1:CH1:STATE 0 indicating channel 1 is off.

## DISplay:WAVEView<x>:CH<x>:VERTical:POSition

Sets or queries the vertical position of the specified channel in the specified Waveform View in divisions. 0.0 divisions is center, 5.0 top of the window, and -5.0 the bottom of the window.

---

**NOTE.** *WAVEView<x> is the specified Waveform View and must be WAVEView1.*

---

<b>Group</b>	Display Control
<b>Syntax</b>	DISplay:WAVEView<x>:CH<x>:VERTical:POSition <NR3> DISplay:WAVEView<x>:CH<x>:VERTical:POSition?
<b>Arguments</b>	<NR3> is the vertical position in divisions. 0.0 divisions is center, 5.0 top of the window, and -5.0 the bottom of the window.
<b>Examples</b>	DISplay:WAVEView1:CH1:VERTical:POSition 1.0e0 sets the position to 1 division.  DISplay:WAVEView1:CH1:VERTical:POSition? might return :DISPLAY:WAVEVIEW1:CH1:VERTICAL:POSITION -3.4400 indicating the channel 1 vertical position is -3.44 divisions.

## DISplay:WAVEView<x>:CH<x>:VERTical:SCALE

Sets or queries the vertical scale of the specified channel in volts per division within the specified Waveform View.

---

**NOTE.** *WAVEView<x>* is the specified Waveform View and must be *WAVEView1*.

---

<b>Group</b>	Display Control
<b>Syntax</b>	DISplay:WAVEView<x>:CH<x>:VERTical:SCALE <NR3> DISplay:WAVEView<x>:CH<x>:VERTical:SCALE?
<b>Arguments</b>	<NR3> is the vertical scale of the specified channel.
<b>Examples</b>	DISplay:WAVEView1:CH1:VERTical:SCALE 2.0e2 sets the vertical scale to 200 mV per division.  DISplay:WAVEView1:CH1:VERTical:SCALE? might return :DISPLAY:WAVEVIEW1:CH1:VERTICAL:SCALE 200.0000E-3 indicating the scale is 200 mV per division.

## DISplay:WAVEView<x>:CH<x>\_DALL:STATE

This command sets or queries the display state of the specified digital channel in the specified Waveform View.

<b>Group</b>	Display Control
<b>Syntax</b>	DISplay:WAVEView<x>:CH<x>_DALL:STATE {<NR1> OFF ON} DISplay:WAVEView<x>:CH<x>_DALL:STATE?
<b>Arguments</b>	<NR1> = 0 disables the display of the specified channels on the specified Waveform View; any other value turns this feature on.  OFF disables the display of the specified channels on the specified Waveform View.  ON enables the display of the specified channels on the specified Waveform View.
<b>Examples</b>	DISplay:WAVEView1:CH1_DALL:STATE ON enables the display of the specified channels on the specified Waveform View.



DISPlay:WAVEView1:CH1\_DALL:STATE? might return  
:DISPLAY:WAVEVIEW1:CH1\_DALL:STATE 0 indicating specified  
digital channels in the specified Waveform View are off.

## DISPlay:WAVEView<x>:CH<x>\_DALL:VERTical:POSition

This command sets or queries the vertical position of the specified digital channel in the specified Waveform View in divisions. The position ranges from 5.0 to -5.0 divisions.

<b>Group</b>	Display Control
<b>Syntax</b>	DISPlay:WAVEView<x>:CH<x>_DALL:VERTical:POSition <NR3> DISPlay:WAVEView<x>:CH<x>_DALL:VERTical:POSition?
<b>Arguments</b>	<NR3> is the vertical position of the specified digital channel in the specified Waveform View in divisions.
<b>Examples</b>	DISPlay:WAVEView1:CH1_DALL:VERTical:POSition 1.0e0 sets the vertical position to 1.0 divisions.  DISPlay:WAVEView1:CH1_DALL:VERTical:POSition? might return :DISPLAY:WAVEVIEW1:CH1_DALL:VERTICAL:POSITION 0.0E+0 indicating the vertical position is 0.0 divisions.

## DISPlay:WAVEView<x>:CH<x>\_D<x>:STATE

This command sets or queries the display state of the specified digital channel in the specified Waveform View.

<b>Group</b>	Display Control
<b>Syntax</b>	DISPlay:WAVEView<x>:CH<x>_D<x>:STATE {<NR1> OFF ON} DISPlay:WAVEView<x>:CH<x>_D<x>:STATE?
<b>Arguments</b>	<NR1> = 0 disables the display of the specified channel on the specified Waveform View; any other value turns this feature on.  OFF disables the display of the specified channel on the specified Waveform View.  ON enables the display of the specified channel on the specified Waveform View.

**Examples**    `DISPlay:WAVEView1:CH1_D1:STATE OFF` turns off the specified digital channel.

`DISPlay:WAVEView1:CH1_D1:STATE?` might return  
`:DISPLAY:WAVEVIEW1:CH1_D1:STATE 1` indicating the specified digital channel is on.

## DISPlay:WAVEView<x>:CURSor? (Query Only)

This query returns the cursor parameters for the specified Waveform View.

---

**NOTE.** *WAVEView<x>* is the specified Waveform View and must be *WAVEView1*.

---

**Group**    Cursor

**Syntax**    `DISPlay:WAVEView<x>:CURSor?`

**Returns**    Returns the cursor parameters for the specified Waveform View.

**Examples**    `DISPlay:WAVEView1:CURSor?` might return  
`WAVEFORM;AUTO;2.4993299784074;2.4958885115371;`  
`-3.4414668702805E-3;"A";"A";300.0E-6;2.23696699999970;`  
`256.967000E-3;-300.0E-6;-300.0E-6;300.0E-6; "????`  
`????";"s";"???? ????";600.0E-6;1.6666666666667E+3;`  
`1;300.0E-6;-300.0E-6;SAME;4.1655499640123E+3;INDEPENDENT;AUTO`

## DISPlay:WAVEView<x>:CURSor:CURSOR<x>? (Query Only)

This query returns the cursor parameters for the specified cursor in the specified Waveform View.

---

**NOTE.** *WAVEView<x>* is the specified Waveform View and must be *WAVEView1*.  
*Cursor<x>* is the specified cursor and must be *CURSOR1*.

---

**Group**    Cursor

**Syntax**    `DISPlay:WAVEView<x>:CURSor:CURSOR<x>?`

<b>Returns</b>	Returns the cursor parameters for the specified cursor in the specified Waveform View.
<b>Examples</b>	<pre> DISplay:WAVEView1:CURSor:CURSOR1? might return :DISPLAY:WAVEVIEW1:CURSOR:CURSOR:WAVEFORM:BPOSITION 5.0E-6;APOSITION -5.0E-6;:DISPLAY:WAVEVIEW1:CURSOR:CURSOR:BSOURCE AUTO;HBARS:BPOSITION 9.91E+37;BUNITS "V";AUNITS "V";APOSITION 9.91E+37;DELTA 9.91E+37;:DISPLAY:WAVEVIEW1:CURSOR:CURSOR:VBA RS:BPOSITION 5.0E-6;APOSITION -5.0E-6;UNITS "s";DELTA 10.0E-6;ALTERNATEB "???? ????";ALTERNATEA "???? ????";:DISPLAY:WAVEVIEW1:CURSOR:CURSOR:STATE 1;FUNCTION WAVEFORM;SCREEN:AYPOSITION -2.0E-3;BXPOSITION -5.0E-6;BYPOSITION -2.0E-3;AXPOSITIO N -5.0E-6;:DISPLAY:WAVEVIEW1:CURSOR:CURSOR:MODE INDEPENDENT;ASOURCE AUTO;DDT 9.91E+37;ONEOVERDELTAVALUE 100.0E+3;SPLITM ODE SAME;LINESTYLE SOLID. </pre>

## DISplay:WAVEView<x>:CURSor:CURSOR<x>:ASOURce

This command sets or queries the cursor A source of the specified cursor in the specified Waveform View.

---

**NOTE.** *WAVEView<x>* is the specified Waveform View and must be *WAVEView1*. *Cursor<x>* is the specified cursor and must be *CURSOR1*.

---

<b>Group</b>	Cursor
<b>Syntax</b>	<pre> DISplay:WAVEView&lt;x&gt;:CURSor:CURSOR&lt;x&gt;:ASOURce {AUTO CH&lt;x&gt; BUS&lt;x&gt; MATH&lt;x&gt; REF&lt;x&gt; PLOT&lt;x&gt;} DISplay:WAVEView&lt;x&gt;:CURSor:CURSOR&lt;x&gt;:ASOURce? </pre>
<b>Arguments</b>	<p>AUTO automatically specifies the source.</p> <p>CH&lt;x&gt; specifies an analog channel as the source.</p> <p>Math&lt;x&gt; specifies a math waveform as the source.</p> <p>REF&lt;x&gt; specifies a reference waveform as the source.</p> <p>PLOT&lt;x&gt; specifies a plot as the source.</p>

**Examples**    `DISPlay:WAVEView1:CURSor:CURSOR1:ASource CH1` sets the cursor 1 source to channel 1.

`DISPlay:WAVEView1:CURSor:CURSOR1:ASource?` might return `:DISPlay:WAVEVIEW1:CURSOR:CURSOR1:ASOURCE REF1` indicating the cursor A source is reference 1.

## DISPlay:WAVEView<x>:CURSor:CURSOR<x>:BSOURce

This command sets or queries the cursor B source of the specified cursor in the specified Waveform View.

---

**NOTE.** *WAVEView<x> is the specified Waveform View and must be WAVEView1. CURSor<x> is the specified cursor and must be CURSOR1.*

---

**Group**    Cursor

**Syntax**    `DISPlay:WAVEView<x>:CURSor:CURSOR<x>:BSOURce`  
`{CH<x>|BUS<x>|MATH<x>|REF<x>|PLOT<x>}`  
`DISPlay:WAVEView<x>:CURSor:CURSOR<x>:BSOURce?`

**Arguments**    `S<x>_Ch<x>` specifies the remote scope number and the analog channel as the source.

`CH<x>` specifies an analog channel as the source.

`Math<x>` specifies a math waveform as the source.

`REF<x>` specifies a reference waveform as the source.

`PLOT<x>` specifies a plot as the source.

**Examples**    `DISPlay:WAVEView1:CURSor:CURSOR1:BSOURce CH1` sets the cursor B source to channel 1.

`DISPlay:WAVEView1:CURSor:CURSOR1:BSOURce?` might return `:DISPlay:WAVEVIEW1:CURSOR:CURSOR1:BSOURCE REF1` indicating the cursor b source is reference 1.

## DISPlay:WAVEView<x>:CURSor:CURSOR<x>:DDT? (Query Only)

This query returns the delta V over delta T cursor readout value of the specified cursor in the specified Waveform View.

---

**NOTE.** *WAVEView<x>* is the specified Waveform View and must be *WAVEView1*.  
*Cursor<x>* is the specified cursor and must be *CURSOR1*.

---

<b>Group</b>	Cursor
<b>Syntax</b>	DISPlay:WAVEView<x>:CURSor:CURSOR<x>:DDT?
<b>Returns</b>	The delta V over delta T cursor readout value of the specified cursor in the specified Waveform View.
<b>Examples</b>	DISPlay:WAVEView1:CURSor:CURSOR1:DDT? might return :DISPLAY:WAVEVIEW1:CURSOR:CURSOR1:DDT 9.91E+37 indicating the delta V over delta T cursor readout value of the specified cursor is 9.91E+37.

## DISPlay:WAVEView<x>:CURSor:CURSOR<x>:FUNctIon

This command sets or queries the cursor type of the specified cursor in the specified Waveform View.

---

**NOTE.** *WAVEView<x>* is the specified Waveform View and must be *WAVEView1*.  
*Cursor<x>* is the specified cursor and must be *CURSOR1*.

---

<b>Group</b>	Cursor
<b>Syntax</b>	DISPlay:WAVEView<x>:CURSor:CURSOR<x>:FUNctIon {SCREEN WAVEFORM VBArS HBArS} DISPlay:WAVEView<x>:CURSor:CURSOR<x>:FUNctIon?
<b>Arguments</b>	<p>HBArS specifies horizontal bar cursors, which measure in vertical units.</p> <p>VBArS specifies vertical bar cursors, which measure in horizontal units.</p> <p>SCREEN specifies both horizontal and vertical bar cursors, which measure in horizontal and vertical units specified by the Cursor 1 and Cursor 2 Sources. Use these cursors to measure anywhere in the waveform display area.</p> <p>WAVEform specifies paired or split cursors in YT display format for measuring waveform amplitude and time. In XY and XYZ format, these cursors indicate the amplitude positions of an XY pair (Ch1 vs Ch2 voltage, where Ch1 is the X axis and Ch2 is the Y axis) relative to the trigger.</p>

**Examples**     `DISPLAY:WAVEVIEW1:CURSOR:CURSOR1:FUNCTION VBARS` selects the vertical bar cursor type for the specified Waveform View and cursor.

`DISPLAY:WAVEVIEW1:CURSOR:CURSOR1:FUNCTION?` might return `:DISPLAY:WAVEVIEW1:CURSOR:CURSOR1:FUNCTION HBARS` indicating that the specified cursor is set to HBARS.

## DISplay:WAVEView<x>:CURSor:CURSOR<x>:HBARs:APOSition

Sets or queries the HBARS vertical A position of the specified cursor in the specified Waveform View.

---

**NOTE.** *WAVEView<x>* is the specified Waveform View and must be *WAVEView1*. *Cursor<x>* is the specified cursor and must be *CURSOR1*.

---

**Group**     Cursor

**Syntax**     `DISplay:WAVEview<x>:CURSor:CURSOR<x>:HBARs:APOSition <NR3>`  
`DISplay:WAVEview<x>:CURSor:CURSOR<x>:HBARs:APOSition?`

**Arguments**     `<NR3>` is the vertical cursor A position of the specified cursor in the specified Waveform View. 0.0 divisions is center, 5.0 top of the waveview, and -5.0 the bottom of the waveview.

**Examples**     `DISplay:WAVEview1:CURSor:CURSOR1:HBARs:APOSition 3.0e0` sets the cursor position to 3 V.

`DISplay:WAVEview1:CURSor:CURSOR1:HBARs:APOSition?` might return `:DISPLAY:WAVEVIEW1:CURSOR:CURSOR1:HBARS:APOSITION 2.9303448275862` indicating the cursor position is 2.93 V.

## DISplay:WAVEView<x>:CURSor:CURSOR<x>:HBARs:AUNIts? (Query Only)

This command queries the cursor A vertical units of the specified cursor in the specified Waveform View.

---

**NOTE.** *WAVEView<x>* is the specified Waveform View and must be *WAVEView1*. *Cursor<x>* is the specified cursor and must be *CURSOR1*.

---

**Group**     Cursor

<b>Syntax</b>	<code>DISPlay:WAVEView&lt;x&gt;:CURSOR:CURSOR&lt;x&gt;:HBARS:AUNITS?</code>
<b>Arguments</b>	<code>&lt;QString&gt;</code> is the cursor A vertical units of the specified cursor in the specified Waveform View.
<b>Examples</b>	<code>DISPlay:WAVEView1:CURSOR:CURSOR1:HBARS:AUNITS?</code> might return <code>:DISPLAY:WAVEVIEW1:CURSOR:CURSOR1:HBARS:AUNITS "V"</code> indicating the AUNITS are set to Volts.

## DISPlay:WAVEView<x>:CURSOR:CURSOR<x>:HBARS:BPOSITION

Sets or queries the HBARS vertical B position of the specified cursor in the specified Waveform View.

---

**NOTE.** *WAVEView<x>* is the specified Waveform View and must be *WAVEView1*. *Cursor<x>* is the specified cursor and must be *CURSOR1*.

---

<b>Group</b>	Cursor
<b>Syntax</b>	<code>DISPlay:WAVEView&lt;x&gt;:CURSOR:CURSOR&lt;x&gt;:HBARS:BPOSITION &lt;NR3&gt;</code> <code>DISPlay:WAVEView&lt;x&gt;:CURSOR:CURSOR&lt;x&gt;:HBARS:BPOSITION?</code>
<b>Arguments</b>	<code>&lt;NR3&gt;</code> is the vertical cursor B position of the specified cursor in the specified Waveform View.
<b>Examples</b>	<code>DISPlay:WAVEView1:CURSOR:CURSOR1:HBARS:BPOSITION 4.0e-1</code> sets the position to 400 mV.  <code>DISPlay:WAVEView1:CURSOR:CURSOR1:HBARS:BPOSITION?</code> might return <code>:DISPLAY:WAVEVIEW1:CURSOR:CURSOR1:HBARS:BPOSITION 387.9148706896567E-3</code> indicating the B cursor position is 387.9 mV.

## DISPlay:WAVEView<x>:CURSOR:CURSOR<x>:HBARS:BUNITS? (Query Only)

This command queries the cursor B vertical units of the specified cursor in the specified Waveform View.

---

**NOTE.** *WAVEView<x>* is the specified Waveform View and must be *WAVEView1*. *Cursor<x>* is the specified cursor and must be *CURSOR1*.

---

<b>Group</b>	Cursor
<b>Syntax</b>	DISPlay:WAVEView<x>:CURSOR:CURSOR<x>:HBARS:BUNITS?
<b>Returns</b>	<QString> is the cursor B vertical units of the specified cursor in the specified Waveform View.
<b>Examples</b>	DISPlay:WAVEView1:CURSOR:CURSOR1:HBARS:BUNITS? might return :DISPLAY:WAVEVIEW1:CURSOR:CURSOR1:HBARS:BUNITS "V" indicating the BUNITS are set to Volts.

### DISPlay:WAVEView<x>:CURSOR:CURSOR<x>:HBARS:DELTA? (Query Only)

This command queries the delta V cursor readout value of the specified cursor in the specified Waveform View.

---

**NOTE.** *WAVEView<x>* is the specified Waveform View and must be *WAVEView1*. *Cursor<x>* is the specified cursor and must be *CURSOR1*.

---

<b>Group</b>	Cursor
<b>Syntax</b>	DISPlay:WAVEView<x>:CURSOR:CURSOR<x>:HBARS:DELTA?
<b>Returns</b>	The delta V cursor readout value of the specified cursor in the specified Waveform View.
<b>Examples</b>	DISPlay:WAVEView1:CURSOR:CURSOR1:HBARS:DELTA? might return :DISPLAY:WAVEVIEW1:CURSOR:CURSOR1:HBARS:DELTA 2.612085129310 indicating the delta between the cursors is 2.61 V.

### DISPlay:WAVEView<x>:CURSOR:CURSOR<x>:MODE

Sets or queries the cursor tracking mode of the specified cursor in the specified Waveform View.

---

**NOTE.** *WAVEView<x>* is the specified Waveform View and must be *WAVEView1*. *Cursor<x>* is the specified cursor and must be *CURSOR1*.

---



<b>Group</b>	Cursor
<b>Syntax</b>	DISPlay:WAVEView<x>:CURSOR:CURSOR<x>:MODE {INDEPENDENT TRACK}
<b>Arguments</b>	<p>TRACK ties the navigational functionality of the two cursors together. For cursor 1 adjustments, this ties the movement of the two cursors together; however, cursor 2 continues to move independently of cursor 1.</p> <p>INDEPENDENT allows independent adjustment of the two cursors.</p>
<b>Examples</b>	<p>DISPLAY:WAVEVIEW1:CURSOR:CURSOR1:MODE TRACK specifies that the cursor positions move in unison.</p> <p>DISPLAY:WAVEVIEW1:CURSOR:CURSOR1:MODE? might return :DISPLAY:WAVEVIEW1:CURSOR:CURSOR1:MODE TRACK, indicating that the two cursors move in unison.</p>

## DISPlay:WAVEView<x>:CURSOR:CURSOR<x>:ONEOVERDELTAVALUE? (Query Only)

This query returns the one over delta T cursor readout value of the specified cursor in the specified Waveform View.

---

**NOTE.** *WAVEView<x> is the specified Waveform View and must be WAVEView1. Cursor<x> is the specified cursor and must be CURSOR1.*

---

<b>Group</b>	Cursor
<b>Syntax</b>	DISPlay:WAVEView<x>:CURSOR:CURSOR<x>:ONEOVERDELTAVALUE?
<b>Returns</b>	The one over delta T cursor readout value of the specified cursor in the specified Waveform View.
<b>Examples</b>	<p>DISPlay:WAVEView1:CURSOR:CURSOR1:ONEOVERDELTAVALUE? might return :DISPLAY:WAVEVIEW1:CURSOR:CURSOR1:ONEOVERDELTAVALUE 179.3188E+3 indicating the one over delta time value is 179.3 kHz.</p>

## DISplay:WAVEView<x>:CURSor:CURSOR<x>:SCREEN:AXPOsition

Sets or queries the horizontal cursor A position of the specified cursor in the specified Waveform View.

---

**NOTE.** *WAVEView<x>* is the specified Waveform View and must be *WAVEView1*. *Cursor<x>* is the specified cursor and must be *CURSOR1*.

---

<b>Group</b>	Cursor
<b>Syntax</b>	DISplay:WAVEView<x>:CURSor:CURSOR<x>:SCREEN:AXPOsition <NR3> DISplay:WAVEView<x>:CURSor:CURSOR<x>:SCREEN:AXPOsition?
<b>Arguments</b>	<NR3> is the horizontal cursor A position of the specified cursor in the specified Waveform View.
<b>Examples</b>	<p>DISPLAY:WAVEVIEW1:CURSOR:CURSOR1:SCREEN:AXPOSITION 15.0E-3 sets the x position of screen cursor1 in waveview1 to 15 mV.</p> <p>DISPLAY:WAVEVIEW1:CURSOR:CURSOR1:SCREEN:AXPOSITION? might return :DISPLAY:WAVEVIEW1:CURSOR:CURSOR1:SCREEN:AXPOSITION -64.0000E-03 indicating that x position of the specified screen cursor in the specified Waveform View is set to -64 mV.</p>

## DISplay:WAVEView<x>:CURSor:CURSOR<x>:SCREEN:AYPOsition

This command sets or queries the vertical cursor A position of the specified cursor in the specified Waveform View.

---

**NOTE.** *WAVEView<x>* is the specified Waveform View and must be *WAVEView1*. *Cursor<x>* is the specified cursor and must be *CURSOR1*.

---

<b>Group</b>	Cursor
<b>Syntax</b>	DISplay:WAVEView<x>:CURSor:CURSOR<x>:SCREEN:AYPOsition <NR3> DISplay:WAVEView<x>:CURSor:CURSOR<x>:SCREEN:AYPOsition?
<b>Arguments</b>	<NR3> the vertical cursor A position of the specified cursor in the specified Waveform View.

**Examples**     `DISPLAY:WAVEVIEW1:CURSOR:CURSOR1:SCREEN:AYPOSITION 25.0E-3`  
 sets the y position of the specified screen cursor of the specified Waveform View to 25 mV.

`DISPLAY:WAVEVIEW1:CURSOR:CURSOR1:SCREEN:AYPOSITION?` might  
 return `:DISPLAY:WAVEVIEW1:CURSOR:CURSOR1:SCREEN:AYPOSITION`  
`-53.0000E-03` indicating that y position of the specified screen cursor of the  
 specified Waveform View is set to -53 mV.

## DISplay:WAVEView<x>:CURSor:CURSOR<x>:SCREEN:BXPOSITION

Sets or queries the horizontal cursor B position of the specified cursor in the specified Waveform View.

---

*NOTE. WAVEView<x> is the specified Waveform View and must be WAVEView1. Cursor<x> is the specified cursor and must be CURSOR1.*

---

**Group**     Cursor

**Syntax**     `DISplay:WAVEView<x>:CURSor:CURSOR<x>:SCREEN:BXPOSITION <NR3>`  
`DISplay:WAVEView<x>:CURSor:CURSOR<x>:SCREEN:BXPOSITION?`

**Arguments**     `<NR3>` is the horizontal cursor B position of the specified cursor in the specified Waveform View.

**Examples**     `DISPLAY:WAVEVIEW1:CURSOR:CURSOR1:SCREEN:AXPOSITION 15.0E-3`  
 sets the x position of the specified screen cursor in the specified Waveform View to 15 mV.

`DISPLAY:WAVEVIEW1:CURSOR:CURSOR1:SCREEN:AXPOSITION?` might  
 return `:DISPLAY:WAVEVIEW1:CURSOR:CURSOR1:SCREEN:AXPOSITION`  
`-64.0000E-03` indicating that x position of the specified screen cursor in the  
 specified Waveform View is set to -64 mV.

## DISplay:WAVEView<x>:CURSor:CURSOR<x>:SCREEN:BYPOSITION

This command sets or queries the vertical cursor B position of the specified cursor in the specified Waveform View.

---

*NOTE. WAVEView<x> is the specified Waveform View and must be WAVEView1. Cursor<x> is the specified cursor and must be CURSOR1.*

---

<b>Group</b>	Cursor
<b>Syntax</b>	DISplay:WAVEview<x>:CURSor:CURSOR<x>:SCREEN:BYPOSITION <NR3> DISplay:WAVEview<x>:CURSor:CURSOR<x>:SCREEN:BYPOSITION?
<b>Arguments</b>	<NR3> the vertical cursor B position of the specified cursor in the specified Waveform View.
<b>Examples</b>	<p>DISPLAY:WAVEVIEW1:CURSOR:CURSOR1:SCREEN:BYPOSITION 25.0E-3 sets the y position of the screen cursor of waveview1 to 25 mV.</p> <p>DISPLAY:WAVEVIEW1:CURSOR:CURSOR1:SCREEN:BYPOSITION? might return :DISPLAY:WAVEVIEW1:CURSOR:CURSOR1:SCREEN:BYPOSITION -53.0000E-03 indicating that y position of the specified screen cursor of the specified Waveform View is set to -53 mV.</p>

## DISplay:WAVEView<x>:CURSor:CURSOR<x>:SPLITMODE

This command sets or queries whether both cursors have the same or different sources.

---

**NOTE.** *WAVEview<x> is the specified Waveform View and must be WAVEview1.  
Cursor<x> is the specified cursor and must be CURSOR1.*

---

<b>Group</b>	Cursor
<b>Syntax</b>	DISplay:WAVEview<x>:CURSor:CURSOR<x>:SPLITMODE {SAME SPLIT} DISplay:WAVEview<x>:CURSor:CURSOR<x>:SPLITMODE?
<b>Arguments</b>	<p>SAME specifies both cursors have the same source.</p> <p>SPLIT specifies the cursors have different sources.</p>
<b>Examples</b>	<p>DISPLAY:WAVEVIEW1:CURSOR:CURSOR1:SPLITMODE SPLIT specifies the cursors have different sources.</p> <p>DISPLAY:WAVEVIEW1:CURSOR:CURSOR1:SPLITMODE? might return :DISPLAY:WAVEVIEW1:CURSOR:CURSOR1:SPLITMODE SAME indicating the cursors have the same source.</p>

**DISplay:WAVEView<x>:CURSOR:CURSOR<x>:STATE**

This command sets or queries the visible state of the specified cursor in the specified Waveform View.

---

**NOTE.** *WAVEView<x>* is the specified Waveform View and must be *WAVEView1*. *Cursor<x>* is the specified cursor and must be *CURSOR1*.

---

<b>Group</b>	Cursor
<b>Syntax</b>	DISplay:WAVEView<x>:CURSOR:CURSOR<x>:STATE {<NR1> OFF ON} DISplay:WAVEView<x>:CURSOR:CURSOR<x>:STATE?
<b>Arguments</b>	<NR1> = 0 disables the specified cursor in the specified Waveform View; any other value turns this feature on.  OFF disables the specified cursor in the specified Waveform View.  ON enables the specified cursor in the specified Waveform View.
<b>Examples</b>	DISplay:WAVEView1:CURSOR:CURSOR1:STATE OFF turns the specified cursor off.  DISplay:WAVEView1:CURSOR:CURSOR1:STATE? might return :DISPLAY:WAVEVIEW1:CURSOR:CURSOR1:STATE 1 indicating the specified cursor in the specified Waveform View is on.

**DISplay:WAVEView<x>:CURSOR:CURSOR<x>:VBARS:APOSITION**

This command sets or queries the cursor A horizontal position of the specified cursor in the specified Waveform View.

---

**NOTE.** *WAVEView<x>* is the specified Waveform View and must be *WAVEView1*. *Cursor<x>* is the specified cursor and must be *CURSOR1*.

---

<b>Group</b>	Cursor
<b>Syntax</b>	DISplay:WAVEView<x>:CURSOR:CURSOR<x>:VBARS:APOSITION <NR3> DISplay:WAVEView<x>:CURSOR:CURSOR<x>:VBARS:APOSITION?

**Arguments** <NR3> is the horizontal cursor A position of the specified cursor in the specified Waveform View.

**Examples** `DISPlay:WAVEView1:CURSOR:CURSOR1:VBARS:APOSITION -4.0e-6` set the cursor position to 4.0  $\mu$ s.

`DISPlay:WAVEView1:CURSOR:CURSOR1:VBARS:APOSITION?` might return `:DISPLAY:WAVEVIEW1:CURSOR:CURSOR1:VBARS:APOSITION -5.0E-6` indicating the cursor A position is -5.0  $\mu$ s.

## DISPlay:WAVEView<x>:CURSOR:CURSOR<x>:VBARS:BPOSITION

This command sets or queries the cursor B horizontal position of the specified cursor in the specified Waveform View.

---

***NOTE.** `WAVEView<x>` is the specified Waveform View and must be `WAVEView1`. `CURSOR<x>` is the specified cursor and must be `CURSOR1`.*

---

**Group** Cursor

**Syntax** `DISPlay:WAVEView<x>:CURSOR:CURSOR<x>:VBARS:BPOSITION <NR3>`  
`DISPlay:WAVEView<x>:CURSOR:CURSOR<x>:VBARS:BPOSITION?`

**Arguments** <NR3> is the horizontal cursor B position of the specified cursor in the specified Waveform View.

**Examples** `DISPlay:WAVEView1:CURSOR:CURSOR1:VBARS:BPOSITION 4.0e-6` sets the cursor position to 4.0  $\mu$ s.

`DISPlay:WAVEView1:CURSOR:CURSOR1:VBARS:BPOSITION?` might return `:DISPLAY:WAVEVIEW1:CURSOR:CURSOR1:VBARS:BPOSITION 3.2736951319481E-6` indicating the B cursor position is 3.27  $\mu$ s.

## DISPlay:WAVEView<x>:CURSOR:CURSOR<x>:VBARS:DELTA? (Query Only)

This query sets or returns the delta T cursor readout value of the specified cursor in the specified Waveform View.

---

***NOTE.** `WAVEView<x>` is the specified Waveform View and must be `WAVEView1`. `CURSOR<x>` is the specified cursor and must be `CURSOR1`.*

---

<b>Group</b>	Cursor
<b>Syntax</b>	DISPlay:WAVEView<x>:CURSOR:CURSOR<x>:VBARS:DELTA?
<b>Returns</b>	The delta T cursor readout value of the specified cursor in the specified Waveform View.
<b>Examples</b>	DISPlay:WAVEView1:CURSOR:CURSOR1:VBARS:DELTA? might return :DISPLAY:WAVEVIEW1:CURSOR:CURSOR1:VBARS:DELTA 6.7926388747725E-6 indicating the delta T cursor readout value is 6.79 $\mu$ s.

### DISPlay:WAVEView<x>:CURSOR:CURSOR<x>:VBARS:UNIts? (Query Only)

This query returns cursor A vertical units of the specified cursor in the specified Waveform View.

---

*NOTE. WAVEView<x> is the specified Waveform View and must be WAVEView1. CURSOR<x> is the specified cursor and must be CURSOR1.*

---

<b>Group</b>	Cursor
<b>Syntax</b>	DISPlay:WAVEView<x>:CURSOR:CURSOR<x>:VBARS:UNIts?
<b>Returns</b>	The cursor A vertical units of the specified cursor in the specified Waveform View.
<b>Examples</b>	DISPlay:WAVEView1:CURSOR:CURSOR1:VBARS:UNIts? might return :DISPLAY:WAVEVIEW1:CURSOR:CURSOR1:VBARS:UNITS "s" indicating the cursor units are seconds.

### DISPlay:WAVEView<x>:CURSOR:CURSOR:WAVEform:ALL:Values? (Query Only)

This query returns all values (Time, Voltage, Delta) associated with all the active sources in the Waveform View. WAVEView<x> is the specified Waveform View and must be WAVEView1.

<b>Group</b>	Cursor
<b>Syntax</b>	DISPlay:WAVEView<x>:CURSOR:CURSOR:WAVEform:ALL:Values?

**Returns** All cursor values (Time, Voltage, Delta) associated with all the active sources of the specified cursor in the specified Waveform View. All the values are separated by a comma. The query command response will be in the following example format: t(<AH>,<BH>,<dt>,<1/dt>), <src1\_name>(<AV>,<BV>,<dv>,<dv/dt>), <src2\_name>(<AV>,<BV>,<dv>,<dv/dt>), <src3\_name>(<AV>,<BV>,<dv>,<dv/dt>), <src4\_name>(<AV>,<BV>,<dv>,<dv/dt>), <src5\_name>(<AV>,<BV>,<dv>,<dv/dt>) etc.

**Examples** DISPLAY:WAVEVIEW1:CURSOR:CURSOR:waveform:ALL:values? might return :DISPLAY:WAVEVIEW1:CURSOR:CURSOR:waveform:ALL:values t(1.2e-06,1.2e-06,2.4e-06,416667),ch1(0.9958,0.9074,1.9032,793000),mathref2(1,0.9,1.9,791667),s1\_ch1(0.9958,0.9074,1.9032,793000).

## DISplay:WAVEView<x>:CURSOR:CURSOR<x>:WAVEform:APOSITION

This command sets or queries the horizontal cursor A position of the specified cursor in the specified Waveform View.

---

**NOTE.** *WAVEView<x> is the specified Waveform View and must be WAVEView1. CURSOR<x> is the specified cursor and must be CURSOR1.*

---

**Group** Cursor

**Syntax** DISplay:WAVEView<x>:CURSOR:CURSOR<x>:WAVEform:APOSITION <NR3>  
DISplay:WAVEView<x>:CURSOR:CURSOR<x>:WAVEform:APOSITION?

**Arguments** <NR3> is the horizontal cursor A position of the specified cursor in the specified Waveform View.

**Examples** DISplay:WAVEView1:CURSOR:CURSOR1:WAVEform:APOSITION 1.5e-6 sets the position to 1.5  $\mu$ s.

DISplay:WAVEView1:CURSOR:CURSOR1:WAVEform:APOSITION? might return :DISPLAY:WAVEVIEW1:CURSOR:CURSOR1:WAVEFORM:APOSITION -1.2667480236557E-6 indicating the position is 1.27  $\mu$ s.

## DISplay:WAVEView<x>:CURSOR:CURSOR:WAVEform:AVPOSITION? (Query Only)

This command queries the vertical waveform value at the cursor A position in the specified Waveform View.



---

**NOTE.** *WAVEView<x> is the specified Waveform View and must be WAVEView1. .*

---

<b>Group</b>	Cursor
<b>Syntax</b>	DISplay:WAVEView<x>:CURSor:CURSOR:WAVEform:AVPOSITION?
<b>Arguments</b>	<NR3> is the horizontal cursor A position of the specified cursor in the specified Waveform View.
<b>Examples</b>	DISplay:WAVEView1:CURSor:CURSOR:WAVEform:AVPOSITION? might return :DISplay:WAVEView1:CURSor:CURSOR:WAVEform:AVPOSITION 1.35, indicating that the vertical waveform value at the Cursor A position is 1.35 V.

## DISplay:WAVEView<x>:CURSor:CURSOR<x>:WAVEform:BPOSITION

This command sets or queries the horizontal cursor B position of the specified cursor in the specified Waveform View.

---

**NOTE.** *WAVEView<x> is the specified Waveform View and must be WAVEView1. Cursor<x> is the specified cursor and must be CURSOR1.*

---

<b>Group</b>	Cursor
<b>Syntax</b>	DISplay:WAVEView<x>:CURSor:CURSOR<x>:WAVEform:BPOSITION <NR3> DISplay:WAVEView<x>:CURSor:CURSOR<x>:WAVEform:BPOSITION?
<b>Arguments</b>	<NR3> is the horizontal cursor B position of the specified cursor in the specified Waveform View.
<b>Examples</b>	DISplay:WAVEView1:CURSor:CURSOR1:WAVEform:BPOSITION 8.0e-9 sets the position to 8.0 ns.  DISplay:WAVEView1:CURSor:CURSOR1:WAVEform:BPOSITION? might return :DISPLAY:WAVEVIEW1:CURSOR:CURSOR1:WAVEFORM:BPOSITION 711.6310718892624E-9 indicating the cursor position is 711.6 ns.

## DISplay:WAVEView<x>:CURSor:CURSOR:WAVEform:BVPOSition? (Query Only)

This command queries the vertical waveform value at the cursor B position in the specified Waveform View.

---

**NOTE.** *WAVEView<x> is the specified Waveform View and must be WAVEView1.*

---

<b>Group</b>	Cursor
<b>Syntax</b>	DISplay:WAVEView<x>:CURSor:CURSOR:WAVEform:BVPOSition?
<b>Arguments</b>	<NR3> is the horizontal cursor A position of the specified cursor in the specified Waveform View.
<b>Examples</b>	DISplay:WAVEView1:CURSor:CURSOR:WAVEform:BVPOSition? might return :DISplay:WAVEView1:CURSor:CURSOR:WAVEform:BVPOSition -0.72, indicating that the vertical waveform value at the Cursor B position is -0.72 V.

## DISplay:WAVEView<x>:FILTer

This command sets or queries the type of interpolation filter for the display.

---

**NOTE.** *WAVEView<x> is the specified Waveform View and must be WAVEView1.*

---

<b>Group</b>	Display Control
<b>Syntax</b>	DISplay:WAVEView<x>:FILTer {SINX LINEar} DISplay:WAVEView<x>:FILTer?
<b>Arguments</b>	LINEAR specifies linear interpolation, where acquired points are connected with straight lines.  SINX specifies sin(x)/x interpolation, where acquired points are fit to a curve.
<b>Examples</b>	DISplay:WAVEView1:FILTer SINX specifies sine-curve interpolation, when magnifying waveforms.

DISplay:WAVEview1:FILTer? might return :DISplay:WAVEview1:FILTer LINEAR, indicating that straight-line interpolation is specified for magnifying waveforms.

## DISplay:WAVEView<x>:GRATICule

This command selects or queries the type of graticule that is displayed.

---

**NOTE.** *WAVEView<x> is the specified Waveform View and must be WAVEView1.*

---

<b>Group</b>	Display Control
<b>Syntax</b>	DISplay:WAVEview<x>:GRATICule {GRID TIME FULL NONE} DISplay:WAVEview<x>:GRATICule?
<b>Arguments</b>	GRID specifies a frame and grid only. TIME specifies a time graticule only. FULL specifies a frame, a grid and cross hairs. NONE specified no graticule.
<b>Examples</b>	DISplay:WAVEview1:GRATICule TIME specifies a time graticule. DISplay:WAVEview1:GRATICule? might return :DISPLAY:WAVEVIEW1:GRATICULE GRID indicating the graticule is a grid.

## DISplay:WAVEView<x>:INTENSITY:GRATICule

This command sets or queries the graticule saturation level.

---

**NOTE.** *WAVEView<x> is the specified Waveform View and must be WAVEView1.*

---

<b>Group</b>	Display Control
<b>Syntax</b>	DISplay:WAVEview<x>:INTENSITY:GRATICule <NR2> DISplay:WAVEview<x>:INTENSITY:GRATICule?
<b>Arguments</b>	<NR2> is the graticule saturation level.

**Examples**    `DISPlay:WAVEView1:INTENSITY:GRATICule 75` sets the saturation level to 75%.

`DISPlay:WAVEView1:INTENSITY:GRATICule?` might return `:DISPlay:WAVEVIEW1:INTENSITY:GRATICULE 66.0000` indicating the saturation level is at 66%.

## DISPlay:WAVEView<x>:INTENSITY:WAVEform

This command sets or queries the waveform saturation level.

---

**NOTE.** *WAVEView<x> is the specified Waveform View and must be WAVEView1.*

---

**Group**        Display Control

**Syntax**        `DISPlay:WAVEView<x>:INTENSITY:WAVEform <NR2>`  
`DISPlay:WAVEView<x>:INTENSITY:WAVEform?`

**Arguments**    <NR2> is the waveform saturation level.

**Examples**        `DISPlay:WAVEView1:INTENSITY:WAVEform 75` sets the saturation level to 75%.

`DISPlay:WAVEView1:INTENSITY:WAVEform?` might return `:DISPlay:WAVEVIEW1:INTENSITY:WAVEFORM 62.0000` indicating the saturation level is 62%.

## DISPlay:WAVEView<x>:MATH:MATH<x>:AUTOScale

This command sets or queries whether the specified math gets auto-scaled when the math equation changes within the specified Waveform View.

**Group**        Display Control

**Syntax**        `DISPlay:WAVEView<x>:MATH:MATH<x>:AUTOScale {<NR1>|OFF|ON}`  
`DISPlay:WAVEView<x>:MATH:MATH<x>:AUTOScale?`

**Arguments**    <NR1> = 0 disables the autoscaling the math in the specified Waveform View; any other value turns this feature on.

                  OFF disables the autoscaling the math in the specified Waveform View.

ON enables the autoscaling the math in the specified Waveform View.

**Examples** `DISPlay:WAVEView1:MATH:MATH3:AUTOScale 1` enables the autoscaling the math in the specified Waveform View.

`DISPlay:WAVEView1:MATH:MATH3:AUTOScale?` might return `:DISPlay:WAVEView1:MATH:MATH3:AUTOScale 0` indicating that Math 3 will not auto-scale.

## DISPlay:WAVEView<x>:MATH:MATH<x>:STATE

This command sets or queries the state of the specified math waveform in the specified Waveform View.

---

**NOTE.** *WAVEView<x> is the specified Waveform View and must be WAVEView1.*

---

**Group** Display Control

**Syntax** `DISPlay:WAVEView<x>:MATH:MATH<x>:STATE {<NR1>|OFF|ON}`  
`DISPlay:WAVEView<x>:MATH:MATH<x>:STATE?`

**Arguments** `<NR1> = 0` disables the specified math in the specified Waveform View; any other value turns this feature on.

OFF disables the specified math in the specified Waveform View.

ON enables the specified math in the specified Waveform View.

**Examples** `DISPlay:WAVEView1:MATH:MATH1:STATE OFF` disables the specified math in the specified Waveform View.

`DISPlay:WAVEView1:MATH:MATH2:STATE?` might return `:DISPlay:WAVEView1:MATH:MATH2:STATE 1` indicating the math is displayed.

## DISPlay:WAVEView<x>:MATH:MATH<x>:VERTical:POStion

This command sets or queries the vertical position in divisions of the specified math waveform in the specified Waveform View.

---

**NOTE.** *WAVEView<x> is the specified Waveform View and must be WAVEView1.*

---

<b>Group</b>	Display Control
<b>Syntax</b>	DISplay:WAVEview<x>:MATH:MATH<x>:VERTical:POsition <NR3> DISplay:WAVEview<x>:MATH:MATH<x>:VERTical:POsition?
<b>Arguments</b>	<NR3> is the vertical position in divisions of the specified math waveform.
<b>Examples</b>	DISplay:WAVEview1:MATH:MATH1:VERTical:POsition 0 sets the position to 0 divisions.  DISplay:WAVEview1:MATH:MATH1:VERTical:POsition? might return :DISPLAY:WAVEVIEW1:MATH:MATH1:VERTICAL:POSITION -2.2800 indicating the position is at -2.28 divisions.

## DISplay:WAVEView<x>:MATH:MATH<x>:VERTical:SCALE

Sets or queries the vertical scale of the specified math in volts per division within the specified Waveform View.

---

**NOTE.** *WAVEView<x> is the specified Waveform View and must be WAVEView1.*

---

<b>Group</b>	Display Control
<b>Syntax</b>	DISplay:WAVEview<x>:MATH:MATH<x>:VERTical:SCALE <NR3> DISplay:WAVEview<x>:MATH:MATH<x>:VERTical:SCALE?
<b>Arguments</b>	<NR3> is the vertical scale of the specified math waveform.
<b>Examples</b>	DISplay:WAVEview1:MATH:MATH1:VERTical:SCALE 400e-3 sets the scale to 400 mV per division.  DISplay:WAVEview1:MATH:MATH1:VERTical:SCALE? might return :DISPLAY:WAVEVIEW1:MATH:MATH1:VERTICAL:SCALE 395.0000E-3 indicating the scale is 395 mV.

## DISplay:WAVEView<x>:PLOT:PLOT<x>:AUTOScale

This command sets or queries whether the specified trend gets auto-scaled when the new data is available within the specified Waveform View.

<b>Group</b>	Display Control
<b>Syntax</b>	<code>DISPlay:WAVEView&lt;x&gt;:PLOT:PLOT&lt;x&gt;:AUTOScale {&lt;NR1&gt; OFF ON}</code> <code>DISPlay:WAVEView&lt;x&gt;:PLOT:PLOT&lt;x&gt;:AUTOScale?</code>
<b>Arguments</b>	<p>&lt;NR1&gt; = 0 disables auto-scaling the specified plot in the specified Waveform View; any other value turns this feature on.</p> <p>OFF disables auto-scaling the specified plot in the specified Waveform View.</p> <p>ON enables auto-scaling the specified plot in the specified Waveform View.</p>
<b>Examples</b>	<p><code>DISPlay:WAVEView1:PLOT:PLOT1:AUTOScale 1</code> enables auto-scaling the specified plot in the specified Waveform View.</p> <p><code>DISPlay:WAVEView1:PLOT:PLOT1:AUTOScale?</code> might return <code>:DISPLAY:WAVEVIEW1:PLOT:PLOT1:AUTOSCALE 0</code> indicating that auto-scaling for plot 1 is off.</p>

## DISPlay:WAVEView<x>:PLOT:PLOT<x>:STATE

This command sets or queries the state of the specified time trend plot waveform in the specified Waveform View.

<b>Group</b>	Display Control
<b>Syntax</b>	<code>DISPlay:WAVEView&lt;x&gt;:PLOT:PLOT&lt;x&gt;:STATE {&lt;NR1&gt; OFF ON}</code> <code>DISPlay:WAVEView&lt;x&gt;:PLOT:PLOT&lt;x&gt;:STATE?</code>
<b>Arguments</b>	<p>&lt;NR1&gt; = 0 disables the specified plot in the specified Waveform View; any other value turns this feature on.</p> <p>OFF disables the specified plot in the specified Waveform View.</p> <p>ON enables the specified plot in the specified Waveform View.</p>
<b>Examples</b>	<p><code>DISPlay:WAVEView1:PLOT:PLOT1:STATE OFF</code> disables the specified plot in the specified Waveform View.</p> <p><code>DISPlay:WAVEView1:PLOT:PLOT1:STATE?</code> might return <code>:DISPLAY:WAVEVIEW1:PLOT:PLOT1:STATE 1</code> indicating the specified plot in the specified Waveform View is on.</p>

## DISplay:WAVEView<x>:PLOT:PLOT<x>:VERTical:POSition

This command sets or queries the vertical position of the specified time trend in the specified Waveform View in absolute units.

<b>Group</b>	Display Control
<b>Syntax</b>	DISplay:WAVEView<x>:PLOT:PLOT<x>:VERTical:POSition <NR3> DISplay:WAVEView<x>:PLOT:PLOT<x>:VERTical:POSition?
<b>Arguments</b>	<NR3> is the vertical position.
<b>Examples</b>	DISplay:WAVEView1:PLOT:PLOT1:VERTical:POSition 2.0e0 sets the position to 2.0 units.  DISplay:WAVEView1:PLOT:PLOT1:VERTical:POSition? might return :DISPLAY:WAVEVIEW1:PLOT:PLOT1:VERTICAL:POSITION 1.9918 indicating the position is 1.99 units.

## DISplay:WAVEView<x>:PLOT:PLOT<x>:VERTical:SCALE

This command sets or queries the vertical scale of the specified time trend in units per division in the specified Waveform View.

<b>Group</b>	Display Control
<b>Syntax</b>	DISplay:WAVEView<x>:PLOT:PLOT<x>:VERTical:SCALE <NR3> DISplay:WAVEView<x>:PLOT:PLOT<x>:VERTical:SCALE?
<b>Arguments</b>	<NR3> is the vertical scale.
<b>Examples</b>	DISplay:WAVEView1:PLOT:PLOT1:VERTical:SCALE 725.0e-3 sets the scale to 725 mUnits.  DISplay:WAVEView1:PLOT:PLOT1:VERTical:SCALE? might return :DISPLAY:WAVEVIEW1:PLOT:PLOT1:VERTICAL:SCALE 730.0000E-3 indicating the scale is 730.0 mUnits.



**DISPlay:WAVEView<x>:REF:REF<x>:STATE**

This command sets or queries the state of the specified reference waveform in the specified Waveform View.

---

**NOTE.** *WAVEView<x> is the specified Waveform View and must be WAVEView1.*

---

<b>Group</b>	Display Control
<b>Syntax</b>	DISPlay:WAVEView<x>:REF:REF<x>:STATE {<NR1> OFF ON} DISPlay:WAVEView<x>:REF:REF<x>:STATE?
<b>Arguments</b>	<NR1> = 0 disables the specified reference in the specified Waveform View; any other value turns this feature on.  OFF disables the specified reference in the specified Waveform View.  ON enables the specified reference in the specified Waveform View.
<b>Examples</b>	DISPlay:WAVEView1:REF:REF1:STATE OFF disables the specified reference in the specified Waveform View.  DISPlay:WAVEView1:REF:REF1:STATE? might return :DISPLAY:WAVEVIEW1:REF:REF1:STATE 1 indicating the specified reference in the specified Waveform View is on.

**DISPlay:WAVEView<x>:REF:REF<x>:VERTical:POSition**

This command sets or queries the vertical position in divisions of the specified reference in the specified Waveform View.

---

**NOTE.** *WAVEView<x> is the specified Waveform View and must be WAVEView1.*

---

<b>Group</b>	Display Control
<b>Syntax</b>	DISPlay:WAVEView<x>:REF:REF<x>:VERTical:POSition <NR3> DISPlay:WAVEView<x>:REF:REF<x>:VERTical:POSition?
<b>Arguments</b>	<NR3> is the vertical position in divisions.

**Examples**    `DISplay:WAVEview1:REF:REF1:VERTical:POSition -2.5e0` sets the position to -2.5 divisions.

`DISplay:WAVEview1:REF:REF1:VERTical:POSition?` might return `:DISPLAY:WAVEVIEW1:REF:REF1:VERTICAL:POSITION -2.6400` indicating the position is set to -2.64 divisions.

## **DISplay:WAVEView<x>:REF:REF<x>:VERTical:SCALE**

This command sets or queries the vertical scale of the specified reference in volts per div within the specified Waveform View.

---

**NOTE.** *WAVEView<x> is the specified Waveform View and must be WAVEView1.*

---

**Group**        Display Control

**Syntax**       `DISplay:WAVEview<x>:REF:REF<x>:VERTical:SCALE <NR3>`  
`DISplay:WAVEview<x>:REF:REF<x>:VERTical:SCALE?`

**Arguments**    <NR3> is the vertical scale of the specified reference waveform.

**Examples**       `DISplay:WAVEview1:REF:REF1:VERTical:SCALE 400e-3` sets the scale to 400 mV per division.

`DISplay:WAVEview1:REF:REF1:VERTical:SCALE?` might return `:DISPLAY:WAVEVIEW1:REF:REF1:VERTICAL:SCALE 378.0000E-3` indicating the scale is 378 mV per division.

## **DISplay:WAVEView<x>:RF\_FREQUENCY<x>:VERTical:POSITION**

This command sets or queries the vertical position of the specified Frequency vs. Time trace in the Waveform View, in divisions.

**Conditions**    Requires option SV-RFVT

**Group**        Display

**Syntax**       `DISplay:WAVEview<x>:RF_FREQUENCY<x>:VERTical:POSITION <NR3>`  
`DISplay:WAVEview<x>:RF_FREQUENCY<x>:VERTical:POSITION?`

- Arguments** `WAVEview<x>` is always `WAVEView1`.
- `RF_FREQUENCY<x>` specifies the number of the Frequency vs. Time waveform.
- `NR3` sets the vertical position in divisions. 0.0 divisions is center, 5.0 is the top of the Waveform View, and -5.0 is the top of the Waveform View.
- Examples** `DISplay:WAVEview1:RF_FREQUENCY2:VERTical:POSITION 1.2` sets the vertical position of the Channel 2 Frequency vs. Time trace to 1.2 divisions.
- `DISplay:WAVEview1:RF_FREQUENCY1:VERTical:POSITION?` might return `DISplay:WAVEview1:RF_FREQUENCY1:VERTical:POSITION -4.79`, indicating the Channel 1 Frequency vs. Time vertical position is -4.79 divisions.

## **DISplay:WAVEView<x>:RF\_FREQUENCY<x>:VERTical:SCALE**

This command sets or queries the vertical scale of the specified Frequency vs. Time trace in the Waveform View, in divisions.

- Conditions** Requires option `SV-RFVT`
- Group** Display
- Syntax** `DISplay:WAVEview<x>:RF_FREQUENCY<x>:VERTical:SCALE <NR3>`  
`DISplay:WAVEview<x>:RF_FREQUENCY<x>:VERTical:SCALE?`
- Arguments** `WAVEview<x>` is always `WAVEView1`.
- `RF_FREQUENCY<x>` specifies the number of the Frequency vs. Time waveform.
- `NR3` sets the vertical scale, in Hertz per division.
- Examples** `DISplay:WAVEview1:RF_FREQUENCY3:VERTical:SCALE 5.0e6` sets the vertical scale of the Channel 3 Frequency vs. Time trace to 5.0 MHz per division.
- `DISplay:WAVEview1:RF_FREQUENCY2:VERTical:SCALE?` might return `DISplay:WAVEview1:RF_FREQUENCY2:VERTical:SCALE 2.0E3`, indicating the vertical scale of the Channel 2 Frequency vs. Time trace is 2 KHz per division.

## **DISplay:WAVEView<x>:RF\_MAGNitude<x>:VERTical:POSITION**

This command sets or queries the vertical position of the specified Magnitude vs. Time trace in the Waveform View, in divisions.

<b>Conditions</b>	Requires option SV-RFVT
<b>Group</b>	Display
<b>Syntax</b>	DISplay:WAVEview<x>:RF_MAGnitude<x>:VERTical:POSition <NR3> DISplay:WAVEview<x>:RF_MAGnitude<x>:VERTical:POSition?
<b>Arguments</b>	WAVEview<x> is always WAVEView1.  RF_MAGnitude<x> specifies the number of the Magnitude vs. Time Frequency waveform.  NR3 sets the vertical position in divisions. 0.0 divisions is center, 5.0 is the top of the Waveform View, and -5.0 is the top of the Waveform View.
<b>Examples</b>	DISplay:WAVEview1:RF_MAGnitude2:VERTical:POSition 1.2 sets the vertical position of the Channel 2 Magnitude vs. Time trace to 1.2 divisions.  DISplay:WAVEview1:RF_MAGnitude1:VERTical:POSition? might return DISplay:WAVEview1:RF_MAGnitude1:VERTical:POSition -4.0, indicating the Channel 1 Magnitude vs. Time vertical position is -4.0 divisions.

## DISplay:WAVEView<x>:RF\_MAGnitude<x>:VERTical:SCALE

This command sets or queries the vertical scale of the specified Magnitude vs. Time trace in the specified Waveform View in Volts, Watts, or dB per division.

<b>Conditions</b>	Requires option SV-RFVT
<b>Group</b>	Display
<b>Syntax</b>	DISplay:WAVEview<x>:RF_MAGnitude<x>:VERTical:SCALE <NR3> DISplay:WAVEview<x>:RF_MAGnitude<x>:VERTical:SCALE?
<b>Arguments</b>	WAVEview<x> is always WAVEView1.  RF_MAGnitude<x> specifies the number of the Magnitude vs. Time Frequency waveform.  NR3 sets the vertical scale. The units for the vertical scale depend on the Magnitude Format setting. If the format is "Amplitude (linear)", then the units are Volts/div. If the format is "Power (linear)", then the units are Watts/div. If the format is "Power (log)", then the units are dB/div.

**Examples** `DISPlay:WAVEView1:RF_MAGNitude3:VERTical:SCALE 5.0` sets the vertical scale of the Channel 3 Magnitude vs. Time trace to 5.0 Volts per division.

`DISPlay:WAVEView1:RF_MAGNitude2:VERTical:SCALE?` might return `DISPlay:WAVEView1:RF_MAGNitude2:VERTical:SCALE 20.0E-3`, indicating the vertical scale of the Channel 2 Magnitude vs. Time trace is 20 mV per division.

## **DISPlay:WAVEView<x>:RF\_PHASE<x>:VERTical:POSITION**

This command sets or queries the vertical position of the specified Phase vs. Time trace in the Waveform View, in divisions.

**Conditions** Requires option SV-RFVT

**Group** Display

**Syntax** `DISPlay:WAVEView<x>:RF_PHASE<x>:VERTical:POSITION <NR3>`  
`DISPlay:WAVEView<x>:RF_PHASE<x>:VERTical:POSITION?`

**Arguments** `WAVEView<x>` is always `WAVEView1`.

`RF_PHASE<x>` specifies the number of the Phase vs. Time Frequency waveform.

`NR3` sets the vertical position in divisions. 0.0 divisions is center, 5.0 is the top of the Waveform View, and -5.0 is the top of the Waveform View.

**Examples** `DISPlay:WAVEView1:RF_PHASE2:VERTical:POSITION 2.1` sets the vertical position of the Channel 2 Phase vs. Time trace to 2.1 divisions.

`DISPlay:WAVEView1:RF_PHASE1:VERTical:POSITION?` might return `DISPlay:WAVEView1:RF_PHASE1:VERTical:POSITION -1.7`, indicating the Channel 1 Phase vs. Time vertical position is -1.7 divisions.

## **DISPlay:WAVEView<x>:RF\_PHASE<x>:VERTical:SCALE**

This command sets or queries the vertical scale of the specified Phase vs. Time trace in the specified Waveform View in degrees per division.

**Conditions** Requires option SV-RFVT

**Group** Display

**Syntax**    `DISplay:WAVEview<x>:RF_PHASE<x>:VERTical:SCALE <NR3>`  
`DISplay:WAVEview<x>:RF_PHASE<x>:VERTical:SCALE?`

**Arguments**    `WAVEview<x>` is always `WAVEView1`.

`RF_MAGNitude<x>` specifies the number of the Phase vs. Time Frequency waveform.

`NR3` sets the vertical scale, in degrees per division.

**Examples**    `DISplay:WAVEview1:RF_PHASE3:VERTical:SCALE 10.0` sets the vertical scale of the Channel 3 Phase vs. Time trace to 10 degrees per division.

`DISplay:WAVEview1:RF_PHASE2:VERTical:SCALE?` might return `DISplay:WAVEview1:RF_PHASE2:VERTical:SCALE 50.0`, indicating the vertical scale of the Channel 2 Phase vs. Time trace is set to 50 degrees per division.

## DISplay:WAVEView<x>:STYLE

This command sets or queries how the waveforms are displayed for analysis mode.

---

**NOTE.** *WAVEView<x> is the specified Waveform View and must be WAVEView1.*

---

**Group**    Display Control

**Syntax**    `DISplay:WAVEview<x>:STYLE {VECTors|DOTsonly}`  
`DISplay:WAVEview<x>:STYLE?`

**Arguments**    `DOTs` displays individual data points. New points immediately replace old ones.

`VECTors` connects adjacent data points. New points immediately replace old ones.

**Examples**    `DISplay:WAVEview1:STYLE VECTORS` sets the display to connect adjacent data points.

`DISplay:WAVEview1:STYLE?` might return `:DISplay:WAVEview1:STYLE DOTs`, indicating that data points are not connected.

## DISplay:WAVEView<x>:VIEWStyle

The command sets or queries the waveform layout style used by the display.

---

**NOTE.** *WAVEView<x> is the specified Waveform View and must be WAVEView1.*

---

<b>Group</b>	Display Control
<b>Syntax</b>	DISPlay:WAVEView<x>:VIEWStyle {OVERlay STACKed} DISPlay:WAVEView<x>:VIEWStyle?
<b>Arguments</b>	OVERlay specifies that the display view style used by the specified Waveform View is overlay.  STACKed specifies that the display view style used by the specified Waveform View is stacked.
<b>Examples</b>	DISPlay:WAVEView1:VIEWStyle OVERLAY sets the view style to overlay.  DISPlay:WAVEView1:VIEWStyle? might return :DISPLAY:WAVEVIEW1:VIEWSTYLE STACKED indicating the view style is stacked.

## DISPlay:WAVEView<x>:ZOOM? (Query Only)

This query returns the zoom parameters of the specified Waveform View.

---

**NOTE.** *WAVEView<x> is the specified Waveform View and must be WAVEView1.*

---

<b>Group</b>	Zoom
<b>Syntax</b>	DISPlay:WAVEView<x>:ZOOM?
<b>Returns</b>	Returns the zoom parameters of the specified Waveform View.
<b>Examples</b>	DISPlay:WAVEView1:ZOOM? might return :DISPLAY:WAVEVIEW1:ZOOM:ZOOM1:HORIZONTAL:SCALE 2.5000;POSITION 70.0000;WINSCALE 400.0000E-9;:DISPLAY:WAVEVIEW1:ZOOM:ZOOM 1:VERTICAL:SCALE 3.8000;POSITION 2.5951;:DISPLAY:WAVEVIEW1:ZOOM:ZOOM1:STATE 0.

## DISplay:WAVEView<x>:ZOOM:ZOOM<x>? (Query Only)

This query returns the zoom parameters of the specified zoom in the specified Waveform View. <x> must be 1.

---

**NOTE.** *WAVEView<x>* is the specified Waveform View and must be *WAVEView1*. *ZOOM<x>* is the specified zoom and must be *ZOOM1*.

---

<b>Group</b>	Zoom
<b>Syntax</b>	DISplay:WAVEView<x>:ZOOM:ZOOM<x>?
<b>Returns</b>	Returns the zoom parameters of the specified zoom in the specified Waveform View.
<b>Examples</b>	DISplay:WAVEView1:ZOOM:ZOOM1? might return :DISPLAY:WAVEVIEW1:ZOOM:ZOOM1:HORIZONTAL:SCALE 2.5000;POSITION 70.0000;WINSCALE 400.0000E-9;:DISPLAY:WAVEVIEW1:ZOOM:ZOOM 1:VERTICAL:SCALE 3.8000;POSITION 2.5951;:DISPLAY:WAVEVIEW1:ZOOM:ZOOM1:STATE 0.

## DISplay:WAVEView<x>:ZOOM:ZOOM<x>:HORizontal:POSition

Sets or queries the horizontal zoom position (of the specified zoom in the specified Waveform View) of the zoomed waveform or zoom waveform in the display, around which the zoom waveform displays. It is freely movable around the acquisition settings (horizontal span). An acquired waveform or reference could extend off screen. The valid zoom area does not care about the waveform itself, only the user setting for acquisition.

For example, if horizontal scale is set to 1 second, position to 50, then the acquisition area will go from -5 s to +5 s. Zoom window 0 will focus on -5 s and zoom area 100 will focus on +5 s. If the instrument is stopped and the scale changed to 0.5 s, there will be data off the ends of the display. However, 0% zoom will put the user focus on -2.5 s, the lower bound of the acquisition span.

---

**NOTE.** *WAVEView<x>* is the specified Waveform View and must be *WAVEView1*. *ZOOM<x>* is the specified zoom and must be *ZOOM1*.

---

<b>Group</b>	Zoom
--------------	------



<b>Syntax</b>	DISPlay:WAVEView<x>:ZOOM:ZOOM<x>:HORizontal:POSITION <NR3> DISPlay:WAVEView<x>:ZOOM:ZOOM<x>:HORizontal:POSITION?
<b>Arguments</b>	<NR3> is a value from 0 to 100.00 and is the percent of the waveform that is to the left of screen center, when the zoom factor is 2× or greater.
<b>Examples</b>	DISPLAY:WAVEVIEW1:ZOOM:ZOOM1:HORIZONTAL:POSITION 50 sets the horizontal position of the zoom box of waveview1 to 50 so that it is centered horizontally on the screen.  DISPLAY:WAVEVIEW1:ZOOM:ZOOM1:HORIZONTAL:POSITION? might return :DISPLAY:WAVEVIEW1:ZOOM:ZOOM1:HORIZONTAL:POSITION 10.0000, indicating that the horizontal position of the zoom box of waveview 1 is centered over the first major graticule division.

## DISPlay:WAVEView<x>:ZOOM:ZOOM<x>:HORizontal:SCALE

This command sets or queries the horizontal zoom factor of the specified zoom in the specified Waveform View.

---

**NOTE.** *WAVEView<x> is the specified Waveform View and must be WAVEView1. ZOOM<x> is the specified zoom and must be ZOOM1.*

---

<b>Group</b>	Zoom
<b>Syntax</b>	DISPlay:WAVEView<x>:ZOOM:ZOOM<x>:HORizontal:SCALE <NR3> DISPlay:WAVEView<x>:ZOOM:ZOOM<x>:HORizontal:SCALE?
<b>Arguments</b>	<NR3> is the amount of expansion in the horizontal direction in 1-2-4 increments of the specified zoom in the specified Waveform View.
<b>Examples</b>	DISPlay:WAVEView1:ZOOM:ZOOM1:HORIZONTAL:SCALE 5 sets the horizontal zoom factor of zoom1 in waveview1 to 5x.  DISPlay:WAVEView1:ZOOM:ZOOM1:HORIZONTAL:SCALE? might return :DISPlay:WAVEView1:ZOOM:ZOOM1:HORIZONTAL:SCALE 10, indicating that the zoom factor of waveview1 is set to 10x.

## DISplay:WAVEView<x>:ZOOM:ZOOM<x>:HORizontal:WINSCALE

This command sets or queries the overview window horizontal scale in the specified Waveform View.

---

**NOTE.** *WAVEView<x>* is the specified Waveform View and must be *WAVEView1*. *ZOOM<x>* is the specified zoom and must be *ZOOM1*.

---

<b>Group</b>	Zoom
<b>Syntax</b>	DISplay:WAVEView<x>:ZOOM:ZOOM<x>:HORizontal:WINSCALE <NR3> DISplay:WAVEView<x>:ZOOM:ZOOM<x>:HORizontal:WINSCALE?
<b>Arguments</b>	<NR3> is the horizontal scale of the zoom window.
<b>Examples</b>	DISplay:WAVEView1:ZOOM:ZOOM1HORizontal:WINSCALE? might return :DISPLAY:WAVEVIEW1:ZOOM:ZOOM1:HORIZONTAL:WINSCALE 80.0000E-9 indicating that the horizontal scale of the overview window is 80 ns per division.

## DISplay:WAVEView<x>:ZOOM:ZOOM<x>:STATE

This command sets or queries the zoom display state of the specified zoom in the specified Waveform View. This command is equivalent to pushing the zoom button on the front panel.

---

**NOTE.** *WAVEView<x>* is the specified Waveform View and must be *WAVEView1*. *ZOOM<x>* is the specified zoom and must be *ZOOM1*.

---

<b>Group</b>	Zoom
<b>Syntax</b>	DISplay:WAVEView<x>:ZOOM:ZOOM<x>:STATE {ON OFF <NR1>} DISplay:WAVEView<x>:ZOOM:ZOOM<x>:STATE?
<b>Arguments</b>	ON turns the specified zoom on.  OFF turns specified zoom off.  <NR1> = 0 disables the specified zoom; any other value enables the specified zoom.

**Examples**    `DISPlay:WAVEView1:ZOOM:ZOOM1:STATE ON` turns the specified zoom on.

`DISPlay:WAVEView1:ZOOM:ZOOM1:STATE?` might return  
`:DISPlay:WAVEView1:ZOOM:ZOOM1:STATE 1`, indicating that specified zoom is on.

## `DISPlay:WAVEView<x>:ZOOM:ZOOM<x>:VERTical:POSition`

This command sets or queries the vertical position of the specified zoom in the specified Waveform View. It is freely movable within the confines of the acquired waveform. It is measured from the top to bottom of the acquisition window. The top of the zoom window is  $-5 * \text{vertical zoom factor}$ . The bottom of the zoom window is  $+5 * \text{the vertical zoom factor}$ . For a zoom of 5x, the position ranges from -25 to 25.

---

**NOTE.** *WAVEView<x> is the specified Waveform View and must be WAVEView1. ZOOM<x> is the specified zoom and must be ZOOM1.*

---

**Group**    Zoom

**Syntax**    `DISPlay:WAVEView<x>:ZOOM:ZOOM<x>:VERTical:POSition <NR3>`  
`DISPlay:WAVEView<x>:ZOOM:ZOOM<x>:VERTical:POSition?`

**Arguments**    NR3 is the vertical position of the specified zoom in the specified Waveform View. It is freely movable within the confines of the acquired waveform. The top of the zoom window is  $-5 * \text{vertical zoom factor}$ . The bottom of the zoom window is  $+5 * \text{the vertical zoom factor}$ . For a vertical zoom of 5x, the position ranges from -25 to 25.

**Examples**    `DISPlay:WAVEView1:ZOOM:ZOOM1:VERTical:POSition 50` sets the vertical position of the specified zoom in the specified Waveform View to 50, where the vertical zoom factor is 10x, top of screen is -50 and bottom if +50, and 0 is the vertical center.

`DISPlay:WAVEView1:ZOOM:ZOOM1:VERTical:POSition?` might return  
`:DISPlay:WAVEView1:ZOOM:ZOOM1:VERTical:POSition 23.90000`,  
indicating that the vertical position of the specified zoom in the specified Waveform View is set to 23.9, where the vertical zoom factor is 10x, top of screen is -50 and bottom if +50, and 0 is the vertical center.

## DISplay:WAVEView<x>:ZOOM:ZOOM<x>:VERTical:SCALE

This command sets or queries the vertical zoom factor of the specified zoom in the specified Waveform View.

---

**NOTE.** *WAVEView<x>* is the specified Waveform View and must be *WAVEView1*. *ZOOM<x>* is the specified zoom and must be *ZOOM1*.

---

<b>Group</b>	Zoom
<b>Syntax</b>	DISplay:WAVEView<x>:ZOOM:ZOOM<x>:VERTical:SCALE <NR3> DISplay:WAVEView<x>:ZOOM:ZOOM<x>:VERTical:SCALE?
<b>Arguments</b>	<NR3> is the amount of vertical expansion or compression. Based on the value that you entered, this command uses the nearest scale factor. Setting the vertical scale to 1 indicates unity (no zoom).
<b>Examples</b>	DISplay:WAVEView1:ZOOM:ZOOM2:VERTical:SCALE 5 sets the vertical scale of zoom1 of waveview1 to 5×.  DISplay:WAVEView1:ZOOM:ZOOM2:VERTical:SCALE? might return :DISplay:WAVEView1:ZOOM:ZOOM2:VERTical:SCALE 2.0000, indicating that the vertical scale of zoom1 of waveview1 is 2×.

## DISplay:WAVEView<y>:REF:REF<x>:FRAME

This command sets or returns the selected frame of the specified analog ref. Each ref has a unique selected frame.

<b>Group</b>	Display Control
<b>Syntax</b>	DISplay:WAVEView<y>:REF:REF<x>:FRAME <NR1> DISplay:WAVEView<y>:REF:REF<x>:FRAME?
<b>Arguments</b>	<NR1> is the selected frame of the specified analog ref.
<b>Examples</b>	DISplay:WAVEView1:REF:REF2:FRAME? might return :DISplay:WAVEView1:REF:REF2:FRAME 1, indicating the selected frame is 1.

**DISplay:WAVEView<y>:REF<x>\_DALL:FRAME**

This command sets or returns the selected frame of the specified digital ref. Each ref has a unique selected frame.

<b>Group</b>	Display Control
<b>Syntax</b>	DISplay:WAVEView<y>:REF<x>_DALL:FRAME <NR1> DISplay:WAVEView<y>:REF<x>_DALL:FRAME?
<b>Arguments</b>	<NR1> is the selected frame of the specified digital ref.
<b>Examples</b>	DISplay:WAVEView<y>:REF<x>_DALL:FRAME? might return :DISPLAY:WAVEVIEW1:REF1_DALL:FRAME 1, indicating the selected frame is 1.

**\*ESE**

This command sets and queries the bits in the Event Status Enable Register (ESER). The ESER prevents events from being reported to the Status Byte Register (STB). For a more detailed discussion of the use of these registers, see Registers.

<b>Group</b>	Status and Error
<b>Syntax</b>	*ESE <NR1> *ESE?
<b>Related Commands</b>	*CLS DESE *ESR? EVENT? EVMsg? *SRE *STB?

**Arguments** <NR1> specifies the binary bits of the ESER according to this value, which ranges from 0 through 255.

The power-on default for the ESER is 0 if \*PSC is 1. If \*PSC is 0, the ESER maintains the previous power cycle value through the current power cycle.

---

**NOTE.** *Setting the DESER and the ESER to the same values allows only those codes to be entered into the Event Queue and summarized on the ESB bit (bit 5) of the Status Byte Register. Use the [DESE](#) command to set the DESER.*

---

**Examples** \*ESE 209 sets the ESER to binary 11010001, which enables the PON, URQ, EXE, and OPC bits.

\*ESE? might return 186, showing that the ESER contains [DESE](#) the binary value 10111010.

## \*ESR? (Query Only)

This query-only command returns the contents of the Standard Event Status Register (SESR). \*ESR? also clears the SESR (since reading the SESR clears it). For a more detailed discussion of the use of these registers, see Registers.

**Group** Status and Error

**Syntax** \*ESR?

**Related Commands** [ALLEv?](#)

[\\*CLS](#)

[DESE](#)

[\\*ESE](#)

[EVENT?](#)

[EVMsg?](#)

[\\*SRE](#)

[\\*STB?](#)

**Examples** \*ESR? might return \*ESR 213, showing that the SESR contains the binary value 11010101.

## EVENT? (Query Only)

This query-only command returns an event code from the Event Queue that provides information about the results of the last [\\*ESR?](#) read. `EVENT?` also removes the returned value from the Event Queue.

**Group** Status and Error

**Syntax** `EVENT?`

**Related Commands** [ALLEv?](#)  
[\\*CLS](#)  
[DESE](#)  
[\\*ESE](#)  
[\\*ESR?](#)  
[EVMsg?](#)  
[\\*SRE](#)  
[\\*STB?](#)

**Examples** `EVENT?` might return `:EVENT 110`, showing that there was an error in a command header.

## EVMsg? (Query Only)

This query-only command removes a single event code from the Event Queue that is associated with the results of the last [\\*ESR?](#) read and returns the event code with an explanatory message. For more information, see [Event Handling](#).

**Group** Status and Error

**Syntax** `EVMsg?`

**Related Commands** [ALLEv?](#)  
[\\*CLS](#)  
[DESE](#)  
[\\*ESE](#)

[\\*ESR?](#)

[EVENT?](#)

[\\*SRE](#)

[\\*STB?](#)

**Returns** The event code and message in the following format:

```
<Event Code><Comma><QString>[<Event Code><Comma><QString>...]<QString>::= <Message>;[<Command>]
```

where <Command> is the command that caused the error and may be returned when a command error is detected by the instrument. As much of the command will be returned as possible without exceeding the 60 character limit of the <Message> and <Command> string combined. The command string is right-justified.

**Examples** EVMSG? might return :EVMSG 110,"Command header error".

## EVQty? (Query Only)

This query-only command returns the number of events that are enabled in the queue. This is useful when using the [ALLEv?](#) query, since it lets you know exactly how many events will be returned.

**Group** Status and Error

**Syntax** EVQty?

**Related Commands** [ALLEv?](#)

[EVENT?](#)

[EVMsg?](#)

**Examples** EVQTY? might return :EVQTY 3, indicating the number of event codes in the Event Queue.

## EYEMASK:MASK<x>:COUNT:HITS? (Query Only)

This command returns the total number of hit violations for all segments in the specified mask test.



**Conditions** Requires option 5-DJA or 6-DJA (Advanced Jitter Analysis).

**Group** Mask

**Syntax** EYEMASK:MASK<x>:COUNT:HITS?

**Related Commands** [PLOT:PLOT<x>:MASK?](#)

**Arguments** MASK<x> is the number of the specified mask test in an eye diagram plot.

**Examples** EYEMASK:MASK2:COUNT:HITS? might return 211, indicating that mask 2 has a total of 211 violations for all segments in the mask.

## EYEMASK:MASK<x>:COUNT:SEG<y>:HITS? (Query Only)

This command returns the number of hit violations for the specified segment (area).

**Conditions** Requires option 5-DJA or 6-DJA (Advanced Jitter Analysis).

**Group** Mask

**Syntax** EYEMASK:MASK<x>:COUNT:SEG<y>:HITS?

**Related Commands** [PLOT:PLOT<x>:MASK?](#)

**Arguments** MASK<x> is the number of the specified mask test (or mask test plot?).  
SEG<y> is the number of the mask segment for which to return hit violations data.

**Returns** Returns an integer number representing the number of mask test violations for the specified mask test and mask segment.

**Examples** EYEMASK:MASK1:COUNT:SEG3:HITS? might return 435, indicating that segment 3 of mask test 1 has 435 hit violations.

## EYEMASK:MASK<x>:CREATOR? (Query Only)

This query-only command returns the name of the eye diagram plot that created the mask.

<b>Conditions</b>	Requires option 5-DJA or 6-DJA (Advanced Jitter Analysis).
<b>Group</b>	Mask
<b>Syntax</b>	EYEMASK:MASK<x>:CREATOR?
<b>Related Commands</b>	<a href="#">PLOT:PLOT&lt;x&gt;:MASK?</a>
<b>Arguments</b>	MASK<x> is the number of the specified mask test (or mask test plot?).
<b>Returns</b>	<Qstring> is a quoted string that contains the name of the eye diagram plot associated with the specified mask.
<b>Examples</b>	EYEMASK:MASK4:CREATOR? might return "plot2".

## EYEMASK:MASK<x>:ENABled

This command enables or disables eye mask testing in the specified plot.

<b>Conditions</b>	Requires option 5-DJA or 6-DJA (Advanced Jitter Analysis).
<b>Group</b>	Mask
<b>Syntax</b>	EYEMASK:MASK<x>:ENABled {ON OFF} EYEMASK:MASK<x>:ENABled?
<b>Related Commands</b>	<a href="#">PLOT:PLOT&lt;x&gt;:MASK?</a>
<b>Arguments</b>	MASK<x> is the number of the specified mask test (or mask test plot?).
<b>Returns</b>	Returns an integer number representing enabled (1) or disabled (0).

**Examples** `EYEMASK:MASK4:ENABled ON` enables the eye mask test in the specified mask plot.

`EYEMASK:MASK2:ENABled?` might return 0, indicating that mask testing is disabled in the specified mask plot.

## EYEMASK:MASK<x>:MASKfile

This command sets or queries the current mask definition file name for the specified mask test.

**Conditions** Requires option 5-DJA or 6-DJA (Advanced Jitter Analysis).

**Group** Mask

**Syntax** `EYEMASK:MASK<x>:MASKfile <Qstring>`  
`EYEMASK:MASK<x>:MASKfile?`

**Related Commands** [PLOT:PLOT<x>:MASK?](#)

**Arguments** <x> is the number of the specified mask test (or mask test plot?).

<Qstring> is a quoted string that defines the file path that specifies the location of the mask file to use, in the format '[<path>]<filename.ext>'. Specifying a path is optional. If no path is entered, the instrument will search in the current working directory as set in [FILESystem:CWD](#).

- If the file argument begins with a file path separator (forward slash character) or a drive designator such as C:, then the file name is interpreted as a full path.
- If the file argument begins with "." or ".." or has a file path separator appearing anywhere other than the first character position, then the file name is treated as a path that is relative to the current working directory.

**Examples** `EYEMASK:MASK1:MASKfile "/C:/Applications/Masks/SerialRapidIO/RIO Serial 2_5G.msk"` sets mask1 to use the RIO serial 2.5G mask file at the specified location

`EYEMASK:MASK4:MASKfile?` might return  
`"/media/C:/Applications/Masks/1394b/S400b T1.msk"`

## EYEMASK:MASK<x>:MASKOffset:HORizontal:AUTOfit? (Query Only)

This command returns the mask offset value in the specified mask in seconds. The mask test number is specified by <x>

**Conditions** Requires option 5-DJA or 6-DJA (Advanced Jitter Analysis).

**Group** Mask

**Syntax** EYEMASK:MASK<x>:MASKOffset:HORizontal:AUTOfit?

**Related Commands** [PLOT:PLOT<x>:MASK?](#)

**Examples** EYEMASK:MASK2:MASKOffset:HORizontal:AUTOfit? might return :EYEMASK:MASK2:MASKOffset:HORizontal:AUTOfit 12e-12, indicating that mask autofit moved mask 2 by 12 ps

## EYEMASK:MASK<x>:TEST:SAMple:THReshold

This command sets or queries the total number of hit violations that will cause a mask test failure.

**Conditions** Requires option 5-DJA or 6-DJA (Advanced Jitter Analysis).

**Group** Mask

**Syntax** EYEMASK:MASK<x>:TEST:SAMple:THReshold <NR1>  
EYEMASK:MASK<x>:TEST:SAMple:THReshold?

**Related Commands** [PLOT:PLOT<x>:MASK?](#)

**Arguments** MASK<x> is the number of the specified mask test (or mask test plot?).  
<NR1> is a positive integer indicating the number of mask hits required to cause a fail condition for that mask test.

**Examples** EYEMASK:MASK1:TEST:SAMple:THReshold 15 sets the specified mask test to fail if 15 or more mask violations occur.

EYEMASK:MASK3:TEST:SAMPLE:THRESHOLD? might return 20, indicating that the specified mask test is set to fail if 20 or more mask violations occur.

## EYEMASK:MASK<x>:TEST:STATUS? (Query Only)

This query-only command returns the mask hit test status.

**Conditions** Requires option 5-DJA or 6-DJA (Advanced Jitter Analysis).

**Group** Mask

**Syntax** EYEMASK:MASK<x>:TEST:STATUS?

**Related Commands** [PLOT:PLOT<x>:MASK?](#)

**Arguments** MASK<x> is the number of the specified mask test (or mask test plot?).

**Returns** This command returns a string with the mask test status. Valid status strings are:

- PASS. The number of mask hits is less than the target fail threshold.
- FAIL. The number of mask hits is greater than or equal to the target fail threshold.
- OFF. Mask testing disabled on the specified mask plot.

**Examples** EYEMASK:MASK2:TEST:STATUS? might return Fail, indicating that mask testing has failed in the specified mask plot.

## FACtory (No Query Form)

This command (no query form) resets the instrument to its factory default settings. This command is equivalent to pressing the DEFAULT SETUP button located on the instrument front panel or selecting Default Setup from the File menu.

This command Performs the following in addition to what is done for the \*RST command:

- Clears any pending OPC operations.
- Resets the following IEEE488.2 registers:
  - \*ESE 0 (Event Status Enable Register)
  - \*SRE 0 (Service Request Enable Register)
  - DESE 255 (Device Event Status Enable Register)
  - \*PSC 1 (Power-on Status Clear Flag)
- Deletes all defined aliases.
- Enables command headers (:HEADer 1).

**Group** Save and Recall

**Syntax** FACTory

**Related Commands** [\\*PSC](#)  
[RECALL:SETUp](#)  
[\\*RST](#)

**Arguments** None

**Examples** FACTORY resets the instrument to its factory default settings.

## FILESYS:COLLECTLOGFILES (No Query Form)

This command copies the internal log files to the local, USB, TekDrive or network drive specified by the quoted string argument.

**Group** Save and Recall

**Syntax** FILESYS:COLLECTLOGFILES <QString>

**Arguments** <QString> is a quoted string that specifies the file path to save the .zip file to.

**Examples**    `FILESYS:COLLECTLOGFILES "C:\Test\logfiles.zip"` saves the internal log files to the specified location.

## FILESystem? (Query Only)

This query-only command returns the directory listing of the current working directory. This query is the same as the `FILESystem:DIR?` query.

**Group**    File System

**Syntax**    `FILESystem?`

**Related Commands**    [FILESystem:COpy](#)  
[FILESystem:CWD](#)  
[FILESystem:DELEte](#)  
[FILESystem:DIR?](#)  
[FILESystem:READFile](#)  
[FILESystem:REName](#)  
[FILESystem:WRITEFile](#)

**Arguments**    None.

**Examples**    `FILESYSTEM?` might return `:FILESYSTEM:DIR`  
`"myFile.txt", "myWaveform.wfm"`.

## FILESystem:COpy (No Query Form)

This command (no query form) copies a named file to a new file. The new file might be in a totally separate directory than the old file. You can only copy one file at a time using this command. Wild card characters are not allowed.

**Group**    File System

**Syntax**    `FILESystem:COpy {<source_file_path>, <destination_file_path>}`

**Related Commands**    [FILESystem:CWD](#)

## FILESystem:DELEte

<b>Arguments</b>	<p>&lt;source_file_path&gt; is a quoted string that defines the file name and path or directory. If the file path is within the current working directory, you need only specify the file name.</p> <p>&lt;destination_file_path&gt; is a quoted string that defines the file name and path. If the file path is within the current working directory, you need only specify the file name.</p>
<b>Examples</b>	<pre>FILESYSTEM:COPY "E:/setup1.set", "E:/SETUPS/setup1.set" copies the file named setup1.set, on the E drive to a file named setup1.set in the SETUPS directory on the E drive.</pre> <pre>:FILESystem:CWD "E:/SETUPS"</pre> <pre>:FILESystem:COPy ".", "I:/Archive/SETUPS"</pre> <pre>:FILESystem:COPy "../ch1.isf", "I:/SavedWfms/ch1_new.isf"</pre>

## FILESystem:CWD

This command sets or queries the current working directory. CWD is short for Current Working Directory. It changes the directory (folder) that the other FILESystem commands operate on.

---

**NOTE.** *There are three host ports on the front panel (E:, F:, and G:), and two on the back panel (H: and I:).*

---

<b>Group</b>	File System
<b>Syntax</b>	<pre>FILESystem:CWD {&lt;new_working_directory_path&gt;} FILESystem:CWD?</pre>
<b>Arguments</b>	<p>&lt;new_working_directory_path&gt; is a quoted string that defines the current working; a directory name can be up to 128 characters.</p>
<b>Examples</b>	<pre>FILESYSTEM:CWD "E:/waveforms/" changes the current working directory to a folder named "waveforms" on the USB flash drive installed in the "E:" USB Host port.</pre> <p>FILESYSTEM:CWD? might return :FILESYSTEM:CWD "E:/" Indicates the current working directory is the root folder of the E: USB flash drive port.</p>



## FILESystem:DELEte (No Query Form)

This command (no query form) deletes a named file or directory from a mass storage device. Once removed, the data in that file or directory can no longer be accessed. If the specified file is a directory, it must be empty before it can be deleted.

**Group** File System

**Syntax** FILESystem:DELEte <file\_path>

**Related Commands** [FILESystem:COPy](#)  
[FILESystem:CWD](#)  
[FILESystem:RMDir](#)

**Arguments** <file\_path> is a quoted string that defines the file name and path. If the file path is within the current working directory, you need only specify the file name.

**Examples** FILESYSTEM:DELETE "NOT\_MINE.SET" deletes the file named NOT\_MINE.SET from the folder referred to by the FILESYSTEM:CWD[FILESystem:CWD](#) command.

## FILESystem:DIR? (Query Only)

This query-only command returns a comma separated list of quoted strings. Each string contains the name of a file or directory in the folder referred to by the FILESYSTEM:CWD[FILESystem:CWD](#) command.

**Group** File System

**Syntax** FILESystem:DIR?

**Related Commands** [FILESystem:CWD](#)  
[FILESystem:MKDir](#)

**Arguments** None

**Examples**    `FILESYSTEM:DIR?` might return `:FILESYSTEM:DIR`  
`"161012_132039_000.wfm","161012_132039_001.wfm","161220_191452.png",`  
`"161220_191554.csv","170320_132925_000.wfm","170320_132929_000.set",`  
`"Ch2-Ch3_000.set","E:","F:","G:","H:","I:","J:","Rgjtest_000.set",`  
`"RgjSetupRuntTrig4chnl`  
`s_000.set","RgjSetup_000.set","ScrnShot1jeh2_000.wfm","ScrnShot1jeh_000.wfm",`  
`"ScrnShot_000.png","ScrnShot_000.wfm","Scrn`  
`_000.set","Scrn_001.set","Scrn_002.set","Scrn_003.set","Scrn_004.set",`  
`"Wfm_000.wfm","Wfm_001.wfm","Wfm_002.wfm","Wfm_003`  
`.wfm","Wfm_004.wfm","Wfm_005.wfm","Wfm_006.wfm","digChans_000.wfm".`

## FILESystem:HOMEDir? (Query Only)

This query returns the current user's home directory.

**Group**    File System

**Syntax**    `FILESystem:HOMEDir?`

**Returns**    The current user's home directory as a quoted string.

**Examples**    `FILESYSTEM:HOMEDIR?` might return: `"C:"`.

## FILESystem:LDIR? (Query Only)

Returns a comma separated list of every file, file size, type, modification date and time, and directory in the folder referred to by the `FILESYSTEM:CWD`[FILESystem:CWD](#) command. This is different than the `:DIR` query in that it provides a long output format with the file size, type, and modification date/time. Each entry is a semicolon separated list: `< file name>;<type>;<size in bytes>;<date>;<time>`

**Group**    File System

**Syntax**    `FILESystem:LDIR?`

**Returns**    A comma separated list of every file, file size, type, modification date and time, and directory in the folder referred to by the [FILESystem:CWD](#) command.

**Examples**    `FILESYSTEM:LDIR?` might return "tek0000CH1.isf;FILE;20342;2009-05-21;13:58:24", "TEMP;DIR;4096;2009-09-15;06:20:44".

## FILESystem:MKDir (No Query Form)

This command (no query form) creates a new directory.

**Group**    File System

**Syntax**    `FILESystem:MKDir <directory_path>`

**Related Commands**    [FILESystem:CWD](#)  
[FILESystem:DIR?](#)

**Arguments**    `<directory_path>` is a quoted string that specifies the directory to create.

**Examples**    `FILESYSTEM:MKDIR "E:\NewDirectory"` creates the directory named *NewDirectory* at the root of the E drive.

These two commands create the directory *MyNewSubDirectory* within the existing directory *MyDirectory* at the root of the E drive:

```
FILESYSTEM:CWD "E:/MyDirectory"; FILESYSTEM:MKDIR  
"MyNewSubDirectory"
```

## FILESystem:MOUNT:DRIVE

The command form mounts a network drive specified by the quoted string argument. The quoted string argument is a semicolon separated list of the following fields:

- Drive name - The drive name to be mounted. It is a case insensitive single letter followed by a colon. The drive name must be a letter between 'L:' and 'Z:', inclusive.
- Server identity - The server identity is the DNS name of the server or the IP address of the server.
- Path - The path to be mounted (e.g. /level1/level2/mydirectory).
- User name - The user name for the drive.
- User password - The password for the drive.
- Domain name - The domain/workgroup of the target mount.
- Verbose - The verbose option to capture mount failure messages.

Domain name, user name, user password, and verbose are optional and are only used for mounts requiring SMB/CIFS interworking (MS Windows and MacOS).

The query form returns a 0 or 1 to indicate that the drive name (quoted string) is currently mounted or not. A return of 1 indicates the drive is mounted. A return of 0 indicated the drive is not mounted.

<b>Group</b>	File System
<b>Syntax</b>	FILESystem:MOUNT:DRIVE <QString> FILESystem:MOUNT:DRIVE? <QString>
<b>Examples</b>	FILESystem:MOUNT:DRIVE "L:;000.000.0.0;/level1/level2/mydir" specifies to mount the L: drive using the drive name, server identity, and path.  FILESystem:MOUNT:DRIVE? "L:" might return 0, indicating the L: drive is not mounted.

## FILESystem:MOUNT:TEKDrive

This command mounts the TekDrive specified by the quoted string arguments.

<b>Group</b>	File System
<b>Syntax</b>	FILESystem:MOUNT:TEKDrive <QString> FILESystem:MOUNT:TEKDrive? <QString>

- Arguments** The quoted string must contain the following information:
- Drive name - The TekDrive name to be mounted. It is a case insensitive.
  - AutoDisconnectMode:
    - **Power Cycle** - Select to unmount the TekDrive after power cycling the oscilloscope. There is no time restriction when this option is selected.
    - **Never** - Select to mount the TekDrive connection permanently.
    - **Custom** - Select to disconnect the TekDrive after a chosen duration. The default selection is Power Cycle.
  - RestrictToCurrentIP - Restrict connection to current network IP only. This may be used for additional network security.
  - AutoDisconnectTime - Enter the required time for the Auto Disconnect. The TekDrive gets disconnected automatically from the instrument after the specified time. The duration is in hours. The minimum is 0.25 hours and the maximum is 744 hours.

**Examples** FILESystem:MOUNT:TEKdrive "TekDrive1;Custom>true;8" specifies to mount TekDrive1, auto disconnect it after 8 hours, and restrict the connection to current network IP only.

FILESYSTEM:MOUNT:DRIVE? "TekDrive1" might return 1, indicating TekDrive1 is mounted.

## FILESystem:READFile (No Query Form)

This command writes the contents of the specified file to the current interface. If the specified file does not exist or is not readable, an appropriate error event is posted.

**Group** File System

**Syntax** FILESystem:READFile <QString>

**Related Commands** [FILESystem:CWD](#)

**Arguments** <QString> is a quoted string that defines the file name and path. If the file path is within the current working directory, you need only specify the file name.

**Examples**     `FILESYSTEM:READFILE "E:/test_data/tek00016CH1.csv"` reads the content of the specified file, if the file exists and is readable, and sends the content of the file to the current interface.

## FILESystem:REName (No Query Form)

This command (no query form) assigns a new name to an existing file or folder.

**Group**     File System

**Syntax**     `FILESystem:REName <old_file_path>,<new_file_path>`

**Related Commands**     [FILESystem:CWD](#)

**Arguments**     `<old_file_path>` is a quoted string that defines the file or folder name and path. If the path is within the current working directory, you need only specify the file or folder name.

`<new_file_path>` is a quoted string that defines the file or folder name and path. If the path is within the current working directory, you need only specify the file or folder name.

**Examples**     `FILESYSTEM:RENAME "E:/TEK00000.SET", "E:/MYSETTING.SET"` gives the file named TEK00000.SET the new name of MYSETTING.SET. The file remains in the root directory on the E drive.

`FILESYSTEM:RENAME "e:/mySettings/tek00000.set", "e:/setup1.set"`. This example illustrates how to move a file from one folder to another.

## FILESystem:RMDir (No Query Form)

This command (no query form) deletes a named directory. The directory must be empty.

**Group**     File System

**Syntax**     `FILESystem:RMDir <directory_path>`

**Related Commands**     [FILESystem:CWD](#)

**Arguments** <directory\_path> is a quoted string that defines the folder name and path. If the folder path is within the current working directory, you need only specify the folder name.

**Examples** FILESYSTEM:RMDIR "E:/OldDirectory" removes the directory named OldDirectory from the root of the E drive.

## FILESystem:TEKDrive:CODE? (Query Only)

This command returns short code in string format. This code must be entered (or pasted) at <http://drive.tekcloud.com/activate>. After the code is entered click the **Activate** button to complete the mounting of the TekDrive.

**Group** File System

**Syntax** FILESystem:TEKDrive:CODE?

**Examples** FILESYSTEM:TEKDRIVE:CODE? might return "xYxrr", indicating the code string xYxrr needs to be entered at <http://drive.tekcloud.com/activate> and activated.

## FILESystem:TEKDrive:CODE:EXPIRYTIME? (Query Only)

This command returns expiry time of short code. It is the absolute time that the expiry command returns. For example, if 2:11 pm is the time the user initiated the TekDrive mounting, then the expiry query returns + 5 minutes (2:16 pm).

**Group** File System

**Syntax** FILESystem:TEKDrive:CODE:EXPIRYTIME?

**Examples** FILESYSTEM:TEKDRIVE:CODE:EXPIRYTIME? might return "Wed Nov 11 17:29:44 2020".

## FILESystem:TEKDrive:CODE:STATUS? (Query Only)

This command returns status of short code.

**Group** File System

<b>Syntax</b>	<code>FILESystem:TEKDrive:CODE:STATUS?</code>
<b>Returns</b>	<p>Success indicates the operation was successful.</p> <p>AccessDenied indicates it is unable to process the request as permission was denied.</p> <p>Invalid indicates the operation was invalid.</p> <p>Unknown indicates it is unable to process the request due to an unknown error.</p> <p>Pending indicates it is able to generate the code.</p> <p>NetworkNotFound indicates it is unable to connect to internet.</p> <p>UserCancelled indicates the operation was cancelled by user.</p>
<b>Examples</b>	<code>FILESYSTEM:TEKDRIVE:CODE:STATUS?</code> might return <code>Pending</code> , indicating it is able to generate the code.

## FILESystem:UNMOUNT:DRive (No Query Form)

This command unmounts the USB drive specified by the quoted string argument.

**Group** File System

**Syntax** `FILESystem:UNMOUNT:DRIVE <QString>`

### Related Commands

**Arguments** `<QString>` is a quoted string that specifies which USB drive to unmount. String is a case insensitive single letter followed by a colon.

**Examples** `FILESYSTEM:UNMOUNT:DRIVE "G:"` specifies to unmount the flash drive installed in the right-most USB slot on the front of the instrument.

## FILESystem:UNMOUNT:TEKDrive (No Query Form)

This command unmounts the TekDrive specified by the quoted string argument and the drive name is case insensitive.

**Group** File System



**Syntax** FILESystem:UNMOUNT:TEKDrive <QString>

### Related Commands

**Arguments** <QString> specifies the TekDrive to unmount.

**Examples** FILESystem:UNMOUNT:TEKDrive "TekDrive1" specifies to unmount the TekDrive named "TekDrive1".

## FILESystem:WRITEFile (No Query Form)

This command (no query form) writes the specified block data to the specified file on the instruments file system. If the destination file cannot be written, an error event is posted.

**Group** File System

**Syntax** FILESystem:WRITEFile <file\_path>,<data>

**Related Commands** [FILESystem:CWD](#)

**Arguments** <file path> is a quoted string that defines the file name and path. If the file path is within the current working directory, you need only specify the file name.  
<data> is the specified block data to be written.

## HEADer

This command sets or queries the Response Header Enable State that causes the instrument to either include or omit headers on query responses.

---

**NOTE.** *This command does not affect IEEE Std 488.2-1987 Common Commands (those starting with an asterisk); these commands never return headers.*

---

Whether the long or short form of header keywords and enumerations are returned is dependent upon the state of :VERBose.

**Group** Miscellaneous

**Syntax**     HEADER {<NR1>|OFF|ON}  
              HEADer?

**Related Commands**   **VERBose**

**Arguments**     <NR1> = 0 sets the Response Header Enable State to false; any other value sets this state to true.

                  OFF sets the Response Header Enable State to false. This causes the instrument to omit headers on query responses, so that only the argument is returned.

                  ON sets the Response Header Enable State to true. This causes the instrument to include headers on applicable query responses. You can then use the query response as a command.

**Examples**     HEADER OFF specifies that the instrument omits headers on query responses, so that only the argument is returned.

                  HEADer? might return :HEADer 1, indicating that the instrument is including headers on applicable query responses.

                  With :VERBose ON and :HEADer ON, the :ACQuire:MODE? query might return: :ACQUIRE:MODE SAMPLE.

                  With :VERBose OFF and :HEADer ON, the :ACQuire:MODE? query might return: :ACQ:MOD SAM

                  With :VERBose ON and :HEADer OFF, the :ACQuire:MODE? query might return: SAMPLE

                  With :VERBose OFF and :HEADer OFF, the :ACQuire:MODE? query might return: SAM

## HISTogram:ADDNew (No Query Form)

This command adds the specified waveform histogram.

**Group**         Histogram

**Syntax**        HISTogram:ADDNew <QString>

**Arguments**    <QString> specifies the waveform histogram to add. The argument is of the form "HIST<NR1>", where NR1 is a number value  $\geq 1$ .

**Examples** HISTogram:ADDNew "HIST7" adds waveform histogram 7.

## HISTogram:DELeTe (No Query Form)

This command deletes the specified histogram.

**Group** Histogram

**Syntax** HISTogram:DELeTe <QString>

**Arguments** <QString> specifies the waveform histogram to delete. The argument is of the form "HIST<NR1>", where NR1 is a number value  $\geq 1$ .

**Examples** HISTogram:DELETE "HIST4" deletes histogram 4.

## HISTogram:DELETEALL (No Query Form)

This command deletes all the active instances of histograms defined in the scope application.

**Group** Histogram

**Syntax** HISTogram:DELETEALL

**Examples** HISTogram:DELETEALL deletes all the active instances of histograms.

## HISTogram:HISTogram<x>:BOX

This command sets or queries the top, left, bottom and right positions of the histogram box in source waveform coordinates. The argument is of the form <top>,<left>,<bottom>,<right>.

**Group** Histogram

**Syntax** HISTogram:HISTogram<x>:BOX <NR3>,<NR3>,<NR3>,<NR3>  
HISTogram:HISTogram<x>:BOX?

<b>Arguments</b>	<p>HISTogram&lt;x&gt; specifies the histogram number.</p> <p>&lt;NR3&gt; specifies four position values, separated by commas. The values are the top, left, bottom, and right coordinates in that order.</p>
<b>Examples</b>	<p>HISTogram:HISTogram2:BOX 250.00E-3, -50.0E-9, -250.00E-3, 50.0E-9 sets the box coordinates of histogram 2 to 250 mV on the top, -50 ns on the left, -250 mV on the bottom, and 50 ns on the right.</p> <p>HISTogram:HISTogram2:BOX? might return :HISTogram:HISTogram2:BOX 250.00E-3, -50.0E-9, -250.00E-3, 50.0E-9, indicating the box coordinates are 250 mV on the top, -50 ns on the left, -250 mV on the bottom, and 50 ns on the right.</p>

## HISTogram:HISTogram<x>:BState

This command sets or queries whether the histogram badge is displayed.

<b>Group</b>	Histogram
<b>Syntax</b>	<p>HISTogram:HISTogram&lt;x&gt;:BState {ON OFF} HISTogram:HISTogram&lt;x&gt;:BState?</p>
<b>Arguments</b>	<p>HISTogram&lt;x&gt; specifies the histogram number.</p> <p>ON enables the histogram badge display.</p> <p>OFF disables the histogram badge display.</p>
<b>Examples</b>	<p>HISTogram:HISTogram2:BState ON enables the badge display for histogram 2.</p> <p>HISTogram:HISTogram2:BState? might return :HISTogram:HISTogram2:BState OFF, indicating the badge display for histogram 2 is disabled.</p>

## HISTogram:HISTogram<x>:DATa? (Query Only)

This query only command returns a comma separated list of numbers representing the histogram bin data.

<b>Group</b>	Histogram
--------------	-----------

<b>Syntax</b>	<code>HISTogram:HISTogram&lt;x&gt;:DATA?</code>
<b>Returns</b>	Returns a comma separated list of the histogram bin data. <code>HISTogram&lt;x&gt;</code> specifies the histogram number.
<b>Examples</b>	<code>HISTogram:HISTogram2:DATA?</code> might return <code>:HISTogram2:DATA 332.224000E+3, 337.415000E+3, 337.415000E+3, 337.415000E+3, 166.112000E+3</code> , listing the histogram bin data.

## `HISTogram:HISTogram<x>:DISPlay`

This command sets or queries the histogram scaling display setting.

<b>Group</b>	Histogram
<b>Syntax</b>	<code>HISTogram:HISTogram&lt;x&gt;:DISPlay {LINEAR LOG}</code> <code>HISTogram:HISTogram&lt;x&gt;:DISPlay?</code>
<b>Arguments</b>	<code>HISTogram&lt;x&gt;</code> specifies the histogram number. <code>LINEAR</code> sets the histogram scaling to linear mode. <code>LOG</code> sets the histogram scaling to logarithmic mode.
<b>Examples</b>	<code>HISTogram:HISTogram2:DISPlay LOG</code> sets the scaling display mode for histogram 2 to logarithmic mode. <code>HISTogram:HISTogram2:DISPlay?</code> might return <code>:HISTogram:HISTogram2:DISPlay LINEAR</code> , indicating the display mode for histogram 2 is linear mode.

## `HISTogram:HISTogram<x>:FUNction`

This command sets or queries the histogram mode.

<b>Group</b>	Histogram
<b>Syntax</b>	<code>HISTogram:HISTogram&lt;x&gt;:FUNction {HORIZONTAL VERTICAL}</code> <code>HISTogram:HISTogram&lt;x&gt;:FUNction?</code>

<b>Arguments</b>	<p>HISTogram&lt;x&gt; specifies the histogram number.</p> <p>HORizontal sets the histogram mode to horizontal.</p> <p>VERTical sets the histogram mode to vertical.</p>
<b>Examples</b>	<p>HISTogram:HISTogram2:FUNction VERTical sets the histogram mode for histogram 2 to Vertical.</p> <p>HISTogram:HISTogram2:FUNction? might return :HISTogram:HISTogram2:FUNction HORIZONTAL, indicating the function for histogram 2 is Horizontal.</p>

## HISTogram:HISTogram<x>:MEASurement:COUNT

This command sets or queries whether the waveform count measurement is enabled on the histogram.

<b>Group</b>	Histogram
<b>Syntax</b>	<p>HISTogram:HISTogram&lt;x&gt;:MEASurement:COUNT {ON OFF}</p> <p>HISTogram:HISTogram&lt;x&gt;:MEASurement:COUNT?</p>
<b>Arguments</b>	<p>HISTogram&lt;x&gt; specifies the histogram number.</p> <p>ON enables the waveform count measurement.</p> <p>OFF disables the waveform count measurement.</p>
<b>Examples</b>	<p>HISTogram:HISTogram2:MEASurement:COUNT ON enables the waveform count measurement for histogram 2.</p> <p>HISTogram:HISTogram2:MEASurement:COUNT? might return :HISTogram:HISTogram2:MEASurement:COUNT OFF, indicating the waveform count measurement for histogram 2 is disabled.</p>

## HISTogram:HISTogram<x>:MEASurement:HITS

This command sets or queries whether the Hits in Box measurement is enabled on the histogram.

<b>Group</b>	Histogram
--------------	-----------

<b>Syntax</b>	<code>HISTogram:HISTogram&lt;x&gt;:MEASurement:HITS {ON OFF}</code> <code>HISTogram:HISTogram&lt;x&gt;:MEASurement:HITS?</code>
<b>Arguments</b>	<code>HISTogram&lt;x&gt;</code> specifies the histogram number. ON enables the Hits in Box measurement. OFF disables the Hits in Box measurement.
<b>Examples</b>	<code>HISTogram:HISTogram2:MEASurement:HITS ON</code> enables the Hits in Box measurement for histogram 2. <code>HISTogram:HISTogram2:MEASurement:HITS?</code> might return <code>:HISTogram:HISTogram2:MEASurement:HITS OFF</code> , indicating the Hits in Box measurement for histogram 2 is disabled.

## **HISTogram:HISTogram<x>:MEASurement:MAX**

This command sets or queries whether the Max measurement is enabled on the histogram.

<b>Group</b>	Histogram
<b>Syntax</b>	<code>HISTogram:HISTogram&lt;x&gt;:MEASurement:MAX {ON OFF}</code> <code>HISTogram:HISTogram&lt;x&gt;:MEASurement:MAX?</code>
<b>Arguments</b>	<code>HISTogram&lt;x&gt;</code> specifies the histogram number. ON enables the Max measurement. OFF disables the Max measurement.
<b>Examples</b>	<code>HISTogram:HISTogram2:MEASurement:MAX ON</code> enables the Max measurement for histogram 2. <code>HISTogram:HISTogram2:MEASurement:MAX?</code> might return <code>:HISTogram:HISTogram2:MEASurement:MAX OFF</code> , indicating the Max measurement for histogram 2 is disabled.

## **HISTogram:HISTogram<x>:MEASurement:MEAN**

This command sets or queries whether the Mean measurement is enabled on the histogram.

<b>Group</b>	Histogram
<b>Syntax</b>	<code>HISTogram:HISTogram&lt;x&gt;:MEASurement:MEAN {ON OFF}</code> <code>HISTogram:HISTogram&lt;x&gt;:MEASurement:MEAN?</code>
<b>Arguments</b>	<p><code>HISTogram&lt;x&gt;</code> specifies the histogram number.</p> <p><code>ON</code> enables the Mean measurement.</p> <p><code>OFF</code> disables the Mean measurement.</p>
<b>Examples</b>	<p><code>HISTogram:HISTogram2:MEASurement:MEAN ON</code> enables the Mean measurement for histogram 2.</p> <p><code>HISTogram:HISTogram2:MEASurement:MEAN?</code> might return <code>:HISTogram:HISTogram2:MEASurement:MEAN OFF</code>, indicating the Mean measurement for histogram 2 is disabled.</p>

## **HISTogram:HISTogram<x>:MEASurement:MEDian**

This command sets or queries whether the Median measurement is enabled on the histogram.

<b>Group</b>	Histogram
<b>Syntax</b>	<code>HISTogram:HISTogram&lt;x&gt;:MEASurement:MEDian {ON OFF}</code> <code>HISTogram:HISTogram&lt;x&gt;:MEASurement:MEDian?</code>
<b>Arguments</b>	<p><code>HISTogram&lt;x&gt;</code> specifies the histogram number.</p> <p><code>ON</code> enables the Median measurement.</p> <p><code>OFF</code> disables the Median measurement.</p>
<b>Examples</b>	<p><code>HISTogram:HISTogram2:MEASurement:MEDian ON</code> enables the Median measurement for histogram 2.</p> <p><code>HISTogram:HISTogram2:MEASurement:MEDian?</code> might return <code>:HISTogram:HISTogram2:MEASurement:MEDian OFF</code>, indicating the Median measurement for histogram 2 is disabled.</p>



## HISTogram:HISTogram<x>:MEASurement:MIN

This command sets or queries whether the Min measurement is enabled on the histogram.

<b>Group</b>	Histogram
<b>Syntax</b>	HISTogram:HISTogram<x>:MEASurement:MIN {ON OFF} HISTogram:HISTogram<x>:MEASurement:MIN?
<b>Arguments</b>	HISTogram<x> specifies the histogram number.  ON enables the Min measurement. OFF disables the Min measurement.
<b>Examples</b>	HISTogram:HISTogram2:MEASurement:MIN ON enables the Min measurement for histogram 2.  HISTogram:HISTogram2:MEASurement:MIN? might return :HISTogram:HISTogram2:MEASurement:MIN OFF, indicating the Min measurement for histogram 2 is disabled.

## HISTogram:HISTogram<x>:MEASurement:MODE

This command sets or queries whether the Mode measurement is enabled on the histogram.

<b>Group</b>	Histogram
<b>Syntax</b>	HISTogram:HISTogram<x>:MEASurement:MODE {ON OFF} HISTogram:HISTogram<x>:MEASurement:MODE?
<b>Arguments</b>	HISTogram<x> specifies the histogram number.  ON enables the Mode measurement. OFF disables the Mode measurement.
<b>Examples</b>	HISTogram:HISTogram2:MEASurement:MODE ON enables the Mode measurement for histogram 2.

HISTogram:HISTogram2:MEASurement:MODE? might return  
:HISTogram:HISTogram2:MEASurement:MODE OFF, indicating the Mode  
measurement for histogram 2 is disabled.

## HISTogram:HISTogram<x>:MEASurement:ONESigma

This command sets or queries whether the  $\mu \pm 1\sigma$  measurement is enabled on the histogram.

**Group** Histogram

**Syntax** HISTogram:HISTogram<x>:MEASurement:ONESigma {ON|OFF}  
HISTogram:HISTogram<x>:MEASurement:ONESigma?

**Arguments** HISTogram<x> specifies the histogram number.  
ON enables the  $\mu \pm 1\sigma$  measurement.  
OFF disables the  $\mu \pm 1\sigma$  measurement.

**Examples** HISTogram:HISTogram2:MEASurement:ONESigma ON enables the  $\mu \pm 1\sigma$   
measurement for histogram 2.  
HISTogram:HISTogram2:MEASurement:ONESigma? might return  
:HISTogram:HISTogram2:MEASurement:ONESigma OFF, indicating the  
 $\mu \pm 1\sigma$  measurement for histogram 2 is disabled.

## HISTogram:HISTogram<x>:MEASurement:PHITs

This command sets or queries whether the Peak Hits measurement is enabled  
on the histogram.

**Group** Histogram

**Syntax** HISTogram:HISTogram<x>:MEASurement:PHITs {ON|OFF}  
HISTogram:HISTogram<x>:MEASurement:PHITs?

**Arguments** HISTogram<x> specifies the histogram number.  
ON enables the Peak Hits measurement.  
OFF disables the Peak Hits measurement.

- Examples** HISTogram:HISTogram2:MEASurement:PHITS ON enables the Peak Hits measurement for histogram 2.
- HISTogram:HISTogram2:MEASurement:PHITS? might return :HISTogram:HISTogram2:MEASurement:PHITS OFF, indicating the Peak Hits measurement for histogram 2 is disabled.

## HISTogram:HISTogram<x>:MEASurement:PK2PK

This command sets or queries whether the Peak-to-peak measurement is enabled on the histogram.

- Group** Histogram
- Syntax** HISTogram:HISTogram<x>:MEASurement:PK2PK {ON|OFF}  
HISTogram:HISTogram<x>:MEASurement:PK2PK?
- Arguments** HISTogram<x> specifies the histogram number.  
ON enables the Peak-to-peak measurement.  
OFF disables the Peak-to-peak measurement.
- Examples** HISTogram:HISTogram2:MEASurement:PK2PK ON enables the Peak-to-peak measurement for histogram 2.
- HISTogram:HISTogram2:MEASurement:PK2PK? might return :HISTogram:HISTogram2:MEASurement:PK2PK OFF, indicating the Peak-to-peak measurement for histogram 2 is disabled.

## HISTogram:HISTogram<x>:MEASurement:RESUltS? (Query Only)

This query only command returns the measurement results from the specified histogram. The argument must be in the form of {argument 1},{argument 2},{argument 3}. Argument 1 specifies which histogram measurement to return results for. Argument 2 specifies which acquisitions to return measurement results for. Argument 3 specifies which statistic to return measurement results for.

- Group** Histogram
- Syntax** HISTogram:HISTogram<x>:MEASurement:RESUltS? {COUNT|HITS|MAX|MIN|PK2PK|MODE|MEAN|MEDIan|PHITS|STDev|

ONESigma| TWOSigma| THRSigma},{ALLAcqs| CURRENTAcq|  
 HISTory},{MAXimum| MEAN| MINimum| PK2PK| POPulation| STDDev}

**Arguments** HISTogram<x> specifies the histogram number.

COUNT specifies the Count as the histogram measurement to return results for.

HITS specifies the Hits as the histogram measurement to return results for.

MAX specifies the Max as the histogram measurement to return results for.

MIN specifies the Min as the histogram measurement to return results for.

PK2PK specifies the Peak-to-peak as the histogram measurement or statistic to return results for.

MODE specifies the Mode as the histogram measurement to return results for.

MEAN specifies the Mean as the histogram measurement or statistic to return results for.

MEDian specifies the Median as the histogram measurement to return results for.

PHITS specifies the Peak Hits as the histogram measurement to return results for.

STDDev specifies the Standard Deviation as the histogram measurement or statistic to return results for.

ONESigma specifies the  $\mu \pm 1\sigma$  as the histogram measurement to return results for.

TWOSigma specifies the  $\mu \pm 2\sigma$  as the histogram measurement to return results for.

THRSigma specifies the  $\mu \pm 3\sigma$  as the histogram measurement to return results for.

ALLAcqs specifies the All Acquisitions as the acquisitions to return results for.

CURRENTAcq specifies the Current Acquisitions as the acquisitions to return results for.

HISTory specifies the History as the acquisitions to return results for.

MAXimum specifies the Maximum as the statistic to return results for.

MINimum specifies the Minimum as the statistic to return results for.

POPulation specifies the Population as the statistic to return results for.

**Returns** Returns results in the form of {histogram measurement results},{acquisition results},{statistic results}.

**Examples** HISTogram:HISTogram2:MEASurement:RESUlts?  
 COUNT,ALLAcqs,MEAN might return  
 :HISTogram:HISTogram2:MEASurement:RESUlts COUN,ALLA,MEAN,1.0.

## HISTogram:HISTogram<x>:MEASurement:STDDev

This command sets or queries whether the Standard Deviation measurement is enabled on the histogram.

<b>Group</b>	Histogram
<b>Syntax</b>	HISTogram:HISTogram<x>:MEASurement:STDDev {ON OFF} HISTogram:HISTogram<x>:MEASurement:STDDev?
<b>Arguments</b>	HISTogram<x> specifies the histogram number. ON enables the Standard Deviation measurement. OFF disables the Standard Deviation measurement.
<b>Examples</b>	HISTogram:HISTogram2:MEASurement:STDDev ON enables the Standard Deviation measurement for histogram 2.  HISTogram:HISTogram2:MEASurement:STDDev? might return :HISTogram:HISTogram2:MEASurement:STDDev OFF, indicating the Standard Deviation measurement for histogram 2 is disabled.

## HISTogram:HISTogram<x>:MEASurement:THRSigma

This command sets or queries whether the  $\mu \pm 3\sigma$  measurement is enabled on the histogram.

<b>Group</b>	Histogram
<b>Syntax</b>	HISTogram:HISTogram<x>:MEASurement:THRSigma {ON OFF} HISTogram:HISTogram<x>:MEASurement:THRSigma?
<b>Arguments</b>	HISTogram<x> specifies the histogram number. ON enables the $\mu \pm 3\sigma$ measurement. OFF disables the $\mu \pm 3\sigma$ measurement.
<b>Examples</b>	HISTogram:HISTogram2:MEASurement:THRSigma ON enables the $\mu \pm 3\sigma$ measurement for histogram 2.

HISTogram:HISTogram2:MEASurement:THRSigma? might return  
:HISTogram:HISTogram2:MEASurement:THRSigma OFF, indicating the  
 $\mu\pm 3\sigma$  measurement for histogram 2 is disabled.

## HISTogram:HISTogram<x>:MEASurement:TWOSigma

This command sets or queries whether the  $\mu\pm 2\sigma$  measurement is enabled on the histogram.

**Group** Histogram

**Syntax** HISTogram:HISTogram<x>:MEASurement:TWOSigma {ON|OFF}  
HISTogram:HISTogram<x>:MEASurement:TWOSigma?

**Arguments** HISTogram<x> specifies the histogram number.  
ON enables the  $\mu\pm 2\sigma$  measurement.  
OFF disables the  $\mu\pm 2\sigma$  measurement.

**Examples** HISTogram:HISTogram2:MEASurement:TWOSigma ON enables the  $\mu\pm 2\sigma$   
measurement for histogram 2.  
HISTogram:HISTogram2:MEASurement:TWOSigma? might return  
:HISTogram:HISTogram2:MEASurement:TWOSigma OFF, indicating the  
 $\mu\pm 2\sigma$  measurement for histogram 2 is disabled.

## HISTogram:HISTogram<x>:SAVe (No Query Form)

This command saves the specified histograms data as a comma separated list of values.

**Group** Histogram

**Syntax** HISTogram:HISTogram<x>:SAVe <QString>

**Arguments** HISTogram<x> specifies the histogram number.  
<QString> is the file path to save the .csv file to.

**Examples** HISTogram:HISTogram2:SAVE  
 "C:/Users/Tek\_Local\_Admin/Documents/hist2.csv" saves the histogram 2 data to the specified location.

## HISTogram:HISTogram<x>:SIZE

This command sets or queries the height or width of the specified histogram bins in divisions. This size can be larger than the box, which allows you to view the histogram bins easily.

**Group** Histogram

**Syntax** HISTogram:HISTogram<x>:SIZE <NR3>  
 HISTogram:HISTogram<x>:SIZE?

**Arguments** HISTogram<x> specifies the histogram number.  
 <NR3> specifies the number of divisions to set the height or width of the histogram bins to.

**Examples** HISTogram:HISTogram2:SIZE 2.5 sets the height or width for the bins of histogram 2 to 2.5 divisions.  
 HISTogram:HISTogram2:SIZE? might return  
 :HISTogram:HISTogram2:SIZE 7.0, indicating the height or width for the bins of histogram 2 is 7 divisions.

## HISTogram:HISTogram<x>:SOURCE

This command sets or queries which source waveform will be compared against the histogram box when the histogram testing is enabled.

**Group** Histogram

**Syntax** HISTogram:HISTogram<x>:SOURCE  
 {S<x>\_CH<x> | CH<x> | MATH<x> | REF<x>}  
 HISTogram:HISTogram<x>:SOURCE?

**Arguments** HISTogram<x> specifies the histogram number.  
 S<x>\_CH<x> specifies is the remote scope number and the analog channel as source.

CH<x> specifies an analog channel as source.

MATH<x> specifies a math channel as source.

REF<x> specifies a reference waveform as the source.

**Examples** HISTogram:HISTogram2:SOURCE CH3 sets the histogram source to channel 3.  
HISTogram:HISTogram2:SOURCE? might return  
:HISTogram:HISTogram2:SOURCE CH2, indicating the histogram source is channel 2.

## HISTogram:HISTogram<x>:STATE

This command sets or queries whether histogram calculations are enabled for the specified histogram.

**Group** Histogram

**Syntax** HISTogram:HISTogram<x>:STATE {ON|OFF}  
HISTogram:HISTogram<x>:STATE?

**Arguments** HISTogram<x> specifies the histogram number.  
ON enables the histogram calculations.  
OFF disables the histogram calculations.

**Examples** HISTogram:HISTogram2:STATE ON enables calculations for histogram 2.  
HISTogram:HISTogram2:STATE? might return  
:HISTogram:HISTogram2:STATE OFF, indicating the calculations for histogram 2 are disabled.

## HISTogram:HISTogram<x>:TRANsparency

This command sets or queries the transparency of the histogram bins.

**Group** Histogram

**Syntax** HISTogram:HISTogram<x>:TRANsparency <NR3>  
HISTogram:HISTogram<x>:TRANsparency?



**Arguments** HISTogram<x> specifies the histogram number.  
 <NR3> specifies the transparency as a percentage, with a minimum of 0 and a maximum of 100.

**Examples** HISTogram:HISTogram2:TRANsparency 50 sets the transparency for histogram 2 to 50%.  
 HISTogram:HISTogram2:TRANsparency? might return :HISTogram:HISTogram2:TRANsparency 70, indicating the transparency of histogram 2 is 70%.

## HISTogram:LIST? (Query Only)

This query returns a comma separated list of all currently defined histograms.

**Group** Histogram

**Syntax** HISTogram:LIST?

**Returns** Returns a comma separated list of all currently defined histograms.

**Examples** HISTogram:LIST? might return :HISTogram:LIST HIST1,HIST2,HIST3,HIST4, indicating 4 histograms are defined.

## HORizontal:DELay:MODE

This command sets or queries the horizontal delay mode.

**Group** Horizontal

**Syntax** HORizontal:DELay:MODE {OFF|ON|<NR1>}  
 HORizontal:DELay:MODE?

**Related Commands** [HORizontal:POSition](#)

**Arguments** OFF sets the Horizontal Delay Mode to off. This causes the HORizontal:POSition command to operate like the HORIZONTAL POSITION knob on the front panel.

ON sets the Horizontal Delay Mode to on. This causes the `HORizontal:DElay:TIME` command to operate like the HORIZONTAL POSITION knob on the front panel.

`<NR1> = 0` sets the Horizontal Delay Mode to off; any other value sets this mode to on.

**Examples** `HORIZONTAL:DELAY:MODE OFF` sets the Horizontal Delay Mode to off, allowing the horizontal position command to operate like the HORIZONTAL POSITION knob on the front panel.

`HORIZONTAL:DELAY:MODE?` might return `HORIZONTAL:DELAY:MODE OFF` indicating that the Horizontal Delay Mode is off and that the horizontal position command operates like the HORIZONTAL POSITION knob on the front panel.

## HORizontal:DElay:TIME

This command sets or queries the horizontal delay time that is used when delay mode is on.

**Group** Horizontal

**Syntax** `HORizontal:DElay:TIME <NR3>`  
`HORizontal:DElay:TIME?`

**Related Commands** HORizontal:POSition

**Arguments** NR3 is the delay in seconds.

**Examples** `HORizontal:DElay:TIME 0.3` sets the delay of acquisition data so that the resulting waveform is centered 300 ms after the trigger occurs.

## HORizontal:MODE

This command set or queries the horizontal operating mode.

**Group** Horizontal

**Syntax** `HORizontal:MODE {AUTO|MANuaL}`  
`HORizontal:MODE?`

<b>Arguments</b>	<p>AUTO selects the automatic horizontal model. Auto mode automatically adjusts the sample rate and record length to provide a high acquisition rate in Fast Acq or signal fidelity in analysis. Record length is read only.</p> <p>MANUAL selects the manual horizontal model. Manual mode lets you change the sample rate, horizontal scale, and record length. These values interact. For example, when you change record length then the horizontal scale also changes.</p>
<b>Examples</b>	<p>HORIZONTAL:MODE AUTO sets the horizontal mode to auto.</p> <p>HORIZONTAL:MODE? might return :HORIZONTAL:MODE MANUAL, indicating that the horizontal mode is manual.</p>

## HORizontal:MODE:MANual:CONFIGure

Sets or queries which horizontal control (scale or record length) will primarily change when the sample rate is changed in Manual mode. If the selected control (scale or record length) reaches a limit then the unselected control (record length or scale) may also change.

<b>Group</b>	Horizontal
<b>Syntax</b>	<pre>HORizontal:MODE:MANual:CONFIGure {HORizontal:scale RECORDLength} HORizontal:MODE:MANual:CONFIGure?</pre>
<b>Arguments</b>	<p>HORizontal:scale will change when sample rate is adjusted.</p> <p>RECORDLength will change when sample rate is adjusted.</p>
<b>Examples</b>	<p>HORIZONTAL:MODE:MANUAL:CONFIGURE RECORDLength allows the record length be adjusted when sample rate is changed in Manual mode.</p>

## HORizontal:POSition

This command sets or queries the horizontal position as a percent of screen width. When Horizontal Delay Mode is turned off, this command is equivalent to adjusting the HORIZONTAL POSITION knob on the front panel. When Horizontal Delay Mode is turned on, the horizontal position is forced to 50%.

<b>Group</b>	Horizontal
--------------	------------

**Syntax**    `HORizontal:POSition <NR3>`  
`HORizontal:POSition?`

**Arguments**    `<NR3>` is from 0 to  $\approx 100$  and is the position of the trigger point on the screen (0 = left edge, 100 = right edge).

**Examples**    `HORIZONTAL:POSITION 10` sets the trigger position of the waveform such that 10% of the display is to the left of the trigger position.

`HORIZONTAL:POSITION?` might return `:HORIZONTAL:POSITION 5.0000E+01` indicates the trigger point displayed on the screen.

## **HORizontal:SAMPLERate**

This command sets or queries the horizontal sample rate.

**Group**    Horizontal

**Syntax**    `HORizontal:SAMPLERate <NR3>`  
`HORizontal:SAMPLERate?`

**Arguments**    `<NR3>` is the horizontal sample rate in samples per second.

**Examples**    `HORIZONTAL:SAMPLERATE 1e6` sets the sample rate to 1 million samples per second.

`HORIZONTAL:SAMPLERATE?` might return `:HORIZONTAL:SAMPLERATE 5.0000E+6`, indicating that the sample rate is set to 5 million samples per second.

## **HORizontal:SCALE**

This command sets or queries the horizontal scale.

**Group**    Horizontal

**Syntax**    `HORizontal:SCALE <NR3>`  
`HORizontal:SCALE?`

**Arguments**    `<NR3>` is the horizontal scale in time per division.

**Returns** The current horizontal scale is returned.

**Examples** HORIZONTAL : SCALE 20e-9 sets the horizontal scale to 20 ns/division.  
HORIZONTAL : SCALE? might return HORIZONTAL : SCALE 20e-9 indicating the horizontal scale is set to 20 ns/division.

## ID? (Query Only)

This query-only command returns identifying information about the instrument and related firmware similar to that returned by the \*IDN? IEEE488.2 common query but does not include the instrument serial number.

**Group** Miscellaneous

**Syntax** ID?

**Related Commands** [\\*IDN?](#)

**Examples** ID? might return ID TEK/MSO54,CF:91.1CT,FV:1.2.0.2886, indicating that the instrument model number is set to MSO54, codes and formats is CF:91.1CT, and firmware version is FV:1.2.0.

## \*IDN? (Query Only)

This query-only command returns the instrument identification code.

**Group** Miscellaneous

**Syntax** \*IDN?

**Related Commands** [ID?](#)

**Examples** \*IDN? might return TEKTRONIX,MSO54,C100123,CF:91.1CT FV:1.2.0.2886, indicating the instrument model number, serial number, codes and formats number, and firmware version number.

## LICense:UNINSTALL? (Query Only)

Returns the exit license indicated for the user to return to their TekAMS account. Active licenses can be specified by their nomenclature. TransactionIDs can be used to specify an active license or a previously uninstalled license. In either case, the exit-license is returned as block-data.

**Group** Miscellaneous

**Syntax** LICense:UNINSTALL? <QString>

**Arguments** <QString> is the nomenclature of an active license or a TransactionIDs to specify an active license or a previously uninstalled license.

**Returns** The exit-license is returned as block-data.

**Examples** LIC:UNINSTALL? "LIC5-SRAERO" uninstalls the given license and returns the license block data.

LIC:UNINSTALL? "569765772" uninstalls the license with the given transaction ID and returns the license block data.

## LICense? (Query Only)

This query-only command returns all license parameters.

**Group** Miscellaneous

**Syntax** LICense?

**Examples** LICENSE? might return :LICENSE:GMT  
"2016-05-23T17:05:10-07:00";HID "TMS-AAA9CS4US5SGJN6X";LIST  
"5-BW-1000";COUNT 1.

## LICense:APPID? (Query Only)

This query returns a comma-separated list of the active application IDs. If a string argument is provided, a "0" or "1" is returned, according to whether the string matches an active application ID.

---

<b>Group</b>	Miscellaneous
<b>Syntax</b>	<code>LICense:APPID? {&lt;QString&gt;}</code>
<b>Returns</b>	This query returns a comma-separated list of the active application IDs. If a string argument is provided, a “0” or “1” is returned, according to whether the string matches an active application ID.
<b>Examples</b>	<code>LIC:APPID?</code> might return “BW5-2000, AFG, DVM, DJA”, which is a complete list of the active applications. <code>LIC:APPID? “AFG”</code> would return “1” because the app is active.

### LICense:COUNT? (Query Only)

This query returns a count of the number of active licenses installed.

<b>Group</b>	Miscellaneous
<b>Syntax</b>	<code>LICense:COUNT?</code>
<b>Returns</b>	A count of the number of active licenses installed.
<b>Examples</b>	<code>LICENSE:COUNT?</code> might return <code>:LICENSE:COUNT 2</code> indicating that 2 active licenses are installed

### LICense:ERRor? (Query Only)

This query-only command prompts the instrument to return all events and their messages (delimited by commas), and removes the returned events from the Event Queue. This command is an alias for `ALLEV?`.

<b>Group</b>	Miscellaneous
<b>Syntax</b>	<code>LICense:ERRor?</code>

**Related Commands**    [ALLEv?](#)  
                          [\\*ESR?](#)  
                          [EVMsg?](#)

**Examples**    LICense:ERRor? might return 0, "No events to report- queue empty".

## LICense:GMT? (Query Only)

This query returns the GMT time in ISO 8601 format, the local date, 24 hour time and time-zone offset.

**Group**    Miscellaneous

**Syntax**    LICense:GMT?

**Returns**    The GMT time in ISO 8601 format, the local date, 24 hour time and time-zone offset.

**Examples**    LICENSE:GMT? might return :LICENSE:GMT  
                  "2016-05-23T17:05:10-07:00" indicating the local GMT time.

## LICense:HID? (Query Only)

This query returns the instrument HostID unique identifier.

**Group**    Miscellaneous

**Syntax**    LICense:HID?

**Returns**    The instrument HostID unique identifier.

**Examples**    LICENSE:HID? might return :LICENSE:HID "TMS-9CS4US5SGJN6X"



## LICense:INSTall (No Query Form)

This command accepts a <block\_data> license and installs it on the instrument. Restarting the instrument may be necessary to fully activate the additional capabilities.

**Group** Miscellaneous

**Syntax** LICense:INSTall <block\_data>

**Arguments** <block\_data> is the license in block data format.

**Examples** LICENSE:INSTALL <block\_data>

## LICense:ITEM? (Query Only)

This query returns the details pertaining to a specific license. The NR1 argument is zero-indexed. If no argument is provided, zero is assumed.

**Group** Miscellaneous

**Syntax** LICense:ITEM? <NR1>

**Arguments** <NR1> is the zero-indexed argument specifying a specific license.

**Returns** The details pertaining to a specific license.

**Examples** LICENSE:ITEM? 0 might return  
"5-BW-1000,Fixed,2116-06-15T14:55:54-07:00,11870047,BW5-1000,1 GHz  
bandwidth on 5 series oscilloscopes"

## LICense:LIST? (Query Only)

This query returns the active license nomenclatures as a comma-separated list of strings. Duplicate nomenclatures, that is, the same license but with different expiration dates, are included.

**Group** Miscellaneous

<b>Syntax</b>	<code>LICense:LIST?</code>
<b>Returns</b>	The active license nomenclatures as a comma-separated list of strings.
<b>Examples</b>	<code>LICENSE:LIST?</code> might return <code>:LICENSE:LIST</code> <code>"5-BW-1000", "SUP5-RL125M"</code> .

## **LICense:VALidate? (Query Only)**

This query accepts a license nomenclature as an argument and returns True (1) if that nomenclature is active and any required hardware is installed, or False (0) if either the nomenclature is not active or required hardware is not installed.

<b>Group</b>	Miscellaneous
<b>Syntax</b>	<code>LICense:VALidate? &lt;QString&gt;</code>
<b>Arguments</b>	<code>&lt;QString&gt;</code> is the license nomenclature.
<b>Returns</b>	<code>True</code> (1) if that nomenclature is active and any required hardware is installed. <code>False</code> (0) if either the nomenclature is not active or required hardware is not installed.
<b>Examples</b>	<code>LICENSE:VALIDATE? "AFG"</code> might return <code>:LICENSE:VALIDATE</code> <code>"AFG",0</code> indicating the license is not active.

## **\*LRN? (Query Only)**

This query-only command returns the commands that list the instrument settings, allowing you to record or “learn” the current instrument settings. You can use these commands to return the instrument to the state it was in when you made the \*LRN? query. This command is identical to the [SET?](#) command.

<b>Group</b>	Miscellaneous
<b>Syntax</b>	<code>*LRN?</code>

**Related Commands**    [SET?](#)

**Examples**    \*LRN? might return the following response: \*RST;;PARAMBATCHING  
 0;;HEADER 1;;VERBOSE 1;;ALIAS:STATE 0;;ACQUIRE:STATE  
 1;;ACQUIRE:NUMENV INFINITE;;FASTACQ:STATE 0;;FASTACQ:PALETTE  
 TEMPERATURE;;HORIZONTAL:SAMPLERATE:ANALYZEMODE:MINIMUM:VALUE  
 AUTOMATIC;;SELECT:CH1 1;;SELECT:CH2 0;;SELECT:CH3  
 0;;SELECT:CH4 0;;SELECT:CH5 0;;SELECT:CH6 0;;SELECT:CH7  
 0;;SELECT:CH8 0;;CH1:BANDWIDTH 250.0000E+6;;CH2:BANDWIDTH  
 500.0000E+6;;CH3:BANDWIDTH 500.0000E+6;;CH4:BANDWIDTH  
 500.0000E+6;;CH5:BANDWIDTH 500.0000E+6;;CH6:BANDWIDTH  
 500.0000E+6;;CH7:BANDWIDTH 120.0000E+6;;CH8:BANDWIDTH  
 500.0000E+6;;CH1:BANDWIDTH:ENHANCED  
 0;;CH2:BANDWIDTH:ENHANCED 0;;CH3:BANDWIDTH:ENHANCED  
 0;;CH4:BANDWIDTH:ENHANCED 0;;CH5:BANDWIDTH:ENHANCED  
 0;;CH6:BANDWIDTH:ENHANCED 0;;CH7:BANDWIDTH:ENHANCED  
 0;;CH8:BANDWIDTH:ENHANCED 0;;DATA:DESTINATION  
 REF1;;DATA:ENCDG ASCII;;DATA:SOURCE CH1;;DATA:START  
 1;;DATA:STOP 1000000;;CH1:PROBETYPE  
 ANALOG;;CH2:PROBETYPE ANALOG;;CH3:PROBETYPE  
 ANALOG;;CH4:PROBETYPE ANALOG;;CH5:PROBETYPE  
 DIGITAL;;CH6:PROBETYPE ANALOG;;CH7:PROBETYPE  
 ANALOG;;CH8:PROBETYPE ANALOG;;HORIZONTAL:MODE  
 AUTO;;HORIZONTAL:SAMPLERATE:ANALYZEMODE:MINIMUM:OVERRIDE  
 1;;HORIZONTAL:MODE:AUTOMATIC:FASTACQ:RECORDLENGTH:MAXIMUM:  
 ZOOMOVERRIDE  
 1;;HORIZONTAL:MODE:AUTOMATIC:FASTACQ:RECORDLENGTH:  
 MAXIMUM:VALUE 1250;;HORIZONTAL:MODE:MANUAL:CONFIGURE  
 HORIZONTALSCALE;;HORIZONTAL:SAMPLERATE  
 6.2500E+9;;DISPLAY:WAVEVIEW1:ZOOM:ZOOM1:VERTICAL:SCALE  
 1.0000;;TRIGGER:B:TYPE EDGE;;TRIGGER:A:TYPE  
 EDGE;;ACQUIRE:SEQUENCE:NUMSEQUENCE  
 1;;ACQUIRE:SEQUENCE:MODE NUMACQS;;ACQUIRE:MODE  
 SAMPLE;;ACQUIRE:STOPAFTER RUNSTOP;;ACQUIRE:FASTACQ:PALETTE  
 TEMPERATURE;;ACQUIRE:FASTACQ:STATE 0;;ACQUIRE:NUMAVG 16T.

## MAINWindow:BADGe:BRINGtview (No Query Form)

This command is used to automatically scroll the specified badge to make it visible. The input to the command is the badge title name.

**Group**    Miscellaneous

**Syntax**    MAINwindow:BADGe:BRINGtview <Qstring>

- Arguments** <Qstring> specifies a badge title name to make the badge visible.
- Examples** MAINwindow:BADge:BRINGtoview "Meas 1" makes sure the Meas1 badge is shown in the RRB.

## MAINWindow:FONTSize (No Query Form)

Sets the font size for UI text elements. Font size range is 12 to 20 points.

- Group** Miscellaneous
- Syntax** MAINwindow:FONTSize <NR1>
- Arguments** <NR1> specifies the font size.
- Examples** MAINwindow:FONTSize 18 sets the UI text size to 18 points.

## MAINWindow:RRBDisplaystate (No Query Form)

Sets the display state of the Results readout bar to ON (displayed) or OFF (not displayed).

- Group** Miscellaneous
- Syntax** MAINwindow:RRBdisplaystate {1|ON|0|OFF}
- Arguments** 1 or ON enables Autoset to change vertical settings.  
0 or OFF disables Autoset from changing vertical settings.
- Examples** MAINwindow:RRBdisplaystate 1 expands (displays) the Results readout bar.

## MASK:DELeTe (No Query Form)

This command deletes all mask segments of the specified mask test.

- Conditions** Requires option MTM.

<b>Group</b>	Mask
<b>Syntax</b>	MASK:DELEte "MASK<x>"
<b>Arguments</b>	MASK<x> specifies the mask test. This argument is enclosed in quotes.
<b>Examples</b>	MASK:DELETE "mask2" will delete all mask segments of mask test 2.

## MASK:MASK<x>:COUNT? (Query Only)

This command returns the total number of mask hits in all segments and the number of mask hits in each individual mask segment for the specified mask test.

<b>Conditions</b>	Requires option MTM.
<b>Group</b>	Mask
<b>Syntax</b>	MASK:MASK<x>:COUNT?
<b>Arguments</b>	MASK<x> specifies the mask test.
<b>Returns</b>	<NR1> is the total number of mask hits in all segments and the number of mask hits in each individual mask segment.
<b>Examples</b>	MASK:MASK1:COUNT? might return :MASK:MASK1:COUNT:HITS 211;SEG1:HITS;:MASK:MASK1:COUNT:SEG2:HITS 199;MASK:MASK1:COUNT:SEG3:HITS 12, indicating the number of mask hits on segment 1, 2, and 3 for mask test 1.

## MASK:MASK<x>:COUNT:HITS? (Query Only)

This command returns the total number of mask hits in all mask segments for the specified mask test.

<b>Conditions</b>	Requires option MTM.
<b>Group</b>	Mask

**Syntax** MASK:MASK<x>:COUNT:HITS?

**Arguments** MASK<x> specifies the mask test.

**Returns** <NR1> is the total number of mask hits in all mask segments.

**Examples** MASK:MASK1:COUNT:HITS? might return :MASK:MASK1:COUNT:HITS 211, indicating 211 mask hits for mask test 1.

## MASK:MASK<x>:DEFinedby

This command sets or queries whether the specified mask is defined by segments or tolerances. Segment masks are defined by one or more polygons. Tolerance masks are defined by specified horizontal and vertical tolerances around the mask source.

**Conditions** Requires option MTM.

**Group** Mask

**Syntax** MASK:MASK<x>:DEFinedby {SEGments|TOLerances}  
MASK:MASK<x>:DEFinedby?

**Related Commands** [MASK:MASK<x>:TOLerance:HORizontal](#)  
[MASK:MASK<x>:TOLerance:VERTical](#)  
[MASK:MASK<x>:TOLerance:UPDatenow](#)

**Arguments** MASK<x> specifies the mask number.  
SEGments defines the mask by segments.  
TOLerances defines the mask by horizontal and vertical tolerances around mask source.

**Examples** MASK:MASK1:Definedby SEGments sets mask 1 to be defined by segments.  
MASK:MASK1:Definedby? might return :MASK:MASK1:Definedby TOLerances, indicating mask 1 is defined by the horizontal and vertical tolerances.

## MASK:MASK<x>:DISplay

This command sets or queries the display state of the mask used for the specified mask test.

**Conditions** Requires option MTM.

**Group** Mask

**Syntax** MASK:MASK<x>:DISplay {ON|OFF}  
MASK:MASK<x>:DISplay?

**Arguments** MASK<x> specifies the mask test.  
ON sets the display state of the specified mask to on.  
OFF sets the display state of the specified mask to off.

**Examples** MASK:MASK1:DISPLAY OFF disables the display of the mask used by mask test 1.  
MASK:MASK1:DISPLAY? might return :MASK:MASK1:DISPLAY OFF, indicating the display state for mask test 1 is off.

## MASK:MASK<x>:LIST? (Query Only)

This command queries the list of segments in the mask used by the specified mask test.

**Conditions** Requires option MTM.

**Group** Mask

**Syntax** MASK:MASK<x>:LIST?

**Arguments** MASK<x> specifies the mask test.

**Returns** A comma separated list of segment names.

**Examples** MASK:MASK1:LIST? might return :MASK:MASK1:LIST  
SEG1, SEG2, SEG3, indicating that segment 1, 2, and 3 are used by  
mask test 1.

## MASK:MASK<x>:SEG<x>:COUNT:HITS? (Query Only)

The command returns the total number of mask hits in the specified mask segment of the specified mask test.

**Conditions** Requires option MTM.

**Group** Mask

**Syntax** MASK:MASK<x>:SEG<x>:COUNT:HITS?

**Arguments** MASK<x> specifies the mask test.  
SEG<x> specifies the mask segment.

**Returns** <NR1> is the total number of mask hits in the specified segment.

**Examples** MASK:MASK1:COUNT:SEG2:HITS? might return  
:MASK:MASK1:COUNT:SEG2:HITS 211, indicating 211 mask 1 hits in segment  
2.

## MASK:MASK<x>:SEG<x>:POINTS

This command sets or queries the X/Y coordinates of all points in the designated mask segment. Mask vertices are in time/volts (currently limited to 1024 characters). The set form defines new points in the mask, replacing any existing points.

**Conditions** Requires option MTM.

**Group** Mask

**Syntax** MASK:MASK<x>:SEG<x>:POINTS <NR3>  
MASK:MASK<x>:SEG<x>:POINTS?



<b>Arguments</b>	MASK<x> specifies the mask test. SEG<x> specifies the mask segment. <NR3> specifies the X/Y coordinates of all points in the designated mask segment.
<b>Examples</b>	MASK:MASK1:SEG1:POINTS "-40E-9,-200E-3,0,0,-40E-9,0" sets the X/Y coordinates of all the points in segment 1 of mask test 1.  MASK:MASK1:SEG1:POINTS? might return :MASK:MASK1:SEG1:POINTS "-40E-9,-200E-3,0,0,-40E-9,0", indicating the X/Y coordinates of all the points in segment 1 of mask test 1.

## MASK:MASK<x>:SOURce

This command sets or queries analog source for the specified mask test.

<b>Conditions</b>	Requires option MTM.
<b>Group</b>	Mask
<b>Syntax</b>	MASK:MASK<x>:SOURce {CH<x> REF<x> MATH<x> RFvsTime} MASK:MASK<x>:SOURce?
<b>Arguments</b>	MASK<x> specifies the mask test. CH<x> specifies an analog channel as the source. Math<x> specifies a math waveform as the source. REF<x> specifies a reference waveform as the source. RFvsTime specifies a RF vs Time as the source.
<b>Examples</b>	MASK:MASK1:SOURce CH2 sets the analog source for mask test 1 to Channel 2.  MASK:MASK1:SOURce? might return :MASK:MASK1:SOURce CH2, indicating the analog source for mask test 1 is Channel 2.

## MASK:MASK<x>:TEST:CTHReshold

This command sets or queries the number of consecutive waveform violations needed for the specified mask test to change from PASS to FAIL.

<b>Conditions</b>	Requires option MTM.
<b>Group</b>	Mask
<b>Syntax</b>	MASK:MASK<x>:TEST:CTHreshold <NR1> MASK:MASK<x>:TEST:CTHreshold?
<b>Arguments</b>	MASK<x> specifies the mask test.  <NR1> specifies the threshold value.
<b>Examples</b>	MASK:MASK1:TEST:CTHRESHOLD 5 sets the number of consecutive waveform violations to 5 for mask test 1 to fail.  MASK:MASK1:TEST:CTHRESHOLD? might return :MASK:MASK1:TEST:CTHRESHOLD 5, indicating 5 consecutive waveform violations must occur on mask test 1 for mask test 1 to fail.

## MASK:MASK<x>:TEST:STATE

This command sets or queries the state of the specified mask test.

<b>Conditions</b>	Requires option MTM.
<b>Group</b>	Mask
<b>Syntax</b>	MASK:MASK<x>:TEST:STATE {ON OFF} MASK:MASK<x>:TEST:STATE?
<b>Arguments</b>	MASK<x> specifies the mask test.  ON sets the mask test state to ON. When the state is ON the Pass/Fail status and hit count information are reset and the mask test is started.  OFF sets the mask test state to OFF. When the mask test completes the state is set to OFF.
<b>Examples</b>	MASK:MASK1:TEST:STATE ON sets the state of mask test 1 to ON.  MASK:MASK1:TEST:STATE? might return :MASK:MASK1:TEST:STATE OFF, indicating mask test 1 is OFF.

## MASK:MASK<x>:TEST:STATUS? (Query Only)

This command returns the status of the specified mask test.

<b>Conditions</b>	Requires option MTM.
<b>Group</b>	Mask
<b>Syntax</b>	MASK:MASK<x>:TEST:STATUS?
<b>Arguments</b>	MASK<x> specifies the mask test.
<b>Returns</b>	Return values are PASSING, FAILING, PASSED, or FAILED. When the total hit count equals or exceeds the minimum threshold the status changes from PASSING to FAILING. When the test completes the status changes to PASSED or FAILED. Default value when test state is first set ON or after CLEAR is PASSING.
<b>Examples</b>	MASK:MASK1:TEST:STATUS? might return :MASK:MASK1:TEST:STATUS PASSED, indicating mask test 1 passed.

## MASK:MASK<x>:TEST:THReshold

This command sets or queries the number of waveform violations needed for the specified mask test to change from PASS to FAIL.

<b>Conditions</b>	Requires option MTM.
<b>Group</b>	Mask
<b>Syntax</b>	MASK:MASK<x>:TEST:THReshold <NR1> MASK:MASK<x>:TEST:THReshold?
<b>Arguments</b>	MASK<x> specifies the mask test.  <NR1> specifies the threshold value.
<b>Examples</b>	MASK:MASK1:TEST:THRESHOLD 10 sets the number of waveform violations to 10 for mask test 1 to fail.

`MASK:MASK1:TEST:THRESHOLD?` might return  
`:MASK:MASK1:TEST:THRESHOLD 10`, indicating 10 waveform violations  
on mask test 1.

## **MASK:MASK<x>:TOLerance:HABSolute**

This command sets or queries the mask horizontal tolerance in absolute units of seconds. This value is used when the mask TTYPE is set to ABSolute and the UPDateNow command is sent.

<b>Conditions</b>	Requires option MTM.
<b>Group</b>	Mask
<b>Syntax</b>	<code>MASK:MASK&lt;x&gt;:TOLerance:HABSolute &lt;NR3&gt;</code> <code>MASK:MASK&lt;x&gt;:TOLerance:HABSolute?</code>
<b>Related Commands</b>	<a href="#">MASK:MASK&lt;x&gt;:TOLerance:UPDateNow</a> <a href="#">MASK:MASK&lt;x&gt;:TTYPE</a>
<b>Arguments</b>	<code>MASK&lt;x&gt;</code> specifies the mask number.  <code>&lt;NR3&gt;</code> is the tolerance in units of seconds. The maximum time is the equivalent of one horizontal graticule division.
<b>Examples</b>	<code>MASK:MASK1:TOLerance:HABSolute 1.5e-9</code> sets the horizontal tolerance of Mask1 to 1.5 ns. The mask is not recalculated until an UPDateNow command is sent.  <code>MASK:MASK2:TOLerance:HABSolute?</code> might return <code>:MASK:MASK2:TOLerance:HABSolute 3.75e-7</code> , indicating that the horizontal tolerance of Mask2 is 375 ns.

## **MASK:MASK<x>:TOLerance:HORizontal**

This command sets or queries the mask horizontal tolerance.

<b>Conditions</b>	Requires option MTM.
<b>Group</b>	Mask

**Syntax** MASK:MASK<x>:TOLerance:HORizontal <NR3>  
MASK:MASK<x>:TOLerance:HORizontal?

**Related Commands** [MASK:MASK<x>:TOLerance:UPDatenow](#)

**Arguments** MASK<x> specifies the mask number.  
<NR3> is the tolerance in units of graticule divisions. The maximum is 1 division.

**Examples** MASK:MASK1:TOLerance:HORizontal .200 sets the tolerance of mask 1 to 200 mdiv or 20% of a division. The mask is not recalculated until an UPDatenow command is sent.

MASK:MASK1:TOLerance:HORizontal? might return  
:MASK:MASK1:TOLerance:HORizontal .200, indicating the tolerance of mask 1 is 200 mdiv.

## MASK:MASK<x>:TOLerance:UPDatenow (No Query Form)

This command causes the tolerance mask to be recalculated with the current horizontal and vertical tolerances.

**Conditions** Requires option MTM.

**Group** Mask

**Syntax** MASK:MASK<x>:TOLerance:UPDatenow

**Related Commands** [MASK:MASK<x>:TOLerance:HORizontal](#)  
[MASK:MASK<x>:TOLerance:VERTical](#)

**Arguments** MASK<x> specifies the mask number.

**Examples** MASK:MASK1:TOLerance:UPDatenow recalculates the tolerance of mask 1 with the current horizontal and vertical tolerance settings.

## MASK:MASK<x>:TOLerance:VABSolute

This command sets or queries the mask vertical tolerance in absolute units of the mask source (generally volts). This value is used when the mask TTYPe is set to ABSolute and the UPDateNow command is sent.

<b>Conditions</b>	Requires option MTM.
<b>Group</b>	Mask
<b>Syntax</b>	MASK:MASK<x>:TOLerance:VABSolute <NR3> MASK:MASK<x>:TOLerance:VABSolute?
<b>Related Commands</b>	<a href="#">MASK:MASK&lt;x&gt;:TOLerance:UPDateNow</a> <a href="#">MASK:MASK&lt;x&gt;:TTYPe</a>
<b>Arguments</b>	MASK<x> specifies the mask number.  <NR3> is the tolerance in units of the mask source. Most traces in the waveform window have vertical units of volts, but other units such as amps or degrees are possible. The maximum value is the equivalent of one vertical graticule division.
<b>Examples</b>	MASK:MASK1:TOLerance:VABSolute 1.75 sets the vertical tolerance of Mask1 to 1.75 V. The mask is not recalculated until an UPDateNow command is sent.  MASK:MASK2:TOLerance:VABSolute? might return :MASK:MASK2:TOLerance:VABSolute 2.5e-2, indicating that the vertical tolerance of Mask2 is 25 mV.

## MASK:MASK<x>:TOLerance:VERTical

This command sets or queries the mask vertical tolerance.

<b>Conditions</b>	Requires option MTM.
<b>Group</b>	Mask
<b>Syntax</b>	MASK:MASK<x>:TOLerance:VERTical <NR3> MASK:MASK<x>:TOLerance:VERTical?

<b>Related Commands</b>	<a href="#">MASK:MASK&lt;x&gt;:TOLerance:UPDatenow</a>
<b>Arguments</b>	MASK<x> specifies the mask number. <NR3> is the tolerance in units of graticule divisions. The maximum is 1 division.
<b>Examples</b>	MASK:MASK1:TOLerance:VERTical .100 sets the tolerance of mask 1 to 100 mdiv or 10% of a division. The mask is not recalculated until an UPDatenow command is sent.  MASK:MASK1:TOLerance:VERTical? might return :MASK:MASK1:TOLerance:VERTical .100, indicating the tolerance of mask 1 is 100 mdiv.

## MASK:MASK<x>:TTYPe

This command sets or queries the type of tolerance values used when defining a tolerance mask.

<b>Conditions</b>	Requires option MTM.
<b>Group</b>	Mask
<b>Syntax</b>	MASK:MASK<x>:TTYPe {SCREen ABSolute} MASK:MASK<x>:TTYPe?

<b>Related Commands</b>	<a href="#">MASK:MASK&lt;x&gt;:TOLerance:HORizontal</a> <a href="#">MASK:MASK&lt;x&gt;:TOLerance:VERTical</a> <a href="#">MASK:MASK&lt;x&gt;:TOLerance:HABSolute</a> <a href="#">MASK:MASK&lt;x&gt;:TOLerance:VABSolute</a>
-------------------------	--------------------------------------------------------------------------------------------------------------------------------------------------------------------------------------------------------------------------------------

<b>Arguments</b>	MASK<x> specifies the mask number.  SCREen indicates that the horizontal and vertical mask tolerances are defined in relative units of graticule divisions. There are always 10 horizontal divisions and 10 vertical divisions on the scope waveform display. When the tolerance type is SCREen, the tolerance values set by the HORizontal and VERTical commands are used to define the tolerance mask when an UPDatenow command is sent.  ABSolute indicates that the horizontal and vertical mask tolerances are defined in the absolute units of the mask source waveform. These units are normally seconds and volts respectively. When the tolerance type is ABSolute, the tolerance values
------------------	---------------------------------------------------------------------------------------------------------------------------------------------------------------------------------------------------------------------------------------------------------------------------------------------------------------------------------------------------------------------------------------------------------------------------------------------------------------------------------------------------------------------------------------------------------------------------------------------------------------------------------------------------------------------------------------------------------------

set by the HABSolute and VABSolute commands are used to define the tolerance mask when an UPDateNow command is sent.

- Examples** MASK:MASK1:TTYPE ABSOLUTE specifies that the horizontal and vertical tolerances for Mask1 are specified in absolute s and V units.
- MASK:MASK2:TTYPE? might return :MASK:MASK2:TTYPE SCREen, indicating that the horizontal and vertical tolerances for Mask2 are defined in screen-relative graticule division units

## MASK:TEST:WAVEforms

This command sets or queries the number of waveform acquisitions to test during mask testing. The number of waveforms applies to all mask tests.

- Conditions** Requires option MTM.
- Group** Mask
- Syntax** MASK:TEST:WAVEforms <NR1>  
MASK:TEST:WAVEforms?
- Arguments** MASK<x> specifies the mask test.  
<NR1> specifies the number of waveform acquisitions.
- Examples** MASK:TEST:WAVEFORMS 1k sets the number of waveform acquisitions to test to 1000.
- MASK:TEST:WAVEFORMS? might return :MASK:TEST:WAVEFORMS 1k, indicating the number of waveform acquisitions to test is 1000.

## MATH:ADDNew (No Query Form)

This command adds the specified math.

- Group** Math
- Syntax** MATH:ADDNew <QString>



<b>Related Commands</b>	<a href="#">MATH:LIST?</a> <a href="#">MATH:DELeTe</a>
<b>Arguments</b>	<QString> is the quoted string specifying the math waveform to add. The argument is of the form "MATH<NR1>", where <NR1> is $\geq 1$ .
<b>Examples</b>	MATH:ADDNEW "MATH2" adds MATH2.

## MATH:DELeTe (No Query Form)

This command deletes the specified math.

<b>Group</b>	Math
<b>Syntax</b>	MATH:DELeTe <QString>
<b>Related Commands</b>	<a href="#">MATH:ADDNew</a> <a href="#">MATH:LIST?</a>
<b>Arguments</b>	<QString> is a quoted string specifying the math waveform to delete. The quoted string is of the form "MATH<NR1>", where <NR1> is $\geq 1$ .
<b>Examples</b>	MATH:DELETE "MATH1", which deletes the MATH1 waveform.

## MATH:LIST? (Query Only)

This query returns a comma separated list of all currently defined math waveforms.

<b>Group</b>	Math
<b>Syntax</b>	MATH:LIST?
<b>Related Commands</b>	<a href="#">MATH:ADDNew</a> <a href="#">MATH:DELeTe</a>

**Returns** All currently defined math waveforms.

**Examples** `MATH:LIST?` Might return `:MATH:LIST MATH1,MATH4`, indicating MATH1 and MATH4 are the currently defined math waveforms.

## MATH:MATH<x>:ARINC429A:SUPPortedfields

This command sets or queries the field type for the math for the bus source for ARINC429A bus. The math waveform is specified by x.

**Group** Math

**Syntax** `MATH:MATH<x>:ARINC429A:SUPPortedfields {DATA}`  
`MATH:MATH<x>:ARINC429A:SUPPortedfields?`

**Arguments** `DATA` sets the field type to `DATA`.

**Examples** `MATH:MATH2:ARINC429A:SUPPortedfields DATA` sets the field type to `DATA`.

`MATH:MATH2:ARINC429A:SUPPortedfields?` might return `:MATH:MATH2:ARINC429A:SUPPortedfields DATA`, indicating the field type for MATH2 for the bus source for ARINC429A bus is `DATA`.

## MATH:MATH<x>:AUDIO:SUPPortedfields

This command sets or queries the field type for the math for the bus source for Audio bus. The math waveform is specified by x.

**Group** Math

**Syntax** `MATH:MATH<x>:AUDIO:SUPPortedfields {LChannel|RChannel|TDMChannel}`  
`MATH:MATH<x>:AUDIO:SUPPortedfields?`

**Arguments** `LChannel` sets the field type to `LChannel`.

`RChannel` sets the field type to `RChannel`.

`TDMChannel` sets the field type to `TDMChannel`.

**Examples** `MATH:MATH2:AUDIO:SUPPortedfields LCHannel` sets the field type to LCHannel.

`MATH:MATH2:AUDIO:SUPPortedfields?` might return `:MATH:MATH2:AUDIO:SUPPortedfields LCHannel`, indicating the field type for MATH2 for the bus source for Audio bus is LCHannel.

## MATH:MATH<x>:AUTOETHERnet:SUPPortedfields

This command sets or queries the field type for the math for the bus source for AUTOETHERnet bus. The math waveform is specified by x.

**Group** Math

**Syntax** `MATH:MATH<x>:AUTOETHERnet:SUPPortedfields {DATA|IPData|TDATA}`  
`MATH:MATH<x>:AUTOETHERnet:SUPPortedfields?`

**Arguments** DATA sets the field type to DATA.  
 IPData sets the field type to IPData.  
 TDATA sets the field type to TDATA.

**Examples** `MATH:MATH2:AUTOETHERnet:SUPPortedfields DATA` sets the field type to DATA.

`MATH:MATH2:AUTOETHERnet:SUPPortedfields?` might return `:MATH:MATH2:AUTOETHERnet:SUPPortedfields DATA`, indicating the field type for MATH2 for the bus source for AUTOETHERnet bus is DATA.

## MATH:MATH<x>:AVG:MODE

This command sets or queries the math average mode flag. If the flag is set to 1, math averaging is turned on. The math waveform is specified by x.

**Group** Math

**Syntax** `MATH:MATH<x>:AVG:MODE {<NR1>|OFF|ON}`  
`MATH:MATH<x>:AVG:MODE?`

**Related Commands** [MATH:MATH<x>:AVG:WEIGHT](#)

**Arguments** <NR1> = 0 turns off average mode, and any other integer turns on average mode.  
OFF turns off average mode.  
ON turns on average mode.

**Examples** MATH:MATH2:AVG:MODE ON sets the average mode on.  
MATH:MATH1:AVG:MODE? might return :MATH:MATH1:AVG:MODE 0,  
indicating average mode is off.

## MATH:MATH<x>:AVG:WEIGHT

This command sets or queries the number of acquisitions at which the averaging algorithm will begin exponential averaging. The math waveform is specified by x.

**Group** Math

**Syntax** MATH:MATH<x>:AVG:WEIGHT <NR1>  
MATH:MATH<x>:AVG:WEIGHT?

**Related Commands** [MATH:MATH<x>:AVG:MODE](#)

**Arguments** <NR1> is the number of acquisitions at which the averaging algorithm will begin exponential averaging.

**Examples** MATH:MATH2:AVG:WEIGHT 143 sets the number of acquisitions needed to begin averaging to 20  
MATH:MATH3:AVG:WEIGHT? might return :MATH:MATH3:AVG:WEIGHT 20 indicating the number of acquisitions needed to begin averaging is 8.

## MATH:MATH<x>:CAN:SUPPORTEDFIELDS

This command sets or queries the field type for the math for the bus source for CAN bus. The math waveform is specified by x.

**Group** Math

**Syntax** MATH:MATH<x>:CAN:SUPPORTEDFIELDS {DATA}  
MATH:MATH<x>:CAN:SUPPORTEDFIELDS?

**Arguments** DATA sets the field type to DATA.

**Examples** MATH:MATH2:CAN:SUPPortedfields DATA sets the field type to DATA.  
 MATH:MATH2:CAN:SUPPortedfields? might return  
 :MATH:MATH2:CAN:SUPPortedfields DATA, indicating the field  
 type for MATH2 for the bus source for CAN bus is DATA.

## MATH:MATH<x>:CXPI:SUPPortedfields

This command sets or queries the field type for the math for the bus source for CXPI bus. The math waveform is specified by x.

**Group** Math

**Syntax** MATH:MATH<x>:CXPI:SUPPortedfields {DATA}  
 MATH:MATH<x>:CXPI:SUPPortedfields?

**Arguments** DATA sets the field type to DATA.

**Examples** MATH:MATH2:CXPI:SUPPortedfields DATA sets the field type to DATA.  
 MATH:MATH2:CXPI:SUPPortedfields? might return  
 :MATH:MATH2:CXPI:SUPPortedfields DATA, indicating the field  
 type for MATH2 for the bus source for CXPI bus is DATA.

## MATH:MATH<x>:DEFine

This command allows you to define new waveforms using mathematical expressions. The query form of this command returns the math definition for the specified math waveform. The math waveform is specified by x.

You can specify a math expression from waveforms, measurements and scalar sources, functions, operands, and numerical constants.

Math expressions can be simple, such as Ch1, which specifies that a waveform should show the signal source of Channel 1 with no mathematical computation. Math expressions can also be complex, consisting of 100 plus characters and comprising many sources (including other math waveforms), functions, and operands. As an example, you can enter the expression Log(Ch1+Ch2), which specifies that the signals from channels 1 and 2 are to be algebraically added, and the base 10 log of the sum is to be shown as the final math waveform.

<b>Group</b>	Math
<b>Syntax</b>	MATH:MATH<x>:DEFine <QString> MATH:MATH<x>:DEFine?
<b>Arguments</b>	<QString> quoted string argument is the mathematical expression that defines the waveform. MATH:MATH<x>:DEFINE? is for use when the MATH:MATH<x>:TYPE is ADVANCED.
<b>Examples</b>	MATH:MATH2:DEFine "CH1+CH2" adds the Channel 1 and Channel 2, defines the Math2 waveform to be Channel1 and Channel2 added together.  MATH:MATH1:DEFine? might return  :MATH:MATH1:DEFine "CH2*REF2" as the expression that defines Math 1 waveform.

## MATH:MATH<x>:ESPI:SUPPortedfields

This command sets or queries the field type for the math for the bus source for ESPI bus. The math waveform is specified by x.

<b>Group</b>	Math
<b>Syntax</b>	MATH:MATH<x>:ESPI:SUPPortedfields {DATA CDATA RDATA} MATH:MATH<x>:ESPI:SUPPortedfields?
<b>Arguments</b>	DATA sets the field type to DATA.  CDATA sets the field type to CDATA.  RDATA sets the field type to RDATA.
<b>Examples</b>	MATH:MATH2:ESPI:SUPPortedfields DATA sets the field type to DATA.  MATH:MATH2:ESPI:SUPPortedfields? might return :MATH:MATH2:ESPI:SUPPortedfields DATA, indicating the field type for MATH2 for the bus source for ESPI bus is DATA.

## MATH:MATH<x>:ETHERCAT:SUPPortedfields

This command sets or queries the field type for the math for the bus source for ETHERCAT bus. The math waveform is specified by x.

<b>Group</b>	Math
<b>Syntax</b>	MATH:MATH<x>:ETHERCAT:SUPPortedfields {DATA SDATA NWVariabledata} MATH:MATH<x>:ETHERCAT:SUPPortedfields?
<b>Arguments</b>	DATA sets the field type to DATA. SDATA sets the field type to SDATA. NWVariabledata sets the field type to NWVariabledata.
<b>Examples</b>	MATH:MATH2:ETHERCAT:SUPPortedfields DATA sets the field type to DATA. MATH:MATH2:ETHERCAT:SUPPortedfields? might return :MATH:MATH2:ETHERCAT:SUPPortedfields DATA, indicating the field type for MATH2 for the bus source for ETHERCAT bus is DATA.

## MATH:MATH<x>:ETHERnet:SUPPortedfields

This command sets or queries the field type for the math for the bus source for ETHERnet bus. The math waveform is specified by x.

<b>Group</b>	Math
<b>Syntax</b>	MATH:MATH<x>:ETHERnet:SUPPortedfields {DATA IPData TDATA} MATH:MATH<x>:ETHERnet:SUPPortedfields?
<b>Arguments</b>	DATA sets the field type to DATA. IPData sets the field type to IPData. TDATA sets the field type to TDATA.
<b>Examples</b>	MATH:MATH2:ETHERnet:SUPPortedfields DATA sets the field type to DATA. MATH:MATH2:ETHERnet:SUPPortedfields? might return :MATH:MATH2:ETHERnet:SUPPortedfields DATA, indicating the field type for MATH2 for the bus source for ETHERnet bus is DATA.

## MATH:MATH<x>:EUSB:SUPPortedfields

This command sets or queries the field type for the math for the bus source for EUSB bus. The math waveform is specified by x.

<b>Group</b>	Math
<b>Syntax</b>	MATH:MATH<x>:EUSB:SUPPortedfields {DATA DDATA} MATH:MATH<x>:EUSB:SUPPortedfields?
<b>Arguments</b>	DATA sets the field type to DATA. DATA field can be set when eUSB Bus configuration for Speed is set to High and Signal type is Diff.  DDATA sets the field type to DDATA.
<b>Examples</b>	MATH:MATH2:EUSB:SUPPortedfields DATA sets the field type to DATA.  MATH:MATH2:EUSB:SUPPortedfields? might return :MATH:MATH2:EUSB:SUPPortedfields DATA, indicating the field type for MATH2 for the bus source for EUSB bus is DATA.

## MATH:MATH<x>:FILTer:CFReq

This command sets or queries the filter cutoff frequency. The math waveform is specified by x.

<b>Conditions</b>	Requires UDFLT licenses on 5, 6 series MSO instruments and Tekscope (Offline).
<b>Group</b>	Math
<b>Syntax</b>	MATH:MATH<x>:FILTer:CFReq <NR3> MATH:MATH<x>:FILTer:CFReq?
<b>Arguments</b>	<NR3> sets the filter cutoff frequency.
<b>Examples</b>	MATH:MATH1:FILTer:CFReq 312.5E+9 sets the filter cutoff frequency to 312.5E+9.  MATH:MATH1:FILTer:CFReq? might return :MATH:MATH1:FILTer:CFReq 312.5E+9, indicating the filter cutoff frequency is 312.5E+9.



## MATH:MATH<x>:FILTER:DELay

This command sets or queries the delay for all pass filter. The math waveform is specified by x.

**Conditions** Requires UDFLT licenses on 5, 6 series MSO instruments and Tekscope (Offline).

**Group** Math

**Syntax** MATH:MATH<x>:FILTER:DELay <NR3>  
MATH:MATH<x>:FILTER:DELay?

**Arguments** <NR3> sets the delay for all pass filter.

**Examples** MATH:MATH1:FILTER:DELay 200E-6 sets the delay for all pass filter to 200E-6.  
MATH:MATH1:FILTER:DELay? might return :MATH:MATH1:FILTER:DELay 200E-6, indicating the delay for all pass filter is 200E-6.

## MATH:MATH<x>:FILTER:DESIgn (No Query Form)

This command performs filter specific Apply, Abort, and Generate operations. The math waveform is specified by x.

**Conditions** Requires UDFLT licenses on 5, 6 series MSO instruments and Tekscope (Offline).

**Group** Math

**Syntax** MATH:MATH<x>:FILTER:DESIgn {EXECUTE|ABORT|APPLY}

**Arguments** EXECUTE executes filter file creation.  
APPLY applies the filter definition on the Math waveform.  
ABORT aborts the filter execution.

**Examples** MATH:MATH1:FILTER:DESIgn EXECUTE executes filter file creation.

## MATH:MATH<x>:FILTer:HCFReq

This command sets or queries the high cutoff frequency for bandpass or band stop filter. The math waveform is specified by x.

**Conditions** Requires UDFLT licenses on 5, 6 series MSO instruments and Tekscope (Offline).

**Group** Math

**Syntax** MATH:MATH<x>:FILTer:HCFReq <NR3>  
MATH:MATH<x>:FILTer:HCFReq?

**Arguments** <NR3> sets the high cutoff frequency for bandpass or band stop filter.

**Examples** MATH:MATH1:FILTer:HCFReq 1.25E+9 sets the high cutoff frequency for bandpass or band stop filter to 1.25E+9.

MATH:MATH1:FILTer:HCFReq? might return :MATH:MATH1:FILTer:HCFReq 1.25E+9, indicating the high cutoff frequency for bandpass or band stop filter is 1.25E+9.

## MATH:MATH<x>:FILTer:INFo? (Query Only)

This command returns filter information output when the user creates a filter. The math waveform is specified by x.

**Conditions** Requires UDFLT licenses on 5, 6 series MSO instruments and Tekscope (Offline).

**Group** Math

**Syntax** MATH:MATH<x>:FILTer:INFo?

**Returns** Returns a filter information message.

**Examples** MATH:MATH1:FILTer:INFo? might return :MATH:MATH1:FILTer:INFo "Info:Filter is valid for these sample rates 2.5 kS/s - 12.5 kS/s", indicating the filter information message is "Filter is valid for these sample rates 2.5 kS/s - 12.5 kS/s".

## MATH:MATH<x>:FILTER:LCFReq

This command sets or queries the low cutoff frequency for bandpass or band stop filter. The math waveform is specified by x.

**Conditions** Requires UDFLT licenses on 5, 6 series MSO instruments and Tekscope (Offline).

**Group** Math

**Syntax** MATH:MATH<x>:FILTER:LCFReq <NR3>  
MATH:MATH<x>:FILTER:LCFReq?

**Arguments** <NR3> sets the low cutoff frequency for bandpass or band stop filter.

**Examples** MATH:MATH1:FILTER:LCFReq 500E+6 sets the low cutoff frequency for bandpass or band stop filter to 500E+6.

MATH:MATH1:FILTER:LCFReq? might return :MATH:MATH1:FILTER:LCFReq 500E+6, indicating the low cutoff frequency for bandpass or band stop filter is 500E+6.

## MATH:MATH<x>:FILTER:LOAD (No Query Form)

This command loads the filter file. The math waveform is specified by x.

**Conditions** Requires UDFLT licenses on 5, 6 series MSO instruments and Tekscope (Offline).

**Group** Math

**Syntax** MATH:MATH<x>:FILTER:LOAD <QString>

**Arguments** <QString> sets the path to the filter file to load. Linux default location is C:\. Windows default location is C:\Users\Public\Tektronix\TekScope\Filters.

**Examples** MATH:MATH1:FILTER:LOAD "C:/Users/filterCoeff.flr" loads filter file filterCoeff.flr from the specified location.

## MATH:MATH<x>:FILTer:LOAD:RESPonse

This command will load the filter responses and automatically apply filter option. The math waveform is specified by x.

**Conditions** Requires UDFLT licenses on 5, 6 series MSO instruments and Tekscope (Offline).

**Group** Math

**Syntax** MATH:MATH<x>:FILTer:LOAD:RESPonse {1|0}  
MATH:MATH<x>:FILTer:LOAD:RESPonse?

**Arguments** 1 enables recall of filter response image.  
0 disables recall of filter response image.

**Examples** MATH:MATH1:FILTer:LOAD:RESPonse 1 enables recall of filter response image.  
MATH:MATH1:FILTer:LOAD:RESPonse? might return  
:MATH:MATH1:FILTer:LOAD:RESPonse 1, indicating the recall of filter response image is enabled.

## MATH:MATH<x>:FILTer:ORDER

This command sets or queries the filter order. The math waveform is specified by x.

**Conditions** Requires UDFLT licenses on 5, 6 series MSO instruments and Tekscope (Offline).

**Group** Math

**Syntax** MATH:MATH<x>:FILTer:ORDER <NR1>  
MATH:MATH<x>:FILTer:ORDER?

**Arguments** <NR1> sets the filter order.

**Examples** `MATH:MATH1:FILTER:ORDER 2` sets the filter order to 2.

`MATH:MATH1:FILTER:ORDER?` might return `:MATH:MATH1:FILTER:ORDER 2`, indicating the filter order is 2.

## MATH:MATH<x>:FILTER:PRIPple

This command sets or queries the pass band ripple in the filter response. The math waveform is specified by x.

**Conditions** Requires UDFLT licenses on 5, 6 series MSO instruments and Tekscope (Offline).

**Group** Math

**Syntax** `MATH:MATH<x>:FILTER:PRIPple <NR3>`  
`MATH:MATH<x>:FILTER:PRIPple?`

**Arguments** `<NR3>` sets the pass band ripple in the filter response.

**Examples** `MATH:MATH1:FILTER:PRIPple 5.0000` sets the pass band ripple in the filter response to 5.0000.

`MATH:MATH1:FILTER:PRIPple?` might return `:MATH:MATH1:FILTER:PRIPple 5.0000`, indicating the pass band ripple in the filter response is 5.0000.

## MATH:MATH<x>:FILTER:RESPonse

This command will load the filter responses and automatically apply filter option. The math waveform is specified by x.

**Conditions** Requires UDFLT licenses on 5, 6, 6B series MSO instruments and Tekscope (Offline).

**Group** Math

**Syntax** `MATH:MATH<x>:FILTER:RESPonse {BUTTerworth| CHEBYOne| CHEBYTwo| ELLiptical| GAUSSian| BESSELcUSTOM}`  
`MATH:MATH<x>:FILTER:RESPonse?`

<b>Arguments</b>	<p>BUTTerworth specifies the filter response as BUTTernworth.</p> <p>CHEBYONE specifies the filter response as CHEBYONE.</p> <p>CHEBYTWO specifies the filter response as CHEBYTWO.</p> <p>ELLiptical specifies the filter response as ELLiptical.</p> <p>GAUSSian specifies the filter response as GAUSSian.</p> <p>BESSELCUSTOM specifies the filter response as BesselCUSTOM.</p>
<b>Examples</b>	<p>MATH:MATH1:FILTer:RESPonse ELLiptical sets the filter response to ELLiptical.</p> <p>MATH:MATH1:FILTer:RESPonse? might return :MATH:MATH1:FILTer:RESPonse ELLiptical, indicating the filter response is ELLiptical.</p>

## MATH:MATH<x>:FILTer:ROFactor

This command sets or queries roll off factor for raised cosine or root raised cosine filter. The math waveform is specified by x.

<b>Conditions</b>	Requires UDFLT licenses on 5, 6 series MSO instruments and Tekscope (Offline).
<b>Group</b>	Math
<b>Syntax</b>	<p>MATH:MATH&lt;x&gt;:FILTer:ROFactor &lt;NR3&gt;</p> <p>MATH:MATH&lt;x&gt;:FILTer:ROFactor?</p>
<b>Arguments</b>	<NR1> specifies the Roll-off Factor value for Rasied-Cosine(RC) filter type.
<b>Examples</b>	<p>MATH:MATH1:FILTer:ROFactor 1 sets the Roll-off Factor value as 1.</p> <p>MATH:MATH1:FILTer:ROFactor? might return :MATH:MATH1:FILTer:ROFactor 1, indicating the Roll-off Factor value is 1.</p>

## MATH:MATH<x>:FILTer:SATTenuation

This command sets or queries the stop band attenuation in the filter response. The math waveform is specified by x.

<b>Conditions</b>	Requires UDFLT licenses on 5, 6 series MSO instruments and Tekscope (Offline).
<b>Group</b>	Math
<b>Syntax</b>	MATH:MATH<x>:FILTer:SATTenuation <NR3> MATH:MATH<x>:FILTer:SATTenuation?
<b>Arguments</b>	<NR3> sets the stop band attenuation in the filter response.
<b>Examples</b>	MATH:MATH1:FILTer:SATTenuation 10.0000 sets the stop band attenuation in the filter response to 10.0000.  MATH:MATH1:FILTer:SATTenuation? might return :MATH:MATH1:FILTer:SATTenuation 10.0000, indicating the stop band attenuation in the filter response is 10.0000.

## MATH:MATH<x>:FILTer:SAVe

This command saves the filter file. The math waveform is specified by x.

<b>Conditions</b>	Requires UDFLT licenses on 5, 6 series MSO instruments and Tekscope (Offline).
<b>Group</b>	Math
<b>Syntax</b>	MATH:MATH<x>:FILTer:SAVe <QString>
<b>Arguments</b>	<QString> saves the created filter in .flt format to the specified save location.
<b>Examples</b>	MATH:MATH1:FILTer:SAVe "LowPassButterworth" saves the LowPassButterworth.flt filter to the specified save location.

## MATH:MATH<x>:FILTer:SAVe:RESPonse

This command set the filter response images to be saved while saving the filter file. The math waveform is specified by x.

<b>Conditions</b>	Requires UDFLT licenses on 5, 6 series MSO instruments and Tekscope (Offline).
-------------------	--------------------------------------------------------------------------------

<b>Group</b>	Math
<b>Syntax</b>	MATH:MATH<x>:FILTer:SAVe:RESPOse {1 0} MATH:MATH<x>:FILTer:SAVe:RESPOse?
<b>Arguments</b>	1 enables the save of the filter response image. 0 disables the save of the filter response image. This is the default value.
<b>Examples</b>	MATH:MATH1:FILTer:SAVe:RESPOse 1 enables the save of the filter response image.  MATH:MATH1:FILTer:SAVe:RESPOse? might return :MATH:MATH1:FILTer:SAVe:RESPOse 1, indicating the save of the filter response image is enabled.

## MATH:MATH<x>:FILTer:SDEviation

This command sets or queries the standard deviation in Gaussian filter. The math waveform is specified by x.

<b>Conditions</b>	Requires UDFLT licenses on 5, 6 series MSO instruments and Tekscope (Offline).
<b>Group</b>	Math
<b>Syntax</b>	MATH:MATH<x>:FILTer:SDEviation <NR3> MATH:MATH<x>:FILTer:SDEviation?
<b>Arguments</b>	<NR3> sets the standard deviation in gaussian filter.
<b>Examples</b>	:MATH:MATH1:FILTer:SDEviation 15 sets the standard deviation in gaussian filter to 15.  MATH:MATH1:FILTer:SDEviation? might return :MATH:MATH1:FILTer:SDEviation 15, indicating the standard deviation in gaussian filter is 15.

## MATH:MATH<x>:FILTer:SDURation

This command sets or queries the symbol duration for raised cosine or root raised cosine filter. The math waveform is specified by x.



<b>Conditions</b>	Requires UDFLT licenses on 5, 6 series MSO instruments and Tekscope (Offline).
<b>Group</b>	Math
<b>Syntax</b>	MATH:MATH<x>:FILTer:SDURation <NR3> MATH:MATH<x>:FILTer:SDURation?
<b>Arguments</b>	<NR3> specifies the number of symbol duration for Root-Raised-Cosine (RRC) filter type.
<b>Examples</b>	:MATH:MATH1:FILTer:SDURation 10.0000E-9 sets the number of symbol duration for Root-Raised-Cosine (RRC) filter type to 10.0000E-9.  MATH:MATH1:FILTer:SDURation? might return ::MATH:MATH1:FILTer:SDURation 10.0000E-9, indicating the number of symbol duration for Root-Raised-Cosine (RRC) filter type is 10.0000E-9. .

## MATH:MATH<x>:FILTer:SOURce

This command sets or queries the math waveform filter source. The math waveform and source are specified by x.

<b>Conditions</b>	Requires UDFLT licenses on 5, 6 series MSO instruments and Tekscope (Offline).
<b>Group</b>	Math
<b>Syntax</b>	MATH:MATH<x>:FILTer:SOURce {S<x>_Ch<x> CH<x> MATH<x> REF<x>} MATH:MATH<x>:FILTer:SOURce?
<b>Arguments</b>	S<x>_Ch<x> specifies the remote scope number and the analog channel as the source.  CH<x> specifies an analog channel as the source.  Math<x> specifies a math waveform as the source.  REF<x> specifies a reference waveform as the source.
<b>Examples</b>	MATH:MATH2:FILTer:SOURce CH1 sets the filter source of Math 2 to Channel 1.  MATH:MATH3:FILTer:SOURce? might return :MATH:MATH3:FILTer:SOURce REF3 indicating the filter source of Math 3 is Ref 3.

## MATH:MATH<x>:FILTer:SYMBols

This command sets or queries the symbol for raised cosine or root raised cosine filter. The math waveform is specified by x.

<b>Conditions</b>	Requires UDFLT licenses on 5, 6 series MSO instruments and Tekscope (Offline).
<b>Group</b>	Math
<b>Syntax</b>	MATH:MATH<x>:FILTer:SYMBols <NR1> MATH:MATH<x>:FILTer:SYMBols?
<b>Arguments</b>	<NR1> specifies the number of symbols for Raised-Cosine (RC) filter type.
<b>Examples</b>	MATH:MATH1:FILTer:SYMBols 2 sets the number of symbols for Raised-Cosine (RC) filter type to 2.  MATH:MATH1:FILTer:SYMBols? might return :MATH:MATH1:FILTer:SYMBols 2, indicating the number of symbols for Raised-Cosine (RC) filter type is 2.

## MATH:MATH<x>:FILTer:TWIDth

This command sets or queries the filter Transition Width for Custom filter response. The math waveform is specified by x.

<b>Conditions</b>	Requires UDFLT licenses on 5, 6 series MSO instruments and Tekscope (Offline).
<b>Group</b>	Math
<b>Syntax</b>	MATH:MATH<x>:FILTer:TWIDth <NR3> MATH:MATH<x>:FILTer:TWIDth?
<b>Arguments</b>	<NR3> specifies the Transition Width for Custom filter response.
<b>Examples</b>	MATH:MATH1:FILTer:TWIDth 1 sets the Transition Width for Custom filter response to 2.  MATH:MATH1:FILTer:TWIDth? might return :MATH:MATH1:FILTer:TWIDth 2, indicating the Transition Width for Custom filter response is 1.

## MATH:MATH<x>:FILTER:TYPE

This command specifies or queries the filter type. The math waveform is specified by *x*.

<b>Conditions</b>	Requires UDFLT licenses on 5, 6, 6B series MSO instruments and Tekscope (Offline).
<b>Group</b>	Math
<b>Syntax</b>	MATH:MATH<x>:FILTER:TYPE {LPASS  HPASS  BPASS  BSTop  APASS  HILbert  DIFFerentiator  RC  RCC} MATH:MATH<x>:FILTER:TYPE?
<b>Arguments</b>	<p>LPASS specifies the filter type as LPASSs.</p> <p>HPASS specifies the filter type as HPASSs.</p> <p>BPASS specifies the filter type as BPASSs.</p> <p>BSTop specifies the filter type as BSTop.</p> <p>APASS specifies the filter type as APASSs.</p> <p>HILbert specifies the filter type as HILbert.</p> <p>DIFFerentiator specifies the filter type as DIFFerentiator.</p> <p>RC specifies the filter type as RC.</p> <p>RCC specifies the filter type as RCC.</p>
<b>Examples</b>	<p>MATH:MATH1:FILTER:TYPE LPASS sets the filter type to LPASSs.</p> <p>MATH:MATH1:FILTER:TYPE? might return :MATH:MATH1:FILTER:TYPE LPASS, indicating the filter type is LPASSs.</p>

## MATH:MATH<x>:FLEXray:SUPPortedfields

This command sets or queries the field type for the math for the bus source for FLEXray bus. The math waveform is specified by *x*.

<b>Group</b>	Math
<b>Syntax</b>	MATH:MATH<x>:FLEXray:SUPPortedfields {DATA} MATH:MATH<x>:FLEXray:SUPPortedfields?

- Arguments**    `DATA` sets the field type to `DATA`.
- Examples**    `MATH:MATH2:FLEXray:SUPportedfields DATA` sets the field type to `DATA`.
- `MATH:MATH2:FLEXray:SUPportedfields?` might return  
`:MATH:MATH2:FLEXray:SUPportedfields DATA`, indicating the field type  
for `MATH2` for the bus source for `FLEXray` bus is `DATA`.

## MATH:MATH<x>:FUNctIon

This command sets or queries the basic math arithmetic function. The math waveform is specified by `x`.

---

**NOTE.** *This command does not affect the same Math equation in Advanced math (also accessed via the command `MATH:MATH<x>:DEFINE`).*

---

- Group**    Math
- Syntax**    `MATH:MATH<x>:FUNctIon {ADD|SUBtract|MULTiply|DIVide}`
- Arguments**    `ADD` sets the basic math function to add.
- `SUBtract` sets the basic math function to subtract.
- `MULTiply` sets the basic math function to multiply.
- `DIVide` sets the basic math function to divide.
- Examples**    `MATH:MATH2:FUNCTION MULTIPLY` sets the basic math function to multiply.
- `MATH:MATH1:FUNCTION?` might return `:MATH:MATH1:FUNCTION ADD`  
indicating the current basic math function is addition.

## MATH:MATH<x>:I2C:SUPportedfields

This command sets or queries the field type for the math for the bus source for I2C bus. The math waveform is specified by `x`.

- Group**    Math
- Syntax**    `MATH:MATH<x>:I2C:SUPportedfields {DATA}`  
`MATH:MATH<x>:I2C:SUPportedfields?`

<b>Arguments</b>	DATA sets the field type to DATA.
<b>Examples</b>	<p>MATH:MATH2:I2C:SUPPortedfields DATA sets the field type to DATA.</p> <p>MATH:MATH2:I2C:SUPPortedfields? might return :MATH:MATH2:I2C:SUPPortedfields DATA, indicating the field type for MATH2 for the bus source for I2C bus is DATA.</p>

## MATH:MATH<x>:I3C:SUPPortedfields

This command sets or queries the field type for the math for the bus source for I3Cbus. The math waveform is specified by x.

<b>Group</b>	Math
<b>Syntax</b>	<p>MATH:MATH&lt;x&gt;:I3C:SUPPortedfields {DATA}</p> <p>MATH:MATH&lt;x&gt;:I3C:SUPPortedfields?</p>
<b>Arguments</b>	DATA sets the field type to DATA.
<b>Examples</b>	<p>MATH:MATH2:I3C:SUPPortedfields DATA sets the field type to DATA.</p> <p>MATH:MATH2:I3C:SUPPortedfields? might return :MATH:MATH2:I3C:SUPPortedfields DATA, indicating the field type for MATH2 for the bus source for I3Cbus is DATA.</p>

## MATH:MATH<x>:INTERpolation

This command sets or queries whether sinc interpolation is enabled for math on bus source. The math waveform is specified by x.

<b>Group</b>	Math
<b>Syntax</b>	<p>MATH:MATH&lt;x&gt;:INTERpolation {ON OFF}</p> <p>MATH:MATH&lt;x&gt;:INTERpolation?</p>
<b>Arguments</b>	<p>ON indicates that the sinc interpolation is used for math waveform.</p> <p>OFF indicates no interpolation is used for math waveform. Waveform will appear “stair-steppy” in this case.</p>

**Examples**    `MATH:MATH2:INTERpolation ON` enables sinc interpolation.  
`MATH:MATH1:INTERpolation?` might return `:MATH:MATH1:INTERpolation ON` indicating that the sinc interpolation is used for math waveform.

## MATH:MATH<x>:GATing

This command specifies or returns the gating setting. It only applies to Math FFT plots. The math waveform is specified by x.

**Group**    Math

**Syntax**    `MATH:MATH<x>:GATing {NONE|SCREEN|CURSOR}`  
`MATH:MATH<x>:GATing?`

**Related Commands**    [MATH:MATH<x>:TYPE](#)

**Arguments**    `NONE` turns off math gating.  
`SCREEN` turns on gating, using the left and right edges of the screen.  
`CURSOR` limits math to the portion of the waveform between the vertical bar cursors, even if they are off screen.

**Examples**    `MATH:MATH3:GATING CURSOR` sets the spectral math plot to be gated by the cursors.  
`MATH:MATH2:GATING?` might return `:MATH:MATH:2:GATING SCREEN` which indicates the spectral math plot is gated by the screen.

## MATH:MATH<x>:LABel:COLor

This command sets or queries color of the specified math's label. The math waveform is specified by x.

**Group**    Math

**Syntax**    `MATH:MATH<x>:LABel:COLor <QString>`  
`MATH:MATH<x>:LABel:COLor?`

**Arguments** <QString> is the color of the label. To return the color to the default color, send an empty string as in this example: `:MATH:MATH1:LABEL:COLOR ""`.

**Examples** `MATH:MATH3:LABEL:COLOR "GREEN"` sets the Math 3 label color to green. `MATH:MATH1:LABEL:COLOR?` might return `:MATH:MATH1:LABEL:COLOR "BLUE"` indicating the color of the Math1 label is blue.

## MATH:MATH<x>:LABel:FONT:BOLD

This command sets or queries the bold state of the specified math label. The math waveform is specified by x.

**Group** Math

**Syntax** `MATH:MATH<x>:LABel:FONT:BOLD {<NR1>|OFF|ON}`  
`MATH:MATH<x>:LABel:FONT:BOLD?`

**Arguments** <NR1> = 0 turns off bold, and any other integer turns on bold.  
 OFF turns off bold.  
 ON turns on bold.

**Examples** `MATH:MATH3:FONT:BOLD ON` set the math 3 label to bold.  
`MATH:MATH2:FONT:BOLD?` might return `:MATH:MATH2:FONT:BOLD 0` indicating the math 2 label is not currently bold.

## MATH:MATH<x>:LABel:FONT:ITALic

This command sets or queries italic state of the specified math label. The math waveform is specified by x.

**Group** Math

**Syntax** `MATH:MATH<x>:LABel:FONT:ITALic {<NR1>|OFF|ON}`  
`MATH:MATH<x>:LABel:FONT:ITALic?`

**Arguments** <NR1> = 0 turns off italic, and any other integer turns on italic.  
 OFF turns off italic.

ON turns on italic.

**Examples** MATH:MATH4:FONT:ITALIC ON set the math 4 label to be italic.  
MATH:MATH1:FONT:ITALIC? might return :MATH:MATH1:FONT:ITALIC  
0 indicating the math 1 label is not currently italic.  
<NR1> is the font size of the label.

## MATH:MATH<x>:LABel:FONT:SIZE

This command sets or queries font size of the specified math label. The math waveform is specified by x.

**Group** Math

**Syntax** MATH:MATH<x>:LABel:FONT:SIZE <NR1>  
MATH:MATH<x>:LABel:FONT:SIZE?

### Arguments

**Examples** MATH:MATH4:LABel:FONT:SIZE 32 sets the math 4 label size to 32.  
MATH:MATH2:LABel:FONT:SIZE? might return  
:MATH:MATH2:LABel:FONT:SIZE 14 indicating the math 2 label size is  
currently 14.

## MATH:MATH<x>:LABel:FONT:TYPE

This command sets or queries font type of the specified math label, such as Arial or Times New Roman. The math waveform is specified by x.

**Group** Math

**Syntax** MATH:MATH<x>:LABel:FONT:TYPE <QString>  
MATH:MATH<x>:LABel:FONT:TYPE?

**Arguments** <QString> is the name of the font type.



**Examples**    `MATH:MATH2:LABEL:FONT:TYPE "Serif"` sets the math 2 label font type to Serif.  
`MATH:MATH3:LABEL:FONT:TYPE?` might return  
`:MATH:MATH3:LABEL:FONT:TYPE "Monospace"` indicating the math 3 font type is currently Monospace.

## **MATH:MATH<x>:LABel:FONT:UNDERline**

This command sets or queries the underline state of the specified math label. The math waveform is specified by x.

**Group**    Math

**Syntax**    `MATH:MATH<x>:LABel:FONT:UNDERline {<NR1>|OFF|ON}`  
`MATH:MATH<x>:LABel:FONT:UNDERline?`

**Arguments**    `<NR1> = 0` turns off underline, and any other integer turns on underline.  
`OFF` turns off underline.  
`ON` turns on underline.

**Examples**    `MATH:MATH3:FONT:UNDERLINE ON` sets the math 3 label to be underlined.  
`MATH:MATH2:FONT:UNDERLINE?` might return  
`:MATH:MATH2:FONT:UNDERLINE 0` indicating the math 2 label is currently not underlined.

## **MATH:MATH<x>:LABel:NAME**

This command sets or queries the label string, which is used for annotating the math waveform on the screen. The math waveform to which the label is attached is specified by x.

**Group**    Math

**Syntax**    `MATH:MATH<x>:LABel:NAME <QString>`  
`MATH:MATH<x>:LABel:NAME?`

**Arguments**    `<QString>` specifies the label to annotate the math waveform.

**Examples**    `MATH:MATH2:LABEL:NAME "PROBE POINT7"` assigns "Probe point7" Math 2 waveform.

`MATH:MATH2:LABEL:NAME?` might return `:MATH:MATH2:LABEL:NAME "Probe point7"`, indicating that Probe point 7 is the label for the Math 2 waveform.

## MATH:MATH<x>:LABEL:XPOS

This command sets or queries the X position of the specified math label. Maths are specified by x.

**Group**    Math

**Syntax**    `MATH:MATH<x>:LABEL:XPOS <NR1>`  
`MATH:MATH<x>:LABEL:XPOS?`

**Related Commands**    [MATH:MATH<x>:LABEL:YPOS](#)

**Arguments**    <NR1> is the location (in pixels) where the label for the selected math waveform is displayed, relative to the left edge of the display.

**Examples**    `MATH:MATH2:LABEL:XPOS 5` moves the waveform label for the Math 2 waveform so that it begins 5 pixels to the right of the left edge of the screen.

`MATH:MATH2:LABEL:XPOS?` might return `:MATH:MATH2:LABEL:XPOS 2.5`, indicating that the waveform label for the Math 2 waveform is currently 2.5 pixels to the right of the left edge of the display.

## MATH:MATH<x>:LABEL:YPOS

This command sets or queries the y-position of the specified math label. The Math waveform is specified by x.

**Group**    Math

**Syntax**    `MATH:MATH<x>:LABEL:YPOS <NR1>`  
`MATH:MATH<x>:LABEL:YPOS?`

**Related Commands**    [MATH:MATH<x>:LABEL:XPOS](#)

- Arguments** <NR1> is the location (in pixels) where the label for the selected math waveform is displayed, relative to the baseline of the waveform.
- Examples** MATH:MATH2:LABEL:YPOS -2.5 moves the waveform label for the Math 2 waveform to 2.5 pixels below the baseline of the waveform.
- MATH:MATH2:LABEL:YPOS? might return :MATH:MATH2:LABEL:YPOS 0, indicating that the waveform label for the Math 2 waveform is currently located at the baseline of the waveform.

## MATH:MATH<x>:LIN:SUPPortedfields

This command sets or queries the field type for the math for the bus source for LIN bus. The math waveform is specified by x.

- Group** Math
- Syntax** MATH:MATH<x>:LIN:SUPPortedfields {DATA}  
MATH:MATH<x>:LIN:SUPPortedfields?
- Arguments** DATA sets the field type to DATA.
- Examples** MATH:MATH2:LIN:SUPPortedfields DATA sets the field type to DATA.
- MATH:MATH2:LIN:SUPPortedfields? might return :MATH:MATH2:LIN:SUPPortedfields DATA, indicating the field type for MATH2 for the bus source for LIN bus is DATA.

## MATH:MATH<x>:MDIO:SUPPortedfields

This command sets or queries the field type for the math for the bus source for MDIO bus. The math waveform is specified by x.

- Group** Math
- Syntax** MATH:MATH<x>:MDIO:SUPPortedfields {DATA}  
MATH:MATH<x>:MDIO:SUPPortedfields?
- Arguments** DATA sets the field type to DATA.

**Examples**    `MATH:MATH2:MDIO:SUPPortedfields DATA` sets the field type to DATA.  
`MATH:MATH2:MDIO:SUPPortedfields?` might return  
`:MATH:MATH2:MDIO:SUPPortedfields DATA`, indicating the field type for MATH2 for the bus source for MDIO bus is DATA.

## **MATH:MATH<x>:MIL1553B:SUPPortedfields**

This command sets or queries the field type for the math for the bus source for MIL1553B bus. The math waveform is specified by x.

**Group**    Math

**Syntax**    `MATH:MATH<x>:MIL1553B:SUPPortedfields {DATA|PAYLoad}`  
`MATH:MATH<x>:MIL1553B:SUPPortedfields?`

**Arguments**    DATA sets the field type to DATA.  
PAYLoad sets the field type to PAYLoad.

**Examples**    `MATH:MATH2:MIL1553B:SUPPortedfields DATA` sets the field type to DATA.  
`MATH:MATH2:MIL1553B:SUPPortedfields?` might return  
`:MATH:MATH2:MIL1553B:SUPPortedfields DATA`, indicating the field type for MATH2 for the bus source for MIL1553B bus is DATA.

## **MATH:MATH<x>:ONEWIRE:SUPPortedfields**

This command sets or queries the field type for the math for the bus source for ONEWIRE bus. The math waveform is specified by x.

**Group**    Math

**Syntax**    `MATH:MATH<x>:ONEWIRE:SUPPortedfields {DATA}`  
`MATH:MATH<x>:ONEWIRE:SUPPortedfields?`

**Arguments**    DATA sets the field type to DATA.

**Examples**    `MATH:MATH2:ONEWIRE:SUPPortedfields DATA` sets the field type to DATA.  
`MATH:MATH2:ONEWIRE:SUPPortedfields?` might return  
`:MATH:MATH2:ONEWIRE:SUPPortedfields DATA`, indicating the field type  
for MATH2 for the bus source for ONEWIRE bus is DATA.

## MATH:MATH<x>:PARAllel:SUPPortedfields

This command sets or queries the field type for the math for the bus source for PARAllel bus. The math waveform is specified by x.

**Group**    Math

**Syntax**    `MATH:MATH<x>:PARAllel:SUPPortedfields {DATA}`  
`MATH:MATH<x>:PARAllel:SUPPortedfields?`

**Arguments**    DATA sets the field type to DATA.

**Examples**    `MATH:MATH2:PARAllel:SUPPortedfields DATA` sets the field type to DATA.  
`MATH:MATH2:PARAllel:SUPPortedfields?` might return  
`:MATH:MATH2:PARAllel:SUPPortedfields DATA`, indicating the field type  
for MATH2 for the bus source for PARAllel bus is DATA.

## MATH:MATH<x>:PSIFIVE:SUPPortedfields

This command sets or queries the field type for the math for the bus source for PSIFIVE bus. The math waveform is specified by x.

**Group**    Math

**Syntax**    `MATH:MATH<x>:PSIFIVE:SUPPortedfields {DATA|DRA|DRB|SDATA}`  
`MATH:MATH<x>:PSIFIVE:SUPPortedfields?`

**Arguments**    DATA sets the field type to DATA.  
DRA sets the field type to DRA.  
DRB sets the field type to DRB.  
SDATA sets the field type to SDATA.

**Examples**    `MATH:MATH2:PSIFIVE:SUPPortedfields DATA` sets the field type to DATA.  
`MATH:MATH2:PSIFIVE:SUPPortedfields?` might return  
`:MATH:MATH2:PSIFIVE:SUPPortedfields DATA`, indicating the field type  
for MATH2 for the bus source for PSIFIVE bus is DATA.

## MATH:MATH<x>:RS232C:SUPPortedfields

This command sets or queries the field type for the math for the bus source for RS232C bus. The math waveform is specified by x.

**Group**    Math

**Syntax**    `MATH:MATH<x>:RS232C:SUPPortedfields {DATA|TXData|RXData}`  
`MATH:MATH<x>:RS232C:SUPPortedfields?`

**Arguments**    DATA sets the field type to DATA.  
  
TXData sets the field type to TXData. TXData field can be set when RS232 Bus configuration for Data Inputs is set to Two.  
  
RXData sets the field type to RXData. RXData field can be set when RS232 Bus configuration for Data Inputs is set to Two.

**Examples**    `MATH:MATH2:RS232C:SUPPortedfields DATA` sets the field type to DATA.  
`MATH:MATH2:RS232C:SUPPortedfields?` might return  
`:MATH:MATH2:RS232C:SUPPortedfields DATA`, indicating the  
field type for MATH2 for the bus source for RS232C bus is DATA.

## MATH:MATH<x>:SDLC:SUPPortedfields

This command sets or queries the field type for the math for the bus source for SDLC bus. The math waveform is specified by x.

**Group**    Math

**Syntax**    `MATH:MATH<x>:SDLC:SUPPortedfields {DATA}`  
`MATH:MATH<x>:SDLC:SUPPortedfields?`

**Arguments**    DATA sets the field type to DATA.

**Examples**    `MATH:MATH2:SDLC:SUPPortedfields DATA` sets the field type to DATA.  
`MATH:MATH2:SDLC:SUPPortedfields?` might return  
`:MATH:MATH2:SDLC:SUPPortedfields DATA`, indicating the field  
type for MATH2 for the bus source for SDLC bus is DATA.

## MATH:MATH<x>:SENT:SUPPortedfields

This command sets or queries the field type for the math for the bus source for SENT bus. The math waveform is specified by x.

**Group**    Math

**Syntax**    `MATH:MATH<x>:SENT:SUPPortedfields`  
`{FCData|FCDFirst|FCDTwo|SDATA}`  
`MATH:MATH<x>:SENT:SUPPortedfields?`

**Arguments**    `FCData` sets the field type to FCData. FCData field is available to select when SENT Bus configuration for Fast Data Channels is set to 2.  
  
`FCDFirst` sets the field type to FCDFirst.  
  
`FCDTwo` sets the field type to FCDTwo.  
  
`SDATA` sets the field type to SDATA. SDATA is available when SENT Bus configuration for Slow Channel is not None.

**Examples**    `MATH:MATH2:SENT:SUPPortedfields FCData` sets the field type to FCData.  
`MATH:MATH2:SENT:SUPPortedfields?` might return  
`:MATH:MATH2:SENT:SUPPortedfields FCData`, indicating the  
field type for MATH2 for the bus source for SENT bus is FCData.

## MATH:MATH<x>:SIGNeddata

This command sets or queries value to denote that bus field is decoded as signed/unsigned data for math on bus source. The math waveform is specified by x.

**Group**    Math

**Syntax**    `MATH:MATH<x>:SIGNeddata {ON|OFF}`  
`MATH:MATH<x>:SIGNeddata?`

**Arguments** ON indicates that the bus field is decoded as signed data for drawing the math waveform.

OFF indicates that the bus field is decoded as unsigned data for drawing the math waveform.

**Examples** MATH:MATH2:SIGNEDdata ON turns on signed data for MATH2 waveform.  
MATH:MATH2:SIGNEDdata? might return :MATH:MATH2:SIGNEDdata ON, indicating that the bus field is decoded as signed data for drawing the math waveform.

## MATH:MATH<x>:SMBUS:SUPPortedfields

This command sets or queries the field type for the math for the bus source for SMBUS bus. The math waveform is specified by x.

**Group** Math

**Syntax** MATH:MATH<x>:SMBUS:SUPPortedfields {DATA}  
MATH:MATH<x>:SMBUS:SUPPortedfields?

**Arguments** DATA sets the field type to DATA.

**Examples** MATH:MATH2:SMBUS:SUPPortedfields DATA sets the field type to DATA.  
MATH:MATH2:SMBUS:SUPPortedfields? might return :MATH:MATH2:SMBUS:SUPPortedfields DATA, indicating the field type for MATH2 for the bus source for SMBUS bus is DATA.

## MATH:MATH<x>:SOURce<x>

This command sets or queries the specified math source. The source in the command can be either 1 or 2. This command sets the Basic Math components in the user interface, with two sources and a function. You would also need to set the math type to Basic to see the change in the user interface but this will not effect the programmable interface. The math waveform and source are specified by x. SOURCE1 and SOURCE2 are for use when the MATH:MATH<x>:TYPE is BASIC.

**Group** Math



**Syntax** MATH:MATH<x>:SOURCE<x> {S<x>\_Ch<x> | CH<x> | MATH<x> | REF<x>}  
MATH:MATH<x>:SOURCE<x>?

**Related Commands** [MATH:MATH<x>:TYPE](#)  
[MATH:MATH<x>:FUNCTION](#)

**Arguments** S<x>\_Ch<x> specifies the remote scope number and the analog channel as the source.  
CH<x> specifies an analog channel as the source.  
Math<x> specifies a math waveform as the source.  
REF<x> specifies a reference waveform as the source.

**Examples** MATH:MATH2:SOURCE1 CH1 sets the first source of math 2 to Channel 1.  
MATH:MATH3:SOURCE2? might return :MATH:MATH3:SOURCE2 REF3 indicating the second source of Math 3 is Ref 3.

## MATH:MATH<x>:SPACEWIRE:SUPPORTEDFIELDS

This command sets or queries the field type for the math for the bus source for SPACEWIRE bus. The math waveform is specified by x.

**Group** Math

**Syntax** MATH:MATH<x>:SPACEWIRE:SUPPORTEDFIELDS {DATA}  
MATH:MATH<x>:SPACEWIRE:SUPPORTEDFIELDS?

**Arguments** DATA sets the field type to DATA.

**Examples** MATH:MATH2:SPACEWIRE:SUPPORTEDFIELDS DATA sets the field type to DATA.  
MATH:MATH2:SPACEWIRE:SUPPORTEDFIELDS? might return :MATH:MATH2:SPACEWIRE:SUPPORTEDFIELDS DATA, indicating the field type for MATH2 for the bus source for SPACEWIRE bus is DATA.

## MATH:MATH<x>:SPECTral:HORZ

This command sets or queries the horizontal display scale of the spectral math waveform. The math waveform is specified by x.

<b>Group</b>	Math
<b>Syntax</b>	MATH:MATH<x>:SPECTral:HORZ {LOG LINEAR} MATH:MATH<x>:SPECTral:HORZ?
<b>Arguments</b>	LINEAR sets the SpectralMag units to linear. LOG sets the SpectralMag units to log.
<b>Examples</b>	MATH:MATH2:SPECTRAL:HORZ LOG sets the horizontal display scale of the spectral math waveform to log. MATH:MATH3:SPECTRAL:HORZ? might return :MATH:MATH3:SPECTRAL:HORZ LINEAR indicating the horizontal display scale of the Math 3 spectral math waveform is currently set to linear.

## MATH:MATH<x>:SPECTral:MAG

This command sets or queries the units of the SpectralMag function in the specified math definition string. The Math waveform is specified by x.

<b>Group</b>	Math
<b>Syntax</b>	MATH:MATH<x>:SPECTral:MAG {LINEAR DBM} MATH:MATH<x>:SPECTral:MAG?
<b>Arguments</b>	LINEAR sets the SpectralMag units to linear. DBM sets the SpectralMag units to decibels. It also sets the Ref Level Offset to a value that is the equivalent of 1 mW into 50 $\Omega$ .
<b>Examples</b>	MATH:MATH2:SPECTral:MAG DBM sets the SpectralMag units for Math 2 waveform to decibels. MATH:MATH2:SPECTral:MAG? might return :MATH:MATH2:SPECTral:MAG DBM, indicating that the SpectralMag units for Math 2 waveform are set to decibels.

## MATH:MATH<x>:SPECTral:PHASE

This command sets or queries the units of a SpectralPhase function in the specified math definition string. The Math waveform is specified by x.

<b>Group</b>	Math
<b>Syntax</b>	MATH:MATH<x>:SPECTral:PHASE {DEGREES RADIANS GROUPDelay} MATH:MATH<x>:SPECTral:PHASE?
<b>Arguments</b>	DEGREES sets the SpectralPhase units to degrees.  RADIANS sets the SpectralPhase units to radians.  GROUPDELAY sets the SpectralPhase units to groupdelay, which computes the derivative of unwrapped phase spectrum. Units are expressed in seconds.
<b>Examples</b>	MATH:MATH2:SPECTral:PHASE DEGREES sets the SpectralPhase units for Math 2 waveform to degrees.  MATH:MATH2:SPECTral:PHASE? might return :MATH:MATH2:SPECTral:PHASE RADIANS, indicating that the SpectralPhase units for Math 2 waveform are set to radians.

## MATH:MATH<x>:SPECTral:SOURce

This command sets or queries the specified spectral math source. This only works with a math of type FFT. The math waveform is specified by x. MATH:MATH<x>:SPECTRAL:SOURCE is for use when the MATH:MATH<x>:TYPE is FFT.

<b>Group</b>	Math
<b>Syntax</b>	MATH:MATH<x>:SPECTral:SOURce {S<x>_Ch<x> CH<x> MATH<x> REF<x>} MATH:MATH<x>:SPECTral:SOURce?
<b>Related Commands</b>	<a href="#">MATH:MATH&lt;x&gt;:TYPE</a>
<b>Arguments</b>	S<x>_Ch<x> specifies the remote scope number and the analog channel as the source.  CH<x> specifies an analog channel as the source.

Math<x> specifies a math waveform as the source.

REF<x> specifies a reference waveform as the source.

**Examples** MATH:MATH3:SPECTRAL:SOURCE REF3 sets the source of the Spectral Math waveform to Ref 3.

MATH:MATH2:SPECTRAL:SOURCE? might return  
:MATH:MATH2:SPECTRAL:SOURCE CH4 indicating the Math 2 spectral source is Channel 4.

## MATH:MATH<x>:SPECTral:SUPPress

This command sets or queries whether suppression threshold for the specified math waveform is enabled. This is only applied when Spectral Plot type is Phase. The math waveform is specified by x.

**Group** Math

**Syntax** MATH:MATH<x>:SPECTral:SUPPress {OFF|ON|0|1}  
MATH:MATH<x>:SPECTral:SUPPress?

**Related Commands** [MATH:MATH<x>:SPECTral:TYPE](#)

**Arguments** 0 disables suppression threshold for the specified math waveform.  
1 enables suppression threshold for the specified math waveform.  
ON enables suppression threshold for the specified math waveform.  
OFF disables suppression threshold for the specified math waveform.

**Examples** MATH:MATH3:SPECTRAL:SUPPRESS ON enables the suppression threshold on the Math 3 spectral waveform.

MATH:MATH2:SPECTRAL:SUPPRESS? might return  
:MATH:MATH2:SPECTRAL:SUPPRESS 0 indicating the suppression threshold is disabled on the Math 2 spectral waveform.

## MATH:MATH<x>:SPECTral:SUPPress:VALue

This command sets or queries in volts the value of suppression threshold of the specified math waveform. This requires the Spectral type to be Phase and the

Suppression to be enabled for this PI command to have any affect. The math waveform is specified by x.

**Group** Math

**Syntax** MATH:MATH<x>:SPECTral:SUPPReSS:VALue <NR3>  
MATH:MATH<x>:SPECTral:SUPPReSS:VALue?

**Related Commands** [MATH:MATH<x>:SPECTral:TYPE](#)  
[MATH:MATH<x>:SPECTral:SUPPReSS](#)

**Arguments** <NR3> is the value of suppression threshold of the specified math waveform in volts.

**Examples** MATH:MATH3:SPECTRAL:SUPPRESS:VALUE 100.0E-3 sets the suppression threshold of Math 3 to 100 mV.  
  
MATH:MATH1:SPECTRAL:SUPPRESS:VALUE? might return  
MATH:MATH1:SPECTRAL:SUPPRESS:VALUE 10.0000E+3 indicating the suppression threshold of Math 1 is currently set to 10 kV.

## MATH:MATH<x>:SPECTral:TYPE

This command sets or queries the FFT type selected for spectral analysis. The math waveform is specified by x.

**Group** Math

**Syntax** MATH:MATH<x>:SPECTral:TYPE {MAGNitude|PHASE|REAL|IMAGinary}  
MATH:MATH<x>:SPECTral:TYPE?

**Arguments** MAGNitude specifies the magnitude spectral function.  
PHASE specifies the phase spectral function.  
REAL specifies the real spectral function.  
IMAGinary specifies the imaginary spectral function.

**Examples**    `MATH:MATH1:SPECTra1:TYPE REAL` specifies the real spectral function.  
`MATH:MATH1:SPECTra1:TYPE?` might return `:MATH:MATH1:SPECTRAL:TYPE MAGNITUDE` indicating the math is the magnitude spectral function.

## **MATH:MATH<x>:SPECTral:UNWRap**

This command sets or queries whether phase unwrap of the spectral analyzer output data is enabled. The Math waveform is specified by x.

**Group**    Math

**Syntax**    `MATH:MATH<x>:SPECTra1:UNWRap {OFF|ON|0|1}`  
`MATH:MATH<x>:SPECTra1:UNWRap?`

**Arguments**    0 disables phase unwrap for the specified math waveform.  
1 enables phase unwrap for the specified math waveform.  
ON enables phase unwrap for the specified math waveform.  
OFF disables phase unwrap for the specified math waveform.

**Examples**    `MATH1:SPECTRAL:UNWRAP ON` enables phase unwrap of the spectral analyzer output data.  
`MATH1:SPECTRAL:UNWRAP?` might return `:MATH1:SPECTRAL:UNWRAP 0`, indicating that the phase unwrap of the spectral analyzer output data is disabled.

## **MATH:MATH<x>:SPECTral:UNWRap:DEGrees**

This command sets or queries how many degrees adjacent phase values can jump before being unwrapped. This requires the Spectral type to be Phase and the UNWRAP to be enabled for this PI command to have any affect. The math waveform is specified by x.

**Group**    Math

**Syntax**    `MATH:MATH<x>:SPECTra1:UNWRap:DEGrees <NR3>`  
`MATH:MATH<x>:SPECTra1:UNWRap:DEGrees?`

**Related Commands**    [MATH:MATH<x>:SPECTral:TYPE](#)  
[MATH:MATH<x>:SPECTral:UNWRap](#)

**Arguments**    <NR3> is the value of unwrap phase in degrees.

**Examples**    MATH:MATH2:SPECTRAL:UNWRAP:DEGREES 90 sets the unwrap phase of the spectral Math 2 to 90 degrees.

MATH:MATH2:SPECTRAL:UNWRAP:DEGREES? might return  
:MATH:MATH2:SPECTRAL:UNWRAP:DEGREES 180 indicating unwrap phase of the spectral math 3 waveform is 180 degrees.

## MATH:MATH<x>:SPECTral:WINDow

This command sets or queries the window function used to apply the specified FFT window to the input data for the specified math waveform. The Math waveform is specified by x. A spectral window determines what the filter shape of the spectral analyzer will be in the frequency domain. It can be described by a mathematical function that is multiplied point-by-point times the input data to the spectral analyzer.

Following is a list of arguments that specify the window function used to multiply the input data. The windows are listed in the order of their ability to resolve frequencies (resolution bandwidth).

**Group**    Math

**Syntax**    MATH:MATH<x>:SPECTral:WINDow {RECTANGular|HAMMING|HANNing|BLACKMANHarris|KAISERBessel|GAUSSian|FLATTOP2|TEKEXponential}  
MATH:MATH<x>:SPECTral:WINDow?

**Related Commands**    [MATH:MATH<x>:TYPE](#)

**Arguments**    RECTANGular window function is equivalent to multiplying all gate data by one.  
HAMMING window function is based on a cosine series.  
HANNing window function is based on a cosine series.  
BLACKMANHarris window function is based on a cosine series.  
KAISERBessel window function is based on a cosine series.

GAUSSian window function has the best localization characteristics in the joint time/frequency plane

FLATTOP2 window function is a cosine series window with a flattened frequency response lobe.

TEKEXponential window has an exponential nonsymmetrical shape in the time domain and a triangular shape in the frequency domain.

**Examples** MATH2:SPECTRAL:WINDOW GAUSSIAN applies a Gaussian window to the spectral analyzer input data.

MATH2:SPECTRAL:WINDOW? might return :MATH2:SPECTRAL:WINDOW BLACKMANHarris, indicating that the window function used to multiply the spectral analyzer input data is the BLACKMANHarris function.

## MATH:MATH<x>:SPI:SUPPortedfields

This command sets or queries the field type for the math for the bus source for SPI bus. The math waveform is specified by x.

**Group** Math

**Syntax** MATH:MATH<x>:SPI:SUPPortedfields {DATA|MOSIdata|MISOdata}  
MATH:MATH<x>:SPI:SUPPortedfields?

**Arguments** DATA sets the field type to DATA.

MOSIdata sets the field type to MOSIdata. MOSIdata field is available to select when SPI Bus configuration for Data Inputs is set to Two.

MISOdata sets the field type to MISOdata. MISOdata field is available to select when SPI Bus configuration for Data Inputs is set to Two.

**Examples** MATH:MATH2:SPI:SUPPortedfields DATA sets the field type to DATA.

MATH:MATH2:SPI:SUPPortedfields? might return :MATH:MATH2:SPI:SUPPortedfields DATA, indicating the field type for MATH2 for the bus source for SPI bus is DATA.

## MATH:MATH<x>:SPMI:SUPPortedfields

This command sets or queries the field type for the math for the bus source for SPMI bus. The math waveform is specified by x.



<b>Group</b>	Math
<b>Syntax</b>	MATH:MATH<x>:SPMI:SUPPortedfields {DATA CDATA RDATA} MATH:MATH<x>:SPMI:SUPPortedfields?
<b>Arguments</b>	DATA sets the field type to DATA. CDATA sets the field type to CDATA. RDATA sets the field type to RDATA.
<b>Examples</b>	MATH:MATH2:SPMI:SUPPortedfields DATA sets the field type to DATA. MATH:MATH2:SPMI:SUPPortedfields? might return :MATH:MATH2:SPMI:SUPPortedfields DATA, indicating the field type for MATH2 for the bus source for SPMI bus is DATA.

## MATH:MATH<x>:SVID:SUPPortedfields

This command sets or queries the field type for the math for the bus source for SVID bus. The math waveform is specified by x.

<b>Group</b>	Math
<b>Syntax</b>	MATH:MATH<x>:SVID:SUPPortedfields {MPAYload SPAYload} MATH:MATH<x>:SVID:SUPPortedfields?
<b>Arguments</b>	MPAYload sets the field type to MPAYload. SPAYload sets the field type to SPAYload.
<b>Examples</b>	MATH:MATH2:SVID:SUPPortedfields MPAYload sets the field type to MPAYload. MATH:MATH2:SVID:SUPPortedfields? might return :MATH:MATH2:SVID:SUPPortedfields MPAYload, indicating the field type for MATH2 for the bus source for SVID bus is MPAYload.

## MATH:MATH<x>:TYPE

This command sets or queries the math type. The math waveform is specified by x.

<b>Group</b>	Math
<b>Syntax</b>	MATH:MATH<x>:TYPE {BASiC FILTER FFT ADVanced} MATH:MATH<x>:TYPE?
<b>Arguments</b>	<p>BASiC set the type to basic math.</p> <p>FILTER sets the math type to filter. Requires UDFLT licenses on 5, 6 series MSO instruments and Tekscope (Offline).</p> <p>FFT sets the type to FFT math, which can use any live analog or reference waveform in the time domain. NOTE. You can also use FFT as part of a math expression by declaring the type</p> <p>ADVanced. See examples for the command <a href="#">MATH:MATH&lt;x&gt;:DEFine</a>.</p> <p>ADVanced sets the type to advanced math.</p>
<b>Examples</b>	<p>MATH:MATH2:TYPE BASIC sets the type of Math 2 to basic.</p> <p>MATH:MATH2:TYPE? might return :MATH:MATH2:TYPE FFT indicating the type of Math 4 is currently FFT.</p>

## MATH:MATH<x>:USB:SUPPortedfields

This command sets or queries the field type for the math for the bus source for USB bus. The math waveform is specified by x.

<b>Group</b>	Math
<b>Syntax</b>	MATH:MATH<x>:USB:SUPPortedfields {DATA} MATH:MATH<x>:USB:SUPPortedfields?
<b>Arguments</b>	DATA sets the field type to DATA.
<b>Examples</b>	<p>MATH:MATH2:USB:SUPPortedfields DATA sets the field type to DATA.</p> <p>MATH:MATH2:USB:SUPPortedfields? might return :MATH:MATH2:USB:SUPPortedfields DATA, indicating the field type for MATH2 for the bus source for USB bus is DATA.</p>

## MATH:MATH<x>:VUNIT

This command specifies or returns the math custom vertical units. The math waveform is specified by x.

<b>Group</b>	Math
<b>Syntax</b>	MATH:MATH<x>:VUNIT <QString> MATH:MATH<x>:VUNIT?
<b>Arguments</b>	<QString> is the custom vertical units.
<b>Examples</b>	MATH:MATH2:VUNIT "Small"  MATH:MATH2:VUNIT? might return :MATH:MATH2:VUNIT "Large" indicating the Math 2 vertical unit is set to "Large".

## MATHArbflt<x>:FILEpath

This command or query sets the file path for a file of filter coefficients for the specified arbitrary filter. Setting a path will read that file and load the filter for ARBFLT<x>. Access these filters using a Math with an expression of the form "ARBFLT<x>()".

<b>Group</b>	Math
<b>Syntax</b>	MATHArbflt<x>:FILEpath <QString> MATHArbflt<x>:FILEpath?
<b>Arguments</b>	<QString> specifies the path to the file of filter coefficients.
<b>Examples</b>	MATHARBFLT8:FILEPATH "c:/myfilters/20mhz.flr" reads filter coefficients from the file and loads the filter for ARBFLT8.  MATHARBFLT1:FILEPATH? might return :MATHARBFLT1:FILEPATH "C:\Users\Public\Tektronix\TekScope\Math Arbitrary Filters\LowPass-Norm\lowpass_0.bw.flr", indicating that the path to the file of filter coefficients is set to "C:\Users\Public\Tektronix\TekScope\Math Arbitrary Filters\LowPass-Norm\lowpass_0.bw.flr".

## MEASTABLE:ADDNew (No Query Form)

This command adds a new measurement results view table to the scope application. The results view table can be named through the argument sent to the command.

**Group** Measurement

**Syntax** MEASTABLE:ADDNew <QString>

**Arguments** <QString> specifies a new measurement results view table to the scope application.

**Examples** MEASTABLE:ADDNew "TABLE1" adds a new table view by name TABLE1.

## MEASTABLE:DELETE (No Query Form)

This command removes the requested measurement results view table from the scope application.

**Group** Measurement

**Syntax** MEASTABLE:DELETE <QString>

**Arguments** <QString> specifies a measurement results view table to remove.

**Examples** MEASTABLE:DELETE "TABLE1" removes TABLE1 from the view.

## MEASU:MEAS1:SUBGROUP:RESULTS:ALLAcqs:MAXimum? (Query Only)

This query returns the maximum value of the measurement specified by the string, for all acquisitions.

**Conditions** Requires option 5-DPM (5 Series MSO instruments) or 6-DPM (6 Series MSO instrument)

**Group** DPM

<b>Syntax</b>	MEASU:MEAS1:SUBGROUP:RESULTS:ALLAcqs:MAXimum? <Qstring>
<b>Arguments</b>	<Qstring> = INPUT OUTPUT1 OUTPUT2 OUTPUT3 OUTPUT4 OUTPUT5 OUTPUT6 OUTPUT7 RAIL1DPMOVERSHOOT RAIL1DPMUNDERSHOOT RAIL1FREQUENCY  RAIL1PK2PK  RAIL1RMS RAIL1RMSFULL RAIL2FREQUENCY  RAIL2PK2PK  RAIL2RMS RAIL2RMSFULL  RAIL3FREQUENCY  RAIL3PK2PK  RAIL3RMS RAIL3RMSFULL  RAIL4FREQUENCY  RAIL4PK2PK  RAIL4RMS  RAIL4RMSFULL  RAIL5FREQUENCY  RAIL5PK2PK RAIL5RMS  RAIL5RMSFULL  RAIL6FREQUENCY  RAIL6PK2PK  RAIL6RMS  RAIL6RMSFULL  RAIL7DPMOVERSHOOT  RAIL7DPMUNDERSHOOT  RAIL7FREQUENCY  RAIL7PK2PK  RAIL7RMS  RAIL7RMSFULL
<b>Examples</b>	MEASU:MEAS1:SUBGROUP:RESULTS:ALLAcqs:MAXimum? "INPUT" returns the maximum value of measurement INPUT, for all acquisitions.

## MEASU:MEAS1:SUBGROUP:RESULTS:ALLAcqs:MEAN? (Query Only)

This query returns the mean value of the measurement specified by the string, for all acquisitions.

<b>Conditions</b>	Requires option 5-DPM (5 Series MSO instruments) or 6-DPM (6 Series MSO instrument)
<b>Group</b>	DPM
<b>Syntax</b>	MEASU:MEAS1:SUBGROUP:RESULTS:ALLAcqs:MEAN? <Qstring>
<b>Arguments</b>	<Qstring> = INPUT OUTPUT1 OUTPUT2 OUTPUT3 OUTPUT4 OUTPUT5 OUTPUT6 OUTPUT7 RAIL1DPMOVERSHOOT RAIL1DPMUNDERSHOOT RAIL1FREQUENCY  RAIL1PK2PK  RAIL1RMS RAIL1RMSFULL RAIL2FREQUENCY  RAIL2PK2PK  RAIL2RMS RAIL2RMSFULL  RAIL3FREQUENCY  RAIL3PK2PK  RAIL3RMS RAIL3RMSFULL  RAIL4FREQUENCY  RAIL4PK2PK  RAIL4RMS  RAIL4RMSFULL  RAIL5FREQUENCY  RAIL5PK2PK RAIL5RMS  RAIL5RMSFULL  RAIL6FREQUENCY  RAIL6PK2PK  RAIL6RMS  RAIL6RMSFULL  RAIL7DPMOVERSHOOT  RAIL7DPMUNDERSHOOT  RAIL7FREQUENCY  RAIL7PK2PK  RAIL7RMS  RAIL7RMSFULL

**Examples** MEASU:MEAS1:SUBGROUP:RESULTS:ALLAcqs:MEAN? "RAIL1DPMOVERSHOOT" returns the mean value of measurement RAIL1DPMOVERSHOOT, for all acquisitions.

## MEASU:MEAS1:SUBGROUP:RESULTS:ALLAcqs:MINimum? (Query Only)

This query returns the minimum value of the measurement specified by the string, for all acquisitions.

**Conditions** Requires option 5-DPM (5 Series MSO instruments) or 6-DPM (6 Series MSO instrument)

**Group** DPM

**Syntax** MEASU:MEAS1:SUBGROUP:RESULTS:ALLAcqs:MINimum? <Qstring>

**Arguments** <Qstring> = INPUT|OUTPUT1|OUTPUT2|OUTPUT3|OUTPUT4|OUTPUT5|OUTPUT6|OUTPUT7|RAIL1DPMOVERSHOOT|RAIL1DPMUNDERSHOOT|RAIL1FREQUENCY|RAIL1PK2PK|RAIL1RMS|RAIL1RMSFULL|RAIL2FREQUENCY|RAIL2PK2PK|RAIL2RMS|RAIL2RMSFULL|RAIL3FREQUENCY|RAIL3PK2PK|RAIL3RMS|RAIL3RMSFULL|RAIL4FREQUENCY|RAIL4PK2PK|RAIL4RMS|RAIL4RMSFULL|RAIL5FREQUENCY|RAIL5PK2PK|RAIL5RMS|RAIL5RMSFULL|RAIL6FREQUENCY|RAIL6PK2PK|RAIL6RMS|RAIL6RMSFULL|RAIL7DPMOVERSHOOT|RAIL7DPMUNDERSHOOT|RAIL7FREQUENCY|RAIL7PK2PK|RAIL7RMS|RAIL7RMSFULL

**Examples** MEASU:MEAS1:SUBGROUP:RESULTS:ALLAcqs:MINimum? "OUTPUT7" returns the minimum value of measurement OUTPUT7, for all acquisitions.

## MEASU:MEAS1:SUBGROUP:RESULTS:ALLAcqs:PK2PK? (Query Only)

This query returns the peak-to-peak value of the measurement specified by the string, for all acquisitions.

**Conditions** Requires option 5-DPM (5 Series MSO instruments) or 6-DPM (6 Series MSO instrument)

**Group** DPM

<b>Syntax</b>	MEASU:MEAS1:SUBGROUP:RESULTS:ALLAcqs:PK2PK? <Qstring>
<b>Arguments</b>	<Qstring> = INPUT OUTPUT1 OUTPUT2 OUTPUT3 OUTPUT4 OUTPUT5 OUTPUT6 OUTPUT7 RAIL1DPMOVERSHOOT RAIL1DPMUNDERSHOOT RAIL1FREQUENCY  RAIL1PK2PK  RAIL1RMS RAIL1RMSFULL RAIL2FREQUENCY  RAIL2PK2PK  RAIL2RMS RAIL2RMSFULL  RAIL3FREQUENCY  RAIL3PK2PK  RAIL3RMS RAIL3RMSFULL  RAIL4FREQUENCY  RAIL4PK2PK  RAIL4RMS  RAIL4RMSFULL  RAIL5FREQUENCY  RAIL5PK2PK RAIL5RMS  RAIL5RMSFULL  RAIL6FREQUENCY  RAIL6PK2PK  RAIL6RMS  RAIL6RMSFULL  RAIL7DPMOVERSHOOT  RAIL7DPMUNDERSHOOT  RAIL7FREQUENCY  RAIL7PK2PK  RAIL7RMS  RAIL7RMSFULL
<b>Examples</b>	MEASU:MEAS1:SUBGROUP:RESULTS:ALLAcqs:PK2PK? "OUTPUT4" returns the peak-to-peak value of measurement OUTPUT4, for all acquisitions.

## MEASU:MEAS1:SUBGROUP:RESULTS:ALLAcqs:POPulation? (Query Only)

This query returns the population value of the measurement specified by the string, for all acquisitions.

<b>Conditions</b>	Requires option 5-DPM (5 Series MSO instruments) or 6-DPM (6 Series MSO instrument)
<b>Group</b>	DPM
<b>Syntax</b>	MEASU:MEAS1:SUBGROUP:RESULTS:ALLAcqs:POPulation? <Qstring>
<b>Arguments</b>	<Qstring> = INPUT OUTPUT1 OUTPUT2 OUTPUT3 OUTPUT4 OUTPUT5 OUTPUT6 OUTPUT7 RAIL1DPMOVERSHOOT RAIL1DPMUNDERSHOOT RAIL1FREQUENCY  RAIL1PK2PK  RAIL1RMS RAIL1RMSFULL RAIL2FREQUENCY  RAIL2PK2PK  RAIL2RMS RAIL2RMSFULL  RAIL3FREQUENCY  RAIL3PK2PK  RAIL3RMS RAIL3RMSFULL  RAIL4FREQUENCY  RAIL4PK2PK  RAIL4RMS  RAIL4RMSFULL  RAIL5FREQUENCY  RAIL5PK2PK RAIL5RMS  RAIL5RMSFULL  RAIL6FREQUENCY  RAIL6PK2PK  RAIL6RMS  RAIL6RMSFULL  RAIL7DPMOVERSHOOT  RAIL7DPMUNDERSHOOT  RAIL7FREQUENCY  RAIL7PK2PK  RAIL7RMS  RAIL7RMSFULL

**Examples** MEASU:MEAS1:SUBGROUP:RESULTS:ALLAcqs:POPulation? "RAIL1DPMUNDERSHOOT" returns the population value of measurement RAIL1DPMUNDERSHOOT, for all acquisitions.

## MEASU:MEAS1:SUBGROUP:RESULTS:ALLAcqs:STDDev? (Query Only)

This query returns the standard deviation value of the measurement specified by the string, for all acquisitions.

**Conditions** Requires option 5-DPM (5 Series MSO instruments) or 6-DPM (6 Series MSO instrument)

**Group** DPM

**Syntax** MEASU:MEAS1:SUBGROUP:RESULTS:ALLAcqs:STDDev? <Qstring>

**Arguments** <Qstring> = INPUT|OUTPUT1|OUTPUT2|OUTPUT3|OUTPUT4|OUTPUT5|OUTPUT6|OUTPUT7|RAIL1DPMOVERSHOOT|RAIL1DPMUNDERSHOOT|RAIL1FREQUENCY|RAIL1PK2PK|RAIL1RMS|RAIL1RMSFULL|RAIL2FREQUENCY|RAIL2PK2PK|RAIL2RMS|RAIL2RMSFULL|RAIL3FREQUENCY|RAIL3PK2PK|RAIL3RMS|RAIL3RMSFULL|RAIL4FREQUENCY|RAIL4PK2PK|RAIL4RMS|RAIL4RMSFULL|RAIL5FREQUENCY|RAIL5PK2PK|RAIL5RMS|RAIL5RMSFULL|RAIL6FREQUENCY|RAIL6PK2PK|RAIL6RMS|RAIL6RMSFULL|RAIL7DPMOVERSHOOT|RAIL7DPMUNDERSHOOT|RAIL7FREQUENCY|RAIL7PK2PK|RAIL7RMS|RAIL7RMSFULL

**Examples** MEASU:MEAS1:SUBGROUP:RESULTS:ALLAcqs:STDDev? "RAIL7PK2PK" returns the standard deviation value of measurement RAIL7PK2PK, for all acquisitions.

## MEASU:MEAS1:SUBGROUP:RESULTS:CURREntacq:MAXimum? (Query Only)

This query returns the maximum value of the measurement specified by the string, for the current acquisition.

**Conditions** Requires option 5-DPM (5 Series MSO instruments) or 6-DPM (6 Series MSO instrument)



<b>Group</b>	DPM
<b>Syntax</b>	MEASU:MEAS1:SUBGROUP:RESULTS:CURRENTACQ:MAXIMUM? <Qstring>
<b>Arguments</b>	<Qstring> = INPUT OUTPUT1 OUTPUT2 OUTPUT3 OUTPUT4 OUTPUT5  OUTPUT6 OUTPUT7 RAIL1DPMOVERSHOOT RAIL1DPMUNDERSHOOT  RAIL1FREQUENCY  RAIL1PK2PK  RAIL1RMS  RAIL1RMSFULL RAIL2FREQUENCY  RAIL2PK2PK  RAIL2RMS  RAIL2RMSFULL  RAIL3FREQUENCY  RAIL3PK2PK  RAIL3RMS RAIL3RMSFULL  RAIL4FREQUENCY  RAIL4PK2PK  RAIL4RMS  RAIL4RMSFULL  RAIL5FREQUENCY  RAIL5PK2PK RAIL5RMS  RAIL5RMSFULL  RAIL6FREQUENCY  RAIL6PK2PK  RAIL6RMS  RAIL6RMSFULL  RAIL7DPMOVERSHOOT  RAIL7DPMUNDERSHOOT  RAIL7FREQUENCY  RAIL7PK2PK  RAIL7RMS  RAIL7RMSFULL
<b>Examples</b>	MEASU:MEAS1:SUBGROUP:RESULTS:CURRENTACQ:MAXIMUM? "INPUT" returns the maximum value of measurement INPUT, for the current acquisition.

## MEASU:MEAS1:SUBGROUP:RESULTS:CURRENTACQ:MEAN? (Query Only)

This query returns the mean value of the measurement specified by the string, for the current acquisition.

<b>Conditions</b>	Requires option 5-DPM (5 Series MSO instruments) or option 5-IMDA (MSO58 and MSO56 instruments) or 6-DPM (6 Series MSO instrument)
<b>Group</b>	DPM, Measurement, IMDA
<b>Syntax</b>	MEASU:MEAS1:SUBGROUP:RESULTS:CURRENTACQ:MEAN? <Qstring>
<b>Arguments</b>	<Qstring> = INPUT  OUTPUT1  OUTPUT2  OUTPUT3  OUTPUT4  OUTPUT5  OUTPUT6  OUTPUT7  RAIL1DPMOVERSHOOT  RAIL1DPMUNDERSHOOT  RAIL1FREQUENCY  RAIL1PK2PK  RAIL1RMS  RAIL1RMSFULL  RAIL2FREQUENCY  RAIL2PK2PK  RAIL2RMS  RAIL2RMSFULL  RAIL3FREQUENCY  RAIL3PK2PK  RAIL3RMS  RAIL3RMSFULL  RAIL4FREQUENCY  RAIL4PK2PK  RAIL4RMS  RAIL4RMSFULL  RAIL5FREQUENCY  RAIL5PK2PK  RAIL5RMS  RAIL5RMSFULL  RAIL6FREQUENCY  RAIL6PK2PK  RAIL6RMS  RAIL6RMSFULL  RAIL7DPMOVERSHOOT  RAIL7DPMUNDERSHOOT  RAIL7FREQUENCY  RAIL7PK2PK

|RAIL7RMS |RAIL7RMSFULL |L2LPH1VRMS |L2LPH1VCFactor  
 |L2LPH1TruePwr |L2LPH1RePwr |L2LPH1AppPwr |L2LPH1PwrFactor  
 |L2LPH1PhaseDiff |L2LPH1VPhase |L2LPH2VRMS |L2LPH2VCFactor  
 |L2LPH2TruePwr |L2LPH2RePwr |L2LPH2AppPwr |L2LPH2PwrFactor  
 |L2LPH2PhaseDiff |L2LPH2VPhase |L2LPH3VRMS |L2LPH3VCFactor  
 |L2LPH3TruePwr |L2LPH3RePwr |L2LPH3AppPwr |L2LPH3PwrFactor  
 |L2LPH3PhaseDiff |L2LPH3VPhase |L2NPH1VRMS |L2NPH1VCFactor  
 |L2NPH1TruePwr |L2NPH1RePwr |L2NPH1AppPwr |L2NPH1PwrFactor  
 |L2NPH1PhaseDiff |L2NPH1VPhase |L2NPH2VRMS |L2NPH2VCFactor  
 |L2NPH2TruePwr |L2NPH2RePwr |L2NPH2AppPwr |L2NPH2PwrFactor  
 |L2NPH2PhaseDiff |L2NPH2VPhase |L2NPH3VRMS |L2NPH3VCFactor  
 |L2NPH3TruePwr |L2NPH3RePwr |L2NPH3AppPwr |L2NPH3PwrFactor  
 |L2NPH3PhaseDiff |L2NPH3VPhase |PH1IRMS |PH1IPhase |PH1ICFactor  
 |PH2IRMS |PH2IPhase |PH2ICFactor |PH3IRMS |PH3IPhase |PH3ICFactor  
 |Frequency |L2LPH1F1Mag |L2LPH1F3Mag |L2LPH1THDF |L2LPH1THDR  
 |L2LPH1RMS |L2LPH1IRMS |L2LPH1Status |L2LPH1HarmonicsNumber  
 |L2LPH1Frequency |L2LPH1MagnitudeAbs |L2LPH1MagnitudePct  
 |L2LPH1Phase |L2LPH1Limits |L2LPH1PassFail |L2LPH1Margin  
 |L2LPH2F1Mag |L2LPH2F3Mag |L2LPH2THDF |L2LPH2THDR  
 |L2LPH2RMS |L2LPH2IRMS |L2LPH2Status |L2LPH2HarmonicsNumber  
 |L2LPH2Frequency |L2LPH2MagnitudeAbs |L2LPH2MagnitudePct  
 |L2LPH2Phase |L2LPH2Limits |L2LPH2PassFail |L2LPH2Margin  
 |L2LPH3F1Mag |L2LPH3F3Mag |L2LPH3THDF |L2LPH3THDR |L2LPH3RMS  
 |L2LPH3IRMS |L2LPH3Status |L2LPH3HarmonicsNumber |L2LPH3Frequency  
 |L2LPH3MagnitudeAbs |L2LPH3MagnitudePct |L2LPH3Phase |L2LPH3Limits  
 |L2LPH3PassFail |L2LPH3Margin |L2NPH1F1Mag |L2NPH1F3Mag  
 |L2NPH1THDF |L2NPH1THDR |L2NPH1RMS |L2NPH1IRMS  
 |L2NPH1Status |L2NPH1HarmonicsNumber |L2NPH1Frequency  
 |L2NPH1MagnitudeAbs |L2NPH1MagnitudePct |L2NPH1Phase|L2NPH1Limits  
 |L2NPH1PassFail|L2NPH1Margin |L2NPH2F1Mag|L2NPH2F3Mag  
 |L2NPH2THDF|L2NPH2THDR |L2NPH2RMS|L2NPH2IRMS  
 |L2NPH2Status |L2NPH2HarmonicsNumber |L2NPH2Frequency  
 |L2NPH2MagnitudeAbs |L2NPH2MagnitudePct |L2NPH2Phase|L2NPH2Limits  
 |L2NPH2PassFail|L2NPH2Margin |L2NPH3F1Mag |L2NPH3F3Mag  
 |L2NPH3THDF |L2NPH3THDR |L2NPH3RMS |L2NPH3IRMS |L2NPH3Status  
 |L2NPH3HarmonicsNumber |L2NPH3Frequency |L2NPH3MagnitudeAbs  
 |L2NPH3MagnitudePct |L2NPH3Phase |L2NPH3Limits |L2NPH3PassFail  
 |L2NPH3Margin |ORDER|PH1INPwr |PH1OUTPwr |PH1Efficiency |PH2INPwr  
 |PH2OUTPwr |PH2Efficiency |TotalEfficiency |PH1LRIPRMS |PH1LRIPPK2PK  
 |PH2LRIPRMS |PH2LRIPPK2PK |PH3LRIPRMS |PH3LRIPPK2PK  
 |PH1SWRIPRMS |PH1SWRIPPK2PK |PH2SWRIPRMS |PH2SWRIPPK2PK  
 |PH3SWRIPRMS |PH3SWRIPPK2PK |TruePwrSum |RePwrSum |AppPwrSum  
 |InPwrSum |OutPwrSum

**Examples** MEASU:MEAS1:SUBGROUP:RESULTS:CURRENTacq:MEAN? "RAIL1DPMOVERSHOOT"  
 returns the mean value of measurement RAIL1DPMOVERSHOOT, for the  
 current acquisition.

## MEASU:MEAS1:SUBGROUP:RESULTS:CURRENTacq:MINimum? (Query Only)

This query returns the minimum value of the measurement specified by the string, for the current acquisition.

<b>Conditions</b>	Requires option 5-DPM (5 Series MSO instruments) or 6-DPM (6 Series MSO instrument)
<b>Group</b>	DPM
<b>Syntax</b>	MEASU:MEAS1:SUBGROUP:RESULTS:CURRENTacq:MINimum? <Qstring>
<b>Arguments</b>	<Qstring> = INPUT OUTPUT1 OUTPUT2 OUTPUT3 OUTPUT4 OUTPUT5 OUTPUT6 OUTPUT7 RAIL1DPMOVERSHOOT RAIL1DPMUNDERSHOOT RAIL1FREQUENCY  RAIL1PK2PK  RAIL1RMS RAIL1RMSFULL RAIL2FREQUENCY  RAIL2PK2PK  RAIL2RMS RAIL2RMSFULL  RAIL3FREQUENCY  RAIL3PK2PK RAIL3RMS RAIL3RMSFULL  RAIL4FREQUENCY  RAIL4PK2PK RAIL4RMS  RAIL4RMSFULL  RAIL5FREQUENCY  RAIL5PK2PK RAIL5RMS  RAIL5RMSFULL  RAIL6FREQUENCY  RAIL6PK2PK  RAIL6RMS  RAIL6RMSFULL  RAIL7DPMOVERSHOOT RAIL7DPMUNDERSHOOT  RAIL7FREQUENCY  RAIL7PK2PK RAIL7RMS  RAIL7RMSFULL
<b>Examples</b>	MEASU:MEAS1:SUBGROUP:RESULTS:CURRENTacq:MINimum? "OUTPUT7" returns the minimum value of measurement OUTPUT7, for the current acquisition.

## MEASU:MEAS1:SUBGROUP:RESULTS:CURRENTacq:PK2PK? (Query Only)

This query returns the peak-to-peak value of the measurement specified by the string, for the current acquisition.

<b>Conditions</b>	Requires option 5-DPM (5 Series MSO instruments) or 6-DPM (6 Series MSO instrument)
<b>Group</b>	DPM
<b>Syntax</b>	MEASU:MEAS1:SUBGROUP:RESULTS:CURRENTacq:PK2PK? <Qstring>

**Arguments** <Qstring> = INPUT|OUTPUT1|OUTPUT2|OUTPUT3|OUTPUT4|OUTPUT5|OUTPUT6|OUTPUT7|RAIL1DPMOVERSHOOT|RAIL1DPMUNDERSHOOT|RAIL1FREQUENCY |RAIL1PK2PK |RAIL1RMS|RAIL1RMSFULL|RAIL2FREQUENCY |RAIL2PK2PK |RAIL2RMS|RAIL2RMSFULL |RAIL3FREQUENCY |RAIL3PK2PK|RAIL3RMS|RAIL3RMSFULL |RAIL4FREQUENCY |RAIL4PK2PK|RAIL4RMS |RAIL4RMSFULL |RAIL5FREQUENCY |RAIL5PK2PK|RAIL5RMS |RAIL5RMSFULL |RAIL6FREQUENCY |RAIL6PK2PK |RAIL6RMS |RAIL6RMSFULL |RAIL7DPMOVERSHOOT |RAIL7DPMUNDERSHOOT |RAIL7FREQUENCY |RAIL7PK2PK |RAIL7RMS |RAIL7RMSFULL

**Examples** MEASU:MEAS1:SUBGROUP:RESULTS:CURRENTacq:PK2PK? "OUTPUT4" returns the peak-to-peak value of measurement OUTPUT4, for the current acquisition.

## MEASU:MEAS1:SUBGROUP:RESULTS:CURRENTacq:POPULATION? (Query Only)

This query returns the population value of the measurement specified by the string, for the current acquisition.

**Conditions** Requires option 5-DPM (5 Series MSO instruments) or 6-DPM (6 Series MSO instrument)

**Group** DPM

**Syntax** MEASU:MEAS1:SUBGROUP:RESULTS:CURRENTacq:POPULATION? <Qstring>

**Arguments** <Qstring> = INPUT|OUTPUT1|OUTPUT2|OUTPUT3|OUTPUT4|OUTPUT5|OUTPUT6|OUTPUT7|RAIL1DPMOVERSHOOT|RAIL1DPMUNDERSHOOT|RAIL1FREQUENCY |RAIL1PK2PK |RAIL1RMS|RAIL1RMSFULL|RAIL2FREQUENCY |RAIL2PK2PK |RAIL2RMS|RAIL2RMSFULL |RAIL3FREQUENCY |RAIL3PK2PK|RAIL3RMS|RAIL3RMSFULL |RAIL4FREQUENCY |RAIL4PK2PK|RAIL4RMS |RAIL4RMSFULL |RAIL5FREQUENCY |RAIL5PK2PK|RAIL5RMS |RAIL5RMSFULL |RAIL6FREQUENCY |RAIL6PK2PK |RAIL6RMS |RAIL6RMSFULL |RAIL7DPMOVERSHOOT |RAIL7DPMUNDERSHOOT |RAIL7FREQUENCY |RAIL7PK2PK |RAIL7RMS |RAIL7RMSFULL

**Examples** MEASU:MEAS1:SUBGROUP:RESULTS:CURRENTacq:POPULATION? "RAIL1DPMUNDERSHOOT" returns the population value of measurement RAIL1DPMUNDERSHOOT, for the current acquisition.

## MEASU:MEAS1:SUBGROUP:RESULTS:CURRENTacq:STDDev? (Query Only)

This query returns the standard deviation value of the measurement specified by the string, for the current acquisition.

**Conditions** Requires option 5-DPM (5 Series MSO instruments) or 6-DPM (6 Series MSO instrument)

**Group** DPM

**Syntax** MEASU:MEAS1:SUBGROUP:RESULTS:CURRENTacq:STDDev? <Qstring>

**Arguments** <Qstring> = INPUT|OUTPUT1|OUTPUT2|OUTPUT3|OUTPUT4|OUTPUT5|OUTPUT6|OUTPUT7|RAIL1DPMOVERSHOOT|RAIL1DPMUNDERSHOOT|RAIL1FREQUENCY |RAIL1PK2PK |RAIL1RMS|RAIL1RMSFULL|RAIL2FREQUENCY |RAIL2PK2PK |RAIL2RMS|RAIL2RMSFULL|RAIL3FREQUENCY |RAIL3PK2PK|RAIL3RMS|RAIL3RMSFULL|RAIL4FREQUENCY |RAIL4PK2PK|RAIL4RMS |RAIL4RMSFULL|RAIL5FREQUENCY|RAIL5PK2PK|RAIL5RMS |RAIL5RMSFULL|RAIL6FREQUENCY|RAIL6PK2PK|RAIL6RMS|RAIL6RMSFULL|RAIL7DPMOVERSHOOT|RAIL7DPMUNDERSHOOT|RAIL7FREQUENCY|RAIL7PK2PK|RAIL7RMS|RAIL7RMSFULL

**Examples** MEASU:MEAS1:SUBGROUP:RESULTS:CURRENTacq:STDDev? "RAIL7PK2PK" returns the standard deviation value of measurement RAIL7PK2PK, for the current acquisition.

## MEASUREMENT? (Query Only)

This query-only command returns all measurement parameters.

**Group** Measurement

**Syntax** MEASUREMENT?

**Examples** MEASUREMENT? might return :MEASUREMENT:GATING  
 OFF;IMMED:TYPE UNDEFINED;UNITS "V";SOURCE1 CH1;SOURCE2  
 CH1;SOURCE1:SIGTYPE PULSE;:MEASUREMENT:IMMED:SOURCE2:SIGTYPE  
 PULSE;:MEASUREMENT:IMMED:DELAY:EDGE1 RISE;EDGE2  
 RISE;DIRECTION FORWARDS;:MEASUREMENT:IMMED:REFLEVEL:METHOD  
 PERCENT;ABSOLUTE:HIGH 0.0000;LOW 0.0000;MID1 0.0000;MID2  
 0.0000;:MEASUREMENT:IMMED:REFLEVEL:PERCENT:HIGH 90.0000;LOW  
 10.0000;MID1 50.0000;MID2 50.0000;:MEASUREMENT:IMMED:METHOD  
 HISTOGRAM;NOISE HIGH;:MEASUREMENT:MEAS1:STATE  
 0;TYPE UNDEFINED;UNITS "V";SOURCE1 CH1;SOURCE2  
 CH1;SOURCE1:SIGTYPE PULSE;:MEASUREMENT:MEAS1:SOURCE2:SIGTYPE  
 PULSE;:MEASUREMENT:MEAS1:DELAY:EDGE1 RISE;EDGE2  
 RISE;DIRECTION FORWARDS;:MEASUREMENT:MEAS1:REFLEVEL:METHOD  
 PERCENT;ABSOLUTE:HIGH 0.0000;LOW 0.0000;MID1 0.0000;MID2  
 0.0000;:MEASUREMENT:MEAS1:REFLEVEL:PERCENT:HIGH 90.0000;LOW  
 10.0000;MID1 50.0000;MID2 50.0000;:MEASUREMENT:MEAS1:METHOD  
 HISTOGRAM;NOISE HIGH;:MEASUREMENT:MEAS2:STATE  
 0;TYPE UNDEFINED;UNITS "V";SOURCE1 CH1;SOURCE2  
 CH1;SOURCE1:SIGTYPE PULSE;:MEASUREMENT:MEAS2:SOURCE2:SIGTYPE  
 PULSE;:MEASUREMENT:MEAS2:DELAY:EDGE1 RISE;EDGE2  
 RISE;DIRECTION.

## MEASUREMENT:ADDMEAS (No Query Form)

This command adds a measurement.

**Conditions** Refer to the Arguments list for measurements are require the DJA option or are not available on 4 Series MSO instruments.

**Group** Measurement, IMDA

**Syntax** MEASUREMENT:ADDMEAS {ACCOMMONMODE |ACRMS |AMP]ITUDE |AREA  
 |BASE |BITAMPLITUDE |BITHIGH |BITLOW |BURSTWIDTH |COMMONMODE  
 |CCJITTER |DATARATE |DCD |DDJ |DDRAOS |DDRAOSPERTCK  
 |DDRAOSPERUI |DDRAUS |DDRAUSPERTCK |DDRAUSPERUI |DDRHOIDDIFF  
 |DDRSETUPDIFF |DDRTCHABS |DDRTCHAVERAGE |DDRTCKAVERAGE  
 |DDRTCLABS |DDRTCLAVERAGE |DDRTERRMN |DDRTERRN |DDRTJITCC  
 |DDRTJITDUTY |DDRTJITPER |DDRTPST |DDRTRPRE |DDRTWPRE  
 |DDRVIXAC |DDRTDQSK |DELAY |DJ |DJDIRAC |EYEHIGH |EYELow  
 |FALLSLEWRATE |FALLTIME |FREQUENCY |F2 |F4 |F8 |HEIGHT  
 |HEIGHTBER |HIGH |HIGHTIME |HOLD |IMDAPOWERQUALITY  
 |IMDAHARMONICS |IMDAINPUTVOLTAGE |IMDAINPUTCURRENT  
 |IMDAINPUTPOWER |IMDAPHASORDIAGRAM |IMDAEFFICIENCY  
 |IMDALINERIPPLE |IMDASWITCHRIPPLE |IMDADQ0 |JITTERSUMMARY  
 |J2 |J9 |LOW |LOWTIME |MAXIMUM |MEAN |MINIMUM |NDUTy  
 |NOVERSHOOT |NPERIOD |NPJ |NWIDTTH |PDUTY |PERIOD |PHASE

```
| PHASENOISE | PJ | PK2Pk | POVERSHOOT | PWIDTH | QFACTOR
| RISESLEWRATE | RISETIME | RJ | RJDIRAC | RMS | SETUP | SKEW | SRJ
| SSCFREQDEV | SSCMODRATE | TIE | TIMEOUTSIDELEVEL | TIMETOMAX
| TIMETOMIN | TJBER | TNTRATIO | TOP | UNITINTERVAL | VDIFFXOVR
| WIDTH | WIDTHBER }
```

## Arguments

**ACCOMMONMODE AC** Common Mode (Pk-Pk) is the peak-to-peak of the common mode voltage of two sources. This measurement is made across the entire record. This measurement requires the DJA option and is not available on a 4 Series MSO instrument.

**ACRMS (AC RMS)** is the true Root Mean Square of the data points, about the Mean. This measurement can be made across the entire record, or on each cycle in the record.

**AMPLITUDE** is the difference between the Top value and the Base value. This measurement can be made across the entire record, or on each cycle in the record.

$$\textit{Amplitude} = \textit{High} - \textit{Low}$$

**AREA** is the area under the curve, calculated by integrating the data points. The area measured above ground is positive. The area measured below ground is negative. This measurement can be made across the entire record, or on each cycle in the record.

**BASE** is the most common data value below the midpoint of the waveform. This measurement can be made across the entire record, or on each cycle in the record.

**BITAMPLITUDE (Bit Amplitude)** is the difference between the amplitudes of the 1 bit and the 0 bit surrounding a transition. The amplitude is measured over a user specified portion at the center of the recovered unit interval. This measurement is made on each transition bit in the record (Mean) or across the entire record (Mode). This measurement requires the DJA option and is not available on a 4 Series MSO instrument.

**BITHIGH (Bit High)** is the amplitude of a 1 bit. The amplitude is measured over a user specified portion at the center of the recovered unit interval. This measurement is made on each high bit in the record (Mean) or across the entire record (Mode). This measurement requires the DJA option and is not available on a 4 Series MSO instrument.

**BITLOW (Bit Low)** is the amplitude of a 0 bit. The amplitude is measured over a user specified portion at the center of the recovered unit interval. This measurement is made on each high bit in the record (Mean) or across the entire record (Mode). This measurement requires the DJA option and is not available on a 4 Series MSO instrument.

**BURSTWIDTH (Burst Width)** is the duration of a series of adjacent crossings of the Mid reference level (RM). Bursts are separated by a user-defined idle time (tI). This measurement is made on each burst in the record.

**COMMONMODE** (DC Common Mode) is the arithmetic mean of the common mode voltage of two sources. This measurement is made across the entire record. This measurement requires the DJA option and is not available on a 4 Series MSO instrument.

**CCJITTER** (Cycle-to-Cycle jitter) measures how much the clock period changes between any two adjacent cycles. Cycle-to-Cycle jitter is measured by applying a first order difference operation to the period jitter.

**DATARATE** (Data Rate) is the reciprocal of Unit Interval. This measurement is made on each bit in the record.

**DCD** (duty cycle distortion) is the peak-to-peak amplitude of the component of the deterministic jitter correlated with the signal polarity. This measurement is made across the entire record. This measurement requires the DJA option and is not available on a 4 Series MSO instrument.

**DDJ** (data dependent jitter) is the peak-to-peak amplitude of the component of the deterministic jitter correlated with the data pattern in the waveform. This measurement is made across the entire record. This measurement requires the DJA option and is not available on a 4 Series MSO instrument.

**DDRAOS** (area above signal) is the total area of the signal above a specified reference level. This measurement is made across the entire record.

**DDRAOSPERTCK** (area over signal for tCK events) is the total area of the signal above a specified reference level calculated over consecutive tCK intervals. It is applicable to clock and address/command waveforms.

**DDRAOSPERUI** (area over signal for UI events) is the total area of the signal above a specified reference level calculated over consecutive unit intervals. It is applicable to data and data strobe waveforms.

**DDRAUS** (area under signal) is the total area of the signal below a specified reference level. This measurement is made across the entire record.

**DDRAUSPERTCK** (area under signal for tCK events) is the total area of the signal below a specified reference level calculated over consecutive tCK intervals. It is applicable to clock and address/command waveforms.

**DDRAUSPERUI** (area under signal for UI events) is the total area of the signal below a specified reference level calculated over consecutive unit intervals. It is applicable to data and data strobe waveforms.

**DDRHOLDDIFF** (hold difference) is the elapsed time between the specified edge of a single-ended clock waveform and the specified edge of a differential data waveform. The measurement uses the closest respective waveform edges that fall within the range limits. This measurement is made across the entire record.

**DDRSETUPDIFF** (setup difference) is the elapsed time between the specified edge of a single-ended clock waveform and when the specified edge of a differential data waveform crosses a specified level. The measurement uses the closest



respective waveform edges that fall within the range limits. This measurement is made across the entire record.

**DDRTCHABS** (absolute high pulse width) is the absolute value of the high pulse width as measured from one rising edge to the next falling edge.

**DDRTCHAVERAGE** (average high pulse width) is the average value of the high pulse width as measured from one rising edge to the next falling edge, across 200 consecutive cycles. This measurement is made across the entire record.

**DDRTCKAVERAGE** (average clock period) is the average clock period calculated from rising edge to rising edge, across 200 consecutive cycles. This measurement is made across the entire record.

**DDRTCLABS** (absolute low pulse width) is the absolute value of the low pulse width as measured from a falling edge to the next rising edge. This measurement is made across the entire record.

**DDRTCLAVERAGE** (average low pulse width) is the average value of the low pulse width as measured from one falling edge to the next rising edge, across 200 consecutive cycles.

**DDRTERRMN** (cumulative error) is the cumulative error across multiple consecutive defined cycles from  $t_{CK}(avg)$ .

**DDRTERRN** (cumulative error) is the cumulative error across specified consecutive cycles from  $t_{CK}(avg)$ . In other words, this measures the time difference between the sum of the clock period from a 200 cycle window and  $n$  times  $t_{CK}(avg)$ .

**DDRTJITCC** (cycle to cycle jitter period) is the absolute difference in clock period between two consecutive clock cycles. This measurement is made across the entire record.

**DDRTJITDUTY** (half period jitter) is the largest elapsed time between  $t_{CH}$  and  $t_{CH}(avg)$ , and  $t_{CL}$  and  $t_{CL}(avg)$ , over 200 consecutive cycles.

**DDRTJITPER** (clock period jitter) is the largest deviation of any  $t_{CK}$  signal from  $t_{CK}(avg)$ . This measurement is made across the entire record.

**DDRTPST** (read/write burst postamble) is the width of the Read or Write burst postamble, measured from the last falling edge of the mid reference level to the start of an undriven state. This measurement is made across the entire record.

**DDRTRPRE** (read burst preamble) is the width of the Read burst preamble, measured from exiting tristate levels to the first driving edge of the differential strobe. This measurement is made across the entire record.

**DDRTWPRE** is the width of the Write burst preamble, measured from exiting tristate levels to the first driving edge of the differential strobe. This measurement is made across the entire record.

**DDRVIXAC** is the differential input cross-point voltage measured from the true state transition (and its complement) to a specified reference level, measured on a single-ended signal.

**DDRTDQSCK** is the strobe output access time, measured between the rising edge of the clock and before or after the differential strobe Read preamble time. Signal edges are determined by the mid-ref threshold level settings.

**DELAy** is the time between the specified Mid reference level (RM) crossing on one source to a specified Mid reference level (RM) crossing on a second source. This measurement is made on the first occurrence in the record.

**DJ** (deterministic jitter) is the peak-to-peak amplitude of all timing errors that exhibit deterministic behavior. This measurement is made across the entire record. This measurement requires the DJA option and is not available on a 4 Series MSO instrument.

**DJDIRAC** (dual-dirac deterministic jitter) is deterministic jitter based on a simplifying assumption that the histogram of all deterministic jitter can be modeled as a pair of equal-magnitude Dirac functions. This measurement is made across the entire record. This measurement requires the DJA option and is not available on a 4 Series MSO instrument.

**EYEHIGH** (Eye High) is the amplitude of a high (1) bit measured at a user specified location within the recovered unit interval. This measurement is made on each high bit in the record. This measurement requires the DJA option and is not available on a 4 Series MSO instrument.

**EYELow** (Eye Low) is the amplitude of a low (0) bit measured at a user specified location within the recovered unit interval. This measurement is made on each low bit in the record. This measurement requires the DJA option and is not available on a 4 Series MSO instrument.

**FALLSLEWRATE** (Falling Slew Rate) is the rate of change in voltage as an edge transitions from the Top reference level (RT) to the Bottom reference level (RB). This measurement is made on each cycle in the record.

**FALLTIME** (Fall Time) is the time required for an edge to fall from the Top reference level (RT) to the Base reference level (RB). This measurement is made on each cycle in the record.

**FREQUency** is the reciprocal of Period. This measurement is made on each cycle in the record.

**F2** is the peak-to-peak amplitude of the periodic jitter occurring at a rate of Fb (data rate) divided by 2. This measurement is made across the entire record. This measurement requires the DJA option and is not available on a 4 Series MSO instrument.

**F4** is the peak-to-peak amplitude of the periodic jitter occurring at a rate of Fb (data rate) divided by 4. This measurement is made across the entire record. This measurement requires the DJA option and is not available on a 4 Series MSO instrument.

**F8** is the peak-to-peak amplitude of the periodic jitter occurring at a rate of Fb (data rate) divided by 8. This measurement is made across the entire record.

This measurement requires the DJA option and is not available on a 4 Series MSO instrument.

**HIGH** (Eye High) is the amplitude of a high (1) bit measured at a user specified location within the recovered unit interval. This measurement is made on each high bit in the record.

**HEIGHT** (Eye Height) is the minimum vertical eye opening at the center of the recovered unit interval. This measurement is made across the entire record. This measurement requires the DJA option and is not available on a 4 Series MSO instrument.

**HEIGHTBER** (Eye Height@BER) is the predicted vertical eye opening that will be violated with a probability equal to the bit error rate. This measurement is made across the entire record. This measurement requires the DJA option and is not available on a 4 Series MSO instrument.

#### **HIGH**

**HIGHTIME** (High Time) is the time the signal remains above the Top reference level (RT). This measurement is made on each cycle in the record.

**HOLD** (Hold Time) is the time between the specified Mid reference level crossing (RM) on the Clock source to the closest specified Mid reference level (RM) crossing on the Data source. This measurement is made on each specified Clock edge in the record.

**IMDAPOWERQUALITY** measures the operating Frequency, RMS values of the voltage and current, Crest Factors of the voltage and current, Real Power, Reactive Power, Apparent Power, Power Factor, and Phase Angle of the AC signal. Plots the Phasor diagram. This measurement requires the IMDA option.

**IMDAHARMONICS** measures the signal amplitudes at the fundamental line frequency and its harmonics. Measures the RMS amplitude and Total Harmonic Distortion of the signal. Plots the Harmonics Bar Graph. This measurement requires the IMDA option.

**IMDAINPUTVOLTAGE** measures the RMS value of the input voltage for all phases based on the configured wiring. This measurement requires the IMDA option.

**IMDAINPUTCURRENT** measures the RMS value of the input current for all phases based on the configured wiring. This measurement requires the IMDA option.

**IMDAINPUTPOWER** measures the RMS and peak-to-peak values of the AC signal. This measurement requires the IMDA option.

**IMDAPHASORDIAGRAM** plots  $V_{rms}$  and  $I_{rms}$  and phase angles between voltage(s) and current(s) per winding pair. This measurement requires the IMDA option.

**IMDAEFFICIENCY** measures the ratio of output power to input power per phase for a AC input and Drive output. Measures the total efficiency of the system. This measurement requires the IMDA option.

IMDALINERIPPLE measures the RMS value of the input power for all phases based on the configured wiring. Measures the True / Apparent / Reactive Power for all the phases. This measurement requires the IMDA option.

IMDASWITCHRIPPLEJITTERSUMMARY measures the RMS and peak-to-peak values of the switching signal. This measurement requires the IMDA option.

IMDADQ0 measures the DQ0 values of the phasor plot. This measurement requires options IMDA and IMDA-DQ0.

JITTERSUMMARY (Jitter Summary) is a group consisting of the following measurements: TIE, TJ@BER, Eye Width@BER, Eye Height@BER, RJ- $\delta\delta$ , DJ- $\delta\delta$ , PJ, DDJ, DcD, F/2, F/4, F/8. This measurement requires the DJA option and is not available on a 4 Series MSO instrument.

J2 is the total jitter at a bit error rate of  $2.5e-3$  (TJ@ $2.5e-3$ ). This measurement is made across the entire record. This measurement requires the DJA option and is not available on a 4 Series MSO instrument.

J9 is the total jitter at a bit error rate of  $2.5e-10$  (TJ@ $2.5e-10$ ). This measurement is made across the entire record. This measurement requires the DJA option and is not available on a 4 Series MSO instrument.

LOW (Eye Low) is the amplitude of a low (0) bit measured at a user specified location within the recovered unit interval. This measurement is made on each low bit in the record.

LOWTIME (Low Time) is the time the signal remains below the Base reference level (RB). This measurement is made on each cycle in the record.

MAXimum is the maximum data point. This measurement can be made across the entire record, or on each cycle in the record.

MEAN is the arithmetic mean of the data points. This measurement can be made across the entire record, or on each cycle in the record.

MINimum is the minimum data point. This measurement can be made across the entire record, or on each cycle in the record.

NDuty (Negative Duty Cycle) is the ratio of the Negative Pulse Width to the Period. This measurement is made on each cycle in the record.

$$\text{Negative Duty Cycle} = (\text{Negative Width}) / \text{Period} \times 100\%$$

NPERIOD (Duration N-Periods) is the time required to complete N cycles. A cycle is the time between two adjacent (same direction) crossings of the Mid reference level (RM). This measurement is made on each cycle in the record.

NPJ (non-periodic jitter) is the portion of the BUJ (bounded uncorrelated jitter) that is random. BUJ excludes DDJ, DCD and RJ. This measurement is made across the entire record. This measurement requires the DJA option and is not available on a 4 Series MSO instrument.

**NOvershoot** (Negative Overshoot) is the difference between Minimum and Base, divided by the Amplitude. This measurement can be made across the entire record, or on each cycle in the record.

$$\text{Negative Overshoot} = (\text{Base} - \text{Minimum}) / \text{Amplitude} \times 100\%$$

**NWIdth** (Negative Pulse Width) is the time the signal remains below the Mid reference level (RM). This measurement is made on each cycle in the record.

**PDUTY** (Positive Duty Cycle) is the ratio of the Positive Pulse Width to the Period. This measurement is made on each cycle in the record.

$$\text{Positive Duty Cycle} = (\text{Positive Width}) / \text{Period} \times 100\%$$

**PERIOD** is the time required to complete a cycle. A cycle is the time between two adjacent (same direction) crossings of the Mid reference level (RM). This measurement is made on each cycle in the record.

**PHASE** is the ratio of the Skew between two sources to the Period of the first source. This measurement is made on each cycle in the record.

**PHASENOISE** (Phase Noise) is the RMS magnitude of all integrated jitter falling within a user specified offset range of the fundamental clock frequency. This measurement is made across the entire record. This measurement is not available on a 4 Series MSO instrument.

**PJ** (periodic jitter) is the peak-to-peak amplitude of the uncorrelated sinusoidal components of the deterministic jitter. This measurement is made across the entire record. This measurement requires the DJA option and is not available on a 4 Series MSO instrument.

**PK2Pk** (Peak-to-peak) is the difference between Maximum and Minimum. This measurement can be made across the entire record, or on each cycle in the record.

**POVERSHOOT** (Positive Overshoot) is the difference between Maximum and Top, divided by the Amplitude. This measurement can be made across the entire record, or on each cycle in the record.

$$\text{Positive Overshoot} = (\text{Maximum} - \text{Top}) / \text{Amplitude} \times 100\%$$

**PWIDTH** (Positive Pulse Width) is the time the signal remains above the Mid reference level (RM). This measurement is made on each cycle in the record.

**QFACTOR** (Q-Factor) is the ratio of the vertical eye opening to RMS vertical noise measured at a user specified location within the recovered unit interval. This measurement is made across the entire record. This measurement requires the DJA option and is not available on a 4 Series MSO instrument.

**RISESLEWRATE** (Rising Slew Rate) is the rate of change in voltage as an edge transitions from the Base reference level (RB) to the Top reference level (RT). This measurement is made on each cycle in the record.

**RISETIME** Rise Time is the time required for an edge to rise from the Base reference level (RB) to the Top reference level (RT). This measurement is made on each cycle in the record.

**RJ** (random jitter) is the RMS magnitude of all random timing errors following a Gaussian distribution. This measurement is made across the entire record. This measurement requires the DJA option and is not available on a 4 Series MSO instrument.

**RJDIRAC** (dual-dirac random jitter) is random jitter based on a simplifying assumption that the histogram of all deterministic jitter can be modeled as a pair of equal-magnitude Dirac functions. This measurement is made across the entire record. This measurement requires the DJA option and is not available on a 4 Series MSO instrument.

**RMS** is the true Root Mean Square of the data points. This measurement can be made across the entire record, or on each cycle in the record.

**SRJ** (sub-rate jitter) is the composite jitter due to periodic components at 1/2, 1/4 and 1/8 of the data rate. This measurement is made across the entire record. This measurement requires the DJA option and is not available on a 4 Series MSO instrument.

**SSCFREQDEV** (SSC Frequency Deviation) is the spread spectrum clock frequency deviation. This measurement enables a time trend plot of the spread spectrum clock modulation profile. This measurement is made on each cycle in the record. This measurement requires the DJA option and is not available on a 4 Series MSO instrument.

**SSCMODRATE** (SSC Modulation Rate) is the modulating frequency of a spread spectrum clock. This measurement is made on each cycle in the record. This measurement requires the DJA option and is not available on a 4 Series MSO instrument.

**SETUP** (Setup Time) is the time between the specified Mid reference level (RM) crossing on the Data source to the closest specified Mid reference level (RM) crossing on the Clock source. This measurement is made on each specified Clock edge in the record.

**SKEW** Skew is the time between the specified Mid reference level (RM) crossing on one source to the following specified Mid reference level (RM) crossing on a second source. This measurement is made on each cycle in the record.

**TIE** (time interval error) is the difference, in time, between an edge in the source waveform and the corresponding edge in a recovered reference clock. This measurement is made on each edge in the waveform. This measurement is not available on a 4 Series MSO instrument.

**TIMEOUTSIDELEVEL** Time Outside Level is the time the signal remains above the Top reference level (RT) and/or below the Base reference level (RB). This measurement is made on each occurrence in the record.

**TIMETOMAX** Time to Max is the amount of time from the trigger point to the maximum data point. This measurement can be made across the entire record or on each cycle in the record.

**TIMETOMIN** Time to Min is the amount of time from the trigger point to the minimum data point. This measurement can be made across the entire record or on each cycle in the record.

**TJBER** (total jitter at a specified bit error rate) is the predicted peak-to-peak amplitude of jitter that will only be exceeded with a probability equal to the bit error rate. This measurement is made across the entire record. This measurement requires the DJA option and is not available on a 4 Series MSO instrument.

**TNTRATIO** T/nT Ratio is the ratio of a non-transition bit voltage (2nd and subsequent bit voltage after a transition) to its nearest preceding transition bit voltage (1st bit voltage after the transition). Bit voltages are measured at the interpolated midpoint of the recovered unit interval. This measurement is made on each non-transition bit in the record. This measurement requires the DJA option and is not available on a 4 Series MSO instrument.

**TOP** is the most common data value above the midpoint of the waveform. This measurement can be made across the entire record, or on each cycle in the record.

**UNITINTERVAL** (Unit Interval) is the time difference between two successive bits. This measurement is made on each bit in the record.

**VDIFFXOVR** (Differential Crossover) is the voltage level of a differential signal pair at the crossover points. This measurement is made at each crossover point in the record. This measurement requires the DJA option and is not available on a 4 Series MSO instrument.

**WIDTH** (Eye Width) is the minimum horizontal eye opening at the user specified reference level. This measurement is made across the entire record. This measurement requires the DJA option and is not available on a 4 Series MSO instrument.

**WIDTHBER** (Eye Width@BER) is the predicted horizontal eye opening that will be violated with a probability equal to the bit error rate. This measurement is made across the entire record. This measurement requires the DJA option and is not available on a 4 Series MSO instrument.

**Examples**    `MEASUREMENT:ADDMEAS FREQUENCY` adds a frequency measurement.

## MEASUREMENT:ADDNew (No Query Form)

This command adds the specified measurement.

**Group**    Measurement

**Syntax** MEASUREMENT:ADDNew "QString"

**Arguments** "QString" is the measurement to add. The argument is of the form "MEAS<NR1>" where  $NR1 \geq 1$ .

**Examples** MEASUREMENT:ADDNew "MEAS11" adds measurement 11.

## MEASUREMENT:ANNOtate

This command sets or queries the annotation state for measurements.

**Group** Measurement

**Syntax** MEASUREMENT:ANNOtate {OFF|AUTO}  
MEASUREMENT:ANNOtate?

**Arguments** OFF turns off measurement annotations.  
AUTO turns on visible measurement annotations.

**Examples** MEASUREMENT:ANNOtate OFF turns off measurement annotations.  
MEASUREMENT:ANNOtate? might return :MEASUREMENT:ANNOtation:STATE OFF, indicating that no measurement annotations are active.

## MEASUREMENT:AUTOset (No Query Form)

This command performs an analysis jitter autoset.

**Group** Measurement, IMDA, WBG, DPM

**Syntax** MEASUREMENT:AUTOset {EXECute |THREEPHASEAUTOset |WBGPREset  
|DPMAutoSet |DPMPREset}

**Arguments** EXECute performs an analysis jitter autoset.  
THREEPHASEAUTOset performs an IMDA 3 phase autoset.  
WBGPREset performs a measurement specific preset. Requires a WBG-DPT license.



**DPMAutoset** performs a power rail autoset. Requires option 5-DPM (5 Series MSO instruments) or 6-DPM (6 Series MSO instrument).

**DPMReset** performs a power rail preset. Requires option 5-DPM (5 Series MSO instruments) or 6-DPM (6 Series MSO instrument).

**Examples** `MEASUREMENT:AUTOSET EXECUTE` performs an analysis jitter autoset.

`MEASUREMENT:AUTOSET THREEPHASEAUTOSET` performs an IMDA 3 phase autoset.

## MEASUREMENT:CH<x>:REFLEVELS:ABSOLUTE:FALLHIGH

This command sets or queries the value used as the high reference level of the falling edge when the source ref level method is set to absolute. The channel number is specified by x.

**Group** Measurement

**Syntax** `MEASUREMENT:CH<x>:REFLEVELS:ABSOLUTE:FALLHIGH <NR3>`  
`MEASUREMENT:CH<x>:REFLEVELS:ABSOLUTE:FALLHIGH?`

**Arguments** <NR3> is the high reference level, and is the zero percent level when `MEASUREMENT:IMMED:REFLEVEL:METHOD` is set to Absolute.

**Examples** `MEASUREMENT:CH2:REFLEVELS:ABSOLUTE:FALLHIGH 1.5` sets the high reference level of the falling edge to 1.5 V.

`MEASUREMENT:CH2:REFLEVELS:ABSOLUTE:FALLHIGH?` might return `:MEASUREMENT:CH2:REFLEVELS:ABSOLUTE:FALLHIGH 1.0000` indicating that the high reference level of the falling edge is 1.0 V.

## MEASUREMENT:CH<x>:REFLEVELS:ABSOLUTE:FALLLOW

This command sets or queries the value used as the low reference level of the falling edge when the source ref level method is set to absolute. The channel number is specified by x.

**Group** Measurement

**Syntax** `MEASUREMENT:CH<x>:REFLEVELS:ABSOLUTE:FALLLOW <NR3>`  
`MEASUREMENT:CH<x>:REFLEVELS:ABSOLUTE:FALLLOW?`

<b>Arguments</b>	<NR3> is the high reference level, and is the zero percent level when MEASUREMENT:IMMed:REFLevel:METHOD is set to Absolute.
<b>Examples</b>	MEASUREMENT:CH2:REFLEVELS:ABSOLUTE:FALLOW 1.5 sets the low reference level of the falling edge to 1.5 V.  MEASUREMENT:CH2:REFLEVELS:ABSOLUTE:FALLOW? might return :MEASUREMENT:CH2:REFLEVELS:ABSOLUTE:FALLOW 1.5000 indicating that the low reference level of the falling edge is 1.5 V.

## MEASUREMENT:CH<x>:REFLEVELS:ABSOLUTE:FALLMID

This command sets or queries the value used as the mid reference level of the falling edge when the source ref level method is set to absolute. The channel number is specified by x.

<b>Group</b>	Measurement
<b>Syntax</b>	MEASUREMENT:CH<x>:REFLEVELS:ABSOLUTE:FALLMID <NR3> MEASUREMENT:CH<x>:REFLEVELS:ABSOLUTE:FALLMID?
<b>Arguments</b>	<NR3> is the mid reference level used to calculate the mid reference level when the measurement's Ref level method is set to Absolute.
<b>Examples</b>	MEASUREMENT:CH2:REFLEVELS:ABSOLUTE:FALLMID 0 sets the mid reference level of the falling edge to 0.0 V.  MEASUREMENT:CH2:REFLEVELS:ABSOLUTE:FALLMID? might return :MEASUREMENT:CH2:REFLEVELS:ABSOLUTE:FALLMID 0.0E+0 indicating that the mid reference level of the falling edge is 0.0 V.

## MEASUREMENT:CH<x>:REFLEVELS:ABSOLUTE:HYS TERESIS

This command sets or queries the value of the hysteresis of the reference level when the source ref level method is set to absolute. The channel number is specified by x.

<b>Group</b>	Measurement
<b>Syntax</b>	MEASUREMENT:CH<x>:REFLEVELS:ABSOLUTE:HYS TERESIS <NR3> MEASUREMENT:CH<x>:REFLEVELS:ABSOLUTE:HYS TERESIS?

- Arguments** <NR3> is the hysteresis value used for autoset.
- Examples** MEASUREMENT:CH2:REFLEVELS:ABSOLUTE:HYSTERESIS 30.0000E-3 sets the reference hysteresis level to 30 mV.
- :MEASUREMENT:CH2:REFLEVELS:ABSOLUTE:HYSTERESIS? might return  
:MEASUREMENT:CH2:REFLEVELS:ABSOLUTE:HYSTERESIS 30.0000E-3 indicating that reference hysteresis level is set to 30 mV.

## MEASUREMENT:CH<x>:REFLEVELS:ABSOLUTE:RISEHIGH

This command sets or queries the value used as the high reference level of the rising edge when the source ref level method is set to absolute. The channel number is specified by x.

- Group** Measurement
- Syntax** MEASUREMENT:CH<x>:REFLEVELS:ABSOLUTE:RISEHIGH <NR3>  
MEASUREMENT:CH<x>:REFLEVELS:ABSOLUTE:RISEHIGH?
- Arguments** <NR3> is the high reference level of the rising edge when the source ref level method is set to absolute.
- Examples** MEASUREMENT:CH2:REFLEVELS:ABSOLUTE:RISEHIGH 1.5 sets the high reference level of the rising edge to 1.5 V.
- MEASUREMENT:CH2:REFLEVELS:ABSOLUTE:RISEHIGH? might return  
:MEASUREMENT:CH2:REFLEVELS:ABSOLUTE:RISEHIGH 1.0000 indicating that the high reference level of the rising edge is 1.0 V.

## MEASUREMENT:CH<x>:REFLEVELS:ABSOLUTE:RISELOW

This command sets or queries the value used as the low reference level of the rising edge when the source ref level method is set to absolute. The channel number is specified by x.

- Group** Measurement
- Syntax** MEASUREMENT:CH<x>:REFLEVELS:ABSOLUTE:RISELOW <NR3>  
MEASUREMENT:CH<x>:REFLEVELS:ABSOLUTE:RISELOW?

**Arguments** <NR3> is the low reference level of the rising edge when the source ref level method is set to absolute.

**Examples** MEASUREMENT:CH2:REFLEVELS:ABSOLUTE:RISELOW 1.5 sets the low reference level of the rising edge to 1.5 V.  
 MEASUREMENT:CH2:REFLEVELS:ABSOLUTE:RISELOW? might return  
 :MEASUREMENT:CH2:REFLEVELS:ABSOLUTE:RISELOW 1.0000 indicating that the low reference level of the rising edge is 1.0 V.

## MEASUREMENT:CH<x>:REFLEVELS:ABSOLUTE:RISEMID

This command sets or queries the value used as the mid reference level of the rising edge when the source ref level method is set to absolute. The channel number is specified by x.

**Group** Measurement

**Syntax** MEASUREMENT:CH<x>:REFLEVELS:ABSOLUTE:RISEMID <NR3>  
 MEASUREMENT:CH<x>:REFLEVELS:ABSOLUTE:RISEMID?

**Arguments** <NR3> is the mid reference level of the rising edge when the source ref level method is set to absolute.

**Examples** MEASUREMENT:CH2:REFLEVELS:ABSOLUTE:RISEMID 0 sets the mid reference level of the rising edge to 0.0 V.  
 MEASUREMENT:CH2:REFLEVELS:ABSOLUTE:RISEMID? might return  
 :MEASUREMENT:CH2:REFLEVELS:ABSOLUTE:RISEMID 0.0E+0 indicating that the mid reference level of the rising edge is 0.0 V.

## MEASUREMENT:CH<x>:REFLEVELS:ABSOLUTE:TYPE

This command sets or queries the reference level type for the source. The channel number is specified by x.

**Group** Measurement

**Syntax** MEASUREMENT:CH<x>:REFLEVELS:ABSOLUTE:TYPE {SAME|UNIQUE}  
 MEASUREMENT:CH<x>:REFLEVELS:ABSOLUTE:TYPE?

**Arguments** SAME specifies that the absolute reference levels for the specified measurement channel are the same.

UNIQUE specifies that the absolute reference levels for the specified measurement channel are not the same.

**Examples** MEASUREMENT:CH2:REFLEVELS:ABSOLUTE:TYPE SAME set the reference levels to be the same.

MEASUREMENT:CH2:REFLEVELS:ABSOLUTE:TYPE? might return  
:MEASUREMENT:CH2:REFLEVELS:ABSOLUTE:TYPE SAME indicating that the reference levels for absolute measurements are the same.

## MEASUREMENT:CH<x>:REFLEVELS:BASETOP

This command sets or queries the method used to calculate the TOP and BASE, used to calculate reference levels for the measurement. The channel number is specified by x.

**Group** Measurement

**Syntax** MEASUREMENT:CH<x>:REFLEVELS:BASETOP  
{AUTO|MINMAX|MEANHISTOGRAM|MODEHISTOGRAM|EYEHISTOGRAM}  
MEASUREMENT:CH<x>:REFLEVELS:BASETOP?

**Arguments** AUTO automatically chooses a reference level method.

MINMAX specifies that reference levels are relative to the measurement MIN and MAX.

MEANHISTOGRAM specifies that reference levels are relative to the histogram mean BASE and TOP.

MODEHISTOGRAM specifies that reference levels are relative to the histogram mode BASE and TOP.

EYEHISTOGRAM specifies that reference levels are relative to the eye histogram BASE and TOP.

**Examples** MEASUREMENT:CH2:REFLEVELS:BASETOP MINMAX specifies that reference levels are relative to the measurement MIN and MAX.

MEASUREMENT:CH2:REFLEVELS:BASETOP? might return  
:MEASUREMENT:CH2:REFLEVELS:BASETOP AUTO indicating the reference levels are chosen automatically.

## MEASUREMENT:CH<x>:REFLEVELS:METHOD

This command sets or queries the method used to calculate reference levels for the measurement. The channel number is specified by x.

<b>Group</b>	Measurement
<b>Syntax</b>	MEASUREMENT:CH<x>:REFLEVELS:METHOD {PERCENT ABSOLUTE} MEASUREMENT:CH<x>:REFLEVELS:METHOD?
<b>Arguments</b>	PERCENT specifies percent reference level units. ABSOLUTE specifies absolute reference level units.
<b>Examples</b>	MEASUREMENT:CH2:REFLEVELS:METHOD PERCENT sets reference levels to be calculated in percent.  MEASUREMENT:CH2:REFLEVELS:METHOD? might return :MEASUREMENT:CH2:REFLEVELS:METHOD PERCENT indicating the reference levels are calculated in percent.

## MEASUREMENT:CH<x>:REFLEVELS:PERCENT:FALLHIGH

This command sets or queries the percentage (where 100% is equal to TOP and 0% is equal to BASE) used to calculate the high reference level of the falling edge when the source ref level method is set to percent. The channel number is specified by x.

<b>Group</b>	Measurement
<b>Syntax</b>	MEASUREMENT:CH<x>:REFLEVELS:PERCENT:FALLHIGH <NR3> MEASUREMENT:CH<x>:REFLEVELS:PERCENT:FALLHIGH?
<b>Arguments</b>	<NR3> is the percentage (where 100% is equal to TOP) used to calculate the high reference level when the measurement's Ref level method is set to Percent.
<b>Examples</b>	MEASUREMENT:CH2:REFLEVELS:PERCENT:FALLHIGH 90.0000 sets the high reference level for the falling edge to 90%.  MEASUREMENT:CH2:REFLEVELS:PERCENT:FALLHIGH? might return :MEASUREMENT:CH2:REFLEVELS:PERCENT:FALLHIGH 90.0000 indicating the high reference level for the falling edge is set to 90%.

**MEASUREMENT:CH<x>:REFLEVELS:PERCENT:FALLLOW**

This command sets or queries the percentage (where 100% is equal to TOP and 0% is equal to BASE) used to calculate the low reference level of the falling edge when the source ref level method is set to percent. The channel number is specified by x.

<b>Group</b>	Measurement
<b>Syntax</b>	MEASUREMENT:CH<x>:REFLEVELS:PERCENT:FALLLOW <NR3> MEASUREMENT:CH<x>:REFLEVELS:PERCENT:FALLLOW?
<b>Arguments</b>	<NR3> is the percentage (where 100% is equal to TOP) used to calculate the low reference level when the measurement Ref level method is set to Percent.
<b>Examples</b>	MEASUREMENT:CH2:REFLEVELS:PERCENT:FALLLOW 10.0000 sets the reference levels for the falling edge to 10%.  MEASUREMENT:CH2:REFLEVELS:PERCENT:FALLLOW? might return :MEASUREMENT:CH2:REFLEVELS:PERCENT:FALLLOW 10.0000 indicating the reference levels for the falling edge is set to 10%.

**MEASUREMENT:CH<x>:REFLEVELS:PERCENT:FALLMID**

This command sets or queries the percentage (where 100% is equal to TOP and 0% is equal to BASE) used to calculate the mid reference level of the falling edge when the source ref level method is set to percent. The channel number is specified by x.

<b>Group</b>	Measurement
<b>Syntax</b>	MEASUREMENT:CH<x>:REFLEVELS:PERCENT:FALLMID <NR3> MEASUREMENT:CH<x>:REFLEVELS:PERCENT:FALLMID?
<b>Arguments</b>	<NR3> is the percentage (where 50% is equal to MID) used to calculate the mid reference level when the measurement's Ref level method is set to Percent.
<b>Examples</b>	MEASUREMENT:CH2:REFLEVELS:PERCENT:FALLMID 50.0000 sets the MID reference level for the falling edge to 50%.

MEASUREMENT:CH2:REFLEVELS:PERCENT:FALLMID? might return  
:MEASUREMENT:CH2:REFLEVELS:PERCENT:FALLMID 50.0000 indicating the  
MID reference level for the falling edge is set to 50%.

## MEASUREMENT:CH<x>:REFLEVELS:PERCENT:HYSTERESIS

This command sets or queries the percentage (where 100% is equal to MAX and 0% is equal to MIN) used to calculate the hysteresis of the reference level when the measurement ref level method is set to percent. The channel number is specified by x.

<b>Group</b>	Measurement
<b>Syntax</b>	MEASUREMENT:CH<x>:REFLEVELS:PERCENT:HYSTERESIS <NR3> MEASUREMENT:CH<x>:REFLEVELS:PERCENT:HYSTERESIS?
<b>Arguments</b>	<NR3> is the hysteresis value used for the autose.
<b>Examples</b>	MEASUREMENT:CH2:REFLEVELS:PERCENT:HYSTERESIS 5.0000 sets the reference level hysteresis to 5.0 mV.  MEASUREMENT:CH2:REFLEVELS:PERCENT:HYSTERESIS? might return :MEASUREMENT:CH2:REFLEVELS:PERCENT:HYSTERESIS 5.0000 indicating the reference level hysteresis is set to 5.0 mV.

## MEASUREMENT:CH<x>:REFLEVELS:PERCENT:RISEHIGH

This command sets or queries the percentage (where 100% is equal to TOP and 0% is equal to BASE) used to calculate the high reference level of the rising edge when the measurement ref level method is set to percent. The channel number is specified by x.

<b>Group</b>	Measurement
<b>Syntax</b>	MEASUREMENT:CH<x>:REFLEVELS:PERCENT:RISEHIGH <NR3> MEASUREMENT:CH<x>:REFLEVELS:PERCENT:RISEHIGH?
<b>Arguments</b>	<NR3> is the percentage (where 100% is equal to TOP) used to calculate the high reference level when the measurement's Ref level method is set to Percent.



**Examples** MEASUREMENT:CH2:REFLEVELS:PERCENT:RISEHIGH 90.0000 sets the high reference level for the rising edge to 90%.

MEASUREMENT:CH2:REFLEVELS:PERCENT:RISEHIGH? might return  
:MEASUREMENT:CH2:REFLEVELS:PERCENT:RISEHIGH 90.0000 indicating the high reference level for the rising edge is set to 90%.

## MEASUREMENT:CH<x>:REFLEVELS:PERCENT:RISELOW

This command sets or queries the percentage (where 100% is equal to TOP and 0% is equal to BASE) used to calculate the low reference level of the rising edge when the measurement ref level method is set to percent. The channel number is specified by x.

**Group** Measurement

**Syntax** MEASUREMENT:CH<x>:REFLEVELS:PERCENT:RISELOW <NR3>  
MEASUREMENT:CH<x>:REFLEVELS:PERCENT:RISELOW?

**Arguments** <NR3> is the percentage (where 100% is equal to TOP) used to calculate the mid reference level when the measurement's Ref level method is set to Percent.

**Examples** MEASUREMENT:CH2:REFLEVELS:PERCENT:RISELOW 10.0000 sets the reference levels for the rising edge to 10%.

MEASUREMENT:CH2:REFLEVELS:PERCENT:RISELOW? might return  
:MEASUREMENT:CH2:REFLEVELS:PERCENT:RISELOW 10.0000 indicating the reference levels for the rising edge is set to 10%.

## MEASUREMENT:CH<x>:REFLEVELS:PERCENT:RISEMID

This command sets or queries the percentage (where 100% is equal to TOP and 0% is equal to BASE) used to calculate the mid reference level of the rising edge when the measurement ref level method is set to percent. The channel number is specified by x.

**Group** Measurement

**Syntax** MEASUREMENT:CH<x>:REFLEVELS:PERCENT:RISEMID <NR3>  
MEASUREMENT:CH<x>:REFLEVELS:PERCENT:RISEMID?

- Arguments** <NR3> is the percentage (where 50% is equal to MID) used to calculate the mid reference level when the measurement's Ref level method is set to Percent.
- Examples** MEASUREMENT:CH2:REFLEVELS:PERCENT:RISEMID 50.0000 sets the MID reference level for the rising edge to 50%.
- MEASUREMENT:CH2:REFLEVELS:PERCENT:RISEMID? might return  
:MEASUREMENT:CH2:REFLEVELS:PERCENT:RISEMID 50.0000 indicating the MID reference level for the rising edge is set to 50%.

## MEASUREMENT:CH<x>:REFLEVELS:PERCENT:TYPE

This command specifies or queries the reference level percent type for the measurement. The channel number is specified by x.

- Group** Measurement
- Syntax** MEASUREMENT:CH<x>:REFLEVELS:PERCENT:TYPE  
{TENNINETY|TWENTYEIGHTY|CUSTOM}  
MEASUREMENT:CH<x>:REFLEVELS:PERCENT:TYPE?
- Arguments** TENNINETY specifies reference levels at the 10 and 90% levels.  
TWENTYEIGHTY specifies reference levels at the 20 and 80% levels.  
CUSTOM specifies custom reference levels.
- Examples** MEASUREMENT:CH2:REFLEVELS:PERCENT:TYPE TENNINETY sets the reference levels to the 10 and 90% levels.
- MEASUREMENT:CH2:REFLEVELS:PERCENT:TYPE? might return  
:MEASUREMENT:CH2:REFLEVELS:PERCENT:TYPE TWENTYEIGHTY indicating the reference levels are set to the 20 and 80% levels.

## MEASUREMENT:CLOCKRECOVERY:ADVANCED:METHOD

This command sets or queries the global advanced clock recovery method. This will affect measurements whose :MEASUREMENT:MEAS<x>:CLOCKRECOVERY:GLOBAL flag is set to 1.

- Group** Measurement

<b>Syntax</b>	<pre>MEASUREMENT:CLOCKRECOVERY:ADVANCED:METHOD {NONE NOMINAL PATTERN} MEASUREMENT:CLOCKRECOVERY:ADVANCED:METHOD?</pre>
<b>Arguments</b>	<p>NONE sets to use no advanced CRD method.</p> <p>NOMINAL sets the advanced CRD method to Nominal Data Rate.</p> <p>PATTERN sets the advanced CDR method to use a Known Data Pattern.</p>
<b>Examples</b>	<p>MEASUREMENT:CLOCKRECOVERY:ADVANCED:METHOD NOMINAL sets the CDR method to use a Known Data Pattern.</p> <p>MEASUREMENT:CLOCKRECOVERY:ADVANCED:METHOD? might return :MEASUREMENT:CLOCKRECOVERY:ADVANCED:METHOD NONE indicating that no advanced CRD method will be used.</p>

## MEASUREMENT:CLOCKRECOVERY:CLOCKFREQUENCY

This command sets or queries the global clock frequency used when fixed constant clock recovery is used for the measurement. This will affect measurements whose :MEASUREMENT:MEAS<x>:CLOCKRECOVERY:GLOBAL flag is set to 1.

<b>Group</b>	Measurement
<b>Syntax</b>	<pre>MEASUREMENT:CLOCKRECOVERY:CLOCKFREQUENCY &lt;NR3&gt; MEASUREMENT:CLOCKRECOVERY:CLOCKFREQUENCY?</pre>
<b>Arguments</b>	<NR3> is the global clock frequency used with Constant Clock - Fixed clock recovery method.
<b>Examples</b>	<p>MEASUREMENT:CLOCKRECOVERY:CLOCKFREQUENCY 2.0E+9 sets the clock frequency to 2.0 GHz.</p> <p>:MEASUREMENT:CLOCKRECOVERY:CLOCKFREQUENCY? might return :MEASUREMENT:CLOCKRECOVERY:CLOCKFREQUENCY 2.5000E+9 indicating the clock frequency is set to 2.5 GHz.</p>

## MEASUREMENT:CLOCKRECOVERY:CLOCKMULTIPLIER

This command sets or queries the global clock multiplier used when explicit clock recovery is used for the measurement. This will affect measurements whose :MEASUREMENT:MEAS<x>:CLOCKRECOVERY:GLOBAL flag is set to 1.

<b>Group</b>	Measurement
<b>Syntax</b>	MEASUREMENT:CLOCKRECOVERY:CLOCKMULTIPLIER <NR3> MEASUREMENT:CLOCKRECOVERY:CLOCKMULTIPLIER?
<b>Arguments</b>	<NR3> is the global clock multiplier.
<b>Examples</b>	MEASUREMENT:CLOCKRECOVERY:CLOCKMULTIPLIER 1.000 sets the clock multiplier to 1.000.  MEASUREMENT:CLOCKRECOVERY:CLOCKMULTIPLIER? might return :MEASUREMENT:CLOCKRECOVERY:CLOCKMULTIPLIER 1.0000 indicating the clock multiplier is set to 1.0000.

## MEASUREMENT:CLOCKRECOVERY:CONSTCLOCKMODE

This command sets or queries the global constant clock mode used when constant clock recovery is used for the measurement. This will affect measurements whose :MEASUREMENT:MEAS<x>:CLOCKRECOVERY:GLOBAL flag is set to 1.

<b>Group</b>	Measurement
<b>Syntax</b>	MEASUREMENT:CLOCKRECOVERY:CONSTCLOCKMODE {MEAN MEDIan FIXed} MEASUREMENT:CLOCKRECOVERY:CONSTCLOCKMODE?
<b>Arguments</b>	MEAN sets the constant clock mode to MEAN.  MEDIan sets the constant clock mode to MEDIan.  FIXed sets the constant clock mode to FIXed.
<b>Examples</b>	MEASUREMENT:CLOCKRECOVERY:CONSTCLOCKMODE MEAN sets the constant clock mode to MEAN.  MEASUREMENT:CLOCKRECOVERY:CONSTCLOCKMODE? might return :MEASUREMENT:CLOCKRECOVERY:CONSTCLOCKMODE MEAN indicating the constant clock mode is set to MEAN.

## MEASUREMENT:CLOCKRECOVERY:DAMPING

This command sets or queries the global damping value used when PLL clock recovery is used for the measurement. This will affect measurements whose :MEASUREMENT:MEAS<x>:CLOCKRECOVERY:GLOBAL flag is set to 1.

<b>Group</b>	Measurement
<b>Syntax</b>	MEASUREMENT:CLOCKRECOVERY:DAMPING <NR3> MEASUREMENT:CLOCKRECOVERY:DAMPING?
<b>Arguments</b>	<NR3> is the global clock recovery damping value.
<b>Examples</b>	MEASUREMENT:CLOCKRECOVERY:DAMPING :MEASUREMENT:CLOCKRECOVERY:DAMPING? might return :MEASUREMENT:CLOCKRECOVERY:DAMPING 700.0000E-3 indicating the damping value is set to

## MEASUREMENT:CLOCKRECOVERY:DATAPATH

This command sets or queries the global file containing the data pattern used when known data pattern clock recovery is used for the measurement. This will affect measurements whose :MEASUREMENT:MEAS<x>:CLOCKRECOVERY:GLOBAL flag is set to 1.

<b>Group</b>	Measurement
<b>Syntax</b>	MEASUREMENT:CLOCKRECOVERY:DATAPATH <QString> MEASUREMENT:CLOCKRECOVERY:DATAPATH?
<b>Arguments</b>	<QString> is the path and filename, in quotes, of the file containing the data pattern.
<b>Examples</b>	MEASUREMENT:CLOCKRECOVERY:DATAPATH "C:/E:" sets the data path to C:/E.. MEASUREMENT:CLOCKRECOVERY:DATAPATH? might return :MEASUREMENT:CLOCKRECOVERY:DATAPATH "C:/E".

## MEASUREMENT:CLOCKRECOVERY:DATARATE

This command sets or queries the global nominal data bit rate used when nominal data rate clock recovery is used for the measurement. This will affect measurements whose :MEASUREMENT:MEAS<x>:CLOCKRECOVERY:GLOBAL flag is set to 1.

<b>Group</b>	Measurement
<b>Syntax</b>	MEASUREMENT:CLOCKRECOVERY:DATARATE <NR3> MEASUREMENT:CLOCKRECOVERY:DATARATE?
<b>Arguments</b>	<NR3> is the global value for the Nominal data rate.
<b>Examples</b>	MEASUREMENT:CLOCKRECOVERY:DATARATE 2.0e+9 sets the data rate for clock recovery to 2.0 GHz.  MEASUREMENT:CLOCKRECOVERY:DATARATE? might return :MEASUREMENT:CLOCKRECOVERY:DATARATE 2.5000E+9 indicating the data rate is 2.5 GHz.

## MEASUREMENT:CLOCKRECOVERY:EXPLICITCLOCKMODE

This command sets or queries the global explicit clock mode used when explicit clock recovery is used for the measurement. This will affect measurements whose :MEASUREMENT:MEAS<x>:CLOCKRECOVERY:GLOBAL flag is set to 1.

<b>Group</b>	Measurement
<b>Syntax</b>	MEASUREMENT:CLOCKRECOVERY:EXPLICITCLOCKMODE {EDGE PLL} MEASUREMENT:CLOCKRECOVERY:EXPLICITCLOCKMODE?
<b>Arguments</b>	EDGE sets the clock mode to clock edge.  PLL sets the clock mode to phase locked loop.
<b>Examples</b>	MEASUREMENT:CLOCKRECOVERY:EXPLICITCLOCKMODE EDGE sets the clock mode to edge.  MEASUREMENT:CLOCKRECOVERY:EXPLICITCLOCKMODE? might return :MEASUREMENT:CLOCKRECOVERY:EXPLICITCLOCKMODE EDGE indicating the clock mode is edge.

## MEASUREMENT:CLOCKRECOVERY:JTFBANDWIDTH

This command sets or queries the global JTF bandwidth used when PLL clock recovery is used for the measurement. This will affect measurements whose :MEASUREMENT:MEAS<x>:CLOCKRECOVERY:GLOBAL flag is set to 1.

<b>Group</b>	Measurement
<b>Syntax</b>	MEASUREMENT:CLOCKRECOVERY:JTFBANDWIDTH <NR3> MEASUREMENT:CLOCKRECOVERY:JTFBANDWIDTH?
<b>Arguments</b>	<NR3> is the global clock recovery JTF bandwidth.
<b>Examples</b>	MEASUREMENT:CLOCKRECOVERY:JTFBANDWIDTH 2.0e6 sets the bandwidth to 2.0 MHz.  MEASUREMENT:CLOCKRECOVERY:JTFBANDWIDTH? might return :MEASUREMENT:CLOCKRECOVERY:JTFBANDWIDTH 1.0000E+6 indicating the bandwidth is 1.0 MHz.

## MEASUREMENT:CLOCKRECOVERY:LOOPBANDWIDTH

This command sets or queries the global loop bandwidth used when PLL clock recovery is used for the measurement. This will affect measurements whose :MEASUREMENT:MEAS<x>:CLOCKRECOVERY:GLOBAL flag is set to 1.

<b>Group</b>	Measurement
<b>Syntax</b>	MEASUREMENT:CLOCKRECOVERY:LOOPBANDWIDTH <NR3> MEASUREMENT:CLOCKRECOVERY:LOOPBANDWIDTH?
<b>Arguments</b>	<NR3> is the global loop bandwidth.
<b>Examples</b>	MEASUREMENT:CLOCKRECOVERY:LOOPBANDWIDTH 2.0e6 sets the loop bandwidth to 2.0 MHz.  MEASUREMENT:CLOCKRECOVERY:LOOPBANDWIDTH? might return :MEASUREMENT:CLOCKRECOVERY:LOOPBANDWIDTH 1.0000E+6 indicating the loop bandwidth is 1.0 MHz.

## MEASUREMENT:CLOCKRECOVERY:MEANAUTOCALCULATE

This command sets or queries how often the clock is calculated when constant clock recovery is used for the measurement. This will affect measurements whose :MEASUREMENT:MEAS<x>:CLOCKRECOVERY:GLOBAL flag is set to 1.

<b>Group</b>	Measurement
<b>Syntax</b>	MEASUREMENT:CLOCKRECOVERY:MEANAUTOCALCULATE {FIRST EVERY} MEASUREMENT:CLOCKRECOVERY:MEANAUTOCALCULATE?
<b>Arguments</b>	FIRST calculates the clock on the first acquisition.  EVERY calculates the clock on every acquisition.
<b>Examples</b>	MEASUREMENT:CLOCKRECOVERY:MEANAUTOCALCULATE EVERY calculates the clock on every acquisition.  MEASUREMENT:CLOCKRECOVERY:MEANAUTOCALCULATE? might return :MEASUREMENT:CLOCKRECOVERY:MEANAUTOCALCULATE FIRST indicating the clock is calculated on the first acquisition.

## MEASUREMENT:CLOCKRECOVERY:METHOd

This command sets or queries the global clock recovery method for the measurement. This will affect measurements whose :MEASUREMENT:MEAS<x>:CLOCKRECOVERY:GLOBAL flag is set to 1.

<b>Group</b>	Measurement
<b>Syntax</b>	MEASUREMENT:CLOCKRECOVERY:METHOd {PLL CONSTANTCLOCK EXPLICITCLOCK} MEASUREMENT:CLOCKRECOVERY:METHOd?
<b>Arguments</b>	PLL specifies using the phase locked loop.  CONSTANTCLOCK specifies using a constant clock.  EXPLICITCLOCK specifies using an explicit clock.
<b>Examples</b>	MEASUREMENT:CLOCKRECOVERY:METHOd EXPLICITCLOCK specifies using an explicit clock.



MEASUREMENT:CLOCKRECOVERY:METHOd? might return  
:MEASUREMENT:CLOCKRECOVERY:METHOd PLL indicating the  
method is set to PLL.

## MEASUREMENT:CLOCKRECOVERY:MODEl

This command sets or queries the global phase locked loop (PLL) clock recovery model used when PLL clock recovery is used for the measurement. This will affect measurements whose :MEASUREMENT:MEAS<x>:CLOCKRECOVERY:GLOBal flag is set to 1.

<b>Group</b>	Measurement
<b>Syntax</b>	MEASUREMENT:CLOCKRECOVERY:MODEl {TYPE1 TYPE2} MEASUREMENT:CLOCKRECOVERY:MODEl?
<b>Arguments</b>	TYPE1 PLL clock recovery uses PLL model type I. TYPE2 PLL clock recovery uses PLL model type II.
<b>Examples</b>	MEASUREMENT:CLOCKRECOVERY:MODEL TYPE2 sets the model to type 2. MEASUREMENT:CLOCKRECOVERY:MODEL? might return :MEASUREMENT:CLOCKRECOVERY:MODEL TYPE1 indicating the recovery model is type 1.

## MEASUREMENT:CLOCKRECOVERY:NOMINALOFFset

This command sets or queries the global offset value used when explicit clock recovery is used for the measurement. This will affect measurements whose :MEASUREMENT:MEAS<x>:CLOCKRECOVERY:GLOBal flag is set to 1.

<b>Group</b>	Measurement
<b>Syntax</b>	MEASUREMENT:CLOCKRECOVERY:NOMINALOFFset <NR3> MEASUREMENT:CLOCKRECOVERY:NOMINALOFFset?
<b>Arguments</b>	<NR3> is the global clock offset.

**Examples**     `MEASUREMENT:CLOCKRECOVERY:NOMINALOFFSET 1.0` sets the offset to 1.0.  
`MEASUREMENT:CLOCKRECOVERY:NOMINALOFFSET?` might return  
`:MEASUREMENT:CLOCKRECOVERY:NOMINALOFFSET 0.0E+0` indicating the  
offset is set to 0.0.

## MEASUREMENT:CLOCKRECOVERY:NOMINALOFFSET:SELECTIONTYPE

This command sets or queries the global offset type used when explicit clock recovery is used for the measurement. This will affect measurements whose `:MEASUREMENT:MEAS<x>:CLOCKRECOVERY:GLOBAL` flag is set to 1.

**Group**     Measurement

**Syntax**     `MEASUREMENT:CLOCKRECOVERY:NOMINALOFFSET:SELECTIONTYPE`  
`{AUTO|MANUAL}`  
`MEASUREMENT:CLOCKRECOVERY:NOMINALOFFSET:SELECTIONTYPE?`

**Arguments**     `AUTO` sets the selection type to `AUTO`.  
`MANUAL` sets the selection type to `MANUAL`.

**Examples**     `MEASUREMENT:CLOCKRECOVERY:NOMINALOFFSET:SELECTIONTYPE AUTO`  
sets the selection type to `auto`.  
`MEASUREMENT:CLOCKRECOVERY:NOMINALOFFSET:SELECTIONTYPE?` might  
return `:MEASUREMENT:CLOCKRECOVERY:NOMINALOFFSET:SELECTIONTYPE`  
`MANUAL` indicating the selection type is `manual`.

## MEASUREMENT:CLOCKRECOVERY:STANDARD

This command sets or queries the global communications standard used when PLL clock recovery is used for the measurement. This will affect measurements whose `:MEASUREMENT:MEAS<x>:CLOCKRECOVERY:GLOBAL` flag is set to 1.

**Group**     Measurement

**Syntax**     `MEASUREMENT:CLOCKRECOVERY:STANDARD`  
`{CUSTOM|ENET100|FW1394BS400B|FW1394BS800B|`  
`FW1394BS1600B|FBD1|FBD2|FBD3|FC133|FC266|`  
`FC531|FC1063|FC2125|FC4250|FC8500|ENET1000|`  
`IBA2500|IBA_GEN2|OC1|OC3|OC12|OC48|PCIE_GEN1|`  
`PCIE_GEN2|PCIE_GEN3|RIO125|RIO250|RIO3125|`

SAS15\_NOSSC | SAS3\_NOSSC | SAS6\_NOSSC | SAS12\_NOSSC |  
 SAS15\_SSC | SAS3\_SSC | SAS6\_SSC | SAS12\_SSC | SATA\_GEN1 |  
 SATA\_GEN2 | SATA\_GEN3 | USB3 | XAUI | XAUI\_GEN2 }  
 MEASUREMENT:CLOCKRECOVERY:STANDARD?

**Arguments** Arguments are the global clock recovery standards.

**Examples** MEASUREMENT:CLOCKRECOVERY:STANDARD PCIE\_GEN3 sets the standard to PCIE\_GEN3.

MEASUREMENT:CLOCKRECOVERY:STANDARD? might return  
 :MEASUREMENT:CLOCKRECOVERY:STANDARD PCIE\_GEN1 indicating  
 the standard is set to PCIE\_GEN1.

## MEASUREMENT:DELETE (No Query Form)

The command deletes the specified measurement.

**Group** Measurement

**Syntax** MEASUREMENT:DELETE <QString>

**Arguments** <QString> is the measurement to delete. Argument is of the form "MEAS<NR1>" where <NR1> is  $\geq 1$ .

**Examples** MEASUREMENT:DELETE "MEAS4" deletes measurement 4.

## MEASUREMENT:DELETEALL (No Query Form)

This command deletes all the active instances of measurements defined in the scope application.

**Group** Measurement

**Syntax** MEASUREMENT:DELETEALL

**Examples** MEASUREMENT:DELETEALL deletes all the active instances of measurements.

## MEASUREMENT:DIRACMODEL

This command sets or queries the dirac model used to separate random from deterministic jitter for jitter measurements.

<b>Group</b>	Measurement
<b>Syntax</b>	MEASUREMENT:DIRACMODEL {PCIExpress FIBREchannel} MEASUREMENT:DIRACMODEL?
<b>Arguments</b>	PCIExpress specifies the PCIExpress dirac model. FIBREchannel specifies the FIBREchannel dirac model.
<b>Examples</b>	MEASUREMENT:DIRACMODEL FIBRECHANNEL sets the dirac model to FIBRECHANNEL. MEASUREMENT:DIRACMODEL? might return :MEASUREMENT:DIRACMODEL PCIEXPRESS indicating the dirac model is set to PCIECPRESS.

## MEASUREMENT:DISPLAYUNITS

This command sets or queries the display units used for jitter summary measurements.

<b>Group</b>	Measurement
<b>Syntax</b>	MEASUREMENT:DISPLAYUNITS {SECONDS UNITINTERVALS} MEASUREMENT:DISPLAYUNITS?
<b>Arguments</b>	SECONDS set the display units to seconds. UNITINTERVALS set the display units to unit intervals.
<b>Examples</b>	MEASUREMENT:DISPLAYUNITS UNITINTERVALS sets the display units to unit intervals. MEASUREMENT:DISPLAYUNITS? might return :MEASUREMENT:DISPLAYUNITS SECONDS indicating the display units are seconds.

## MEASUREMENT:EDGE<x>

This command sets or queries the type of the edge for the measurement.

<b>Group</b>	Measurement
<b>Syntax</b>	MEASUREMENT:EDGE<x> {RISE   FALL   BOTH} MEASUREMENT:EDGE<x>?
<b>Arguments</b>	FALL specifies the falling edge of the waveform. RISE specifies the rising edge of the waveform. BOTH specifies both a rising and falling edge of the waveform.
<b>Examples</b>	MEASUREMENT:EDGE2 MEASUREMENT:EDGE2? might return :MEASUREMENT:EDGE2 BOTH indicating

## MEASUREMENT:EYERENDER

This command sets or queries the state of high-performance eye rendering for an eye diagram.

<b>Group</b>	Measurement
<b>Syntax</b>	MEASUREMENT:EYERENDER {<NR1>   OFF   ON} MEASUREMENT:EYERENDER?
<b>Arguments</b>	<NR1> = 0 disables high-performance eye rendering for an eye diagram; any other value turns this feature on. OFF disables high-performance eye rendering for an eye diagram. ON enables high-performance eye rendering for an eye diagram.
<b>Examples</b>	MEASUREMENT:EYERENDER MEASUREMENT:EYERENDER? might return :MEASUREMENT:EYERENDER 1 indicating high-performance eye rendering is on.

## MEASUREMENT:FILTERS:BLANKINGTIME

This command sets or queries the global filter blanking time.

<b>Group</b>	Measurement
<b>Syntax</b>	MEASUREMENT:FILTERS:BLANKINGTIME <NR3> MEASUREMENT:FILTERS:BLANKINGTIME?
<b>Arguments</b>	<NR3> is the current filter blanking time.
<b>Examples</b>	MEASUREMENT:FILTERS:BLANKINGTIME 3.0 sets the blanking time to 3.0. MEASUREMENT:FILTERS:BLANKINGTIME? might return :MEASUREMENT:FILTERS:BLANKINGTIME 4.0000 indicating the blanking time is 4.0.

## MEASUREMENT:FILTERS:HIGHPASS:FREQ

This command sets or queries the global high pass filter frequency for the measurement.

<b>Group</b>	Measurement
<b>Syntax</b>	MEASUREMENT:FILTERS:HIGHPASS:FREQ <NR3> MEASUREMENT:FILTERS:HIGHPASS:FREQ?
<b>Arguments</b>	<NR3> is the current high pass filter frequency.
<b>Examples</b>	MEASUREMENT:FILTERS:HIGHPASS:FREQ 20.0e6 sets the frequency to 20 MHz. MEASUREMENT:FILTERS:HIGHPASS:FREQ? might return :MEASUREMENT:FILTERS:HIGHPASS:FREQ 10.0000E+6 indicating the filter frequency is set to 10.0 MHz.

## MEASUREMENT:FILTERS:HIGHPASS:SPEC

This command sets or queries the global high pass filter order for the measurement.

<b>Group</b>	Measurement
<b>Syntax</b>	MEASUREMENT:FILTERS:HIGHPASS:SPEC {NONE FIRST SECOND THIRD} MEASUREMENT:FILTERS:HIGHPASS:SPEC?
<b>Arguments</b>	NONE specifies no high pass filter. FIRST specifies a first order high pass filter. SECOND specifies a second order high pass filter. THIRD specifies a third order high pass filter.
<b>Examples</b>	MEASUREMENT:FILTERS:HIGHPASS:SPEC NONE specifies no high pass filter. MEASUREMENT:FILTERS:HIGHPASS:SPEC? might return :MEASUREMENT:FILTERS:HIGHPASS:SPEC SECOND indicating a second order high pass filter.

## MEASUREMENT:FILTERS:LOWPASS:FREQ

This command sets or queries the global low pass filter cutoff frequency for the measurement.

<b>Group</b>	Measurement
<b>Syntax</b>	MEASUREMENT:FILTERS:LOWPASS:FREQ <NR3> MEASUREMENT:FILTERS:LOWPASS:FREQ?
<b>Arguments</b>	<NR3> is the current low pass filter frequency.
<b>Examples</b>	MEASUREMENT:FILTERS:LOWPASS:FREQ 20.0e6 sets the low pass frequency to 20 MHz. MEASUREMENT:FILTERS:LOWPASS:FREQ? might return :MEASUREMENT:FILTERS:LOWPASS:FREQ 10.0000E+6 indicating the low pass frequency is 10.0 MHz.

## MEASUREMENT:FILTERS:LOWPASS:SPEC

This command sets or queries the global low pass filter order for the measurement.

<b>Group</b>	Measurement
<b>Syntax</b>	MEASUREMENT:FILTERS:LOWPASS:SPEC {NONE FIRST SECOND THIRD} MEASUREMENT:FILTERS:LOWPASS:SPEC?
<b>Arguments</b>	NONE specifies no low pass filter. FIRST specifies a first order low pass filter. SECOND specifies a second order low pass filter. THIRD specifies a third order low pass filter.
<b>Examples</b>	MEASUREMENT:FILTERS:LOWPASS:SPEC SECOND specifies a second order low pass filter. MEASUREMENT:FILTERS:LOWPASS:SPEC? might return :MEASUREMENT:FILTERS:LOWPASS:SPEC NONE indicating no low pass filter.

## MEASUREMENT:FILTERS:RAMPTIME

This command sets or queries the global filter ramp time for the measurement.

<b>Group</b>	Measurement
<b>Syntax</b>	MEASUREMENT:FILTERS:RAMPTIME <NR3> MEASUREMENT:FILTERS:RAMPTIME?
<b>Arguments</b>	<NR3> is the current filter ramp time.
<b>Examples</b>	MEASUREMENT:FILTERS:RAMPTIME 3.0 sets the ramp time to 3.0. MEASUREMENT:FILTERS:RAMPTIME? might return :MEASUREMENT:FILTERS:RAMPTIME 2.0000 indicating the ramp time is 2.0.

## MEASUREMENT:GATING

This command sets or queries the global gating type for the measurement.

<b>Group</b>	Measurement
--------------	-------------



**Syntax** MEASUREMENT:GATING {NONE|SCREEN|CURSOR|LOGIC|SEARCH|TIME}  
MEASUREMENT:GATING?

**Related Commands** [MEASUREMENT:GATING:ENDTIME](#)  
[MEASUREMENT:GATING:STARTTIME](#)

**Arguments** NONE turns off measurement gating.  
SCREEN turns on gating, using the left and right edges of the screen.  
CURSOR limits measurements to the portion of the waveform between the vertical bar cursors, even if they are off screen.  
LOGIC specifies that measurements are taken only on the portion of the waveform where the logic source is in the active state.  
SEARCH specifies that measurements are taken based on search criteria.  
TIME limits measurements to the portion of the waveform between the Start and End gate times

**Examples** MEASUREMENT:GATING SCREEN turns on measurement gating, using the left and right edges of the screen.  
MEASUREMENT:GATING? might return :MEASUREMENT:GATING CURSOR, indicating that measurements are limited to the portion of the waveform between the vertical bar cursors.

## MEASUREMENT:GATING:ACTIVE

This command sets or queries the global gating active level used for logic gating.

**Group** Measurement

**Syntax** MEASUREMENT:GATING:ACTIVE {HIGH|LOW}  
MEASUREMENT:GATING:ACTIVE?

**Arguments** HIGH specifies the gate is HIGH.  
LOW specifies the gate is LOW.

**Examples**    `MEASUREMENT:GATING:ACTIVE LOW` specifies a low gate.  
`MEASUREMENT:GATING:ACTIVE?` might return  
`:MEASUREMENT:GATING:ACTIVE HIGH` indicating the gate is high.

## MEASUREMENT:GATING:ENDtime

Sets or queries the end gate time for all measurements that use Global gating.

**Group**    Measurement

**Syntax**    `MEASUREMENT:GATING:ENDtime <NR3>`  
`MEASUREMENT:GATING:ENDtime?`

**Related Commands**    [MEASUREMENT:GATING](#)

**Arguments**    `<NR3>` is the time gating end gate time in seconds. The valid range is -10000 s to 10000 s.

**Examples**    `MEASUREMENT:GATING:ENDtime 5.31e-2` sets the global end gate time to 53.1 ms.  
`MEASUREMENT:GATING:ENDtime?` might return 1.05 indicating that the global end gate time is 1.05 s

## MEASUREMENT:GATING:HYSteresis

This command sets or queries the global gating hysteresis value used for logic gating.

**Group**    Measurement

**Syntax**    `MEASUREMENT:GATING:HYSteresis <NR3>`  
`MEASUREMENT:GATING:HYSteresis?`

**Arguments**    `<NR3>` is the gating hysteresis.

**Examples** MEASUREMENT:GATING:HYSTERESIS 40.0e-3 sets the hysteresis to 40 mV.  
 MEASUREMENT:GATING:HYSTERESIS? might return  
 :MEASUREMENT:GATING:HYSTERESIS 30.0000E-3 indicating the hysteresis  
 is 30 mV.

## MEASUREMENT:GATING:LOGICSource

This command sets or queries the gating data source used for logic gating.

**Group** Measurement

**Syntax** MEASUREMENT:GATING:LOGICSource  
 {S<x>\_Ch<x>|CH<x>|MATH<x>|REF<x>}  
 MEASUREMENT:GATING:LOGICSource?

**Arguments** S<x>\_Ch<x> specifies the remote scope number and the analog channel as the source.  
 CH<x> specifies an analog channel as the source.  
 Math<x> specifies a math waveform as the source.  
 REF<x> specifies a reference waveform as the source.

**Examples** MEASUREMENT:GATING:LOGICSOURCE MATH1 sets the logic source to MATH 1.  
 MEASUREMENT:GATING:LOGICSOURCE? might return  
 :MEASUREMENT:GATING:LOGICSOURCE CH6 indicating the logic source is  
 channel 6.

## MEASUREMENT:GATING:MIDRef

This command sets or queries the global gating mid ref value used for logic gating.

**Group** Measurement

**Syntax** MEASUREMENT:GATING:MIDRef <NR3>  
 MEASUREMENT:GATING:MIDRef?

**Arguments** <NR3> is the mid ref value for gating.

**Examples**    `MEASUREMENT:GATING:MIDREF 2.0` set the gating mid ref to 2.0 V.  
`MEASUREMENT:GATING:MIDREF?` might return  
`:MEASUREMENT:GATING:MIDREF 1.5000` indicating the gating mid ref is 1.5 V.

## MEASUREMENT:GATING:SEARCHSOURCE

This command sets or queries the global gating search source when the gating type is search.

**Group**    Measurement

**Syntax**    `MEASUREMENT:GATING:SEARCHSOURCE SEARCH1`  
`MEASUREMENT:GATING:SEARCHSOURCE?`

**Arguments**    Argument is the search source.

**Examples**    `MEASUREMENT:GATING:SEARCHSOURCE SEARCH1` set the search source to search 1.  
`MEASUREMENT:GATING:SEARCHSOURCE?` might return  
`:MEASUREMENT:GATING:SEARCHSOURCE UNDEFINED` indicating the search source is not defined.

## MEASUREMENT:GATING:STARTTIME

Sets or queries the start gate time for all measurements that use Global gating.

**Group**    Measurement

**Syntax**    `MEASUREMENT:GATING:STARTTIME <NR3>`  
`MEASUREMENT:GATING:STARTTIME?`

**Related Commands**    [MEASUREMENT:GATING](#)

**Arguments**    <NR3> is the time gating start gate time in seconds. The valid range is -10000 s to 10000 s.

**Examples**    `MEASUREMENT:GATING:STARTTIME -1.5e-3` sets the global start gate time to -1.5 ms.

MEASUREMENT:GATING:STARTtime? might return 3.0e-9, indicating that the global start gate time is 3 ns.

## MEASUREMENT:HIGHEVEL:CONFIGURATION

This command sets or queries the global input and output configuration.

<b>Group</b>	Measurement, IMDA
<b>Syntax</b>	MEASUREMENT:HIGHEVEL:CONFIGURATION {INPUT OUTPUT} MEASUREMENT:HIGHEVEL:CONFIGURATION?
<b>Arguments</b>	INPUT specifies the source settings configuration as input. OUTPUT specifies the source settings configuration as output.
<b>Examples</b>	MEASUREMENT:HIGHEVEL:CONFIGURATION INPUT sets the source settings configuration as input.  MEASUREMENT:HIGHEVEL:CONFIGURATION? might return :MEASUREMENT:HIGHEVEL:CONFIGURATION INPUT, indicating the source settings configuration is input.

## MEASUREMENT:HIGHEVEL:EDGEQUALIFIER

This command sets or queries global input edge qualifier source.

<b>Group</b>	Measurement, IMDA
<b>Syntax</b>	MEASUREMENT:HIGHEVEL:EDGEQUALIFIER {S<x>_Ch<x> CH<x> MATH<x> REF<x>} MEASUREMENT:HIGHEVEL:EDGEQUALIFIER?
<b>Arguments</b>	S<x>_Ch<x> specifies the remote scope number and the analog channel as the source.  CH<x> specifies an analog channel as the source.  Math<x> specifies a math waveform as the source.  REF<x> specifies a reference waveform as the source.

**Examples**    `MEASUREMENT:HIGHLEVEL:EDGEQUALIFIER CH1` sets the global input edge qualifier source as channel 1.

`MEASUREMENT:HIGHLEVEL:EDGEQUALIFIER?` might return  
`:MEASUREMENT:HIGHLEVEL:EDGEQUALIFIER CH1`, indicating the global input edge qualifier source is channel 1.

## MEASUREMENT:HIGHLEVEL:INLOWPASS:FREQ

This command sets or queries global input low pass filter frequency.

**Group**    Measurement, IMDA

**Syntax**    `MEASUREMENT:HIGHLEVEL:INLOWPASS:FREQ <NR3>`  
`MEASUREMENT:HIGHLEVEL:INLOWPASS:FREQ?`

**Arguments**    `<NR3>` specifies the global input low pass filter frequency. The argument range is 20 Hz to 10e6 Hz.

**Examples**    `MEASUREMENT:HIGHLEVEL:INLOWPASS:FREQ 1e3` sets the global input low pass filter frequency as 1e3 Hz.

`MEASUREMENT:HIGHLEVEL:INLOWPASS:FREQ?` might return  
`:MEASUREMENT:HIGHLEVEL:INLOWPASS:FREQ 1e3`, indicating the global input low pass filter frequency is 1e3 Hz.

## MEASUREMENT:HIGHLEVEL:INLOWPASS:SPEC

This command sets or queries global input low pass filter order.

**Group**    Measurement, IMDA

**Syntax**    `MEASUREMENT:HIGHLEVEL:INLOWPASS:SPEC`  
`{NONE|FIRST|SECOND|THIRD}`  
`MEASUREMENT:HIGHLEVEL:INLOWPASS:SPEC?`

**Arguments**    `NONE` specifies the global input low pass filter order as none.  
`FIRST` specifies the global input low pass filter order as first.  
`SECOND` specifies the global input low pass filter order as second.  
`THIRD` specifies the global input low pass filter order as third.

**Examples**    `MEASUREMENT:HIGHLEVEL:INLOWPASS:SPEC FIRST` sets the global input low pass filter order as first.

`MEASUREMENT:HIGHLEVEL:INLOWPASS:SPEC?` might return `:MEASUREMENT:HIGHLEVEL:INLOWPASS:SPEC FIRST`, indicating the global input low pass filter order is first.

## MEASUREMENT:HIGHLEVEL:L2LTOL2N

This command enables the Line-to-Line to Line-to-Neutral Conversion.

**Group**    Measurement, IMDA

**Syntax**    `MEASUREMENT:HIGHLEVEL:L2LTOL2N {0|1}`  
`MEASUREMENT:HIGHLEVEL:L2LTOL2N?`

**Examples**    `MEASUREMENT:HIGHLEVEL:L2LTOL2N 1` enables Line-to-Line to Line-to-Neutral Conversion.

`MEASUREMENT:HIGHLEVEL:L2LTOL2N?` might return `:MEASUREMENT:HIGHLEVEL:L2LTOL2N 0`, indicating Line-to-Line to Line-to-Neutral Conversion is disabled.

## MEASUREMENT:HIGHLEVEL:LINESELECTED

This command sets or queries global input select lines.

**Group**    Measurement, IMDA

**Syntax**    `MEASUREMENT:HIGHLEVEL:LINESELECTED {ABCB|ACBC|BACA|AN|BN|CN}`  
`MEASUREMENT:HIGHLEVEL:LINESELECTED?`

**Arguments**    `ABCB` specifies the global input select lines as ABCB.  
`ACBC` specifies the global input select lines as ACBC.  
`BACA` specifies the global input select lines as BACA.  
`AN` specifies the global input select lines as AN.  
`BN` specifies the global input select lines as BN.  
`CN` specifies the global input select lines as CN.

**Examples**    `MEASUREMENT:HIGHLEVEL:LINESELECTED ABCB` sets the global input select lines as ABCB.

`MEASUREMENT:HIGHLEVEL:LINESELECTED?` might return `:MEASUREMENT:HIGHLEVEL:LINESELECTED ABCB`, indicating the global input select lines is ABCB.

## **MEASUREMENT:HIGHLEVEL:OUTEDGEQUALIFIER**

This command sets or queries global output edge qualifier source.

**Group**    Measurement, IMDA

**Syntax**    `MEASUREMENT:HIGHLEVEL:OUTEDGEQUALIFIER`  
`{S<x>_Ch<x>|CH<x>|MATH<x>|REF<x>}`  
`MEASUREMENT:HIGHLEVEL:OUTEDGEQUALIFIER?`

**Arguments**    `S<x>_Ch<x>` specifies the remote scope number and the analog channel as the source.

`CH<x>` specifies an analog channel as the source.

`Math<x>` specifies a math waveform as the source.

`REF<x>` specifies a reference waveform as the source.

**Examples**    `MEASUREMENT:HIGHLEVEL:OUTEDGEQUALIFIER CH1` sets the global output edge qualifier source as channel 1.

`MEASUREMENT:HIGHLEVEL:OUTEDGEQUALIFIER?` might return `:MEASUREMENT:HIGHLEVEL:OUTEDGEQUALIFIER CH1`, indicating the global output edge qualifier source is channel 1.

## **MEASUREMENT:HIGHLEVEL:OUTLOWPASS:FREQ**

This command sets or queries global output low pass filter frequency.

**Group**    Measurement, IMDA

**Syntax**    `MEASUREMENT:HIGHLEVEL:OUTLOWPASS:FREQ <NR3>`  
`MEASUREMENT:HIGHLEVEL:OUTLOWPASS:FREQ?`



**Arguments** <NR3> specifies the global output low pass filter frequency. The argument range is 20 Hz to 10e6 Hz.

**Examples** MEASUREMENT:HIGHLEVEL:OUTLOWPASS:FREQ 1e3 sets the global output low pass filter frequency as 1e3 Hz.

MEASUREMENT:HIGHLEVEL:OUTLOWPASS:FREQ? might return  
:MEASUREMENT:HIGHLEVEL:OUTLOWPASS:FREQ 1e3, indicating the global output low pass filter frequency is 1e3 Hz.

## MEASUREMENT:HIGHLEVEL:OUTLOWPASS:SPEC

This command sets or queries global output low pass filter order.

**Group** Measurement, IMDA

**Syntax** MEASUREMENT:HIGHLEVEL:OUTLOWPASS:SPEC  
{NONE|FIRST|SECOND|THIRD}  
MEASUREMENT:HIGHLEVEL:OUTLOWPASS:SPEC?

**Arguments** NONE specifies the global output low pass filter order as none.  
FIRST specifies the global output low pass filter order as first.  
SECOND specifies the global output low pass filter order as second.  
THIRD specifies the global output low pass filter order as third.

**Examples** MEASUREMENT:HIGHLEVEL:OUTLOWPASS:SPEC FIRST sets the global output low pass filter order as first.

MEASUREMENT:HIGHLEVEL:OUTLOWPASS:SPEC? might return  
:MEASUREMENT:HIGHLEVEL:OUTLOWPASS:SPEC FIRST, indicating the global output low pass filter order is first.

## MEASUREMENT:HIGHLEVEL:OUTL2LTOL2N

This command sets or queries global output Line-to-Line to Line-to-Neutral Conversion.

**Group** Measurement, IMDA

**Syntax**    `MEASUREMENT:HIGHLEVEL:OUTL2LTOL2N {0|1}`  
`MEASUREMENT:HIGHLEVEL:OUTL2LTOL2N?`

**Examples**    `MEASUREMENT:HIGHLEVEL:OUTL2LTOL2N 1` enables global output Line-to-Line to Line-to-Neutral Conversion.

`MEASUREMENT:HIGHLEVEL:OUTL2LTOL2N?` might return  
`:MEASUREMENT:HIGHLEVEL:OUTL2LTOL2N 0`, indicating global output Line-to-Line to Line-to-Neutral Conversion is disabled.

## MEASUREMENT:HIGHLEVEL:OUTLINESELECTED

This command sets or queries global output select lines.

**Group**    Measurement, IMDA

**Syntax**    `MEASUREMENT:HIGHLEVEL:OUTLINESELECTED`  
`{XYZY|XZYX|YXZX|XN|YN|ZN}`  
`MEASUREMENT:HIGHLEVEL:OUTLINESELECTED?`

**Arguments**    `XYZY` specifies the global output select lines as `XYZY`.  
`XZYX` specifies the global output select lines as `XZYX`.  
`YXZX` specifies the global output select lines as `YXZX`.  
`XN` specifies the global output select lines as `XN`.  
`YN` specifies the global output select lines as `YN`.  
`ZN` specifies the global output select lines as `ZN`.

**Examples**    `MEASUREMENT:HIGHLEVEL:OUTLINESELECTED XYZY` sets the global output select lines as `XYZY`.  
`MEASUREMENT:HIGHLEVEL:OUTLINESELECTED?` might return  
`:MEASUREMENT:HIGHLEVEL:OUTLINESELECTED XYZY`, indicating the global output select lines is `XYZY`.

## MEASUREMENT:HIGHLEVEL:OUTSOURCE

This command sets or queries global output source.

**Group**    Measurement, IMDA

<b>Syntax</b>	<pre>MEASUREMENT:HIGLEVEL:OUTSOURCE {S&lt;x&gt;_Ch&lt;x&gt; CH&lt;x&gt; MATH&lt;x&gt; REF&lt;x&gt;} MEASUREMENT:HIGLEVEL:OUTSOURCE?</pre>
<b>Arguments</b>	<p>S&lt;x&gt;_Ch&lt;x&gt; specifies the remote scope number and the analog channel as the source.</p> <p>CH&lt;x&gt; specifies an analog channel as the source.</p> <p>Math&lt;x&gt; specifies a math waveform as the source.</p> <p>REF&lt;x&gt; specifies a reference waveform as the source.</p>
<b>Examples</b>	<p>MEASUREMENT:HIGLEVEL:OUTSOURCE CH1 sets the global output source as channel 1.</p> <p>MEASUREMENT:HIGLEVEL:OUTSOURCE? might return :MEASUREMENT:HIGLEVEL:OUTSOURCE CH1, indicating the global output source is channel 1.</p>

## MEASUREMENT:HIGLEVEL:OUTWIRING

This command sets or queries the global output wiring.

<b>Group</b>	Measurement, IMDA
<b>Syntax</b>	<pre>MEASUREMENT:HIGLEVEL:OUTWIRING {P1W2V1I1 P1W3V2I2 P3W3V2I2 P3W3V3I3 P3W4 DCP1W2} MEASUREMENT:HIGLEVEL:OUTWIRING?</pre>
<b>Arguments</b>	<p>P1W2V1I1 specifies 1 phase- 2 wire (with 1 voltage and 1 current sources) wiring configuration.</p> <p>P1W3V2I2 specifies 1 phase- 3 wire (with 2 voltage and 2 current sources) wiring configuration.</p> <p>P3W3V2I2 specifies 3 phase- 3 wire (with 2 voltage and 2 current sources) wiring configuration.</p> <p>P3W3V3I3 specifies 3 phase- 3 wire (with 3 voltage and 3 current sources) wiring configuration.</p> <p>P3W3 specifies 3 phase and 3 wire, the 3rd wire being Neutral.</p> <p>DCP1W2 specifies DC 1 phase and 2 wire, the 2nd wire being Neutral.</p>

- Examples**    `MEASUREMENT:HIGHLEVEL:OUTWIRING P3W4` sets the global output wiring configuration to P3W3.
- `MEASUREMENT:HIGHLEVEL:OUTWIRING?` might return  
`:MEASUREMENT:HIGHLEVEL:OUTWIRING P3W3V3I3`, indicating the global output wiring configuration is P3W3V3I3.

## MEASUREMENT:HIGHLEVEL:SOURCE

This command sets or queries global input source.

- Group**    Measurement, IMDA
- Syntax**    `MEASUREMENT:HIGHLEVEL:SOURCE`  
`{S<x>_Ch<x>|CH<x>|MATH<x>|REF<x>}`  
`MEASUREMENT:HIGHLEVEL:SOURCE?`
- Arguments**    `S<x>_Ch<x>` specifies the remote scope number and the analog channel as the source.
- `CH<x>` specifies an analog channel as the source.
- `MATH<x>` specifies a math waveform as the source.
- `REF<x>` specifies a reference waveform as the source.
- Examples**    `MEASUREMENT:HIGHLEVEL:SOURCE CH1` sets the global input source as channel 1.
- `MEASUREMENT:HIGHLEVEL:SOURCE?` might return  
`:MEASUREMENT:HIGHLEVEL:SOURCE CH1`, indicating the global input source is channel 1.

## MEASUREMENT:HIGHLEVEL:WIRING

This command sets or queries the wiring configuration for the measurement.

- Group**    Measurement, IMDA
- Syntax**    `MEASUREMENT:HIGHLEVEL:WIRING`  
`{P1W2V1I1|P1W3V2I2|P3W3V2I2|P3W3V3I3|P3W3|DCP1W2}`  
`MEASUREMENT:HIGHLEVEL:WIRING?`

<b>Arguments</b>	<p>P1W2V1I1 specifies 1 phase- 2 wire (with 1 voltage and 1 current sources) wiring configuration.</p> <p>P1W3V2I2 specifies 1 phase- 3 wire (with 2 voltage and 2 current sources) wiring configuration.</p> <p>P3W3V2I2 specifies 3 phase- 3 wire (with 2 voltage and 2 current sources) wiring configuration.</p> <p>P3W3V3I3 specifies 3 phase- 3 wire (with 3 voltage and 3 current sources) wiring configuration.</p> <p>P3W3 specifies 3 phase and 3 wire, the 3rd wire being Neutral.</p> <p>DCP1W2 specifies DC 1 phase and 2 wire, the 2nd wire being Neutral.</p>
<b>Examples</b>	<p>MEASUREMENT:HIGHLEVEL:WIRING P3W4 sets the wiring configuration to P3W3.</p> <p>MEASUREMENT:HIGHLEVEL:WIRING? might return :MEASUREMENT:HIGHLEVEL:WIRING P3W3V3I3, indicating the wiring configuration is P3W3V3I3.</p>

## MEASUREMENT:INTERP

This command sets or queries the interpolation mode used to locate edge crossings.

<b>Group</b>	Measurement
<b>Syntax</b>	<p>MEASUREMENT:INTERP {AUTO SINX LINEAR}</p> <p>MEASUREMENT:INTERP?</p>
<b>Arguments</b>	<p>AUTO automatically selects the interpolation mode.</p> <p>SINX specifies <math>\sin(x)/x</math> interpolation, where acquired points are fit to a curve.</p> <p>LINEAR specifies linear interpolation, where acquired points are connected with straight lines.</p>
<b>Examples</b>	<p>MEASUREMENT:INTERP SINX set the interpolation mode to <math>\sin(x)/x</math>.</p> <p>MEASUREMENT:INTERP? might return :MEASUREMENT:INTERP AUTO indicating the interpolation mode is auto.</p>

## MEASUREMENT:JITTERMODEL

This command sets or queries the model used to separate random from deterministic jitter for jitter measurements.

<b>Group</b>	Measurement
<b>Syntax</b>	MEASUREMENT:JITTERMODEL {SPECTRAL SPECTRALBUJ} MEASUREMENT:JITTERMODEL?
<b>Arguments</b>	SPECTRAL sets the jitter separation model to spectral only. SPECTRALBUJ sets the jitter separation model to spectral plus BUJ.
<b>Examples</b>	MEASUREMENT:JITTERMODEL SPECTRAL set the jitter model to spectral. MEASUREMENT:JITTERMODEL? might return :MEASUREMENT:JITTERMODEL SPECTRAL indicating the jitter model is set to spectral.

## MEASUREMENT:LIST? (Query Only)

This query returns a comma separated list of all currently defined measurements.

<b>Group</b>	Measurement
<b>Syntax</b>	MEASUREMENT:LIST?
<b>Returns</b>	Returns a list of all currently defined measurements. When no measurements are defined, the command returns NONE.
<b>Examples</b>	MEASUREMENT:LIST? might return :MEASUREMENT:LIST MEAS1,MEAS2,MEAS3,MEAS4,MEAS5,MEAS6 indicating 6 measurements are defined.

## MEASUREMENT:LOCKRJ

This command sets or queries the state of RJ locking.

<b>Group</b>	Measurement
--------------	-------------

<b>Syntax</b>	MEASUREMENT:LOCKRJ {OFF ON <NR1>} MEASUREMENT:LOCKRJ?
<b>Arguments</b>	MEAS<x> specifies the measurement number.  ON indicates that RJ locking is active.  OFF indicates that RJ locking is off.  <NR1> a 0 turns off RJ locking; any other value activates RJ locking.
<b>Examples</b>	MEASUREMENT:LOCKRJ ON activates RJ locking

## MEASUREMENT:LOCKRJValue

This command sets or queries the RJ lock value.

<b>Group</b>	Measurement
<b>Syntax</b>	MEASUREMENT:LOCKRJValue <NR3> MEASUREMENT:LOCKRJValue?
<b>Arguments</b>	MEAS<x> specifies the measurement number.  <NR3> default value = 1e-12; minimum value = 1e-15; maximum value = 1.
<b>Examples</b>	MEASUREMENT:LOCKRJVALUE 1 sets the lock value to the maximum value of 1.  MEASUREMENT:LOCKRJVALUE? might return :MEASUREMENT:LOCKRJVALUE 1.0000E-12, indicating the lock value is set to the default value of 1e-12.

## MEASUREMENT:MATH<x>:REFLevels:ABSolute:FALLHigh

This command sets or queries the value used as the high reference level of the falling edge when the measurement ref level method is set to absolute. The math number is specified by x.

<b>Group</b>	Measurement
<b>Syntax</b>	MEASUREMENT:MATH<x>:REFLevels:ABSolute:FALLHigh <NR3> MEASUREMENT:MATH<x>:REFLevels:ABSolute:FALLHigh?

<b>Arguments</b>	MEAS<x> specifies the measurement number.  <NR3> is the high reference level, and is the zero percent level when MEASUREMENT:IMMed:REFLevel:METHOD is set to Absolute.
<b>Examples</b>	MEASUREMENT:MATH1:REFLevels:ABSolute:FALLHigh 1.5 sets the reference level to 1.5 V.  MEASUREMENT:MATH2:REFLevels:ABSolute:FALLHigh? might return :MEASUREMENT:MATH2:REFLEVELS:ABSOLUTE:FALLHIGH 1.0000 indicating the reference level is 1.0 V.

## MEASUREMENT:MATH<x>:REFLevels:ABSolute:FALLLow

This command sets or queries the value used as the low reference level of the falling edge when the measurement ref level method is set to absolute. The math number is specified by x.

<b>Group</b>	Measurement
<b>Syntax</b>	MEASUREMENT:MATH<x>:REFLevels:ABSolute:FALLLow <NR3> MEASUREMENT:MATH<x>:REFLevels:ABSolute:FALLLow?
<b>Arguments</b>	MEAS<x> specifies the measurement number.  <NR3> is the high reference level, and is the zero percent level when MEASUREMENT:IMMed:REFLevel:METHOD is set to Absolute.
<b>Examples</b>	MEASUREMENT:MATH2:REFLevels:ABSolute:FALLLow -1.5 sets the reference level to -1.5 V.  MEASUREMENT:MATH2:REFLevels:ABSolute:FALLLow? might return :MEASUREMENT:MATH2:REFLEVELS:ABSOLUTE:FALLLOW -1.0000 indicating the reference level is -1.0 V.

## MEASUREMENT:MATH<x>:REFLevels:ABSolute:FALLMid

This command sets or queries the value used as the mid reference level of the falling edge when the measurement ref level method is set to absolute. The math number is specified by x.

<b>Group</b>	Measurement
--------------	-------------



<b>Syntax</b>	<pre>MEASUREMENT:MATH&lt;x&gt;:REFLEVELS:ABSOLUTE:FALLMID &lt;NR3&gt; MEASUREMENT:MATH&lt;x&gt;:REFLEVELS:ABSOLUTE:FALLMID?</pre>
<b>Arguments</b>	<p>MEAS&lt;x&gt; specifies the measurement number.</p> <p>&lt;NR3&gt; is the mid reference level (where 50% is equal to MID) used to calculate the mid reference level when the measurement's Ref level method is set to Absolute.</p>
<b>Examples</b>	<p>MEASUREMENT:MATH2:REFLEVELS:ABSOLUTE:FALLMID 0.0 sets the reference level to 0.0 V.</p> <p>MEASUREMENT:MATH2:REFLEVELS:ABSOLUTE:FALLMID? might return :MEASUREMENT:MATH2:REFLEVELS:ABSOLUTE:FALLMID 0.0E+0 indicating the reference level is 0.0 V.</p>

## MEASUREMENT:MATH<x>:REFLEVELS:ABSOLUTE:HYS TERESIS

This command sets or queries the value of the hysteresis of the reference level when the measurement ref level method is set to absolute. The math number is specified by x.

<b>Group</b>	Measurement
<b>Syntax</b>	<pre>MEASUREMENT:MATH&lt;x&gt;:REFLEVELS:ABSOLUTE:HYS TERESIS &lt;NR3&gt; MEASUREMENT:MATH&lt;x&gt;:REFLEVELS:ABSOLUTE:HYS TERESIS?</pre>
<b>Arguments</b>	<p>MEAS&lt;x&gt; specifies the measurement number.</p> <p>&lt;NR3&gt; is the hysteresis value used for the autoset.</p>
<b>Examples</b>	<p>MEASUREMENT:MATH2:REFLEVELS:ABSOLUTE:HYS TERESIS 20.0E-3 sets the hysteresis to 20.0 mV.</p> <p>MEASUREMENT:MATH2:REFLEVELS:ABSOLUTE:HYS TERESIS? might return :MEASUREMENT:MATH2:REFLEVELS:ABSOLUTE:HYS TERESIS 30.0000E-3 indicating the hysteresis value is 30.0 mV.</p>

## MEASUREMENT:MATH<x>:REFLEVELS:ABSOLUTE:RISEHIGH

This command sets or queries the value used as the high reference level of the rising edge when the measurement ref level method is set to absolute. The math number is specified by x.

<b>Group</b>	Measurement
<b>Syntax</b>	<pre>MEASUREMENT:MATH&lt;x&gt;:REFLEVELS:ABSOLUTE:RISEHIGH &lt;NR3&gt; MEASUREMENT:MATH&lt;x&gt;:REFLEVELS:ABSOLUTE:RISEHIGH?</pre>
<b>Arguments</b>	<p>MEAS&lt;x&gt; specifies the measurement number.</p> <p>&lt;NR3&gt; is the high reference level, and is the zero percent level when MEASUREMENT:IMMED:REFLEVEL:METHOD is set to Absolute.</p>
<b>Examples</b>	<p>MEASUREMENT:MATH2:REFLEVELS:ABSOLUTE:RISEHIGH 1.5 sets the reference level to 1.5 V.</p> <p>MEASUREMENT:MATH2:REFLEVELS:ABSOLUTE:RISEHIGH? might return :MEASUREMENT:MATH2:REFLEVELS:ABSOLUTE:RISEHIGH 1.0000 indicating the reference level is 1.0 V.</p>

## MEASUREMENT:MATH<x>:REFLEVELS:ABSOLUTE:RISELOW

This command sets or queries the value used as the low reference level of the rising edge when the measurement ref level method is set to absolute. The math number is specified by x.

<b>Group</b>	Measurement
<b>Syntax</b>	<pre>MEASUREMENT:MATH&lt;x&gt;:REFLEVELS:ABSOLUTE:RISELOW &lt;NR3&gt; MEASUREMENT:MATH&lt;x&gt;:REFLEVELS:ABSOLUTE:RISELOW?</pre>
<b>Arguments</b>	<p>MEAS&lt;x&gt; specifies the measurement number.</p> <p>&lt;NR3&gt; is the high reference level, and is the zero percent level when MEASUREMENT:IMMED:REFLEVEL:METHOD is set to Absolute.</p>
<b>Examples</b>	<p>MEASUREMENT:MATH2:REFLEVELS:ABSOLUTE:RISELOW -1.5 sets the reference level to -1.5 V.</p> <p>MEASUREMENT:MATH2:REFLEVELS:ABSOLUTE:RISELOW? might return :MEASUREMENT:MATH2:REFLEVELS:ABSOLUTE:RISELOW -1.0000 indicating the reference level is -1.0 V.</p>

## MEASUREMENT:MATH<x>:REFLEVELS:ABSOLUTE:RISEMID

This command sets or queries the value used as the mid reference level of the rising edge when the measurement ref level method is set to absolute. The math number is specified by x.

<b>Group</b>	Measurement
<b>Syntax</b>	MEASUREMENT:MATH<x>:REFLEVELS:ABSOLUTE:RISEMID <NR3> MEASUREMENT:MATH<x>:REFLEVELS:ABSOLUTE:RISEMID?
<b>Arguments</b>	MEAS<x> specifies the measurement number.  <NR3> is the mid reference level (where 50% is equal to MID) used to calculate the mid reference level when the measurement Ref level method is set to Absolute.
<b>Examples</b>	MEASUREMENT:MATH2:REFLEVELS:ABSOLUTE:RISEMID 30.0E-3 sets the reference level to 30 mV.  MEASUREMENT:MATH2:REFLEVELS:ABSOLUTE:RISEMID? might return :MEASUREMENT:MATH2:REFLEVELS:ABSOLUTE:RISEMID 0.0E+0 indicating the reference level is 0.0 V.

## MEASUREMENT:MATH<x>:REFLEVELS:ABSOLUTE:TYPE

This command sets or queries the reference level type for the measurement. The math number is specified by x.

<b>Group</b>	Measurement
<b>Syntax</b>	MEASUREMENT:MATH<x>:REFLEVELS:ABSOLUTE:TYPE {SAME UNIQUE} MEASUREMENT:MATH<x>:REFLEVELS:ABSOLUTE:TYPE?
<b>Arguments</b>	MEAS<x> specifies the measurement number.  SAME specifies that the absolute levels are set the same.  UNIQUE specifies that the absolute levels can be set independently.
<b>Examples</b>	MEASUREMENT:MATH2:REFLEVELS:ABSOLUTE:TYPE UNIQUE specifies that the absolute levels can be set independently.

MEASUREMENT:MATH2:REFLEVELS:ABSOLUTE:TYPE? might return  
:MEASUREMENT:MATH2:REFLEVELS:ABSOLUTE:TYPE SAME indicating that  
the absolute levels are set the same.

## MEASUREMENT:MATH<x>:REFLEVELS:BASETOP

This command sets or queries the method used to calculate the TOP and BASE used to calculate reference levels for the measurement. The math number is specified by x.

**Group** Measurement

**Syntax** MEASUREMENT:MATH<x>:REFLEVELS:BASETOP  
{AUTO|MINMAX|MEANHISTOGRAM|MODEHISTOGRAM|EYEHISTOGRAM}  
MEASUREMENT:MATH<x>:REFLEVELS:BASETOP?

**Arguments** MEAS<x> specifies the measurement number.

AUTO automatically chooses a reference level method.

MINMAX specifies that reference levels are relative to the measurement MIN and MAX.

MEANHISTOGRAM specifies that reference levels are relative to the histogram mean BASE and TOP.

MODEHISTOGRAM specifies that reference levels are relative to the histogram mode BASE and TOP.

EYEHISTOGRAM specifies that reference levels are relative to the eye histogram BASE and TOP.

**Examples** MEASUREMENT:MATH1:REFLEVELS:BASETOP MINMAX specifies that reference levels are relative to the measurement MIN and MAX.

MEASUREMENT:MATH1:REFLEVELS:BASETOP? might return  
:MEASUREMENT:MATH2:REFLEVELS:BASETOP AUTO indicating the instrument automatically chooses a reference level method.

## MEASUREMENT:MATH<x>:REFLEVELS:METHOD

This command sets or queries the method used to calculate reference levels for the measurement. The math number is specified by x.

<b>Group</b>	Measurement
<b>Syntax</b>	MEASUREMENT:MATH<x>:REFLEVELS:METHOD {PERCENT ABSOLUTE} MEASUREMENT:MATH<x>:REFLEVELS:METHOd?
<b>Arguments</b>	<p>MEAS&lt;x&gt; specifies the measurement number.</p> <p>PERCENT specifies that the reference levels are calculated as a percent relative to HIGH and LOW. The percentages are defined using the MEASUREMENT:MATH&lt;x&gt;:REFLEVEL:PERCENT commands.</p> <p>ABSOLUTE specifies that the reference levels are set explicitly using the MEASUREMENT:MATH&lt;x&gt;:REFLEVEL:ABSOLUTE commands. This method is useful when precise values are required.</p>
<b>Examples</b>	<p>MEASUREMENT:MATH2:REFLEVELS:METHOD ABSOLUTE specifies that the reference levels are set explicitly</p> <p>MEASUREMENT:MATH2:REFLEVELS:METHOd? might return :MEASUREMENT:MATH2:REFLEVELS:METHOD PERCENT indicating reference levels are in percent relative to HIGH and LOW.</p>

## MEASUREMENT:MATH<x>:REFLEVELS:PERCENT:FALLHigh

This command sets or queries the percentage (where 100% is equal to TOP and 0% is equal to BASE) used to calculate the high reference level of the falling edge when the measurement ref level method is set to percent. The math number is specified by x.

<b>Group</b>	Measurement
<b>Syntax</b>	MEASUREMENT:MATH<x>:REFLEVELS:PERCENT:FALLHigh <NR3> MEASUREMENT:MATH<x>:REFLEVELS:PERCENT:FALLHigh?
<b>Arguments</b>	<p>MEAS&lt;x&gt; specifies the measurement number.</p> <p>&lt;NR3&gt; is the percentage (where 100% is equal to HIGH) used to calculate the high reference level when the measurement Ref level method is set to Percent.</p>
<b>Examples</b>	MEASUREMENT:MATH2:REFLEVELS:PERCENT:FALLHigh 95 sets the reference level to 95% of TOP.

MEASUREMENT:MATH2:REFLEVELS:PERCENT:FALLHIGH? might return  
:MEASUREMENT:MATH2:REFLEVELS:PERCENT:FALLHIGH 90.0000  
indicating the reference level is set to 90% of TOP.

## MEASUREMENT:MATH<x>:REFLEVELS:PERCENT:FALLLOW

This command sets or queries the percentage (where 100% is equal to TOP and 0% is equal to BASE) used to calculate the low reference level of the falling edge when the measurement ref level method is set to percent. The math number is specified by x.

**Group** Measurement

**Syntax** MEASUREMENT:MATH<x>:REFLEVELS:PERCENT:FALLLOW <NR3>  
MEASUREMENT:MATH<x>:REFLEVELS:PERCENT:FALLLOW?

**Arguments** MEAS<x> specifies the measurement number.  
  
<NR3> is the percentage (where 100% is equal to HIGH) used to calculate the mid reference level when the measurement's Ref level method is set to Percent.

**Examples** MEASUREMENT:MATH2:REFLEVELS:PERCENT:FALLLOW 5 sets the reference level to 5% of TOP.  
  
MEASUREMENT:MATH2:REFLEVELS:PERCENT:FALLLOW? might return  
:MEASUREMENT:MATH2:REFLEVELS:PERCENT:FALLLOW 10.0000 indicating the reference level is set to 10% of TOP.

## MEASUREMENT:MATH<x>:REFLEVELS:PERCENT:FALLMID

This command sets or queries the percentage (where 100% is equal to TOP and 0% is equal to BASE) used to calculate the mid reference level of the falling edge when the measurement ref level method is set to percent. The math number is specified by x.

**Group** Measurement

**Syntax** MEASUREMENT:MATH<x>:REFLEVELS:PERCENT:FALLMID <NR3>  
MEASUREMENT:MATH<x>:REFLEVELS:PERCENT:FALLMID?

<b>Arguments</b>	<p>MEAS&lt;x&gt; specifies the measurement number.</p> <p>&lt;NR3&gt; is the percentage (where 50% is equal to MID) used to calculate the mid reference level when the measurement Ref level method is set to Percent.</p>
<b>Examples</b>	<p>MEASUREMENT:MATH2:REFLEVELS:PERCENT:FALLMID 50 sets the reference level to 50% of TOP.</p> <p>MEASUREMENT:MATH2:REFLEVELS:PERCENT:FALLMID? might return :MEASUREMENT:MATH2:REFLEVELS:PERCENT:FALLMID 50.0000 indicating the reference level is set to 50% of TOP.</p>

## MEASUREMENT:MATH<x>:REFLEVELS:PERCENT:HYSTERESIS

This command sets or queries the percentage (where 100% is equal to MAX and 0% is equal to MIN) used to calculate the hysteresis of the reference level when the measurement ref level method is set to percent. The math number is specified by x.

<b>Group</b>	Measurement
<b>Syntax</b>	<p>MEASUREMENT:MATH&lt;x&gt;:REFLEVELS:PERCENT:HYSTERESIS &lt;NR3&gt;</p> <p>MEASUREMENT:MATH&lt;x&gt;:REFLEVELS:PERCENT:HYSTERESIS?</p>
<b>Arguments</b>	<p>MEAS&lt;x&gt; specifies the measurement number.</p> <p>&lt;NR3&gt; is the hysteresis value used for the autoset.</p>
<b>Examples</b>	<p>MEASUREMENT:MATH2:REFLEVELS:PERCENT:HYSTERESIS 2.5 sets the hysteresis to 2.5% of MAX</p> <p>MEASUREMENT:MATH2:REFLEVELS:PERCENT:HYSTERESIS? might return :MEASUREMENT:MATH2:REFLEVELS:PERCENT:HYSTERESIS 5.0000 indicating the hysteresis is set to 5% of MAX.</p>

## MEASUREMENT:MATH<x>:REFLEVELS:PERCENT:RISEHIGH

This command sets or queries the percentage (where 100% is equal to TOP and 0% is equal to BASE) used to calculate the high reference level of the rising edge when the measurement ref level method is set to percent. The math number is specified by x. The measurement number is specified by x.

<b>Group</b>	Measurement
--------------	-------------

**Syntax**    `MEASUREMENT:MATH<x>:REFLEVELS:PERCENT:RISEHIGH <NR3>`  
`MEASUREMENT:MATH<x>:REFLEVELS:PERCENT:RISEHIGH?`

**Arguments**    `MEAS<x>` specifies the measurement number.  
  
<NR3> is the percentage (where 100% is equal to TOP) used to calculate the high reference level when the measurement's Ref level method is set to Percent.

**Examples**    `MEASUREMENT:MATH2:REFLEVELS:PERCENT:RISEHIGH 95` sets the reference level to 95% of TOP.  
  
`MEASUREMENT:MATH2:REFLEVELS:PERCENT:RISEHIGH?` might return  
`:MEASUREMENT:MATH2:REFLEVELS:PERCENT:RISEHIGH 90.0000`  
indicating the reference level is set to 90% of TOP.

## MEASUREMENT:MATH<x>:REFLEVELS:PERCENT:RISELOW

This command sets or queries the percentage (where 100% is equal to TOP and 0% is equal to BASE) used to calculate the low reference level of the rising edge when the measurement ref level method is set to percent. The math number is specified by x.

**Group**    Measurement

**Syntax**    `MEASUREMENT:MATH<x>:REFLEVELS:PERCENT:RISELOW <NR3>`  
`MEASUREMENT:MATH<x>:REFLEVELS:PERCENT:RISELOW?`

**Arguments**    `MEAS<x>` specifies the measurement number.  
  
<NR3> is the percentage (where 100% is equal to TOP) used to calculate the mid reference level when the measurement Ref level method is set to Percent.

**Examples**    `MEASUREMENT:MATH2REFLEVELS:PERCENT:RISELOW 5` sets the reference level to 5% of TOP.  
  
`MEASUREMENT:MATH2REFLEVELS:PERCENT:RISELOW?` might return  
`:MEASUREMENT:MATH2:REFLEVELS:PERCENT:RISELOW 10.0000` indicating the reference level is set to 10% of TOP.

## MEASUREMENT:MATH<x>:REFLEVELS:PERCENT:RISEMID

This command sets or queries the percentage (where 100% is equal to TOP and 0% is equal to BASE) used to calculate the mid reference level of the rising edge



when the measurement ref level method is set to percent. The math number is specified by x.

<b>Group</b>	Measurement
<b>Syntax</b>	<pre>MEASUREMENT:MATH&lt;x&gt;:REFLEVELS:PERCENT:RISEMID &lt;NR3&gt; MEASUREMENT:MATH&lt;x&gt;:REFLEVELS:PERCENT:RISEMID?</pre>
<b>Arguments</b>	<p>MEAS&lt;x&gt; specifies the measurement number.</p> <p>&lt;NR3&gt; is the percentage (where 50% is equal to MID) used to calculate the mid reference level when the measurement Ref level method is set to Percent.</p>
<b>Examples</b>	<p>MEASUREMENT:MATH2:REFLEVELS:PERCENT:RISEMID 50 sets the reference level to 50% of TOP.</p> <p>MEASUREMENT:MATH2:REFLEVELS:PERCENT:RISEMID? might return :MEASUREMENT:MATH2:REFLEVELS:PERCENT:RISEMID 50.0000 indicating the reference level is set to 50% of TOP.</p>

## MEASUREMENT:MATH<x>:REFLEVELS:PERCENT:TYPE

This command specifies or queries the reference level percent type for the measurement. The math number is specified by x.

<b>Group</b>	Measurement
<b>Syntax</b>	<pre>MEASUREMENT:MATH&lt;x&gt;:REFLEVELS:PERCENT:TYPE {TENNINETY TWENTYEIGHTY CUSTOM} MEASUREMENT:MATH&lt;x&gt;:REFLEVELS:PERCENT:TYPE?</pre>
<b>Arguments</b>	<p>MEAS&lt;x&gt; specifies the measurement number.</p> <p>TENNINETY sets the values for Low, Mid and High Ref to 10%, 50% and 90% respectively.</p> <p>TWENTYEIGHTY sets the values for Low, Mid and High Ref are set to 20%, 50% and 80% respectively.</p> <p>CUSTOM allows setting other reference level percents.</p>
<b>Examples</b>	<p>MEASUREMENT:MATH2:REFLEVELS:PERCENT:TYPE TWENTYEIGHTY sets the values for Low, Mid and High Ref are set to 20%, 50% and 80% respectively.</p>

MEASUREMENT:MATH2:REFLEVELS:PERCENT:TYPE? might return  
:MEASUREMENT:MATH2:REFLEVELS:PERCENT:TYPE TENNINETY indicating  
the reference levels are set to 10%, 50% and 90%.

## MEASUREMENT:MEASRANGE:MAX

This command sets or queries the global range maximum value.

<b>Group</b>	Measurement
<b>Syntax</b>	MEASUREMENT:MEASRANGE:MAX <NR3> MEASUREMENT:MEASRANGE:MAX?
<b>Arguments</b>	MEAS<x> specifies the measurement number. <NR3> is the maximum measurement range limit value.
<b>Examples</b>	MEASUREMENT:MEASRANGE:MAX 1.5 sets the maximum range limit to 1.5 V. MEASUREMENT:MEASRANGE:MAX? might return :MEASUREMENT:MEASRANGE:MAX 1.0000 indicating the maximum range limit is 1.0 V.

## MEASUREMENT:MEASRANGE:MIN

This command sets or queries the global range minimum value.

<b>Group</b>	Measurement
<b>Syntax</b>	MEASUREMENT:MEASRANGE:MIN <NR3> MEASUREMENT:MEASRANGE:MIN?
<b>Arguments</b>	MEAS<x> specifies the measurement number. <NR3> is the minimum measurement range limit value.
<b>Examples</b>	MEASUREMENT:MEASRANGE:MIN 30.0E-3 sets the minimum measurement range limit to 30.0 mV. MEASUREMENT:MEASRANGE:MIN? might return :MEASUREMENT:MEASRANGE:MIN 0.0E+0 indicating minimum range limit is 0.0 V.

## MEASUREMENT:MEASRange:STATE

This command sets or queries the global range state.

<b>Group</b>	Measurement
<b>Syntax</b>	MEASUREMENT:MEASRange:STATE {OFF ON 0 1} MEASUREMENT:MEASRange:STATE?
<b>Arguments</b>	<p>MEAS&lt;x&gt; specifies the measurement number.</p> <p>OFF specifies that the measurement results are not limited.</p> <p>ON specifies that the measurement results are limited to results with values between the range minimum and maximum.</p> <p>0 specifies that the measurement results are not limited.</p> <p>1 specifies that the measurement results are limited to results with values between the range minimum and maximum.</p>
<b>Examples</b>	<p>MEASUREMENT:MEASRANGE:STATE 1 specifies that the measurement results are limited to results with values between the range minimum and maximum.</p> <p>MEASUREMENT:MEASRANGE:STATE? might return :MEASUREMENT:MEASRANGE:STATE 0 indicating that the measurement results are not limited.</p>

## MEASUREMENT:MEAS<x>:BER

This command sets or queries BER value for the measurement. Measurements are specified by x.

<b>Group</b>	Measurement
<b>Syntax</b>	MEASUREMENT:MEAS<x>:BER <NR3> MEASUREMENT:MEAS<x>:BER?
<b>Arguments</b>	<p>MEAS&lt;x&gt; specifies the measurement number.</p> <p>&lt;NR3&gt; is BER value for the measurement.</p>

**Examples**    `MEASUREMENT:MEAS2:BER 10.0` sets the BER for the measurement to 10.0.  
`MEASUREMENT:MEAS2:BER?` might return `:MEASUREMENT:MEAS2:BER 12.0000` indicating the measurement BER is 12.0.

## MEASUREMENT:MEAS<x>:BER:TARGETBER

This command sets or queries the target BER value for the measurement. Measurements are specified by x.

**Group**    Measurement

**Syntax**    `MEASUREMENT:MEAS<x>:BER:TARGETBER <NR3>`  
`MEASUREMENT:MEAS<x>:BER:TARGETBER?`

**Arguments**    `MEAS<x>` specifies the measurement number.  
`<NR3>` is the target BER value.

**Examples**    `MEASUREMENT:MEAS1:BER:TARGETBER 14.0` sets the target BER to 14.0.  
`MEASUREMENT:MEAS1:BER:TARGETBER?` might return `:MEASUREMENT:MEAS1:BER:TARGETBER 12.0000` indicating the target BER is 12.0.

## MEASUREMENT:MEAS<x>:BIN

This command sets or queries the bin count for the measurement. Measurements are specified by x.

**Group**    Measurement

**Syntax**    `MEASUREMENT:MEAS<x>:BIN <NR3>`  
`MEASUREMENT:MEAS<x>:BIN?`

**Arguments**    `MEAS<x>` specifies the measurement number.  
`<NR3>` is the bin count.

**Examples**    `MEASUREMENT:MEAS1:BIN 2` sets the bin count to 2.  
`MEASUREMENT:MEAS1:BIN?` might return `:MEASUREMENT:MEAS1:BIN 1` indicating the bin count is 1.

## MEASUREMENT:MEAS<x>:BITCfmode

This command sets or queries whether the measurement returns the mean or mode statistic result when the measurement type is bit amplitude/high/low. Measurements are specified by x.

**Group**    Measurement

**Syntax**    `MEASUREMENT:MEAS<x>:BITCfmode {MEAN|MODE}`  
`MEASUREMENT:MEAS<x>:BITCfmode?`

**Arguments**    `MEAS<x>` specifies the measurement number.  
`MEAN` specifies that the measurement returns results for each bit.  
`MODE` specifies that the measurement returns the mode of its results.

**Examples**    `MEASUREMENT:MEAS1:BITCfmode MODE` specifies that the measurement returns the mode of its results.  
`MEASUREMENT:MEAS1:BITCfmode?` might return `:MEASUREMENT:MEAS1:BITCFGMODE MEAN` indicating the configuration mode is set to `MEAN`.

## MEASUREMENT:MEAS<x>:BITEnd

This command sets or queries the bit end as a percentage of the unit interval. Measurements are specified by x.

**Group**    Measurement

**Syntax**    `MEASUREMENT:MEAS<x>:BITEnd <NR3>`  
`MEASUREMENT:MEAS<x>:BITEnd?`

**Arguments**    `MEAS<x>` specifies the measurement number.  
`<NR3>` is the bit end.

**Examples**    `MEASUREMENT:MEAS2:BITEnd 60` sets the bit end to 60% of the unit interval.  
`MEASUREMENT:MEAS2:BITEnd?` might return `:MEASUREMENT:MEAS2:BITEND 50.0000` indicating the bit end is 50%.

## MEASUREMENT:MEAS<x>:BITPcnt

This command sets or queries the bit center as a percentage of the unit interval. Measurements are specified by x.

**Group**    Measurement

**Syntax**    `MEASUREMENT:MEAS<x>:BITPcnt <NR3>`  
`MEASUREMENT:MEAS<x>:BITPcnt?`

**Arguments**    `MEAS<x>` specifies the measurement number.  
`<NR3>` is the bit center percentage value to be measured for the bit type selected.

**Examples**    `MEASUREMENT:MEAS2:BITPcnt 55` sets the bit center to 55% of the unit interval.  
`MEASUREMENT:MEAS2:BITPcnt?` might return `:MEASUREMENT:MEAS2:BITPCNT 50.0000` indicating bit center is 50% of the unit interval.

## MEASUREMENT:MEAS<x>:BITStart

This command sets or queries the bit start as a percentage of the unit interval. Measurements are specified by x.

**Group**    Measurement

**Syntax**    `MEASUREMENT:MEAS<x>:BITStart <NR3>`  
`MEASUREMENT:MEAS<x>:BITStart?`

**Arguments**    `MEAS<x>` specifies the measurement number.  
`<NR3>` is the bit start.

**Examples**    `MEASUREMENT:MEAS2:BITSTART 45` sets the bit start to 45% of the unit interval.  
`MEASUREMENT:MEAS2:BITSTART?` might return  
`:MEASUREMENT:MEAS2:BITSTART 50.0000` indicating the bit start is 50% of the unit interval.

## MEASUREMENT:MEAS<x>:BITType

This command sets or queries the bit type for the measurement. Measurements are specified by x.

**Group**    Measurement

**Syntax**    `MEASUREMENT:MEAS<x>:BITType`  
`{ALLBITS|TRANSITION|NONTRANSITION}`  
`MEASUREMENT:MEAS<x>:BITType?`

**Arguments**    `MEAS<x>` specifies the measurement number.  
`ALLBITS` specifies that the measurement returns results for all bits.  
`TRANSITION` specifies that the measurement returns results for transitions bit only.  
`NONTRANSITION` specifies that the measurement returns results for non-transition bits only.

**Examples**    `MEASUREMENT:MEAS1:BITType TRANSITION` specifies that the measurement returns results for transition bits only.  
`MEASUREMENT:MEAS1:BITType?` might return  
`:MEASUREMENT:MEAS1:BITType ALLBITS` indicating that measurements return results for all bits.

## MEASUREMENT:MEAS<x>:BURSTEDGTYPE

This command sets or queries the burst edge type for the measurement. Measurements are specified by x.

**Group**    Measurement

**Syntax**    `MEASUREMENT:MEAS<x>:BURSTEDGTYPE` `{RISE|FALL}`  
`MEASUREMENT:MEAS<x>:BURSTEDGTYPE?`

<b>Arguments</b>	MEAS<x> specifies the measurement number. RISE specifies a burst with a rising edge. FALL specifies a burst with a falling edge.
<b>Examples</b>	MEASUREMENT:MEAS2:BURSTEDGTYPE FALL specifies a burst with a falling edge. MEASUREMENT:MEAS2:BURSTEDGTYPE? might return :MEASUREMENT:MEAS2:BURSTEDGTYPE RISE indicating a burst with a rising edge.

### MEASUREMENT:MEAS<x>:CCRESULTS:ALLAcqs:MAXimum? (Query Only)

This query-only command returns the maximum cycle-cycle value for the specified measurement for all acquisitions. Measurements are specified by x.

<b>Group</b>	Measurement
<b>Syntax</b>	MEASUREMENT:MEAS<x>:CCRESULTS:ALLAcqs:MAXimum?
<b>Returns</b>	The maximum cycle-cycle statistic value for the specified measurement for all acquisitions.
<b>Examples</b>	MEASUREMENT:MEAS2:CCRESULTS:ALLAcqs:MAXimum? might return :MEASUREMENT:MEAS2:CCRESULTS:ALLAcqs:MAXIMUM 9.91E+37.

### MEASUREMENT:MEAS<x>:CCRESULTS:ALLAcqs:MEAN? (Query Only)

This query-only command returns the mean cycle-cycle value for the specified measurement for all acquisitions. Measurements are specified by x.

<b>Group</b>	Measurement
<b>Syntax</b>	MEASUREMENT:MEAS<x>:CCRESULTS:ALLAcqs:MEAN?
<b>Returns</b>	The mean cycle-cycle statistic value for the specified measurement for all acquisitions.



**Examples**    `MEASUREMENT:MEAS2:CCRESULTS:ALLACQS:MEAN?` might return  
                  `:MEASUREMENT:MEAS2:CCRESULTS:ALLACQS:MEAN 9.91E+37.`

## **MEASUREMENT:MEAS<x>:CCRESULTS:ALLACQS:MINIMUM? (Query Only)**

This query-only command returns the minimum cycle-cycle value for the specified measurement for all acquisitions. Measurements are specified by x.

**Group**    Measurement

**Syntax**    `MEASUREMENT:MEAS<x>:CCRESULTS:ALLACQS:MINIMUM?`

**Returns**    The minimum cycle-cycle statistic value for the specified measurement for all acquisitions.

**Examples**    `MEASUREMENT:MEAS2:CCRESULTS:ALLACQS:MINIMUM?` might return  
                  `:MEASUREMENT:MEAS2:CCRESULTS:ALLACQS:MINIMUM 9.91E+37.`

## **MEASUREMENT:MEAS<x>:CCRESULTS:ALLACQS:PK2PK? (Query Only)**

This query-only command returns the peak to peak cycle-cycle statistic for the specified measurement for all acquisitions. Measurements are specified by x.

**Group**    Measurement

**Syntax**    `MEASUREMENT:MEAS<x>:CCRESULTS:ALLACQS:PK2PK?`

**Returns**    The peak to peak cycle-cycle statistic value for the specified measurement all acquisitions.

**Examples**    `MEASUREMENT:MEAS2:CCRESULTS:ALLACQS:PK2PK?` might return  
                  `:MEASUREMENT:MEAS2:CCRESULTS:ALLACQS:PK2PK 9.91E+37.`

## **MEASUREMENT:MEAS<x>:CCRESULTS:ALLACQS:POPULATION? (Query Only)**

This query-only command returns the population of all cycle-cycle statistics for the specified measurement for all acquisitions accumulated since statistics were last reset. Measurements are specified by x.

<b>Group</b>	Measurement
<b>Syntax</b>	MEASUREMENT:MEAS<x>:CCRESULTS:ALLAcqs:POPULATION?
<b>Returns</b>	The population of all cycle-cycle statistics for the specified measurement accumulated over all acquisitions since statistics were last reset.
<b>Examples</b>	MEASUREMENT:MEAS2:CCRESULTS:ALLAcqs:POPULATION? might return :MEASUREMENT:MEAS2:CCRESULTS:ALLAcqs:POPULATION 0 indicating no statistics for the measurement.

### MEASUREMENT:MEAS<x>:CCRESULTS:ALLAcqs:STDDev? (Query Only)

This query-only command returns the standard deviation cycle-cycle for the specified measurement for all acquisitions. Measurements are specified by x.

<b>Group</b>	Measurement
<b>Syntax</b>	MEASUREMENT:MEAS<x>:CCRESULTS:ALLAcqs:STDDev?
<b>Returns</b>	The standard deviation cycle-cycle statistic value for the specified measurement all acquisitions.
<b>Examples</b>	MEASUREMENT:MEAS2:CCRESULTS:ALLAcqs:STDDev? might return :MEASUREMENT:MEAS2:CCRESULTS:ALLAcqs:STDDev 9.91E+37.

### MEASUREMENT:MEAS<x>:CCRESULTS:CURRENTAcq:MAXimum? (Query Only)

This query-only command returns the maximum cycle-cycle value for the specified measurement for the current acquisition. Measurements are specified by x.

<b>Group</b>	Measurement
<b>Syntax</b>	MEASUREMENT:MEAS<x>:CCRESULTS:CURRENTAcq:MAXimum?
<b>Returns</b>	The maximum cycle-cycle statistic value for the specified measurement for the current acquisition.

**Examples**    `MEASUREMENT:MEAS2:CCRESULTS:CURRENTACQ:MAXIMUM?` might return  
`:MEASUREMENT:MEAS1:CCRESULTS:CURRENTACQ:MAXIMUM 9.91E+37.`

## **MEASUREMENT:MEAS<x>:CCRESULTS:CURRENTACQ:MEAN? (Query Only)**

This query-only command returns the mean cycle-cycle value for the specified measurement for the current acquisition. Measurements are specified by x.

**Group**    Measurement

**Syntax**    `MEASUREMENT:MEAS<x>:CCRESULTS:CURRENTACQ:MEAN?`

**Returns**    The mean cycle-cycle statistic value for the specified measurement for the current acquisition.

**Examples**    `MEASUREMENT:MEAS1:CCRESULTS:CURRENTACQ:MEAN?` might return  
`:MEASUREMENT:MEAS1:CCRESULTS:CURRENTACQ:MEAN 9.91E+37.`

## **MEASUREMENT:MEAS<x>:CCRESULTS:CURRENTACQ:MINIMUM? (Query Only)**

This query-only command returns the minimum cycle-cycle value for the specified measurement for the current acquisition. Measurements are specified by x.

**Group**    Measurement

**Syntax**    `MEASUREMENT:MEAS<x>:CCRESULTS:CURRENTACQ:MINIMUM?`

**Returns**    The minimum cycle-cycle statistic value for the specified measurement for the current acquisition.

**Examples**    `MEASUREMENT:MEAS2:CCRESULTS:CURRENTACQ:MINIMUM?` might return  
`:MEASUREMENT:MEAS1:CCRESULTS:CURRENTACQ:MINIMUM 9.91E+37.`

## **MEASUREMENT:MEAS<x>:CCRESULTS:CURRENTACQ:PK2PK? (Query Only)**

This query-only command returns the peak to peak cycle-cycle statistic for the specified measurement for the current acquisition. Measurements are specified by x.

<b>Group</b>	Measurement
<b>Syntax</b>	MEASUREMENT:MEAS<x>:CCRESULTS:CURRENTACQ:PK2PK?
<b>Returns</b>	The peak to peak cycle-cycle statistic value for the specified measurement for the current acquisition.
<b>Examples</b>	MEASUREMENT:MEAS1:CCRESULTS:CURRENTACQ:PK2PK? might return :MEASUREMENT:MEAS1:CCRESULTS:CURRENTACQ:PK2PK 9.91E+37.

### MEASUREMENT:MEAS<x>:CCRESULTS:CURRENTACQ:POPULATION? (Query Only)

This query-only command returns the population of the cycle-cycle statistics for the specified measurement for the current acquisition. Measurements are specified by x.

<b>Group</b>	Measurement
<b>Syntax</b>	MEASUREMENT:MEAS<x>:CCRESULTS:CURRENTACQ:POPULATION?
<b>Returns</b>	The population of the cycle-cycle statistics for the specified measurement for the current acquisition.
<b>Examples</b>	MEASUREMENT:MEAS1:CCRESULTS:CURRENTACQ:POPULATION? might return :MEASUREMENT:MEAS1:CCRESULTS:CURRENTACQ:POPULATION 0 indicating the population is 0.

### MEASUREMENT:MEAS<x>:CCRESULTS:CURRENTACQ:STDDEV? (Query Only)

This query-only command returns the standard deviation cycle-cycle for the specified measurement for the current acquisition. Measurements are specified by x.

<b>Group</b>	Measurement
<b>Syntax</b>	MEASUREMENT:MEAS<x>:CCRESULTS:CURRENTACQ:STDDEV?

**Returns** The standard deviation cycle-cycle statistic value for the specified measurement for the current acquisition.

**Examples** `MEASUREMENT:MEAS1:CCRESULTS:CURRENTACQ:STDDEV?` might return `:MEASUREMENT:MEAS1:CCRESULTS:CURRENTACQ:STDDEV 9.91E+37.`

## MEASUREMENT:MEAS<x>:CLOCKRECOVERY:ADVANCED:METHOd

This command sets or queries the advanced clock recovery method when advanced clock recovery is used for the measurement. Measurements are specified by x.

**Group** Measurement

**Syntax** `MEASUREMENT:MEAS<x>:CLOCKRECOVERY:ADVANCED:METHOd {NONE|NOMInal|PATTern}`  
`MEASUREMENT:MEAS<x>:CLOCKRECOVERY:ADVANCED:METHOd?`

**Arguments** `MEAS<x>` specifies the measurement number.  
`NOMInal` sets the advanced CRD method to Nominal Data Rate.  
`PATTern` sets the advanced CDR method to use a Known Data Pattern.  
`NONE` sets no advanced CRD method.

**Examples** `MEASUREMENT:MEAS1:CLOCKRECOVERY:ADVANCED:METHOd PATTERN` sets the advanced CDR method to use a Known Data Pattern.  
`MEASUREMENT:MEAS1:CLOCKRECOVERY:ADVANCED:METHOd?` might return `:MEASUREMENT:MEAS1:CLOCKRECOVERY:ADVANCED:METHOd NONE` indicating no advanced CRD method.

## MEASUREMENT:MEAS<x>:CLOCKRECOVERY:CLOCKFrequency

This command sets or queries the clock frequency used when fixed constant clock recovery is used for the measurement. Measurements are specified by x.

**Group** Measurement

**Syntax** `MEASUREMENT:MEAS<x>:CLOCKRECOVERY:CLOCKFrequency <NR3>`  
`MEASUREMENT:MEAS<x>:CLOCKRECOVERY:CLOCKFrequency?`

<b>Arguments</b>	MEAS<x> specifies the measurement number.  <NR3> is the clock frequency.
<b>Examples</b>	MEASUREMENT:MEAS1:CLOCKRECOVERY:CLOCKFREQUENCY 2.0E+9 sets the frequency to 2.0 GHz.  MEASUREMENT:MEAS1:CLOCKRECOVERY:CLOCKFREQUENCY? might return :MEASUREMENT:MEAS1:CLOCKRECOVERY:CLOCKFREQUENCY 2.5000E+9 indicating the frequency is 2.5 GHz.

## MEASUREMENT:MEAS<x>:CLOCKRECOVERY:CLOCKMULTIPLIER

This command sets or queries the clock multiplier used when explicit clock recovery is used for the measurement. Measurements are specified by x.

<b>Group</b>	Measurement
<b>Syntax</b>	MEASUREMENT:MEAS<x>:CLOCKRECOVERY:CLOCKMULTIPLIER <NR3> MEASUREMENT:MEAS<x>:CLOCKRECOVERY:CLOCKMULTIPLIER?
<b>Arguments</b>	MEAS<x> specifies the measurement number.  <NR3> is the clock multiplier.
<b>Examples</b>	MEASUREMENT:MEAS1:CLOCKRECOVERY:CLOCKMULTIPLIER 1.5 sets the clock multiplier to 1.5.  MEASUREMENT:MEAS1:CLOCKRECOVERY:CLOCKMULTIPLIER? might return :MEASUREMENT:MEAS1:CLOCKRECOVERY:CLOCKMULTIPLIER 1.0000 indicating the clock multiplier is 1.0.

## MEASUREMENT:MEAS<x>:CLOCKRECOVERY:CONSTCLOCKMODE

This command sets or queries the constant clock mode used when constant clock recovery is used for the measurement. The measurement number is specified by x.

<b>Group</b>	Measurement
<b>Syntax</b>	MEASUREMENT:MEAS<x>:CLOCKRECOVERY:CONSTCLOCKMODE {MEAN MEDIan FIXed} MEASUREMENT:MEAS<x>:CLOCKRECOVERY:CONSTCLOCKMODE?

<b>Arguments</b>	<p>MEAS&lt;x&gt; specifies the measurement number.</p> <p>MEAN specifies that clock recovery uses the mean of the clock signal as the clock frequency.</p> <p>MEDian specifies that clock recovery uses the mode of the clock signal as the clock frequency.</p> <p>FIXed specifies that clock recovery uses the value set by the user as the clock frequency.</p>
<b>Examples</b>	<p>MEASUREMENT:MEAS1:CLOCKRECOVERY:CONSTCLOCKMODE FIXED specifies that clock recovery uses the value set by the user as the clock frequency.</p> <p>MEASUREMENT:MEAS1:CLOCKRECOVERY:CONSTCLOCKMODE? might return :MEASUREMENT:MEAS1:CLOCKRECOVERY:CONSTCLOCKMODE MEAN indicating that clock recovery uses the mean of the clock signal as the clock frequency.</p>

## MEASUREMENT:MEAS<x>:CLOCKRECOVERY:DAMPing

This command sets or queries the damping value used when PLL clock recovery is used for the measurement. Measurements are specified by x.

<b>Group</b>	Measurement
<b>Syntax</b>	<p>MEASUREMENT:MEAS&lt;x&gt;:CLOCKRECOVERY:DAMPing &lt;NR3&gt;          MEASUREMENT:MEAS&lt;x&gt;:CLOCKRECOVERY:DAMPing?</p>
<b>Arguments</b>	<p>MEAS&lt;x&gt; specifies the measurement number.</p> <p>&lt;NR3&gt; is the clock recovery damping value.</p>
<b>Examples</b>	<p>MEASUREMENT:MEAS1:CLOCKRECOVERY:DAMPing 700.0E-3 sets the damping value to 0.70.</p> <p>MEASUREMENT:MEAS1:CLOCKRECOVERY:DAMPing? might return :MEASUREMENT:MEAS1:CLOCKRECOVERY:DAMPING 700.0000E-3 indicating the damping value is 0.70.</p>

## MEASUREMENT:MEAS<x>:CLOCKRECOVERY:DATAPath

This command sets or queries the file containing the data pattern used when known data pattern clock recovery is used for the measurement. Measurements are specified by x.

<b>Group</b>	Measurement
<b>Syntax</b>	MEASUREMENT:MEAS<x>:CLOCKRECOVERY:DATAPATH <QString> MEASUREMENT:MEAS<x>:CLOCKRECOVERY:DATAPATH?
<b>Arguments</b>	MEAS<x> specifies the measurement number.  <QString> is the file containing the data pattern to be used for known data pattern clock recovery.
<b>Examples</b>	MEASUREMENT:MEAS1:CLOCKRECOVERY:DATAPATH "TEST125.txt" specifies the file containing the data pattern is TEST125.txt.  MEASUREMENT:MEAS1:CLOCKRECOVERY:DATAPATH? might return :MEASUREMENT:MEAS1:CLOCKRECOVERY:DATAPATH "PRBS127.txt" indicating the file containing the data pattern is PRBS127.txt.

## MEASUREMENT:MEAS<x>:CLOCKRECOVERY:DATARATE

This command sets or queries the nominal data bit rate when nominal data rate clock recovery is used for the measurement. Measurements are specified by x.

<b>Group</b>	Measurement
<b>Syntax</b>	MEASUREMENT:MEAS<x>:CLOCKRECOVERY:DATARATE <NR3> MEASUREMENT:MEAS<x>:CLOCKRECOVERY:DATARATE?
<b>Arguments</b>	MEAS<x> specifies the measurement number.  <NR3> is the value for the Nominal data rate.
<b>Examples</b>	MEASUREMENT:MEAS1:CLOCKRECOVERY:DATARATE 2.0000E+9 sets the data rate to 2.0 Gb/s.  MEASUREMENT:MEAS1:CLOCKRECOVERY:DATARATE? might return :MEASUREMENT:MEAS1:CLOCKRECOVERY:DATARATE 2.5000E+9 indicating the data rate is 2.5 Gb/s.

## MEASUREMENT:MEAS<x>:CLOCKRECOVERY:EXPLICITCLOCKMODE

This command sets or queries the explicit clock mode used when explicit clock recovery is used for the measurement. The measurement number is specified by x.



<b>Group</b>	Measurement
<b>Syntax</b>	<pre>MEASUREMENT:MEAS&lt;x&gt;:CLOCKRECOVERY:EXPLICITCLOCKMODE {EDGE PLL} MEASUREMENT:MEAS&lt;x&gt;:CLOCKRECOVERY:EXPLICITCLOCKMODE?</pre>
<b>Arguments</b>	<p>MEAS&lt;x&gt; specifies the measurement number.</p> <p>EDGE specifies the clock edge.</p> <p>PLL specifies the phase locked loop.</p>
<b>Examples</b>	<p>MEASUREMENT:MEAS1:CLOCKRECOVERY:EXPLICITCLOCKMODE EDGE sets the clock mode to edge.</p> <p>MEASUREMENT:MEAS1:CLOCKRECOVERY:EXPLICITCLOCKMODE? might return :MEASUREMENT:MEAS1:CLOCKRECOVERY:EXPLICITCLOCKMODE EDGE indicating the explicit clock mode is edge.</p>

## MEASUREMENT:MEAS<x>:CLOCKRECOVERY:GLOBAL

This command sets or queries the clock recovery settings global flag for the measurement. Measurements are specified by x.

<b>Group</b>	Measurement
<b>Syntax</b>	<pre>MEASUREMENT:MEAS&lt;x&gt;:CLOCKRECOVERY:GLOBAL {OFF ON 0 1} MEASUREMENT:MEAS&lt;x&gt;:CLOCKRECOVERY:GLOBAL?</pre>
<b>Arguments</b>	<p>MEAS&lt;x&gt; specifies the measurement number.</p> <p>OFF clock recovery settings are changed independently for each individual measurement.</p> <p>ON applies global clock recovery settings to all the measurements' clock recovery settings.</p> <p>0 clock recovery settings are changed independently for each individual measurement.</p> <p>1 applies global clock recovery settings to all the measurements' clock recovery settings.</p>
<b>Examples</b>	<p>MEASUREMENT:MEAS1:CLOCKRECOVERY:GLOBAL 1 applies global clock recovery settings to all the measurements' clock recovery settings.</p>

MEASUREMENT:MEAS1:CLOCKRECOVERY:GLOBAL? might return  
:MEASUREMENT:MEAS1:CLOCKRECOVERY:GLOBAL 0 indicating clock recovery  
settings are changed independently for each individual measurement.

## MEASUREMENT:MEAS<x>:CLOCKRECOVERY:JTFBANDWIDTH

This command sets or queries the JTF bandwidth used when PLL clock recovery is used for the measurement. Measurements are specified by x.

<b>Group</b>	Measurement
<b>Syntax</b>	MEASUREMENT:MEAS<x>:CLOCKRECOVERY:JTFBANDWIDTH <NR3> MEASUREMENT:MEAS<x>:CLOCKRECOVERY:JTFBANDWIDTH?
<b>Arguments</b>	MEAS<x> specifies the measurement number. <NR3> is the clock recovery JTF bandwidth.
<b>Examples</b>	MEASUREMENT:MEAS1:CLOCKRECOVERY:JTFBANDWIDTH 1.10E+6 sets the bandwidth to 1.1 MHz.  MEASUREMENT:MEAS1:CLOCKRECOVERY:JTFBANDWIDTH? might return :MEASUREMENT:MEAS1:CLOCKRECOVERY:JTFBANDWIDTH 1.0000E+6 indicating the bandwidth is 1.0 MHz.

## MEASUREMENT:MEAS<x>:CLOCKRECOVERY:LOOPBANDWIDTH

This command sets or queries the loop bandwidth used when PLL clock recovery is used for the measurement. Measurements are specified by x.

<b>Group</b>	Measurement
<b>Syntax</b>	MEASUREMENT:MEAS<x>:CLOCKRECOVERY:LOOPBANDWIDTH <NR3> MEASUREMENT:MEAS<x>:CLOCKRECOVERY:LOOPBANDWIDTH?
<b>Arguments</b>	MEAS<x> specifies the measurement number. <NR3> is the clock recovery loop bandwidth.
<b>Examples</b>	MEASUREMENT:MEAS1:CLOCKRECOVERY:LOOPBANDWIDTH 1.10E+6 sets the bandwidth to 1.1 Mhz.

MEASUREMENT:MEAS1:CLOCKRECOVERY:LOOPBANDWIDTH? might return  
:MEASUREMENT:MEAS1:CLOCKRECOVERY:LOOPBANDWIDTH 1.0000E+6  
indicating the bandwidth is 1.0 MHz.

## MEASUREMENT:MEAS<x>:CLOCKRECOVERY:MEANAUTOCALCULATE

This command sets or queries how often the clock is calculated when constant clock recovery is used for the measurement. The measurement number is specified by x.

<b>Group</b>	Measurement
<b>Syntax</b>	MEASUREMENT:MEAS<x>:CLOCKRECOVERY:MEANAUTOCALCULATE {FIRST EVERY} MEASUREMENT:MEAS<x>:CLOCKRECOVERY:MEANAUTOCALCULATE?
<b>Arguments</b>	MEAS<x> specifies the measurement number.  FIRST calculates the clock on the first acquisition.  EVERY calculates the clock on every acquisition.
<b>Examples</b>	MEASUREMENT:MEAS1:CLOCKRECOVERY:MEANAUTOCALCULATE EVERY causes the clock to be calculated on every acquisition.  MEASUREMENT:MEAS1:CLOCKRECOVERY:MEANAUTOCALCULATE? might return :MEASUREMENT:MEAS1:CLOCKRECOVERY:MEANAUTOCALCULATE FIRST indicating the clock is calculated on the first acquisition.

## MEASUREMENT:MEAS<x>:CLOCKRECOVERY:METHOD

This command sets or queries the clock recovery method for the measurement. Measurements are specified by x.

<b>Group</b>	Measurement
<b>Syntax</b>	MEASUREMENT:MEAS<x>:CLOCKRECOVERY:METHOD {PLL CONSTANTCLOCK EXPLICITCLOCK} MEASUREMENT:MEAS<x>:CLOCKRECOVERY:METHOD?

<b>Arguments</b>	<p>MEAS&lt;x&gt; specifies the measurement number.</p> <p>PLL specifies a phase locked loop clock recovery method.</p> <p>CONSTANTCLOCK specifies using a constant clock.</p> <p>EXPLICITCLOCK specifies using an explicit clock.</p>
<b>Examples</b>	<p>MEASUREMENT:MEAS1:CLOCKRECOVERY:METHOD PLL specifies a phase locked loop clock recovery method.</p> <p>MEASUREMENT:MEAS1:CLOCKRECOVERY:METHOD? might return :MEASUREMENT:MEAS1:CLOCKRECOVERY:METHOD CONSTANTCLOCK indicating a constant clock is in use.</p>

## MEASUREMENT:MEAS<x>:CLOCKRECOVERY:MODE1

This command sets or queries the PLL clock recovery model used when PLL clock recovery is used for the measurement. Measurements are specified by x.

<b>Group</b>	Measurement
<b>Syntax</b>	<p>MEASUREMENT:MEAS&lt;x&gt;:CLOCKRECOVERY:MODE1 {TYPE1 TYPE2}</p> <p>MEASUREMENT:MEAS&lt;x&gt;:CLOCKRECOVERY:MODE1?</p>
<b>Arguments</b>	<p>MEAS&lt;x&gt; specifies the measurement number.</p> <p>Arguments are the clock recovery model type.</p>
<b>Examples</b>	<p>MEASUREMENT:MEAS1:CLOCKRECOVERY:MODE1 TYPE1 set the clock recovery model lto type 1.</p> <p>MEASUREMENT:MEAS1:CLOCKRECOVERY:MODE1? might return :MEASUREMENT:MEAS1:CLOCKRECOVERY:MODEL TYPE1 indicating the clock recovery model is type 1.</p>

## MEASUREMENT:MEAS<x>:CLOCKRECOVERY:NOMINALOFFSET

This command sets or queries the offset value used when explicit clock recovery is used for the measurement. Measurements are specified by x.

<b>Group</b>	Measurement
--------------	-------------

<b>Syntax</b>	<pre>MEASUREMENT:MEAS&lt;x&gt;:CLOCKRECOVERY:NOMINALOFFSET &lt;NR3&gt; MEASUREMENT:MEAS&lt;x&gt;:CLOCKRECOVERY:NOMINALOFFSET?</pre>
<b>Arguments</b>	<p>MEAS&lt;x&gt; specifies the measurement number.</p> <p>&lt;NR3&gt; is the clock offset.</p>
<b>Examples</b>	<p>MEASUREMENT:MEAS1:CLOCKRECOVERY:NOMINALOFFSET 1.0e-9 sets the clock offset to 1 ns.</p> <p>MEASUREMENT:MEAS1:CLOCKRECOVERY:NOMINALOFFSET? might return :MEASUREMENT:MEAS1:CLOCKRECOVERY:NOMINALOFFSET 0.0E+0 indicating the offset is 0.0 ns.</p>

## MEASUREMENT:MEAS<x>:CLOCKRECOVERY:NOMINALOFFSET:SELECTIONTYPE

This command sets or queries the offset type used when explicit clock recovery is used for the measurement. The measurement number is specified by x.

<b>Group</b>	Measurement
<b>Syntax</b>	<pre>MEASUREMENT:MEAS&lt;x&gt;:CLOCKRECOVERY:NOMINALOFFSET:SELECTIONTYPE {AUTO MANUAL} MEASUREMENT:MEAS&lt;x&gt;:CLOCKRECOVERY:NOMINALOFFSET:SELECTIONTYPE?</pre>
<b>Arguments</b>	<p>MEAS&lt;x&gt; specifies the measurement number.</p> <p>AUTO automatically calculates the offset.</p> <p>MANUAL allows the user to set the offset.</p>
<b>Examples</b>	<p>MEASUREMENT:MEAS1:CLOCKRECOVERY:NOMINALOFFSET:SELECTIONTYPE AUTO sets the offset selection type to auto.</p> <p>MEASUREMENT:MEAS1:CLOCKRECOVERY:NOMINALOFFSET:SELECTIONTYPE? might return :MEASUREMENT:MEAS1:CLOCKRECOVERY:NOMINALOFFSET:SELECTIONTYPE MANUAL indicating the selection type is manual.</p>

## MEASUREMENT:MEAS<x>:CLOCKRECOVERY:STANDARD

This command sets or queries the communications standard when PLL clock recovery is used for the measurement. The measurement number is specified by x.

<b>Group</b>	Measurement
<b>Syntax</b>	<pre>MEASUREMENT:MEAS&lt;x&gt;:CLOCKRECOVERY:STANDARD {CUSTOM  ENET100 FW1394BS400B FW1394BS800B FW1394BS1600B FBD1  FBD2 FBD3 FC133 FC266 FC531 FC1063 FC2125 FC4250  FC8500 ENET1000 IBA2500 IBA_GEN2 OC1 OC3 OC12 OC48  PCIE_GEN1 PCIE_GEN2 PCIE_GEN3 RIO125 RIO250 RIO3125  SAS15_NOSSC SAS3_NOSSC SAS6_NOSSC SAS12_NOSSC SAS15_SSC  SAS3_SSC SAS6_SSC SAS12_SSC SATA_GEN1 SATA_GEN2  SATA_GEN3 USB3 XAUI XAUI_GEN2} MEASUREMENT:MEAS&lt;x&gt;:CLOCKRECOVERY:STANDARD?</pre>
<b>Arguments</b>	<p>MEAS&lt;x&gt; specifies the measurement number.</p> <p>Arguments are the clock recovery standards.</p>
<b>Examples</b>	<p>MEASUREMENT:MEAS1:CLOCKRECOVERY:STANDARD PCIE_GEN2 sets the standard to PCIE_GEN2.</p> <p>MEASUREMENT:MEAS1:CLOCKRECOVERY:STANDARD? might return :MEASUREMENT:MEAS1:CLOCKRECOVERY:STANDARD PCIE_GEN1 indicating the standard is PCIE_GEN1.</p>

## MEASUREMENT:MEAS<x>:COMMONMODE:FILTERS:STATE

This command sets or queries whether a filter is used for the measurement when the measurement type is AC common mode. Measurements are specified by x.

<b>Group</b>	Measurement
<b>Syntax</b>	<pre>MEASUREMENT:MEAS&lt;x&gt;:COMMONMODE:FILTERS:STATE {OFF ON 0 1} MEASUREMENT:MEAS&lt;x&gt;:COMMONMODE:FILTERS:STATE?</pre>
<b>Arguments</b>	<p>MEAS&lt;x&gt; specifies the measurement number.</p> <p>OFF turns the filter off.</p> <p>ON turns the filter on.</p> <p>0 turns the filter off.</p> <p>1 turns the filter on.</p>

**Examples**    `MEASUREMENT:MEAS1:COMMONMODE:FILTERs:STATE ON` sets the filter to on.  
`MEASUREMENT:MEAS1:COMMONMODE:FILTERs:STATE?` might return  
`:MEASUREMENT:MEAS1:COMMONMODE:FILTERs:STATE 0` indicating the filter  
is off.

## MEASUREMENT:MEAS<x>:COMMONMODE:SOURCES

This command sets or queries the number of sources for the measurement when the measurement type is AC common mode. Measurements are specified by x.

**Group**    Measurement

**Syntax**    `MEASUREMENT:MEAS<x>:COMMONMODE:SOURCES {SINGLE|DOUBLE}`  
`MEASUREMENT:MEAS<x>:COMMONMODE:SOURCES?`

**Arguments**    `MEAS<x>` specifies the measurement number.  
  
`SINGLE` specifies a single source.  
  
`DOUBLE` specifies double sources.

**Examples**    `MEASUREMENT:MEAS1:COMMONMODE:SOURCES SINGLE` specifies a single  
source.  
  
`MEASUREMENT:MEAS1:COMMONMODE:SOURCES?` might return  
`:MEASUREMENT:MEAS1:COMMONMODE:SOURCES DOUBLE` indicating sources  
are set to double.

## MEASUREMENT:MEAS<x>:COVER

This command sets or queries the Calculate Over for the Power Quality measurement. Measurements are specified by x.

**Conditions**    IMDA license on MSO 5 and 6 Series MSO instruments and 3-Phase license  
on 4 Series MSO instruments.

**Group**    Measurement, IMDA

**Syntax**    `MEASUREMENT:MEAS<x>:COVER {FFREQUENCY|AFREQUENCIES}`  
`MEASUREMENT:MEAS<x>:COVER?`

<b>Arguments</b>	<code>FFREQUENCY</code> sets Calculate Power Quality measurement. <code>AFREQUENCIES</code> sets Calculate Power Quality measurement for all frequencies.
<b>Examples</b>	<code>MEASUREMENT:MEAS1:COVER AFREQUENCIES</code> sets Calculate Power Quality measurement for all frequencies. <code>MEASUREMENT:MEAS1:COVER?</code> might return <code>:MEASUREMENT:MEAS1:COVER AFREQUENCIES</code> , indicating the Calculate Power Quality measurement is set for all frequencies.

## MEASUREMENT:MEAS<x>:CUSTOMLIMITSFile

This command sets or queries the custom limits file path for custom harmonics standard. Measurements are specified by x.

<b>Group</b>	Measurement, IMDA
<b>Syntax</b>	<code>MEASUREMENT:MEAS&lt;x&gt;:CUSTOMLIMITSFile &lt;Qstring&gt;</code> <code>MEASUREMENT:MEAS&lt;x&gt;:CUSTOMLIMITSFile?</code>
<b>Arguments</b>	<code>MEAS&lt;x&gt;</code> specifies the measurement number. <code>&lt;Qstring&gt;</code> specifies the location of limits file.
<b>Examples</b>	<code>MEASUREMENT:MEAS1:CUSTOMLIMITSFile &lt;C:\MyDir\Limits.csv&gt;</code> sets the location of the limits file as <code>C:\MyDir\</code> . <code>MEASUREMENT:MEAS1:CUSTOMLIMITSFile?</code> might return <code>:MEASUREMENT:MEAS1:CUSTOMLIMITSFile &lt;C:\MyDir\Limits.csv&gt;</code> , indicating the location of the <code>Limits.csv</code> file.

## MEASUREMENT:MEAS<x>:CYCLEmode

This command sets or queries the cycle mode for the measurement. Measurements are specified by x.

<b>Group</b>	Measurement, IMDA
<b>Syntax</b>	<code>MEASUREMENT:MEAS&lt;x&gt;:CYCLEmode {RECORD CYCLE}</code> <code>MEASUREMENT:MEAS&lt;x&gt;:CYCLEmode?</code>



**Arguments** MEAS<x> specifies the measurement number.  
 RECORD specifies that the measurement is taken over the whole record.  
 CYCLE specifies that measurements are taken on each cycle of the source.

**Examples** MEASUREMENT:MEAS1:CYCLEmode CYCLE sets the measurement to be taken over each cycle of the source.  
 MEASUREMENT:MEAS1:CYCLEmode? might return  
 :MEASUREMENT:MEAS1:CYCLEMODE RECORD indicating the measurement is taken over the whole record.

## MEASUREMENT:MEAS<x>:DELAY:EDGE<x>

This command sets or queries the 'to edge' type when EDGE<x> is EDGE1 and the 'from edge' type when EDGE<x> is EDG2, for the measurement when the measurement type is DELAY. Measurements are specified by x.

**Group** Measurement

**Syntax** MEASUREMENT:MEAS<x>:DELAY:EDGE<x>  
 {FALL|RISe|BOTH|SAMEas|OPPOSITEas}  
 MEASUREMENT:MEAS<x>:DELAY:EDGE<x>?

**Related Commands** [MEASUREMENT:MEAS<x>:TOEdge](#)

**Arguments** MEAS<x> specifies the measurement number.  
 FALL specifies the falling edge of the waveform.  
 RISE specifies the rising edge of the waveform.  
 BOTH specifies both a rising and falling edge of the waveform.  
 SAMEas specifies that both edges of the waveform are the same.  
 OPPOSITEas specifies that the edges of the waveform are not the same.

**Examples** MEASUREMENT:MEAS3:DELAY:EDGE2 RISE specifies that the rising edge of the waveform be used for measurement 3.  
 MEASUREMENT:MEAS1:DELAY:EDGE2? might return  
 :MEASUREMENT:MEAS1:DELAY:EDGE2 FALL, indicating that the falling edge of the waveform is being used for measurement 1.

## MEASUREMENT:MEAS<x>:DISPLAYSTAT:ENABLE

This command turns on and off display of statistics in measurement badges in the user interface. This command affects only the display of statistics, basic-statistics are computed regardless of the state of this command. Measurements are specified by x.

**Group** Measurement

**Syntax** MEASUREMENT:MEAS<x>:DISPLAYSTAT:ENABLE {OFF|ON|<NR1>}  
MEASUREMENT:MEAS<x>:DISPLAYSTAT:ENABLE?

**Arguments** MEAS<x> specifies the measurement number.

OFF turns off the display of statistics in measurement badges.

ON turns on the display of statistics in measurement badges.

<NR1> = 0 turns off the display of statistics in the measurement badge, any other value turns on the display of statistics.

**Examples** MEASUREMENT:MEAS<x>:DISPLAYSTAT:ENABLE 0 turns off the display of statistics in the measurement badge.

MEASUREMENT:MEAS<x>:DISPLAYSTAT:ENABLE? might return  
:MEASUREMENT:MEAS1:DISPLAYSTAT:ENABLE 1 indicating that the display of statistics in the measurement badge is on.

## MEASUREMENT:MEAS<x>:EDGEINCR

This command sets or queries the edge increment value for the measurement. Measurements are specified by x.

**Group** Measurement

**Syntax** MEASUREMENT:MEAS<x>:EDGEINCR <NR3>  
MEASUREMENT:MEAS<x>:EDGEINCR?

**Arguments** MEAS<x> specifies the measurement number.

<NR3> is the measurements edge increment value.

**Examples**     :MEASUREMENT:MEAS2:EDGEINCRE? might return  
                   :MEASUREMENT:MEAS2:EDGEINCRE 1.0000 indicating the edge increment  
                   value is set to 1.0000.

## MEASUREMENT:MEAS<x>:EDGEQUALIFIER

This command sets or queries the edge qualifier source.

**Conditions**   Requires option 5-DPM (5 Series MSO instruments) or 6-DPM (6 Series MSO  
 instrument)

**Group**        DPM, IMDA

**Syntax**       MEASUREMENT:MEAS<x>:EDGEQUALIFIER {CH<x>|MATH<x>|REF<x>}  
 MEASUREMENT:MEAS<x>:EDGEQUALIFIER?

**Arguments**   MEAS<x> is the measurement number.  
 CH<x> is the edge qualifier source channel.  
 MATH<x> is the edge qualifier source math waveform; <x> is  $\geq 1$ .  
 REF<x> is the edge qualifier source reference waveform; <x> is  $\geq 1$ .

**Examples**     MEASUREMENT:MEAS1:EDGEQUALIFIER CH4 sets the edge qualifier source for  
 measurement 1 to Channel 4.  
 MEASUREMENT:MEAS3:EDGEQUALIFIER? might return UNDEFINED, indicating  
 that there is no edge qualifier source set for measurement 3.

## MEASUREMENT:MEAS<x>:EDGEQUALONE

This command set or queries the measurement 1 input edge qualifier one source  
 for Efficiency measurement.

**Group**        Measurement, IMDA

**Syntax**       MEASUREMENT:MEAS<x>:EDGEQUALONE <Qstring>  
 MEASUREMENT:MEAS<x>:EDGEQUALONE?

**Arguments** MEAS<x> is the measurement number.  
<Qstring> specifies the edge qualifier source at input configuration.

**Examples** MEASUREMENT:MEAS1:EDGEQUALONE Vac sets the edge qualifier source for measurement 1 to Vac at input configuration.  
MEASUREMENT:MEAS1:EDGEQUALONE? might return Vac, indicating that the edge qualifier source for measurement 1 is Vac at input configuration.

## MEASUREMENT:MEAS<x>:EDGEQUALTWO

This command sets or queries the measurement 1 output edge qualifier two source for Efficiency measurement.

**Group** Measurement, IMDA

**Syntax** MEASUREMENT:MEAS<x>:EDGEQUALTWO <Qstring>  
MEASUREMENT:MEAS<x>:EDGEQUALTWO?

**Arguments** MEAS<x> is the measurement number.  
<Qstring> specifies the edge qualifier source at output configuration.

**Examples** MEASUREMENT:MEAS1:EDGEQUALTWO Vxz sets the edge qualifier source for measurement 1 to Vxz at output configuration.  
MEASUREMENT:MEAS1:EDGEQUALTWO? might return Vxz, indicating that the edge qualifier source for measurement 1 is Vxz at output configuration.

## MEASUREMENT:MEAS<x>:EDGES:FROMLevel

This command sets or queries the 'from level' edge for the measurement. Measurements are specified by x.

**Group** Measurement

**Syntax** MEASUREMENT:MEAS<x>:EDGES:FROMLevel {MID|LOW|HIGH}  
MEASUREMENT:MEAS<x>:EDGES:FROMLevel?

<b>Arguments</b>	<p>MEAS&lt;x&gt; specifies the measurement number.</p> <p>MID specifies the MID level.</p> <p>HIGH specifies the HIGH level.</p> <p>LOW specifies the LOW level.</p>
<b>Examples</b>	<p>MEASUREMENT:MEAS1:EDGES:FROMLevel1 HIGH set the from level to the high level</p> <p>MEASUREMENT:MEAS1:EDGES:FROMLevel1? might return :MEASUREMENT:MEAS1:EDGES:FROMLEVEL LOW indicating the from level is the low level.</p>

## MEASUREMENT:MEAS<x>:EDGES:LEVEL

This sets or queries the level type for the 'time outside level' measurement. Measurements are specified by x.

<b>Group</b>	Measurement
<b>Syntax</b>	<p>MEASUREMENT:MEAS&lt;x&gt;:EDGES:LEVEL {HIGH LOW BOTH}</p> <p>MEASUREMENT:MEAS&lt;x&gt;:EDGES:LEVEL?</p>
<b>Arguments</b>	<p>MEAS&lt;x&gt; specifies the measurement number.</p> <p>HIGH specifies the HIGH level.</p> <p>LOW specifies the LOW level.</p> <p>BOTH specifies both the HIGH and LOW level.</p>
<b>Examples</b>	<p>MEASUREMENT:MEAS1:EDGES:LEVEL LOW sets the level to the low level.</p> <p>MEASUREMENT:MEAS1:EDGES:LEVEL? might return :MEASUREMENT:MEAS1:EDGES:LEVEL HIGH indicating the level is set to the high level.</p>

## MEASUREMENT:MEAS<x>:EDGES:LOWERFREQUENCY

This command sets or queries the lower frequency for the measurement when the measurement type is phase noise. Lower frequencies are ignored. Measurements are specified by x.

<b>Group</b>	Measurement
<b>Syntax</b>	MEASUREMENT:MEAS<x>:EDGES:LOWERFREQUENCY <NR3> MEASUREMENT:MEAS<x>:EDGES:LOWERFREQUENCY?
<b>Arguments</b>	MEAS<x> specifies the measurement number.  <NR3> is the lower frequency of the edge.
<b>Examples</b>	MEASUREMENT:MEAS1:EDGES:LOWERFREQUENCY 1.0e3 sets the lower frequency to 1 kHz.  MEASUREMENT:MEAS1:EDGES:LOWERFREQUENCY? might return :MEASUREMENT:MEAS1:EDGES:LOWERFREQUENCY 0.0E+0 indicating the lower frequency is set to 0.0 Hertz.

## MEASUREMENT:MEAS<x>:EDGES:N

The command sets or queries the number of accumulation cycles for the measurement when the measurement type is nperiod. Measurements are specified by x.

<b>Group</b>	Measurement
<b>Syntax</b>	MEASUREMENT:MEAS<x>:EDGES:N <NR3> MEASUREMENT:MEAS<x>:EDGES:N?
<b>Arguments</b>	MEAS<x> specifies the measurement number.  <NR3> is the maximum number of edges used by the measurement.
<b>Examples</b>	measurement:meas1:edges:n 2 sets the number of edges to 2.  measurement:meas1:edges:n? might return :MEASUREMENT:MEAS1:EDGES:N 6.0000.

## MEASUREMENT:MEAS<x>:EDGES:SLEWRATEMethod

This command sets or queries the slew rate method for the measurement. Measurements are specified by x.

<b>Group</b>	Measurement
<b>Syntax</b>	MEASUREMENT:MEAS<x>:EDGES:SLEWRATEMethod {NOMINAL DDR} MEASUREMENT:MEAS<x>:EDGES:SLEWRATEMethod?
<b>Arguments</b>	MEAS<x> specifies the measurement number. NOMINAL specifies the nominal slew rate method. DDR specifies the DDR slew rate method.
<b>Examples</b>	measurement:meas1:edges:slewratemethod NOMINAL specifies the nominal slew rate method. measurement:meas1:edges:slewratemethod? might return :MEASUREMENT:MEAS1:EDGES:SLEWRATEMETHOD NOMINAL indicating the slew rate method is set to NOMINAL.

## MEASUREMENT:MEAS<x>:EDGES:TOLevel

This command sets or queries the 'to level' edge for the measurement. Measurements are specified by x.

<b>Group</b>	Measurement
<b>Syntax</b>	MEASUREMENT:MEAS<x>:EDGES:TOLevel {HIGH MID LOW} MEASUREMENT:MEAS<x>:EDGES:TOLevel?
<b>Arguments</b>	MEAS<x> specifies the measurement number. HIGH specifies the HIGH level. MID specifies the MID level. LOW specifies the LOW level.
<b>Examples</b>	MEASUREMENT:MEAS1:EDGES:TOLevel HIGH specifies the High to level. MEASUREMENT:MEAS1:EDGES:TOLevel? might return :MEASUREMENT:MEAS1:EDGES:TOLEVEL LOW indicating the to level edge is set to the Low level.

## MEASUREMENT:MEAS<x>:EDGES:UPPERFREQUENCY

This command sets or queries the upper frequency for the measurement when the measurement type is phase noise. Higher frequencies are ignored. Measurements are specified by x.

<b>Group</b>	Measurement
<b>Syntax</b>	MEASUREMENT:MEAS<x>:EDGES:UPPERFREQUENCY <NR3> MEASUREMENT:MEAS<x>:EDGES:UPPERFREQUENCY?
<b>Arguments</b>	MEAS<x> specifies the measurement number.  <NR3> is the upper frequency of the edge.
<b>Examples</b>	MEASUREMENT:MEAS1:EDGES:UPPERFREQUENCY 1.5 sets the upper frequency to 1.5 MHz.  MEASUREMENT:MEAS1:EDGES:UPPERFREQUENCY? might return :MEASUREMENT:MEAS1:EDGES:UPPERFREQUENCY 1.0000E+6 indicating the upper frequency is 1.0 MHz.

## MEASUREMENT:MEAS<x>:EDGE<x>

This command sets or queries the type of the specified edge, rise or fall, for the measurement. The measurement number is specified by x.

<b>Group</b>	Measurement
<b>Syntax</b>	MEASUREMENT:MEAS<x>:EDGE<x> {RISE FALL BOTH} MEASUREMENT:MEAS<x>:EDGE<x>?
<b>Arguments</b>	MEAS<x> specifies the measurement number.  RISE specifies the rising edge.  FALL specifies the falling edge.  BOTH specifies either the rising or falling edge.
<b>Examples</b>	MEASUREMENT:MEAS2:EDGE1? might return :MEASUREMENT:MEAS2:EDGE1 RISE indicating that edge 1 of measurement 2 is the rising edge.



## MEASUREMENT:MEAS<x>:EEQUAL

This command turns on or off the edge qualifier settings as input waveform to measurement. The measurement number is specified by x.

<b>Conditions</b>	Requires a WBG-DPT license.
<b>Group</b>	Measurement, WBG
<b>Syntax</b>	MEASUREMENT:MEAS<x>:EEQUAL {ON OFF} MEASUREMENT:MEAS<x>:EEQUAL?
<b>Arguments</b>	ON specifies the edge qualifier settings has been turned on. OFF specifies the edge qualifier settings has been turned off.
<b>Examples</b>	MEASUREMENT:MEAS1:EEQUAL ON the edge qualifier settings to on. MEASUREMENT:MEAS1:EEQUAL? might return :MEASUREMENT:MEAS1:EEQUAL OFF, indicating the edge qualifier settings is off.

## MEASUREMENT:MEAS<x>:FAILCOUNT? (Query Only)

This command returns the number of measurement failures, if applicable, for the selected measurement. The measurement number is specified by x.

<b>Group</b>	Measurement
<b>Syntax</b>	MEASUREMENT:MEAS<x>:FAILCOUNT?
<b>Related Commands</b>	<a href="#">ACTONEVENT:ENABLE</a>
<b>Returns</b>	A running sum of the number of violations of the user specified measurement limit.
<b>Examples</b>	MEASUREMENT:MEAS2:FAILCOUNT? might return :MEASUREMENT:MEAS2:FAILCOUNT 2 indicating that measurement 2 has two measurement failures.

## MEASUrement:MEAS<x>:FILTERRANGEFROM

This command sets or queries harmonics filter from order. Measurements are specified by x.

<b>Group</b>	Measurement, IMDA
<b>Syntax</b>	MEASUrement:MEAS<x>:FILTERRANGEFROM <NR3> MEASUrement:MEAS<x>:FILTERRANGEFROM?
<b>Arguments</b>	MEAS<x> specifies the measurement number.  <NR3> specifies the filter range from value. The default value is 1.
<b>Examples</b>	MEASUrement:MEAS1:FILTERRANGEFROM 4 sets filter range from value for measurement 1 to 4.  MEASUrement:MEAS1:FILTERRANGEFROM? might return :MEASUrement:MEAS1:FILTERRANGEFROM 3, indicating the filter range from value is 3.

## MEASUrement:MEAS<x>:FILTERRANGETO

This command sets or queries harmonics filter to order. Measurements are specified by x.

<b>Group</b>	Measurement, IMDA
<b>Syntax</b>	MEASUrement:MEAS<x>:FILTERRANGETO <NR3> MEASUrement:MEAS<x>:FILTERRANGETO?
<b>Arguments</b>	MEAS<x> specifies the measurement number.  <NR3> specifies the filter range to value. The default value is 50.
<b>Examples</b>	MEASUrement:MEAS1:FILTERRANGETO 50 sets filter range to value for measurement 1 to 50.  MEASUrement:MEAS1:FILTERRANGETO? might return :MEASUrement:MEAS1:FILTERRANGETO 50, indicating the filter range to value is 50.

## MEASUREMENT:MEAS<x>:FILTERS:BLANKINGtime

This command sets or queries the filter blanking time for the measurement. Measurements are specified by x.

<b>Group</b>	Measurement
<b>Syntax</b>	MEASUREMENT:MEAS<x>:FILTERS:BLANKINGtime <NR3> MEASUREMENT:MEAS<x>:FILTERS:BLANKINGtime?
<b>Arguments</b>	MEAS<x> specifies the measurement number.  <NR3> is the current filter blanking time.
<b>Examples</b>	MEASUREMENT:MEAS1:FILTERS:BLANKINGtime 3.5 sets the blanking time to 3.5.  MEASUREMENT:MEAS1:FILTERS:BLANKINGtime? might return :MEASUREMENT:MEAS1:FILTERS:BLANKINGTIME 4.0000 indicating the filter blanking time is 4.0.

## MEASUREMENT:MEAS<x>:FILTERS:GLOBAL

This command sets or queries the global flag for filter settings for the measurement. Measurements are specified by x.

<b>Group</b>	Measurement
<b>Syntax</b>	MEASUREMENT:MEAS<x>:FILTERS:GLOBAL {OFF ON 0 1} MEASUREMENT:MEAS<x>:FILTERS:GLOBAL?
<b>Arguments</b>	MEAS<x> specifies the measurement number.  OFF causes filter settings to be changed independently for each individual measurement.  ON applies global filter settings to all the measurements' filter settings.  0 causes filter settings to be changed independently for each individual measurement.  1 applies global filter settings to all the measurements' filter settings.

**Examples**    `MEASUREMENT:MEAS<x>:FILTERS:GLOBAL OFF` causes filter settings to be changed independently for each individual measurement.

`MEASUREMENT:MEAS<x>:FILTERS:GLOBAL?` might return  
`:MEASUREMENT:MEAS1:FILTERS:GLOBAL 1` indicating filter settings are for all measurements.

## MEASUREMENT:MEAS<x>:FILTERS:HIGHPASS:FREQ

This command sets or queries the high pass filter frequency for the measurement. Measurements are specified by x.

**Group**    Measurement

**Syntax**    `MEASUREMENT:MEAS<x>:FILTERS:HIGHPASS:FREQ <NR3>`  
`MEASUREMENT:MEAS<x>:FILTERS:HIGHPASS:FREQ?`

**Arguments**    `MEAS<x>` specifies the measurement number.  
`<NR3>` is the current high pass filter frequency.

**Examples**    `MEASUREMENT:MEAS1:FILTERS:HIGHPASS:FREQ 15.0E+6` sets the high pass frequency to 15.0 MHz.

`MEASUREMENT:MEAS1:FILTERS:HIGHPASS:FREQ?` might return  
`:MEASUREMENT:MEAS1:FILTERS:HIGHPASS:FREQ 10.0000E+6` indicating the high pass frequency is set to 10.0 MHz.

## MEASUREMENT:MEAS<x>:FILTERS:HIGHPASS:SPEC

This command sets or queries the high pass filter order for the measurement. Measurements are specified by x.

**Group**    Measurement

**Syntax**    `MEASUREMENT:MEAS<x>:FILTERS:HIGHPASS:SPEC`  
`{NONE | FIRST | SECOND | THIRD}`  
`MEASUREMENT:MEAS<x>:FILTERS:HIGHPASS:SPEC?`

**Arguments**    `MEAS<x>` specifies the measurement number.  
`NONE` specifies no filter.

FIRST specifies a first-order filter.

SECOND specifies a second-order filter.

THIRD specifies a third-order filter.

**Examples** MEASUREMENT:MEAS1:FILTERs:HIGHPass:SPEC FIRST specifies a first-order filter.

MEASUREMENT:MEAS1:FILTERs:HIGHPass:SPEC? might return  
:MEASUREMENT:MEAS1:FILTERs:HIGHPASS:SPEC NONE indicating no high pass filter is used.

## MEASUREMENT:MEAS<x>:FILTERs:LOWPass:FREQ

This command sets or queries the low pass filter cutoff frequency for the measurement. Measurements are specified by x.

**Group** Measurement

**Syntax** MEASUREMENT:MEAS<x>:FILTERs:LOWPass:FREQ <NR3>  
MEASUREMENT:MEAS<x>:FILTERs:LOWPass:FREQ?

**Arguments** MEAS<x> specifies the measurement number.

<NR3> is the current low pass filter frequency. The argument range is 20 Hz to 10e6 Hz.

**Examples** MEASUREMENT:MEAS1:FILTERs:LOWPass:FREQ 5.0E+6 sets the low pass frequency to 5.0 MHz.

MEASUREMENT:MEAS1:FILTERs:LOWPass:FREQ? might return  
:MEASUREMENT:MEAS1:FILTERs:LOWPASS:FREQ 10.0000E+6 indicating the low pass frequency is 10.0 MHz.

## MEASUREMENT:MEAS<x>:FILTERs:LOWPass:SPEC

This command sets or queries the low pass filter order for the measurement. Measurements are specified by x.

**Group** Measurement

**Syntax**    MEASUREMENT:MEAS<x>:FILTERS:LOWPASS:SPEC  
                  {NONE|FIRST|SECOND|THIRD}  
                  MEASUREMENT:MEAS<x>:FILTERS:LOWPASS:SPEC?

**Arguments**    MEAS<x> specifies the measurement number.  
                  NONE specifies no filter.  
                  FIRST specifies a first-order filter.  
                  SECOND specifies a second-order filter.  
                  THIRD specifies a third-order filter.

**Examples**    MEASUREMENT:MEAS1:FILTERS:LOWPASS:SPEC FIRST specifies a first-order filter.  
                  MEASUREMENT:MEAS1:FILTERS:LOWPASS:SPEC? might return  
                  :MEASUREMENT:MEAS1:FILTERS:LOWPASS:SPEC NONE indicating no low pass filter is used.

## MEASUREMENT:MEAS<x>:FILTERS:RAMPTIME

This command sets or queries the filter ramp time for the measurement. Measurements are specified by x.

**Group**    Measurement

**Syntax**    MEASUREMENT:MEAS<x>:FILTERS:RAMPTIME <NR3>  
                  MEASUREMENT:MEAS<x>:FILTERS:RAMPTIME?

**Arguments**    MEAS<x> specifies the measurement number.  
                  <NR3> is the current filter ramp time.

**Examples**    MEASUREMENT:MEAS1:FILTERS:RAMPTIME 1.5 sets the ramp time to 1.5.  
                  MEASUREMENT:MEAS1:FILTERS:RAMPTIME? might return  
                  :MEASUREMENT:MEAS1:FILTERS:RAMPTIME 2.0000 indicating the ramp time is 2.0.

## MEASUREMENT:MEAS<x>:FREQ

This command sets or queries switching frequency for Switching Ripple measurement. Measurements are specified by x.

<b>Group</b>	Measurement, IMDA
<b>Syntax</b>	MEASUREMENT:MEAS<x>:FREQ <NR3> MEASUREMENT:MEAS<x>:FREQ?
<b>Arguments</b>	MEAS<x> specifies the measurement number.  <NR3> specifies the switching frequency. The default is 100k Hz, The minimum is 50 Hz, and the maximum is 1 GHz
<b>Examples</b>	MEASUREMENT:MEAS1:FREQ 50k sets the switching frequency of measurement 1 to 50k Hz.  MEASUREMENT:MEAS1:FREQ? might return :MEASUREMENT:MEAS1:FREQ 100k, indicating the switching frequency is 100k Hz.

## MEASUREMENT:MEAS<x>:FROMEDGE

This command sets or queries the from edge type for the measurement. Measurements are specified by x.

<b>Group</b>	Measurement
<b>Syntax</b>	MEASUREMENT:MEAS<x>:FROMEDGE {RISE FALL BOTH} MEASUREMENT:MEAS<x>:FROMEDGE?
<b>Arguments</b>	MEAS<x> specifies the measurement number.  FALL specifies the falling edge of the waveform.  RISE specifies the rising edge of the waveform.  BOTH specifies both the rising and falling edges of the waveform.
<b>Examples</b>	MEASUREMENT:MEAS1:FROMEDGE RISE specifies the rising edge of the waveform.  MEASUREMENT:MEAS1:FROMEDGE? might return :MEASUREMENT:MEAS1:FROMEDGE BOTH indicating both the rising and falling edges of the waveform.

## MEASUREMENT:MEAS<x>:FROMEDGESEARCHDIRECT

This command sets or queries the from edge search direction for the measurement. Measurements are specified by x.

<b>Group</b>	Measurement
<b>Syntax</b>	MEASUREMENT:MEAS<x>:FROMEDGESEARCHDIRECT {FORWARD BACKWARD} MEASUREMENT:MEAS<x>:FROMEDGESEARCHDIRECT?
<b>Arguments</b>	MEAS<x> specifies the measurement number.  FORWARD specifies a forward search from the edge.  BACKWARD specifies a backward search from the edge.
<b>Examples</b>	MEASUREMENT:MEAS1:FROMEDGESEARCHDIRECT BACKWARD specifies a backward search from the edge.  MEASUREMENT:MEAS1:FROMEDGESEARCHDIRECT? might return MEASUREMENT:MEAS1:FROMEDGESEARCHDIRECT FORWARD indicating a forward search from the edge.

## MEASUREMENT:MEAS<x>:FROMSYMBOL:LOGIC2SOURCE

This command sets or queries the DDR digital measurement logic 1 source From symbol.

<b>Conditions</b>	Requires option 6-DBDDR3.  Requires a 6 Series MSO instrument.
<b>Group</b>	Measurement
<b>Syntax</b>	MEASUREMENT:MEAS<x>:FROMSYMBOL:LOGIC2SOURCE {H L X} MEASUREMENT:MEAS<x>:FROMSYMBOL:LOGIC2SOURCE?
<b>Related Commands</b>	<a href="#">MEASUREMENT:ADDMEAS</a>
<b>Arguments</b>	MEAS<x> specifies the measurement number.  H sets the logic source 1 From Symbol to H (High).



L sets the logic source 1 From Symbol to L (Low).

X sets the logic source 1 From Symbol to X (Don't care).

**Examples** `MEASUREMENT:MEAS1:FROMSYMBOL:LOGIC2SOURCE H` sets the DDR digital measurement (DDRTRPMRS/DDRTRPACT) logic 1 source From Symbol to High.

`MEASUREMENT:MEAS1:FROMSYMBOL:LOGIC2SOURCE?` might return `MEASUREMENT:MEAS1:FROMSYMBOL:LOGIC2SOURCE H`, indicating that the DDR digital measurement (DDRTRPMRS/DDRTRPACT) From symbol is set to H.

## MEASUREMENT:MEAS<x>:FROMSYMBOL:LOGIC3SOURCE

This command sets or queries the DDR digital measurement logic 2 source From symbol.

**Conditions** Requires option 6-DBDDR3.

Requires a 6 Series MSO instrument.

**Group** Measurement

**Syntax** `MEASUREMENT:MEAS<x>:FROMSYMBOL:LOGIC3SOURCE {H|L|X}`  
`MEASUREMENT:MEAS<x>:FROMSYMBOL:LOGIC3SOURCE?`

**Related Commands** [MEASUREMENT:ADDMEAS](#)

**Arguments** `MEAS<x>` specifies the measurement number.

H sets the logic source 2 From Symbol to H (High).

L sets the logic source 2 From Symbol to L (Low).

X sets the logic source 2 From Symbol to X (Don't care).

**Examples** `MEASUREMENT:MEAS1:FROMSYMBOL:LOGIC3SOURCE H` sets the DDR digital measurement (DDRTRPMRS/DDRTRPACT) logic 1 source From Symbol to High.

`MEASUREMENT:MEAS1:FROMSYMBOL:LOGIC3SOURCE?` might return `MEASUREMENT:MEAS1:FROMSYMBOL:LOGIC3SOURCE H`, indicating that the

DDR digital measurement (DDRTRPMRS/DDRTRPACT) From symbol is set to H.

## MEASUREMENT:MEAS<x>:FROMSYMBOL:LOGIC4SOURCE

This command sets or queries the DDR digital measurement logic 3 source From symbol.

**Conditions** Requires option 6-DBDDR3.  
Requires a 6 Series MSO instrument.

**Group** Measurement

**Syntax** MEASUREMENT:MEAS<x>:FROMSYMBOL:LOGIC4SOURCE {H|L|X}  
MEASUREMENT:MEAS<x>:FROMSYMBOL:LOGIC4SOURCE?

**Related Commands** [MEASUREMENT:ADDMEAS](#)

**Arguments** MEAS<x> specifies the measurement number.  
H sets the logic source 3 From Symbol to H (High).  
L sets the logic source 3 From Symbol to L (Low).  
X sets the logic source 3 From Symbol to X (Don't care).

**Examples** MEASUREMENT:MEAS1:FROMSYMBOL:LOGIC4SOURCE H sets the DDR digital measurement (DDRTRPMRS/DDRTRPACT) logic 1 source From Symbol to High.  
MEASUREMENT:MEAS1:FROMSYMBOL:LOGIC4SOURCE? might return  
MEASUREMENT:MEAS1:FROMSYMBOL:LOGIC4SOURCE H, indicating that the DDR digital measurement (DDRTRPMRS/DDRTRPACT) From symbol is set to H.

## MEASUREMENT:MEAS<x>:FROMSYMBOL:LOGIC5SOURCE

This command sets or queries the DDR digital measurement logic 4 source From symbol.

**Conditions** Requires option 6-DBDDR3.

Requires a 6 Series MSO instrument.

**Group** Measurement

**Syntax** MEASUREMENT:MEAS<x>:FROMSymbol:LOGIC5SOURCE {H|L|X}  
MEASUREMENT:MEAS<x>:FROMSymbol:LOGIC5SOURCE?

**Related Commands** [MEASUREMENT:ADDMEAS](#)

**Arguments** MEAS<x> specifies the measurement number.  
H sets the logic source 4 From Symbol to H (High).  
L sets the logic source 4 From Symbol to L (Low).  
X sets the logic source 4 From Symbol to X (Don't care).

**Examples** MEASUREMENT:MEAS1:FROMSymbol:LOGIC5SOURCE H sets the DDR digital measurement (DDRTRPMRS/DDRTRPACT) logic 1 source From Symbol to High.  
MEASUREMENT:MEAS1:FROMSymbol:LOGIC5SOURCE? might return MEASUREMENT:MEAS1:FROMSymbol:LOGIC5SOURCE H, indicating that the DDR digital measurement (DDRTRPMRS/DDRTRPACT) From symbol is set to H.

## MEASUREMENT:MEAS<x>:FROMSymbol:MEASUREAT

This command sets or queries the DDR digital measurement From Symbol MeasureAT value.

**Conditions** Requires option 6-DBDDR3.  
Requires a 6 Series MSO instrument.

**Group** Measurement

**Syntax** MEASUREMENT:MEAS<x>:FROMSymbol:MEASUREAT  
{Start|Stop|ClockEdge}  
MEASUREMENT:MEAS<x>:FROMSymbol:MEASUREAT?

**Related Commands** [MEASUREMENT:ADDMEAS](#)

<b>Arguments</b>	<p>MEAS&lt;x&gt; specifies the measurement number.</p> <p>Start sets the FromSymbol MeasureAT to Start.</p> <p>Stop sets the FromSymbol MeasureAT to Stop.</p> <p>ClockEdge sets the FromSymbol MeasureAT to ClockEdge.</p>
<b>Examples</b>	<p>MEASUREMENT:MEAS1:FROMSYMBOL:MEASUREAT Start sets the DDR digital measurement (DDRTRPMRS/DDRTRPACT/DDRTCKSRE/DDRTCKSRX) FromSymbol MeasureAT value to Start.</p> <p>MEASUREMENT:MEAS1:FROMSYMBOL:MEASUREAT? might return the MEASUREMENT:MEAS1:FROMSYMBOL:MEASUREAT Stop, indicating that the DDR digital measurement (DDRTRPMRS/DDRTRPACT/DDRTCKSRE/DDRTCKSRX) FromSymbol MeasureAT value is set to Stop.</p>

## MEASUREMENT:MEAS<x>:FUNDCURRENT

This command sets or queries the fundamental current value for IEC-Class C type harmonics standard. Measurements are specified by x.

<b>Group</b>	Measurement, IMDA
<b>Syntax</b>	MEASUREMENT:MEAS<x>:FUNDCURRENT <NR3> MEASUREMENT:MEAS<x>:FUNDCURRENT?
<b>Arguments</b>	<p>MEAS&lt;x&gt; specifies the measurement number.</p> <p>&lt;NR3&gt; specifies the value for the fundamental current for class C harmonics standard.</p> <p>\</p>
<b>Examples</b>	<p>MEASUREMENT:MEAS1:FUNDCURRENT 16.0000 specifies the fundamental current as 16.</p> <p>MEASUREMENT:MEAS1:FUNDCURRENT? might return :MEASUREMENT:MEAS1:FUNDCURRENT 16.0000 indicating the fundamental current is 16.</p>

## MEASUREMENT:MEAS<x>:GATING

This command sets or queries the gating type for the measurement. Measurements are specified by x.

**Group** Measurement

**Syntax** MEASUREMENT:MEAS<x>:GATING  
{NONE|SCREEN|CURSOR|LOGIC|SEARCH|TIME}  
MEASUREMENT:MEAS<x>:GATING?

**Related Commands** [MEASUREMENT:MEAS<x>:GATING:ENDTIME](#)  
[MEASUREMENT:MEAS<x>:GATING:STARTTIME](#)

**Arguments** MEAS<x> is the measurement number for which to return a value.

NONE specifies measurements are taken across the entire record.

SCREEN turns on gating, using the left and right edges of the screen.

CURSOR limits measurements to the portion of the waveform between the vertical bar cursors, even if they are off screen.

LOGIC specifies that measurements are taken only when the logical state of other waveforms is true.

SEARCH specifies that measurements are taken only where the results of a user specified search are found.

TIME limits measurements to the portion of the waveform between the Start and End gate times.

**Examples** MEASUREMENT:MEAS1:GATING CURSOR limits measurements to the portion of the waveform between the vertical bar cursor.

MEASUREMENT:MEAS1:GATING? might return :MEASUREMENT:MEAS1:GATING NONE indicating measurements are taken across the entire record.

## MEASUREMENT:MEAS<x>:GATING:ACTIVE

This command sets or queries the gating active level when the gating type is logic. Measurements are specified by x.

**Group** Measurement

**Syntax**    `MEASUREMENT:MEAS<x>:GATING:ACTIVE {HIGH|LOW}`  
`MEASUREMENT:MEAS<x>:GATING:ACTIVE?`

**Arguments**    `MEAS<x>` specifies the measurement number.  
  
`HIGH` takes a measurement when logic gating is High.  
  
`LOW` takes a measurement when logic gating Low.

**Examples**    `MEASUREMENT:MEAS1:GATING:ACTIVE LOW` specifies taking measurements when logic gating is Low.  
  
`MEASUREMENT:MEAS1:GATING:ACTIVE?` might return  
`:MEASUREMENT:MEAS1:GATING:ACTIVE HIGH` indicating measurements are taken when logic gating is High.

## **MEASUREMENT:MEAS<x>:GATING:ENDTIME**

Sets or queries the end gate time for the measurement when using Local gating.

**Group**    Measurement

**Syntax**    `MEASUREMENT:MEAS<x>:GATING:ENDTIME <NR3>`  
`MEASUREMENT:MEAS<x>:GATING:ENDTIME?`

**Related Commands**    [MEASUREMENT:MEAS<x>:GATING](#)

**Arguments**    `MEAS<x>` specifies the measurement number.  
  
`<NR3>` is the time gating end gate time in seconds. The valid range is -10000 s to 10000 s.

**Examples**    `MEASUREMENT:MEAS4:GATING:ENDTIME 5.31e-2` sets the local end gate time for Meas 4 to 53.1 ms.  
  
`MEASUREMENT:MEAS6:GATING:ENDTIME?` might return 1.05, indicating that the local end gate time for Meas 6 is 1.05 s.

## **MEASUREMENT:MEAS<x>:GATING:GLOBAL**

This command sets or queries the gating settings global flag. Measurements are specified by x.

<b>Group</b>	Measurement
<b>Syntax</b>	<pre>MEASUREMENT:MEAS&lt;x&gt;:GATING:GLOBAL {OFF ON 0 1} MEASUREMENT:MEAS&lt;x&gt;:GATING:GLOBAL?</pre>
<b>Arguments</b>	<p>MEAS&lt;x&gt; specifies the measurement number.</p> <p>OFF specifies gate settings can be changed independently for each individual measurement.</p> <p>ON applies global gate settings to all the measurements' gate settings.</p> <p>0 specifies gate settings can be changed independently for each individual measurement.</p> <p>1 applies global gate settings to all the measurements' gate settings.</p>
<b>Examples</b>	<p>MEASUREMENT:MEAS1:GATING:GLOBAL OFF specifies gate settings can be changed independently for each individual measurement.</p> <p>MEASUREMENT:MEAS1:GATING:GLOBAL? might return :MEASUREMENT:MEAS1:GATING:GLOBAL 1 indicating that gating settings apply to all measurements.</p>

## MEASUREMENT:MEAS<x>:GATING:HYS TERESIS

This command sets or queries the gating hysteresis value when the gating type is logic. Measurements are specified by x.

<b>Group</b>	Measurement
<b>Syntax</b>	<pre>MEASUREMENT:MEAS&lt;x&gt;:GATING:HYS TERESIS &lt;NR3&gt; MEASUREMENT:MEAS&lt;x&gt;:GATING:HYS TERESIS?</pre>
<b>Arguments</b>	<p>MEAS&lt;x&gt; specifies the measurement number.</p> <p>&lt;NR3&gt; is the gating hysteresis.</p>
<b>Examples</b>	<p>MEASUREMENT:MEAS1:GATING:HYS TERESIS 25.0E-3 sets the hysteresis to 25 mV.</p> <p>MEASUREMENT:MEAS1:GATING:HYS TERESIS? might return :MEASUREMENT:MEAS1:GATING:HYS TERESIS 30.0000E-3 indicating the hysteresis is set to 30.0 mV.</p>

## MEASUREMENT:MEAS<x>:GATING:LOGICSource

This command sets or queries the gating data source when the gating type is logic. The measurement number is specified by x.

<b>Group</b>	Measurement
<b>Syntax</b>	<pre>MEASUREMENT:MEAS&lt;x&gt;:GATING:LOGICSource {S&lt;x&gt;_Ch&lt;x&gt; CH&lt;x&gt; MATH&lt;x&gt; REF&lt;x&gt;} MEASUREMENT:MEAS&lt;x&gt;:GATING:LOGICSource?</pre>
<b>Arguments</b>	<p>MEAS&lt;x&gt; specifies the measurement number.</p> <p>S&lt;x&gt;_Ch&lt;x&gt; specifies the remote scope number and the analog channel as the source.</p> <p>CH&lt;x&gt; specifies an analog channel as the source.</p> <p>Math&lt;x&gt; specifies a math waveform as the source.</p> <p>REF&lt;x&gt; specifies a reference waveform as the source.</p>
<b>Examples</b>	<p>MEASUREMENT:MEAS1:GATING:LOGICSource CH3 sets the gating logic source to channel 3.</p> <p>MEASUREMENT:MEAS1:GATING:LOGICSource? might return :MEASUREMENT:MEAS1:GATING:LOGICSOURCE CH2 indicating the gating logic source is channel 2.</p>

## MEASUREMENT:MEAS<x>:GATING:MIDRef

This command sets or queries the gating mid ref value when the gating type is logic. Measurements are specified by x.

<b>Group</b>	Measurement
<b>Syntax</b>	<pre>MEASUREMENT:MEAS&lt;x&gt;:GATING:MIDRef &lt;NR3&gt; MEASUREMENT:MEAS&lt;x&gt;:GATING:MIDRef?</pre>
<b>Arguments</b>	<p>MEAS&lt;x&gt; specifies the measurement number.</p> <p>&lt;NR3&gt; is the mid ref value for gating.</p>



**Examples**    `MEASUREMENT:MEAS1:GATING:MIDREF 1.0E+0` sets the gating midref to 1.0.  
`MEASUREMENT:MEAS1:GATING:MIDREF?` might return  
`:MEASUREMENT:MEAS1:GATING:MIDREF 0.0E+0` indicating the  
midref value is set to 0.0.

## MEASUREMENT:MEAS<x>:GATING:SEARCHSOURCE

This command sets or queries the gating search source when the gating type is search. The measurement number is specified by x.

**Group**    Measurement

**Syntax**    `MEASUREMENT:MEAS<x>:GATING:SEARCHSOURCE SEARCH1`  
`MEASUREMENT:MEAS<x>:GATING:SEARCHSOURCE?`

**Arguments**    `MEAS<x>` specifies the measurement number.  
`SEARCH1` is the gating source for search gating.

**Examples**    `MEASUREMENT:MEAS1:GATING:SEARCHSOURCE SEARCH1` sets the gating  
search source to `SEARCH1`.  
`MEASUREMENT:MEAS1:GATING:SEARCHSOURCE?` might return  
`:MEASUREMENT:MEAS1:GATING:SEARCHSOURCE SEARCH1` indicating the  
gating search source is `SEARCH1`.

## MEASUREMENT:MEAS<x>:GATING:STARTTIME

Sets or queries the start gate time for the measurement when using Local gating.

**Group**    Measurement

**Syntax**    `MEASUREMENT:MEAS<x>:GATING:STARTTIME <NR3>`  
`MEASUREMENT:MEAS<x>:GATING:STARTTIME?`

**Related Commands**    [MEASUREMENT:MEAS<x>:GATING](#)

**Arguments**    `MEAS<x>` specifies the measurement number.  
`<NR3>` is the time gating start gate time in seconds. The valid range is -10000  
s to 10000 s.

**Examples**    `MEASUREMENT:MEAS1:GATING:STARTTIME -1.5e-3` sets the local start gate time for Meas 1 to -1.5 ms.

`MEASUREMENT:MEAS1:GATING:STARTTIME?` might return `3.0e-9`, indicating that the local start gate time for Meas 1 is 3 ns.

## MEASUREMENT:MEAS<x>:GLOBALREF

This command sets or queries the reference levels global flag for the measurement. Measurements are specified by x.

**Group**    Measurement

**Syntax**    `MEASUREMENT:MEAS<x>:GLOBALREF {OFF|ON|0|1}`  
`MEASUREMENT:MEAS<x>:GLOBALREF?`

**Arguments**    `MEAS<x>` specifies the measurement number.

`OFF` allows ref levels to be set separately for each measurement.

`ON` applies the same ref levels to all measurements.

`0` allows ref levels to be set separately for each measurement.

`1` applies the same ref levels to all measurements.

**Examples**    `MEASUREMENT:MEAS1:GLOBALREF 0` allows ref levels to be set separately for each measurement.

`MEASUREMENT:MEAS1:GLOBALREF?` might return  
`:MEASUREMENT:MEAS1:GLOBALREF 1` indicating the same ref levels apply to all measurements.

## MEASUREMENT:MEAS<x>:HARMONICSCCLASS

This command sets or queries the class type for the harmonics measurement. Measurements are specified by x.

**Group**    Measurement, IMDA

**Syntax**    `MEASUREMENT:MEAS<x>:HARMONICSCCLASS`  
`{CLASSA|CLASSB|CLASSC|CLASSD}`  
`MEASUREMENT:MEAS<x>:HARMONICSCCLASS?`

<b>Arguments</b>	MEAS<x> specifies the measurement number. CLASSA-D specifies the class type.
<b>Examples</b>	MEASUREMENT:MEAS1:HARMONICSClass CLASSC sets the class type for measurement 1 as class C. MEASUREMENT:MEAS1:HARMONICSClass? might return :MEASUREMENT:MEAS1:HARMONICSClass A, indicating the class type is set to class A.

## MEASUREMENT:MEAS<x>:HARMONICSSOURCE

This command sets or queries harmonics source. Measurements are specified by x.

<b>Group</b>	Measurement, IMDA
<b>Syntax</b>	MEASUREMENT:MEAS<x>:HARMONICSSOURCE {CURRENT VOLTAGE} MEASUREMENT:MEAS<x>:HARMONICSSOURCE?
<b>Arguments</b>	MEAS<x> specifies the measurement number. CURRENT specifies current as the harmonics source. VOLTAGE specifies voltage as the harmonics source.
<b>Examples</b>	MEASUREMENT:MEAS1:HARMONICSSOURCE CURRENT sets the harmonics source for measurement 1 as current. MEASUREMENT:MEAS1:HARMONICSSOURCE? might return :MEASUREMENT:MEAS1:HARMONICSSOURCE VOLTAGE, indicating the harmonics source as voltage.

## MEASUREMENT:MEAS<x>:HARMONICSStd

This command sets or queries harmonics standard. Measurements are specified by x.

<b>Group</b>	Measurement, IMDA
<b>Syntax</b>	MEASUREMENT:MEAS<x>:HARMONICSStd {NONE IEC IEEE519 CUSTOM} MEASUREMENT:MEAS<x>:HARMONICSStd?

<b>Arguments</b>	<p>MEAS&lt;x&gt; specifies the measurement number.</p> <p>NONE specifies none as the harmonics test standard.</p> <p>IEC specifies IEC as the harmonics test standard.</p> <p>IEEE519 specifies IEEE519 as the harmonics test standard.</p> <p>CUSTOM specifies that there is a custom harmonics test standard.</p>
<b>Examples</b>	<p>MEASUREMENT:MEAS1:HARMONICSStd IEC sets the harmonics test standard for measurement 1 as IEC.</p> <p>MEASUREMENT:MEAS1:HARMONICSStd? might return :MEASUREMENT:MEAS1:HARMONICSStd NONE, indicating no harmonics test standard has been set.</p>

## MEASUREMENT:MEAS<x>:HARMONICSUNITS

This command sets or queries harmonics units. Measurements are specified by x.

<b>Group</b>	Measurement, IMDA
<b>Syntax</b>	MEASUREMENT:MEAS<x>:HARMONICSUNITS {LOGARITHM LINEAR} MEASUREMENT:MEAS<x>:HARMONICSUNITS?
<b>Arguments</b>	<p>MEAS&lt;x&gt; specifies the measurement number.</p> <p>LOGARITHM specifies logarithmic as the harmonics units.</p> <p>LINEAR specifies linear as the harmonics units.</p>
<b>Examples</b>	<p>MEASUREMENT:MEAS1:HARMONICSUNITS LINEAR sets the harmonics units standard for measurement 1 as linear.</p> <p>MEASUREMENT:MEAS1:HARMONICSUNITS? might return :MEASUREMENT:MEAS1:HARMONICSUNITS LINEAR, indicating the harmonics units are linear.</p>

## MEASUREMENT:MEAS<x>:HIGHLEVEL:CONFIGURATION

This command sets or queries the local input and output configuration.

<b>Group</b>	Measurement, IMDA
--------------	-------------------

<b>Syntax</b>	<pre>MEASUREMENT:MEAS&lt;x&gt;:HIGHLEVEL:CONFIGURATION {INPUT OUTPUT} MEASUREMENT:MEAS&lt;x&gt;:HIGHLEVEL:CONFIGURATION?</pre>
<b>Arguments</b>	<p>MEAS&lt;x&gt; specifies the measurement number.</p> <p>INPUT specifies the local Input or Output source settings as input.</p> <p>OUTPUT specifies the local Input or Output source settings as output.</p>
<b>Examples</b>	<p>MEASUREMENT:MEAS1:HIGHLEVEL:CONFIGURATION INPUT sets the local Input or Output source settings for measurement 1 as input.</p> <p>MEASUREMENT:MEAS1:HIGHLEVEL:CONFIGURATION? might return :MEASUREMENT:MEAS1:HIGHLEVEL:CONFIGURATION INPUT, indicating the local Input or Output source settings for measurement 1 is input.</p>

## MEASUREMENT:MEAS<x>:HIGHLEVEL:L2LTOL2N

This command sets or queries local input Line-to-Line to Line-to-Neutral Conversion.

<b>Group</b>	Measurement, IMDA
<b>Syntax</b>	<pre>MEASUREMENT:MEAS&lt;x&gt;:HIGHLEVEL:L2LTOL2N {0 1} MEASUREMENT:MEAS&lt;x&gt;:HIGHLEVEL:L2LTOL2N?</pre>
<b>Examples</b>	<p>MEASUREMENT:MEAS1:HIGHLEVEL:L2LTOL2N 1 enables local input Line-to-Line to Line-to-Neutral Conversion.</p> <p>MEASUREMENT:MEAS1:HIGHLEVEL:L2LTOL2N? might return :MEASUREMENT:HIGHLEVEL:L2LTOL2N 0, indicating local input Line-to-Line to Line-to-Neutral Conversion is disabled.</p>

## MEASUREMENT:MEAS<x>:HIGHLEVEL:LINESELECTED

This command sets or queries local input select lines.

<b>Group</b>	Measurement, IMDA
<b>Syntax</b>	<pre>MEASUREMENT:MEAS&lt;x&gt;:HIGHLEVEL:LINESELECTED {ABCB ACBC BACA AN BN CN} MEASUREMENT:MEAS&lt;x&gt;:HIGHLEVEL:LINESELECTED ?</pre>

<b>Arguments</b>	ABCB specifies the local input select lines as ABCB. ACBC specifies the local input select lines as ACBC. BACA specifies the local input select lines as BACA. AN specifies the local input select lines as AN. BN specifies the local input select lines as BN. CN specifies the local input select lines as CN.
<b>Examples</b>	MEASUREMENT:MEAS1:HIGHLEVEL:LINESELECTED ABCB sets the local input select lines as ABCB.  MEASUREMENT:MEAS1:HIGHLEVEL:LINESELECTED? might return :MEASUREMENT:MEAS1:HIGHLEVEL:LINESELECTED ABCB, indicating the local input select lines is ABCB.

## MEASUREMENT:MEAS<x>:HIGHLEVEL:OUTL2LTOL2N

This command sets or queries local output Line-to-Line to Line-to-Neutral Conversion .

<b>Group</b>	Measurement, IMDA
<b>Syntax</b>	MEASUREMENT:MEAS<x>:HIGHLEVEL:OUTL2LTOL2N {0 1} MEASUREMENT:MEAS<x>:HIGHLEVEL:OUTL2LTOL2N?
<b>Examples</b>	MEASUREMENT:MEAS?:HIGHLEVEL:OUTL2LTOL2N 1 enables local output Line-to-Line to Line-to-Neutral Conversion.  MEASUREMENT:MEAS?:HIGHLEVEL:OUTL2LTOL2N? might return :MEASUREMENT:MEAS?:HIGHLEVEL:OUTL2LTOL2N 0, indicating local output Line-to-Line to Line-to-Neutral Conversion is disabled.

## MEASUREMENT:MEAS<x>:HIGHLEVEL:OUTLINESELECTED

This command sets or queries local output select lines.

<b>Group</b>	Measurement, IMDA
<b>Syntax</b>	MEASUREMENT:MEAS<x>:HIGHLEVEL:OUTLINESELECTED {XYZY XZYX YXZX XN YN ZN}

`MEASUREMENT:MEAS<x>:HIGHLEVEL:OUTLINESELECTED?`

**Arguments** XYZY specifies the local output select lines as XYZY.  
 XZYX specifies the local output select lines as XZYX.  
 YXZX specifies the local output select lines as YXZX.  
 XN specifies the local output select lines as XN.  
 YN specifies the local output select lines as YN.  
 ZN specifies the local output select lines as ZN.

**Examples** `MEASUREMENT:MEAS1:HIGHLEVEL:OUTLINESELECTED XYZY` sets the local output select lines as XYZY.  
`MEASUREMENT:MEAS1:HIGHLEVEL:OUTLINESELECTED?` might return `:MEASUREMENT:MEAS1:HIGHLEVEL:OUTLINESELECTED XYZY`, indicating the local output select lines is XYZY.

## MEASUREMENT:MEAS<x>:HIGHLEVEL:OUTWIRING

This command sets or queries the local output wiring.

**Group** Measurement, IMDA

**Syntax** `MEASUREMENT:MEAS<x>:HIGHLEVEL:OUTWIRING {P1W2V1I1|P1W3V2I2|P3W3V3I3|P3W4|DCP1W2}`  
`MEASUREMENT:MEAS<x>:HIGHLEVEL:OUTWIRING?`

**Arguments** MEAS<x> specifies the measurement number.  
 P1W2V1I1 specifies P1W2V1I1 as the local output wiring.  
 P1W3V2I2 specifies P1W3V2I2 as the local output wiring.  
 P3W3V3I3 specifies P3W3V3I3 as the local output wiring.  
 P3W4 specifies P3W4 as the local output wiring.  
 DCP1W2 specifies DCP1W2 as the local output wiring.

**Examples** `MEASUREMENT:MEAS1:HIGHLEVEL:OUTWIRING P1W2V1I1` sets the local output wiring for measurement 1 as P1W2V1I1.

MEASUREMENT:MEAS1:HIGHPLEVEL:OUTWIRING? might return  
:MEASUREMENT:MEAS1:HIGHPLEVEL:OUTWIRING P1W2V1I1, indicating the  
local output wiring is configured as P1W2V1I1.

## MEASUREMENT:MEAS<x>:HIGHLEVEL:USEGLOBAL

This command sets or queries the IMDA source settings as global or local.

<b>Group</b>	Measurement, IMDA
<b>Syntax</b>	MEASUREMENT:MEAS<x>:HIGHLEVEL:USEGLOBAL {1 0 ON OFF} MEASUREMENT:MEAS<x>:HIGHLEVEL:USEGLOBAL?
<b>Arguments</b>	MEAS<x> specifies the measurement number.  1 specifies the source settings as global.  0 specifies the source settings as local.  ON specifies the source settings as global.  OFF specifies the source settings as local.
<b>Examples</b>	MEASUREMENT:MEAS1:HIGHPLEVEL:USEGLOBAL 1 sets the IMDA source settings for measurement 1 as global.  MEASUREMENT:MEAS1:HIGHPLEVEL:USEGLOBAL? might return :MEASUREMENT:MEAS1:HIGHPLEVEL:USEGLOBAL 1, indicating the IMDA source settings are global.

## MEASUREMENT:MEAS<x>:HIGHLEVEL:WIRING

This command sets or queries the local Input wiring.

<b>Group</b>	Measurement, IMDA
<b>Syntax</b>	MEASUREMENT:MEAS<x>:HIGHLEVEL:WIRING {P1W2V1I1 P1W3V2I2 P3W3V2I2 P3W3V3I3 P3W3 DCP1W2} MEASUREMENT:MEAS<x>:HIGHLEVEL:WIRING?
<b>Arguments</b>	MEAS<x> specifies the measurement number.  P1W2V1I1 specifies P1W2V1I1 as the local input wiring.



P1W3V2I2 specifies P1W3V2I2 as the local input wiring.

P3W3V2I2 specifies P3W3V2I2 as the local input wiring.

P3W3V2I2 specifies P3W3V2I2 as the local input wiring.

P3W3 specifies P3W3 as the local input wiring.

DCP1W2 specifies DCP1W2 as the local input wiring.

**Examples** MEASUREMENT:MEAS1:HIGHPLEVEL:WIRING P1W2V1I1 sets the local input wiring for measurement 1 as P1W2V1I1.

MEASUREMENT:MEAS1:HIGHPLEVEL:WIRING? might return  
:MEASUREMENT:MEAS1:HIGHPLEVEL:WIRING P1W2V1I1, indicating the local input wiring is configured as P1W2V1I1.

## MEASUREMENT:MEAS<x>:HIGHREFVOLTAGE

This command sets or queries the high reference voltage value for the 'time outside level' measurement. Measurements are specified by x.

**Group** Measurement

**Syntax** MEASUREMENT:MEAS<x>:HIGHREFVOLTAGE <NR3>  
MEASUREMENT:MEAS<x>:HIGHREFVOLTAGE?

**Arguments** MEAS<x> specifies the measurement number.

<NR3> is the high reference voltage value for the selected configuration.

**Examples** MEASUREMENT:MEAS1:HIGHREFVOLTAGE 1.5 sets the high reference voltage to 1.5 V.

MEASUREMENT:MEAS1:HIGHREFVOLTAGE? might return  
:MEASUREMENT:MEAS1:HIGHREFVOLTAGE 1.0000 indicating the high reference voltage is set to 1.0 V.

## MEASUREMENT:MEAS<x>:HLEVEL:OUTPUT:UGLOBAL

This command turns on or off output global settings for measurement. Measurements are specified by x.

**Conditions** Requires IMDA-MECH license on MSO 5, 6, 6B series instruments.

<b>Group</b>	Measurement, IMDA
<b>Syntax</b>	MEASUREMENT:MEAS<x>:HLEVEL:OUTPUT:UGLOBAL {ON OFF} MEASUREMENT:MEAS<x>:HLEVEL:OUTPUT:UGLOBAL?
<b>Arguments</b>	ON sets the output global settings for measurement to on. OFF sets the output global settings for measurement to off.
<b>Examples</b>	MEASUREMENT:MEAS1:HLEVEL:OUTPUT:UGLOBAL ON sets the output global settings for measurement to on. MEASUREMENT:MEAS1:HLEVEL:OUTPUT:UGLOBAL? might return :MEASUREMENT:MEAS1:HLEVEL:OUTPUT:UGLOBAL OFF indicating the output global settings for measurement is off.

## MEASUREMENT:MEAS<x>:HTORQUE

This command sets or queries the measurement High Torque value.

<b>Conditions</b>	Requires IMDA-MECH license on MSO 5, 6, 6B series instruments.
<b>Group</b>	IMDA
<b>Syntax</b>	MEASUREMENT:MEAS<x>:HTORQUE <NR1> MEASUREMENT:MEAS<x>:HTORQUE?
<b>Arguments</b>	MEAS<x> specifies the measurement number. <NR1> specifies the High Torque value of the measurement in the range of 11 to 10000000.
<b>Examples</b>	MEASUREMENT:MEAS1:HTORQUE 15.2 sets the High Torque value for measurement 1 to 15.2. MEASUREMENT:MEAS1:HTORQUE? might return :MEASUREMENT:MEAS1:HTORQUE 15.2, indicating the High Torque value for measurement 1 is 15.2.

## MEASUREMENT:MEAS<x>:HVOLTAGE

This command sets or queries the measurement Torque High Voltage value.

<b>Conditions</b>	Requires IMDA-MECH license on MSO 5, 6, 6B series instruments.
<b>Group</b>	IMDA
<b>Syntax</b>	MEASUREMENT:MEAS<x>:HVOLTage <NR1> MEASUREMENT:MEAS<x>:HVOLTage?
<b>Arguments</b>	MEAS<x> specifies the measurement number.  <NR1> specifies the High Voltage value of the measurement in the range of 1 to 100.
<b>Examples</b>	MEASUREMENT:MEAS1:HVOLTage 15.2 sets the High Voltage value for measurement 1 to 15.2.  MEASUREMENT:MEAS1:HVOLTage? might return :MEASUREMENT:MEAS1:HVOLTage 15.2, indicating the High Voltage value for measurement 1 is 15.2.

## MEASUREMENT:MEAS<x>:IDLETime

This command sets or queries the idle time for the measurement when the measurement type is burst width. Measurements are specified by x.

<b>Group</b>	Measurement
<b>Syntax</b>	MEASUREMENT:MEAS<x>:IDLETime <NR3> MEASUREMENT:MEAS<x>:IDLETime?
<b>Arguments</b>	MEAS<x> specifies the measurement number.  <NR3> is the idle time.
<b>Examples</b>	MEASUREMENT:MEAS1:IDLETime 40.0E-6 sets the idle time to 40.0 $\mu$ s.  MEASUREMENT:MEAS1:IDLETime? might return :MEASUREMENT:MEAS1:IDLETIME 50.0000E-6 indicating the idle time is 50.0 $\mu$ s.

## MEASUREMENT:MEAS<x>:INPUTLeVel

Sets or queries the input trigger voltage level.

<b>Conditions</b>	Requires option 5-DPM (5 Series MSO instruments) or 6-DPM (6 Series MSO instrument)
<b>Group</b>	DPM
<b>Syntax</b>	MEASUREMENT:MEAS<x>:INPUTLEVEL <NR2> MEASUREMENT:MEAS<x>:INPUTLEVEL?
<b>Arguments</b>	MEAS<x> is the measurement number.  <NR2> is the trigger voltage, in the range of -500 V to +500 V.
<b>Examples</b>	MEASUREMENT:MEAS1:INPUTLEVEL 60 sets the input trigger level of measurement 1 to +60 volts.  MEASUREMENT:MEAS3:INPUTLEVEL? might return 1.2500, indicating that the input trigger level of measurement 3 is +1.25 volts.

## MEASUREMENT:MEAS<x>:INPUTPOWER

This command sets or queries the input power value for IEC-Class C and Class D harmonics standard .

<b>Group</b>	Measurement, IMDA
<b>Syntax</b>	MEASUREMENT:MEAS<x>:INPUTPOWER <NR3> MEASUREMENT:MEAS<x>:INPUTPOWER?
<b>Arguments</b>	MEAS<x> is the measurement number.  <NR3> specifies the input power value for class C harmonics standard.
<b>Examples</b>	MEASUREMENT:MEAS1:INPUTPOWER 100W sets the input power value for class C harmonics standard to 100W.  MEASUREMENT:MEAS1:INPUTPOWER? might return :MEASUREMENT:MEAS1:INPUTPOWER 100W, indicating that the input power value for class C harmonics standard is 100W.

## MEASUREMENT:MEAS<x>:JITTERSummary:DCD

This command sets or queries whether DCD is included in the jitter summary for the measurement. Measurements are specified by x.

<b>Group</b>	Measurement
<b>Syntax</b>	MEASUREMENT:MEAS<x>:JITTERSummary:DCD {0 1} MEASUREMENT:MEAS<x>:JITTERSummary:DCD?
<b>Arguments</b>	MEAS<x> specifies the measurement number.  1 adds the DCD measurement as part of jitter summary.  0 do not add the DCD measurement as part of jitter summary.
<b>Examples</b>	MEASUREMENT:MEAS1:JITTERSummary:DCD 0 specifies that the DCD measurement is not part of the jitter summary.  MEASUREMENT:MEAS1:JITTERSummary:DCD? might return :MEASUREMENT:MEAS4:JITTERSUMMARY:DCD 1 indicating the DCD measurement is part of the jitter summary.

## MEASUREMENT:MEAS<x>:JITTERSummary:DDJ

This command sets or queries whether DDJ is included in the jitter summary for the measurement. Measurements are specified by x.

<b>Group</b>	Measurement
<b>Syntax</b>	MEASUREMENT:MEAS<x>:JITTERSummary:DDJ {0 1} MEASUREMENT:MEAS<x>:JITTERSummary:DDJ?
<b>Arguments</b>	MEAS<x> specifies the measurement number.  1 adds the DDJ measurement as part of jitter summary.  0 do not add the DDJ measurement as part of jitter summary.
<b>Examples</b>	MEASUREMENT:MEAS4:JITTERSummary:DDJ 0 specifies that the DDJ measurement is not part of the jitter summary.

MEASUREMENT:MEAS4:JITTERSummary:DDJ? might return  
:MEASUREMENT:MEAS4:JITTERSUMMARY:DDJ 1 indicating the DDJ  
measurement is part of the jitter summary.

## MEASUREMENT:MEAS<x>:JITTERSummary:DJDD

This command sets or queries whether DJ-dd is included in the jitter summary for the measurement. Measurements are specified by x.

<b>Group</b>	Measurement
<b>Syntax</b>	MEASUREMENT:MEAS<x>:JITTERSummary:DJDD {0 1} MEASUREMENT:MEAS<x>:JITTERSummary:DJDD?
<b>Arguments</b>	MEAS<x> specifies the measurement number.  1 add the DJDD measurement as part of jitter summary.  0 do not add the DJDD measurement as part of jitter summary.
<b>Examples</b>	MEASUREMENT:MEAS4:JITTERSummary:DJDD 0 specifies the DJDD measurement is not part of the jitter summary.  MEASUREMENT:MEAS4:JITTERSummary:DJDD? might return :MEASUREMENT:MEAS4:JITTERSUMMARY:DJDD 1 indicating the DJDD measurement is part of the jitter summary.

## MEASUREMENT:MEAS<x>:JITTERSummary:EYEWIDTHBER

This command sets or queries whether EyeWidth@BER is included in the jitter summary for the measurement. Measurements are specified by x.

<b>Group</b>	Measurement
<b>Syntax</b>	MEASUREMENT:MEAS<x>:JITTERSummary:EYEWIDTHBER {0 1} MEASUREMENT:MEAS<x>:JITTERSummary:EYEWIDTHBER?
<b>Arguments</b>	MEAS<x> specifies the measurement number.  1 add the EyeWidth@BER measurement as part of jitter summary.  0 do not add the EyeWidth@BER measurement as part of jitter summary.

**Examples**    `MEASUREMENT:MEAS4:JITTERSummary:EYEWIDTHBER 0` specifies that the EyeWidth@BER measurement is not part of the jitter summary.

`MEASUREMENT:MEAS4:JITTERSummary:EYEWIDTHBER?` might return `:MEASUREMENT:MEAS4:JITTERSUMMARY:EYEWIDTHBER 1` indicating EyeWidth@BER is part of the jitter summary

## MEASUREMENT:MEAS<x>:JITTERSummary:NPJ

This command sets or queries whether NPJ is included in the jitter summary for the measurement. Measurements are specified by x.

**Group**    Measurement

**Syntax**    `MEASUREMENT:MEAS<x>:JITTERSummary:NPJ {0|1}`  
`MEASUREMENT:MEAS<x>:JITTERSummary:NPJ?`

**Arguments**    `MEAS<x>` specifies the measurement number.

1 add the NPJ measurement as part of jitter summary.

0 do not add the NPJ measurement as part of jitter summary.

**Examples**    `MEASUREMENT:MEAS4:JITTERSummary:NPJ 0` specifies that the NPJ measurement is not part of jitter summary.

`MEASUREMENT:MEAS4:JITTERSummary:NPJ?` might return `:MEASUREMENT:MEAS4:JITTERSUMMARY:NPJ 1` indicating the NPJ measurement is part of the jitter summary.

## MEASUREMENT:MEAS<x>:JITTERSummary:PJ

This command sets or queries whether PJ is included in the jitter summary for the measurement. Measurements are specified by x.

**Group**    Measurement

**Syntax**    `MEASUREMENT:MEAS<x>:JITTERSummary:PJ {0|1}`  
`MEASUREMENT:MEAS<x>:JITTERSummary:PJ?`

**Arguments**    `MEAS<x>` specifies the measurement number.

1 add the PJ measurement as part of jitter summary.

0 do not add the PJ measurement as part of jitter summary.

**Examples**    `MEASUREMENT:MEAS4:JITTERSummary:PJ 0` specifies the PJ measurement is not part of jitter summary.

`MEASUREMENT:MEAS4:JITTERSummary:PJ?` might return  
`:MEASUREMENT:MEAS4:JITTERSUMMARY:PJ 1` indicating the PJ measurement is part of jitter summary.

## MEASUREMENT:MEAS<x>:JITTERSummary:RJDD

This command sets or queries whether RJ-dd is included in the jitter summary for the measurement. Measurements are specified by x.

**Group**    Measurement

**Syntax**    `MEASUREMENT:MEAS<x>:JITTERSummary:RJDD {0|1}`  
`MEASUREMENT:MEAS<x>:JITTERSummary:RJDD?`

**Arguments**    `MEAS<x>` specifies the measurement number.  
1 add the RJ-dd measurement as part of jitter summary.  
0 do not add the RJ-dd measurement as part of jitter summary.

**Examples**    `MEASUREMENT:MEAS4:JITTERSummary:RJDD 0` specifies the RJ-dd measurement is not part of the jitter summary.  
`MEASUREMENT:MEAS4:JITTERSummary:RJDD?` might return  
`:MEASUREMENT:MEAS4:JITTERSUMMARY:RJDD 1` indicating the RJ-dd measurement is part of the jitter summary.

## MEASUREMENT:MEAS<x>:JITTERSummary:TIE

This command sets or queries whether TIE is included in the jitter summary for the measurement. Measurements are specified by x.

**Group**    Measurement

**Syntax**    `MEASUREMENT:MEAS<x>:JITTERSummary:TIE {0|1}`  
`MEASUREMENT:MEAS<x>:JITTERSummary:TIE?`



<b>Arguments</b>	<p>MEAS&lt;x&gt; specifies the measurement number.</p> <p>1 add the TIE measurement as part of jitter summary.</p> <p>0 do not add the TIE measurement as part of jitter summary.</p>
<b>Examples</b>	<p>MEASUREMENT:MEAS4:JITTERSummary:TIE 0 specifies the TIE measurement is not part of jitter summary.</p> <p>MEASUREMENT:MEAS4:JITTERSummary:TIE? might return :MEASUREMENT:MEAS4:JITTERSUMMARY:TIE 1 indicating the TIE measurement is part of jitter summary.</p>

## MEASUREMENT:MEAS<x>:JITTERSummary:TJBER

This command sets or queries whether TJ@BER is included in the jitter summary for the measurement. Measurements are specified by x.

<b>Group</b>	Measurement
<b>Syntax</b>	<p>MEASUREMENT:MEAS&lt;x&gt;:JITTERSummary:TJBER {0 1}</p> <p>MEASUREMENT:MEAS&lt;x&gt;:JITTERSummary:TJBER?</p>
<b>Arguments</b>	<p>MEAS&lt;x&gt; specifies the measurement number.</p> <p>1 add the TJ@BER measurement as part of jitter summary.</p> <p>0 do not add the TJ@BER measurement as part of jitter summary.</p>
<b>Examples</b>	<p>MEASUREMENT:MEAS4:JITTERSummary:TJBER 0 specifies that the TJ@BER measurement is not part of jitter summary.</p> <p>MEASUREMENT:MEAS4:JITTERSummary:TJBER? might return :MEASUREMENT:MEAS4:JITTERSUMMARY:TJBER 1 indicating the TJ@BER measurement is part of jitter summary.</p>

## MEASUREMENT:MEAS<x>:LABEL

This command sets or queries the label for the measurement. As the label can contain non 7-bit ASCII text, it is stored in Percent Encoding format. The measurement number is specified by x.

<b>Group</b>	Measurement
--------------	-------------

**Syntax**    `MEASUREMENT:MEAS<x>:LABEL <QString>`  
`MEASUREMENT:MEAS<x>:LABEL?`

**Arguments**    `MEAS<x>` specifies the measurement number.  
`<QString>` is the measurement label.

**Examples**    `MEASUREMENT:MEAS1:LABEL "Delay"` sets the label to Delay.  
`MEASUREMENT:MEAS1:LABEL?` might return `:MEASUREMENT:MEAS1:LABEL "Peak-to-Peak"` indicating that the measurement 1 label is Peak-to-peak.

## MEASUREMENT:MEAS<x>:LINESELECTED

This command sets or queries selected lines for the measurement. The measurement number is specified by x.

**Group**    Measurement, IMDA

**Syntax**    `MEASUREMENT:MEAS<x>:LINESELECTED`  
`{ACBC|ACBC|BACA|XYZY|XZYX|YXZX}`  
`MEASUREMENT:MEAS<x>:LINESELECTED?`

**Arguments**    `MEAS<x>` specifies the measurement number.  
The arguments specify the selected lines.

**Examples**    `MEASUREMENT:MEAS1:LINESELECTED ABCB` sets the selected lines for measurement 1.  
`MEASUREMENT:MEAS1:LINESELECTED?` might return `:MEASUREMENT:MEAS1:LINESELECTED ABCB`, indicating that selected lines for measurement 1 are ABCB.

## MEASUREMENT:MEAS<x>:LOWREFVOLTAGE

This command sets or queries the low reference voltage value for the 'time outside level' measurement. Measurements are specified by x.

**Group**    Measurement

<b>Syntax</b>	<pre>MEASUREMENT:MEAS&lt;x&gt;:LOWREFVOLTAGE &lt;NR3&gt; MEASUREMENT:MEAS&lt;x&gt;:LOWREFVOLTAGE?</pre>
<b>Arguments</b>	<p>MEAS&lt;x&gt; specifies the measurement number.</p> <p>&lt;NR3&gt; is the low reference voltage value for the selected configuration.</p>
<b>Examples</b>	<pre>MEASUREMENT:MEAS1:LOWREFVOLTAGE -1.30</pre> <p>sets the low reference voltage to -1.3 V.</p> <pre>MEASUREMENT:MEAS1:LOWREFVOLTAGE?</pre> <p>might return</p> <pre>:MEASUREMENT:MEAS1:LOWREFVOLTAGE -1.0000</pre> <p>indicating the low ref voltage is -1.0 V.</p>

## MEASUREMENT:MEAS<x>:LTORQUE

This command sets or queries the measurement Low Torque value.

<b>Conditions</b>	Requires IMDA-MECH license on MSO 5, 6, 6B series instruments.
<b>Group</b>	IMDA
<b>Syntax</b>	<pre>MEASUREMENT:MEAS&lt;x&gt;:LTORQUE &lt;NR1&gt; MEASUREMENT:MEAS&lt;x&gt;:LTORQUE?</pre>
<b>Arguments</b>	<p>MEAS&lt;x&gt; specifies the measurement number.</p> <p>&lt;NR1&gt; specifies the Low Torque value of the measurement in the range of 0 to 10000000.</p>
<b>Examples</b>	<pre>MEASUREMENT:MEAS1:LTORQUE 10.5</pre> <p>sets the Low Torque value for measurement 1 to 10.5.</p> <pre>MEASUREMENT:MEAS1:LTORQUE?</pre> <p>might return</p> <pre>:MEASUREMENT:MEAS1:LTORQUE 10.5</pre> <p>indicating the Low Torque value for measurement 1 is 10.5.</p>

## MEASUREMENT:MEAS<x>:LTYPE

This command sets or returns the value for the level type as auto or custom. Measurements are specified by x.

<b>Conditions</b>	Requires a WBG-DPT license.
<b>Group</b>	Measurement, WBG
<b>Syntax</b>	MEASUREMENT:MEAS<x>:LTYPE {AUTO CUSTOM} MEASUREMENT:MEAS<x>:LTYPE?
<b>Arguments</b>	AUTO specifies the value for the level type as auto. CUSTOM specifies the value for the level type as custom.
<b>Examples</b>	MEASUREMENT:MEAS1:LTYPE AUTO sets the value for the level type to auto. MEASUREMENT:MEAS1:LTYPE? might return :MEASUREMENT:MEAS1:LTYPE AUTO, indicating the value for the level type is auto.

## MEASUREMENT:MEAS<x>:LUNITS

This command sets or returns the value for the level units as percentage or absolute. Measurements are specified by x.

<b>Conditions</b>	Requires a WBG-DPT license.
<b>Group</b>	Measurement, WBG
<b>Syntax</b>	MEASUREMENT:MEAS<x>:LUNITS {PERCENT ABSOLUTE} MEASUREMENT:MEAS<x>:LUNITS?
<b>Arguments</b>	PERCENT specifies the value for the level units as percent. ABSOLUTE specifies the value for the level units as absolute.
<b>Examples</b>	MEASUREMENT:MEAS1:LUNITS PERCENT sets the value for the level units as percent. MEASUREMENT:MEAS1:LUNITS? might return :MEASUREMENT:MEAS1:LUNITS PERCENT, indicating the value for the level units is percent.

## MEASUREMENT:MEAS<x>:LVOLTage

This command sets or queries the measurement Torque Low Voltage value.

<b>Conditions</b>	Requires IMDA-MECH license on MSO 5, 6, 6B series instruments.
<b>Group</b>	IMDA
<b>Syntax</b>	MEASUREMENT:MEAS<x>:LVOLTage <NR1> MEASUREMENT:MEAS<x>:LVOLTage?
<b>Arguments</b>	MEAS<x> specifies the measurement number.  <NR1> specifies the Low Voltage value of the measurement in the range of -100 to 100.
<b>Examples</b>	MEASUREMENT:MEAS1:LVOLTage 10.5 sets the Low Voltage value for measurement 1 to 10.5.  MEASUREMENT:MEAS1:LVOLTage? might return :MEASUREMENT:MEAS1:LVOLTage 10.5, indicating the Low Voltage value for measurement 1 is 10.5.

## MEASUREMENT:MEAS<x>:MAXCURRENT

This command sets or returns the maximum current. Measurements are specified by x.

<b>Conditions</b>	Requires a WBG-DPT license.
<b>Group</b>	Measurement, WBG
<b>Syntax</b>	MEASUREMENT:MEAS<x>:MAXCURRENT <NR3> MEASUREMENT:MEAS<x>:MAXCURRENT?
<b>Arguments</b>	<NR3> specifies the maximum current.
<b>Examples</b>	MEASUREMENT:MEAS1:MAXCURRENT 5.0000 sets the maximum current as 5.0000.  MEASUREMENT:MEAS1:MAXCURRENT? might return :MEASUREMENT:MEAS1:MAXCURRENT 5.0000, indicating the maximum current is 5.0000.

## MEASUREMENT:MEAS<x>:MAXCYCLE

This command sets or queries the maximum cycle value for the DDRTERRN and DDRTERRMN measurements.

<b>Conditions</b>	Requires option 6-DBDDR3 Requires 6 Series MSO instrument
<b>Group</b>	Measurement
<b>Syntax</b>	MEASUREMENT:MEAS<x>:MAXCYCLE <NR1> MEASUREMENT:MEAS<x>:MAXCYCLE?
<b>Arguments</b>	MEAS<x> specifies the measurement number. <NR1> is the maximum cycle range limit value in the range of 2 to 50.
<b>Examples</b>	MEASUREMENT:MEAS2:MAXCYCLE 45 sets the maximum cycle value for measurement 2 to 45.  MEASUREMENT:MEAS1:MAXCYCLE? might return MEASUREMENT:MEAS1:MAXCYCLE 17, indicating the maximum cycle value is set to 17 for measurement 1.

## MEASUREMENT:MEAS<x>:MAXGVOLTAGE

This command sets or returns the maximum gate voltage. Measurements are specified by x.

<b>Conditions</b>	Requires a WBG-DPT license.
<b>Group</b>	Measurement, WBG
<b>Syntax</b>	MEASUREMENT:MEAS<x>:MAXGVOLTAGE <NR3> MEASUREMENT:MEAS<x>:MAXGVOLTAGE?
<b>Arguments</b>	<NR3> specifies the maximum gate voltage.
<b>Examples</b>	MEASUREMENT:MEAS1:MAXGVOLTAGE 10.0000 sets the maximum gate voltage as 10.0000.

MEASUREMENT:MEAS1:MAXVOLTAGE? might return  
:MEASUREMENT:MEAS1:MAXVOLTAGE 10.0000, indicating the maximum gate  
voltage is 10.0000.

## MEASUREMENT:MEAS<x>:MAXVOLTAGE

Sets or queries the maximum input voltage. Measurements are specified by x.

<b>Conditions</b>	Requires option 5-DPM (5 Series MSO instruments) or 6-DPM (6 Series MSO instrument) or a WBG-DPT license.
<b>Group</b>	DPM, WBG
<b>Syntax</b>	MEASUREMENT:MEAS<x>:MAXVOLTAGE <NR2> MEASUREMENT:MEAS<x>:MAXVOLTAGE?
<b>Arguments</b>	<NR2> is the maximum input voltage, in the range of -61 V to +61 V.
<b>Examples</b>	MEASUREMENT:MEAS2:MAXVOLTAGE 40 sets the maximum input voltage of measurement 2 to +40 volts.  MEASUREMENT:MEAS4:MAXVOLTAGE? might return 2.5000, indicating that the maximum input voltage of measurement 4 is +2.5 volts.

## MEASUREMENT:MEAS<x>:MEASRANGE:GLOBAL

This command sets or queries the range settings global flag for the measurement.  
Measurements are specified by x.

<b>Group</b>	Measurement
<b>Syntax</b>	MEASUREMENT:MEAS<x>:MEASRANGE:GLOBAL {OFF ON 0 1} MEASUREMENT:MEAS<x>:MEASRANGE:GLOBAL?
<b>Arguments</b>	MEAS<x> specifies the measurement number.  OFF specifies that range settings can be set independently for each individual measurement.  ON applies global measurement range settings to all the measurements' range settings.

0 specifies that range settings can be set independently for each individual measurement.

1 applies global measurement range settings to all the measurements' range settings.

**Examples**    `MEASUREMENT:MEAS1:MEASRange:GLOBAL 1` applies global measurement range settings to all the measurements' range settings.

`MEASUREMENT:MEAS1:MEASRange:GLOBAL?` might return `:MEASUREMENT:MEAS1:MEASRange:GLOBAL 0` indicating that range settings can be set independently for each individual measurement.

## MEASUREMENT:MEAS<x>:MEASRange:MAX

This command sets or queries the range maximum value for the measurement. Measurements are specified by x.

**Group**    Measurement

**Syntax**    `MEASUREMENT:MEAS<x>:MEASRange:MAX <NR3>`  
`MEASUREMENT:MEAS<x>:MEASRange:MAX?`

**Arguments**    `MEAS<x>` specifies the measurement number.  
`<NR3>` is the maximum measurement range limit value.

**Examples**    `MEASUREMENT:MEAS1:MEASRange:MAX 2.50` sets the maximum range to 2.5 V.  
`MEASUREMENT:MEAS1:MEASRange:MAX?` might return `:MEASUREMENT:MEAS1:MEASRange:MAX 1.0000` indicating the maximum range is 1.0 V.

## MEASUREMENT:MEAS<x>:MEASRange:MIN

This command sets or queries the range minimum value for the measurement. Measurements are specified by x.

**Group**    Measurement

**Syntax**    `MEASUREMENT:MEAS<x>:MEASRange:MIN <NR3>`  
`MEASUREMENT:MEAS<x>:MEASRange:MIN?`



- Arguments** MEAS<x> specifies the measurement number.  
 <NR3> is the minimum measurement range limit value.
- Examples** MEASUREMENT:MEAS1:MEASRange:MIN -1.0 sets the minimum measurement range to -1.0 V.  
 MEASUREMENT:MEAS1:MEASRange:MIN? might return  
 :MEASUREMENT:MEAS1:MEASRANGE:MIN 0.0E+0 indicating the minimum range is 0.0 V.

## MEASUREMENT:MEAS<x>:MEASRange:STATE

This command sets or queries the range state for the measurement. Measurements are specified by x.

- Group** Measurement
- Syntax** MEASUREMENT:MEAS<x>:MEASRange:STATE {OFF|ON|0|1}  
 MEASUREMENT:MEAS<x>:MEASRange:STATE?
- Arguments** MEAS<x> specifies the measurement number.  
 OFF turns off the measurement range limits.  
 ON turns on the measurement range limits.  
 0 turns off the measurement range limits.  
 1 turns on the measurement range limits.
- Examples** MEASUREMENT:MEAS1:MEASRange:STATE 0 turns off the measurement range limits.  
 MEASUREMENT:MEAS1:MEASRange:STATE? might return  
 :MEASUREMENT:MEAS1:MEASRANGE:STATE 1 indicating the measurement range limits are on.

## MEASUREMENT:MEAS<x>:MECH:EINDEXz

This command sets or queries the specified mechanical Index Z source. Measurements are specified by x.

- Conditions** Requires IMDA-MECH license on MSO 5, 6, 6B series instruments.

<b>Group</b>	IMDA
<b>Syntax</b>	MEASUREMENT:MEAS<x>:MECH:EINDEXz {ON OFF 1 0} MEASUREMENT:MEAS<x>:MECH:EINDEXz?
<b>Arguments</b>	ON specifies the Index Z check box state as enabled. OFF specifies the Index Z check box state as disabled. 1 specifies the Index Z check box state as enabled. 0 specifies the Index Z check box state as disabled.
<b>Examples</b>	MEASUREMENT:MEAS1:MECH:EINDEXz ON sets the Index Z check box state as enabled.  MEASUREMENT:MEAS1:MECH:EINDEXz? might return :MEASUREMENT:MEAS1:MECH:EINDEXz ON, indicating the Index Z check box state is enabled.

## MEASUREMENT:MEAS<x>:MECH:GRATIO

This command sets or queries the gear ratio for the specific measurement. Measurements are specified by x.

<b>Conditions</b>	IMDA-MECH license on 5 and 6 Series MSO instruments.
<b>Group</b>	Measurement, IMDA
<b>Syntax</b>	MEASUREMENT:MEAS<x>:MECH:GRATIO <NR3> MEASUREMENT:MEAS<x>:MECH:GRATIO?
<b>Arguments</b>	<NR3> defines the gear ratio value for specified measurement. The minimum to maximum range is 0.001-1000.
<b>Examples</b>	MEASUREMENT:MEAS1:MECH:GRATIO 1.000E-3 defines the gear ratio value for specified measurement as 1.000E-3.  MEASUREMENT:MEAS1:MECH:GRATIO? might return :MEASUREMENT:MEAS1:MECH:GRATIO 1.000E-3 indicating the gear ratio value for specified measurement is 1.000E-3.

## MEASUREMENT:MEAS<x>:MECH:MUNITS

This command sets or queries the specified mechanical measurement results units. Measurements are specified by x.

<b>Conditions</b>	Requires IMDA-MECH license on MSO 5, 6, 6B series instruments.
<b>Group</b>	IMDA
<b>Syntax</b>	MEASUREMENT:MEAS<x>:MECH:MUNITS {NM OZINCH FTLB INCHLB DEGREES RADIANS} MEASUREMENT:MEAS<x>:MECH:MUNITS?
<b>Arguments</b>	NM defines the results units of the measurement as NM. OZINCH defines the results units of the measurement as OZINCH. FTLB defines the results units of the measurement as FTLB. INCHLB defines the results units of the measurement as INCHLB. DEGREES defines the results units of the measurement as DEGREES. RADIANS defines the results units of the measurement as RADIANS.
<b>Examples</b>	MEASUREMENT:MEAS1:MECH:MUNITS DEGREES defines the results units of the measurement as DEGREES.  MEASUREMENT:MEAS1:MECH:MUNITS? might return :MEASUREMENT:MEAS1:MECH:MUNITS DEGREES, indicating the results units of the measurement is DEGREES.

## MEASUREMENT:MEAS<x>:MECH:PPAIRS

This command sets or queries the number of pole pairs for the specific measurement. Measurements are specified by x.

<b>Conditions</b>	IMDA-MECH license on 5 and 6 Series MSO instruments.
<b>Group</b>	Measurement, IMDA
<b>Syntax</b>	MEASUREMENT:MEAS<x>:MECH:PPAIRS <NR1> MEASUREMENT:MEAS<x>:MECH:PPAIRS?

<b>Arguments</b>	<NR1> defines the number of pole pairs for the specified measurement. The minimum to maximum range is 1 to 20.
<b>Examples</b>	<p>MEASUREMENT:MEAS1:MECH:PPAIRS 4 defines the number of pole pairs for the specified measurement as 4.</p> <p>MEASUREMENT:MEAS1:MECH:PPAIRS? might return :MEASUREMENT:MEAS1:MECH:PPAIRS 4 indicating the number of pole pairs for the specified measurement is 4.</p>

## MEASUREMENT:MEAS<x>:MECH:PPROTATION

This command sets or queries the specified pulses per rotation of the measurement.

<b>Conditions</b>	Requires IMDA license on MSO 5, 6, 6B series instruments, 3-Phase license on MSO 4 series.
<b>Group</b>	IMDA
<b>Syntax</b>	<p>MEASUREMENT:MEAS&lt;x&gt;:MECH:PPROTATION &lt;NR1&gt;</p> <p>MEASUREMENT:MEAS&lt;x&gt;:MECH:PPROTATION?</p>
<b>Arguments</b>	<p>MEAS&lt;x&gt; specifies the measurement number.</p> <p>&lt;NR1&gt; defines the pulses per rotation of the measurement in the range of 1 to 10000.</p>
<b>Examples</b>	<p>MEASUREMENT:MEAS1:PPROTATION 25 defines the pulses per rotation for measurement 1 as 25.</p> <p>MEASUREMENT:MEAS1:PPROTATION? might return :MEASUREMENT:MEAS1:PPROTATION 25, indicating the pulses per rotation for measurement 1 is 25.</p>

## MEASUREMENT:MEAS<x>:MECH:STYPE

This command sets or queries the local measurement sensor type.

<b>Conditions</b>	IMDA-MECH license on 5 and 6 Series MSO instruments.
<b>Group</b>	Measurement, IMDA

<b>Syntax</b>	<pre>MEASUREMENT:MEAS&lt;x&gt;:MECH:SType {HSENSOR QEI} MEASUREMENT:MEAS&lt;x&gt;:MECH:SType?</pre>
<b>Arguments</b>	<p>MEAS&lt;x&gt; specifies the measurement number.</p> <p>HSENSOR specifies the sensor type as HSENSOR.</p> <p>QEI specifies the sensor type as QEI.</p>
<b>Examples</b>	<p>MEASUREMENT:MEAS1:MECH:SType HSENSOR specifies the sensor type as HSENSOR.</p> <p>MEASUREMENT:MEAS1:MECH:SType? might return :MEASUREMENT:MEAS1:MECH:SType HSENSOR, indicating the sensor type is HSENSOR.</p>

## MEASUREMENT:MEAS<x>:MINCycle

This command sets or queries the minimum cycle value for the DDRTERRN and DDRTERRMN measurements.

<b>Conditions</b>	<p>Requires option 6-DBDDR3</p> <p>Requires 6 Series MSO instrument</p>
<b>Group</b>	Measurement
<b>Syntax</b>	<pre>MEASUREMENT:MEAS&lt;x&gt;:MINCycle &lt;NR1&gt; MEASUREMENT:MEAS&lt;x&gt;:MINCycle?</pre>
<b>Arguments</b>	<p>MEAS&lt;x&gt; specifies the measurement number.</p> <p>&lt;NR1&gt; is the minimum cycle range limit value in the range or 2 to 50.</p>
<b>Examples</b>	<p>MEASUREMENT:MEAS2:MINCycle 20 sets the minimum cycle value for measurement 2 to 20.</p> <p>MEASUREMENT:MEAS1:MINCycle? might return MEASUREMENT:MEAS1:MINCycle 17, indicating the minimum cycle value is set to 17 for measurement 1.</p>

## MEASUREMENT:MEAS<x>:ODDEVEN

This command sets or queries harmonics oddeven.

**Group** Measurement, IMDA

**Syntax** MEASUREMENT:MEAS<x>:ODDEVEN {ALL|EVEN|ODD}  
MEASUREMENT:MEAS<x>:ODDEVEN?

**Arguments** MEAS<x> specifies the measurement number.

ALL displays all the results.

EVEN displays the even results.

ODD displays the odd results.

**Examples** MEASUREMENT:MEAS1:ODDEVEN ALL displays all the harmonics results for measurement 1.

MEASUREMENT:MEAS1:ODDEVEN? might return  
:MEASUREMENT:MEAS1:ODDEVEN EVEN, indicating the even results are displayed.

## MEASUREMENT:MEAS<x>:OFILTERS:LOWPASS:FREQ

This command sets or returns the cut-off frequency value for a measurement.

**Conditions** Requires IMDA-MECH license on MSO 5, 6, 6B series instruments.

**Group** Measurement, IMDA

**Syntax** MEASUREMENT:MEAS<x>:OFILTERS:LOWPASS:FREQ <NR3>  
MEASUREMENT:MEAS<x>:OFILTERS:LOWPASS:FREQ?

**Arguments** MEAS<x> specifies the measurement number.

<NR3> specifies the cut-off frequency value for a measurement.

**Examples** MEASUREMENT:MEAS1:OFILTERS:LOWPASS:FREQ 500E+6 specifies the cut-off frequency value of the measurement as 500E+6 for measurement 1.

MEASurement:MEAS1:OFILters:LOWPass:FREQ? might return  
:MEASurement:MEAS1:OFILters:LOWPass:FREQ 500E+6, indicating the  
cut-off frequency value of the measurement is 500E+6.

## MEASUREMENT:MEAS<x>:OFILTERS:LOWPASS:SPEC

This command sets or returns low pass filter specification for a measurement.

<b>Conditions</b>	Requires IMDA-MECH license on MSO 5, 6, 6B series instruments.
<b>Group</b>	Measurement, IMDA
<b>Syntax</b>	MEASUREMENT:MEAS<x>:OFILTERS:LOWPASS:SPEC {NONE   FIRST   SECOND   THIRD} MEASUREMENT:MEAS<x>:OFILTERS:LOWPASS:SPEC?
<b>Arguments</b>	MEAS<x> specifies the measurement number.  NONE specifies the low pass filter specification as none.  FIRST specifies the low pass filter specification set to 1st Order for the measurement.  SECOND specifies the low pass filter specification set to 2nd Order for the measurement.  THIRD specifies the low pass filter specification set to 3rd Order for the measurement.
<b>Examples</b>	MEASUREMENT:MEAS1:OFILTERS:LOWPASS:SPEC FIRST specifies the low pass filter specification set to 1st Order for the measurement.  MEASUREMENT:MEAS1:OFILTERS:LOWPASS:SPEC? might return :MEASUREMENT:MEAS1:OFILTERS:LOWPASS:SPEC FIRST, indicating the low pass filter specification is set to 1st Order for the measurement.

## MEASUREMENT:MEAS<x>:OSANGLE

This command sets or queries the specified measurement Offset angle.

<b>Conditions</b>	Requires IMDA-MECH license on MSO 5, 6, 6B series instruments.
<b>Group</b>	IMDA

**Syntax**    MEASUREMENT:MEAS<x>:OSANGLE <NR1>  
 MEASUREMENT:MEAS<x>:OSANGLE?

**Arguments**    MEAS<x> specifies the measurement number.  
 <NR1> specifies the offset angle of the measurement in the range or -360 to 360.

**Examples**    MEASUREMENT:MEAS1:OSANGLE 10 specifies the offset angle of the measurement as 10 for measurement 1.  
 MEASUREMENT:MEAS1:OSANGLE? might return  
 :MEASUREMENT:MEAS1:OSANGLE 10, indicating the offset angle of the measurement is 10.

## MEASUREMENT:MEAS<x>:OUTEDGEQUALIFIER

This command sets or queries local output edge qualifier source.

**Group**    Measurement, IMDA

**Syntax**    MEASUREMENT:MEAS<x>:OUTEDGEQUALIFIER  
 {S<x>\_CH<x>|CH<x>|MATH<x>|REF<x>}  
 MEASUREMENT:MEAS<x>:OUTEDGEQUALIFIER?

**Arguments**    MEAS<x> specifies the measurement number.  
 S<x>\_CH<x> specifies the remote scope number and the analog channel as the source.  
 CH<x> specifies an analog channel as the source.  
 MATH<x> specifies a math waveform as the source.  
 REF<x> specifies a reference waveform as the source.

**Examples**    MEASUREMENT:MEAS1:OUTEDGEQUALIFIER CH3 sets the local output edge qualifier source to channel 3.  
 MEASUREMENT:MEAS1:OUTEDGEQUALIFIER? might return  
 :MEASUREMENT:MEAS1:OUTEDGEQUALIFIER CH2 indicating the local output edge qualifier source is channel 2.



**MEASUREMENT:MEAS<x>:OUTFILTERS:LOWPASS:FREQ**

This command sets or queries the measurement output low pass filter frequency cutoff frequency on the scope.

<b>Group</b>	Measurement, IMDA
<b>Syntax</b>	MEASUREMENT:MEAS<x>:OUTFILTERS:LOWPASS:FREQ <NR2> MEASUREMENT:MEAS<x>:OUTFILTERS:LOWPASS:FREQ?
<b>Arguments</b>	MEAS<x> specifies the measurement number.  <NR2> specifies the values for the output filter cutoff frequency. The argument range is 20 Hz to 10e6 Hz.
<b>Examples</b>	MEASUREMENT:MEAS1:OUTFILTERS:LOWPASS:FREQ 2.000E+6 sets the value for the output filter cutoff frequency for measurement 1 as 2.000E+6.  MEASUREMENT:MEAS1:OUTFILTERS:LOWPASS:FREQ? might return :MEASUREMENT:MEAS1:OUTFILTERS:LOWPASS:FREQ 2.000E+6, indicating the value for the output filter cutoff frequency for is 2.000E+6.

**MEASUREMENT:MEAS<x>:OUTFILTERS:LOWPASS:SPEC**

This command sets or queries the measurement output low pass filter specification filter order on the scope. Measurements are specified by x.

<b>Group</b>	Measurement, IMDA
<b>Syntax</b>	MEASUREMENT:MEAS<x>:OUTFILTERS:LOWPASS:SPEC {NONE   FIRST   SECOND   THIRD} MEASUREMENT:MEAS<x>:OUTFILTERS:LOWPASS:SPEC?
<b>Arguments</b>	MEAS<x> specifies the measurement number.  NONE specifies the filter order none.  FIRST specifies the filter order first.  SECOND specifies the filter order second.  THIRD specifies the filter order third.

**Examples**    `MEASUREMENT:MEAS1:OUTFILTERS:LOWPASS:SPEC SECOND` sets the filter order of measurement 1 to second.

`MEASUREMENT:MEAS1:OUTFILTERS:LOWPASS:SPEC?` might return `:MEASUREMENT:MEAS1:OUTFILTERS:LOWPASS:SPEC SECOND`, indicating the filter order is set to second.

## MEASUREMENT:MEAS<x>:OUTPUT<n>VOLTage

Sets or queries the voltage level for the specified output voltage source n.

**Conditions**    Requires option 5-DPM (5 Series MSO instruments) or 6-DPM (6 Series MSO instrument)

**Group**        DPM

**Syntax**       `MEASUREMENT:MEAS<x>:OUTPUT<n>VOLTage <NR2>`  
`MEASUREMENT:MEAS<x>:OUTPUT<n>VOLTage?`

**Arguments**    `MEAS<x>` specifies the measurement number.

`<NR2>` is the output voltage for source n, in the range of -61 V to +61 V.

**Examples**    `MEASUREMENT:MEAS1:OUTPUT3VOLTage -24` sets the output voltage for source 3 of measurement 1 to -24 volts.

`MEASUREMENT:MEAS1:OUTPUT3VOLTage?` might return `2.500`, indicating that the output voltage for source 3 of measurement 1 is 2.5 volts.

## MEASUREMENT:MEAS<x>:PASSFAILENabled

This command returns or sets the pass/fail test enable status. If enabled, this will turn on pass fail testing for the specified measurement. Measurements are specified by x.

**Group**        Measurement

**Syntax**       `MEASUREMENT:MEAS<x>:PASSFAILENabled <NR1>`  
`MEASUREMENT:MEAS<x>:PASSFAILENabled?`

**Related Commands**    [ACTONEVENT:ENable](#)

**Arguments** <NR1> enables or disables pass fail testing for the specified measurement. A value of 1 enables and a value of 0 disables.

**Examples** MEASUREMENT:MEAS1:PASSFAILENabled 1 enables pass fail testing for the specified measurement.

MEASUREMENT:MEAS1:PASSFAILENabled? might return  
:MEASUREMENT:MEAS1:PASSFAILENabled 0 indicating that pass fail testing for the specified measurement is disabled.

## MEASUREMENT:MEAS<x>:PASSFAILHIGHlimit

This command returns or sets the high limit for a measurement test. Used as the test value when the "fail when" criteria is set to "less than" or "greater than". Measurements are specified by x.

**Group** Measurement

**Syntax** MEASUREMENT:MEAS<x>:PASSFAILHIGHlimit <NR2>  
MEASUREMENT:MEAS<x>:PASSFAILHIGHlimit?

**Related Commands** [ACTONEVent:ENable](#)

**Arguments** <NR2> sets the high limit for a measurement test. The high limit is a number which a measurement result will be tested against.

**Examples** MEASUREMENT:MEAS1:PASSFAILHIGHlimit 710 specifies 710 as the high limit for measurement 1.

MEASUREMENT:MEAS1:PASSFAILHIGHlimit? might return  
:MEASUREMENT:MEAS1:PASSFAILHIGHlimit 710 indicating that 710 is the high limit for measurement 1.

## MEASUREMENT:MEAS<x>:PASSFAILLimit

This command returns or sets the limit for a measurement test. Used as the test value when the "fail when" criteria is set to "less than" or "greater than". Measurements are specified by x.

**Group** Measurement

**Syntax**      `MEASUREMENT:MEAS<x>:PASSFAILLIMIT <NR2>`  
`MEASUREMENT:MEAS<x>:PASSFAILLIMIT?`

**Related Commands**      [ACTONEVENT:ENABLE](#)

**Arguments**      <NR2> sets the limit for a measurement test. The limit is a number which a measurement result will be tested against.

**Examples**      `MEASUREMENT:MEAS1:PASSFAILLIMIT 710` specifies 710 as the limit for measurement 1.  
  
`MEASUREMENT:MEAS1:PASSFAILLIMIT?` might return  
`:MEASUREMENT:MEAS1:PASSFAILLIMIT 710` indicating that 710 is the limit for measurement 1.

## MEASUREMENT:MEAS<x>:PASSFAILLIMIT

This command returns or sets the low limit for a measurement test. Used as the test value when the "fail when" criteria is set to "less than" or "greater than". Measurements are specified by x.

**Group**      Measurement

**Syntax**      `MEASUREMENT:MEAS<x>:PASSFAILLIMIT <NR2>`  
`MEASUREMENT:MEAS<x>:PASSFAILLIMIT?`

**Related Commands**      [ACTONEVENT:ENABLE](#)

**Arguments**      <NR2> sets the low limit for a measurement test. The limit is a number which a measurement result will be tested against.

**Examples**      `MEASUREMENT:MEAS1:PASSFAILLIMIT 690` specifies 690 as the limit for measurement 1.  
  
`MEASUREMENT:MEAS1:PASSFAILLIMIT?` might return  
`:MEASUREMENT:MEAS1:PASSFAILLIMIT 690` indicating that 690 is the low limit for measurement 1.

## MEASUREMENT:MEAS<x>:PASSFAILMARGIN

This command returns or sets the allowed margin for limit comparisons for all pass/fail checks. This is given as a percentage with a default value of 0.05 representing 5%. Measurements are specified by x.

**Group** Measurement

**Syntax** MEASUREMENT:MEAS<x>:PASSFAILMARGIN <NR2>  
MEASUREMENT:MEAS<x>:PASSFAILMARGIN?

**Related Commands** [ACTONEVENT:ENABLE](#)

**Arguments** <NR2> sets the allowed margin for limit comparisons for all pass/fail checks. The margin as a percentage of the limit.

**Examples** MEASUREMENT:MEAS1:PASSFAILMARGIN 0.10 specifies 10% as the allowed margin for limit comparisons for all pass/fail checks.

MEASUREMENT:MEAS1:PASSFAILMARGIN? might return  
:MEASUREMENT:MEAS1:PASSFAILMARGIN 0.10 indicating that 10% is the allowed margin for limit comparisons for all pass/fail checks on measurement 1.

## MEASUREMENT:MEAS<x>:PASSFAILWHEN

This command sets or returns the condition on which a measurement test fails. Measurements are specified by x.

**Group** Measurement

**Syntax** MEASUREMENT:MEAS<x>:PASSFAILWHEN {LESSthan| GREATERthan|  
EQUALS| NOTEQUALS| INSIDERANGE| OUTSIDERANGE}  
MEASUREMENT:MEAS<x>:PASSFAILWHEN?

**Related Commands** [ACTONEVENT:ENABLE](#)

**Arguments** LESSthan sets the condition for measurement test failure as less than the given limit. This is the default value.

**GREATERthan** sets the condition for measurement test failure as greater than the given limit.

**Equals** sets the condition for measurement test failure as equals the given limit.

**NOTEEquals** sets the condition for measurement test failure as not equal to the given limit.

**INSIDERange** sets the condition for measurement test failure as inside the limit range.

**OUTSIDERange** sets the condition for measurement test failure as outside the limit range.

**Examples** `MEASUREMENT:MEAS1:PASSFAILWHEN LESSthan` specifies the condition for measurement 1 test failure as less than the given limit.

`MEASUREMENT:MEAS1:PASSFAILWHEN?` might return `:MEASUREMENT:MEAS1:PASSFAILWHEN LESSthan` indicating that the condition for measurement 1 test failure is less than the given limit.

## MEASUREMENT:MEAS<x>:PATTERNDETECTION

This command sets or queries the pattern detection type for the measurement. Measurements are specified by x.

**Group** Measurement

**Syntax** `MEASUREMENT:MEAS<x>:PATTERNDETECTION {AUTO|MANUAL}`  
`MEASUREMENT:MEAS<x>:PATTERNDETECTION?`

**Arguments** `MEAS<x>` specifies the measurement number.

`AUTO` automatically detects the pattern.

`MANUAL` requires manually detecting the pattern.

**Examples** `MEASUREMENT:MEAS1:PATTERNDETECTION MANUAL` specifies manually detecting the pattern.

`MEASUREMENT:MEAS1:PATTERNDETECTION?` might return `:MEASUREMENT:MEAS1:PATTERNDETECTION AUTO` indicating patterns are automatically detected.

## MEASUREMENT:MEAS<x>:PATTERNLENGTH

This command sets or queries the pattern length for the measurement. Measurements are specified by x.

<b>Group</b>	Measurement
<b>Syntax</b>	MEASUREMENT:MEAS<x>:PATTERNLENGTH <NR3> MEASUREMENT:MEAS<x>:PATTERNLENGTH?
<b>Arguments</b>	MEAS<x> specifies the measurement number.  <NR3> is the pattern length.
<b>Examples</b>	MEASUREMENT:MEAS1:PATTERNLENGTH 3.0 sets the pattern length to 3.0.  MEASUREMENT:MEAS1:PATTERNLENGTH? might return :MEASUREMENT:MEAS1:PATTERNLENGTH 2.0000 indicating the patternlength is 2.0.

## MEASUREMENT:MEAS<x>:PATTERNTYPE

This command sets or queries the pattern type for the measurement. Measurements are specified by x.

<b>Group</b>	Measurement
<b>Syntax</b>	MEASUREMENT:MEAS<x>:PATTERNTYPE {REPEATING ARBITRARY} MEASUREMENT:MEAS<x>:PATTERNTYPE?
<b>Arguments</b>	MEAS<x> specifies the measurement number.  REPEATING specifies a repeating pattern.  ARBITRARY specifies an arbitrary pattern.
<b>Examples</b>	MEASUREMENT:MEAS1:PATTERNTYPE ARBITRARY specifies an arbitrary pattern.  MEASUREMENT:MEAS1:PATTERNTYPE? might return :MEASUREMENT:MEAS1:PATTERNTYPE REPEATING indicating a repeating pattern.

## MEASUREMENT:MEAS<x>:PCOUNT

This command sets or returns number of pulses. Measurements are specified by x.

<b>Conditions</b>	Requires a WBG-DPT license.
<b>Group</b>	Measurement, WGB
<b>Syntax</b>	MEASUREMENT:MEAS<x>:PCOUNT <NR3> MEASUREMENT:MEAS<x>:PCOUNT?
<b>Arguments</b>	MEAS<x> specifies the measurement number.  <NR3> is the number of pulses.
<b>Examples</b>	MEASUREMENT:MEAS1:PCOUNT 10 sets the number of pulses to 10.  MEASUREMENT:MEAS1:PCOUNT? might return :MEASUREMENT:MEAS1:PCOUNT 10, indicating the number of pulses is 10.

## MEASUREMENT:MEAS<x>:PERFREQ:EDGE

This command sets or queries the edge type of a Period/Frequency measurement. The measurement number is specified by x.

<b>Group</b>	Measurement
<b>Syntax</b>	MEASUREMENT:MEAS<x>:PERFREQ:EDGE {FIRST RISE FALL} MEASUREMENT:MEAS<x>:PERFREQ:EDGE?
<b>Arguments</b>	MEAS<x> specifies the measurement number.  FIRST computes the measurement between Rising edges if the first edge is Rising. Computes the measurement between Falling edges if the first edge is Falling.  RISE computes the measurement between Rising edges.  FALL computes the measurement between Falling edges.
<b>Examples</b>	MEASUREMENT:MEAS1:PERFREQ:EDGE RISE specifies computing the measurement between Rising edges.



`measurement:meas1:perfreq:edge?` might return  
`:MEASUREMENT:MEAS1:PERFREQ:EDGE FIRST` if the measurement  
 is computed between edges of the first type edge found.

## MEASUREMENT:MEAS<x>:POLARITY

This command sets or queries the polarity for the measurement when the measurement type is burst width. Measurements are specified by x.

<b>Group</b>	Measurement
<b>Syntax</b>	<code>MEASUREMENT:MEAS&lt;x&gt;:POLARITY {NORMAL INVERTED}</code> <code>MEASUREMENT:MEAS&lt;x&gt;:POLARITY?</code>
<b>Arguments</b>	<code>MEAS&lt;x&gt;</code> specifies the measurement number. <code>NORMAL</code> specifies normal polarity. <code>INVERTED</code> specifies inverted polarity.
<b>Examples</b>	<code>MEASUREMENT:MEAS1:POLARITY INVERTED</code> specifies inverted polarity. <code>MEASUREMENT:MEAS1:POLARITY?</code> might return <code>:MEASUREMENT:MEAS1:POLARITY NORMAL</code> indicating normal polarity.

## MEASUREMENT:MEAS<x>:POPULATION:GLOBAL

This command sets or queries the population settings global flag. The measurement number is specified by x.

<b>Group</b>	Measurement
<b>Syntax</b>	<code>MEASUREMENT:MEAS&lt;x&gt;:POPULATION:GLOBAL {OFF ON 0 1}</code> <code>MEASUREMENT:MEAS&lt;x&gt;:POPULATION:GLOBAL?</code>
<b>Arguments</b>	<code>MEAS&lt;x&gt;</code> specifies the measurement number. <code>OFF</code> specifies that population settings can be changed independently for each individual measurement. <code>ON</code> applies the global population settings to all the measurements' population settings.

0 specifies that population settings can be changed independently for each individual measurement.

1 applies the global population settings to all the measurements' population settings.

**Examples**    `MEASUREMENT:MEAS1:POPULATION:GLOBAL 1` applies the global population settings to all the measurements' population settings.

`MEASUREMENT:MEAS1:POPULATION:GLOBAL?` might return  
`:MEASUREMENT:MEAS1:POPULATION:GLOBAL 0` indicating that population settings can be changed independently for each individual measurement.

## MEASUREMENT:MEAS<x>:POPULATION:LIMIT:STATE

This command sets or queries the population limit state for the measurement. The measurement number is specified by x.

**Group**    Measurement

**Syntax**    `MEASUREMENT:MEAS<x>:POPULATION:LIMIT:STATE {OFF|ON|0|1}`  
`MEASUREMENT:MEAS<x>:POPULATION:LIMIT:STATE?`

**Arguments**    `MEAS<x>` specifies the measurement number.

`OFF` turns off the population limit.

`ON` turns on the population limit.

`0` turns off the population limit.

`1` turns on the population limit.

**Examples**    `MEASUREMENT:MEAS1:POPULATION:LIMIT:STATE 0` turns off the population limit.

`MEASUREMENT:MEAS1:POPULATION:LIMIT:STATE?` might return  
`:MEASUREMENT:MEAS1:POPULATION:LIMIT:STATE 1` indicating the population limit is on.

## MEASUREMENT:MEAS<x>:POPULATION:LIMIT:VALUE

This command sets or queries the population limit value for the measurement. The measurement number is specified by x.

<b>Group</b>	Measurement
<b>Syntax</b>	MEASUREMENT:MEAS<x>:POPULATION:LIMIT:VALUE <NR3> MEASUREMENT:MEAS<x>:POPULATION:LIMIT:VALUE?
<b>Arguments</b>	MEAS<x> specifies the measurement number.  <NR3> the current limit value.
<b>Examples</b>	MEASUREMENT:MEAS1:POPULATION:LIMIT:VALUE 2000 sets the population limit to 2000.  MEASUREMENT:MEAS1:POPULATION:LIMIT:VALUE? might return :MEASUREMENT:MEAS1:POPULATION:LIMIT:VALUE 1000 indicating the limit is set to 1000.

## MEASUREMENT:MEAS<x>:POWERFACTOR

This command sets or queries the power factor value for IEC-Class C type harmonics standard. The measurement number is specified by x.

<b>Group</b>	Measurement, IMDA
<b>Syntax</b>	MEASUREMENT:MEAS<x>:POWERFACTOR <NR2> MEASUREMENT:MEAS<x>:POWERFACTOR?
<b>Arguments</b>	MEAS<x> specifies the measurement number.  <NR2> specifies the power factor value for class C harmonics standard.
<b>Examples</b>	MEASUREMENT:MEAS1:POWERFACTOR sets the .  MEASUREMENT:MEAS1:POWERFACTOR? might return :MEASUREMENT:MEAS1:POWERFACTOR indicating the .

## MEASUREMENT:MEAS<x>:PREGION

This command sets or returns pulse region for a measurement. Measurements are specified by x.

<b>Conditions</b>	Requires a WBG-DPT license.
-------------------	-----------------------------

<b>Group</b>	Measurement, WGB
<b>Syntax</b>	MEASUREMENT:MEAS<x>:PREGion {FPULSE SPULSE MPULSE} MEASUREMENT:MEAS<x>:PREGion?
<b>Arguments</b>	FPULSE is the pulse region as Fpulse. SPULSE is the pulse region as Spulse. MPULSE is the pulse region as Mpulse.
<b>Examples</b>	MEASUREMENT:MEAS1:PREGion Fpulse sets the pulse region to Fpulse. MEASUREMENT:MEAS1:PREGion? might return :MEASUREMENT:MEAS1:PREGion Fpulse, indicating the pulse region is set to Fpulse.

## MEASUREMENT:MEAS<x>:PWIDth

This command sets or returns pulse width. Measurements are specified by x.

<b>Conditions</b>	Requires a WBG-DPT license.
<b>Group</b>	Measurement, WGB
<b>Syntax</b>	MEASUREMENT:MEAS<x>:PWIDth <NR3> MEASUREMENT:MEAS<x>:PWIDth?
<b>Arguments</b>	<NR3> specifies the pulse width.
<b>Examples</b>	MEASUREMENT:MEAS1:PWIDth 15.0000 sets the pulse width to 15. MEASUREMENT:MEAS1:PWIDth? might return :MEASUREMENT:MEAS1:PWIDth 15.0000, indicating the pulse width is 15.

## MEASUREMENT:MEAS<x>:REDGe

This command turns on or off the Refine edge on qualifier. Measurements are specified by x.

<b>Conditions</b>	Requires a WBG-DPT license.
-------------------	-----------------------------

<b>Group</b>	Measurement, WGB
<b>Syntax</b>	MEASUREMENT:MEAS<x>:REDGe {ON OFF} MEASUREMENT:MEAS<x>:REDGe?
<b>Arguments</b>	ON specifies the Refine edge settings has been turned on. OFF specifies the Refine edge settings has been turned off.
<b>Examples</b>	MEASUREMENT:MEAS1:REDGe ON turns on the Refine edge on qualifier. MEASUREMENT:MEAS1:REDGe? might return :MEASUREMENT:MEAS1:REDGe ON, indicating the Refine edge settings has been turned on.

## MEASUREMENT:MEAS<x>:REFLEVELS:ABSOLUTE:FALLHIGH

This command sets or queries the value used as the high reference level of the falling edge when the measurement's ref level method is set to absolute. Measurements are specified by x.

---

**NOTE.** *This command affects the results of rise and fall measurements*

---

<b>Group</b>	Measurement
<b>Syntax</b>	MEASUREMENT:MEAS<x>:REFLEVELS:ABSOLUTE:FALLHIGH <NR3> MEASUREMENT:MEAS<x>:REFLEVELS:ABSOLUTE:FALLHIGH?
<b>Arguments</b>	MEAS<x> specifies the measurement number. <NR3> is the high reference level in volts. The default is 0.0 V.
<b>Examples</b>	MEASUREMENT:MEAS1:REFLEVELS:ABSOLUTE:FALLHIGH 1.71 sets the high reference level to 1.71 V. MEASUREMENT:MEAS1:REFLEVELS:ABSOLUTE:FALLHIGH? might return :MEASUREMENT:MEAS1:REFLEVELS:ABSOLUTE:FALLHIGH 1.7100E+00, indicating that the absolute high reference level is set to 1.71 V.

## MEASUREMENT:MEAS<x>:REFLEVELS<x>:ABSOLUTE:FALLLOW

This command sets or queries the value used as the low reference level of the falling edge when the measurement's ref level method is set to absolute. Measurements are specified by x.

---

**NOTE.** *This command affects the results of rise and fall measurements.*

---

<b>Group</b>	Measurement
<b>Syntax</b>	MEASUREMENT:MEAS<x>:REFLEVELS<x>:ABSOLUTE:FALLLOW <NR3> MEASUREMENT:MEAS<x>:REFLEVELS<x>:ABSOLUTE:FALLLOW?
<b>Arguments</b>	MEAS<x> specifies the measurement number.  <NR3> is the low reference level in volts. The default is 0.0 V.
<b>Examples</b>	MEASUREMENT:MEAS1:REFLEVELS1:ABSOLUTE:FALLLOW 0.0 V sets the low reference level to 0.0 V.  MEASUREMENT:MEAS1:REFLEVELS1:ABSOLUTE:FALLLOW? might return :MEASUREMENT:MEAS1:REFLEVELS1:ABSOLUTE:FALLLOW 0.0000E+00, indicating that the absolute low reference level is set to 0.0 V.

## MEASUREMENT:MEAS<x>:REFLEVELS<x>:ABSOLUTE:FALLMID

This command sets or queries the value used as the mid reference level of the falling edge when the measurement's ref level method is set to absolute. Measurements are specified by x.

---

**NOTE.** *This command affects the results of period, frequency, delay, and all cyclic measurements.*

---

<b>Group</b>	Measurement
<b>Syntax</b>	MEASUREMENT:MEAS<x>:REFLEVELS<x>:ABSOLUTE:FALLMID <NR3> MEASUREMENT:MEAS<x>:REFLEVELS<x>:ABSOLUTE:FALLMID?
<b>Arguments</b>	MEAS<x> specifies the measurement number.  <NR3> is the mid reference level in volts. The default is 0.0 V.

**Examples**    `MEASUREMENT:MEAS1:REFLEVELS1:ABSOLUTE:FALLMID 0.5` sets the mid reference level for the delay waveform to 0.5 V.

`MEASUREMENT:MEAS1:REFLEVELS1:ABSOLUTE:FALLMID?` might return `:MEASUREMENT:MEAS1:REFLEVELS1:ABSOLUTE:FALLMID 0.5000E+00`, indicating that the absolute mid reference level is set to 0.5 V.

## MEASUREMENT:MEAS<x>:REFLEVELS<x>:ABSOLUTE:HYS TERESIS

This command sets or queries the value of the hysteresis of the reference level when the measurement's ref level method is set to absolute. The measurement number is specified by x.

**Group**    Measurement

**Syntax**    `MEASUREMENT:MEAS<x>:REFLEVELS<x>:ABSOLUTE:HYS TERESIS <NR3>`  
`MEASUREMENT:MEAS<x>:REFLEVELS<x>:ABSOLUTE:HYS TERESIS?`

**Arguments**    `MEAS<x>` specifies the measurement number.  
`<NR3>` is the hysteresis value used for autoset.

**Examples**    `MEASUREMENT:MEAS1:REFLEVELS1:ABSOLUTE:HYS TERESIS 25.0E-3` sets the hysteresis to 25 mV.

`MEASUREMENT:MEAS1:REFLEVELS1:ABSOLUTE:HYS TERESIS?` might return `:MEASUREMENT:MEAS1:REFLEVELS1:ABSOLUTE:HYS TERESIS 30.0000E-3` indicating the hysteresis is set to 30 mV.

## MEASUREMENT:MEAS<x>:REFLEVELS<x>:ABSOLUTE:RISEHIGH

This command sets or queries the value used as the high reference level of the rising edge when the measurement's ref level method is set to absolute. The measurement number is specified by x.

**Group**    Measurement

**Syntax**    `MEASUREMENT:MEAS<x>:REFLEVELS<x>:ABSOLUTE:RISEHIGH <NR3>`  
`MEASUREMENT:MEAS<x>:REFLEVELS<x>:ABSOLUTE:RISEHIGH?`

<b>Arguments</b>	MEAS<x> specifies the measurement number.  <NR3> is the high reference level, and is the zero percent level when the measurement's Ref level method is set to Absolute.
<b>Examples</b>	MEASUREMENT:MEAS1:REFLEVELS1:ABSOLUTE:RISEHIGH 1.50 sets the high reference level to 1.5 V.  MEASUREMENT:MEAS1:REFLEVELS1:ABSOLUTE:RISEHIGH? might return :MEASUREMENT:MEAS1:REFLEVELS1:ABSOLUTE:RISEHIGH 1.0000 indicating the high reference level is set to 1.0 V.

## MEASUREMENT:MEAS<x>:REFLEVELS<x>:ABSOLUTE:RISELOW

This command sets or queries the value used as the low reference level of the rising edge when the measurement's ref level method is set to absolute. The measurement number is specified by x.

<b>Group</b>	Measurement
<b>Syntax</b>	MEASUREMENT:MEAS<x>:REFLEVELS<x>:ABSOLUTE:RISELOW <NR3> MEASUREMENT:MEAS<x>:REFLEVELS<x>:ABSOLUTE:RISELOW?
<b>Arguments</b>	MEAS<x> specifies the measurement number.  <NR3> is the low reference level, and is the zero percent level when the measurement's Ref level method is set to Absolute.
<b>Examples</b>	MEASUREMENT:MEAS1:REFLEVELS1:ABSOLUTE:RISELOW -1.50 sets the low reference level to -1.5 V.  MEASUREMENT:MEAS1:REFLEVELS1:ABSOLUTE:RISELOW? might return :MEASUREMENT:MEAS1:REFLEVELS1:ABSOLUTE:RISELOW -1.0000 indicating the low reference level is -1.0 V.

## MEASUREMENT:MEAS<x>:REFLEVELS<x>:ABSOLUTE:RISEMID

This command sets or queries the value used as the mid reference level of the rising edge when the measurement's ref level method is set to absolute. The measurement number is specified by x.

<b>Group</b>	Measurement
--------------	-------------



<b>Syntax</b>	<pre>MEASUREMENT:MEAS&lt;x&gt;:REFLEVELS&lt;x&gt;:ABSOLUTE:RISEMID &lt;NR3&gt; MEASUREMENT:MEAS&lt;x&gt;:REFLEVELS&lt;x&gt;:ABSOLUTE:RISEMID?</pre>
<b>Arguments</b>	<p>MEAS&lt;x&gt; specifies the measurement number.</p> <p>&lt;NR3&gt; is the mid reference level (where 50% is equal to MID) used to calculate the mid reference level when the measurement's Ref level method is set to Absolute.</p>
<b>Examples</b>	<pre>MEASUREMENT:MEAS1:REFLEVELS1:ABSOLUTE:RISEMID 30.0E-3</pre> sets the mid reference level to 30 mV. <p> <pre>MEASUREMENT:MEAS1:REFLEVELS1:ABSOLUTE:RISEMID?</pre> might return <pre>:MEASUREMENT:MEAS1:REFLEVELS1:ABSOLUTE:RISEMID 0.0E+0</pre> indicating the mid reference level is 0.0 V. </p>

## MEASUREMENT:MEAS<x>:REFLEVELS<x>:ABSOLUTE:TYPE

This command sets or queries the reference level type for the measurement. The measurement number is specified by x.

<b>Group</b>	Measurement
<b>Syntax</b>	<pre>MEASUREMENT:MEAS&lt;x&gt;:REFLEVELS&lt;x&gt;:ABSOLUTE:TYPE {SAME UNIQUE} MEASUREMENT:MEAS&lt;x&gt;:REFLEVELS&lt;x&gt;:ABSOLUTE:TYPE?</pre>
<b>Arguments</b>	<p>MEAS&lt;x&gt; specifies the measurement number.</p> <p>SAME specifies that the absolute levels are set the same.</p> <p>UNIQUE specifies that the absolute levels can be set independently.</p>
<b>Examples</b>	<pre>MEASUREMENT:MEAS1:REFLEVELS1:ABSOLUTE:TYPE UNIQUE</pre> specifies that the absolute levels can be set independently. <p> <pre>MEASUREMENT:MEAS1:REFLEVELS1:ABSOLUTE:TYPE?</pre> might return <pre>:MEASUREMENT:MEAS1:REFLEVELS1:ABSOLUTE:TYPE SAME</pre> indicating the absolute levels are set the same. </p>

## MEASUREMENT:MEAS<x>:REFLEVELS<x>:BASETOP

This command sets or queries the method used to calculate the TOP and BASE used to calculate reference levels for the measurement. The measurement number is specified by x.

<b>Group</b>	Measurement
<b>Syntax</b>	<pre>MEASUREMENT:MEAS&lt;x&gt;:REFLEVELS&lt;x&gt;:BASETOP {AUTO MINMAX MEANHISTOGRAM MODEHISTOGRAM EYEHISTOGRAM} MEASUREMENT:MEAS&lt;x&gt;:REFLEVELS&lt;x&gt;:BASETOP?</pre>
<b>Arguments</b>	<p>MEAS&lt;x&gt; specifies the measurement number.</p> <p>AUTO automatically chooses a reference level method.</p> <p>MINMAX specifies that reference levels are relative to the measurement MIN and MAX.</p> <p>MEANHISTOGRAM specifies that reference levels are relative to the histogram mean BASE and TOP.</p> <p>MODEHISTOGRAM specifies that reference levels are relative to the histogram mode BASE and TOP.</p> <p>EYEHISTOGRAM specifies that reference levels are relative to the eye histogram BASE and TOP.</p>
<b>Examples</b>	<pre>MEASUREMENT:MEAS1:REFLEVELS1:BASETOP MINMAX specifies that reference levels are relative to the measurement MIN and MAX.</pre> <pre>MEASUREMENT:MEAS1:REFLEVELS1:BASETOP? might return :MEASUREMENT:MEAS1:REFLEVELS1:BASETOP AUTO indicating the instrument automatically chooses a reference level method.</pre>

## MEASUREMENT:MEAS<x>:REFLEVELS<x>:METHOD

This command sets or queries the method used to calculate reference levels for the measurement. The measurement number is specified by x.

<b>Group</b>	Measurement
<b>Syntax</b>	<pre>MEASUREMENT:MEAS&lt;x&gt;:REFLEVELS&lt;x&gt;:METHOD {PERCENT ABSOLUTE} MEASUREMENT:MEAS&lt;x&gt;:REFLEVELS&lt;x&gt;:METHOD?</pre>
<b>Arguments</b>	<p>MEAS&lt;x&gt; specifies the measurement number.</p> <p>PERCENT specifies that the reference levels are calculated as a percent relative to HIGH and LOW. The percentages are defined using the MEASUREMENT:MEAS&lt;x&gt;:REFLEVEL:PERCENT commands.</p>

**ABSolute** specifies that the reference levels are set explicitly using the `MEASUREMENT:MEAS<x>:REFLEVEL:ABSOLUTE` commands. This method is useful when precise values are required.

**Examples** `MEASUREMENT:MEAS1:REFLEVELS1:METHOD ABSOLUTE` specifies that explicit user-defined values are used for the reference levels.

`MEASUREMENT:MEAS1:REFLEVELS1:METHOD?` might return `:MEASUREMENT:MEAS1:REFLEVELS1:METHOD PERCENT`, indicating that the reference level units used are calculated as a percent relative to HIGH and LOW.

## **MEASUREMENT:MEAS<x>:REFLEVELS<x>:PERCENT:FALLHIGH**

This command sets or queries the percentage (where 100% is equal to TOP and 0% is equal to BASE) used to calculate the high reference level of the falling edge when the measurement's ref level method is set to percent. The measurement number is specified by x.

**Group** Measurement

**Syntax** `MEASUREMENT:MEAS<x>:REFLEVELS<x>:PERCENT:FALLHIGH <NR3>`  
`MEASUREMENT:MEAS<x>:REFLEVELS<x>:PERCENT:FALLHIGH?`

**Arguments** `MEAS<x>` specifies the measurement number.

`<NR3>` is the percentage (where 100% is equal to HIGH) used to calculate the high reference level.

**Examples** `MEASUREMENT:MEAS1:REFLEVELS1:PERCENT:FALLHIGH 95.0` sets the high reference level of the falling edge to 95%.

`MEASUREMENT:MEAS1:REFLEVELS1:PERCENT:FALLHIGH?` might return `:MEASUREMENT:MEAS1:REFLEVELS1:PERCENT:FALLHIGH 90.0000` indicating the high reference level is set to 90%.

## **MEASUREMENT:MEAS<x>:REFLEVELS<x>:PERCENT:FALLLOW**

This command sets or queries the percentage (where 100% is equal to TOP and 0% is equal to BASE) used to calculate the low reference level of the falling edge when the measurement's ref level method is set to percent. The measurement number is specified by x.

<b>Group</b>	Measurement
<b>Syntax</b>	<pre>MEASUrement:MEAS&lt;x&gt;:REFLeve1s&lt;x&gt;:PERCent:FALLLow &lt;NR3&gt; MEASUrement:MEAS&lt;x&gt;:REFLeve1s&lt;x&gt;:PERCent:FALLLow?</pre>
<b>Arguments</b>	<p>MEAS&lt;x&gt; specifies the measurement number.</p> <p>&lt;NR3&gt; is the percentage (where 100% is equal to HIGH) used to calculate the mid reference level.</p>
<b>Examples</b>	<p>MEASUrement:MEAS1:REFLeve1s1:PERCent:FALLLow 5.0 sets the low reference level of the falling edge is 5%.</p> <p>MEASUrement:MEAS1:REFLeve1s1:PERCent:FALLLow? might return :MEASUREMENT:MEAS1:REFLEVELS1:PERCENT:FALLLOW 10.0000 indicating the low reference level of the falling edge is 10%.</p>

## MEASUrement:MEAS<x>:REFLeve1s<x>:PERCent:FALLMid

This command sets or queries the percentage (where 100% is equal to TOP and 0% is equal to BASE) used to calculate the mid reference level of the falling edge when the measurement's ref level method is set to percent. The measurement number is specified by x.

<b>Group</b>	Measurement
<b>Syntax</b>	<pre>MEASUrement:MEAS&lt;x&gt;:REFLeve1s&lt;x&gt;:PERCent:FALLMid &lt;NR3&gt; MEASUrement:MEAS&lt;x&gt;:REFLeve1s&lt;x&gt;:PERCent:FALLMid?</pre>
<b>Arguments</b>	<p>MEAS&lt;x&gt; specifies the measurement number.</p> <p>&lt;NR3&gt; is the percentage (where 50% is equal to MID) used to calculate the mid reference level.</p>
<b>Examples</b>	<p>MEASUrement:MEAS1:REFLeve1s1:PERCent:FALLMid 50.0 sets the mid reference level of the falling edge to 50%.</p> <p>MEASUrement:MEAS1:REFLeve1s1:PERCent:FALLMid? might return :MEASUREMENT:MEAS1:REFLEVELS1:PERCENT:FALLMID 50.0000 indicating the mid reference level of the falling edge is set to 50%.</p>

## MEASUREMENT:MEAS<x>:REFLEVELS<x>:PERCENT:HYSTERESIS

This command sets or queries the percentage (where 100% is equal to MAX and 0% is equal to MIN) used to calculate the hysteresis of the reference level when the measurement's ref level method is set to percent. The measurement number is specified by x.

<b>Group</b>	Measurement
<b>Syntax</b>	MEASUREMENT:MEAS<x>:REFLEVELS<x>:PERCENT:HYSTERESIS <NR3> MEASUREMENT:MEAS<x>:REFLEVELS<x>:PERCENT:HYSTERESIS?
<b>Arguments</b>	MEAS<x> specifies the measurement number.  <NR3> is the hysteresis value used for the autoset.
<b>Examples</b>	MEASUREMENT:MEAS1:REFLEVELS1:PERCENT:HYSTERESIS 5.0 sets the hysteresis level to 5%.  MEASUREMENT:MEAS1:REFLEVELS1:PERCENT:HYSTERESIS? might return :MEASUREMENT:MEAS1:REFLEVELS1:PERCENT:HYSTERESIS 5.0000 indicating the hysteresis is 5.0%.

## MEASUREMENT:MEAS<x>:REFLEVELS<x>:PERCENT:RISEHIGH

This command sets or queries the percentage (where 100% is equal to TOP and 0% is equal to BASE) used to calculate the high reference level of the rising edge when the measurement's ref level method is set to percent. The measurement number is specified by x.

<b>Group</b>	Measurement
<b>Syntax</b>	MEASUREMENT:MEAS<x>:REFLEVELS<x>:PERCENT:RISEHIGH <NR3> MEASUREMENT:MEAS<x>:REFLEVELS<x>:PERCENT:RISEHIGH?
<b>Arguments</b>	MEAS<x> specifies the measurement number.  <NR3> is the percentage (where 100% is equal to TOP) used to calculate the high reference level when the measurement's Ref level method is set to Percent.
<b>Examples</b>	MEASUREMENT:MEAS1:REFLEVELS1:PERCENT:RISEHIGH 95.0 sets the high reference level of the rising edge is set to 95%.

MEASUREMENT:MEAS1:REFLEVELS1:PERCENT:RISEHIGH? might return  
 :MEASUREMENT:MEAS1:REFLEVELS1:PERCENT:RISEHIGH 90.0000  
 indicating the high reference level of the rising edge is set to 90%.

## MEASUREMENT:MEAS<x>:REFLEVELS<x>:PERCENT:RISELow

This command sets or queries the percentage (where 100% is equal to TOP and 0% is equal to BASE) used to calculate the low reference level of the rising edge when the measurement's ref level method is set to percent. The measurement number is specified by x.

**Group** Measurement

**Syntax** MEASUREMENT:MEAS<x>:REFLEVELS<x>:PERCENT:RISELow <NR3>  
 MEASUREMENT:MEAS<x>:REFLEVELS<x>:PERCENT:RISELow?

**Arguments** MEAS<x> specifies the measurement number.  
 <NR3> is the percentage (where 100% is equal to TOP) used to calculate the mid reference level when the measurement's Ref level method is set to Percent.

**Examples** MEASUREMENT:MEAS1:REFLEVELS1:PERCENT:RISELow 5.0 sets the low reference level is set to 5.0%.

MEASUREMENT:MEAS1:REFLEVELS1:PERCENT:RISELow? might return  
 :MEASUREMENT:MEAS1:REFLEVELS1:PERCENT:RISELow 10.0000  
 indicating the low reference level is set to 10.0%.

## MEASUREMENT:MEAS<x>:REFLEVELS<x>:PERCENT:RISEMid

This command sets or queries the percentage (where 100% is equal to TOP and 0% is equal to BASE) used to calculate the mid reference level of the rising edge when the measurement's ref level method is set to percent. The measurement number is specified by x.

**Group** Measurement

**Syntax** MEASUREMENT:MEAS<x>:REFLEVELS<x>:PERCENT:RISEMid <NR3>  
 MEASUREMENT:MEAS<x>:REFLEVELS<x>:PERCENT:RISEMid?

<b>Arguments</b>	<p>MEAS&lt;x&gt; specifies the measurement number.</p> <p>&lt;NR3&gt; the percentage (where 50% is equal to MID) used to calculate the mid reference level when the measurement Ref level method is set to Percent.</p>
<b>Examples</b>	<p>MEASUREMENT:MEAS1:REFLEVELS1:PERCENT:RISEMID 50.0000 sets the mid reference level of the rising edge is set to 50.0%.</p> <p>MEASUREMENT:MEAS1:REFLEVELS1:PERCENT:RISEMID? might return :MEASUREMENT:MEAS1:REFLEVELS1:PERCENT:RISEMID 50.0000 indicating the mid reference level of the rising edge is set to 50.0%.</p>

## MEASUREMENT:MEAS<x>:REFLEVELS<x>:PERCENT:TYPE

This command specifies or queries the reference level percent type for the measurement. The measurement number is specified by x.

<b>Group</b>	Measurement
<b>Syntax</b>	<pre>MEASUREMENT:MEAS&lt;x&gt;:REFLEVELS&lt;x&gt;:PERCENT:TYPE {TENNINETY TWENTYEIGHTY CUSTOM} MEASUREMENT:MEAS&lt;x&gt;:REFLEVELS&lt;x&gt;:PERCENT:TYPE?</pre>
<b>Arguments</b>	<p>MEAS&lt;x&gt; specifies the measurement number.</p> <p>TENNINETY sets the values for Low, Mid and High Ref to 10%, 50% and 90% respectively.</p> <p>TWENTYEIGHTY sets the values for Low, Mid and High Ref are set to 20%, 50% and 80% respectively.</p> <p>CUSTOM allows setting other reference level percents.</p>
<b>Examples</b>	<p>MEASUREMENT:MEAS1:REFLEVELS1:PERCENT:TYPE TWENTYEIGHTY sets the reference levels percent to 20%, 50% and 80%.</p> <p>MEASUREMENT:MEAS1:REFLEVELS1:PERCENT:TYPE? might return :MEASUREMENT:MEAS1:REFLEVELS1:PERCENT:TYPE TENNINETY indicating the reference levels percent type is 10%, 50% and 90% respectively</p>

## MEASUREMENT:MEAS<x>:REFMODE

This command sets or queries the reference level mode for the measurement. The measurement number is specified by x.

<b>Group</b>	Measurement
<b>Syntax</b>	MEASUREMENT:MEAS<x>:REFMODE {AUTO MANUAL} MEASUREMENT:MEAS<x>:REFMODE?
<b>Arguments</b>	MEAS<x> specifies the measurement number.  AUTO sets the reference level for the measurement automatically.  MANUAL allows the user to set the reference level for the measurement.
<b>Examples</b>	MEASUREMENT:MEAS1:REFMODE MANUAL allows the user to set the reference level for the measurement.  MEASUREMENT:MEAS1:REFMODE? might return :MEASUREMENT:MEAS1:REFMODE AUTO indicating the reference levels for the measurement are set automatically.

## MEASUREMENT:MEAS<x>:REFVOLTAGE

This command sets or queries the reference voltage value for the measurement. The measurement number is specified by x.

<b>Group</b>	Measurement
<b>Syntax</b>	MEASUREMENT:MEAS<x>:REFVOLTAGE <NR3> MEASUREMENT:MEAS<x>:REFVOLTAGE?
<b>Arguments</b>	<NR3> is the reference voltage value for the selected configuration.
<b>Examples</b>	MEASUREMENT:MEAS1:REFVOLTAGE 30.E-3 sets the reference voltage value for the measurement to 30 mV.  MEASUREMENT:MEAS1:REFVOLTAGE? might return :MEASUREMENT:MEAS1:REFVOLTAGE 0.0E+0 indicating the reference voltage value for the measurement is 0.0 V.

## MEASUREMENT:MEAS<x>:REFVOLTAGE<n>VAL

Sets or queries the reference voltage per rail of Overshoot and Undershoot measurements.



<b>Conditions</b>	Requires option 5-DPM (5 Series MSO instruments) or 6-DPM (6 Series MSO instrument)
<b>Group</b>	DPM
<b>Syntax</b>	MEASUREMENT:MEAS<x>:REFVOLTAGE<n>Vn1 <NR2> MEASUREMENT:MEAS<x>:REFVOLTAGE<n>Vn1?
<b>Arguments</b>	MEAS<x> is the measurement number. <n> is the rail number. <NR2> is the reference voltage, in the range of -500 V to +500 V.
<b>Examples</b>	MEASUREMENT:MEAS1:REFVOLTAGE3Vn1 -125 sets the reference voltage for rail 3 of measurement 1 to -125 volts.  MEASUREMENT:MEAS3:REFVOLTAGE1Vn1? might return 55.200, indicating that the reference voltage of rail 1 on measurement 3 is set to +55.2 volts.

## MEASUREMENT:MEAS<x>:RESULTS:ALLACQS:MAXIMUM? (Query Only)

This query-only command returns the maximum value for all accumulated measurement acquisitions of the specified measurement. The measurement number is specified by x.

<b>Group</b>	Measurement
<b>Syntax</b>	MEASUREMENT:MEAS<x>:RESULTS:ALLACQS:MAXIMUM?
<b>Returns</b>	The maximum value for all accumulated measurement acquisitions of the specified measurement.
<b>Examples</b>	MEASUREMENT:MEAS1:RESULTS:ALLACQS:MAXIMUM? might return :MEASUREMENT:MEAS1:RESULTS:ALLACQS:MAXIMUM 2.420 indicating the maximum measurement value is 2.420 V.

## MEASUREMENT:MEAS<x>:RESULTS:ALLACQS:MEAN? (Query Only)

This query-only command returns the mean value for all accumulated measurement acquisitions for measurement <x>.

<b>Group</b>	Measurement
<b>Syntax</b>	MEASUREMENT:MEAS<x>:RESULTS:ALLACQS:MEAN?
<b>Returns</b>	The mean value for all accumulated measurement acquisitions for measurement <x>.
<b>Examples</b>	MEASUREMENT:MEAS1:RESULTS:ALLACQS:MEAN? might return :MEASUREMENT:MEAS1:RESULTS:ALLACQS:MEAN 2.2807617754647 indicating the measurement mean is 2.28 V.

### MEASUREMENT:MEAS<x>:RESULTS:ALLACQS:MINIMUM? (Query Only)

This query-only command returns the minimum value for all accumulated measurement acquisitions for measurement <x>.

<b>Group</b>	Measurement
<b>Syntax</b>	MEASUREMENT:MEAS<x>:RESULTS:ALLACQS:MINIMUM?
<b>Returns</b>	The minimum value for all accumulated measurement acquisitions for measurement <x>.
<b>Examples</b>	MEASUREMENT:MEAS1:RESULTS:ALLACQS:MINIMUM? might return :MEASUREMENT:MEAS1:RESULTS:ALLACQS:MINIMUM 2.220 indicating the measurement minimum value is 2.220 V.

### MEASUREMENT:MEAS<x>:RESULTS:ALLACQS:PK2PK? (Query Only)

This query-only command returns the peak-to-peak value for all accumulated measurement acquisitions for measurement <x>.

<b>Group</b>	Measurement
<b>Syntax</b>	MEASUREMENT:MEAS<x>:RESULTS:ALLACQS:PK2PK?
<b>Returns</b>	The peak-to-peak value for all accumulated measurement acquisitions for measurement <x>.

**Examples** `MEASUREMENT:MEAS1:RESULTS:ALLACQS:PK2PK?` might return `:MEASUREMENT:MEAS1:RESULTS:ALLACQS:PK2PK 200.0E-3` indicating the measurement peak-to-peak value is 200 mV.

## **MEASUREMENT:MEAS<x>:RESULTS:ALLACQS:POPULATION? (Query Only)**

This query-only command returns the population measurement value for measurement <x>.

**Group** Measurement

**Syntax** `MEASUREMENT:MEAS<x>:RESULTS:ALLACQS:POPULATION?`

**Returns** The population measurement value for measurement <x>.

**Examples** `MEASUREMENT:MEAS1:RESULTS:ALLACQS:POPULATION?` might return `:MEASUREMENT:MEAS1:RESULTS:ALLACQS:POPULATION 29825` indicating the measurement population is 29825 measurements.

## **MEASUREMENT:MEAS<x>:RESULTS:ALLACQS:STDDEV? (Query Only)**

This query-only command returns the standard deviation for all accumulated measurement acquisitions for measurement <x>.

**Group** Measurement

**Syntax** `MEASUREMENT:MEAS<x>:RESULTS:ALLACQS:STDDEV?`

**Returns** The standard deviation for all accumulated measurement acquisitions for measurement <x>.

**Examples** `MEASUREMENT:MEAS1:RESULTS:ALLACQS:STDDEV?` might return `:MEASUREMENT:MEAS1:RESULTS:ALLACQS:STDDEV 23.5741246494459E-3` indicating the measurement standard deviation is 23.57 mV.

## MEASUREMENT:MEAS<x>:RESULTS:CURRENTACQ:MAXIMUM? (Query Only)

This query-only command returns the maximum value found for the specified measurement since the last statistical reset. The measurement number is specified by x.

<b>Group</b>	Measurement
<b>Syntax</b>	MEASUREMENT:MEAS<x>:RESULTS:CURRENTACQ:MAXIMUM?
<b>Returns</b>	The maximum value found for the specified measurement since the last statistical reset.
<b>Examples</b>	MEASUREMENT:MEAS1:RESULTS:CURRENTACQ:MAXIMUM? might return :MEASUREMENT:MEAS1:RESULTS:CURRENTACQ:MAXIMUM 2.280 indicating the current measurement maximum value is 2.28 V.

## MEASUREMENT:MEAS<x>:RESULTS:CURRENTACQ:MEAN? (Query Only)

This query-only command returns the mean value for the measurement for the current acquisition.

<b>Group</b>	Measurement
<b>Syntax</b>	MEASUREMENT:MEAS<x>:RESULTS:CURRENTACQ:MEAN?
<b>Arguments</b>	MEAS<x> is the measurement number for which to return a value. This is the equivalent of the number shown in the measurement badge on the UI.
<b>Returns</b>	The mean value accumulated for the specified measurement since the last statistical reset.
<b>Examples</b>	MEASUREMENT:MEAS3:RESULTS:CURRENTACQ:MEAN? might return :MEASUREMENT:MEAS3:RESULTS:CURRENTACQ:MEAN 2.30 indicating the mean of measurement 3 in the current acquisition is 2.3 V.

**MEASUREMENT:MEAS<x>:RESULTS:CURRENTACQ:MINIMUM? (Query Only)**

This query-only command returns the minimum value found for the specified measurement since the last statistical reset. The measurement number is specified by x.

<b>Group</b>	Measurement
<b>Syntax</b>	MEASUREMENT:MEAS<x>:RESULTS:CURRENTACQ:MINIMUM?
<b>Returns</b>	The minimum value found for the specified measurement since the last statistical reset.
<b>Examples</b>	MEASUREMENT:MEAS1:RESULTS:CURRENTACQ:MINIMUM? might return :MEASUREMENT:MEAS1:RESULTS:CURRENTACQ:MINIMUM 2.260 indicating the minimum value of the measurement in the current acquisition is 2.26 V.

**MEASUREMENT:MEAS<x>:RESULTS:CURRENTACQ:PK2PK? (Query Only)**

This query-only command returns the peak-to-peak value for the specified measurement for the current acquisition. The measurement number is specified by x.

<b>Group</b>	Measurement
<b>Syntax</b>	MEASUREMENT:MEAS<x>:RESULTS:CURRENTACQ:PK2PK?
<b>Returns</b>	The peak-to-peak value for the specified measurement.
<b>Examples</b>	MEASUREMENT:MEAS1:RESULTS:CURRENTACQ:PK2PK? might return :MEASUREMENT:MEAS1:RESULTS:CURRENTACQ:PK2PK 0.0E+0 indicating the peak-to-peak value for the specified measurement for the current acquisition is 0.0 V.

**MEASUREMENT:MEAS<x>:RESULTS:CURRENTACQ:POPULATION? (Query Only)**

This query-only command returns the population for the specified measurement for the current acquisition. The measurement number is specified by x.

<b>Group</b>	Measurement
<b>Syntax</b>	MEASUREMENT:MEAS<x>:RESULTS:CURRENTACQ:POPULATION?
<b>Returns</b>	The population measurement value for the specified measurement.
<b>Examples</b>	MEASUREMENT:MEAS<x>:RESULTS:CURRENTACQ:POPULATION? might return :MEASUREMENT:MEAS1:RESULTS:CURRENTACQ:POPULATION 1 indicating the population for the current measurement is 1 measurement.

### MEASUREMENT:MEAS<x>:RESULTS:CURRENTACQ:STDDEV? (Query Only)

This query-only command returns the standard deviation for the specified measurement for all acquisitions accumulated since statistics were last reset. The measurement number is specified by x.

<b>Group</b>	Measurement
<b>Syntax</b>	MEASUREMENT:MEAS<x>:RESULTS:CURRENTACQ:STDDEV?
<b>Returns</b>	The standard deviation of values accumulated for the specified measurement since the last statistical reset.
<b>Examples</b>	MEASUREMENT:MEAS<x>:RESULTS:CURRENTACQ:STDDEV? might return :MEASUREMENT:MEAS1:RESULTS:CURRENTACQ:STDDEV 0.0E+0 indicating the standard deviation for the measurement is 0.0 V.

### MEASUREMENT:MEAS<x>:RESULTS:HISTORY:MAXIMUM? (Query Only)

This query-only command returns the maximum value for the specified measurement for each acquisition in the history. The measurement number is specified by x.

<b>Group</b>	Measurement
<b>Syntax</b>	MEASUREMENT:MEAS<x>:RESULTS:HISTORY:MAXIMUM?
<b>Returns</b>	A comma-separated list of the maximum values for each acquisition in the history.

**Examples** `MEASUREMENT:MEAS1:RESULTS:HISTORY:MAXIMUM?` might return `:MEASUREMENT:MEAS1:RESULTS:HISTORY:MAXIMUM 2.28,2.31,2.27` indicating there are three acquisitions in the history and the maximum value for measurement 1 is 2.28 V for the first acquisition, 2.31 V for the second acquisition and 2.27 V for the third acquisition.

## **MEASUREMENT:MEAS<x>:RESULTS:HISTORY:MEAN? (Query Only)**

This query-only command returns the mean value for the specified measurement for each acquisition in the history. The measurement number is specified by x.

**Group** Measurement

**Syntax** `MEASUREMENT:MEAS<x>:RESULTS:HISTORY:MEAN?`

**Returns** A comma-separated list of the mean values for each acquisition in the history.

**Examples** `MEASUREMENT:MEAS1:RESULTS:HISTORY:MEAN?` might return `:MEASUREMENT:MEAS1:RESULTS:HISTORY:MEAN 2.30,2.25,2.32` indicating there are three acquisitions in the history and the mean value for measurement 1 is 2.3 V for the first acquisition, 2.25 V for the second acquisition, and 2.32 V for the third acquisition.

## **MEASUREMENT:MEAS<x>:RESULTS:HISTORY:MINIMUM? (Query Only)**

This query-only command returns the minimum value for the specified measurement for each acquisition in the history. The measurement number is specified by x.

**Group** Measurement

**Syntax** `MEASUREMENT:MEAS<x>:RESULTS:HISTORY:MINIMUM?`

**Returns** A comma-separated list of the minimum values for each acquisition in the history.

**Examples** `MEASUREMENT:MEAS1:RESULTS:HISTORY:MINIMUM?` might return `:MEASUREMENT:MEAS1:RESULTS:HISTORY:MINIMUM 2.26,2.14,2.29` indicating there are three acquisitions in the history and the minimum value

for measurement 1 is 2.26 V for the first acquisition, 2.14 V for the second acquisition, and 2.29 V for the third acquisition.

## MEASUREMENT:MEAS<x>:RESULTS:HISTORY:PK2PK? (Query Only)

This query-only command returns the peak-to-peak value for the specified measurement for each acquisition in the history. The measurement number is specified by x.

<b>Group</b>	Measurement
<b>Syntax</b>	MEASUREMENT:MEAS<x>:RESULTS:HISTORY:PK2PK?
<b>Returns</b>	A comma-separated list of the peak-to-peak values for each acquisition in the history.
<b>Examples</b>	MEASUREMENT:MEAS1:RESULTS:HISTORY:PK2PK? might return :MEASUREMENT:MEAS1:RESULTS:HISTORY:PK2PK 0.0E+0,0.0E+0,0.0E+0 indicating there are three acquisitions in the history and the peak-to-peak value for measurement 1 for each acquisition is 0.0 V.

## MEASUREMENT:MEAS<x>:RESULTS:HISTORY:POPULATION? (Query Only)

This query-only command returns the population value for the specified measurement for each acquisition in the history. The measurement number is specified by x.

<b>Group</b>	Measurement
<b>Syntax</b>	MEASUREMENT:MEAS<x>:RESULTS:HISTORY:POPULATION?
<b>Returns</b>	A comma-separated list of the population values for each acquisition in the history.
<b>Examples</b>	MEASUREMENT:MEAS<x>:RESULTS:HISTORY:POPULATION? might return :MEASUREMENT:MEAS1:RESULTS:HISTORY:POPULATION 1,1,1 indicating there are three acquisitions in the history and the population for measurement 1 for each acquisition is 1.



**MEASUREMENT:MEAS<x>:RESULTS:HISTORY:STDDEV? (Query Only)**

This query-only command returns the standard deviation value for the specified measurement for each acquisition in the history. The measurement number is specified by x.

<b>Group</b>	Measurement
<b>Syntax</b>	MEASUREMENT:MEAS<x>:RESULTS:HISTORY:STDDEV?
<b>Returns</b>	A comma-separated list of the standard deviation values for each acquisition in the history.
<b>Examples</b>	MEASUREMENT:MEAS<x>:RESULTS:HISTORY:STDDEV? might return :MEASUREMENT:MEAS1:RESULTS:HISTORY:STDDEV 0.0E+0,0.0E+0,0.0E+0 indicating there are three acquisitions in the history and the standard deviation value for measurement 1 for each acquisition is 0.0 V.

**MEASUREMENT:MEAS<x>:RIPPLEFREQ<n>VAL**

Sets or queries the ripple frequency per specified rail for Ripple measurement.

<b>Conditions</b>	Requires option 5-DPM (5 Series MSO instruments) or 6-DPM (6 Series MSO instrument)
<b>Group</b>	DPM
<b>Syntax</b>	MEASUREMENT:MEAS<x>:RIPPLEFREQ<n>VAL <NR3> MEASUREMENT:MEAS<x>:RIPPLEFREQ<n>VAL?
<b>Arguments</b>	MEAS<x> is the measurement number.  <n> is the rail number.  <NR3> is the frequency, in the range of 1 Hz to 4 GHz.
<b>Examples</b>	MEASUREMENT:MEAS1:RIPPLEFREQ3VAL 5.2e6 sets the ripple frequency for rail 3 of measurement 1 to 5.2 MHz.  MEASUREMENT:MEAS3:RIPPLEFREQ1VAL? might return 1.0000E+6, indicating that the ripple frequency of rail 1 on measurement 3 is set to 1 MHz.

## MEASUREMENT:MEAS<x>:SEQUENCE

This command sets or queries the sequence of hall edges. The measurement number is specified by x.

**Conditions** IMDA-MECH license on 5 and 6 Series MSO instruments.

**Group** Measurement, IMDA

**Syntax** MEASUREMENT:MEAS<x>:SEQUENCE {ABC|ACB}  
MEASUREMENT:MEAS<x>:SEQUENCE?

**Arguments** MEAS<x> specifies the measurement number.  
ABC specifies the motor Hall edges sequence as ABC.  
ACB specifies the motor Hall edges sequence as ACB.

**Examples** MEASUREMENT:MEAS1:SEQUENCE ACB specifies the motor Hall edges sequence as ACB.  
MEASUREMENT:MEAS1:SEQUENCE? might return  
:MEASUREMENT:MEAS1:SEQUENCE ACB, indicating the motor Hall edges sequence is ACB.

## MEASUREMENT:MEAS<x>:SIGNALFREQUENCY

This command sets or queries line frequency for Harmonics and Ripple line frequency. The measurement number is specified by x.

**Group** Measurement, IMDA

**Syntax** MEASUREMENT:MEAS<x>:SIGNALFREQUENCY  
{AUTO|FIFTYHZ|SIXTYHZ|FOURHUNDREDHZ|CUSTOM}  
MEASUREMENT:MEAS<x>:SIGNALFREQUENCY?

**Arguments** MEAS<x> specifies the measurement number.  
AUTO specifies the line frequency as auto. Only available for Harmonics line frequency.  
FIFTYHZ specifies the line frequency as 50 Hz.  
SIXTYHZ specifies the line frequency as 60 Hz.

FOURHUNDREDHZ specifies the line frequency as 400 Hz. .

CUSTOM specifies the line frequency as custom.

**Examples** MEASUREMENT:MEAS1:SIGNALFREQUENCY FIFTYHZ specifies the line frequency as 50 Hz for measurement 1.

MEASUREMENT:MEAS1:SIGNALFREQUENCY? might return  
:MEASUREMENT:MEAS1:SIGNALFREQUENCY FIFTYHZ, indicating the line frequency is 50 Hz.

## MEASUREMENT:MEAS<x>:SIGNALType

This command sets or queries the signal type of source 1 for the measurement. The measurement number is specified by x.

**Group** Measurement

**Syntax** MEASUREMENT:MEAS<x>:SIGNALType {CLOCK|DATA|AUTO}  
MEASUREMENT:MEAS<x>:SIGNALType?

**Arguments** MEAS<x> specifies the measurement number.

CLOCK specifies a clock signal type.

DATA specifies a data signal type.

AUTO automatically selects the signal type.

**Examples** MEASUREMENT:MEAS1:SIGNALType CLOCK specifies a clock signal type.

MEASUREMENT:MEAS1:SIGNALType? might return  
:MEASUREMENT:MEAS1:SIGNALType AUTO indicating the instrument automatically selects the signal type.

## MEASUREMENT:MEAS<x>:SLABs

This command sets or returns the value for the start level in absolute.

**Conditions** Requires a WBG-DPT license.

**Group** Measurement, WBG

**Syntax**    `MEASUREMENT:MEAS<x>:SLABS <NR3>`  
`MEASUREMENT:MEAS<x>:SLABS?`

**Arguments**    `MEAS<x>` specifies the measurement number.  
`<NR3>` specifies the value for the start level in absolute.

**Examples**    `MEASUREMENT:MEAS1:SLABS -100.0000` sets the value for the start level to -100.  
`MEASUREMENT:MEAS1:SLABS?` might return `:MEASUREMENT:MEAS1:SLABS -100.0000`, indicating the value for the start level is -100.

## MEASUREMENT:MEAS<x>:SLPct

This command sets or returns the value for the start level in percentage.

**Conditions**    Requires a WBG-DPT license.

**Group**    Measurement, WBG

**Syntax**    `MEASUREMENT:MEAS<x>:SLPct <NR3>`  
`MEASUREMENT:MEAS<x>:SLPct?`

**Arguments**    `MEAS<x>` specifies the measurement number.  
`<NR3>` specifies the value for the start level in percentage

**Examples**    `MEASUREMENT:MEAS1:SLPct 10.0000E-3` sets the value for the start level in percentage to 10.0000E-3.  
`MEASUREMENT:MEAS1:SLPct?` might return `:MEASUREMENT:MEAS1:SLPct 10.0000E-3`, indicating the value for the start level in percentage is 10.0000E-3.

## MEASUREMENT:MEAS<x>:SLTYpe

This command sets or returns the start level source type.

**Conditions**    Requires a WBG-DPT license.

**Group**    Measurement, WBG

<b>Syntax</b>	<code>MEASUREMENT:MEAS&lt;x&gt;:SLTYPE {VDS ID VGE VCE IC}</code> <code>MEASUREMENT:MEAS&lt;x&gt;:SLTYPE?</code>
<b>Arguments</b>	<p><code>MEAS&lt;x&gt;</code> specifies the measurement number.</p> <p><code>VDS</code> specifies the start level source type as VDS.</p> <p><code>ID</code> specifies the start level source type as ID.</p> <p><code>VGE</code> specifies the start level source type as VGE.</p> <p><code>VCE</code> specifies the start level source type as VCE.</p> <p><code>IC</code> specifies the start level source type as IC.</p>
<b>Examples</b>	<p><code>MEASUREMENT:MEAS1:SLTYPE ID</code> sets the start level source type to ID.</p> <p><code>MEASUREMENT:MEAS1:SLTYPE?</code> might return <code>:MEASUREMENT:MEAS1:SLTYPE ID</code>, indicating the start level source type is ID.</p>

## MEASUREMENT:MEAS<x>:SMOOTHINGFILTER

This command sets or queries the status of smoothing filter.

<b>Group</b>	Measurement
<b>Syntax</b>	<code>MEASUREMENT:MEAS&lt;x&gt;:SMOOTHINGFILTER &lt;NR1&gt;</code> <code>MEASUREMENT:MEAS&lt;x&gt;:SMOOTHINGFILTER?</code>
<b>Arguments</b>	<p><code>MEAS&lt;x&gt;</code> specifies the measurement number.</p> <p><code>&lt;NR1&gt;</code> sets the value to 1 or 0. 1 enables smoothing filter and 0 disables it.</p>
<b>Examples</b>	<p><code>MEASUREMENT:MEAS1:SMOOTHINGFILTER 1</code> sets smoothing filter to ON.</p> <p><code>MEASUREMENT:MEAS1:SMOOTHINGFILTER?</code> might return <code>:MEASUREMENT:MEAS1:SMOOTHINGFILTER 1</code>, indicating the smoothing filter is ON.</p>

## MEASUREMENT:MEAS<x>:SOURCE

This command sets or queries local input source.

<b>Group</b>	Measurement, IMDA
--------------	-------------------

**Syntax**      MEASUREMENT:MEAS<x>:SOURCE {S<x>\_Ch<x> | CH<x> | MATH<x> | REF<x>}  
 MEASUREMENT:MEAS<x>:SOURCE?

**Arguments**    MEAS<x> specifies the measurement number.

S<x>\_Ch<x> specifies the remote scope number and the analog channel as the source.

CH<x> specifies an analog channel as the source.

MATH<x> specifies a math waveform as the source.

REF<x> specifies a reference waveform as the source.

**Examples**      MEASUREMENT:MEAS1:SOURCE CH3 sets the local input source to channel 3.

MEASUREMENT:MEAS1:SOURCE? might return :MEASUREMENT:MEAS1:SOURCE CH2 indicating the local input source is channel 2.

## MEASUREMENT:MEAS<x>:SOURCE<x>

This command sets or queries the measurement source. The measurement number and source are specified by x.

**Group**          Measurement

**Syntax**          MEASUREMENT:MEAS<x>:SOURCE<x>  
 {S<x>\_Ch<x> | CH<x> | MATH<x> | REF<x>}  
 MEASUREMENT:MEAS<x>:SOURCE<x>?

**Arguments**    MEAS<x> specifies the measurement number.

SOURCE<x> specifies the source number.

S<x>\_Ch<x> specifies the remote scope number and the analog channel as the source.

CH<x> specifies an analog channel as the source.

MATH<x> specifies a math waveform as the source.

REF<x> specifies a reference waveform as the source.

**Examples**      MEASUREMENT:MEAS1:SOURCE1 CH1 sets the source for measurement 1 to channel 1.

MEASUREMENT:MEAS1:SOURCE1? might return  
:MEASUREMENT:MEAS1:SOURCE1 CH1 indicating the measurement source is  
channel 1.

## MEASUREMENT:MEAS<x>:SSC:NOMINALFREQ

This command sets or queries the user-defined frequency for the measurement when the measurement type is SSC. The measurement number is specified by x.

<b>Group</b>	Measurement
<b>Syntax</b>	MEASUREMENT:MEAS<x>:SSC:NOMINALFREQ <NR3> MEASUREMENT:MEAS<x>:SSC:NOMINALFREQ?
<b>Arguments</b>	MEAS<x> specifies the measurement number.  <NR3> is the user-defined nominal frequency type for SSC configurations.
<b>Examples</b>	MEASUREMENT:MEAS1:SSC:NOMINALFREQ 2.0E+9 sets the frequency to 2.0 GHz.  MEASUREMENT:MEAS1:SSC:NOMINALFREQ? might return :MEASUREMENT:MEAS1:SSC:NOMINALFREQ 2.5000E+9 indicating the frequency is 2.5 GH.

## MEASUREMENT:MEAS<x>:SSC:NOMINALFREQ:SELECTIONTYPE

This command sets or queries the frequency detection type for the measurement when the measurement type is SSC. The measurement number is specified by x.

<b>Group</b>	Measurement
<b>Syntax</b>	MEASUREMENT:MEAS<x>:SSC:NOMINALFREQ:SELECTIONTYPE {AUTO MANUAL} MEASUREMENT:MEAS<x>:SSC:NOMINALFREQ:SELECTIONTYPE?
<b>Arguments</b>	MEAS<x> specifies the measurement number.  AUTO automatically sets the detection type.  MANUAL specifies the manual detection type.

**Examples**    `MEASUREMENT:MEAS1:SSC:NOMINALFREQ:SELECTIONTYPE AUTO` specifies the auto-detection type.

`MEASUREMENT:MEAS1:SSC:NOMINALFREQ:SELECTIONTYPE? MIGHT`  
`RETURN :MEASUREMENT:MEAS1:SSC:NOMINALFREQ:SELECTIONTYPE AUTO` indicating the auto-detection type is selected.

## MEASUREMENT:MEAS<x>:STATUS? (Query Only)

This command returns the pass fail status, if applicable, for the selected measurement. Measurements are specified by x.

**Group**        Measurement

**Syntax**       `MEASUREMENT:MEAS<x>:STATUS?`

**Related Commands**    [ACTONEVENT:ENABLE](#)

**Arguments**       `PASS` specifies that the user specified measurement limit has not been violated.  
`FAIL` specifies that the user specified measurement limit has been violated.

**Examples**        `MEASUREMENT:MEAS1:STATUS?` might return `:MEASUREMENT:MEAS1:STATUS PASS` indicating that the user specified measurement limit has not been violated.

## MEASUREMENT:MEAS<x>:STLABs

This command sets or returns the value for the stop level in absolute.

**Conditions**       Requires a WBG-DPT license.

**Group**        Measurement, WBG

**Syntax**        `MEASUREMENT:MEAS<x>:STLABs <NR3>`  
`MEASUREMENT:MEAS<x>:STLABs?`

**Arguments**       `MEAS<x>` specifies the measurement number.  
`<NR3>` specifies the value for the stop level in absolute.



**Examples**    `MEASUREMENT:MEAS1:STLABS 5.0000` sets the value for the stop level in absolute to 5.

`MEASUREMENT:MEAS1:STLABS 5.0000?` might return `:MEASUREMENT:MEAS1:STLABS 5.0000`, indicating the value for the stop level in absolute is 5.

## MEASUREMENT:MEAS<x>:STLPct

This command sets or returns the value for the stop level in percentage.

**Conditions**    Requires a WBG-DPT license.

**Group**        Measurement, WBG

**Syntax**       `MEASUREMENT:MEAS<x>:STLPct <NR3>`  
`MEASUREMENT:MEAS<x>:STLPct?`

**Arguments**    `MEAS<x>` specifies the measurement number.

`<NR3>` specifies the value for the stop level in percentage

**Examples**     `MEASUREMENT:MEAS1:STLPct 10.0000E-3` sets the value for the stop level in percentage to 10.0000E-3.

`MEASUREMENT:MEAS1:STLPct?` might return `:MEASUREMENT:MEAS1:STLPct 10.0000E-3`, indicating the value for the stop level in percentage is 10.0000E-3.

## MEASUREMENT:MEAS?:STLTYpe

This command sets or returns the stop level source type.

**Conditions**    Requires a WBG-DPT license.

**Group**        Measurement, WBG

**Syntax**       `MEASUREMENT:MEAS?:STLTYpe {VDS|ID|VGE|VCE|IC}`  
`MEASUREMENT:MEAS?:STLTYpe?`

<b>Arguments</b>	MEAS<x> specifies the measurement number. VDS specifies the stop level source type as VDS. ID specifies the stop level source type as ID. VGE specifies the stop level source type as VGE. VCE specifies the stop level source type as VCE. IC specifies the stop level source type as IC.
<b>Examples</b>	MEASUREMENT:MEAS1:SLTYPE ID sets the stop level source type to ID. MEASUREMENT:MEAS1:SLTYPE? might return :MEASUREMENT:MEAS1:SLTYPE ID, indicating the stop level source type is ID.

## MEASUREMENT:MEAS<x>:SType

This command sets or queries the source type.

<b>Group</b>	Measurement, IMDA
<b>Syntax</b>	MEASUREMENT:MEAS<x>:SType {VOLTage CURRENT} MEASUREMENT:MEAS<x>:SType?
<b>Arguments</b>	MEAS<x> specifies the measurement number. VOLTage sets source type as Voltage. CURRENT sets source type as Current.
<b>Examples</b>	MEASUREMENT:MEAS1:SType VOLTage sets source type as Voltage. MEASUREMENT:MEAS1:SType? might return MEASUREMENT:MEAS1:SType VOLTage, indicating that the sets source type is Voltage.

## MEASUREMENT:MEAS<x>:SUNits

This command sets or queries the speed units for the specific measurement.

<b>Conditions</b>	IMDA-MECH license on 5 and 6 Series MSO instrument.
<b>Group</b>	Measurement, IMDA

<b>Syntax</b>	MEASUREMENT:MEAS<x>:SUNITS {RPM HZ} MEASUREMENT:MEAS<x>:SUNITS?
<b>Arguments</b>	MEAS<x> specifies the measurement number. RPM defines the speed measurement units as RPM. HZ defines the speed measurement units as HZ.
<b>Examples</b>	MEASUREMENT:MEAS1:SUNITS HZ sets the speed measurement units as HZ. MEASUREMENT:MEAS1:SUNITS? might return MEASUREMENT:MEAS1:SUNITS HZ, indicating that the speed measurement units is HZ.

## MEASUREMENT:MEAS<x>:TCKAVG

This command sets or queries the average clock period value used in DDR measurements.

<b>Group</b>	Measurement
<b>Syntax</b>	MEASUREMENT:MEAS<x>:TCKAVG <NR3> MEASUREMENT:MEAS<x>:TCKAVG?
<b>Related Commands</b>	<a href="#">MEASUREMENT:MEAS&lt;x&gt;:TIMINGMODE</a>
<b>Arguments</b>	MEAS<x> specifies the measurement number. NR3 is a floating point number that represents the DDR average clock period in seconds.
<b>Examples</b>	MEASUREMENT:MEAS7:TCKAVG 2.5E-9 sets the average clock period value as 3.2 ns for measurement 7. MEASUREMENT:MEAS2:TCKAVG? might return MEASUREMENT:MEAS2:TCKAVG 2.0E-9 indicating that average clock period is set to 2.0 ns for measurement 2.

## MEASUREMENT:MEAS<x>:TCONSTANT

This command sets or queries the measurement Torque Constant.

<b>Conditions</b>	Requires IMDA-MECH license on MSO 5, 6, 6B series instruments.
-------------------	----------------------------------------------------------------

<b>Group</b>	IMDA
<b>Syntax</b>	MEASUREMENT:MEAS<x>:TCONSTANT <NR1> MEASUREMENT:MEAS<x>:TCONSTANT?
<b>Arguments</b>	MEAS<x> specifies the measurement number.  NR1 specifies the current multiplier value of the measurement in the range of 0 to 100.
<b>Examples</b>	MEASUREMENT:MEAS7:TCONSTANT 15.2 specifies the current multiplier value for measurement 7 as 15.2.  MEASUREMENT:MEAS2:TCONSTANT? might return MEASUREMENT:MEAS2:TCONSTANT 15.2 , indicating the current multiplier value for measurement 2 is 15.2.

## MEASUREMENT:MEAS<x>:TMETHOD

This command sets or queries the measurement torque method.

<b>Conditions</b>	Requires IMDA-MECH license on MSO 5, 6, 6B series instruments.
<b>Group</b>	IMDA
<b>Syntax</b>	MEASUREMENT:MEAS<x>:TMETHOD {SENSOR CURRENT} MEASUREMENT:MEAS<x>:TMETHOD?
<b>Arguments</b>	MEAS<x> specifies the measurement number.  SENSOR specifies the Torque Method as SENSOR.  CURRENT specifies the Torque Method as CURRENT.
<b>Examples</b>	MEASUREMENT:MEAS7:TMETHOD SENSOR specifies the Torque Method for measurement 7 as SENSOR.  MEASUREMENT:MEAS2:TMETHOD? might return MEASUREMENT:MEAS2:TMETHOD SENSOR , indicating the Torque Method for measurement 2 is SENSOR.

## MEASUREMENT:MEAS<x>:TIMINGMode

This command sets or queries the Timing mode for the specified DDR measurement.

**Group** Measurement

**Syntax** MEASUREMENT:MEAS<x>:TIMINGMode  
{EACHCLOCKCYCLE|TWOLOCKCYCLES}  
MEASUREMENT:MEAS<x>:TIMINGMode?

**Related Commands** [MEASUREMENT:MEAS<x>:TCKAVG](#)

**Arguments** MEAS<x> specifies the measurement number.  
EACHCLOCKCYCLE sets the DDR Timing Mode to use each clock cycle at a time.  
TWOLOCKCYCLES sets the DDR Timing Mode to use two cycles at a time.

**Examples** MEASUREMENT:MEAS1:TIMINGMode EACHCLOCKCYCLE sets the Timing Mode to consider each clock cycle.  
MEASUREMENT:MEAS1:TIMINGMode? might return  
MEASUREMENT:MEAS1:TIMINGMode EACHCLOCKCYCLE, indicating that Timing Mode is set to EACHCLOCKCYCLE.

## MEASUREMENT:MEAS<x>:TOEdge

This command sets or queries the 'to edge' type for the measurement. The measurement number is specified by x.

**Group** Measurement

**Syntax** MEASUREMENT:MEAS<x>:TOEdge  
{SAMEas|OPPOSITEas|RISE|FALL|BOTH}  
MEASUREMENT:MEAS<x>:TOEdge?

**Arguments** MEAS<x> specifies the measurement number.  
FALL specifies the falling edge of the waveform.  
RISE specifies the rising edge of the waveform.  
BOTH specifies both a rising and falling edge of the waveform.

**SAMEAs** specifies that both edges of the waveform are the same.

**OPPOSITEAs** specifies that the edges of the waveform are not the same.

- Examples** `MEASUREMENT:MEAS1:TOEDGE FALL` specifies the to edge is the falling edge of the waveform.
- `MEASUREMENT:MEAS1:TOEDGE?` might return `:MEASUREMENT:MEAS1:TOEDGE SAMEAS` indicating that both edges of the waveform are the same.

## **MEASUREMENT:MEAS<x>:TOEDGESEARCHDIRECT**

This command sets or queries the to edge search direction for the measurement. The measurement number is specified by *x*.

**Group** Measurement

**Syntax** `MEASUREMENT:MEAS<x>:TOEDGESEARCHDIRECT {FORWARD|BACKWARD}`  
`MEASUREMENT:MEAS<x>:TOEDGESEARCHDIRECT?`

- Arguments** `MEAS<x>` specifies the measurement number.
- `FORWARD` specifies a forward search to the edge.
- `BACKWARD` specifies a backward search to the edge.

- Examples** `MEASUREMENT:MEAS1:TOEDGESEARCHDIRECT FORWARD` specifies a forward search to the edge.
- `MEASUREMENT:MEAS1:TOEDGESEARCHDIRECT?` might return `:MEASUREMENT:MEAS1:TOEDGESEARCHDIRECT FORWARD` indicating the instrument will search in the forward direction for the to edge.

## **MEASUREMENT:MEAS<x>:TOSYMBOL:LOGIC2SOURCE**

This command sets or queries the DDR digital measurement logic 1 source To Symbol.

- Conditions** Requires option 6-DBDDR3.
- Requires a 6 Series MSO instrument.

**Group** Measurement

**Syntax** MEASUREMENT:MEAS<x>:TOSYMBOL:LOGIC2SOURCE {H|L|X}  
MEASUREMENT:MEAS<x>:TOSYMBOL:LOGIC2SOURCE?

**Related Commands** [MEASUREMENT:ADDMEAS](#)

**Arguments** MEAS<x> specifies the measurement number.  
H sets the logic source 1 To Symbol to H (High).  
L sets the logic source 1 To Symbol to L (Low).  
X sets the logic source 1 To Symbol to X (Don't care).

**Examples** MEASUREMENT:MEAS1:TOSYMBOL:LOGIC2SOURCE H sets the DDR digital measurement (DDRTRPMRS/DDRTRPACT/DDRTCKSRE/DDRTCKSRX) logic 1 source To Symbol to High.  
MEASUREMENT:MEAS1:TOSYMBOL:LOGIC2SOURCE? might return MEASUREMENT:MEAS1:TOSYMBOL:LOGIC2SOURCE H, indicating that the DDR digital measurement (DDRTRPMRS/DDRTRPACT/DDRTCKSRE/DDRTCKSRX) To Symbol is set to High.

## MEASUREMENT:MEAS<x>:TOSYMBOL:LOGIC3SOURCE

This command sets or queries the DDR digital measurement logic 2 source To Symbol.

**Conditions** Requires option 6-DBDDR3.  
Requires a 6 Series MSO instrument.

**Group** Measurement

**Syntax** MEASUREMENT:MEAS<x>:TOSYMBOL:LOGIC3SOURCE {H|L|X}  
MEASUREMENT:MEAS<x>:TOSYMBOL:LOGIC3SOURCE?

**Related Commands** [MEASUREMENT:ADDMEAS](#)

**Arguments** MEAS<x> specifies the measurement number.  
H sets the logic source 2 To Symbol to H (High).  
L sets the logic source 2 To Symbol to L (Low).

X sets the logic source 2 To Symbol to X (Don't care).

**Examples** `MEASUREMENT:MEAS1:TOSYMBOL:LOGIC3SOURCE H` sets the DDR digital measurement (DDRTRPMRS/DDRTRPACT/DDRTCKSRE/DDRTCKSRX) logic 1 source To Symbol to High.

`MEASUREMENT:MEAS1:TOSYMBOL:LOGIC3SOURCE?` might return `MEASUREMENT:MEAS1::TOSYMBOL:LOGIC3SOURCE H`, indicating that the DDR digital measurement (DDRTRPMRS/DDRTRPACT/DDRTCKSRE/DDRTCKSRX) To Symbol is set to High.

## MEASUREMENT:MEAS<x>:TOSYMBOL:LOGIC4SOURCE

This command sets or queries the DDR digital measurement logic 3 source To Symbol.

**Conditions** Requires option 6-DBDDR3.  
Requires a 6 Series MSO instrument.

**Group** Measurement

**Syntax** `MEASUREMENT:MEAS<x>:TOSYMBOL:LOGIC4SOURCE {H|L|X}`  
`MEASUREMENT:MEAS<x>:TOSYMBOL:LOGIC4SOURCE?`

**Related Commands** [MEASUREMENT:ADDMEAS](#)

**Arguments** `MEAS<x>` specifies the measurement number.

H sets the logic source 3 To Symbol to H (High).

L sets the logic source 3 To Symbol to L (Low).

X sets the logic source 3 To Symbol to X (Don't care).

**Examples** `MEASUREMENT:MEAS1:TOSYMBOL:LOGIC4SOURCE H` sets the DDR digital measurement (DDRTRPMRS/DDRTRPACT/DDRTCKSRE/DDRTCKSRX) logic 1 source To Symbol to High.

`MEASUREMENT:MEAS1:TOSYMBOL:LOGIC4SOURCE?` might return `MEASUREMENT:MEAS1::TOSYMBOL:LOGIC4SOURCE H`, indicating that the DDR digital measurement



(DDRTRPMRS/DDRTRPACT/DDRTCKSRE/DDRTCKSRX) To Symbol is set to High.

## MEASUREMENT:MEAS<x>:TOSYMBOL:LOGIC5SOURCE

This command sets or queries the DDR digital measurement logic 4 source To Symbol.

<b>Conditions</b>	Requires option 6-DBDDR3. Requires a 6 Series MSO instrument.
<b>Group</b>	Measurement
<b>Syntax</b>	MEASUREMENT:MEAS<x>:TOSYMBOL:LOGIC5SOURCE {H L X} MEASUREMENT:MEAS<x>:TOSYMBOL:LOGIC5SOURCE?

**Related Commands** [MEASUREMENT:ADDMEAS](#)

<b>Arguments</b>	MEAS<x> specifies the measurement number. H sets the logic source 4 To Symbol to H (High). L sets the logic source 4 To Symbol to L (Low). X sets the logic source 4 To Symbol to X (Don't care).
------------------	------------------------------------------------------------------------------------------------------------------------------------------------------------------------------------------------------------

<b>Examples</b>	MEASUREMENT:MEAS1:TOSYMBOL:LOGIC5SOURCE H sets the DDR digital measurement (DDRTRPMRS/DDRTRPACT/DDRTCKSRE/DDRTCKSRX) logic 1 source To Symbol to High.  MEASUREMENT:MEAS1:TOSYMBOL:LOGIC5SOURCE? might return MEASUREMENT:MEAS1::TOSYMBOL:LOGIC5SOURCE H, indicating that the DDR digital measurement (DDRTRPMRS/DDRTRPACT/DDRTCKSRE/DDRTCKSRX) To Symbol is set to High.
-----------------	---------------------------------------------------------------------------------------------------------------------------------------------------------------------------------------------------------------------------------------------------------------------------------------------------------------------------------------------------------------------------------

## MEASUREMENT:MEAS<x>:TOSYMBOL:MEASUREAT

This command sets or queries the DDR digital measurement ToSymbol MeasureAT value.

<b>Conditions</b>	Requires option 6-DBDDR3. Requires a 6 Series MSO instrument.
<b>Group</b>	Measurement
<b>Syntax</b>	MEASurement:MEAS<x>:TOSymbol:MEASUREAT {Start Stop ClockEdge} MEASurement:MEAS<x>:TOSymbol:MEASUREAT?
<b>Related Commands</b>	<a href="#">MEASurement:ADDMEAS</a>
<b>Arguments</b>	MEAS<x> specifies the measurement number. Start sets the ToSymbol MeasureAT to Start. Stop sets the ToSymbol MeasureAT to Stop. ClockEdge sets the sets the ToSymbol MeasureAT to ClockEdge.
<b>Examples</b>	MEASurement:MEAS1:ToSymbol:MEASUREAT Start sets the DDR digital measurement (DDRTRPMRS/DDRTRPACT/DDRTCKSRE/DDRTCKSRX) ToSymbol MeasureAT value to Start.  MEASurement:MEAS1:ToSymbol:MEASUREAT? might return the MEASurement:MEAS1:ToSymbol:MEASUREAT Stop, indicating that the DDR digital measurement (DDRTRPMRS/DDRTRPACT/DDRTCKSRE/DDRTCKSRX) ToSymbol MeasureAT value is set to Stop.

## MEASurement:MEAS<x>:TRANSition

This command sets or queries the transition edges flag for the measurement. The measurement number is specified by x.

<b>Group</b>	Measurement
<b>Syntax</b>	MEASurement:MEAS<x>:TRANSition {<NR1> OFF ON} MEASurement:MEAS<x>:TRANSition?
<b>Arguments</b>	<NR1> = 1, the measurement is computed on rising (if measurement type is rise time) or falling edges (if measurement type is fall time) following a double

transition only. If it is set to 0, the measurement is computed on all rising (if measurement type is rise time) or falling (if measurement type is fall time) edges.

OFF computes the measurement on all rising (if measurement type is rise time) or falling (if measurement type is fall time) edges.

ON computes the measurement on rising (if measurement type is rise time) or falling edges (if measurement type is fall time) following a double transition only.

**Examples** `MEASUREMENT:MEAS1:TRANSITION 1` specifying the measurement is computed on rising (if measurement type is rise time) or falling edges (if measurement type is fall time) following a double transition only.

`MEASUREMENT:MEAS1:TRANSITION?` might return `:MEASUREMENT:MEAS1:TRANSITION 0` indicating the measurement is computed on all rising (if measurement type is rise time) or falling (if measurement type is fall time) edges.

## MEASUREMENT:MEAS<x>:TYPE

This command sets or queries the measurement type for the measurement specified by x.

**Conditions** Refer to the Arguments list for measurements are require the DJA option or are not available on 4 Series MSO instruments.

**Group** Measurement, IMDA

**Syntax** `MEASUREMENT:MEAS<x>:TYPE {ACCOMMONMODE |ACRMS |AMPLITUDE |AREA |BASE |BITAMPLITUDE |BITHIGH |BITLOW |BURSTWIDTH |COMMONMODE |DATARATE |DCD |DDJ |DDRAOS |DDRAOSPERTCK |DDRAOSPERUI |DDRAUS |DDRAUSPERTCK |DDRAUSPERUI |DDRHOLDDIFF |DDRSETUPDIFF |DDRTCHABS |DDRTCHAVERAGE |DDRTCKAVERAGE |DDRTCLABS |DDRTCLAVERAGE |DDRTERRMN |DDRTERRN |DDRTJITCC |DDRTJITDUTY |DDRTJITPER |DDRTPST |DDRTRPRE |DDRTWPRE |DDRVIXAC |DDRTDQSK |DELAY |DJ |DJDIRAC |DPMOVERSHOOT |DPMUNDERSHOOT |DPMRIPPLE |DPMTURNOFFTIME |DPMTURNONTIME |EYEHIGH |EYELOW |FALLSLEWRATE |FALLTIME |FREQUENCY |F2 |F4 |F8 |HIGH |HEIGHT |HEIGHTBER |HIGHTIME |HOLD |IMDAPOWERQUALITY |IMDAHARMONICS |IMDAINPUTVOLTAGE |IMDAINPUTCURRENT |IMDAINPUTPOWER |IMDAPHASORDIAGRAM |IMDAEFFICIENCY |IMDALINERIPPLE |IMDASWITCHRIPPLE |IMDADQO |JITTERSUMMARY |J2 |J9 |LOW |LOWTIME |MAXIMUM |MEAN |MINIMUM |NDUTY |NPERIOD |NPJ |NOVERSHOOT |NWIDTH |PDUTTY |PERIOD |PHASE |PHASENOISE |PJ |PK2PK |POVERSHOOT |PWIDTH |QFACTOR |RISESLEWRATE |RISETIME |RJ |RJDIRAC |RMS |SRJ |SSCFREQDEV`

```
|SSCMODRATE |SETUP |SKEW |TIE |TIMEOUTSIDELEVEL |TJBER
|TNTRATIO |TOP |UNITINTERVAL |VDIFFXOVR |WIDTH |WIDTHBER}
MEASUREMENT:MEAS<x>:TYPE?
```

## Arguments

**ACCOMMONMODE AC Common Mode (Pk-Pk)** is the peak-to-peak of the common mode voltage of two sources. This measurement is made across the entire record. This measurement requires the DJA option and is not available on a 4 Series MSO instrument.

**ACRMS (AC RMS)** is the true Root Mean Square of the data points, about the Mean. This measurement can be made across the entire record, or on each cycle in the record.

**AMPLITUDE** is the difference between the Top value and the Base value. This measurement can be made across the entire record, or on each cycle in the record.

$$\textit{Amplitude} = \textit{High} - \textit{Low}$$

**AREA** is the area under the curve, calculated by integrating the data points. The area measured above ground is positive. The area measured below ground is negative. This measurement can be made across the entire record, or on each cycle in the record.

**BASE** is the most common data value below the midpoint of the waveform. This measurement can be made across the entire record, or on each cycle in the record.

**BITAMPLITUDE (Bit Amplitude)** is the difference between the amplitudes of the 1 bit and the 0 bit surrounding a transition. The amplitude is measured over a user specified portion at the center of the recovered unit interval. This measurement is made on each transition bit in the record (Mean) or across the entire record (Mode). This measurement requires the DJA option and is not available on a 4 Series MSO instrument.

**BITHIGH (Bit High)** is the amplitude of a 1 bit. The amplitude is measured over a user specified portion at the center of the recovered unit interval. This measurement is made on each high bit in the record (Mean) or across the entire record (Mode). This measurement requires the DJA option and is not available on a 4 Series MSO instrument.

**BITLOW (Bit Low)** is the amplitude of a 0 bit. The amplitude is measured over a user specified portion at the center of the recovered unit interval. This measurement is made on each high bit in the record (Mean) or across the entire record (Mode). This measurement requires the DJA option and is not available on a 4 Series MSO instrument.

**BURSTWIDTH (Burst Width)** is the duration of a series of adjacent crossings of the Mid reference level (RM). Bursts are separated by a user-defined idle time (tI). This measurement is made on each burst in the record.

**COMMONMODE (DC Common Mode)** is the arithmetic mean of the common mode voltage of two sources. This measurement is made across the entire record.

This measurement requires the DJA option and is not available on a 4 Series MSO instrument.

DATARATE (Data Rate) is the reciprocal of Unit Interval. This measurement is made on each bit in the record.

DCD (duty cycle distortion) is the peak-to-peak amplitude of the component of the deterministic jitter correlated with the signal polarity. This measurement is made across the entire record. This measurement requires the DJA option and is not available on a 4 Series MSO instrument.

DDJ (data dependent jitter) is the peak-to-peak amplitude of the component of the deterministic jitter correlated with the data pattern in the waveform. This measurement is made across the entire record. This measurement requires the DJA option and is not available on a 4 Series MSO instrument.

DDRAOS (area above signal) is the total area of the signal above a specified reference level. This measurement is made across the entire record.

DDRAOSPERTCK (area over signal for tCK events) is the total area of the signal above a specified reference level calculated over consecutive tCK intervals. It is applicable to clock and address/command waveforms.

DDRAOSPERUI (area over signal for UI events) is the total area of the signal above a specified reference level calculated over consecutive unit intervals. It is applicable to data and data strobe waveforms.

DDRAUS (area under signal) is the total area of the signal below a specified reference level. This measurement is made across the entire record.

DDRAUSPERTCK (area under signal for tCK events) is the total area of the signal below a specified reference level calculated over consecutive tCK intervals. It is applicable to clock and address/command waveforms.

DDRAUSPERUI (area under signal for UI events) is the total area of the signal below a specified reference level calculated over consecutive unit intervals. It is applicable to data and data strobe waveforms.

DDRHOLDDIFF (hold difference) is the elapsed time between the specified edge of a single-ended clock waveform and the specified edge of a differential data waveform. The measurement uses the closest respective waveform edges that fall within the range limits. This measurement is made across the entire record.

DDRSETUPDIFF (setup difference) is the elapsed time between the specified edge of a single-ended clock waveform and when the specified edge of a differential data waveform crosses a specified level. The measurement uses the closest respective waveform edges that fall within the range limits. This measurement is made across the entire record.

DDRTCHABS (absolute high pulse width) is the absolute value of the high pulse width as measured from one rising edge to the next falling edge.

**DDRTCHAVERAGE** (average high pulse width) is the average value of the high pulse width as measured from one rising edge to the next falling edge, across 200 consecutive cycles. This measurement is made across the entire record.

**DDRTCKAVERAGE** (average clock period) is the average clock period calculated from rising edge to rising edge, across 200 consecutive cycles. This measurement is made across the entire record.

**DDRTCLABS** (absolute low pulse width) is the absolute value of the low pulse width as measured from a falling edge to the next rising edge. This measurement is made across the entire record.

**DDRTCLAVERAGE** (average low pulse width) is the average value of the low pulse width as measured from one falling edge to the next rising edge, across 200 consecutive cycles.

**DDRTERRMN** (cumulative error) is the cumulative error across multiple consecutive defined cycles from  $t_{CK}(avg)$ .

**DDRTERRN** (cumulative error) is the cumulative error across specified consecutive cycles from  $t_{CK}(avg)$ . In other words, this measures the time difference between the sum of the clock period from a 200 cycle window and  $n$  times  $t_{CK}(avg)$ .

**DDRTJITCC** (cycle to cycle jitter period) is the absolute difference in clock period between two consecutive clock cycles. This measurement is made across the entire record.

**DDRTJITDUTY** (half period jitter) is the largest elapsed time between  $t_{CH}$  and  $t_{CH}(avg)$ , and  $t_{CL}$  and  $t_{CL}(avg)$ , over 200 consecutive cycles.

**DDRTJITPER** (clock period jitter) is the largest deviation of any  $t_{CK}$  signal from  $t_{CK}(avg)$ . This measurement is made across the entire record.

**DDRTPST** (read/write burst postamble) is the width of the Read or Write burst postamble, measured from the last falling edge of the mid reference level to the start of an undriven state. This measurement is made across the entire record.

**DDRTRPRE** (read burst preamble) is the width of the Read burst preamble, measured from exiting tristate levels to the first driving edge of the differential strobe. This measurement is made across the entire record.

**DDRTWPRE** is the width of the Write burst preamble, measured from exiting tristate levels to the first driving edge of the differential strobe. This measurement is made across the entire record.

**DDRVIXAC** is the differential input cross-point voltage measured from the true state transition (and its complement) to a specified reference level, measured on a single-ended signal.

**DDRTDQSCK** is the strobe output access time, measured between the rising edge of the clock and before or after the differential strobe Read preamble time. Signal edges are determined by the mid-ref threshold level settings.

**DELAY** is the time between the specified Mid reference level (RM) crossing on one source to a specified Mid reference level (RM) crossing on a second source. This measurement is made on the first occurrence in the record.

**DJ** (deterministic jitter) is the peak-to-peak amplitude of all timing errors that exhibit deterministic behavior. This measurement is made across the entire record. This measurement requires the DJA option and is not available on a 4 Series MSO instrument.

**DJDIRAC** (dual-dirac deterministic jitter) is deterministic jitter based on a simplifying assumption that the histogram of all deterministic jitter can be modeled as a pair of equal-magnitude Dirac functions. This measurement is made across the entire record. This measurement requires the DJA option and is not available on a 4 Series MSO instrument.

**DPMOVERSHOOT** is the difference between Maximum and Top, divided by the amplitude. This measurement can be made across the entire record or on each cycle in the record at the specified reference voltage.

**DPMUNDERSHOOT** is the difference between Minimum and Base, divided by the amplitude. This measurement can be made across the entire record or on each cycle in the record at the specified reference voltage.

**DPMRIPPLE** is the RMS and peak-to-peak values of the output signal on the DC Rail.

**DPMTURNOFFTIME** is the time delay between load current going low to other rail outputs going low during power down.

**DPMTURNONTIME** is the time delay between load current going high to other rail outputs going high during power on

**EYEHIGH** (Eye High) is the amplitude of a high (1) bit measured at a user specified location within the recovered unit interval. This measurement is made on each high bit in the record. This measurement requires the DJA option and is not available on a 4 Series MSO instrument.

**EYELOW** (Eye Low) is the amplitude of a low (0) bit measured at a user specified location within the recovered unit interval. This measurement is made on each low bit in the record. This measurement requires the DJA option and is not available on a 4 Series MSO instrument.

**FALLSLEWRATE** (Falling Slew Rate) is the rate of change in voltage as an edge transitions from the Top reference level (RT) to the Bottom reference level (RB). This measurement is made on each cycle in the record.

**FALLTIME** (Fall Time) is the time required for an edge to fall from the Top reference level (RT) to the Base reference level (RB). This measurement is made on each cycle in the record.

**FREQUENCY** is the reciprocal of Period. This measurement is made on each cycle in the record.

F2 is the peak-to-peak amplitude of the periodic jitter occurring at a rate of Fb (data rate) divided by 2. This measurement is made across the entire record. This measurement requires the DJA option and is not available on a 4 Series MSO instrument.

F4 is the peak-to-peak amplitude of the periodic jitter occurring at a rate of Fb (data rate) divided by 4. This measurement is made across the entire record. This measurement requires the DJA option and is not available on a 4 Series MSO instrument.

F8 is the peak-to-peak amplitude of the periodic jitter occurring at a rate of Fb (data rate) divided by 8. This measurement is made across the entire record. This measurement requires the DJA option and is not available on a 4 Series MSO instrument.

HIGH (Eye High) is the amplitude of a high (1) bit measured at a user specified location within the recovered unit interval. This measurement is made on each high bit in the record.

HEIGHT (Eye Height) is the minimum vertical eye opening at the center of the recovered unit interval. This measurement is made across the entire record. This measurement requires the DJA option and is not available on a 4 Series MSO instrument.

HEIGHTBER (Eye Height@BER) is the predicted vertical eye opening that will be violated with a probability equal to the bit error rate. This measurement is made across the entire record. This measurement requires the DJA option and is not available on a 4 Series MSO instrument.

#### HIGH

HIGHTIME (High Time) is the time the signal remains above the Top reference level (RT). This measurement is made on each cycle in the record.

HOLD (Hold Time) is the time between the specified Mid reference level crossing (RM) on the Clock source to the closest specified Mid reference level (RM) crossing on the Data source. This measurement is made on each specified Clock edge in the record.

IMDAPOWERQUALITY (Power Quality) measures the Frequency and RMS values of the voltage and current, Crest Factors of the voltage and current, True Power (PTRUE), Reactive Power (PRE), Apparent Power (PAPP), Power Factor, and Phase Angle ( $\theta$ ) of the AC signal.

IMDAHARMONICS (Harmonics) plots the signal amplitude at the fundamental line frequency and its harmonics and measures the RMS amplitude and Total Harmonic Distortion of the signal.

IMDAINPUTVOLTAGE (Input Voltage) measures the RMS value of the Input Voltages. The number of voltages can vary with wiring configuration.

IMDAINPUTCURRENT (Input Current) measures the RMS value of the Input Currents. The number of currents can vary with wiring configuration.



**IMDAINPUTPOWER** (Input Power) measures the RMS value of the Input Power. The power waveforms are shown as derived MATH waveforms, which are respective pairs of Input Voltage \* Current waveforms

**IMDAPHASORDIAGRAM** (Phasor Diagram) represents magnitudes and phase angles between voltage(s) and current(s) per winding pair.

**IMDAEFFICIENCY** (Efficiency) measures the ratio of sum of output power(s) to input power for respective input and output Voltage and Current pairs. Note: the current release cannot support 3V and 3I pairs, since this requires 12 channels. We restrict to 2V and 2I which needs 8 scope channels.

**IMDALINERIPPLE** (Line Ripple) provides the RMS and peak-to-peak measurements of the line frequency portion of the respective AC Voltage or Current signals.

**IMDASWITCHINGRIPPLE** (Switching Ripple) provides the RMS and peak-to-peak measurements of the respective Voltage or Current signals.

**IMDADQ0** measures the DQ0 values of the phasor plot. This measurement requires options IMDA and IMDA-DQ0.

**JITTERSUMMARY** (Jitter Summary) is a group consisting of the following measurements: TIE, TJ@BER, Eye Width@BER, Eye Height@BER, RJ- $\delta\delta$ , DJ- $\delta\delta$ , PJ, DDJ, DcD, F/2, F/4, F/8. This measurement requires the DJA option and is not available on a 4 Series MSO instrument.

**J2** is the total jitter at a bit error rate of  $2.5e-3$  (TJ@ $2.5e-3$ ). This measurement is made across the entire record. This measurement requires the DJA option and is not available on a 4 Series MSO instrument.

**J9** is the total jitter at a bit error rate of  $2.5e-10$  (TJ@ $2.5e-10$ ). This measurement is made across the entire record. This measurement requires the DJA option and is not available on a 4 Series MSO instrument.

**LOW** (Eye Low) is the amplitude of a low (0) bit measured at a user specified location within the recovered unit interval. This measurement is made on each low bit in the record.

**LOWTIME** (Low Time) is the time the signal remains below the Base reference level (RB). This measurement is made on each cycle in the record.

**MAXimum** is the maximum data point. This measurement can be made across the entire record, or on each cycle in the record.

**MEAN** is the arithmetic mean of the data points. This measurement can be made across the entire record, or on each cycle in the record.

**MINimum** is the minimum data point. This measurement can be made across the entire record, or on each cycle in the record.

**NDuty** (Negative Duty Cycle) is the ratio of the Negative Pulse Width to the Period. This measurement is made on each cycle in the record.

$$\text{Negative Duty Cycle} = (\text{Negative Width}) / \text{Period} \times 100\%$$

**NPERIOD** (Duration N-Periods) is the time required to complete N cycles. A cycle is the time between two adjacent (same direction) crossings of the Mid reference level (RM). This measurement is made on each cycle in the record.

**NPJ** (non-periodic jitter) is the portion of the BUJ (bounded uncorrelated jitter) that is random. BUJ excludes DDJ, DCD and RJ. This measurement is made across the entire record. This measurement requires the DJA option and is not available on a 4 Series MSO instrument.

**NOvershoot** (Negative Overshoot) is the difference between Minimum and Base, divided by the Amplitude. This measurement can be made across the entire record, or on each cycle in the record.

$$\text{Negative Overshoot} = (\text{Base} - \text{Minimum}) / \text{Amplitude} \times 100\%$$

**NWIdth** (Negative Pulse Width) is the time the signal remains below the Mid reference level (RM). This measurement is made on each cycle in the record.

**PDUTY** (Positive Duty Cycle) is the ratio of the Positive Pulse Width to the Period. This measurement is made on each cycle in the record.

$$\text{Positive Duty Cycle} = (\text{Positive Width}) / \text{Period} \times 100\%$$

**PERIOD** is the time required to complete a cycle. A cycle is the time between two adjacent (same direction) crossings of the Mid reference level (RM). This measurement is made on each cycle in the record.

**PHASE** is the ratio of the Skew between two sources to the Period of the first source. This measurement is made on each cycle in the record.

**PHASENOISE** (Phase Noise) is the RMS magnitude of all integrated jitter falling within a user specified offset range of the fundamental clock frequency. This measurement is made across the entire record. This measurement is not available on a 4 Series MSO instrument.

**PJ** (periodic jitter) is the peak-to-peak amplitude of the uncorrelated sinusoidal components of the deterministic jitter. This measurement is made across the entire record. This measurement requires the DJA option and is not available on a 4 Series MSO instrument.

**PK2Pk** (Peak-to-peak) is the difference between Maximum and Minimum. This measurement can be made across the entire record, or on each cycle in the record.

**POVERSHOOT** (Positive Overshoot) is the difference between Maximum and Top, divided by the Amplitude. This measurement can be made across the entire record, or on each cycle in the record.

$$\text{Positive Overshoot} = (\text{Maximum} - \text{Top}) / \text{Amplitude} \times 100\%$$

**PWIDTH** (Positive Pulse Width) is the time the signal remains above the Mid reference level (RM). This measurement is made on each cycle in the record.

**QFACTOR** (Q-Factor) is the ratio of the vertical eye opening to RMS vertical noise measured at a user specified location within the recovered unit interval. This measurement is made across the entire record. This measurement requires the DJA option and is not available on a 4 Series MSO instrument.

**RISESLEWRATE** (Rising Slew Rate) is the rate of change in voltage as an edge transitions from the Base reference level (RB) to the Top reference level (RT). This measurement is made on each cycle in the record.

**RISETIME** Rise Time is the time required for an edge to rise from the Base reference level (RB) to the Top reference level (RT). This measurement is made on each cycle in the record.

**RJ** (random jitter) is the RMS magnitude of all random timing errors following a Gaussian distribution. This measurement is made across the entire record. This measurement requires the DJA option and is not available on a 4 Series MSO instrument.

**RJDIRAC** (dual-dirac random jitter) is random jitter based on a simplifying assumption that the histogram of all deterministic jitter can be modeled as a pair of equal-magnitude Dirac functions. This measurement is made across the entire record. This measurement requires the DJA option and is not available on a 4 Series MSO instrument.

**RMS** is the true Root Mean Square of the data points. This measurement can be made across the entire record, or on each cycle in the record.

**SRJ** (sub-rate jitter) is the composite jitter due to periodic components at 1/2, 1/4 and 1/8 of the data rate. This measurement is made across the entire record. This measurement requires the DJA option and is not available on a 4 Series MSO instrument.

**SSCFREQDEV** (SSC Frequency Deviation) is the spread spectrum clock frequency deviation. This measurement enables a time trend plot of the spread spectrum clock modulation profile. This measurement is made on each cycle in the record. This measurement requires the DJA option and is not available on a 4 Series MSO instrument.

**SSCMODRATE** (SSC Modulation Rate) is the modulating frequency of a spread spectrum clock. This measurement is made on each cycle in the record. This measurement requires the DJA option and is not available on a 4 Series MSO instrument.

**SETUP** (Setup Time) is the time between the specified Mid reference level (RM) crossing on the Data source to the closest specified Mid reference level (RM) crossing on the Clock source. This measurement is made on each specified Clock edge in the record.

**SKEW** Skew is the time between the specified Mid reference level (RM) crossing on one source to the following specified Mid reference level (RM) crossing on a second source. This measurement is made on each cycle in the record.

**TIE** (time interval error) is the difference, in time, between an edge in the source waveform and the corresponding edge in a recovered reference clock. This measurement is made on each edge in the waveform. This measurement is not available on a 4 Series MSO instrument.

**TIMEOUTSIDELEVEL** Time Outside Level is the time the signal remains above the Top reference level (RT) and/or below the Base reference level (RB). This measurement is made on each occurrence in the record.

**TJBER** (total jitter at a specified bit error rate) is the predicted peak-to-peak amplitude of jitter that will only be exceeded with a probability equal to the bit error rate. This measurement is made across the entire record. This measurement requires the DJA option and is not available on a 4 Series MSO instrument.

**TNTRATIO** T/nT Ratio is the ratio of a non-transition bit voltage (2nd and subsequent bit voltage after a transition) to its nearest preceding transition bit voltage (1st bit voltage after the transition). Bit voltages are measured at the interpolated midpoint of the recovered unit interval. This measurement is made on each non-transition bit in the record. This measurement requires the DJA option and is not available on a 4 Series MSO instrument.

**TOP** is the most common data value above the midpoint of the waveform. This measurement can be made across the entire record, or on each cycle in the record.

**UNITINTERVAL** (Unit Interval) is the time difference between two successive bits. This measurement is made on each bit in the record.

**VDIFFXOVR** (Differential Crossover) is the voltage level of a differential signal pair at the crossover points. This measurement is made at each crossover point in the record. This measurement requires the DJA option and is not available on a 4 Series MSO instrument.

**WIDTH** (Eye Width) is the minimum horizontal eye opening at the user specified reference level. This measurement is made across the entire record. This measurement requires the DJA option and is not available on a 4 Series MSO instrument.

**WIDTHBER** (Eye Width@BER) is the predicted horizontal eye opening that will be violated with a probability equal to the bit error rate. This measurement is made across the entire record. This measurement requires the DJA option and is not available on a 4 Series MSO instrument.

### Examples

**MEASUREMENT:MEAS2:TYPE FREQUENCY** defines measurement 2 as a measurement of the frequency of a waveform.

**MEASUREMENT:MEAS1:TYPE?** might return **:MEASUREMENT:MEAS1:TYPE RMS**, indicating that measurement 1 is defined to measure the RMS value of a waveform.

## MEASUREMENT:MEAS<x>:WAITTIME

Sets or queries the wait time.

**Conditions** Requires option 5-DPM (5 Series MSO instruments) or 6-DPM (6 Series MSO instrument)

**Group** DPM

**Syntax** MEASUREMENT:MEAS<x>:WAITTIME <NR2>  
MEASUREMENT:MEAS<x>:WAITTIME?

**Arguments** MEAS<x> is the measurement number.  
<NR2> is the wait time, in the range of 1 s to 500 s.

**Examples** MEASUREMENT:MEAS1:WAITTIME 60 sets the input trigger level of measurement 1 to +60 volts.

MEASUREMENT:MEAS3:WAITTIME? might return 2.500, indicating that the wait time of measurement 3 is 2.5 seconds.

## MEASUREMENT:MEAS<x>:WINDOWLENGTH

This command sets or queries the window length for the measurement. The measurement number is specified by x.

**Group** Measurement

**Syntax** MEASUREMENT:MEAS<x>:WINDOWLENGTH <NR3>  
MEASUREMENT:MEAS<x>:WINDOWLENGTH?

**Arguments** <NR3> is the value for the window length.

**Examples** MEASUREMENT:MEAS1:WINDOWLENGTH 10 sets the window length to 10.

MEASUREMENT:MEAS1:WINDOWLENGTH? might return  
:MEASUREMENT:MEAS1:WINDOWLENGTH 10.0000 indicating the window length is 10.

## MEASUrement:MEAS<x>:XUNIT? (Query Only)

Returns the horizontal scale units of the specified measurement.

**Group** Measurement

**Syntax** MEASUrement:MEAS<x>:XUNIT?

**Arguments** MEAS<x> specifies the measurement number.

**Examples** MEASUrement:MEAS2:XUNIT? might return "V", indicating that the horizontal unit for measurement 2 is seconds.

## MEASUrement:MEAS<x>:YUNIT? (Query Only)

Returns the vertical scale units of the specified measurement.

**Group** Measurement

**Syntax** MEASUrement:MEAS<x>:YUNIT?

**Arguments** MEAS<x> specifies the measurement number.

**Examples** MEASUrement:MEAS12:YUNIT? might return "V", indicating that the vertical unit for measurement 12 is volts.

## MEASUrement:MECH:EINDEXz

This command sets or queries the global mechanical Index Z source.

**Conditions** IMDA-MECH license on 5, 6, 6B series MSO instruments.

**Group** IMDA

**Syntax** MEASUrement:MECH:EINDEXz {ON|OFF|1|0}  
MEASUrement:MECH:EINDEXz?

<b>Arguments</b>	<p>ON specifies the Index Z check box state as enabled.</p> <p>OFF specifies the Index Z check box state as disabled.</p> <p>1 specifies the Index Z check box state as enabled.</p> <p>0 specifies the Index Z check box state as disabled.</p>
<b>Examples</b>	<p>MEASUREMENT:MECH:EINDEXZ ON specifies the global mechanical Index Z source as enabled.</p> <p>MEASUREMENT:MECH:EINDEXZ? might return :MEASUREMENT:MECH:EINDEXZ ON, indicating the global mechanical Index Z source is enabled.</p>

## MEASUREMENT:MECH:GRATIO

This command sets or queries the measurement gear ratio.

<b>Conditions</b>	IMDA-MECH license on 5 and 6 Series MSO instruments.
<b>Group</b>	Measurement, IMDA
<b>Syntax</b>	<p>MEASUREMENT:MECH:GRATIO &lt;NR3&gt;</p> <p>MEASUREMENT:MECH:GRATIO?</p>
<b>Arguments</b>	<NR3> specifies the gear ratio value for a specified measurement. The minimum and maximum values are 0.001 to 1000.
<b>Examples</b>	<p>MEASUREMENT:MECH:GRATIO 1.000E-3 sets the gear ratio value to 1.000E-3.</p> <p>MEASUREMENT:MECH:GRATIO? might return :MEASUREMENT:MECH:GRATIO 1.000E-3, indicating the gear ratio value is 1.000E-3.</p>

## MEASUREMENT:MECH:MUNITS

This command sets or queries the global mechanical measurement results units.

<b>Conditions</b>	IMDA-MECH license on 5, 6, 6B series MSO instruments.
<b>Group</b>	IMDA

**Syntax** MEASUREMENT:MECH:MUNITS  
 {NM|OZINCH|FTLB|INCHLB|DEGREES|RADIANS}  
 MEASUREMENT:MECH:MUNITS?

**Arguments** NM specifies the results units of mechanical Torque measurement as NM.  
 OZINCH specifies the results units of mechanical Torque measurement as OZINCH.  
 FTLB specifies the results units of mechanical Torque measurement as FTLB.  
 INCHLB specifies the results units of mechanical Torque measurement as INCHLB.  
 DEGREES specifies the results units of mechanical Torque measurement as DEGREES.  
 RADIANS specifies the results units of mechanical Torque measurement as RADIANS.

**Examples** MEASUREMENT:MECH:MUNITS NM specifies the results units of mechanical Torque measurement as NM.  
 MEASUREMENT:MECH:MUNITS? might return :MEASUREMENT:MECH:MUNITS NM, indicating the results units of mechanical Torque measurement is NM.

## MEASUREMENT:MECH:PPAIRS

This command sets or queries the measurement number of pole pairs.

**Conditions** IMDA-MECH license on 5 and 6 Series MSO instruments.

**Group** Measurement, IMDA

**Syntax** MEASUREMENT:MECH:PPAIRS <NR1>  
 MEASUREMENT:MECH:PPAIRS?

**Arguments** <NR1> defines the number of pole pairs for the specified measurement. The minimum to maximum range is 1 to 20.

**Examples** MEASUREMENT:MECH:PPAIRS 4 defines the number of pole pairs as 4.  
 MEASUREMENT:MECH:PPAIRS? might return :MEASUREMENT:MECH:PPAIRS 4 indicating the number of pole pairs is 4.



## MEASUREMENT:MECH:PPROTATION

This command sets or queries the global pulses per rotation of the measurement.

<b>Conditions</b>	IMDA-MECH license on 5, 6, 6B series MSO instruments.
<b>Group</b>	IMDA
<b>Syntax</b>	MEASUREMENT:MECH:PPROTATION <NR1> MEASUREMENT:MECH:PPROTATION?
<b>Arguments</b>	<NR1> defines the pulses per rotation of the measurement. The minimum to maximum range is 1 to 100000.
<b>Examples</b>	MEASUREMENT:MECH:PPROTATION 25 defines the pulses per rotation of the measurement as 25.  MEASUREMENT:MECH:PPROTATION? might return :MEASUREMENT:MECH:PPROTATION 25, indicating the pulses per rotation of the measurement is 25.

## MEASUREMENT:MECH:SOURCE<x>

This command sets or queries the global mechanical source of the specified source number.

<b>Conditions</b>	IMDA-MECH license on 5 and 6 Series MSO instruments.
<b>Group</b>	Measurement, IMDA
<b>Syntax</b>	MEASUREMENT:MECH:SOURCE<x> {S<x>_Ch<x>   CH<x>   MATH<x>   REF<x>   CH<x>_D<x>} MEASUREMENT:MECH:SOURCE<x>?
<b>Arguments</b>	S<x>_Ch<x> specifies the remote scope number and the analog channel as the source.  CH<x> specifies an analog channel as the source waveform.  MATH<x> specifies a math waveform as the source waveform.  REF<x> specifies an reference waveform as the source waveform .

CH<x>\_D<x> specifies a digital channel as the source waveform.

- Examples** MEASUREMENT:MECH:SOURCE2 CH2 defines the global mechanical source as channel 2.
- MEASUREMENT:MECH:SOURCE2? might return :MEASUREMENT:MECH:SOURCE2 CH2, indicating the global mechanical source is channel 2.

## MEASUREMENT:MECH:SType

This command sets or queries the measurement sensor type.

- Conditions** IMDA-MECH license on 5 and 6 Series MSO instruments.
- Group** Measurement, IMDA
- Syntax** MEASUREMENT:MECH:SType {HSENSOR|QEI}  
MEASUREMENT:MECH:SType?
- Arguments** HSENSOR specifies the sensor type as HSENSOR.  
QEI specifies the sensor type as QEI.
- Examples** MEASUREMENT:MECH:SType HSENSOR specifies the sensor type as HSENSOR.  
MEASUREMENT:MECH:SType? might return :MEASUREMENT:MECH:SType HSENSOR, indicating the sensor type is HSENSOR.

## MEASUREMENT:MINUI

This command sets or queries the minimum number of unit intervals required for BUJ analysis.

- Group** Measurement
- Syntax** MEASUREMENT:MINUI <NR3>  
MEASUREMENT:MINUI?
- Arguments** <NR3> is the minimum number of unit intervals required for BUJ analysis.

**Examples** MEASUREMENT:MINUI 1.0000E+6 sets the minimum number of unit intervals required for BUJ analysis to 1,000,000.

MEASUREMENT:MINUI? might return :MEASUREMENT:MINUI 1.0000E+6 indicating the minimum number of unit intervals required for BUJ analysis is 1,000,000.

## MEASUREMENT:POPULATION:LIMIT:STATE

This command sets or queries the global population limit state for the measurement.

**Group** Measurement

**Syntax** MEASUREMENT:POPULATION:LIMIT:STATE {OFF|ON|0|1 }  
MEASUREMENT:POPULATION:LIMIT:STATE?

**Arguments** OFF turns off the population limit.  
ON turns on the population limit.  
0 turns off the population limit.  
1 turns on the population limit.

**Examples** MEASUREMENT:POPULATION:LIMIT:STATE 1 turns on the population limit.

MEASUREMENT:POPULATION:LIMIT:STATE? might return :MEASUREMENT:POPULATION:LIMIT:STATE 0 indicating the population limit is off.

## MEASUREMENT:POPULATION:LIMIT:VALUE

This command sets or queries the global population limit value for the measurement.

**Group** Measurement

**Syntax** MEASUREMENT:POPULATION:LIMIT:VALUE <NR1>  
MEASUREMENT:POPULATION:LIMIT:VALUE?

**Arguments** <NR1> is the current limit value.

**Examples**    `MEASUREMENT:POPULATION:LIMIT:VALUE 2000` sets the population limit to 2000.

`MEASUREMENT:POPULATION:LIMIT:VALUE?` might return  
`:MEASUREMENT:POPULATION:LIMIT:VALUE 1000` indicating the population limit value is 1000.

## MEASUREMENT:REFLEVELS:ABSOLUTE:FALLHIGH

This command sets or queries the value used as the high reference level of the falling edge when the measurement's ref level method is set to absolute.

**Group**    Measurement

**Syntax**    `MEASUREMENT:REFLEVELS:ABSOLUTE:FALLHIGH <NR3>`  
`MEASUREMENT:REFLEVELS:ABSOLUTE:FALLHIGH?`

**Arguments**    `<NR3>` is the value used as the high reference level of the falling edge when the measurement's ref level method is set to absolute.

**Examples**    `MEASUREMENT:REFLEVELS:ABSOLUTE:FALLHIGH 1.5` sets the high reference level to 1.5 V.

`MEASUREMENT:REFLEVELS:ABSOLUTE:FALLHIGH?` might return  
`:MEASUREMENT:REFLEVELS:ABSOLUTE:FALLHIGH 1.0000` indicating the high reference level is 1.0 V.

## MEASUREMENT:REFLEVELS:ABSOLUTE:FALLLOW

This command sets or queries the value used as the low reference level of the falling edge when the measurement's ref level method is set to absolute.

**Group**    Measurement

**Syntax**    `MEASUREMENT:REFLEVELS:ABSOLUTE:FALLLOW <NR3>`  
`MEASUREMENT:REFLEVELS:ABSOLUTE:FALLLOW?`

**Arguments**    `<NR3>` is the value used as the low reference level of the falling edge.

**Examples**    `MEASUREMENT:REFLEVELS:ABSOLUTE:FALLLOW -1.5` sets the low reference level to -1.5 V.

`MEASUREMENT:REFLEVELS:ABSOLUTE:FALLLOW?` might return  
`:MEASUREMENT:REFLEVELS:ABSOLUTE:FALLLOW -1.0000` indicating the low reference level is -1.0 V.

## MEASUREMENT:REFLEVELS:ABSOLUTE:FALLMID

This command sets or queries the value used as the mid reference level of the falling edge when the measurement's ref level method is set to absolute.

**Group**    Measurement

**Syntax**    `MEASUREMENT:REFLEVELS:ABSOLUTE:FALLMID <NR3>`  
`MEASUREMENT:REFLEVELS:ABSOLUTE:FALLMID?`

**Arguments**    `<NR3>` is the value used as the mid reference level of the falling edge.

**Examples**    `MEASUREMENT:REFLEVELS:ABSOLUTE:FALLMID 10.0E-3` sets the mid reference level to 10.0 mV.

`MEASUREMENT:REFLEVELS:ABSOLUTE:FALLMID?` might return  
`:MEASUREMENT:REFLEVELS:ABSOLUTE:FALLMID 0.0E+0` indicating the mid reference level is 0.0 V.

## MEASUREMENT:REFLEVELS:ABSOLUTE:HYS TERESIS

This command sets or queries the value of the hysteresis of the reference level when the measurement's ref level method is set to absolute.

**Group**    Measurement

**Syntax**    `MEASUREMENT:REFLEVELS:ABSOLUTE:HYS TERESIS <NR3>`  
`MEASUREMENT:REFLEVELS:ABSOLUTE:HYS TERESIS?`

**Arguments**    `<NR3>` is the value of the hysteresis of the reference level.

**Examples**    `MEASUREMENT:REFLEVELS:ABSOLUTE:HYS TERESIS 20.0E-3` sets the hysteresis to 20.0 mV.

MEASUREMENT:REFLEVELS:ABSOLUTE:HYSTERESIS? might return  
:MEASUREMENT:REFLEVELS:ABSOLUTE:HYSTERESIS 30.0000E-3  
indicating the hysteresis is set to 30.0 mV.

## MEASUREMENT:REFLEVELS:ABSOLUTE:RISEHIGH

This command sets or queries the value used as the high reference level of the rising edge when the measurement's ref level method is set to absolute.

<b>Group</b>	Measurement
<b>Syntax</b>	MEASUREMENT:REFLEVELS:ABSOLUTE:RISEHIGH <NR3> MEASUREMENT:REFLEVELS:ABSOLUTE:RISEHIGH?
<b>Arguments</b>	<NR3> is the value used as the high reference level of the rising edge.
<b>Examples</b>	MEASUREMENT:REFLEVELS:ABSOLUTE:RISEHIGH 1.5 sets the high reference to 1.5 V.  MEASUREMENT:REFLEVELS:ABSOLUTE:RISEHIGH? might return :MEASUREMENT:REFLEVELS:ABSOLUTE:RISEHIGH 1.0000 indicating the high reference is 1.0 V.

## MEASUREMENT:REFLEVELS:ABSOLUTE:RISELOW

This command sets or queries the value used as the low reference level of the rising edge when the measurement's ref level method is set to absolute.

<b>Group</b>	Measurement
<b>Syntax</b>	MEASUREMENT:REFLEVELS:ABSOLUTE:RISELOW <NR3> MEASUREMENT:REFLEVELS:ABSOLUTE:RISELOW?
<b>Arguments</b>	<NR3> is the value used as the the low reference level of the rising edge
<b>Examples</b>	MEASUREMENT:REFLEVELS:ABSOLUTE:RISELOW -1.5 sets the low reference level to -1.5 V.

MEASUREMENT:REFLEVELS:ABSOLUTE:RISELOW? might return  
 :MEASUREMENT:REFLEVELS:ABSOLUTE:RISELOW -1.0000 indicating the  
 low reference level is -1.0 V.

## MEASUREMENT:REFLEVELS:ABSOLUTE:RISEMID

This command sets or queries the value used as the mid reference level of the rising edge when the measurement's ref level method is set to absolute.

<b>Group</b>	Measurement
<b>Syntax</b>	MEASUREMENT:REFLEVELS:ABSOLUTE:RISEMID <NR3> MEASUREMENT:REFLEVELS:ABSOLUTE:RISEMID?
<b>Arguments</b>	<NR3> is the mid reference level of the rising edge.
<b>Examples</b>	MEASUREMENT:REFLEVELS:ABSOLUTE:RISEMID 10.0E-3 sets the mid reference to 10.0 mV.  MEASUREMENT:REFLEVELS:ABSOLUTE:RISEMID? might return :MEASUREMENT:REFLEVELS:ABSOLUTE:RISEMID 0.0E+0 indicating the mid reference is 0.0 V.

## MEASUREMENT:REFLEVELS:ABSOLUTE:TYPE

This command sets or queries the reference level type for the measurement.

<b>Group</b>	Measurement
<b>Syntax</b>	MEASUREMENT:REFLEVELS:ABSOLUTE:TYPE {SAME UNIQUE} MEASUREMENT:REFLEVELS:ABSOLUTE:TYPE?
<b>Arguments</b>	SAME specifies that the absolute levels are set the same.  UNIQUE specifies that the absolute levels can be set independently.
<b>Examples</b>	MEASUREMENT:REFLEVELS:ABSOLUTE:TYPE UNIQUE specifies that the absolute levels can be set independently.

MEASUREMENT:REFLEVELS:ABSOLUTE:TYPE? might return  
:MEASUREMENT:REFLEVELS:ABSOLUTE:TYPE SAME indicating the absolute  
levels are set the same.

## MEASUREMENT:REFLEVELS:BASETOP

This command sets or queries the method used to calculate the TOP and BASE,  
used to calculate reference levels for the measurement.

<b>Group</b>	Measurement
<b>Syntax</b>	MEASUREMENT:REFLEVELS:BASETOP {AUTO MINMAX MEANHISTOGRAM MODEHISTOGRAM EYEHISTOGRAM} MEASUREMENT:REFLEVELS:BASETOP?
<b>Arguments</b>	Arguments are the base top methods.
<b>Examples</b>	MEASUREMENT:REFLEVELS:BASETOP MINMAX selects the MINMAX base top method.  MEASUREMENT:REFLEVELS:BASETOP? might return :MEASUREMENT:REFLEVELS:BASETOP MINMAX indicating the base top method is MINMAX.

## MEASUREMENT:REFLEVELS:JITTERMODE

This command sets or queries how often reference levels are calculated on Jitter  
measurements. If the mode is set to Latch, ref levels are calculated only on the  
first acquisition after a statistics reset. If it is set to Continuous, reference levels  
are calculated on every acquisition.

<b>Group</b>	Measurement
<b>Syntax</b>	MEASUREMENT:REFLEVELS:JITTERMODE {CONTINUOUS LATCH} MEASUREMENT:REFLEVELS:JITTERMODE?
<b>Arguments</b>	CONTINUOUS specifies that reference levels are calculated on every acquisition.  LATCH specifies that reference levels are calculated only on the first acquisition after a statistics reset.



- Examples** `MEASUREMENT:REFLEVELS:JITTERMODE CONTINUOUS` specifies that reference levels are calculated on every acquisition.
- `MEASUREMENT:REFLEVELS:JITTERMODE?` might return `LATCH` indicating that reference levels are calculated only on the first acquisition after a statistics reset.

## MEASUREMENT:REFLEVELS:METHOd

This command sets or queries the method used to calculate reference levels for the measurement.

- Group** Measurement
- Syntax** `MEASUREMENT:REFLEVELS:METHOd {PERCENT|ABSOLUTE}`  
`MEASUREMENT:REFLEVELS:METHOd?`
- Arguments** `PERCENT` specifies that the reference levels are calculated as a percent relative to `HIGH` and `LOW`. The percentages are defined using the `MEASUREMENT:REFLEVELS:REFLEVEL:PERCENT` commands.
- `ABSOLUTE` specifies that the reference levels are set explicitly using the `MEASUREMENT:REFLEVELS:REFLEVEL:ABSOLUTE` commands. This method is useful when precise values are required.
- Examples** `MEASUREMENT:REFLEVELS:METHOd ABSOLUTE` specifies that the reference levels are set explicitly.
- `MEASUREMENT:REFLEVELS:METHOd?` might return  
`:MEASUREMENT:REFLEVELS:METHOd PERCENT` indicating the reference levels are calculated as a percent relative to `HIGH` and `LOW`.

## MEASUREMENT:REFLEVELS:MODE

This command sets or queries how often reference levels are calculated.

- Group** Measurement
- Syntax** `MEASUREMENT:REFLEVELS:MODE {LATCH|CONTINUOUS}`  
`MEASUREMENT:REFLEVELS:MODE?`
- Arguments** `LATCH` calculates reference levels only on the first acquisition after a statistics reset.

CONTinuous calculates reference levels on every acquisition.

**Examples** MEASUREMENT:REFLEVELS:MODE CONTINUOUS calculates reference levels on every acquisition.

MEASUREMENT:REFLEVELS:MODE? might return  
:MEASUREMENT:REFLEVELS:MODE LATCH indicating reference levels are calculated only on the first acquisition after a statistics reset.

## MEASUREMENT:REFLEVELS:PERCENT:FALLHIGH

This command sets or queries the percentage (where 100% is equal to TOP and 0% is equal to BASE) used to calculate the high reference level of the falling edge when the measurement's ref level method is set to percent.

**Group** Measurement

**Syntax** MEASUREMENT:REFLEVELS:PERCENT:FALLHIGH <NR3>  
MEASUREMENT:REFLEVELS:PERCENT:FALLHIGH?

**Arguments** <NR3> is the percentage used to calculate the high reference level of the falling edge

**Examples** MEASUREMENT:REFLEVELS:PERCENT:FALLHIGH 90 sets the high reference level to 90%.

MEASUREMENT:REFLEVELS:PERCENT:FALLHIGH? might return  
:MEASUREMENT:REFLEVELS:PERCENT:FALLHIGH 80.0000 indicating the high reference level is 80%.

## MEASUREMENT:REFLEVELS:PERCENT:FALLLOW

This command sets or queries the percentage (where 100% is equal to TOP and 0% is equal to BASE) used to calculate the mid reference level of the falling edge when the measurement's ref level method is set to percent.

**Group** Measurement

**Syntax** MEASUREMENT:REFLEVELS:PERCENT:FALLLOW <NR3>  
MEASUREMENT:REFLEVELS:PERCENT:FALLLOW?

<b>Arguments</b>	<NR3> is the percentage used to calculate the mid reference level of the falling edge.
<b>Examples</b>	<p>MEASUREMENT:REFLEVELS:PERCENT:FALLLOW 10 sets the low reference level to 10%.</p> <p>MEASUREMENT:REFLEVELS:PERCENT:FALLLOW? might return :MEASUREMENT:REFLEVELS:PERCENT:FALLLOW 20.0000 indicating the low reference level is 20%.</p>

## MEASUREMENT:REFLEVELS:PERCENT:FALLMID

This command sets or queries the percentage (where 100% is equal to TOP and 0% is equal to BASE) used to calculate the mid reference level of the falling edge when the measurement's ref level method is set to percent.

<b>Group</b>	Measurement
<b>Syntax</b>	<p>MEASUREMENT:REFLEVELS:PERCENT:FALLMID &lt;NR3&gt; MEASUREMENT:REFLEVELS:PERCENT:FALLMID?</p>
<b>Arguments</b>	<NR3> is the percentage used to calculate the mid reference level of the falling edge
<b>Examples</b>	<p>MEASUREMENT:REFLEVELS:PERCENT:FALLMID 55 sets the mid reference level to 55%.</p> <p>MEASUREMENT:REFLEVELS:PERCENT:FALLMID? might return :MEASUREMENT:REFLEVELS:PERCENT:FALLMID 50.0000 indicating the mid reference level is 50%.</p>

## MEASUREMENT:REFLEVELS:PERCENT:HYS TERESIS

This command sets or queries the percentage (where 100% is equal to MAX and 0% is equal to MIN) used to calculate the hysteresis of the reference level when the measurement's ref level method is set to percent.

<b>Group</b>	Measurement
<b>Syntax</b>	<p>MEASUREMENT:REFLEVELS:PERCENT:HYS TERESIS &lt;NR3&gt; MEASUREMENT:REFLEVELS:PERCENT:HYS TERESIS?</p>

- Arguments** <NR3> is the percentage used to calculate the hysteresis of the reference level.
- Examples** MEASUREMENT:REFLEVELS:PERCENT:HYSTERESIS 3 sets the hysteresis to 3%.  
MEASUREMENT:REFLEVELS:PERCENT:HYSTERESIS? might return  
:MEASUREMENT:REFLEVELS:PERCENT:HYSTERESIS 5.0000 indicating the hysteresis is set to 5%.

## MEASUREMENT:REFLEVELS:PERCENT:RISEHIGH

This command sets or queries the percentage (where 100% is equal to TOP and 0% is equal to BASE) used to calculate the high reference level of the rising edge when the measurement's ref level method is set to percent.

- Group** Measurement
- Syntax** MEASUREMENT:REFLEVELS:PERCENT:RISEHIGH <NR3>  
MEASUREMENT:REFLEVELS:PERCENT:RISEHIGH?
- Arguments** <NR3> is the percentage used to calculate the high reference level of the rising edge.
- Examples** MEASUREMENT:REFLEVELS:PERCENT:RISEHIGH 90 sets the high reference level to 90%.  
MEASUREMENT:REFLEVELS:PERCENT:RISEHIGH? might return  
:MEASUREMENT:REFLEVELS:PERCENT:RISEHIGH 80.0000 indicating the high ref level is 80%.

## MEASUREMENT:REFLEVELS:PERCENT:RISELOW

This command sets or queries the percentage (where 100% is equal to TOP and 0% is equal to BASE) used to calculate the low reference level of the rising edge when the measurement's ref level method is set to percent.

- Group** Measurement
- Syntax** MEASUREMENT:REFLEVELS:PERCENT:RISELOW <NR3>  
MEASUREMENT:REFLEVELS:PERCENT:RISELOW?

**Arguments** <NR3> is the percentage used to calculate the low reference level of the rising edge.

**Examples** `MEASUREMENT:REFLEVELS:PERCENT:RISELOW 10` sets the low reference level to 10%.

`MEASUREMENT:REFLEVELS:PERCENT:RISELOW?` might return  
`:MEASUREMENT:REFLEVELS:PERCENT:RISELOW 20.0000` indicating the low reference level is 20%.

## MEASUREMENT:REFLEVELS:PERCENT:RISEMID

This command sets or queries the percentage (where 100% is equal to TOP and 0% is equal to BASE) used to calculate the mid reference level of the rising edge when the measurement's ref level method is set to percent.

**Group** Measurement

**Syntax** `MEASUREMENT:REFLEVELS:PERCENT:RISEMID <NR3>`  
`MEASUREMENT:REFLEVELS:PERCENT:RISEMID?`

**Arguments** <NR3> is the percentage used to calculate the mid reference level of the rising edge.

**Examples** `MEASUREMENT:REFLEVELS:PERCENT:RISEMID 55` sets the mid reference level to 55%.

`MEASUREMENT:REFLEVELS:PERCENT:RISEMID?` might return  
`:MEASUREMENT:REFLEVELS:PERCENT:RISEMID 50.0000` indicating the mid reference level is 50%.

## MEASUREMENT:REFLEVELS:PERCENT:TYPE

This command sets or queries the reference level percent type for the measurement.

**Group** Measurement

**Syntax** `MEASUREMENT:REFLEVELS:PERCENT:TYPE`  
`{TENNINETY|TWENTYEIGHTY|CUSTOM}`  
`MEASUREMENT:REFLEVELS:PERCENT:TYPE?`

<b>Arguments</b>	<p>TENNINETY sets the values for Low, Mid and High Ref to 10%, 50% and 90% respectively.</p> <p>TWENTYEIGHTY sets the values for Low, Mid and High Ref are set to 20%, 50% and 80% respectively.</p> <p>CUSTOM allows setting other reference level percents.</p>
<b>Examples</b>	<p>MEASUREMENT:REFLEVELS:PERCENT:TYPE TENNINETY sets the values for Low, Mid and High Ref to 10%, 50% and 90% respectively.</p> <p>MEASUREMENT:REFLEVELS:PERCENT:TYPE? might return :MEASUREMENT:REFLEVELS:PERCENT:TYPE CUSTOM indicating that custom reference levels can be set.</p>

## MEASUREMENT:REFLEVELS:TYPE

This command sets or queries the shared reference level method used for sources of measurement calculations.

<b>Group</b>	Measurement
<b>Syntax</b>	<p>MEASUREMENT:REFLEVELS:TYPE {GLOBAL PERSOURCE}</p> <p>MEASUREMENT:REFLEVELS:TYPE?</p>
<b>Arguments</b>	<p>GLOBAL shares reference levels across measurements.</p> <p>PERSOURCE causes reference levels to be used on individual measurements.</p>
<b>Examples</b>	<p>MEASUREMENT:REFLEVELS:TYPE PERSOURCE causes reference levels to be used on individual measurements.</p> <p>MEASUREMENT:REFLEVELS:TYPE? might return :MEASUREMENT:REFLEVELS:TYPE GLOBAL indicating reference levels are shared across measurements.</p>

## MEASUREMENT:REF<x>:REFLEVELS:ABSOLUTE:FALLHIGH

This command sets or queries the value used as the high reference level of the falling edge when the measurement's ref level method is set to absolute.

<b>Group</b>	Measurement
--------------	-------------

<b>Syntax</b>	<code>MEASUREMENT:REF&lt;x&gt;:REFLEVELS:ABSOLUTE:FALLHIGH &lt;NR3&gt;</code> <code>MEASUREMENT:REF&lt;x&gt;:REFLEVELS:ABSOLUTE:FALLHIGH?</code>
<b>Arguments</b>	<NR3> is the value used as the high reference level of the falling edge when the measurement's ref level method is set to absolute.
<b>Examples</b>	<code>MEASUREMENT:REF1:REFLEVELS:ABSOLUTE:FALLHIGH 1.5</code> sets the reference level to 1.5 V.  <code>MEASUREMENT:REF1:REFLEVELS:ABSOLUTE:FALLHIGH?</code> might return <code>:MEASUREMENT:REF1:REFLEVELS:ABSOLUTE:FALLHIGH 1.0000</code> indicating the reference level is 1.0 V.

## MEASUREMENT:REF<x>:REFLEVELS:ABSOLUTE:FALLLOW

This command sets or queries the value used as the low reference level of the falling edge when the measurement's ref level method is set to absolute.

<b>Group</b>	Measurement
<b>Syntax</b>	<code>MEASUREMENT:REF&lt;x&gt;:REFLEVELS:ABSOLUTE:FALLLOW &lt;NR3&gt;</code> <code>MEASUREMENT:REF&lt;x&gt;:REFLEVELS:ABSOLUTE:FALLLOW?</code>
<b>Arguments</b>	<NR3> is the value used as the low reference level of the falling edge when the measurement's ref level method is set to absolute.
<b>Examples</b>	<code>MEASUREMENT:REF1:REFLEVELS:ABSOLUTE:FALLLOW -1.5</code> sets the low reference level to -1.5 V.  <code>MEASUREMENT:REF1:REFLEVELS:ABSOLUTE:FALLLOW?</code> might return <code>:MEASUREMENT:REF1:REFLEVELS:ABSOLUTE:FALLLOW -1.0000</code> indicating the low reference level is -1.0 V.

## MEASUREMENT:REF<x>:REFLEVELS:ABSOLUTE:FALLMID

This command sets or queries the value used as the mid reference level of the falling edge when the measurement's ref level method is set to absolute.

<b>Group</b>	Measurement
--------------	-------------

**Syntax**    `MEASUREMENT:REF<x>:REFLEVELS:ABSOLUTE:FALLMID <NR3>`  
`MEASUREMENT:REF<x>:REFLEVELS:ABSOLUTE:FALLMID?`

**Arguments**    <NR3> is the value used as the mid reference level of the falling edge when the measurement's ref level method is set to absolute.

**Examples**    `MEASUREMENT:REF1:REFLEVELS:ABSOLUTE:FALLMID 50.0E-3` sets the mid reference level to 50.0 mV.  
`MEASUREMENT:REF1:REFLEVELS:ABSOLUTE:FALLMID?` might return `:MEASUREMENT:REF1:REFLEVELS:ABSOLUTE:FALLMID 0.0E+0` indicating the reference level is 0.0 V.

## MEASUREMENT:REF<x>:REFLEVELS:ABSOLUTE:HYS TERESIS

This command sets or queries the value of the hysteresis of the reference level when the measurement's ref level method is set to absolute.

**Group**    Measurement

**Syntax**    `MEASUREMENT:REF<x>:REFLEVELS:ABSOLUTE:HYS TERESIS <NR3>`  
`MEASUREMENT:REF<x>:REFLEVELS:ABSOLUTE:HYS TERESIS?`

**Arguments**    <NR3> is the value of the hysteresis of the reference level when the measurement's ref level method is set to absolute.

**Examples**    `MEASUREMENT:REF1:REFLEVELS:ABSOLUTE:HYS TERESIS 20.0E-3` sets the hysteresis to 20.0 mV.  
`MEASUREMENT:REF1:REFLEVELS:ABSOLUTE:HYS TERESIS?` might return `:MEASUREMENT:REF1:REFLEVELS:ABSOLUTE:HYS TERESIS 30.0000E-3` indicating the hysteresis is 30.0 mV.

## MEASUREMENT:REF<x>:REFLEVELS:ABSOLUTE:RISEHigh

This command sets or queries the value used as the high reference level of the rising edge when the measurement's ref level method is set to absolute.

**Group**    Measurement



<b>Syntax</b>	<code>MEASUREMENT:REF&lt;x&gt;:REFLEVELS:ABSOLUTE:RISEHIGH &lt;NR3&gt;</code> <code>MEASUREMENT:REF&lt;x&gt;:REFLEVELS:ABSOLUTE:RISEHIGH?</code>
<b>Arguments</b>	<NR3> is the value used as the high reference level of the rising edge when the measurement's ref level method is set to absolute.
<b>Examples</b>	<code>MEASUREMENT:REF1:REFLEVELS:ABSOLUTE:RISEHIGH 1.5</code> sets the reference level to 1.5 V.  <code>MEASUREMENT:REF1:REFLEVELS:ABSOLUTE:RISEHIGH?</code> might return <code>:MEASUREMENT:REF1:REFLEVELS:ABSOLUTE:RISEHIGH 1.0000</code> indicating the reference level is 1.0 V.

## MEASUREMENT:REF<x>:REFLEVELS:ABSOLUTE:RISELOW

This command sets or queries the value used as the low reference level of the rising edge when the measurement's ref level method is set to absolute.

<b>Group</b>	Measurement
<b>Syntax</b>	<code>MEASUREMENT:REF&lt;x&gt;:REFLEVELS:ABSOLUTE:RISELOW &lt;NR3&gt;</code> <code>MEASUREMENT:REF&lt;x&gt;:REFLEVELS:ABSOLUTE:RISELOW?</code>
<b>Arguments</b>	<NR3> is the value used as the low reference level of the rising edge when the measurement's ref level method is set to absolute.
<b>Examples</b>	<code>MEASUREMENT:REF1:REFLEVELS:ABSOLUTE:RISELOW -1.5</code> sets the reference level to -1.5 V.  <code>MEASUREMENT:REF1:REFLEVELS:ABSOLUTE:RISELOW?</code> might return <code>:MEASUREMENT:REF1:REFLEVELS:ABSOLUTE:RISELOW -1.0000</code> indicating the reference level is -1.0 V.

## MEASUREMENT:REF<x>:REFLEVELS:ABSOLUTE:RISEMID

This command sets or queries the value used as the mid reference level of the rising edge when the measurement's ref level method is set to absolute.

<b>Group</b>	Measurement
--------------	-------------

**Syntax**    `MEASUREMENT:REF<x>:REFLEVELS:ABSOLUTE:RISEMID <NR3>`  
`MEASUREMENT:REF<x>:REFLEVELS:ABSOLUTE:RISEMID?`

**Arguments**    <NR3> is the value used as the mid reference level of the rising edge when the measurement's ref level method is set to absolute.

**Examples**    `MEASUREMENT:REF1:REFLEVELS:ABSOLUTE:RISEMID 10.0E-3` sets the reference level to 10.0 mV.  
`MEASUREMENT:REF1:REFLEVELS:ABSOLUTE:RISEMID?` might return `:MEASUREMENT:REF1:REFLEVELS:ABSOLUTE:RISEMID 0.0E+0` indicating the mid reference level is 0.0 V.

## MEASUREMENT:REF<x>:REFLEVELS:ABSOLUTE:TYPE

This command sets or queries the reference level type for the measurement.

**Group**    Measurement

**Syntax**    `MEASUREMENT:REF<x>:REFLEVELS:ABSOLUTE:TYPE {SAME|UNIQUE}`  
`MEASUREMENT:REF<x>:REFLEVELS:ABSOLUTE:TYPE?`

**Arguments**    `SAME` specifies that the absolute levels are set the same.  
`UNIQUE` specifies that the absolute levels can be set independently.

**Examples**    `MEASUREMENT:REF1:REFLEVELS:ABSOLUTE:TYPE UNIQUE` specifies that the absolute levels can be set independently.  
`MEASUREMENT:REF1:REFLEVELS:ABSOLUTE:TYPE?` might return `:MEASUREMENT:REF1:REFLEVELS:ABSOLUTE:TYPE SAME` indicating that the absolute levels are set the same.

## MEASUREMENT:REF<x>:REFLEVELS:BASETOP

This command sets or queries the method used to calculate the TOP and BASE, used to calculate reference levels for the measurement.

**Group**    Measurement

<b>Syntax</b>	<pre>MEASUREMENT:REF&lt;x&gt;:REFLEVELS:BASETOP {AUTO  MINMAX  MEANHISTOGRAM  MODEHISTOGRAM  EYEHISTOGRAM} MEASUREMENT:REF&lt;x&gt;:REFLEVELS:BASETOP?</pre>
<b>Arguments</b>	<p>AUTO automatically chooses a reference level method.</p> <p>MINMAX specifies that reference levels are relative to the measurement MIN and MAX.</p> <p>MEANHISTOGRAM specifies that reference levels are relative to the histogram mean BASE and TOP.</p> <p>MODEHISTOGRAM specifies that reference levels are relative to the histogram mode BASE and TOP.</p> <p>EYEHISTOGRAM specifies that reference levels are relative to the eye histogram BASE and TOP.</p>
<b>Examples</b>	<pre>MEASUREMENT:REF1:REFLEVELS:BASETOP MINMAX</pre> <p>specifies that reference levels are relative to the measurement MIN and MAX.</p> <pre>MEASUREMENT:REF1:REFLEVELS:BASETOP?</pre> <p>might return :MEASUREMENT:REF1:REFLEVELS:BASETOP AUTO indicating the instrument automatically chooses a reference level method.</p>

## MEASUREMENT:REF<x>:REFLEVELS:METHOd

This command sets or queries the method used to calculate reference levels for the measurement.

<b>Group</b>	Measurement
<b>Syntax</b>	<pre>MEASUREMENT:REF&lt;x&gt;:REFLEVELS:METHOd {PERCENT ABSOLUTE} MEASUREMENT:REF&lt;x&gt;:REFLEVELS:METHOd?</pre>
<b>Arguments</b>	<p>PERCENT specifies that the reference levels are calculated as a percent relative to HIGH and LOW. The percentages are defined using the MEASUREMENT:REF&lt;x&gt;:REFLEVEL:PERCENT commands.</p> <p>ABSOLUTE specifies that the reference levels are set explicitly using the MEASUREMENT:REF&lt;x&gt;:REFLEVEL:ABSOLUTE commands. This method is useful when precise values are required.</p>
<b>Examples</b>	<pre>MEASUREMENT:REF1:REFLEVELS:METHOd ABSOLUTE</pre> <p>specifies that the reference levels are set explicitly.</p>

MEASUREMENT:REF1:REFLEVELS:METHOD? might return  
:MEASUREMENT:REF1:REFLEVELS:METHOD PERCENT indicating the  
reference levels are calculated as a percent relative to HIGH and LOW.

## MEASUREMENT:REF<x>:REFLEVELS:PERCENT:FALLHIGH

This command sets or queries the percentage (where 100% is equal to TOP and 0% is equal to BASE) used to calculate the high reference level of the falling edge when the measurement's ref level method is set to percent.

<b>Group</b>	Measurement
<b>Syntax</b>	MEASUREMENT:REF<x>:REFLEVELS:PERCENT:FALLHIGH <NR3> MEASUREMENT:REF<x>:REFLEVELS:PERCENT:FALLHIGH?
<b>Arguments</b>	<NR3> is the percentage used to calculate the high reference level of the falling edge
<b>Examples</b>	MEASUREMENT:REF1:REFLEVELS:PERCENT:FALLHIGH 95 sets the reference level to 95%.  MEASUREMENT:REF1:REFLEVELS:PERCENT:FALLHIGH? might return :MEASUREMENT:REF1:REFLEVELS:PERCENT:FALLHIGH 90.0000 indicating the reference level is 90%.

## MEASUREMENT:REF<x>:REFLEVELS:PERCENT:FALLLOW

This command sets or queries the percentage (where 100% is equal to TOP and 0% is equal to BASE) used to calculate the low reference level of the falling edge when the measurement's ref level method is set to percent.

<b>Group</b>	Measurement
<b>Syntax</b>	MEASUREMENT:REF<x>:REFLEVELS:PERCENT:FALLLOW <NR3> MEASUREMENT:REF<x>:REFLEVELS:PERCENT:FALLLOW?
<b>Arguments</b>	<NR3> is the percentage used to calculate the low reference level
<b>Examples</b>	MEASUREMENT:REF1:REFLEVELS:PERCENT:FALLLOW 5 sets the low reference level to 5%.

MEASUREMENT:REF1:REFLEVELS:PERCENT:FALLLOW? might return  
:MEASUREMENT:REF1:REFLEVELS:PERCENT:FALLLOW 10.0000 indicating  
the low reference level is 10%.

## MEASUREMENT:REF<x>:REFLEVELS:PERCENT:FALLMID

This command sets or queries the percentage (where 100% is equal to TOP and 0% is equal to BASE) used to calculate the mid reference level of the falling edge when the measurement's ref level method is set to percent.

<b>Group</b>	Measurement
<b>Syntax</b>	MEASUREMENT:REF<x>:REFLEVELS:PERCENT:FALLMID <NR3> MEASUREMENT:REF<x>:REFLEVELS:PERCENT:FALLMID?
<b>Arguments</b>	<NR3> is the percentage used to calculate the mid reference level of the falling edge.
<b>Examples</b>	MEASUREMENT:REF1:REFLEVELS:PERCENT:FALLMID 55 sets the reference level to 50%.  MEASUREMENT:REF1:REFLEVELS:PERCENT:FALLMID? might return :MEASUREMENT:REF1:REFLEVELS:PERCENT:FALLMID 50.0000 indicating the mid reference level is 50%.

## MEASUREMENT:REF<x>:REFLEVELS:PERCENT:HYSTERESIS

This command sets or queries the percentage (where 100% is equal to MAX and 0% is equal to MIN) used to calculate the hysteresis of the reference level when the measurement's ref level method is set to percent.

<b>Group</b>	Measurement
<b>Syntax</b>	MEASUREMENT:REF<x>:REFLEVELS:PERCENT:HYSTERESIS <NR3> MEASUREMENT:REF<x>:REFLEVELS:PERCENT:HYSTERESIS?
<b>Arguments</b>	<NR3> is the percentage used to calculate the hysteresis of the reference level.
<b>Examples</b>	MEASUREMENT:REF1:REFLEVELS:PERCENT:HYSTERESIS 2 sets the hysteresis to 2%.

```
MEASUREMENT:REF1:REFLEVELS:PERCENT:HYSTERESIS? might return  
:MEASUREMENT:REF1:REFLEVELS:PERCENT:HYSTERESIS 5.0000  
indicating the hysteresis is 5%.
```

## MEASUREMENT:REF<x>:REFLEVELS:PERCENT:RISEHigh

This command sets or queries the percentage (where 100% is equal to TOP and 0% is equal to BASE) used to calculate the high reference level of the rising edge when the measurement's ref level method is set to percent.

<b>Group</b>	Measurement
<b>Syntax</b>	MEASUREMENT:REF<x>:REFLEVELS:PERCENT:RISEHigh <NR3> MEASUREMENT:REF<x>:REFLEVELS:PERCENT:RISEHigh?
<b>Arguments</b>	<NR3> is the percentage used to calculate the high reference level of the rising edge
<b>Examples</b>	MEASUREMENT:REF1:REFLEVELS:PERCENT:RISEHigh 95 sets the reference level to 95%.  MEASUREMENT:REF1:REFLEVELS:PERCENT:RISEHigh? might return :MEASUREMENT:REF1:REFLEVELS:PERCENT:RISEHIGH 90.0000 indicating the reference level is 90%.

## MEASUREMENT:REF<x>:REFLEVELS:PERCENT:RISELow

This command sets or queries the percentage (where 100% is equal to TOP and 0% is equal to BASE) used to calculate the low reference level of the rising edge when the measurement's ref level method is set to percent.

<b>Group</b>	Measurement
<b>Syntax</b>	MEASUREMENT:REF<x>:REFLEVELS:PERCENT:RISELow <NR3> MEASUREMENT:REF<x>:REFLEVELS:PERCENT:RISELow?
<b>Arguments</b>	<NR3> is the percentage used to calculate the low reference level of the rising edge.
<b>Examples</b>	MEASUREMENT:REF1:REFLEVELS:PERCENT:RISELow 5 sets the low reference level to 5%.

`MEASUREMENT:REF1:REFLEVELS:PERCENT:RISELOW?` might return  
`:MEASUREMENT:REF1:REFLEVELS:PERCENT:RISELOW 10.0000` indicating  
the reference level is 10%.

## MEASUREMENT:REF<x>:REFLEVELS:PERCENT:RISEMID

This command sets or queries the percentage (where 100% is equal to TOP and 0% is equal to BASE) used to calculate the mid reference level of the rising edge when the measurement's ref level method is set to percent.

<b>Group</b>	Measurement
<b>Syntax</b>	<code>MEASUREMENT:REF&lt;x&gt;:REFLEVELS:PERCENT:RISEMID &lt;NR3&gt;</code> <code>MEASUREMENT:REF&lt;x&gt;:REFLEVELS:PERCENT:RISEMID?</code>
<b>Arguments</b>	<NR3> is the percentage used to calculate the mid reference level of the rising edge.
<b>Examples</b>	<code>MEASUREMENT:REF1:REFLEVELS:PERCENT:RISEMID 55</code> sets the mid reference level to 55%.  <code>MEASUREMENT:REF1:REFLEVELS:PERCENT:RISEMID?</code> might return <code>:MEASUREMENT:REF1:REFLEVELS:PERCENT:RISEMID 50.0000</code> indicating the mid reference level is 50%.

## MEASUREMENT:REF<x>:REFLEVELS:PERCENT:TYPE

This command sets or queries the reference level percent type for the measurement.

<b>Group</b>	Measurement
<b>Syntax</b>	<code>MEASUREMENT:REF&lt;x&gt;:REFLEVELS:PERCENT:TYPE</code> <code>{TENNINETY TWENTYEIGHTY CUSTOM}</code> <code>MEASUREMENT:REF&lt;x&gt;:REFLEVELS:PERCENT:TYPE?</code>
<b>Arguments</b>	<code>TENNINETY</code> sets the values for Low, Mid and High Ref to 10%, 50% and 90% respectively.  <code>TWENTYEIGHTY</code> sets the values for Low, Mid and High Ref are set to 20%, 50% and 80% respectively.  <code>CUSTOM</code> allows setting other reference level percents.

**Examples**    `MEASUREMENT:REF1:REFLEVELS:PERCENT:TYPE TWENTYEIGHTY` sets the values for Low, Mid and High Ref are set to 20%, 50% and 80% respectively.

`MEASUREMENT:REF1:REFLEVELS:PERCENT:TYPE?` might return `:MEASUREMENT:REF1:REFLEVELS:PERCENT:TYPE TENNINETY` indicating the values for Low, Mid and High Ref to 10%, 50% and 90% respectively.

## MEASUREMENT:RESULTS:HISTORY:START

This command sets or queries the starting acquisition number for transferring measurement history results.

**Group**    Measurement

**Syntax**    `MEASUREMENT:RESULTS:HISTORY:START <NR1>`  
`MEASUREMENT:RESULTS:HISTORY:START?`

**Related Commands**    [MEASUREMENT:RESULTS:HISTORY:STOP](#),  
[MEASUREMENT:MEAS<x>:RESULTS:HISTORY:MAXIMUM?](#),  
[MEASUREMENT:MEAS<x>:RESULTS:HISTORY:MEAN?](#),  
[MEASUREMENT:MEAS<x>:RESULTS:HISTORY:MINIMUM?](#),  
[MEASUREMENT:MEAS<x>:RESULTS:HISTORY:PK2PK?](#),  
[MEASUREMENT:MEAS<x>:RESULTS:HISTORY:POPULATION?](#),  
[MEASUREMENT:MEAS<x>:RESULTS:HISTORY:STDDEV?](#)

**Arguments**    `<NR1>` is the first acquisition that will be transferred, which ranges from 1 to the number of history acquisitions. Results will be transferred from acquisitions `<NR1>` to `MEASUREMENT:RESULTS:HISTORY:STOP`.

**Examples**    `MEASUREMENT:RESULTS:HISTORY:START 25` specifies that measurement history results transfer will begin with acquisition 25.

`MEASUREMENT:RESULTS:HISTORY:START?` might return `:MEASUREMENT:RESULTS:HISTORY:START 10` indicating that measurement history results transfer will begin at acquisition 10.



## MEASUREMENT:RESULTS:HISTORY:STOP

This command sets or queries the last acquisition number that will be transferred for measurement history results.

**Group** Measurement

**Syntax** MEASUREMENT:RESULTS:HISTORY:STOP <NR1>  
MEASUREMENT:RESULTS:HISTORY:STOP?

**Related Commands** [MEASUREMENT:RESULTS:HISTORY:START](#),  
[MEASUREMENT:MEAS<x>:RESULTS:HISTORY:MAXIMUM?](#),  
[MEASUREMENT:MEAS<x>:RESULTS:HISTORY:MEAN?](#),  
[MEASUREMENT:MEAS<x>:RESULTS:HISTORY:MINIMUM?](#),  
[MEASUREMENT:MEAS<x>:RESULTS:HISTORY:PK2PK?](#),  
[MEASUREMENT:MEAS<x>:RESULTS:HISTORY:POPULATION?](#),  
[MEASUREMENT:MEAS<x>:RESULTS:HISTORY:STDDDEV?](#)

**Arguments** <NR1> is the last acquisition that will be transferred, which ranges from 1 to the number of history acquisitions. Results will be transferred from MEASUREMENT:RESULTS:HISTORY:START to <NR1>. A special value of 0 for <NR1> indicates that the stop position is always the last history acquisition.

**Examples** MEASUREMENT:RESULTS:HISTORY:STOP 50 specifies that measurement history results transfer will end with acquisition 50.

MEASUREMENT:RESULTS:HISTORY:STOP? might return  
:MEASUREMENT:RESULTS:HISTORY:STOP 0 indicating that measurement history results transfer will end with the last history acquisition.

## MEASUREMENT:STATISTICS:CYCLEMODE

This command turns on and off cycle to cycle measurement statistics tracking and affects computation and display of cycle-cycle statistics in the Measurement Result table. It affects measurement statistics after being enabled and after new data is acquired and measured.

**Group** Measurement

<b>Syntax</b>	<code>MEASUREMENT:STATISTICS:CYCLEMODE {OFF ON 0 1}</code> <code>MEASUREMENT:STATISTICS:CYCLEMODE?</code>
<b>Arguments</b>	<p>OFF turns off statistics for all measurements. This is the default value.</p> <p>ON turns on statistics and displays all statistics for each measurement.</p> <p>0 turns off statistics for all measurements.</p> <p>1 turns on statistics and displays all statistics for each measurement.</p>
<b>Examples</b>	<p><code>MEASUREMENT:STATISTICS:CYCLEMODE OFF</code> turns off statistics for all measurements.</p> <p><code>MEASUREMENT:STATISTICS:CYCLEMODE?</code> might return <code>:MEASUREMENT:STATISTICS:CYCLEMODE 1</code> indicating that statistics are displayed for each measurement.</p>

## MEASUREMENT:WBG:PDEVICE

This command sets or returns the type of the Power device.

<b>Group</b>	Measurement
<b>Syntax</b>	<code>MEASUREMENT:WBG:PDEVICE {IGBT MOSFET}</code> <code>MEASUREMENT:WBG:PDEVICE?</code>
<b>Arguments</b>	<p>IGBT specifies the type of the Power device as IGBT.</p> <p>MOSFET specifies the type of the Power device as MOSFET.</p>
<b>Examples</b>	<p><code>MEASUREMENT:WBG:PDEVICE MOSFET</code> sets the type of the Power device to MOSFET.</p> <p><code>MEASUREMENT:WBG:PDEVICE?</code> might return <code>:MEASUREMENT:WBG:PDEVICE MOSFET</code> indicating that the type of the Power device is MOSFET.</p>

## \*OPC

This command generates the operation complete message in the Standard Event Status Register (SESR) when all pending commands that generate an OPC message are complete. The `*OPC?` query places the ASCII character “1” into the output queue when all such OPC commands are complete. The `*OPC?` response is

not available to read until all pending operations finish. For a complete discussion of the use of these registers and the output queue, see Registers and Queues.

The \*OPC command allows you to synchronize the operation of the instrument with your application program. For more information, see Synchronization Methods. Refer to the *Oscilloscope operations that can generate OPC* table for a list of commands that generate an OPC message. (See Table 3-3.)

<b>Group</b>	Status and Error
<b>Syntax</b>	*OPC *OPC?
<b>Related Commands</b>	<a href="#">BUSY?</a> <a href="#">*WAI</a>
<b>Examples</b>	*OPC generates the operation complete message in the SESR at the completion of all pending OPC operations.  *OPC? might return 1 to indicate that all pending OPC operations are finished.

## \*OPT? (Query Only)

This query-only command returns a comma separated list of installed options as an arbitrary ASCII string (no quotes) of the form:

<optionCode>:<optionDescription>,<optionCode>:<optionDescription>...

The last section of each entry (the text following the last hyphen) indicates the license type.

If no options are found, NONE is returned.

<b>Group</b>	Status and Error
<b>Syntax</b>	*OPT?
<b>Examples</b>	*OPT? response (with each option listed on a separate line for clarity): 5-BW-1000 – 1 GHz , 5-DJA – Advanced Jitter and Eye Analysis– NODE.

## PAUSE (No Query Form)

This command causes the interface to pause the specified number of seconds before processing any other commands.

**Group** Miscellaneous

**Syntax** PAUSE <NR3>

**Arguments** <NR3> is the specified number of seconds the interface is to pause before processing any other commands. The pause time is specified as a floating point value in seconds and must be  $> 0.0$  and  $\geq 1800.0$ .

**Examples** PAUSE 10.0e0; :ACQUIRE:NUMACQ causes the interface to pause 10 seconds before returning the number of acquisitions.

## PEAKSTABLE:ADDNew (No Query Form)

This command adds the specified peak markers table.

**Group** Spectrum View

**Syntax** PEAKSTABLE:ADDNew <QString>

**Arguments** <QString> is a quoted string that is the name of the new peak markers table. The argument is of the form "TABLE<NR1>", where  $<NR1> \geq 1$ .

**Examples** PEAKSTABLE:ADDNEW "Table1" adds peak markers table, Table1.

## PEAKSTABLE:DELEte (No Query Form)

This command deletes the specified peak markers table.

**Group** Spectrum View

**Syntax** PEAKSTABLE:DELEte <QString>

**Arguments** <QString> is a quoted string that is the name of the peak markers table to delete. The argument is of the form "TABLE<NR1>", where <NR1> ≥ 1.

**Examples** PEAKSTABLE:DELETE "Table1" deletes peak markers table, Table1.

## PEAKSTABLE:LIST? (Query Only)

This command deletes the specified peak markers table.

**Group** Spectrum View

**Syntax** PEAKSTABle:LIST?

**Returns** Returns a list of all currently defined peak markers tables.

**Examples** PEAKSTABLE:LIST? might return :PEAKSTABle:LIST TABLE1 , indicating TABLE1 is currently the only defined peak markers table.

## PEAKSTABLE:TABLE<x>:FRESolution

This command sets or queries the Frequency Resolution state for peak markers table.

**Group** Plot

**Syntax** PEAKSTABle:TABLE<x>:FRESolution {AUTO|PRECISE}  
PEAKSTABle:TABLE<x>:FRESolution?

**Arguments** AUTO shows the frequency with the same precision as shown in the Spectrum View display.

PRECISE shows the frequency down to single Hz resolution.

**Examples** PEAKSTABle:TABLE1:FRESolution AUTO sets Frequency Resolution to Auto.  
PEAKSTABle:TABLE1:FRESolution? might return :PEAKSTABle:TABLE1:FRESolution AUTO, indicating Frequency Resolution is Auto.

## PLOT:ADDNew (No Query Form)

This command adds the specified plot.

**Group** Plot

**Syntax** PLOT:ADDNew <QString>

**Arguments** <QString> is the specified plot. The argument is of the form “PLOT<NR1>”, where <NR1>  $\geq$  1.

**Examples** PLOT:ADDNEW "PLOT1" adds PLOT1.

## PLOT:DELEte (No Query Form)

This command deletes the specified plot.

**Group** Plot

**Syntax** PLOT:DELEte <QString>

**Arguments** <QString> is the specified plot. Argument is of the form “PLOT<NR1>”, where <NR1> is  $\geq$  1).

**Examples** PLOT:DELETE "PLOT1" deletes PLOT1.

## PLOT:LIST? (Query Only)

This command lists all currently defined plots.

**Group** Plot

**Syntax** PLOT:LIST?

**Returns** A list of all currently defined plots is returned.

**Examples** PLOT:LIST? might return :PLOT:LIST  
PLOT1,PLOT3,PLOT4,PLOT5,PLOT6,PLOT7 listing all currently defined plots.

## PLOT:PLOT<x>:BAThtub:BER

This command sets or queries the bathtub BER value.

**Group** Plot

**Syntax** PLOT:PLOT<x>:BAThtub:BER <NR1>  
PLOT:PLOT<x>:BAThtub:BER?

**Arguments** <NR1> is the bathtub BER value.

**Examples** PLOT:PLOT1:BAThtub:BER 16 sets the BER value to 16.  
PLOT:PLOT1:BAThtub:BER? might return :PLOT:PLOT1:BATHTUB:BER 14  
indicating the BER value is 14.

## PLOT:PLOT<x>:BAThtub:XAXISUnits

This command sets or queries the X-Axis unit, either unit intervals or seconds.

**Group** Plot

**Syntax** PLOT:PLOT<x>:BAThtub:XAXISUnits {UNITIntervals|SECONDS}  
PLOT:PLOT<x>:BAThtub:XAXISUnits?

**Arguments** UNITIntervals specifies units as unit intervals.  
SECONDS specifies units as seconds.

**Examples** PLOT:PLOT1:BAThtub:XAXISUnits SECONDS sets the units to seconds.  
PLOT:PLOT1:BAThtub:XAXISUnits? might return SECONDS.

## PLOT:PLOT<x>:BITType

This command sets or queries the bit type to display for the specified eye diagram plot.

<b>Group</b>	Plot
<b>Syntax</b>	PLOT:PLOT<x>:BITType {ALLBits TRANSition NONTRANSition} PLOT:PLOT<x>:BITType?
<b>Arguments</b>	<p>PLOT&lt;x&gt; is the plot number.</p> <p>ALLBits sets the eye diagram plot to show both transition and nontransition bits.</p> <p>TRANSition sets the eye diagram plot to show only bits where a logic level transition occurs.</p> <p>NONTRANSition sets the eye diagram plot to show only bits where no logic level transition occurs.</p>
<b>Examples</b>	<p>PLOT:PLOT1:BITType TRANSition sets the eye diagram in Plot 1 to only show transition bits.</p> <p>PLOT:PLOT3:BITType? might return ALLBITS, indicating that the eye diagram in Plot 3 is set to show both transition and nontransition bits in the plot.</p>

## PLOT:PLOT<x>:EXPORTRaw? (Query Only)

This command returns a binary stream of double values containing the x,y and hits value. Use this command along with MEASUREMENT:ADDMEAS TIE, PLOT:PLOT1:TYPE EYEDIAGRAM, DISPLAY:SELECT:VIEW plotview1 to export the eye diagram plot data.

<b>Group</b>	Plot
<b>Syntax</b>	PLOT:PLOT<x>:EXPORTRaw?
<b>Related Commands</b>	<p><a href="#">MEASUREMENT:ADDMEAS</a></p> <p><a href="#">DISPLAY:SELECT:VIEW</a></p> <p><a href="#">PLOT:PLOT&lt;x&gt;:TYPE</a></p>
<b>Returns</b>	A binary stream of double values containing the x,y and hits value. The data that is returned is of binary format.
<b>Examples</b>	PLOT:PLOT1:EXPORTRaw? might return :#73000000{øø\$y¾,, ^Æ B @, indicating the x,y and hits value.



## PLOT:PLOT<x>:EXTENDuis

This command sets or queries number of UIs surrounding the eye boundary UIs that are used for fast eye rendering.

<b>Conditions</b>	Requires option DJA.
<b>Group</b>	Plot
<b>Syntax</b>	PLOT:PLOT<x>:EXTENDuis <NR1> PLOT:PLOT<x>:EXTENDuis?
<b>Arguments</b>	PLOT<x> is the plot number. <NR1> is the number of surrounding UIs.
<b>Examples</b>	PLOT:PLOT2:EXTENDUIS 250 sets fast eye rendering to use 250 UIs in plot 2. PLOT:PLOT2:EXTENDUIS? might return :PLOT:PLOT2:EXTENDUIS 250, indicating that 250 UIs are used for fast eye rendering in plot 2.

## PLOT:PLOT<x>:EYERender

This command sets or queries the eye rendering method for the specified plot.

<b>Conditions</b>	Requires option DJA.
<b>Group</b>	Plot
<b>Syntax</b>	PLOT:PLOT<x>:EYERender {FAST COMPlete} PLOT:PLOT<x>:EYERender?
<b>Arguments</b>	PLOT<x> is the plot number. FAST sets the eye rendering method to fast. COMPlete sets the eye rendering method to complete.
<b>Examples</b>	PLOT:PLOT2:EYERENDER FAST enables fast eye rendering for plot 2. PLOT:PLOT2:EYERENDER? might return :PLOT:PLOT2:EYERENDER FAST, indicating that fast eye rendering is enabled in plot 2.

## PLOT:PLOT<x>:IMDA:MEAS

This command sets or returns the measurement selection of trend plot and acq trend plot.

**Conditions** Requires option IMDA.

**Group** Plot

**Syntax** PLOT:PLOT<x>:IMDA:MEAS {VRMS |IRMS |PHASE |FREQuency |TRPWR |REPWR |APPPWR |TRPWRSUM |REPWRSUM |APPPWRSUM |DCPWR |INPWR |OUTPWR |EFFiciency |TOTALEFFiciency |INPWRSUM |OUTPWRSUM}  
PLOT:PLOT<x>:IMDA:MEAS?

**Arguments** PLOT<x> is the plot number.

VRMS sets the IMDA measurement selection to VRMS.

IRMS sets the IMDA measurement selection to IRMS.

PHASE sets the IMDA measurement selection to PHASE.

FREQuency sets the IMDA measurement selection to FREQuency.

TRPWR sets the IMDA measurement selection to TRPWR.

REPWR sets the IMDA measurement selection to REPWR.

APPPWR sets the IMDA measurement selection to APPPWR.

TRPWRSUM sets the IMDA measurement selection to TRPWRSUM.

REPWRSUM sets the IMDA measurement selection to REPWRSUM.

APPPWRSUM sets the IMDA measurement selection to APPPWRSUM.

DCPWR sets the IMDA measurement selection to DCPWR. This selection is applicable only for acq trend plots.

INPWR sets the IMDA measurement selection to INPWR. This selection is applicable only for acq trend plots.

OUTPWR sets the IMDA measurement selection to OUTPWR. This selection is applicable only for acq trend plots.

EFFiciency sets the IMDA measurement selection to EFFiciency.

TOTALEFFiciency sets the IMDA measurement selection to TOTALEFFiciency. This selection is applicable only for acq trend plots.

INPWRSUM sets the IMDA measurement selection to INPWRSUM. This selection is applicable only for acq trend plots.

OUTPWRSUM sets the IMDA measurement selection to OUTPWRSUM. This selection is applicable only for acq trend plots.

**Examples** PLOT:PLOT1:IMDA:MEAS VRMS sets the measurement selection to VRMS.

PLOT:PLOT1:IMDA:MEAS? might return :PLOT:PLOT1:IMDA:MEAS VRMS indicating the measurement selection is set to VRMS.

## PLOT:PLOT<x>:IMDAPLOTDisplay

This command sets or returns the IMDA time trend and acq trend plot display configuration.

**Conditions** Requires option IMDA.

**Group** Plot

**Syntax** PLOT:PLOT<x>:IMDAPLOTDisplay {ALL |ONEPAIRVI |ONEPAIRV  
|ONEPAIRI |PHASEONE |PHASETWO |PHASETHREE |ABC |DQ0}  
PLOT:PLOT<x>:IMDAPLOTDisplay?

**Arguments** PLOT<x> is the plot number.

ALL sets the IMDA time trend and acq trend plot display configuration to ALL.

ONEPAIRVI sets the IMDA time trend and acq trend plot display configuration to ONEPAIRVI.

ONEPAIRV sets the IMDA time trend and acq trend plot display configuration to ONEPAIRV.

ONEPAIRI sets the IMDA time trend and acq trend plot display configuration to ONEPAIRI.

PHASEONE sets the IMDA time trend and acq trend plot display configuration to PHASEONE.

PHASETWO sets the IMDA time trend and acq trend plot display configuration to PHASETWO.

PHASETHREE sets the IMDA time trend and acq trend plot display configuration to PHASETHREE.

ABC sets the IMDA time trend plot display to ABC.

DQ0 sets the IMDA time trend plot display to DQ0.

**Examples**    `PLOT:PLOT1:IMDAPLOTDisplay ALL` sets the plot display configuration to all.  
`PLOT:PLOT1:IMDAPLOTDisplay?` might return  
`:PLOT:PLOT1:IMDAPLOTDisplay ALL` indicating the plot display configuration is set to all.

## **PLOT:PLOT<x>:LABEL:COLOR**

This command sets or queries the color of the specified trend label. This command/query only applies to Time Trend plots.

**Group**    Plot

**Syntax**    `PLOT:PLOT<x>:LABEL:COLOR <QString>`  
`PLOT:PLOT<x>:LABEL:COLOR?`

**Arguments**    `<QString>` is the label color. The default color is specified by a quoted empty string, and is the only available color.

**Examples**    `PLOT:PLOT2:LABEL:COLOR ""` sets the plot color to the default color.  
`PLOT:PLOT2:LABEL:COLOR?` might return `:PLOT:PLOT2:LABEL:COLOR ""` indicating the plot color is the default color.

## **PLOT:PLOT<x>:LABEL:FONT:BOLD**

This command sets or queries the bold state of the specified trend label. This command/query only applies to Time Trend plots.

**Group**    Plot

**Syntax**    `PLOT:PLOT<x>:LABEL:FONT:BOLD {<NR1>|OFF|ON}`  
`PLOT:PLOT<x>:LABEL:FONT:BOLD?`

**Arguments**    `<NR1> = 0` disables bold font; any other value turns this feature on.  
`OFF` disables bold font.  
`ON` enables bold font.

**Examples** PLOT:PLOT1:LABEL:FONT:BOLD 1 sets the label to a bold font.  
 PLOT:PLOT1:LABEL:FONT:BOLD? might return  
 :PLOT:PLOT1:LABEL:FONT:BOLD 1 indicating the label is bold.

## PLOT:PLOT<x>:LABEl:FONT:ITALic

This command sets or queries the italic state of the specified trend label. This command/query only applies to Time Trend plots.

**Group** Plot

**Syntax** PLOT:PLOT<x>:LABEl:FONT:ITALic {<NR1>|OFF|ON}  
 PLOT:PLOT<x>:LABEl:FONT:ITALic?

**Arguments** <NR1> = 0 disables italic font; any other value turns this feature on.  
 OFF disables italic font.  
 ON enables italic font.

**Examples** PLOT:PLOT1:LABEl:FONT:ITALic 1 sets the font to italic.  
 PLOT:PLOT1:LABEl:FONT:ITALic? might return  
 :PLOT:PLOT1:LABEL:FONT:ITALIC 0 indicating the font in not italic.

## PLOT:PLOT<x>:LABEl:FONT:SIZE

This command sets or queries the font size of the specified trend label. This command/query only applies to Time Trend plots.

**Group** Plot

**Syntax** PLOT:PLOT<x>:LABEl:FONT:SIZE <NR1>  
 PLOT:PLOT<x>:LABEl:FONT:SIZE?

**Arguments** <NR1> is the font size.

**Examples** PLOT:PLOT1:LABEl:FONT:SIZE 12 sets the font size to 12 points.  
 PLOT:PLOT1:LABEl:FONT:SIZE? might return  
 :PLOT:PLOT1:LABEL:FONT:SIZE 72 indicating the font size is 72 points.

## PLOT:PLOT<x>:LABel:FONT:TYPE

This command sets or queries the font type of the specified trend label, such as Arial or Times New Roman. This command/query only applies to Time Trend plots.

**Group** Plot

**Syntax** PLOT:PLOT<x>:LABel:FONT:TYPE <QString>  
PLOT:PLOT<x>:LABel:FONT:TYPE?

**Arguments** <QString> is the font type: Times New Roman, Arial, Frutiger LT Std 55 Roman, DejaVu Sans, DejaVu Sans Mono, Frutiger LT Std, Monospace, Sans Serif, Serif, Ubuntu, Ubuntu Condensed, and Ubuntu Mono.

**Examples** PLOT:PLOT1:LABel:FONT:TYPE Arial sets the font type to Arial.  
PLOT:PLOT1:LABel:FONT:TYPE? might return  
:PLOT:PLOT1:LABel:FONT:TYPE "Frutiger LT Std 55 Roman" indicating the font type is Frutiger LT Std 55 Roman.

## PLOT:PLOT<x>:LABel:FONT:UNDERline

This command sets or queries the underline state of the specified trend label. This command/query only applies to Time Trend plots.

**Group** Plot

**Syntax** PLOT:PLOT<x>:LABel:FONT:UNDERline {<NR1>|OFF|ON}  
PLOT:PLOT<x>:LABel:FONT:UNDERline?

**Arguments** <NR1> = 0 disables underline font; any other value turns this feature on.  
OFF disables underline font.  
ON enables underline font.

**Examples** PLOT:PLOT1:LABel:FONT:UNDERline 1 set the font to underlined.  
PLOT:PLOT1:LABel:FONT:UNDERline?  
:PLOT:PLOT1:LABel:FONT:UNDERLINE 0 indicating the font is underlined.

## PLOT:PLOT<x>:LABel:NAME

This command sets or queries the specified trend's label. This command/query only applies to Time Trend plots.

<b>Group</b>	Plot
<b>Syntax</b>	PLOT:PLOT<x>:LABel:NAME <QString> PLOT:PLOT<x>:LABel:NAME?
<b>Arguments</b>	<QString> is the label.
<b>Examples</b>	PLOT:PLOT1:LABel:NAME "Time Trend number 1" sets the plot name to Time Trend number 1.  PLOT:PLOT1:LABel:NAME? might return :PLOT:PLOT1:LABel:NAME "This is a label test plot" indicating the label name is This is a label test plot.

## PLOT:PLOT<x>:LABel:XPOS

This command sets or queries the x-position of the specified trend label. This command/query only applies to Time Trend plots.

<b>Group</b>	Plot
<b>Syntax</b>	PLOT:PLOT<x>:LABel:XPOS <NR3> PLOT:PLOT<x>:LABel:XPOS?
<b>Arguments</b>	<NR3> is the y-position, in pixels relative to the left edge of the display, of the label.
<b>Examples</b>	PLOT:PLOT1:LABel:XPOS 200 sets the X position to 200.  PLOT:PLOT1:LABel:XPOS? might return :PLOT:PLOT1:LABel:XPOS 45.0000 indicating the X position is 45.0 pixels to the right of the left edge of the display.

## PLOT:PLOT<x>:LABel:YPOS

This command sets or queries the y-position of the specified trend label. This command/query only applies to Time Trend plots.

<b>Group</b>	Plot
<b>Syntax</b>	PLOT:PLOT<x>:LABE1:YPOS <NR3> PLOT:PLOT<x>:LABE1:YPOS?
<b>Arguments</b>	<NR3> is the x-position, in pixels relative to the baseline of the waveform, of the label.
<b>Examples</b>	PLOT:PLOT1:LABE1:YPOS 100 sets the Y position to 100.  PLOT:PLOT1:LABE1:YPOS? might return :PLOT:PLOT1:LABEL:YPOS 0.0E+0 indicating the Y position of the label is at the baseline of the waveform.

## PLOT:PLOT<x>:MASK? (Query Only)

This command returns the name of the mask test associated with the specified eye diagram plot.

<b>Group</b>	Plot
<b>Syntax</b>	PLOT:PLOT<x>:MASK?
<b>Arguments</b>	PLOT<x> is the plot number.
<b>Returns</b>	<String> is a quoted string that contains the name of the eye diagram mask test associated with the specified plot. If a plot does not have an eye diagram mask test, the command returns an empty string "".
<b>Examples</b>	PLOT:PLOT1:MASK? might return "mask2", indicating that the eye diagram mask test mask2 is associated with plot 1.

## PLOT:PLOT<x>:MASKOffset:HORizontal:AUTOfit

This command enables or disables eye mask autofit in the specified plot.

**Conditions** Requires option 5-DJA or 6-DJA (Advanced Jitter Analysis).

**Group** Plot



<b>Syntax</b>	<code>PLOT:PLOT&lt;x&gt;:MASKOffset:HORizontal:AUTOfit {ON OFF}</code> <code>PLOT:PLOT&lt;x&gt;:MASKOffset:HORizontal:AUTOfit?</code>
<b>Arguments</b>	<code>PLOT&lt;x&gt;</code> is the plot number. ON enables eye mask autofit. OFF disables eye mask autofit.
<b>Examples</b>	<code>PLOT:PLOT1:MASKOffset:HORizontal:AUTOfit ON</code> enables the eye mask autofit in mask plot 1. <code>PLOT:PLOT2:MASKOffset:HORizontal:AUTOfit?</code> might return <code>:PLOT:PLOT2:MASKOffset:HORizontal:AUTOfit 0</code> , indicating that mask autofit is disabled in mask plot 2.

## PLOT:PLOT<x>:NUMBins

This command sets or queries the current histogram resolution.

<b>Group</b>	Plot
<b>Syntax</b>	<code>PLOT:PLOT&lt;x&gt;:NUMBins {TWENTYfive FIFTY HUNDred TWOifty FIVEHundred TWOThousand MAXimum}</code> <code>PLOT:PLOT&lt;x&gt;:NUMBins?</code>
<b>Arguments</b>	Arguments are the number of bins.
<b>Examples</b>	<code>PLOT:PLOT4:NUMBins TWENTYFIVE</code> sets the number of bins to 25. <code>PLOT:PLOT4:NUMBins?</code> might return <code>:PLOT:PLOT4:NUMBINS TWOFIFTY</code> indicating the histogram resolution is 250 bins.

## PLOT:PLOT<x>:MASKOffset:PERCENTui:FROM

This command sets or queries the allowed range for the mask to move in the left direction. Only applies to eye diagram plots.

<b>Group</b>	Plot
--------------	------

**Syntax** PLOT:PLOT<x>:MASKOffset:PERCENTui:FROM <NR3>  
PLOT:PLOT<x>:MASKOffset:PERCENTui:FROM?

**Arguments** PLOT<x> is the plot number.  
  
<NR3> is the allowed range in percentage for the mask to move in the left direction.

**Examples** PLOT:PLOT1:MASKOffset:PERCENTui:FROM 10 sets the mask movement range (From) to 10%.  
  
PLOT:PLOT1:MASKOffset:PERCENTui:FROM? might return  
:PLOT:PLOT1:MASKOffset:PERCENTui:FROM 10.0, indicating the mask movement range (From) is 10%.

## PLOT:PLOT<x>:MASKOffset:PERCENTui:TO

This command sets or queries the allowed range for the mask to move in the right direction. Only applies to eye diagram plots.

**Group** Plot

**Syntax** PLOT:PLOT<x>:MASKOffset:PERCENTui:TO <NR3>  
PLOT:PLOT<x>:MASKOffset:PERCENTui:TO?

**Arguments** PLOT<x> is the plot number.  
  
<NR3> is the allowed range in percentage for the mask to move in the right direction.

**Examples** PLOT:PLOT1:MASKOffset:PERCENTui:TO 10 sets the mask movement range (To) to 10%.  
  
PLOT:PLOT1:MASKOffset:PERCENTui:TO? might return  
:PLOT:PLOT1:MASKOffset:PERCENTui:TO 10.0, indicating the mask movement range (To) is 10%.

## PLOT:PLOT<x>:PTYPE

This command sets or returns the phasor type of the phasor diagram plot.

**Group** Plot

<b>Syntax</b>	<code>PLOT:PLOT&lt;x&gt;:PTYPE {RMS MAGNITUDE}</code> <code>PLOT:PLOT&lt;x&gt;:PTYPE?</code>
<b>Arguments</b>	<code>PLOT&lt;x&gt;</code> is the plot number.  RMS sets the phasor type to RMS.  MAGNITUDE sets the phasor type to MAGNITUDE.
<b>Examples</b>	<code>PLOT:PLOT1:PTYPE?</code> Returns RMS sets the phasor type to RMS.  <code>PLOT:PLOT1:PTYPE?</code> might return <code>:PLOT:PLOT1:PTYPE? RMS</code> indicating the phasor type is RMS.

## PLOT:PLOT<x>:RAILNUM

Sets the DPM histogram source.

<b>Conditions</b>	Requires option 5-DPM (5 Series MSO instruments) or 6-DPM (6 Series MSO instrument)
<b>Group</b>	DPM
<b>Syntax</b>	<code>PLOT:PLOT&lt;x&gt;:RAILNUM RAIL [1-7]</code> <code>PLOT:PLOT&lt;x&gt;:RAILNUM?</code>
<b>Arguments</b>	<code>PLOT&lt;x&gt;</code> is the plot number.  <code>Rail [1-7]</code> is the rail number.
<b>Examples</b>	<code>PLOT:PLOT2:RAILNUM RAIL6</code> sets the DPM histogram source to Rail 6 of plot 2.  <code>PLOT:PLOT5:RAILNUM?</code> might return <code>RAIL1</code> , indicating that the DPM histogram source is Rail 1 of plot 5.

## PLOT:PLOT<x>:SOURCE<x>

This command sets or queries the plot source.

<b>Group</b>	Plot
--------------	------

**Syntax** PLOT:PLOT<x>:SOURCE<x> MEAS<x>  
PLOT:PLOT<x>:SOURCE<x>?

**Arguments** MEAS<x> is the specified measurement source for the specified plot.

**Examples** PLOT:PLOT1:SOURCE1 MEAS2 sets source 1 of plot 1 to measurement 2.  
PLOT:PLOT1:SOURCE1? might return :PLOT:PLOT1:SOURCE1 MEAS1  
indicating the specified source of the specified plot is measurement 1.

## PLOT:PLOT<x>:SPECTrum:BASE

This command sets or queries the spectrum base. Undefined for non-spectrum plots.

**Group** Plot

**Syntax** PLOT:PLOT<x>:SPECTrum:BASE <NR1>  
PLOT:PLOT<x>:SPECTrum:BASE?

**Arguments** <NR1> is the spectrum base.

**Examples** PLOT:PLOT3:SPECTrum:BASE -10 sets the base to -10.  
PLOT:PLOT3:SPECTrum:BASE? might return :PLOT:PLOT3:SPECTRUM:BASE  
-15 indicating the base is -15.

## PLOT:PLOT<x>:SPECTrum:DYNRange

This command sets or queries the dynamic range value.

**Group** Plot

**Syntax** PLOT:PLOT<x>:SPECTrum:DYNRange <NR3>  
PLOT:PLOT<x>:SPECTrum:DYNRange?

**Arguments** <NR3> is the dynamic range value.

**Examples** PLOT:PLOT3:SPECTrum:DYNRange 150 sets the dynamic range to 150 dB.  
 PLOT:PLOT3:SPECTrum:DYNRange? might return  
 :PLOT:PLOT3:SPECTRUM:DYNRANGE 100 indicating the dynamic range  
 is 100 dB.

## PLOT:PLOT<x>:TYPE

This command sets or returns the current plot type of the specified plot.

**Group** Plot

**Syntax** PLOT:PLOT<x>:TYPE  
 {NONE|BATHTUB|EYEDIAGRAM|HARMONICS|HISTOGRAM|  
 IMDATIMETREND|IMDAACQTREND  
 |INDUCTANCE|IVSINTEGRALV|MAGPROPERTY|PHASENOISE|PHASOR  
 |SOA|SPECTRUM|SSCPROFILE|SWL|TIEHISTOGRAM|TIETIMETREND|  
 TIESPECTRUM|TIMETREND|XY|XYZ}

**Arguments** <x> is the plot number. This is the equivalent of the number shown on a plot heading in the UI.

NONE does not create a plot.

BATHTUB creates a bathtub plot.

EYEDIAGRAM creates an eye diagram. This plot type is not available on a 4 Series MSO instrument.

HARMONICS creates a harmonics bar graph.

HISTOGRAM creates a histogram plot.

IMDATIMETREND creates a IMDA time trend plot. This plot type requires option IMDA.

IMDAACQTREND creates a IMDA acq trend plot. This plot type requires option IMDA.

INDUCTANCE creates a inductance plot.

IVSINTEGRALV creates a I vs.  $\int V$  plot.

PHASENOISE creates a phase noise plot.

PHASOR creates the Phasor Diagram. This plot type requires option 5-DPM on MSO58/56 series instruments.

MAGPROPERTY creates a BH curve.

SOA creates an SOA plot.

SPECTRUM creates a spectrum plot.  
SSCPROFILE creates a SSC profile plot.  
SWL creates a Switching Loss plot  
TIEHISTOGRAM creates a TIE histogram plot.  
TIESPECTRUM creates a TIE spectrum plot.  
TIETIMETREND creates a TIE time trend plot.  
TIMETREND creates a time trend plot.  
XY creates a XY plot.  
XYZ creates a XYZ plot.

**Examples** PLOT:PLOT2:TYPE BATHTUB creates a bathtub plot.  
PLOT:PLOT2:TYPE? might return :PLOT:PLOT2:TYPE EYEDIAGRAM  
indicating the plot is an eye diagram.

## POWer:ADDNew (No Query Form)

This command adds the specified power measurement number. The power measurement number is specified by x.

**Conditions** Requires option PWR or PS2.

**Group** Power

**Syntax** POWer:ADDNew "POWER<x>"

**Examples** POWer:ADDNEW "POWER1" adds POWER1 measurement badge and selects Switching Loss measurement by default.

## POWer:DELeTe (No Query Form)

This command deletes the specified power measurement number. The power measurement number is specified by x.

**Conditions** Requires option PWR or PS2.

<b>Group</b>	Power
<b>Syntax</b>	Power:DELEte "POWER<x>"
<b>Examples</b>	POWER:DELETE "POWER1" deletes the POWER1 measurement badge.

## POWer:POWer<x>:AUTOSet (No Query Form)

This command executes power autosest for the specified power measurement number.

<b>Conditions</b>	Requires option PWR or PS2.
<b>Group</b>	Power
<b>Syntax</b>	Power:POWer<x>:AUTOSet EXECute
<b>Arguments</b>	Power<x> is the power measurement number. This is the equivalent of the number shown on a power measurement badge in the UI.
<b>Examples</b>	Power:Power1:AUTOSet EXECute executes the power autosest for the power measurement Power 1.

## POWer:POWer<x>:CLRESPONSE:AMP[1-10]Val

This command sets or queries the generator amplitude value of the specified configuration step for the Control Loop Response power measurement.

<b>Conditions</b>	Requires option 5-PWR or 6-PWR
<b>Group</b>	Power
<b>Syntax</b>	Power:POWer<x>:CLRESPONSE:AMP[1-10]Val <NR3> Power:POWer<x>:CLRESPONSE:AMP[1-10]Val?
<b>Arguments</b>	Power<x> sets the power measurement number. This is the equivalent of the number shown in the UI for a power measurement badge.

AMP[1–10] sets the configuration step number, in the range of 1 to 10. Values outside this range will report an error.

<NR3> sets the generator amplitude for the specified configuration step, in the range of –100 V to 100 V.

**Examples**     `Power:Power1:CLRESPONSE:AMP3V1 20` sets the generator output amplitude for configuration step 3 to 20 volts, for power measurement 1.

`Power:Power2:CLRESPONSE:AMP8V1?` might return 60, indicating that the generator output amplitude setting of configuration step 8 is 60 volts, for power measurement 2.

## POWER:POWER<x>:CLRESPONSE:AMPMode

This command sets or queries the amplitude mode for the Control Loop Response power measurement.

**Conditions**     Requires option 5-PWR or 6-PWR

**Group**     Power

**Syntax**     `Power:Power<x>:CLRESPONSE:AMPMode {CONSTant|PROFile}`  
`Power:Power<x>:CLRESPONSE:AMPMode?`

**Arguments**     `Power<x>` is the power measurement number. This is the equivalent of the number shown in the UI for a power measurement badge.

`CONSTant` sets the amplitude mode to output a constant amplitude signal from the DUT stimulus generator for all frequency bands.

`PROFile` enables configuring the generator to set amplitude values for each frequency band.

**Examples**     `Power:Power1:CLRESPONSE:AMPMode Constant` sets the amplitude mode to Constant for power measurement 1.

`Power:Power2:CLRESPONSE:AMPMode?` might return `PROFile`, indicating that the amplitude mode power measurement 2 is set to Profile.



## POWer:POWer<x>:CLRESPONSE:ANALYSISMethod

This command sets or queries the Analysis Method for Control Loop Response measurement.

<b>Group</b>	Power
<b>Syntax</b>	<code>POWer:POWer&lt;x&gt;:CLRESPONSE:ANALYSISMethod {SV FFT}</code> <code>POWer:POWer&lt;x&gt;:CLRESPONSE:ANALYSISMethod?</code>
<b>Arguments</b>	<p><code>Power&lt;x&gt;</code> is the power measurement number. This is the equivalent of the number shown in the UI for a power measurement badge.</p> <p><code>SV</code> sets the Analysis Method as Spectrum View.</p> <p><code>FFT</code> sets the Analysis Method as FFT.</p>
<b>Examples</b>	<p><code>POWer:POWer1:CLRESPONSE:ANALYSISMethod SV</code> sets the Analysis Method as Spectrum View for power measurement 1.</p> <p><code>POWer:POWer1:CLRESPONSE:ANALYSISMethod?</code> might return <code>:POWer:POWer1:CLRESPONSE:ANALYSISMethod SV</code>, indicating that the Analysis Method is Spectrum View.</p>

## POWer:POWer<x>:CLRESPONSE:AUTORbw

This command enables Auto RBW computation.

<b>Group</b>	Power
<b>Syntax</b>	<code>POWer:POWer&lt;x&gt;:CLRESPONSE:AUTORbw {True False}</code> <code>POWer:POWer&lt;x&gt;:CLRESPONSE:AUTORbw?</code>
<b>Arguments</b>	<p><code>Power&lt;x&gt;</code> is the power measurement number. This is the equivalent of the number shown in the UI for a power measurement badge.</p> <p><code>True</code> enables Auto RBW computation.</p> <p><code>False</code> disables Auto RBW computation.</p>

**Examples**     `Power:Power1:CLRESPONSE:AUTORbw true` enables Auto RBW computation.  
`Power:Power1:CLRESPONSE:AUTORbw?` might return  
`:Power:Power1:CLRESPONSE:AUTORbw true`, indicating that  
Auto RBW computation is enabled.

## **POWER:POWER<x>:CLRESPONSE:CONNECTSTATUS? (Query Only)**

Queries connection status to the external generator used with the specified Control Loop Response power measurement.

**Conditions**     Requires option 5-PWR (5 Series MSO instruments) or 6-PWR (6 Series MSO instrument)

**Group**     Power

**Syntax**     `Power:Power<x>:CLRESPONSE:CONNECTSTATUS?`

**Related Commands**     [POWER:POWER<x>:CLRESPONSE:GENIPADDRESS](#)  
[POWER:POWER<x>:CLRESPONSE:GENERATOR](#)

**Arguments**     `Power<x>` is the number of the power measurement.

**Returns**     `SUCCESS` indicates the instrument recognizes the connection to the external generator.  
`FAILURE` indicates the instrument could not make the connection to the external generator.  
`UNSUPPORTED` indicates that the connected generator is not recognized.

**Examples**     `Power:Power<x>:CLRESPONSE:CONNECTSTATUS?` might return `FAILURE`, indicating that the instrument could not connect to the external generator at the specified IP address.

## **POWER:POWER<x>:CLRESPONSE:CONSTAMPLITUDE**

This command sets or queries the constant amplitude voltage for the Control Loop Response power measurement.

<b>Conditions</b>	Requires option 5-PWR or 6-PWR
<b>Group</b>	Power
<b>Syntax</b>	<pre>Power:Power&lt;x&gt;:CLRESPONSE:CONSTAMPLitude &lt;NR3&gt; Power:Power&lt;x&gt;:CLRESPONSE:CONSTAMPLitude?</pre>
<b>Arguments</b>	<p>Power&lt;x&gt; is the power measurement number. This is the equivalent of the number shown in the UI for a power measurement badge.</p> <p>&lt;NR3&gt; is the constant amplitude voltage value for the measurement, in the range of -100 V to 100 V.</p>
<b>Examples</b>	<p>Power:Power3:CLRESPONSE:CONSTAMPLitude 120 sets the constant amplitude voltage for Power measurement 3 to be 120 volts.</p> <p>Power:Power5:CLRESPONSE:CONSTAMPLitude? might return -15, indicating that the constant amplitude voltage for power measurement 5 is -15 volts.</p>

## POWER:POWER<x>:CLRESPONSE:FREQ[1-11]Val

This command sets or queries the generator frequency value of the specified configuration step for the Control Loop Response power measurement.

<b>Conditions</b>	Requires option 5-PWR or 6-PWR
<b>Group</b>	Power
<b>Syntax</b>	<pre>Power:Power&lt;x&gt;:CLRESPONSE:FREQ[1-11]Val &lt;NR3&gt; Power:Power&lt;x&gt;:CLRESPONSE:FREQ[1-11]Val?</pre>
<b>Arguments</b>	<p>Power&lt;x&gt; sets the power measurement number. This is the equivalent of the number shown in the UI for a power measurement badge.</p> <p>FREQ[1-11] sets the configuration step number, in the range of 1 to 11. Values outside this range will report an error.</p> <p>&lt;NR3&gt; sets the frequency of the specified configuration step number, in the range of 10 Hz to 50 MHz.</p>
<b>Examples</b>	<p>Power:Power5:CLRESPONSE:FREQ1Val 200 sets the generator frequency value for frequency band 1 to 200 Hz, for power measurement 5.</p>

`Power:Power2:CLRESPONSE:FREQ3Va1?` might return `2.000E+6`, indicating that the generator frequency output for frequency band 3 is 2.0 MHz, for power measurement 2.

## **POWER:POWER<x>:CLRESPONSE:GENERATOR**

This command sets or queries the generator source used to send stimulus signals to the DUT, for the Control Loop Response power measurement.

<b>Conditions</b>	Requires option 5-PWR or 6-PWR
<b>Group</b>	Power
<b>Syntax</b>	<code>Power:Power&lt;x&gt;:CLRESPONSE:GENERATOR {INTERNAL}</code> <code>Power:Power&lt;x&gt;:CLRESPONSE:GENERATOR?</code>
<b>Arguments</b>	<p><code>Power&lt;x&gt;</code> is the power measurement number. This is the equivalent of the number shown in the UI for a power measurement badge.</p> <p><code>INTERNAL</code> sets the generator to the instrument AFG. This is the only valid argument.</p>
<b>Examples</b>	<p><code>Power:Power3:CLRESPONSE:GENERATOR INTERNAL</code> sets the generator to the instrument AFG for power measurement 3.</p> <p><code>Power:Power2:CLRESPONSE:GENERATOR?</code> might return <code>INTERNAL</code>, indicating that the generator source for power measurement 2 is the instrument AFG.</p>

## **POWER:POWER<x>:CLRESPONSE:GENERATOR**

Sets or queries the generator source for the specified Control Loop Response power measurement.

<b>Conditions</b>	Requires option 5-PWR (5 Series MSO instruments) or 6-PWR (6 Series MSO instrument)
<b>Group</b>	Power
<b>Syntax</b>	<code>Power:Power&lt;x&gt;:CLRESPONSE:GENERATOR {INTERNAL EXTERNAL}</code> <code>Power:Power&lt;x&gt;:CLRESPONSE:GENERATOR?</code>

<b>Arguments</b>	<p><code>Power&lt;x&gt;</code> is the number of the power measurement. <code>INTernal</code> sets the internal generator as the source for the Control Loop Response power measurement.</p> <p><code>EXternal</code> sets the external generator as the source for the Control Loop Response power measurement.</p>
<b>Examples</b>	<p><code>POWER:Power1:CLRESPONSE:Generator Internal</code> sets the internal generator as the source for the Control Loop Response measurement.</p> <p><code>POWER:Power1:CLRESPONSE:Generator?</code> might return <code>EXTERNAL</code>, indicating that the Control Loop Response measurement is set to use an external generator.</p>

## **POWER:POWER<x>:CLRESPONSE:GENIPADDRESS**

Sets or queries the IP address of the external generator to be used with the specified Control Loop Response measurement.

<b>Conditions</b>	Requires option 5-PWR (5 Series MSO instruments) or 6-PWR (6 Series MSO instrument)
<b>Group</b>	Power
<b>Syntax</b>	<p><code>POWER:Power&lt;x&gt;:CLRESPONSE:GENIPADDRESS &lt;NR2&gt;</code></p> <p><code>POWER:Power&lt;x&gt;:CLRESPONSE:GENIPADDRESS?</code></p>
<b>Arguments</b>	<code>Power&lt;x&gt;</code> is the number of the power measurement. <code>&lt;NR2&gt;</code> is the IP address of the generator.
<b>Examples</b>	<p><code>POWER:Power4:CLRESPONSE:GENIPADDRESS 127.1.1.1</code> sets the IP address of the external generator to 127.1.1.1.</p> <p><code>POWER:Power1:CLRESPONSE:GENIPADDRESS?</code> might return "", indicating that there is no address set for the external generator associated with Control Loop Response power measurement 4.</p>

## **POWER:POWER<x>:CLRESPONSE:IMPEDANCE**

This command sets or queries the vertical termination impedance for the Control Loop Response power measurement.

<b>Conditions</b>	Requires option 5-PWR or 6-PWR
-------------------	--------------------------------

<b>Group</b>	Power
<b>Syntax</b>	<pre>Power:Power&lt;x&gt;:CLRESPONSE:IMPEDance {FIFTy HIGHZ} Power:Power&lt;x&gt;:CLRESPONSE:IMPEDance?</pre>
<b>Arguments</b>	<p>Power&lt;x&gt; is the power measurement number. This is the equivalent of the number shown in the UI for a power measurement badge.</p> <p>FIFTy sets the impedance to be 50 <math>\Omega</math>.</p> <p>HIGHZ sets the impedance to be 1 M<math>\Omega</math>.</p>
<b>Examples</b>	<p>Power:Power3:CLRESPONSE:IMPEDance FIFTy sets the vertical termination impedance for power measurement 3 to be 50 <math>\Omega</math>.</p> <p>Power:Power2:CLRESPONSE:IMPEDance? might return HIGHZ, indicating that the vertical termination impedance for power measurement 2 is 1 M<math>\Omega</math>.</p>

## POWER:POWER<x>:CLRESPONSE:INPUTSource

This command sets or queries the input source for the Control Loop Response power measurement.

<b>Conditions</b>	Requires option 5-PWR or 6-PWR
<b>Group</b>	Power
<b>Syntax</b>	<pre>Power:Power&lt;x&gt;:CLRESPONSE:INPUTSource CH&lt;x&gt; Power:Power&lt;x&gt;:CLRESPONSE:INPUTSource?</pre>
<b>Arguments</b>	<p>Power&lt;x&gt; is the power measurement number. This is the equivalent of the number shown in the UI for a power measurement badge.</p> <p>CH&lt;x&gt; sets the channel to use for the output signal source.</p>
<b>Examples</b>	<p>Power:Power2:CLRESPONSE:INPUTSource CH8 sets the input for power measurement 2 to be the channel 8 waveform.</p> <p>Power:Power2:CLRESPONSE:INPUTSource? might return CH1, indicating that the input source for power measurement 1 is channel 1.</p>

## POWer:POWer<x>:CLRESPONSE:MON

This command sets or returns the measure on for the control loop response, PSRR or impedance measurement.

<b>Conditions</b>	Requires option 5-PWR or 6-PWR
<b>Group</b>	Power
<b>Syntax</b>	POWer:POWer<x>:CLRESPONSE:MON {SAVG SSEQ} POWer:POWer<x>:CLRESPONSE:MON?
<b>Arguments</b>	<p>Power&lt;x&gt; is the power measurement number. This is the equivalent of the number shown in the UI for a power measurement badge.</p> <p>SAVG specifies the measure analysis method for the Control Loop Response/PSRR or Impedance measurement to SAVG.</p> <p>SSEQ specifies the measure analysis method for the Control Loop Response/PSRR or Impedance measurement to SSEQ.</p>
<b>Examples</b>	<p>POWer:POWer2:CLRESPONSE:INPUTSource SSEQ sets the measure analysis method for the Control Loop Response/PSRR or Impedance measurement to SSEQ.</p> <p>POWer:POWer2:CLRESPONSE:INPUTSource? might return :POWer:POWer2:CLRESPONSE:INPUTSource SSEQ, indicating that the measure analysis method for the Control Loop Response/PSRR or Impedance measurement is SSEQ.</p>

## POWer:POWer<x>:CLRESPONSE:OUTPUTSource

This command sets or queries the output source for the Control Loop Response power measurement.

<b>Conditions</b>	Requires option 5-PWR or 6-PWR
<b>Group</b>	Power
<b>Syntax</b>	POWer:POWer<x>:CLRESPONSE:OUTPUTSource CH<x> POWer:POWer<x>:CLRESPONSE:OUTPUTSource?

<b>Arguments</b>	<p>Power&lt;x&gt; is the power measurement number. This is the equivalent of the number shown in the UI for a power measurement badge.</p> <p>CH&lt;x&gt; sets the channel to use for the output signal source.</p>
<b>Examples</b>	<p>Power:Power1:CLRESPONSE:OUTPUTSource CH5 sets the output source for power measurement 1 to be the channel 5 waveform.</p> <p>Power:Power3:CLRESPONSE:OUTPUTSource? might return CH6, indicating that the output source for power measurement 3 is channel 6.</p>

## POWER:POWER<x>:CLRESPONSE:PPD

This command sets or queries the points per decade (PPD) value for the Control Loop Response power measurement.

<b>Conditions</b>	Requires option 5-PWR or 6-PWR
<b>Group</b>	Power
<b>Syntax</b>	Power:Power<x>:CLRESPONSE:PPD <NR3> Power:Power<x>:CLRESPONSE:PPD?
<b>Arguments</b>	<p>Power&lt;x&gt; is the power measurement number. This is the equivalent of the number shown in the UI for a power measurement badge.</p> <p>&lt;NR3&gt; is the PPD value for the measurement, in the range of 10 to 100 points.</p>
<b>Examples</b>	<p>Power:Power3:CLRESPONSE:PPD 30 sets the PPD for Power measurement 3 to be 30 points.</p> <p>Power:Power5:CLRESPONSE:PPD? might return 20, indicating that the PPD value for power measurement 5 is 20 points.</p>

## POWER:POWER<x>:CLRESPONSE:STARTFREQUENCY

This command sets or queries the start frequency value for the Control Loop Response power measurement.

<b>Conditions</b>	Requires option 5-PWR or 6-PWR
-------------------	--------------------------------



<b>Group</b>	Power
<b>Syntax</b>	<pre>Power:Power&lt;x&gt;:CLRESPONSE:STARTFREQUENCY &lt;NR3&gt; Power:Power&lt;x&gt;:CLRESPONSE:STARTFREQUENCY?</pre>
<b>Arguments</b>	<p>Power&lt;x&gt; is the power measurement number. This is the equivalent of the number shown in the UI for a power measurement badge.</p> <p>&lt;NR3&gt; is the starting frequency for the measurement, in the range of 10 Hz to 50 MHz.</p>
<b>Examples</b>	<p>Power:Power8:CLRESPONSE:STARTFREQUENCY 12 sets the starting frequency for power measurement 8 to be 12 Hz.</p> <p>Power:Power3:CLRESPONSE:STARTFREQUENCY? might return 2400, indicating that the starting frequency for power measurement 3 is 2400 Hz.</p>

## POWER:POWER<x>:CLRESPONSE:STOPFREQUENCY

This command sets or queries the stop frequency value for the Control Loop Response power measurement.

<b>Conditions</b>	Requires option 5-PWR or 6-PWR
<b>Group</b>	Power
<b>Syntax</b>	<pre>Power:Power&lt;x&gt;:CLRESPONSE:STOPFREQUENCY &lt;NR3&gt; Power:Power&lt;x&gt;:CLRESPONSE:STOPFREQUENCY?</pre>
<b>Arguments</b>	<p>Power&lt;x&gt; is the power measurement number. This is the equivalent of the number shown in the UI for a power measurement badge.</p> <p>&lt;NR3&gt; is the stop frequency for the measurement, in the range of 10 Hz to 50 MHz.</p>
<b>Examples</b>	<p>Power:Power3:CLRESPONSE:STOPFREQUENCY 120 sets the stop frequency for the control loop response power measurement 8 to be 120 Hz.</p> <p>Power:Power5:CLRESPONSE:STOPFREQUENCY? might return 2000, indicating that the stop frequency for the control loop response power measurement 5 is 2000 Hz.</p>

## POWER:POWER<x>:CLRESPONSE:TESTCONNECTION (No Query Form)

This command tests the connection to the external generator used with the specified Control Loop Response power measurement.

<b>Conditions</b>	Requires option 5-PWR (5 Series MSO instruments) or 6-PWR (6 Series MSO instrument)
<b>Group</b>	Power
<b>Syntax</b>	POWER:POWER<x>:CLRESPONSE:TESTCONNECTION EXECUTE
<b>Related Commands</b>	<a href="#">POWER:POWER&lt;x&gt;:CLRESPONSE:CONNECTSTATUS?</a> <a href="#">POWER:POWER&lt;x&gt;:CLRESPONSE:GENIPADDRESS</a>
<b>Arguments</b>	POWER<x> is the number of the PSRR power measurement. EXECUTE runs the test connection function.
<b>Examples</b>	POWER:POWER5:CLRESPONSE:TESTCONNECTION EXECUTE runs the test connection function for Control Loop Response power measurement 5.

## POWER:POWER<x>:CYCLEAMP:INPUTSOURCE

This command sets or queries the input source for cycle amplitude measurement of the specified power measurement number.

<b>Conditions</b>	Requires option PWR or PS2.
<b>Group</b>	Power
<b>Syntax</b>	POWER:POWER<x>:CYCLEAMP:INPUTSOURCE {S<x>_Ch<x> CH<x> MATH<x> REF<x>} POWER:POWER<x>:CYCLEAMP:INPUTSOURCE?
<b>Arguments</b>	POWER<x> is the power measurement number. This is the equivalent of the number shown on a power measurement badge in the UI. S<x>_Ch<x> specifies the remote scope number and the analog channel.

CH<x> = A channel specifier; <x> is 1 through 8 and is limited by the number of FlexChannels in your instrument.

MATH<x> = A math waveform specifier; <x> is  $\geq 1$ .

REF<x> = A reference waveform specifier; <x> is  $\geq 1$ .

**Examples**    `Power:Power1:CYCAmp:INPUTSource CH1` sets the input source for cycle amplitude measurement as CH1 for the power measurement badge Power 1.

## POWer:POWer<x>:CYCLEBase:INPUTSource

This command sets or queries the input source for cycle base measurement of the specified power measurement number.

**Conditions**    Requires option PWR or PS2.

**Group**        Power

**Syntax**       `Power:Power<x>:CYCLEBase:INPUTSource`  
                   `{S<x>_Ch<x> | CH<x> | MATH<x> | REF<x>}`  
                   `Power:Power<x>:CYCLEBase:INPUTSource?`

**Arguments**    `Power<x>` is the power measurement number. This is the equivalent of the number shown on a power measurement badge in the UI.

`S<x>_Ch<x>` specifies the remote scope number and the analog channel.

CH<x> = A channel specifier; <x> is 1 through 8 and is limited by the number of FlexChannels in your instrument.

MATH<x> = A math waveform specifier; <x> is  $\geq 1$ .

REF<x> = A reference waveform specifier; <x> is  $\geq 1$ .

**Examples**    `Power:Power1:CYCLEBase:INPUTSource CH2` sets the input source for cycle base measurement as CH2 for the power measurement badge Power 1.

## POWer:POWer<x>:CYCLEMAX:INPUTSource

This command sets or queries the input source for cycle maximum measurement in the specified power measurement number.

<b>Conditions</b>	Requires option PWR or PS2.
<b>Group</b>	Power
<b>Syntax</b>	<pre>Power:Power&lt;x&gt;:CYCLEMAX:INPUTSource {S&lt;x&gt;_Ch&lt;x&gt; CH&lt;x&gt; MATH&lt;x&gt; REF&lt;x&gt;} Power:Power&lt;x&gt;:CYCLEMAX:INPUTSource?</pre>
<b>Arguments</b>	<p>Power&lt;x&gt; is the power measurement number. This is the equivalent of the number shown on a power measurement badge in the UI.</p> <p>S&lt;x&gt;_Ch&lt;x&gt; specifies the remote scope number and the analog channel.</p> <p>CH&lt;x&gt; = A channel specifier; &lt;x&gt; is 1 through 8 and is limited by the number of FlexChannels in your instrument.</p> <p>MATH&lt;x&gt; = A math waveform specifier; &lt;x&gt; is <math>\geq 1</math>.</p> <p>REF&lt;x&gt; = A reference waveform specifier; &lt;x&gt; is <math>\geq 1</math>.</p>
<b>Examples</b>	<pre>Power:Power1:CYCMAx:INPUTSource CH2</pre> <p>sets the input source for cycle maximum measurement as CH2 for the power measurement badge Power 1.</p>

## POWER:POWER<x>:CYCLEMin:INPUTSource

This command sets or queries the input source for cycle minimum measurement in the specified power measurement number.

<b>Conditions</b>	Requires option PWR or PS2.
<b>Group</b>	Power
<b>Syntax</b>	<pre>Power:Power&lt;x&gt;:CYCLEMin:INPUTSource {S&lt;x&gt;_Ch&lt;x&gt; CH&lt;x&gt; MATH&lt;x&gt; REF&lt;x&gt;} Power:Power&lt;x&gt;:CYCLEMin:INPUTSource?</pre>
<b>Arguments</b>	<p>Power&lt;x&gt; is the power measurement number. This is the equivalent of the number shown on a power measurement badge in the UI.</p> <p>S&lt;x&gt;_Ch&lt;x&gt; specifies the remote scope number and the analog channel.</p> <p>CH&lt;x&gt; = A channel specifier; &lt;x&gt; is 1 through 8 and is limited by the number of FlexChannels in your instrument.</p>

MATH<x> = A math waveform specifier; <x> is  $\geq 1$ .

REF<x> = A reference waveform specifier; <x> is  $\geq 1$ .

**Examples** `Power:Power1:CYCMin:INPUTSource CH2` sets the input source for cycle minimum measurement as CH2 for the power measurement badge Power 1.

## POWER:POWER<x>:CYCLEPKPK:INPUTSource

This command sets or queries the input source for cycle peak-to-peak measurement in the specified power measurement number.

**Conditions** Requires option PWR or PS2.

**Group** Power

**Syntax** `Power:Power<x>:CYCLEPKPK:INPUTSource`  
`{S<x>_Ch<x> | CH<x> | MATH<x> | REF<x>}`  
`Power:Power<x>:CYCLEPKPK:INPUTSource?`

**Arguments** `Power<x>` is the power measurement number. This is the equivalent of the number shown on a power measurement badge in the UI.

`S<x>_Ch<x>` specifies the remote scope number and the analog channel.

`CH<x>` = A channel specifier; <x> is 1 through 8 and is limited by the number of FlexChannels in your instrument.

`MATH<x>` = A math waveform specifier; <x> is  $\geq 1$ .

`REF<x>` = A reference waveform specifier; <x> is  $\geq 1$ .

**Examples** `Power:Power1:CYCPKPK:INPUTSource REF1` sets the input source for cycle peak-to-peak measurement as REF1 for the power measurement badge Power 1.

## POWER:POWER<x>:CYCLETop:INPUTSource

This command sets or queries the input source for cycle top measurement in the specified power measurement number.

**Conditions** Requires option PWR or PS2.

<b>Group</b>	Power
<b>Syntax</b>	<pre>Power:Power&lt;x&gt;:CYCLETop:INPUTSource {S&lt;x&gt;_Ch&lt;x&gt; CH&lt;x&gt; MATH&lt;x&gt; REF&lt;x&gt;} Power:Power&lt;x&gt;:CYCLETop:INPUTSource?</pre>
<b>Arguments</b>	<p>Power&lt;x&gt; is the power measurement number. This is the equivalent of the number shown on a power measurement badge in the UI.</p> <p>S&lt;x&gt;_Ch&lt;x&gt; specifies the remote scope number and the analog channel.</p> <p>CH&lt;x&gt; = A channel specifier; &lt;x&gt; is 1 through 8 and is limited by the number of FlexChannels in your instrument.</p> <p>MATH&lt;x&gt; = A math waveform specifier; &lt;x&gt; is <math>\geq 1</math>.</p> <p>REF&lt;x&gt; = A reference waveform specifier; &lt;x&gt; is <math>\geq 1</math>.</p>
<b>Examples</b>	<pre>Power:Power1:CYCTop:INPUTSource REF3</pre> <p>sets the input source for cycle top measurement as REF3 for the power measurement badge Power 1.</p>

## POWER:POWER<x>:DIDT:INPUTSource

This command sets or queries the input source for di/dt measurement in the specified power measurement number.

<b>Conditions</b>	Requires option PWR or PS2.
<b>Group</b>	Power
<b>Syntax</b>	<pre>Power:Power&lt;x&gt;:DIDT:INPUTSource {S&lt;x&gt;_Ch&lt;x&gt; CH&lt;x&gt; MATH&lt;x&gt; REF&lt;x&gt;} Power:Power&lt;x&gt;:DIDT:INPUTSource?</pre>
<b>Arguments</b>	<p>Power&lt;x&gt; is the power measurement number. This is the equivalent of the number shown on a power measurement badge in the UI.</p> <p>S&lt;x&gt;_Ch&lt;x&gt; specifies the remote scope number and the analog channel.</p> <p>CH&lt;x&gt; = A channel specifier; &lt;x&gt; is 1 through 8 and is limited by the number of FlexChannels in your instrument.</p> <p>MATH&lt;x&gt; = A math waveform specifier; &lt;x&gt; is <math>\geq 1</math>.</p> <p>REF&lt;x&gt; = A reference waveform specifier; &lt;x&gt; is <math>\geq 1</math>.</p>

**Examples** `Power:Power1:DIDT:INPUTSource CH6` sets the input source for di/dt measurement as channel 2.

## POWer:POWer<x>:DIDT:SOURCEEDGEType

This command sets or queries the edge type for di/dt measurement of the specified power measurement number. <x> specifies the number of the power measurement badge.

**Conditions** Requires option PWR or PS2.

**Group** Power

**Syntax** `Power:Power<x>:DIDT:SOURCEEDGEType {RISE|FALL}`  
`Power:Power<x>:DIDT:SOURCEEDGEType?`

**Examples** `Power:Power1:DIDT:SOURCEEDGEType RISE` sets the edge type as rise for the di/dt measurement.

## POWer:POWer<x>:DVDT:INPUTSource

This command sets or queries the input source for dv/dt measurement of the specified power measurement number.

**Conditions** Requires option PWR or PS2.

**Group** Power

**Syntax** `Power:Power<x>:DVDT:INPUTSource`  
`{S<x>_Ch<x>|CH<x>|MATH<x>|REF<x>}`  
`Power:Power<x>:DVDT:INPUTSource?`

**Arguments** `Power<x>` is the power measurement number. This is the equivalent of the number shown on a power measurement badge in the UI.

`S<x>_Ch<x>` specifies the remote scope number and the analog channel.

`CH<x>` = A channel specifier; <x> is 1 through 8 and is limited by the number of FlexChannels in your instrument.

`MATH<x>` = A math waveform specifier; <x> is  $\geq 1$ .

REF<x> = A reference waveform specifier; <x> is  $\geq 1$ .

**Examples**     `Power:Power1:DVDT:INPUTSource CH1` sets the input source for dv/dt measurement as channel 1.

## POWER:POWER<x>:DVDT:SOURCEEDGEType

This command sets or queries the edge type for dv/dt measurement in the specified power measurement number. The power measurement number is specified by x.

**Conditions**     Requires option PWR or PS2.

**Group**     Power

**Syntax**     `Power:Power<x>:DVDT:SOURCEEDGEType {RISE|FALL}`  
`Power:Power<x>:DVDT:SOURCEEDGEType?`

**Examples**     `Power:Power1:DVDT:SOURCEEDGEType RISE` sets the edge type as rise for the dv/dt measurement.

## POWER:POWER<x>:EFFICIENCY:INPUTType

This command sets or queries the input type (AC or DC) for power Efficiency measurement of the specified power measurement number.

**Conditions**     Requires option PWR or PS2.

**Group**     Power

**Syntax**     `Power:Power<x>:EFFICIENCY:INPUTType {AC|DC}`  
`Power:Power<x>:EFFICIENCY:INPUTType?`

**Related Commands**     [POWER:POWER<x>:EFFICIENCY:OUTPUT1Type](#)

**Arguments**     `Power<x>` is the number of a power efficiency measurement. This is the equivalent of the number shown on the power measurement badge of the UI.  
`AC` sets the input voltage type to AC.



DC sets the input voltage type to DC.

**Examples** `Power:Power1:EFFICIENCY:INPUTType DC` sets the input voltage type to DC for power Efficiency measurement 1

`Power:Power2:EFFICIENCY:INPUTType?` might return AC, indicating that the input voltage type for power Efficiency measurement 2 is AC.

## POWER:POWER<x>:EFFICIENCY:IOUT1SOURCE

This command sets or queries the output 1 current source for the power Efficiency measurement of the specified power measurement number.

**Conditions** Requires option PWR or PS2.

**Group** Power

**Syntax** `Power:Power<x>:EFFICIENCY:IOUT1SOURCE`  
`{S<x>_Ch<x> | CH<x> | MATH<x> | REF<x>}`  
`Power:Power<x>:EFFICIENCY:IOUT1SOURCE?`

**Related Commands** [POWER:POWER<x>:EFFICIENCY:IOUT2SOURCE](#)  
[POWER:POWER<x>:EFFICIENCY:IOUT3SOURCE](#)

**Arguments** `Power<x>` is the number of a power efficiency measurement. This is the equivalent of the number shown in the power measurement badge on the UI.

`S<x>_Ch<x>` specifies the remote scope number and the analog channel.

`CH<x>` = A channel specifier; `<x>` is 1 through 8 and is limited by the number of FlexChannels in your instrument.

`MATH<x>` = A math waveform specifier; `<x>` is  $\geq 1$ .

`REF<x>` = A reference waveform specifier; `<x>` is  $\geq 1$ .

**Examples** `Power:Power1:EFFICIENCY:IOUT1SOURCE CH4` sets the source for the output 1 current efficiency measurement of power measurement 1 to Channel 4.

`Power:Power1:EFFICIENCY:IOUT1SOURCE?` might return CH6, indicating that the source for the output 1 current efficiency measurement of power measurement 1 is Channel 6.

## POWer:POWer<x>:EFFICIENCY:IOUT2SOUrce

This command sets or queries the output 2 current source for the power Efficiency measurement of the specified power measurement number.

<b>Conditions</b>	Requires option PWR or PS2.
<b>Group</b>	Power
<b>Syntax</b>	<pre>POWer:POWer&lt;x&gt;:EFFICIENCY:IOUT2SOUrce {S&lt;x&gt;_Ch&lt;x&gt; CH&lt;x&gt; MATH&lt;x&gt; REF&lt;x&gt;} POWer:POWer&lt;x&gt;:EFFICIENCY:IOUT2SOUrce?</pre>
<b>Related Commands</b>	<p><a href="#">POWer:POWer&lt;x&gt;:EFFICIENCY:IOUT1SOUrce</a></p> <p><a href="#">POWer:POWer&lt;x&gt;:EFFICIENCY:IOUT3SOUrce</a></p>
<b>Arguments</b>	<p>Power&lt;x&gt; is the number of a power efficiency measurement. This is the equivalent of the number shown in the power measurement badge on the UI.</p> <p>S&lt;x&gt;_Ch&lt;x&gt; specifies the remote scope number and the analog channel.</p> <p>CH&lt;x&gt; = A channel specifier; &lt;x&gt; is 1 through 8 and is limited by the number of FlexChannels in your instrument.</p> <p>MATH&lt;x&gt; = A math waveform specifier; &lt;x&gt; is <math>\geq 1</math>.</p> <p>REF&lt;x&gt; = A reference waveform specifier; &lt;x&gt; is <math>\geq 1</math>.</p>
<b>Examples</b>	<p>POWer:POWer3:EFFICIENCY:IOUT2SOUrce REF2 sets the source for the output 2 current efficiency measurement of power measurement 3 to Reference waveform 2.</p> <p>POWer:POWer1:EFFICIENCY:IOUT2SOUrce? might return MATH1, indicating that the source for the output 2 current efficiency measurement of power measurement 1 is Math waveform 1.</p>

## POWer:POWer<x>:EFFICIENCY:IOUT3SOUrce

This command sets or queries the output 3 current source for the power Efficiency measurement of the specified power measurement number.

<b>Conditions</b>	Requires option PWR or PS2.
-------------------	-----------------------------

<b>Group</b>	Power
<b>Syntax</b>	<pre>Power:Power&lt;x&gt;:EFFICIENCY:IOUT3SOURCE {S&lt;x&gt;_Ch&lt;x&gt; CH&lt;x&gt; MATH&lt;x&gt; REF&lt;x&gt;} Power:Power&lt;x&gt;:EFFICIENCY:IOUT3SOURCE?</pre>
<b>Related Commands</b>	<pre>POWER:POWER&lt;x&gt;:EFFICIENCY:IOUT1SOURCE POWER:POWER&lt;x&gt;:EFFICIENCY:IOUT2SOURCE</pre>
<b>Arguments</b>	<p>Power&lt;x&gt; is the number of a power efficiency measurement. This is the equivalent of the number shown on the power measurement badge in the UI.</p> <p>S&lt;x&gt;_Ch&lt;x&gt; specifies the remote scope number and the analog channel.</p> <p>CH&lt;x&gt; = A channel specifier; &lt;x&gt; is 1 through 8 and is limited by the number of FlexChannels in your instrument.</p> <p>MATH&lt;x&gt; = A math waveform specifier; &lt;x&gt; is <math>\geq 1</math>.</p> <p>REF&lt;x&gt; = A reference waveform specifier; &lt;x&gt; is <math>\geq 1</math>.</p>
<b>Examples</b>	<pre>Power:Power1:EFFICIENCY:IOUT3SOURCE REF2</pre> <p>sets the source for the output 3 current efficiency measurement of power measurement 1 to Reference waveform 2.</p> <pre>Power:Power4:EFFICIENCY:IOUT3SOURCE?</pre> <p>might return CH8, indicating that the source for the output 3 current efficiency measurement of power measurement 4 is Channel 8.</p>

## POWER:POWER<x>:EFFICIENCY:ISOURCE

This command sets or queries the current source for the power Efficiency measurement of the specified power measurement number.

<b>Conditions</b>	Requires option PWR or PS2.
<b>Group</b>	Power
<b>Syntax</b>	<pre>Power:Power&lt;x&gt;:EFFICIENCY:ISOURCE {CH&lt;x&gt; MATH&lt;x&gt; REF&lt;x&gt;} Power:Power&lt;x&gt;:EFFICIENCY:ISOURCE?</pre>
<b>Related Commands</b>	<a href="#">POWER:POWER&lt;x&gt;:EFFICIENCY:VSOURCE</a>

**Arguments**     `Power<x>` is the number of a power efficiency measurement. This is the equivalent of the number shown in the power measurement badge on the UI.

`CH<x>` = A channel specifier; `<x>` is 1 through 8 and is limited by the number of FlexChannels in your instrument.

`MATH<x>` = A math waveform specifier; `<x>` is  $\geq 1$ .

`REF<x>` = A reference waveform specifier; `<x>` is  $\geq 1$ .

**Examples**     `Power:Power1:EFFICIENCY:ISOURCE CH2` sets the input current source for power Efficiency measurement 1 to Channel 2.

`Power:Power6:EFFICIENCY:ISOURCE?` might return CH2, indicating that the input current source for power Efficiency measurement 6 is Channel 2.

## POWER:POWER<x>:EFFICIENCY:NUMOFOutputs

This command sets or queries the number of outputs for the power Efficiency measurement of the specified power measurement number.

**Conditions**     Requires option PWR or PS2.

**Group**            Power

**Syntax**           `Power:Power<x>:EFFICIENCY:NUMOFOutputs {ONE|TWO|THREE}`  
`Power:Power<x>:EFFICIENCY:NUMOFOutputs?`

**Related Commands**     [POWER:POWER<x>:EFFICIENCY:IOUT1SOURCE](#)  
[POWER:POWER<x>:EFFICIENCY:IOUT2SOURCE](#)  
[POWER:POWER<x>:EFFICIENCY:IOUT3SOURCE](#)  
[POWER:POWER<x>:EFFICIENCY:VOUT1SOURCE](#)  
[POWER:POWER<x>:EFFICIENCY:VOUT2SOURCE](#)  
[POWER:POWER<x>:EFFICIENCY:VOUT3SOURCE](#)

**Arguments**     `Power<x>` is the number of a power efficiency measurement. This is the equivalent of the number shown in the power measurement badge on the UI.

`ONE, TWO, THREE` sets the number of outputs to test in the power efficiency measurement.

**Examples** `Power:Power4:EFFICIENCY:NUMOFOutputs TWO` sets the number of outputs to measure in power measurement 4 to two.

`Power:Power3:EFFICIENCY:NUMOFOutputs?` might return ONE, indicating that the number of outputs being measured in power measurement 3 is one.

## POWer:POWer<x>:EFFICIENCY:OUTPUT1Type

This command sets or queries the Output1 type (AC or DC) for the power Efficiency measurement of the specified power measurement number.

**Conditions** Requires option PWR or PS2.

**Group** Power

**Syntax** `Power:Power<x>:EFFICIENCY:OUTPUT1Type {AC|DC}`  
`Power:Power<x>:EFFICIENCY:OUTPUT1Type?`

**Related Commands** [POWer:POWer<x>:EFFICIENCY:INPUTType](#)

**Arguments** `Power<x>` is the number of a power efficiency measurement. This is the equivalent of the number shown on the power measurement badge of the UI.

AC sets the output1 voltage type to AC.

DC sets the output1 voltage type to DC.

**Examples** `Power:Power1:EFFICIENCY:OUTPUT1Type DC` sets the output type to DC for power Efficiency measurement 1.

`Power:Power3:EFFICIENCY:OUTPUT1Type?` might return AC, indicating that the power output type for power Efficiency measurement 3 is AC.

## POWer:POWer<x>:EFFICIENCY:OUTPUT2Type

This command sets or queries the Output2 type (AC or DC) for the power Efficiency measurement of the specified power measurement number.

**Conditions** Requires option PWR or PS2.

**Group** Power

**Syntax**      `POWER:POWER<x>:EFFICIENCY:OUTPUT2Type {AC|DC}`  
`POWER:POWER<x>:EFFICIENCY:OUTPUT2Type?`

**Related Commands**      [POWER:POWER<x>:EFFICIENCY:INPUTType](#)

**Arguments**      `Power<x>` is the number of a power efficiency measurement. This is the equivalent of the number shown on the power measurement badge of the UI.

AC sets the Output2 voltage type to AC.

DC sets the Output2 voltage type to DC.

**Examples**      `POWER:POWER1:EFFICIENCY:OUTPUT2Type DC` sets the Output2 type to DC for power Efficiency measurement 1.

`POWER:POWER3:EFFICIENCY:OUTPUT2Type?` might return AC, indicating that the power Output2 type for power Efficiency measurement 3 is AC.

## POWER:POWER<x>:EFFICIENCY:OUTPUT3Type

This command sets or queries the Output3 type (AC or DC) for the power Efficiency measurement of the specified power measurement number.

**Conditions**      Requires option PWR or PS2.

**Group**      Power

**Syntax**      `POWER:POWER<x>:EFFICIENCY:OUTPUT3Type {AC|DC}`  
`POWER:POWER<x>:EFFICIENCY:OUTPUT3Type?`

**Related Commands**      [POWER:POWER<x>:EFFICIENCY:INPUTType](#)

**Arguments**      `Power<x>` is the number of a power efficiency measurement. This is the equivalent of the number shown on the power measurement badge of the UI.

AC sets the Output3 voltage type to AC.

DC sets the Output3 voltage type to DC.

**Examples**      `POWER:POWER1:EFFICIENCY:OUTPUT3Type DC` sets the Output3 type to DC for power Efficiency measurement 1.

`Power:Power3:EFFICIENCY:OUTPUT3Type?` might return AC, indicating that the power Output3 type for power Efficiency measurement 3 is AC.

## POWer:POWer<x>:EFFICIENCY:OUTPUTType

This command sets or queries the output type (AC or DC) for power Efficiency measurement of the specified power measurement number.

**Conditions** Requires option PWR or PS2.

**Group** Power

**Syntax** `Power:Power<x>:EFFICIENCY:OUTPUTType {AC|DC}`  
`Power:Power<x>:EFFICIENCY:OUTPUTType?`

**Related Commands** [POWer:POWer<x>:EFFICIENCY:INPUTType](#)

**Arguments** `Power<x>` is the number of a power efficiency measurement. This is the equivalent of the number shown on the power measurement badge of the UI.

AC sets the output voltage type to AC.

DC sets the output voltage type to DC.

**Examples** `Power:Power1:EFFICIENCY:OUTPUTType DC` sets the output type to DC for power Efficiency measurement 1

`Power:Power3:EFFICIENCY:OUTPUTType?` might return AC, indicating that the power output type for power Efficiency measurement 3 is AC.

## POWer:POWer<x>:EFFICIENCY:VOUT1SOUrce

This command sets or queries the output 1 voltage source for the power Efficiency measurement of the specified power measurement number.

**Conditions** Requires option PWR or PS2.

**Group** Power

<b>Syntax</b>	<pre>Power:Power&lt;x&gt;:EFFICIENCY:VOUT1SOURCE {S&lt;x&gt;_Ch&lt;x&gt; CH&lt;x&gt; MATH&lt;x&gt; REF&lt;x&gt;} Power:Power&lt;x&gt;:EFFICIENCY:VOUT1SOURCE?</pre>
<b>Related Commands</b>	<pre>POWer:POWer&lt;x&gt;:EFFICIENCY:VOUT2SOURCE POWer:POWer&lt;x&gt;:EFFICIENCY:VOUT3SOURCE</pre>
<b>Arguments</b>	<p>Power&lt;x&gt; is the number of a power efficiency measurement. This is the equivalent of the number shown in the power measurement badge on the UI.</p> <p>S&lt;x&gt;_Ch&lt;x&gt; specifies the remote scope number and the analog channel.</p> <p>CH&lt;x&gt; = A channel specifier; &lt;x&gt; is 1 through 8 and is limited by the number of FlexChannels in your instrument.</p> <p>MATH&lt;x&gt; = A math waveform specifier; &lt;x&gt; is <math>\geq 1</math>.</p> <p>REF&lt;x&gt; = A reference waveform specifier; &lt;x&gt; is <math>\geq 1</math>.</p>
<b>Examples</b>	<pre>Power:Power4:EFFICIENCY:VOUT1SOURCE CH4</pre> <p>sets the source for the output 1 voltage efficiency measurement of power measurement 4 to Channel 4.</p> <pre>Power:Power1:EFFICIENCY:VOUT1SOURCE?</pre> <p>might return CH3, indicating that the source for the output 1 voltage efficiency measurement of power measurement 1 is Channel 3.</p>

## POWer:POWer<x>:EFFICIENCY:VOUT2SOURCE

This command sets or queries the output 2 voltage source for the power Efficiency measurement of the specified power measurement number.

<b>Conditions</b>	Requires option PWR or PS2.
<b>Group</b>	Power
<b>Syntax</b>	<pre>Power:Power&lt;x&gt;:EFFICIENCY:VOUT2SOURCE {S&lt;x&gt;_Ch&lt;x&gt; CH&lt;x&gt; MATH&lt;x&gt; REF&lt;x&gt;} Power:Power&lt;x&gt;:EFFICIENCY:VOUT2SOURCE?</pre>
<b>Related Commands</b>	<pre>POWer:POWer&lt;x&gt;:EFFICIENCY:VOUT1SOURCE POWer:POWer&lt;x&gt;:EFFICIENCY:VOUT3SOURCE</pre>



<b>Arguments</b>	<p>Power&lt;x&gt; is the number of a power efficiency measurement. This is the equivalent of the number shown in the power measurement badge on the UI.</p> <p>S&lt;x&gt;_Ch&lt;x&gt; specifies the remote scope number and the analog channel.</p> <p>CH&lt;x&gt; = A channel specifier; &lt;x&gt; is 1 through 8 and is limited by the number of FlexChannels in your instrument.</p> <p>MATH&lt;x&gt; = A math waveform specifier; &lt;x&gt; is <math>\geq 1</math>.</p> <p>REF&lt;x&gt; = A reference waveform specifier; &lt;x&gt; is <math>\geq 1</math>.</p>
<b>Examples</b>	<p>Power:Power4:EFFICIENCY:VOUT2SOURCE CH5 sets the source for the output 2 voltage efficiency measurement of power measurement 4 to Channel 5.</p> <p>Power:Power1:EFFICIENCY:VOUT2SOURCE? might return CH3, indicating that the source for the output 2 voltage efficiency measurement of power measurement 1 is Channel 3.</p>

## POWER:POWER<x>:EFFICIENCY:VOUT3SOURCE

This command sets or queries the output 3 voltage source for the power Efficiency measurement of the specified power measurement number.

<b>Conditions</b>	Requires option PWR or PS2.
<b>Group</b>	Power
<b>Syntax</b>	<p>Power:Power&lt;x&gt;:EFFICIENCY:VOUT3SOURCE          {S&lt;x&gt;_Ch&lt;x&gt;   CH&lt;x&gt;   MATH&lt;x&gt;   REF&lt;x&gt;}          Power:Power&lt;x&gt;:EFFICIENCY:VOUT3SOURCE?</p>
<b>Related Commands</b>	<p><a href="#">POWER:POWER&lt;x&gt;:EFFICIENCY:VOUT1SOURCE</a></p> <p><a href="#">POWER:POWER&lt;x&gt;:EFFICIENCY:VOUT2SOURCE</a></p>
<b>Arguments</b>	<p>Power&lt;x&gt; is the number of a power efficiency measurement. This is the equivalent of the number shown on the power measurement badge in the UI.</p> <p>S&lt;x&gt;_Ch&lt;x&gt; specifies the remote scope number and the analog channel.</p> <p>CH&lt;x&gt; = A channel specifier; &lt;x&gt; is 1 through 8 and is limited by the number of FlexChannels in your instrument.</p> <p>MATH&lt;x&gt; = A math waveform specifier; &lt;x&gt; is <math>\geq 1</math>.</p> <p>REF&lt;x&gt; = A reference waveform specifier; &lt;x&gt; is <math>\geq 1</math>.</p>

- Examples** `Power:Power4:EFFICIENCY:VOUT3SOURCE REF7` sets the source for the output 3 voltage efficiency measurement of power measurement 4 to Reference waveform 7.
- `Power:Power1:EFFICIENCY:VOUT3SOURCE?` might return CH5, indicating that the source for the output 3 voltage efficiency measurement of power measurement 1 is Channel 5.

## POWER:POWER<x>:EFFICIENCY:VSOURCE

This command sets or queries the voltage source for the power Efficiency measurement of the specified power measurement number.

- Conditions** Requires option PWR or PS2.
- Group** Power
- Syntax** `Power:Power<x>:EFFICIENCY:VSOURCE {CH<x>|MATH<x>|REF<x>}`  
`Power:Power<x>:EFFICIENCY:VSOURCE?`
- Related Commands** [POWER:POWER<x>:EFFICIENCY:ISOURCE](#)
- Arguments** `Power<x>` is the number of a power efficiency measurement. This is the equivalent of the number shown in the power measurement badge on the UI.
- `CH<x>` = A channel specifier; <x> is 1 through 8 and is limited by the number of FlexChannels in your instrument.
- `MATH<x>` = A math waveform specifier; <x> is  $\geq 1$ .
- `REF<x>` = A reference waveform specifier; <x> is  $\geq 1$ .
- Examples** `Power:Power2:EFFICIENCY:VSOURCE CH4` sets the input voltage source for power Efficiency measurement 2 to Channel 4.
- `Power:Power1:EFFICIENCY:VSOURCE?` might return CH3, indicating that the input voltage source for power Efficiency measurement 1 is Channel 3.

## POWER:POWER<x>:FREQUENCY:EDGE

This command sets or queries the edge type for frequency measurement of the specified power measurement number.

<b>Conditions</b>	Requires option PWR or PS2.
<b>Group</b>	Power
<b>Syntax</b>	Power:Power<x>:FREQUENCY:EDGE {RISE FALL} Power:Power<x>:FREQUENCY:EDGE?
<b>Related Commands</b>	<a href="#">POWER:Power&lt;x&gt;:FREQUENCY:INPUTSource</a>
<b>Arguments</b>	Power<x> is the power measurement number. This is the equivalent of the number shown in the power measurement badge on the UI.
<b>Examples</b>	Power:Power1:FREQUENCY:EDGE FALL sets the edge type as fall for the frequency measurement.

## POWER:Power<x>:FREQUENCY:INPUTSource

This command sets or queries the input source for frequency measurement of the specified power measurement number.

<b>Conditions</b>	Requires option PWR or PS2.
<b>Group</b>	Power
<b>Syntax</b>	Power:Power<x>:FREQUENCY:INPUTSource {S<x>_Ch<x> CH<x> MATH<x> REF<x>} Power:Power<x>:FREQUENCY:INPUTSource?
<b>Related Commands</b>	<a href="#">POWER:Power&lt;x&gt;:FREQUENCY:EDGE</a>
<b>Arguments</b>	Power<x> is the power measurement number. This is the equivalent of the number shown on a power measurement badge in the UI.  S<x>_Ch<x> specifies the remote scope number and the analog channel.  CH<x> = A channel specifier; <x> is 1 through 8 and is limited by the number of FlexChannels in your instrument.  MATH<x> = A math waveform specifier; <x> is ≥1.  REF<x> = A reference waveform specifier; <x> is ≥1.

**Examples**    `Power:Power1:FREQUENCY:INPUTSource REF1` sets the input source for frequency measurement as REF1.

## **POWER:POWER<x>:GATing**

This command sets or queries the gating type for the specified power measurement number.

**Conditions**    Requires option PWR or PS2.

**Group**        Power

**Syntax**       `Power:Power<x>:GATing {NONE|CURSOR|SCREEN|LOGIC}`  
`Power:Power<x>:GATing?`

**Arguments**    `Power<x>` is the power measurement number. This is the equivalent of the number shown on a power measurement badge in the UI.

NONE makes measurement across the entire waveform record.

CURSOR makes measurements on that portion of the waveform between the cursors. Selecting Cursors opens cursors on the measurement source. Set the cursors so that the waveform area of interest is in between the cursors.

SCREEN takes measurements on that portion of the waveform shown in the display. When Zoom is on, the display is the zoom window.

LOGIC takes measurements only when the logical state of a specified waveform is true.

**Examples**       `Power:Power1:GATing CURSOR` sets the gating type for the power measurement badge 1 as Cursor.

`Power:Power2:GATing?` might return SCREEN indicating the configured gating type for the power measurement badge 2.

## **POWER:POWER<x>:GATing:GLOBal**

This command sets or queries the gating settings for the specified power measurement number.

**Conditions**    Requires option PWR or PS2.

<b>Group</b>	Power
<b>Syntax</b>	<pre>Power:Power&lt;x&gt;:GATing:GLOBal {ON OFF 1 0} Power:Power&lt;x&gt;:GATing:GLOBal?</pre>
<b>Arguments</b>	<p>Power&lt;x&gt; is the power measurement number. This is the equivalent of the number shown on a power measurement badge in the UI.</p> <p>1   ON selects the gating settings as Global.</p> <p>0   OFF selects the gating settings as Local.</p>
<b>Examples</b>	<pre>Power:Power1:GATing:GLOBal 1</pre> <p>1 selects the gating settings as Global for the power measurement badge 1.</p>

## POWer:POWer<x>:HARMONICS:CLASs

This command sets or queries the class type for the harmonics measurement in the specified power measurement number. The power measurement number is specified by x.

<b>Conditions</b>	Requires option PWR or PS2.
<b>Group</b>	Power
<b>Syntax</b>	<pre>Power:Power&lt;x&gt;:HARMONICS:CLASS {CLASSA   CLASSB   CLASSC   CLASSD} Power:Power&lt;x&gt;:HARMONICS:CLASS?</pre>
<b>Related Commands</b>	<a href="#">POWer:POWer&lt;x&gt;:HARMONICS:STANDard</a>
<b>Examples</b>	<pre>Power:Power1:HARMONICS:CLASS CLASSB</pre> <p>sets the class type for harmonics measurement as CLASSB.</p>

## POWer:POWer<x>:HARMONICS:CLFile

This command sets or queries the custom limits file path for the harmonics measurement. The power measurement number is specified by x.

<b>Conditions</b>	Requires option PWR or PS2.
-------------------	-----------------------------

<b>Group</b>	Power
<b>Syntax</b>	POWER:POWER<x>:HARMONICS:CLFile <QString> POWER:POWER<x>:HARMONICS:CLFile?
<b>Arguments</b>	<QString> specifies the custom limits file path that can be loaded when the harmonics standard type selected is CUSTom.
<b>Examples</b>	POWER:POWER1:HARMONICS:CLFile "C:/Applications/Power/Harmonics Limits/userdefineslimits.csv" specifies the custom limits file path.  POWER:POWER1:HARMONICS:CLFile? might return :POWER:POWER1:HARMONICS:CLFile "C:/Applications/Power/Harmonics Limits/userdefineslimits.csv", indicating the custom limits file path.

## POWER:POWER<x>:HARMONICS:CMETHOD

This command sets or queries the fundamental current method for the harmonics measurement of the specified power measurement number.

<b>Conditions</b>	Requires option PWR or PS2.
<b>Group</b>	Power
<b>Syntax</b>	POWER:POWER<x>:HARMONICS:CMETHOD {RATED   MEASURED} POWER:POWER<x>:HARMONICS:CMETHOD?
<b>Related Commands</b>	<a href="#">POWER:POWER&lt;x&gt;:HARMONICS:STANDARD</a>
<b>Arguments</b>	Power<x> is the power measurement number. This is the equivalent of the number shown on a power measurement badge in the UI.  RATED: select to use the standard input current values in the measurement.  MEASURED: select to use the measured the input current values in the measurement.
<b>Examples</b>	POWER:POWER1:HARMONICS:CMETHOD RATED sets the current method for harmonics measurement as rated.

## POWer:POWer<x>:HARMONICS:FUNDCURRent

This command sets or queries the fundamental current value for the harmonics measurement of the specified power measurement number.

**Conditions** Requires option PWR or PS2.

**Group** Power

**Syntax** `POWer:POWer<x>:HARMONICS:FUNDCURRent <NR1>`  
`POWer:POWer<x>:HARMONICS:FUNDCURRent?`

**Related Commands** [POWer:POWer<x>:HARMONICS:CLASs](#)

**Arguments** Power<x> is the power measurement number. This is the equivalent of the number shown on a power measurement badge in the UI.  
<NR1> ranges from 0 to 16.

**Examples** `POWer:POWer<x>:HARMONICS:FUNDCURRent 1.5` sets the fundamental current for the harmonics measurement as 1.5.

## POWer:POWer<x>:HARMONICS:HORDER

This command sets or queries the order value for the harmonics measurement of the specified power measurement number.

**Conditions** Requires option PWR or PS2.

**Group** Power

**Syntax** `POWer:POWer<x>:HARMONICS:HORDER <NR1>`  
`POWer:POWer<x>:HARMONICS:HORDER?`

**Arguments** Power<x> is the power measurement number. This is the equivalent of the number shown on a power measurement badge in the UI.  
<NR1> ranges from 40 to 100.

**Examples** `POWER:POWER1:HARMONICS:HORDER 70` sets the order value for the harmonics measurement as 70.

## **POWER:POWER<x>:HARMONICS:HSOURCE**

This command sets or queries the source type for the harmonics measurement of the specified power measurement number. The power measurement number is specified by x.

**Conditions** Requires option PWR or PS2.

**Group** Power

**Syntax** `POWER:POWER<x>:HARMONICS:HSOURCE {CURRENT | VOLTAGE}`  
`POWER:POWER<x>:HARMONICS:HSOURCE?`

**Related Commands** [POWER:POWER<x>:HARMONICS:STANDARD](#)

**Examples** `POWER:POWER1:HARMONICS:HSOURCE CURRENT` sets the source as current for the harmonics measurement.

## **POWER:POWER<x>:HARMONICS:IPOWER**

This command sets or queries the input power value for the harmonics measurement of the specified power measurement number.

**Conditions** Requires option PWR or PS2.

**Group** Power

**Syntax** `POWER:POWER<x>:HARMONICS:IPOWER <NR1>`  
`POWER:POWER<x>:HARMONICS:IPOWER?`

**Related Commands** [POWER:POWER<x>:HARMONICS:CLASS](#)

**Arguments** `Power<x>` is the power measurement number. This is the equivalent of the number shown on a power measurement badge in the UI.



<NR1> ranges from 0 to 600.

**Examples** `Power:Power<x>:HARMONICS:IPower 150` sets the input power for the harmonics measurement as 150.

## POWER:POWER<x>:HARMONICS:ISOURce

This command sets or queries the current source for SOA measurement of the specified power measurement number.

**Conditions** Requires option PWR or PS2.

**Group** Power

**Syntax** `Power:Power<x>:HARMONICS:ISOURce`  
`{S<x>_Ch<x> | CH<x> | MATH<x> | REF<x>}`  
`Power:Power<x>:HARMONICS:ISOURce?`

**Arguments** `Power<x>` is the power measurement number. This is the equivalent of the number shown on a power measurement badge in the UI.

`S<x>_Ch<x>` specifies the remote scope number and the analog channel.

`CH<x>` = A channel specifier; <x> is 1 through 8 and is limited by the number of FlexChannels in your instrument.

`MATH<x>` = A math waveform specifier; <x> is  $\geq 1$ .

`REF<x>` = A reference waveform specifier; <x> is  $\geq 1$ .

**Examples** `Power:Power1:HARMONICS:ISOURce CH2` sets the current source for harmonics measurement as channel 2.

## POWER:POWER<x>:HARMONICS:LINEFREQUency

This command sets or queries the value for the line frequency for the Harmonics measurement.

**Conditions** Requires option PWR or PS2.

**Group** Power

**Syntax** `Power:Power<x>:HARMONICS:LINEFREQUENCY {Auto|FIFTYhz|SIXTYhz|THREESIXTYhz|FOURHUNDREdHz|SIXFIFTYhz|EIGHTHUNDREdHz|CUSTOm} Power:Power<x>:HARMONICS:LINEFREQUENCY?`

**Related Commands** [POWer:POWer<x>:HARMONICS:LINEFREQUENCY](#)

**Arguments** `Power<x>` is the Power measurement identifier number.

`Auto` automatically detects and sets the line frequency value.

`FIFTYhz` sets the line frequency value to 50 Hz.

`SIXTYhz` sets the line frequency value to 60 Hz.

`THREESIXTYhz` sets the line frequency value to 360 Hz.

`FOURHUNDREdHz` sets the line frequency value to 400 Hz.

`SIXFIFTYhz` sets the line frequency value to 650 Hz.

`EIGHTHUNDREdHz` sets the line frequency value to 800 Hz.

`CUSTOm` sets the line frequency value to Custom. The default value for custom is 100 Hz. Use the [POWer:POWer<x>:HARMONICS:LINEFREQUENCY](#) command to set a custom line frequency value.

**Examples** `Power:Power3:HARMONICS:LINEFREQUENCY FIFTYhz` sets the line frequency value for the Harmonics power measurement 3 to 50 Hz.

`Power:Power1:HARMONICS:LINEFREQUENCY?` might return `Power:Power1:HARMONICS:LINEFREQUENCY CUSTOm`, indicating that the line frequency setting for Harmonics power measurement 1 is a custom value.

## POWer:POWer<x>:HARMONICS:ODDEVen

This command sets or queries the harmonics value analysis format of the specified power measurement number.

**Conditions** Requires option PWR or PS2.

**Group** Power

**Syntax** `Power:Power<x>:HARMONICS:ODDEVen {ALL | ODD | EVEN} Power:Power<x>:HARMONICS:ODDEVen?`

<b>Arguments</b>	<p>Power&lt;x&gt; is the power measurement number. This is the equivalent of the number shown on a power measurement badge in the UI.</p> <p>ALL to display all harmonics values</p> <p>ODD to display only the odd values of harmonics</p> <p>EVEN to display only the even values of harmonics</p>
<b>Examples</b>	<p>Power:Power3:HARMONICS:ODDEVEN ALL sets the harmonics value analysis format to display all result values for harmonics measurement 3.</p>

## POWer:POWer<x>:HARMONICS:PFACTOR

This command sets or queries the value of power factor for the harmonics measurement of the specified power measurement number.

**Conditions** Requires option PWR or PS2.

**Group** Power

**Syntax** Power:POWer<x>:HARMONICS:PFACTOR <NR1>  
Power:POWer<x>:HARMONICS:PFACTOR?

**Related Commands** [POWer:POWer<x>:HARMONICS:CLASS](#)

**Arguments** Power<x> is the power measurement number. This is the equivalent of the number shown on a power measurement badge in the UI.

<NR1> ranges from 0 to 1.

**Examples** Power:Power2:HARMONICS:PFACTOR 0.7 sets the power factor as 0.7 for harmonics measurement 2.

## POWer:POWer<x>:HARMONICS:POWERRATING

This command sets or queries the power level for the harmonics measurement of the specified power measurement number. The power measurement number is specified by x.

**Conditions** Requires option PWR or PS2.

<b>Group</b>	Power
<b>Syntax</b>	POWER:POWER<x>:HARMONICS:POWERRating {HIGH   LOW} POWER:POWER<x>:HARMONICS:POWERRating?
<b>Related Commands</b>	<a href="#">POWER:POWER&lt;x&gt;:HARMONICS:STANDARD</a>
<b>Examples</b>	POWER:POWER1:HARMONICS:POWERRating HIGH sets the power level as high for harmonics measurement 1.

## POWER:POWER<x>:HARMONICS:RCURRENT

This command sets or queries the rated current for the harmonics measurement of the specified power measurement number.

<b>Conditions</b>	Requires option PWR or PS2.
<b>Group</b>	Power
<b>Syntax</b>	POWER:POWER<x>:HARMONICS:RCURRENT <NR1> POWER:POWER<x>:HARMONICS:RCURRENT?
<b>Related Commands</b>	<a href="#">POWER:POWER&lt;x&gt;:HARMONICS:CMETHOD</a>
<b>Arguments</b>	Power<x> is the power measurement number. This is the equivalent of the number shown on a power measurement badge in the UI.  <NR1> ranges from 0 to 100
<b>Examples</b>	POWER:POWER2:HARMONICS:RCURRENT 1.5 sets the rated current as 1.5 for harmonics measurement 2.

## POWER:POWER<x>:HARMONICS:STANDARD

This command sets or queries the test mode for harmonics measurement of the specified power measurement number.

<b>Conditions</b>	Requires option PWR or PS2.
-------------------	-----------------------------

<b>Group</b>	Power
<b>Syntax</b>	<pre>POWER:POWER&lt;x&gt;:HARMONICS:STANDARD {NONE  IEC  MIL  AM14  DO160  CUSTOM} POWER:POWER&lt;x&gt;:HARMONICS:STANDARD?</pre>
<b>Arguments</b>	<p>Power&lt;x&gt; is the power measurement number. This is the equivalent of the number shown on a power measurement badge in the UI.</p> <p>NONE = No standard</p> <p>IEC = IEC 61000-3-2 standard</p> <p>MIL = MIL-STD-1399 standard</p> <p>AM14 = AM14 standard</p> <p>DO160 = DO160 standard</p> <p>CUSTOM = CUSTOM standard</p>
<b>Examples</b>	<pre>POWER:POWER3:HARMONICS:STANDARD AM14</pre> <p>sets the test mode for harmonics measurement as AM14 for harmonics measurement 3.</p>

## POWER:POWER<x>:HARMONICS:STARTFREQUENCY

This command sets or queries the value for the start frequency for the Harmonics measurement. in the range of 1 Hz to 1 GHz.

<b>Conditions</b>	Requires option PWR or PS2.
<b>Group</b>	Power
<b>Syntax</b>	<pre>POWER:POWER&lt;x&gt;:HARMONICS:STARTFREQUENCY &lt;NR2&gt; POWER:POWER&lt;x&gt;:HARMONICS:STARTFREQUENCY?</pre>
<b>Arguments</b>	<p>Power&lt;x&gt; is the Power measurement.</p> <p>&lt;NR2&gt; sets the starting frequency, in hertz.</p>
<b>Examples</b>	<pre>POWER:POWER1:HARMONICS:STARTFREQUENCY 1000</pre> <p>sets the Harmonics measurement start frequency to 1 kHz for power measurement 1.</p>

Power:Power4:HARMONICS:STARTFREQUENCY? might return  
Power:Power4:HARMONICS:STARTFREQUENCY 60. indicating that the start  
frequency for Harmonics power measurement 4 is 60 Hz.

## POWER:POWER<x>:HARMONICS:UNITS

This command sets or queries the harmonics results units of the specified power measurement number. The power measurement number is specified by x.

<b>Conditions</b>	Requires option PWR or PS2.
<b>Group</b>	Power
<b>Syntax</b>	Power:Power<x>:HARMONICS:UNITS {LOG   LINEar} Power:Power<x>:HARMONICS:UNITS?
<b>Examples</b>	Power:Power1:HARMONICS:UNITS LOG sets the harmonics results units as logarithmic for harmonics measurement 1.

## POWER:POWER<x>:HARMONICS:VSOURCE

This command sets or queries the voltage source for SOA measurement of the specified power measurement number.

<b>Conditions</b>	Requires option PWR or PS2.
<b>Group</b>	Power
<b>Syntax</b>	Power:Power<x>:HARMONICS:VSOURCE {S<x>_Ch<x>   CH<x>   MATH<x>   REF<x>} Power:Power<x>:HARMONICS:VSOURCE?
<b>Arguments</b>	Power<x> is the power measurement number. This is the equivalent of the number shown on a power measurement badge in the UI.  S<x>_Ch<x> specifies the remote scope number and the analog channel.  CH<x> = A channel specifier; <x> is 1 through 8 and is limited by the number of FlexChannels in your instrument.  MATH<x> = A math waveform specifier; <x> is $\geq 1$ .

REF<x> = A reference waveform specifier; <x> is  $\geq 1$ .

**Examples** `Power:Power4:HARMONICS:VSOURCE CH1` sets the voltage source for harmonics measurement 4 as channel 1.

## POWER:POWER<x>:IMPEDANCE:AMP[1-10]Val

Sets or queries the signal generator amplitude setting of the specified profile step, for the specified Impedance measurement.

**Conditions** Requires option 5-PWR (5 Series MSO instruments) or 6-PWR (6 Series MSO instrument).

**Group** Power

**Syntax** `Power:Power<x>:IMPEDANCE:AMP[1-10]Val <NR3>`  
`Power:Power<x>:IMPEDANCE:AMP[1-10]Val?`

**Arguments** `Power<x>` is the number of the Impedance power measurement.  
`AMP[1-10]` specifies the number of the profile step.  
`<NR3>` sets the generator output amplitude for the specified profile step, in the range -100 V to 100 V.

**Examples** `Power:Power2:IMPEDANCE:AMP1Val 35` sets the generator output amplitude of profile step 1 to 35 volts, for impedance measurement 2.  
`Power:Power3:IMPEDANCE:AMP2Val?` might return `200.0000E-3`, indicating that the signal generator output amplitude is set to 200 mV for profile step 2, for impedance measurement 3.

## POWER:POWER<x>:IMPEDANCE:AMPMode

Sets or queries the power amplitude mode for the Impedance measurement.

**Conditions** Requires option 5-PWR (5 Series MSO instruments) or 6-PWR (6 Series MSO instrument).

**Group** Power

<b>Syntax</b>	<code>Power:Power&lt;x&gt;:IMPEDANCE:AMPMode {CONSTant PROFile}</code> <code>Power:Power&lt;x&gt;:IMPEDANCE:AMPMode?</code>
<b>Related Commands</b>	<a href="#">POWER:Power&lt;x&gt;:IMPEDANCE:AMP[1-10]Val</a> <a href="#">POWER:Power&lt;x&gt;:IMPEDANCE:FREQ[1-10]Val</a>
<b>Arguments</b>	<code>Power&lt;x&gt;</code> is the number of the Impedance power measurement. <code>CONSTant</code> sets the generator to output a constant level signal. <code>PROFile</code> uses related commands to set the generator output signal profile (Start frequency, Stop frequency, and Amplitude for each profile step).
<b>Examples</b>	<code>Power:Power3:Impedance:AMPMode PROFile</code> sets the Impedance measurement 3 amplitude mode to Profile. <code>Power:Power1:Impedance:AMPMode?</code> might return <code>CONSTANT</code> , indicating that the Impedance measurement 1 amplitude mode is set to Constant.

## POWER:Power<x>:IMPEDANCE:ANALYSISMethod

This command sets or queries the Analysis Method for Impedance measurements.

<b>Group</b>	Power
<b>Syntax</b>	<code>Power:Power&lt;x&gt;:IMPEDANCE:ANALYSISMethod {SV FFT}</code> <code>Power:Power&lt;x&gt;:IMPEDANCE:ANALYSISMethod?</code>
<b>Arguments</b>	<code>Power&lt;x&gt;</code> is the power measurement number. This is the equivalent of the number shown in the UI for a power measurement badge. <code>SV</code> sets the Analysis Method as Spectrum View. <code>FFT</code> sets the Analysis Method as FFT.
<b>Examples</b>	<code>Power:Power1:IMPEDANCE:ANALYSISMethod SV</code> sets the Analysis Method as Spectrum View for power measurement 1. <code>Power:Power1:IMPEDANCE:ANALYSISMethod?</code> might return <code>:Power:Power1:IMPEDANCE:ANALYSISMethod SV</code> , indicating that the Analysis Method is Spectrum View.



**POWer:POWer<x>:IMPEDANCE:AUTORbw**

This command enables Auto RBW computation.

<b>Group</b>	Power
<b>Syntax</b>	POWer:POWer<x>:IMPEDANCE:AUTORbw {True False} POWer:POWer<x>:IMPEDANCE:AUTORbw?
<b>Arguments</b>	<p>Power&lt;x&gt; is the power measurement number. This is the equivalent of the number shown in the UI for a power measurement badge.</p> <p>True enables Auto RBW computation.</p> <p>False disables Auto RBW computation.</p>
<b>Examples</b>	<p>POWer:POWer1:IMPEDANCE:AUTORbw true enables Auto RBW computation.</p> <p>POWer:POWer1:IMPEDANCE:AUTORbw? might return :POWer:POWer1:IMPEDANCE:AUTORbw true, indicating that Auto RBW computation is enabled.</p>

**POWer:POWer<x>:IMPEDANCE:CONNECTSTATUs? (Query Only)**

Queries the instrument's connection status to the external generator, for the specified Impedance measurement. The Impedance measurement generator IP address (for external generators) is set with [POWer:POWer<x>:IMPEDANCE:GENIPADDRESS](#).

<b>Conditions</b>	Requires option 5-PWR (5 Series MSO instruments) or 6-PWR (6 Series MSO instrument).
<b>Group</b>	Power
<b>Syntax</b>	POWer:POWer<x>:IMPEDANCE:CONNECTSTATUs?
<b>Arguments</b>	Power<x> is the number of the Impedance power measurement.
<b>Returns</b>	SUCCESS indicates the instrument recognizes the connection to the external generator.

FAILUre indicates the instrument could not make the connection to the external generator.

UNSUPPorted indicates that the connected generator is not recognized.

**Examples**    `Power:Power1:IMPEDANCE:CONNECTSTATUS?` might return `FAILURE`, indicating that the instrument could not connect to the external generator at the specified IP address.

## **POWer:POWer<x>:IMPEDANCE:CONSTAMPlitude**

Sets or queries the constant amplitude value for the specified Impedance measurement.

**Conditions**    Requires option 5-PWR (5 Series MSO instruments) or 6-PWR (6 Series MSO instrument).

**Group**        Power

**Syntax**       `Power:Power<x>:IMPEDANCE:CONSTAMPlitude <NR3>`  
`Power:Power<x>:IMPEDANCE:CONSTAMPlitude?`

**Arguments**    `Power<x>` is the number of the Impedance power measurement.  
`<NR3>` specifies the constant amplitude value, in the range of -100 V to 100 V.

**Examples**       `Power:Power3:IMPEDANCE:CONSTAMPlitude 20` sets the constant amplitude value for Impedance power measurement 3 to 20 volts.

`Power:Power2:IMPEDANCE:CONSTAMPlitude?` might return `100.0000`, indicating the constant amplitude setting for Impedance power measurement 2 is 100 Hz.

## **POWer:POWer<x>:IMPEDANCE:FREQ[1-10]Val**

Sets or queries the signal generator start frequency of the specified profile step, for the specified Impedance measurement.

**Conditions**    Requires option 5-PWR (5 Series MSO instruments) or 6-PWR (6 Series MSO instrument).

<b>Group</b>	Power
<b>Syntax</b>	<pre>Power:POWER&lt;x&gt;:IMPEDANCE:FREQ[1-10]Val &lt;NR3&gt; Power:POWER&lt;x&gt;:IMPEDANCE:FREQ[1-10]Val?</pre>
<b>Arguments</b>	<p>Power&lt;x&gt; is the number of the Impedance power measurement.</p> <p>FREQ[1-10] specifies the number of the profile step.</p> <p>&lt;NR3&gt; sets the start frequency, in the range of 10 Hz to 50 MHz, for the specified profile step. You can only set the starting frequency for each profile step; the stop frequency is automatically set to same value as the start frequency of the next profile step. For example, if Step one is set to 1`MHz, and Step two is set to 2`MHz, then the Step one stop frequency is 2`MHz.</p>
<b>Examples</b>	<pre>Power:POWER5:IMPEDANCE:FREQ3Val 1e3</pre> <p>sets the start frequency of profile step 3 to 1 kHz, for impedance measurement 5.</p> <pre>Power:POWER8:IMPEDANCE:FREQ2Val?</pre> <p>might return 2.0000E+6, indicating that the start frequency of profile step 2 is 2`MHz, for impedance measurement 8.</p>

## POWER:POWER<x>:IMPEDANCE:GENERator

Sets or queries the generator source for the Impedance power measurement.

<b>Conditions</b>	Requires option 5-PWR (5 Series MSO instruments) or 6-PWR (6 Series MSO instrument).
<b>Group</b>	Power
<b>Syntax</b>	<pre>Power:POWER&lt;x&gt;:IMPEDANCE:GENERator {INTERNAL EXTERNAL} Power:POWER&lt;x&gt;:IMPEDANCE:GENERator?</pre>
<b>Arguments</b>	<p>Power&lt;x&gt; is the number of the Impedance power measurement.</p> <p>INTERNAL sets the internal generator as the source for the Impedance power measurement.</p> <p>EXTERNAL sets the external generator as the source for the Impedance power measurement. Supported external generators are the Tektronix AFG31000 and AFG3000 series.</p>

- Examples** `Power:Power1:Impedance:Generator Internal` sets the internal generator as the source for the Impedance measurement.
- `Power:Power7:Impedance:Generator?` might return `EXTERNAL`, indicating that the Impedance measurement 7 is set to use an external generator.

## **POWER:POWER<x>:IMPEDANCE:GENIPADDRESS**

Sets or queries the external generator IP Address associated with the specified Impedance measurement.

- Conditions** Requires option 5-PWR (5 Series MSO instruments) or 6-PWR (6 Series MSO instrument).
- Group** Power
- Syntax** `Power:Power<x>:IMPEDANCE:GENIPADDRESS <String>`  
`Power:Power<x>:IMPEDANCE:GENIPADDRESS?`
- Arguments** `Power<x>` is the number of the Impedance power measurement. `<string>` is the IP address of the generator.
- Examples** `Power:Power4:IMPEDANCE:GENIPADDRESS 164.32.1.5` sets the IP address of the external generator to 164.32.1.5 for the Impedance power measurement 4.
- `Power:Power2:IMPEDANCE:GENIPADDRESS?` might return `""`, indicating that there is no address set for the external generator associated with Impedance power measurement 2.

## **POWER:POWER<x>:IMPEDANCE:IMPEDANCE**

Sets or queries the output impedance of the generator for the specified Impedance power measurement.

- Conditions** Requires option 5-PWR (5 Series MSO instruments) or 6-PWR (6 Series MSO instrument).
- Group** Power
- Syntax** `Power:Power<x>:IMPEDANCE:IMPEDANCE {FIFTY|HIGHZ}`  
`Power:Power<x>:IMPEDANCE:IMPEDANCE?`

<b>Arguments</b>	<p>POWER&lt;x&gt; is the number of the Impedance power measurement.</p> <p>FIFTY sets the measurement impedance to 50`Ω.</p> <p>HIGHZ sets the measurement impedance to 1`MΩ.</p>
<b>Examples</b>	<p>Power:Power1:IMPEDANCE:IMPEDANCE FIFTY sets the impedance value for Impedance power measurement 1 to 50 Ω.</p> <p>Power:Power2:IMPEDANCE:IMPEDANCE? might return HIGHZ, indicating that the impedance value for Impedance power measurement 2 is 1`MΩ</p>

## POWER:POWER<x>:IMPEDANCE:INPUTSource

Sets or queries the source for the Impedance input measurement.

<b>Conditions</b>	Requires option 5-PWR (5 Series MSO instruments) or 6-PWR (6 Series MSO instrument)
-------------------	-------------------------------------------------------------------------------------

**Group** Power

**Syntax** POWER:Power<x>:IMPEDANCE:INPUTSource  
{S<x>\_Ch<x>|CH<x>|MATH<x>|REF<x>}  
Power:Power<x>:IMPEDANCE:INPUTSource?

<b>Arguments</b>	<p>POWER&lt;x&gt; is the number of the Impedance power measurement.</p> <p>S&lt;x&gt;_Ch&lt;x&gt; specifies the remote scope number and the analog channel.</p> <p>CH&lt;x&gt; specifies the instrument input channel number.</p> <p>MATH&lt;x&gt; specifies the instrument math waveform number.</p> <p>REF&lt;x&gt; specifies the instrument reference waveform number.</p>
<b>Examples</b>	<p>Power:Power1:IMPEDANCE:INPUTSource MATH5 sets the signal source for the input Impedance power measurement 2 to Math waveform 5.</p> <p>Power:Power2:IMPEDANCE:INPUTSource? might return CH3, indicating that the signal source for the input Impedance power measurement 2 is channel 3.</p>

## POWER:POWER<x>:IMPEDANCE:OUTPUTSource

Sets or queries the source for the Impedance output measurement.

<b>Conditions</b>	Requires option 5-PWR (5 Series MSO instruments) or 6-PWR (6 Series MSO instrument)
<b>Group</b>	Power
<b>Syntax</b>	<pre> POWER:POWER&lt;x&gt;:IMPEDANCE:OUTPUTSource {S&lt;x&gt;_Ch&lt;x&gt; CH&lt;x&gt; MATH&lt;x&gt; REF&lt;x&gt;} POWER:POWER&lt;x&gt;:IMPEDANCE:OUTPUTSource?                     </pre>
<b>Arguments</b>	<p>POWER&lt;x&gt; is the number of the Impedance power measurement.</p> <p>S&lt;x&gt;_Ch&lt;x&gt; specifies the remote scope number and the analog channel.</p> <p>CH&lt;x&gt; specifies the instrument input channel number.</p> <p>MATH&lt;x&gt; specifies the instrument math waveform number.</p> <p>REF&lt;x&gt; specifies the instrument reference waveform number.</p>
<b>Examples</b>	<p>POWER:POWER1:IMPEDANCE:OUTPUTSource REF3 sets the signal source for the output Impedance power measurement 1 to Reference waveform 3.</p> <p>POWER:POWER2:IMPEDANCE:OUTPUTSource? might return CH3, indicating that the signal source for the output Impedance power measurement 2 is channel 3.</p>

## POWER:POWER<x>:IMPEDANCE:PPD

Sets or queries the value for points per decade for the specified Impedance measurement.

<b>Conditions</b>	Requires option 5-PWR (5 Series MSO instruments) or 6-PWR (6 Series MSO instrument).
<b>Group</b>	Power
<b>Syntax</b>	<pre> POWER:POWER&lt;x&gt;:IMPEDANCE:PPD &lt;NR1&gt; POWER:POWER&lt;x&gt;:IMPEDANCE:PPD?                     </pre>
<b>Arguments</b>	<p>POWER&lt;x&gt; is the number of the Impedance power measurement.</p> <p>&lt;NR1&gt; specifies the number of frequency points between the start and stop frequency in terms of log scale, in the range of 10 to 100 points.</p>

- Examples** `Power:Power1:IMPEDANCE:PPD 20` sets the constant amplitude value for Impedance power measurement 1 to 20 points per decade.
- `Power:Power2:IMPEDANCE:PPD?` might return 30, indicating that the points per decade setting for Impedance power measurement 2 is 30 points per decade.

## **Power:Power<x>:IMPEDANCE:STARTFREQUENCY**

Sets or queries the value for the start frequency of the specified Impedance measurement.

- Conditions** Requires option 5-PWR (5 Series MSO instruments) or 6-PWR (6 Series MSO instrument).

**Group** Power

- Syntax** `Power:Power<x>:IMPEDANCE:STARTFREQUENCY <NR3>`  
`Power:Power<x>:IMPEDANCE:STARTFREQUENCY?`

**Related Commands** [Power:Power<x>:IMPEDANCE:STOPFREQUENCY](#)

- Arguments** `Power<x>` is the number of the Impedance power measurement.
- `<NR3>` is a floating point number representing the start frequency, in the range of 10 Hz to 50 MHz.

- Examples** `Power:Power1:IMPEDANCE:STARTFREQUENCY 1.500e3` sets the start frequency for Impedance power measurement 1 to 1.5 kHz.
- `Power:Power2:IMPEDANCE:STARTFREQUENCY?` might return 100.0000, indicating the start frequency for Impedance power measurement 2 is 100 Hz.

## **Power:Power<x>:IMPEDANCE:STOPFREQUENCY**

Sets or queries the value of the specified Impedance measurement.

- Conditions** Requires option 5-PWR (5 Series MSO instruments) or 6-PWR (6 Series MSO instrument).

**Group** Power

**Syntax**      `POWER:POWER<x>:IMPEDANCE:STOPFREQUENCY <NR3>`  
`POWER:POWER<x>:IMPEDANCE:STOPFREQUENCY?`

**Related Commands**    [POWER:POWER<x>:IMPEDANCE:STARTFREQUENCY](#)

**Arguments**      `POWER<x>` is the number of the Impedance power measurement.  
`<NR3>` specifies the start frequency, in the range of 10 Hz to 50 MHz.

**Examples**      `POWER:POWER1:IMPEDANCE:STOPFREQUENCY 180` sets the stop frequency for Impedance power measurement 1 to 180 Hz.  
`POWER:POWER2:IMPEDANCE:STARTFREQUENCY?` might return `100.0000`, indicating the stop frequency for Impedance power measurement 2 is 100`Hz.

## POWER:POWER<x>:IMPEDANCE:TESTCONNECTION (No Query Form)

This command tests the connection with the external instrument for the specified Impedance measurement.

**Conditions**      Requires option 5-PWR (5 Series MSO instruments) or 6-PWR (6 Series MSO instrument).

**Group**          Power

**Syntax**          `POWER:POWER<x>:IMPEDANCE:TESTCONNECTION {EXECUTE}`

**Related Commands**    [POWER:POWER<x>:IMPEDANCE:CONNECTSTATUS?](#)  
[POWER:POWER<x>:IMPEDANCE:GENIPADDRESS](#)

**Arguments**      `POWER<x>` is the number of the Impedance power measurement.  
`EXECUTE` runs the test connection function.

**Examples**      `POWER:POWER3:PSRR:TESTCONNECTION EXECUTE` runs the test connection function for the Impedance power measurement 3.



## POWer:POWer<x>:INDUCTANCE:EDGESource

This command sets or queries the edge source for the power inductance measurement of the specified power measurement number.

**Conditions** Requires option PWR or PS2.

**Group** Power

**Syntax** `POWer:POWer<x>:INDUCTANCE:EDGESource`  
`{S<x>_Ch<x>|CH<x>|MATH<x>|REF<x>}`  
`POWer:POWer<x>:INDUCTANCE:EDGESource?`

**Related Commands** [POWer:POWer<x>:INDUCTANCE:ISOURce](#)

[POWer:POWer<x>:INDUCTANCE:VSOURce](#)

**Arguments** `Power<x>` is the power measurement number. This is the equivalent of the number shown on a power measurement badge in the UI.

`S<x>_Ch<x>` specifies the remote scope number and the analog channel.

`CH<x>` = A channel specifier; `<x>` is 1 through 8 and is limited by the number of FlexChannels in your instrument.

`MATH<x>` = A math waveform specifier; `<x>` is  $\geq 1$ .

`REF<x>` = A reference waveform specifier; `<x>` is  $\geq 1$ .

**Examples** `POWer:POWer1:HARMONICS:INDUCTANCE:EDGESource CH2` sets the signal edge source for inductance measurement 1 as Channel 2.

`POWer:POWer3:HARMONICS:INDUCTANCE:EDGESource?` might return CH4, indicating that the signal edge source for inductance measurement 3 is Channel 4.

## POWer:POWer<x>:INDUCTANCE:ISOURce

This command sets or queries the current signal source for the inductance measurement of the specified power measurement number.

**Conditions** Requires option PWR or PS2.

**Group** Power

<b>Syntax</b>	<code>Power:Power&lt;x&gt;:INDUCTANCE:ISOURce {CH&lt;x&gt; MATH&lt;x&gt; REF&lt;x&gt;}</code> <code>Power:Power&lt;x&gt;:INDUCTANCE:ISOURce?</code>
<b>Related Commands</b>	<a href="#">POWER:POWER&lt;x&gt;:INDUCTANCE:EDGESource</a> <a href="#">POWER:POWER&lt;x&gt;:INDUCTANCE:VSOURce</a>
<b>Arguments</b>	<p><code>Power&lt;x&gt;</code> is the power measurement number. This is the equivalent of the number shown on a power measurement badge in the UI.</p> <p><code>CH&lt;x&gt;</code> = A channel specifier; <code>&lt;x&gt;</code> is 1 through 8 and is limited by the number of FlexChannels in your instrument.</p> <p><code>MATH&lt;x&gt;</code> = A math waveform specifier; <code>&lt;x&gt;</code> is <math>\geq 1</math>.</p> <p><code>REF&lt;x&gt;</code> = A reference waveform specifier; <code>&lt;x&gt;</code> is <math>\geq 1</math>.</p>
<b>Examples</b>	<p><code>Power:Power7:HARMONICS:INDUCTANCE:ISOURce CH3</code> sets the current signal source for inductance measurement 7 as Channel 3.</p> <p><code>Power:Power3:HARMONICS:INDUCTANCE:ISOURce?</code> might return CH4, indicating that the current signal source for inductance measurement 3 is Channel 4.</p>

## POWER:POWER<x>:INDUCTANCE:VSOURce

This command sets or queries the voltage source for inductance measurement of the specified power measurement number.

<b>Conditions</b>	Requires option PWR or PS2.
<b>Group</b>	Power
<b>Syntax</b>	<code>Power:Power&lt;x&gt;:INDUCTANCE:VSOURce {CH&lt;x&gt; MATH&lt;x&gt; REF&lt;x&gt;}</code> <code>Power:Power&lt;x&gt;:INDUCTANCE:VSOURce?</code>
<b>Related Commands</b>	<a href="#">POWER:POWER&lt;x&gt;:INDUCTANCE:EDGESource</a> <a href="#">POWER:POWER&lt;x&gt;:INDUCTANCE:ISOURce</a>
<b>Arguments</b>	<code>Power&lt;x&gt;</code> is the power measurement number. This is the equivalent of the number shown on a power measurement badge in the UI.

CH<x> = A channel specifier; <x> is 1 through 8 and is limited by the number of FlexChannels in your instrument.

MATH<x> = A math waveform specifier; <x> is  $\geq 1$ .

REF<x> = A reference waveform specifier; <x> is  $\geq 1$ .

**Examples** `Power:Power7:HARMONICS:INDUCTANCE:VSource CH3` sets the voltage signal source for inductance measurement 7 as Channel 3.

`Power:Power1:HARMONICS:INDUCTANCE:VSource?` might return `MATH2`, indicating that the voltage signal source for inductance measurement 1 is Math waveform 2.

## POWER:POWER<x>:INPUTCAP:ISOURCE

This command sets or queries the inrush current input source of the specified Input Capacitance measurement.

**Conditions** Requires option PWR or PS2.

**Group** Power

**Syntax** `Power:Power<x>:INPUTCAP:ISOURCE {CH<x>|REF<x>|MATH<x>}`  
`Power:Power<x>:INPUTCAP:ISOURCE?`

**Arguments** `Power<x>` is the power measurement number. This is the equivalent of the number shown on a power measurement badge in the UI.

`CH<x>` is the channel specifier in the range of 1 through 8 and is limited by the number of instrument input channels.

`REF<x>` is the Reference waveform specifier  $\geq 1$ . This is the equivalent of the number shown on a Reference waveform badge in the UI.

`MATH<x>` is the Math waveform specifier  $\geq 1$ . This is the equivalent of the number shown on a Math waveform badge in the UI.

**Examples** `Power:Power1:INRUSHcurrent:ISOURCE REF3` sets the current source of Input Capacitance 1 to Reference waveform 3.

`Power:Power2:INRUSHcurrent:ISOURCE?` might return `Power:Power2:INRUSHcurrent:ISOURCE CH6`, indicating that the current source of the Input Capacitance measurement 2 is Channel 6.

## POWer:POWer<x>:INPUTCAP:PEAKCURRent

This command sets or queries the peak current value of the specified Input Capacitance measurement.

<b>Conditions</b>	Requires option PWR or PS2.
<b>Group</b>	Power
<b>Syntax</b>	<code>POWer:POWer&lt;x&gt;:INPUTCAP:PEAKCURRENT &lt;NR3&gt;</code> <code>POWer:POWer&lt;x&gt;:INPUTCAP:PEAKCURRENT?</code>
<b>Arguments</b>	<p><code>Power&lt;x&gt;</code> is the power measurement number. This is the equivalent of the number shown on a power measurement badge in the UI.</p> <p><code>&lt;NR3&gt;</code> is a floating point number that represents the peak current value, in amps, in the range -100 A to 100 A.</p>
<b>Examples</b>	<p><code>POWer:POWer4:INPUTCAP:PEAKCURRENT 12.5</code> sets the peak current value of Input Capacitance measurement 4 to 12.5 amps.</p> <p><code>POWer:POWer2:INPUTCAP:PEAKCURRENT?</code> might return <code>POWer:POWer2:INPUTCAP:PEAKCURRENT -85</code>, indicating that the peak current setting of Input Capacitance measurement 2 is -85 amps.</p>

## POWer:POWer<x>:INPUTCAP:PEAKVOLTage

This command sets or queries the peak voltage value of the specified Input Capacitance measurement.

<b>Conditions</b>	Requires option PWR or PS2.
<b>Group</b>	Power
<b>Syntax</b>	<code>POWer:POWer&lt;x&gt;:INPUTCAP:PEAKVOLTage &lt;NR3&gt;</code> <code>POWer:POWer&lt;x&gt;:INPUTCAP:PEAKVOLTage?</code>
<b>Arguments</b>	<p><code>Power&lt;x&gt;</code> is the power measurement number. This is the equivalent of the number shown on a power measurement badge in the UI.</p>

<NR3> is a floating point number that represents the peak voltage value in the range -100 V to 100 V.

**Examples** `POWER:POWER4:INPUTCAP:PEAKVOLTage 122.5` sets the peak voltage value of Input Capacitance measurement 4 to 122.5 volts.

`POWER:POWER2:INPUTCAP:PEAKVOLTage?` might return `POWER:POWER2:INPUTCAP:PEAKVOLTage 955`, indicating that the peak voltage setting of Input Capacitance measurement 2 to 955 volts.

## POWER:POWER<x>:INPUTCAP:VSOURCE

This command sets or queries the input voltage source of the specified Input Capacitance measurement.

**Conditions** Requires option PWR or PS2.

**Group** Power

**Syntax** `POWER:POWER<x>:INPUTCAP:VSOURCE {CH<x>|REF<x>|MATH<x>}`  
`POWER:POWER<x>:INPUTCAP:VSOURCE?`

**Arguments** `Power<x>` is the power measurement number. This is the equivalent of the number shown on a power measurement badge in the UI.

`CH<x>` is the channel specifier in the range of 1 through 8 and is limited by the number of instrument input channels.

`REF<x>` is the Reference waveform specifier  $\geq 1$ . This is the equivalent of the number shown on a Reference waveform badge in the UI.

`MATH<x>` is the Math waveform specifier  $\geq 1$ . This is the equivalent of the number shown on a Math waveform badge in the UI.

**Examples** `POWER:POWER1:INPUTCAP:VSOURCE CH2` sets the voltage source of the input capacitance measurement 1 to Reference Channel 2.

`POWER:POWER1:INPUTCAP:VSOURCE?` might return `POWER:POWER2:INPUTCAP:VSOURCE MATH6`, indicating that the voltage source of Input Capacitance measurement 2 is Math waveform 6.

## POWER:POWER<x>:INRUSHcurrent:INPUTSource

This command sets or returns the input source of the specified Inrush Current measurement.

**Conditions** Requires option PWR or PS2.

**Group** Power

**Syntax** POWER:POWER<x>:INRUSHcurrent:INPUTSource  
{CH<x>|MATH<x>|REF<x>}  
POWER:POWER<x>:INRUSHcurrent:INPUTSource?

**Arguments** Power<x> is the power measurement number. This is the equivalent of the number shown on a power measurement badge in the UI.

CH<x> is the channel specifier in the range of 1 through 8 and is limited by the number of instrument input channels.

REF<x> is the Reference waveform specifier  $\geq 1$ . This is the equivalent of the number shown on a Reference waveform badge in the UI.

MATH<x> is the Math waveform specifier  $\geq 1$ . This is the equivalent of the number shown on a Math waveform badge in the UI.

**Examples** POWER:POWER3:INRUSHcurrent:INPUTSource MATH1 sets the input source of Inrush Current measurement 3 to Math waveform 1.

POWER:POWER2:INRUSHcurrent:INPUTSource? might return  
POWER:POWER2:INRUSHcurrent:INPUTSource CH7, indicating that the input source of Inrush Current measurement 2 is Channel 7.

## POWER:POWER<x>:INRUSHcurrent:PEAKCURRENT

This command sets or returns the peak current value of the specified Inrush Current measurement.

**Conditions** Requires option PWR or PS2.

**Group** Power

**Syntax** POWER:POWER<x>:INRUSHcurrent:PEAKCURRENT <NR3>  
POWER:POWER<x>:INRUSHcurrent:PEAKCURRENT?

**Arguments** Power<x> is the power measurement number. This is the equivalent of the number shown on a power measurement badge in the UI.

<NR3> is a floating point number that represents the peak current value, in amps, in the range -100 A to 100 A.

**Examples** POWER:POWER4:INRUSHcurrent:PEAKCURRENT 12.5 sets the peak current value of Inrush Current measurement 4 to 12.5 amps.

POWER:POWER2:INRUSHcurrent:PEAKCURRENT? might return  
POWER:POWER2:INRUSHcurrent:PEAKCURRENT 75, indicating that the peak current setting of Inrush Current measurement 2 is 75 amps.

## POWER:POWER<x>:IVSINTEGRALV:ISOURce

This command sets or queries the current source for I vs Integral V measurement of the specified power measurement number.

**Conditions** Requires option PWR or PS2.

**Group** Power

**Syntax** POWER:Power<x>:IVSINTEGRALV:ISOURce  
{S<x>\_Ch<x>|CH<x>|MATH<x>|REF<x>}  
POWER:POWER<x>:IVSINTEGRALV:ISOURce?

**Related Commands** [POWER:POWER<x>:IVSINTEGRALV:VSOURce](#)

**Arguments** Power<x> is the power measurement number. This is the equivalent of the number shown in the power measurement badge on the UI.

S<x>\_Ch<x> specifies the remote scope number and the analog channel.

CH<x> sets the channel specifier; <x> is 1 through 8 and is limited by the number of FlexChannels in your instrument.

MATH<x> = A math waveform specifier; <x> is  $\geq 1$ .

REF<x> = A reference waveform specifier; <x> is  $\geq 1$ .

**Examples** POWER:POWER1:IVSINTEGRALV:ISOURce CH7 sets power measurement 1 to use Channel 7 as the current signal source for the measurement.

POWER:POWER2:IVSINTEGRALV:ISOURce? might return CH1, indicating that channel 1 is the current signal source for power measurement number 2.

## POWer:POWer<x>:IVSINTEGRALV:VSOURce

This command sets or queries the voltage source for I vs Integral V measurement of the specified power measurement number.

**Conditions** Requires option PWR or PS2.

**Group** Power

**Syntax** `POWer:POWer<x>:IVSINTEGRALV:VSOURce`  
`{S<x>_Ch<x>|CH<x>|MATH<x>|REF<x>}`  
`POWer:POWer<x>:IVSINTEGRALV:VSOURce?`

**Related Commands** [POWer:POWer<x>:IVSINTEGRALV:ISOURce](#)

**Arguments** `Power<x>` is the power measurement number. This is the equivalent of the number shown in the power measurement badge on the UI.

`S<x>_Ch<x>` specifies the remote scope number and the analog channel.

`CH<x>` sets the channel specifier; `<x>` is 1 through 8 and is limited by the number of FlexChannels in your instrument.

`MATH<x>` = A math waveform specifier; `<x>` is  $\geq 1$ .

`REF<x>` = A reference waveform specifier; `<x>` is  $\geq 1$ .

**Examples** `POWer:POWer2:IVSINTEGRALV:VSOURce CH1` sets I vs Integral V power measurement 2 to use Channel 1 as the voltage signal source for the measurement.

`POWer:POWer4:IVSINTEGRALV:VSOURce?` might return CH1, indicating that channel 1 is the voltage source for I vs Integral V power measurement number 4.

## POWer:POWer<x>:LABel

This command sets or queries the label for the specified power measurement. As the label can contain non 7-bit ASCII text, it is stored in Percent Encoding format. The power measurement badge is specified by x.

**Conditions** Requires option PWR or PS2.

**Group** Power



**Syntax**    `Power:Power<x>:LABel <QString>`  
`Power:Power<x>:LABel?`

**Examples**    `Power:Power1:LABel "NewMeasurement"` sets the custom measurement name for the measurement in Power 1 badge as New Measurement.

## POWer:POWer<x>:LINERIPPLE:INPUTSource

This command sets or queries the input source for line ripple measurement of the specified power measurement number.

**Conditions**    Requires option PWR or PS2.

**Group**    Power

**Syntax**    `Power:Power<x>:LINERIPPLE:INPUTSource`  
`{S<x>_Ch<x>|CH<x>|MATH<x>|REF<x>}`  
`Power:Power<x>:LINERIPPLE:INPUTSource?`

**Arguments**    `Power<x>` is the power measurement number. This is the equivalent of the number shown on a power measurement badge in the UI.

`S<x>_Ch<x>` specifies the remote scope number and the analog channel.

`CH<x>` = A channel specifier; `<x>` is 1 through 8 and is limited by the number of FlexChannels in your instrument.

`MATH<x>` = A math waveform specifier; `<x>` is  $\geq 1$ .

`REF<x>` = A reference waveform specifier; `<x>` is  $\geq 1$ .

**Examples**    `Power:Power1:LINERIPPLE:INPUTSource CH1` sets channel 1 as the input source for line ripple measurement of power measurement badge Power 1.

## POWer:POWer<x>:LINERIPPLE:LFREQuency

This command sets or queries the frequency present for line ripple measurement of the specified power measurement number. The power measurement number is specified by `x`.

**Conditions**    Requires option PWR or PS2.

<b>Group</b>	Power
<b>Syntax</b>	POWER:POWER<x>:LINERIPPLE:LFREQUENCY {FIFTY   SIXTY   FOURHUNDRED} POWER:POWER<x>:LINERIPPLE:LFREQUENCY?
<b>Examples</b>	POWER:POWER2:LINERIPPLE:LFREQUENCY FIFTY sets the frequency present for line ripple measurement as 50 Hz for power measurement 2.

## POWER:POWER<x>:MAGNETICLOSS:ISOURCE

This command sets or queries the current source for the magnetic loss measurement of the specified power measurement number.

<b>Conditions</b>	Requires option PWR or PS2.
<b>Group</b>	Power
<b>Syntax</b>	POWER:POWER<x>:MAGNETICLOSS:ISOURCE {S<x>_CH<x>   CH<x>   MATH<x>   REF<x>} POWER:POWER<x>:MAGNETICLOSS:ISOURCE?
<b>Related Commands</b>	<a href="#">POWER:POWER&lt;x&gt;:MAGNETICLOSS:VSOURCE</a>
<b>Arguments</b>	<p>Power&lt;x&gt; is the power measurement number. This is the equivalent of the number shown in the power measurement badge on the UI.</p> <p>S&lt;x&gt;_CH&lt;x&gt; specifies the remote scope number and the analog channel.</p> <p>CH&lt;x&gt; sets the channel specifier; &lt;x&gt; is 1 through 8 and is limited by the number of FlexChannels in your instrument.</p> <p>MATH&lt;x&gt; = A math waveform specifier; &lt;x&gt; is <math>\geq 1</math>.</p> <p>REF&lt;x&gt; = A reference waveform specifier; &lt;x&gt; is <math>\geq 1</math>.</p>
<b>Examples</b>	<p>POWER:POWER1:MAGNETICLOSS:ISOURCE CH7 sets power measurement 1 to use Channel 7 as the current signal source for the magnetic loss measurement.</p> <p>POWER:POWER2:MAGNETICLOSS:ISOURCE? might return CH1, indicating that channel 1 is the current signal source for the magnetic loss measurement number 2.</p>

**POWer:POWer<x>:MAGNETICLOSS:VSOURce**

This command sets or queries the voltage source for magnetic measurement of the specified power measurement number.

**Conditions** Requires option PWR or PS2.

**Group** Power

**Syntax** `POWer:POWer<x>:MAGNETICLOSS:VSOURce`  
`{S<x>_Ch<x> | CH<x> | MATH<x> | REF<x>}`  
`POWer:POWer<x>:MAGNETICLOSS:VSOURce?`

**Related Commands** [POWer:POWer<x>:MAGNETICLOSS:ISOURce](#)

**Arguments** `Power<x>` is the power measurement number. This is the equivalent of the number shown in the power measurement badge on the UI.

`S<x>_Ch<x>` specifies the remote scope number and the analog channel.

`CH<x>` sets the channel specifier; `<x>` is 1 through 8 and is limited by the number of FlexChannels in your instrument.

`MATH<x>` = A math waveform specifier; `<x>` is  $\geq 1$ .

`REF<x>` = A reference waveform specifier; `<x>` is  $\geq 1$ .

**Examples** `POWer:POWer2:MAGNETICLOSS:VSOURce CH4` sets power measurement 2 to use Channel 4 as the voltage signal source for the magnetic loss measurement.

`POWer:POWer1:MAGNETICLOSS:VSOURce?` might return CH1, indicating that channel 1 is the voltage source for the magnetic loss measurement number 1.

**POWer:POWer<x>:MAGPROPERTY:AREAofcrosssection**

This command sets or queries the coil cross section area for magnetic measurement of the specified power measurement number.

**Conditions** Requires option PWR or PS2.

**Group** Power

**Syntax**      `Power:Power<x>:MAGPROPERTY:AREAofcrosssection <NR2>`  
`Power:Power<x>:MAGPROPERTY:AREAofcrosssection?`

**Related Commands**      [POWER:POWER<x>:MAGPROPERTY:UNITS](#)

**Arguments**      `Power<x>` is the magnetic property power measurement number. This is the equivalent of the number shown in the power measurement badge on the UI.  
  
`<NR2>` is the cross section area in square meters, in the range of 1 nanometer<sup>2</sup> to 1 M<sup>2</sup>.

**Examples**      `Power:Power2:MAGPROPERTY:AREAofcrosssection .005` sets the primary winding cross section area to 5 for power measurement 2.  
  
`Power:Power4:MAGPROPERTY:AREAofcrosssection?` might return `10.54E-3`, indicating that the coil cross section area for power measurement 4 is 0.01054.

---

***NOTE.** The coil Cross Section Area unit depends on the setting of the Units value (see [POWER:POWER<x>:MAGPROPERTY:UNITS](#)). The command returns the same numeric value regardless of the units setting.*

---

## POWER:POWER<x>:MAGPROPERTY:EDGESOURCE

This command sets or queries the edge source type for the magnetic property measurement of the specified power measurement number.

**Conditions**      Requires option PWR or PS2.

**Group**      Power

**Syntax**      `Power:Power<x>:MAGPROPERTY:EDGESOURCE {Current | VOLTAGE}`  
`Power:Power<x>:MAGPROPERTY:EDGESOURCE?`

**Arguments**      `Power<x>` is the magnetic property power measurement number. This is the equivalent of the number shown on a power measurement badge in the UI.  
  
`Current` sets the measurement to use the primary voltage source as the signal edge for the magnetic property measurement.  
  
`VOLTAGE` sets the measurement to use the primary current source as the signal edge for the magnetic property measurement.

**Examples** `Power:Power1:MAGPROPERTY:EDGESource VOLTAGE` sets the signal edge source for power measurement 1 to use the primary voltage source.

`Power:Power3:MAGPROPERTY:EDGESource?` might return `CURRENT`, indicating that the signal edge source for power measurement 3 is the primary current source.

## **POWer:POWer<x>:MAGPROPERTY:ISOURce**

This command sets or queries the current source for the magnetic property measurement of the specified power measurement number.

**Conditions** Requires option PWR or PS2.

**Group** Power

**Syntax** `Power:Power<x>:MAGPROPERTY:ISOURce`  
`{S<x>_Ch<x> | CH<x> | MATH<x> | REF<x>}`  
`Power:Power<x>:MAGPROPERTY:ISOURce?`

**Related Commands** [POWer:POWer<x>:MAGPROPERTY:VSOURce](#)

**Arguments** `Power<x>` is the magnetic property power measurement number. This is the equivalent of the number shown in the power measurement badge on the UI.

`S<x>_Ch<x>` specifies the remote scope number and the analog channel.

`CH<x>` sets the channel specifier; `<x>` is 1 through 8 and is limited by the number of FlexChannels in your instrument.

`MATH<x>` = A math waveform specifier; `<x>` is  $\geq 1$ .

`REF<x>` = A reference waveform specifier; `<x>` is  $\geq 1$ .

**Examples** `Power:Power1:MAGPROPERTY:ISOURce CH4` sets power measurement 1 to use channel 4 as the primary winding current source for the magnetic power measurement.

`Power:Power2:MAGPROPERTY:ISOURce?` might return `CH1`, indicating that channel 1 is the primary winding current source for the magnetic power measurement number 2.

## POWer:POWer<x>:MAGPROPERTY:LENgth

This command sets or queries the conductor length of the primary winding for magnetic measurement of the specified power measurement number.

**Conditions** Requires option PWR or PS2.

**Group** Power

**Syntax** Power:POWer<x>:MAGPROPERTY:LENgth <NR2>  
Power:POWer<x>:MAGPROPERTY:LENgth?

**Related Commands** [POWer:POWer<x>:MAGPROPERTY:UNITs](#)

**Arguments** Power<x> is the magnetic property power measurement number. This is the equivalent of the number shown in the power measurement badge on the UI.

<NR2> is the magnetic length, in the range of 1.00E-09 through 1,000,000.

**Examples** Power:POWer2:MAGPROPERTY:LENgth 2.5 sets the primary winding length to 2.5 for power measurement 2.

Power:POWer5:MAGPROPERTY:LENgth? might return 10.54E-3, indicating that the primary winding length for power measurement 5 is 0.01054.

---

**NOTE.** The Magnetic Length unit depends on the setting of the Units value (see [POWer:POWer<x>:MAGPROPERTY:UNITs](#)). The command returns the same numeric value regardless of the units setting.

---

## POWer:POWer<x>:MAGPROPERTY:PRIMARYTURNs

This command sets or queries the number of primary turns for magnetic measurement of the specified power measurement number.

**Conditions** Requires option PWR or PS2.

**Group** Power

**Syntax** Power:POWer<x>:MAGPROPERTY:PRIMARYTURNs <NR1>  
Power:POWer<x>:MAGPROPERTY:PRIMARYTURNs?

<b>Related Commands</b>	<p><a href="#">POWER:POWer&lt;x&gt;:MAGPROPERTY:LENgth</a></p> <p><a href="#">POWER:POWer&lt;x&gt;:MAGPROPERTY:AREAofcrosssection</a></p>
<b>Arguments</b>	<p>Power&lt;x&gt; is the magnetic property power measurement number. This is the equivalent of the number shown in the power measurement badge on the UI.</p> <p>&lt;NR1&gt; is the integer number of turns in the primary winding, in the range of 1 to 1 M.</p>
<b>Examples</b>	<p>Power:POWer2:MAGPROPERTY:PRIMARYTURNS 150 sets the primary winding turn count to 150 for power measurement 2.</p> <p>Power:POWer5:MAGPROPERTY:PRIMARYTURNS? might return 50, indicating that the primary winding has 50 turns for power measurement 5.</p>

## POWER:POWer<x>:MAGPROPERTY:SEC1SOURce

This command sets or queries the current source channel for secondary winding 1 for magnetic measurement of the specified power measurement number.

<b>Conditions</b>	Requires option PWR or PS2.
<b>Group</b>	Power
<b>Syntax</b>	<pre>Power:POWer&lt;x&gt;:MAGPROPERTY:SEC1SOURce {S&lt;x&gt;_Ch&lt;x&gt; CH&lt;x&gt; MATH&lt;x&gt; REF&lt;x&gt;} Power:POWer&lt;x&gt;:MAGPROPERTY:SEC1SOURce?</pre>
<b>Related Commands</b>	<p><a href="#">POWER:POWer&lt;x&gt;:MAGPROPERTY:SEC2SOURce</a></p> <p><a href="#">POWER:POWer&lt;x&gt;:MAGPROPERTY:SEC3SOURce</a></p> <p><a href="#">POWER:POWer&lt;x&gt;:MAGPROPERTY:SEC4SOURce</a></p> <p><a href="#">POWER:POWer&lt;x&gt;:MAGPROPERTY:SEC5SOURce</a></p> <p><a href="#">POWER:POWer&lt;x&gt;:MAGPROPERTY:SEC6SOURce</a></p>
<b>Arguments</b>	<p>Power&lt;x&gt; is the power measurement number. This is the equivalent of the number shown in the power measurement badge on the UI.</p> <p>S&lt;x&gt;_Ch&lt;x&gt; specifies the remote scope number and the analog channel.</p>

CH<x> sets the channel specifier; <x> is 1 through 8 and is limited by the number of FlexChannels in your instrument.

MATH<x> = A math waveform specifier; <x> is  $\geq 1$ .

REF<x> = A reference waveform specifier; <x> is  $\geq 1$ .

- Examples**
- Power:Power3:MAGPROPERTY:SEC1SOURCE CH7 sets power measurement number 3 to use channel 7 as the current source for measuring secondary winding 1.
- Power:Power1:MAGPROPERTY:SEC1SOURCE? might return CH3, indicating that channel 3 is the source for measuring secondary winding 1 of magnetic power measurement number 1.

## POWER:POWER<x>:MAGPROPERTY:SEC1TURNS

This command sets or queries the number of turns of secondary winding 1 for magnetic measurement of the specified power measurement number.

- Conditions** Requires option PWR or PS2.
- Group** Power
- Syntax** Power:Power<x>:MAGPROPERTY:SEC1TURNS <NR1>  
Power:Power<x>:MAGPROPERTY:SEC1TURNS?
- Related Commands** [POWER:POWER<x>:MAGPROPERTY:SEC2TURNS](#)  
[POWER:POWER<x>:MAGPROPERTY:SEC3TURNS](#)  
[POWER:POWER<x>:MAGPROPERTY:SEC4TURNS](#)  
[POWER:POWER<x>:MAGPROPERTY:SEC5TURNS](#)  
[POWER:POWER<x>:MAGPROPERTY:SEC6TURNS](#)
- Arguments** Power<x> is the power measurement number. This is the equivalent of the number shown in the power measurement badge on the UI.
- <NR1> is the number of turns on the secondary winding, and ranges from 0 to 1,000,000.
- Examples** Power:Power3:MAGPROPERTY:SEC1TURNS 500 sets the number of turns on secondary winding 1 to 500 for magnetic power measurement number 3.



`Power:Power3:MAGPROPERTY:SEC1TURNS?` might return 2500, indicating that there are 2,500 turns on secondary winding 4 for magnetic power measurement number 3.

## **POWer:POWer<x>:MAGPROPERTY:SEC2SOURce**

This command sets or queries the current source for secondary winding2 for magnetic measurement of the specified power measurement number.

**Conditions** Requires option PWR or PS2.

**Group** Power

**Syntax** `Power:Power<x>:MAGPROPERTY:SEC2SOURce`  
`{S<x>_Ch<x> | CH<x> | MATH<x> | REF<x>}`  
`Power:Power<x>:MAGPROPERTY:SEC2SOURce?`

**Related Commands** [Power:Power<x>:MAGPROPERTY:SEC1SOURce](#)  
[Power:Power<x>:MAGPROPERTY:SEC3SOURce](#)  
[Power:Power<x>:MAGPROPERTY:SEC4SOURce](#)  
[Power:Power<x>:MAGPROPERTY:SEC5SOURce](#)  
[Power:Power<x>:MAGPROPERTY:SEC6SOURce](#)

**Arguments** `Power<x>` is the power measurement number. This is the equivalent of the number shown in the power measurement badge on the UI.

`S<x>_Ch<x>` specifies the remote scope number and the analog channel.

`CH<x>` sets the channel specifier; `<x>` is 1 through 8 and is limited by the number of FlexChannels in your instrument.

`MATH<x>` = A math waveform specifier; `<x>` is  $\geq 1$ .

`REF<x>` = A reference waveform specifier; `<x>` is  $\geq 1$ .

**Examples** `Power:Power1:MAGPROPERTY:SEC2SOURce CH2` sets power measurement number 1 to use channel 2 as the current source for measuring secondary winding 2.

`Power:Power3:MAGPROPERTY:SEC2SOURce?` might return `MATH2`, indicating that math waveform 2 is the source for measuring secondary winding 2 of magnetic power measurement number 3.

## POWer:POWer<x>:MAGPROPERTY:SEC2TURNs

This command sets or queries the number of turns of secondary winding 2 for magnetic measurement of the specified power measurement number.

<b>Conditions</b>	Requires option PWR or PS2.
<b>Group</b>	Power
<b>Syntax</b>	<code>POWer:POWer&lt;x&gt;:MAGPROPERTY:SEC2TURNs &lt;NR1&gt;</code> <code>POWer:POWer&lt;x&gt;:MAGPROPERTY:SEC2TURNs?</code>
<b>Related Commands</b>	<a href="#">POWer:POWer&lt;x&gt;:MAGPROPERTY:SEC1TURNs</a> <a href="#">POWer:POWer&lt;x&gt;:MAGPROPERTY:SEC3TURNs</a> <a href="#">POWer:POWer&lt;x&gt;:MAGPROPERTY:SEC4TURNs</a> <a href="#">POWer:POWer&lt;x&gt;:MAGPROPERTY:SEC5TURNs</a> <a href="#">POWer:POWer&lt;x&gt;:MAGPROPERTY:SEC6TURNs</a>
<b>Arguments</b>	<p><code>Power&lt;x&gt;</code> is the power measurement number. This is the equivalent of the number shown in the power measurement badge on the UI.</p> <p><code>&lt;NR1&gt;</code> is the number of turns on the secondary winding, and ranges from 0 to 1,000,000.</p>
<b>Examples</b>	<p><code>POWer:POWer1:MAGPROPERTY:SEC2TURNs 50</code> sets the number of turns on secondary winding 2 to 50 for magnetic power measurement number 3.</p> <p><code>POWer:POWer7:MAGPROPERTY:SEC2TURNs?</code> might return 250, indicating that there are 250 turns on secondary winding 2 for magnetic power measurement number 7.</p>

## POWer:POWer<x>:MAGPROPERTY:SEC3SOURce

This command sets or queries the current source channel for secondary winding 3 for magnetic measurement of the specified power measurement number.

**Conditions** Requires option PWR or PS2.

**Group** Power

**Syntax**     `POWer:POWer<x>:MAGPROPERTY:SEC3SOURCE`  
                   `{S<x>_Ch<x>|CH<x>|MATH<x>|REF<x>}`  
                   `POWer:POWer<x>:MAGPROPERTY:SEC3SOURCE?`

**Related Commands**     `POWer:POWer<x>:MAGPROPERTY:SEC1SOURCE`  
                               `POWer:POWer<x>:MAGPROPERTY:SEC2SOURCE`  
                               `POWer:POWer<x>:MAGPROPERTY:SEC4SOURCE`  
                               `POWer:POWer<x>:MAGPROPERTY:SEC5SOURCE`  
                               `POWer:POWer<x>:MAGPROPERTY:SEC6SOURCE`

**Arguments**     `Power<x>` is the power measurement number. This is the equivalent of the number shown in the power measurement badge on the UI.

`S<x>_Ch<x>` specifies the remote scope number and the analog channel.

`CH<x>` sets the channel specifier; `<x>` is 1 through 8 and is limited by the number of FlexChannels in your instrument.

`MATH<x>` = A math waveform specifier; `<x>` is  $\geq 1$ .

`REF<x>` = A reference waveform specifier; `<x>` is  $\geq 1$ .

**Examples**     `Power:Power1:MAGPROPERTY:SEC3SOURCE CH1` sets power measurement number 1 to use channel 1 as the current source for measuring secondary winding 3.

`Power:Power1:MAGPROPERTY:SEC3SOURCE?` might return CH1, indicating that channel 1 is the source for measuring secondary winding 3 of magnetic power measurement number 1.

## **POWer:POWer<x>:MAGPROPERTY:SEC3TURNS**

This command sets or queries the number of turns of secondary winding 3 for magnetic measurement of the specified power measurement number.

**Conditions**     Requires option PWR or PS2.

**Group**            Power

**Syntax**           `Power:Power<x>:MAGPROPERTY:SEC3TURNS <NR1>`  
                       `Power:Power<x>:MAGPROPERTY:SEC3TURNS?`

**Related Commands**    [POWer:POWer<x>:MAGPROPERTY:SEC1TURNs](#)  
[POWer:POWer<x>:MAGPROPERTY:SEC2TURNs](#)  
[POWer:POWer<x>:MAGPROPERTY:SEC4TURNs](#)  
[POWer:POWer<x>:MAGPROPERTY:SEC5TURNs](#)  
[POWer:POWer<x>:MAGPROPERTY:SEC6TURNs](#)

**Arguments**    Power<x> is the power measurement number. This is the equivalent of the number shown in the power measurement badge on the UI.  
 <NR1> is the number of turns on the secondary winding, and ranges from 0 to 1,000,000.

**Examples**    Power:Power1:MAGPROPERTY:SEC3TURNs 15 sets the number of turns on secondary winding 3 to 15 for magnetic power measurement number 1.  
 Power:Power3:MAGPROPERTY:SEC3TURNs? might return 2500, indicating that there are 2,500 turns on secondary winding 3 for magnetic power measurement number 3.

## POWer:POWer<x>:MAGPROPERTY:SEC4SOURce

This command sets or queries the current source for secondary winding 4 for magnetic measurement of the specified power measurement number.

**Conditions**    Requires option PWR or PS2.

**Group**    Power

**Syntax**    Power:Power<x>:MAGPROPERTY:SEC4SOURce  
 {S<x>\_Ch<x>|CH<x>|MATH<x>|REF<x>}  
 Power:Power<x>:MAGPROPERTY:SEC4SOURce?

**Related Commands**    [POWer:POWer<x>:MAGPROPERTY:SEC1SOURce](#)  
[POWer:POWer<x>:MAGPROPERTY:SEC2SOURce](#)  
[POWer:POWer<x>:MAGPROPERTY:SEC3SOURce](#)  
[POWer:POWer<x>:MAGPROPERTY:SEC5SOURce](#)  
[POWer:POWer<x>:MAGPROPERTY:SEC6SOURce](#)

<b>Arguments</b>	<p>Power&lt;x&gt; is the power measurement number. This is the equivalent of the number shown in the power measurement badge on the UI.</p> <p>S&lt;x&gt;_Ch&lt;x&gt; specifies the remote scope number and the analog channel.</p> <p>CH&lt;x&gt; sets the channel specifier; &lt;x&gt; is 1 through 8 and is limited by the number of FlexChannels in your instrument.</p> <p>MATH&lt;x&gt; = A math waveform specifier; &lt;x&gt; is <math>\geq 1</math>.</p> <p>REF&lt;x&gt; = A reference waveform specifier; &lt;x&gt; is <math>\geq 1</math>.</p>
<b>Examples</b>	<p>Power:Power3:MAGPROPERTY:SEC4SOURCE CH7 sets power measurement number 3 to use channel 7 as the current source for measuring secondary winding 4.</p> <p>Power:Power12:MAGPROPERTY:SEC4SOURCE? might return CH1, indicating that Channel 1 is the source for measuring secondary winding 4 of magnetic power measurement number 12.</p>

## POWER:POWER<x>:MAGPROPERTY:SEC4TURNS

This command sets or queries the number of turns of secondary winding 4 for magnetic measurement of the specified power measurement number.

<b>Conditions</b>	Requires option PWR or PS2.
<b>Group</b>	Power
<b>Syntax</b>	<pre>Power:Power&lt;x&gt;:MAGPROPERTY:SEC4TURNS &lt;NR1&gt; Power:Power&lt;x&gt;:MAGPROPERTY:SEC4TURNS?</pre>
<b>Related Commands</b>	<p><a href="#">POWER:POWER&lt;x&gt;:MAGPROPERTY:SEC1TURNS</a></p> <p><a href="#">POWER:POWER&lt;x&gt;:MAGPROPERTY:SEC2TURNS</a></p> <p><a href="#">POWER:POWER&lt;x&gt;:MAGPROPERTY:SEC3TURNS</a></p> <p><a href="#">POWER:POWER&lt;x&gt;:MAGPROPERTY:SEC5TURNS</a></p> <p><a href="#">POWER:POWER&lt;x&gt;:MAGPROPERTY:SEC6TURNS</a></p>
<b>Arguments</b>	<p>Power&lt;x&gt; is the power measurement number. This is the equivalent of the number shown in the power measurement badge on the UI.</p> <p>&lt;NR1&gt; is the number of turns on the secondary winding, and ranges from 0 to 1,000,000.</p>

**Examples**     `Power:Power4:MAGPROPERTY:SEC4TURNS 500` sets the number of turns on secondary winding 4 to 500 for magnetic power measurement number 4.

`Power:Power1:MAGPROPERTY:SEC4TURNS?` might return 90, indicating that there are 90 turns on secondary winding 4 for magnetic power measurement number 3.

## POWER:POWER<x>:MAGPROPERTY:SEC5SOURCE

This command sets or queries the current source for secondary winding 5 for magnetic measurement of the specified power measurement number.

**Conditions**     Requires option PWR or PS2.

**Group**            Power

**Syntax**           `Power:Power<x>:MAGPROPERTY:SEC5SOURCE`  
                       `{S<x>_Ch<x>|CH<x>|MATH<x>|REF<x>}`  
                       `Power:POWER<x>:MAGPROPERTY:SEC5SOURCE?`

**Related Commands**     [POWER:POWER<x>:MAGPROPERTY:SEC1SOURCE](#)  
                                   [POWER:POWER<x>:MAGPROPERTY:SEC2SOURCE](#)  
                                   [POWER:POWER<x>:MAGPROPERTY:SEC3SOURCE](#)  
                                   [POWER:POWER<x>:MAGPROPERTY:SEC4SOURCE](#)  
                                   [POWER:POWER<x>:MAGPROPERTY:SEC6SOURCE](#)

**Arguments**        `Power<x>` is the power measurement number. This is the equivalent of the number shown in the power measurement badge on the UI.

`S<x>_Ch<x>` specifies the remote scope number and the analog channel.

`CH<x>` sets the channel specifier; `<x>` is 1 through 8 and is limited by the number of FlexChannels in your instrument.

`MATH<x>` = A math waveform specifier; `<x>` is  $\geq 1$ .

`REF<x>` = A reference waveform specifier; `<x>` is  $\geq 1$ .

**Examples**        `Power:Power3:MAGPROPERTY:SEC5SOURCE MATH1` sets power measurement number 3 to use math waveform 1 as the current source for measuring secondary winding 5.

`POWer:POWer4:MAGPROPERTY:SEC5SOURCE?` might return CH2, indicating that channel 2 is the source for measuring secondary winding 5 of magnetic power measurement number 4.

## **POWer:POWer<x>:MAGPROPERTY:SEC5TURNS**

This command sets or queries the number of turns of secondary winding 5 for magnetic measurement of the specified power measurement badge.

**Conditions** Requires option PWR or PS2.

**Group** Power

**Syntax** `POWer:POWer<x>:MAGPROPERTY:SEC5TURNS <NR1>`  
`POWer:POWer<x>:MAGPROPERTY:SEC5TURNS?`

**Related Commands** [POWer:POWer<x>:MAGPROPERTY:SEC1TURNS](#)  
[POWer:POWer<x>:MAGPROPERTY:SEC2TURNS](#)  
[POWer:POWer<x>:MAGPROPERTY:SEC3TURNS](#)  
[POWer:POWer<x>:MAGPROPERTY:SEC4TURNS](#)  
[POWer:POWer<x>:MAGPROPERTY:SEC6TURNS](#)

**Arguments** `Power<x>` is the power measurement number. This is the equivalent of the number shown in the power measurement badge on the UI.  
`<NR1>` is the number of turns on the secondary winding, and ranges from 0 to 1,000,000.

**Examples** `POWer:POWer3:MAGPROPERTY:SEC5TURNS 250` sets the number of turns on secondary winding 5 to 250 for magnetic power measurement number 3.  
`POWer:POWer1:MAGPROPERTY:SEC5TURNS?` might return 150, indicating that there are 150 turns on secondary winding 5 for magnetic power measurement number 1.

## **POWer:POWer<x>:MAGPROPERTY:SEC6SOURCE**

This command sets or queries the current source for secondary winding 6 for magnetic measurement of the specified power measurement number.

<b>Conditions</b>	Requires option PWR or PS2.
<b>Group</b>	Power
<b>Syntax</b>	<pre>Power:Power&lt;x&gt;:MAGPROPERTY:SEC6SOURCE {S&lt;x&gt;_Ch&lt;x&gt; CH&lt;x&gt; MATH&lt;x&gt; REF&lt;x&gt;} Power:Power&lt;x&gt;:MAGPROPERTY:SEC6SOURCE?</pre>
<b>Related Commands</b>	<pre>POWer:POWer&lt;x&gt;:MAGPROPERTY:SEC1SOURCE POWer:POWer&lt;x&gt;:MAGPROPERTY:SEC2SOURCE POWer:POWer&lt;x&gt;:MAGPROPERTY:SEC3SOURCE POWer:POWer&lt;x&gt;:MAGPROPERTY:SEC4SOURCE POWer:POWer&lt;x&gt;:MAGPROPERTY:SEC5SOURCE</pre>
<b>Arguments</b>	<p>Power&lt;x&gt; is the power measurement number. This is the equivalent of the number shown in the power measurement badge on the UI.</p> <p>S&lt;x&gt;_Ch&lt;x&gt; specifies the remote scope number and the analog channel.</p> <p>CH&lt;x&gt; sets the channel specifier; &lt;x&gt; is 1 through 8 and is limited by the number of FlexChannels in your instrument.</p> <p>MATH&lt;x&gt; = A math waveform specifier; &lt;x&gt; is <math>\geq 1</math>.</p> <p>REF&lt;x&gt; = A reference waveform specifier; &lt;x&gt; is <math>\geq 1</math>.</p>
<b>Examples</b>	<pre>Power:Power3:MAGPROPERTY:SEC6SOURCE CH4 sets power measurement number 3 to use channel 4 as the current source for measuring secondary winding 6.</pre> <p>Power:Power2:MAGPROPERTY:SEC6SOURCE? might return CH4, indicating that channel 4 is the source for measuring secondary winding 3 of magnetic power measurement number 2.</p>

## POWer:POWer<x>:MAGPROPERTY:SEC6TURNS

This command sets or queries the number of turns of secondary winding 6 for magnetic measurement of the specified power measurement number.

**Conditions** Requires option PWR or PS2.



<b>Group</b>	Power
<b>Syntax</b>	<pre>POWER:POWER&lt;x&gt;:MAGPROPERTY:SEC6TURNS &lt;NR1&gt; POWER:POWER&lt;x&gt;:MAGPROPERTY:SEC6TURNS?</pre>
<b>Related Commands</b>	<pre>POWER:POWER&lt;x&gt;:MAGPROPERTY:SEC1TURNS POWER:POWER&lt;x&gt;:MAGPROPERTY:SEC2TURNS POWER:POWER&lt;x&gt;:MAGPROPERTY:SEC3TURNS POWER:POWER&lt;x&gt;:MAGPROPERTY:SEC4TURNS POWER:POWER&lt;x&gt;:MAGPROPERTY:SEC5TURNS</pre>
<b>Arguments</b>	<p>Power&lt;x&gt; is the power measurement number. This is the equivalent of the number shown in the power measurement badge on the UI.</p> <p>&lt;NR1&gt; is the number of turns on the secondary winding, and ranges from 0 to 1,000,000.</p>
<b>Examples</b>	<pre>POWER:POWER8:MAGPROPERTY:SEC6TURNS 22</pre> <p>sets the number of turns on secondary winding 6 to 22 for magnetic power measurement number 8.</p> <pre>POWER:POWER9:MAGPROPERTY:SEC6TURNS?</pre> <p>might return 7000, indicating that their are 7,000 turns on secondary winding 6 for magnetic power measurement number 9.</p>

## POWER:POWER<x>:MAGPROPERTY:SECPhase

This command sets or returns the value for the phase difference between secondary and primary voltage.

<b>Group</b>	Power
<b>Syntax</b>	<pre>POWER:POWER&lt;x&gt;:MAGPROPERTY:SECPhase &lt;NR3&gt; POWER:POWER&lt;x&gt;:MAGPROPERTY:SECPhase?</pre>
<b>Arguments</b>	<p>Power&lt;x&gt; is the power measurement number. This is the equivalent of the number shown in the UI for a power measurement badge.</p> <p>&lt;NR3&gt; sets the value for the phase difference between secondary and primary voltage, in the range of -180 to 180 degrees.</p>

**Examples** `Power:Power1:MAGPROPERTY:SECPhase 180` sets the value for the phase difference between secondary and primary voltage to 180 degrees.

`Power:Power1:MAGPROPERTY:SECPhase?` might return `:Power:Power1:MAGPROPERTY:SECPhase 180`, indicating that the value for the phase difference between secondary and primary voltage is 180 degrees.

## **POWER:POWER<x>:MAGPROPERTY:SECVolt**

This command enables or disables secondary voltage input for measurement.

**Group** Power

**Syntax** `Power:Power<x>:MAGPROPERTY:SECVolt {True|False}`  
`Power:Power<x>:MAGPROPERTY:SECVolt?`

**Arguments** `Power<x>` is the power measurement number. This is the equivalent of the number shown in the power measurement badge on the UI.

`True` enables secondary voltage source.

`False` disables secondary voltage source.

**Examples** `Power:Power1:MAGPROPERTY:SECVolt true` enables secondary voltage source.

`Power:Power1:MAGPROPERTY:SECVolt?` might return `:Power:Power1:MAGPROPERTY:SECVolt true`, indicating that the secondary voltage source is enabled.

## **POWER:POWER<x>:MAGPROPERTY:SECWINDings**

This command sets or queries the number of secondary windings for the magnetic property measurement of the specified power measurement number.

**Conditions** Requires option PWR or PS2.

**Group** Power

**Syntax** `Power:Power<x>:MAGPROPERTY:SECWINDings`  
`{None|ONE|TWO|THREE|FOUR|FIVE|SIX}`

`Power:Power<x>:MAGPROPERTY:SECWINDings?`

**Related Commands**

`Power:Power<x>:MAGPROPERTY:SEC1SOURce`  
`Power:Power<x>:MAGPROPERTY:SEC1TURNs`  
`Power:Power<x>:MAGPROPERTY:SEC2SOURce`  
`Power:Power<x>:MAGPROPERTY:SEC2TURNs`  
`Power:Power<x>:MAGPROPERTY:SEC3SOURce`  
`Power:Power<x>:MAGPROPERTY:SEC3TURNs`  
`Power:Power<x>:MAGPROPERTY:SEC4SOURce`  
`Power:Power<x>:MAGPROPERTY:SEC4TURNs`  
`Power:Power<x>:MAGPROPERTY:SEC5SOURce`  
`Power:Power<x>:MAGPROPERTY:SEC5TURNs`  
`Power:Power<x>:MAGPROPERTY:SEC6SOURce`  
`Power:Power<x>:MAGPROPERTY:SEC6TURNs`

**Arguments**

`Power<x>` is the magnetic property power measurement number. This is the equivalent of the number shown in the power measurement badge on the UI.

None, ONE, TWO, THREE, FOUR, FIVE, SIX sets the number of secondary windings to the specified value.

**Examples**

`Power:Power2:MAGPROPERTY:SECWINDings 4` sets power measurement 2 to use 4 secondary transformer windings.

`Power:Power11:MAGPROPERTY:SECWINDings?` might return FOUR, indicating that there are four secondary transformer windings for power measurement 11.

## **Power:Power<x>:MAGPROPERTY:UNITS**

This command sets or queries the units for magnetic measurements of the specified power measurement number.

**Conditions**

Requires option PWR or PS2.

**Group**

Power

<b>Syntax</b>	<pre>Power:Power&lt;x&gt;:MAGPROPERTY:UNITS {SI CGS} Power:Power&lt;x&gt;:MAGPROPERTY:UNITS?</pre>
<b>Related Commands</b>	<p><a href="#">POWer:POWer&lt;x&gt;:MAGPROPERTY:AREAOfcrosssection</a></p> <p><a href="#">POWer:POWer&lt;x&gt;:MAGPROPERTY:LENgth</a></p>
<b>Arguments</b>	<p>Power&lt;x&gt; is the power measurement number. This is the equivalent of the number shown in the power measurement badge on the UI.</p> <p>SI sets the measurement to International System of Units.</p> <p>CGS sets the measurement to Gaussian units.</p>
<b>Examples</b>	<p>Power:Power5:MAGPROPERTY:UNITS SI sets magnetic property measurement 5 to use SI units.</p> <p>Power:Power1:MAGPROPERTY:UNITS? might return CGS, indicating that the measurement unit for power measurement 1 is set to CGS.</p>

## POWer:POWer<x>:MAGPROPERTY:VSOURce

This command sets or queries the primary winding voltage source for the magnetic measurement of the specified power measurement number.

<b>Conditions</b>	Requires option PWR or PS2.
<b>Group</b>	Power
<b>Syntax</b>	<pre>Power:Power&lt;x&gt;:MAGPROPERTY:VSOURce {S&lt;x&gt;_Ch&lt;x&gt; CH&lt;x&gt; MATH&lt;x&gt; REF&lt;x&gt;} Power:Power&lt;x&gt;:MAGPROPERTY:VSOURce?</pre>
<b>Related Commands</b>	<a href="#">POWer:POWer&lt;x&gt;:MAGPROPERTY:ISOURce</a>
<b>Arguments</b>	<p>Power&lt;x&gt; is the power measurement number. This is the equivalent of the number shown in the power measurement badge on the UI.</p> <p>S&lt;x&gt;_Ch&lt;x&gt; specifies the remote scope number and the analog channel.</p> <p>CH&lt;x&gt; sets the channel specifier; &lt;x&gt; is 1 through 8 and is limited by the number of FlexChannels in your instrument.</p> <p>MATH&lt;x&gt; = A math waveform specifier; &lt;x&gt; is <math>\geq 1</math>.</p>

REF<x> = A reference waveform specifier; <x> is  $\geq 1$ .

- Examples** `POWER:POWER1:MAGPROPERTY:VSOURCE CH4` sets power measurement 1 to use channel 4 as the primary winding voltage source for the magnetic power measurement.
- `POWER:POWER2:MAGPROPERTY:VSOURCE?` might return CH1, indicating that channel 1 is the primary winding voltage source for the magnetic power measurement number 2.

## POWER:POWER<x>:NDUTYCYCLE:EDGEType

This command sets or queries the clock edge type for negative duty cycle measurement in the specified power measurement number. The power measurement number is specified by x.

- Conditions** Requires option PWR or PS2.
- Group** Power
- Syntax** `POWER:POWER<x>:NDUTYCYCLE:EDGEType {RISE | FALL | BOTH}`  
`POWER:POWER<x>:NDUTYCYCLE:EDGEType?`
- Examples** `POWER:POWER1:NDUTYCYCLE:EDGEType RISE` sets the clock edge type as rise for the negative duty cycle measurement.

## POWER:POWER<x>:NDUTYCYCLE:INPUTSource

This command sets or queries the input source for negative duty cycle measurement in the specified power measurement number.

- Conditions** Requires option PWR or PS2.
- Group** Power
- Syntax** `POWER:POWER<x>:NDUTYCYCLE:INPUTSource`  
`{S<x>_Ch<x> | CH<x> | MATH<x> | REF<x>}`  
`POWER:POWER<x>:NDUTYCYCLE:INPUTSource?`

<b>Arguments</b>	<p>Power&lt;x&gt; is the power measurement number. This is the equivalent of the number shown on a power measurement badge in the UI.</p> <p>S&lt;x&gt;_Ch&lt;x&gt; specifies the remote scope number and the analog channel.</p> <p>CH&lt;x&gt; = A channel specifier; &lt;x&gt; is 1 through 8 and is limited by the number of FlexChannels in your instrument.</p> <p>MATH&lt;x&gt; = A math waveform specifier; &lt;x&gt; is <math>\geq 1</math>.</p> <p>REF&lt;x&gt; = A reference waveform specifier; &lt;x&gt; is <math>\geq 1</math>.</p>
<b>Examples</b>	<p>Power:Power1:NDUTYCYCLE:INPUTSource CH3 sets the input source for negative duty cycle measurement as CH3 for the power measurement badge Power 1.</p>

## POWER:POWER<x>:NPULSEWIDTH:INPUTSource

This command sets or queries the input source for negative pulse width measurement in the specified power measurement number.

<b>Conditions</b>	Requires option PWR or PS2.
<b>Group</b>	Power
<b>Syntax</b>	<pre>Power:Power&lt;x&gt;:NPULSEWIDTH:INPUTSource {S&lt;x&gt;_Ch&lt;x&gt; CH&lt;x&gt; MATH&lt;x&gt; REF&lt;x&gt;} Power:Power&lt;x&gt;:NPULSEWIDTH:INPUTSource?</pre>
<b>Arguments</b>	<p>Power&lt;x&gt; is the power measurement number. This is the equivalent of the number shown on a power measurement badge in the UI.</p> <p>S&lt;x&gt;_Ch&lt;x&gt; specifies the remote scope number and the analog channel.</p> <p>CH&lt;x&gt; = A channel specifier; &lt;x&gt; is 1 through 8 and is limited by the number of FlexChannels in your instrument.</p> <p>MATH&lt;x&gt; = A math waveform specifier; &lt;x&gt; is <math>\geq 1</math>.</p> <p>REF&lt;x&gt; = A reference waveform specifier; &lt;x&gt; is <math>\geq 1</math>.</p>
<b>Examples</b>	<p>Power:Power1:NPULSEWIDTH:INPUTSource CH1 sets the input source for negative pulse width measurement as channel 1.</p>

## POWer:POWer<x>:PDUTYCYCLE:EDGEType

This command sets or queries the clock edge type for positive duty cycle measurement in the specified power measurement number. The power measurement number is specified by x.

<b>Conditions</b>	Requires option PWR or PS2.
<b>Group</b>	Power
<b>Syntax</b>	<pre>POWer:POWer&lt;x&gt;:PDUTYCYCLE:EDGEType {S&lt;x&gt;_Ch&lt;x&gt; CH&lt;x&gt; MATH&lt;x&gt; REF&lt;x&gt;} POWer:POWer&lt;x&gt;:PDUTYCYCLE:EDGEType?</pre>
<b>Arguments</b>	<p>S&lt;x&gt;_Ch&lt;x&gt; specifies the remote scope number and the analog channel as the source.</p> <p>CH&lt;x&gt; specifies an analog channel as the source.</p> <p>Math&lt;x&gt; specifies a math waveform as the source.</p> <p>REF&lt;x&gt; specifies a reference waveform as the source.</p>
<b>Examples</b>	<pre>POWer:POWer1:PDUTYCYCLE:EDGEType BOTH</pre> <p>sets the clock edge type as both (rise and fall) for the positive duty cycle measurement.</p>

## POWer:POWer<x>:PDUTYCYCLE:INPUTSource

This command sets or queries the input source for positive duty cycle measurement in the specified power measurement number.

<b>Conditions</b>	Requires option PWR or PS2.
<b>Group</b>	Power
<b>Syntax</b>	<pre>POWer:POWer&lt;x&gt;:PDUTYCYCLE:INPUTSource {S&lt;x&gt;_Ch&lt;x&gt; CH&lt;x&gt; MATH&lt;x&gt; REF&lt;x&gt;} POWer:POWer&lt;x&gt;:PDUTYCYCLE:INPUTSource?</pre>
<b>Arguments</b>	<p>Power&lt;x&gt; is the power measurement number. This is the equivalent of the number shown on a power measurement badge in the UI.</p>

S<x>\_Ch<x> specifies the remote scope number and the analog channel.

CH<x> = A channel specifier; <x> is 1 through 8 and is limited by the number of FlexChannels in your instrument.

MATH<x> = A math waveform specifier; <x> is  $\geq 1$ .

REF<x> = A reference waveform specifier; <x> is  $\geq 1$ .

**Examples**    `Power:Power1:PDUTYCYCLE:INPUTSource CH4` sets the input source for positive duty cycle measurement as channel 4.

## POWer:POWer<x>:PERIOD:EDGE

This command sets or queries the edge type for period measurement in the specified power measurement number. The power measurement number is specified by x.

**Conditions**    Requires option PWR or PS2.

**Group**        Power

**Syntax**       `Power:Power<x>:PERIOD:EDGE {RISE | FALL}`  
`Power:Power<x>:PERIOD:EDGE?`

**Examples**    `Power:Power1:PERIOD:EDGE RISE` sets the edge type as rise for the period measurement.

## POWer:POWer<x>:PERIOD:INPUTSource

This command sets or queries the input source for period measurement in the specified power measurement number.

**Conditions**    Requires option PWR or PS2.

**Group**        Power

**Syntax**       `Power:Power<x>:PERIOD:INPUTSource`  
`{S<x>_Ch<x> | CH<x> | MATH<x> | REF<x>}`  
`Power:Power<x>:PERIOD:INPUTSource?`



<b>Arguments</b>	<p><b>Power&lt;x&gt;</b> is the power measurement number. This is the equivalent of the number shown in the UI for a power measurement badge.</p> <p><b>S&lt;x&gt;_Ch&lt;x&gt;</b> specifies the remote scope number and the analog channel.</p> <p><b>CH&lt;x&gt;</b> = A channel specifier; &lt;x&gt; is 1 through 8 and is limited by the number of FlexChannels in your instrument.</p> <p><b>MATH&lt;x&gt;</b> = A math waveform specifier; &lt;x&gt; is <math>\geq 1</math>.</p> <p><b>REF&lt;x&gt;</b> = A reference waveform specifier; &lt;x&gt; is <math>\geq 1</math>.</p>
<b>Examples</b>	<p><b>Power:Power1:PERIOD:INPUTSource CH6</b> sets the input source for period measurement as channel 6.</p>

## POWer:POWer<x>:POWERQUALITY:CCYClEs

This command sets or queries the calculate cycles over full cycles settings for the specified power quality measurement number.

<b>Conditions</b>	Requires option PWR or PS2.
<b>Group</b>	Power
<b>Syntax</b>	<p><b>Power:Power&lt;x&gt;:POWERQUALITY:CCYClEs {ON   OFF 1   0}</b></p> <p><b>Power:Power&lt;x&gt;:POWERQUALITY:CCYClEs?</b></p>
<b>Arguments</b>	<p><b>Power&lt;x&gt;</b> is the power measurement number. This is the equivalent of the number shown in the UI for a power measurement badge.</p> <p><b>1   ON</b> selects the calculate cycles over full cycles.</p> <p><b>0   OFF</b> unselects the calculate cycles over full cycles.</p>
<b>Examples</b>	<p><b>Power:Power1:POWERQUALITY:CCYClEs 1</b> selects the calculate cycles over full cycles for the power measurement badge 1.</p>

## POWer:POWer<x>:POWERQUALITY:FREFerence

This command sets or queries the frequency reference type for power quality measurement in the specified power measurement number. The power measurement number is specified by x.

<b>Conditions</b>	Requires option PWR or PS2.
<b>Group</b>	Power
<b>Syntax</b>	POWER:POWER<x>:POWERQUALITY:FREFerence {VOLTage   CURRENT} POWER:POWER<x>:POWERQUALITY:FREFerence?
<b>Examples</b>	POWER:POWER1:POWERQUALITY:FREFerence CURRENT sets the frequency reference type for power quality measurement as current.

## POWER:POWER<x>:POWERQUALITY:ISOURce

This command sets or queries the current source for power quality measurement in the specified power measurement number.

<b>Conditions</b>	Requires option PWR or PS2.
<b>Group</b>	Power
<b>Syntax</b>	POWER:POWER<x>:POWERQUALITY:ISOURce {CH<x>   MATH<x>   REF<x>} POWER:POWER<x>:POWERQUALITY:ISOURce?
<b>Arguments</b>	<p>Power&lt;x&gt; is the power measurement number. This is the equivalent of the number shown in the UI for a power measurement badge.</p> <p>CH&lt;x&gt; = A channel specifier; &lt;x&gt; is 1 through 8 and is limited by the number of FlexChannels in your instrument.</p> <p>MATH&lt;x&gt; = A math waveform specifier; &lt;x&gt; is <math>\geq 1</math>.</p> <p>REF&lt;x&gt; = A reference waveform specifier; &lt;x&gt; is <math>\geq 1</math>.</p>
<b>Examples</b>	POWER:POWER1:POWERQUALITY:VSOURce CH2 sets the current source for power quality measurement as channel 2.

## POWER:POWER<x>:POWERQUALITY:STYPe

This command sets or queries the source type.

<b>Group</b>	Power
<b>Syntax</b>	<pre>Power:Power&lt;x&gt;:POWERQUALITY:SType {AC DC} Power:Power&lt;x&gt;:POWERQUALITY:SType?</pre>
<b>Arguments</b>	<p>Power&lt;x&gt; is the power measurement number. This is the equivalent of the number shown in the UI for a power measurement badge.</p> <p>AC sets the signal type as AC.</p> <p>DC sets the signal type as DC.</p>
<b>Examples</b>	<pre>Power:Power1:POWERQUALITY:SType AC</pre> <p>sets the signal type as AC for power measurement 1.</p> <pre>Power:Power1:POWERQUALITY:SType?</pre> <p>might return</p> <pre>:Power:Power1:POWERQUALITY:SType AC</pre> <p>indicating that the signal type is AC.</p>

## POWer:POWer<x>:POWERQUALITY:VSOURce

This command sets or queries the voltage source for power quality measurement in the specified power measurement number.

<b>Conditions</b>	Requires option PWR or PS2.
<b>Group</b>	Power
<b>Syntax</b>	<pre>Power:Power&lt;x&gt;:POWERQUALITY:VSOURce {S&lt;x&gt;_Ch&lt;x&gt; CH&lt;x&gt; MATH&lt;x&gt; REF&lt;x&gt;} Power:Power&lt;x&gt;:POWERQUALITY:VSOURce?</pre>
<b>Arguments</b>	<p>Power&lt;x&gt; is the power measurement number. This is the equivalent of the number shown in the UI for a power measurement badge.</p> <p>S&lt;x&gt;_Ch&lt;x&gt; specifies the remote scope number and the analog channel.</p> <p>CH&lt;x&gt; = A channel specifier; &lt;x&gt; is 1 through 8 and is limited by the number of FlexChannels in your instrument.</p> <p>MATH&lt;x&gt; = A math waveform specifier; &lt;x&gt; is <math>\geq 1</math>.</p> <p>REF&lt;x&gt; = A reference waveform specifier; &lt;x&gt; is <math>\geq 1</math>.</p>

**Examples**     `Power:Power1:POWERQUALITY:VSOURCE CH1` sets the voltage source for power quality measurement as channel 1.

## **POWER:POWER<x>:PPULSEWIDTH:INPUTSOURCE**

This command sets or queries the input source for positive pulse width measurement in the specified power measurement number.

**Conditions**     Requires option PWR or PS2.

**Group**         Power

**Syntax**        `Power:Power<x>:PPULSEWIDTH:INPUTSOURCE`  
                  `{S<x>_Ch<x>|CH<x>|MATH<x>|REF<x>}`  
                  `Power:Power<x>:PPULSEWIDTH:INPUTSOURCE?`

**Arguments**     `Power<x>` is the power measurement number. This is the equivalent of the number shown in the UI for a power measurement badge.

`S<x>_Ch<x>` specifies the remote scope number and the analog channel.

`CH<x>` = A channel specifier; `<x>` is 1 through 8 and is limited by the number of FlexChannels in your instrument.

`MATH<x>` = A math waveform specifier; `<x>` is  $\geq 1$ .

`REF<x>` = A reference waveform specifier; `<x>` is  $\geq 1$ .

**Examples**     `Power:Power1:PPULSEWIDTH:INPUTSOURCE CH5` sets channel 5 as the input source for the positive pulse width measurement 1.

## **POWER:POWER<x>:PRESET (No Query Form)**

This command runs a power preset action for the specified power measurement number.

**Conditions**     Requires option 5-PWR, 6-PWR, or PS2.

**Group**         Power

**Syntax**        `Power:Power<x>:PRESET {EXECute}`

**Arguments** Power<x> is the power measurement number. This is the equivalent of the number shown in the UI for a power measurement badge.

EXECute runs the power preset action.

**Examples** POWER:POWER5:PRESET EXECute runs the power preset action for power measurement 5.

## POWER:POWER<x>:PSRR:AMP[1-10]Val

This command sets or queries the generator amplitude value of the specified configuration step for the Power Supply Rejection Ratio (PSRR) power measurement.

**Conditions** Requires option 5-PWR or 6-PWR

**Group** Power

**Syntax** POWER:POWER<x>:PSRR:AMP[1-10]Val <NR3>  
POWER:POWER<x>:PSRR:AMP[1-10]Val?

**Arguments** Power<x> sets the power measurement number. This is the equivalent of the number shown in the UI for a power measurement badge.

AMP[1-10] sets the configuration step number, in the range of 1 to 10. Values outside this range will report an error.

<NR3> sets the generator amplitude for the specified configuration step, in the range of -100 V to 100 V.

**Examples** POWER:POWER1:PSRR:AMP3Val 20 sets the generator output amplitude for configuration step 3 to 20 volts, for power measurement 1.

POWER:POWER2:PSRR:AMP8Val? might return 60, indicating that the generator output amplitude setting of configuration step 8 is 60 volts, for power measurement 2.

## POWER:POWER<x>:PSRR:AMPMode

This command sets or queries the amplitude mode for the Power Supply Rejection Ratio (PSRR) power measurement.

<b>Conditions</b>	Requires option 5-PWR or 6-PWR
<b>Group</b>	Power
<b>Syntax</b>	<pre>Power:POWER&lt;x&gt;:PSRR:AMPMode {CONSTant PROFile} Power:POWER&lt;x&gt;:PSRR:AMPMode?</pre>
<b>Arguments</b>	<p>Power&lt;x&gt; is the power measurement number. This is the equivalent of the number shown in the UI for a power measurement badge.</p> <p>CONSTant sets the amplitude mode to output a constant amplitude signal from the DUT stimulus generator for all frequency bands.</p> <p>PROFile enables configuring the generator to set amplitude values for each frequency band.</p>
<b>Examples</b>	<p>Power:POWER1:PSRR:AMPMode Constant sets the amplitude mode to Constant for power measurement 1.</p> <p>Power:POWER2:PSRR:AMPMode? might return PROFile, indicating that the amplitude mode power measurement 2 is set to Profile.</p>

## POWER:POWER<x>:PSRR:ANALYSISMethod

This command sets or queries the Analysis Method for PSRR measurements.

<b>Group</b>	Power
<b>Syntax</b>	<pre>Power:POWER&lt;x&gt;:PSRR:ANALYSISMethod {SV FFT} Power:POWER&lt;x&gt;:PSRR:ANALYSISMethod?</pre>
<b>Arguments</b>	<p>Power&lt;x&gt; is the power measurement number. This is the equivalent of the number shown in the UI for a power measurement badge.</p> <p>SV sets the Analysis Method as Spectrum View.</p> <p>FFT sets the Analysis Method as FFT.</p>
<b>Examples</b>	<p>Power:POWER1:PSRR:ANALYSISMethod SV sets the Analysis Method as Spectrum View for power measurement 1.</p>

`Power:Power1:PSRR:ANALYSISMethod?` might return  
`:Power:Power1:PSRR:ANALYSISMethod SV`, indicating that the  
 Analysis Method is Spectrum View.

## Power:Power<x>:PSRR:AUTOBw

This command enables Auto RBW computation.

<b>Group</b>	Power
<b>Syntax</b>	<code>Power:Power&lt;x&gt;:PSRR:AUTOBw {True False}</code> <code>Power:Power&lt;x&gt;:PSRR:AUTOBw?</code>
<b>Arguments</b>	<code>Power&lt;x&gt;</code> is the power measurement number. This is the equivalent of the number shown in the UI for a power measurement badge.  <code>True</code> enables Auto RBW computation. <code>False</code> disables Auto RBW computation.
<b>Examples</b>	<code>Power:Power1:PSRR:AUTOBw true</code> enables Auto RBW computation.  <code>Power:Power1:PSRR:AUTOBw?</code> might return <code>:Power:Power1:PSRR:AUTOBw true</code> , indicating that Auto RBW computation is enabled.

## Power:Power<x>:PSRR:CONNECTSTATUS? (Query Only)

Queries the external instrument's connection status for the specified Power Supply Rejection Ratio (PSRR) measurement.

<b>Conditions</b>	Requires option 5-PWR (5 Series MSO instruments) or 6-PWR (6 Series MSO instrument)
<b>Group</b>	Power
<b>Syntax</b>	<code>Power:Power&lt;x&gt;:PSRR:CONNECTSTATUS?</code>
<b>Arguments</b>	<code>Power&lt;x&gt;</code> is the number of the PSRR power measurement.

- Returns**      **SUCCESS** indicates the instrument recognizes the connection to the external generator.
- FAILURE** indicates the instrument could not make the connection to the external generator.
- UNSUPPORTED** indicates that the connected generator is not recognized.
- Examples**      **POWER:POWER<x>:PSRR:CONNECTSTATUS?** might return **FAILURE**, indicating that the instrument could not connect to the external generator at the specified IP address.

## **POWER:POWER<x>:PSRR:CONSTAMPLITUDE**

This command sets or queries the constant amplitude voltage for the Power Supply Rejection Ratio (PSRR) power measurement.

- Conditions**      Requires option 5-PWR or 6-PWR
- Group**            Power
- Syntax**          **POWER:POWER<x>:PSRR:CONSTAMPLITUDE <NR3>**  
**POWER:POWER<x>:PSRR:CONSTAMPLITUDE?**
- Arguments**      **Power<x>** is the power measurement number. This is the equivalent of the number shown in the UI for a power measurement badge.
- <NR3>** is the constant amplitude voltage value for the measurement, in the range of -100 V to 100 V.
- Examples**      **POWER:POWER3:PSRR:CONSTAMPLITUDE 120** sets the constant amplitude voltage for Power measurement 3 to be 120 volts.
- POWER:POWER5:PSRR:CONSTAMPLITUDE?** might return **-15**, indicating that the constant amplitude voltage for power measurement 5 is -15 volts.

## **POWER:POWER<x>:PSRR:FREQ[1-11]VAL**

This command sets or queries the generator frequency value of the specified configuration step for the Power Supply Rejection Ratio (PSRR) power measurement.



<b>Conditions</b>	Requires option 5-PWR or 6-PWR
<b>Group</b>	Power
<b>Syntax</b>	<pre>POWER:POWER&lt;x&gt;:PSRR:FREQ[1-11]Val &lt;NR3&gt; POWER:POWER&lt;x&gt;:PSRR:FREQ[1-11]Val?</pre>
<b>Arguments</b>	<p><code>Power&lt;x&gt;</code> sets the power measurement number. This is the equivalent of the number shown in the UI for a power measurement badge.</p> <p><code>FREQ[1-11]</code> sets the configuration step number, in the range of 1 to 11. Values outside this range will report an error.</p> <p><code>&lt;NR3&gt;</code> sets the frequency of the specified configuration step number, in the range of 10 Hz to 50 MHz.</p>
<b>Examples</b>	<p><code>POWER:POWER5:PSRR:FREQ1Val 200</code> sets the generator frequency value for frequency band 1 to 200 Hz, for power measurement 5.</p> <p><code>POWER:POWER2:PSRR:FREQ3Val?</code> might return <code>2.000E+6</code>, indicating that the generator frequency output for frequency band 3 is 2.0 MHz, for power measurement 2.</p>

## POWER:POWER<x>:PSRR:GENerator

This command sets or queries the generator source used to send stimulus signals to the DUT, for the Power Supply Rejection Ratio (PSRR) power measurement.

<b>Conditions</b>	Requires option 5-PWR or 6-PWR
<b>Group</b>	Power
<b>Syntax</b>	<pre>POWER:POWER&lt;x&gt;:PSRR:GENerator {INTERNAL} POWER:POWER&lt;x&gt;:PSRR:GENerator?</pre>
<b>Arguments</b>	<p><code>Power&lt;x&gt;</code> is the power measurement number. This is the equivalent of the number shown in the UI for a power measurement badge.</p> <p><code>INTERNAL</code> sets the generator to the instrument AFG signal source. This is the only valid argument.</p>

- Examples** `Power:Power3:PSRR:Generator Internal` sets the generator to the instrument AFG for power measurement 3.
- `Power:Power2:PSRR:Generator?` might return `INTERNAL`, indicating that the generator source for power measurement 2 is the instrument AFG.

## **POWer:POWer<x>:PSRR:GENErator**

Sets or queries the generator source for the Power Supply Rejection Ratio (PSRR) power measurement.

- Conditions** Requires option 5-PWR (5 Series MSO instruments) or 6-PWR (6 Series MSO instrument)
- Group** Power
- Syntax** `Power:Power<x>:PSRR:Generator {Internal|External}`  
`Power:Power<x>:PSRR:Generator?`
- Arguments** `Power<x>` is the number of the PSRR power measurement.
- `Internal` sets the internal generator as the source for the Power Supply Rejection Ratio (PSRR) power measurement.
- `External` sets the external generator as the source for the Power Supply Rejection Ratio (PSRR) power measurement.
- Examples** `Power:Power1:PSRR:Generator Internal` sets the internal generator as the source for the Power Supply Rejection Ratio (PSRR) measurement.
- `Power:Power7:PSRR:Generator?` might return `EXTERNAL`, indicating that the Power Supply Rejection Ratio (PSRR) measurement 7 is set to use an external generator.

## **POWer:POWer<x>:PSRR:GENIPADDrESS**

Sets or queries the instrument's IP Address associated with the specified Power Supply Rejection Ratio (PSRR) measurement.

- Conditions** Requires option 5-PWR (5 Series MSO instruments) or 6-PWR (6 Series MSO instrument)

<b>Group</b>	Power
<b>Syntax</b>	<pre>POWER:POWER&lt;x&gt;:PSRR:GENIPADDRESS &lt;Qstring&gt; POWER:POWER&lt;x&gt;:PSRR:GENIPADDRESS?</pre>
<b>Arguments</b>	POWER<x> is the number of the PSRR power measurement.<NR2> is the IP address of the generator.
<b>Examples</b>	<p>POWER:POWER4:PSRR:GENIPADDRESS 127.1.1.1 sets the IP address of the external generator to 127.1.1.1 for Power Supply Rejection Ratio (PSRR) power measurement 4.</p> <p>POWER:POWER2:PSRR:GENIPADDRESS? might return "", indicating that there is no address set for the external generator associated with Power Supply Rejection Ratio (PSRR) power measurement 2.</p>

## POWER:POWER<x>:PSRR:IMPEDance

This command sets or queries the vertical termination impedance for the Power Supply Rejection Ratio (PSRR) power measurement.

<b>Conditions</b>	Requires option 5-PWR or 6-PWR
<b>Group</b>	Power
<b>Syntax</b>	<pre>POWER:POWER&lt;x&gt;:PSRR:IMPEDance {FIFTy HIGHZ} POWER:POWER&lt;x&gt;:PSRR:IMPEDance?</pre>
<b>Arguments</b>	<p>POWER&lt;x&gt; is the power measurement number. This is the equivalent of the number shown in the UI for a power measurement badge.</p> <p>FIFTy sets the impedance to be 50 Ω.</p> <p>HIGHZ sets the impedance to be 1 MΩ.</p>
<b>Examples</b>	<p>POWER:POWER3:PSRR:IMPEDance FIFTy sets the vertical termination impedance for power measurement 3 to be 50 Ω.</p> <p>POWER:POWER2:PSRR:IMPEDance? might return HIGHZ, indicating that the vertical termination impedance for power measurement 2 is 1 MΩ.</p>

## POWer:POWer<x>:PSRR:INPUTSource

This command sets or queries the input source for the Power Supply Rejection Ratio (PSRR) power measurement.

<b>Conditions</b>	Requires option 5-PWR or 6-PWR
<b>Group</b>	Power
<b>Syntax</b>	<code>POWer:POWer&lt;x&gt;:PSRR:INPUTSource CH&lt;x&gt;</code> <code>POWer:POWer&lt;x&gt;:PSRR:INPUTSource?</code>
<b>Arguments</b>	<code>Power&lt;x&gt;</code> is the power measurement number. This is the equivalent of the number shown in the UI for a power measurement badge.  <code>CH&lt;x&gt;</code> sets the channel to use for the input source.
<b>Examples</b>	<code>POWer:POWer2:PSRR:INPUTSource CH3</code> sets the input for power measurement 2 to be the channel 3 waveform.  <code>POWer:POWer2:PSRR:INPUTSource?</code> might return <code>CH1</code> , indicating that the input source for power measurement 1 is channel 1.

## POWer:POWer<x>:PSRR:OUTPUTSource

This command sets or queries the output source for the Power Supply Rejection Ratio (PSRR) power measurement.

<b>Conditions</b>	Requires option 5-PWR or 6-PWR
<b>Group</b>	Power
<b>Syntax</b>	<code>POWer:POWer&lt;x&gt;:PSRR:OUTPUTSource CH&lt;x&gt;</code> <code>POWer:POWer&lt;x&gt;:PSRR:OUTPUTSource?</code>
<b>Arguments</b>	<code>Power&lt;x&gt;</code> is the power measurement number. This is the equivalent of the number shown in the UI for a power measurement badge.  <code>CH&lt;x&gt;</code> sets the channel to use for the output source.

- Examples** `Power:Power1:PSRR:OUTPUTSource CH3` sets the output source for power measurement 1 to be the channel 3 waveform.
- `Power:Power3:PSRR:OUTPUTSource?` might return CH6, indicating that the output source for power measurement 3 is channel 6.

## POWER:POWER<x>:PSRR:PPD

This command sets or queries the points per decade (PPD) value for the Power Supply Rejection Ratio (PSRR) power measurement.

- Conditions** Requires option 5-PWR or 6-PWR
- Group** Power
- Syntax** `Power:POWER<x>:PSRR:PPD <NR3>`  
`Power:POWER<x>:PSRR:PPD?`
- Arguments** `Power<x>` is the power measurement number. This is the equivalent of the number shown in the UI for a power measurement badge.
- `<NR3>` is the PPD value for the measurement, in the range of 10 to 100 points.
- Examples** `Power:Power3:PSRR:PPD 30` sets the PPD for Power measurement 3 to be 30 points.
- `Power:Power5:PSRR:PPD?` might return 20, indicating that the PPD value for power measurement 5 is 20 points.

## POWER:POWER<x>:PSRR:STARTFREQUENCY

This command sets or queries the start frequency value for the Power Supply Rejection Ratio (PSRR) power measurement.

- Conditions** Requires option 5-PWR or 6-PWR
- Group** Power
- Syntax** `Power:POWER<x>:PSRR:STARTFREQUENCY <NR3>`  
`Power:POWER<x>:PSRR:STARTFREQUENCY?`

<b>Arguments</b>	<p><code>Power&lt;x&gt;</code> is the power measurement number. This is the equivalent of the number shown in the UI for a power measurement badge.</p> <p><code>&lt;NR3&gt;</code> is the starting frequency for the measurement, in the range of 10 Hz to 50 MHz.</p>
<b>Examples</b>	<p><code>POWER:POWER8:PSRR:STARTFREQUENCY 12</code> sets the starting frequency for power measurement 8 to be 12 Hz.</p> <p><code>POWER:POWER3:PSRR:STARTFREQUENCY?</code> might return 2400, indicating that the starting frequency for power measurement 3 is 2400 Hz.</p>

## **POWER:POWER<x>:PSRR:STOPFREQUENCY**

This command sets or queries the stop frequency value for the Power Supply Rejection Ratio (PSRR) power measurement.

<b>Conditions</b>	Requires option 5-PWR or 6-PWR
<b>Group</b>	Power
<b>Syntax</b>	<code>POWER:POWER&lt;x&gt;:PSRR:STOPFREQUENCY &lt;NR3&gt;</code> <code>POWER:POWER&lt;x&gt;:PSRR:STOPFREQUENCY?</code>
<b>Arguments</b>	<p><code>Power&lt;x&gt;</code> is the power measurement number. This is the equivalent of the number shown in the UI for a power measurement badge.</p> <p><code>&lt;NR3&gt;</code> is the stop frequency for the measurement, in the range of 10 Hz to 50 MHz.</p>
<b>Examples</b>	<p><code>POWER:POWER3:PSRR:STOPFREQUENCY 120</code> sets the stop frequency for Power measurement 8 to be 120 Hz.</p> <p><code>POWER:POWER5:PSRR:STOPFREQUENCY?</code> might return 2000, indicating that the stop frequency for power measurement 5 is 2000 Hz.</p>

## **POWER:POWER<x>:PSRR:TESTCONNECTION (No Query Form)**

This command tests the connection with the external instrument for the specified Power Supply Rejection Ratio (PSRR) measurement.

<b>Conditions</b>	Requires option 5-PWR (5 Series MSO instruments) or 6-PWR (6 Series MSO instrument)
-------------------	-------------------------------------------------------------------------------------

<b>Group</b>	Power
<b>Syntax</b>	<code>Power:Power&lt;x&gt;:PSRR:TESTCONNECTION {EXECUTE}</code>
<b>Related Commands</b>	<a href="#">Power:Power&lt;x&gt;:PSRR:CONNECTSTATUS?</a> <a href="#">Power:Power&lt;x&gt;:PSRR:GENIPADDRESS</a>
<b>Arguments</b>	<code>Power&lt;x&gt;</code> is the number of the PSRR power measurement. <code>EXECUTE</code> runs the test connection function.
<b>Examples</b>	<code>Power:Power3:PSRR:TESTCONNECTION EXECUTE</code> runs the test connection function for the Power Supply Rejection Ratio (PSRR) power measurement 3.

## Power:Power<x>:RDSOn:DEVICEType

This command sets or queries the device type for the power drain source on resistance measurement for RDSon measurement of the specified power measurement number.

<b>Conditions</b>	Requires option PWR or PS2.
<b>Group</b>	Power
<b>Syntax</b>	<code>Power:Power&lt;x&gt;:RDSOn:DEVICEType {SWITCHING   PNJUNCTION}</code> <code>Power:Power&lt;x&gt;:RDSOn:DEVICEType?</code>
<b>Arguments</b>	<code>Power&lt;x&gt;</code> is the power measurement number. This is the equivalent of the number shown in the power measurement badge on the UI. <code>SWITCHING</code> sets the Device Type to a switching device (v/i). <code>PNJUNCTION</code> sets the Device Type to a PN Junction device (dv/di).
<b>Examples</b>	<code>Power:Power3:RDSOn:DEVICEType PNJUNCTION</code> sets the RDSon power measurement number 3 to measure a PN junction device. <code>Power:Power1:RDSOn:DEVICEType?</code> might return <code>SWITCHING</code> , indicating that RDSon power measurement number 1 is set to measure a switching device.

## POWer:POWer<x>:RDSON:ISOURce

This command sets or queries the current source for RDSon measurement of the specified power measurement number.

**Conditions** Requires option PWR or PS2.

**Group** Power

**Syntax** Power:POWer<x>:RDSON:ISOURce  
{S<x>\_Ch<x>|CH<x>|MATH<x>|REF<x>}  
Power:POWer<x>:RDSON:ISOURce?

**Related Commands** [POWer:POWer<x>:RDSON:VSOURce](#)

**Arguments** Power<x> is the power measurement number. This is the equivalent of the number shown in the power measurement badge on the UI.

S<x>\_Ch<x> specifies the remote scope number and the analog channel.

CH<x> sets the channel specifier; <x> is 1 through 8 and is limited by the number of FlexChannels in your instrument.

MATH<x> = A math waveform specifier; <x> is  $\geq 1$ .

REF<x> = A reference waveform specifier; <x> is  $\geq 1$ .

**Examples** Power:POWer1:RDSON:ISOURce REF2 sets RDSon power measurement number 1 to use Reference waveform 2 as the current signal source.

Power:POWer1:RDSON:ISOURce? might return CH1, indicating that channel 1 is the current signal source for the RDSon power measurement number 1.

## POWer:POWer<x>:RDSON:VSOURce

This command sets or queries the voltage source for RDSon measurement of the specified power measurement number.

**Conditions** Requires option PWR or PS2.

**Group** Power



**Syntax** `Power:Power<x>:RDSOn:VSOURce`  
`{S<x>_Ch<x> | CH<x> | MATH<x> | REF<x>}`  
`Power:Power<x>:RDSOn:VSOURce?`

**Related Commands** [POWER:POWER<x>:RDSOn:ISOURce](#)

**Arguments** `Power<x>` is the power measurement number. This is the equivalent of the number shown in the power measurement badge on the UI.

`S<x>_Ch<x>` specifies the remote scope number and the analog channel.

`CH<x>` sets the channel specifier; `<x>` is 1 through 8 and is limited by the number of FlexChannels in your instrument.

`MATH<x>` = A math waveform specifier; `<x>` is  $\geq 1$ .

`REF<x>` = A reference waveform specifier; `<x>` is  $\geq 1$ .

**Examples** `Power:Power2:RDSOn:VSOURce CH7` sets RDSon power measurement number 2 to use channel 7 as the voltage source.

`Power:Power1:RDSOn:VSOURce?` might return CH7, indicating that channel 1 is the voltage signal source for RDSon power measurement number 1.

## POWER:POWER<x>:REFLevels:ABSolute:FALLHigh

This command sets or queries the falling edge for high reference level in absolute units for the specified power measurement number.

**Conditions** Requires option PWR or PS2.

**Group** Power

**Syntax** `Power:Power<x>:REFLevels:ABSolute:FALLHigh <NR1>`  
`Power:Power<x>:REFLevels:ABSolute:FALLHigh?`

**Related Commands** [POWER:POWER<x>:REFLevels:METHod](#)  
[POWER:POWER<x>:REFLevels:ABSolute:TYPE](#)

**Arguments** `Power<x>` is the power measurement number. This is the equivalent of the number shown in the UI for a power measurement badge.

`<NR1>` ranges from -40000 to 40000

**Examples**     `POWER:POWER1:REFLevels:ABSolute:FALLHigh 1` sets the high reference level for falling edge as 1 volt.

## **POWER:POWER<x>:REFLevels:ABSolute:FALLLow**

This command sets or queries the falling edge for low reference level in absolute units for the specified power measurement number.

**Conditions**     Requires option PWR or PS2.

**Group**     Power

**Syntax**     `POWER:POWER<x>:REFLevels:ABSolute:FALLLow <NR1>`  
`POWER:POWER<x>:REFLevels:ABSolute:FALLLow?`

**Related Commands**     [POWER:POWER<x>:REFLevels:METHOD](#)  
[POWER:POWER<x>:REFLevels:ABSolute:TYPE](#)

**Arguments**     `Power<x>` is the power measurement number. This is the equivalent of the number shown in the UI for a power measurement badge.  
`<NR1>` ranges from -40000 to 40000

**Examples**     `POWER:POWER1:REFLevels:ABSolute:FALLLow -1` sets the low reference level for falling edge as -1 volt.

## **POWER:POWER<x>:REFLevels:ABSolute:FALLMid**

This command sets or queries the falling edge for mid reference level in absolute units for the specified power measurement number.

**Conditions**     Requires option PWR or PS2.

**Group**     Power

**Syntax**     `POWER:POWER<x>:REFLevels:ABSolute:FALLMid <NR1>`  
`POWER:POWER<x>:REFLevels:ABSolute:FALLMid?`

<b>Related Commands</b>	<a href="#">POWER:POWER&lt;x&gt;:REFLevels:METHOD</a> <a href="#">POWER:POWER&lt;x&gt;:REFLevels:ABSolute:TYPE</a>
<b>Arguments</b>	Power<x> is the power measurement number. This is the equivalent of the number shown in the UI for a power measurement badge.  <NR1> ranges from -40000 to 40000
<b>Examples</b>	POWER:POWER1:REFLevels:ABSolute:FALLMid 0 sets the mid reference level for falling edge as 0 volt.

## POWER:POWER<x>:REFLevels:ABSolute:HYSTeresis

This command sets or queries the absolute hysteresis value for the specified power measurement number.

<b>Conditions</b>	Requires option PWR or PS2.
<b>Group</b>	Power
<b>Syntax</b>	POWER:POWER<x>:REFLevels:ABSolute:HYSTeresis <NR1> POWER:POWER<x>:REFLevels:ABSolute:HYSTeresis?

<b>Related Commands</b>	<a href="#">POWER:POWER&lt;x&gt;:REFLevels:METHOD</a>
<b>Arguments</b>	Power<x> is the power measurement number. This is the equivalent of the number shown in the UI for a power measurement badge.  <NR1> ranges from 0.0000005 to 10
<b>Examples</b>	POWER:POWER1:REFLevels:ABSolute:HYSTeresis 10 sets the reference level hysteresis value in absolute to 10.

## POWER:POWER<x>:REFLevels:ABSolute:RISEHigh

This command sets or queries the rising edge for high reference level in absolute units for the specified power measurement number.

<b>Conditions</b>	Requires option PWR or PS2.
-------------------	-----------------------------

<b>Group</b>	Power
<b>Syntax</b>	POWER:POWER<x>:REFLevels:ABSolute:RISEHigh <NR1> POWER:POWER<x>:REFLevels:ABSolute:RISEHigh?
<b>Related Commands</b>	<a href="#">POWER:POWER&lt;x&gt;:REFLevels:METHOD</a> <a href="#">POWER:POWER&lt;x&gt;:REFLevels:ABSolute:TYPE</a>
<b>Arguments</b>	Power<x> is the power measurement number. This is the equivalent of the number shown in the UI for a power measurement badge.  <NR1> ranges from -40000 to 40000
<b>Examples</b>	POWER:POWER1:REFLevels:ABSolute:RISEHigh 1 sets the high reference level for rising edge as 1 volt.

## POWER:POWER<x>:REFLevels:ABSolute:RISELow

This command sets or queries the rising edge for low reference level in absolute units for the specified power measurement number.

<b>Conditions</b>	Requires option PWR or PS2.
<b>Group</b>	Power
<b>Syntax</b>	POWER:POWER<x>:REFLevels:ABSolute:RISELow <NR1> POWER:POWER<x>:REFLevels:ABSolute:RISELow?
<b>Related Commands</b>	<a href="#">POWER:POWER&lt;x&gt;:REFLevels:METHOD</a> <a href="#">POWER:POWER&lt;x&gt;:REFLevels:ABSolute:TYPE</a>
<b>Arguments</b>	Power<x> is the power measurement number. This is the equivalent of the number shown in the UI for a power measurement badge.  <NR1> ranges from -40000 to 40000.
<b>Examples</b>	POWER:POWER1:REFLevels:ABSolute:RISELow -1 sets the low reference level for rising edge as -1 volt.

**POWer:POWer<x>:REFLevels:ABSolute:RISEMid**

This command sets or queries the rising edge for mid reference level in absolute units for the specified power measurement number.

**Conditions** Requires option PWR or PS2.

**Group** Power

**Syntax** `POWer:POWer<x>:REFLevels:ABSolute:RISEMid <NR1>`  
`POWer:POWer<x>:REFLevels:ABSolute:RISEMid?`

**Related Commands** [POWer:POWer<x>:REFLevels:METhod](#)  
[POWer:POWer<x>:REFLevels:ABSolute:TYPE](#)

**Arguments** Power<x> is the power measurement number. This is the equivalent of the number shown in the UI for a power measurement badge.  
 <NR1> ranges from -40000 to 40000.

**Examples** `POWer:POWer1:REFLevels:ABSolute:RISEMid 0` sets the mid reference level for rising edge as 0 volt.

**POWer:POWer<x>:REFLevels:ABSolute:TYPE**

This command sets or queries the type of measurement levels when reference level is set to absolute for the specified power measurement number.

**Conditions** Requires option PWR or PS2.

**Group** Power

**Syntax** `POWer:POWer<x>:REFLevels:ABSolute:TYPE {SAME | UNIQUE}`  
`POWer:POWer<x>:REFLevels:ABSolute:TYPE?`

**Related Commands** [POWer:POWer<x>:REFLevels:METhod](#)

<b>Arguments</b>	<p>Power&lt;x&gt; is the power measurement number. This is the equivalent of the number shown in the UI for a power measurement badge.</p> <p>SAME: select when the rising edge and falling edge reference levels are same.</p> <p>UNIQUE: select when the rising edge and falling edge reference levels are different.</p>
<b>Examples</b>	<p>POWER:POWER1:REFLevels:ABSolute:TYPE UNIQUE sets the type of measurement levels as unique for the specified power measurement badge.</p>

## POWER:POWER<x>:REFLevels:BASETop

This command sets or queries the reference level base top method for the specified power measurement number. The power measurement number is specified by x.

<b>Conditions</b>	Requires option PWR or PS2.
<b>Group</b>	Power
<b>Syntax</b>	<pre>POWER:POWER&lt;x&gt;:REFLevels:BASETop {AUTO   MINMax   MEANhistogram   MODEhistogram   EYEhistogram} POWER:POWER&lt;x&gt;:REFLevels:BASETop?</pre>
<b>Related Commands</b>	<a href="#">POWER:POWER&lt;x&gt;:REFLevels:METHOD</a>
<b>Examples</b>	<p>POWER:POWER1:REFLevels:BASETop AUTO sets the reference level base top method as auto for the power measurement badge 1.</p>

## POWER:POWER<x>:REFLevels:METHOD

This command sets or queries the method to configure reference level values for the specified power measurement number.

<b>Conditions</b>	Requires option PWR or PS2.
<b>Group</b>	Power
<b>Syntax</b>	<pre>POWER:POWER&lt;x&gt;:REFLevels:METHOD {PERCent   ABSolute} POWER:POWER&lt;x&gt;:REFLevels:METHOD?</pre>

- Arguments** `Power<x>` is the power measurement number. This is the equivalent of the number shown in the UI for a power measurement badge.
- `PERCent` sets the power measurement to use absolute values to configure reference level values.
- `ABSolute` sets the power measurement to use percentage to configure reference level values.
- Examples** `Power:Power3:REFLevels:METHOD PERCent` sets power measurement 3 to use percentage to configure reference level values.

## Power:Power<x>:REFLevels:PERCent:FALLHigh

This command sets or queries the falling edge for high reference level in percentage for the specified power measurement number.

- Conditions** Requires option PWR or PS2.
- Group** Power
- Syntax** `Power:Power<x>:REFLevels:PERCent:FALLHigh <NR1>`  
`Power:Power<x>:REFLevels:PERCent:FALLHigh?`

**Related Commands** [Power:Power<x>:REFLevels:METHOD](#)  
[Power:Power<x>:REFLevels:PERCent:TYPE](#)

- Arguments** `Power<x>` is the power measurement number. This is the equivalent of the number shown in the UI for a power measurement badge.
- `<NR1>` ranges from 1 to 99.
- Examples** `Power:Power1:REFLevels:PERCent:FALLHigh 1` sets the high reference level for falling edge as 1 percentage.

## Power:Power<x>:REFLevels:PERCent:FALLLow

This command sets or queries the falling edge for low reference level in percentage for the specified power measurement number.

<b>Conditions</b>	Requires option PWR or PS2.
<b>Group</b>	Power
<b>Syntax</b>	<code>POWER:POWER&lt;x&gt;:REFLeve1s:PERCent:FALLLow &lt;NR1&gt;</code> <code>POWER:POWER&lt;x&gt;:REFLeve1s:PERCent:FALLLow?</code>
<b>Related Commands</b>	<a href="#">POWER:POWER&lt;x&gt;:REFLevels:METHOD</a> <a href="#">POWER:POWER&lt;x&gt;:REFLevels:PERCent:TYPE</a>
<b>Arguments</b>	<code>Power&lt;x&gt;</code> is the power measurement number. This is the equivalent of the number shown in the UI for a power measurement badge. <code>&lt;NR1&gt;</code> ranges from 1 to 99.
<b>Examples</b>	<code>POWER:POWER1:REFLeve1s:PERCent:FALLLow 0</code> sets the low reference level for falling edge as 0 percentage.

## **POWER:POWER<x>:REFLevels:PERCent:FALLMid**

This command sets or queries the falling edge for mid reference level in percentage for the specified power measurement number.

<b>Conditions</b>	Requires option PWR or PS2.
<b>Group</b>	Power
<b>Syntax</b>	<code>POWER:POWER&lt;x&gt;:REFLeve1s:PERCent:FALLMid &lt;NR1&gt;</code> <code>POWER:POWER&lt;x&gt;:REFLeve1s:PERCent:FALLMid?</code>
<b>Related Commands</b>	<a href="#">POWER:POWER&lt;x&gt;:REFLevels:METHOD</a> <a href="#">POWER:POWER&lt;x&gt;:REFLevels:PERCent:TYPE</a>
<b>Arguments</b>	<code>Power&lt;x&gt;</code> is the power measurement number. This is the equivalent of the number shown in the UI for a power measurement badge. <code>&lt;NR1&gt;</code> ranges from 1 to 99.



**Examples** `POWER:POWER1:REFLevels:PERCent:FALLMid 50` sets the mid reference level for falling edge as 50 percentage.

## POWER:POWER<x>:REFLevels:PERCent:HYSTeresis

This command sets or queries the hysteresis in percentage for the specified power measurement number.

**Conditions** Requires option PWR or PS2.

**Group** Power

**Syntax** `POWER:POWER<x>:REFLevels:PERCent:HYSTeresis <NR1>`  
`POWER:POWER<x>:REFLevels:PERCent:HYSTeresis?`

**Related Commands** [POWER:POWER<x>:REFLevels:METHod](#)

**Arguments** `Power<x>` is the power measurement number. This is the equivalent of the number shown in the UI for a power measurement badge.  
`<NR1>` ranges from 1 to 99.

**Examples** `POWER:POWER1:REFLevels:PERCent:HYSTeresis 25` sets the hysteresis as 25 percentage.

## POWER:POWER<x>:REFLevels:PERCent:RISEHigh

This command sets or queries the rising edge for high reference level in percentage for the specified power measurement number.

**Conditions** Requires option PWR or PS2.

**Group** Power

**Syntax** `POWER:POWER<x>:REFLevels:PERCent:RISEHigh <NR1>`  
`POWER:POWER<x>:REFLevels:PERCent:RISEHigh?`

<b>Related Commands</b>	<a href="#">POWER:POWER&lt;x&gt;:REFLevels:METHOD</a> <a href="#">POWER:POWER&lt;x&gt;:REFLevels:PERCent:TYPE</a>
<b>Arguments</b>	Power<x> is the power measurement number. This is the equivalent of the number shown in the UI for a power measurement badge.  <NR1> ranges from 1 to 99.
<b>Examples</b>	POWER:POWER1:REFLevels:PERCent:RISEHigh 85 sets the high reference level for rising edge as 85 percentage.

## POWER:POWER<x>:REFLevels:PERCent:RISELow

This command sets or queries the rising edge for low reference level in percentage for the specified power measurement number.

<b>Conditions</b>	Requires option PWR or PS2.
<b>Group</b>	Power
<b>Syntax</b>	POWER:POWER<x>:REFLevels:PERCent:RISELow <NR1> POWER:POWER<x>:REFLevels:PERCent:RISELow?
<b>Related Commands</b>	<a href="#">POWER:POWER&lt;x&gt;:REFLevels:METHOD</a> <a href="#">POWER:POWER&lt;x&gt;:REFLevels:PERCent:TYPE</a>
<b>Arguments</b>	Power<x> is the power measurement number. This is the equivalent of the number shown in the UI for a power measurement badge.  <NR1> ranges from 1 to 99.
<b>Examples</b>	POWER:POWER1:REFLevels:PERCent:RISELow 10 sets the low reference level for rising edge as 10 percentage.

## POWER:POWER<x>:REFLevels:PERCent:RISEMid

This command sets or queries the rising edge for mid reference level in percentage for the specified power measurement number. The power measurement number is specified by x.

<b>Conditions</b>	Requires option PWR or PS2.
<b>Group</b>	Power
<b>Syntax</b>	Power:Power<x>:REFLevels:PERCent:RISEMid <NR1> Power:Power<x>:REFLevels:PERCent:RISEMid?
<b>Related Commands</b>	<a href="#">POWER:POWER&lt;x&gt;:REFLevels:METHod</a> <a href="#">POWER:POWER&lt;x&gt;:REFLevels:PERCent:TYPE</a>
<b>Arguments</b>	Power<x> is the power measurement number. This is the equivalent of the number shown in the UI for a power measurement badge.  <NR1> ranges from 1 to 99.
<b>Examples</b>	Power:Power1:REFLevels:PERCent:RISEMid 55 sets the mid reference level for rising edge as 55 percentage.

## POWER:POWER<x>:REFLevels:PERCent:TYPE

This command sets or queries the reference levels for the specified power measurement number.

<b>Conditions</b>	Requires option PWR or PS2.
<b>Group</b>	Power
<b>Syntax</b>	Power:Power<x>:REFLevels:PERCent:TYPE {TENNinety   TWENTyeighty   CUSTOM} Power:Power<x>:REFLevels:PERCent:TYPE?
<b>Related Commands</b>	<a href="#">POWER:POWER&lt;x&gt;:REFLevels:METHod</a> <a href="#">POWER:POWER&lt;x&gt;:REFLevels:PERCent:FALLHigh</a> <a href="#">POWER:POWER&lt;x&gt;:REFLevels:PERCent:FALLLow</a> <a href="#">POWER:POWER&lt;x&gt;:REFLevels:PERCent:FALLMid</a> <a href="#">POWER:POWER&lt;x&gt;:REFLevels:PERCent:RISEHigh</a> <a href="#">POWER:POWER&lt;x&gt;:REFLevels:PERCent:RISELow</a>

**POWER:POWER<x>:REFLevels:PERCent:RISEMid**

**Arguments** Power<x> is the power measurement number. This is the equivalent of the number shown in the UI for a power measurement badge.

TENNinety to set the low reference levels as 10% and high reference levels as 90%

TWENTyeighty to set the low reference levels as 20% and high reference levels as 80%

CUSTOM to set the custom low, high, and mid reference levels for rising and falling edges

**Examples** POWER:Power1:REFLevels:PERCent:TYPE TENNinety sets the low reference levels as 10% and high reference levels as 90% for the power measurement badge 1.

**POWER:POWER<x>:RESULTS:ALLAcqs:MAXimum? (Query Only)**

This command queries the maximum value of all acquisitions for the measurement parameter in the specified power measurement number. The power measurement number is specified by x.

**Conditions** Requires option PWR or PS2.

**Group** Power

**Syntax** POWER:POWER<x>:RESULTS:ALLAcqs:MAXimum? {InputPwr|Output1Pwr|Output2Pwr|Output3Pwr|Efficiency1|Efficiency2|Efficiency3|TotalEfficiency|INDUCT|IVSINTV|MAGLOSS|Bpeak|Br|Hc|Hmax|IRipple|DeltaB|DeltaH|Permeability|RDS|TRUEPWR|APPPWR|REPWR|PWRFACTOR|PHASE|PWRFREQ|ICFACTOR|VCFACOR|IRMS|VRMS|TONENRG|TONLOSS|TOFFENRG|TOFFLOSS|CONDENRG|CONDLOSS|TTLLOSS|TTLENRG|DVBYDT|DIBYDT|SOAHITS CNT|LRIPRMS|LRIPPKPK|SWRIPRMS|SWRIPPKPK|PRIOD|FREQ|PDUTY|NDUTY|PPULSE|NPULSE|AMPL|PKPK|HIGH|LOW|MAX|MIN|INRUSH|CAPACITANCE|OUTPUT1|OUTPUT2|OUTPUT3|OUTPUT4|OUTPUT5|OUTPUT6|OUTPUT7|GAINCROSSOVERFREQ|PHASECROSSOVERFREQ|GM|PM|MAXPSRR|MAXPSRRFREQ|MINPSRR|MINPSRRFREQ}

---

**NOTE.** Above entries are <QString> entries, and must be entered in enclosing quotes.

---

## Arguments

Power<x> is the power measurement number. This is the equivalent of the number shown in the UI for a power measurement badge.

<QString> = the measurement result that you want to return from the specified power measurement number. Available results depend on the power measurement being taken in the specified measurement number. The valid <Qstring> arguments are:

For the Efficiency measurement, the parameters are "InputPwr", "Output1Pwr", "Output2Pwr", "Output3Pwr", "Efficiency1", "Efficiency2", "Efficiency3", "TotalEfficiency".

For Inductance measurement, the parameter is "INDUCT".

For IVSIntegralV measurement, the parameter is "IVSINTV".

For Magnetic Loss measurement, the parameter is "MAGLOSS".

For Magnetic Property measurement, the parameters are "Bpeak", "Br", "Hc", "Hmax", "IRipple", "DeltaB", "DeltaH", "Permeability".

For RDSon measurement, the parameter is "RDS".

For Power Quality measurement, the parameters are "TRUEPWR", "APPPWR", "REPWR", "PWRFACTOR", "PHASE", "PWRFREQ", "ICFACTOR", "VCFACOR", "IRMS", "VRMS".

For Switching Loss measurement, the parameters are "TONENRG", "TONLOSS", "TOFFENRG", "TOFFLOSS", "CONDENRG", "CONDLOSS", "TTLLOSS", "TTLENRG".

"DVBYDT" is the parameter for the dV by dt measurement.

"DIBYDT" is the parameter for the dI by dt measurement.

"SOAHITSCNT" is the parameter for the SOA measurement.

"LRIPRMS" and "LRIPPKPK" are the parameters for the Line Ripple measurement.

"SWRIPRMS" and "SWRIPPKPK" are the parameters for the Switching Ripple measurement.

"PRIOD" is the parameter for the Cycle Period measurement.

"FREQ" is the parameter for the Cycle Frequency measurement.

"PDUTY" is the parameter for the Positive Duty Cycle measurement.

"NDUTY" is the parameter for the Negative Duty Cycle measurement.

"PPULSE" is the parameter for the Positive Pulse Width measurement.

"NPULSE" is the parameter for the Negative Pulse Width measurement.

"AMPL" is the parameter for the Cycle Amplitude measurement.

"PKPK" is the parameter for the Cycle Peak–Peak measurement.

"HIGH" is the parameter for the Cycle Top measurement.

"LOW" is the parameter for the Cycle Base measurement.

"Max" is the parameter for the Cycle Max measurement.

"MIN" is the parameter for the Cycle Min measurement.

"INRUSH" is the parameter for the Inrush Current measurement.

"CAPACITANCE" is the parameter for the Input Capacitance measurement.

"OUTPUT1" - "OUTPUT7" are the parameters for the Turn On Time and Turn Off Time measurements.

"GAINCROSSOVERFREQ", "PHASECROSSOVERFREQ", "GM", "PM" are the parameters for the Control Loop Response measurement.

"MAXPSRR", "MAXPSRRFREQ", "MINPSRR", "MINPSRRFREQ" are the parameters for the PSRR measurement

**Examples**     `Power:Power4:RESULTS:ALLAcqs:MAXimum?`     "PKPK" might return 28.56, indicating the maximum value of the Peak-to-Peak measurement for power measurement 4.

## **POWER:POWER<x>:RESULTS:ALLAcqs:MEAN? (Query Only)**

This command queries the mean value of all acquisitions for the measurement parameter in the specified power measurement number <x>.

**Conditions**     Requires option PWR or PS2.

**Group**     Power

**Syntax**     `Power:Power<x>:RESULTS:ALLAcqs:MEAN?`  
`{InputPwr|Output1Pwr|Output2Pwr|`  
`Output3Pwr|Efficiency1|Efficiency2|`  
`Efficiency3|TotalEfficiency|`  
`INDUCT|IVSINTV|MAGLOSS|Bpeak|Br|Hc|Hmax|`  
`IRipple|DeltaB|DeltaH|Permeability|RDS|TRUEPWR|`  
`APPPWR|REPWR|PWRFACTOR|PHASE|PWRFREQ|`  
`ICFACTOR|VCFACtor|IRMS|VRMS|TONENRG|`  
`TONLOSS|TOFFENRG|TOFFLOSS|CONDENRG|CONDLOSS|`

---

```
TTLLOSS | TTLENRG | DVBYDT | DIBYDT | SOAHITSCNT |
LRIPRMS | LRIPPKPK | SWRIPRMS | SWRIPPKPK | PRIOD |
FREQ | PDUTY | NDUTY | PPULSE | NPULSE | AMPL |
PKPK | HIGH | LOW | MAX | MIN | INRUSH | CAPACITANCE | OUTPUT1 |
OUTPUT2 | OUTPUT3 | OUTPUT4 | OUTPUT5 | OUTPUT6 | OUTPUT7 |
GAINCROSSOVERFREQ | PHASECROSSOVERFREQ | GM | PM |
MAXPSRR | MAXPSRRFREQ | MINPSRR | MINPSRRFREQ }
```

---

**NOTE.** Above entries are <QString> entries, and must be entered in enclosing quotes.

---

## Arguments

Power<x> is the power measurement number. This is the equivalent of the number shown in the UI for a power measurement badge.

<QString> = the measurement result that you want to return from the specified power measurement number. Available results depend on the power measurement being taken in the specified measurement number. The valid <Qstring> arguments are:

For Efficiency measurement, the parameters are "InputPwr", "Output1Pwr", "Output2Pwr", "Output3Pwr", "Efficiency1", "Efficiency2", "Efficiency3", "TotalEfficiency".

For Inductance measurement, the parameter is "INDUCT".

For IVSIntegralV measurement, the parameter is "IVSINTV".

For Magnetic Loss measurement, the parameter is "MAGLOSS".

For Magnetic Property measurement, the parameters are "Bpeak", "Br", "Hc", "Hmax", "IRipple", "DeltaB", "DeltaH", "Permeability".

For RDSon measurement, the parameter is "RDS".

For Power Quality measurement, the parameters are "TRUEPWR", "APPPWR", "REPWR", "PWRFACTOR", "PHASE", "PWRFREQ", "ICFACTOR", "VCFACOR", "IRMS", "VRMS".

For Switching Loss measurement, the parameters are "TONENRG", "TONLOSS", "TOFFENRG", "TOFFLOSS", "CONDENRG", "CONDLOSS", "TTLLOSS", "TTLENRG".

"DVBYDT" is the parameter for the dV by dt measurement.

"DIBYDT" is the parameter for the dI by dt measurement.

"SOAHITSCNT" is the parameter for the SOA measurement.

"LRIPRMS" and "LRIPPKPK" are the parameters for the Line Ripple measurement.

"SWRIPRMS" and "SWRIPPKPK" are the parameters for the Switching Ripple measurement.

"PRIOD" is the parameter for the Cycle Period measurement.  
"FREQ" is the parameter for the Cycle Frequency measurement.  
"PDUTY" is the parameter for the Positive Duty Cycle measurement.  
"NDUTY" is the parameter for the Negative Duty Cycle measurement.  
"PPULSE" is the parameter for the Positive Pulse Width measurement.  
"NPULSE" is the parameter for the Negative Pulse Width measurement.  
"AMPL" is the parameter for the Cycle Amplitude measurement.  
"PKPK" is the parameter for the Cycle Peak–Peak measurement.  
"HIGH" is the parameter for the Cycle Top measurement.  
"LOW" is the parameter for the Cycle Base measurement.  
"Max" is the parameter for the Cycle Max measurement.  
"MIN" is the parameter for the Cycle Min measurement.  
"INRUSH" is the parameter for the Inrush Current measurement.  
"CAPACITANCE" is the parameter for the Input Capacitance measurement.  
"OUTPUT1" - "OUTPUT7" are the parameters for the Turn On Time and Turn Off Time measurements.  
"GAINCROSSOVERFREQ", "PHASECROSSOVERFREQ", "GM", "PM" are the parameters for the Control Loop Response measurement.  
"MAXPSRR", "MAXPSRRFREQ", "MINPSRR", "MINPSRRFREQ" are the parameters for the PSRR measurement

**Examples**    `Power:Power2:RESULTS:ALLAcqs:MEAN?` "AMPL" might return 57.45, indicating the mean value of the Amplitude measurement for all acquisitions of power measurement 2.

## **POWER:POWER<x>:RESULTS:ALLAcqs:MINimum? (Query Only)**

This command queries the minimum value of all acquisitions for the measurement parameter of the specified power measurement <x>.

**Conditions**    Requires option PWR or PS2.

**Group**        Power



**Syntax**    `Power:Power<x>:RESULTS:ALLAcqs:  
 MINimum? {InputPwr|Output1Pwr|  
 Output2Pwr|Output3Pwr|Efficiency1|Efficiency2|Efficiency3|  
 TotalEfficiency|INDUCT|IVSINTV|MAGLOSS|  
 Bpeak|Br|Hc|Hmax|IRipple|DeltaB|DeltaH|  
 Permeability|RDS|TRUEPWR|APPPWR|REPWR|  
 PWRFACTOR|PHASE|PWRFREQ|ICFACTOR|VCFACtor|  
 IRMS|VRMS|TONENRG|TONLOSS|TOFFENRG|  
 TOFFLOSS|CONDENRG|CONDLOSS|TTLLOSS|TTLENRG|  
 DVBYDT|DIBYDT|SOAHITSCNT|LRIPRMS|LRIPPKPK|  
 SWRIPRMS|SWRIPPKPK|PRIOD|FREQ|PDUTY|  
 NDUTY|PPULSE|NPULSE|AMPL|PKPK|  
 HIGH|LOW|MAX|MIN|INRUSH|CAPACITANCE|OUTPUT1|  
 OUTPUT2|OUTPUT3|OUTPUT4|OUTPUT5|OUTPUT6|OUTPUT7|  
 GAINCROSSOVERFREQ|PHASECROSSOVERFREQ|GM|PM|  
 MAXPSRR|MAXPSRRFREQ|MINPSRR|MINPSRRFREQ}`

---

**NOTE.** *Above entries are <QString> entries, and must be entered in enclosing quotes.*

---

**Arguments**

Power<x> is the power measurement number. This is the equivalent of the number shown in the UI for a power measurement badge.

<Qstring> = the measurement result that you want to return from the specified power measurement number. Available results depend on the power measurement being taken in the specified measurement number. The valid <Qstring> arguments are:

For Efficiency measurement, the parameters are "InputPwr", "Output1Pwr", "Output2Pwr", "Output3Pwr", "Efficiency1", "Efficiency2", "Efficiency3", "TotalEfficiency".

For Inductance measurement, the parameter is "INDUCT".

For IVSIntegralV measurement, the parameter is "IVSINTV".

For Magnetic Loss measurement, the parameter is "MAGLOSS".

For Magnetic Property measurement, the parameters are "Bpeak", "Br", "Hc", "Hmax", "IRipple", "DeltaB", "DeltaH", "Permeability".

For RDSon measurement, the parameter is "RDS".

For Power Quality measurement, the parameters are "TRUEPWR", "APPPWR", "REPWR", "PWRFACTOR", "PHASE", "PWRFREQ", "ICFACTOR", "VCFACtor", "IRMS", "VRMS".

For Switching Loss measurement, the parameters are "TONENRG", "TONLOSS", "TOFFENRG", "TOFFLOSS", "CONDENRG", "CONDLOSS", "TTLLOSS", "TTLENRG".

"DVBYDT" is the parameter for the dV by dt measurement.

"DIBYDT is the parameter for the dI by dt measurement.

"SOAHITSCNT is the parameter for the SOA measurement.

"LRIPRMS" and "LRIPPKPK" are the parameters for the Line Ripple measurement.

"SWRIPRMS" and "SWRIPPKPK" are the parameters for the Switching Ripple measurement.

"PRIOD" is the parameter for the Cycle Period measurement.

"FREQ" is the parameter for the Cycle Frequency measurement.

"PDUTY" is the parameter for the Positive Duty Cycle measurement.

"NDUTY" is the parameter for the Negative Duty Cycle measurement.

"PPULSE" is the parameter for the Positive Pulse Width measurement.

"NPULSE" is the parameter for the Negative Pulse Width measurement.

"AMPL" is the parameter for the Cycle Amplitude measurement.

"PKPK" is the parameter for the Cycle Peak–Peak measurement.

"HIGH" is the parameter for the Cycle Top measurement.

"LOW" is the parameter for the Cycle Base measurement.

"Max" is the parameter for the Cycle Max measurement.

"MIN" is the parameter for the Cycle Min measurement.

"INRUSH" is the parameter for the Inrush Current measurement.

"CAPACITANCE" is the parameter for the Input Capacitance measurement.

"OUTPUT1" - "OUTPUT7" are the parameters for the Turn On Time and Turn Off Time measurements.

"GAINCROSSOVERFREQ", "PHASECROSSOVERFREQ", "GM", "PM" are the parameters for the Control Loop Response measurement.

"MAXPSRR", "MAXPSRRFREQ", "MINPSRR", "MINPSRRFREQ" are the parameters for the PSRR measurement

**Examples**    `Power:POWER5:RESULTS:ALLAcqs:MINimum?` "FREQ" might return 5.1307829019093E6, indicating the minimum frequency measurement for all acquisitions of power measurement 5.

## **POWER:POWER<x>:RESULTS:ALLAcqs:PK2PK? (Query Only)**

This command queries the peak-to-peak value of all acquisitions for the measurement parameter in the specified power measurement number.

<b>Conditions</b>	Requires option PWR or PS2.
<b>Group</b>	Power
<b>Syntax</b>	<pre>Power:Power&lt;x&gt;:RESULTS:ALLAcqs:PK2PK? {InputPwr Output1Pwr  Output2Pwr Output3Pwr Efficiency1 Efficiency2 Efficiency3  TotalEfficiency INDUCT IVSINTV MAGLOSS Bpeak  Br Hc Hmax IRipple DeltaB DeltaH  Permeability RDS TRUEPWR APPPWR REPWR  PWRFACTOR PHASE PWRFREQ ICFACTOR VCFACOR  IRMS VRMS TONENRG TONLOSS TOFFENRG  TOFFLOSS CONDENRG CONDLOSS TTLLOSS TTLENRG  DVBYDT DIBYDT SOAHITSCNT LRIPRMS LRIPPKPK  SWRIPRMS SWRIPPKPK PRIOD FREQ PDUTY  NDUTY PPULSE NPULSE AMPL PKPK  HIGH LOW MAX MIN INRUSH CAPACITANCE OUTPUT1  OUTPUT2 OUTPUT3 OUTPUT4 OUTPUT5 OUTPUT6 OUTPUT7  GAINCROSSOVERFREQ PHASECROSSOVERFREQ GM PM  MAXPSRR MAXPSRRFREQ MINPSRR MINPSRRFREQ}</pre>

---

**NOTE.** Above entries are <QString> entries, and must be entered in enclosing quotes.

---

<b>Arguments</b>	<p>Power&lt;x&gt; is the power measurement number. This is the equivalent of the number shown in the UI for a power measurement badge.</p> <p>&lt;QString&gt; = the measurement result that you want to return from the specified power measurement number. Available results depend on the power measurement being taken in the specified measurement number. The valid &lt;Qstring&gt; arguments are:</p> <p>For Efficiency measurement, the parameters are "InputPwr", "Output1Pwr", "Output2Pwr", "Output3Pwr", "Efficiency1", "Efficiency2", "Efficiency3", "TotalEfficiency".</p> <p>For Inductance measurement, the parameter is "INDUCT".</p> <p>For IVSIntegralV measurement, the parameter is "IVSINTV".</p> <p>For Magnetic Loss measurement, the parameter is "MAGLOSS".</p> <p>For Magnetic Property measurement, the parameters are "Bpeak", "Br", "Hc", "Hmax", "IRipple", "DeltaB", "DeltaH", "Permeability".</p> <p>For RDSon measurement, the parameter is "RDS".</p> <p>For Power Quality measurement, the parameters are "TRUEPWR", "APPPWR", "REPWR", "PWRFACTOR", "PHASE", "PWRFREQ", "ICFACTOR", "VCFACOR", "IRMS", "VRMS".</p>
------------------	--------------------------------------------------------------------------------------------------------------------------------------------------------------------------------------------------------------------------------------------------------------------------------------------------------------------------------------------------------------------------------------------------------------------------------------------------------------------------------------------------------------------------------------------------------------------------------------------------------------------------------------------------------------------------------------------------------------------------------------------------------------------------------------------------------------------------------------------------------------------------------------------------------------------------------------------------------------------------------------------------------------------------------------------------------------------------------------------------------------------------------------------------------

For Switching Loss measurement, the parameters are "TONENRG", "TONLOSS", "TOFFENRG", "TOFFLOSS", "CONDENRG", "CONDLOSS", "TTLLOSS", "TTLENRG".

"DVBYDT" is the parameter for the dV by dt measurement.

"DIBYDT" is the parameter for the dI by dt measurement.

"SOAHITSCNT" is the parameter for the SOA measurement.

"LRIPRMS" and "LRIPKPK" are the parameters for the Line Ripple measurement.

"SWRIPRMS" and "SWRIPKPK" are the parameters for the Switching Ripple measurement.

"PRIOD" is the parameter for the Cycle Period measurement.

"FREQ" is the parameter for the Cycle Frequency measurement.

"PDUTY" is the parameter for the Positive Duty Cycle measurement.

"NDUTY" is the parameter for the Negative Duty Cycle measurement.

"PPULSE" is the parameter for the Positive Pulse Width measurement.

"NPULSE" is the parameter for the Negative Pulse Width measurement.

"AMPL" is the parameter for the Cycle Amplitude measurement.

"PKPK" is the parameter for the Cycle Peak–Peak measurement.

"HIGH" is the parameter for the Cycle Top measurement.

"LOW" is the parameter for the Cycle Base measurement.

"Max" is the parameter for the Cycle Max measurement.

"MIN" is the parameter for the Cycle Min measurement.

"INRUSH" is the parameter for the Inrush Current measurement.

"CAPACITANCE" is the parameter for the Input Capacitance measurement.

"OUTPUT1" - "OUTPUT7" are the parameters for the Turn On Time and Turn Off Time measurements.

"GAINCROSSOVERFREQ", "PHASECROSSOVERFREQ", "GM", "PM" are the parameters for the Control Loop Response measurement.

"MAXPSRR", "MAXPSRRFREQ", "MINPSRR", "MINPSRRFREQ" are the parameters for the PSRR measurement

**Examples**    `POWER:POWER1:RESULTS:ALLAcqs:PK2PK? "TONLoss"` might return 9.91, indicating the peak-to-peak value of T-On Energy for all acquisitions.

## POWer:POWer<x>:RESUlts:ALLAcqs:POPULation? (Query Only)

This command queries the population (number of complete cycles) of all acquisitions for the measurement parameter in the specified power measurement number.

**Conditions** Requires option PWR or PS2.

**Group** Power

**Syntax** Power:Power<x>:RESUlts:ALLAcqs:  
POPULation? {InputPwr|Output1Pwr|  
Output2Pwr|Output3Pwr|Efficiency1|Efficiency2|Efficiency3|  
TotalEfficiency|INDUCT|IVSINTV|MAGLOSS|Bpeak|  
Br|Hc|Hmax|IRipple|DeltaB|DeltaH|  
Permeability|RDS|TRUEPWR|APPPWR|REPWR|PWRFACTOR|  
PHASE|PWRFREQ|ICFACTOR|VCFACOR|IRMS|VRMS|  
TONENRG|TONLOSS|TOFFENRG|TOFFLOSS|CONDENRG|CONDLOSS|  
TTLLOSS|TTLENRG|DVBYDT|DIBYDT|SOAHITSCNT|  
LRIPRMS|LRIPPKPK|SWRIPRMS|SWRIPPKPK|PRIOD|  
FREQ|PDUTY|NDUTY|PPULSE|NPULSE|  
AMPL|PKPK|HIGH|LOW|MAX|MIN|INRUSH|CAPACITANCE|OUTPUT1|  
OUTPUT2|OUTPUT3|OUTPUT4|OUTPUT5|OUTPUT6|OUTPUT7|  
GAINCROSSOVERFREQ|PHASECROSSOVERFREQ|GM|PM|  
MAXPSRR|MAXPSRRFREQ|MINPSRR|MINPSRRFREQ}

---

**NOTE.** Above entries are <QString> entries, and must be entered in enclosing quotes.

---

**Arguments** Power<x> is the power measurement number. This is the equivalent of the number shown in the UI for a power measurement badge.

<QString> = the measurement result that you want to return from the specified power measurement number. Available results depend on the power measurement being taken in the specified measurement number. The valid <Qstring> arguments are:

For Efficiency measurement, the parameters are "InputPwr", "Output1Pwr", "Output2Pwr", "Output3Pwr", "Efficiency1", "Efficiency2", "Efficiency3", "TotalEfficiency".

For Inductance measurement, the parameter is "INDUCT".

For IVSIntegralV measurement, the parameter is "IVSINTV".

For Magnetic Loss measurement, the parameter is "MAGLOSS".

For Magnetic Property measurement, the parameters are "Bpeak", "Br", "Hc", "Hmax", "IRipple", "DeltaB", "DeltaH", "Permeability".

For RDSon measurement, the parameter is "RDS".

For Power Quality measurement, the parameters are "TRUEPWR", "APPPWR", "REPWR", "PWRFACTOR", "PHASE", "PWRFREQ", "ICFACTOR", "VCFACTOR", "IRMS", "VRMS".

For Switching Loss measurement, the parameters are "TONENRG", "TONLOSS", "TOFFENRG", "TOFFLOSS", "CONDENRG", "CONDLOSS", "TTLLOSS", "TTLENRG".

"DVBYDT" is the parameter for the dV by dt measurement.

"DIBYDT" is the parameter for the dI by dt measurement.

"SOAHITSCNT" is the parameter for the SOA measurement.

"LRIPRMS" and "LRIPPKPK" are the parameters for the Line Ripple measurement.

"SWRIPRMS" and "SWRIPPKPK" are the parameters for the Switching Ripple measurement.

"PRIOD" is the parameter for the Cycle Period measurement.

"FREQ" is the parameter for the Cycle Frequency measurement.

"PDUTY" is the parameter for the Positive Duty Cycle measurement.

"NDUTY" is the parameter for the Negative Duty Cycle measurement.

"PPULSE" is the parameter for the Positive Pulse Width measurement.

"NPULSE" is the parameter for the Negative Pulse Width measurement.

"AMPL" is the parameter for the Cycle Amplitude measurement.

"PKPK" is the parameter for the Cycle Peak–Peak measurement.

"HIGH" is the parameter for the Cycle Top measurement.

"LOW" is the parameter for the Cycle Base measurement.

"Max" is the parameter for the Cycle Max measurement.

"MIN" is the parameter for the Cycle Min measurement.

"INRUSH" is the parameter for the Inrush Current measurement.

"CAPACITANCE" is the parameter for the Input Capacitance measurement.

"OUTPUT1" - "OUTPUT7" are the parameters for the Turn On Time and Turn Off Time measurements.

"GAINCROSSOVERFREQ", "PHASECROSSOVERFREQ", "GM", "PM" are the parameters for the Control Loop Response measurement.

"MAXPSRR", "MAXPSRRFREQ", "MINPSRR", "MINPSRRFREQ" are the parameters for the PSRR measurement

**Examples** Power:Power1:RESULTS:ALLAcqs:POPulation? "CondEnrg" might return 4.91E-3, indicating the population (number of complete cycles) of conduction energy for all acquisitions.

## POWER:POWER<x>:RESULTS:ALLAcqs:STDDDev? (Query Only)

This command queries the standard deviation value of all acquisitions for the measurement parameter in the specified power measurement number.

**Conditions** Requires option PWR or PS2.

**Group** Power

**Syntax** Power:Power<x>:RESULTS:ALLAcqs:STDDDev? {InputPwr|Output1Pwr|Output2Pwr|Output3Pwr|Efficiency1|Efficiency2|Efficiency3|TotalEfficiency|INDUCT|IVSINTV|MAGLOSS|Bpeak|Br|Hc|Hmax|IRipple|DeltaB|DeltaH|Permeability|RDS|TRUEPWR|APPPWR|REPWR|PWRFACTOR|PHASE|PWRFREQ|ICFACTOR|VCFACOR|IRMS|VRMS|TONENRG|TONLOSS|TOFFENRG|TOFFLOSS|CONDENRG|CONDLOSS|TTLLOSS|TTLENRG|DVBYDT|DIBYDT|SOAHITSCNT|LRIPRMS|LRIPPKPK|SWRIPRMS|SWRIPPKPK|PRIOD|FREQ|PDUTY|NDUTY|PPULSE|NPULSE|AMPL|PKPK|HIGH|LOW|MAX|MIN|INRUSH|CAPACITANCE|OUTPUT1|OUTPUT2|OUTPUT3|OUTPUT4|OUTPUT5|OUTPUT6|OUTPUT7|GAINCROSSOVERFREQ|PHASECROSSOVERFREQ|GM|PM|MAXPSRR|MAXPSRRFREQ|MINPSRR|MINPSRRFREQ}

---

**NOTE.** Above entries are <QString> entries, and must be entered in enclosing quotes.

---

**Arguments** Power<x> is the power measurement number. This is the equivalent of the number shown in the UI for a power measurement badge.

<Qstring> = the measurement result that you want to return from the specified power measurement number. Available results depend on the power measurement being taken in the specified measurement number. The valid <Qstring> arguments are:

For Efficiency measurement, the parameters are "InputPwr", "Output1Pwr", "Output2Pwr", "Output3Pwr", "Efficiency1", "Efficiency2", "Efficiency3", "TotalEfficiency".

For Inductance measurement, the parameter is "INDUCT".

For IVSIntegralV measurement, the parameter is "IVSINTV".

For Magnetic Loss measurement, the parameter is "MAGLOSS".

For Magnetic Property measurement, the parameters are "Bpeak", "Br", "Hc", "Hmax", "IRipple", "DeltaB", "DeltaH", "Permeability".

For RDSon measurement, the parameter is "RDS".

For Power Quality measurement, the parameters are "TRUEPWR", "APPPWR", "REPWR", "PWRFACTOR", "PHASE", "PWRFREQ", "ICFACTOR", "VCFACOR", "IRMS", "VRMS".

For Switching Loss measurement, the parameters are "TONENRG", "TONLOSS", "TOFFENRG", "TOFFLOSS", "CONDENRG", "CONDLOSS", "TTLLOSS", "TTLENRG".

"DVBYDT" is the parameter for the dV by dt measurement.

"DIBYDT" is the parameter for the dI by dt measurement.

"SOAHITSCNT" is the parameter for the SOA measurement.

"LRIPRMS" and "LRIPPCK" are the parameters for the Line Ripple measurement.

"SWRIPRMS" and "SWRIPPCK" are the parameters for the Switching Ripple measurement.

"PRIOD" is the parameter for the Cycle Period measurement.

"FREQ" is the parameter for the Cycle Frequency measurement.

"PDUTY" is the parameter for the Positive Duty Cycle measurement.

"NDUTY" is the parameter for the Negative Duty Cycle measurement.

"PPULSE" is the parameter for the Positive Pulse Width measurement.

"NPULSE" is the parameter for the Negative Pulse Width measurement.

"AMPL" is the parameter for the Cycle Amplitude measurement.

"PKPK" is the parameter for the Cycle Peak–Peak measurement.

"HIGH" is the parameter for the Cycle Top measurement.

"LOW" is the parameter for the Cycle Base measurement.

"Max" is the parameter for the Cycle Max measurement.

"MIN" is the parameter for the Cycle Min measurement.



"INRUSH" is the parameter for the Inrush Current measurement.

"CAPACITANCE" is the parameter for the Input Capacitance measurement.

"OUTPUT1" - "OUTPUT7" are the parameters for the Turn On Time and Turn Off Time measurements.

"GAINCROSSOVERFREQ", "PHASECROSSOVERFREQ", "GM", "PM" are the parameters for the Control Loop Response measurement.

"MAXPSRR", "MAXPSRRFREQ", "MINPSRR", "MINPSRRFREQ" are the parameters for the PSRR measurement

**Examples** `Power:Power1:RESULTS:ALLAcqs:STDDev?` "TONLoss" might return 4.25, indicating the standard deviation value of T-On Energy loss for all acquisitions.

## **POWER:POWER<x>:RESULTS:CURRENTacq:F1MAG? (Query Only)**

This command queries the first harmonics magnitude value for the specified power measurement number.

**Conditions** Requires option PWR or PS2.

**Group** Power

**Syntax** `Power:Power<x>:RESULTS:CURRENTacq:F1MAG?` "harmonics"

**Arguments** `Power<x>` is the power measurement number. This is the equivalent of the number shown in the UI for a power measurement badge.

**Examples** `Power:Power1:RESULTS:CURRENTacq:F1MAG?` "harmonics" might return 1.4151834770090, indicating the value of the first harmonics magnitude for the power measurement badge 1.

## **POWER:POWER<x>:RESULTS:CURRENTacq:F3MAG? (Query Only)**

This command queries the third harmonics magnitude value for the specified power measurement number.

**Conditions** Requires option PWR or PS2.

<b>Group</b>	Power
<b>Syntax</b>	<code>POWER:POWER&lt;x&gt;:RESULTS:CURREntacq:F3MAG? "harmonics"</code>
<b>Arguments</b>	Power<x> is the power measurement number. This is the equivalent of the number shown in the UI for a power measurement badge.
<b>Examples</b>	<code>POWER:POWER1:RESULTS:CURREntacq:f3MAG? "harmonics"</code> might return 234.0187140104806E-6, indicating the value of third harmonics magnitude for the power measurement badge 1.

### **POWER:POWER<x>:RESULTS:CURREntacq:FREQUENCY? (Query Only)**

This command queries the fundamental frequency for the specified power measurement number.

<b>Conditions</b>	Requires option PWR or PS2.
<b>Group</b>	Power
<b>Syntax</b>	<code>POWER:POWER&lt;x&gt;:RESULTS:CURREntacq:FREQUENCY? "harmonics"</code>
<b>Arguments</b>	Power<x> is the power measurement number. This is the equivalent of the number shown in the UI for a power measurement badge.
<b>Examples</b>	<code>POWER:POWER1:RESULTS:CURREntacq:FREQUENCY? "harmonics"</code> might return 100.0067656931537E+3, indicating the fundamental frequency for the power measurement badge 1.

### **POWER:POWER<x>:RESULTS:CURREntacq:IRMS? (Query Only)**

This command queries the RMS current value for the specified power measurement number.

<b>Conditions</b>	Requires option PWR or PS2.
<b>Group</b>	Power

<b>Syntax</b>	<code>Power:Power&lt;x&gt;:RESULTS:CURRENTacq:IRMS? "harmonics"</code>
<b>Arguments</b>	Power<x> is the power measurement number. This is the equivalent of the number shown in the UI for a power measurement badge.
<b>Examples</b>	<code>Power:Power1:RESULTS:CURRENTacq:IRMS? "harmonics"</code> might return 1.4149980733491, indicating the RMS current value for the power measurement badge 1.

## POWER:POWER<x>:RESULTS:CURRENTacq:MAXimum? (Query Only)

This command queries the maximum value of the current acquisition for the measurement parameter in the specified power measurement number.

<b>Conditions</b>	Requires option PWR or PS2.
<b>Group</b>	Power
<b>Syntax</b>	<code>Power:Power&lt;x&gt;:RESULTS:CURRENTacq:MAXimum? {InputPwr Output1Pwr Output2Pwr Output3Pwr Efficiency1 Efficiency2 Efficiency3 TotalEfficiency INDUCT IVSINTV MAGLOSS Bpeak Br Hc Hmax IRipple DeltaB DeltaH Permeability RDS TRUEPWR APPPWR REPWR PWRFACTOR PHASE PWRFREQ ICFACTOR VCFACOR IRMS VRMS TONENRG TONLOSS TOFFENRG TOFFLOSS CONDENRG CONDLOSS TTLLLOSS TTLENRG DVBYDT DIBYDT SOAHITSCNT LRIPRMS LRIPPKPK SWRIPRMS SWRIPPKPK PRIOD FREQ PDUTY NDUTY PPULSE NPULSE AMPL PKPK HIGH LOW MAX MIN INRUSH CAPACITANCE OUTPUT1 OUTPUT2 OUTPUT3 OUTPUT4 OUTPUT5 OUTPUT6 OUTPUT7 GAINCROSSOVERFREQ PHASECROSSOVERFREQ GM PM MAXPSRR MAXPSRRFREQ MINPSRR MINPSRRFREQ}</code>

---

**NOTE.** Above entries are <QString> entries, and must be entered in enclosing quotes.

---

<b>Arguments</b>	Power<x> is the power measurement number. This is the equivalent of the number shown in the UI for a power measurement badge.
	<Qstring> = the measurement result that you want to return from the specified power measurement number. Available results depend on the power measurement being taken in the specified measurement number. The valid <Qstring> arguments are:

For Efficiency measurement, the parameters are "InputPwr", "Output1Pwr", "Output2Pwr", "Output3Pwr", "Efficiency1", "Efficiency2", "Efficiency3", "TotalEfficiency".

For Inductance measurement, the parameter is "INDUCT".

For IVSIntegralV measurement, the parameter is "IVSINTV".

For Magnetic Loss measurement, the parameter is "MAGLOSS".

For Magnetic Property measurement, the parameters are "Bpeak", "Br", "Hc", "Hmax", "IRipple", "DeltaB", "DeltaH", "Permeability".

For RDSon measurement, the parameter is "RDS".

For Power Quality measurement, the parameters are "TRUEPWR", "APPPWR", "REPWR", "PWRFACTOR", "PHASE", "PWRFREQ", "ICFACTOR", "VCFACOR", "IRMS", "VRMS".

For Switching Loss measurement, the parameters are "TONENRG", "TONLOSS", "TOFFENRG", "TOFFLOSS", "CONDENRG", "CONDLOSS", "TTLLOSS", "TTLENRG".

"DVBYDT" is the parameter for the dV by dt measurement.

"DIBYDT" is the parameter for the dI by dt measurement.

"SOAHITSCNT" is the parameter for the SOA measurement.

"LRIPRMS" and "LRIPPCK" are the parameters for the Line Ripple measurement.

"SWRIPRMS" and "SWRIPPCK" are the parameters for the Switching Ripple measurement.

"PRIOD" is the parameter for the Cycle Period measurement.

"FREQ" is the parameter for the Cycle Frequency measurement.

"PDUTY" is the parameter for the Positive Duty Cycle measurement.

"NDUTY" is the parameter for the Negative Duty Cycle measurement.

"PPULSE" is the parameter for the Positive Pulse Width measurement.

"NPULSE" is the parameter for the Negative Pulse Width measurement.

"AMPL" is the parameter for the Cycle Amplitude measurement.

"PKPK" is the parameter for the Cycle Peak–Peak measurement.

"HIGH" is the parameter for the Cycle Top measurement.

"LOW" is the parameter for the Cycle Base measurement.

"Max" is the parameter for the Cycle Max measurement.

"MIN" is the parameter for the Cycle Min measurement.

"INRUSH" is the parameter for the Inrush Current measurement.

"CAPACITANCE" is the parameter for the Input Capacitance measurement.

"OUTPUT1" - "OUTPUT7" are the parameters for the Turn On Time and Turn Off Time measurements.

"GAINCROSSOVERFREQ", "PHASECROSSOVERFREQ", "GM", "PM" are the parameters for the Control Loop Response measurement.

"MAXPSRR", "MAXPSRRFREQ", "MINPSRR", "MINPSRRFREQ" are the parameters for the PSRR measurement

**Examples**    `Power:Power1:RESULTS:CURRENTacq:MAXimum?` "TONEnrg" might return 32.8, indicating the maximum value of Ton Energy for the current acquisition.

## POWER:POWER<x>:RESULTS:CURRENTacq:MEAN? (Query Only)

This command queries the mean value of the current acquisition for the measurement parameter of the specified power measurement <x>.

**Conditions**    Requires option PWR or PS2.

**Group**    Power

**Syntax**    `Power:Power<x>:RESULTS:CURRENTacq:MEAN? {InputPwr|Output1Pwr|Output2Pwr|Output3Pwr|Efficiency1|Efficiency2|Efficiency3|TotalEfficiency|INDUCT|IVSINTV|MAGLOSS|Bpeak|Br|Hc|Hmax|IRipple|DeltaB|DeltaH|Permeability|RDS|TRUEPWR|APPPWR|REPWR|PWRFACTOR|PHASE|PWRFREQ|ICFACTOR|VCFACOR|IRMS|VRMS|TONENRG|TONLOSS|TOFFENRG|TOFFLOSS|CONDENRG|CONDLOSS|TTLLLOSS|TTLENRG|DVBYDT|DIBYDT|SOAHITSCNT|LRIPRMS|LRIPPKPK|SWRIPRMS|SWRIPPKPK|PRIOD|FREQ|PDUTY|NDUTY|PPULSE|NPULSE|AMPL|PKPK|HIGH|LOW|MAX|MIN|INRUSH|CAPACITANCE|OUTPUT1|OUTPUT2|OUTPUT3|OUTPUT4|OUTPUT5|OUTPUT6|OUTPUT7|GAINCROSSOVERFREQ|PHASECROSSOVERFREQ|GM|PM|MAXPSRR|MAXPSRRFREQ|MINPSRR|MINPSRRFREQ}`

---

**NOTE.** Above entries are <QString> entries, and must be entered in enclosing quotes.

---

**Arguments**    `Power<x>` is the power measurement number. This is the equivalent of the number shown in the UI for a power measurement badge.

<Qstring> = the measurement result that you want to return from the specified power measurement number. Available results depend on the power measurement being taken in the specified measurement number. The valid <Qstring> arguments are:

For Efficiency measurement, the parameters are "InputPwr", "Output1Pwr", "Output2Pwr", "Output3Pwr", "Efficiency1", "Efficiency2", "Efficiency3", "TotalEfficiency".

For Inductance measurement, the parameter is "INDUCT".

For IVSIntegralV measurement, the parameter is "IVSINTV".

For Magnetic Loss measurement, the parameter is "MAGLOSS".

For Magnetic Property measurement, the parameters are "Bpeak", "Br", "Hc", "Hmax", "IRipple", "DeltaB", "DeltaH", "Permeability".

For RDSon measurement, the parameter is "RDS".

For Power Quality measurement, the parameters are "TRUEPWR", "APPPWR", "REPWR", "PWRFACTOR", "PHASE", "PWRFREQ", "ICFACTOR", "VCFACOR", "IRMS", "VRMS".

For Switching Loss measurement, the parameters are "TONENRG", "TONLOSS", "TOFFENRG", "TOFFLOSS", "CONDENRG", "CONDLOSS", "TTLLOSS", "TTLENRG".

"DVBYDT" is the parameter for the dV by dt measurement.

"DIBYDT" is the parameter for the dI by dt measurement.

"SOAHITSCNT" is the parameter for the SOA measurement.

"LRIPRMS" and "LRIPPKPK" are the parameters for the Line Ripple measurement.

"SWRIPRMS" and "SWRIPPKPK" are the parameters for the Switching Ripple measurement.

"PRIOD" is the parameter for the Cycle Period measurement.

"FREQ" is the parameter for the Cycle Frequency measurement.

"PDUTY" is the parameter for the Positive Duty Cycle measurement.

"NDUTY" is the parameter for the Negative Duty Cycle measurement.

"PPULSE" is the parameter for the Positive Pulse Width measurement.

"NPULSE" is the parameter for the Negative Pulse Width measurement.

"AMPL" is the parameter for the Cycle Amplitude measurement.

"PKPK" is the parameter for the Cycle Peak–Peak measurement.

"HIGH" is the parameter for the Cycle Top measurement.

"LOW" is the parameter for the Cycle Base measurement.

"Max" is the parameter for the Cycle Max measurement.

"MIN" is the parameter for the Cycle Min measurement.

"INRUSH" is the parameter for the Inrush Current measurement.

"CAPACITANCE" is the parameter for the Input Capacitance measurement.

"OUTPUT1" - "OUTPUT7" are the parameters for the Turn On Time and Turn Off Time measurements.

"GAINCROSSOVERFREQ", "PHASECROSSOVERFREQ", "GM", "PM" are the parameters for the Control Loop Response measurement.

"MAXPSRR", "MAXPSRRFREQ", "MINPSRR", "MINPSRRFREQ" are the parameters for the PSRR measurement

**Examples**     `Power:Power2:RESULTS:CURRENTacq:MEAN?` "TruePwr" might return 42.6097255943E-2, indicating the mean value of true power for the current acquisition of power measurement 2.

## POWER:POWER<x>:RESULTS:CURRENTacq:MINimum? (Query Only)

This command queries the minimum value of the current acquisition for the measurement parameter in the specified power measurement number.

**Conditions**     Requires option PWR or PS2.

**Group**     Power

**Syntax**     `Power:Power<x>:RESULTS:CURRENTacq:MINimum? {InputPwr|Output1Pwr|Output2Pwr|Output3Pwr|Efficiency1|Efficiency2|Efficiency3|TotalEfficiency|INDUCT|IVSINTV|MAGLOSS|Bpeak|Br|Hc|Hmax|IRipple|DeltaB|DeltaH|Permeability|RDS|TRUEPWR|APPPWR|REPWR|PWRFACTOR|PHASE|PWRFREQ|ICFACTOR|VCFACOR|IRMS|VRMS|TONENRG|TONLOSS|TOFFENRG|TOFFLOSS|CONDENRG|CONDLOSS|TTLLLOSS|TTLENRG|DVBYDT|DIBYDT|SOAHITSCNT|LRIPRMS|LRIPPCK|SWRIPRMS|SWRIPPCK|PRIOD|FREQ|PDUTY|NDUTY|PPULSE|NPULSE|AMPL|PKPK|HIGH|LOW|MAX|MIN|INRUSH|CAPACITANCE|OUTPUT1|OUTPUT2|OUTPUT3|OUTPUT4|OUTPUT5|OUTPUT6|OUTPUT7|GAINCROSSOVERFREQ|PHASECROSSOVERFREQ|GM|PM|MAXPSRR|MAXPSRRFREQ|MINPSRR|MINPSRRFREQ}`

---

**NOTE.** Above entries are <QString> entries, and must be entered in enclosing quotes.

---

**Arguments**    **Power<x>** is the power measurement number. This is the equivalent of the number shown in the UI for a power measurement badge.

**<QString>** = the measurement result that you want to return from the specified power measurement number. Available results depend on the power measurement being taken in the specified measurement number. The valid <Qstring> arguments are:

For Efficiency measurement, the parameters are "InputPwr", "Output1Pwr", "Output2Pwr", "Output3Pwr", "Efficiency1", "Efficiency2", "Efficiency3", "TotalEfficiency".

For Inductance measurement, the parameter is "INDUCT".

For IVSIntegralV measurement, the parameter is "IVSINTV".

For Magnetic Loss measurement, the parameter is "MAGLOSS".

For Magnetic Property measurement, the parameters are "Bpeak", "Br", "Hc", "Hmax", "IRipple", "DeltaB", "DeltaH", "Permeability".

For RDSon measurement, the parameter is "RDS".

For Power Quality measurement, the parameters are "TRUEPWR", "APPPWR", "REPWR", "PWRFACTOR", "PHASE", "PWRFREQ", "ICFACTOR", "VCFACOR", "IRMS", "VRMS".

For Switching Loss measurement, the parameters are "TONENRG", "TONLOSS", "TOFFENRG", "TOFFLOSS", "CONDENRG", "CONDLOSS", "TTLLOSS", "TTLENRG".

"DVBYDT" is the parameter for the dV by dt measurement.

"DIBYDT" is the parameter for the dI by dt measurement.

"SOAHITSCNT" is the parameter for the SOA measurement.

"LRIPRMS" and "LRIPPKPK" are the parameters for the Line Ripple measurement.

"SWRIPRMS" and "SWRIPPKPK" are the parameters for the Switching Ripple measurement.

"PRIOD" is the parameter for the Cycle Period measurement.

"FREQ" is the parameter for the Cycle Frequency measurement.

"PDUTY" is the parameter for the Positive Duty Cycle measurement.

"NDUTY" is the parameter for the Negative Duty Cycle measurement.

"PPULSE" is the parameter for the Positive Pulse Width measurement.

"NPULSE" is the parameter for the Negative Pulse Width measurement.

"AMPL" is the parameter for the Cycle Amplitude measurement.



"PKPK" is the parameter for the Cycle Peak–Peak measurement.

"HIGH" is the parameter for the Cycle Top measurement.

"LOW" is the parameter for the Cycle Base measurement.

"Max" is the parameter for the Cycle Max measurement.

"MIN" is the parameter for the Cycle Min measurement.

"INRUSH" is the parameter for the Inrush Current measurement.

"CAPACITANCE" is the parameter for the Input Capacitance measurement.

"OUTPUT1" - "OUTPUT7" are the parameters for the Turn On Time and Turn Off Time measurements.

"GAINCROSSOVERFREQ", "PHASECROSSOVERFREQ", "GM", "PM" are the parameters for the Control Loop Response measurement.

"MAXPSRR", "MAXPSRRFREQ", "MINPSRR", "MINPSRRFREQ" are the parameters for the PSRR measurement

**Examples**     `Power:Power1:RESULTS:CURRENTacq:MINimum?` "TruePwr" might return `4.17829019093E-9`, indicating the minimum value of true power for the current acquisition.

## **Power:Power<x>:RESULTS:CURRENTacq:PK2PK? (Query Only)**

This command queries the peak-to-peak value of the current acquisition for the measurement parameter in the specified power measurement number.

**Conditions**     Requires option PWR or PS2.

**Group**     Power

**Syntax**     `Power:Power<x>:RESULTS:CURRENTacq:PK2PK? {InputPwr|Output1Pwr|Output2Pwr|Output3Pwr|Efficiency1|Efficiency2|Efficiency3|TotalEfficiency|INDUCT|IVSINTV|MAGLOSS|Bpeak|Br|Hc|Hmax|IRipple|DeltaB|DeltaH|Permeability|RDS|TRUEPWR|APPPWR|REPWR|PWRFACTOR|PHASE|PWRFREQ|ICFACTOR|VCFACOR|IRMS|VRMS|TONENRG|TONLOSS|TOFFENRG|TOFFLOSS|CONDENRG|CONDLOSS|TTLLOSS|TTLENRG|DVBYDT|DIBYDT|SOAHITSCNT|LRIPRMS|LRIPPKPK|SWRIPRMS|SWRIPPKPK|PRIOD|FREQ|PDUTY|NDUTY|PPULSE|NPULSE|AMPL|PKPK|HIGH|LOW|MAX|MIN|INRUSH|CAPACITANCE|OUTPUT1|OUTPUT2|OUTPUT3|OUTPUT4|OUTPUT5|OUTPUT6|OUTPUT7|GAINCROSSOVERFREQ|PHASECROSSOVERFREQ|GM|PM|MAXPSRR|MAXPSRRFREQ|MINPSRR|MINPSRRFREQ}`

---

**NOTE.** Above entries are <QString> entries, and must be entered in enclosing quotes.

---

## Arguments

Power<x> is the power measurement number. This is the equivalent of the number shown in the UI for a power measurement badge.

<Qstring> = the measurement result that you want to return from the specified power measurement number. Available results depend on the power measurement being taken in the specified measurement number. The valid <Qstring> arguments are:

For Efficiency measurement, the parameters are "InputPwr", "Output1Pwr", "Output2Pwr", "Output3Pwr", "Efficiency1", "Efficiency2", "Efficiency3", "TotalEfficiency".

For Inductance measurement, the parameter is "INDUCT".

For IVSIntegralV measurement, the parameter is "IVSINTV".

For Magnetic Loss measurement, the parameter is "MAGLOSS".

For Magnetic Property measurement, the parameters are "Bpeak", "Br", "Hc", "Hmax", "IRipple", "DeltaB", "DeltaH", "Permeability".

For RDSon measurement, the parameter is "RDS".

For Power Quality measurement, the parameters are "TRUEPWR", "APPPWR", "REPWR", "PWRFACTOR", "PHASE", "PWRFREQ", "ICFACTOR", "VCFACOR", "IRMS", "VRMS".

For Switching Loss measurement, the parameters are "TONENRG", "TONLOSS", "TOFFENRG", "TOFFLOSS", "CONDENRG", "CONDLOSS", "TTLOSS", "TTLENRG".

"DVBYDT" is the parameter for the dV by dt measurement.

"DIBYDT" is the parameter for the dI by dt measurement.

"SOAHITSCNT" is the parameter for the SOA measurement.

"LRIPRMS" and "LRIPPKPK" are the parameters for the Line Ripple measurement.

"SWRIPRMS" and "SWRIPPKPK" are the parameters for the Switching Ripple measurement.

"PRIOD" is the parameter for the Cycle Period measurement.

"FREQ" is the parameter for the Cycle Frequency measurement.

"PDUTY" is the parameter for the Positive Duty Cycle measurement.

"NDUTY" is the parameter for the Negative Duty Cycle measurement.

"PPULSE" is the parameter for the Positive Pulse Width measurement.

"NPULSE" is the parameter for the Negative Pulse Width measurement.

"AMPL" is the parameter for the Cycle Amplitude measurement.

"PKPK" is the parameter for the Cycle Peak–Peak measurement.

"HIGH" is the parameter for the Cycle Top measurement.

"LOW" is the parameter for the Cycle Base measurement.

"Max" is the parameter for the Cycle Max measurement.

"MIN" is the parameter for the Cycle Min measurement.

"INRUSH" is the parameter for the Inrush Current measurement.

"CAPACITANCE" is the parameter for the Input Capacitance measurement.

"OUTPUT1" - "OUTPUT7" are the parameters for the Turn On Time and Turn Off Time measurements.

"GAINCROSSOVERFREQ", "PHASECROSSOVERFREQ", "GM", "PM" are the parameters for the Control Loop Response measurement.

"MAXPSRR", "MAXPSRRFREQ", "MINPSRR", "MINPSRRFREQ" are the parameters for the PSRR measurement

**Examples**     `Power:Power1:RESULTS:CURRENTacq:PK2PK? "TONLoss"` might return 9.91, indicating the peak-to-peak value of Ton Energy for the current acquisition.

## POWER:POWER<x>:RESULTS:CURRENTacq:POHCL? (Query Only)

This command queries the limit of partial odd harmonic current for the specified power measurement number. The power measurement number is specified by x.

**Conditions**     Requires option PWR or PS2.

**Group**     Power

**Syntax**     `Power:POWER<x>:RESULTS:CURRENTacq:POHCL? "harmonics"`

**Arguments**     `Power<x>` is the power measurement number. This is the equivalent of the number shown in the UI for a power measurement badge.

**Examples**     `Power:Power1:RESULTS:CURRENTacq:POHCL? "harmonics"` might return 251.3529788962128E-3, indicating the limit of partial odd harmonic current for the power measurement badge 1.

## POWER:POWER<x>:RESULTS:CURRENTacq:POHCM? (Query Only)

This command queries the measured value of partial odd harmonic current for the specified power measurement number. The power measurement number is specified by x.

<b>Conditions</b>	Requires option PWR or PS2.
<b>Group</b>	Power
<b>Syntax</b>	POWER:POWER<x>:RESULTS:CURRENTacq:POHCM? "harmonics"
<b>Examples</b>	POWER:POWER1:RESULTS:CURRENTacq:POHCM? "harmonics" might return 515.422617782020E-6, indicating the measured value of partial odd harmonic current for the power measurement badge 1.

## POWER:POWER<x>:RESULTS:CURRENTacq:POHCS? (Query Only)

This command queries the status of partial odd harmonic current for the specified power measurement number. The power measurement number is specified by x.

<b>Conditions</b>	Requires option PWR or PS2.
<b>Group</b>	Power
<b>Syntax</b>	POWER:POWER<x>:RESULTS:CURRENTacq:POHCS? "harmonics"
<b>Arguments</b>	Power<x> is the power measurement number. This is the equivalent of the number shown in the UI for a power measurement badge.
<b>Examples</b>	POWER:POWER1:RESULTS:CURRENTacq:POHCS? "harmonics" might return Pass, indicating the status of partial odd harmonic current for power measurement 1.

## POWER:POWER<x>:RESULTS:CURRENTacq:POPULATION? (Query Only)

This command queries the population (number of complete cycles) of the current acquisition for the measurement parameter in the specified power measurement number. The power measurement number is specified by x.

**Conditions** Requires option PWR or PS2.

**Group** Power

**Syntax** `Power:Power<x>:RESUlts:CURRentacq:POPULation? {InputPwr|Output1Pwr|Output2Pwr|Output3Pwr|Efficiency1|Efficiency2|Efficiency3|TotalEfficiency|INDUCT|IVSINTV|MAGLOSS|Bpeak|Br|Hc|Hmax|IRipple|DeltaB|DeltaH|Permeability|RDS|TRUEPWR|APPPWR|REPWR|PWRFACTOR|PHASE|PWRFREQ|ICFACTOR|VCFACtor|IRMS|VRMS|TONENRG|TONLOSS|TOFFENRG|TOFFLOSS|CONDENRG|CONDLOSS|TTLLOSS|TTLENRG|DVBYDT|DIBYDT|SOAHITSCNT|LRIPRMS|LRIPPKPK|SWRIPRMS|SWRIPPKPK|PRIOD|FREQ|PDUTY|NDUTY|PPULSE|NPULSE|AMPL|PKPK|HIGH|LOW|MAX|MIN|INRUSH|CAPACITANCE|OUTPUT1|OUTPUT2|OUTPUT3|OUTPUT4|OUTPUT5|OUTPUT6|OUTPUT7|GAINCROSSOVERFREQ|PHASECROSSOVERFREQ|GM|PM|MAXPSRR|MAXPSRRFREQ|MINPSRR|MINPSRRFREQ}`

---

**NOTE.** Above entries are <QString> entries, and must be entered in enclosing quotes.

---

**Arguments** Power<x> is the power measurement number. This is the equivalent of the number shown in the UI for a power measurement badge.

<Qstring> = the measurement result that you want to return from the specified power measurement number. Available results depend on the power measurement being taken in the specified measurement number. The valid <Qstring> arguments are:

For Efficiency measurement, the parameters are "InputPwr", "Output1Pwr", "Output2Pwr", "Output3Pwr", "Efficiency1", "Efficiency2", "Efficiency3", "TotalEfficiency".

For Inductance measurement, the parameter is "INDUCT".

For IVSIntegralV measurement, the parameter is "IVSINTV".

For Magnetic Loss measurement, the parameter is "MAGLOSS".

For Magnetic Property measurement, the parameters are "Bpeak", "Br", "Hc", "Hmax", "IRipple", "DeltaB", "DeltaH", "Permeability".

For RDSon measurement, the parameter is "RDS".

For Power Quality measurement, the parameters are "TRUEPWR", "APPPWR", "REPWR", "PWRFACTOR", "PHASE", "PWRFREQ", "ICFACTOR", "VCFACtor", "IRMS", "VRMS".

For Switching Loss measurement, the parameters are "TONENRG", "TONLOSS", "TOFFENRG", "TOFFLOSS", "CONDENRG", "CONDLOSS", "TTLLOSS", "TTLENRG".

"DVBYDT" is the parameter for the dV by dt measurement.

"DIBYDT" is the parameter for the dI by dt measurement.

"SOAHITSCNT" is the parameter for the SOA measurement.

"LRIPRMS" and "LRIPKPK" are the parameters for the Line Ripple measurement.

"SWRIPRMS" and "SWRIPKPK" are the parameters for the Switching Ripple measurement.

"PRIOD" is the parameter for the Cycle Period measurement.

"FREQ" is the parameter for the Cycle Frequency measurement.

"PDUTY" is the parameter for the Positive Duty Cycle measurement.

"NDUTY" is the parameter for the Negative Duty Cycle measurement.

"PPULSE" is the parameter for the Positive Pulse Width measurement.

"NPULSE" is the parameter for the Negative Pulse Width measurement.

"AMPL" is the parameter for the Cycle Amplitude measurement.

"PKPK" is the parameter for the Cycle Peak–Peak measurement.

"HIGH" is the parameter for the Cycle Top measurement.

"LOW" is the parameter for the Cycle Base measurement.

"Max" is the parameter for the Cycle Max measurement.

"MIN" is the parameter for the Cycle Min measurement.

"INRUSH" is the parameter for the Inrush Current measurement.

"CAPACITANCE" is the parameter for the Input Capacitance measurement.

"OUTPUT1" - "OUTPUT7" are the parameters for the Turn On Time and Turn Off Time measurements.

"GAINCROSSOVERFREQ", "PHASECROSSOVERFREQ", "GM", "PM" are the parameters for the Control Loop Response measurement.

"MAXPSRR", "MAXPSRRFREQ", "MINPSRR", "MINPSRRFREQ" are the parameters for the PSRR measurement

**Examples**    `POWER:POWER1:RESULTS:CURRENTACQ:POPULATION?` "CondEnrg" might return 9.24E+4, indicating the population (number of complete cycles) of conduction energy for the current acquisition.

## POWer:POWer<x>:RESUlts:CURRentacq:RMS? (Query Only)

This command queries the RMS value of the source selected for the specified power measurement number. The power measurement number is specified by x.

**Conditions** Requires option PWR or PS2.

**Group** Power

**Syntax** `POWer:POWer<x>:RESUlts:CURRentacq:RMS? "harmonics"`

**Arguments** `Power<x>` is the power measurement number. This is the equivalent of the number shown in the UI for a power measurement badge.

**Examples** `POWer:POWer1:RESUlts:CURRentacq:RMS? "harmonics"` might return 1.4143420437461, indicating the RMS value of the source selected for power measurement 1.

## POWer:POWer<x>:RESUlts:CURRentacq:STATUS? (Query Only)

This command queries the status of the measurement for the specified power measurement number. The power measurement number is specified by x.

**Conditions** Requires option PWR or PS2.

**Group** Power

**Syntax** `POWer:POWer<x>:RESUlts:CURRentacq:STATUS? "harmonics"`

**Arguments** `Power<x>` is the power measurement number. This is the equivalent of the number shown in the UI for a power measurement badge.

**Examples** `POWer:POWer1:RESUlts:CURRentacq:STATUS? "harmonics"` might return `PASS`, indicating that the measurement has passed according to the standard for power measurement 1.

## POWER:POWER<x>:RESULTS:CURRENTacq:STDDev? (Query Only)

This command queries the standard deviation value of the current acquisition for the measurement parameter in the specified power measurement number. The power measurement number is specified by x.

**Conditions** Requires option PWR or PS2.

**Group** Power

**Syntax** Power:POWER<x>:RESULTS:CURRENTacq:STDDev?  
 {InputPwr|Output1Pwr|  
 Output2Pwr|Output3Pwr|Efficiency1|Efficiency2|Efficiency3|  
 TotalEfficiency|INDUCT|IVSINTV|MAGLOSS|Bpeak|Br|Hc|Hmax|IRipple|  
 DeltaB|DeltaH|Permeability|RDS|TRUEPWR|APPPWR|REPWR|PWRFACTOR|  
 PHASE|PWRFREQ|ICFACTOR|VCFACOR|IRMS|VRMS|TONENRG|TONLOSS|  
 TOFFENRG|TOFFLOSS|CONDENRG|CONDLOSS|TTLLOSS|TTLENRG|DVBYDT|  
 DIBYDT|SOAHITSCNT|LRIPRMS|LRIPPKPK|SWRIPRMS|SWRIPPKPK|PRIOD|  
 FREQ|PDUTY|NDUTY|PPULSE|NPULSE|AMPL|PKPK|HIGH|LOW|MAX|MIN  
 |INRUSH|CAPACITANCE|OUTPUT1|  
 OUTPUT2|OUTPUT3|OUTPUT4|OUTPUT5|OUTPUT6|OUTPUT7|  
 GAINCROSSOVERFREQ|PHASECROSSOVERFREQ|GM|PM|  
 MAXPSRR|MAXPSRRFREQ|MINPSRR|MINPSRRFREQ}

---

**NOTE.** Above entries are <QString> entries, and must be entered in enclosing quotes.

---

**Arguments** Power<x> is the power measurement number. This is the equivalent of the number shown in the UI for a power measurement badge.

<Qstring> = the measurement result that you want to return from the specified power measurement number. Available results depend on the power measurement being taken in the specified measurement number. The valid <Qstring> arguments are:

For Efficiency measurement, the parameters are "InputPwr", "Output1Pwr", "Output2Pwr", "Output3Pwr", "Efficiency1", "Efficiency2", "Efficiency3", "TotalEfficiency".

For Inductance measurement, the parameter is "INDUCT".

For IVSIntegralV measurement, the parameter is "IVSINTV".

For Magnetic Loss measurement, the parameter is "MAGLOSS".

For Magnetic Property measurement, the parameters are "Bpeak", "Br", "Hc", "Hmax", "IRipple", "DeltaB", "DeltaH", "Permeability".



For RDSon measurement, the parameter is "RDS".

For Power Quality measurement, the parameters are "TRUEPWR", "APPPWR", "REPWR", "PWRFACTOR", "PHASE", "PWRFREQ", "ICFACTOR", "VCFACOR", "IRMS", "VRMS".

For Switching Loss measurement, the parameters are "TONENRG", "TONLOSS", "TOFFENRG", "TOFFLOSS", "CONDENRG", "CONDLOSS", "TTLLOSS", "TTLENRG".

"DVBYDT" is the parameter for the dV by dt measurement.

"DIBYDT" is the parameter for the dI by dt measurement.

"SOAHITSCNT" is the parameter for the SOA measurement.

"LRIPRMS" and "LRIPPKPK" are the parameters for the Line Ripple measurement.

"SWRIPRMS" and "SWRIPPKPK" are the parameters for the Switching Ripple measurement.

"PRIOD" is the parameter for the Cycle Period measurement.

"FREQ" is the parameter for the Cycle Frequency measurement.

"PDUTY" is the parameter for the Positive Duty Cycle measurement.

"NDUTY" is the parameter for the Negative Duty Cycle measurement.

"PPULSE" is the parameter for the Positive Pulse Width measurement.

"NPULSE" is the parameter for the Negative Pulse Width measurement.

"AMPL" is the parameter for the Cycle Amplitude measurement.

"PKPK" is the parameter for the Cycle Peak–Peak measurement.

"HIGH" is the parameter for the Cycle Top measurement.

"LOW" is the parameter for the Cycle Base measurement.

"Max" is the parameter for the Cycle Max measurement.

"MIN" is the parameter for the Cycle Min measurement.

"INRUSH" is the parameter for the Inrush Current measurement.

"CAPACITANCE" is the parameter for the Input Capacitance measurement.

"OUTPUT1" - "OUTPUT7" are the parameters for the Turn On Time and Turn Off Time measurements.

"GAINCROSSOVERFREQ", "PHASECROSSOVERFREQ", "GM", "PM" are the parameters for the Control Loop Response measurement.

"MAXPSRR", "MAXPSRRFREQ", "MINPSRR", "MINPSRRFREQ" are the parameters for the PSRR measurement

**Examples**    `Power:Power2:RESULTS:CURRENTacq:STDDev?` "TONLoss" might return 1.31E+2, indicating the standard deviation value of Ton Energy for current acquisition of power measurement 2.

## **POWER:POWER<x>:RESULTS:CURRENTacq:THDF? (Query Only)**

This command queries the total harmonic distortion (fundamental) value for the specified power measurement number. The power measurement number is specified by x.

**Conditions**    Requires option PWR or PS2.

**Group**        Power

**Syntax**       `Power:Power<x>:RESULTS:CURRENTacq:THDF? "harmonics"`

**Arguments**    `Power<x>` is the power measurement number. This is the equivalent of the number shown in the UI for a power measurement badge.

**Examples**    `Power:Power1:RESULTS:CURRENTacq:THDF? "harmonics"` might return 96.9846996670887E-3, indicating the value of total harmonic distortion (fundamental) for power measurement 1.

## **POWER:POWER<x>:RESULTS:CURRENTacq:THDR? (Query Only)**

This command queries the total harmonic distortion (RMS) value for the specified power measurement number. The power measurement number is specified by x.

**Conditions**    Requires option PWR or PS2.

**Group**        Power

**Syntax**       `Power:Power<x>:RESULTS:CURRENTacq:THDR? "harmonics"`

**Arguments**    `Power<x>` is the power measurement number. This is the equivalent of the number shown in the UI for a power measurement badge.

**Examples** `Power:Power1:RESULTS:CURRENTacq:THDR?` "harmonics" might return 107.1384597967292E-3, indicating the value of total harmonic distortion (fundamental) for power measurement 1.

## **Power:Power<x>:RESULTS:CURRENTacq:TRPWR? (Query Only)**

This command queries the true power value for the specified power measurement number. The power measurement number is specified by x.

**Conditions** Requires option PWR or PS2.

**Group** Power

**Syntax** `Power:Power<x>:RESULTS:CURRENTacq:TRPWR?` "harmonics"

**Arguments** `Power<x>` is the power measurement number. This is the equivalent of the number shown in the UI for a power measurement badge.

**Examples** `Power:Power1:RESULTS:CURRENTacq:TRPWR?` "harmonics" might return 2.0002612633993, indicating the true power value for power measurement 1.

## **Power:Power<x>:RESULTS:CURRENTacq:VRMS? (Query Only)**

This command queries the RMS voltage value for the specified power measurement number. The power measurement number is specified by x.

**Conditions** Requires option PWR or PS2.

**Group** Power

**Syntax** `Power:Power<x>:RESULTS:CURRENTacq:VRMS?` "harmonics"

**Arguments** `Power<x>` is the power measurement number. This is the equivalent of the number shown in the UI for a power measurement badge.

**Examples** `Power:Power3:RESULTS:CURRENTacq:VRMS?` "harmonics" might return 1.4117680233354, indicating the RMS voltage value for the power measurement 3.

## POWer:POWer<x>:SEQSETup (No Query Form)

This command sets up the instrument's horizontal, vertical, and trigger parameters to optimize for taking the specified power measurement.

<b>Conditions</b>	Requires option PWR or PS2.
<b>Group</b>	Power
<b>Syntax</b>	POWER:POWER<x>:SEQSETup Execute
<b>Arguments</b>	<p>POWER&lt;x&gt; is the Power measurement identifier number. The number must be for a power measurement that requires a single sequence acquisition.</p> <p>RUN sets the measurement to run an acquisition and acquire data for the specified single sequence power measurement.</p>
<b>Examples</b>	POWER:POWER3:SEQUENCE Execute runs the power measurement 3 sequence setup.

## POWer:POWer<x>:SEQUence

This command sets or queries the run state of a single sequence power measurement.

<b>Conditions</b>	Requires option PWR or PS2.
<b>Group</b>	Power
<b>Syntax</b>	POWER:POWER<x>:SEQUENCE {RUN RERUN} POWER:POWER<x>:SEQUENCE?
<b>Arguments</b>	<p>POWER&lt;x&gt; is the Power measurement identifier number. The number must be for a power measurement that requires a single sequence acquisition.</p> <p>RUN sets the measurement to run an acquisition and acquire data for the specified single sequence power measurement.</p> <p>RERUN sets the measurement to rerun an acquisition and acquire data for the specified single sequence power measurement.</p>

- Examples** `Power:Power3:Sequence RUN` sets power measurement 3 to run the measurement.
- `Power:Power1:Sequence?` might return `Power:Power1:Sequence RERUN`, indicating that the current state of the power measurement is rerun.

## POWer:POWer<x>:SOA:ISOURce

This command sets or queries the current source for SOA measurement in the specified power measurement number. The power measurement number is specified by x.

- Conditions** Requires option PWR or PS2.
- Group** Power
- Syntax** `Power:Power<x>:SOA:ISOURce {S<x>_Ch<x>|CH<x>|MATH<x>|REF<x>}`  
`Power:Power<x>:SOA:ISOURce?`
- Arguments** `Power<x>` is the power measurement number. This is the equivalent of the number shown in the UI for a power measurement badge.
- `S<x>_Ch<x>` specifies the remote scope number and the analog channel.
- `CH<x>` = A channel specifier; <x> is 1 through 8 and is limited by the number of FlexChannels on your instrument.
- `MATH<x>` = A math waveform specifier; <x> is  $\geq 1$ .
- `REF<x>` = A reference waveform specifier; <x> is  $\geq 1$ .
- Examples** `Power:Power1:SOA:ISOURce CH2` sets the current source for the SOA measurement 1 as channel 2.

## POWer:POWer<x>:SOA:POINT

This command sets or queries the X or Y coordinate value for an SOA mask of a specified power measurement.

- Conditions** Requires option PWR or PS2.
- Group** Power

**Syntax**    `POWER:POWER<x>:SOA:POINT <QString> <NR1>`  
`POWER:POWER<x>:SOA:POINT <QString>?`

**Arguments**    `Power<x>` is the power measurement number. This is the equivalent of the number shown in the UI for a power measurement badge.

`<QString>` = 1X | 2X | 3X | 4X | 5X | 6X | 7X | 8X | 9X | 10X | 11X | 12X | 13X | 14X | 15X | 16X | 17X | 18X | 19X | 20X | 21X | 22X | 23X | 24X | 25X | 26X | 27X | 28X | 29X | 30X | 31X | 32X | 1Y | 2Y | 3Y | 4Y | 5Y | 6Y | 7Y | 8Y | 9Y | 10Y | 11Y | 12Y | 13Y | 14Y | 15Y | 16Y | 17Y | 18Y | 19Y | 20Y | 21Y | 22Y | 23Y | 24Y | 25Y | 26Y | 27Y | 28Y | 29Y | 30Y | 31Y | 32Y

`<NR2>` sets the specified SOA mask X or Y point value, as a floating number, in the range from -5000 to 5000.

**Examples**    `POWER:POWER1:SOA:POINT6Y 0.125` sets the #6Y coordinate value of the SOA mask of power measurement 1 to 0.125.

`POWER:POWER3:SOA:POINT12X?` might return  
`POWER:POWER3:SOA:POINT12X 1.435`, indicating that the #12X coordinate value of the SOA mask of power measurement 3 is 1.435.

## POWER:POWER<x>:SOA:RECALLmask

This command recalls or queries the recall mask file name in the specified power measurement number. The power measurement number is specified by `x`.

**Conditions**    Requires option PWR or PS2.

**Group**    Power

**Syntax**    `POWER:POWER<x>:SOA:RECALLmask`  
`POWER:POWER<x>:SOA:RECALLmask?`

**Examples**    `POWER:POWER1:SOA:RECALLmask?` might return `Tek000.msk`, indicating the file name of the mask that will be recalled.

## POWER:POWER<x>:SOA:RECALLmask:FILENAME

This command sets or queries the file name for saving SOA mask file name in the specified power measurement number. The power measurement number is specified by `x`.

<b>Conditions</b>	Requires option PWR or PS2.
<b>Group</b>	Power
<b>Syntax</b>	POWER:POWER<x>:SOA:RECALLmask:FILENAME POWER:POWER<x>:SOA:RECALLmask:FILENAME?
<b>Examples</b>	POWER:POWER1:SOA:RECALLmask:FILENAME

## POWER:POWER<x>:SOA:SAVEmask

This command saves the mask file as per the name configured and at the configured path or queries the mask file name, path, and file type for the SOA measurement in the specified power measurement number. The power measurement number is specified by x.

<b>Conditions</b>	Requires option PWR or PS2.
<b>Group</b>	Power
<b>Syntax</b>	POWER:POWER<x>:SOA:SAVEmask POWER:POWER<x>:SOA:SAVEmask?
<b>Related Commands</b>	<a href="#">POWER:POWER&lt;x&gt;:SOA:SAVEmask:FILENAME</a>
<b>Examples</b>	POWER:POWER1:SOA:SAVEmask saves the mask file of SOA measurement as the configured file name at the configured path.

## POWER:POWER<x>:SOA:SAVEmask:AUTOINCrement

This command sets or queries the state of auto-increment for saved SOA mask file names in the specified power measurement number. The power measurement number is specified by x.

<b>Conditions</b>	Requires option PWR or PS2.
<b>Group</b>	Power

**Syntax**    `Power:POWER<x>:SOA:SAVemask:AUTOINCrement`  
`Power:POWER<x>:SOA:SAVemask:AUTOINCrement?`

## **POWer:POWer<x>:SOA:SAVemask:FILEName**

This command sets or queries the mask file name for SOA measurement in the specified power measurement number. The power measurement number is specified by x.

**Conditions**    Requires option PWR or PS2.

**Group**        Power

**Syntax**       `Power:POWER<x>:SOA:SAVemask:FILEName`  
`Power:POWER<x>:SOA:SAVemask:FILEName?`

**Examples**     `Power:POWER1:SOA:SAVemask:FILEName "Tek001.msk"` sets the mask file name for SOA measurement as Tek001.msk.

## **POWer:POWer<x>:SOA:SAVemask:FOLDer**

This command sets or queries the mask file folder path for SOA measurement in the specified power measurement number. The power measurement number is specified by x.

**Conditions**    Requires option PWR or PS2.

**Group**        Power

**Syntax**       `Power:POWER<x>:SOA:SAVemask:FOLDer`  
`Power:POWER<x>:SOA:SAVemask:FOLDer?`

**Examples**     `Power:POWER1:SOA:SAVemask:FOLDer "C:"` sets the mask file folder path for SOA measurement as C drive.



**POWer:POWer<x>:SOA:VSOURce**

This command sets or queries the voltage source for SOA measurement in the specified power measurement number. The power measurement number is specified by x.

**Conditions** Requires option PWR or PS2.

**Group** Power

**Syntax** `POWer:POWer<x>:SOA:VSOURce {CH<x> | MATH<x> | REF<x>}`  
`POWer:POWer<x>:SOA:VSOURce?`

**Arguments** `Power<x>` is the power measurement number. This is the equivalent of the number shown in the UI for a power measurement badge.

`CH<x>` = A channel specifier; `<x>` is 1 through 8 and is limited by the number of FlexChannels in your instrument.

`MATH<x>` = A math waveform specifier; `<x>` is  $\geq 1$ .

`REF<x>` = A reference waveform specifier; `<x>` is  $\geq 1$ .

**Examples** `POWer:POWer1:SOA:VSOURce CH1` sets the voltage source for SOA measurement as channel 1.

**POWer:POWer<x>:SWITCHINGLOSS:DEVICEType**

This command sets or queries the conduction calculation method for switching loss measurement in the specified power measurement number. The power measurement number is specified by x.

**Conditions** Requires option PWR or PS2.

**Group** Power

**Syntax** `POWer:POWer<x>:SWITCHINGLOSS:DEVICEType {MOSFET | BJT}`  
`POWer:POWer<x>:SWITCHINGLOSS:DEVICEType?`

**Examples** `Power:Power1:SWITCHINGLOSS:DEVICETYPE MOSFET` sets the conduction calculation method as mosfet for switching loss measurement of the power measurement badge Power 1.

## **POWER:POWER<x>:SWITCHINGLOSS:GATESOURCE**

This command sets or queries the gate voltage ( $V_g$ ) for the switching loss measurement in the specified power measurement number. The power measurement number is specified by  $x$ .

**Conditions** Requires option PWR or PS2.

**Group** Power

**Syntax** `Power:Power<x>:SWITCHINGLOSS:GATESOURCE {CH<x> | MATH<x> | REF<x>}`  
`Power:Power<x>:SWITCHINGLOSS:GATESOURCE?`

**Arguments** `Power<x>` is the power measurement number. This is the equivalent of the number shown in the UI for a power measurement badge.

`CH<x>` = A channel specifier;  $<x>$  is 1 through 8 and is limited by the number of FlexChannels in your instrument.

`MATH<x>` = A math waveform specifier;  $<x>$  is  $\geq 1$ .

`REF<x>` = A reference waveform specifier;  $<x>$  is  $\geq 1$ .

**Examples** `Power:Power1:SWITCHINGLOSS:GATESOURCE MATH1` sets the gate voltage ( $V_g$ ) source for switching loss measurement of power measurement 1 as MATH1.

`Power:Power2:SWITCHINGLOSS:VSOURCE?` might return MATH3 indicating the gate voltage ( $V_g$ ) for switching loss measurement of power measurement 2.

## **POWER:POWER<x>:SWITCHINGLOSS:ILEVELABS**

This command sets or queries the current level (Ton-Start & Stop) in absolute units for switching loss measurement in the specified power measurement number. The power measurement number is specified by  $x$ .

**Conditions** Requires option PWR or PS2.

<b>Group</b>	Power
<b>Syntax</b>	<pre>POWer:POWer&lt;x&gt;:SWITCHINGLOSS:ILEVELAbs &lt;NR1&gt; POWer:POWer&lt;x&gt;:SWITCHINGLOSS:ILEVELAbs?</pre>
<b>Related Commands</b>	<a href="#">POWer:POWer&lt;x&gt;:SWITCHINGLOSS:LEVELUNIts</a>
<b>Arguments</b>	<p>Power&lt;x&gt; is the power measurement number. This is the equivalent of the number shown in the UI for a power measurement badge.</p> <p>&lt;NR1&gt; ranges from -100 to 100</p>
<b>Examples</b>	<p>POWer:POWer1:SWITCHINGLOSS:ILEVELAbs 1.2 sets the current level (Ton-Start &amp; Stop) value as 1.2 for the switching loss measurement in the power measurement badge 1.</p>

## POWer:POWer<x>:SWITCHINGLOSS:ILEVELPct

This command sets or queries the current level (Ton-Start & Stop) in percentage for switching loss measurement in the specified power measurement number. The power measurement number is specified by x.

<b>Conditions</b>	Requires option PWR or PS2.
<b>Group</b>	Power
<b>Syntax</b>	<pre>POWer:POWer&lt;x&gt;:SWITCHINGLOSS:ILEVELPct &lt;NR1&gt; POWer:POWer&lt;x&gt;:SWITCHINGLOSS:ILEVELPct?</pre>
<b>Related Commands</b>	<a href="#">POWer:POWer&lt;x&gt;:SWITCHINGLOSS:LEVELUNIts</a>
<b>Arguments</b>	<p>Power&lt;x&gt; is the power measurement number. This is the equivalent of the number shown in the UI for a power measurement badge.</p> <p>&lt;NR1&gt; ranges from 0.0001 to 90</p>
<b>Examples</b>	<p>POWer:POWer1:SWITCHINGLOSS:ILEVELPct 6 sets the current level (Ton-Start &amp; Stop) value as 6 percentage for the switching loss measurement in the power measurement badge 1.</p>

## POWer:POWer<x>:SWITCHINGLOSS:ISOURce

This command sets or queries the current source for the switching loss measurement in the specified power measurement number. The power measurement number is specified by x.

**Conditions** Requires option PWR or PS2.

**Group** Power

**Syntax** `POWer:POWer<x>:SWITCHINGLOSS:ISOURce {CH<x> | MATH<x> | REF<x>}`  
`POWer:POWer<x>:SWITCHINGLOSS:ISOURce?`

**Arguments** Power<x> is the power measurement number. This is the equivalent of the number shown in the UI for a power measurement badge.

CH<x> = A channel specifier; <x> is 1 through 8 and is limited by the number of FlexChannels in your instrument.

MATH<x> = A math waveform specifier; <x> is  $\geq 1$ .

REF<x> = A reference waveform specifier; <x> is  $\geq 1$ .

**Examples** `POWer:POWer1:SWITCHINGLOSS:ISOURce CH2` sets the current source for the switching loss measurement in the specified power measurement badge as CH2.

`POWer:POWer2:SWITCHINGLOSS:ISOURce?` might return CH1 indicating the current source for switching loss measurement of Power 2 power measurement badge.

## POWer:POWer<x>:SWITCHINGLOSS:LEVELUNIts

This command sets or queries the level units for switching loss measurement in the specified power measurement number. The power measurement number is specified by x.

**Conditions** Requires option PWR or PS2.

**Group** Power

**Syntax** `POWer:POWer<x>:SWITCHINGLOSS:LEVELUNIts {PERCent | ABSolute}`  
`POWer:POWer<x>:SWITCHINGLOSS:LEVELUNIts?`

<b>Arguments</b>	<p><code>Power&lt;x&gt;</code> is the power measurement number. This is the equivalent of the number shown in the UI for a power measurement badge.</p> <p><code>PERCent</code> to set the High, Mid, and Low reference levels in percentage.</p> <p><code>ABSolute</code> to set the High, Mid, and Low reference levels to specific signal levels.</p>
<b>Examples</b>	<p><code>Power:Power1:SWITCHINGLOSS:LEVELUNITS ABSolute</code> sets the level units as Absolute for switching loss measurement of the power measurement badge Power 1.</p>

## POWer:POWer<x>:SWITCHINGLOSS:RDSON

This command sets or queries the RDS(on) value for switching loss measurement in the specified power measurement number. The power measurement number is specified by x.

<b>Conditions</b>	Requires option PWR or PS2.
<b>Group</b>	Power
<b>Syntax</b>	<pre>Power:Power&lt;x&gt;:SWITCHINGLOSS:RDSON &lt;NR1&gt; Power:Power&lt;x&gt;:SWITCHINGLOSS:RDSON?</pre>
<b>Related Commands</b>	<a href="#">POWer:POWer&lt;x&gt;:SWITCHINGLOSS:DEVICETYPE</a>

<b>Arguments</b>	<p><code>Power&lt;x&gt;</code> is the power measurement number. This is the equivalent of the number shown in the UI for a power measurement badge.</p> <p><code>&lt;NR1&gt;</code> ranges from 0 to 100</p>
<b>Examples</b>	<p><code>Power:Power1:SWITCHINGLOSS:RDSON 2</code> sets the switching loss RDSON value as 2 for switching loss measurement of the power measurement badge Power 1.</p>

## POWer:POWer<x>:SWITCHINGLOSS:SWLCONFIGType

This command sets or queries the configuration type for the switching loss measurement in the specified power measurement number. The power measurement number is specified by x.

<b>Conditions</b>	Requires option PWR or PS2.
<b>Group</b>	Power
<b>Syntax</b>	<pre>Power:Power&lt;x&gt;:SWITCHINGLOSS:SWLCONFIGType {SMPS   PFC   FLYBACK} Power:Power&lt;x&gt;:SWITCHINGLOSS:SWLCONFIGType?</pre>
<b>Arguments</b>	<p>Power&lt;x&gt; is the power measurement number. This is the equivalent of the number shown in the UI for a power measurement badge.</p> <p>SMPS: Select this option in case of signals without noise and ringing. The <math>V_g</math> source is not required. Select <math>V_g</math> source (Source 3), in case of noisy signal.</p> <p>PFC: Select this option when input DUT signals are from Power Factor Correction Circuit. For this case, <math>V_g</math> source is mandatory.</p> <p>FLYBACK: Select this option when input signals are ringing. This option does not require a <math>V_g</math> source.</p>
<b>Examples</b>	<pre>Power:Power1:SWITCHINGLOSS:SWLCONFIGType PFC</pre> <p>sets the configuration type as PFC for the switching loss measurement of the power measurement badge Power 1.</p>

## POWER:POWER<x>:SWITCHINGLOSS:VCESat

This command sets or queries the value for the VCE(sat) value for switching loss measurement in the specified power measurement number. The power measurement number is specified by x.

<b>Conditions</b>	Requires option PWR or PS2.
<b>Group</b>	Power
<b>Syntax</b>	<pre>Power:Power&lt;x&gt;:SWITCHINGLOSS:VCESat &lt;NR1&gt; Power:Power&lt;x&gt;:SWITCHINGLOSS:VCESat?</pre>
<b>Related Commands</b>	<a href="#">POWER:POWER&lt;x&gt;:SWITCHINGLOSS:DEVICETYPE</a>
<b>Arguments</b>	Power<x> is the power measurement number. This is the equivalent of the number shown in the UI for a power measurement badge.

<NR1> ranges from 0.001 to 100

**Examples** `Power:Power1:SWITCHINGLOSS:VCEsat 6` sets VCE(sat) value as 6 for switching loss measurement of the power measurement badge Power 1.

## POWER:POWER<x>:SWITCHINGLOSS:VGLevel

This command sets or queries the gate voltage value ( $V_g$  Level Ton-Start) for the switching loss measurement in the specified power measurement number. The power measurement number is specified by x.

**Conditions** Requires option PWR or PS2.

**Group** Power

**Syntax** `Power:POWER<x>:SWITCHINGLOSS:VGLevel <NR1>`  
`Power:POWER<x>:SWITCHINGLOSS:VGLevel?`

**Arguments** Power<x> is the power measurement number. This is the equivalent of the number shown in the UI for a power measurement badge.

<NR1> ranges from -100 to 100

**Examples** `Power:Power1:SWITCHINGLOSS:VGLevel 1.2` sets the gate voltage value ( $V_g$  Level Ton-Start) for the switching loss measurement of the power measurement badge Power 1.

## POWER:POWER<x>:SWITCHINGLOSS:VLEVELAbs

This command sets or queries the voltage level (Ton-Start & Stop) in absolute units for switching loss measurement in the specified power measurement number. The power measurement number is specified by x.

**Conditions** Requires option PWR or PS2.

**Group** Power

**Syntax** `Power:POWER<x>:SWITCHINGLOSS:VLEVELAbs <NR1>`  
`Power:POWER<x>:SWITCHINGLOSS:VLEVELAbs?`

- Arguments** Power<x> is the power measurement number. This is the equivalent of the number shown in the UI for a power measurement badge.  
<NR1> ranges from -100 to 100
- Examples** POWER:POWER1:SWITCHINGLOSS:VLEVELAbs 2 sets the voltage level (Ton-Start & Stop) value as 2 for the switching loss measurement in the power measurement badge 1.

## POWER:POWER<x>:SWITCHINGLOSS:VLEVELPct

This command sets or queries the voltage level (Ton-Start & Stop) in percentage for switching loss measurement in the specified power measurement number. The power measurement number is specified by x.

- Conditions** Requires option PWR or PS2.
- Group** Power
- Syntax** POWER:POWER<x>:SWITCHINGLOSS:VLEVELPct <NR1>  
POWER:POWER<x>:SWITCHINGLOSS:VLEVELPct?
- Related Commands** [POWER:POWER<x>:SWITCHINGLOSS:LEVELUNIts](#)
- Arguments** Power<x> is the power measurement number. This is the equivalent of the number shown in the UI for a power measurement badge.  
<NR1> ranges from 0.0001 to 90
- Examples** POWER:POWER1:SWITCHINGLOSS:VLEVELPct 7 sets the voltage level (Ton-Start & Stop) value as 7 percentage for the switching loss measurement in the power measurement badge 1.

## POWER:POWER<x>:SWITCHINGLOSS:VSOURCE

This command sets or queries the voltage source for the switching loss measurement in the specified power measurement number. The power measurement number is specified by x.

- Conditions** Requires option PWR or PS2.



<b>Group</b>	Power
<b>Syntax</b>	<pre>POWER:POWER&lt;x&gt;:SWITCHINGLOSS:VSOURCE {CH&lt;x&gt;   MATH&lt;x&gt;   REF&lt;x&gt;} POWER:POWER&lt;x&gt;:SWITCHINGLOSS:VSOURCE?</pre>
<b>Arguments</b>	<p>Power&lt;x&gt; is the power measurement number. This is the equivalent of the number shown in the UI for a power measurement badge.</p> <p>CH&lt;x&gt; = A channel specifier; &lt;x&gt; is 1 through 8 and is limited by the number of FlexChannels in your instrument.</p> <p>MATH&lt;x&gt; = A math waveform specifier; &lt;x&gt; is <math>\geq 1</math>.</p> <p>REF&lt;x&gt; = A reference waveform specifier; &lt;x&gt; is <math>\geq 1</math>.</p>
<b>Examples</b>	<p>POWER:Power1:SWITCHINGLOSS:VSOURCE REF1 sets the voltage source for the switching loss measurement in the specified power measurement badge as REF1.</p> <p>POWER:Power2:SWITCHINGLOSS:VSOURCE? might return REF3 indicating the voltage source for switching loss measurement of Power 2 power measurement badge.</p>

## POWER:POWER<x>:SWITCHINGRIPPLE:INPUTSOURCE

This command sets or queries the input source for switching ripple measurement in the specified power measurement number. The power measurement number is specified by x.

<b>Conditions</b>	Requires option PWR or PS2.
<b>Group</b>	Power
<b>Syntax</b>	<pre>POWER:POWER&lt;x&gt;:SWITCHINGRIPPLE:INPUTSOURCE {CH&lt;x&gt;   MATH&lt;x&gt;   REF&lt;x&gt;} POWER:POWER&lt;x&gt;:SWITCHINGRIPPLE:INPUTSOURCE?</pre>
<b>Arguments</b>	<p>Power&lt;x&gt; is the power measurement number. This is the equivalent of the number shown in the UI for a power measurement badge.</p> <p>CH&lt;x&gt; = A channel specifier; &lt;x&gt; is 1 through 8 and is limited by the number of FlexChannels in your instrument.</p>

MATH<x> = A math waveform specifier; <x> is  $\geq 1$ .

REF<x> = A reference waveform specifier; <x> is  $\geq 1$ .

**Examples**    `Power:Power1:SWITCHINGRIPPLE:INPUTSource CH5` sets the input source for switching ripple measurement as CH5 for the power measurement badge Power 1.

## POWER:POWER<x>:SWITCHINGRIPPLE:LFREQUENCY

This command sets or queries the switching frequency for switching ripple measurement in the specified power measurement number. The power measurement number is specified by x.

**Conditions**    Requires option PWR or PS2.

**Group**    Power

**Syntax**    `Power:Power<x>:SWITCHINGRIPPLE:LFREQUENCY <NR1>`  
`Power:Power<x>:SWITCHINGRIPPLE:LFREQUENCY?`

**Arguments**    `Power<x>` is the power measurement number. This is the equivalent of the number shown in the UI for a power measurement badge.  
  
`<NR1>` ranges from 50 to 1000000

**Examples**    `Power:Power1:SWITCHINGRIPPLE:SFREQUENCY 60000` sets the frequency present for line ripple measurement as 60000 Hz.

## POWER:POWER<x>:TURNOFFtime:FREQUENCY

This command sets or queries the input frequency used by the AC or DC converter of the specified Turn Off Time measurement.

**Conditions**    Requires option PWR or PS2.

**Group**    Power

**Syntax**    `Power:Power<x>:TURNOFFtime:FREQUENCY <NR3>`  
`Power:Power<x>:TURNOFFtime:FREQUENCY?`

**Arguments** Power<x> is the power measurement number. This is the equivalent of the number shown on a power measurement badge in the UI.

<NR3> is a floating point number that represents the frequency, in Hertz, from 1 Hz to 500 Hz.

**Examples** POWER:POWER1:TURNOFFtime:FREQUENCY 50 sets the frequency value of Turn Off Time measurement 1 to 50 Hz.

POWER:POWER4:TURNOFFtime:FREQUENCY? might return  
POWER:POWER4:TURNOFFtime:FREQUENCY 350, indicating that the frequency value of Turn Off Time measurement 4 is set to 350 Hz.

## POWER:POWER<x>:TURNOFFtime:INPUTLEVEL

This command sets or queries the input voltage level of the specified Turn Off Time measurement.

**Conditions** Requires option PWR or PS2.

**Group** Power

**Syntax** POWER:POWER<x>:TURNOFFtime:INPUTLEVEL <NR3>  
POWER:POWER<x>:TURNOFFtime:INPUTLEVEL?

**Arguments** Power<x> is the power measurement number. This is the equivalent of the number shown on a power measurement badge in the UI.

<NR3> is a floating point number that represents the voltage level, in volts, from -500 V to 500 V.

**Examples** POWER:POWER1:TURNOFFtime:INPUTLEVEL -350 sets the input voltage level of Turn Off Time measurement 1 to -350 V.

POWER:POWER4:TURNOFFtime:INPUTLEVEL? might return  
POWER:POWER4:TURNOFFtime:INPUTLEVEL 200, indicating that the input voltage level value of Turn Off Time measurement 4 is set to 200 V.

## POWER:POWER<x>:TURNOFFtime:INPUTSOURCE

This command sets or queries the input source of the specified Turn Off Time measurement.

<b>Conditions</b>	Requires option PWR or PS2.
<b>Group</b>	Power
<b>Syntax</b>	<pre>POWER:POWER&lt;x&gt;:TURNOFFtime:INPUTSource {CH&lt;x&gt; REF&lt;x&gt; MATH&lt;x&gt;} POWER:POWER&lt;x&gt;:TURNOFFtime:INPUTSource?</pre>
<b>Arguments</b>	<p>Power&lt;x&gt; is the power measurement number. This is the equivalent of the number shown on a power measurement badge in the UI.</p> <p>CH&lt;x&gt; is the channel specifier in the range of 1 through 8 and is limited by the number of instrument input channels.</p> <p>REF&lt;x&gt; is the Reference waveform specifier <math>\geq 1</math>. This is the equivalent of the number shown on a Reference waveform badge in the UI.</p> <p>MATH&lt;x&gt; is the Math waveform specifier <math>\geq 1</math>. This is the equivalent of the number shown on a Math waveform badge in the UI.</p>
<b>Examples</b>	<pre>POWER:POWER1:TURNOFFtime:INPUTSource CH4 sets the input source of Turn Off Time measurement 1 to Channel 4.</pre> <pre>POWER:POWER6:TURNOFFtime:INPUTSource? might return POWER:POWER6:TURNOFFtime:INPUTSource MATH2, indicating that the input source of Turn Off Time measurement 6 is set to Math waveform 2.</pre>

## POWER:POWER<x>:TURNOFFtime:MAXTIME

This command sets or queries the maximum turn off time of the specified Turn Off Time measurement.

<b>Conditions</b>	Requires option PWR or PS2.
<b>Group</b>	Power
<b>Syntax</b>	<pre>POWER:POWER&lt;x&gt;:TURNOFFtime:MAXTIME &lt;NR3&gt; POWER:POWER&lt;x&gt;:TURNOFFtime:MAXTIME?</pre>
<b>Arguments</b>	Power<x> is the power measurement number. This is the equivalent of the number shown on a power measurement badge in the UI.

<NR3> is a floating point number that represents the maximum time value, in seconds, in the range 1 second to 500 seconds.

**Examples** `POWER:POWER1:TURNOFFtime:MAXTIME 70` sets the maximum time value of Turn Off Time measurement 1 to 70 seconds.

`POWER:POWER5:TURNOFFtime:MAXTIME?` might return `POWER:POWER5:TURNOFFtime:MAXTIME 120`, indicating that the maximum time value of Turn Off Time measurement 5 is 120 seconds.

## POWER:POWER<x>:TURNOFFtime:MAXVoltage

This command sets or queries the maximum voltage of the specified Turn OffTime measurement.

**Conditions** Requires option PWR or PS2.

**Group** Power

**Syntax** `POWER:POWER<x>:TURNOFFtime:MAXVoltage <NR3>`  
`POWER:POWER<x>:TURNOFFtime:MAXVoltage?`

**Arguments** `Power<x>` is the power measurement number. This is the equivalent of the number shown on a power measurement badge in the UI.

<NR3> is a floating point number that represents the maximum voltage in the range 1 V to 500 V.

**Examples** `POWER:POWER1:TURNOFFtime:MAXVoltage 50` sets the maximum voltage value of Turn Off Time measurement 1 to 50 volts.

`POWER:POWER4:TURNOFFtime:MAXVoltage?` might return `POWER:POWER4:TURNOFFtime:MAXVoltage 12`, indicating that the maximum voltage value of Turn Off Time measurement 4 is 12 volts.

## POWER:POWER<x>:TURNOFFtime:NUMOUTputs

This command sets or queries the number of outputs of the specified Turn Off Time power measurement.

**Conditions** Requires option PWR or PS2.

<b>Group</b>	Power
<b>Syntax</b>	<pre>Power:POWER&lt;x&gt;:TURNOFFtime:NUMOUTputs {ONE TWO THREE FOUR FIVE SIX SEVEN} Power:POWER&lt;x&gt;:TURNOFFtime:NUMOUTputs?</pre>
<b>Related Commands</b>	<pre>POWer:POWer&lt;x&gt;:TURNOFFtime:OUTPUT1SOURce POWer:POWer&lt;x&gt;:TURNOFFtime:OUTPUT1VOLTage POWer:POWer&lt;x&gt;:TURNOFFtime:OUTPUT2SOURce POWer:POWer&lt;x&gt;:TURNOFFtime:OUTPUT2VOLTage POWer:POWer&lt;x&gt;:TURNOFFtime:OUTPUT3SOURce POWer:POWer&lt;x&gt;:TURNOFFtime:OUTPUT3VOLTage POWer:POWer&lt;x&gt;:TURNOFFtime:OUTPUT4SOURce POWer:POWer&lt;x&gt;:TURNOFFtime:OUTPUT4VOLTage POWer:POWer&lt;x&gt;:TURNOFFtime:OUTPUT5SOURce POWer:POWer&lt;x&gt;:TURNOFFtime:OUTPUT5VOLTage POWer:POWer&lt;x&gt;:TURNOFFtime:OUTPUT6SOURce POWer:POWer&lt;x&gt;:TURNOFFtime:OUTPUT6VOLTage POWer:POWer&lt;x&gt;:TURNOFFtime:OUTPUT7SOURce POWer:POWer&lt;x&gt;:TURNOFFtime:OUTPUT7VOLTage</pre>
<b>Arguments</b>	<p>Power&lt;x&gt; is the power measurement number. This is the equivalent of the number shown on a power measurement badge in the UI.</p> <p>ONE through SEVEN sets the number of outputs for the Turn Off Time measurement.</p>
<b>Examples</b>	<pre>Power:POWER1:TURNOFFtime:NUMOUTputs TWO sets the number of outputs of Turn Off Time measurement 1 to two.</pre> <p>Power:POWER3:TURNOFFtime:NUMOUTputs? might return  Power:POWER3:TURNOFFtime:NUMOUTputs FOUR, indicating that the number  of outputs of Turn Off Time measurement 3 is set to four inputs.</p>

## POWER:POWER<x>:TURNOFFtime:OUTPUT1SOURCE

This command sets or queries the output 1 source of the specified Turn Off Time measurement.

**Conditions** Requires option PWR or PS2.

**Group** Power

**Syntax** POWER:POWER<x>:TURNOFFtime:OUTPUT1SOURCE  
{CH<x>|REF<x>|MATH<x>}  
POWER:POWER<x>:TURNOFFtime:OUTPUT1SOURCE?

**Arguments** Power<x> is the power measurement number. This is the equivalent of the number shown on a power measurement badge in the UI.

CH<x> A channel specifier in the range of 1 through 8 and is limited by the number of instrument input channels.

REF<x> A Reference waveform specifier  $\geq 1$ . This is the equivalent of the number shown on a Reference waveform badge in the UI.

MATH<x> A Math waveform specifier  $\geq 1$ . This is the equivalent of the number shown on a Math waveform badge in the UI.

**Examples** POWER:POWER2:TURNOFFtime:OUTPUT1SOURCE CH2 sets the output 1 source of Turn Off Time measurement 2 to Channel 2.

POWER:POWER1:TURNOFFtime:OUTPUT1SOURCE? might return  
POWER:POWER1:TURNOFFtime:OUTPUT1SOURCE CH4, indicating that the output 1 source of Turn Off Time measurement 1 is Channel 4.

## POWER:POWER<x>:TURNOFFtime:OUTPUT1VOLTage

This command sets or queries the output 1 voltage level of the of the specified Turn Off Time power measurement.

**Conditions** Requires option PWR or PS2.

**Group** Power

**Syntax** POWER:POWER<x>:TURNOFFtime:OUTPUT1VOLTage <NR2>  
POWER:POWER<x>:TURNOFFtime:OUTPUT1VOLTage?

**Related Commands**    [POWER:POWER<x>:TURNOFFtime:NUMOUTputs](#)  
[POWER:POWER<x>:TURNOFFtime:OUTPUT1SOURCE](#)

**Arguments**    Power<x> is the power measurement number. This is the equivalent of the number shown on a power measurement badge in the UI.  
 <NR2> sets the output voltage value, in the range of –6,000 volts to +6,000 volts.

**Examples**    `Power:Power7:TURNOFFtime:OUTPUT1VOLTage -2550` sets the output 1 voltage value of Turn Off Time power measurement 7 to –2,550 volts.  
`Power:Power3:TURNOFFtime:OUTPUT1VOLTage?` might return  
`Power:Power3:TURNOFFtime:OUTPUT1VOLTage 1000`, indicating that the output 1 voltage value of Turn Off Time power measurement 3 is set to 1,000 volts.

## POWER:POWER<x>:TURNOFFtime:OUTPUT2SOURCE

This command sets or queries the output 2 source of the specified Turn Off Time measurement.

**Conditions**    Requires option PWR or PS2.

**Group**    Power

**Syntax**    `Power:Power<x>:TURNOFFtime:OUTPUT2SOURCE`  
`{CH<x>|REF<x>|MATH<x>}`  
`Power:Power<x>:TURNOFFtime:OUTPUT2SOURCE?`

**Arguments**    Power<x> is the power measurement number. This is the equivalent of the number shown on a power measurement badge in the UI.  
 CH<x> A channel specifier in the range of 1 through 8 and is limited by the number of instrument input channels.  
 REF<x> A Reference waveform specifier  $\geq 1$ . This is the equivalent of the number shown on a Reference waveform badge in the UI.  
 MATH<x> A Math waveform specifier  $\geq 1$ . This is the equivalent of the number shown on a Math waveform badge in the UI.

**Examples**    `Power:Power3:TURNOFFtime:OUTPUT2SOURCE CH2` sets the output 2 source of Turn Off Time measurement 3 to Channel 2.



Power:Power5:TURNOfftime:OUTPUT2SOURCE? might return  
 Power:Power5:TURNOfftime:OUTPUT2SOURCE CH8, indicating that the  
 output 2 source of Turn Off Time measurement 5 is Channel 8.

## Power:Power<x>:TURNOfftime:OUTPUT2VOLTage

This command sets or queries the output 2 voltage level of the specified Turn Off Time power measurement.

**Conditions** Requires option PWR or PS2.

**Group** Power

**Syntax** Power:Power<x>:TURNOfftime:OUTPUT2VOLTage <NR2>  
 Power:Power<x>:TURNOfftime:OUTPUT2VOLTage?

**Related Commands** [Power:Power<x>:TURNOfftime:NUMOUTputs](#)  
[Power:Power<x>:TURNOfftime:OUTPUT2SOURCE](#)

**Arguments** Power<x> is the power measurement number. This is the equivalent of the number shown on a power measurement badge in the UI.  
 <NR2> sets the output voltage value, in the range of –6,000 volts to +6,000 volts.

**Examples** Power:Power3:TURNOfftime:OUTPUT2VOLTage -550 sets the output 2 voltage value of Turn Off Time power measurement 3 to –550 volts.  
 Power:Power1:TURNOfftime:OUTPUT2VOLTage? might return  
 Power:Power1:TURNOfftime:OUTPUT2VOLTage 100, indicating that the output 2 voltage value of Turn Off Time power measurement 1 is set to 100 volts.

## Power:Power<x>:TURNOfftime:OUTPUT3SOURCE

This command sets or queries the output 3 source of the specified Turn Off Time measurement.

**Conditions** Requires option PWR or PS2.

**Group** Power

**Syntax** `Power:Power<x>:TURNOFFtime:OUTPUT3SOURCE`  
`{CH<x>|REF<x>|MATH<x>}`  
`Power:Power<x>:TURNOFFtime:OUTPUT3SOURCE?`

**Arguments** `Power<x>` is the power measurement number. This is the equivalent of the number shown on a power measurement badge in the UI.

`CH<x>` A channel specifier in the range of 1 through 8 and is limited by the number of instrument input channels.

`REF<x>` A Reference waveform specifier  $\geq 1$ . This is the equivalent of the number shown on a Reference waveform badge in the UI.

`MATH<x>` A Math waveform specifier  $\geq 1$ . This is the equivalent of the number shown on a Math waveform badge in the UI.

**Examples** `Power:Power3:TURNOFFtime:OUTPUT3SOURCE CH8` sets the output 3 source of Turn Off Time measurement 3 to Channel 8.

`Power:Power1:TURNOFFtime:OUTPUT3SOURCE?` might return `Power:Power1:TURNOFFtime:OUTPUT3SOURCE CH4`, indicating that the output 3 source of Turn Off Time measurement 1 is Channel 4.

## **POWER:POWER<x>:TURNOFFtime:OUTPUT3VOLTage**

This command sets or queries the output 3 voltage level of the specified Turn Off Time power measurement.

**Conditions** Requires option PWR or PS2.

**Group** Power

**Syntax** `Power:Power<x>:TURNOFFtime:OUTPUT3VOLTage <NR2>`  
`Power:Power<x>:TURNOFFtime:OUTPUT3VOLTage?`

**Related Commands** [POWER:POWER<x>:TURNOFFtime:NUMOUTputs](#)  
[POWER:POWER<x>:TURNOFFtime:OUTPUT3SOURCE](#)

**Arguments** `Power<x>` is the power measurement number. This is the equivalent of the number shown on a power measurement badge in the UI.

`<NR2>` sets the output voltage value, in the range of -6,000 volts to +6,000 volts.

- Examples** `Power:Power4:TURNOFFtime:OUTPUT3VOLTage -50` sets the output 3 voltage value of Turn Off Time power measurement 4 to -50 volts.
- `Power:Power8:TURNOFFtime:OUTPUT3VOLTage?` might return `Power:Power8:TURNOFFtime:OUTPUT3VOLTage -200`, indicating that the output 3 voltage value of Turn Off Time power measurement 8 is set to -200 volts.

## POWER:POWER<x>:TURNOFFtime:OUTPUT4SOURce

This command sets or queries the output 4 source of the specified Turn Off Time measurement.

- Conditions** Requires option PWR or PS2.

- Group** Power

- Syntax** `Power:Power<x>:TURNOFFtime:OUTPUT4SOURce`  
`{CH<x>|REF<x>|MATH<x>}`  
`Power:Power<x>:TURNOFFtime:OUTPUT4SOURce?`

- Arguments** `Power<x>` is the power measurement number. This is the equivalent of the number shown on a power measurement badge in the UI.
- `CH<x>` A channel specifier in the range of 1 through 8 and is limited by the number of instrument input channels.
- `REF<x>` A Reference waveform specifier  $\geq 1$ . This is the equivalent of the number shown on a Reference waveform badge in the UI.
- `MATH<x>` A Math waveform specifier  $\geq 1$ . This is the equivalent of the number shown on a Math waveform badge in the UI.

- Examples** `Power:Power3:TURNOFFtime:OUTPUT4SOURce CH2` sets the output 4 source of Turn Off Time measurement 3 is Channel 2.
- `Power:Power10:TURNOFFtime:OUTPUT4SOURce?` might return `Power:Power10:TURNOFFtime:OUTPUT4SOURce REF4`, indicating that the output 4 source of Turn Off Time measurement 10 is Reference waveform 4.

## POWER:POWER<x>:TURNOFFtime:OUTPUT4VOLTage

This command sets or queries the output 4 voltage level of the specified Turn Off Time power measurement.

<b>Conditions</b>	Requires option PWR or PS2.
<b>Group</b>	Power
<b>Syntax</b>	<pre>Power:Power&lt;x&gt;:TURNOFFtime:OUTPUT4VOLTage &lt;NR2&gt; Power:Power&lt;x&gt;:TURNOFFtime:OUTPUT4VOLTage?</pre>
<b>Related Commands</b>	<pre>POWer:POWer&lt;x&gt;:TURNOFFtime:NUMOUTputs POWer:POWer&lt;x&gt;:TURNOFFtime:OUTPUT4SOURce</pre>
<b>Arguments</b>	<p>Power&lt;x&gt; is the power measurement number. This is the equivalent of the number shown on a power measurement badge in the UI.</p> <p>&lt;NR2&gt; sets the output voltage value, in the range of –6,000 volts to +6,000 volts.</p>
<b>Examples</b>	<pre>Power:Power8:TURNOFFtime:OUTPUT4VOLTage 50</pre> sets the output 4 voltage value of Turn Off Time power measurement 8 to 50 volts. <p> <pre>Power:Power4:TURNOFFtime:OUTPUT4VOLTage?</pre> might return <pre>Power:Power4:TURNOFFtime:OUTPUT4VOLTage 1000</pre>, indicating that the output 4 voltage value of Turn Off Time power measurement 4 is set to 1,000 volts. </p>

## POWer:POWer<x>:TURNOFFtime:OUTPUT5SOURce

This command sets or queries the output 5 source of the specified Turn Off Time measurement.

<b>Conditions</b>	Requires option PWR or PS2.
<b>Group</b>	Power
<b>Syntax</b>	<pre>Power:Power&lt;x&gt;:TURNOFFtime:OUTPUT5SOURce {CH&lt;x&gt; REF&lt;x&gt; MATH&lt;x&gt;} Power:Power&lt;x&gt;:TURNOFFtime:OUTPUT5SOURce?</pre>
<b>Arguments</b>	<p>Power&lt;x&gt; is the power measurement number. This is the equivalent of the number shown on a power measurement badge in the UI.</p> <p>CH&lt;x&gt; A channel specifier in the range of 1 through 8 and is limited by the number of instrument input channels.</p>

REF<x> A Reference waveform specifier  $\geq 1$ . This is the equivalent of the number shown on a Reference waveform badge in the UI.

MATH<x> A Math waveform specifier  $\geq 1$ . This is the equivalent of the number shown on a Math waveform badge in the UI.

**Examples** `POWER:Power3:TURNOFFtime:OUTPUT5SOURCE CH2` sets the output 5 source of Turn Off Time measurement 3 to Channel 2.

`POWER:Power11:TURNOFFtime:OUTPUT5SOURCE?` might return `POWER:Power11:TURNOFFtime:OUTPUT5SOURCE CH4`, indicating that the output 5 source of Turn Off Time measurement 11 is Channel 4.

## POWER:POWER<x>:TURNOFFtime:OUTPUT5VOLTage

This command sets or queries the output 5 voltage level of the specified Turn Off Time power measurement.

**Conditions** Requires option PWR or PS2.

**Group** Power

**Syntax** `POWER:Power<x>:TURNOFFtime:OUTPUT5VOLTage <NR2>`  
`POWER:Power<x>:TURNOFFtime:OUTPUT5VOLTage?`

**Related Commands** [POWER:POWER<x>:TURNOFFtime:NUMOUTputs](#)  
[POWER:POWER<x>:TURNOFFtime:OUTPUT5SOURCE](#)

**Arguments** `Power<x>` is the power measurement number. This is the equivalent of the number shown on a power measurement badge in the UI.  
`<NR2>` sets the output voltage value, in the range of  $-6,000$  volts to  $+6,000$  volts.

**Examples** `POWER:Power2:TURNOFFtime:OUTPUT5VOLTage -255` sets the output 5 voltage value of Turn Off Time power measurement 2 to  $-250$  volts.  
`POWER:Power3:TURNOFFtime:OUTPUT5VOLTage?` might return `POWER:Power3:TURNOFFtime:OUTPUT5VOLTage 100`, indicating that the output 5 voltage value of Turn Off Time power measurement 3 is set to 100 volts.

## POWER:POWER<x>:TURNOFFtime:OUTPUT6SOURce

This command sets or queries the output 6 source of the specified Turn Off Time measurement.

**Conditions** Requires option PWR or PS2.

**Group** Power

**Syntax** POWER:POWER<x>:TURNOFFtime:OUTPUT6SOURce  
{CH<x>|REF<x>|MATH<x>}  
POWER:POWER<x>:TURNOFFtime:OUTPUT6SOURce?

**Arguments** Power<x> is the power measurement number. This is the equivalent of the number shown on a power measurement badge in the UI.

CH<x> A channel specifier in the range of 1 through 8 and is limited by the number of instrument input channels.

REF<x> A Reference waveform specifier  $\geq 1$ . This is the equivalent of the number shown on a Reference waveform badge in the UI.

MATH<x> A Math waveform specifier  $\geq 1$ . This is the equivalent of the number shown on a Math waveform badge in the UI.

**Examples** POWER:POWER3:TURNOFFtime:OUTPUT6SOURce CH2 sets the output 6 source of Turn Off Time measurement 3 to Channel 2.

POWER:POWER1:TURNOFFtime:OUTPUT6SOURce? might return  
POWER:POWER1:TURNOFFtime:OUTPUT6SOURce CH4, indicating that the output 6 source of Turn Off Time measurement 1 is Channel 4.

## POWER:POWER<x>:TURNOFFtime:OUTPUT6VOLTage

This command sets or queries the output 6 voltage level of the specified Turn Off Time power measurement.

**Conditions** Requires option PWR or PS2.

**Group** Power

**Syntax** POWER:POWER<x>:TURNOFFtime:OUTPUT6VOLTage <NR2>  
POWER:POWER<x>:TURNOFFtime:OUTPUT6VOLTage?

**Related Commands**    [POWER:Power<x>:TURNOFFtime:NUMOUTputs](#)  
[POWER:Power<x>:TURNOFFtime:OUTPUT6SOURCE](#)

**Arguments**    Power<x> is the power measurement number. This is the equivalent of the number shown on a power measurement badge in the UI.  
 <NR2> sets the output voltage value, in the range of –6,000 volts to +6,000 volts.

**Examples**    `Power:Power5:TURNOFFtime:OUTPUT6VOLTage 1550` sets the output 6 voltage value of Turn Off Time power measurement 5 to 1,550 volts.  
`Power:Power2:TURNOFFtime:OUTPUT6VOLTage?` might return  
`Power:Power2:TURNOFFtime:OUTPUT6VOLTage -100`, indicating that the output 6 voltage value of Turn Off Time power measurement 2 is set to –100 volts.

## POWER:Power<x>:TURNOFFtime:OUTPUT7SOURCE

This command sets or queries the output 7 source of the specified Turn Off Time measurement.

**Conditions**    Requires option PWR or PS2.

**Group**    Power

**Syntax**    `Power:Power<x>:TURNOFFtime:OUTPUT7SOURCE`  
`{CH<x>|REF<x>|MATH<x>}`  
`Power:Power<x>:TURNOFFtime:OUTPUT7SOURCE?`

**Arguments**    Power<x> is the power measurement number. This is the equivalent of the number shown on a power measurement badge in the UI.  
 CH<x> A channel specifier in the range of 1 through 8 and is limited by the number of instrument input channels.  
 REF<x> A Reference waveform specifier  $\geq 1$ . This is the equivalent of the number shown on a Reference waveform badge in the UI.  
 MATH<x> A Math waveform specifier  $\geq 1$ . This is the equivalent of the number shown on a Math waveform badge in the UI.

**Examples**    `Power:Power3:TURNOFFtime:OUTPUT7SOURCE CH2` sets the output 7 source of Turn Off Time measurement 3 is Channel 2.

Power:Power1:TURNOfftime:OUTPUT7SOURCE? might return  
Power:Power1:TURNOfftime:OUTPUT7SOURCE CH4, indicating that the  
output 7 source of Turn Off Time measurement 1 is channel 4.

## Power:Power<x>:TURNOfftime:OUTPUT7VOLTage

This command sets or queries the output 7 voltage level of the specified Turn Off Time power measurement.

<b>Conditions</b>	Requires option PWR or PS2.
<b>Group</b>	Power
<b>Syntax</b>	Power:Power<x>:TURNOfftime:OUTPUT7VOLTage <NR2> Power:Power<x>:TURNOfftime:OUTPUT7VOLTage?
<b>Related Commands</b>	<a href="#">Power:Power&lt;x&gt;:TURNOfftime:NUMOUTputs</a> <a href="#">Power:Power&lt;x&gt;:TURNOfftime:OUTPUT7SOURCE</a>
<b>Arguments</b>	Power<x> is the power measurement number. This is the equivalent of the number shown on a power measurement badge in the UI.  <NR2> sets the output voltage value, in the range of -6,000 volts to +6,000 volts.
<b>Examples</b>	Power:Power2:TURNOfftime:OUTPUT7VOLTage -2100 sets the output 7 voltage value of Turn Off Time power measurement 2 to -2,100 volts.  Power:Power3:TURNOfftime:OUTPUT7VOLTage? might return Power:Power3:TURNOfftime:OUTPUT7VOLTage 450, indicating that the output 7 voltage value of Turn Off Time power measurement 3 is set to 450 volts.

## Power:Power<x>:TURNOfftime:TYPE

This command sets or queries the type of AC/DC converter used in the specified Turn Off Time power measurement.

<b>Conditions</b>	Requires option PWR or PS2.
<b>Group</b>	Power



<b>Syntax</b>	<code>Power:Power&lt;x&gt;:TURNOFFtime:TYPE {DCDC ACDC}</code> <code>Power:Power&lt;x&gt;:TURNOFFtime:TYPE?</code>
<b>Arguments</b>	<p><code>Power&lt;x&gt;</code> is the power measurement number. This is the equivalent of the number shown on a power measurement badge in the UI.</p> <p>DCDC sets the measurement to use a DC to DC converter.</p> <p>ACDC sets the measurement to use an AC to DC converter.</p>
<b>Examples</b>	<p><code>Power:Power1:TURNOFFtime:TYPE ACDC</code> sets Turn Off time measurement 1 to use an AC to DC converter.</p> <p><code>Power:Power5:TURNOFFtime:TYPE?</code> might return <code>Power:Power5:TURNOFFtime:TYPE DCDC</code>, indicating that the converter type for Turn Off Time measurement 5 is set to use a DC to DC converter.</p>

## POWer:POWer<x>:TURNONtime:FREQUency

This command sets or queries the input frequency used by the AC or DC converter of the specified Turn On Time measurement.

<b>Conditions</b>	Requires option PWR or PS2.
<b>Group</b>	Power
<b>Syntax</b>	<code>Power:Power&lt;x&gt;:TURNONtime:FREQUency &lt;NR3&gt;</code> <code>Power:Power&lt;x&gt;:TURNONtime:FREQUency?</code>
<b>Arguments</b>	<p><code>Power&lt;x&gt;</code> is the power measurement number. This is the equivalent of the number shown on a power measurement badge in the UI.</p> <p><code>&lt;NR3&gt;</code> is a floating point number that represents the frequency, in Hertz, from 1 Hz to 500 Hz.</p>
<b>Examples</b>	<p><code>Power:Power1:TURNONtime:FREQUency 50</code> sets the frequency value of the AC/DC converter in Turn On Time measurement 1 to 50 Hz.</p> <p><code>Power:Power4:TURNONtime:FREQUency?</code> might return <code>Power:Power4:TURNONtime:FREQUency 200</code>, indicating that the frequency value of the AC/DC converter in Turn On Time measurement 4 is set to 200 Hz.</p>

## POWER:POWER<x>:TURNONtime:INPUTLEVEL

This command sets or returns the input voltage level of the specified Turn On Time measurement.

**Conditions** Requires option PWR or PS2.

**Group** Power

**Syntax** POWER:POWER<x>:TURNONtime:INPUTLEVEL <NR3>  
POWER:POWER<x>:TURNONtime:INPUTLEVEL?

**Arguments** Power<x> is the power measurement number. This is the equivalent of the number shown on a power measurement badge in the UI.  
  
<NR3> is a floating point number that represents the voltage level, in volts, from -500 V to 500 V.

**Examples** POWER:POWER12:TURNONtime:INPUTLEVEL -350 sets the input voltage level of Turn On Time measurement 12 to -350 V.  
  
POWER:POWER4:TURNONtime:INPUTLEVEL? might return  
POWER:POWER4:TURNONtime:INPUTLEVEL 230, indicating that the input voltage level value of Turn ON Time measurement 4 is set to 230 V.

## POWER:POWER<x>:TURNONtime:INPUTSource

This command sets or queries the input source of the specified Turn On Time measurement.

**Group** Power

**Syntax** POWER:POWER<x>:TURNONtime:INPUTSource  
POWER:POWER<x>:TURNONtime:INPUTSource?

**Arguments** Power<x> is the power measurement number. This is the equivalent of the number shown on a power measurement badge in the UI.  
  
CH<x> is the channel specifier in the range of 1 through 8 and is limited by the number of instrument input channels.  
  
REF<x> is the Reference waveform specifier  $\geq 1$ . This is the equivalent of the number shown on a Reference waveform badge in the UI.

MATH<x> is the Math waveform specifier  $\geq 1$ . This is the equivalent of the number shown on a Math waveform badge in the UI.

**Examples** `POWER:Power1:TURNONtime:INPUTSource CH2` sets the input source of Turn On Time measurement 1 to Channel 2.

`POWER:Power2:TURNONtime:INPUTSource?` might return `POWER:Power2:TURNONtime:INPUTSource MATH6`, indicating that the input source of Turn On Time measurement 2 is Math waveform 6.

## POWER:POWER<x>:TURNONtime:MAXTIME

This command sets or returns the maximum turn on time of the specified Turn On Time measurement.

**Conditions** Requires option PWR or PS2.

**Group** Power

**Syntax** `POWER:POWER<x>:TURNONtime:MAXTIME <NR3>`  
`POWER:POWER<x>:TURNONtime:MAXTIME?`

**Arguments** `Power<x>` is the power measurement number. This is the equivalent of the number shown on a power measurement badge in the UI.

`<NR3>` is a floating point number that represents the maximum time value, in seconds, in the range 1 second to 500 seconds.

**Examples** `POWER:Power3:TURNONtime:MAXTIME 30` sets the maximum time value of Turn On Time measurement 3 to 30 seconds.

`POWER:Power5:TURNONtime:MAXTIME?` might return `POWER:Power5:TURNONtime:MAXTIME 120`, indicating that the maximum time value of Turn On Time measurement 5 is set to 120 seconds.

## POWER:POWER<x>:TURNONtime:MAXVoltage

This command sets or returns the maximum voltage setting of the specified Turn On Time measurement.

**Conditions** Requires option PWR or PS2.

<b>Group</b>	Power
<b>Syntax</b>	<pre>POWER:POWER&lt;x&gt;:TURNONtime:MAXVoltage &lt;NR3&gt; POWER:POWER&lt;x&gt;:TURNONtime:MAXVoltage?</pre>
<b>Arguments</b>	<p>Power&lt;x&gt; is the power measurement number. This is the equivalent of the number shown on a power measurement badge in the UI.</p> <p>&lt;NR3&gt; is a floating point number that represents the maximum voltage in the range 1 V to 500 V.</p>
<b>Examples</b>	<p>POWER:POWER1:TURNONtime:MAXVoltage 50 sets the maximum voltage value of Turn On Time measurement 1 to 50 volts.</p> <p>POWER:POWER4:TURNONtime:MAXVoltage? might return POWER:POWER4:TURNONtime:MAXVoltage 12, indicating that the maximum voltage value of Turn On Time measurement 4 is set to 12 volts.</p>

## POWER:POWER<x>:TURNONtime:NUMOUTputs

This command sets or queries the number of outputs for the specified Turn On Time power measurement.

<b>Conditions</b>	Requires option PWR or PS2.
<b>Group</b>	Power
<b>Syntax</b>	<pre>POWER:POWER&lt;x&gt;:TURNONtime:NUMOUTputs {ONE TWO THREE FOUR FIVE SIX SEVEN} POWER:POWER&lt;x&gt;:TURNONtime:NUMOUTputs?</pre>
<b>Related Commands</b>	<p><a href="#">POWER:POWER&lt;x&gt;:TURNONtime:INPUTSource</a></p> <p><a href="#">POWER:POWER&lt;x&gt;:TURNONtime:OUTPUT1Source</a></p> <p><a href="#">POWER:POWER&lt;x&gt;:TURNONtime:OUTPUT1Voltage</a></p> <p><a href="#">POWER:POWER&lt;x&gt;:TURNONtime:OUTPUT2Source</a></p> <p><a href="#">POWER:POWER&lt;x&gt;:TURNONtime:OUTPUT2Voltage</a></p> <p><a href="#">POWER:POWER&lt;x&gt;:TURNONtime:OUTPUT3Source</a></p> <p><a href="#">POWER:POWER&lt;x&gt;:TURNONtime:OUTPUT3Voltage</a></p>

POWer:POWer<x>:TURNONtime:OUTPUT4SOURce  
 POWer:POWer<x>:TURNONtime:OUTPUT4VOLTage  
 POWer:POWer<x>:TURNONtime:OUTPUT5SOURce  
 POWer:POWer<x>:TURNONtime:OUTPUT5VOLTage  
 POWer:POWer<x>:TURNONtime:OUTPUT6SOURce  
 POWer:POWer<x>:TURNONtime:OUTPUT6VOLTage  
 POWer:POWer<x>:TURNONtime:OUTPUT7SOURce  
 POWer:POWer<x>:TURNONtime:OUTPUT7VOLTage

**Arguments** Power<x> is the power measurement number. This is the equivalent of the number shown on a power measurement badge in the UI.  
 ONE through SEVEN sets the number of outputs for the specified Turn On Time power measurement.

**Examples** POWer:POWer1:TURNONtime:NUMOUTputs TWO sets the number of outputs of Turn On Time measurement 1 to two.  
 POWer:POWer3:TURNONtime:NUMOUTputs? might return  
 POWer:POWer3:TURNONtime:NUMOUTputs FOUR, indicating that the number of outputs of Turn On Time measurement 3 is set to four inputs.

## POWer:POWer<x>:TURNONtime:OUTPUT1SOURce

This command sets or queries the output 1 source of the specified Turn On Time measurement.

**Conditions** Requires option PWR or PS2.

**Group** Power

**Syntax** POWer:POWer<x>:TURNONtime:OUTPUT1SOURce  
 {CH<x>|REF<x>|MATH<x>}  
 POWer:POWer<x>:TURNONtime:OUTPUT1SOURce?

**Arguments** Power<x> is the power measurement number. This is the equivalent of the number shown on a power measurement badge in the UI.  
 CH<x> A channel specifier in the range of 1 through 8 and is limited by the number of instrument input channels.

REF<x> A Reference waveform specifier  $\geq 1$ . This is the equivalent of the number shown on a Reference waveform badge in the UI.

MATH<x> A Math waveform specifier  $\geq 1$ . This is the equivalent of the number shown on a Math waveform badge in the UI.

**Examples** `POWER:Power5:TURNONtime:OUTPUT1SOURCE CH2` sets the output 1 source of Turn On Time measurement 5 to Channel 2.

`POWER:Power1:TURNONtime:OUTPUT1SOURCE?` might return `POWER:Power1:TURNONtime:OUTPUT1SOURCE CH4`, indicating that the output 1 source of Turn On Time measurement 1 is Channel 4.

## POWER:POWER<x>:TURNONtime:OUTPUT1VOLTage

This command sets or queries the output 1 voltage level of the specified Turn On Time power measurement.

**Conditions** Requires option PWR or PS2.

**Group** Power

**Syntax** `POWER:POWER<x>:TURNONtime:OUTPUT1VOLTage <NR2>`  
`POWER:POWER<x>:TURNONtime:OUTPUT1VOLTage?`

**Related Commands** [POWER:POWER<x>:TURNONtime:NUMOUTputs](#)  
[POWER:POWER<x>:TURNONtime:OUTPUT1SOURCE](#)

**Arguments** `Power<x>` is the power measurement number. This is the equivalent of the number shown on a power measurement badge in the UI.

`<NR2>` sets the output voltage value, in the range of  $-6,000$  volts to  $+6,000$  volts.

**Examples** `POWER:Power1:TURNONtime:OUTPUT1VOLTage -2550` sets the output 1 voltage value of Turn On Time power measurement 1 to  $-2,550$  volts.

`POWER:Power3:TURNONtime:OUTPUT1VOLTage?` might return `POWER:Power3:TURNONtime:OUTPUT1VOLTage 1000`, indicating that the output 1 voltage value of Turn On Time power measurement 3 is set to  $1,000$  volts.

## POWER:POWER<x>:TURNONtime:OUTPUT2SOURce

This command sets or queries the output 2 source of the specified Turn On Time measurement.

**Conditions** Requires option PWR or PS2.

**Group** Power

**Syntax** POWER:POWER<x>:TURNONtime:OUTPUT2SOURce  
{CH<x>|REF<x>|MATH<x>}  
POWER:POWER<x>:TURNONtime:OUTPUT2SOURce?

**Arguments** Power<x> is the power measurement number. This is the equivalent of the number shown on a power measurement badge in the UI.

CH<x> A channel specifier in the range of 1 through 8 and is limited by the number of instrument input channels.

REF<x> A Reference waveform specifier  $\geq 1$ . This is the equivalent of the number shown on a Reference waveform badge in the UI.

MATH<x> A Math waveform specifier  $\geq 1$ . This is the equivalent of the number shown on a Math waveform badge in the UI.

**Examples** POWER:POWER2:TURNONtime:OUTPUT2SOURce CH2 sets the output 2 source of Turn On Time measurement 2 to Channel 2.

POWER:Power1:TURNONTIME:OUTPUT2SOURce? might return  
POWER:POWER1:TURNONTIME:OUTPUT2SOURce CH4, indicating that the output 2 source of Turn On Time measurement 1 is Channel 4.

## POWER:POWER<x>:TURNONtime:OUTPUT2VOLTage

This command sets or queries the output 2 voltage level of the specified Turn On Time power measurement.

**Conditions** Requires option PWR or PS2.

**Group** Power

**Syntax** POWER:POWER<x>:TURNONtime:OUTPUT2VOLTage <NR2>  
POWER:POWER<x>:TURNONtime:OUTPUT2VOLTage?

<b>Related Commands</b>	<code>POWer:POWer&lt;x&gt;:TURNONtime:NUMOUTputs</code> <code>POWer:POWer&lt;x&gt;:TURNONtime:OUTPUT2SOURCce</code>
<b>Arguments</b>	<code>Power&lt;x&gt;</code> is the power measurement number. This is the equivalent of the number shown on a power measurement badge in the UI.  <code>&lt;NR2&gt;</code> sets the output voltage value, in the range of -6,000 volts to +6,000 volts.
<b>Examples</b>	<code>Power:Power7:TURNONtime:OUTPUT2VOLTage -2550</code> sets the output 2 voltage value of Turn On Time power measurement 7 to -2,550 volts.  <code>Power:Power1:TURNONtime:OUTPUT2VOLTage?</code> might return <code>Power:Power1:TURNONtime:OUTPUT2VOLTage 120</code> , indicating that the output 2 voltage value of Turn On Time power measurement 1 is set to 120 volts.

## `POWer:POWer<x>:TURNONtime:OUTPUT3SOURCce`

This command sets or queries the output 3 source of the specified Turn On Time measurement.

<b>Conditions</b>	Requires option PWR or PS2.
<b>Group</b>	Power
<b>Syntax</b>	<code>Power:Power&lt;x&gt;:TURNONtime:OUTPUT3SOURCE</code> <code>{CH&lt;x&gt; REF&lt;x&gt; MATH&lt;x&gt;}</code> <code>Power:Power&lt;x&gt;:TURNONtime:OUTPUT3SOURCE?</code>
<b>Arguments</b>	<code>Power&lt;x&gt;</code> is the power measurement number. This is the equivalent of the number shown on a power measurement badge in the UI.  <code>CH&lt;x&gt;</code> A channel specifier in the range of 1 through 8 and is limited by the number of instrument input channels.  <code>REF&lt;x&gt;</code> A Reference waveform specifier $\geq 1$ . This is the equivalent of the number shown on a Reference waveform badge in the UI.  <code>MATH&lt;x&gt;</code> A Math waveform specifier $\geq 1$ . This is the equivalent of the number shown on a Math waveform badge in the UI.
<b>Examples</b>	<code>Power:Power3:TURNONtime:OUTPUT3SOURCE CH2</code> sets the output 3 source of Turn On Time measurement 3 to Channel 2.



Power:Power13:TURNONtime:OUTPUT3SOURCE? might return  
 Power:Power13:TURNONtime:OUTPUT3SOURCE REF3, indicating that the  
 output 3 source of Turn On Time measurement 13 is Reference waveform 3.

## POWer:POWer<x>:TURNONtime:OUTPUT3VOLTage

This command sets or queries the output 3 voltage level of the specified Turn On Time power measurement.

**Conditions** Requires option PWR or PS2.

**Group** Power

**Syntax** Power:Power<x>:TURNONtime:OUTPUT3VOLTage <NR2>  
 Power:Power<x>:TURNONtime:OUTPUT3VOLTage?

**Related Commands** [Power:Power<x>:TURNONtime:NUMOUTputs](#)  
[Power:Power<x>:TURNONtime:OUTPUT3SOURCE](#)

**Arguments** Power<x> is the power measurement number. This is the equivalent of the number shown on a power measurement badge in the UI.  
 <NR2> sets the output voltage value, in the range of –6,000 volts to +6,000 volts.

**Examples** Power:Power7:TURNONtime:OUTPUT3VOLTage -550 sets the output 3 voltage value of Turn On Time power measurement 7 to –550 volts.  
 Power:Power3:TURNONtime:OUTPUT3VOLTage? might return  
 Power:Power3:TURNONtime:OUTPUT3VOLTage -200, indicating that the output 3 voltage value of Turn On Time power measurement 3 is set to –200 volts.

## POWer:POWer<x>:TURNONtime:OUTPUT4SOURCE

This command sets or queries the output 4 source of the specified Turn On Time measurement.

**Conditions** Requires option PWR or PS2.

**Group** Power

**Syntax**     `Power:Power<x>:TURNONtime:OUTPUT4SOURCE`  
                   `{CH<x>|REF<x>|MATH<x>}`  
                   `Power:Power<x>:TURNONtime:OUTPUT4SOURCE?`

**Arguments**     `Power<x>` is the power measurement number. This is the equivalent of the number shown on a power measurement badge in the UI.

`CH<x>` A channel specifier in the range of 1 through 8 and is limited by the number of instrument input channels.

`REF<x>` A Reference waveform specifier  $\geq 1$ . This is the equivalent of the number shown on a Reference waveform badge in the UI.

`MATH<x>` A Math waveform specifier  $\geq 1$ . This is the equivalent of the number shown on a Math waveform badge in the UI.

**Examples**     `Power:Power3:TURNONtime:OUTPUT4SOURCE CH2` sets the output 4 source of Turn On Time measurement 3 to Channel 2.

`Power:Power1:TURNONTIME:OUTPUT4SOURCE?` might return  
`Power:Power1:TURNONTIME:OUTPUT4SOURCE MATH3`, indicating that the output 4 source of Turn On Time measurement 1 is Math waveform 3.

## **POWER:POWER<x>:TURNONtime:OUTPUT4VOLTage**

This command sets or queries the output 4 voltage level of the specified Turn On Time power measurement.

**Conditions**     Requires option PWR or PS2.

**Group**            Power

**Syntax**            `Power:Power<x>:TURNONtime:OUTPUT4VOLTage <NR2>`  
                   `Power:Power<x>:TURNONtime:OUTPUT4VOLTage?`

**Related Commands**     [POWER:POWER<x>:TURNONtime:NUMOUTputs](#)  
                                   [POWER:POWER<x>:TURNONtime:OUTPUT4SOURCE](#)

**Arguments**     `Power<x>` is the power measurement number. This is the equivalent of the number shown on a power measurement badge in the UI.

`<NR2>` sets the output voltage value, in the range of -6,000 volts to +6,000 volts.

- Examples** `Power:Power8:TURNONtime:OUTPUT4VOLTage 50` sets the output 4 voltage value of Turn On Time power measurement 8 to 50 volts.
- `Power:Power2:TURNONtime:OUTPUT4VOLTage?` might return `Power:Power2:TURNONtime:OUTPUT4VOLTage 1000`, indicating that the output 4 voltage value of Turn On Time power measurement 2 is set to 1,000 volts.

## POWER:POWER<x>:TURNONtime:OUTPUT5SOURCE

This command sets or queries the output 5 source of the specified Turn On Time measurement.

- Conditions** Requires option PWR or PS2.

- Group** Power

- Syntax** `Power:Power<x>:TURNONtime:OUTPUT5SOURCE`  
`{CH<x>|REF<x>|MATH<x>}`  
`Power:Power<x>:TURNONtime:OUTPUT5SOURCE?`

- Arguments** `Power<x>` is the power measurement number. This is the equivalent of the number shown on a power measurement badge in the UI.
- `CH<x>` A channel specifier in the range of 1 through 8 and is limited by the number of instrument input channels.
- `REF<x>` A Reference waveform specifier  $\geq 1$ . This is the equivalent of the number shown on a Reference waveform badge in the UI.
- `MATH<x>` A Math waveform specifier  $\geq 1$ . This is the equivalent of the number shown on a Math waveform badge in the UI.

- Examples** `Power:Power3:TURNONtime:OUTPUT5SOURCE CH2` sets the output 5 source of Turn On Time measurement 3 to Channel 2.
- `Power:Power1:TURNONtime:OUTPUT5SOURCE?` might return `Power:Power1:TURNONtime:OUTPUT5SOURCE CH4`, indicating that the output 5 source of Turn On Time measurement 1 is Channel 4.

## POWER:POWER<x>:TURNONtime:OUTPUT5VOLTage

This command sets or queries the output 5 voltage level of the specified Turn On Time power measurement.

<b>Conditions</b>	Requires option PWR or PS2.
<b>Group</b>	Power
<b>Syntax</b>	<pre>Power:Power&lt;x&gt;:TURNONtime:OUTPUT5VOLTage &lt;NR2&gt; Power:Power&lt;x&gt;:TURNONtime:OUTPUT5VOLTage?</pre>
<b>Related Commands</b>	<pre>POWer:POWer&lt;x&gt;:TURNONtime:NUMOUTputs POWer:POWer&lt;x&gt;:TURNONtime:OUTPUT5SOURce</pre>
<b>Arguments</b>	<p>Power&lt;x&gt; is the power measurement number. This is the equivalent of the number shown on a power measurement badge in the UI.</p> <p>&lt;NR2&gt; sets the output voltage value, in the range of –6,000 volts to +6,000 volts.</p>
<b>Examples</b>	<pre>Power:Power2:TURNONtime:OUTPUT5VOLTage -255</pre> <p>sets the output 5 voltage value of Turn On Time power measurement 2 to –250 volts.</p> <pre>Power:Power3:TURNONtime:OUTPUT5VOLTage?</pre> <p>might return</p> <pre>Power:Power3:TURNONtime:OUTPUT5VOLTage 100</pre> <p>indicating that the output 5 voltage value of Turn On Time power measurement 3 is set to 100 volts.</p>

## POWer:POWer<x>:TURNONtime:OUTPUT6SOURce

This command sets or queries the output 6 source of the specified Turn On Time measurement.

<b>Conditions</b>	Requires option PWR or PS2.
<b>Group</b>	Power
<b>Syntax</b>	<pre>Power:Power&lt;x&gt;:TURNONtime:OUTPUT6SOURce {CH&lt;x&gt; REF&lt;x&gt; MATH&lt;x&gt;} Power:Power&lt;x&gt;:TURNONtime:OUTPUT6SOURce?</pre>
<b>Arguments</b>	<p>Power&lt;x&gt; is the power measurement number. This is the equivalent of the number shown on a power measurement badge in the UI.</p> <p>CH&lt;x&gt; A channel specifier in the range of 1 through 8 and is limited by the number of instrument input channels.</p>

REF<x> A Reference waveform specifier  $\geq 1$ . This is the equivalent of the number shown on a Reference waveform badge in the UI.

MATH<x> A Math waveform specifier  $\geq 1$ . This is the equivalent of the number shown on a Math waveform badge in the UI.

**Examples** `POWER:Power3:TURNONtime:OUTPUT6SOURCE CH2` sets the output 6 source of Turn On Time measurement 3 to Channel 2.

`POWER:Power8:TURNONtime:OUTPUT6SOURCE?` might return `POWER:Power8:TURNONtime:OUTPUT6SOURCE CH4`, indicating that the output 6 source of Turn On Time measurement 8 is set to Channel 4.

## POWER:POWER<x>:TURNONtime:OUTPUT6VOLTage

This command sets or queries the output 6 voltage level of the specified Turn On Time power measurement.

**Conditions** Requires option PWR or PS2.

**Group** Power

**Syntax** `POWER:POWER<x>:TURNONtime:OUTPUT6VOLTage <NR2>`  
`POWER:POWER<x>:TURNONtime:OUTPUT6VOLTage?`

**Related Commands** [POWER:POWER<x>:TURNONtime:NUMOUTputs](#)  
[POWER:POWER<x>:TURNONtime:OUTPUT6SOURCE](#)

**Arguments** `Power<x>` is the power measurement number. This is the equivalent of the number shown on a power measurement badge in the UI.

`<NR2>` sets the output voltage value, in the range of  $-6,000$  volts to  $+6,000$  volts.

**Examples** `POWER:Power5:TURNONtime:OUTPUT6VOLTage 1550` sets the output 6 voltage value of Turn On Time power measurement 5 to 1,550 volts.

`POWER:Power2:TURNONtime:OUTPUT6VOLTage?` might return `POWER:Power2:TURNONtime:OUTPUT6VOLTage -100`, indicating that the output 6 voltage value of Turn On Time power measurement 2 is set to  $-100$  volts.

## POWER:POWER<x>:TURNONtime:OUTPUT7SOURCE

This command sets or queries the output 7 source of the specified Turn On Time measurement.

**Conditions** Requires option PWR or PS2.

**Group** Power

**Syntax** POWER:POWER<x>:TURNONtime:OUTPUT7SOURCE  
 {CH<x>|REF<x>|MATH<x>}  
 POWER:POWER<x>:TURNONtime:OUTPUT7SOURCE?

**Arguments** Power<x> is the power measurement number. This is the equivalent of the number shown on a power measurement badge in the UI.

CH<x> A channel specifier in the range of 1 through 8 and is limited by the number of instrument input channels.

REF<x> A Reference waveform specifier  $\geq 1$ . This is the equivalent of the number shown on a Reference waveform badge in the UI.

MATH<x> A Math waveform specifier  $\geq 1$ . This is the equivalent of the number shown on a Math waveform badge in the UI.

**Examples** POWER:POWER3:TURNONtime:OUTPUT6SOURCE CH1 sets the output 7 source of Turn On Time measurement 3 to Channel 1.

POWER:POWER7:TURNONtime:OUTPUT6SOURCE? might return  
 POWER:POWER7:TURNONtime:OUTPUT6SOURCE REF4, indicating that the output 7 source of Turn On Time measurement 7 is set to Reference waveform 4.

## POWER:POWER<x>:TURNONtime:OUTPUT7VOLTage

This command sets or queries the output 7 voltage level of the specified Turn On Time power measurement.

**Conditions** Requires option PWR or PS2.

**Group** Power

**Syntax** POWER:POWER<x>:TURNONtime:OUTPUT7VOLTage <NR2>  
 POWER:POWER<x>:TURNONtime:OUTPUT7VOLTage?

<b>Related Commands</b>	<p><a href="#">POWER:POWer&lt;x&gt;:TURNONtime:NUMOUTputs</a></p> <p><a href="#">POWER:POWer&lt;x&gt;:TURNONtime:OUTPUT7SOURce</a></p>
<b>Arguments</b>	<p>Power&lt;x&gt; is the power measurement number. This is the equivalent of the number shown on a power measurement badge in the UI.</p> <p>&lt;NR2&gt; sets the output voltage value, in the range of –6,000 volts to +6,000 volts.</p>
<b>Examples</b>	<p>POWER:POWer12:TURNONtime:OUTPUT7VOLTage -2100 sets the output 7 voltage value of Turn On Time power measurement 12 to –2,100 volts.</p> <p>POWER:POWer3:TURNONtime:OUTPUT7VOLTage? might return POWER:POWer3:TURNONtime:OUTPUT7VOLTage 450, indicating that the output 7 voltage value of Turn On Time power measurement 3 is set to 450 volts.</p>

## POWER:POWer<x>:TURNONtime:TYPE

This command sets or queries the type of AC/DC converter used in the specified Turn On Time power measurement.

<b>Conditions</b>	Requires option PWR or PS2.
<b>Group</b>	Power
<b>Syntax</b>	<p>POWER:POWer&lt;x&gt;:TURNONtime:TYPE {DCDC ACDC}</p> <p>POWER:POWer&lt;x&gt;:TURNONtime:TYPE?</p>
<b>Arguments</b>	<p>Power&lt;x&gt; is the power measurement number. This is the equivalent of the number shown on a power measurement badge in the UI.</p> <p>DCDC sets the measurement to use a DC to DC converter.</p> <p>ACDC sets the measurement to use an AC to DC converter.</p>
<b>Examples</b>	<p>POWER:POWer3:TURNONtime:TYPE ACDC sets Turn On time measurement 3 to use an AC to DC converter.</p> <p>POWER:POWer12:TURNONtime:TYPE? might return POWER:POWer12:TURNONtime:TYPE DCDC, indicating that the converter type for Turn On Time power measurement 12 is set to use a DC-DC converter.</p>

## POWer:POWer<x>:TYPe

This command sets or queries the measurement type of the specified power measurement number. If the measurement number does not exist, this command creates a new power measurement, assigns the specified measurement number to the new measurement, and then assigns the measurement type to the new measurement.

**Conditions** Requires option PWR or PS2.

**Group** Power

**Syntax** POWer:POWer<x>:TYPe <Measurement Type>  
POWer:POWer<x>:TYPe?

**Arguments** Power<x> is the power measurement number. This is the equivalent of the number shown in the UI for a power measurement badge.

<Measurement Type> = CYCLEAmp | CYCLEBase | CYCLEMAx | CYCLEMIn | CYCLEPKpk | CYCLETop | DIDT | DVDT | EFFICIENCY | FREQuency | HARMonics | IMPEDANCE | INDUCTANCE | INPUTCAP | INRUSHcurrent | IVSINTEGRALV | LINERipple | MAGNETICLOSS | MAGPROPERTY | NDUTYCycle | NPULSEWidth | PDUTYCycle | PERIod | POWERQUALity | PPULSEWidth | RDSON | SOA | SWITCHINGLOSS | SWITCHINGRIpple | TURNOFFtime | TURNONtime | CLRESPONSE | PSRR

**Examples** POWer:POWer6:TYPe INDUCTANCE sets power measurement 6 to be an Inductance measurement.

POWer:POWer1:TYPe? might return INPUTCAP, indicating that power measurement 1 is an Input Capacitance measurement.

## \*PSC

This command sets and queries the power-on status flag that controls the automatic power-on handling of the DESER, SRER, and ESER registers. When \*PSC is true, the DESER register is set to 255 and the SRER and ESER registers are set to 0 at power-on. When \*PSC is false, the current values in the DESER, SRER, and ESER registers are preserved in nonvolatile memory when power is shut off and are restored at power-on.

**Group** Status and Error



**Syntax** \*PSC {<NR1>|OFF|ON}  
\*PSC?

**Related Commands** DESE  
\*ESE  
FACtory  
\*RST  
\*SRE

**Arguments** <NR1> = 0 sets the power-on status clear flag to false, disables the power-on clear and allows the instrument to possibly assert SRQ after power-on; any other value sets the power-on status clear flag to true, enabling the power-on status clear and prevents any SRQ assertion after power on.

OFF sets the power-on status clear flag to false, disables the power-on clear and allows the instrument to possibly assert SRQ after power-on.

ON sets the power-on status clear flag to true, enabling the power-on status clear and prevents any SRQ assertion after power on.

**Examples** \*PSC 0 sets the power-on status clear flag to false.  
\*PSC? might return 1 to indicate that the power-on status clear flag is set to true.

## \*PUD

This command sets or queries a string of Protected User Data. This data is protected by the PASSWord command. You can modify it only by first entering the correct password. This password is not necessary to query the data.

**Group** Status and Error

**Syntax** \*PUD {<Block>|<QString>}  
\*PUD?

**Arguments** <Block> is a block containing up to 100 characters.  
<QString> is a string containing up to 100 characters.

**Examples** \*PUD #229This instrument belongs to me stores the string "This instrument belongs to me" in the user protected data area.

\*PUD? might return #221PROPERTY OF COMPANY X.

## RECALL:MASK (No Query Form)

This command recalls a saved mask definition from a Mask File. File suffixes can be xml or msk. If the specified mask test already exists the mask associated with that mask test will be replaced, otherwise a new mask test is created.

<b>Conditions</b>	Requires option MTM.
<b>Group</b>	Mask
<b>Syntax</b>	RECALL:MASK <source file>,MASK<x>
<b>Arguments</b>	<p>MASK&lt;x&gt; is the destination mask.</p> <p>&lt;source file&gt; is the source file. The file is expected to be located in a directory relative to the current working directory (specified by <a href="#">FILESystem:CWD</a>) unless a complete path is specified:</p> <ul style="list-style-type: none"><li>■ Complete path specification. If the file argument begins with a drive designator (such as C:), then the file name is interpreted as a full path.</li><li>■ Relative path specification. If the file argument begins with "." or "" or has a file path separator appearing anywhere other than the first character position, then the file name is treated as a path that is relative to the current working directory.</li></ul>
<b>Examples</b>	RECALL:MASK "MaskWD17",MASK1 recalls the mask stored in the file named MASKWD17 and stores it in mask 1. If mask 1 already exists then its mask will be replaced.

## RECALL:SESSion (No Query Form)

Restores the state of the instrument, including reference waveforms, from a saved session file.

<b>Group</b>	Save and Recall
<b>Syntax</b>	RECALL:SESSion <file_path>

<b>Arguments</b>	<p>&lt;file_path&gt; is the file path that specifies the location of the specified instrument session file.</p> <p>If a file name or path is specified, the file is expected to be located in a directory relative to the current working directory (specified by <a href="#">FILESystem:CWD</a>) unless a complete path is specified:</p> <ul style="list-style-type: none"> <li>■ Complete path specification. If the file argument begins with a drive designator (such as C), then the file name is interpreted as a full path.</li> <li>■ Relative path specification. If the file argument begins with "." or ".." or has a file path separator appearing anywhere other than the first character position, then the file name is treated as a path that is relative to the current working directory.</li> </ul>
<b>Returns</b>	Recalls the instrument session from the specified session file.
<b>Examples</b>	<pre>RECALL:SESSION "TEK00000.TSS"</pre> <p>recalls the setup from the file TEK00000.TSS in the current working directory.</p>

## RECALL:SETUp (No Query Form)

This command (no query form) returns stored or factory settings to the instrument from a copy of the settings stored in memory. This command performs the same function as selecting Recall from the File menu, and then choosing the Setup button.

<b>Group</b>	Save and Recall
<b>Syntax</b>	RECALL:SETUp {FACTory <file_path>}
<b>Related Commands</b>	<p><a href="#">FACTory</a></p> <p><a href="#">*RST</a></p>
<b>Arguments</b>	<p>FACTory restores the factory setup. Performs the same operation as the :FACTory command.</p> <p>&lt;file_path&gt; specifies a location for an instrument setup file. &lt;file path&gt; is a quoted string that defines the file name and path. If a file name or path is specified, the file is expected to be located in a directory relative to the current working directory (specified by <a href="#">FILESystem:CWD</a>) unless a complete path is specified:</p>

- Complete path specification. If the file argument begins with drive designator (such as C:), then the file name is interpreted as a full path.
- Relative path specification. If the file argument begins with "." or ".." or has a file path separator appearing anywhere other than the first character position, then the file name is treated as a path that is relative to the current working directory.

**Examples**    `RECALL:SETUP FACTORY` recalls (and makes current) the instrument setup to its factory defaults.

`RECALL:SETUP "TEK00000.SET"` recalls the setup from the file `TEK00000.SET` in the default directory for setups.

## RECALL:WAVEform (No Query Form)

This command recalls a stored waveform to a reference memory location.

**Group**    Save and Recall

**Syntax**    `RECALL:WAVEform <source file>,<destination>`

**Arguments**    `<source file>` is the source file. The file is expected to be located in a directory relative to the current working directory (specified by [FILESystem:CWD](#)) unless a complete path is specified:

- Complete path specification. If the file argument begins with drive designator (such as C:), then the file name is interpreted as a full path.
- Relative path specification. If the file argument begins with "." or ".." or has a file path separator appearing anywhere other than the first character position, then the file name is treated as a path that is relative to the current working directory.

`<destination>` is `REF<x>` which specifies a reference to create from the recalled waveform data file.

**Examples**    `RECALL:WAVEFORM "TEK00000.ISF",REF1` recalls the waveform stored in the file named `TEK00000.ISF` from the current directory to reference 1.

## REF:ADDNew (No Query Form)

This command adds the specified reference. Argument is of the form `"REF<NR1>"`, where  $NR1 \geq 1$ .

<b>Group</b>	Vertical
<b>Syntax</b>	REF:ADDNew <QString>
<b>Arguments</b>	<QString> is the specified reference. Argument is of the form "REF<NR1> ", where $NR1 \geq 1$ .
<b>Examples</b>	REF:ADDNEW "REF2" adds reference 2 to the display.

### REF:DELeTe (No Query Form)

Deletes the specified reference. Argument is of the form "REF<NR1>", where  $NR1 \geq 1$ .

<b>Conditions</b>	Vertical
<b>Group</b>	Vertical
<b>Syntax</b>	REF:DELeTe <QString>
<b>Arguments</b>	<QString> is the specified reference. Argument is of the form "REF<NR1>", where $NR1 \geq 1$ .
<b>Examples</b>	REF:DELETE "REF2" deletes reference 2 from the display.

### REF:LIST? (Query Only)

This command returns a comma separated list of all currently defined references.

<b>Group</b>	Vertical
<b>Syntax</b>	REF:LIST?
<b>Returns</b>	All currently defined references.

**Examples** REF:LIST? might return :REF:LIST REF1,REF2 indicating references 1 and 2 are defined.

## REF:REF<x>:DESKew

This command sets or queries the deskew value used for the specified reference.

**Group** Vertical

**Syntax** REF:REF<x>:DESKew <NR3>  
REF:REF<x>:DESKew?

**Arguments** <NR3> is the deskew value used for the specified reference.

**Examples** REF:REF1:DESKew -1.5e-9 sets the deskew value to -1.5 ns.  
REF:REF1:DESKew? might return :REF:REF1:DESKew 1.5200E-9 indicating the deskew value is 1.52 ns.

## REF:REF<x>:LABel:COLor

This command sets or queries the color of the specified ref label.

**Group** Vertical

**Syntax** REF:REF<x>:LABel:COLor <QString>  
REF:REF<x>:LABel:COLor?

**Arguments** <QString> is the label. To return the color to the default color, send an empty string as in this example: :REF:REF1:LABel:COLor "".

**Examples** REF:REF1:LABel:COLor "#FFFF00" sets the font color to yellow.  
REF:REF1:LABel:COLor? might return :REF:REF1:LABel:COLor "#FF0000" indicating the font color is red.

## REF:REF<x>:LABel:FONT:BOLD

This command sets or queries the bold state of the specified reference label.

<b>Group</b>	Vertical
<b>Syntax</b>	REF:REF<x>:LABel:FONT:BOLD {<NR1> OFF ON} REF:REF<x>:LABel:FONT:BOLD?
<b>Arguments</b>	<NR1> = 0 disables bold font; any other value turns this feature on. OFF disables bold font. ON enables bold font.
<b>Examples</b>	REF:REF1:LABel:FONT:BOLD ON turns on the bold font. REF:REF1:LABel:FONT:BOLD? might return :REF:REF1:LABEL:FONT:BOLD 0 indicating the bold font is off.

## REF:REF<x>:LABel:FONT:ITALic

This command sets or queries the italic state of the specified reference label.

<b>Group</b>	Vertical
<b>Syntax</b>	REF:REF<x>:LABel:FONT:ITALic {<NR1> OFF ON} REF:REF<x>:LABel:FONT:ITALic?
<b>Arguments</b>	<NR1> = 0 disables italic font; any other value turns this feature on. OFF disables italic font. ON enables italic font.
<b>Examples</b>	REF:REF1:LABel:FONT:ITALic ON turns on the italic font. REF:REF1:LABel:FONT:ITALic? might return :REF:REF1:LABEL:FONT:ITALIC 0 indicating the italic font is off.

## REF:REF<x>:LABel:FONT:SIZE

This command sets or queries the font size of the specified reference label.

<b>Group</b>	Vertical
--------------	----------

**Syntax** REF:REF<x>:LABel:FONT:SIZE <NR1>  
REF:REF<x>:LABel:FONT:SIZE?

**Arguments** <NR1> is the font size of the label.

**Examples** REF:REF1:LABel:FONT:SIZE 20 sets the font size to 20 points.  
REF:REF1:LABel:FONT:SIZE? might return :REF:REF1:LABEL:FONT:SIZE 14 indicating that the font size is 14 points.

## REF:REF<x>:LABel:FONT:TYPE

This command sets or queries the font type of the specified reference label, such as Arial or Times New Roman.

**Group** Vertical

**Syntax** REF:REF<x>:LABel:FONT:TYPE <QString>  
REF:REF<x>:LABel:FONT:TYPE?

**Arguments** <QString> is the font type.

**Examples** REF:REF1:LABel:FONT:TYPE "Monospace" specifies a mono spaced font.  
REF:REF1:LABel:FONT:TYPE? might return :REF:REF1:LABEL:FONT:TYPE "Frutiger LT Std 55 Roman".

## REF:REF<x>:LABel:FONT:UNDERline

This command sets or queries the underline state of the specified reference label.

**Group** Vertical

**Syntax** REF:REF<x>:LABel:FONT:UNDERline {<NR1>|OFF|ON}  
REF:REF<x>:LABel:FONT:UNDERline?

**Arguments** <NR1> = 0 disables underline font; any other value turns this feature on.  
OFF disables underline font.  
ON enables underline font.



**Examples** REF:REF1:LABEL:FONT:UNDERLINE ON turns on the underline font.  
 REF:REF1:LABEL:FONT:UNDERLINE? might return  
 :REF:REF1:LABEL:FONT:UNDERLINE 0 indicating that underline is off.

## REF:REF<x>:LABEL:NAME

This command sets or queries the label of the specified reference. The reference waveform is specified by x.

**Group** Vertical

**Syntax** REF:REF<x>:LABEL:NAME <QString>  
 REF:REF<x>:LABEL:NAME?

**Arguments** <QString> is the character string that will be used for the reference waveform label name.

**Examples** REF:REF4:LABEL:NAME "My Reference" sets the label name of Reference 4 waveform to "My Reference".  
 REF:REF3:LABEL:NAME? might return :REF:REF3:LABEL:NAME "Signal2", indicating that the label name for Reference 3 waveform is currently set to "Signal2".

## REF:REF<x>:LABEL:XPOS

This command sets or queries the X-position at which the label (attached to the displayed waveform of the specified reference) is displayed, relative to the left edge of the waveview. The reference waveform is specified by x.

**Group** Vertical

**Syntax** REF:REF<x>:LABEL:XPOS <NR1>  
 REF:REF<x>:LABEL:XPOS?

**Arguments** <NR1> is the location (control in divisions) where the waveform label for the selected reference is displayed, relative to the left edge of the screen.

**Examples**    `REF:REF4:LABEL:XPOS 10` moves the waveform label for the Reference 3 waveform, so that it begins 10 divisions to the right of the left edge of the screen.

`REF:REF2:LABEL:XPOS?` might return `:REF:REF2:LABEL:XPOS 1.5`, indicating that the x-axis for the Reference 2 waveform is currently 1.5 divisions to the right of the left edge of the screen.

## REF:REF<x>:LABel:YPOS

This command sets or queries the Y-position of the label (attached to the displayed waveform of the specified reference), relative to the baseline of the waveform. The reference waveform is specified by x.

**Group**    Vertical

**Syntax**    `REF:REF<x>:LABel:YPOS <NR1>`  
`REF:REF<x>:LABel:YPOS?`

**Arguments**    <NR1> is the location where the waveform label for the selected reference is displayed, relative to the baseline of the waveform.

**Examples**    `REF:REF3:LABEL:YPOS -10` moves the waveform label for the Reference 3 waveform 10 vertical units below the baseline of the waveform.

`REF:REF2:LABEL:YPOS?` might return `:REF:REF2:LABEL:YPOS 0`, indicating that the waveform label for the Reference 2 waveform is currently located at the baseline of the waveform.

## REF:REF<x>:SOUrce

This command sets or queries the filename used by the given reference.

**Group**    Vertical

**Syntax**    `REF:REF<x>:SOUrce <QString>`  
`REF:REF<x>:SOUrce?`

**Arguments**    <QString> is the reference file name.

**Examples**    `REF:REF1:SOURCE`  
`"/home/guest/.local/share/Tektronix/TekScope/`  
`FirstRecalledSession/161012_132000_000.wfm"` sets the source of  
the reference.

`REF:REF1:SOURCE?` might return `:REF:REF1:SOURCE`  
`"/home/guest/.local/share/Tektronix/TekScope/`  
`LastRecalledSession/161012_132039_000.wfm"`.

## REF<x>\_DALL:LABel:COLor

This command sets or queries the color of the specified digital group. The reference is specified by x.

**Group**    Digital

**Syntax**    `REF<x>_DALL:LABel:COLor <QString>`  
`REF<x>_DALL:LABel:COLor?`

**Arguments**    `<QString>` is the color of the digital group label. To return the color to the default color, send an empty string as in this example: `:REF5_DALL:LABEL:COLOR ""`.

**Examples**    `REF1_DALL:LABel:COLor "#FF0000"` sets the font color to red.

`REF1_DALL:LABel:COLor?` might return `:REF1_DALL:LABEL:COLOR`  
`"#FFFF00"` indicating the font color is yellow.

## REF<x>\_DALL:LABel:FONT:BOLD

This command sets or queries the bold state of the specified digital group. The reference is specified by x.

**Group**    Digital

**Syntax**    `REF<x>_DALL:LABel:FONT:BOLD {ON|OFF|<NR1>}`  
`REF<x>_DALL:LABel:FONT:BOLD?`

**Arguments**    OFF argument turns off bold font.

ON argument turns on bold font.

`<NR1> = 0` turns off bold font; any other value turns on bold font.

**Examples** REF1\_DALL:LABEL:FONT:BOLD ON sets the font to bold.  
REF1\_DALL:LABEL:FONT:BOLD? might return  
:REF1\_DALL:LABEL:FONT:BOLD 0 indicating the font is not bold.

## REF<x>\_DALL:LABEL:FONT:ITALic

This command sets or queries the italic state of the specified digital group. The reference is specified by x.

**Group** Digital

**Syntax** REF<x>\_DALL:LABEL:FONT:ITALic {ON|OFF|<NR1>}  
REF<x>\_DALL:LABEL:FONT:ITALic?

**Arguments** OFF argument turns off italic font.  
ON argument turns on italic font.  
<NR1> = 0 turns off italic font; any other value turns on italic font.

**Examples** REF1\_DALL:LABEL:FONT:ITALic 1 turns on italic font.  
REF1\_DALL:LABEL:FONT:ITALic? might return  
:REF1\_DALL:LABEL:FONT:ITALIC 0 indicating the font is not italic.

## REF<x>\_DALL:LABEL:FONT:SIZE

This command sets or queries the font size of the specified digital group. The reference is specified by x.

**Group** Digital

**Syntax** REF<x>\_DALL:LABEL:FONT:SIZE <NR1>  
REF<x>\_DALL:LABEL:FONT:SIZE?

**Arguments** <NR1> is the font size.

**Examples** REF1\_DALL:LABEL:FONT:SIZE 16 sets the font size to 16 points.  
REF1\_DALL:LABEL:FONT:SIZE? might return  
:REF1\_DALL:LABEL:FONT:SIZE 20 indicating the font size is 20 points.

## REF<x>\_DALL:LABel:FONT:TYPE

This command sets or queries the font type of the specified digital group, such as Arial or Times New Roman. The reference is specified by x.

<b>Group</b>	Digital
<b>Syntax</b>	REF<x>_DALL:LABel:FONT:TYPE <QString> REF<x>_DALL:LABel:FONT:TYPE?
<b>Arguments</b>	<QString> is the font type.
<b>Examples</b>	REF1_DALL:LABel:FONT:TYPE "Monospace" sets the font to a monospace font.  REF1_DALL:LABel:FONT:TYPE? might return :REF1_DALL:LABel:FONT:TYPE "Frutiger LT Std 55 Roman".

## REF<x>\_DALL:LABel:FONT:UNDERline

This command sets or queries the underline state of the specified digital group. The reference is specified by x.

<b>Group</b>	Digital
<b>Syntax</b>	REF<x>_DALL:LABel:FONT:UNDERline {ON OFF <NR1>} REF<x>_DALL:LABel:FONT:UNDERline?
<b>Arguments</b>	OFF argument turns off underline font.  ON argument turns on underline font.  <NR1> = 0 turns off underline font; any other value turns on underline font.
<b>Examples</b>	REF1_DALL:LABel:FONT:UNDERline ON specifies an underlined font.  REF1_DALL:LABel:FONT:UNDERline? might return :REF1_DALL:LABel:FONT:UNDERLINE 0 indicating underline is off.

## REF<x>\_DALL:LABel:NAME

This command sets or queries the label of the specified digital group. The reference is specified by x.

**Group** Digital

**Syntax** REF<x>\_DALL:LABel:NAME <QString>  
REF<x>\_DALL:LABel:NAME?

**Arguments** <QString> is the name of the group.

**Examples** REF1\_DALL:LABel:NAME "Clock Out" sets the label name to Clock Out.  
REF1\_DALL:LABel:NAME? might return :REF1\_DALL:LABel:NAME "This is the digital name".

## REF<x>\_DALL:LABel:XPOS

This command sets or queries the x-position of the label of the specified digital group. The reference is specified by x.

**Group** Digital

**Syntax** REF<x>\_DALL:LABel:XPOS <NR3>  
REF<x>\_DALL:LABel:XPOS?

**Arguments** <NR3> is the x-position, in pixels relative to the left edge of the display, of the group.

**Examples** REF1\_DALL:LABel:XPOS 90.0e0 sets the x position of the label to 90.  
REF1\_DALL:LABel:XPOS? might return :REF1\_DALL:LABel:XPOS 45.0000 indicating the x position of the label is at 45 pixels to the right of the left edge of the display.

## REF<x>\_DALL:LABel:YPOS

This command sets or queries the y-position of the label of the specified digital group. The reference is specified by x.

<b>Group</b>	Digital
<b>Syntax</b>	REF<x>_DALL:LABel:YPOS <NR3> REF<x>_DALL:LABel:YPOS?
<b>Arguments</b>	<NR3> is the y-position, in pixels relative to the baseline of the waveform, of the group.
<b>Examples</b>	REF1_DALL:LABel:YPOS 50 sets the y position to 50. REF1_DALL:LABel:YPOS? might return :REF1_DALL:LABel:YPOS 0.0E+0 indicating the y position of the label is at the baseline of the waveform.

## REF<x>\_D<x>:LABel:COLor

This command sets or queries the color of the label of the specified digital bit. The reference is specified by x.

<b>Group</b>	Digital
<b>Syntax</b>	REF<x>_D<x>:LABel:COLor <QString> REF<x>_D<x>:LABel:COLor?
<b>Arguments</b>	<QString> is the label color. To return the color to the default color, send an empty string as in this example: :REF5_D1:LABel:COLor "".
<b>Examples</b>	REF1_D1:LABel:COLor "#FF0000" sets the color to red. REF1_D1:LABel:COLor? might return :REF1_D1:LABel:COLor "#FFFF00" indicating the color is yellow.

## REF<x>\_D<x>:LABel:FONT:BOLD

This command sets or queries the bold state of the label of the specified digital bit. The reference is specified by x.

<b>Group</b>	Digital
<b>Syntax</b>	REF<x>_D<x>:LABel:FONT:BOLD {ON OFF <NR1>} REF<x>_D<x>:LABel:FONT:BOLD?

**Arguments** OFF argument turns off bold font.  
ON argument turns on bold font.  
<NR1> = 0 turns off bold font; any other value turns on bold font.

**Examples** REF1\_D1:LABE1:FONT:BOLD ON sets the font to bold.  
REF1\_D1:LABE1:FONT:BOLD? might return :REF1\_D1:LABEL:FONT:BOLD 0 indicating the font is not bold.

## REF<x>\_D<x>:LABE1:FONT:ITALic

This command sets or queries the italic state of the label of the specified digital bit. The reference is specified by x.

**Group** Digital

**Syntax** REF<x>\_D<x>:LABE1:FONT:ITALic {ON|OFF|<NR1>}  
REF<x>\_D<x>:LABE1:FONT:ITALic?

**Arguments** OFF argument turns off italic font.  
ON argument turns on italic font.  
<NR1> = 0 turns off italic font; any other value turns on italic font.

**Examples** REF1\_D1:LABE1:FONT:ITALic OFF turns off italic font.  
REF1\_D1:LABE1:FONT:ITALic? might return  
:REF1\_D1:LABEL:FONT:ITALIC 1 indicating the font is italic.

## REF<x>\_D<x>:LABE1:FONT:SIZE

This command sets or queries the font size of the label of the specified digital bit. The reference is specified by x.

**Group** Digital

**Syntax** REF<x>\_D<x>:LABE1:FONT:SIZE <NR1>  
REF<x>\_D<x>:LABE1:FONT:SIZE?



**Arguments** <NR1> is the font size.

**Examples** REF1\_D1:LABel:FONT:SIZE 16 sets the font size to 16 points.  
 REF1\_D1:LABel:FONT:SIZE? might return :REF1\_D1:LABEL:FONT:SIZE 20 indicating the font size is 20 points.

## REF<x>\_D<x>:LABel:FONT:TYPE

This command sets or queries the font type of the label of the specified digital bit, such as Arial or Times New Roman. The reference is specified by x.

**Group** Digital

**Syntax** REF<x>\_D<x>:LABel:FONT:TYPE <QString>  
 REF<x>\_D<x>:LABel:FONT:TYPE?

**Arguments** <QString> is the font type of the label.

**Examples** REF1\_D1:LABel:FONT:TYPE "Monospace" sets the font to Monospace.  
 CHREF1\_D1:LABel:FONT:TYPE? might return :REF1\_D1:LABEL:FONT:TYPE "Frutiger LT Std 55 Roman".

## REF<x>\_D<x>:LABel:FONT:UNDERline

This command sets or queries the underline state of the label of the specified digital bit. The reference is specified by x.

**Group** Digital

**Syntax** REF<x>\_D<x>:LABel:FONT:UNDERline {ON|OFF|<NR1>}  
 REF<x>\_D<x>:LABel:FONT:UNDERline?

**Arguments** OFF argument turns off underline font.  
 ON argument turns on underline font.  
 <NR1> = 0 turns off underline font; any other value turns on underline font.

**Examples** REF1\_D1:LABel:FONT:UNDERline ON turns on underline font.  
REF1\_D1:LABel:FONT:UNDERline? might return  
:REF1\_D1:LABEL:FONT:UNDERLINE 0 indicating the underline font is off.

## REF<x>\_D<x>:LABel:NAME

Sets or queries the label of the specified digital bit. The channel is specified by x.

**Group** Digital

**Syntax** REF<x>\_D<x>:LABel:NAME <QString>  
REF<x>\_D<x>:LABel:NAME?

**Arguments** <QString> is the label.

**Examples** REF1\_D1:LABel:NAME "Clock in" sets the name to Clock in.  
REF1\_D1:LABel:NAME? might return :REF1\_D1:LABEL:NAME "Digital 1".

## REF<x>\_D<x>:LABel:XPOS

This command sets or queries the x-position of the label of the specified digital bit. The reference is specified by x.

**Group** Digital

**Syntax** REF<x>\_D<x>:LABel:XPOS <NR3>  
REF<x>\_D<x>:LABel:XPOS?

**Arguments** <NR3> is the x-position, in pixels relative to the left edge of the display, of the label.

**Examples** REF1\_D1:LABel:XPOS 90 sets the x position to 90.  
REF1\_D1:LABel:XPOS? might return :REF1\_D1:LABEL:XPOS 45.0000  
indicating the position is 45 pixels to the right of the left edge of the waveform.

## REF<x>\_D<x>:LABel:YPOS

This command sets or queries the y-position of the label of the specified digital bit. The channel is specified by x.

<b>Group</b>	Digital
<b>Syntax</b>	REF<x>_D<x>:LABel:YPOS <NR3> REF<x>_D<x>:LABel:YPOS?
<b>Arguments</b>	<NR3> is the y-position, in pixels relative to the baseline of the waveform, of the label.
<b>Examples</b>	REF1_D1:LABel:YPOS 10 sets the y position to 10.  REF1_D1:LABel:YPOS? might return :REF1_D1:LABEL:YPOS 0.0E+0 indicating the y position of the label is at the baseline of the waveform.

## REM (No Query Form)

This command (no query form) embeds a comment within programs as a means of internally documenting the programs. This is how to embed comments in a .set file. The instrument ignores these embedded comment lines.

<b>Group</b>	Miscellaneous
<b>Syntax</b>	REM <QString>
<b>Arguments</b>	<QString> is a string that can contain a maximum of 80 characters.
<b>Examples</b>	REM "This is a comment" is a comment string that the instrument will ignore.

## REMOTE:ACQUIRE (No Query Form)

This command acquires a single sequence on the specified remote Scope.

<b>Group</b>	Remote Scope
--------------	--------------

**Syntax**     REMOTE:ACQUIRE <NR1>

**Arguments**     <NR1> specifies the Remote Scope.

**Examples**     REMOTE:ACQUIRE 1 acquires a single sequence on Scope1.

## REMOTE:ACQStatus? (Query Only)

This command queries the status of the remote scope acquisition.

**Group**     Remote Scope

**Syntax**     REMOTE:ACQStatus?

**Returns**     Triggered indicates remote scope is reading the waveform in progress.  
Arming indicates remote scope is setting up the scope for trigger.  
Acquire indicates remote scope is performing acquisition.  
Offline indicates TekScope is offline.  
Cancel indicates remote scope is waiting for scope to trigger.  
Logging indicates Data Logging is in progress.  
Stopped indicates Data Logging in paused.  
Transfer indicates Continuous acquisition is in progress  
(:REMOTE:ACQMethod is set to CONTINUous or SEQuence and  
:REMOTE:RUNSTOP is set to RUN).

**Examples**     REMOTE:ACQStatus? might return :REMOTE:ACQStatus Auto, indicating the remote scope has been triggered by an input waveform.

## REMOTE:ADDNew (No Query Form)

This command adds the specified remote scope.

**Group**     Remote Scope

**Syntax**     REMOTE:ADDNew <Qstring>

**Arguments** <Qstring> is the remote scope to add. The argument is of the form "Scope<NR1>" where NR1 ≥ 1.

**Examples** REMOTE:ADDNEW "Scope1" adds Scope 1.

## REMOTE:ACQMethod

This command sets or queries whether the instrument continually acquires acquisitions or acquires a single sequence.

**Group** Acquisition

**Syntax** REMOTE:ACQMethod {CONTINUous | SINGLE | SEQUENCE}  
REMOTE:ACQMethod?

**Arguments** CONTINUous specifies that the instrument will continually acquire data if :REMOTE:RUNStop is set to RUN.

SINGLE specifies that the next acquisition will be a single-sequence acquisition if :REMOTE:RUNStop is set to RUN.

SEQUENCE specifies that the next acquisition will be a single-sequence acquisition if REMOTE:ACQUIRE is set to 1.

**Examples** REMOTE:ACQMETHOD CONTINUous sets the instrument to continually acquire data.

REMOTE:ACQMETHOD? might return SEQUENCE, indicating that the next acquisition the instrument makes will be of the single-sequence type.

## REMOTE:COMMInter

This command sets or queries communication Interface for remote connection.

**Group** Remote Scope

**Syntax** REMOTE:COMMInter {visa | Socket}  
REMOTE:COMMInter?

- Arguments**    `Vi sa` sets the remote communication interface to Visa.  
                  `Socket` sets the remote communication interface to Socket.
- Examples**      `REMOTE:COMMINTER Vi sa` sets the remote communication interface to Visa.  
                  `REMOTE:COMMINTER?` might return `Socket`, indicating the remote communication interface is set to Socket.

## REMOTE:CONTROL

This command sets or queries control the settings on the remote scope.

- Group**          Remote Scope
- Syntax**        `REMOTE:CONTROL <NR1>`  
                  `REMOTE:CONTROL?`
- Arguments**    `<NR1>` sets the control to 0 or 1. 0 sets the remote control to off. 1 sets the remote control to on.
- Examples**      `REMOTE:CONTROL 1` sets the remote control to on.  
                  `REMOTE:CONTROL?` might return 0, indicating remote control is off.

## REMOTE:DELEte (No Query Form)

This command delete the specified remote scope.

- Group**          Remote Scope
- Syntax**        `REMOTE:DELEte <Qstring>`
- Arguments**    `<Qstring>` is the remote scope to delete. The argument is of the form "Scope<NR1>" where  $NR1 \geq 1$ .
- Examples**      `REMOTE:DELETE "Scope1"` deletes Scope 1.

## REMOTE:LOGGING

This command sets or queries the act on event data logging feature.

<b>Group</b>	Act On Event
<b>Syntax</b>	REMOTE:LOGGING {START PAUSE STOP} REMOTE:LOGGING?
<b>Arguments</b>	START specifies that the act on event data logging feature is started, if REMOTE:ACQStatus is set to Acquire.  PAUSE specifies that the act on event data logging feature is paused.  STOP specifies that the act on event data logging feature is stopped.
<b>Examples</b>	REMOTE:LOGGING START starts the act on event data logging feature.  REMOTE:LOGGING? might return STOP, indicating that the act on event data logging feature is stopped.

## REMOTE:NUMACq? (Query Only)

This query-only command returns the number of waveform acquisitions that have occurred since the last time acquisitions were stopped.

<b>Group</b>	Acquisition
<b>Syntax</b>	REMOTE:NUMACq?
<b>Examples</b>	REMOTE:NUMACq? might return :REMOTE:NUMACQ 350, indicating that 350 acquisitions have occurred since executing an REMOTE:ACQMethod CONTINUous command.

## REMOTE:S<x>\_CH<x>:SV:CENTERFrequency

This command sets or queries the center frequency of the specified spectrum trace channel for Spectrum View. The scope and channel are specified by x.

<b>Group</b>	Spectrum View
--------------	---------------

**Syntax**      `REMOTE:S<x>_CH<x>:SV:CENTERFrequency <NR3>`  
`REMOTE:S<x>_CH<x>:SV:CENTERFrequency?`

**Related Commands**      [SV:LOCKCenter](#)

**Arguments**      <NR3> specifies the spectrum trace center frequency for the specified channel, in hertz. The range of values is 0.0 to the maximum licensed bandwidth of the instrument.

**Examples**      `REMOTE:S1_CH2:SV:CENTERFrequency 3.0E+06` sets the center frequency of the Scope 1 channel 2 spectrum trace to 3 MHz.

`REMOTE:S1_CH2:SV:CENTERFrequency?` might return `1.0E+07`, indicating that the center frequency of the Scope 1 channel 2 spectrum trace is set to 10 MHz.

## REMOTE:S<x>\_CH<x>:DIGGRP:THReshold

This command sets or queries the threshold level in volts for the specified remote scope channel. The scope and channel are specified by x.

**Group**      Digital

**Syntax**      `REMOTE:S<x>_CH<x>:DIGGRP:THReshold <NR3>`  
`REMOTE:S<x>_CH<x>:DIGGRP:THReshold?`

**Arguments**      <NR3> is the threshold level in volts for the specified remote scope digital channel.

**Examples**      `REMOTE:S1_CH1:DIGGRP:THReshold 30.0E-3` sets the threshold to 30 mV.

`REMOTE:S1_CH2:DIGGRP:THReshold?` might return  
`:REMOTE:S1_CH2:DIGGRP:THReshold 0.0E+0` , indicating the threshold is 0.0 V.

## REMOTE:S<x>\_CH<x>:DIGGRP:D<x>:THReshold

This command sets or queries the threshold level in volts for the specified digital channel. If the source channel doesn't exist, a hardware missing error event is set. The scope, channel, and digital channel bit number (0-7) are specified by x.

**Group**      Digital



<b>Syntax</b>	<pre>REMOTE:S&lt;x&gt;_CH&lt;x&gt;:DIGGRP:D&lt;x&gt;:THResho1d &lt;NR3&gt; REMOTE:S&lt;x&gt;_CH&lt;x&gt;:DIGGRP:D&lt;x&gt;:THResho1d?</pre>
<b>Arguments</b>	<NR3> is the threshold level in volts for the specified digital channel.
<b>Examples</b>	<pre>REMOTE:S1_CH1:DIGGRP:D1:THResho1d 30.0E-3 sets the threshold to 30 mV.  REMOTE:S1_CH2:DIGGRP:D2:THResho1d? might return :REMOTE:S1_CH2:DIGGRP:D2:THResho1d 0.0E+0 indicating the threshold is 0.0 V.</pre>

## REMOTE:S<x>\_CH<x>:SV:POSition

This command sets or queries the Spectrum Time setting of the specified spectrum trace channel in the Spectrum View. Remote scope and channel are specified by x.

<b>Group</b>	Spectrum View
<b>Syntax</b>	<pre>REMOTE:S&lt;x&gt;_CH&lt;x&gt;:SV:POSition &lt;NR3&gt; REMOTE:S&lt;x&gt;_CH&lt;x&gt;:SV:POSition?</pre>
<b>Related Commands</b>	<a href="#">SV:LOCKpectrum</a>
<b>Arguments</b>	<NR3> specifies the spectrum time location, as a percentage of the record length. The range of values is 0.0% to 100%.
<b>Examples</b>	<pre>REMOTE:S1_CH2:SV:POSition 25 sets the Scope 1 channel 2 spectrum trace spectrum time value to 25%.  REMOTE:S1_CH4:POSition? might return 74.0, indicating that the spectrum time value of the Scope 1 channel 4 spectrum trace is set to 74%.</pre>

## REMOTE:S<x>\_CH<x>:PROBETYPE? (Query Only)

This command returns the probe type connected to the specified channel. Remote scope and channel are specified by x.

<b>Group</b>	Vertical
--------------	----------

**Syntax** REMOTE:S<x>\_CH<x>:PROBETYPE?

**Returns** The probe type value returns analog or digital.

**Examples** REMOTE:S1\_CH1:PROBETYPE? might return :REMOTE:S1\_CH1:PROBETYPE ANALOG, indicating the probe type for Scope 1 channel 1 is analog.

## REMOTE:S<x>\_CH<x>:SElect:DIGGRP:Da11

This command sets or queries the display state of the specified digital channel in the specified Waveform View. The scope and channel are specified by x.

**Group** Digital

**Syntax** REMOTE:S<x>\_CH<x>:SElect:DIGGRP:Da11 {<NR1>|OFF|ON}  
REMOTE:S<x>\_CH<x>:SElect:DIGGRP:Da11?

**Arguments** <NR1> sets the display state. 0 disables the display of the specified channels on the specified Waveform View; any other value turns this feature on.  
OFF disables the display of the specified channels on the specified Waveform View.  
ON enables the display of the specified channels on the specified Waveform View.

**Examples** REMOTE:S1\_CH1:SElect:DIGGRP:Da11 ON enables the display of the specified channels on the specified Waveform View.

REMOTE:S1\_CH2:SElect:DIGGRP:Da11? might return :REMOTE:S1\_CH2:SElect:DIGGRP:Da11 0, indicating specified digital channels in the specified Waveform View are off.

## REMOTE:S<x>\_CH<x>:STAtE

This command sets or queries the state of the specified remote channel in the specified Waveform View.

**Group** Remote Scope

**Syntax** REMOTE:S<x>\_CH<x>:STAtE <NR1>  
REMOTE:S<x>\_CH<x>:STAtE?

**Arguments** S<x> indicates the remote scope.  
 CH<x> indicates the channel number associated with remote scope.  
 <NR1> sets the channel state value 0 or 1. 0 sets the channel state to false. 1 sets the channel state to true.

**Examples** REMOTE:S1\_CH2:STATe 0 sets the remote scope 1 channel 2 state to false.  
 REMOTE:S1\_CH4:STATe? might return 1, indicating the remote scope 1 channel 4 state is true.

## REMOTE:S<x>\_CH<x>:SV:STATE

This command sets or queries the on/off setting of data acquisition for the specified spectrum trace channel. S<x> is the remote scope number and Ch<x> is the channel number.

**Group** Spectrum View

**Syntax** REMOTE:S<x>\_CH<x>:SV:STATE {ON|OFF}  
 REMOTE:S<x>\_CH<x>:SV:STATE?

**Arguments** ON enables spectrum data acquisition for the specified spectrum trace channel source.  
 OFF disables spectrum data acquisition for the specified spectrum trace channel source.

**Examples** REMOTE:S1\_CH2:SV:STATE ON turns on Spectrum View data acquisition for Scope 1 channel 2 spectrum trace.  
 REMOTE:S1\_CH4:STATE? might return OFF, indicating that Spectrum View data acquisition is turned off for Scope 1 channel 2 spectrum trace.

## REMOTE:S<x>\_CH<x>:SV:STARTFrequency? (Query Only)

This command queries the start frequency of the specified spectrum trace channel in the Spectrum View window. S<x> is the remote scope number and Ch<x> is the channel number.

**Group** Spectrum View

**Syntax** REMOTE:S<x>\_CH<x>:SV:STARTFrequency?

**Returns** <NR3> specifies the start frequency value in hertz.

**Examples** REMOTE:S1\_CH4:SV:STARTFrequency? might return 35.7E+6, indicating the start frequency for the Scope 1 channel 4 spectrum trace is 35.7 MHz.

## REMOTE:S<x>\_CH<x>:SV:STOPFrequency? (Query Only)

This command queries the stop frequency of the specified spectrum trace channel in the Spectrum View window. S<x> is the remote scope number and Ch<x> is the channel number.

**Group** Spectrum View

**Syntax** REMOTE:S<x>\_CH<x>:SV:STOPFrequency?

**Returns** <NR3> specifies the stop frequency value in hertz.

**Examples** REMOTE:S1\_CH4:SV:STOPFrequency? might return 95.1E+6, indicating the stop frequency for the Scope 1 channel 4 spectrum trace is 95.1 MHz.

## REMOTE:S<x>\_DCH<x>:D<x>:THReshold

This command sets or queries the threshold level in volts for the specified digital channel. The scope, channel, and digital channel bit number (0-15) are specified by x.

**Group** Digital

**Syntax** REMOTE:S<x>\_DCH<x>:D<x>:THReshold <NR3>  
REMOTE:S<x>\_DCH<x>:D<x>:THReshold?

**Returns** <NR3> is the threshold level in volts for the specified digital channel.

**Examples**    `REMOTE:S1_DCH1:D1:THReshold 30.0E-3` sets the threshold to 30 mV.  
`REMOTE:S1_DCH1:D1:THReshold?` might return  
`:REMOTE:S1_DCH1:D1:THReshold 0.0E+0`, indicating the threshold is 0.0 V.

## REMOTE:S<x>\_DCH<x>:GROUP<x>THReshold

This command sets or queries the digital threshold of all bits in digital group 0 (D0-D7) or group 1 (D8-D15) on S<x>\_DCH<x>. The scope and channel are specified by x.

**Group**    Digital

**Syntax**    `REMOTE:S<x>_DCH<x>:GROUP<x>THReshold <NR3>`  
`REMOTE:S<x>_DCH<x>:GROUP<x>THReshold?`

**Returns**    `GROUP<x>` specifies the digital group number. The valid values are 0 or 1. Group 0 is D0 - D7. Group 1 is D8 - D15.  
<NR3> specifies the threshold level in volts for the specified digital channel group.

**Examples**    `REMOTE:S1_DCH1:GROUP1THReshold 30.0E-3` sets the threshold to 30 mV for digital group1 (D8 - D15).  
`REMOTE:S1_DCH1:GROUP1THReshold?` might return  
`:REMOTE:S1_DCH1:GROUP1THReshold 0.0E+0` , indicating the threshold is 0.0 V for digital group1 (D8 - D15).

## REMOTE:S<x>\_DCH<x>:SElect:DAI1

This command turns on or off all constituent digital channels (D0 through D15) of the specified source channel. The scope and channel are specified by x.

**Group**    Digital

**Syntax**    `REMOTE:S<x>_DCH<x>:SElect:DAI1 {<NR1>|OFF|ON}`  
`REMOTE:S<x>_DCH<x>:SElect:DAI1?`

**Returns**    <NR1> sets the display state. 0 disables the display of the specified channels on the specified Waveform View; any other value turns this feature on.  
OFF disables the display of the specified channels on the specified Waveform View.

ON enables the display of the specified channels on the specified Waveform View.

**Examples**    `REMOTE:S1_DCH1:SElect:DA11 ON` enables the display of the specified channels on the specified Waveform View.

`REMOTE:S1_DCH1:SElect:DA11?` might return  
`:REMOTE:S1_DCH1:SElect:DA11 0`, indicating specified digital channels in the specified Waveform View are off.

## REMOTE:SEquence:CURrent? (Query Only)

In single sequence acquisition mode, this query returns the number of acquisitions or measurements in the sequence completed so far.

**Group**    Acquisition

**Syntax**    `REMOTE:SEquence:CURrent?`

**Examples**    `REMOTE:SEQUENCE:CURRENT?` might return `:REMOTE:SEQUENCE:CURRENT 5`, indicating the number of acquisitions is 5.

## REMOTE:SEquence:NUMSEquence

In single sequence acquisition mode, specify the number of acquisitions or measurements that comprise the sequence. The default is 1.

**Group**    Acquisition

**Syntax**    `REMOTE:SEquence:NUMSEquence <NR1>`  
`REMOTE:SEquence:NUMSEquence?`

**Arguments**    `<NR1>` is the number of acquisitions or measurements that comprise the sequence.

**Examples**    `REMOTE:SEQUENCE:NUMSEQUENCE 2` sets the number of acquisition in a sequence is set to 2.

`ACQUIRE:SEQUENCE:NUMSEQUENCE?` might return 1, indicating that the number of acquisition in a sequence is set to 1.

## REMOTE:SCOPE<x>:BANDWidth? (Query Only)

This command queries the maximum licensed bandwidth of the specified remote scope.

**Group** Remote Scope

**Syntax** REMOTE:SCOPE<x>:BANDwidth?

**Arguments** SCOPE<x> specifies the remote scope number.

**Examples** REMOTE:SCOPE1:BANDwidth? might return :REMOTE:SCOPE1:BANDwidth 2.0000E+9, indicating the maximum licensed bandwidth of Scope1 is 2.0000E+9.

## REMOTE:SCOPE<x>:CONNECT (No Query Form)

This command connects the specified Remote Scope.

**Group** Remote Scope

**Syntax** REMOTE:SCOPE<x>:CONNECT <NR1>

**Arguments** SCOPE<x> specifies the remote scope number.  
<NR1> sets the Remote Scope to connect to.

**Examples** REMOTE:SCOPE1:CONNECT 1 connects to Remote Scope1.

## REMOTE:SCOPE<x>:CONNECTIONMessage? (Query Only)

This command queries the connection status message for the specified remote scope.

**Group** Remote Scope

**Syntax** REMOTE:SCOPE<x>:CONNECTIONMessage?

**Arguments** SCOPE<x> specifies the remote scope number.

**Examples** REMOTE:SCOPE1:CONNECTIONState? might return  
:REMOTE:SCOPE1:CONNECTIONState "Connected" if the scope is connected  
and the waveform is acquired without any error else returns actual error message.

## REMOTE:SCOPE<x>:CONNECTIONState? (Query Only)

This command queries the connected state for the specified remote scope.

**Group** Remote Scope

**Syntax** REMOTE:SCOPE<x>:CONNECTIONState?

**Arguments** SCOPE<x> specifies the remote scope number.

**Examples** REMOTE:SCOPE1:CONNECTIONState? might return might return error, warning,  
or ok.

## REMOTE:SCOPE<x>:DISCONNECT (No Query Form)

This command disconnects the specified Remote Scope.

**Group** Remote Scope

**Syntax** REMOTE:SCOPE<x>:DISCONNECT

**Arguments** SCOPE<x> specifies the remote scope number.  
<NR1> sets the Remote Scope to disconnect.

**Examples** REMOTE:SCOPE1:DISCONNECT disconnects the Remote Scope1.

## REMOTE:SCOPE<x>:HORIZONTAL:FASTframe:COUNT? (Query Only)

This command returns the number of frames.



FastFrame on the Remote scope should be turned ON before connecting from TekScope.

<b>Group</b>	Remote Scope
<b>Syntax</b>	REMOTE:SCOPE<x>:HORizontal:FASTframe:COUNT?
<b>Arguments</b>	SCOPE<x> specifies the remote scope number.
<b>Examples</b>	REMOTE:SCOPE1:HORizontal:FASTframe:COUNT? might return :REMOTE:SCOPE1:HORizontal:FASTframe:COUNT 10, indicating number of frames is 10.

## REMOTE:SCOPE<x>:HORizontal:FASTframe:MAXFrames? (Query Only)

This query returns the maximum number of frames.

FastFrame on the Remote scope should be turned ON before connecting from TekScope.

<b>Group</b>	Remote Scope
<b>Syntax</b>	REMOTE:SCOPE<x>:HORizontal:FASTframe:MAXFrames?
<b>Arguments</b>	SCOPE<x> specifies the remote scope number.
<b>Examples</b>	REMOTE:SCOPE1:HORizontal:FASTframe:MAXFrames? might return :REMOTE:SCOPE1:HORizontal:FASTframe:MAXFrames 2, indicating the maximum number of frames is 2.

## REMOTE:SCOPE<x>:HORizontal:FASTframe:SELECTED? (Query Only)

This command returns the selected frame number for acquired frames. Refs have their own selected frames.

FastFrame on the Remote scope should be turned ON before connecting from TekScope.

<b>Group</b>	Remote Scope
--------------	--------------

**Syntax** REMOTE:SCOPE<x>:HORIZONTAL:FASTframe:SELECTED?

**Arguments** SCOPE<x> specifies the remote scope number.

**Examples** REMOTE:SCOPE1:HORIZONTAL:FASTframe:SELECTED? might return  
:REMOTE:SCOPE1:HORIZONTAL:FASTframe:SELECTED 1, indicating the  
selected frame number is 1.

## REMOTE:SCOPE<x>:HORIZONTAL:FASTframe:STATE? (Query Only)

This command returns the state of FastFrame. Acquisition modes Envelope and Average are not compatible with FastFrame. If FastFrame is on, an attempted set to those acquisition modes will fail and revert to Sample mode. If FastFrame is turned on while in one of those acquisition modes, the acquisition mode is changed to Sample.

FastFrame on the Remote scope should be turned ON before connecting from TekScope.

**Group** Remote Scope

**Syntax** REMOTE:SCOPE<x>:HORIZONTAL:FASTframe:STATE?

**Arguments** SCOPE<x> specifies the remote scope number.

**Examples** REMOTE:SCOPE1:HORIZONTAL:FASTframe:STATE? might return  
:REMOTE:SCOPE1:HORIZONTAL:FASTframe:STATE 1, indicating FastFrame  
is on.

## REMOTE:SCOPE<x>:HORIZONTAL:FASTframe:SUMFrame? (Query Only)

This command returns the summary frame type. Turning on Summary Frame does not adjust the numberFrames value as long as there is room for an additional frame. If there is not enough room then numberFrames will be reduced by 1. The numberFrames value is always the number of frames to acquire.

FastFrame on the Remote scope should be turned ON before connecting from TekScope.

**Group** Remote Scope

<b>Syntax</b>	REMOTE:SCOPE<x>:HORizontal:FASTframe:SUMFrame?
<b>Arguments</b>	SCOPE<x> specifies the remote scope number.
<b>Examples</b>	REMOTE:SCOPE1:HORizontal:FASTframe:SUMFrame? might return :REMOTE:SCOPE1:HORizontal:FASTframe:SUMFrame AVERAGE, indicating the summary frame is Average.

## REMOTE:SCOPE<x>:HORizontal:FASTframe:SUMFrame:STATE? (Query Only)

This command returns the state of FastFrame summary frame. Summary frame mode is set automatically based on the acquisition mode. When in Sample mode, the summary frame type is set to Average. When in Peak Detect mode, the summary frame type is set to Envelope. When in High Res mode, the summary frame type is set to Average.

FastFrame on the Remote scope should be turned ON before connecting from TekScope.

<b>Group</b>	Remote Scope
<b>Syntax</b>	REMOTE:SCOPE<x>:HORizontal:FASTframe:SUMFrame:STATE?
<b>Arguments</b>	SCOPE<x> specifies the remote scope number.
<b>Examples</b>	REMOTE:SCOPE1:HORizontal:FASTframe:SUMFrame:STATE? might return :REMOTE:SCOPE1:HORizontal:FASTframe:SUMFrame:STATE 0, indicating the summary frame is off.

## REMOTE:SCOPE<x>:IPADDRESS

This command sets or queries the IP Address or host name for the specified remote scope.

<b>Group</b>	Remote Scope
<b>Syntax</b>	REMOTE:SCOPE<x>:IPADDRESS <Qstring> REMOTE:SCOPE<x>:IPADDRESS?

- Arguments** SCOPE<x> specifies the remote scope number.
- <Qstring> is the remote scope IP Address or host name. The argument is of the form "ScopeIPAddress".
- Examples** REMOTE:SCOPE1:IPADDRESS "123.45.67.89" sets the remote Scope1 IP Address to 123.45.67.89.
- REMOTE:SCOPE1:IPADDRESS? might return :REMOTE:SCOPE1:IPADDRESS 1.1.1.1 if IP Address is not set, else returns the remote Scope1 IP Address.

## REMOTE:SCOPE<x>:MODELname? (Query Only)

This command returns model name of the specified remote scope.

- Group** Remote Scope
- Syntax** REMOTE:SCOPE<x>:MODELname?
- Arguments** SCOPE<x> specifies the remote scope number.
- Examples** REMOTE:SCOPE1:MODELname? will return the model name of Scope1.

## REMOTE:SCOPE<x>:PORT

This command sets or queries the port number for the specified remote scope.

- Group** Remote Scope
- Syntax** REMOTE:SCOPE<x>:PORT <NR1>  
REMOTE:SCOPE<x>:PORT?
- Arguments** SCOPE<x> specifies the remote scope number.
- <NR1> is the remote scope port number. The argument is of the form <NR1> where  $NR1 \geq 1$ .

**Examples**    `REMOTE:SCOPE1:PORT 4000` sets the remote Scope1 port number to 4000.

`REMOTE:SCOPE1:PORT?` might return `:REMOTE:SCOPE1:PORT 4000`, indicating that the port number is 4000.

## REMOTE:SCOPE<x>:SCREEn:CAPTuRe (No Query Form)

This command saves a capture of the Remote Scope screen contents to the specified image file. The supported image formats are PNG and JPEG. When specifying the file name with this command, use the correct file extension (".png" for PNG format, or ".jpg" for JPEG format). If a file name or path is specified, the file is expected to be located in a directory relative to the current working directory (specified by `:FILESystem:CWD` unless a complete path is specified: Complete path specification. If the file argument begins with drive designator (such as C:), then the file name is interpreted as a full path. Relative path specification. If the file argument begins with "." or ".." or has a file path separator appearing anywhere other than the first character position, then the file name is treated as a path that is relative to the current working directory.

**Group**    Remote Scope

**Syntax**    `REMOTE:SCOPE<x>:SCREEn:CAPTuRe <QString>`

**Arguments**    `SCOPE<x>` specifies the remote scope number.

`<QString>` is the file name and location used to store the image file.

**Examples**    `REMOTE:SCOPE1:SCREEn:CAPTuRe "C:/Dut12-tests.png"` saves the image at the location specified.

## REMOTE:SCOPE<x>:State? (Query Only)

This command queries the connected state for the specified remote scope.

**Group**    Remote Scope

**Syntax**    `REMOTE:SCOPE<x>:State?`

**Arguments**    `SCOPE<x>` specifies the remote scope number.

**Returns** Returns the remote scope state as none, CONNECTED, CONNECTWITHWARNING, or DISCONNECTED.

**Examples** REMOTE:SCOPE1:State? might return :REMOTE:SCOPE1:State CONNECTED, indicating that Scope1 is connected.

## REMOTE:SCOPE<x>:SYNC (No Query Form)

This command refreshes the channel data from the specified remote scope.

**Group** Remote Scope

**Syntax** REMOTE:SCOPE<x>:SYNC <NR1>

**Arguments** SCOPE<x> specifies the remote scope number.  
<NR1> is the remote scope port number. The argument is of the form <NR1> where  $NR1 \geq 1$ .

**Examples** REMOTE:SCOPE1:SYNC 1 sets the remote Scope1 port number to 4000.

## REMOTE:SCOPE<x>:VISACONNECTIONtype

This command sets or queries VISA connection type for remote scope connection.

**Group** Remote Scope

**Syntax** REMOTE:SCOPE<x>:VISACONNECTIONtype {Network|USB}  
REMOTE:SCOPE<x>:VISACONNECTIONtype?

**Arguments** SCOPE<x> specifies the remote scope number.  
Network sets the remote scope connection type to Network.  
USB sets the remote scope connection type to USB.

**Examples** REMOTE:SCOPE1:VISACONNECTIONtype Network sets the remote Scope1 connection type to Network.

REMOTE:SCOPE1:VISACONNECTIONtype? might return  
:REMOTE:SCOPE1:VISACONNECTIONtype Network, indicating that  
the Scope1 connection type is Network.

## REMOTE:SV:RBW

This command sets or queries the resolution bandwidth (RBW) when the RBW mode has been set to MANUAL (using the command REMOTE:SV:RBWMode).

The resolution bandwidth is the width of the narrowest measurable band of frequencies in a Spectrum View trace. By default, the RBW tracks the span value in a 1000:1 ratio. The RBW determines the level to which the instrument can resolve individual frequencies in the frequency domain. For example, if the input signal contains two carriers separated by 1 kHz, you will not be able to discriminate between them unless the RBW is less than 1 kHz.

**Group** Spectrum View

**Syntax** REMOTE:SV:RBW <NR3>  
REMOTE:SV:RBW?

**Related Commands** [REMOTE:SV:RBWMode](#)

**Arguments** <NR3> specifies the width of the narrowest measurable band of frequencies in a Spectrum View trace, in Hz.

**Examples** REMOTE:SV:RBW 2.0E+04 sets the RBW to 20 kHz.  
REMOTE:SV:RBW? might return 3.0E+6, indicating that the RBW has been set to 3 MHz.

## REMOTE:SV:RBWMode

This command sets or queries the resolution bandwidth (RBW) mode, either Automatic or Manual.

**Group** Spectrum View

**Syntax** REMOTE:SV:RBWMode {AUTOMATIC|MANUAL}  
REMOTE:SV:RBWMode?

**Related Commands**    [REMOTE:SV:RBW](#)  
                               [REMOTE:SV:SPANRBWRatio](#)

**Arguments**    **AUTOMATIC** specifies the resolution bandwidth automatically as the span is changed. The default behavior is 1000:1, but you can set it to other values in a 1-2-5 sequence (e.g. 10000, 20000, 50000). To specify the RBW ratio that will be used when the mode is set to automatic, use the command `REMOTE:SV:SPANRBWRatio`.

**MANUAL** specifies to set the resolution bandwidth, independently from the span, using the command `REMOTE:SV:RBW`.

**Examples**    `REMOTE:SV:RBWMode MANUAL` sets the RBW mode to Manual.

`REMOTE:SV:RBWMode?` might return `AUTO`, indicating that the RBW mode is set to Automatic mode (default).

## REMOTE:SV:SPAN

This command sets or queries the span setting for all channels in the Spectrum View. The span is the range of frequencies that can be observed centered on the center frequency. This is the width of the frequency domain trace, which is from the center frequency  $- \frac{1}{2}$ span to the center frequency  $+ \frac{1}{2}$  span.

**Group**    Spectrum View

**Syntax**    `REMOTE:SV:SPAN <NR3>`  
               `REMOTE:SV:SPAN?`

**Arguments**    `<NR3>` specifies the span value in Hz.

**Examples**    `REMOTE:SV:SPAN 2E+9` sets the span to 2 GHz.

`REMOTE:SV:SPAN?` might return `10.0E+6`, indicating that the span is 10 MHz.

## REMOTE:SV:SPANRBWRatio

This command sets or queries the ratio of the span to the resolution bandwidth (RBW) that will be used when the RBW Mode is set to `AUTO`.

The span is the width of the frequency domain trace in Hz, which is equal to the stop frequency minus the start frequency. The RBW is the width of the narrowest



measurable band of frequencies in a frequency domain trace. The default RBW ratio is 1000 : 1.

Use the command `REMOTE:SV:RBWMode` to set the RBW Mode to Automatic.

**Group** Spectrum View

**Syntax** `REMOTE:SV:SPANRBWRatio <NR3>`  
`REMOTE:SV:SPANRBWRatio?`

**Related Commands** [REMOTE:SV:RBWMode](#)

**Arguments** `<NR3>` specifies the span-to-RBW ratio.

**Examples** `REMOTE:SV:SPANRBWRatio 1000` sets the RBW to one one-thousandth of the span.

`REMOTE:SV:SPANRBWRatio?` might return `1.00E+3`, which means the RBW has been set to one one-thousandth of the span.

## REMOTE:SV:WINDOW

This command sets or queries the window type used by the windowing function of the Spectrum View. The windowing function is a Fast Fourier Transform (FFT) technique used to minimize the discontinuities between successive frames of an RF time domain signal. The default window type is Blackman-Harris.

**Group** Spectrum View

**Syntax** `REMOTE:SV:WINDOW {KAISerbessel|RECTangular|HAMMING|HANNing|BLACKmanharris|FLATtop2}`  
`REMOTE:SV:WINDOW?`

**Arguments** `KAISerbessel` specifies the Kaiser-Bessel window type (a high or moderate resolution window).

`RECTangular` specifies the Rectangular window type (a window function is equivalent to multiplying all gate data by one).

`HAMMING` specifies the Hamming window type (a high or moderate resolution window based on a cosine series).

**HANNing** specifies the Hanning window type (a high or moderate resolution window based on a cosine series).

**BLACKmanharris** specifies the Blackman-Harris window type (a low-resolution (high dynamic range) window based on a cosine series).

**FLATtop2** specifies the Flattop2 window type (a low-resolution (high dynamic range) window).

**Examples** `REMOTE:SV:WINDOW BLACKmanharris` sets the window to Blackman-Harris.  
`REMOTE:SV:WINDOW?` might return `KAISER`, indicating that the window function is set to Kaiser-Bessel.

## REMOTE:USBDEscriptors

This command sets or queries the USB descriptors available for remote connection.

**Group** Remote Scope

**Syntax** `REMOTE:USBDEscriptors {Usb0|Usb1}`  
`REMOTE:USBDEscriptors?`

**Arguments** `Usb0` sets the usb address of the first specified scope.  
`Usb1` sets the usb address of the second specified scope.

**Examples** `REMOTE:USBDESCRIPTORS Usb0` sets the usb address of Scope1.  
`REMOTE:USBDESCRIPTORS?` might return `Usb1`, indicating the scope connected to the PC in which TekScope is running is Usb1.

## \*RST (No Query Form)

This command (no query form) resets the instrument to the factory default settings.

This command does the following:

- Recalls the default instrument setup.
- Clears the current `*DDT` command.
- Disables aliases (`:ALIAS:STATE 0`).
- Disables the user password (for the `*PUD` command).

The \*RST command does not change the following:

- The current working directory (:FILESystem:CWD command).
- The state of command headers (:HEADer command).
- The state of keyword and enumeration verbosity (:VERBOse command).
- The Power-on Status Clear Flag (\*PSC command).
- The Event Status Enable Register (\*ESE command).
- The Service Request Enable Register (\*SRE command).
- The Device Event Status Enable Register (DESE command).
- The user password for protected user data (:PASSWOrd command).
- The content of protected user data (\*PUD command).
- The enabled state of the socket server (:SOCKETServer:ENAbLe command).
- The socket server port number (:SOCKETServer:PORT command).
- The socket server protocol (:SOCKETServer:PROTOCOl command).
- The USBTMC port configuration (:USBDeVice:CONFIgure command).
- The destination reference waveform or file path for the :CURVe command (:DATA:DESTInation command).
- The source waveform for the :CURVe? or :WAVFrm? queries (:DATA:SOURce command).
- The waveform data encoding for the :CURVe command or query or the :WAVFrm? query (:DATA:ENCdg command).
- The starting point for :CURVe? queries (:DATA:STARt command).
- The ending point for :CURVe? queries (:DATA:STOP command).
- All settings associated the :WFMIpre commands.
- All user settable settings associated with the WFMOutpre commands.

\*RST only resets the programmable interface settings, it does not change the user interface settings.

**Group** Status and Error

**Syntax** \*RST

**Related Commands** [FACtory](#)  
[RECAIl:SETUp](#)

**Arguments** None

**Examples** \*RST resets the instrument settings to factory defaults.

## S<x>\_CH<x>:BANDwidth:ACTUal? (Query Only)

Queries whether the actual bandwidth of the specified remote scope channel. The remote scope and channel is specified by x.

**Group** Vertical

**Syntax** S<x>\_CH<x>:BANDwidth:ACTUal?

**Examples** S1\_CH4: BANDwidth: ACTUal? might return :S1\_CH4: BANDwidth: ACTUal 500.0000E+6, indicating that the Scope 1 channel actual bandwidth is 500 MHz.

## S<x>\_CH<x>:CLIPping? (Query Only)

Queries whether the specified remote scope channel's input signal is clipping (exceeding) the channel A/D converter range. The remote scope and channel is specified by x.

**Group** Vertical

**Syntax** S<x>\_CH<x>:CLIPping?

**Related Commands** [S<x>\\_CH<x>:SCALE](#)  
[S<x>\\_CH<x>:POSITION](#)

**Returns** This query will return one of the following:  
0 indicates the channel is not clipping.  
1 indicates the channel is clipping.

**Examples** S1\_CH4: CLIPping? might return S1\_CH4: CLIPping? 1, indicating that the input signal range is exceeding (clipping) the scope 1 channel 4 A/D converter range.

## S<x>\_CH<x>:COUPLing

This command sets or queries the input coupling setting for the specified remote scope analog channel. The remote scope and the channel is specified by x.

---

**NOTE.** *The available arguments depend on the attached accessories.*

---

<b>Group</b>	Vertical
<b>Syntax</b>	S<x>_CH<x>:COUPLing {AC DC DCREJ} S<x>_CH<x>:COUPLing?
<b>Arguments</b>	AC sets the specified channel to AC coupling. DC sets the specified channel to DC coupling. DCREJECT sets DC Reject coupling when probes are attached that support that feature.
<b>Examples</b>	S1_CH2:COUPLING AC sets Scope 1 Channel 2 coupling to AC. S1_CH4:COUPLING? might return :S1_CH3:COUPLING DC, indicating that Scope 1 Channel 4 is set to DC coupling.

## S<x>\_CH<x>:DESKew

This command sets or queries the horizontal deskew time for the specified channel. The remote scope and channel is specified by x.

<b>Group</b>	Vertical
<b>Syntax</b>	S<x>_CH<x>:DESKew <NR3> S<x>_CH<x>:DESKew?
<b>Arguments</b>	<NR3> is the deskew time for this channel, ranging from -125 ns to +125 ns with a resolution of 40 ps. Out-of-range values are clipped.
<b>Examples</b>	S1_CH4:DESKew 5.0E-9 sets the deskew time for Scope 1 Channel 4 to 5 ns. S1_CH2:DESKew? might return :S1_CH2:DESKew 2.0000E-09, indicating that the deskew time for Scope 1 Channel 2 is set to 2 ns.

## S<x>\_CH<x>:LABel:COLor

This command sets or queries the color of the specified remote scope channel label. The remote scope and channel is specified by x.

**Group** Vertical

**Syntax** S<x>\_CH<x>:LABel:COLor <QString>  
S<x>\_CH<x>:LABel:COLor?

**Arguments** <QString> is the label color. To return the color to the default color, send an empty string as in this example: S1\_CH5:LABEL:COLOR "".

**Examples** S1\_CH2:LABel:COLor "#FFFF00" sets the label color to yellow.  
S1\_CH2:LABel:COLor? might return S1\_CH2:LABEL:COLOR "#FF0000" indicating the color is red.

## S<x>\_CH<x>:LABel:FONT:BOLD

This command sets or queries the bold state of the specified remote scope channel label. The remote scope and channel is specified by x.

**Group** Vertical

**Syntax** S<x>\_CH<x>:LABel:FONT:BOLD {ON|OFF|<NR1>}  
S<x>\_CH<x>:LABel:FONT:BOLD?

**Arguments** OFF argument turns off bold font.  
ON argument turns on bold font.  
<NR1> = 0 turns off bold font; any other value turns on bold font.

**Examples** S1\_CH2:LABel:FONT:BOLD OFF turns off the bold font.  
S1\_CH2:LABel:FONT:BOLD? might return :S1\_CH2:LABEL:FONT:BOLD 1 indicating a bold font.

## S<x>\_CH<x>:LABel:FONT:ITALic

This command sets or queries the italic state of the specified remote scope channel label. The remote scope and channel is specified by x.

**Group** Vertical

**Syntax** S<x>\_CH<x>:LABel:FONT:ITALic {ON|OFF|<NR1>}  
S<x>\_CH<x>:LABel:FONT:ITALic?

**Arguments** OFF argument turns off italic font.  
ON argument turns on italic font.  
<NR1> = 0 turns off italic font; any other value turns on italic font.

**Examples** S1\_CH2:LABel:FONT:ITALic ON set the font to italic.  
S1\_CH2:LABel:FONT:ITALic? might return :S1\_CH2:LABEL:FONT:ITALIC  
0 indicating the font is not italic.

## S<x>\_CH<x>:LABel:FONT:SIZE

This command sets or queries the font size of the specified channel label. The remote scope and channel is specified by x.

**Group** Vertical

**Syntax** S<x>\_CH<x>:LABel:FONT:SIZE <NR1>  
S<x>\_CH<x>:LABel:FONT:SIZE?

**Arguments** <NR1> is the font size.

**Examples** S1\_CH2:LABel:FONT:SIZE 16 sets the font size to 16 point size.  
S1\_CH2:LABel:FONT:SIZE? might return :S1\_CH2:LABEL:FONT:SIZE 20  
indicating a 20 point font size.

## S<x>\_CH<x>:LABel:FONT:TYPE

This command sets or queries the font type of the specified remote scope channel label, such as Arial or Times New Roman. The remote scope and channel is specified by x.

**Group** Vertical

**Syntax** S<x>\_CH<x>:LABel:FONT:TYPE <QString>  
S<x>\_CH<x>:LABel:FONT:TYPE?

**Arguments** <QString> is the specified font type.

**Examples** S1\_CH2:LABel:FONT:TYPE "Monospace" sets the font to a mono space font.  
S1\_CH2:LABel:FONT:TYPE? might return :S1\_CH2:LABel:FONT:TYPE "Frutiger LT Std 55 Roman".

## S<x>\_CH<x>:LABel:FONT:UNDERline

This command sets or queries the underline state of the specified channel label. The channel is specified by x.

**Group** Vertical

**Syntax** S<x>\_CH<x>:LABel:FONT:UNDERline {ON|OFF|<NR1>}  
S<x>\_CH<x>:LABel:FONT:UNDERline?

**Arguments** OFF argument turns off underlined font.  
ON argument turns on underlined font.  
<NR1> = 0 turns off underlined font; any other value turns on underlined font.

**Examples** S1\_CH2:LABel:FONT:UNDERline ON sets the font to underlined.  
S1\_CH2:LABel:FONT:UNDERline? might return :S1\_CH2:LABel:FONT:UNDERLINE 0 indicating the font is not underlined.



## S<x>\_CH<x>:LABel:NAME

This command sets or queries the label attached to the displayed waveform for the specified remote scope channel. The remote scope and channel is specified by x.

**Group** Vertical

**Syntax** S<x>\_CH<x>:LABel:NAME <QString>  
S<x>\_CH<x>:LABel:NAME?

**Arguments** <QString> is an alphanumeric character string, ranging from 1 through 32 characters in length.

**Examples** S1\_CH2:LABEL:NAME "Pressure" changes the waveform label for the Scope 1 Channel 2 waveform to "Pressure".

S1\_CH3:LABEL:NAME? might return CH3:LABEL:NAME "Force", indicating that the waveform label for the Scope 1 Channel 3 waveform is "Force".

## S<x>\_CH<x>:LABel:XPOS

This command sets or queries the X-position of the specified remote scope channel. The remote scope and channel is specified by x.

**Group** Vertical

**Syntax** S<x>\_CH<x>:LABel:XPOS <NR3>  
S<x>\_CH<x>:LABel:XPOS?

**Arguments** <NR3> is the location (in pixels) where the waveform label for the selected channel is displayed, relative to the left edge of the screen.

**Examples** S1\_CH2:LABEL:XPOS 5 moves the waveform label for Scope 1 Channel 2 so that it begins 5 pixels to the right of the left edge of the screen.

S1\_CH2:LABEL:XPOS? might return :S1\_CH2:LABEL:XPOS 5, indicating that the waveform label for Scope 1 Channel 2 currently 5 pixels to the right of the left edge of the screen.

## S<x>\_CH<x>:LABel:YPOS

This command sets or queries the Y-position of the specified remote scope channel. The remote scope and channel is specified by x.

**Group** Vertical

**Syntax** S<x>\_CH<x>:LABel:YPOS <NR3>  
S<x>\_CH<x>:LABel:YPOS?

**Arguments** <NR3> is the location (in pixels) where the waveform label for the selected channel is displayed, relative to the baseline of the waveform. Positive values are above the baseline and negative values are below.

**Examples** S1\_CH2:LABel:YPOS -20 moves the waveform label for Scope 1 Channel 2 20 pixels below the baseline of the waveform.

S1\_CH2:LABel:YPOS? might return :S1\_CH2:LABel:YPOS 0, indicating that the waveform label for Scope 1 Channel 2 is currently located at the baseline of the waveform.

## S<x>\_CH<x>:OFFSet

This command sets or queries the vertical offset for the specified remote scope analog channel. The remote scope and channel is specified by x.

**Group** Vertical

**Syntax** S<x>\_CH<x>:OFFSet <NR3>  
S<x>\_CH<x>:OFFSet?

**Arguments** <NR3> is the offset value for the specified remote scope analog channel.

**Examples** S1\_CH2:OFFSet 2.0E-3 sets the offset for Scope 1 Channel 2 to 2 mV.

S1\_CH2:OFFSet? might return :S1\_CH4:OFFSet 1.0000E-03, indicating that the offset for Scope 1 Channel 2 is set to 1 mV.

## S<x>\_CH<x>:POSition

This command sets or queries the vertical position for the specified analog channel. The remote scope and channel is specified by x.

<b>Group</b>	Vertical
<b>Syntax</b>	S<x>_CH<x>:POSition <NR1> S<x>_CH<x>:POSition?
<b>Arguments</b>	<NR1> is the vertical position for the specified analog channel.
<b>Examples</b>	S1_CH2:POSition -2.0 sets the position to -2 divisions.  S1_CH2:POSition? might return :S1_CH2:POSITION -2.2400 indicating the position is -2.24 divisions.

## S<x>\_CH<x>:SCALE

This command sets or returns the vertical scale for the specified remote scope analog channel. The remote scope and the channel is specified by x.

<b>Group</b>	Vertical
<b>Syntax</b>	S<x>_CH<x>:SCALE <NR3> S<x>_CH<x>:SCALE?
<b>Arguments</b>	<NR3> is the vertical scale for the specified analog channel.
<b>Examples</b>	S1_CH2:SCALE 200E-3 sets the scale to 200 mV per division.  S1_CH2:SCALE? might return CH2:SCALE 500.0000E-3 indicating the vertical scale for remote scope 1 channel 2 is 500 mV per division.

## SAVE:EVENTtable:BUS (No Query Form)

This command saves bus results table to the specified file.

<b>Group</b>	Save and Recall
--------------	-----------------

**Syntax**    `SAVE:EVENTtable:BUS <QString>`

**Arguments**    `<QString>` is the specified file. If a file name or path is specified, the file is expected to be located in a directory relative to the current working directory (specified by [FILESystem:CWD](#)) unless a complete path is specified.

- Complete path specification. If the file argument begins with drive designator (such as C:), then the file name is interpreted as a full path.
- Relative path specification. If the file argument begins with "." or ".." or has a file path separator appearing anywhere other than the first character position, then the file name is treated as a path that is relative to the current working directory.

**Examples**    `SAVE:EVENTtable:BUS "TEK000.CSV"` saves the bus decode event table in the file named TEK000.CSV.

## SAVE:EVENTtable:CUSTOM (No Query Form)

This command saves the results table to the specified file path and name.

**Group**    Save and Recall

**Syntax**    `SAVE:EVENTtable:CUSTOM <QString>`

**Arguments**    `<QString>` is the specified file. If a file name or path is specified, the file is expected to be located in a directory relative to the current working directory (specified by [FILESystem:CWD](#)) unless a complete path is specified.

- Complete path specification. If the file argument begins with drive designator (such as C:), then the file name is interpreted as a full path.
- Relative path specification. If the file argument begins with "." or ".." or has a file path separator appearing anywhere other than the first character position, then the file name is treated as a path that is relative to the current working directory.

**Examples**    `SAVE:EVENTtable:CUSTOM "C:/TEK000.CSV"` sets the instrument to save the results table in the top level C: directory in a file named TEK000.CSV.

## SAVE:EVENTtable:CUSTOM:COMMENTS

This command sets or queries comments to be included in saved results table files.

<b>Group</b>	Save and Recall
<b>Syntax</b>	SAVE:EVENTtable:CUSTOM:COMMENTS <Qstring> SAVE:EVENTtable:CUSTOM:COMMENTS?
<b>Arguments</b>	<Qstring> sets the instrument to save the quoted string as a comment in the saved results table file.
<b>Examples</b>	SAVE:EVENTtable:CUSTOM:COMMENTS "PSRR batch 2 testing." sets the instrument to save the quoted string in all following saved results table files.  SAVE:EVENTtable:CUSTOM:COMMENTS? might return "", indicating that there is no comment set to be saved in results table files.

## SAVE:EVENTtable:CUSTOM:DATAFormat

This command sets or queries the data format to use for saving results table data.

<b>Group</b>	Save and Recall
<b>Syntax</b>	SAVE:EVENTtable:CUSTOM:DATAFormat [SCIENTIFIC ENGINEERING] SAVE:EVENTtable:CUSTOM:DATAFormat?
<b>Arguments</b>	SCIENTIFIC sets the instrument to save results tables data in scientific notation (for example, 5.0100E-12).  ENGINEERING sets the instrument to save results tables data in engineering notation (for example, 5.0100ps).
<b>Examples</b>	SAVE:EVENTtable:CUSTOM:DATAFormat SCIENTIFIC sets the instrument to save results tables data in scientific notation.  SAVE:EVENTtable:CUSTOM:DATAFormat? might return ENGINEERING, indicating that the instrument is set to save results tables data in engineering notation.

## SAVE:EVENTtable:CUSTOM:INCLUDEREFs

This command sets or queries whether to include displayed reference waveforms with saved results table files.

<b>Group</b>	Save and Recall
<b>Syntax</b>	SAVE:EVENTtable:CUSTOM:INCLUDEREFS {1 0} SAVE:EVENTtable:CUSTOM:INCLUDEREFS?
<b>Arguments</b>	1 sets the instrument to save all displayed reference waveforms as part of a saved results table file.  0 sets the instrument to not save all displayed reference waveforms as part of a saved results table file.
<b>Examples</b>	SAVE:EVENTtable:CUSTOM:INCLUDEREFS 1 sets the instrument to save all displayed reference waveforms as part of a saved results table file.  SAVE:EVENTtable:CUSTOM:INCLUDEREFS? might return 0, indicating that the instrument will not save all displayed reference waveforms as part of a saved results table file.

## SAVE:EVENTtable:MEASUREMENT (No Query Form)

This command saves data (measurement) results to the specified file.

<b>Group</b>	Save and Recall
<b>Syntax</b>	SAVE:EVENTtable:MEASUREMENT <QString>
<b>Arguments</b>	<QString> is the specified file. If a file name or path is specified, the file is expected to be located in a directory relative to the current working directory (specified by <a href="#">FILESystem:CWD</a> ) unless a complete path is specified: <ul style="list-style-type: none"> <li>■ Complete path specification. If the file argument begins with drive designator (such as C:), then the file name is interpreted as a full path.</li> <li>■ Relative path specification. If the file argument begins with "." or ".." or has a file path separator appearing anywhere other than the first character position, then the file name is treated as a path that is relative to the current working directory.</li> </ul>
<b>Examples</b>	SAVE:EVENTtable:MEASUREMENT "TEK000.CSV" saves the measurement in the file named TEK000.CSV.

## SAVe:EVENTtable:PEAKS (No Query Form)

This command saves peak markers results table to the specified file.

**Group** Save and Recall

**Syntax** SAvE:EVENTtable:PEAKS <QString>

**Arguments** <QString> is the specified file. If a file name or path is specified, the file is expected to be located in a directory relative to the current working directory (specified by [FILESystem:CWD](#)) unless a complete path is specified:

- Complete path specification. If the file argument begins with drive designator (such as C:), then the file name is interpreted as a full path.
- Relative path specification. If the file argument begins with "." or ".." or has a file path separator appearing anywhere other than the first character position, then the file name is treated as a path that is relative to the current working directory.

**Examples** SAvE:EVENTtable:PEAKS "TEK000.CSV" saves the peak markers table in the file named TEK000.CSV.

## SAVe:EVENTtable:SEARCHTable (No Query Form)

This command saves a search results table to the specified file.

**Group** Save and Recall

**Syntax** SAvE:EVENTtable:SEARCHTable <QString>

**Arguments** <QString> is the specified file. If a file name or path is specified, the file is expected to be located in a directory relative to the current working directory (specified by [FILESystem:CWD](#)) unless a complete path is specified:

- Complete path specification. If the file argument begins with drive designator (such as C:), then the file name is interpreted as a full path.
- Relative path specification. If the file argument begins with "." or ".." or has a file path separator appearing anywhere other than the first character position, then the file name is treated as a path that is relative to the current working directory.

**Examples**    `SAVe:EVENTtable:SEARCHTable`  
                  `"C:\Users\Tek_Local_Admin\Tektronix\TekScope\Results`  
                  `Tables\Tek002.csv"` saves the search results table in the file named  
                  `TEK002.CSV.`

## SAVE:IMAGe (No Query Form)

Saves a capture of the screen contents to the specified image file. Supported image formats are PNG, Windows Bitmap, and JPEG.

**Group**        Save and Recall

**Syntax**       `SAVe:IMAGe <QString>`

**Arguments**    `<QString>` is the file name and location used to store the image file.

When specifying the file name with this command, use the correct file extension (".png" for PNG format, ".bmp" for BMP format, or ".jpg" for JPEG format). If a file name or path is specified, the file is expected to be located in a directory relative to the current working directory (specified by `:FILESystem:CWD`[FILESystem:CWD](#)) unless a complete path is specified:

- Complete path specification. If the file argument begins with drive designator (such as C:), then the file name is interpreted as a full path.
- Relative path specification. If the file argument begins with "." or ".." or has a file path separator appearing anywhere other than the first character position, then the file name is treated as a path that is relative to the current working directory.

**Examples**     `SAVe:IMAGe "C:/Dut12-tests.png"` saves the image at the location specified.

## SAVE:IMAGe:COMPosition

Sets or queries the color mode for saved images (normal or inverted).

**Group**        Save and Recall

**Syntax**       `SAVe:IMAGe:COMPosition {NORMal|INVERTed}`  
                  `SAVe:IMAGe:COMPosition?`



<b>Arguments</b>	<code>NORMAL</code> Sets the saved screen capture to Normal colors. <code>INVERTED</code> sets the saved screen capture to Inverted colors.
<b>Examples</b>	<code>SAVE:IMAGE:COMPOSITION NORMAL</code> saves the screen image using the current normal color settings. <code>SAVE:IMAGE:COMPOSITION?</code> might return <code>INVERTED</code> , indicating that captured screen images will be saved using the inverted color settings.

## SAVE:IMAGE:VIEWType

Sets or queries the view type for saved images. Currently only `FULLScreen` is supported.

<b>Group</b>	Save and Recall
<b>Syntax</b>	<code>SAVE:IMAGE:VIEWType {FULLScreen}</code> <code>SAVE:IMAGE:VIEWType?</code>
<b>Arguments</b>	<code>FULLScreen</code> sets the screen capture mode to capture the full screen.
<b>Examples</b>	<code>SAVE:IMAGE:VIEWTYPE FULLScreen</code> sets the screen capture mode to capture the full screen. <code>SAVE:IMAGE:VIEWTYPE?</code> might return <code>FULLScreen</code> , indicating that the screen capture mode is set to full screen.

## SAVE:PLOTData (No Query Form)

Saves the plot data of the currently selected plot to a specified file. Supported file format is CSV.

<b>Group</b>	Save and Recall
<b>Syntax</b>	<code>SAVE:PLOTData &lt;Qstring&gt;</code>
<b>Related Commands</b>	<a href="#">DISplay:SElect:VIEW</a> <a href="#">FILESystem:CWD</a>

**Arguments** `Qstring` sets the file name and location used to store the plot data. When specifying the file name with this command, use the correct file extension (.CSV). If a file name or path is specified, the file is expected to be located in a directory relative to the current working directory (specified by [FILESystem:CWD](#)) unless a complete path is specified.

If the file argument begins with a drive designator (such as C:), then the file name is interpreted as a full path. If the file argument begins with "." or "", or has a file path separator appearing anywhere other than the first character position, then the file name is treated as a path that is relative to the current working directory.

To export an eye diagram plot data to a .csv file, the prerequisite command is `MEASurement:ADDMEAS TIE`

**Examples** `SAVE:PLOTDATA "plot1.csv"` saves the plot to the designated file in the current working directory.

The following is the example of exporting an XY plot data to a .csv file:

```
PLOT:PLOT1:TYPE XY
```

```
DISplay:SElect:VIEW PLOTVIEW1
```

```
SAVE:PLOTData "C:/plot1.csv" (On standard instruments)
```

```
SAVE:PLOTData "C:\Temp\plot1.csv" (On instruments with optional Windows 10)
```

## SAVE:REPORt (No Query Form)

This command saves a report to the specified file. Supported report formats are PDF and MHT (web page archive file).

**Group** Save and Recall

**Syntax** `SAVE:REPORt <Qstring>`

**Related Commands** [SAVE:REPORt:COMMENTS](#)

**Arguments** `<Qstring>` is the complete path specification. When specifying the file name with this command, use the correct file extension (.pdf for PDF format, or .mht for MHT format).

If a file name or path is specified, the file is expected to be located in a directory relative to the current working directory (specified by [FILESystem:CWD](#)) unless a complete path is specified:

- Complete path specification. If the file argument begins with a file path separator (forward slash character) or a Windows drive designator such as C:), then the file name is interpreted as a full path.
- Relative path specification. If the file argument begins with "." or ".." or has a file path separator appearing anywhere other than the first character position, then the file name is treated as a path that is relative to the current working directory.

**Examples**     `SAVE:REPORT "report.pdf"` creates a report in PDF format, in the location specified.

## SAVe:REPOrt:COMMeNts

This command sets or queries the comments to be included in saved report files.

**Group**     Save and Recall

**Syntax**     `SAVe:REPOrt:COMMeNts <QString>`  
`SAVe:REPOrt:COMMeNts?`

**Arguments**     `<QString>` is the comments to be included in saved report files.

**Examples**     `SAVE:REPORT:COMMENTS "Test 3"` adds comments to the report.  
`SAVE:REPORT:COMMENTS?` might return `:SAVE:REPORT:COMMENTS "High Temp Test 1"`.

## SAVe:SESSion (No Query Form)

Saves the state of the instrument, including reference waveforms, to a saved session file.

**Group**     Save and Recall

**Syntax**     `SAVe:SESSion <QString>`

**Arguments**     `<QString>` is the file path that specifies the location to save the specified instrument session file. If a file name or path is specified, the file is expected to

be located in a directory relative to the current working directory (specified by `FILESystem:CWD`) unless a complete path is specified:

- Complete path specification. If the file argument begins with a file path separator (forward slash character) or a Windows drive designator such as C:), then the file name is interpreted as a full path.
- Relative path specification. If the file argument begins with "." or ".." or has a file path separator appearing anywhere other than the first character position, then the file name is treated as a path that is relative to the current working directory.

**Examples** `SAVE:SESSION "c:/rose_was_here.tss"` saves the instrument state in the specified file.

## SAVE:SETUp (No Query Form)

Saves the current instrument state to the specified file.

**Group** Save and Recall

**Syntax** `SAVE:SETUp <QString>`

**Related Commands** [SAVE:SETUp:INCLUDEREFs](#)

**Arguments** `<QString>` is a quoted string that is the complete path specification. If a file name or path is specified, the file is expected to be located in a directory relative to the current working directory (specified by `FILESystem:CWD`) unless a complete path is specified:

- Complete path specification. If the file argument begins with a file path separator (forward slash character) or a Windows drive designator such as C:), then the file name is interpreted as a full path.
- Relative path specification. If the file argument begins with "." or ".." or has a file path separator appearing anywhere other than the first character position, then the file name is treated as a path that is relative to the current working directory.

**Examples** `SAVE:SETUP "c:/rose_was_here.set"` saves the instrument setup in the specified file.

## SAVe:SETUp:INCLUDEREFs

This command sets or queries whether displayed reference waveforms are to be included in saved setups.

<b>Group</b>	Save and Recall
<b>Syntax</b>	SAVe:SETUp:INCLUDEREFs {OFF ON 0 1} SAVe:SETUp:INCLUDEREFs?
<b>Arguments</b>	OFF specifies not including displayed reference waveforms in saved setups. ON specifies including displayed reference waveforms in saved setups. 0 specifies not including displayed reference waveforms in saved setups. 1 specifies including displayed reference waveforms in saved setups.
<b>Examples</b>	SAVe:SETUp:INCLUDEREFs 0 sets reference waveforms not to be included in saved setups.  SAVe:SETUp:INCLUDEREFs? might return :SAVe:SETUp:INCLUDEREFs 1 indicating that reference waveforms are to be included in saved setups.

## SAVe:WAVEform (No Query Form)

This command saves the specified waveform(s) to the specified destination file. The waveform source or sources must be active (turned on) to save data to a file.

<b>Conditions</b>	<u>_MAG_VS_TIME</u> , <u>_FREQ_VS_TIME</u> , <u>_PHASE_VS_TIME</u> , and <u>_SV_BASEBAND_IQ</u> require option SV-RFVT.  Option SV-RFVT on the 4 Series MSO instruments requires option SV-BAS.
<b>Group</b>	Save and Recall
<b>Syntax</b>	SAVe:WAVEform {CH<x>[_DALL _SV_NORMa _SV_AVErage _SV_MAXHo d _SV_MINHo d _MAG_VS_TIME _FREQ_VS_TIME _PHASE_VS_TIME] MATH<x> REF<x> ALL  }, <QString>
<b>Related Commands</b>	<a href="#">FILESystem:CWD</a> <a href="#">SAVe:WAVEform:SOURCEList?</a>

- Arguments** <x> is the number of the analog channel, math, or reference waveform source used to save the waveform data.
- `_DALL` saves the digital channel waveform data of the specified channel. This argument is required if the channel specified is a digital channel.
- `_SV_NORMa1` saves the Normal Spectrum view waveform of the specified channel.
- `_SV_AVErage` saves the Average Spectrum view waveform of the specified channel.
- `_SV_MAXHO1d` saves the Maximum Hold Spectrum view waveform of the specified channel.
- `_SV_MINHO1d` saves the Minimum Hold Spectrum view waveform of the specified channel.
- `_MAG_VS_TIME` saves the Magnitude vs. Time waveform of the specified channel.
- `_FREQ_VS_TIME` saves the Frequency vs. Time waveform of the specified channel.
- `_PHASE_VS_TIME` saves the Phase vs. Time waveform of the specified channel.
- `_SV_BASEBAND_IQ` saves the baseband I & Q data of the specified channel. The data is saved in Tektronix TIQ format using a .TIQ file extension. You can import .TIQ files into Tektronix SignalVu-PC software (PC based), SignalVu software (oscilloscope based), RSAVu software (PC based) or into a Tektronix real-time spectrum analyzer for pulse analysis and demodulation analysis.
- `ALL` saves all displayed analog, math, and reference waveforms to individual files. Each file name created includes the name of the source (ch1, math3, and so on) used to create that file. `ALL` is not supported when FastAcq Mode is enabled.
- <Qstring> is a quoted string that defines the path and file name to use to save the specified file, in the format '[<path>]<filename.ext>'. Specifying a path is optional. If no path is entered, the file is saved to the current working directory as set in [FILESystem:CWD](#).
- <path> uses the form '<drive>/<dir>.../'. You can specify a relative path or a complete path:
- Relative path specification. If the file argument begins with "." or ".." or has a file path separator appearing anywhere other than the first character position, then the file name is treated as a path that is relative to the current working directory.
  - Complete path specification. If the file argument begins with a file path separator (forward slash character) or a drive designator (such as C:), then the file name is interpreted as a full path from the specified drive.
- <filename> sets the file name to use to create the file. A file can have up to 125 characters. When using the `ALL` argument to save multiple files, each filename has the filename appended with the source used to create that file. For example, a

filename of `QualTest` can create `QualTest_ch1.xxx`, `QualTest_ref1.xxx`, and so on.

`<.ext>` sets the file format to which to save the data. To save Channel FastAcq data, only `.csv` format is supported. The saved fastacq pixmap data `.csv` file cannot be recalled.

- Use the `.wfm` extension to save waveform data to a Tektronix Internal format.
- Use the `.csv` extension to save waveform data to a comma separated values spreadsheet format.
- Use the `.mat` extension to save waveform data to a matlab compatible file format.

**Examples** `SAVE:WAVEFORM MATH1, "TEK0000.WFM"` saves the Math1 waveform to the file `TEK0000.WFM` in the current working directory.

## SAVE:WAVEform:GATing

This command specifies the method to save a specified part of the waveform data or the entire waveform.

**Group** Save and Recall

**Syntax** `SAVE:WAVEform:GATing {NONE|CURSors|SCREEN|RESAMPLE|SELEcted}`  
`SAVE:WAVEform:GATing?`

**Arguments** `NONE` saves the full waveform data.

`CURSors` saves the waveform data located between the vertical cursors.

`SCREEN` saves the waveform data that is on the screen. Nothing outside the waveform will be saved.

`RESAMPLE` saves the waveform data at a sample interval set by the user. The resulting saved waveform is a resampled version of the original waveform with fewer data points.

`SELEcted` saves the data from the currently selected history or FastFrame acquisition.

**Examples** `SAVE:WAVEFORM:GATING NONE` saves the entire waveform.

`SAVE:WAVEFORM:GATING?` might return `:SAVE:WAVEform:GATing SCREEN`, indicating the save waveform operation is set to save the waveform data on the screen.

## SAVE:WAVEform:GATing:RESAMPLERate

This command saves the waveform data at a sample interval. The resulting saved waveform is a resampled version of the original waveform with fewer data points.

<b>Group</b>	Save and Recall
<b>Syntax</b>	SAVE:WAVEform:GATing:RESAMPLERate <NR1> SAVE:WAVEform:GATing:RESAMPLERate?
<b>Arguments</b>	<NR1> specifies the resample interval.
<b>Examples</b>	SAVE:WAVEFORM:GATING:RESAMPLERATE 3 sets to save waveform data every third data point.  SAVE:WAVEFORM:GATING:RESAMPLERATE? might return :SAVE:WAVEform:GATing:RESAMPLERate 2, indicating the saved waveform will have half as many data points. This command saves the first data point and then every other following data point.

## SAVE:WAVEform:SOURCEList? (Query Only)

This query returns a list of the available waveforms that can be specified as the source for the SAVE:WAVEform command. Source waveforms must have their display mode set to On to appear in this list and to be saved.

<b>Group</b>	Save and Recall
<b>Syntax</b>	SAVE:WAVEform:SOURCEList?
<b>Examples</b>	SAVE:WAVEFORM:SOURCELIST? might return ALL, CH1_DALL, CH2, CH3, CH8, MATH1, MATH2, REF2, REF4.

## SAVEONEVent:FILEDest

This command sets or queries the location where files are saved. This command replaces SAVEON:FILE:DEST (still valid command, but only an alias for this new command).

<b>Group</b>	Act On Event
--------------	--------------



<b>Syntax</b>	SAVEONEEvent:FILEDest SAVEONEEvent:FILEDest? <Qstring>
<b>Arguments</b>	<QString> specifies the location to store files.
<b>Examples</b>	<p>SAVEONEEVENT:FILEDEST "C:\users\username\Tektronix\TekScope\SaveOnTrigger" sets this as the location to save files (named by the SAVEONEEvent:FILENAME command), when there is a trigger.</p> <p>SAVEONEEVENT:FILEDEST? might return :SAVEONEEvent:FILEDest "C:\users\username\Tektronix\TekScope\SaveOnTrigger", indicating the drive location where files will be saved when there is a trigger.</p>

## SAVEONEEvent:FILENAME

This command sets or queries the file name without the extension. This command replaces SAVEON:FILE:NAME (still valid command, but only an alias for this new command).

<b>Group</b>	Act On Event
<b>Syntax</b>	SAVEONEEvent:FILENAME <QString> SAVEONEEvent:FILENAME?
<b>Arguments</b>	<QString> specifies the name of the file.
<b>Examples</b>	<p>SAVEONEEVENT:FILENAME "ActOnEvent" sets the name of the file to ActOnEvent.</p> <p>SAVEONEEVENT:FILENAME? might return :SAVEONEEvent:FILENAME "ActOnEvent", indicating the name you set for the instrument to use.</p>

## SAVEONEEvent:IMAGE:FILEFormat

This command sets or returns the image file extension (png, jpg, bmp). This command replaces SAVEON:IMAGE:FILEFormat (still valid command, but only an alias for this new command).

<b>Group</b>	Act On Event
--------------	--------------

**Syntax**     `SAVEONEEvent:IMAGE:FILEFormat {PNG|BMP|JPG}`  
`SAVEONEEvent:IMAGE:FILEFormat?`

**Arguments**     PNG specifies using PNG format for saved image files.  
                  BMP specifies using BMP format for saved image files.  
                  JPG specifies using JPEG format for saved image files.

When specifying the file name with this command, use the correct file extension (".png" for PNG format, ".bmp" for BMP format, or ".jpg" for JPEG format). If a file name or path is specified, the file is expected to be located in a directory relative to the current working directory (specified by `FILESystem:CWD`) unless a complete path is specified:

- Complete path specification. If the file argument begins with drive designator (such as C:), then the file name is interpreted as a full path.
- Relative path specification. If the file argument begins with "." or "" or has a file path separator appearing anywhere other than the first character position, then the file name is treated as a path that is relative to the current working directory.

**Examples**     `SAVEONEEvent:IMAGE:FILEFORMAT JPG` sets the image file format to JPEG.  
`SAVEONEEvent:IMAGE:FILEFORMAT?` might return  
:SAVEON:IMAGE:FILEFORMAT PNG indicating that the file format is set to PNG.

## SAVEONEEvent:WAVEform:FILEFormat

This command sets or returns the file extension (csv, wfm, mat). This command replaces `SAVEON:WAVEform:FILEFormat` (still valid command, but only an alias for this new command).

**Group**     Act On Event

**Syntax**     `SAVEONEEvent:WAVEform:FILEFormat`  
`{INTERNAL|SPREADSheet|MATlab}`  
`SAVEONEEvent:WAVEform:FILEFormat?`

**Arguments**     `INTERNAL` specifies saving the waveform in the instrument internal format.  
                  `SPREADSheet` specifies saving the waveform in comma separated values format.  
                  `MATlab` specifies saving the waveform in matlab compatible file format.

**Examples** SAVEONEVENT:WAVEFORM:FILEFORMAT SPREADSheet sets the file format to spreadsheet (csv).

SAVEONEVENT:WAVEFORM:FILEFORMAT? might return  
:SAVEONEVENT:WAVEFORM:FILEFORMAT INTERNAL, indicating the file format is set to INTERNAL.

## SAVEONEVENT:WAVEFORM:SOURC

This command sets or returns the sources for saving waveforms when an event occurs. This command replaces SAVEON:WAVEFORM:SOURC (still valid command, but only an alias for this new command).

**Group** Act On Event

**Syntax** SAVEONEVENT:WAVEFORM:SOURC  
{S<x>\_CH<x> | CH<x> | MATH<x> | REF<x> | ALL}  
SAVEONEVENT:WAVEFORM:SOURC?

**Arguments** S<x>\_CH<x> specifies the remote scope and the analog channel.  
CH<x> specifies an analog channel as the source waveform for saving.  
MATH<x> specifies a math waveform as the source waveform for saving.  
REF<x> specifies a reference waveform as the source waveform for saving.  
ALL specifies all analog, math, and reference waveforms as the source waveforms for saving.

**Examples** SAVEONEVENT:WAVEFORM:SOURC MATH1 specifies MATH 1 as the save on source.

SAVEONEVENT:WAVEFORM:SOURC? might return  
:SAVEONEVENT:IMAGE:FILEFORMAT REF1, indicating the save on source is REF 1.

## SCOPEApp REBOOT (No Query Form)

This command reboots the scope.

**Group** Miscellaneous

**Syntax** SCOPEApp REBOOT

**Examples** SCOPEApp REBOOT reboots the scope.

## SEARCH:ADDNew (No Query Form)

This command adds the specified search.

**Group** Search and Mark

**Syntax** SEARCH:ADDNew <QString>

**Arguments** <QString> is the specified search. The argument is of the form "SEARCH<NR1>", where <NR1> is  $\geq 1$ .

**Examples** SEARCH:ADDNEW "SEARCH2" adds a new search named SEARCH 2.

## SEARCH:DELeTe (No Query Form)

This command deletes the specified search.

**Group** Search and Mark

**Syntax** SEARCH:DELeTe <QString>

**Arguments** <QString> is the specified search. The argument is of the form "SEARCH<NR1>", where <NR1> is  $\geq 1$ .

**Examples** SEARCH:DELETE "SEARCH3" deletes SEARCH 3.

## SEARCH:DELETEALL (No Query Form)

This command deletes all the active instances of search definitions defined in the scope application.

**Group** Search and Mark

**Syntax** SEARCH:DELETEALL

**Examples** SEARCH:DELETEALL deletes all the active instances of search definitions.

## SEARCH:LIST? (Query Only)

This command returns a comma separated list of all currently defined searches.

**Group** Search and Mark

**Syntax** SEARCH:LIST?

**Returns** All currently defined searches.

**Examples** SEARCH:LIST? might return :SEARCH:LIST SEARCH1,SEARCH2 indicating that Search 1 and Search 2 are defined.

## SEARCH:SEARCH<x>:COPY (No Query Form)

This command (no query form) copies the search criteria to or from the trigger. The search number is specified by x.

**Group** Search and Mark

**Syntax** SEARCH:SEARCH<x>:COPY {SEARCHtotrigger|TRIGgertosearch}

**Arguments** SEARCHtotrigger copies the search criteria to the trigger.

TRIGgertosearch copies the trigger criteria to the search.

**Examples** SEARCH:SEARCH1:COPY TRIGGERTOSEARCH copies the trigger criteria to the search 1 criteria.

SEARCH:SEARCH1:COPY SEARCHTOTRIGGER copies the search criteria to the trigger.

## SEARCH:SEARCH<x>:NAVigate (No Query Form)

This command sets the navigation action for search marks. The NONE action is the default setting when no action is being taken. The search number is specified by x.

<b>Group</b>	Search and Mark
<b>Syntax</b>	SEARCH:SEARCH<x>:NAVIGate {NEXT PREVIOUS MIN NONE MAX}
<b>Arguments</b>	<p>NEXT goes to the next search mark.</p> <p>PREVIOUS goes to the previous search mark.</p> <p>MIN goes to the search result with the smallest value. Only supported by search results which have quantitative values (example: pulse width is supported, but not edge).</p> <p>NONE is the default setting when no action is being taken.</p> <p>MAX goes to the search result with the largest value. Only supported by search results which have quantitative values (example: pulse width is supported, but not edge).</p>
<b>Examples</b>	SEARCH:SEARCH1:NAVIGate NEXT goes to the next search mark.

## SEARCH:SEARCH<x>:TOTAL? (Query Only)

This query-only command returns the total number of found search marks for this search. The search number is specified by x.

<b>Group</b>	Search and Mark
<b>Syntax</b>	SEARCH:SEARCH<x>:TOTAL?
<b>Examples</b>	SEARCH:SEARCH1:TOTAL? might return SEARCH:SEARCH1:TOTAL 7, indicating that there are 7 matches for search 1.

## SEARCH:SEARCH<x>:TRIGger:A:BUS:ARINC429A:CONDition

This command specifies a field or condition for an ARINC429 bus to search on. The search number is specified by x.

<b>Conditions</b>	Requires option 5-SRAERO or SUP5-SRAERO Triggering and Analysis application.
<b>Group</b>	Search and Mark

<b>Syntax</b>	SEARCH:SEARCH<x>:TRIGger:A:BUS:ARINC429A:CONDition {SOW LABe1 DATA LABELANDDATA EOW ERROR} SEARCH:SEARCH<x>:TRIGger:A:BUS:ARINC429A:CONDition?
<b>Arguments</b>	SOW specifies a search for the first bit of a word.  LABe1 specifies a search for a matching label.  DATA specifies a search for matching packet data fields.  LABELANDDATA specifies a search for a matching label and matching packet data field(s).  EOW specifies a search for the 32nd bit of a word.  ERROR specifies a search for a specified error condition.
<hr/>	
<i><b>NOTE.</b> The type of error searched for is specified by SEARCH:SEARCH&lt;x&gt;:TRIGger:A:BUS:ARINC429A:ERRType.</i>	
<hr/>	
<b>Examples</b>	SEARCH:SEARCH1:TRIGGER:A:BUS:ARINC429A:CONDITION DATA specifies finding packets that contain matching data field(s).  SEARCH:SEARCH1:TRIGGER:A:BUS:ARINC429A:CONDITION? might return SOW, indicating that the bus is being searched for the first bit of each word in the packet.

## SEARCH:SEARCH<x>:TRIGger:A:BUS:ARINC429A:DATA:HIVALue

This command sets or queries the high value when searching on an ARINC429 data field. The search number is specified by x. The search condition must be set to DATA or LABELANDDATA, and the data qualifier must be INrange or OUTrange.

<b>Conditions</b>	Requires option 5-SRAERO or SUP5-SRAERO Triggering and Analysis application.
<b>Group</b>	Search and Mark
<b>Syntax</b>	SEARCH:SEARCH<x>:TRIGger:A:BUS:ARINC429A:DATA:HIVALue <QString> SEARCH:SEARCH<x>:TRIGger:A:BUS:ARINC429A:DATA:HIVALue?
<b>Arguments</b>	<QString> is the label value.

**Examples**      `SEARCH:SEARCH1:TRIGGER:A:BUS:ARINC429A:DATA:HIVALUE`  
"XXXXXXXXXXXXXXXXX1000" sets the value to XXXXXXXXXXXXXXXXXXXX1000.

`SEARCH:SEARCH1:TRIGGER:A:BUS:ARINC429A:DATA:HIVALUE?` might  
return "XXXXXXXXXXXXXXXXXXXXXXXX", indicating that the value is  
XXXXXXXXXXXXXXXXXXXXXXXX.

## SEARCH:SEARCH<x>:TRIGger:A:BUS:ARINC429A:DATA:QUALifier

This command sets or queries the qualifier to be used when searching on data in the DATA field for an ARINC429 bus signal. The search number is specified by x. The search condition must be set to DATA or LABELANDDATA.

**Conditions**      Requires option 5-SRAERO or SUP5-SRAERO Triggering and Analysis application.

**Group**            Search and Mark

**Syntax**          `SEARCH:SEARCH<x>:TRIGger:A:BUS:ARINC429A:DATA:`  
`QUALifier {EQUAL|UNEQUAL|LESSTHAN|MORETHAN`  
`|LESSEQUAL|MOREEQUAL|INrange|OUTrange}`  
`SEARCH:SEARCH<x>:TRIGger:A:BUS:ARINC429A:DATA:QUALifier?`

**Arguments**      Arguments are the available data qualifiers.

---

***NOTE.** The search qualifier only applies to the bits defined as the data field via the bus data field format specifier (using `BUS:B<x>:ARINC429A:DATAFormat`).*

---

**Examples**      `SEARCH:SEARCH1:TRIGGER:A:BUS:ARINC429A:DATA:QUALIFIER`  
`LESSTHAN` sets the data qualifier to less than.

`SEARCH:SEARCH1:TRIGGER:A:BUS:ARINC429A:DATA:QUALIFIER?` might  
return EQUAL, indicating that the data qualifier is set to equal.

## SEARCH:SEARCH<x>:TRIGger:A:BUS:ARINC429A:DATA:VALue

This command sets or queries the low value when searching on an ARINC429 data field. The search number is specified by x. The search condition must be set to DATA or LABELANDDATA.

**Conditions**      Requires option 5-SRAERO or SUP5-SRAERO Triggering and Analysis application.



<b>Group</b>	Search and Mark
<b>Syntax</b>	SEARCH:SEARCH<x>:TRIGger:A:BUS:ARINC429A:DATA:VALUE <QString> SEARCH:SEARCH<x>:TRIGger:A:BUS:ARINC429A:DATA:VALUE?
<b>Arguments</b>	<QString> is the label value.
<b>Examples</b>	SEARCH:SEARCH1:TRIGGER:A:BUS:ARINC429A:DATA:VALUE "XXXXXXXXXXXXXXXXX1000" sets the value to XXXXXXXXXXXXXXXXXXXX1000.  SEARCH:SEARCH1:TRIGGER:A:BUS:ARINC429A:DATA:VALUE? might return "XXXXXXXXXXXXXXXXXXXXXXXXX", indicating that the value is XXXXXXXXXXXXXXXXXXXXXXXXX.

## SEARCH:SEARCH<x>:TRIGger:A:BUS:ARINC429A:ERRTYPe

This command sets or queries the error type when searching on an ARINC429 bus signal. The search number is specified by x. The search condition must be set to ERRor.

<b>Conditions</b>	Requires option 5-SRAERO or SUP5-SRAERO Triggering and Analysis application.
<b>Group</b>	Search and Mark
<b>Syntax</b>	SEARCH:SEARCH<x>:TRIGger:A:BUS:ARINC429A:ERRTYPe {ANY PARity WORD GAP} SEARCH:SEARCH<x>:TRIGger:A:BUS:ARINC429A:ERRTYPe?
<b>Arguments</b>	ANY sets the error type to match any of the other available error types.  PARity sets the error type to match on parity errors (parity value results in even parity count for a word).  WORD sets the error type to match on word errors (any unframed or unknown decode data).  GAP sets the error type to match on gap violations (less than 4 bits idle time between two packets on the bus).
<b>Examples</b>	SEARCH:SEARCH1:TRIGGER:A:BUS:ARINC429A:ERRTYPe PARITY sets the error type to match on parity errors.

SEARCH:SEARCH1:TRIGGER:A:BUS:ARINC429A:ERRTYPE? might return ANY, indicating that any error condition will produce a match.

## SEARCH:SEARCH<x>:TRIGger:A:BUS:ARINC429A:LABel:HIVALue

This command sets or queries the high value when searching on an ARINC429 label field. The search number is specified by x. The search condition must be set to LABel, and the label qualifier must be INrange or OUTrange.

**Conditions** Requires option 5-SRAERO or SUP5-SRAERO Triggering and Analysis application.

**Group** Search and Mark

**Syntax** SEARCH:SEARCH<x>:TRIGger:A:BUS:ARINC429A:LABel:HIVALue  
<QString>  
SEARCH:SEARCH<x>:TRIGger:A:BUS:ARINC429A:LABel:HIVALue?

**Arguments** <QString> is the label value.

**Examples** SEARCH:SEARCH1:TRIGGER:A:BUS:ARINC429A:LABEL:HIVALUE  
"XXXX1010" sets the value to XXXX1010.  
  
SEARCH:SEARCH1:TRIGGER:A:BUS:ARINC429A:LABEL:HIVALUE? might  
return "XXXXXXXX", indicating that the value is XXXXXXXX.

## SEARCH:SEARCH<x>:TRIGger:A:BUS:ARINC429A:LABel:QUALifier

This command sets or queries the qualifier to be used when searching on label data for an ARINC429 bus signal. The search number is specified by x. The search condition must be set to LABel or LABELANDDATA.

**Conditions** Requires option 5-SRAERO or SUP5-SRAERO Triggering and Analysis application.

**Group** Search and Mark

**Syntax** SEARCH:SEARCH<x>:TRIGger:A:BUS:ARINC429A:LABel:  
QUALifier {Equal|UNEQual|LESsthan|MOREthan  
|LESSEQual|MOREEQual|INrange|OUTrange}

SEARCH:SEARCH<x>:TRIGger:A:BUS:ARINC429A:LABel:QUALifier?

**Arguments** Arguments are the available data qualifiers.

---

**NOTE.** *If the search condition is set to LABELANDDATA, the label qualifier will be locked to Equal until the search condition is changed again.*

---

**Examples** SEARCH:SEARCH1:TRIGGER:A:BUS:ARINC429A:LABEL:QUALIFIER  
LESSTHAN sets the label qualifier to less than.

SEARCH:SEARCH1:TRIGGER:A:BUS:ARINC429A:LABEL:QUALIFIER? might return EQUAL, indicating that the label qualifier is set to equal.

## SEARCH:SEARCH<x>:TRIGger:A:BUS:ARINC429A:LABel:VALue

This command sets or queries the low value when searching on an ARINC429 label field. The search number is specified by x. The search condition must be set to LABEL or LABELANDDATA.

**Conditions** Requires option 5-SRAERO or SUP5-SRAERO Triggering and Analysis application.

**Group** Search and Mark

**Syntax** SEARCH:SEARCH<x>:TRIGger:A:BUS:ARINC429A:LABel:VALue  
<QString>  
SEARCH:SEARCH<x>:TRIGger:A:BUS:ARINC429A:LABel:VALue?

**Arguments** <QString> is the label value.

**Examples** SEARCH:SEARCH1:TRIGGER:A:BUS:ARINC429A:LABEL:VALUE  
"XXXX1010" sets the value to XXXX1010.

SEARCH:SEARCH1:TRIGGER:A:BUS:ARINC429A:LABEL:VALUE? might return "XXXXXXXX", indicating that the value is XXXXXXXX.

## SEARCH:SEARCH<x>:TRIGger:A:BUS:ARINC429A:SDI:VALue

This command sets or queries the label when searching on an ARINC429 SDI field. The search number is specified by x. The search condition must be set to DATA or LABELANDDATA, and the data format must be set to DATA.

<b>Conditions</b>	Requires option 5-SRAERO or SUP5-SRAERO Triggering and Analysis application.
<b>Group</b>	Search and Mark
<b>Syntax</b>	SEARCH:SEARCH<x>:TRIGger:A:BUS:ARINC429A:SDI:VALue <QString> SEARCH:SEARCH<x>:TRIGger:A:BUS:ARINC429A:SDI:VALue?
<b>Arguments</b>	<QString> is the label value.

---

**NOTE.** The SDI field is only present when the selected data field format is DATA (using *BUS:B<x>:ARINC429A:DATAFormat*). Also, the stored QString is reset to its default value whenever the data field format is changed.

---

<b>Examples</b>	SEARCH:SEARCH1:TRIGGER:A:BUS:ARINC429A:SDI:VALUE "X0" sets the value to X0.  SEARCH:SEARCH1:TRIGGER:A:BUS:ARINC429A:SDI:VALUE? might return "XX", indicating that the value is XX.
-----------------	------------------------------------------------------------------------------------------------------------------------------------------------------------------------------------------

## SEARCH:SEARCH<x>:TRIGger:A:BUS:ARINC429A:SSM:VALue

This command sets or queries the label when searching on an ARINC429 SSM field. The search number is specified by x. The search condition must be set to DATA or LABELANDDATA, and the data format must be set to DATA or SDIDATA.

<b>Conditions</b>	Requires option 5-SRAERO or SUP5-SRAERO Triggering and Analysis application.
<b>Group</b>	Search and Mark
<b>Syntax</b>	SEARCH:SEARCH<x>:TRIGger:A:BUS:ARINC429A:SSM:VALue <QString> SEARCH:SEARCH<x>:TRIGger:A:BUS:ARINC429A:SSM:VALue?
<b>Arguments</b>	<QString> is the label value.
<b>Examples</b>	SEARCH:SEARCH1:TRIGGER:A:BUS:ARINC429A:SSM:VALUE "X0" sets the value to X0.

SEARCH:SEARCH1:TRIGGER:A:BUS:ARINC429A:SSM:VALUE? might return "XX", indicating that the value is XX.

## SEARCH:SEARCH<x>:TRIGger:A:BUS:AUDio:CONDition

This command sets or queries the condition (word select / frame sync, or matching data) to be used when searching on an audio bus signal. The search number is specified by x.

<b>Conditions</b>	Requires option 5-SRAUDIO or SUP5-SRAUDIO Triggering and Analysis application.
<b>Group</b>	Search and Mark
<b>Syntax</b>	SEARCH:SEARCH<x>:TRIGger:A:BUS:AUDio:CONDition {SOF DATA} SEARCH:SEARCH<x>:TRIGger:A:BUS:AUDio:CONDition?
<b>Arguments</b>	SOF specifies to search on a word select or start of frame (depending on Audio Type).  DATA specifies to search on matching data.
<b>Examples</b>	SEARCH:SEARCH1:TRIGger:A:BUS:AUDio:CONDition SOF sets conditions to search on start of frame.  SEARCH:SEARCH1:TRIGger:A:BUS:AUDio:CONDition? might return SEARCH:SEARCH1:TRIGGER:A:BUS:AUDIO:CONDITION DATA indicating settings for a search on DATA.

## SEARCH:SEARCH<x>:TRIGger:A:BUS:AUDio:DATA:HITDMVALue

This command sets or queries the binary data string for the high data word to be used when searching on an TDM audio bus signal. The search condition must be set to DATA using SEARCH:SEARCH{x}:TRIGger:A:BUS:AUDio:CONDition.

<b>Group</b>	Search and Mark
<b>Syntax</b>	SEARCH:SEARCH<x>:TRIGger:A:BUS:AUDio:DATA:HITDMVALue <QString> SEARCH:SEARCH<x>:TRIGger:A:BUS:AUDio:DATA:HITDMVALue?

**Arguments** <QString> is the binary data string for the high data word to be used when searching on an TDM audio bus signal.

**Examples** SEARCH:SEARCH1:TRIGger:A:BUS:AUDio:DATA:HITDMVALue "XXXXXXXXXXXXXXXXXXXX1100" sets the high value to 1100.  
 SEARCH:SEARCH1:TRIGger:A:BUS:AUDio:DATA:HITDMVALue? might return SEARCH:SEARCH1:TRIGGER:A:BUS:AUDIO:DATA:HITDMVALUE "XXXXXXXXXXXXXXXXXXXX1010" indicating the high value is set to 1010.

## SEARCH:SEARCH<x>:TRIGger:A:BUS:AUDio:DATA:HIVALue

This command sets or queries the binary data string for the high data word to be used when searching on an audio bus signal. The search condition must be set to DATA using :SEARCH:SEARCH<x>:TRIGger:A:BUS:AUDio:CONDition. The search number is specified by x.

**Group** Search and Mark

**Syntax** SEARCH:SEARCH<x>:TRIGger:A:BUS:AUDio:DATA:HIVALue <QString>  
 SEARCH:SEARCH<x>:TRIGger:A:BUS:AUDio:DATA:HIVALue?

**Arguments** <QString> specifies the upper word value.

**Examples** SEARCH:SEARCH1:TRIGger:A:BUS:AUDio:DATA:HIVALue "XXXX" sets the HIVALUE to XXXX.  
 SEARCH:SEARCH1:TRIGger:A:BUS:AUDio:DATA:HIVALue? might return SEARCH:SEARCH1:TRIGGER:A:BUS:AUDIO:DATA:HIVALUE "TEST\_001101", indicating the HIVALUE is set to TEST\_001101.

## SEARCH:SEARCH<x>:TRIGger:A:BUS:AUDio:DATA:OFFSet

This command sets or queries the data offset value (TDM channel) to be used when searching on a TDM type audio bus signal. The search condition must be set to DATA using SEARCH:SEARCH<x>:TRIGger:A:BUS:AUDio:TDM:CONDition. The search number is specified by x.

**Conditions** Requires option 5-SRAUDIO or SUP5-SRAUDIO Triggering and Analysis application.

<b>Group</b>	Search and Mark
<b>Syntax</b>	SEARCH:SEARCH<x>:TRIGger:A:BUS:AUDio:DATA:OFFSet <NR1> SEARCH:SEARCH<x>:TRIGger:A:BUS:AUDio:DATA:OFFSet?
<b>Arguments</b>	<NR1> is the data offset value.
<b>Examples</b>	SEARCH:SEARCH1:TRIGger:A:BUS:AUDio:DATA:OFFSet 2 sets the data offset value to 2.  SEARCH:SEARCH1:TRIGger:A:BUS:AUDio:DATA:OFFSet? might return SEARCH:SEARCH1:TRIGGER:A:BUS:AUDIO:DATA:OFFSET 1 indicating data offset value is set to TDM channel 1.

## SEARCH:SEARCH<x>:TRIGger:A:BUS:AUDio:DATA:QUALifier

This command sets or queries the qualifier to be used when searching on an audio bus signal. The search condition must be set to DATA using SEARCH:SEARCH<x>:TRIGger:A:BUS:AUDio:{NONtdm|TDM}:CONDition. The search number is specified by x.

**Conditions** Requires option 5-SRAUDIO or SUP5-SRAUDIO Triggering and Analysis application.

**Group** Search and Mark

**Syntax** SEARCH:SEARCH<x>:TRIGger:A:BUS:AUDio:DATA:QUALifier {EQua|UNEQua|LESSthan|MORethan|LESSEQua|MORREEQua|INrange|OUTrange}  
SEARCH:SEARCH<x>:TRIGger:A:BUS:AUDio:DATA:QUALifier?

**Arguments** LESSthan sets the qualifier to less than.  
MORethan sets the qualifier to greater than.  
EQua sets the qualifier to equal.  
UNEQua sets the qualifier to not equal.  
LESSEQua sets the qualifier to less than or equal.  
MORREEQua sets the qualifier to greater than or equal.  
INrange sets the qualifier to in range.

OUTrange sets the qualifier to out of range.

**Examples** SEARCH:SEARCH1:TRIGGER:A:BUS:AUDIO:DATA:QUALIFIER LESSthan sets the qualifier to LESSthan.

SEARCH:SEARCH1:TRIGGER:A:BUS:AUDIO:DATA:QUALIFIER? might return SEARCH:SEARCH1:TRIGGER:A:BUS:AUDIO:DATA:QUALIFIER EQUAL indicating the qualifier is set to EQUAL.

## SEARCH:SEARCH<x>:TRIGGER:A:BUS:AUDIO:DATA:TDMVALue

This command sets or queries the binary data string for the single or low data word to be used when searching on an TDM audio bus signal. The search condition must be set to DATA using SEARCH:SEARCH{x}:TRIGGER:A:BUS:AUDIO:CONDITION.

**Group** Search and Mark

**Syntax** SEARCH:SEARCH<x>:TRIGGER:A:BUS:AUDIO:DATA:TDMVALue <QString>  
SEARCH:SEARCH<x>:TRIGGER:A:BUS:AUDIO:DATA:TDMVALue?

**Arguments** <QString> is the binary data string for the single or low data word to be used when searching on an TDM audio bus signal.

**Examples** SEARCH:SEARCH1:TRIGGER:A:BUS:AUDIO:DATA:TDMVALue "1100" sets the TDMVALUE to 1100.

SEARCH:SEARCH1:TRIGGER:A:BUS:AUDIO:DATA:TDMVALue? might return SEARCH:SEARCH1:TRIGGER:A:BUS:AUDIO:DATA:TDMVALUE "XXXXXXXXXXXXXXXXXXXX1010", indicating the TDM value is 1010.

## SEARCH:SEARCH<x>:TRIGGER:A:BUS:AUDIO:DATA:VALue

This command sets or queries the binary data string for the single or low data word to be used when searching on an audio bus signal. The search condition must be set to DATA using SEARCH:SEARCH<x>:TRIGGER:A:BUS:AUDIO:{NONTdm|TDM}:CONDITION. The search number is specified by x.

**Conditions** Requires option 5-SRAUDIO or SUP5-SRAUDIO Triggering and Analysis application.



<b>Group</b>	Search and Mark
<b>Syntax</b>	SEARCH:SEARCH<x>:TRIGger:A:BUS:AUDio:DATA:VALue <QString> SEARCH:SEARCH<x>:TRIGger:A:BUS:AUDio:DATA:VALue?
<b>Arguments</b>	<QString> is the lower word value.
<b>Examples</b>	SEARCH:SEARCH1:TRIGger:A:BUS:AUDio:DATA:VALue "X0X011" sets the data value to X0X011.  SEARCH:SEARCH1:TRIGger:A:BUS:AUDio:DATA:VALue? might return SEARCH:SEARCH1:TRIGGER:A:BUS:AUDIO:DATA:VALUE "XXXXXXXXXXXXXXXXXXXXXXXXXXXX", indicating the data value is set to XXXXXXXXXXXXXXXXXXXXXXXXXXXX.

## SEARCH:SEARCH<x>:TRIGger:A:BUS:AUDio:DATA:WORD

This command sets or queries the alignment of the data (left, right or either) to be used when searching on a non-TDM type audio bus signal. The search condition must be set to DATA using SEARCH:SEARCH<x>:TRIGger:A:BUS:AUDio:NONtdm:CONDition. The search number is specified by x.

<b>Conditions</b>	Requires option 5-SRAUDIO or SUP5-SRAUDIO Triggering and Analysis application.
<b>Group</b>	Search and Mark
<b>Syntax</b>	SEARCH:SEARCH<x>:TRIGger:A:BUS:AUDio:DATA:WORD {EITHer LEFt RIGht} SEARCH:SEARCH<x>:TRIGger:A:BUS:AUDio:DATA:WORD?
<b>Arguments</b>	EITHer aligns the data to either left or right.  LEFt aligns the data to the left.  RIGht aligns the data to the right.
<b>Examples</b>	SEARCH:SEARCH1:TRIGger:A:BUS:AUDio:DATA:WORD LEFt aligns the data to the left.

SEARCH:SEARCH1:TRIGGER:A:BUS:AUDIO:DATA:WORD? might return  
SEARCH:SEARCH1:TRIGGER:A:BUS:AUDIO:DATA:WORD EITHER indicating  
the data is aligned either to the left or right.

## SEARCH:SEARCH<x>:TRIGGER:A:BUS:AUTOETHERnet:CONDition

This command sets or queries the field or condition for which to search an AutoEthernet.

<b>Conditions</b>	Requires option SR-AUTOENET  Most of the other SEARCH:SEARCH<x>:TRIGGER:A:BUS:B:AUTOETHERnet commands are impacted by the setting of this command.
<b>Group</b>	Search and Mark
<b>Syntax</b>	SEARCH:SEARCH<x>:TRIGGER:A:BUS:AUTOETHERnet: CONDition {SSD SFD MACADDRESS MACLENGTH IPHeader  TCPHeader DATA EOP FCSErrror QTAG} SEARCH:SEARCH<x>:TRIGGER:A:BUS:AUTOETHERnet:CONDition?
<b>Arguments</b>	Search<x> is the Search number.  SSD specifies to search for Start of frame.  SFD specifies to search for Start of frame delimiter.  MACADDRESS specifies to search for MAC addresses field.  MACLENGTH specifies to search for MAC length/type field.  IPHeader specifies to search for IP header field.  TCPHeader specifies to search for TCP header field.  DATA specifies to search for TCP/IPv4 or MAC protocol client data field.  EOP specifies to search for End of Packet field.  FCSErrror specifies to search for Frame Check Sequence Error (CRC) field.  QTAG specifies to search for IEEE 802.1Q (VLAN) control information field.
<b>Examples</b>	SEARCH:SEARCH1:TRIGGER:A:BUS:AUTOETHERnet:CONDition MACADDRESS specifies MACADDRESS as the field within an AutoEthernet frame to search on.

SEARCH:SEARCH1:TRIGGER:A:BUS:AUTOETHERnet:CONDITION? might return SEARCH:SEARCH1:TRIGGER:A:BUS:AUTOETHERnet:CONDITION DATA, indicating that DATA is the currently specified field within an AutoEthernet frame to search on.

## SEARCH:SEARCH<x>:TRIGger:A:BUS:AUTOETHERnet:DATA:HIVALue

This command sets or queries the binary data value to be used when searching on an AutoEthernet bus signal. The search condition must be set to DATA and the data qualifier to inside or outside range.

**Conditions** Requires option SR-AUTOENET

**Group** Search and Mark

**Syntax** SEARCH:SEARCH<x>:TRIGger:A:BUS:AUTOETHERnet:DATA:HIVALue  
<QString>  
SEARCH:SEARCH<x>:TRIGger:A:BUS:AUTOETHERnet:DATA:HIVALue?

**Arguments** Search<x> is the Search number.  
  
QString specifies the binary data value to be used when searching on an AutoEthernet bus signal.

**Examples** SEARCH:SEARCH1:TRIGger:A:BUS:AUTOETHERnet:DATA:HIVALue  
"101011" sets the data HIVALue to 101011.  
  
SEARCH:SEARCH1:TRIGger:A:BUS:AUTOETHERnet:DATA:HIVALue? might  
returnSEARCH:SEARCH1:TRIGGER:A:BUS:AUTOETHERnet:DATA:HIVALUE  
"10110".

## SEARCH:SEARCH<x>:TRIGger:A:BUS:AUTOETHERnet:DATA:OFFSet

This command sets or queries the data offset value, in bytes, to use when searching on the AutoEthernet data field. The search condition needs to be set to DATA.

**Conditions** Requires option SR-AUTOENET

**Group** Search and Mark

**Syntax** SEARCH:SEARCH<x>:TRIGger:A:BUS:AUTOETHERnet:DATA:OFFSet <NR1>  
SEARCH:SEARCH<x>:TRIGger:A:BUS:AUTOETHERnet:DATA:OFFSet?

**Related Commands** [SEARCH:SEARCH<x>:TRIGger:A:BUS:AUTOETHERnet:CONDition](#)  
[SEARCH:SEARCH<x>:TRIGger:A:BUS:AUTOETHERnet:DATA:SIZE](#)  
[SEARCH:SEARCH<x>:TRIGger:A:BUS:AUTOETHERnet:TCPHeader:SOUrceport:VALue](#)

**Arguments** Search<x> is the Search number.  
NR1 sets the data offset value, in bytes. It is an integer value whose minimum and default values are -1 (don't care) and maximum is 1,499.

**Examples** SEARCH:SEARCH1:TRIGGER:A:BUS:AUTOETHERnet:DATA:OFFSet 36 sets the data offset to 36 bytes.  
SEARCH:SEARCH1:TRIGGER:A:BUS:AUTOETHERnet:DATA:OFFSet? might return SEARCH:SEARCH1:TRIGGER:A:BUS:AUTOETHERnet:DATA:OFFSet -1, indicating that the data offset value is the default value (-1), meaning "don't care".

## SEARCH:SEARCH<x>:TRIGger:A:BUS:AUTOETHERnet:DATA:SIZE

This command sets or queries the length of the data string, in bytes, to use when searching on the AutoEthernet bus signal. The search condition needs to be set to DATA.

**Conditions** Requires option SR-AUTOENET  
The search condition needs to be set to DATA.

**Group** Search and Mark

**Syntax** SEARCH:SEARCH<x>:TRIGger:A:BUS:AUTOETHERnet:DATA:SIZE <NR1>  
SEARCH:SEARCH<x>:TRIGger:A:BUS:AUTOETHERnet:DATA:SIZE?

**Related Commands** [SEARCH:SEARCH<x>:TRIGger:A:BUS:AUTOETHERnet:CONDition](#)

<b>Arguments</b>	<p>Search&lt;x&gt; is the Search number.</p> <p>NR1 sets the data length, in bytes. It is an integer value whose minimum and default values are 1, and the maximum value is 16.</p>
<b>Examples</b>	<p>SEARCH:SEARCH1:TRIGGER:A:BUS:AUTOETHERnet:DATA:SIZE 4 specifies 4 as the number of contiguous TCP/IPv4/MAC client bytes to use when searching on the AutoEthernet data field.</p> <p>SEARCH:SEARCH1:TRIGGER:A:BUS:AUTOETHERnet:DATA:SIZE? might return SEARCH:SEARCH1:TRIGGER:A:BUS:AUTOETHERnet:DATA:SIZE 8.</p>

## SEARCH:SEARCH<x>:TRIGger:A:BUS:AUTOETHERnet:DATA:VALue

This command sets or queries the binary value to use when searching on the AutoEthernet bus signal. The search condition needs to be set to DATA.

<b>Conditions</b>	<p>Requires option SR-AUTOENET</p> <p>The search condition needs to be set to DATA.</p>
<b>Group</b>	Search and Mark
<b>Syntax</b>	<pre>SEARCH:SEARCH&lt;x&gt;:TRIGger:A:BUS:AUTOETHERnet:DATA:VALue &lt;QString&gt; SEARCH:SEARCH&lt;x&gt;:TRIGger:A:BUS:AUTOETHERnet:DATA:VALue?</pre>

**Related Commands**

[SEARCH:SEARCH<x>:TRIGger:A:BUS:AUTOETHERnet:CONDition](#)  
[SEARCH:SEARCH<x>:TRIGger:A:BUS:AUTOETHERnet:DATA:OFFSet](#)  
[SEARCH:SEARCH<x>:TRIGger:A:BUS:AUTOETHERnet:DATA:SIZE](#)

<b>Arguments</b>	<p>Search&lt;x&gt; is the Search number.</p> <p>QString is a quoted string where the allowable characters are 0, 1, and X. The allowable number of characters depends on the setting for size (using SEARCH:SEARCH&lt;x&gt;:TRIGger:A:BUS:AUTOETHERnet:DATA:SIZE). The bits specified in the quoted string replace the least significant bits (LSB), leaving any unspecified upper bits unchanged.</p>
<b>Examples</b>	<p>SEARCH:SEARCH1:TRIGGER:A:BUS:AUTOETHERnet:DATA:VALUE "00001000" specifies 00001000 as the value to use when triggering on the AutoEthernet binary data field, assuming that</p>

SEARCH:SEARCH1:TRIGGER:A:BUS:AUTOETHERnet:DATA:SIZE is set to 1 byte.

SEARCH:SEARCH1:TRIGGER:A:BUS:AUTOETHERnet:DATA:VALUE? might return SEARCH:SEARCH1:TRIGGER:A:BUS:AUTOETHERnet:DATA:VALUE "00001000", indicating 0000100 is the currently specified value used when searching on the AutoEthernet binary data field.

## SEARCH:SEARCH<x>:TRIGger:A:BUS:AUTOETHERnet:IPHeader:DESTinationaddr:VALue

This command sets or queries the binary destination address value to use when searching on an AutoEthernet bus signal. The search condition needs to be set to IPHeader.

**Conditions** Requires option SR-AUTOENET

The search condition needs to be set to IPHeader.

**Group** Search and Mark

**Syntax** SEARCH:SEARCH<x>:TRIGger:A:BUS:AUTOETHERnet:IPHeader:DESTinationaddr:VALue <QString>  
SEARCH:SEARCH<x>:TRIGger:A:BUS:AUTOETHERnet:IPHeader:DESTinationaddr:VALue?

**Related Commands** [SEARCH:SEARCH<x>:TRIGger:A:BUS:AUTOETHERnet:CONDition](#)

**Arguments** Search<x> is the Search number.

QString is a quoted string of up to 32 characters that sets the IP address, where the allowable characters are 0, 1, and X. The bits specified in the quoted string replace the least significant bits (LSB), leaving any unspecified upper bits unchanged.

**Examples** SEARCH:SEARCH1:TRIGGER:A:BUS:AUTOETHERnet:IPHEADER:DESTINATIONADDR:VALUE "11000000101010000000000000000001" specifies 192.168.0.1 as the value to use when searching on the AutoEthernet IPv4 header address destination field.

SEARCH:SEARCH1:TRIGGER:A:BUS:AUTOETHERnet:IPHEADER:DESTINATIONADDR:VALUE? might return  
SEARCH:SEARCH1:TRIGGER:A:BUS:AUTOETHERnet:IPHEADER:DESTINATIONADDR:VALUE "11000000101010000000000000000001",

indicating that 192.168.0.1 is the currently specified value used when searching on the AutoEthernet IPv4 header address destination field.

## SEARCH:SEARCH<x>:TRIGger:A:BUS:AUTOETHERnet:IPHeader:PROTOcol:VALue

This command sets or queries the binary protocol value to use when searching on the Ethernet bus signal. The search condition needs to be set to IPHeader.

**Conditions** Requires option SR-AUTOENET

The search condition needs to be set to IPHeader.

**Group** Search and Mark

**Syntax** SEARCH:SEARCH<x>:TRIGger:A:BUS:AUTOETHERnet:IPHeader:PROTOcol:VALue <QString>  
SEARCH:SEARCH<x>:TRIGger:A:BUS:AUTOETHERnet:IPHeader:PROTOcol:VALue?

**Related Commands** [SEARCH:SEARCH<x>:TRIGger:A:BUS:AUTOETHERnet:CONDition](#)

**Arguments** Search<x> is the Search number.

QString is a quoted string of up to eight (8) characters where the allowable characters are 0, 1, and X. The bits specified in the quoted string replace the least significant bits (LSB), leaving any unspecified upper bits unchanged.

**Examples** SEARCH:SEARCH1:TRIGGER:A:BUS:AUTOETHERnet:IPHEADER:PROTOCOL:VALUE "01010010" specifies 01010010 as the value to use when searching on the AutoEthernet IP header protocol field.

SEARCH:SEARCH1:TRIGGER:A:BUS:AUTOETHERnet:IPHEADER:PROTOCOL:VALUE? might return  
SEARCH:SEARCH1:TRIGGER:A:BUS:AUTOETHERnet:IPHEADER:PROTOCOL:VALUE "XXXXXXXX", indicating that the trigger value has been set to "don't care".

## SEARCH:SEARCH<x>:TRIGger:A:BUS:AUTOETHERnet:IPHeader:SOURceaddr:VALue

This command sets or queries the binary source address value to use when searching on an AutoEthernet bus signal. The search condition needs to be set to IPHeader.

<b>Conditions</b>	Requires option SR-AUTOENET The search condition needs to be set to IPHeader.
<b>Group</b>	Search and Mark
<b>Syntax</b>	SEARCH:SEARCH<x>:TRIGger:A:BUS:AUTOETHERnet:IPHeader: SOURceaddr:VALue <QString> SEARCH:SEARCH<x>:TRIGger:A:BUS:AUTOETHERnet:IPHeader: SOURceaddr:VALue?
<b>Related Commands</b>	<a href="#">SEARCH:SEARCH&lt;x&gt;:TRIGger:A:BUS:AUTOETHERnet:CONDition</a>
<b>Arguments</b>	Search<x> is the Search number.  QString is a quoted string of up to 32 characters, where the allowable characters are 0, 1, and X. The bits specified in the quoted string replace the least significant bits (LSB), leaving any unspecified upper bits unchanged.
<b>Examples</b>	SEARCH:SEARCH1:TRIGGER:A:BUS:AUTOETHERnet:IPHEADER:SOURCEADDR:VALUE "11000000101010000000000000000001" specifies to use the value of 192.168.0.1 when searching on the AutoEthernet IP header address source field.  SEARCH:SEARCH1:TRIGGER:A:BUS:AUTOETHERnet:IPHEADER:SOURCEADDR:VALUE? might return SEARCH:SEARCH1:TRIGGER:A:BUS:AUTOETHERnet:IPHEADER:SOURCEADDR:VALUE "11000000101010000000000000000001", indicating that the search value has been set to 192.168.0.1.

## SEARCH:SEARCH<x>:TRIGger:A:BUS:AUTOETHERnet:MAC:ADDRESS:DESTINATION:VALue

This command sets or queries the binary MAC address destination value to use when searching on an AutoEthernet bus signal. The search condition needs to be set to MACADDRESS.

<b>Conditions</b>	Requires option SR-AUTOENET The search condition needs to be set to MACADDRESS.
<b>Group</b>	Search and Mark
<b>Syntax</b>	SEARCH:SEARCH<x>:TRIGger:A:BUS:AUTOETHERnet:MAC:ADDRESS: DESTINATION:VALue <QString>



SEARCH:SEARCH<x>:TRIGger:A:BUS:AUTOETHERnet:MAC:ADDRESS:DESTINATION:VALUE ?

**Related Commands** [SEARCH:SEARCH<x>:TRIGger:A:BUS:AUTOETHERnet:CONDition](#)

**Arguments** Search<x> is the Search number.

QString is a quoted string of up to 48 characters where the allowable characters are 0, 1, and X. The bits specified in the quoted string replace the least significant bits (LSB), leaving any unspecified upper bits unchanged.

**Examples**

SEARCH:SEARCH1:TRIGGER:A:BUS:AUTOETHERnet:MAC:ADDRESS:DESTINATION:VALUE  
 "XXXXXXXX0011010111111100000001111010101011001000" specifies to use the value of XX:35:FC:07:AA:C8 hex when searching on the Ethernet MAC address destination field.

SEARCH:SEARCH1:TRIGGER:A:BUS:AUTOETHERnet:MAC:ADDRESS:DESTINATION:VALUE? might return  
 SEARCH:SEARCH1:TRIGGER:A:BUS:AUTOETHERnet:MAC:ADDRESS:DESTINATION:VALUE  
 "XXXXXXXX0011010111111100000001111010101011001000", indicating a MAC address destination field value of XX:35:FC:07:AA:C8 hex.

## SEARCH:SEARCH<x>:TRIGger:A:BUS:AUTOETHERnet:MAC:ADDRESS:SOURce:VALue

This command sets or queries the binary MAC address source value to use when searching on an AutoEthernet bus signal. The search condition needs to be set to MACADDRESS.

**Conditions** Requires option SR-AUTOENET  
 The search condition needs to be set to MACADDRESS.

**Group** Search and Mark

**Syntax** SEARCH:SEARCH<x>:TRIGger:A:BUS:AUTOETHERnet:MAC:ADDRESS:SOURCE:VALUE <QString>  
 SEARCH:SEARCH<x>:TRIGger:A:BUS:AUTOETHERnet:MAC:ADDRESS:SOURCE:VALUE?

**Related Commands** [SEARCH:SEARCH<x>:TRIGger:A:BUS:AUTOETHERnet:CONDition](#)

<b>Arguments</b>	<p>Search&lt;x&gt; is the Search number.</p> <p>QString is a quoted string of up to 48 characters where the allowable characters are 0, 1, and X. The bits specified in the quoted string replace the least significant bits (LSB), leaving any unspecified upper bits unchanged.</p>
<b>Examples</b>	<p>SEARCH:SEARCH1:TRIGGER:A:BUS:AUTOETHERnet:MAC:ADDRESS:SOURCE:VALUE "XXXXXXXX001101011111100000001111010101011001000" specifies to use the value of XX:35:FC:07:AA:C8 hex when searching on the Ethernet MAC address source field.</p> <p>SEARCH:SEARCH1:TRIGGER:A:BUS:AUTOETHERnet:MAC:ADDRESS:SOURCE:VALUE? might return SEARCH:SEARCH1:TRIGGER:A:BUS:AUTOETHERnet:MAC:ADDRESS:SOURCE:VALUE "XXXXXXXX001101011111100000001111010101011001000", indicating a MAC address source field value of XX:35:FC:07:AA:C8 hex.</p>

## SEARCH:SEARCH<x>:TRIGger:A:BUS:AUTOETHERnet:MAC:LENGth:HIVALue

This command sets or queries the binary MAC length high value to use when searching on an AutoEthernet bus signal. The search condition needs to be set to MACADDRESS.

<b>Conditions</b>	<p>Requires option SR-AUTOENET</p> <p>The search condition needs to be set to MACADDRESS.</p>
<b>Group</b>	Search and Mark
<b>Syntax</b>	<p>SEARCH:SEARCH&lt;x&gt;:TRIGger:A:BUS:AUTOETHERnet:MAC:LENGth:HIVALue &lt;QString&gt;</p> <p>SEARCH:SEARCH&lt;x&gt;:TRIGger:A:BUS:AUTOETHERnet:MAC:LENGth:HIVALue?</p>
<b>Related Commands</b>	<a href="#">SEARCH:SEARCH&lt;x&gt;:TRIGger:A:BUS:AUTOETHERnet:CONDition</a>
<b>Arguments</b>	<p>Search&lt;x&gt; is the Search number.</p> <p>QString is a quoted string of up to 16 characters where the allowable characters are 0, 1, and X. The bits specified in the quoted string replace the least significant bits (LSB), leaving any unspecified upper bits unchanged.</p>

**Examples** SEARCH:SEARCH1:TRIGGER:A:BUS:AUTOETHERnet:MAC:LENGTH:HIVALUE "XXXXXXXX00001000" specifies to use the hexadecimal value XX08 when searching on the AutoEthernet MAC length.

SEARCH:SEARCH1:TRIGGER:A:BUS:AUTOETHERnet:MAC:LENGTH:HIVALUE? might return  
SEARCH:SEARCH1:TRIGGER:A:BUS:AUTOETHERnet:MAC:LENGTH:HIVALUE "XXXXXXXX00001000", indicating an AutoEthernet MAC length value of XX08 hex.

## SEARCH:SEARCH<x>:TRIGger:A:BUS:AUTOETHERnet:MAC:LENgth:VALue

This command sets or queries the MAC length value to use when searching on an Ethernet bus signal. The search condition needs to be set to MACADDRess.

**Conditions** Requires option SR-AUTOENET  
The search condition needs to be set to MACADDRess.

**Group** Search and Mark

**Syntax** SEARCH:SEARCH<x>:TRIGger:A:BUS:AUTOETHERnet:MAC:LENgth:VALue <QString>  
SEARCH:SEARCH<x>:TRIGger:A:BUS:AUTOETHERnet:MAC:LENgth:VALue?

**Related Commands** [SEARCH:SEARCH<x>:TRIGger:A:BUS:AUTOETHERnet:CONDition](#)

**Arguments** Search<x> is the Search number.

QString is a quoted string of up to 16 characters where the allowable characters are 0, 1, and X. The bits specified in the quoted string replace the least significant bits (LSB), leaving any unspecified upper bits unchanged.

**Examples** SEARCH:SEARCH1:TRIGGER:A:BUS:AUTOETHERnet:MAC:LENGTH:HIVALUE "XXXXXXXX00001000" specifies to use the hexadecimal value XX08 when searching on the AutoEthernet MAC length.

SEARCH:SEARCH1:TRIGGER:A:BUS:AUTOETHERnet:MAC:LENGTH:HIVALUE? might return  
SEARCH:SEARCH1:TRIGGER:A:BUS:AUTOETHERnet:MAC:LENGTH:HIVALUE "XXXXXXXX00001000", indicating an AutoEthernet MAC length value of XX08 hex.

## SEARCH:SEARCH<x>:TRIGger:A:BUS:AUTOETHERnet:QTAG:VALue

This command sets or queries the binary Q-tag information to use when searching on an AutoEthernet bus signal. The search condition needs to be set to QTAG.

<b>Conditions</b>	Requires option SR-AUTOENET The search condition needs to be set to QTAG.
<b>Group</b>	Search and Mark
<b>Syntax</b>	SEARCH:SEARCH<x>:TRIGger:A:BUS:AUTOETHERnet:QTAG:VALue <QString> SEARCH:SEARCH<x>:TRIGger:A:BUS:AUTOETHERnet:QTAG:VALue?

**Related Commands**    [SEARCH:SEARCH<x>:TRIGger:A:BUS:AUTOETHERnet:CONDition](#)

**Arguments**    Search<x> is the Search number.  
  
QString is a quoted string of up to 32 characters where the allowable characters are 0, 1, and X. The bits specified in the quoted string replace the least significant bits (LSB), leaving any unspecified upper bits unchanged.

**Examples**    SEARCH:SEARCH1:TRIGGER:A:BUS:AUTOETHERnet:QTAG:VALUE  
"XXXXXXXXXXXXXXXXXXXX010010001010" specifies to use the value of hexadecimal XXXXX48A when searching on the AutoEthernet Q-Tag field.  
  
SEARCH:SEARCH1:TRIGGER:A:BUS:AUTOETHERnet:QTAG:VALUE? might return SEARCH:SEARCH1:TRIGGER:A:BUS:AUTOETHERnet:QTAG:VALUE "XXXXXXXXXXXXXXXXXXXX010010001010", indicating that hexadecimal XXXXX48A has been set as the AutoEthernet Q-Tag field search value.

## SEARCH:SEARCH<x>:TRIGger:A:BUS:AUTOETHERnet:QUALifier

This command sets or queries the qualifier to be used when searching on an AutoEthernet bus signal. The search condition must be set to Client Data or MAC Length/Type.

<b>Conditions</b>	Requires option SR-AUTOENET The search condition must be set to Client Data or MAC Length/Type.
-------------------	----------------------------------------------------------------------------------------------------

<b>Group</b>	Search and Mark
--------------	-----------------

**Syntax** SEARCH:SEARCH<x>:TRIGger:A:BUS:AUTOETHERnet:QUALifier  
 {LESSthan|MOREthan|Equal|UNEQual| LESSEQual|MOREEQual|  
 INrange|OUTrange}  
 SEARCH:SEARCH<x>:TRIGger:A:BUS:AUTOETHERnet:QUALifier?

**Related Commands** [SEARCH:SEARCH<x>:TRIGger:A:BUS:AUTOETHERnet:CONDition](#)

**Arguments** Search<x> is the Search number.  
 LESSthan sets the qualifier to less than.  
 MOREthan sets the qualifier to greater than.  
 Equal sets the qualifier to equal.  
 UNEQual sets the qualifier to not equal.  
 LESSEQual sets the qualifier to less than or equal.  
 MOREEQual sets the qualifier to greater than or equal.  
 INrange sets the qualifier to in range.  
 OUTrange sets the qualifier to out of range.

**Examples** SEARCH:SEARCH1:TRIGGER:A:BUS:AUTOETHERnet:QUALIFIER LESSTHAN  
 sets the qualifier to "less than".  
 SEARCH:SEARCH1:TRIGGER:A:BUS:AUTOETHERnet:QUALIFIER? might  
 return SEARCH:SEARCH1:TRIGGER:A:BUS:AUTOETHERnet:QUALIFIER  
 EQUAL, indicating that the qualifier is set to EQUAL.

## SEARCH:SEARCH<x>:TRIGger:A:BUS:AUTOETHERnet:TCPHeader:ACKnum:VALue

This command sets or queries the binary ack number value to use when searching on an AutoEthernet bus signal. The default is all X's (don't care). The search condition needs to be set to TCPHeader.

**Conditions** Requires option SR-AUTOENET  
 The search condition needs to be set to TCPHeader.

**Group** Search and Mark

**Syntax** SEARCH:SEARCH<x>:TRIGger:A:BUS:AUTOETHERnet:TCPHeader:  
 ACKnum:VALue <Qstring>

SEARCH:SEARCH<x>:TRIGger:A:BUS:AUTOETHERnet:TCPHeader:ACKnum:VALue?

**Related Commands**    [SEARCH:SEARCH<x>:TRIGger:A:BUS:AUTOETHERnet:CONDition](#)

**Arguments**    Search<x> is the Search number.  
  
QString is a quoted string of up to 32 characters where the allowable characters are 0, 1, and X. The bits specified in the quoted string replace the least significant bits (LSB), leaving any unspecified upper bits unchanged.

**Examples**    SEARCH:SEARCH1:TRIGGER:A:BUS:AUTOETHERnet:TCPHEADER:ACKNUM:VALUE "XXXXXXXXXXXXXXXXXXXX00001000" specifies hexadecimal XXXXXX08 as the value to use when searching on the AutoEthernet TCP header acknowledgement number.

SEARCH:SEARCH1:TRIGGER:A:BUS:AUTOETHERnet:TCPHEADER:ACKNUM:VALUE? might return  
SEARCH:SEARCH1:TRIGGER:A:BUS:AUTOETHERnet:TCPHEADER:ACKNUM:VALUE "XXXXXXXXXXXXXXXXXXXX00001000", indicating that hexadecimal XXXXXX08 has been specified as the value to use when searching on the Auto Ethernet TCP header acknowledgement number.

## SEARCH:SEARCH<x>:TRIGger:A:BUS:AUTOETHERnet:TCPHeader:DESTinationport:VALue?

This command sets or queries the binary destination port value to use when searching on the AutoEthernet TCP header destination port number. The search condition needs to be set to TCPHeader.

**Conditions**    Requires option SR-AUTOENET  
  
The search condition needs to be set to TCPHeader.

**Group**    Search and Mark

**Syntax**    SEARCH:SEARCH<x>:TRIGger:A:BUS:AUTOETHERnet:TCPHeader:DESTinationport:VALue <QString>  
SEARCH:SEARCH<x>:TRIGger:A:BUS:AUTOETHERnet:TCPHeader:DESTinationport:VALue?

**Related Commands**    [SEARCH:SEARCH<x>:TRIGger:A:BUS:AUTOETHERnet:CONDition](#)

<b>Arguments</b>	<p>Search&lt;x&gt; is the Search number.</p> <p>QString is a quoted string of up to 16 characters where the allowable characters are 0, 1, and X. The bits specified in the quoted string replace the least significant bits (LSB), leaving any unspecified upper bits unchanged.</p>
<b>Examples</b>	<pre>SEARCH:SEARCH1:TRIGGER:A:BUS:AUTOETHERnet:TCPHEADER: DESTINATIONPORT:VALUE "XXXXXXXX00100010" specifies to use the value of hexadecimal XX22 when searching on the AutoEthernet TCP header destination port number.</pre> <pre>SEARCH:SEARCH1:TRIGGER:A:BUS:AUTOETHERnet:TCPHEADER: DESTINATIONPORT:VALUE? might return SEARCH:SEARCH1:TRIGGER:A:BUS:AUTOETHERnet:TCPHEADER: DESTINATIONPORT:VALUE "XXXXXXXX00100010", indicating that hexadecimal XX22 has been set as the value to use when searching on the AutoEthernet TCP header destination port number.</pre>

## SEARCH:SEARCH<x>:TRIGger:A:BUS:AUTOETHERnet:TCPHeader:SEQnum:VALue

This command sets or queries the TCP header sequence number value to use when searching on the AutoEthernet TCP header destination port number. The search condition needs to be set to TCPHeader.

<b>Conditions</b>	<p>Requires option SR-AUTOENET</p> <p>The search condition needs to be set to TCPHeader.</p>
<b>Group</b>	Search and Mark
<b>Syntax</b>	<pre>SEARCH:SEARCH&lt;x&gt;:TRIGger:A:BUS:AUTOETHERnet:TCPHeader: SEQnum:VALue &lt;QString&gt; SEARCH:SEARCH&lt;x&gt;:TRIGger:A:BUS:AUTOETHERnet:TCPHeader: SEQnum:VALue?</pre>
<b>Related Commands</b>	<a href="#">SEARCH:SEARCH&lt;x&gt;:TRIGger:A:BUS:AUTOETHERnet:CONDition</a>

<b>Arguments</b>	<p>Search&lt;x&gt; is the Search number.</p> <p>QString is a quoted string of up to 32 characters where the allowable characters are 0, 1, and X. The bits specified in the quoted string replace the least significant bits (LSB), leaving any unspecified upper bits unchanged.</p>
------------------	---------------------------------------------------------------------------------------------------------------------------------------------------------------------------------------------------------------------------------------------------------------------------------------

**Examples**     SEARCH:SEARCH1:TRIGGER:A:BUS:AUTOETHERnet:TCPHEADER:SEQNUM:VALUE  
 "XXXXXXXXXXXXXXXXXXXX000100010001" specifies to use the value of hexadecimal XXXXX111 when searching on the AutoEthernet TCP header sequence number.

SEARCH:SEARCH1:TRIGGER:A:BUS:AUTOETHERnet:TCPHEADER:SEQNUM:VALUE?  
 might return  
 SEARCH:SEARCH1:TRIGGER:A:BUS:AUTOETHERnet:TCPHEADER:SEQNUM:VALUE  
 "XXXXXXXXXXXXXXXXXXXX0010010100", indicating that hexadecimal XXXXX111 has been specified as the value to use when searching on the AutoEthernet TCP header sequence number.

## SEARCH:SEARCH<x>:TRIGger:A:BUS:AUTOETHERnet:TCPHeader:SOUrceport:VALue

This command sets or queries the binary source port value to use when searching on an AutoEthernet bus signal. The search condition needs to be set to TCPHeader.

**Conditions**     Requires option SR-AUTOENET  
 The search condition needs to be set to TCPHeader.

**Group**            Search and Mark

**Syntax**            SEARCH:SEARCH<x>:TRIGger:A:BUS:AUTOETHERnet:TCPHeader:  
 SOUrceport:VALue <QString>  
 SEARCH:SEARCH<x>:TRIGger:A:BUS:AUTOETHERnet:TCPHeader:  
 SOUrceport:VALue?

**Related Commands**     [SEARCH:SEARCH<x>:TRIGger:A:BUS:AUTOETHERnet:CONDition](#)

**Arguments**        Search<x> is the Search number.

QString is a quoted string of up to 16 characters where the allowable characters are 0, 1, and X. The bits specified in the quoted string replace the least significant bits (LSB), leaving any unspecified upper bits unchanged.

**Examples**        SEARCH:SEARCH1:TRIGGER:A:BUS:AUTOETHERnet:TCPHEADER:SOURCEPORT:VALUE  
 "XXX000010100110" specifies to use the value of hexadecimal X0A6 when searching on the AutoEthernet TCP header source port number.

SEARCH:SEARCH1:TRIGGER:A:BUS:AUTOETHERnet:TCPHEADER:SOURCEPORT:VALUE?  
 might return  
 SEARCH:SEARCH1:TRIGGER:A:BUS:AUTOETHERnet:TCPHEADER:SOURCEPORT:VALUE



"XXXXX01001010110", indicating that hexadecimal X0A6 has been specified as the value to use when searching on the Ethernet TCP header source port number.

## SEARCH:SEARCH<x>:TRIGger:A:BUS:CAN:CONDition

This command sets or queries the search condition for a CAN bus. The search number is specified by x.

<b>Conditions</b>	Requires option 5-SRAUTO or SUP5-SRAUTO Triggering and Analysis application.
<b>Group</b>	Search and Mark
<b>Syntax</b>	SEARCH:SEARCH<x>:TRIGger:A:BUS:CAN:CONDition {SOF FRAMetype IDentifier DATA IDANDDATA EOF ERRor FDBITS} SEARCH:SEARCH<x>:TRIGger:A:BUS:CAN:CONDition?
<b>Arguments</b>	Arguments specify the CAN bus trigger condition.
<b>Examples</b>	SEARCH:SEARCH1:TRIGger:A:BUS:CAN:CONDition EOF sets the CAN bus trigger condition to end of frame.  SEARCH:SEARCH1:TRIGger:A:BUS:CAN:CONDition? might return SEARCH:SEARCH1:TRIGGER:A:BUS:CAN:CONDITION SOF, indicating the CAN bus trigger condition is set to start of frame.

## SEARCH:SEARCH<x>:TRIGger:A:BUS:CAN:DATA:DIRection

This command specifies the CAN search type to be valid on a Read, Write, or Either condition. The search number is specified by x.

<b>Group</b>	Search and Mark
<b>Syntax</b>	SEARCH:SEARCH<x>:TRIGger:A:BUS:CAN:DATA:DIRection {READ WRITE NOCARE} SEARCH:SEARCH<x>:TRIGger:A:BUS:CAN:DATA:DIRection?
<b>Arguments</b>	READ specifies the read direction.  WRITE specifies the write direction.

NOCARE specifies either data direction.

**Examples**     `SEARCH:SEARCH1:TRIGGER:A:BUS:CAN:DATA:DIRECTION READ` sets the data direction to READ.

`SEARCH:SEARCH1:TRIGGER:A:BUS:CAN:DATA:DIRECTION?` might return `SEARCH:SEARCH1:TRIGGER:A:BUS:CAN:DATA:DIRECTION NOCARE`, indicating the data direction is set to either data direction.

## SEARCH:SEARCH<x>:TRIGGER:A:BUS:CAN:DATA:OFFSet

This command sets or queries the data offset value, in bytes, to use when searching on the CAN data field. The search number is specified by x. The search condition must be set to DATA or IDANDDATA.

**Conditions**     Requires option 5-SRAERO or SUP5-SRAERO Triggering and Analysis application.

**Group**            Search and Mark

**Syntax**            `SEARCH:SEARCH<x>:TRIGGER:A:BUS:CAN:DATA:OFFSet <NR1>`  
`SEARCH:SEARCH<x>:TRIGGER:A:BUS:CAN:DATA:OFFSet?`

**Related Commands**     [BUS:B<x>:CAN:STANDARD](#)  
[SEARCH:SEARCH<x>:TRIGGER:A:BUS:CAN:DATA:SIZE](#)  
[SEARCH:SEARCH<x>:TRIGGER:A:BUS:CAN:DATA:VALUE](#)

**Arguments**        <NR1> is an integer whose minimum and default values are -1 (don't care) and maximum is up to 7 (for CAN 2.0) or up to 63 (for ISO CAN FD and Non-ISO CAN FD). The maximum is dependent on the number of bytes being matched and the CAN standard selected. Its value is calculated as [Absolute Maximum] - [Data Match Size]. For CAN 2.0, the absolute maximum is 8 bytes. For ISO CAN FD and Non-ISO CAN FD, the absolute maximum is 64 bytes. The minimum data match size is 1 byte, which produces the ranges listed above. Increasing the data match size above 1 byte will adjust the range of valid data offset values accordingly.

**Examples**        `SEARCH:SEARCH1:TRIGGER:A:BUS:CAN:DATA:OFFSET 5` sets the CAN data offset to 5 bytes.

SEARCH:SEARCH1:TRIGGER:A:BUS:CAN:DATA:OFFSET? might return 7, indicating the CAN data offset is 7 bytes. If the CAN standard is set for CAN 2.0 and the search data size is set to 3, the maximum value for the data offset will be 5 ( $8 - 3 = 5$ ). If the CAN standard is set for ISO CAN FD or Non-ISO CAN FD and the search data size is set to 8, the maximum value for the data offset will be 56 ( $64 - 8 = 56$ ).

## SEARCH:SEARCH<x>:TRIGger:A:BUS:CAN:DATA:QUALifier

This command sets or queries the CAN bus trigger data qualifier to be used when searching on a CAN bus signal. The search number is specified by x.

<b>Conditions</b>	Requires option 5-SRAUTO or SUP5-SRAUTO Triggering and Analysis application.
<b>Group</b>	Search and Mark
<b>Syntax</b>	SEARCH:SEARCH<x>:TRIGger:A:BUS:CAN:DATA:QUALifier {EQUAL LESSEQUAL MOREEQUAL UNEQUAL LESSTHAN MORETHAN} SEARCH:SEARCH<x>:TRIGger:A:BUS:CAN:DATA:QUALifier?
<b>Arguments</b>	Arguments are the data qualifier types.
<b>Examples</b>	SEARCH:SEARCH1:TRIGger:A:BUS:CAN:DATA:QUALifier UNEQUAL sets the data qualifier to unequal.  SEARCH:SEARCH1:TRIGger:A:BUS:CAN:DATA:QUALifier? might return SEARCH:SEARCH1:TRIGGER:A:BUS:CAN:DATA:QUALIFIER EQUAL, indicating that the data qualifier is set to equal.

## SEARCH:SEARCH<x>:TRIGger:A:BUS:CAN:DATA:SIZE

This command sets or queries the length of the data string, in bytes, to be used when searching on a CAN bus signal. The search condition must be set to IDANDDATA or DATA. The search number is specified by x.

<b>Conditions</b>	Requires option 5-SRAUTO or SUP5-SRAUTO Triggering and Analysis application.
<b>Group</b>	Search and Mark

**Syntax** SEARCH:SEARCH<x>:TRIGger:A:BUS:CAN:DATA:SIZE <NR1>  
SEARCH:SEARCH<x>:TRIGger:A:BUS:CAN:DATA:SIZE?

**Arguments** <NR1> specifies the data size.

**Examples** SEARCH:SEARCH1:TRIGger:A:BUS:CAN:DATA:SIZE 1 sets the data size to 1.  
SEARCH:SEARCH1:TRIGger:A:BUS:CAN:DATA:SIZE? might return  
SEARCH:SEARCH1:TRIGGER:A:BUS:CAN:DATA:SIZE 1, indicating the data  
size is set to 1.

## SEARCH:SEARCH<x>:TRIGger:A:BUS:CAN:DATA:VALUE

This command sets or queries the binary data value to be used when searching on a CAN bus signal. The search condition must be set to IDANDDATA OR DATA.

**Group** Search and Mark

**Syntax** SEARCH:SEARCH<x>:TRIGger:A:BUS:CAN:DATA:VALUE <QString>  
SEARCH:SEARCH<x>:TRIGger:A:BUS:CAN:DATA:VALUE?

**Arguments** <QString>

**Examples** SEARCH:SEARCH1:TRIGger:A:BUS:CAN:DATA:VALUE "1111" sets the data  
value to 1111.  
SEARCH:SEARCH1:TRIGger:A:BUS:CAN:DATA:VALUE? might return  
SEARCH:SEARCH1:TRIGGER:A:BUS:CAN:DATA:VALUE "1010" indicating  
the data value is 1010.

## SEARCH:SEARCH<x>:TRIGger:A:BUS:CAN:ERRType

This command sets or queries the type of error condition for a CAN bus to search on. The search number is specified by x. The search condition must be set to ERRor.

**Conditions** Requires option 5-SRAERO or SUP5-SRAERO Triggering and Analysis application.

**Group** Search and Mark

<b>Syntax</b>	SEARCH:SEARCH<x>:TRIGger:A:BUS:CAN:ERRTYPE {ACKMISS BITSTUFFing FORMERror  ANYERror} SEARCH:SEARCH<x>:TRIGger:A:BUS:CAN:ERRTYPE?
<b>Arguments</b>	ACKMISS specifies a search based on a missing ACK field.  BITSTUFFing specifies a search based on a bit stuffing error.  FORMERror specifies a search based on a CAN FD form error. To use this option, the CAN standard must be set to FDISO or FDNONISO.  ANYERror specifies a search based on any error type.
<b>Examples</b>	SEARCH:SEARCH1:TRIGGER:A:BUS:CAN:ERRTYPE ACKMISS specifies searching for any missing ACK fields.  SEARCH:SEARCH1:TRIGGER:A:BUS:CAN:ERRTYPE? might return ANYERROR, indicating that the bus is being searched for all error types.

## SEARCH:SEARCH<x>:TRIGger:A:BUS:CAN:FD:BRSBit

This command sets or queries the value of the bit rate switch bit (BRS bit) for a CAN bus to search on. The search number is specified by x. The search condition must be set to FDBITS, and the CAN standard must be FDISO or FDNONISO.

<b>Conditions</b>	Requires option 5-SRAERO or SUP5-SRAERO Triggering and Analysis application.
<b>Group</b>	Search and Mark
<b>Syntax</b>	SEARCH:SEARCH<x>:TRIGger:A:BUS:CAN:FD:BRSBit {ONE ZERO NOCARE} SEARCH:SEARCH<x>:TRIGger:A:BUS:CAN:FD:BRSBit?
<b>Arguments</b>	ONE filters CAN FD packets to only match those where the BRS bit has a value of 1 (fast data enabled).  ZERO filters CAN FD packets to only match those where the BRS bit has a value of 0 (fast data disabled).  NOCARE disables filtering of CAN FD packets on the BRS bit.
<b>Examples</b>	SEARCH:SEARCH1:TRIGGER:A:BUS:CAN:FD:BRSBit ONE specifies filtering CAN FD packets for those where the BRS bit has a value of 1.

SEARCH:SEARCH1:TRIGGER:A:BUS:CAN:FD:BRSBIT? might return NOCARE, indicating that CAN FD packets are not being filtered based on the BRS bit value.

## SEARCH:SEARCH<x>:TRIGger:A:BUS:CAN:FD:ESIBit

This command sets or queries the value of the error state indicator bit (ESI bit) for a CAN bus to search on. The search number is specified by x. The search condition must be set to FDBITS, and the CAN standard must be FDISO or FDNONISO.

<b>Conditions</b>	Requires option 5-SRAERO or SUP5-SRAERO Triggering and Analysis application.
<b>Group</b>	Search and Mark
<b>Syntax</b>	SEARCH:SEARCH<x>:TRIGger:A:BUS:CAN:FD:ESIBit {ONE ZERO NOCARE} SEARCH:SEARCH<x>:TRIGger:A:BUS:CAN:FD:ESIBit?
<b>Arguments</b>	ONE filters CAN FD packets to only match those where the ESI bit has a value of 1 (recessive).  ZERO filters CAN FD packets to only match those where the ESI bit has a value of 0 (dominant).  NOCARE disables filtering of CAN FD packets on the ESI bit.
<b>Examples</b>	SEARCH:SEARCH1:TRIGGER:A:BUS:CAN:FD:ESIBit ONE specifies filtering CAN FD packets for those where the ESI bit has a value of 1.  SEARCH:SEARCH1:TRIGGER:A:BUS:CAN:FD:ESIBIT? might return NOCARE, indicating that CAN FD packets are not being filtered based on the ESI bit value.

## SEARCH:SEARCH<x>:TRIGger:A:BUS:CAN:FRAMetype

This command sets or queries CAN bus trigger frame type to be used when searching on a CAN bus signal. The search condition must be set to FRAMetype. The search number is specified by x.

<b>Conditions</b>	Requires option 5-SRAUTO or SUP5-SRAUTO Triggering and Analysis application.
-------------------	------------------------------------------------------------------------------

<b>Group</b>	Search and Mark
<b>Syntax</b>	SEARCH:SEARCH<x>:TRIGger:A:BUS:CAN:FRAMeType {DATA ERRor OVERLoad REMOte} SEARCH:SEARCH<x>:TRIGger:A:BUS:CAN:FRAMeType?
<b>Arguments</b>	Arguments are the available frame types.
<b>Examples</b>	SEARCH:SEARCH1:TRIGger:A:BUS:CAN:FRAMeType ERROR sets the frame type to error.  SEARCH:SEARCH1:TRIGger:A:BUS:CAN:FRAMeType? might return SEARCH:SEARCH1:TRIGGER:A:BUS:CAN:FRAMETYPE DATA, indicates the frame type is set to data.

## SEARCH:SEARCH<x>:TRIGger:A:BUS:CAN:IDentifier:MODE

This command sets or queries the CAN bus trigger identifier (address) mode to be used when searching on a CAN bus signal. The search number is specified by x. The search condition must be set to IDANDDATA or DATA.

<b>Conditions</b>	Requires option 5-SRAUTO or SUP5-SRAUTO Triggering and Analysis application.
<b>Group</b>	Search and Mark
<b>Syntax</b>	SEARCH:SEARCH<x>:TRIGger:A:BUS:CAN:IDentifier:MODE {EXTENDED STANDARD} SEARCH:SEARCH<x>:TRIGger:A:BUS:CAN:IDentifier:MODE?
<b>Arguments</b>	EXTENDED specifies the extended identifier mode.  STANDARD specifies the standard identifier mode.
<b>Examples</b>	SEARCH:SEARCH1:TRIGger:A:BUS:CAN:IDentifier:MODE EXTEND sets the identifier mode to extended.  SEARCH:SEARCH1:TRIGger:A:BUS:CAN:IDentifier:MODE? might return SEARCH:SEARCH1:TRIGGER:A:BUS:CAN:IDENTIFIER:MODE STANDARD, indicating the identifier mode is set to standard.

## SEARCH:SEARCH<x>:TRIGger:A:BUS:CAN:IDentifier:VALue

This command sets or queries CAN bus trigger identifier (address) value to be used when searching on a CAN bus signal. The search number is specified by x. The search condition must be set to IDANDDATA or DATA.

**Conditions** Requires option 5-SRAUTO or SUP5-SRAUTO Triggering and Analysis application.

**Group** Search and Mark

**Syntax** SEARCH:SEARCH<x>:TRIGger:A:BUS:CAN:IDentifier:VALue <QString>  
SEARCH:SEARCH<x>:TRIGger:A:BUS:CAN:IDentifier:VALue?

**Arguments** <QString> is the identifier value.

**Examples** SEARCH:SEARCH1:TRIGger:A:BUS:CAN:IDentifier:VALue "1010" sets the identifier value to 1010.

SEARCH:SEARCH1:TRIGger:A:BUS:CAN:IDentifier:VALue? might return SEARCH:SEARCH1:TRIGGER:A:BUS:CAN:IDENTIFIER:VALUE "101011", indicating the identifier value is 101011.

## SEARCH:SEARCH<x>:TRIGger:A:BUS:CPHY:BLUe:VALue

This command specifies the blue data string used for CPHY triggering if the trigger condition is on RGB packet.

**Conditions** Requires option SR-CPHY.

**Group** Search and Mark

**Syntax** SEARCH:SEARCH<x>:TRIGger:A:BUS:CPHY:BLUe:VALue <QString>  
SEARCH:SEARCH<x>:TRIGger:A:BUS:CPHY:BLUe:VALue?

**Arguments** <QString> is the identifier value. The default blue value is XXXXXXXXXXXX.

**Examples** SEARCH:SEARCH1:TRIGger:A:BUS:CPHY:BLUe:VALue "BE4" specifies BE4 as the field within a CPHY frame to search on.



SEARCH:SEARCH1:TRIGGER:A:BUS:CPHY:BLUe:VALue? might return  
SEARCH:SEARCH1:TRIGGER:A:BUS:CPHY:BLUe:VALue "BE4", indicating  
that BE4 is the currently specified field within a CPHY frame to search on.

## SEARCH:SEARCH<x>:TRIGger:A:BUS:CPHY:CONDition

This command sets or queries the trigger condition for an CPHY bus. The default trigger on condition is SOT.

**Conditions** Requires option SR-CPHY.

**Group** Search and Mark

**Syntax** SEARCH:SEARCH<x>:TRIGger:A:BUS:CPHY:CONDition {SOT| EOT|  
DATA| EOTPDATa| OPTIONALPARAm| SCRAmbling| COMPRESSion|  
PACKets| BUSTURNAROUnd| ESCAPEMODE| STOP| ERRors| MODE|  
WORD| SYMBol}  
SEARCH:SEARCH<x>:TRIGger:A:BUS:CPHY:CONDition?

**Arguments** SOT specifies SOT as the field within a CPHY frame to search on.  
EOT specifies EOT as the field within a CPHY frame to search on.  
DATA specifies DATA as the field within a CPHY frame to search on  
EOTPDATa specifies EOTPDATa as the field within a CPHY frame to search on.  
OPTIONALPARAm specifies OPTIONALPARAm as the field within a CPHY frame  
to search on.  
SCRAmbling specifies SCRAmbling as the field within a CPHY frame to search  
on.  
COMPRESSion specifies COMPRESSion as the field within a CPHY frame to  
search on.  
PACKets specifies PACKets as the field within a CPHY frame to search on.  
BUSTURNAROUnd specifies BUSTURNAROUnd as the field within a CPHY  
frame to search on.  
ESCAPEMODE specifies ESCAPEMODE as the field within a CPHY frame to  
search on.  
STOP specifies STOP as the field within a CPHY frame to search on.  
ERRors specifies ERRors as the field within a CPHY frame to search on.  
MODE specifies MODE as the field within a CPHY frame to search on.

WORD specifies WORD as the field within a CPHY frame to search on.

SYMBOL specifies SYMBOL as the field within a CPHY frame to search on.

**Examples** SEARCH:SEARCH1:TRIGGER:A:BUS:CPHY:CONDITION SOT specifies SOT as the field within a CPHY frame to search on.

SEARCH:SEARCH1:TRIGGER:A:BUS:CPHY:CONDITION? might return :SEARCH:SEARCH1:TRIGGER:A:BUS:CPHY:CONDITION SOT, indicating that SOT is the currently specified field within a CPHY frame to search on.

## SEARCH:SEARCH<x>:TRIGGER:A:BUS:CPHY:DATA:SIZE

This command specifies the length of the data string in bytes to be used for an CPHY trigger if the trigger condition is DATA.

**Conditions** Requires option SR-CPHY.

**Group** Search and Mark

**Syntax** SEARCH:SEARCH<x>:TRIGGER:A:BUS:CPHY:DATA:SIZE <NR1>  
SEARCH:SEARCH<x>:TRIGGER:A:BUS:CPHY:DATA:SIZE?

**Arguments** <NR1> specifies the data size. The default data size is 1 byte and otherwise ranges between 1 and 5.

**Examples** SEARCH:SEARCH1:TRIGGER:A:BUS:CPHY:DATA:SIZE 2 specifies 2 as the field within a CPHY frame to search on.

SEARCH:SEARCH1:TRIGGER:A:BUS:CPHY:DATA:SIZE? might return :SEARCH:SEARCH1:TRIGGER:A:BUS:CPHY:DATA:SIZE 1, indicating that 2 is the currently specified field within a CPHY frame to search on.

## SEARCH:SEARCH<x>:TRIGGER:A:BUS:CPHY:DATA:VALUE

This command specifies the binary data string used for CPHY triggering if the trigger condition is DATA.

**Conditions** Requires option SR-CPHY.

**Group** Search and Mark

<b>Syntax</b>	SEARCH:SEARCH<x>:TRIGger:A:BUS:CPHY:DATA:VALue <QString> SEARCH:SEARCH<x>:TRIGger:A:BUS:CPHY:DATA:VALue?
<b>Arguments</b>	<QString> is the identifier value. The default value is XXXXXXXX.
<b>Examples</b>	SEARCH:SEARCH1:TRIGger:A:BUS:CPHY:DATA:VALue "11110000" specifies 11110000 as the field within a CPHY frame to search on.  SEARCH:SEARCH1:TRIGGER:A:BUS:CPHY:DATA:VALue? might return :SEARCH:SEARCH1:TRIGGER:A:BUS:CPHY:DATA:VALue "11110000", indicating that 11110000 is the currently specified field within a CPHY frame to search on.

## SEARCH:SEARCH<x>:TRIGger:A:BUS:CPHY:ERRor:TYPE

This command sets or queries the error type for CPHY bus. The default error type condition is ANY.

<b>Conditions</b>	Requires option SR-CPHY.
<b>Group</b>	Search and Mark
<b>Syntax</b>	SEARCH:SEARCH<x>:TRIGger:A:BUS:CPHY:ERRor:TYPE {ANY ECC CRC} SEARCH:SEARCH<x>:TRIGger:A:BUS:CPHY:ERRor:TYPE?
<b>Arguments</b>	ANY specifies ANY as the field within a CPHY frame to search on. ECC specifies ECC as the field within a CPHY frame to search on. CRC specifies CRC as the field within a CPHY frame to search on
<b>Examples</b>	SEARCH:SEARCH1:TRIGger:A:BUS:CPHY:ERRor:TYPE ECC specifies ECC as the field within a CPHY frame to search on.  SEARCH:SEARCH1:TRIGGER:A:BUS:CPHY:ERRor:TYPE? might return :SEARCH:SEARCH1:TRIGGER:A:BUS:CPHY:ERRor:TYPE ECC, indicating that ECC is the currently specified field within a CPHY frame to search on.

## SEARCH:SEARCH<x>:TRIGger:A:BUS:CPHY:ESCAPEMODE:COMManD

This command sets or queries the escape mode command type for CPHY bus..

<b>Conditions</b>	Requires option SR-CPHY.
<b>Group</b>	Search and Mark
<b>Syntax</b>	SEARCH:SEARCH<x>:TRIGger:A:BUS:CPHY:ESCAPEMODE:COMMAND {LPDT ULPS RESETRIGGER ANY} SEARCH:SEARCH<x>:TRIGger:A:BUS:CPHY:ESCAPEMODE:COMMAND?
<b>Arguments</b>	LPDT specifies LPDT as the field within a CPHY frame to search on. ULPS specifies ULPS as the field within a CPHY frame to search on. RESETRIGGER specifies RESETRIGGER as the field within a CPHY frame to search on ANY specifies ANY as the field within a CPHY frame to search on. ANY is the default value.
<b>Examples</b>	SEARCH:SEARCH1:TRIGger:A:BUS:CPHY:ESCAPEMODE:COMMAND ULPS specifies ULPS as the field within a CPHY frame to search on. SEARCH:SEARCH1:TRIGger:A:BUS:CPHY:ESCAPEMODE:COMMAND? might return :SEARCH:SEARCH1:TRIGger:A:BUS:CPHY:ESCAPEMODE:COMMAND ULPS, indicating that ULPS is the currently specified field within a CPHY frame to search on.

## SEARCH:SEARCH<x>:TRIGger:A:BUS:CPHY:GREEN:VALue

This command specifies the green data string used for CPHY triggering if the trigger condition is on RGB packet.

<b>Conditions</b>	Requires option SR-CPHY.
<b>Group</b>	Search and Mark
<b>Syntax</b>	SEARCH:SEARCH<x>:TRIGger:A:BUS:CPHY:GREEN:VALue <QString> SEARCH:SEARCH<x>:TRIGger:A:BUS:CPHY:GREEN:VALue?
<b>Arguments</b>	<QString> is the identifier value. The default green value is XXXXXXXXXXXX.
<b>Examples</b>	SEARCH:SEARCH1:TRIGger:A:BUS:CPHY:GREEN:VALue "243" specifies 243 as the field within a CPHY frame to search on.

SEARCH:SEARCH1:TRIGGER:A:BUS:CPHY:GREEN:VALUE? might return  
:SEARCH:SEARCH1:TRIGGER:A:BUS:CPHY:GREEN:VALUE "243", indicating  
that 243 is the currently specified field within a CPHY frame to search on.

## SEARCH:SEARCH<x>:TRIGger:A:BUS:CPHY:MODE:TYPE

This command sets or queries the mode type for CPHY bus.

<b>Conditions</b>	Requires option SR-CPHY.
<b>Group</b>	Search and Mark
<b>Syntax</b>	SEARCH:SEARCH<x>:TRIGger:A:BUS:CPHY:MODE:TYPE {HS LP} SEARCH:SEARCH<x>:TRIGger:A:BUS:CPHY:MODE:TYPE?
<b>Arguments</b>	HS specifies HS as the mode within a CPHY frame to search on. HS is default mode type condition.  LP specifies LP as the mode within a CPHY frame to search on.
<b>Examples</b>	SEARCH:SEARCH1:TRIGger:A:BUS:CPHY:MODE:TYPE LP specifies LP as the mode within a CPHY frame to search on.  SEARCH:SEARCH1:TRIGger:A:BUS:CPHY:MODE:TYPE? might return :SEARCH:SEARCH1:TRIGger:A:BUS:CPHY:MODE:TYPE LP, indicating that LP is the currently specified mode within a CPHY frame to search on.

## SEARCH:SEARCH<x>:TRIGger:A:BUS:CPHY:PACKets:LIST

This command sets or queries the packet list for CPHY bus. The default packet list condition is VSYNCSTART.

<b>Conditions</b>	Requires option SR-CPHY.
<b>Group</b>	Search and Mark
<b>Syntax</b>	SEARCH:SEARCH<x>:TRIGger:A:BUS:CPHY:PACKets:LIST {VSYNCSTART  VSYNCEND  HSYNCSTART  HSYNCEND  EOTP  COLOROFF  COLORON  SHUTDOWN  TURNON  GSW  GR  COMPRESSION  SCRAMBLING  EXECUTEQUEUE  DCSSW  DCSR  GLONGWRITE  DSINULL  DSIBLANK  MAXRETSIZE  DCSGLONGWRITE  PICParameter  COMPRESSEDPStream

PPS101010| PPS121212| PPS565| PPS666| LPS666| PPS888|  
YCBCR24| LPYCBCR24| YCBCR16| YCBCR12| ACKNowledge|  
ERRORREPort| GSRR| GLONGREAD| DCSLONGREAD| DCSSRR|  
FRAMEStArt| FRAMEEND| LINESTArt| LINEEND| GSP| CSINULL|  
CSIBLANK| EMBEDDED| USEREIGHTB| RGB565| RGB555| RGB444|  
RGB666| RAW6| RAW7| RAW8| RAW10| RAW12| RAW14| RAW16| RAW20|  
RGB888| YUV420L8| YUV8BIT| YUV422B10| YUV420B10}  
SEARCH:SEARCH<x>:TRIGger:A:BUS:CPHY:PACKets:LIST?

## Arguments

VSYNcSTART specifies VSYNcSTART as the packet within CPHY frame to search on.

VSYNcEND specifies VSYNcEND as the packet within CPHY frame to search on.

HSYNcSTART specifies HSYNcSTART as the packet within CPHY frame to search on.

HSYNcEND specifies HSYNcEND as the packet within CPHY frame to search on.

EOTp specifies EOTp as the packet within CPHY frame to search on.

COLOrOFF specifies COLOrOFF as the packet within CPHY frame to search on.

COLOrON specifies COLOrON as the packet within CPHY frame to search on.

SHUTDOWN specifies SHUTDOWN as the packet within CPHY frame to search on.

TURNON specifies TURNON as the packet within CPHY frame to search on.

GSW specifies GSW as the packet within CPHY frame to search on.

GR specifies GR as the packet within CPHY frame to search on.

COMPRESSION specifies COMPRESSION as the packet within CPHY frame to search on.

SCRAMBLING specifies SCRAMBLING as the packet within CPHY frame to search on.

EXECUTEQUEue specifies EXECUTEQUEue as the packet within CPHY frame to search on.

DCSSW specifies DCSSW as the packet within CPHY frame to search on.

DCSR specifies DCSR as the packet within CPHY frame to search on.

GLONGWRITE specifies GLONGWRITE as the packet within CPHY frame to search on.

DSINULL specifies DSINULL as the packet within CPHY frame to search on.

DSIBLANK specifies DSIBLANK as the packet within CPHY frame to search on.

MAXRETSIZE specifies MAXRETSIZE as the packet within CPHY frame to search on.

DCSGLONGWRITE specifies DCSGLONGWRITE as the packet within CPHY frame to search on.

PICPARAMeter specifies PICPARAMeter as the packet within CPHY frame to search on.

COMPRESSEDPSStream specifies COMPRESSEDPSStream as the packet within CPHY frame to search on.

PPS101010 specifies PPS101010 as the packet within CPHY frame to search on.

PPS121212 specifies PPS121212 as the packet within CPHY frame to search on.

PPS565 specifies PPS565 as the packet within CPHY frame to search on.

PPS666 specifies PPS666 as the packet within CPHY frame to search on.

LPS666 specifies LPS666 as the packet within CPHY frame to search on.

PPS888 specifies LPS666 as the packet within CPHY frame to search on.

YCBCR24 specifies YCBCR24 as the packet within CPHY frame to search on.

LPYCBCR24 specifies LPYCBCR24 as the packet within CPHY frame to search on.

YCBCR16 specifies YCBCR16 as the packet within CPHY frame to search on.

YCBCR12 specifies YCBCR12 as the packet within CPHY frame to search on.

ACKNOWLEDge specifies ACKNOWLEDge as the packet within CPHY frame to search on.

ERRORREPort specifies ERRORREPort as the packet within CPHY frame to search on.

GSRR specifies GSRR as the packet within CPHY frame to search on.

GLONGREAD specifies GLONGREAD as the packet within CPHY frame to search on.

DCSLONGREAD specifies DCSLONGREAD as the packet within CPHY frame to search on.

DCSSRR specifies DCSSRR as the packet within CPHY frame to search on.

FRAMESTART specifies FRAMESTART as the packet within CPHY frame to search on.

FRAMEEND specifies FRAMEEND as the packet within CPHY frame to search on.

LINESTART specifies LINESTART as the packet within CPHY frame to search on.

LINEEND specifies LINEEND as the packet within CPHY frame to search on.

GSP specifies GSP as the packet within CPHY frame to search on.

CSINULL specifies CSINULL as the packet within CPHY frame to search on.

CSIBLANK specifies CSIBLANK as the packet within CPHY frame to search on.

EMBEDDED specifies EMBEDDED as the packet within CPHY frame to search on.

USEREIGHTB specifies USEREIGHTB as the packet within CPHY frame to search on.

RGB565 specifies RGB565 as the packet within CPHY frame to search on.

RGB555 specifies RGB555 as the packet within CPHY frame to search on.

RGB444 specifies RGB444 as the packet within CPHY frame to search on.

RGB666 specifies RGB666 as the packet within CPHY frame to search on.

RAW6 specifies RAW6 as the packet within CPHY frame to search on.

RAW7 specifies RAW7 as the packet within CPHY frame to search on.

RAW8 specifies RAW8 as the packet within CPHY frame to search on.

RAW10 specifies RAW10 as the packet within CPHY frame to search on.

RAW12 specifies RAW12 as the packet within CPHY frame to search on.

RAW14 specifies RAW14 as the packet within CPHY frame to search on.

RAW16 specifies RAW16 as the packet within CPHY frame to search on.

RAW20 specifies RAW20 as the packet within CPHY frame to search on.

RGB888 specifies RGB888 as the packet within CPHY frame to search on.

YUV420L8 specifies YUV420L8 as the packet within CPHY frame to search on.

YUV8BIT specifies YUV8BIT as the packet within CPHY frame to search on.

YUV422B10 specifies YUV422B10 as the packet within CPHY frame to search on.

YUV420B10 specifies YUV420B10 as the packet within CPHY frame to search on.

**Examples**    `SEARCH:SEARCH1:TRIGGER:A:BUS:CPHY:PACKets:LIST VSYNCSTART`  
specifies VSYNCSTART of set command as the packet within CPHY frame to search on.

`SEARCH:SEARCH1:TRIGGER:A:BUS:CPHY:PACKets:LIST?` might return  
`:SEARCH:SEARCH1:TRIGGER:A:BUS:CPHY:PACKets:LIST VSYNCSTART`,  
indicating that VSYNCSTART is the currently the packet within CPHY frame to search on

## **SEARCH:SEARCH<x>:TRIGger:A:BUS:CPHY:PACKets:TYPE**

This command sets or queries the packet type for CPHY bus.



<b>Conditions</b>	Requires option SR-CPHY.
<b>Group</b>	Search and Mark
<b>Syntax</b>	SEARCH:SEARCH<x>:TRIGger:A:BUS:CPHY:PACKets:TYPE {SHORT LONG} SEARCH:SEARCH<x>:TRIGger:A:BUS:CPHY:PACKets:TYPE?
<b>Arguments</b>	SHORT specifies SHORT as the field within a CPHY frame to search on. SHORT is the default packet type condition.  LONG specifies LONG as the field within a CPHY frame to search on.
<b>Examples</b>	SEARCH:SEARCH1:TRIGger:A:BUS:CPHY:PACKets:TYPE LONG specifies LONG as the field within a CPHY frame to search on.  SEARCH:SEARCH1:TRIGGER:A:BUS:CPHY:PACKets:TYPE? might return :SEARCH:SEARCH1:TRIGGER:A:BUS:CPHY:PACKets:TYPE LONG, indicating that LONG is the currently specified field within a CPHY frame to search on.

## SEARCH:SEARCH<x>:TRIGger:A:BUS:CPHY:PIXel:NUMBer

This command specifies the pixel number to be used for CPHY triggering if the trigger condition is on pixel number pattern. The search number is specified by x.

<b>Conditions</b>	Requires option SR-CPHY.
<b>Group</b>	Search and Mark
<b>Syntax</b>	SEARCH:SEARCH<x>:TRIGger:A:BUS:CPHY:PIXel:NUMBer <NR1> SEARCH:SEARCH<x>:TRIGger:A:BUS:CPHY:PIXel:NUMBer?
<b>Arguments</b>	<NR1> specifies the pixel number. The default pixel number value is 0
<b>Examples</b>	SEARCH:SEARCH1:TRIGger:A:BUS:CPHY:PIXel:NUMBer 1234 specifies 1234 as the field within a CPHY frame to search on.  SEARCH:SEARCH1:TRIGGER:A:BUS:CPHY:PIXel:NUMBer? might return :SEARCH:SEARCH1:TRIGGER:A:BUS:CPHY:PIXel:NUMBer 1234, indicating that 1234 is the currently specified field within a CPHY frame to search on.

## SEARCH:SEARCH<x>:TRIGger:A:BUS:CPHY:PIXel:SEARCHOPTion

This command sets or queries the search pattern type for CPHY bus. The default search pattern type value is PIXELVALue.

<b>Conditions</b>	Requires option SR-CPHY.
<b>Group</b>	Search and Mark
<b>Syntax</b>	SEARCH:SEARCH<x>:TRIGger:A:BUS:CPHY:PIXel:SEARCHOPTion {PIXELVALue PIXELNUMBER} SEARCH:SEARCH<x>:TRIGger:A:BUS:CPHY:PIXel:SEARCHOPTion?
<b>Arguments</b>	PIXELVALue specifies PIXELVALue as the field within a CPHY frame to search on.  PIXELNUMBER specifies PIXELNUMBER as the field within a CPHY frame to search on.
<b>Examples</b>	SEARCH:SEARCH1:TRIGger:A:BUS:CPHY:PIXel:SEARCHOPTion PIXELNUMBER specifies PIXELNUMBER as the field within a CPHY frame to search on.  SEARCH:SEARCH1:TRIGGER:A:BUS:CPHY:PIXel:SEARCHOPTion? might return :SEARCH:SEARCH1:TRIGGER:A:BUS:CPHY:PIXel:SEARCHOPTion PIXELNUMBER, indicating that PIXELNUMBER is the currently specified field within a CPHY frame to search on.

## SEARCH:SEARCH<x>:TRIGger:A:BUS:CPHY:RED:VALue

This command specifies the red data string used for CPHY triggering if the trigger condition is on RGB packet.

<b>Conditions</b>	Requires option SR-CPHY.
<b>Group</b>	Search and Mark
<b>Syntax</b>	SEARCH:SEARCH<x>:TRIGger:A:BUS:CPHY:RED:VALue <QString> SEARCH:SEARCH<x>:TRIGger:A:BUS:CPHY:RED:VALue?
<b>Arguments</b>	<QString> is the identifier value. The default red value is XXXXXXXXXXXX.

**Examples**     `SEARCH:SEARCH1:TRIGger:A:BUS:CPHY:RED:VALue "1A1"` specifies 1A1 as the field within a CPHY frame to search on.

`SEARCH:SEARCH1:TRIGGER:A:BUS:CPHY:RED:VALue?` might return `:SEARCH:SEARCH1:TRIGGER:A:BUS:CPHY:RED:VALue "1A1"`, indicating that 1A1 is the currently specified field within a CPHY frame to search on.

## **SEARCH:SEARCH<x>:TRIGger:A:BUS:CPHY:SYMBol:SIZE**

This command specifies the length of the data string in bytes to be used for an CPHY trigger if the trigger condition is SYMBol. The search number is specified by x.

**Conditions**     Requires option SR-CPHY.

**Group**             Search and Mark

**Syntax**            `SEARCH:SEARCH<x>:TRIGger:A:BUS:CPHY:SYMBol:SIZE <NR1>`  
`SEARCH:SEARCH<x>:TRIGger:A:BUS:CPHY:SYMBol:SIZE?`

**Arguments**        <NR1> specifies the length of the data string. The default symbol size is 7 symbols and otherwise ranges between 1 and 14.

**Examples**         `SEARCH:SEARCH1:TRIGger:A:BUS:CPHY:SYMBol:SIZE 2` specifies 2 as the field within a CPHY frame to search on.

`SEARCH:SEARCH1:TRIGGER:A:BUS:CPHY:SYMBol:SIZE?` might return `:SEARCH:SEARCH1:TRIGGER:A:BUS:CPHY:SYMBol:SIZE 2`, indicating that 2 is the currently specified field within a CPHY frame to search on.

## **SEARCH:SEARCH<x>:TRIGger:A:BUS:CPHY:SYMBol:VALue**

This command specifies the binary data string used for CPHY triggering if the trigger condition is SYMBol. The search number is specified by x.

**Conditions**        Requires option SR-CPHY.

**Group**             Search and Mark

**Syntax**            `SEARCH:SEARCH<x>:TRIGger:A:BUS:CPHY:SYMBol:VALue <QString>`  
`SEARCH:SEARCH<x>:TRIGger:A:BUS:CPHY:SYMBol:VALue?`

**Arguments** <QString> specifies the binary data string. The default data value is XXX.

**Examples** SEARCH:SEARCH1:TRIGGER:A:BUS:CPHY:SYMBOL:VALUE "11110000" specifies 11110000 as the field within a CPHY frame to search on.

SEARCH:SEARCH1:TRIGGER:A:BUS:CPHY:SYMBOL:VALUE? might return :SEARCH:SEARCH1:TRIGGER:A:BUS:CPHY:SYMBOL:VALUE "11110000", indicating that 11110000 is the currently specified field within a CPHY frame to search on.

## SEARCH:SEARCH<x>:TRIGGER:A:BUS:CPHY:WORD:SIZE

This command specifies the length of the word string in bytes to be used for an CPHY trigger if the trigger condition is WORD. The search number is specified by x.

**Conditions** Requires option SR-CPHY.

**Group** Search and Mark

**Syntax** SEARCH:SEARCH<x>:TRIGGER:A:BUS:CPHY:WORD:SIZE <NR1>  
SEARCH:SEARCH<x>:TRIGGER:A:BUS:CPHY:WORD:SIZE ?

**Arguments** <NR1> specifies the length of the data string. The default word size is 1 byte and otherwise ranges between 1 and 5.

**Examples** SEARCH:SEARCH1:TRIGGER:A:BUS:CPHY:WORD:SIZE 2 specifies 2 as the field within a CPHY frame to search on.

SEARCH:SEARCH1:TRIGGER:A:BUS:CPHY:WORD:SIZE? might return :SEARCH:SEARCH1:TRIGGER:A:BUS:CPHY:WORD:SIZE 2, indicating that 2 is the currently specified field within a CPHY frame to search on.

## SEARCH:SEARCH<x>:TRIGGER:A:BUS:CPHY:WORD:VALUE

This command specifies the binary data string used for CPHY triggering if the trigger condition is Word. The search number is specified by x.

**Conditions** Requires option SR-CPHY.

<b>Group</b>	Search and Mark
<b>Syntax</b>	SEARCH:SEARCH<x>:TRIGger:A:BUS:CPHY:WORD:VALue <QString> SEARCH:SEARCH<x>:TRIGger:A:BUS:CPHY:WORD:VALue?
<b>Arguments</b>	<QString> specifies the binary data string. The default data value is XXXXXXXXXXXXXXXXXXXX.
<b>Examples</b>	SEARCH:SEARCH1:TRIGger:A:BUS:CPHY:WORD:VALue "11110000" specifies 11110000 as the field within a CPHY frame to search on.  SEARCH:SEARCH1:TRIGger:A:BUS:CPHY:WORD:VALue? might return :SEARCH:SEARCH1:TRIGger:A:BUS:CPHY:WORD:VALue "11110000", indicating that 11110000 is the currently specified field within a CPHY frame to search on.

## SEARCH:SEARCH<x>:TRIGger:A:BUS:CPHY:WORDCOUNT:VALue

This command specifies the word count data string used for CPHY triggering if the trigger condition is on any rgb/ycbcr/yuv packet. The search number is specified by x.

<b>Conditions</b>	Requires option SR-CPHY.
<b>Group</b>	Search and Mark
<b>Syntax</b>	SEARCH:SEARCH<x>:TRIGger:A:BUS:CPHY:WORDCOUNT:VALue <QString> SEARCH:SEARCH<x>:TRIGger:A:BUS:CPHY:WORDCOUNT:VALue?
<b>Arguments</b>	<QString> specifies the word count data string. The default data value is XXXXXXXXXXXXXXXXXXXX.
<b>Examples</b>	SEARCH:SEARCH1:TRIGger:A:BUS:CPHY:WORDCOUNT:VALue "0003" specifies 0003 as the field within a CPHY frame to search on.  SEARCH:SEARCH1:TRIGger:A:BUS:CPHY:WORDCOUNT:VALue? might return :SEARCH:SEARCH1:TRIGger:A:BUS:CPHY:WORDCOUNT:VALue "0003", indicating that 0003 is the currently specified field within a CPHY frame to search on.

## SEARCH:SEARCH<x>:TRIGger:A:BUS:CPHY:YCBCR:CB

This command specifies the Cb data string used for CPHY triggering if the trigger condition is on YCbCr packet. The search number is specified by x.

<b>Conditions</b>	Requires option SR-CPHY.
<b>Group</b>	Search and Mark
<b>Syntax</b>	SEARCH:SEARCH<x>:TRIGger:A:BUS:CPHY:YCBCR:CB <QString> SEARCH:SEARCH<x>:TRIGger:A:BUS:CPHY:YCBCR:CB?
<b>Arguments</b>	<QString> is the identifier value. The default YCBCR packets CB value is XXXXXXXXXXXX.
<b>Examples</b>	SEARCH:SEARCH1:TRIGger:A:BUS:CPHY:YCBCR:CB "1BA" specifies 1BA as the field within a CPHY frame to search on.  SEARCH:SEARCH1:TRIGGER:A:BUS:CPHY:YCBCR:CB? might return :SEARCH:SEARCH1:TRIGger:A:BUS:CPHY:YCBCR:CB "1BA", indicating that 1BA is the currently specified field within a CPHY frame to search on.

## SEARCH:SEARCH<x>:TRIGger:A:BUS:CPHY:YCBCR:CR

This command specifies the Cr data string used for CPHY triggering if the trigger condition is on YCbCr packet. The search number is specified by x.

<b>Conditions</b>	Requires option SR-CPHY.
<b>Group</b>	Search and Mark
<b>Syntax</b>	SEARCH:SEARCH<x>:TRIGger:A:BUS:CPHY:YCBCR:CR <QString> SEARCH:SEARCH<x>:TRIGger:A:BUS:CPHY:YCBCR:CR?
<b>Arguments</b>	<QString> is the identifier value. The default YCBCR packets CR value is XXXXXXXXXXXX.
<b>Examples</b>	SEARCH:SEARCH1:TRIGger:A:BUS:CPHY:YCBCR:CR "2EE" specifies 2EE as the field within a CPHY frame to search on.

SEARCH:SEARCH1:TRIGger:A:BUS:CPHY:YCBCR:CR? might return  
:SEARCH:SEARCH1:TRIGger:A:BUS:CPHY:YCBCR:CR "2EE", indicating that  
2EE is the currently specified field within a CPHY frame to search on.

## SEARCH:SEARCH<x>:TRIGger:A:BUS:CPHY:YCBCR:Y

This command specifies the Y data string used for CPHY triggering if the trigger condition is on YCbCr packet. The search number is specified by x.

<b>Conditions</b>	Requires option SR-CPHY.
<b>Group</b>	Search and Mark
<b>Syntax</b>	SEARCH:SEARCH<x>:TRIGger:A:BUS:CPHY:YCBCR:Y <QString> SEARCH:SEARCH<x>:TRIGger:A:BUS:CPHY:YCBCR:Y?
<b>Arguments</b>	<QString> is the identifier value. The default YCBCR packets Y value is XXXXXXXXXX.
<b>Examples</b>	SEARCH:SEARCH1:TRIGger:A:BUS:CPHY:YCBCR:Y "1AA" specifies 1AA as the field within a CPHY frame to search on.  SEARCH:SEARCH1:TRIGger:A:BUS:CPHY:YCBCR:Y? might return :SEARCH:SEARCH1:TRIGger:A:BUS:CPHY:YCBCR:Y "1AA", indicating that 1AA is the currently specified field within a CPHY frame to search on.

## SEARCH:SEARCH<x>:TRIGger:A:BUS:CPHY:YUV:U

This command specifies the U data string used for CPHY triggering if the trigger condition is on YUV packet. The search number is specified by x.

<b>Conditions</b>	Requires option SR-CPHY.
<b>Group</b>	Search and Mark
<b>Syntax</b>	SEARCH:SEARCH<x>:TRIGger:A:BUS:CPHY:YUV:U <QString> SEARCH:SEARCH<x>:TRIGger:A:BUS:CPHY:YUV:U?

<b>Arguments</b>	<code>&lt;Qstring&gt;</code> is the identifier value. The default YUV packets U value is <code>XXXXXXXXXX</code> .
<b>Examples</b>	<code>SEARCH:SEARCH1:TRIGger:A:BUS:CPHY:YUV:U "123"</code> specifies 123 as the field within a CPHY frame to search on.  <code>SEARCH:SEARCH1:TRIGger:A:BUS:CPHY:YUV:U?</code> might return <code>:SEARCH:SEARCH1:TRIGger:A:BUS:DPHY:YUV:U "123"</code> , indicating that 123 is the currently specified field within a CPHY frame to search on.

## **SEARCH:SEARCH<x>:TRIGger:A:BUS:CPHY:YUV:V**

This command specifies the V data string used for CPHY triggering if the trigger condition is on YUV packet. The search number is specified by x.

<b>Conditions</b>	Requires option SR-CPHY.
<b>Group</b>	Search and Mark
<b>Syntax</b>	<code>SEARCH:SEARCH&lt;x&gt;:TRIGger:A:BUS:CPHY:YUV:V &lt;Qstring&gt;</code> <code>SEARCH:SEARCH&lt;x&gt;:TRIGger:A:BUS:CPHY:YUV:V?</code>
<b>Arguments</b>	<code>&lt;Qstring&gt;</code> is the identifier value. The default YUV packets V value is <code>XXXXXXXXXX</code> .
<b>Examples</b>	<code>SEARCH:SEARCH1:TRIGger:A:BUS:CPHY:YUV:V "12A"</code> specifies 12A as the field within a CPHY frame to search on.  <code>SEARCH:SEARCH1:TRIGger:A:BUS:CPHY:YUV:V?</code> might return <code>:SEARCH:SEARCH1:TRIGger:A:BUS:CPHY:YUV:V "12A"</code> , indicating that 12A is the currently specified field within a CPHY frame to search on.

## **SEARCH:SEARCH<x>:TRIGger:A:BUS:CPHY:YUV:Y**

This command specifies the Y data string used for CPHY triggering if the trigger condition is on YUV packet. The search number is specified by x.

<b>Conditions</b>	Requires option SR-CPHY.
<b>Group</b>	Search and Mark



<b>Syntax</b>	SEARCH:SEARCH<x>:TRIGger:A:BUS:CPHY:YUV:Y <QString> SEARCH:SEARCH<x>:TRIGger:A:BUS:CPHY:YUV:Y?
<b>Arguments</b>	<QString> is the identifier value. The default YUV packets Y value is XXXXXXXXXXXX.
<b>Examples</b>	SEARCH:SEARCH1:TRIGger:A:BUS:CPHY:YUV:Y "81A" specifies 12A as the field within a CPHY frame to search on.  SEARCH:SEARCH1:TRIGger:A:BUS:CPHY:YUV:Y? might return :SEARCH:SEARCH1:TRIGger:A:BUS:CPHY:YUV:Y "81A", indicating that 81A is the currently specified field within a CPHY frame to search on.

## SEARCH:SEARCH<x>:TRIGger:A:BUS:CXPI:CONDition

This command sets or queries the trigger condition for a CXPI bus. The search number is specified by x.

<b>Conditions</b>	Requires option SR-CXPI .
<b>Group</b>	Search and Mark
<b>Syntax</b>	SEARCH:SEARCH<x>:TRIGger:A:BUS:CXPI:CONDition {START FRAMES FRAMEID PTYPE DLC EXTDLC NETMN COUNTER DATA ERRORS} SEARCH:SEARCH<x>:TRIGger:A:BUS:CXPI:CONDition?
<b>Arguments</b>	START specifies START as the event for a CXPI frame to search on. This is the default value.  FRAMES specifies FRAMES as the frame types for CXPI packets to search on. FRAMEID specifies FRAMEID as the field within a CXPI frame to search on PTYPE specifies PTYPE as the field within a CXPI frame to search on. DLC specifies DLC as the field within a CXPI frame to search on. EXTDLC specifies EXTDLC as the field within a CXPI frame to search on. NETMN specifies NETMN as the field within a CXPI frame to search on. COUNTER specifies COUNTER as the field within a CXPI frame to search on. DATA specifies DATA as the field within a CXPI frame to search on. ERRORS specifies ERRORS as type of error within a CXPI frame to search on.

**Examples** SEARCH:SEARCH1:TRIGGER:A:BUS:CXPI:CONDition START specifies start as the field within a CXPI frame to search on.

SEARCH:SEARCH1:TRIGGER:A:BUS:CXPI:CONDition? might return :SEARCH:SEARCH1:TRIGGER:A:BUS:CXPI:CONDition START, indicating that start is the currently specified field within a CXPI frame to search on.

## SEARCH:SEARCH<x>:TRIGger:A:BUS:CXPI:COUNTER:VALue

This command specifies the binary counter string used for CXPI triggering if the trigger condition is COUNTER. The search number is specified by x.

**Conditions** Requires option SR-CXPI .

**Group** Search and Mark

**Syntax** SEARCH:SEARCH<x>:TRIGger:A:BUS:CXPI:COUNTER:VALue <Qstring>  
SEARCH:SEARCH<x>:TRIGger:A:BUS:CXPI:COUNTER:VALue?

**Arguments** <Qstring> specifies the binary counter string. The default size and value Counter is 2 bits and "XX" respectively

**Examples** SEARCH:SEARCH1:TRIGGER:A:BUS:CXPI:COUNTER:VALue "01" specifies the binary counter string used for CXPI triggering if the trigger condition is COUNTER as "01".

SEARCH:SEARCH1:TRIGGER:A:BUS:CXPI:COUNTER:VALue? might return :SEARCH:SEARCH1:TRIGGER:A:BUS:CXPI:COUNTER:VALue "01", indicating the binary counter string used for CXPI triggering if the trigger condition is COUNTER is "01".

## SEARCH:SEARCH<x>:TRIGger:A:BUS:CXPI:DATA:SIZE

This command specifies the length of the data string in bytes to be used for CXPI triggering if the trigger condition is DATA. The search number is specified by x.

**Conditions** Requires option SR-CXPI.

**Group** Search and Mark

<b>Syntax</b>	SEARCH:SEARCH<x>:TRIGger:A:BUS:CXPI:DATA:SIZE <NR1> SEARCH:SEARCH<x>:TRIGger:A:BUS:CXPI:DATA:SIZE?
<b>Arguments</b>	<NR1> specifies the data size. The default data size is 1 and the valid range is 1 to 5.
<b>Examples</b>	SEARCH:SEARCH1:TRIGGER:A:BUS:CXPI:DATA:SIZE 4 sets the data size value to 4.  SEARCH:SEARCH1:TRIGGER:A:BUS:CXPI:DATA:SIZE? might return :SEARCH:SEARCH1:TRIGGER:A:BUS:CXPI:DATA:SIZE 4, indicating that the data size value is 4.

## SEARCH:SEARCH<x>:TRIGger:A:BUS:CXPI:DATA:VALue

This command specifies the binary data string used for CXPI triggering if the trigger condition is DATA. The search number is specified by x.

<b>Conditions</b>	Requires option SR-CXPI.
<b>Group</b>	Search and Mark
<b>Syntax</b>	SEARCH:SEARCH<x>:TRIGger:A:BUS:CXPI:DATA:VALue <QString> SEARCH:SEARCH<x>:TRIGger:A:BUS:CXPI:DATA:VALue?
<b>Arguments</b>	<QString> is the identifier value. The default size and value for DATA is 8 bits and "XXXX XXXX" respectively.
<b>Examples</b>	SEARCH:SEARCH1:TRIGGER:A:BUS:CXPI:DATA:VALue "0111100111" sets the data value as "0111100111".  SEARCH:SEARCH1:TRIGGER:A:BUS:CXPI:DATA:VALue? might return :SEARCH:SEARCH1:TRIGGER:A:BUS:CXPI:DATA:VALue "0111100111", indicating the data value is "0111100111".

## SEARCH:SEARCH<x>:TRIGger:A:BUS:CXPI:DLC:VALue

This command specifies the binary DLC string used for CXPI triggering if the trigger condition is DLC. The search number is specified by x.

<b>Conditions</b>	Requires option SR-CXPI.
-------------------	--------------------------

<b>Group</b>	Search and Mark
<b>Syntax</b>	SEARCH:SEARCH<x>:TRIGger:A:BUS:CXPI:DLC:VALue <QString> SEARCH:SEARCH<x>:TRIGger:A:BUS:CXPI:DLC:VALue?
<b>Arguments</b>	<QString> is the identifier value. The default size and value of DLC is 4 bits and "XXXX" respectively.
<b>Examples</b>	SEARCH:SEARCH1:TRIGGER:A:BUS:CXPI:DLC:VALue "110" specifies the binary DLC string used for CXPI triggering if the trigger condition is DLC and sets it to "X110".  SEARCH:SEARCH1:TRIGGER:A:BUS:CXPI:DLC:VALue? might return :SEARCH:SEARCH1:TRIGGER:A:BUS:CXPI:DLC:VALue "110", indicating the value of the DLC is "X110".

## SEARCH:SEARCH<x>:TRIGger:A:BUS:CXPI:ERROR:TYPE

This command sets or queries the Error Type in CXPI bus. The search number is specified by x.

<b>Conditions</b>	Requires option SR-CXPI.
<b>Group</b>	Search and Mark
<b>Syntax</b>	SEARCH:SEARCH<x>:TRIGger:A:BUS:CXPI:ERROR:TYPE {CRC  PARity  FRAME  IBS  ANY} SEARCH:SEARCH<x>:TRIGger:A:BUS:CXPI:ERROR:TYPE?
<b>Arguments</b>	CRC specifies CRC as the field within a CXPI frame to search on.  PARity specifies PARity as the field within a CXPI frame to search on. The default Error Type is Parity.  FRAME specifies FRAME as the field within a CXPI frame to search on.  IBS specifies IBS as the field within a CXPI frame to search on.  ANY specifies ANY as any type of error within a CXPI frame to search on.
<b>Examples</b>	SEARCH:SEARCH1:TRIGGER:A:BUS:CXPI:ERROR:TYPE CRC sets the Error Type as CRC.

SEARCH:SEARCH1:TRIGGER:A:BUS:CXPI:ERROR:TYPE? might return  
:SEARCH:SEARCH1:TRIGGER:A:BUS:CXPI:ERROR:TYPE CRC, indicating  
the type of the error is CRC.

## SEARCH:SEARCH<x>:TRIGger:A:BUS:CXPI:EXTDLC:VALue

This command specifies the binary DLC string used for CXPI triggering if the trigger condition is Ext DLC. The search number is specified by x.

<b>Conditions</b>	Requires option SR-CXPI.
<b>Group</b>	Search and Mark
<b>Syntax</b>	SEARCH:SEARCH<x>:TRIGger:A:BUS:CXPI:EXTDLC:VALue <QString> SEARCH:SEARCH<x>:TRIGger:A:BUS:CXPI:EXTDLC:VALue?
<b>Arguments</b>	<QString> is the identifier value. The default size and value of Ext DLC is 8 bits and "XXXX XXXX" respectively.
<b>Examples</b>	SEARCH:SEARCH1:TRIGGER:A:BUS:CXPI:EXTDLC:VALue "11010010" specifies the binary DLC string used for CXPI triggering if the trigger condition is Ext DLC as "1010010".  SEARCH:SEARCH1:TRIGGER:A:BUS:CXPI:EXTDLC:VALue? might return :SEARCH:SEARCH1:TRIGGER:A:BUS:CXPI:EXTDLC:VALue "110", indicating the value of the Ext DLC is "11010010".

## SEARCH:SEARCH<x>:TRIGger:A:BUS:CXPI:FRAME:TYPE

This command sets or queries the frame type in CXPI bus. The search number is specified by x.

<b>Conditions</b>	Requires option SR-CXPI.
<b>Group</b>	Search and Mark
<b>Syntax</b>	SEARCH:SEARCH<x>:TRIGger:A:BUS:CXPI:FRAME:TYPE {NORMa  SLEEp  LONG  POLLINGNORMa  POLLINGLONG} SEARCH:SEARCH<x>:TRIGger:A:BUS:CXPI:FRAME:TYPE?

**Arguments**    **NORMa1** specifies NORMAl as the packet type CXPI frame to search on. The default frame type is normal.

**SLEEp** specifies SLEEp as the packet type CXPI frame to search on.

**LONG** specifies LONG as the packet type CXPI frame to search on.

**POLLINGNORMa1** specifies POLLINGNORMAl as the packet type CXPI frame to search on.

**POLLINGLONG** specifies POLLINGLONG as the packet type CXPI frame to search on.

**Examples**    **SEARCH:SEARCH1:TRIGGER:A:BUS:CXPI:FRAME:TYPE SLEEp** specifies the frame type as sleep.

**SEARCH:SEARCH1:TRIGGER:A:BUS:CXPI:FRAME:TYPE?** might return **:SEARCH:SEARCH1:TRIGGER:A:BUS:CXPI:FRAME:TYPE SLEEp**, indicating the type of the frame to sleep.

## **SEARCH:SEARCH<x>:TRIGger:A:BUS:CXPI:FRAMEID:VALue**

This command specifies the binary frameId string used for CXPI triggering if the trigger condition is FRAMEID. The search number is specified by x.

**Conditions**    Requires option SR-CXPI.

**Group**        Search and Mark

**Syntax**        **SEARCH:SEARCH<x>:TRIGger:A:BUS:CXPI:FRAMEID:VALue <QString>**  
**SEARCH:SEARCH<x>:TRIGger:A:BUS:CXPI:FRAMEID:VALue?**

**Arguments**    <QString> is the identifier value. The default size and value of frame ID is 7 bits and "XXX XXXX" respectively.

**Examples**    **SEARCH:SEARCH1:TRIGGER:A:BUS:CXPI:FRAMEID:VALue "1000"** specifies the binary frameId string used for CXPI triggering if the trigger condition is FRAMEID as "XXX1000".

**SEARCH:SEARCH1:TRIGGER:A:BUS:CXPI:FRAMEID:VALue?** might return **:SEARCH:SEARCH1:TRIGGER:A:BUS:CXPI:FRAMEID:VALue "1000"**, indicating the value of the frameId is "XXX1000".

**SEARCH:SEARCH<x>:TRIGger:A:BUS:CXPI:NETMN:SLEEPIND**

This command sets or queries the Sleep Status in CXPI bus. The search number is specified by x.

<b>Conditions</b>	Requires option SR-CXPI.
<b>Group</b>	Search and Mark
<b>Syntax</b>	SEARCH:SEARCH<x>:TRIGger:A:BUS:CXPI:NETMN:SLEEPIND {ON OFF EITHER} SEARCH:SEARCH<x>:TRIGger:A:BUS:CXPI:NETMN:SLEEPIND?
<b>Arguments</b>	ON specifies the Sleep Status as on. The default status is on. OFF specifies the Sleep Status as off. EITHER specifies the Sleep Status as either.
<b>Examples</b>	SEARCH:SEARCH1:TRIGGER:A:BUS:CXPI:NETMN:SLEEPIND OFF specifies the Sleep Status as off.  SEARCH:SEARCH1:TRIGGER:A:BUS:CXPI:NETMN:SLEEPIND? might return :SEARCH:SEARCH1:TRIGGER:A:BUS:CXPI:NETMN:SLEEPIND OFF, indicating the status of the Sleep to off.

**SEARCH:SEARCH<x>:TRIGger:A:BUS:CXPI:NETMN:WAKEUPIND**

This command sets or queries the Wakeup Status in CXPI bus. The search number is specified by x.

<b>Conditions</b>	Requires option SR-CXPI.
<b>Group</b>	Search and Mark
<b>Syntax</b>	SEARCH:SEARCH<x>:TRIGger:A:BUS:CXPI:NETMN:WAKEUPIND {ON OFF EITHER} SEARCH:SEARCH<x>:TRIGger:A:BUS:CXPI:NETMN:WAKEUPIND?
<b>Arguments</b>	ON specifies the Wakeup Status as on. The default status is on. OFF specifies the Wakeup Status as off.

EITHER specifies the Wakeup Status as either.

**Examples** SEARCH:SEARCH1:TRIGGER:A:BUS:CXPI:NETMN:WAKEUPIND ON specifies the Wakeup Status as on.

SEARCH:SEARCH1:TRIGGER:A:BUS:CXPI:NETMN:WAKEUPIND? might return :SEARCH:SEARCH1:TRIGGER:A:BUS:CXPI:NETMN:WAKEUPIND ON, indicating the status of the Wakeup to on.

## SEARCH:SEARCH<x>:TRIGger:A:BUS:DPHY:BLUe:VALue

This command specifies the blue data string used for DPHY triggering if the trigger condition is on RGB packet.

**Conditions** Requires option SR-DPHY.

**Group** Search and Mark

**Syntax** SEARCH:SEARCH<x>:TRIGger:A:BUS:DPHY:BLUe:VALue <QString>  
SEARCH:SEARCH<x>:TRIGger:A:BUS:DPHY:BLUe:VALue?

**Arguments** <QString> is the identifier value. The default blue value is XXXXXXXXXXXX.

**Examples** SEARCH:SEARCH1:TRIGger:A:BUS:DPHY:BLUe:VALue "BE4" specifies BE4 as the field within a DPHY frame to search on.

SEARCH:SEARCH1:TRIGGER:A:BUS:DPHY:BLUe:VALue? might return SEARCH:SEARCH1:TRIGGER:A:BUS:DPHY:BLUe:VALue "BE4", indicating that BE4 is the currently specified field within a DPHY frame to search on.

## SEARCH:SEARCH<x>:TRIGger:A:BUS:DPHY:CONDition

This command sets or queries the trigger condition for an DPHY bus. The default trigger on condition is SOT.

**Conditions** Requires option SR-DPHY.

**Group** Search and Mark



**Syntax** SEARCH:SEARCH<x>:TRIGger:A:BUS:DPHY:CONDition {SOT| EOT| DATA| EOTPDATa| OPTIONALPARAm| SCRambling| COMPression| PACKets| BUSTURNAROUnd| ESCAPEMODE| SToP| ERRors| MODE}  
SEARCH:SEARCH<x>:TRIGger:A:BUS:DPHY:CONDition?

**Arguments** SOT specifies SOT as the field within a DPHY frame to search on.  
EOT specifies EOT as the field within a DPHY frame to search on.  
DATA specifies DATA as the field within a DPHY frame to search on  
EOTPDATa specifies EOTPDATa as the field within a DPHY frame to search on.  
OPTIONALPARAm specifies OPTIONALPARAm as the field within a DPHY frame to search on.  
SCRambling specifies SCRambling as the field within a DPHY frame to search on.  
COMPression specifies COMPression as the field within a DPHY frame to search on.  
PACKets specifies PACKets as the field within a DPHY frame to search on.  
BUSTURNAROUnd specifies BUSTURNAROUnd as the field within a DPHY frame to search on.  
ESCAPEMODE specifies ESCAPEMODE as the field within a DPHY frame to search on.  
SToP specifies SToP as the field within a DPHY frame to search on.  
ERRors specifies ERRors as the field within a DPHY frame to search on.  
MODE specifies MODE as the field within a DPHY frame to search on.

**Examples** SEARCH:SEARCH1:TRIGger:A:BUS:DPHY:CONDition SOT specifies SOT as the field within a DPHY frame to search on.  
SEARCH:SEARCH1:TRIGGER:A:BUS:DPHY:CONDition? might return :SEARCH:SEARCH1:TRIGGER:A:BUS:DPHY:CONDition SOT, indicating that SOT is the currently specified field within a DPHY frame to search on.

## SEARCH:SEARCH<x>:TRIGger:A:BUS:DPHY:DATA:SIZE

This command specifies the length of the data string in bytes to be used for an DPHY trigger if the trigger condition is DATA. The default data size is 1 byte and ranges between 1 and 5. The search number is specified by x.

**Conditions** Requires option SR-DPHY.

<b>Group</b>	Search and Mark
<b>Syntax</b>	SEARCH:SEARCH<x>:TRIGger:A:BUS:DPHY:DATA:SIZE <NR1> SEARCH:SEARCH<x>:TRIGger:A:BUS:DPHY:DATA:SIZE?
<b>Arguments</b>	<NR1> specifies the data size.
<b>Examples</b>	SEARCH:SEARCH1:TRIGger:A:BUS:DPHY:DATA:SIZE 2 specifies 2 as the field within a DPHY frame to search on.  SEARCH:SEARCH1:TRIGGER:A:BUS:DPHY:DATA:SIZE? might return :SEARCH:SEARCH1:TRIGGER:A:BUS:DPHY:DATA:SIZE 2, indicating 2 is the currently specified field within a DPHY frame to search on.

## SEARCH:SEARCH<x>:TRIGger:A:BUS:DPHY:DATA:VALue

This command specifies the binary data string used for DPHY triggering if the trigger condition is DATA.

<b>Conditions</b>	Requires option SR-DPHY.
<b>Group</b>	Search and Mark
<b>Syntax</b>	SEARCH:SEARCH<x>:TRIGger:A:BUS:DPHY:DATA:VALue <QString> SEARCH:SEARCH<x>:TRIGger:A:BUS:DPHY:DATA:VALue?
<b>Arguments</b>	<QString> is the identifier value. The default value is XXXXXXXX.
<b>Examples</b>	SEARCH:SEARCH1:TRIGger:A:BUS:DPHY:DATA:VALue "11110000" specifies 11110000 as the field within a DPHY frame to search on.  SEARCH:SEARCH1:TRIGGER:A:BUS:DPHY:DATA:VALue? might return :SEARCH:SEARCH1:TRIGGER:A:BUS:DPHY:DATA:VALue "11110000", indicating that 11110000 is the currently specified field within a DPHY frame to search on.

## SEARCH:SEARCH<x>:TRIGger:A:BUS:DPHY:ERRor:TYPE

This command sets or queries the error type for DPHY bus. The default error type condition is ANY.

<b>Conditions</b>	Requires option SR-DPHY.
<b>Group</b>	Search and Mark
<b>Syntax</b>	SEARCH:SEARCH<x>:TRIGger:A:BUS:DPHY:ERRor:TYPe {ANY ECC CRC} SEARCH:SEARCH<x>:TRIGger:A:BUS:DPHY:ERRor:TYPe?
<b>Arguments</b>	ANY specifies ANY as the field within a DPHY frame to search on. ECC specifies ECC as the field within a DPHY frame to search on. CRC specifies CRC as the field within a DPHY frame to search on
<b>Examples</b>	SEARCH:SEARCH1:TRIGger:A:BUS:DPHY:ERRor:TYPe ECC specifies ECC as the field within a DPHY frame to search on.  SEARCH:SEARCH1:TRIGGER:A:BUS:DPHY:ERRor:TYPe? might return :SEARCH:SEARCH1:TRIGGER:A:BUS:DPHY:ERRor:TYPe ECC, indicating that ECC is the currently specified field within a DPHY frame to search on.

## SEARCH:SEARCH<x>:TRIGger:A:BUS:DPHY:ESCAPEMODE:COMManD

This command sets or queries the escape mode command type for DPHY bus.

<b>Conditions</b>	Requires option SR-DPHY.
<b>Group</b>	Search and Mark
<b>Syntax</b>	SEARCH:SEARCH<x>:TRIGger:A:BUS:DPHY:ESCAPEMODE:COMManD {LPDT ULPS RESEtTRIGger ANY} SEARCH:SEARCH<x>:TRIGger:A:BUS:DPHY:ESCAPEMODE:COMManD?
<b>Arguments</b>	LPDT specifies LPDT as the field within a DPHY frame to search on. ULPS specifies ULPS as the field within a DPHY frame to search on. RESEtTRIGger specifies RESEtTRIGger as the field within a DPHY frame to search on  ANY specifies ANY as the field within a DPHY frame to search on. ANY is the default value.

- Examples**     `SEARCH:SEARCH1:TRIGGER:A:BUS:DPHY:ESCAPEMODE:COMMAND ULPS` specifies ULPS as the field within a DPHY frame to search on.
- `SEARCH:SEARCH1:TRIGGER:A:BUS:DPHY:ESCAPEMODE:COMMAND?` might return `:SEARCH:SEARCH1:TRIGGER:A:BUS:DPHY:ESCAPEMODE:COMMAND ULPS`, indicating that ULPS is the currently specified field within a DPHY frame to search on.

## **SEARCH:SEARCH<x>:TRIGGER:A:BUS:DPHY:GREEN:VALUE**

This command specifies the green data string used for DPHY triggering if the trigger condition is on RGB packet.

- Conditions**     Requires option SR-DPHY.
- Group**           Search and Mark
- Syntax**          `SEARCH:SEARCH<x>:TRIGGER:A:BUS:DPHY:GREEN:VALUE <QString>`  
`SEARCH:SEARCH<x>:TRIGGER:A:BUS:DPHY:GREEN:VALUE?`
- Arguments**      `<QString>` is the identifier value. The default green value is `XXXXXXXXXXXX`.
- Examples**        `SEARCH:SEARCH1:TRIGGER:A:BUS:DPHY:GREEN:VALUE "243"` specifies 243 as the field within a DPHY frame to search on.
- `SEARCH:SEARCH1:TRIGGER:A:BUS:DPHY:GREEN:VALUE?` might return `:SEARCH:SEARCH1:TRIGGER:A:BUS:DPHY:GREEN:VALUE "243"`, indicating that 243 is the currently specified field within a DPHY frame to search on.

## **SEARCH:SEARCH<x>:TRIGGER:A:BUS:DPHY:MODE:TYPE**

This command sets or queries the mode type for DPHY bus. The default mode type condition is HS.

- Conditions**      Requires option SR-DPHY.
- Group**           Search and Mark
- Syntax**          `SEARCH:SEARCH<x>:TRIGGER:A:BUS:DPHY:MODE:TYPE {HS|LP}`  
`SEARCH:SEARCH<x>:TRIGGER:A:BUS:DPHY:MODE:TYPE?`

- Arguments** HS specifies HS as the mode within a DPHY frame to search on. HS is default mode type condition.
- LP specifies LP as the mode within a DPHY frame to search on.
- Examples** SEARCH:SEARCH1:TRIGger:A:BUS:DPHY:MODE:TYPE LP specifies LP as the mode within a DPHY frame to search on.
- SEARCH:SEARCH1:TRIGger:A:BUS:DPHY:MODE:TYPE? might return :SEARCH:SEARCH1:TRIGger:A:BUS:DPHY:MODE:TYPE LP, indicating that LP is the currently specified mode within a DPHY frame to search on.

## SEARCH:SEARCH<x>:TRIGger:A:BUS:DPHY:PACKets:LIST

This command sets or queries the packet list for DPHY bus. The default packet list condition is VSYNCSTART.

- Conditions** Requires option SR-DPHY.
- Group** Search and Mark
- Syntax** SEARCH:SEARCH<x>:TRIGger:A:BUS:DPHY:PACKets:LIST  
 {VSYNCSTART| VSYNCEND| HSYNCSTART| HSYNCEND| EOTP| COLOROFF|  
 COLORON| SHUTDOWN| TURNON| GSW| GR| COMPRESSION| SCRAMBLING|  
 EXECUTEQUEue| DCSSW| DCSR| GLONGWRITE| DSINULL| DSIBLANK|  
 MAXRETSIZE| DCSGLONGWRITE| PICParameter| COMPRESSEDPStream|  
 PPS101010| PPS121212| PPS565| PPS666| LPS666| PPS888|  
 YBCR24| LPYBCR24| YBCR16| YBCR12| ACKNowledge|  
 ERRORREPort| GSRR| GLONGREAD| DCSLONGREAD| DCSSRR|  
 FRAMESTART| FRAMEEND| LINESTART| LINEEND| GSP| CSINULL|  
 CSIBLANK| EMBEDDED| USEREIGHTB| RGB565| RGB555| RGB444|  
 RGB666| RAW6| RAW7| RAW8| RAW10| RAW12| RAW14| RAW16| RAW20|  
 RGB888| YUV420L8| YUV8BIT| YUV422B10| YUV420B10}  
 SEARCH:SEARCH<x>:TRIGger:A:BUS:DPHY:PACKets:LIST?
- Arguments** VSYNCSTART specifies VSYNCSTART as the packet within DPHY frame to search on.
- VSYNCEND specifies VSYNCEND as the packet within DPHY frame to search on.
- HSYNCSTART specifies HSYNCSTART as the packet within DPHY frame to search on.
- HSYNCEND specifies HSYNCEND as the packet within DPHY frame to search on.
- EOTP specifies EOTP as the packet within DPHY frame to search on.

COLOROFF specifies COLOROFF as the packet within DPHY frame to search on.

COLORON specifies COLORON as the packet within DPHY frame to search on.

SHUTDOWN specifies SHUTDOWN as the packet within DPHY frame to search on.

TURNON specifies TURNON as the packet within DPHY frame to search on.

GSW specifies GSW as the packet within DPHY frame to search on.

GR specifies GR as the packet within DPHY frame to search on.

COMPRESSION specifies COMPRESSION as the packet within DPHY frame to search on.

SCRAMBLING specifies SCRAMBLING as the packet within DPHY frame to search on.

EXECUTEQUEue specifies EXECUTEQUEue as the packet within DPHY frame to search on.

DCSSW specifies DCSSW as the packet within DPHY frame to search on.

DCSR specifies DCSR as the packet within DPHY frame to search on.

GLONGWRITE specifies GLONGWRITE as the packet within DPHY frame to search on.

DSINULL specifies DSINULL as the packet within DPHY frame to search on.

DSIBLANK specifies DSIBLANK as the packet within DPHY frame to search on.

MAXRETSIZE specifies MAXRETSIZE as the packet within DPHY frame to search on.

DCSGLONGWRITE specifies DCSGLONGWRITE as the packet within DPHY frame to search on.

PICPARAMeter specifies PICPARAMeter as the packet within DPHY frame to search on.

COMPRESSEDPSTReam specifies COMPRESSEDPSTReam as the packet within DPHY frame to search on.

PPS101010 specifies PPS101010 as the packet within DPHY frame to search on.

PPS121212 specifies PPS121212 as the packet within DPHY frame to search on.

PPS565 specifies PPS565 as the packet within DPHY frame to search on.

PPS666 specifies PPS666 as the packet within DPHY frame to search on.

LPS666 specifies LPS666 as the packet within DPHY frame to search on.

PPS888 specifies LPS666 as the packet within DPHY frame to search on.

YBCR24 specifies YBCR24 as the packet within DPHY frame to search on.

LPYBCR24 specifies LPYBCR24 as the packet within DPHY frame to search on.

YBCR16 specifies YBCR16 as the packet within DPHY frame to search on.

YBCR12 specifies YBCR12 as the packet within DPHY frame to search on.

ACKnowledge specifies ACKnowledge as the packet within DPHY frame to search on.

ERRORREPort specifies ERRORREPort as the packet within DPHY frame to search on.

GSRR specifies GSRR as the packet within DPHY frame to search on.

GLONGREAD specifies GLONGREAD as the packet within DPHY frame to search on.

DCSLONGREAD specifies DCSLONGREAD as the packet within DPHY frame to search on.

DCSSRR specifies DCSSRR as the packet within DPHY frame to search on.

FRAMEStArt specifies FRAMEStArt as the packet within DPHY frame to search on.

FRAMEEND specifies FRAMEEND as the packet within DPHY frame to search on.

LINEStArt specifies LINEStArt as the packet within DPHY frame to search on.

LINEEND specifies LINEEND as the packet within DPHY frame to search on.

GSP specifies GSP as the packet within DPHY frame to search on.

CSINULL specifies CSINULL as the packet within DPHY frame to search on.

CSIBLAnk specifies CSIBLAnk as the packet within DPHY frame to search on.

EMBEDEDDED specifies EMBEDDED as the packet within DPHY frame to search on.

USEREIGHTB specifies USEREIGHTB as the packet within DPHY frame to search on.

RGB565 specifies RGB565 as the packet within DPHY frame to search on.

RGB555 specifies RGB555 as the packet within DPHY frame to search on.

RGB444 specifies RGB444 as the packet within DPHY frame to search on.

RGB666 specifies RGB666 as the packet within DPHY frame to search on.

RAW6 specifies RAW6 as the packet within DPHY frame to search on.

RAW7 specifies RAW7 as the packet within DPHY frame to search on.

RAW8 specifies RAW8 as the packet within DPHY frame to search on.

RAW10 specifies RAW10 as the packet within DPHY frame to search on.

RAW12 specifies RAW12 as the packet within DPHY frame to search on.  
RAW14 specifies RAW14 as the packet within DPHY frame to search on.  
RAW16 specifies RAW16 as the packet within DPHY frame to search on.  
RAW20 specifies RAW20 as the packet within DPHY frame to search on.  
RGB888 specifies RGB888 as the packet within DPHY frame to search on.  
YUV420L8 specifies YUV420L8 as the packet within DPHY frame to search on.  
YUV8BIT specifies YUV8BIT as the packet within DPHY frame to search on.  
YUV422B10 specifies YUV422B10 as the packet within DPHY frame to search on.  
YUV420B10 specifies YUV420B10 as the packet within DPHY frame to search on.

**Examples** SEARCH:SEARCH1:TRIGger:A:BUS:DPHY:PACKets:LIST VSYNCSTART specifies VSYNCSTART of set command as the packet within DPHY frame to search on.

SEARCH:SEARCH1:TRIGGER:A:BUS:DPHY:PACKets:LIST? might return :SEARCH:SEARCH1:TRIGGER:A:BUS:DPHY:PACKets:LIST VSYNCSTART, indicating that VSYNCSTART is the currently the packet within DPHY frame to search on

## SEARCH:SEARCH<x>:TRIGger:A:BUS:DPHY:PACKets:TYPE

This command sets or queries the packet type for DPHY bus. The default packet type condition is SHORT.

**Conditions** Requires option SR-DPHY.

**Group** Search and Mark

**Syntax** SEARCH:SEARCH<x>:TRIGger:A:BUS:DPHY:PACKets:TYPE {SHORT|LONG}  
SEARCH:SEARCH<x>:TRIGger:A:BUS:DPHY:PACKets:TYPE?

**Arguments** SHORT specifies SHORT as the field within a DPHY frame to search on. SHORT is the default packet type condition.  
LONG1 specifies LONG as the field within a DPHY frame to search on.

**Examples** SEARCH:SEARCH1:TRIGger:A:BUS:DPHY:PACKets:TYPE LONG specifies LONG as the field within a DPHY frame to search on.



SEARCH:SEARCH1:TRIGGER:A:BUS:DPHY:PACKets:TYPE? might return :SEARCH:SEARCH1:TRIGGER:A:BUS:DPHY:PACKets:TYPE LONG, indicating that LONG is the currently specified field within a DPHY frame to search on.

## SEARCH:SEARCH<x>:TRIGger:A:BUS:DPHY:PIXel:NUMBER

This command specifies the pixel number to be used for DPHY triggering if the trigger condition is on pixel number pattern. The search number is specified by x.

<b>Conditions</b>	Requires option SR-DPHY.
<b>Group</b>	Search and Mark
<b>Syntax</b>	SEARCH:SEARCH<x>:TRIGger:A:BUS:DPHY:PIXel:NUMBER <NR1> SEARCH:SEARCH<x>:TRIGger:A:BUS:DPHY:PIXel:NUMBER?
<b>Arguments</b>	<NR1> specifies the pixel number. The default pixel number value is 0
<b>Examples</b>	SEARCH:SEARCH1:TRIGger:A:BUS:DPHY:PIXel:NUMBER 1234 specifies 1234 as the field within a DPHY frame to search on.  SEARCH:SEARCH1:TRIGGER:A:BUS:DPHY:PIXel:NUMBER? might return :SEARCH:SEARCH1:TRIGGER:A:BUS:DPHY:PIXel:NUMBER 1234, indicating that 1234 is the currently specified field within a DPHY frame to search on.

## SEARCH:SEARCH<x>:TRIGger:A:BUS:DPHY:PIXel:SEARCHOPTion

This command sets or queries the search pattern type for DPHY bus. The default search pattern type value is PIXELVALue.

<b>Conditions</b>	Requires option SR-DPHY.
<b>Group</b>	Search and Mark
<b>Syntax</b>	SEARCH:SEARCH<x>:TRIGger:A:BUS:DPHY:PIXel:SEARCHOPTion {PIXELVALue PIXELNUMBER} SEARCH:SEARCH<x>:TRIGger:A:BUS:DPHY:PIXel:SEARCHOPTion?

<b>Arguments</b>	<p>PIXELVALue specifies PIXELVALue as the field within a DPHY frame to search on.</p> <p>PIXELNUMBer specifies PIXELNUMBer as the field within a DPHY frame to search on.</p>
<b>Examples</b>	<p>SEARCH:SEARCH1:TRIGger:A:BUS:DPHY:PIXe1:SEARCHOPTion PIXELNUMBer specifies PIXELNUMBer as the field within a DPHY frame to search on.</p> <p>SEARCH:SEARCH1:TRIGGER:A:BUS:DPHY:PIXe1:SEARCHOPTion? might return :SEARCH:SEARCH1:TRIGGER:A:BUS:DPHY:PIXe1:SEARCHOPTion PIXELNUMBer, indicating that PIXELNUMBer is the currently specified field within a DPHY frame to search on.</p>

## SEARCH:SEARCH<x>:TRIGger:A:BUS:DPHY:RED:VALue

This command specifies the red data string used for DPHY triggering if the trigger condition is on RGB packet.

<b>Conditions</b>	Requires option SR-DPHY.
<b>Group</b>	Search and Mark
<b>Syntax</b>	SEARCH:SEARCH<x>:TRIGger:A:BUS:DPHY:RED:VALue <QString> SEARCH:SEARCH<x>:TRIGger:A:BUS:DPHY:RED:VALue?
<b>Arguments</b>	<QString> is the identifier value. The default red value is XXXXXXXXXXXX.
<b>Examples</b>	<p>SEARCH:SEARCH1:TRIGger:A:BUS:DPHY:RED:VALue "1A1" specifies 1A1 as the field within a DPHY frame to search on.</p> <p>SEARCH:SEARCH1:TRIGGER:A:BUS:DPHY:RED:VALue? might return :SEARCH:SEARCH1:TRIGGER:A:BUS:DPHY:RED:VALue "1A1", indicating that 1A1 is the currently specified field within a DPHY frame to search on.</p>

## SEARCH:SEARCH<x>:TRIGger:A:BUS:DPHY:WORDCOUNT:VALue

This command specifies the word count data string used for DPHY triggering if the trigger condition is set on any pixel packet.

<b>Conditions</b>	Requires option SR-DPHY.
-------------------	--------------------------

<b>Group</b>	Search and Mark
<b>Syntax</b>	SEARCH:SEARCH<x>:TRIGger:A:BUS:DPHY:WORDCOUNT:VALue <QString> SEARCH:SEARCH<x>:TRIGger:A:BUS:DPHY:WORDCOUNT:VALue?
<b>Arguments</b>	<QString> is the identifier value. The default word count value is XXXXXXXXXXXXXXXXXXXX.
<b>Examples</b>	SEARCH:SEARCH1:TRIGger:A:BUS:DPHY:WORDCOUNT:VALue "0003" specifies 1A1 as the field within a DPHY frame to search on.  SEARCH:SEARCH1:TRIGGER:A:BUS:DPHY:WORDCOUNT:VALue? might return :SEARCH:SEARCH1:TRIGGER:A:BUS:DPHY:WORDCOUNT:VALue "0003", indicating that 0003 is the currently specified field within a DPHY frame to search on.

## SEARCH:SEARCH<x>:TRIGger:A:BUS:DPHY:YCBCR:CB

This command specifies the Cb data string used for DPHY triggering if the trigger condition is on YCbCr packet.

<b>Conditions</b>	Requires option SR-DPHY.
<b>Group</b>	Search and Mark
<b>Syntax</b>	SEARCH:SEARCH<x>:TRIGger:A:BUS:DPHY:YCBCR:CB <QString> SEARCH:SEARCH<x>:TRIGger:A:BUS:DPHY:YCBCR:CB?
<b>Arguments</b>	<QString> is the identifier value. The default YCBCR packets CB value is XXXXXXXXXXXX.
<b>Examples</b>	SEARCH:SEARCH1:TRIGger:A:BUS:DPHY:YCBCR:CB "1BA" specifies 1BA as the field within a DPHY frame to search on.  SEARCH:SEARCH1:TRIGGER:A:BUS:DPHY:YCBCR:CB? might return :SEARCH:SEARCH1:TRIGger:A:BUS:DPHY:YCBCR:CB "1BA", indicating that 1BA is the currently specified field within a DPHY frame to search on.

## SEARCH:SEARCH<x>:TRIGger:A:BUS:DPHY:YCBCR:CR

This command specifies the Cr data string used for DPHY triggering if the trigger condition is on YCbCr packet.

<b>Conditions</b>	Requires option SR-DPHY.
<b>Group</b>	Search and Mark
<b>Syntax</b>	SEARCH:SEARCH<x>:TRIGger:A:BUS:DPHY:YCBCR:CR <QString> SEARCH:SEARCH<x>:TRIGger:A:BUS:DPHY:YCBCR:CR?
<b>Arguments</b>	<QString> is the identifier value. The default YCBCR packets CR value is XXXXXXXXXXXX.
<b>Examples</b>	SEARCH:SEARCH1:TRIGger:A:BUS:DPHY:YCBCR:CR "2EE" specifies 2EE as the field within a DPHY frame to search on.  SEARCH:SEARCH1:TRIGger:A:BUS:DPHY:YCBCR:CR? might return :SEARCH:SEARCH1:TRIGger:A:BUS:DPHY:YCBCR:CR "2EE", indicating that 2EE is the currently specified field within a DPHY frame to search on.

## SEARCH:SEARCH<x>:TRIGger:A:BUS:DPHY:YCBCR:Y

This command specifies the Y data string used for DPHY triggering if the trigger condition is on YCbCr packet.

<b>Conditions</b>	Requires option SR-DPHY.
<b>Group</b>	Search and Mark
<b>Syntax</b>	SEARCH:SEARCH<x>:TRIGger:A:BUS:DPHY:YCBCR:Y <QString> SEARCH:SEARCH<x>:TRIGger:A:BUS:DPHY:YCBCR:Y?
<b>Arguments</b>	<QString> is the identifier value. The default YCBCR packets Y value is XXXXXXXXXXXX.
<b>Examples</b>	SEARCH:SEARCH1:TRIGger:A:BUS:DPHY:YCBCR:Y "1AA" specifies 1AA as the field within a DPHY frame to search on.

SEARCH:SEARCH1:TRIGger:A:BUS:DPHY:YCBCR:Y? might return  
:SEARCH:SEARCH1:TRIGger:A:BUS:DPHY:YCBCR:Y "1AA", indicating that  
1AA is the currently specified field within a DPHY frame to search on.

## SEARCH:SEARCH<x>:TRIGger:A:BUS:DPHY:YUV:U

This command specifies the U data string used for DPHY triggering if the trigger condition is on YUV packet.

<b>Conditions</b>	Requires option SR-DPHY.
<b>Group</b>	Search and Mark
<b>Syntax</b>	SEARCH:SEARCH<x>:TRIGger:A:BUS:DPHY:YUV:U <QString> SEARCH:SEARCH<x>:TRIGger:A:BUS:DPHY:YUV:U?
<b>Arguments</b>	<QString> is the identifier value. The default YUV packets U value is XXXXXXXXXX.
<b>Examples</b>	SEARCH:SEARCH1:TRIGger:A:BUS:DPHY:YUV:U "123" specifies 123 as the field within a DPHY frame to search on.  SEARCH:SEARCH1:TRIGger:A:BUS:DPHY:YUV:U? might return :SEARCH:SEARCH1:TRIGger:A:BUS:DPHY:YUV:U "123", indicating that 123 is the currently specified field within a DPHY frame to search on.

## SEARCH:SEARCH<x>:TRIGger:A:BUS:DPHY:YUV:V

This command specifies the V data string used for DPHY triggering if the trigger condition is on YUV packet.

<b>Conditions</b>	Requires option SR-DPHY.
<b>Group</b>	Search and Mark
<b>Syntax</b>	SEARCH:SEARCH<x>:TRIGger:A:BUS:DPHY:YUV:V <QString> SEARCH:SEARCH<x>:TRIGger:A:BUS:DPHY:YUV:V?

<b>Arguments</b>	<Qstring> is the identifier value. The default YUV packets V value is XXXXXXXXXXXX.
<b>Examples</b>	SEARCH:SEARCH1:TRIGger:A:BUS:DPHY:YUV:V "12A" specifies 12A as the field within a DPHY frame to search on.  SEARCH:SEARCH1:TRIGger:A:BUS:DPHY:YUV:V? might return :SEARCH:SEARCH1:TRIGger:A:BUS:DPHY:YUV:V "12A", indicating that 12A is the currently specified field within a DPHY frame to search on.

## SEARCH:SEARCH<x>:TRIGger:A:BUS:DPHY:YUV:Y

This command specifies the Y data string used for DPHY triggering if the trigger condition is on YUV packet.

<b>Conditions</b>	Requires option SR-DPHY.
<b>Group</b>	Search and Mark
<b>Syntax</b>	SEARCH:SEARCH<x>:TRIGger:A:BUS:DPHY:YUV:Y <Qstring> SEARCH:SEARCH<x>:TRIGger:A:BUS:DPHY:YUV:Y?
<b>Arguments</b>	<Qstring> is the identifier value. The default YUV packets Y value is XXXXXXXXXXXX.
<b>Examples</b>	SEARCH:SEARCH1:TRIGger:A:BUS:DPHY:YUV:Y "81A" specifies 12A as the field within a DPHY frame to search on.  SEARCH:SEARCH1:TRIGger:A:BUS:DPHY:YUV:Y? might return :SEARCH:SEARCH1:TRIGger:A:BUS:DPHY:YUV:Y "81A", indicating that 81A is the currently specified field within a DPHY frame to search on.

## SEARCH:SEARCH<x>:TRIGger:A:BUS:ESPI:ADDRess:VALue

This command specifies the binary data string used for ESPI triggering if the trigger condition is Address. The search number is specified by x.

<b>Conditions</b>	Requires option SR-ESPI.
<b>Group</b>	Search and Mark

<b>Syntax</b>	SEARCH:SEARCH<x>:TRIGger:A:BUS:ESPI:ADDDress:VALue <QString> SEARCH:SEARCH<x>:TRIGger:A:BUS:ESPI:ADDDress:VALue?
<b>Arguments</b>	<QString> is the identifier value. The default value is XXXXXXXX.
<b>Examples</b>	SEARCH:SEARCH1:TRIGGER:A:BUS:ESPI:ADDDress:VALue "0111101101011010" specifies 0111101101011010 as the field within a ESPI frame to search on.  SEARCH:SEARCH1:TRIGGER:A:BUS:ESPI:ADDDress:VALue? might return :SEARCH:SEARCH1:TRIGGER:A:BUS:ESPI:ADDDress:VALue "0111101101011010", indicating that 0111101101011010 is the currently specified field within a ESPI frame to search on.

## SEARCH:SEARCH<x>:TRIGger:A:BUS:ESPI:COMMAND:OPCode

This command sets or queries the command opcode in ESPI bus. The search number is specified by x.

<b>Conditions</b>	Requires option SR-ESPI.
<b>Group</b>	Search and Mark
<b>Syntax</b>	SEARCH:SEARCH<x>:TRIGger:A:BUS:ESPI:COMMAND:OPCode {GETSTATus  GETCONFig  SETCONFig  GETNP  GETPC  PUTNP  PUTPC  PUTIORDSHORT  PUTIOWRSHORT  PUTMEMRD32SHORT  PUTMEMWR32SHORT  PUTOOB  GETOOB  PUTFLASHC  GETFLASHNP  PUTVWIRE  GETVWIRE} SEARCH:SEARCH<x>:TRIGger:A:BUS:ESPI:COMMAND:OPCode?
<b>Related Commands</b>	<a href="#">SEARCH:SEARCH&lt;x&gt;:TRIGger:A:BUS:ESPI:PHASe</a>
<b>Arguments</b>	GETSTATus specifies get status as the command opcode in ESPI bus to search on. GETCONFig specifies get configuration as the command opcode in ESPI bus to search on. SETCONFig specifies set configuration as the command opcode in ESPI bus to search on.. GETNP specifies GETNP as the command opcode in ESPI bus to search on. GETPC specifies GETPC as the command opcode in ESPI bus to search on. PUTNP specifies PUTNP as the command opcode in ESPI bus to search on.

PUTPC specifies PUTPC as the command opcode in ESPI bus to search on.

PUTIORDSHORT specifies put IO read short as the command opcode in ESPI bus to search on.

PUTIOWRSHORT specifies put IO write short as the command opcode in ESPI bus to search on.

PUTMEMRD32SHORT specifies put memory read 32 short as the command opcode in ESPI bus to search on.

PUTMEMWR32SHORT specifies put memory write 32 short as the command opcode in ESPI bus to search on.

PUTOOB specifies PUTOOB as the command opcode in ESPI bus to search on.

GETOOB specifies GETOOB as the command opcode in ESPI bus to search on.

PUTFLASHC specifies PUTFLASHC as the command opcode in ESPI bus to search on.

GETFLASHNP specifies GETFLASHNP as the command opcode in ESPI bus to search on.

PUTVWIRE specifies put virtual wire as the command opcode in ESPI bus to search on.

GETVWIRE specifies get virtual wire as the command opcode in ESPI bus to search on.

**Examples** SEARCH:SEARCH1:TRIGGER:A:BUS:ESPI:COMMAND:OPCode specifies the search to happen on which command opcode.

SEARCH:SEARCH1:TRIGGER:A:BUS:ESPI:COMMAND:OPCode? might return :SEARCH:SEARCH1:TRIGGER:A:BUS:ESPI:COMMAND:OPCode GETNP, indicating that command is the currently selected command opcode where the search will be performed.

## SEARCH:SEARCH<x>:TRIGger:A:BUS:ESPI:CONDition

This command sets or queries the trigger condition for a ESPI bus. The search number is specified by x.

**Conditions** Requires option SR-ESPI.

**Group** Search and Mark



<b>Syntax</b>	<pre>SEARCH:SEARCH&lt;x&gt;:TRIGGER:A:BUS:ESPI:CONDITION {START  CHINdependent  PERICHANnel  OOBCHANnel  VWCHANnel  FACHANnel  DATA  STATUS  ERRors  WAIT  END}  SEARCH:SEARCH&lt;x&gt;:TRIGGER:A:BUS:ESPI:CONDITION?</pre>
<b>Arguments</b>	<p><b>START</b> specifies START as the event for ESPI frame to search on.</p> <p><b>CHINdependent</b> specifies CHINdependent channel for ESPI protocol to search on.</p> <p><b>PERICHANnel</b> specifies peripheral channel for ESPI protocol to search on.</p> <p><b>OOBCHANnel</b> specifies OOBCHANnel channel for ESPI protocol to search on.</p> <p><b>VWCHANnel</b> specifies virtual wire channel for ESPI protocol to search on.</p> <p><b>FACHANnel</b> specifies flash channel for ESPI protocol to search on.</p> <p><b>DATA</b> specifies DATA as the field within a ESPI frame to search on.</p> <p><b>STATUS</b> specifies STATUS as the field within a ESPI frame to search on.</p> <p><b>ERRors</b> specifies ERRors as the type of error ESPI frame to search on.</p> <p><b>WAIT</b> specifies WAIT as the field within a ESPI frame to search on.</p> <p><b>END</b> specifies END as the event for a ESPI frame to search on.</p>
<b>Examples</b>	<pre>SEARCH:SEARCH1:TRIGGER:A:BUS:ESPI:CONDITION START specifies START as the field within a ESPI frame to search on.  SEARCH:SEARCH1:TRIGGER:A:BUS:ESPI:CONDITION? might return :SEARCH:SEARCH1:TRIGGER:A:BUS:ESPI:CONDITION START, indicating that START is the currently specified field within a ESPI frame to search on.</pre>

## SEARCH:SEARCH<x>:TRIGGER:A:BUS:ESPI:CYCLETYPE

This command sets or queries the cycle type on command in ESPI bus. The search number is specified by x.

<b>Conditions</b>	Requires option SR-ESPI.
<b>Group</b>	Search and Mark
<b>Syntax</b>	<pre>SEARCH:SEARCH&lt;x&gt;:TRIGGER:A:BUS:ESPI:CYCLETYPE {MEMRD32  MEMRD64  MEMWR32  MEMWR64  MESSAGE  MSGWITHDATA  SUCCESSNODATA  SUCCESSDATA  UNSUCCESSNODATA  OOBMBUS </pre>

MCTP| FLASHREAD| FLASHWRITE| FLASHERASE| FLSUCCESSNODATA|  
FLSUCCESSDATA| FLUNSUCCESSNODATA}

SEARCH:SEARCH<x>:TRIGGER:A:BUS:ESPI:CYCLETYPE?

**Related Commands**    [SEARCH:SEARCH<x>:TRIGGER:A:BUS:ESPI:PHASE](#)

**Arguments**

- MEMRD32 specifies Memory Read 32 as the cycle type to search on.
- MEMRD64 specifies Memory Read 64 as the cycle type to search on.
- MEMWR32 specifies Memory Read Write 32 as the cycle type to search on.
- MEMWR64 specifies Memory Read Write 64 as the cycle type to search on.
- MESSAGE specifies MESSAGE as the cycle type to search on.
- MSGWITHDATA specifies message with Data as the cycle type to search on.
- SUCCESSNODATA specifies success without data as the cycle type to search on.
- SUCCESSDATA specifies success with data as the cycle type to search on.
- UNSUCCESSNODATA specifies unsuccess without data as the cycle type to search on.
- OOBSMBUS specifies OOB SMBus as the cycle type to search on.
- MCTP specifies MCTP as the cycle type to search on.
- FLASHREAD specifies FLASHREAD as the cycle type to search on.
- FLASHWRITE specifies FLASHWRITE as the cycle type to search on.
- FLASHERASE specifies FLASHERASE as the cycle type to search on.
- FLSUCCESSNODATA specifies flash success without data as the cycle type to search on.
- FLSUCCESSDATA specifies flash Success with data as the cycle type to search on.
- FLUNSUCCESSNODATA specifies flash unsuccess without data as the cycle type to search on.

**Examples**

SEARCH:SEARCH1:TRIGGER:A:BUS:ESPI:CYCLETYPE MCTP specifies MCTP as the cycle type to search on.

SEARCH:SEARCH1:TRIGGER:A:BUS:ESPI:CYCLETYPE? might return  
:SEARCH:SEARCH1:TRIGGER:A:BUS:ESPI:CYCLETYPE MCTP, indicating that MCTP is the cycle type to search on.

## SEARCH:SEARCH<x>:TRIGger:A:BUS:ESPI:DATA:SIZE

This command specifies the length of the data string in bytes to be used for ESPI triggering if the trigger condition is DATA. The default data size is 1 byte and ranges between 1 and 5. The search number is specified by x.

<b>Conditions</b>	Requires option SR-ESPI.
<b>Group</b>	Search and Mark
<b>Syntax</b>	SEARCH:SEARCH<x>:TRIGger:A:BUS:ESPI:DATA:SIZE <NR1> SEARCH:SEARCH<x>:TRIGger:A:BUS:ESPI:DATA:SIZE?
<b>Arguments</b>	<NR1> specifies the data size. The default data size is 1 and the valid range is 1 to 5.
<b>Examples</b>	SEARCH:SEARCH1:TRIGGER:A:BUS:ESPI:DATA:SIZE 4 sets the data size value as 4.  SEARCH:SEARCH1:TRIGGER:A:BUS:ESPI:DATA:SIZE? might return :SEARCH:SEARCH1:TRIGGER:A:BUS:ESPI:DATA:SIZE 4, indicating that the data size value is 4.

## SEARCH:SEARCH<x>:TRIGger:A:BUS:ESPI:DATA:VALue

This command specifies the binary data string used for ESPI triggering if the trigger condition is DATA. The search number is specified by x.

<b>Conditions</b>	Requires option SR-ESPI.
<b>Group</b>	Search and Mark
<b>Syntax</b>	SEARCH:SEARCH<x>:TRIGger:A:BUS:ESPI:DATA:VALue <QString> SEARCH:SEARCH<x>:TRIGger:A:BUS:ESPI:DATA:VALue?
<b>Arguments</b>	<QString> is the identifier value. The default value is XXXXXXXX.
<b>Examples</b>	SEARCH:SEARCH1:TRIGGER:A:BUS:ESPI:DATA:VALue "0111100111" sets the data value as "0111100111".

SEARCH:SEARCH1:TRIGGER:A:BUS:ESPI:DATA:VALUE? might return  
:SEARCH:SEARCH1:TRIGGER:A:BUS:ESPI:DATA:VALUE "0111100111",  
indicating that the data value is "0111100111".

## SEARCH:SEARCH<x>:TRIGger:A:BUS:ESPI:ERRor:TYPE

This command sets or queries the error type on command or response in ESPI bus. The search number is specified by x.

<b>Conditions</b>	Requires option SR-ESPI.
<b>Group</b>	Search and Mark
<b>Syntax</b>	SEARCH:SEARCH<x>:TRIGger:A:BUS:ESPI:ERRor:TYPE {CRC  DEFer  FATA  NONFATA  NORESPonse  CMDOPCODE  CYCLETYPE}  SEARCH:SEARCH<x>:TRIGger:A:BUS:ESPI:ERRor:TYPE?
<b>Arguments</b>	CRC specifies CRC as the error type to search on. DEFer specifies DEFer as the error type to search on. FATA  specifies FATA  as the error type to search on. NONFATA  specifies NONFATA  as the error type to search on. NORESPonse specifies NORESPonse as the error type to search on. CMDOPCODE specifies CMDOPCODE as the error type to search on. CYCLETYPE specifies CYCLETYPE as the error type to search on.
<b>Examples</b>	SEARCH:SEARCH1:TRIGGER:A:BUS:ESPI:ERRor:TYPE CRC specifies CRC as the error type to search on.  SEARCH:SEARCH1:TRIGGER:A:BUS:ESPI:ERRor:TYPE? might return :SEARCH:SEARCH1:TRIGGER:A:BUS:ESPI:ERRor:TYPE CRC, indicating that CRC is the error type to search on.

## SEARCH:SEARCH<x>:TRIGger:A:BUS:ESPI:LENGth:VALue

This command specifies the binary data string used for ESPI triggering if the trigger condition is Length. The search number is specified by x.

<b>Conditions</b>	Requires option SR-ESPI.
<b>Group</b>	Search and Mark
<b>Syntax</b>	SEARCH:SEARCH<x>:TRIGger:A:BUS:ESPI:LENGth:VALue <QString> SEARCH:SEARCH<x>:TRIGger:A:BUS:ESPI:LENGth:VALue?
<b>Arguments</b>	<QString> is the identifier value. The default value is XXXXXXXXXXXXXXXX.
<b>Examples</b>	SEARCH:SEARCH1:TRIGGER:A:BUS:ESPI:LENGth:VALue "011110110101" sets the tag value as "011110110101".  SEARCH:SEARCH1:TRIGGER:A:BUS:ESPI:LENGth:VALue? might return :SEARCH:SEARCH1:TRIGGER:A:BUS:ESPI:LENGth:VALue "011110110101", indicating that the tag value is "011110110101".

## SEARCH:SEARCH<x>:TRIGger:A:BUS:ESPI:PHASe

This command sets or queries the phase in ESPI bus. The search number is specified by *x*.

<b>Conditions</b>	Requires option SR-ESPI.
<b>Group</b>	Search and Mark
<b>Syntax</b>	SEARCH:SEARCH<x>:TRIGger:A:BUS:ESPI:PHASe {COMMANd  RESPONSe  RESPONSeHEADer  RESPONSeNOHEADer} SEARCH:SEARCH<x>:TRIGger:A:BUS:ESPI:PHASe?
<b>Arguments</b>	COMMANd specifies command as the field/packet to search on.  RESPONSe specifies response as the field/packet to search on.  RESPONSeHEADer specifies the response header as the field/packet to search on.  RESPONSeNOHEADer specifies the response without header as the field/packet to search on.
<b>Examples</b>	SEARCH:SEARCH1:TRIGGER:A:BUS:ESPI:PHASe COMMANd specifies command as the field/packet to search on.

SEARCH:SEARCH1:TRIGGER:A:BUS:ESPI:PHASE? might return  
:SEARCH:SEARCH1:TRIGGER:A:BUS:ESPI:PHASE COMMAND, indicating that  
command is the field/packet to search on.

## SEARCH:SEARCH<x>:TRIGger:A:BUS:ESPI:RESPCYCLE:TYPE

This command sets or queries the response cycle type on command in ESPI bus.  
The search number is specified by x.

<b>Conditions</b>	Requires option SR-ESPI.
<b>Group</b>	Search and Mark
<b>Syntax</b>	<pre>SEARCH:SEARCH&lt;x&gt;:TRIGger:A:BUS:ESPI:RESPCYCLE:TYPE {MEMRDWR32  MEMRDWR64  MESSAGE  MSGWITHDATA  SUCCESSNODATA  SUCCESSDATA  UNSUCCESSNODATA  LTR  FLASHREAD  FLASHWRITE  FLASHERASE}</pre> <pre>SEARCH:SEARCH&lt;x&gt;:TRIGger:A:BUS:ESPI:RESPCYCLE:TYPE?</pre>
<b>Arguments</b>	<p>MEMRDWR32 specifies Memory Read/Write 32 as the cycle type to search on.</p> <p>MEMRDWR64 specifies Memory Read/Write 64 as the cycle type to search on.</p> <p>MESSAGE specifies message as the cycle type to search on.</p> <p>MSGWITHDATA specifies message with Data as the cycle type to search on.</p> <p>SUCCESSNODATA specifies success without data as the cycle type to search on.</p> <p>SUCCESSDATA specifies success with data as the cycle type to search on.</p> <p>UNSUCCESSNODATA specifies unsuccess without data as the cycle type to search on.</p> <p>LTR specifies LTR as the cycle type to search on.</p> <p>FLASHREAD specifies flash read as the cycle type to search on.</p> <p>FLASHWRITE specifies flash write as the cycle type to search on.</p> <p>FLASHERASE specifies flash erase as the cycle type to search on.</p>
<b>Examples</b>	<pre>SEARCH:SEARCH1:TRIGGER:A:BUS:ESPI:RESPCYCLE:TYPE LTR</pre> specifies LTR as the cycle type to search on.

SEARCH:SEARCH1:TRIGGER:A:BUS:ESPI:RESPCYCLE:TYPE? might return :SEARCH:SEARCH1:TRIGGER:A:BUS:ESPI:RESPCYCLE:TYPE LTR, indicating that LTR is the cycle type to search on.

## SEARCH:SEARCH<x>:TRIGger:A:BUS:ESPI:SMBUS:DESTination:ADDRESS

This command specifies the binary data string used for ESPI triggering if the trigger condition is SMBus Source/Destination Address. The search number is specified by x.

<b>Conditions</b>	Requires option SR-ESPI.
<b>Group</b>	Search and Mark
<b>Syntax</b>	SEARCH:SEARCH<x>:TRIGger:A:BUS:ESPI:SMBUS:DESTination:ADDRESS <QString> SEARCH:SEARCH<x>:TRIGger:A:BUS:ESPI:SMBUS:DESTination:ADDRESS?
<b>Arguments</b>	<QString> is the identifier value. The default value is XXXXXXXX.
<b>Examples</b>	SEARCH:SEARCH1:TRIGGER:A:BUS:ESPI:SMBUS:DESTination:ADDRESS "01111011" sets the tag value as "01111011".  SEARCH:SEARCH1:TRIGGER:A:BUS:ESPI:SMBUS:DESTination:ADDRESS? might return :SEARCH:SEARCH1:TRIGGER:A:BUS:ESPI:SMBUS:DESTination:ADDRESS "01111011", indicating that the tag value is "01111011".

## SEARCH:SEARCH<x>:TRIGger:A:BUS:ESPI:SMBUS:SLAVe:ADDRESS

This command specifies the binary data string used for ESPI triggering if the trigger condition is SMBus Slave Address. The search number is specified by x.

<b>Conditions</b>	Requires option SR-ESPI.
<b>Group</b>	Search and Mark
<b>Syntax</b>	SEARCH:SEARCH<x>:TRIGger:A:BUS:ESPI:SMBUS:SLAVe:ADDRESS <QString>

SEARCH:SEARCH<x>:TRIGger:A:BUS:ESPI:SMBUS:SLAVE:ADDRESS?

**Arguments** <Qstring> is the identifier value. The default value is XXXXXXXXX.

**Examples** SEARCH:SEARCH1:TRIGGER:A:BUS:ESPI:SMBUS:SLAVE:ADDRESS  
"01111011" sets the tag value as "01111011".

SEARCH:SEARCH1:TRIGGER:A:BUS:ESPI:SMBUS:SLAVE:ADDRESS? might  
return :SEARCH:SEARCH1:TRIGGER:A:BUS:ESPI:SMBUS:SLAVE:ADDRESS  
"01111011", indicating that the tag value is "01111011".

## SEARCH:SEARCH<x>:TRIGger:A:BUS:ESPI:STATUS:VALue

This command specifies the binary data string used for ESPI triggering if the trigger condition is Virtual wire Status. The search number is specified by x.

**Conditions** Requires option SR-ESPI.

**Group** Search and Mark

**Syntax** SEARCH:SEARCH<x>:TRIGger:A:BUS:ESPI:STATUS:VALue <Qstring>  
SEARCH:SEARCH<x>:TRIGger:A:BUS:ESPI:STATUS:VALue?

**Arguments** <Qstring> is the identifier value. The default value is  
XXXXXXXXXXXXXXXXXXXX.

**Examples** SEARCH:SEARCH1:TRIGGER:A:BUS:ESPI:STATUS:VALue  
"0111101110101010" sets the tag value as "0111101110101010".

SEARCH:SEARCH1:TRIGGER:A:BUS:ESPI:STATUS:VALue? might  
return :SEARCH:SEARCH1:TRIGGER:A:BUS:ESPI:STATUS:VALue  
"0111101110101010", indicating that the tag value is "0111101110101010".

## SEARCH:SEARCH<x>:TRIGger:A:BUS:ESPI:TAG:VALue

This command specifies the binary data string used for ESPI triggering if the trigger condition is Tag. The search number is specified by x.

**Conditions** Requires option SR-ESPI.



<b>Group</b>	Search and Mark
<b>Syntax</b>	SEARCH:SEARCH<x>:TRIGger:A:BUS:ESPI:TAG:VALue <QString> SEARCH:SEARCH<x>:TRIGger:A:BUS:ESPI:TAG:VALue?
<b>Arguments</b>	<QString> is the identifier value. The default value is XXXX.
<b>Examples</b>	SEARCH:SEARCH1:TRIGGER:A:BUS:ESPI:TAG:VALue "0111" sets the tag value as "0111".  SEARCH:SEARCH1:TRIGGER:A:BUS:ESPI:TAG:VALue? might return :SEARCH:SEARCH1:TRIGGER:A:BUS:ESPI:TAG:VALue "0111", indicating that the tag value is "0111".

## SEARCH:SEARCH<x>:TRIGger:A:BUS:ESPI:VIRTUALWIRE:COUNT:VALue

This command specifies the binary data string used for ESPI triggering if the trigger condition is Virtual wire count. The search number is specified by x.

<b>Conditions</b>	Requires option SR-ESPI.
<b>Group</b>	Search and Mark
<b>Syntax</b>	SEARCH:SEARCH<x>:TRIGger:A:BUS:ESPI:VIRTUALWIRE:COUNT:VALue <QString> SEARCH:SEARCH<x>:TRIGger:A:BUS:ESPI:VIRTUALWIRE:COUNT:VALue?
<b>Arguments</b>	<QString> is the identifier value. The default value is XXXXXXXX.
<b>Examples</b>	SEARCH:SEARCH1:TRIGGER:A:BUS:ESPI:VIRTUALWIRE:COUNT:VALue "01111011" sets the tag value as "01111011".  SEARCH:SEARCH1:TRIGGER:A:BUS:ESPI:VIRTUALWIRE:COUNT:VALue? might return :SEARCH:SEARCH1:TRIGGER:A:BUS:ESPI:VIRTUALWIRE:COUNT:VALue "01111011", indicating that the tag value is "01111011".

## SEARCH:SEARCH<x>:TRIGger:A:BUS:ESPI:VIRTUALWIRE:DATA:VALue

This command specifies the binary data string used for ESPI triggering if the trigger condition is Virtual wire Data. The search number is specified by x.

<b>Conditions</b>	Requires option SR-ESPI.
<b>Group</b>	Search and Mark
<b>Syntax</b>	SEARCH:SEARCH<x>:TRIGger:A:BUS:ESPI:VIRTUALWIRE:DATA:VALue <Qstring> SEARCH:SEARCH<x>:TRIGger:A:BUS:ESPI:VIRTUALWIRE:DATA:VALue?
<b>Arguments</b>	<Qstring> is the identifier value. The default value is XXXXXXXX.
<b>Examples</b>	SEARCH:SEARCH1:TRIGGER:A:BUS:ESPI:VIRTUALWIRE:DATA:VALue "01111011" sets the tag value as "01111011".  SEARCH:SEARCH1:TRIGGER:A:BUS:ESPI:VIRTUALWIRE:DATA:VALue? might return :SEARCH:SEARCH1:TRIGGER:A:BUS:ESPI:VIRTUALWIRE:DATA:VALue "01111011", indicating that the tag value is "01111011".

## SEARCH:SEARCH<x>:TRIGger:A:BUS:ESPI:VIRTUALWIRE:INDEX:VALue

This command specifies the binary data string used for ESPI triggering if the trigger condition is Virtual wire Index. The search number is specified by x.

<b>Conditions</b>	Requires option SR-ESPI.
<b>Group</b>	Search and Mark
<b>Syntax</b>	SEARCH:SEARCH<x>:TRIGger:A:BUS:ESPI:VIRTUALWIRE:INDEX:VALue <Qstring> SEARCH:SEARCH<x>:TRIGger:A:BUS:ESPI:VIRTUALWIRE:INDEX:VALue?
<b>Arguments</b>	<Qstring> is the identifier value. The default value is XXXXXXXX.
<b>Examples</b>	SEARCH:SEARCH1:TRIGGER:A:BUS:ESPI:VIRTUALWIRE:INDEX:VALue "01111011" sets the tag value as "01111011".  SEARCH:SEARCH1:TRIGGER:A:BUS:ESPI:VIRTUALWIRE:INDEX:VALue? might return :SEARCH:SEARCH1:TRIGGER:A:BUS:ESPI:VIRTUALWIRE:INDEX:VALue "01111011", indicating that the tag value is "01111011".

## SEARCH:SEARCH<x>:TRIGger:A:BUS:ESPI:VIRTUALWIRE:RESPonse:VALue

This command specifies the binary data string used for ESPI triggering if the trigger condition is Virtual wire Response. The search number is specified by x.

<b>Conditions</b>	Requires option SR-ESPI.
<b>Group</b>	Search and Mark
<b>Syntax</b>	SEARCH:SEARCH<x>:TRIGger:A:BUS:ESPI:VIRTUALWIRE:RESPonse:VALue <QString> SEARCH:SEARCH<x>:TRIGger:A:BUS:ESPI:VIRTUALWIRE:RESPonse:VALue?
<b>Arguments</b>	<QString> is the identifier value. The default value is XXXXXXXX.
<b>Examples</b>	SEARCH:SEARCH1:TRIGGER:A:BUS:ESPI:RESPonse:VALue "01111011" sets the tag value as "01111011".  SEARCH:SEARCH1:TRIGGER:A:BUS:ESPI:RESPonse:VALue? might return :SEARCH:SEARCH1:TRIGGER:A:BUS:ESPI:RESPonse:VALue "01111011", indicating that the tag value is "01111011".

## SEARCH:SEARCH<x>:TRIGger:A:BUS:ETHERCAT:ADDRESSMODE

This command sets or queries the Address Mode in EtherCAT bus. The search number is specified by x.

<b>Conditions</b>	Requires option SR-ETHERCAT.
<b>Group</b>	Search and Mark
<b>Syntax</b>	SEARCH:SEARCH<x>:TRIGger:A:BUS:ETHERCAT:ADDRESSMODE {DEViCe LOGiCaL} SEARCH:SEARCH<x>:TRIGger:A:BUS:ETHERCAT:ADDRESSMODE?
<b>Arguments</b>	DEViCe sets the Address Mode to Device. This is the default value. LOGiCaL sets the Address Mode to Logical.

**Examples**     `SEARCH:SEARCH1:TRIGGER:A:BUS:ETHERCAT:ADDRESSMODE LOGical` sets the Address Mode to Logical.

`SEARCH:SEARCH1:TRIGGER:A:BUS:ETHERCAT:ADDRESSMODE?` might return `:SEARCH:SEARCH1:TRIGGER:A:BUS:ETHERCAT:ADDRESSMODE LOGical`, indicating the Address Mode is Logical.

## **SEARCH:SEARCH<x>:TRIGger:A:BUS:ETHERCAT:CNTNV:VALue**

This command sets the binary Network Variable Count to be used for EtherCAT bus. The search number is specified by x.

**Conditions**     Requires option SR-ETHERCAT.

**Group**           Search and Mark

**Syntax**         `SEARCH:SEARCH<x>:TRIGger:A:BUS:ETHERCAT:CNTNV:VALue`  
                  `<Qstring>`  
                  `SEARCH:SEARCH<x>:TRIGger:A:BUS:ETHERCAT:CNTNV:VALue?`

**Arguments**     `<Qstring>` is the binary Network Variable Count to be used when searching on an EtherCAT bus signal. The default size and value of Network Variable Count is 16 bits and "XXXXXXXX XXXXXXXX" respectively.

**Examples**     `SEARCH:SEARCH1:TRIGGER:A:BUS:ETHERCAT:CNTNV:VALue`  
                  `"1100110011001100"` sets the Network Variable Count value as  
                  `"1100110011001100"`.

`SEARCH:SEARCH1:TRIGGER:A:BUS:ETHERCAT:CNTNV:VALue?` might  
return `:SEARCH:SEARCH1:TRIGGER:A:BUS:ETHERCAT:CNTNV:VALue`  
`"1100110011001100"`, indicating the Network Variable Count value is  
`"1100110011001100"`.

## **SEARCH:SEARCH<x>:TRIGger:A:BUS:ETHERCAT:COMMANDTYPe**

This command sets or queries the Command Type in EtherCAT bus. The search number is specified by x.

**Conditions**     Requires option SR-ETHERCAT.

**Group**           Search and Mark

**Syntax** SEARCH:SEARCH<x>:TRIGger:A:BUS:ETHERCAT:COMMANDTYPE {NOP|APRD|APWR|APRW|FPRD|FPWR|FPRW|BRD|BWR|BRW|LRD|LWR|LRW|ARMW|FRMW|REServed}  
SEARCH:SEARCH<x>:TRIGger:A:BUS:ETHERCAT:COMMANDTYPE?

**Arguments** NOP specifies the Command Type and sets it to NOP. This is the default value.  
APRD specifies the Command Type and sets it to APRD.  
APWR specifies the Command Type and sets it to APWR.  
APRW specifies the Command Type and sets it to APRW.  
FPRD specifies the Command Type and sets it to FPRD.  
FPWR specifies the Command Type and sets it to FPWR.  
FPRW specifies the Command Type and sets it to FPRW.  
BRD specifies the Command Type and sets it to BRD.  
BWR specifies the Command Type and sets it to BWR.  
BRW specifies the Command Type and sets it to BRW.  
LRD specifies the Command Type and sets it to LRD.  
LWR specifies the Command Type and sets it to LWR.  
LRW specifies the Command Type and sets it to LRW.  
ARMW specifies the Command Type and sets it to ARMW.  
FRMW specifies the Command Type and sets it to FRMW.  
REServed specifies the Command Type and sets it to REServed.

**Examples** SEARCH:SEARCH1:TRIGGER:A:BUS:ETHERCAT:COMMANDTYPE APRD specifies the Command Type and sets it to APRD.  
SEARCH:SEARCH1:TRIGGER:A:BUS:ETHERCAT:COMMANDTYPE? might return :SEARCH:SEARCH1:TRIGGER:A:BUS:ETHERCAT:COMMANDTYPE APRD, indicating the Command Type is APRD.

## SEARCH:SEARCH<x>:TRIGger:A:BUS:ETHERCAT:CONDition

This command sets or queries the trigger condition for a EtherCAT bus. The search number is specified by x.

**Conditions** Requires option SR-ETHERCAT.

<b>Group</b>	Search and Mark
<b>Syntax</b>	<pre>SEARCH:SEARCH&lt;x&gt;:TRIGGER:A:BUS:ETHERCAT:CONDition {SOF  PROTOcol  IPHEAdEr  UDPIPHEAdEr  MACAdDRESS  TCI  ECATHEAdERLENGth  DATAgAm  NETWORKVARIAbLe  MAILBOX  FCSERRor  EOF} SEARCH:SEARCH&lt;x&gt;:TRIGGER:A:BUS:ETHERCAT:CONDition?</pre>
<b>Arguments</b>	<p>SOF specifies the field within a EtherCAT frame to search on as SOF. This is the default value.</p> <p>PROTOcol specifies the field within a EtherCAT frame to search on as PROTOcol.</p> <p>IPHEAdEr specifies the field within a EtherCAT frame to search on as IPHEAdEr.</p> <p>UDPIPHEAdEr specifies the field within a EtherCAT frame to search on as UDPIPHEAdEr.</p> <p>MACAdDRESS specifies the field within a EtherCAT frame to search on as MACAdDRESS.</p> <p>TCI specifies the field within a EtherCAT frame to search on as TCI.</p> <p>ECATHEAdERLENGth specifies the field within a EtherCAT frame to search on as ECATHEAdERLENGth.</p> <p>DATAgAm specifies the field within a EtherCAT frame to search on as DATAgAm.</p> <p>NETWORKVARIAbLe specifies the field within a EtherCAT frame to search on as NETWORKVARIAbLe.</p> <p>MAILBOX specifies the field within a EtherCAT frame to search on as MAILBOX.</p> <p>FCSERRor specifies the field within a EtherCAT frame to search on as FCSERRor.</p> <p>EOF specifies the field within a EtherCAT frame to search on as EOF.</p>
<b>Examples</b>	<pre>SEARCH:SEARCH1:TRIGGER:A:BUS:ETHERCAT:CONDition TCI specifies TCI as the field within a EtherCAT frame to search on.</pre> <p>SEARCH:SEARCH1:TRIGGER:A:BUS:ETHERCAT:CONDition? might return :SEARCH:SEARCH1:TRIGGER:A:BUS:ETHERCAT:CONDition TCI, indicating TCI is the currently specified field within a EtherCAT frame to search on.</p>

## SEARCH:SEARCH<x>:TRIGger:A:BUS:ETHERCAT:CYC:VALue

This command sets the binary Cycle Number to be used for EtherCAT bus. The search number is specified by x.

<b>Conditions</b>	Requires option SR-ETHERCAT.
<b>Group</b>	Search and Mark
<b>Syntax</b>	SEARCH:SEARCH<x>:TRIGger:A:BUS:ETHERCAT:CYC:VALue <QString> SEARCH:SEARCH<x>:TRIGger:A:BUS:ETHERCAT:CYC:VALue?
<b>Arguments</b>	<QString> is the binary Cycle Number to be used when searching on an EtherCAT bus signal. The default size and value of Network Variable Count is 16 bits and "XXXXXXXX XXXXXXXX" respectively.
<b>Examples</b>	SEARCH:SEARCH1:TRIGGER:A:BUS:ETHERCAT:CYC:VALue "1100110011001100" sets the Cycle Number value as "1100110011001100".  SEARCH:SEARCH1:TRIGGER:A:BUS:ETHERCAT:CYC:VALue? might return :SEARCH:SEARCH1:TRIGGER:A:BUS:ETHERCAT:CYC:VALue "1100110011001100", indicating the Cycle Number value is "1100110011001100".

## SEARCH:SEARCH<x>:TRIGger:A:BUS:ETHERCAT:DATA:SIZE

This command specifies the length of the data string in bytes to be used for EtherCAT bus. The search number is specified by x.

<b>Conditions</b>	Requires option SR-ETHERCAT.
<b>Group</b>	Search and Mark
<b>Syntax</b>	SEARCH:SEARCH<x>:TRIGger:A:BUS:ETHERCAT:DATA:SIZE <NR1> SEARCH:SEARCH<x>:TRIGger:A:BUS:ETHERCAT:DATA:SIZE?
<b>Arguments</b>	<NR1> is the binary data value to be used when searching on an Ethernet bus signal. The default size is 1. The valid range is 1 to 5.
<b>Examples</b>	SEARCH:SEARCH1:TRIGGER:A:BUS:ETHERCAT:DATA:SIZE 4 sets the data size value as 4.  SEARCH:SEARCH1:TRIGGER:A:BUS:ETHERCAT:DATA:SIZE? might return :SEARCH:SEARCH1:TRIGGER:A:BUS:ETHERCAT:DATA:SIZE 4, indicating the data size value is 4.

## SEARCH:SEARCH<x>:TRIGger:A:BUS:ETHERCAT:DATA:VALue

This command specifies the binary data string used for EtherCAT bus. The search number is specified by x.

<b>Conditions</b>	Requires option SR-ETHERCAT.
<b>Group</b>	Search and Mark
<b>Syntax</b>	SEARCH:SEARCH<x>:TRIGger:A:BUS:ETHERCAT:DATA:VALue <QString> SEARCH:SEARCH<x>:TRIGger:A:BUS:ETHERCAT:DATA:VALue?
<b>Arguments</b>	<QString> is the binary Cycle Number to be used when searching on an EtherCAT bus signal. The default data size and value is 8 bits and "XXXXXXXX" respectively.
<b>Examples</b>	SEARCH:SEARCH1:TRIGGER:A:BUS:ETHERCAT:DATA:VALue "00001111" sets the data value to "00001111".  SEARCH:SEARCH1:TRIGGER:A:BUS:ETHERCAT:DATA:VALue? might return :SEARCH:SEARCH1:TRIGGER:A:BUS:ETHERCAT:DATA:VALue "00001111", indicating the data value is "00001111".

## SEARCH:SEARCH<x>:TRIGger:A:BUS:ETHERCAT:DATAGRAM

This command sets or queries the Datagram fields in EtherCAT bus. The search number is specified by x.

<b>Conditions</b>	Requires option SR-ETHERCAT.
<b>Group</b>	Search and Mark
<b>Syntax</b>	SEARCH:SEARCH<x>:TRIGger:A:BUS:ETHERCAT:DATAGRAM {HEADer DATA WKC} SEARCH:SEARCH<x>:TRIGger:A:BUS:ETHERCAT:DATAGRAM?
<b>Arguments</b>	HEADer specifies the Datagram field and sets it to Header. This is the default value.  DATA specifies the Datagram field and sets it to Data.  WKC specifies the Datagram field and sets it to WKC.



**Examples**     `SEARCH:SEARCH1:TRIGGER:A:BUS:ETHERCAT:DATAGRAM DATA` specifies the Datagram field and sets it to Data.

`SEARCH:SEARCH1:TRIGGER:A:BUS:ETHERCAT:DATAGRAM?` might return `:SEARCH:SEARCH1:TRIGGER:A:BUS:ETHERCAT:DATAGRAM DATA`, indicating the Datagram field is Data.

## **SEARCH:SEARCH<x>:TRIGger:A:BUS:ETHERCAT:DATAGRAMHEADer**

This command sets or queries the Datagram Header fields in EtherCAT bus. The search number is specified by x.

**Conditions**     Requires option SR-ETHERCAT.

**Group**     Search and Mark

**Syntax**     `SEARCH:SEARCH<x>:TRIGger:A:BUS:ETHERCAT:DATAGRAMHEADer {CMD|IDX|ADDRESS|LEN|CIRCulating|IRQ}`  
`SEARCH:SEARCH<x>:TRIGger:A:BUS:ETHERCAT:DATAGRAMHEADer?`

**Arguments**     `CMD` specifies the Datagram Header field as `CMD`. This is the default value.  
`IDX` specifies the Datagram Header field as `IDX`.  
`ADDRESS` specifies the Datagram Header field as `ADDRESS`.  
`LEN` specifies the Datagram Header field as `LEN`.  
`CIRCulating` specifies the Datagram Header field as `CIRCulating`.  
`IRQ` specifies the Datagram Header field as `IRQ`.

**Examples**     `SEARCH:SEARCH1:TRIGGER:A:BUS:ETHERCAT:DATAGRAMHEADer LEN` specifies the Datagram Header field and sets it to `LEN`.

`SEARCH:SEARCH1:TRIGGER:A:BUS:ETHERCAT:DATAGRAMHEADer?` might return `:SEARCH:SEARCH1:TRIGGER:A:BUS:ETHERCAT:DATAGRAMHEADer LEN`, indicating the Datagram Header field is `LEN`.

## **SEARCH:SEARCH<x>:TRIGger:A:BUS:ETHERCAT:DATAGRAMHEADer:LENGth**

This command sets the binary Datagram length information to be used for EtherCAT bus. The search number is specified by x.

<b>Conditions</b>	Requires option SR-ETHERCAT.
<b>Group</b>	Search and Mark
<b>Syntax</b>	SEARCH:SEARCH<x>:TRIGger:A:BUS:ETHERCAT:DATAGRAMHEADer:LENGTH <QString> SEARCH:SEARCH<x>:TRIGger:A:BUS:ETHERCAT:DATAGRAMHEADer:LENGTH?
<b>Arguments</b>	<QString> is the binary Datagram length information to be used when searching on an EtherCAT bus signal. The default size and value Datagram length information is 11 bits and "XXXXXXXX XXX" respectively.
<b>Examples</b>	SEARCH:SEARCH1:TRIGGER:A:BUS:ETHERCAT:DATAGRAMHEADer:LENGTH "11001100110" sets the data value to "11001100110".  SEARCH:SEARCH1:TRIGGER:A:BUS:ETHERCAT:DATAGRAMHEADer:LENGTH? might return :SEARCH:SEARCH1:TRIGGER:A:BUS:ETHERCAT:DATAGRAMHEADer:LENGTH "11001100110", indicating the data value is "11001100110".

## SEARCH:SEARCH<x>:TRIGger:A:BUS:ETHERCAT:DESTINATIONADDRess:VALue

This command sets the binary MAC destination address value to be used for EtherCAT bus. The search number is specified by x.

<b>Conditions</b>	Requires option SR-ETHERCAT.
<b>Group</b>	Search and Mark
<b>Syntax</b>	SEARCH:SEARCH<x>:TRIGger:A:BUS:ETHERCAT:DESTINATIONADDRess:VALue <QString> SEARCH:SEARCH<x>:TRIGger:A:BUS:ETHERCAT:DESTINATIONADDRess:VALue?
<b>Arguments</b>	<QString> is the binary MAC destination address value to be used when searching on an EtherCAT bus signal. The default size and value of MAC Destination Address is 48 bits and "XXXXXXXX XXXXXXXXXXX XXXXXXXXXXX XXXXXXXXXXX XXXXXXXXXXX XXXXXXXXXXX" respectively.

**Examples**    `SEARCH:SEARCH1:TRIGGER:A:BUS:ETHERCAT:DESTINATIONADDRESS:VALUE`  
`"100000001000000010000000100000001000000010000000"`  
 sets the MAC destination address value to  
`"100000001000000010000000100000001000000010000000"`.

`SEARCH:SEARCH1:TRIGGER:A:BUS:ETHERCAT:DESTINATIONADDRESS:VALUE?`  
 might return  
`:SEARCH:SEARCH1:TRIGGER:A:BUS:ETHERCAT:DESTINATIONADDRESS:VALUE`  
`"100000001000000010000000100000001000000010000000"`,  
 indicating the MAC destination address value is  
`"100000001000000010000000100000001000000010000000"`.

## SEARCH:SEARCH<x>:TRIGger:A:BUS:ETHERCAT:DEVICEADDRess

This command sets or queries the Device Address in EtherCAT bus. The search number is specified by x.

**Conditions**    Requires option SR-ETHERCAT.

**Group**        Search and Mark

**Syntax**        `SEARCH:SEARCH<x>:TRIGger:A:BUS:ETHERCAT:DEVICEADDRESS`  
`{POSITION|OFFSET}`  
`SEARCH:SEARCH<x>:TRIGger:A:BUS:ETHERCAT:DEVICEADDRESS?`

**Arguments**    `POSITION` specifies the Device Address to position. This is the default value.  
`OFFSET` specifies the Device Address to offset.

**Examples**        `SEARCH:SEARCH1:TRIGGER:A:BUS:ETHERCAT:DEVICEADDRESS OFFSET`  
 sets the Device Address to offset.

`SEARCH:SEARCH1:TRIGGER:A:BUS:ETHERCAT:DEVICEADDRESS?` might  
 return `:SEARCH:SEARCH1:TRIGGER:A:BUS:ETHERCAT:DEVICEADDRESS`  
`OFFSET`, indicating the Device Address is offset.

## SEARCH:SEARCH<x>:TRIGger:A:BUS:ETHERCAT:ERRor:REPLy:SERVice:DATA

This command sets or queries the error reply service data fields in EtherCAT bus. The search number is specified by x.

**Conditions**    Requires option SR-ETHERCAT.

<b>Group</b>	Search and Mark
<b>Syntax</b>	SEARCH:SEARCH<x>:TRIGger:A:BUS:ETHERCAT:ERROR:REPLY:SERvice:DATA {TYPE DETAil} SEARCH:SEARCH<x>:TRIGger:A:BUS:ETHERCAT:ERROR:REPLY:SERvice:DATA?
<b>Arguments</b>	TYPE specifies the Error Reply Service Data to type. This is the default value. DETAil specifies the Error Reply Service Data to detail.
<b>Examples</b>	SEARCH:SEARCH1:TRIGGER:A:BUS:ETHERCAT:ERROR:REPLY:SERvice:DATA DETAil sets the Error Reply Service Data to detail.  SEARCH:SEARCH1:TRIGGER:A:BUS:ETHERCAT:ERROR:REPLY:SERvice:DATA? might return :SEARCH:SEARCH1:TRIGGER:A:BUS:ETHERCAT:ERROR:REPLY:SERvice:DATA DETAil, indicating the Error Reply Service Data is detail.

## SEARCH:SEARCH<x>:TRIGger:A:BUS:ETHERCAT:FRAMETYPe

This command sets or queries the Frame Type in EtherCAT bus. The search number is specified by x.

<b>Conditions</b>	Requires option SR-ETHERCAT.
<b>Group</b>	Search and Mark
<b>Syntax</b>	SEARCH:SEARCH<x>:TRIGger:A:BUS:ETHERCAT:FRAMETYPe {BASiC UDPIP} SEARCH:SEARCH<x>:TRIGger:A:BUS:ETHERCAT:FRAMETYPe?
<b>Arguments</b>	BASiC specifies the Frame Type as BASiC. This is the default value. UDPIP specifies the Frame Type as UDPIP.
<b>Examples</b>	SEARCH:SEARCH1:TRIGGER:A:BUS:ETHERCAT:FRAMETYPe UDPIP specifies the Frame Type and sets it to UDPIP.  SEARCH:SEARCH1:TRIGGER:A:BUS:ETHERCAT:FRAMETYPe? might return :SEARCH:SEARCH1:TRIGGER:A:BUS:ETHERCAT:FRAMETYPe UDPIP, indicating the Frame Type is UDPIP.

**SEARCH:SEARCH<x>:TRIGger:A:BUS:ETHERCAT:HASH:VALue**

This command sets the binary HASH to be used for EtherCAT bus. The search number is specified by x.

<b>Conditions</b>	Requires option SR-ETHERCAT.
<b>Group</b>	Search and Mark
<b>Syntax</b>	SEARCH:SEARCH<x>:TRIGger:A:BUS:ETHERCAT:HASH:VALue <QString> SEARCH:SEARCH<x>:TRIGger:A:BUS:ETHERCAT:HASH:VALue?
<b>Arguments</b>	<QString> is the binary Hash value to be used when searching on an EtherCAT bus signal. The default size and value of Hash is 16 bits and "XXXXXXXXXXXXXXXXXX" respectively.
<b>Examples</b>	SEARCH:SEARCH1:TRIGGER:A:BUS:ETHERCAT:HASH:VALue "1100110011001100" sets the Hash value to "1100110011001100".  SEARCH:SEARCH1:TRIGGER:A:BUS:ETHERCAT:HASH:VALue? might return :SEARCH:SEARCH1:TRIGGER:A:BUS:ETHERCAT:HASH:VALue "1100110011001100", indicating the Hash value is "1100110011001100".

**SEARCH:SEARCH<x>:TRIGger:A:BUS:ETHERCAT:HEADer:LENGth**

This command sets or queries the binary header length to be used for EtherCAT bus. The search number is specified by x.

<b>Conditions</b>	Requires option SR-ETHERCAT.
<b>Group</b>	Search and Mark
<b>Syntax</b>	SEARCH:SEARCH<x>:TRIGger:A:BUS:ETHERCAT:HEADer:LENGth <QString> SEARCH:SEARCH<x>:TRIGger:A:BUS:ETHERCAT:HEADer:LENGth?
<b>Arguments</b>	<QString> is the binary header length to be used when searching on an EtherCAT bus signal. The default size and value of Length is 11 bits and "XXXXXXXXXX" respectively.

**Examples**     `SEARCH:SEARCH1:TRIGGER:A:BUS:ETHERCAT:HEADER:LENGTH`  
"00011100" specifies the binary Length to be used for EtherCAT triggering if the trigger condition is EtherCAT Header Length and sets it to "XXX00011100".

`SEARCH:SEARCH1:TRIGGER:A:BUS:ETHERCAT:HEADER:LENGTH?` might return `:SEARCH:SEARCH1:TRIGGER:A:BUS:ETHERCAT:HEADER:LENGTH` "00011100", indicating the value of the Length is "XXX00011100".

## **SEARCH:SEARCH<x>:TRIGger:A:BUS:ETHERCAT:IDENTification:VALue**

This command sets the IP Identification to be used for EtherCAT bus. The search number is specified by x.

**Conditions**     Requires option SR-ETHERCAT.

**Group**            Search and Mark

**Syntax**           `SEARCH:SEARCH<x>:TRIGger:A:BUS:ETHERCAT:IDENTification:VALue`  
`<QString>`  
`SEARCH:SEARCH<x>:TRIGger:A:BUS:ETHERCAT:IDENTification:`  
`VALue?`

**Arguments**      `<QString>` is the binary IP Identification to be used when searching on an EtherCAT bus signal. The default size and value of Identification is 16 bits and "XXXXXXXX XXXXXXXX" respectively.

**Examples**        `SEARCH:SEARCH1:TRIGGER:A:BUS:ETHERCAT:IDENTification:VALue`  
"0101101001011010" specifies the binary Identification to be used for EtherCAT triggering if the trigger condition is IP Header and sets it to "0101101001011010".

`SEARCH:SEARCH1:TRIGGER:A:BUS:ETHERCAT:IDENTification:VALue?`  
might return  
`:SEARCH:SEARCH1:TRIGGER:A:BUS:ETHERCAT:IDENTification:VALue`  
"0101101001011010", indicating the Identification value is  
"0101101001011010".

## **SEARCH:SEARCH<x>:TRIGger:A:BUS:ETHERCAT:IDX:VALue**

This command sets the binary Indexing information to be used for EtherCAT bus. The search number is specified by x.

<b>Conditions</b>	Requires option SR-ETHERCAT.
<b>Group</b>	Search and Mark
<b>Syntax</b>	SEARCH:SEARCH<x>:TRIGger:A:BUS:ETHERCAT:IDX:VALue <QString> SEARCH:SEARCH<x>:TRIGger:A:BUS:ETHERCAT:IDX:VALue?
<b>Arguments</b>	<QString> is the binary Index value to be used when searching on an EtherCAT bus signal. The default size and value of Index is 8 bits and "XXXXXXXX" respectively.
<b>Examples</b>	SEARCH:SEARCH1:TRIGGER:A:BUS:ETHERCAT:IDX:VALue "00010001" sets the Index value as "00010001".  SEARCH:SEARCH1:TRIGGER:A:BUS:ETHERCAT:IDX:VALue? might return :SEARCH:SEARCH1:TRIGGER:A:BUS:ETHERCAT:IDX:VALue "00010001", indicating the Index value is "00010001".

## SEARCH:SEARCH<x>:TRIGger:A:BUS:ETHERCAT:INDEX:VALue

This command sets the binary Index to be used for EtherCAT bus. The search number is specified by x.

<b>Conditions</b>	Requires option SR-ETHERCAT.
<b>Group</b>	Search and Mark
<b>Syntax</b>	SEARCH:SEARCH<x>:TRIGger:A:BUS:ETHERCAT:INDEX:VALue <QString> SEARCH:SEARCH<x>:TRIGger:A:BUS:ETHERCAT:INDEX:VALue?
<b>Arguments</b>	<QString> is the binary Index to be used when searching on an EtherCAT bus signal. The default size and value of Index is 16 bits and "XXXXXXXXXXXXXXXX" respectively.
<b>Examples</b>	SEARCH:SEARCH1:TRIGGER:A:BUS:ETHERCAT:INDEX:VALue "1100110011001100" sets the Index value as "1100110011001100".  SEARCH:SEARCH1:TRIGGER:A:BUS:ETHERCAT:INDEX:VALue? might return :SEARCH:SEARCH1:TRIGGER:A:BUS:ETHERCAT:INDEX:VALue "1100110011001100", indicating the Index value is "1100110011001100".

## SEARCH:SEARCH<x>:TRIGger:A:BUS:ETHERCAT:IPDESTination:ADDRess:VALue

This command sets the Destination IP Address to be used for EtherCAT bus. The search number is specified by x.

<b>Conditions</b>	Requires option SR-ETHERCAT.
<b>Group</b>	Search and Mark
<b>Syntax</b>	SEARCH:SEARCH<x>:TRIGger:A:BUS:ETHERCAT:IPDESTination:ADDRess:VALue <QString> SEARCH:SEARCH<x>:TRIGger:A:BUS:ETHERCAT:IPDESTination:ADDRess:VALue?
<b>Arguments</b>	<QString> is the binary Destination IP Address to be used when searching on an EtherCAT bus signal. The default size and value of Destination Address is 32 bits and "XXXXXXXX XXXXXXXX XXXXXXXX XXXXXXXX"
<b>Examples</b>	SEARCH:SEARCH1:TRIGGER:A:BUS:ETHERCAT:IPDESTination:ADDRess:VALue "01011010010110100101101001011010" specifies the binary Destination IP Address to be used for EtherCAT triggering if the trigger condition is IP Header and sets it to "01011010010110100101101001011010".  SEARCH:SEARCH1:TRIGGER:A:BUS:ETHERCAT:IPDESTination:ADDRess:VALue? might return :SEARCH:SEARCH1:TRIGGER:A:BUS:ETHERCAT:IPDESTination:ADDRess:VALue "01011010010110100101101001011010", indicating the Destination IP Address value is "01011010010110100101101001011010".

## SEARCH:SEARCH<x>:TRIGger:A:BUS:ETHERCAT:IPSOURce:ADDRess:VALue

This command sets the Source IP Address to be used for EtherCAT bus. The search number is specified by x.

<b>Conditions</b>	Requires option SR-ETHERCAT.
<b>Group</b>	Search and Mark
<b>Syntax</b>	SEARCH:SEARCH<x>:TRIGger:A:BUS:ETHERCAT:IPSOURce:ADDRess:VALue <QString> SEARCH:SEARCH<x>:TRIGger:A:BUS:ETHERCAT:IPSOURce:ADDRess:VALue?



**Arguments** <QString> is the binary Source IP Address to be used when searching on an EtherCAT bus signal. The default size and value of Source Address is 32 bits and "XXXXXXXX XXXXXXXX XXXXXXXX XXXXXXXX"

**Examples** SEARCH:SEARCH1:TRIGGER:A:BUS:ETHERCAT:IPSource:ADDRESS:VALUE "01011010010110100101101001011010" specifies the binary Source IP Address to be used for EtherCAT triggering if the trigger condition is IP Header and sets it to "01011010010110100101101001011010".

SEARCH:SEARCH1:TRIGGER:A:BUS:ETHERCAT:IPSource:ADDRESS:VALUE? might return :SEARCH:SEARCH1:TRIGGER:A:BUS:ETHERCAT:IPSource:ADDRESS:VALUE "01011010010110100101101001011010", indicating the Source IP Address is "01011010010110100101101001011010".

## SEARCH:SEARCH<x>:TRIGGER:A:BUS:ETHERCAT:IRQ:VALUE

This command sets the binary interrupt request information to be used for EtherCAT bus. The search number is specified by x.

**Conditions** Requires option SR-ETHERCAT.

**Group** Search and Mark

**Syntax** SEARCH:SEARCH<x>:TRIGGER:A:BUS:ETHERCAT:IRQ:VALUE <QString>  
SEARCH:SEARCH<x>:TRIGGER:A:BUS:ETHERCAT:IRQ:VALUE?

**Arguments** <QString> is the binary interrupt request information to be used when searching on an EtherCAT bus signal. The default size and value interrupt request information is 16 bits and "XXXXXXXX XXXXXXXX" respectively.

**Examples** SEARCH:SEARCH1:TRIGGER:A:BUS:ETHERCAT:IRQ:VALUE "1100110011001100" sets the interrupt request information value as "1100110011001100".

SEARCH:SEARCH1:TRIGGER:A:BUS:ETHERCAT:IRQ:VALUE? might return :SEARCH:SEARCH1:TRIGGER:A:BUS:ETHERCAT:IRQ:VALUE "1100110011001100", indicating the interrupt request information value is "1100110011001100".

## SEARCH:SEARCH<x>:TRIGger:A:BUS:ETHERCAT:LEN:VALue

This command sets the binary Length to be used for EtherCAT bus. The search number is specified by x.

<b>Conditions</b>	Requires option SR-ETHERCAT.
<b>Group</b>	Search and Mark
<b>Syntax</b>	SEARCH:SEARCH<x>:TRIGger:A:BUS:ETHERCAT:LEN:VALue <QString> SEARCH:SEARCH<x>:TRIGger:A:BUS:ETHERCAT:LEN:VALue?
<b>Arguments</b>	<QString> is the binary Length to be used when searching on an EtherCAT bus signal. The default size and value of Length is 16 bits and "XXXXXXXXXXXXXXXX" respectively.
<b>Examples</b>	SEARCH:SEARCH1:TRIGGER:A:BUS:ETHERCAT:LEN:VALue "1100110011001100" sets the Length value as "1100110011001100".  SEARCH:SEARCH1:TRIGGER:A:BUS:ETHERCAT:LEN:VALue? might return :SEARCH:SEARCH1:TRIGGER:A:BUS:ETHERCAT:LEN:VALue "1100110011001100", indicating the Length value is "1100110011001100".

## SEARCH:SEARCH<x>:TRIGger:A:BUS:ETHERCAT:LOGICALADDRess:VALue

This command sets the binary logical address information to be used for EtherCAT bus. The search number is specified by x.

<b>Conditions</b>	Requires option SR-ETHERCAT.
<b>Group</b>	Search and Mark
<b>Syntax</b>	SEARCH:SEARCH<x>:TRIGger:A:BUS:ETHERCAT:LOGICALADDRess:VALue <QString> SEARCH:SEARCH<x>:TRIGger:A:BUS:ETHERCAT:LOGICALADDRess: VALue?
<b>Arguments</b>	<QString> is the binary Logical Address to be used when searching on an EtherCAT bus signal. The default size and value Logical Address is 32 bits and "XXXXXXXXXXXXXXXXXXXXXXXXXXXXXXXX" respectively.

**Examples**     `SEARCH:SEARCH1:TRIGGER:A:BUS:ETHERCAT:LOGICALADDRESS:VALUE "110011001100110011001100110011001100110011001100"` sets the Logical Address value as "11001100110011001100110011001100".

`SEARCH:SEARCH1:TRIGGER:A:BUS:ETHERCAT:LOGICALADDRESS:VALUE?` might return  
`:SEARCH:SEARCH1:TRIGGER:A:BUS:ETHERCAT:LOGICALADDRESS:VALUE "110011001100110011001100110011001100110011001100"`, indicating the Logical Address value is "110011001100110011001100110011001100110011001100".

## SEARCH:SEARCH<x>:TRIGger:A:BUS:ETHERCAT:MAILbox

This command sets or queries the Mailbox fields in EtherCAT bus. The search number is specified by x.

**Conditions**     Requires option SR-ETHERCAT.

**Group**     Search and Mark

**Syntax**     `SEARCH:SEARCH<x>:TRIGger:A:BUS:ETHERCAT:MAILbox {MAILBOXHEADer | SERVICEDATa | ERRSERVICEDATa}`  
`SEARCH:SEARCH<x>:TRIGger:A:BUS:ETHERCAT:MAILbox?`

**Arguments**     `MAILBOXHEADer` specifies the Mailbox fields as mailbox header. This is the default value.

`SERVICEDATa` specifies the Mailbox fields as service data.

`ERRSERVICEDATa` specifies the Mailbox fields as error reply service data.

**Examples**     `SEARCH:SEARCH1:TRIGGER:A:BUS:ETHERCAT:MAILbox ERRSERVICEDATa` sets the Mailbox field to Error Reply Service Data.

`SEARCH:SEARCH1:TRIGGER:A:BUS:ETHERCAT:MAILbox?` might return `:SEARCH:SEARCH1:TRIGGER:A:BUS:ETHERCAT:MAILbox ERRSERVICEDATa`, indicating the Mailbox field is Error Reply Service Data.

## SEARCH:SEARCH<x>:TRIGger:A:BUS:ETHERCAT:MAILbox:ADDRESS:VALUE

This command sets the binary Mailbox Address to be used for EtherCAT bus. The search number is specified by x.

**Conditions**     Requires option SR-ETHERCAT.

<b>Group</b>	Search and Mark
<b>Syntax</b>	SEARCH:SEARCH<x>:TRIGger:A:BUS:ETHERCAT:MAILbox:ADDRESS:VALUE <QString> SEARCH:SEARCH<x>:TRIGger:A:BUS:ETHERCAT:MAILbox:ADDRESS:VALUE?
<b>Arguments</b>	<QString> is the binary Mailbox Address to be used when searching on an EtherCAT bus signal. The default size and value of Address is 16 bits and "XXXXXXXX XXXXXXXX" respectively.
<b>Examples</b>	SEARCH:SEARCH1:TRIGGER:A:BUS:ETHERCAT:MAILbox:ADDRESS:VALUE "0000111100001111" sets the Mailbox Address value as "0000111100001111".  SEARCH:SEARCH1:TRIGGER:A:BUS:ETHERCAT:MAILbox:ADDRESS:VALUE? might return :SEARCH:SEARCH1:TRIGGER:A:BUS:ETHERCAT:MAILbox:ADDRESS:VALUE "0000111100001111", indicating the Mailbox Address value is "0000111100001111".

## SEARCH:SEARCH<x>:TRIGger:A:BUS:ETHERCAT:MAILbox:CNT:VALue

This command sets the binary counter of the mailbox services to be used for EtherCAT bus. The search number is specified by x.

<b>Conditions</b>	Requires option SR-ETHERCAT.
<b>Group</b>	Search and Mark
<b>Syntax</b>	SEARCH:SEARCH<x>:TRIGger:A:BUS:ETHERCAT:MAILbox:CNT:VALue <QString> SEARCH:SEARCH<x>:TRIGger:A:BUS:ETHERCAT:MAILbox:CNT:VALue?
<b>Arguments</b>	<QString> is the binary Counter value to be used when searching on an EtherCAT bus signal. The default size and value of Counter is 3 bits and "XXX" respectively.
<b>Examples</b>	SEARCH:SEARCH1:TRIGGER:A:BUS:ETHERCAT:MAILbox:CNT:VALue "011" sets the Counter value as "011".  SEARCH:SEARCH1:TRIGGER:A:BUS:ETHERCAT:MAILbox:CNT:VALue? might return

:SEARCH:SEARCH1:TRIGGER:A:BUS:ETHERCAT:MAILbox:CNT:VALUE  
"011", indicating the Counter value is "011".

## SEARCH:SEARCH<x>:TRIGger:A:BUS:ETHERCAT:MAILbox:DETail

This command sets or queries the Error Reply Service Data Details in EtherCAT bus. The search number is specified by x.

<b>Conditions</b>	Requires option SR-ETHERCAT.
<b>Group</b>	Search and Mark
<b>Syntax</b>	SEARCH:SEARCH<x>:TRIGger:A:BUS:ETHERCAT:MAILbox:DETail {ONE  TWO THRee FOUR FIVE SIX SEVEN EIGHt NINE} SEARCH:SEARCH<x>:TRIGger:A:BUS:ETHERCAT:MAILbox:DETail?
<b>Arguments</b>	ONE specifies the Detail field as ONE. This is the default value. TWO specifies the Detail field as TWO. THRee specifies the Detail field as THRee. FOUR specifies the Detail field as FOUR. FIVE specifies the Detail field as FIVE. SIX specifies the Detail field as SIX. SEVEN specifies the Detail field as SEVEN. EIGHt specifies the Detail field as EIGHt. NINE specifies the Detail field as NINE.
<b>Examples</b>	SEARCH:SEARCH1:TRIGGER:A:BUS:ETHERCAT:MAILbox:DETail TWO sets the Detail field to TWO.  SEARCH:SEARCH1:TRIGGER:A:BUS:ETHERCAT:MAILbox:DETail? might return :SEARCH:SEARCH1:TRIGGER:A:BUS:ETHERCAT:MAILbox:DETail TWO, indicating the Detail field is TWO.

## SEARCH:SEARCH<x>:TRIGger:A:BUS:ETHERCAT:MAILbox:HEADer

This command sets or queries the Mailbox Header fields in EtherCAT bus. The search number is specified by x.

<b>Conditions</b>	Requires option SR-ETHERCAT.
<b>Group</b>	Search and Mark
<b>Syntax</b>	SEARCH:SEARCH<x>:TRIGger:A:BUS:ETHERCAT:MAILbox:HEADer {LENGTH  ADDRESS  CHANnel  PRIority  TYPE  CNT} SEARCH:SEARCH<x>:TRIGger:A:BUS:ETHERCAT:MAILbox:HEADer?
<b>Arguments</b>	LENGTH specifies the Mailbox Header as Length. This is the default value. ADDRESS specifies the Mailbox Header as Address. CHANnel specifies the Mailbox Header as Channel. PRIority specifies the Mailbox Header as Priority. TYPE specifies the Mailbox Header as Type. CNT specifies the Mailbox Header as Count.
<b>Examples</b>	SEARCH:SEARCH1:TRIGGER:A:BUS:ETHERCAT:MAILbox:HEADer TYPE sets the Mailbox Header to Type.  SEARCH:SEARCH1:TRIGGER:A:BUS:ETHERCAT:MAILbox:HEADer? might return :SEARCH:SEARCH1:TRIGGER:A:BUS:ETHERCAT:MAILbox:HEADer TYPE, indicating the Mailbox Header is Type.

## SEARCH:SEARCH<x>:TRIGger:A:BUS:ETHERCAT:MAILBOXTYPE

This command sets or queries the Mailbox Type fields in EtherCAT bus. The search number is specified by x.

<b>Conditions</b>	Requires option SR-ETHERCAT.
<b>Group</b>	Search and Mark
<b>Syntax</b>	SEARCH:SEARCH<x>:TRIGger:A:BUS:ETHERCAT:MAILBOXTYPE {ZERO  ONE  TWO  THRee  FOUR  FIVE  RESERVED  FIFteen} SEARCH:SEARCH<x>:TRIGger:A:BUS:ETHERCAT:MAILBOXTYPE?
<b>Arguments</b>	ZERO specifies the Mailbox Type as ZERo. This is the default value. ONE specifies the Mailbox Type as ONE.

TWO specifies the Mailbox Type as TWO.

THRee specifies the Mailbox Type as THRee.

FOUR specifies the Mailbox Type as FOUR.

FIVE specifies the Mailbox Type as FIVE.

RESERVed specifies the Mailbox Type as RESERVed.

FIFTEen specifies the Mailbox Type as FIFTEen.

**Examples** SEARCH:SEARCH1:TRIGGER:A:BUS:ETHERCAT:MAILBOXTYPE FIVE sets the Mailbox Type as FIVE.

SEARCH:SEARCH1:TRIGGER:A:BUS:ETHERCAT:MAILBOXTYPE? might return :SEARCH:SEARCH1:TRIGGER:A:BUS:ETHERCAT:MAILBOXTYPE FIVE, indicating the Mailbox Type is FIVE.

## SEARCH:SEARCH<x>:TRIGger:A:BUS:ETHERCAT:NETWork:VARiable

This command sets or queries the Network Variable fields in EtherCAT bus. The search number is specified by x.

**Conditions** Requires option SR-ETHERCAT.

**Group** Search and Mark

**Syntax** SEARCH:SEARCH<x>:TRIGger:A:BUS:ETHERCAT:NETWork:VARiable  
{PUBHEADer|NVHEADer|NVDATA}  
SEARCH:SEARCH<x>:TRIGger:A:BUS:ETHERCAT:NETWork:VARiable?

**Arguments** PUBHEADer specifies the Network Variable as PUBHEADer. This is the default value.

NVHEADer specifies the Network Variable as NVHEADer.

NVDATA specifies the Network Variable as NVDATA.

**Examples** SEARCH:SEARCH1:TRIGGER:A:BUS:ETHERCAT:NETWork:VARiable NVHEADer sets the Network Variable to NV Header.

SEARCH:SEARCH1:TRIGGER:A:BUS:ETHERCAT:NETWork:VARiable? might return :SEARCH:SEARCH1:TRIGGER:A:BUS:ETHERCAT:NETWork:VARiable NVHEADer, indicating the Network Variable is NV Header.

## SEARCH:SEARCH<x>:TRIGger:A:BUS:ETHERCAT:NETWork:VARiable:HEADer

This command sets or queries the Network Variable Header fields in EtherCAT bus. The search number is specified by x.

**Conditions** Requires option SR-ETHERCAT.

**Group** Search and Mark

**Syntax** SEARCH:SEARCH<x>:TRIGger:A:BUS:ETHERCAT:NETWork:VARiable:HEADer {INDEX|HASH|NVLEN|Q}  
SEARCH:SEARCH<x>:TRIGger:A:BUS:ETHERCAT:NETWork:VARiable:HEADer?

**Arguments** INDEX specifies the Network Variable Header field as INDEX. This is the default value.

HASH specifies the Network Variable Header field as HASH.

NVLEN specifies the Network Variable Header field as NVLEN.

Q specifies the Network Variable Header field as Q.

**Examples** SEARCH:SEARCH1:TRIGGER:A:BUS:ETHERCAT:NETWork:VARiable:HEADer NVLEN sets the Network Variable Header field as NVLEN.  
  
SEARCH:SEARCH1:TRIGGER:A:BUS:ETHERCAT:NETWork:VARiable:HEADer? might return  
:SEARCH:SEARCH1:TRIGGER:A:BUS:ETHERCAT:NETWork:VARiable:HEADer NVLEN, indicating the Network Variable Header field as NVLEN.

## SEARCH:SEARCH<x>:TRIGger:A:BUS:ETHERCAT:NETWORKVARiable:DATA:SIZE

This command specifies the length of the network variable data string in bytes to be used for EtherCAT bus. The search number is specified by x.

**Conditions** Requires option SR-ETHERCAT.

**Group** Search and Mark

**Syntax** SEARCH:SEARCH<x>:TRIGger:A:BUS:ETHERCAT:NETWORKVARiable:DATA:SIZE <NR1>



SEARCH:SEARCH<x>:TRIGGER:A:BUS:ETHERCAT:NETWORKVARIABLE:DATA:SIZE?

**Arguments** <NR1> is the Network Variable Data size. The default value is 1. The valid range is 1 to 5.

**Examples** SEARCH:SEARCH1:TRIGGER:A:BUS:ETHERCAT:NETWORKVARIABLE:DATA:SIZE 3 sets the Network Variable Data size as 3.

SEARCH:SEARCH1:TRIGGER:A:BUS:ETHERCAT:NETWORKVARIABLE:DATA:SIZE? might return  
:SEARCH:SEARCH1:TRIGGER:A:BUS:ETHERCAT:NETWORKVARIABLE:DATA:SIZE 3, indicating the Network Variable Data size is 3.

## SEARCH:SEARCH<x>:TRIGGER:A:BUS:ETHERCAT:NETWORKVARIABLE:DATA:VALUE

This command specifies the binary network variable data string used for EtherCAT bus. The search number is specified by x.

**Conditions** Requires option SR-ETHERCAT.

**Group** Search and Mark

**Syntax** SEARCH:SEARCH<x>:TRIGGER:A:BUS:ETHERCAT:NETWORKVARIABLE:DATA:VALUE <QString>  
SEARCH:SEARCH<x>:TRIGGER:A:BUS:ETHERCAT:NETWORKVARIABLE:DATA:VALUE?

**Arguments** <QString> is the binary network variable data value to be used when searching on an EtherCAT bus signal. The default Network Variable Data value is "XXXXXXXX".

**Examples** SEARCH:SEARCH1:TRIGGER:A:BUS:ETHERCAT:NETWORKVARIABLE:DATA:VALUE "00110011" sets the Network Variable Data value to "00110011".

SEARCH:SEARCH1:TRIGGER:A:BUS:ETHERCAT:NETWORKVARIABLE:DATA:VALUE? might return  
:SEARCH:SEARCH1:TRIGGER:A:BUS:ETHERCAT:NETWORKVARIABLE:DATA:VALUE "00110011", indicating the Network Variable Data value is "00110011".

## SEARCH:SEARCH<x>:TRIGger:A:BUS:ETHERCAT:OFFSet:VALue

This command sets the binary address offset information to be used for EtherCAT bus. The search number is specified by x.

<b>Conditions</b>	Requires option SR-ETHERCAT.
<b>Group</b>	Search and Mark
<b>Syntax</b>	SEARCH:SEARCH<x>:TRIGger:A:BUS:ETHERCAT:OFFSet:VALue <QString> SEARCH:SEARCH<x>:TRIGger:A:BUS:ETHERCAT:OFFSet:VALue?
<b>Arguments</b>	<QString> is the binary Address Offset data value to be used when searching on an EtherCAT bus signal. The default size and value Address Offset is 16 bits and "XXXXXXXX XXXXXXXX" respectively.
<b>Examples</b>	SEARCH:SEARCH1:TRIGGER:A:BUS:ETHERCAT:OFFSet:VALue "1100110011001100" sets the Address Offset value to "1100110011001100".  SEARCH:SEARCH1:TRIGGER:A:BUS:ETHERCAT:OFFSet:VALue? might return :SEARCH:SEARCH1:TRIGGER:A:BUS:ETHERCAT:OFFSet:VALue "1100110011001100", indicating the Address Offset value is "1100110011001100".

## SEARCH:SEARCH<x>:TRIGger:A:BUS:ETHERCAT:POSition:VALue

This command sets the binary address position information to be used for EtherCAT bus. The search number is specified by x.

<b>Conditions</b>	Requires option SR-ETHERCAT.
<b>Group</b>	Search and Mark
<b>Syntax</b>	SEARCH:SEARCH<x>:TRIGger:A:BUS:ETHERCAT:POSition:VALue <QString> SEARCH:SEARCH<x>:TRIGger:A:BUS:ETHERCAT:POSition:VALue?
<b>Arguments</b>	<QString> is the binary Address Position value to be used when searching on an EtherCAT bus signal. The default size and value Address Position is 16 bits and "XXXXXXXX XXXXXXXX" respectively.

**Examples**     `SEARCH:SEARCH1:TRIGGER:A:BUS:ETHERCAT:POSITION:VALUE "1100110011001100"` sets the Address Position value to "1100110011001100".

`SEARCH:SEARCH1:TRIGGER:A:BUS:ETHERCAT:POSITION:VALUE?` might return `:SEARCH:SEARCH1:TRIGGER:A:BUS:ETHERCAT:POSITION:VALUE "1100110011001100"`, indicating the Address Position value is "1100110011001100".

## SEARCH:SEARCH<x>:TRIGger:A:BUS:ETHERCAT:PROTOCOLTYPE

This command sets or queries the EtherCAT Protocol Type in EtherCAT bus. The search number is specified by x.

**Conditions**     Requires option SR-ETHERCAT.

**Group**     Search and Mark

**Syntax**     `SEARCH:SEARCH<x>:TRIGger:A:BUS:ETHERCAT:PROTOCOLTYPE {PDU|NETWORKVARIABLES|MAILBOX}`  
`SEARCH:SEARCH<x>:TRIGger:A:BUS:ETHERCAT:PROTOCOLTYPE?`

**Arguments**     PDU specifies the Protocol Type as PDU. This is the default value.  
 NETWORKVARIABLES specifies the Protocol Type as NETWORKVARIABLES.  
 MAILBOX specifies the Protocol Type as MAILBOX.

**Examples**     `SEARCH:SEARCH1:TRIGGER:A:BUS:ETHERCAT:PROTOCOLTYPE MAILBOX` sets the Protocol Type as MAILBOX.

`SEARCH:SEARCH1:TRIGGER:A:BUS:ETHERCAT:PROTOCOLTYPE?` might return `:SEARCH:SEARCH1:TRIGGER:A:BUS:ETHERCAT:PROTOCOLTYPE MAILBOX`, indicating the Protocol Type as MAILBOX.

## SEARCH:SEARCH<x>:TRIGger:A:BUS:ETHERCAT:PUBID:VALUE

This command sets the binary Publisher ID to be used for EtherCAT bus. The search number is specified by x.

**Conditions**     Requires option SR-ETHERCAT.

**Group**     Search and Mark

**Syntax** SEARCH:SEARCH<x>:TRIGger:A:BUS:ETHERCAT:PUBID:VALue  
<QString>  
SEARCH:SEARCH<x>:TRIGger:A:BUS:ETHERCAT:PUBID:VALue?

**Arguments** <QString> is the binary Publisher ID value to be used when searching on an EtherCAT bus signal. The default size and value of Publisher ID is 48 bits and "XXXXXXXX XXXXXXXX XXXXXXXX XXXXXXXX XXXXXXXX XXXXXXXX XXXXXXXX" respectively.

**Examples** SEARCH:SEARCH1:TRIGGER:A:BUS:ETHERCAT:PUBID:VALue  
"11001100110011001100110011001100110011001100110011001100"  
sets the Publisher ID value to  
"11001100110011001100110011001100110011001100110011001100".  
  
SEARCH:SEARCH1:TRIGGER:A:BUS:ETHERCAT:PUBID:VALue? might  
return :SEARCH:SEARCH1:TRIGGER:A:BUS:ETHERCAT:PUBID:VALue  
"11001100110011001100110011001100110011001100110011001100",  
indicating the Publisher ID value is  
"11001100110011001100110011001100110011001100110011001100".

## SEARCH:SEARCH<x>:TRIGger:A:BUS:ETHERCAT:QUALity:VALue

This command sets the binary quality to be used for EtherCAT bus. The search number is specified by x.

**Conditions** Requires option SR-ETHERCAT.

**Group** Search and Mark

**Syntax** SEARCH:SEARCH<x>:TRIGger:A:BUS:ETHERCAT:QUALity:VALue  
<QString>  
SEARCH:SEARCH<x>:TRIGger:A:BUS:ETHERCAT:QUALity:VALue?

**Arguments** <QString> is the binary Quality value to be used when searching on an EtherCAT bus signal. The default size and value of Quality is 16 bits and "XXXXXXXX XXXXXXXX" respectively.

**Examples** SEARCH:SEARCH1:TRIGGER:A:BUS:ETHERCAT:QUALity:VALue  
"1100110011001100" sets the Quality value to "1100110011001100".  
  
SEARCH:SEARCH1:TRIGGER:A:BUS:ETHERCAT:QUALity:VALue? might  
return :SEARCH:SEARCH1:TRIGGER:A:BUS:ETHERCAT:QUALity:VALue  
"1100110011001100", indicating the Quality value is "1100110011001100".

## SEARCH:SEARCH<x>:TRIGger:A:BUS:ETHERCAT:SERVice:DATA:LENGth

This command sets the binary Service Data Length to be used for EtherCAT bus. The search number is specified by x.

<b>Conditions</b>	Requires option SR-ETHERCAT.
<b>Group</b>	Search and Mark
<b>Syntax</b>	SEARCH:SEARCH<x>:TRIGger:A:BUS:ETHERCAT:SERVice:DATA:LENGth <QString> SEARCH:SEARCH<x>:TRIGger:A:BUS:ETHERCAT:SERVice:DATA:LENGth?
<b>Arguments</b>	<QString> is the binary Service Data Length to be used when searching on an EtherCAT bus signal. The default size and value of Service Data Length is 16 bits and "XXXXXXXX XXXXXXXX" respectively.
<b>Examples</b>	SEARCH:SEARCH1:TRIGGER:A:BUS:ETHERCAT:SERVice:DATA:LENGth "0000111100001111" sets the Service Data Length to "0000111100001111".  SEARCH:SEARCH1:TRIGGER:A:BUS:ETHERCAT:SERVice:DATA:LENGth? might return :SEARCH:SEARCH1:TRIGGER:A:BUS:ETHERCAT:SERVice:DATA:LENGth "0000111100001111", indicating the Service Data Length is "0000111100001111".

## SEARCH:SEARCH<x>:TRIGger:A:BUS:ETHERCAT:SERVice:DATA:SIZE

This command specifies the length of the service data string in bytes to be used for EtherCAT bus. The search number is specified by x.

<b>Conditions</b>	Requires option SR-ETHERCAT.
<b>Group</b>	Search and Mark
<b>Syntax</b>	SEARCH:SEARCH<x>:TRIGger:A:BUS:ETHERCAT:SERVice:DATA:SIZE <NR1> SEARCH:SEARCH<x>:TRIGger:A:BUS:ETHERCAT:SERVice:DATA:SIZE?
<b>Arguments</b>	<NR1> is the Service Data size. The default value is 1. The valid range is 1 to 5.

**Examples**     `SEARCH:SEARCH1:TRIGGER:A:BUS:ETHERCAT:SERVICE:DATA:SIZE 2`  
sets the Service Data size as 2.

`SEARCH:SEARCH1:TRIGGER:A:BUS:ETHERCAT:SERVICE:DATA:SIZE?`  
might return  
`:SEARCH:SEARCH1:TRIGGER:A:BUS:ETHERCAT:SERVICE:DATA:SIZE 2,`  
indicating the Service Data size is 2.

## **SEARCH:SEARCH<x>:TRIGGER:A:BUS:ETHERCAT:SERVICE:DATA:VALUE**

This command specifies the length of the service data string in bytes to be used for EtherCAT bus. The search number is specified by x.

**Conditions**     Requires option SR-ETHERCAT.

**Group**           Search and Mark

**Syntax**          `SEARCH:SEARCH<x>:TRIGGER:A:BUS:ETHERCAT:SERVICE:DATA:VALUE`  
`<QString>`  
`SEARCH:SEARCH<x>:TRIGGER:A:BUS:ETHERCAT:SERVICE:DATA:VALUE?`

**Arguments**      `<QString>` is the binary Service Data value to be used when searching on an EtherCAT bus signal. The default size and value of Service Data is 8 bits and "XXXXXXXX" respectively.

**Examples**        `SEARCH:SEARCH1:TRIGGER:A:BUS:ETHERCAT:SERVICE:DATA:VALUE`  
`"10100110"` sets the Service Data value to "10100110".

`SEARCH:SEARCH1:TRIGGER:A:BUS:ETHERCAT:SERVICE:DATA:VALUE?`  
might return  
`:SEARCH:SEARCH1:TRIGGER:A:BUS:ETHERCAT:SERVICE:DATA:VALUE`  
`"10100110",` indicating the Service Data value is "10100110".

## **SEARCH:SEARCH<x>:TRIGGER:A:BUS:ETHERCAT:SOURCEADDRESS:VALUE**

This command sets the binary MAC source address value to be used for EtherCAT bus. The search number is specified by x.

**Conditions**      Requires option SR-ETHERCAT.

**Group**           Search and Mark

<b>Syntax</b>	SEARCH:SEARCH<x>:TRIGger:A:BUS:ETHERCAT:SOURCEADDRESS:VALue <QString> SEARCH:SEARCH<x>:TRIGger:A:BUS:ETHERCAT:SOURCEADDRESS:VALue?
<b>Arguments</b>	<QString> is the binary MAC source address value to be used when searching on an EtherCAT bus signal. The default size and value of MAC Source Address is 48 bits and "XXXXXXXX XXXXXXXX XXXXXXXX XXXXXXXX XXXXXXXX XXXXXXXX" respectively.
<b>Examples</b>	SEARCH:SEARCH1:TRIGGER:A:BUS:ETHERCAT:SOURCEADDRESS:VALue "100000001000000010000000100000001000000010000000" specifies the binary MAC source address value used for EtherCAT triggering if the trigger condition is MACADDRESS and sets it to "100000001000000010000000100000001000000010000000".  SEARCH:SEARCH1:TRIGGER:A:BUS:ETHERCAT:SOURCEADDRESS:VALue? might return :SEARCH:SEARCH1:TRIGGER:A:BUS:ETHERCAT:SOURCEADDRESS:VALue "100000001000000010000000100000001000000010000000", indicating the MAC source address value is "100000001000000010000000100000001000000010000000".

## SEARCH:SEARCH<x>:TRIGger:A:BUS:ETHERCAT:SRC:PORT:VALue

This command sets the UDP Source port to be used for EtherCAT bus. The search number is specified by x.

<b>Conditions</b>	Requires option SR-ETHERCAT.
<b>Group</b>	Search and Mark
<b>Syntax</b>	SEARCH:SEARCH<x>:TRIGger:A:BUS:ETHERCAT:SRC:PORT:VALue <QString> SEARCH:SEARCH<x>:TRIGger:A:BUS:ETHERCAT:SRC:PORT:VALue?
<b>Arguments</b>	<QString> is the binary Source Port value to be used when searching on an EtherCAT bus signal. The default size and value of Source Port is 16 bits and "XXXXXXXX XXXXXXXX" respectively.
<b>Examples</b>	SEARCH:SEARCH1:TRIGGER:A:BUS:ETHERCAT:SRC:PORT:VALue "0101101001011010" specifies the binary Source Port to be used for

EtherCAT triggering if the trigger condition is UDP Header and sets it to "0101101001011010".

SEARCH:SEARCH1:TRIGGER:A:BUS:ETHERCAT:SRC:PORT:VALue? might return :SEARCH:SEARCH1:TRIGGER:A:BUS:ETHERCAT:SRC:PORT:VALue "0101101001011010", indicating the Source Port value is "0101101001011010".

## SEARCH:SEARCH<x>:TRIGger:A:BUS:ETHERCAT:TCI:VALue

This command sets the binary Tag control Information to be used for EtherCAT bus. The search number is specified by x.

<b>Conditions</b>	Requires option SR-ETHERCAT.
<b>Group</b>	Search and Mark
<b>Syntax</b>	SEARCH:SEARCH<x>:TRIGger:A:BUS:ETHERCAT:TCI:VALue <QString> SEARCH:SEARCH<x>:TRIGger:A:BUS:ETHERCAT:TCI:VALue?
<b>Arguments</b>	<QString> is the binary TCI value to be used when searching on an EtherCAT bus signal. The default size and value of TCI is 16 bits and "XXXXXXXXXXXXXXXX" respectively.
<b>Examples</b>	SEARCH:SEARCH1:TRIGGER:A:BUS:ETHERCAT:TCI:VALue "11010010" specifies the binary Tag control Information used for EtherCAT triggering if the trigger condition is TCI and sets it to "XXXXXXXX1010010".  SEARCH:SEARCH1:TRIGGER:A:BUS:ETHERCAT:TCI:VALue? might return :SEARCH:SEARCH1:TRIGGER:A:BUS:ETHERCAT:TCI:VALue "11010010", indicating the TCI value is "XXXXXXXX1010010".

## SEARCH:SEARCH<x>:TRIGger:A:BUS:ETHERCAT:WKC:VALue

This command sets the binary Working Counter information to be used for EtherCAT bus. The search number is specified by x.

<b>Conditions</b>	Requires option SR-ETHERCAT.
<b>Group</b>	Search and Mark



<b>Syntax</b>	SEARCH:SEARCH<x>:TRIGger:A:BUS:ETHERCAT:WKC:VALue <QString> SEARCH:SEARCH<x>:TRIGger:A:BUS:ETHERCAT:WKC:VALue?
<b>Arguments</b>	<QString> is the binary Working Counter information value to be used when searching on an EtherCAT bus signal. The default size and value of Working Counter information is 16 bits and "XXXXXXXX XXXXXXXX" respectively.
<b>Examples</b>	SEARCH:SEARCH1:TRIGGER:A:BUS:ETHERCAT:WKC:VALue "1100110011001100" sets the Working Counter information value as "1100110011001100".  SEARCH:SEARCH1:TRIGGER:A:BUS:ETHERCAT:WKC:VALue? might return :SEARCH:SEARCH1:TRIGGER:A:BUS:ETHERCAT:WKC:VALue "1100110011001100", indicating the Working Counter information value is "1100110011001100".

## SEARCH:SEARCH<x>:TRIGger:A:BUS:ETHERnet:CONDition

This command specifies a field or condition for an Ethernet bus to search on. The search number is specified by x.

<b>Conditions</b>	Requires option 5-SRENET or SUP5-SRENET Triggering and Analysis application.
<b>Group</b>	Search and Mark
<b>Syntax</b>	SEARCH:SEARCH<x>:TRIGger:A:BUS:ETHERnet:CONDition {SFD MACADDRESS MACLENGTH IPHeader TCPHeader DATA EOP IDLe FCSError QTAG}  SEARCH:SEARCH<x>:TRIGger:A:BUS:ETHERnet:CONDition?
<b>Related Commands</b>	Most of the other TRIGger:A:BUS:B<x>:ETHERnet commands are impacted by the setting of this command.
<b>Arguments</b>	SFD – Start of frame delimiter.  MACADDRESS – MAC addresses field.  MACLENGTH – MAC length/type field.  IPHeader – IP header field.  TCPHeader – TCP header field.

**DATA** – TCP/IPv4 or MAC protocol client data field.

**EOP** – End of Packet field.

**IDLE** – Idle field.

**FCSError** – Frame Check Sequence Error (CRC) field.

**QTAG** – IEEE 802.1Q (VLAN) control information field.

**Examples**    `SEARCH:SEARCH1:TRIGGER:A:BUS:ETHERNET:CONDITION MACADDRESS`  
 specifies MACADDRESS as the field within an Ethernet frame to search on.

`SEARCH:SEARCH1:TRIGGER:A:BUS:ETHERNET:CONDITION?` might return DATA, indicating that DATA is the currently specified field within an Ethernet frame to search on.

## **SEARCH:SEARCH<x>:TRIGger:A:BUS:ETHERnet:DATA:HIVALue**

This command sets or queries the binary data value to be used when searching on an Ethernet bus signal. The search condition must be set to DATA and the data qualifier to inside or outside range. The search number is specified by x.

**Conditions**    Requires option 5-SRENET or SUP5-SRENET Triggering and Analysis application.

**Group**        Search and Mark

**Syntax**        `SEARCH:SEARCH<x>:TRIGger:A:BUS:ETHERnet:DATA:HIVALue`  
`<Qstring>`  
`SEARCH:SEARCH<x>:TRIGger:A:BUS:ETHERnet:DATA:HIVALue?`

**Arguments**    `<Qstring>` is the binary data value to be used when searching on an Ethernet bus signal.

**Examples**        `SEARCH:SEARCH1:TRIGger:A:BUS:ETHERnet:DATA:HIVALue "101011"`  
 sets the data HIVALue to 101011.

`SEARCH:SEARCH1:TRIGger:A:BUS:ETHERnet:DATA:HIVALue?` might return `SEARCH:SEARCH1:TRIGGER:A:BUS:ETHERNET:DATA:HIVALUE "10101"`.

## SEARCH:SEARCH<x>:TRIGger:A:BUS:ETHERnet:DATA:OFFSet

This command specifies the data offset value, in bytes, to use when searching on the Ethernet data field. The search condition needs to be set to DATA. The search number is specified by x.

**Conditions** Requires option 5-SRENET or SUP5-SRENET Triggering and Analysis application.

**Group** Search and Mark

**Syntax** SEARCH:SEARCH<x>:TRIGger:A:BUS:ETHERnet:DATA:OFFSet <NR1>  
SEARCH:SEARCH<x>:TRIGger:A:BUS:ETHERnet:DATA:OFFSet?

**Related Commands** [SEARCH:SEARCH<x>:TRIGger:A:BUS:ETHERnet:CONDition](#)  
[SEARCH:SEARCH<x>:TRIGger:A:BUS:ETHERnet:DATA:VALue](#)  
[SEARCH:SEARCH<x>:TRIGger:A:BUS:ETHERnet:DATA:SIZE](#)

**Arguments** <NR1> is an integer whose minimum and default values are -1 (don't care) and maximum is 1,499.

**Examples** SEARCH:SEARCH1:TRIGGER:A:BUS:ETHERNET:DATA:OFFSET 36 sets the data offset to 36 bytes.

SEARCH:SEARCH1:TRIGGER:A:BUS:ETHERNET:DATA:OFFSET? might return -1, indicating that the data offset value is the default value, -1, meaning "don't care".

## SEARCH:SEARCH<x>:TRIGger:A:BUS:ETHERnet:DATA:QUALifier

This command specifies the qualifier to be used when searching on an Ethernet bus signal. The search condition must be set to DATA. The search number is specified by x.

**Conditions** Requires option 5-SRENET or SUP5-SRENET Triggering and Analysis application.

**Group** Search and Mark

**Syntax** SEARCH:SEARCH<x>:TRIGger:A:BUS:ETHERnet:DATA:QUALifier  
{LESSthan|MORERthan|EQua1|UNEQua1|LESSEQua1|MORREEQua1|  
INrange|OUTrange}

SEARCH:SEARCH<x>:TRIGger:A:BUS:ETHERnet:DATA:QUALifier?

**Related Commands** [SEARCH:SEARCH<x>:TRIGger:A:BUS:ETHERnet:CONDition](#)

**Arguments** LESSthan sets the qualifier to less than.  
MORERthan sets the qualifier to greater than.  
EQua1 sets the qualifier to equal.  
UNEQua1 sets the qualifier to not equal.  
LESSEQua1 sets the qualifier to less than or equal.  
MORREEQua1 sets the qualifier to greater than or equal.  
INrange sets the qualifier to in range.  
OUTrange sets the qualifier to out of range.

**Examples** SEARCH:SEARCH1:TRIGGER:A:BUS:ETHERNET:DATA:QUALIFIER  
LESSTHAN sets the qualifier to "less than".  
SEARCH:SEARCH1:TRIGGER:A:BUS:ETHERNET:DATA:QUALIFIER? might  
return SEARCH:SEARCH1:TRIGGER:A:BUS:ETHERNET:DATA:QUALIFIER  
EQUAL indicating that the qualifier is set to EQUAL.

## SEARCH:SEARCH<x>:TRIGger:A:BUS:ETHERnet:DATA:SIZE

This command specifies the length of the data string, in bytes, to use when searching on the Ethernet bus signal. The search condition needs to be set to DATA. The search number is specified by x.

**Conditions** Requires option 5-SRENET or SUP5-SRENET Triggering and Analysis application.

**Group** Search and Mark

**Syntax** SEARCH:SEARCH<x>:TRIGger:A:BUS:ETHERnet:DATA:SIZE <NR1>  
SEARCH:SEARCH<x>:TRIGger:A:BUS:ETHERnet:DATA:SIZE?

<b>Related Commands</b>	<a href="#">SEARCH:SEARCH&lt;x&gt;:TRIGger:A:BUS:ETHERnet:CONDition</a>
<b>Arguments</b>	The minimum and default values are 1, and the maximum value is 16.
<b>Examples</b>	<p>SEARCH:SEARCH1:TRIGGER:A:BUS:ETHERNET:DATA:SIZE 4 specifies 4 as the number of contiguous TCP/IPv4/MAC client bytes to use when searching on the Ethernet data field.</p> <p>SEARCH:SEARCH1:TRIGGER:A:BUS:ETHERNET:DATA:SIZE? might return 6, indicating that 6 is the currently specified number of contiguous TCP/IPv4/MAC client bytes to use when searching on the Ethernet data field.</p>

## SEARCH:SEARCH<x>:TRIGger:A:BUS:ETHERnet:DATA:VALue

This command specifies the binary value to use when searching on the Ethernet bus signal. The search condition needs to be set to DATA. The search number is specified by x.

<b>Conditions</b>	Requires option 5-SRENET or SUP5-SRENET Triggering and Analysis application.
<b>Group</b>	Search and Mark
<b>Syntax</b>	SEARCH:SEARCH<x>:TRIGger:A:BUS:ETHERnet:DATA:VALue <QString> SEARCH:SEARCH<x>:TRIGger:A:BUS:ETHERnet:DATA:VALue?
<b>Related Commands</b>	<a href="#">SEARCH:SEARCH&lt;x&gt;:TRIGger:A:BUS:ETHERnet:CONDition</a> <a href="#">SEARCH:SEARCH&lt;x&gt;:TRIGger:A:BUS:ETHERnet:DATA:OFFSet</a> <a href="#">SEARCH:SEARCH&lt;x&gt;:TRIGger:A:BUS:ETHERnet:DATA:SIZE</a>
<b>Arguments</b>	<QString> is a quoted string where the allowable characters are 0, 1, and X. The allowable number of characters depends on the setting for size (using <a href="#">SEARCH:SEARCH&lt;x&gt;:TRIGger:A:BUS:ETHERnet:DATA:SIZE</a> ). The bits specified in the quoted string replace the least significant bits, leaving any unspecified upper bits unchanged.
<b>Examples</b>	SEARCH:SEARCH1:TRIGGER:A:BUS:ETHERNET:DATA:VALUE "00001000" specifies 00001000 as the value to use when triggering on the Ethernet binary data field, assuming that TRIGGER:A:BUS:ETHERNET:DATA:SIZE is set to 1 byte.

SEARCH:SEARCH1:TRIGGER:A:BUS:ETHERNET:DATA:VALUE? might return "00001000", indicating 0000100 is the currently specified value used when searching on the Ethernet binary data field.

## SEARCH:SEARCH<x>:TRIGger:A:BUS:ETHERnet:IPHeader:DESTInationaddr:VALue

This command specifies the binary destination address value to use when searching on an Ethernet bus signal. The search condition needs to be set to IPHeader. The search number is specified by x.

**Conditions** Requires option 5-SRENET or SUP5-SRENET Triggering and Analysis application.

**Group** Search and Mark

**Syntax** SEARCH:SEARCH<x>:TRIGger:A:BUS:ETHERnet:IPHeader:DESTInationaddr:VALue <QString>  
SEARCH:SEARCH<x>:TRIGger:A:BUS:ETHERnet:IPHeader:DESTInationaddr:VALue?

**Related Commands** [SEARCH:SEARCH<x>:TRIGger:A:BUS:ETHERnet:CONDition](#)

**Arguments** <QString> is a quoted string of up to 32 characters where the allowable characters are 0, 1, and X. The bits specified in the quoted string replace the least significant bits, leaving any unspecified upper bits unchanged.

**Examples** SEARCH:SEARCH1:TRIGGER:A:BUS:ETHERNET:IPHEADER:DESTINATIONADDR:VALUE "11000000101010000000000000000001" specifies 192.168.0.1 as the value to use when searching on the Ethernet IPv4 header address destination field.

SEARCH:SEARCH1:TRIGGER:A:BUS:ETHERNET:IPHEADER:DESTINATIONADDR:VALUE? might return "11000000101010000000000000000001", indicating that 192.168.0.1 is the currently specified value used when searching on the Ethernet IPv4 header address destination field.

## SEARCH:SEARCH<x>:TRIGger:A:BUS:ETHERnet:IPHeader:PROTOcol:VALue

This command specifies the binary protocol value to use when searching on the Ethernet bus signal. The search condition needs to be set to IPHeader. The search number is specified by x.

---

**NOTE.** Commonly used protocol values are 1 (ICMP), 2 (IGMP), 6 (TCP) and 17 (UDP).

---

**Conditions** Requires option 5-SRENET or SUP5-SRENET Triggering and Analysis application.

**Group** Search and Mark

**Syntax** SEARCH:SEARCH<x>:TRIGger:A:BUS:ETHERnet:IPHeader:PROTOCOL:VALUE <QString>  
SEARCH:SEARCH<x>:TRIGger:A:BUS:ETHERnet:IPHeader:PROTOCOL:VALUE?

**Related Commands** [SEARCH:SEARCH<x>:TRIGger:A:BUS:ETHERnet:CONDition](#)

**Arguments** <QString> is a quoted string of up to 8 characters where the allowable characters are 0, 1, and X. The bits specified in the quoted string replace the least significant bits, leaving any unspecified upper bits unchanged.

**Examples** SEARCH:SEARCH1:TRIGGER:A:BUS:ETHERNET:IPHEADER:PROTOCOL:VALUE "01010010" specifies 01010010 as the value to use when searching on the Ethernet IP header protocol field.

SEARCH:SEARCH1:TRIGGER:A:BUS:ETHERNET:IPHEADER:PROTOCOL:VALUE? might return "XXXXXXXX", indicating that the trigger value has been set to "don't care".

## SEARCH:SEARCH<x>:TRIGger:A:BUS:ETHERnet:IPHeader:SOURceaddr:VALue

This command specifies the binary source address value to use when searching on an Ethernet bus signal. The search condition needs to be set to IPHeader. The search number is specified by x.

**Conditions** Requires option 5-SRENET or SUP5-SRENET Triggering and Analysis application.

**Group** Search and Mark

**Syntax** SEARCH:SEARCH<x>:TRIGger:A:BUS:ETHERnet:IPHeader:SOURceaddr:VALUE <QString>

SEARCH:SEARCH<x>:TRIGger:A:BUS:ETHERnet:IPHeader:SOURceaddr:VALue?

**Related Commands**     [SEARCH:SEARCH<x>:TRIGger:A:BUS:ETHERnet:CONDition](#)

**Arguments**     QString is a quoted string of up to 32 characters where the allowable characters are 0, 1, and X. The bits specified in the quoted string replace the least significant bits, leaving any unspecified upper bits unchanged.

**Examples**     SEARCH:SEARCH1:TRIGGER:A:BUS:ETHERNET:IPHEADER:SOURCEADDR:VALUE "110000001010100000000000000001" specifies to use the value of 192.168.0.1 when searching on the Ethernet IP header address source field.

SEARCH:SEARCH1:TRIGGER:A:BUS:ETHERNET:IPHEADER:SOURCEADDR:VALUE might return "110000001010100000000000000001", indicating that the search value has been set to 192.168.0.1.

## SEARCH:SEARCH<x>:TRIGger:A:BUS:ETHERnet:MAC:ADDRESS:DESTination:VALue

This command specifies the binary MAC address destination value to use when searching on an Ethernet bus signal. The search condition needs to be set to MACADDRESS. The search number is specified by x.

---

**NOTE.** MAC Addresses are 48-bit values such as 08:00:11:1E:C9:AE hex.

---

**Conditions**     Requires option 5-SRENET or SUP5-SRENET Triggering and Analysis application.

**Group**     Search and Mark

**Syntax**     SEARCH:SEARCH<x>:TRIGger:A:BUS:ETHERnet:MAC:ADDRESS:DESTination:VALue <QString>  
SEARCH:SEARCH<x>:TRIGger:A:BUS:ETHERnet:MAC:ADDRESS:DESTination:VALue?

**Related Commands**     [SEARCH:SEARCH<x>:TRIGger:A:BUS:ETHERnet:CONDition](#)

**Arguments**     <QString> is a quoted string of up to 48 characters where the allowable characters are 0, 1, and X. The bits specified in the quoted string replace the least significant bits, leaving any unspecified upper bits unchanged.



**Examples**     `SEARCH:SEARCH1:TRIGGER:A:BUS:ETHERNET:MAC:ADDRESS:DESTINATION:VALUE`  
`"XXXXXXXX0011010111111100000001111010101011001000"` specifies to use the value of `XX:35:FC:07:AA:C8` hex when searching on the Ethernet MAC address destination field.

`SEARCH:SEARCH1:TRIGGER:A:BUS:ETHERNET:MAC:ADDRESS:DESTINATION:VALUE?` might return `"XXXXXXXX0011010111111100000001111010101011001000"`, indicating a MAC address destination field value of `XX:35:FC:07:AA:C8` hex.

## SEARCH:SEARCH<x>:TRIGger:A:BUS:ETHERnet:MAC:ADDRes:SOUrce:VALue

This command specifies the binary MAC address source value to use when searching on an Ethernet bus signal. The search condition needs to be set to `MACADDRESS`. The search number is specified by `x`.

---

**NOTE.** *MAC Addresses are 48-bit values such as 08:00:11:1E:C9:AE hex.*

---

**Conditions**     Requires option 5-SRENET or SUP5-SRENET Triggering and Analysis application.

**Group**            Search and Mark

**Syntax**            `SEARCH:SEARCH<x>:TRIGger:A:BUS:ETHERnet:MAC:ADDRes:SOUrce:VALue <QString>`  
`SEARCH:SEARCH<x>:TRIGger:A:BUS:ETHERnet:MAC:ADDRes:SOUrce:VALue?`

**Related Commands**     [SEARCH:SEARCH<x>:TRIGger:A:BUS:ETHERnet:CONDition](#)

**Arguments**        `<QString>` is a quoted string of up to 48 characters where the allowable characters are 0, 1, and X. The bits specified in the quoted string replace the least significant bits, leaving any unspecified upper bits unchanged.

**Examples**            `SEARCH:SEARCH1:TRIGGER:A:BUS:ETHERNET:MAC:ADDRESS:SOURCE:VALUE`  
`"XXXXXXXX0011010111111100000001111010101011001000"` specifies to use the value of `XX:35:FC:07:AA:C8` hex when searching on the Ethernet MAC address source field.

`SEARCH:SEARCH1:TRIGGER:A:BUS:ETHERNET:MAC:ADDRESS:SOURCE:VALUE?` might return `"XXXXXXXX0011010111111100000001111010101011001000"`, indicating a MAC address source field value of `XX:35:FC:07:AA:C8` hex.

## SEARCH:SEARCH<x>:TRIGger:A:BUS:ETHERnet:MAC:LENgth:HIVALue

This command specifies the binary MAC length high value to use when searching on an Ethernet bus signal. The search condition needs to be set to `MACADDRESS`. The search number is specified by `x`.

**Conditions** Requires option 5-SRENET or SUP5-SRENET Triggering and Analysis application.

**Group** Search and Mark

**Syntax** SEARCH:SEARCH<x>:TRIGger:A:BUS:ETHERnet:MAC:LENgth:HIVALue  
<QString>  
SEARCH:SEARCH<x>:TRIGger:A:BUS:ETHERnet:MAC:LENgth:HIVALue?

**Related Commands** [SEARCH:SEARCH<x>:TRIGger:A:BUS:ETHERnet:CONDition](#)

**Arguments** <QString> is a quoted string of up to 16 characters where the allowable characters are 0, 1, and X. The bits specified in the quoted string replace the least significant bits, leaving any unspecified upper bits unchanged.

**Examples** SEARCH:SEARCH1:TRIGGER:A:BUS:ETHERNET:MAC:LENGTH:HIVALUE  
"XXXXXXXX00001000" specifies to use the hexadecimal value XX08 when searching on the Ethernet MAC length.

SEARCH:SEARCH1:TRIGGER:A:BUS:ETHERNET:MAC:LENGTH:HIVALUE?  
might return "XXXXXXXX00001000", indicating an Ethernet MAC length value of XX08 hex.

## SEARCH:SEARCH<x>:TRIGger:A:BUS:ETHERnet:MAC:LENgth:VALue

This command specifies the MAC length value to use when searching on an Ethernet bus signal. The search condition needs to be set to `MACADDRESS`. The search number is specified by `x`.

**Conditions** Requires option 5-SRENET or SUP5-SRENET Triggering and Analysis application.

**Group** Search and Mark

**Syntax** SEARCH:SEARCH<x>:TRIGger:A:BUS:ETHERnet:MAC:LENGth:VALue <QString>  
SEARCH:SEARCH<x>:TRIGger:A:BUS:ETHERnet:MAC:LENGth:VALue?

**Related Commands** [SEARCH:SEARCH<x>:TRIGger:A:BUS:ETHERnet:CONDition](#)

**Arguments** QString is a quoted string of up to 16 characters where the allowable characters are 0, 1, and X. The bits specified in the quoted string replace the least significant bits, leaving any unspecified upper bits unchanged.

**Examples** SEARCH:SEARCH1:TRIGGER:A:BUS:ETHERNET:MAC:LENGTH:HIVALUE "XXXXXXXX00001000" specifies to use the hexadecimal value XX08 when searching on the Ethernet MAC length.

SEARCH:SEARCH1:TRIGGER:A:BUS:ETHERNET:MAC:LENGTH:HIVALUE? might return "XXXXXXXX00001000", indicating an Ethernet MAC length value of XX08 hex.

## SEARCH:SEARCH<x>:TRIGger:A:BUS:ETHERnet:QTAG:VALue

This command specifies the binary Q-tag information to use when searching on an Ethernet bus signal. The search condition needs to be set to QTAG. The search number is specified by x.

**Conditions** Requires option 5-SRENET or SUP5-SRENET Triggering and Analysis application.

**Group** Search and Mark

**Syntax** SEARCH:SEARCH<x>:TRIGger:A:BUS:ETHERnet:QTAG:VALue <QString>  
SEARCH:SEARCH<x>:TRIGger:A:BUS:ETHERnet:QTAG:VALue?

**Related Commands** [SEARCH:SEARCH<x>:TRIGger:A:BUS:ETHERnet:CONDition](#)

**Arguments** <QString> is a quoted string of up to 32 characters where the allowable characters are 0, 1, and X. The bits specified in the quoted string replace the least significant bits, leaving any unspecified upper bits unchanged.

**Examples** SEARCH:SEARCH1:TRIGGER:A:BUS:ETHERNET:QTAG:VALUE "XXXXXXXXXXXXXXXXXXXX010010001010" specifies to use the value of hexadecimal XXXXX48A when searching on the Ethernet Q-Tag field.

SEARCH:SEARCH1:TRIGGER:A:BUS:ETHERNET:QTAG:VALUE? might return "XXXXXXXXXXXXXXXXXXXX010010001010", indicating that hexadecimal XXXXX48A has been set as the Ethernet Q-Tag field search value.

## SEARCH:SEARCH<x>:TRIGger:A:BUS:ETHERnet:TCPHeader:ACKnum:VALue

This command specifies the binary ack number value to use when searching on an Ethernet bus signal. The default is all X's (don't care). The search condition needs to be set to TCPHeader. The search number is specified by x.

**Conditions** Requires option 5-SRENET or SUP5-SRENET Triggering and Analysis application.

**Group** Search and Mark

**Syntax** SEARCH:SEARCH<x>:TRIGger:A:BUS:ETHERnet:TCPHeader:ACKnum:VALue <QString>  
SEARCH:SEARCH<x>:TRIGger:A:BUS:ETHERnet:TCPHeader:ACKnum:VALue?

**Related Commands** [SEARCH:SEARCH<x>:TRIGger:A:BUS:ETHERnet:CONDition](#)

**Arguments** QString is a quoted string of up to 32 characters where the allowable characters are 0, 1, and X. The bits specified in the quoted string replace the least significant bits, leaving any unspecified upper bits unchanged.

**Examples** SEARCH:SEARCH1:TRIGGER:A:BUS:ETHERNET:TCPHEADER:ACKNUM:VALUE "XXXXXXXXXXXXXXXXXXXX00001000" specifies hexadecimal XXXXXX08 as the value to use when searching on the Ethernet TCP header acknowledgement number.

TRIGGER:A:BUS:ETHERNET:TCPHEADER:ACKNUM:VALUE? might return "XXXXXXXXXXXXXXXXXXXX00001000", indicating that hexadecimal XXXXXX08 has been specified as the value to use when searching on the Ethernet TCP header acknowledgement number.

## SEARCH:SEARCH<x>:TRIGger:A:BUS:ETHERnet:TCPHeader:DESTinationport:VALue

This command specifies the binary destination port value to use when searching on the Ethernet TCP header destination port number. The search condition needs to be set to TCPHeader. The search number is specified by x.

**Conditions** Requires option 5-SRENET or SUP5-SRENET Triggering and Analysis application.

**Group** Search and Mark

**Syntax** SEARCH:SEARCH<x>:TRIGger:A:BUS:ETHERnet:TCPHeader:DESTInationport:VALue <QString>  
SEARCH:SEARCH<x>:TRIGger:A:BUS:ETHERnet:TCPHeader:DESTInationport:VALue?

**Related Commands** [SEARCH:SEARCH<x>:TRIGger:A:BUS:ETHERnet:CONDition](#)

**Arguments** <QString> is a quoted string of up to 16 characters where the allowable characters are 0, 1, and X. The bits specified in the quoted string replace the least significant bits, leaving any unspecified upper bits unchanged.

**Examples** SEARCH:SEARCH1:TRIGGER:A:BUS:ETHERNET:TCPHEADER:DESTINATIONPORT:VALUE "XXXXXXXX00100010" specifies to use the value of hexadecimal XX22 when searching on the Ethernet TCP header destination port number.  
  
SEARCH:SEARCH1:TRIGGER:A:BUS:ETHERNET:TCPHEADER:DESTINATIONPORT:VALUE? might return "XXXXXXXXXXXXXXXXXXXX", indicating that hexadecimal XX22 has been set as the value to use when searching on the Ethernet TCP header destination port number.

## SEARCH:SEARCH<x>:TRIGger:A:BUS:ETHERnet:TCPHeader:SEQnum:VALue

This command specifies the binary sequence number value to use when searching on an Ethernet bus signal. The default is all X's (don't care). The search condition needs to be set to TCPHeader. The search number is specified by x.

**Conditions** Requires option 5-SRENET or SUP5-SRENET Triggering and Analysis application.

**Group** Search and Mark

**Syntax** SEARCH:SEARCH<x>:TRIGger:A:BUS:ETHERnet:TCPHeader:SEQnum:VALue <QString>  
SEARCH:SEARCH<x>:TRIGger:A:BUS:ETHERnet:TCPHeader:SEQnum:VALue?

<b>Related Commands</b>	<a href="#">SEARCH:SEARCH&lt;x&gt;:TRIGger:A:BUS:ETHERnet:CONDition</a>
<b>Arguments</b>	QString is a quoted string of up to 32 characters where the allowable characters are 0, 1, and X. The bits specified in the quoted string replace the least significant bits, leaving any unspecified upper bits unchanged.
<b>Examples</b>	<p>SEARCH:SEARCH1:TRIGGER:A:BUS:ETHERNET:TCPHEADER:SEQNUM:VALUE "XXXXXXXXXXXXXXXXXXXX000100010001" specifies to use the value of hexadecimal XXXXX111 when searching on the Ethernet TCP header sequence number.</p> <p>SEARCH:SEARCH1:TRIGGER:A:BUS:ETHERNET:TCPHEADER:SEQNUM:VALUE? might return "XXXXXXXXXXXXXXXXXXXX0010010100", indicating that hexadecimal XXXXX111 has been specified as the value to use when searching on the Ethernet TCP header sequence number.</p>

## SEARCH:SEARCH<x>:TRIGger:A:BUS:ETHERnet:TCPHeader:SOUrceport:VALue

This command specifies the binary source port value to use when searching on an Ethernet bus signal. The search condition needs to be set to TCPHeader. The search number is specified by x.

<b>Conditions</b>	Requires option 5-SRENET or SUP5-SRENET Triggering and Analysis application.
<b>Group</b>	Search and Mark
<b>Syntax</b>	<pre>SEARCH:SEARCH&lt;x&gt;:TRIGger:A:BUS:ETHERnet:TCPHeader: SOUrceport:VALue &lt;QString&gt; SEARCH:SEARCH&lt;x&gt;:TRIGger:A:BUS:ETHERnet:TCPHeader: SOUrceport:VALue?</pre>
<b>Related Commands</b>	<a href="#">SEARCH:SEARCH&lt;x&gt;:TRIGger:A:BUS:ETHERnet:CONDition</a>
<b>Arguments</b>	<QString> is a quoted string of up to 16 characters where the allowable characters are 0, 1, and X. The bits specified in the quoted string replace the least significant bits, leaving any unspecified upper bits unchanged.
<b>Examples</b>	SEARCH:SEARCH1:TRIGGER:A:BUS:ETHERNET:TCPHEADER:SOURCEPORT:VALUE "XXXX000010100110" specifies to use the value of

hexadecimal X0A6 when searching on the Ethernet TCP header source port number.

SEARCH:SEARCH1:TRIGGER:A:BUS:ETHERNET:TCPHEADER:SOURCEPORT:VALUE? might return "XXXXX01001010110", indicating that hexadecimal X0A6 has been specified as the value to use when searching on the Ethernet TCP header source port number.

## SEARCH:SEARCH<x>:TRIGger:A:BUS:EUSB:ADdRESS:HIVALue

This command sets the high binary address value to be used when triggering on a eUSB bus signal. The trigger condition must be set to TOKEN.

<b>Conditions</b>	Requires option SR-EUSB2
<b>Group</b>	Search and Mark
<b>Syntax</b>	SEARCH:SEARCH<x>:TRIGger:A:BUS:EUSB:ADdRESS:HIVALue <QString> SEARCH:SEARCH<x>:TRIGger:A:BUS:EUSB:ADdRESS:HIVALue?
<b>Arguments</b>	<QString> specifies the value in the specified valid format. The valid characters are 0, 1, and X (for binary, for hexadecimal, and symbolic).
<b>Examples</b>	SEARCH:SEARCH1:TRIGger:A:BUS:EUSB:ADdRESS:HIVALue XXXXXXXX specifies high binary address value as XXXXXXXX within an eUSB frame to search on.  SEARCH:SEARCH1:TRIGger:A:BUS:EUSB:ADdRESS:HIVALue? might return SEARCH:SEARCH1:TRIGger:A:BUS:EUSB:ADdRESS:HIVALue XXXXXXXX, indicating the high binary address value as XXXXXXXX in the currently specified field within an eUSB frame to search on.

## SEARCH:SEARCH<x>:TRIGger:A:BUS:EUSB:ADdRESS:VALue

This command sets the binary address value to be used when triggering on a eUSB bus signal. The trigger condition must be set to TOKEN. The search number is specified by x.

<b>Conditions</b>	Requires option SR-EUSB2
-------------------	--------------------------

<b>Group</b>	Search and Mark
<b>Syntax</b>	SEARCH:SEARCH<x>:TRIGger:A:BUS:EUSB:ADDRESS:VALue <QString> SEARCH:SEARCH<x>:TRIGger:A:BUS:EUSB:ADDRESS:VALue?
<b>Arguments</b>	<QString> specifies the value in the specified valid format. The valid characters are 0, 1, and X (for binary, for hexadecimal, and symbolic).
<b>Examples</b>	SEARCH:SEARCH1:TRIGger:A:BUS:EUSB:ADDRESS:VALue XXXXXXXX specifies binary address value as XXXXXXXX within an eUSB frame to search on.  SEARCH:SEARCH1:TRIGger:A:BUS:EUSB:ADDRESS:VALue? might return SEARCH:SEARCH1:TRIGger:A:BUS:EUSB:ADDRESS:VALue XXXXXXXX, indicating the binary address value as XXXXXXXX in the currently specified field within an eUSB frame to search on.

## SEARCH:SEARCH<x>:TRIGger:A:BUS:EUSB:CONDition

This command sets or queries the search type for the specified search. The search number is specified by x.

<b>Conditions</b>	Requires option SR-EUSB2
<b>Group</b>	Search and Mark
<b>Syntax</b>	SEARCH:SEARCH<x>:TRIGger:A:BUS:EUSB:CONDition {SYNC  HANDSHAKEPacket  SPECIALPacket  ERROR  TOKENPacket  DATAPacket  RESET  CONNect  CONTROLMESSAge  SUSPEND  DEVICEChirp  HOSTChirp  PORTReset  PORTConfiguration  RESUME  EOP} SEARCH:SEARCH<x>:TRIGger:A:BUS:EUSB:CONDition?
<b>Arguments</b>	SYNC specifies the search condition as Sync.  HANDSHAKEPacket specifies the search condition as Handshake Packet.  SPECIALPacket specifies the search condition as Special Packet.  ERROR specifies the search condition as Error.  TOKENPacket specifies the search condition as Token (Address) Packet.  DATAPacket specifies the search condition as Data Packet.  RESET specifies the search condition as Reset.



CONNECT specifies the search condition as connect.

CONTROLMESSAGE specifies the search condition as Control Message.

SUSPEND specifies the search condition as Suspend.

DEVICEChirp specifies the search condition as Device chirp.

HOSTChirp specifies the search condition as Host Chirp.

PORTReset specifies the search condition as Port Reset.

PORTConfiguration specifies the search condition as Port Configuration.

RESUME specifies the search condition as Resume.

RAP specifies the search condition as Register Access Protocol.

EOP specifies the search condition as End of Packet.

**Examples** SEARCH:SEARCH1:TRIGger:A:BUS:EUSB:CONDition SYNC specifies sync as the field within a eUSB frame to search on.

SEARCH:SEARCH1:TRIGger:A:BUS:EUSB:CONDition? might return SEARCH:SEARCH1:TRIGger:A:BUS:EUSB:CONDition START, indicating that START is the currently specified field within a eUSB frame to search on.

## SEARCH:SEARCH<x>:TRIGger:A:BUS:EUSB:DATA:HIVALue

This command sets the high binary data value to be used when triggering on a eUSB bus signal. The trigger condition must be set to DATA. The search number is specified by x.

**Conditions** Requires option SR-EUSB2

**Group** Search and Mark

**Syntax** SEARCH:SEARCH<x>:TRIGger:A:BUS:EUSB:DATA:HIVALue <QString>  
SEARCH:SEARCH<x>:TRIGger:A:BUS:EUSB:DATA:HIVALue?

**Arguments** <QString> specifies the value in the specified valid format. The valid characters are 0, 1, and X (for binary, for hexadecimal, and symbolic).

**Examples** SEARCH:SEARCH1:TRIGger:A:BUS:EUSB:DATA:HIVALue XXXXXXXX specifies high binary data value as XXXXXXXX within an eUSB frame to search on.

SEARCH:SEARCH1:TRIGger:A:BUS:EUSB:DATA:HIVALue? might return  
SEARCH:SEARCH1:TRIGger:A:BUS:EUSB:DATA:HIVALue XXXXXXXX,  
indicating the high binary data value as XXXXXXXX in the currently specified  
field within an eUSB frame to search on.

## SEARCH:SEARCH<x>:TRIGger:A:BUS:EUSB:DATA:OFFSet

This command sets the byte offset to look for a data pattern at, in bytes, to be used when triggering on a eUSB bus signal. The trigger condition must be set to DATA. The search number is specified by x.

<b>Conditions</b>	Requires option SR-EUSB2
<b>Group</b>	Search and Mark
<b>Syntax</b>	SEARCH:SEARCH<x>:TRIGger:A:BUS:EUSB:DATA:OFFSet <NR1> SEARCH:SEARCH<x>:TRIGger:A:BUS:EUSB:DATA:OFFSet?
<b>Arguments</b>	<NR1> specifies the byte offset. Default offset value is -1. The argument range is -1 to 1024
<b>Examples</b>	SEARCH:SEARCH1:TRIGger:A:BUS:EUSB:DATA:OFFSet -1 specifies the byte offset as -1 within an eUSB frame to search on.  SEARCH:SEARCH1:TRIGger:A:BUS:EUSB:DATA:OFFSet? might return SEARCH:SEARCH1:TRIGger:A:BUS:EUSB:DATA:OFFSet XXXXXXXX, indicating that the offset value is -1 in the currently specified field within an eUSB frame to search on.

## SEARCH:SEARCH<x>:TRIGger:A:BUS:EUSB:DATA:QUALifier

This command sets the qualifier to be used when triggering on a eUSB bus signal. The trigger condition must be set to IDANDDATA OR DATA. The search number is specified by x.

<b>Conditions</b>	Requires option SR-EUSB2
<b>Group</b>	Search and Mark

<b>Syntax</b>	SEARCH:SEARCH<x>:TRIGger:A:BUS:EUSB:DATA:QUALifier {Equal UNEQual LESSthan MOREthan LESSEQual MOREEQual Inrange OUTrange} SEARCH:SEARCH<x>:TRIGger:A:BUS:EUSB:DATA:QUALifier?
<b>Arguments</b>	Equal specifies the qualifier as Equal. UNEQual specifies the qualifier as Not Equal to. LESSthan specifies the qualifier as Less Than. MOREthan specifies the qualifier as More Than. LESSEQual specifies the qualifier as Less Than or Equal to. MOREEQual specifies the qualifier as More Than or Equal to. Inrange specifies the qualifier as Inside Range. OUTrange specifies the qualifier as Out of Range.
<b>Examples</b>	SEARCH:SEARCH1:TRIGger:A:BUS:EUSB:DATA:QUALifier Equal specifies trigger value as Equal.  SEARCH:SEARCH1:TRIGger:A:BUS:EUSB:DATA:QUALifier? might return SEARCH:SEARCH1:TRIGger:A:BUS:EUSB:DATA:QUALifier Equal, indicating the trigger value as Equal.

## SEARCH:SEARCH<x>:TRIGger:A:BUS:EUSB:DATA:SIZE

This command sets the length of the data string, in bytes, to be used when triggering on a eUSB bus signal. The trigger condition must be set to DATA. The search number is specified by x.

<b>Conditions</b>	Requires option SR-EUSB2
<b>Group</b>	Search and Mark
<b>Syntax</b>	SEARCH:SEARCH<x>:TRIGger:A:BUS:EUSB:DATA:SIZE <NR1> SEARCH:SEARCH<x>:TRIGger:A:BUS:EUSB:DATA:SIZE?
<b>Arguments</b>	<NR1> specifies the length of the data string. Default data size value is 1. The argument range is 1 to 16 bytes.

**Examples**     `SEARCH:SEARCH1:TRIGger:A:BUS:EUSB:DATA:SIZE 1` specifies the data size as 1 byte within an eUSB frame to search on.

`SEARCH:SEARCH1:TRIGger:A:BUS:EUSB:DATA:SIZE?` might return `SEARCH:SEARCH1:TRIGger:A:BUS:EUSB:DATA:SIZE 1`, indicating that data size value is 1 in the currently specified field within an eUSB frame to search on.

## **SEARCH:SEARCH<x>:TRIGger:A:BUS:EUSB:DATA:TYPE**

This command specifies the eUSB trigger type to be valid on any, data0, data1, data2, or mdata condition. The search number is specified by x.

**Conditions**     Requires option SR-EUSB2

**Group**             Search and Mark

**Syntax**            `SEARCH:SEARCH<x>:TRIGger:A:BUS:EUSB:DATA:TYPE {ANY| DATA0| DATA1| DATA2| MDATA}`  
`SEARCH:SEARCH<x>:TRIGger:A:BUS:EUSB:DATA:TYPE?`

**Arguments**        ANY specifies either a DATA0 or DATA1 data packet type.

                      DATA0 specifies a DATA0 data packet type.

                      DATA1 specifies a DATA1 data packet type.

                      DATA2 specifies a DATA2 data packet type when on HIGH speed.

                      MDATA specifies a MDATA data packet type when on HIGH speed.

**Examples**         `SEARCH:SEARCH1:TRIGger:A:BUS:EUSB:DATA:TYPE DATA0` sets the data type as DATA0.

`SEARCH:SEARCH1:TRIGger:A:BUS:EUSB:DATA:TYPE?` might return `SEARCH:SEARCH1:TRIGger:A:BUS:EUSB:DATA:TYPE DATA0`, indicating that the data type is DATA0.

## **SEARCH:SEARCH<x>:TRIGger:A:BUS:EUSB:DATA:VALue**

This command sets the binary data value to be used when triggering on a eUSB bus signal. The trigger condition must be set to DATA. The search number is specified by x.

**Conditions**        Requires option SR-EUSB2

<b>Group</b>	Search and Mark
<b>Syntax</b>	SEARCH:SEARCH<x>:TRIGger:A:BUS:EUSB:DATA:VALue <QString> SEARCH:SEARCH<x>:TRIGger:A:BUS:EUSB:DATA:VALue?
<b>Arguments</b>	<QString> specifies the value in the specified valid format. The valid characters are 0, 1, and X (for binary, for hexadecimal, and symbolic).
<b>Examples</b>	SEARCH:SEARCH1:TRIGger:A:BUS:EUSB:DATA:VALue XXXXXXXX specifies the data value as XXXXXXXX within an eUSB frame to search on.  SEARCH:SEARCH1:TRIGger:A:BUS:EUSB:DATA:VALue? might return SEARCH:SEARCH1:TRIGger:A:BUS:EUSB:DATA:VALue XXXXXXXX, indicating the data value as XXXXXXXX in the currently specified field within an eUSB frame to search on.

## SEARCH:SEARCH<x>:TRIGger:A:BUS:EUSB:DATABITS:SIZE

This command sets the number of Sync bits, in bytes, to be used when triggering on a eUSB bus signal. The trigger condition must be set to SYNC. The search number is specified by x.

<b>Conditions</b>	Requires option SR-EUSB2
<b>Group</b>	Search and Mark
<b>Syntax</b>	SEARCH:SEARCH<x>:TRIGger:A:BUS:EUSB:DATABITS:SIZE <NR1> SEARCH:SEARCH<x>:TRIGger:A:BUS:EUSB:DATABITS:SIZE?
<b>Arguments</b>	<NR1> specifies the number of the Sync bits. The default Sync bits is 12. The argument range is 12 to 32 bits.
<b>Examples</b>	SEARCH:SEARCH1:TRIGger:A:BUS:EUSB:DATABITS:SIZE 12 specifies Sync bits as 12 within an eUSB frame to search on.  SEARCH:SEARCH1:TRIGger:A:BUS:EUSB:DATABITS:SIZE? might return :SEARCH:SEARCH1:TRIGger:A:BUS:EUSB:DATABITS:SIZE 12, indicating that Sync bits value is 12 in the currently specified field within an eUSB frame to search on.

## SEARCH:SEARCH<x>:TRIGger:A:BUS:EUSB:ENDPoint:VALue

This command sets the endpoint binary value to be used when triggering on a eUSB bus signal. The trigger condition must be set to TOKEN. The search number is specified by x.

<b>Conditions</b>	Requires option SR-EUSB2
<b>Group</b>	Search and Mark
<b>Syntax</b>	SEARCH:SEARCH<x>:TRIGger:A:BUS:EUSB:ENDPoint:VALue <QString> SEARCH:SEARCH<x>:TRIGger:A:BUS:EUSB:ENDPoint:VALue?
<b>Arguments</b>	<QString> specifies the data value in the specified valid format. The valid characters are 0, 1, and X for binary format; A-F, 0-9 and X for hexadecimal format.
<b>Examples</b>	SEARCH:SEARCH1:TRIGger:A:BUS:EUSB:ENDPoint:VALue XXXX specifies end point value as XXXX within an eUSB frame to search on.  SEARCH:SEARCH1:TRIGger:A:BUS:EUSB:ENDPoint:VALue? might return SEARCH:SEARCH1:TRIGger:A:BUS:EUSB:ENDPoint:VALue XXXX, indicating that end point value as XXXX in the currently specified field within an eUSB frame to search on.

## SEARCH:SEARCH<x>:TRIGger:A:BUS:EUSB:ERRType

This command specifies the eUSB trigger type to be valid on a PID, Token CRC5, Data CRC16, or Bit stuffing condition. The search number is specified by x.

<b>Conditions</b>	Requires option SR-EUSB2
<b>Group</b>	Search and Mark
<b>Syntax</b>	SEARCH:SEARCH<x>:TRIGger:A:BUS:EUSB:ERRType {BITSTUFFing CRC5 CRC16 PID} SEARCH:SEARCH<x>:TRIGger:A:BUS:EUSB:ERRType?
<b>Arguments</b>	BITSTUFFing specifies the error type as Bit Stuffing.  CRC5 specifies the error type as Token CRC5 (Cyclic Redundancy Check 5).

CRC16 specifies the error type as Data CRC16 (Cyclic Redundancy Check 16).

PID specifies the error type as PID Check Bits.

**Examples**     `SEARCH:SEARCH1:TRIGger:A:BUS:EUSB:ERRType PID` specifies PID as the field within an eUSB frame to search on.

`SEARCH:SEARCH1:TRIGger:A:BUS:EUSB:ERRType?` might return `SEARCH:SEARCH1:TRIGger:A:BUS:EUSB:ERRType PID`, indicating that PID is the currently specified field within a eUSB frame to search on.

## **SEARCH:SEARCH<x>:TRIGger:A:BUS:EUSB:ENDSEARCh**

This command specifies eUSB Search EOP Bits to be On and Off. The search number is specified by x.

**Conditions**     Requires option SR-EUSB2

**Group**            Search and Mark

**Syntax**            `SEARCH:SEARCH<x>:TRIGger:A:BUS:EUSB:ENDSEARCh {OFF|ON}`  
`SEARCH:SEARCH<x>:TRIGger:A:BUS:EUSB:ENDSEARCh?`

**Arguments**        `OFF` specifies the EOP bits as OFF (for Low Speed and Full Speed).  
`ON` specifies the EOP bits as ON (for High Speed).

**Examples**         `SEARCH:SEARCH1:TRIGger:A:BUS:EUSB:ENDSEARCh OFF` specifies the EOP bits as OFF.

`SEARCH:SEARCH1:TRIGger:A:BUS:EUSB:ENDSEARCh?` might return `:SEARCH:SEARCH1:TRIGger:A:BUS:EUSB:ENDSEARCh OFF`, indicating the EOP bits as off.

## **SEARCH:SEARCH<x>:TRIGger:A:BUS:EUSB:EOP:DATABITS:SIZE**

This command sets the number of EOP bits, in bytes, to be used when triggering on a eUSB bus signal. The trigger condition must be set to EOP. The search number is specified by x.

**Conditions**        Requires option SR-EUSB2

<b>Group</b>	Search and Mark
<b>Syntax</b>	SEARCH:SEARCH<x>:TRIGger:A:BUS:EUSB:EOP:DATABITS:SIZE <NR1> SEARCH:SEARCH<x>:TRIGger:A:BUS:EUSB:EOP:DATABITS:SIZE?
<b>Arguments</b>	<NR1> specifies the number of EOP bits. The default EOP bits is 8. The argument range is 8 to 100 bits.
<b>Examples</b>	SEARCH:SEARCH1:TRIGger:A:BUS:EUSB:EOP:DATABITS:SIZE 8 specifies EOP bits as 8 within an eUSB frame to search on.  SEARCH:SEARCH1:TRIGger:A:BUS:EUSB:EOP:DATABITS:SIZE? might return :SEARCH:SEARCH1:TRIGger:A:BUS:EUSB:EOP:DATABITS:SIZE 8, indicating that EOP bits value is 8 in the currently specified field within an eUSB frame to search on.

## SEARCH:SEARCH<x>:TRIGger:A:BUS:EUSB:EOP:QUALifier

This command sets the qualifier to be used when triggering on a eUSB bus signal. The trigger condition must be set to EOP Bits. The search number is specified by x.

<b>Conditions</b>	Requires option SR-EUSB2
<b>Group</b>	Search and Mark
<b>Syntax</b>	SEARCH:SEARCH<x>:TRIGger:A:BUS:EUSB:EOP:QUALifier {Equal UNEQUAL LESSthan MOREthan LESSEQUAL MOREEQUAL INrange OUTrange} SEARCH:SEARCH<x>:TRIGger:A:BUS:EUSB:EOP:QUALifier?
<b>Arguments</b>	Equal specifies the qualifier as Equal. UNEQUAL specifies the qualifier as Not Equal to. LESSthan specifies the qualifier as Less Than. MOREthan specifies the qualifier as More Than. LESSEQUAL specifies the qualifier as Less Than or Equal to. MOREEQUAL specifies the qualifier as More Than or Equal to. INrange specifies the qualifier as Inside Range.



OUTrange specifies the qualifier as Out of Range.

**Examples** SEARCH:SEARCH1:TRIGger:A:BUS:EUSB:EOP:QUALifier Equal specifies the trigger value as Equal.

SEARCH:SEARCH1:TRIGger:A:BUS:EUSB:EOP:QUALifier? might return :SEARCH:SEARCH1:TRIGger:A:BUS:EUSB:EOP:QUALifier Equal, indicating the trigger value is Equal.

## SEARCH:SEARCH<x>:TRIGger:A:BUS:EUSB:EOPBITS:MAX:SIZE

This command sets the number of EOP bits to be used when triggering on a eUSB bus signal. The trigger condition must be set to EOP. The search number is specified by x.

**Conditions** Requires option SR-EUSB2

**Group** Search and Mark

**Syntax** SEARCH:SEARCH<x>:TRIGger:A:BUS:EUSB:EOPBITS:MAX:SIZE <NR1>  
SEARCH:SEARCH<x>:TRIGger:A:BUS:EUSB:EOPBITS:MAX:SIZE?

**Arguments** <NR1> specifies the number of EOP bits. The default maximum EOP bits is 100. The argument range is 9 to 100 bits.

**Examples** SEARCH:SEARCH1:TRIGger:A:BUS:EUSB:EOPBITS:MAX:SIZE 100 specifies maximum EOP bits as 100 within an eUSB frame to search on.

SEARCH:SEARCH1:TRIGger:A:BUS:EUSB:EOPBITS:MAX:SIZE? might return :SEARCH:SEARCH1:TRIGger:A:BUS:EUSB:EOPBITS:MAX:SIZE 100, indicating that maximum EOP bits value is 100 in the currently specified field within an eUSB frame to search on.

## SEARCH:SEARCH<x>:TRIGger:A:BUS:EUSB:EOPBITS:MIN:SIZE

This command sets the number of EOP bits to be used when triggering on a eUSB bus signal. The trigger condition must be set to EOP. The search number is specified by x.

**Conditions** Requires option SR-EUSB2

<b>Group</b>	Search and Mark
<b>Syntax</b>	SEARCH:SEARCH<x>:TRIGger:A:BUS:EUSB:EOPBITS:MIN:SIZE <NR1> SEARCH:SEARCH<x>:TRIGger:A:BUS:EUSB:EOPBITS:MIN:SIZE?
<b>Arguments</b>	<NR1> specifies the number of EOP bits. The default minimum EOP bits is 8. The argument range is 8 to 99 bits.
<b>Examples</b>	SEARCH:SEARCH1:TRIGger:A:BUS:EUSB:EOPBITS:MIN:SIZE 8 specifies minimum EOP bits as 8 within an eUSB frame to search on.  SEARCH:SEARCH1:TRIGger:A:BUS:EUSB:EOPBITS:MIN:SIZE? might return :SEARCH:SEARCH1:TRIGger:A:BUS:EUSB:EOPBITS:MIN:SIZE 8, indicating that minimum EOP bits value is 8 in the currently specified field within an eUSB frame to search on.

## SEARCH:SEARCH<x>:TRIGger:A:BUS:EUSB:HANDSHAKEType

This command specifies the eUSB trigger type to be valid on any, ack, nak, stall, or nyet condition. The search number is specified by x.

<b>Conditions</b>	Requires option SR-EUSB2
<b>Group</b>	Search and Mark
<b>Syntax</b>	SEARCH:SEARCH<x>:TRIGger:A:BUS:EUSB:HANDSHAKEType {ANY ACK NAK STALL NYET} SEARCH:SEARCH<x>:TRIGger:A:BUS:EUSB:HANDSHAKEType?
<b>Arguments</b>	ANY specifies the handshake type as Any (0010).  ACK specifies the handshake type as Acknowledgement (positive) (XX10).  NAK specifies the handshake type as Negative Acknowledgment (1010).  STALL specifies the error type as PID Check Bits.  NYET specifies the handshake type as Stall (endpoint is halted or control pipe request not supported) (1110).
<b>Examples</b>	SEARCH:SEARCH1:TRIGger:A:BUS:EUSB:HANDSHAKEType ANY specifies any as the field within an eUSB frame to search on.

SEARCH:SEARCH1:TRIGger:A:BUS:EUSB:HANDSHAKEType? might return SEARCH:SEARCH1:TRIGger:A:BUS:EUSB:HANDSHAKEType ANY, indicating that any is the currently specified field within a eUSB frame to search on.

## SEARCH:SEARCH<x>:TRIGger:A:BUS:EUSB:RAP:ADDress:VALue

This command sets the binary Register Access Protocol address value to be used when triggering on a eUSB bus signal. The trigger condition must be set to TOKEN. The search number is specified by x.

<b>Conditions</b>	Requires option SR-EUSB2
<b>Group</b>	Search and Mark
<b>Syntax</b>	SEARCH:SEARCH<x>:TRIGger:A:BUS:EUSB:RAP:ADDress:VALue <QString> SEARCH:SEARCH<x>:TRIGger:A:BUS:EUSB:RAP:ADDress:VALue?
<b>Arguments</b>	<QString> specifies the value in the specified valid format. The valid characters are 0, 1, and X for binary; for hexadecimal; and symbolic.
<b>Examples</b>	SEARCH:SEARCH1:TRIGger:A:BUS:EUSB:RAP:ADDress:VALue XXXXXX specifies RAP address as XXXXXX within an eUSB frame to search on.  SEARCH:SEARCH1:TRIGger:A:BUS:EUSB:RAP:ADDress:VALue? might return :SEARCH:SEARCH1:TRIGger:A:BUS:EUSB:RAP:ADDress:VALue XXXXXX, indicating that RAP address value XXXXXX is the currently specified field within an eUSB frame to search on.

## SEARCH:SEARCH<x>:TRIGger:A:BUS:EUSB:RAP:COMManD

This command specifies the eUSB Register Access Protocol search option. The search number is specified by x.

<b>Conditions</b>	Requires option SR-EUSB2
<b>Group</b>	Search and Mark
<b>Syntax</b>	SEARCH:SEARCH<x>:TRIGger:A:BUS:EUSB:RAP:COMManD {ALL WRITE READ CLEAR SET}

SEARCH:SEARCH<x>:TRIGger:A:BUS:EUSB:RAP:COMManD?

**Arguments** ALL specifies the RAP command as All.  
 WRITe specifies the RAP command as Write.  
 READ specifies the RAP command as Read.  
 CLear specifies the RAP command as Clear.  
 SET specifies the RAP command as Set.

**Examples** SEARCH:SEARCH1:TRIGger:A:BUS:EUSB:RAP:COMManD ALL specifies the command as the field within an eUSB frame to search on.  
 SEARCH:SEARCH1:TRIGger:A:BUS:EUSB:RAP:COMManD? might return :SEARCH:SEARCH1:TRIGger:A:BUS:EUSB:RAP:COMManD ALL, indicating that command type is ALL.

## SEARCH:SEARCH<x>:TRIGger:A:BUS:EUSB:RAP:DATA:VALue

This command sets the binary Register Access Protocol data value to be used when triggering on a eUSB bus signal. The trigger condition must be set to TOKEN. The search number is specified by x.

**Conditions** Requires option SR-EUSB2

**Group** Search and Mark

**Syntax** SEARCH:SEARCH<x>:TRIGger:A:BUS:EUSB:RAP:DATA:VALue <QString>  
 SEARCH:SEARCH<x>:TRIGger:A:BUS:EUSB:RAP:DATA:VALue?

**Arguments** <QString> specifies the value in the specified valid format. The valid characters are 0, 1, and X for binary; for hexadecimal; and symbolic.

**Examples** SEARCH:SEARCH1:TRIGger:A:BUS:EUSB:RAP:DATA:VALue XXXXXXXX specifies RAP data value as XXXXXXXX within an eUSB frame to search on.  
 SEARCH:SEARCH1:TRIGger:A:BUS:EUSB:RAP:DATA:VALue? might return :SEARCH:SEARCH1:TRIGger:A:BUS:EUSB:RAP:DATA:VALue XXXXXXXX, indicating that RAP data value XXXXXXXX is the currently specified field within an eUSB frame to search on.

## SEARCH:SEARCH<x>:TRIGger:A:BUS:EUSB:RAP:OPTion

This command specifies the eUSB Register Access Protocol search option. The search number is specified by x.

<b>Conditions</b>	Requires option SR-EUSB2
<b>Group</b>	Search and Mark
<b>Syntax</b>	SEARCH:SEARCH<x>:TRIGger:A:BUS:EUSB:RAP:OPTion {COMMAND ADDRESS RAPDATA} SEARCH:SEARCH<x>:TRIGger:A:BUS:EUSB:RAP:OPTion?
<b>Arguments</b>	COMMAND specifies the RAP option as Command. ADDRESS specifies the RAP option as Address. RAPDATA specifies the RAP option as RapData.
<b>Examples</b>	SEARCH:SEARCH1:TRIGger:A:BUS:EUSB:RAP:OPTion COMMAND specifies the RAP option as the field within an eUSB frame to search on.  SEARCH:SEARCH1:TRIGger:A:BUS:EUSB:RAP:OPTion? might return :SEARCH:SEARCH1:TRIGger:A:BUS:EUSB:RAP:OPTion COMMAND, indicating that RAP option is COMMAND.

## SEARCH:SEARCH<x>:TRIGger:A:BUS:EUSB:SOFFRAMENUMber

This command sets the binary frame number to be used when triggering on a eUSB bus signal. The trigger condition must be set to TOKEN. The search number is specified by x.

<b>Conditions</b>	Requires option SR-EUSB2
<b>Group</b>	Search and Mark
<b>Syntax</b>	SEARCH:SEARCH<x>:TRIGger:A:BUS:EUSB:SOFFRAMENUMber <QString> SEARCH:SEARCH<x>:TRIGger:A:BUS:EUSB:SOFFRAMENUMber?
<b>Arguments</b>	<QString> specifies the binary frame number within the range 000 0000 0000 to 111 1111 1111 (000 hex to 7FF hex).

**Examples**     `SEARCH:SEARCH1:TRIGger:A:BUS:EUSB:SOFFRAMENUMber XXXXXXXXXXXX`  
specifies frame number as XXXXXXXXXXXX within an eUSB frame to search on.

`SEARCH:SEARCH1:TRIGger:A:BUS:EUSB:SOFFRAMENUMber?` might return  
`SEARCH:SEARCH1:TRIGger:A:BUS:EUSB:SOFFRAMENUMber XXXXXXXXXXXX`,  
indicating that XXXXXXXXXXXX in the currently specified field within an eUSB  
frame to search on.

## **SEARCH:SEARCH<x>:TRIGger:A:BUS:EUSB:SPECIALType**

This command specifies the eUSB trigger type to be valid on any, err, split, ping, or reserved condition. The search number is specified by x.

**Conditions**     Requires option SR-EUSB2

**Group**            Search and Mark

**Syntax**           `SEARCH:SEARCH<x>:TRIGger:A:BUS:EUSB:SPECIALType {ANY|`  
`PREAmbLe| ERROR| SPLit| PING| RESERVed}`  
`SEARCH:SEARCH<x>:TRIGger:A:BUS:EUSB:SPECIALType?`

**Arguments**     ANY specifies the PID value as Any (XX00).  
PREAmbLe specifies the PID value as PRE (1100).  
ERROR specifies the PID value as ERR (1100).  
SPLit specifies the PID value as Split (1000).  
PING specifies the PID value as PING (0100).  
RESERVed specifies the PID value as Reserved (0000).

**Examples**     `SEARCH:SEARCH1:TRIGger:A:BUS:EUSB:SPECIALType ANY` specifies the  
special type as any.

`SEARCH:SEARCH1:TRIGger:A:BUS:EUSB:SPECIALType?` might return  
`SEARCH:SEARCH1:TRIGger:A:BUS:EUSB:SPECIALType ANY`, indicating  
the special type is any.

## **SEARCH:SEARCH<x>:TRIGger:A:BUS:EUSB:SPLit:ET:VALue**

This command specifies the eUSB trigger type endpoint condition. The search number is specified by x.

<b>Conditions</b>	Requires option SR-EUSB2
<b>Group</b>	Search and Mark
<b>Syntax</b>	SEARCH:SEARCH<x>:TRIGger:A:BUS:EUSB:SPLit:ET:VALue {NOCARE  CONTRol  ISOchronous  BULK  INTERRUPT} SEARCH:SEARCH<x>:TRIGger:A:BUS:EUSB:SPLit:ET:VALue?
<b>Arguments</b>	NOCARE specifies the Endpoint Type value as Don't Care. CONTRol specifies the Endpoint Type value as Control (00). ISOchronous specifies the Endpoint Type value as Isochronous (01). BULK specifies the Endpoint Type value as Bulk (10). INTERRUPT specifies the Endpoint Type value as Interrupt (11).
<b>Examples</b>	SEARCH:SEARCH1:TRIGger:A:BUS:EUSB:SPLit:ET:VALue CONTRol sets the endpoint condition as Control.  SEARCH:SEARCH1:TRIGger:A:BUS:EUSB:SPLit:ET:VALue? might return SEARCH:SEARCH1:TRIGger:A:BUS:EUSB:SPLit:ET:VALue CONTRol, indicating the endpoint condition is Control.

## SEARCH:SEARCH<x>:TRIGger:A:BUS:EUSB:SPLit:HUB:VALue

This command sets the binary hub address value to be used when triggering on a eUSB bus signal. The trigger condition must be set to Special with packet type SPLIT. The search number is specified by x.

<b>Conditions</b>	Requires option SR-EUSB2
<b>Group</b>	Search and Mark
<b>Syntax</b>	SEARCH:SEARCH<x>:TRIGger:A:BUS:EUSB:SPLit:HUB:VALue <QString> SEARCH:SEARCH<x>:TRIGger:A:BUS:EUSB:SPLit:HUB:VALue?
<b>Arguments</b>	<QString> specifies the value in the specified valid format. The valid characters are 0, 1, and X (for binary, for hexadecimal, and symbolic).

- Examples**     `SEARCH:SEARCH1:TRIGger:A:BUS:EUSB:SPLit:HUB:VALue XXXXXXX` specifies hub address value as XXXXXXX within an eUSB frame to search on.
- `SEARCH:SEARCH1:TRIGger:A:BUS:EUSB:SPLit:HUB:VALue?` might return `SEARCH:SEARCH1:TRIGger:A:BUS:EUSB:SPLit:HUB:VALue XXXXXXX`, indicating that hub address value is XXXXXXX in the currently specified field within an eUSB frame to search on.

## **SEARCH:SEARCH<x>:TRIGger:A:BUS:EUSB:SPLit:PORT:VALue**

This command sets the binary port address value to be used when triggering on a eUSB bus signal. The trigger condition must be set to Special with a packet type SPLIT. The search number is specified by x.

- Conditions**     Requires option SR-EUSB2
- Group**             Search and Mark
- Syntax**            `SEARCH:SEARCH<x>:TRIGger:A:BUS:EUSB:SPLit:PORT:VALue <QString>`  
`SEARCH:SEARCH<x>:TRIGger:A:BUS:EUSB:SPLit:PORT:VALue?`
- Arguments**        `<QString>` specifies the value in the specified valid format. The valid characters are 0, 1, and X (for binary, for hexadecimal, and symbolic).
- Examples**         `SEARCH:SEARCH1:TRIGger:A:BUS:EUSB:SPLit:PORT:VALue XXXXXXX` specifies port address as XXXXXXX within an eUSB frame to search on.
- `SEARCH:SEARCH1:TRIGger:A:BUS:EUSB:SPLit:PORT:VALue?` might return `SEARCH:SEARCH1:TRIGger:A:BUS:EUSB:SPLit:PORT:VALue XXXXXXX`, indicating that port address value is XXXXXXX in the currently specified field within an eUSB frame to search on.

## **SEARCH:SEARCH<x>:TRIGger:A:BUS:EUSB:SPLit:SC:VALue**

This command specifies the eUSB trigger type start/complete condition. The search number is specified by x.

- Conditions**        Requires option SR-EUSB2
- Group**             Search and Mark



<b>Syntax</b>	SEARCH:SEARCH<x>:TRIGger:A:BUS:EUSB:SPLit:SC:VALue {NOCARE SSPLIT CSPLIT} SEARCH:SEARCH<x>:TRIGger:A:BUS:EUSB:SPLit:SC:VALue?
<b>Arguments</b>	NOCARE sets the trigger on either the start or complete phase of the split transaction.  SSPLIT sets the trigger on the start phase of the split transaction.  CSPLIT sets the trigger on the complete phase of the split transaction.
<b>Examples</b>	SEARCH:SEARCH1:TRIGger:A:BUS:EUSB:SPLit:SC:VALue NOCARE sets the start/complete condition as nocare.  SEARCH:SEARCH1:TRIGger:A:BUS:EUSB:SPLit:SC:VALue? might return SEARCH:SEARCH1:TRIGger:A:BUS:EUSB:SPLit:SC:VALue NOCARE, indicating that the start/complete condition is nocare.

## SEARCH:SEARCH<x>:TRIGger:A:BUS:EUSB:SPLit:SE:VALue

This command specifies the eUSB trigger type start/complete condition. The search number is specified by x.

<b>Conditions</b>	Requires option SR-EUSB2
<b>Group</b>	Search and Mark
<b>Syntax</b>	SEARCH:SEARCH<x>:TRIGger:A:BUS:EUSB:SPLit:SE:VALue {NOCARE FULLSPEED LOWSPEED ISOSTART ISOMID ISOEND ISOALL} SEARCH:SEARCH<x>:TRIGger:A:BUS:EUSB:SPLit:SE:VALue?
<b>Arguments</b>	NOCARE sets the trigger on any combination of S and E bits.  FULLSPEED sets the trigger on S bit = 0 and E bit = 0.  LOWSPEED sets the trigger on S bit = 1 and E bit = 0.  ISOSTART sets the trigger on S bit = 1, E bit = 0.  ISOMID specifies Isochronous Data is Middle (00) Start/End bit value.  ISOEND specifies Isochronous Data is End (01) Start/End bit value.  ISOALL specifies Isochronous Data is All (11) Start/End bit value.

**Examples**     `SEARCH:SEARCH1:TRIGGER:A:BUS:EUSB:SPLIT:SE:VALUE FULLSPEED`  
sets the start/complete condition as fullspeed.

`SEARCH:SEARCH1:TRIGGER:A:BUS:EUSB:SPLIT:SE:VALUE?` might return  
`SEARCH:SEARCH1:TRIGGER:A:BUS:EUSB:SPLIT:SE:VALUE FULLSPEED`,  
indicating that the start/complete condition is fullspeed.

## **SEARCH:SEARCH<x>:TRIGGER:A:BUS:EUSB:SYNC:QUALIFIER**

This command sets the qualifier to be used when triggering on a eUSB bus signal. The trigger condition must be set to Sync Bits. The search number is specified by x.

**Conditions**     Requires option SR-EUSB2

**Group**           Search and Mark

**Syntax**         `SEARCH:SEARCH<x>:TRIGGER:A:BUS:EUSB:SYNC:QUALIFIER {EQUAL|`  
`UNEQUAL| LESSTHAN| MORETHAN| LESSEQUAL| MOREEQUAL| INRANGE|`  
`OUTRANGE}`  
`SEARCH:SEARCH<x>:TRIGGER:A:BUS:EUSB:SYNC:QUALIFIER?`

**Arguments**     `EQUAL` specifies the qualifier as Equal.  
`UNEQUAL` specifies the qualifier as Not Equal to.  
`LESSTHAN` specifies the qualifier as Less Than.  
`MORETHAN` specifies the qualifier as More Than.  
`LESSEQUAL` specifies the qualifier as Less Than or Equal to.  
`MOREEQUAL` specifies the qualifier as More Than or Equal to.  
`INRANGE` specifies the qualifier as Inside Range.  
`OUTRANGE` specifies the qualifier as Out of Range.

**Examples**     `SEARCH:SEARCH1:TRIGGER:A:BUS:EUSB:SYNC:QUALIFIER EQUAL`  
specifies the trigger value as Equal.

`SEARCH:SEARCH1:TRIGGER:A:BUS:EUSB:SYNC:QUALIFIER?` might return  
`:SEARCH:SEARCH1:TRIGGER:A:BUS:EUSB:SYNC:QUALIFIER EQUAL`,  
indicating the trigger value is Equal.

**SEARCH:SEARCH<x>:TRIGger:A:BUS:EUSB:SYNcBITS:MAX:SIZE**

This command sets the number of sync bits, to be used when triggering on a eUSB bus signal. The trigger condition must be set to SYNC. The search number is specified by x.

<b>Conditions</b>	Requires option SR-EUSB2
<b>Group</b>	Search and Mark
<b>Syntax</b>	SEARCH:SEARCH<x>:TRIGger:A:BUS:EUSB:SYNcBITS:MAX:SIZE <NR1> SEARCH:SEARCH<x>:TRIGger:A:BUS:EUSB:SYNcBITS:MAX:SIZE?
<b>Arguments</b>	<NR1> specifies the number of sync bits. The default maximum Sync bits is 32. The argument range is 13 to 32 bits.
<b>Examples</b>	SEARCH:SEARCH1:TRIGger:A:BUS:EUSB:SYNcBITS:MAX:SIZE 32 specifies minimum Sync bits as 32 within an eUSB frame to search on.  SEARCH:SEARCH1:TRIGger:A:BUS:EUSB:SYNcBITS:MAX:SIZE? might return :SEARCH:SEARCH1:TRIGger:A:BUS:EUSB:SYNcBITS:MAX:SIZE 32, indicating that minimum Sync bits value is 32 in the currently specified field within an eUSB frame to search on.

**SEARCH:SEARCH<x>:TRIGger:A:BUS:EUSB:SYNcBITS:MIN:SIZE**

This command sets the number of sync bits, in bits, to be used when triggering on a eUSB bus signal. The trigger condition must be set to SYNC. The search number is specified by x.

<b>Conditions</b>	Requires option SR-EUSB2
<b>Group</b>	Search and Mark
<b>Syntax</b>	SEARCH:SEARCH<x>:TRIGger:A:BUS:EUSB:SYNcBITS:MIN:SIZE <NR1> SEARCH:SEARCH<x>:TRIGger:A:BUS:EUSB:SYNcBITS:MIN:SIZE?
<b>Arguments</b>	<NR1> specifies the number of sync bits. The default minimum Sync bits is 12. The argument range is 12 to 31 bits.

- Examples**     `SEARCH:SEARCH1:TRIGger:A:BUS:EUSB:SYNCBITS:MIN:SIZE 12`  
specifies minimum Sync bits as 12 within an eUSB frame to search on.
- `SEARCH:SEARCH1:TRIGger:A:BUS:EUSB:SYNCBITS:MIN:SIZE?` might  
return `:SEARCH:SEARCH1:TRIGger:A:BUS:EUSB:SYNCBITS:MIN:SIZE 12,`  
indicating that minimum Sync bits value is 12 in the currently specified field  
within an eUSB frame to search on.

## **SEARCH:SEARCH<x>:TRIGger:A:BUS:EUSB:SYNCSEARCh**

This command specifies eUSB Search Sync Bits to be On and Off. The search number is specified by x.

- Conditions**     Requires option SR-EUSB2
- Group**            Search and Mark
- Syntax**           `SEARCH:SEARCH<x>:TRIGger:A:BUS:EUSB:SYNCSEARCH {OFF|ON}`  
`SEARCH:SEARCH<x>:TRIGger:A:BUS:EUSB:SYNCSEARCH?`
- Arguments**      OFF specifies the Sync bits as OFF (for Low Speed and Full Speed).  
ON specifies the Sync bits as ON (for High Speed).
- Examples**        `SEARCH:SEARCH1:TRIGger:A:BUS:EUSB:SYNCSEARCH OFF` specifies the  
SYNC bits as off.
- `SEARCH:SEARCH1:TRIGger:A:BUS:EUSB:SYNCSEARCH?` might return  
`:SEARCH:SEARCH1:TRIGger:A:BUS:EUSB:SYNCSEARCH OFF,` indicating  
the SYNC bits is off.

## **SEARCH:SEARCH<x>:TRIGger:A:BUS:EUSB:TOKENType**

This command specifies the eUSB trigger type to be valid on any, sof, out, in, or setup condition. The search number is specified by x.

- Conditions**      Requires option SR-EUSB2
- Group**            Search and Mark

<b>Syntax</b>	SEARCH:SEARCH<x>:TRIGger:A:BUS:EUSB:TOKENType {ANY SOF OUT IN SETUP} SEARCH:SEARCH<x>:TRIGger:A:BUS:EUSB:TOKENType?
<b>Arguments</b>	ANY specifies the token type as Any (XX01). SOF specifies the token type as Start Of Frame (0101). OUT specifies the token type as OUT (0001). IN specifies the token type as IN (1001). SETUP specifies the token type as SETUP (1101).
<b>Examples</b>	SEARCH:SEARCH1:TRIGger:A:BUS:EUSB:TOKENType SETUP specifies the token type Setup as the field within an eUSB frame to search on.  SEARCH:SEARCH1:TRIGger:A:BUS:EUSB:TOKENType? might return SEARCH:SEARCH1:TRIGger:A:BUS:EUSB:TOKENType SETUP, indicating that the token type is Setup.

## SEARCH:SEARCH<x>:TRIGger:A:BUS:FLEXRAY:CONDition

This command sets or queries the FlexRay bus search condition. The search number is specified by x.

<b>Conditions</b>	Requires option 5-SRAUTO or SUP5-SRAUTO Triggering and Analysis application.
<b>Group</b>	Search and Mark
<b>Syntax</b>	SEARCH:SEARCH<x>:TRIGger:A:BUS: FLEXRAY:CONDition {SOF FRAMEType  IDentifier CYCLEcount HEADER DATA IDANDDATA EOF ERROR} SEARCH:SEARCH<x>:TRIGger:A:BUS:FLEXRAY:CONDition?
<b>Arguments</b>	Arguments are the available trigger conditions.
<b>Examples</b>	SEARCH:SEARCH1:TRIGger:A:BUS:FLEXRAY:CONDition SOF sets the trigger condition to start of frame.  SEARCH:SEARCH1:TRIGger:A:BUS:FLEXRAY:CONDition? might return SEARCH:SEARCH1:TRIGGER:A:BUS:FLEXRAY:CONDITION SOF, indicating the FlexRay trigger condition is start of frame.

## SEARCH:SEARCH<x>:TRIGger:A:BUS:FLEXRAY:CYCLEcount:HIVALue

This command sets or queries the heigh value when searching on a FlexRay bus cycle count field. The search number is specified by x. The search condition must be set to CYCLEcount.

<b>Conditions</b>	Requires option 5-SRAUTO or SUP5-SRAUTO Triggering and Analysis application.
<b>Group</b>	Search and Mark
<b>Syntax</b>	SEARCH:SEARCH<x>:TRIGger:A:BUS:FLEXRAY:CYCLEcount:HIVALue <Qstring> SEARCH:SEARCH<x>:TRIGger:A:BUS:FLEXRAY:CYCLEcount:HIVALue?
<b>Arguments</b>	<Qstring> specifies the cycle count value.
<b>Examples</b>	SEARCH:SEARCH1:TRIGger:A:BUS:FLEXRAY:CYCLEcount:HIVALue "1010" sets the cycle count value to XX1010.  SEARCH:SEARCH1:TRIGger:A:BUS:FLEXRAY:CYCLEcount:HIVALue? might return SEARCH:SEARCH1:TRIGGER:A:BUS:FLEXRAY:CYCLECOUNT:HIVALUE "XXXXXX", indicating the cycle count value is don't care, and it will trigger on any cycle count.

## SEARCH:SEARCH<x>:TRIGger:A:BUS:FLEXRAY:CYCLEcount:QUALifier

This command sets or queries the qualifier to be used when searching on a FlexRay bus search cycle count field. The search number is specified by x. The search condition must be set to CYCLEcount.

<b>Conditions</b>	Requires option 5-SRAUTO or SUP5-SRAUTO Triggering and Analysis application.
<b>Group</b>	Search and Mark
<b>Syntax</b>	SEARCH:SEARCH<x>:TRIGger:A:BUS:FLEXRAY:CYCLEcount:QUALifier {EQUa LESSEQua MOREEQua UNEQua LESSthan MOREthan INrange OUTrange} SEARCH:SEARCH<x>:TRIGger:A:BUS:FLEXRAY:CYCLEcount:QUALifier?

**Arguments** Arguments are the available cycle count qualifiers.

**Examples** SEARCH:SEARCH1:TRIGger:A:BUS:FLEXRAY:CYCLEcount:QUALifier  
LESSthan sets the cycle count qualifier to less than.

SEARCH:SEARCH1:TRIGger:A:BUS:FLEXRAY:CYCLEcount:QUALifier?  
might return  
SEARCH:SEARCH1:TRIGGER:A:BUS:FLEXRAY:CYCLECOUNT:QUALIFIER  
EQUAL, indicating the cycle count qualifier is set to equal.

## SEARCH:SEARCH<x>:TRIGger:A:BUS:FLEXRAY:CYCLEcount:VALue

This command sets or queries the low value when searching on a FlexRay bus cycle count field. The search number is specified by x. The search condition must be set to CYCLEcount.

**Conditions** Requires option 5-SRAUTO or SUP5-SRAUTO Triggering and Analysis application.

**Group** Search and Mark

**Syntax** SEARCH:SEARCH<x>:TRIGger:A:BUS:FLEXRAY:CYCLEcount:VALue  
<QString>  
SEARCH:SEARCH<x>:TRIGger:A:BUS:FLEXRAY:CYCLEcount:VALue?

**Arguments** <QString> specifies the cycle count value.

**Examples** SEARCH:SEARCH1:TRIGger:A:BUS:FLEXRAY:CYCLEcount:VALue "1010"  
sets the cycle count value to XX1010.

SEARCH:SEARCH1:TRIGger:A:BUS:FLEXRAY:CYCLEcount:VALue? might  
return SEARCH:SEARCH1:TRIGGER:A:BUS:FLEXRAY:CYCLECOUNT:VALUE  
"XXXXXX", indicating the cycle count value is don't care, and it will trigger on  
any cycle count.

## SEARCH:SEARCH<x>:TRIGger:A:BUS:FLEXRAY:DATA:HIVALue

This command sets or queries the high value when searching on a FlexRay bus data field. The search number is specified by x. The search condition must be set to IDANDDATA OR DATA.

<b>Conditions</b>	Requires option 5-SRAUTO or SUP5-SRAUTO Triggering and Analysis application.
<b>Group</b>	Search and Mark
<b>Syntax</b>	SEARCH:SEARCH<x>:TRIGger:A:BUS:FLEXRAY:DATA:HIVALue <QString> SEARCH:SEARCH<x>:TRIGger:A:BUS:FLEXRAY:DATA:HIVALue?
<b>Arguments</b>	<QString> specifies the data value.
<b>Examples</b>	SEARCH:SEARCH1:TRIGger:A:BUS:FLEXRAY:DATA:HIVALue "1010" sets the data value to XXXXXX1010.  SEARCH:SEARCH1:TRIGger:A:BUS:FLEXRAY:DATA:HIVALue? might return SEARCH:SEARCH1:TRIGGER:A:BUS:FLEXRAY:DATA:HIVALUE "XXXXXXXXXX", indicating the data value is a don't care.

## SEARCH:SEARCH<x>:TRIGger:A:BUS:FLEXRAY:DATA:OFFSet

This command sets or queries the offset of the data string, in bytes, when searching on a FlexRay bus data field. The search number is specified by x. The search condition must be set to IDANDDATA OR DATA.

<b>Conditions</b>	Requires option 5-SRAUTO or SUP5-SRAUTO Triggering and Analysis application.
<b>Group</b>	Search and Mark
<b>Syntax</b>	SEARCH:SEARCH<x>:TRIGger:A:BUS:FLEXRAY:DATA:OFFSet <NR3> SEARCH:SEARCH<x>:TRIGger:A:BUS:FLEXRAY:DATA:OFFSet?
<b>Arguments</b>	<NR3> specifies the data offset in bytes. A setting of X/Don't care is accomplished by setting the offset to -1.
<b>Examples</b>	SEARCH:SEARCH1:TRIGger:A:BUS:FLEXRAY:DATA:OFFSet 2 sets the data offset to 2 bytes.  SEARCH:SEARCH1:TRIGger:A:BUS:FLEXRAY:DATA:OFFSet? might return SEARCH:SEARCH1:TRIGGER:A:BUS:FLEXRAY:DATA:OFFSet -1, indicating the data offset is don't care.



**SEARCH:SEARCH<x>:TRIGger:A:BUS:FLEXRAY:DATA:QUALifier**

This command sets or queries the qualifier to be used when searching on a FlexRay bus signal. The search number is specified by x.

<b>Conditions</b>	Requires option 5-SRAUTO or SUP5-SRAUTO Triggering and Analysis application.
<b>Group</b>	Search and Mark
<b>Syntax</b>	SEARCH:SEARCH<x>:TRIGger:A:BUS:FLEXRAY:DATA:QUALifier {EQUAL LESSEQUAL MOREEQUAL UNEQUAL LESSthan MOREthan INrange OUTrange} SEARCH:SEARCH<x>:TRIGger:A:BUS:FLEXRAY:DATA:QUALifier?
<b>Arguments</b>	Arguments are the available data qualifiers.
<b>Examples</b>	SEARCH:SEARCH1:TRIGger:A:BUS:FLEXRAY:DATA:QUALifier LESSTHAN sets the data qualifier to less than.  SEARCH:SEARCH1:TRIGger:A:BUS:FLEXRAY:DATA:QUALifier? might return SEARCH:SEARCH1:TRIGGER:A:BUS:FLEXRAY:DATA:QUALIFIER EQUAL, indicating the data qualifier is equal.

**SEARCH:SEARCH<x>:TRIGger:A:BUS:FLEXRAY:DATA:SIZE**

This command sets or queries the length of the data string, in bytes, to be used when searching on a FlexRay bus data field. The search number is specified by x. The search condition must be set to IDANDDATA OR DATA.

<b>Conditions</b>	Requires option 5-SRAUTO or SUP5-SRAUTO Triggering and Analysis application.
<b>Group</b>	Search and Mark
<b>Syntax</b>	SEARCH:SEARCH<x>:TRIGger:A:BUS:FLEXRAY:DATA:SIZE <NR1> SEARCH:SEARCH<x>:TRIGger:A:BUS:FLEXRAY:DATA:SIZE?
<b>Arguments</b>	<NR1> specifies the data size in bytes. A data size of -1 is don't care.

- Examples**     `SEARCH:SEARCH1:TRIGger:A:BUS:FLEXRAY:DATA:SIZE 2` sets the data size to 2.
- `SEARCH:SEARCH1:TRIGger:A:BUS:FLEXRAY:DATA:SIZE?` might return `SEARCH:SEARCH1:TRIGGER:A:BUS:FLEXRAY:DATA:SIZE 1`, indicating the data size is 1 byte.

## **SEARCH:SEARCH<x>:TRIGger:A:BUS:FLEXRAY:DATA:VALue**

This command sets or queries the low value to be used when searching on a FlexRay bus data field. The search number is specified by x. The search condition must be set to IDANDDATA or DATA.

- Conditions**     Requires option 5-SRAUTO or SUP5-SRAUTO Triggering and Analysis application.
- Group**            Search and Mark
- Syntax**           `SEARCH:SEARCH<x>:TRIGger:A:BUS:FLEXRAY:DATA:VALue <QString>`  
`SEARCH:SEARCH<x>:TRIGger:A:BUS:FLEXRAY:DATA:VALue?`
- Arguments**      <QString> specifies the data value.
- Examples**        `SEARCH:SEARCH1:TRIGger:A:BUS:FLEXRAY:DATA:VALue "1010"` sets the data value to XXXXXX1010.
- `SEARCH:SEARCH1:TRIGger:A:BUS:FLEXRAY:DATA:VALue?` might return `SEARCH:SEARCH1:TRIGGER:A:BUS:FLEXRAY:DATA:VALUE "XXXXXXXXXX"`, indicating the data value is a don't care.

## **SEARCH:SEARCH<x>:TRIGger:A:BUS:FLEXRAY:EOFTYPE**

This command sets or queries the end of frame type when searching on a FlexRay bus signal. The search number is specified by x. The search condition must be set to EOF.

- Conditions**      Requires option 5-SRAUTO or SUP5-SRAUTO Triggering and Analysis application.
- Group**            Search and Mark

<b>Syntax</b>	SEARCH:SEARCH<x>:TRIGger:A:BUS:FLEXRAY:EOFTYPE {ANY STATIC DYNAMIC} SEARCH:SEARCH<x>:TRIGger:A:BUS:FLEXRAY:EOFTYPE?
<b>Arguments</b>	ALL specifies either end of file type.  STATIC specifies the static end of file type.  DYNAMIC specifies the static end of file type.
<b>Examples</b>	SEARCH:SEARCH1:TRIGger:A:BUS:FLEXRAY:EOFTYPE STATIC sets the end of file type to static.  SEARCH:SEARCH1:TRIGger:A:BUS:FLEXRAY:EOFTYPE? might return SEARCH:SEARCH1:TRIGGER:A:BUS:FLEXRAY:EOFTYPE ANY, indicating either end of file type will cause a trigger.

## SEARCH:SEARCH<x>:TRIGger:A:BUS:FLEXRAY:ERRTYPE

This command sets or queries the error type when searching on a FlexRay bus signal. The search number is specified by x. The search condition must be set to ERROR.

<b>Conditions</b>	Requires option 5-SRAUTO or SUP5-SRAUTO Triggering and Analysis application.
<b>Group</b>	Search and Mark
<b>Syntax</b>	SEARCH:SEARCH<x>:TRIGger:A:BUS:FLEXRAY:ERRTYPE {CRCHeader CRCTrailer NULLFRStatic NULLFRDynamic  SYNCFrame STARTupnosync} SEARCH:SEARCH<x>:TRIGger:A:BUS:FLEXRAY:ERRTYPE?
<b>Arguments</b>	Arguments are the available error types.
<b>Examples</b>	SEARCH:SEARCH1:TRIGger:A:BUS:FLEXRAY:ERRTYPE SYNCFRAME sets the error type to SYNCFRAME.  SEARCH:SEARCH1:TRIGger:A:BUS:FLEXRAY:ERRTYPE? might return SEARCH:SEARCH1:TRIGGER:A:BUS:FLEXRAY:ERRTYPE CRCHEADER, indicating the error type is CRCHEADER.

## SEARCH:SEARCH<x>:TRIGger:A:BUS:FLEXRAY:FRAMEID:HIVALue

This command sets or queries the high value when searching on a FlexRay bus frame id field. The search condition must be set to IDentifier. The search number is specified by x.

<b>Group</b>	Search and Mark
<b>Syntax</b>	SEARCH:SEARCH<x>:TRIGger:A:BUS:FLEXRAY:FRAMEID:HIVALue <QString> SEARCH:SEARCH<x>:TRIGger:A:BUS:FLEXRAY:FRAMEID:HIVALue?
<b>Arguments</b>	<QString> is the frame id high value.
<b>Examples</b>	SEARCH:SEARCH1:TRIGger:A:BUS:FLEXRAY:FRAMEID:HIVALue "XXXXXXXX1010" sets the HIVALUE to XXXXXXXX1010.  SEARCH:SEARCH1:TRIGger:A:BUS:FLEXRAY:FRAMEID:HIVALue? might return SEARCH:SEARCH1:TRIGGER:A:BUS:FLEXRAY:FRAMEID:HIVALUE "XXXXXXXXXXXX" indicating the HIVALUE is XXXXXXXXXXXX.

## SEARCH:SEARCH<x>:TRIGger:A:BUS:FLEXRAY:FRAMEID:QUALifier

This command sets the qualifier to be used when searching on a FlexRay bus signal. The search condition must be set to Identifier. The search number is specified by x.

<b>Group</b>	Search and Mark
<b>Syntax</b>	SEARCH:SEARCH<x>:TRIGger:A:BUS:FLEXRAY:FRAMEID:QUALifier {EQUAL UNEQUAL LESSthan MOREthan LESSEQUAL MOREEQUAL  INrange OUTrange} SEARCH:SEARCH<x>:TRIGger:A:BUS:FLEXRAY:FRAMEID:QUALifier?
<b>Arguments</b>	Arguments are the available data qualifiers.
<b>Examples</b>	SEARCH:SEARCH1:TRIGger:A:BUS:FLEXRAY:FRAMEID:QUALifier UNEQUAL sets the qualifier to unequal.  SEARCH:SEARCH1:TRIGger:A:BUS:FLEXRAY:FRAMEID:QUALifier? might return SEARCH:SEARCH1:TRIGGER:A:BUS:FLEXRAY:FRAMEID:QUALIFIER EQUAL indicating the qualifier is set to equal.

## SEARCH:SEARCH<x>:TRIGger:A:BUS:FLEXRAY:FRAMEID:VALue

This command sets the low value when searching on a FlexRay bus id field. The search condition must be set to Identifier. The search number is specified by x.

<b>Group</b>	Search and Mark
<b>Syntax</b>	SEARCH:SEARCH<x>:TRIGger:A:BUS:FLEXRAY:FRAMEID:VALue <QString> SEARCH:SEARCH<x>:TRIGger:A:BUS:FLEXRAY:FRAMEID:VALue?
<b>Arguments</b>	<QString> is the frame id value.
<b>Examples</b>	SEARCH:SEARCH1:TRIGger:A:BUS:FLEXRAY:FRAMEID:VALue "XXXXXXXX1010" sets the value to XXXXXXXX1010.  SEARCH:SEARCH1:TRIGger:A:BUS:FLEXRAY:FRAMEID:VALue? might return SEARCH:SEARCH1:TRIGGER:A:BUS:FLEXRAY:FRAMEID:VALUE "XXXXXXXXXXXX" indicating the value is XXXXXXXXXXXX.

## SEARCH:SEARCH<x>:TRIGger:A:BUS:FLEXRAY:FRAMEType

This command sets or queries the FlexRay bus search frame type. The search number is specified by x.

<b>Conditions</b>	Requires option 5-SRAUTO or SUP5-SRAUTO Triggering and Analysis application.
<b>Group</b>	Search and Mark
<b>Syntax</b>	SEARCH:SEARCH<x>:TRIGger:A:BUS:FLEXRAY:FRAMEType {NORMAL PAYload NULL SYNC STARTup} SEARCH:SEARCH<x>:TRIGger:A:BUS:FLEXRAY:FRAMEType?
<b>Arguments</b>	Arguments are the available frame types.
<b>Examples</b>	SEARCH:SEARCH1:TRIGger:A:BUS:FLEXRAY:FRAMEType startup sets the frame type to startup.

SEARCH:SEARCH1:TRIGGER:A:BUS:FLEXRAY:FRAMETYPE? might return  
SEARCH:SEARCH1:TRIGGER:A:BUS:FLEXRAY:FRAMETYPE NORMAL,  
indicating the frame type is normal.

## SEARCH:SEARCH<x>:TRIGGER:A:BUS:FLEXRAY:HEADER:CRC

This command sets or queries the CRC portion of the binary header string when searching on a FlexRay bus header. The search number is specified by x.

<b>Conditions</b>	Requires option 5-SRAUTO or SUP5-SRAUTO Triggering and Analysis application.
<b>Group</b>	Search and Mark
<b>Syntax</b>	SEARCH:SEARCH<x>:TRIGGER:A:BUS:FLEXRAY:HEADER:CRC <QString> SEARCH:SEARCH<x>:TRIGGER:A:BUS:FLEXRAY:HEADER:CRC?
<b>Arguments</b>	<QString> specifies the CRC.
<b>Examples</b>	SEARCH:SEARCH<x>:TRIGGER:A:BUS:FLEXRAY:HEADER:CRC "1010" sets the header CRC to XXXXXX101.  SEARCH:SEARCH<x>:TRIGGER:A:BUS:FLEXRAY:HEADER:CRC? might return SEARCH:SEARCH1:TRIGGER:A:BUS:FLEXRAY:HEADER:CRC "XXXXXXXXXXXX", indicating the header CRC is a don't care.

## SEARCH:SEARCH<x>:TRIGGER:A:BUS:FLEXRAY:HEADER:CYCLECount

This command sets or queries the cycle count portion of the binary header string when searching on a FlexRay bus header. The search number is specified by x. The search condition must be set to HEADER.

<b>Conditions</b>	Requires option 5-SRAUTO or SUP5-SRAUTO Triggering and Analysis application.
<b>Group</b>	Search and Mark
<b>Syntax</b>	SEARCH:SEARCH<x>:TRIGGER:A:BUS:FLEXRAY:HEADER:CYCLECount <QString> SEARCH:SEARCH<x>:TRIGGER:A:BUS:FLEXRAY:HEADER:CYCLECount?

**Arguments** <QString> specifies the header cycle count.

**Examples** SEARCH:SEARCH1:TRIGger:A:BUS:FLEXRAY:HEADER:CYCLECount "1010" sets the header cycle count to XX1010.

SEARCH:SEARCH1:TRIGger:A:BUS:FLEXRAY:HEADER:CYCLECount? might return SEARCH:SEARCH1:TRIGGER:A:BUS:FLEXRAY:HEADER:CYCLECOUNT "XXXXXX" indicating the cycle count has not been set.

## SEARCH:SEARCH<x>:TRIGger:A:BUS:FLEXRAY:HEADER:FRAMEID

This command sets or queries the frame id portion of the binary header string when searching on a FlexRay bus header. The search number is specified by x. The search condition must be set to HEADer or IDANDDATA.

**Conditions** Requires option 5-SRAUTO or SUP5-SRAUTO Triggering and Analysis application.

**Group** Search and Mark

**Syntax** SEARCH:SEARCH<x>:TRIGger:A:BUS:FLEXRAY:HEADER:FRAMEID <QString>  
SEARCH:SEARCH<x>:TRIGger:A:BUS:FLEXRAY:HEADER:FRAMEID?

**Arguments** <QString> specifies the frame ID.

**Examples** SEARCH:SEARCH1:TRIGger:A:BUS:FLEXRAY:HEADER:FRAMEID "1010" sets the header frame ID to XXXXXXXX1010.

SEARCH:SEARCH1:TRIGger:A:BUS:FLEXRAY:HEADER:FRAMEID? might return SEARCH:SEARCH1:TRIGGER:A:BUS:FLEXRAY:HEADER:FRAMEID "XXXXXXXXXXXX", indicating the frame ID is a don't care.

## SEARCH:SEARCH<x>:TRIGger:A:BUS:FLEXRAY:HEADER:INDBits

This command sets or queries the Indicator bits portion of the binary header string when searching on a FlexRay bus header. The search number is specified by x. The search condition must be set to HEADer.

**Conditions** Requires option 5-SRAUTO or SUP5-SRAUTO Triggering and Analysis application.

<b>Group</b>	Search and Mark
<b>Syntax</b>	SEARCH:SEARCH<x>:TRIGger:A:BUS:FLEXRAY:HEADER:INDBits <QString> SEARCH:SEARCH<x>:TRIGger:A:BUS:FLEXRAY:HEADER:INDBits?
<b>Arguments</b>	<QString> specifies the header Indicator Bits.
<b>Examples</b>	SEARCH:SEARCH<x>:TRIGger:A:BUS:FLEXRAY:HEADER:INDBits "1010" sets the header Indicator Bits to X1010.  SEARCH:SEARCH<x>:TRIGger:A:BUS:FLEXRAY:HEADER:INDBits? might return SEARCH:SEARCH1:TRIGGER:A:BUS:FLEXRAY:HEADER:INDBITS "XXXXX", indicating the Indicator Bits have not been set.

## SEARCH:SEARCH<x>:TRIGger:A:BUS:FLEXRAY:HEADER:PAYLENGTH

This command sets or queries the payload length portion of the binary header string when searching on a FlexRay bus search trigger header. The search number is specified by x. The search condition must be set to HEADER.

<b>Conditions</b>	Requires option 5-SRAUTO or SUP5-SRAUTO Triggering and Analysis application.
<b>Group</b>	Search and Mark
<b>Syntax</b>	SEARCH:SEARCH<x>:TRIGger:A:BUS:FLEXRAY:HEADER:PAYLENGTH <QString> SEARCH:SEARCH<x>:TRIGger:A:BUS:FLEXRAY:HEADER:PAYLENGTH?
<b>Arguments</b>	<QString> specifies the header Payload Length.
<b>Examples</b>	SEARCH:SEARCH1:TRIGger:A:BUS:FLEXRAY:HEADER:PAYLENGTH "1010" sets the Payload Length to 1010.  SEARCH:SEARCH1:TRIGger:A:BUS:FLEXRAY:HEADER:PAYLENGTH? might return SEARCH:SEARCH1:TRIGGER:A:BUS:FLEXRAY:HEADER:PAYLENGTH "XXXXXXX", indicating the Payload Length has not been set.



## SEARCH:SEARCH<x>:TRIGger:A:BUS:I2C:ADDReSS:MODE

This command sets or queries the I2C address mode for the specified bus search to determine where to place a mark. The search number is specified by x.

<b>Conditions</b>	Requires option 5-SREMBD or SUP5-SREMBD Triggering and Analysis application.
<b>Group</b>	Search and Mark
<b>Syntax</b>	SEARCH:SEARCH<x>:TRIGger:A:BUS:I2C:ADDReSS:MODE {ADDR10 ADDR7} SEARCH:SEARCH<x>:TRIGger:A:BUS:I2C:ADDReSS:MODE?
<b>Arguments</b>	ADDR10 specifies the address mode as ADDR10. ADDR7 specifies the address mode as ADDR7.
<b>Examples</b>	SEARCH:SEARCH1:TRIGGER:A:BUS:I2C:ADDRESS:MODE ADDR10 sets the address mode for I2C bus trigger search 1 to ADDR10.  SEARCH:SEARCH2:TRIGGER:A:BUS:I2C:ADDRESS:MODE? might return :SEARCH:SEARCH2:TRIGGER:A:BUS:I2C:ADDRESS:MODE ADDR7, indicating that the address mode for I2C bus trigger search 2 is set to ADDR7.

## SEARCH:SEARCH<x>:TRIGger:A:BUS:I2C:ADDReSS:VALue

This command sets or queries the binary address string used for the I2C search the specified search condition is Address or AddressData. The search number is specified by x.

<b>Conditions</b>	Requires option 5-SREMBD or SUP5-SREMBD Triggering and Analysis application.
<b>Group</b>	Search and Mark
<b>Syntax</b>	SEARCH:SEARCH<x>:TRIGger:A:BUS:I2C:ADDReSS:VALue <QString> SEARCH:SEARCH<x>:TRIGger:A:BUS:I2C:ADDReSS:VALue?

**Related Commands** [SEARCH:SEARCH<x>:TRIGger:A:BUS:I2C:ADDReSS:MODE](#)

<b>Arguments</b>	<QString> specifies the address value. This is either a 7-bit or 10-bit value depending on the address mode. The valid characters are 0-9, A-F, and X for addresses in hexadecimal format; and 0, 1, and X otherwise.
<b>Examples</b>	<p>SEARCH:SEARCH2:TRIGGER:A:BUS:I2C:ADDRESS:VALUE "01XXXXX" sets the address value to "01XXXXX" when the mode is ADDR7 and the format is binary.</p> <p>SEARCH:SEARCH1:TRIGGER:A:BUS:I2C:ADDRESS:VALUE? might return SEARCH:SEARCH1:TRIGGER:A:BUS:I2C:ADDRESS:VALUE "XX", indicating that the address value is "XX" when the address mode is set to ADDR7 and the address format is hexadecimal.</p>

## SEARCH:SEARCH<x>:TRIGger:A:BUS:I2C:CONDition

This command sets or queries the search condition for an I2C bus. The search number is specified by x.

<b>Conditions</b>	Requires option 5-SREMBD or SUP5-SREMBD Triggering and Analysis application.
<b>Group</b>	Search and Mark
<b>Syntax</b>	<pre>SEARCH:SEARCH&lt;x&gt;:TRIGger:A:BUS:I2C:CONDition {ADDRESS ADDRANDDATA DATA ACKMISS REPEATstart START STOP} SEARCH:SEARCH&lt;x&gt;:TRIGger:A:BUS:I2C:CONDition?</pre>
<b>Arguments</b>	<p>ADDRESS specifies the trigger condition as Address.</p> <p>ADDRANDDATA specifies the trigger condition as Address and Data.</p> <p>DATa specifies the trigger condition as Data.</p> <p>ACKMISS specifies the trigger condition as Missing of Acknowledgement.</p> <p>REPEATstart specifies the trigger condition as Repeat of Start.</p> <p>START specifies the trigger condition as Start.</p> <p>STOP specifies the trigger condition as Stop.</p>
<b>Examples</b>	<p>SEARCH:SEARCH1:TRIGGER:A:BUS:I2C:CONDITION ADDRESS sets the trigger condition for I2C bus trigger search 1 to Address.</p> <p>SEARCH:SEARCH1:TRIGGER:A:BUS:I2C:CONDITION? might return SEARCH:SEARCH1:TRIGGER:A:BUS:I2C:CONDITION ADDRANDDATA,</p>

indicating that the trigger condition for I2C bus trigger search 1 is set to Address and Data.

## SEARCH:SEARCH<x>:TRIGger:A:BUS:I2C:DATA:DIRection

This command sets or queries the direction of the data for the I2C bus search to determine where to place a mark. The search number is specified by x. Read or write is indicated by the R/W bit in the I2C protocol.

<b>Conditions</b>	Requires option 5-SREMBD or SUP5-SREMBD Triggering and Analysis application.
<b>Group</b>	Search and Mark
<b>Syntax</b>	SEARCH:SEARCH<x>:TRIGger:A:BUS:I2C:DATA:DIRection {NOCARE READ WRITE} SEARCH:SEARCH<x>:TRIGger:A:BUS:I2C:DATA:DIRection?
<b>Arguments</b>	NOCARE specifies the direction of data as Don't Care. READ specifies the direction of data as Read. WRITE specifies the direction of data as Write.
<b>Examples</b>	SEARCH:SEARCH1:TRIGGER:A:BUS:I2C:DATA:DIRECTION READ sets the data direction for I2C bus trigger search 1 to READ.  SEARCH:SEARCH2:TRIGGER:A:BUS:I2C:DATA:DIRECTION? might return :SEARCH:SEARCH2:TRIGGER:A:BUS:I2C:DATA:DIRECTION DONTCARE, indicating that the data direction of the I2C bus trigger search 2 is DONTCare.

## SEARCH:SEARCH<x>:TRIGger:A:BUS:I2C:DATA:SIZE

This command sets or queries the length of the data string in bytes used for an I2C bus search to determine where to place a mark. The search number is specified by x. The search condition must be DATA or ADDRANDDATA.

<b>Conditions</b>	Requires option 5-SREMBD or SUP5-SREMBD Triggering and Analysis application.
<b>Group</b>	Search and Mark

**Syntax** SEARCH:SEARCH<x>:TRIGger:A:BUS:I2C:DATA:SIZE <NR1>  
SEARCH:SEARCH<x>:TRIGger:A:BUS:I2C:DATA:SIZE?

**Arguments** <NR1> specifies the data size in bytes.

**Examples** SEARCH:SEARCH1:TRIGGER:A:BUS:I2C:DATA:SIZE 1 sets the length of the data string for I2C bus trigger search 1 to 1 byte.  
SEARCH:SEARCH1:TRIGGER:A:BUS:I2C:DATA:SIZE? might return  
SEARCH:SEARCH1:TRIGGER:A:BUS:I2C:DATA:SIZE 3, indicating that the length of the data string for I2C bus trigger search 1 is 3 bytes.

## SEARCH:SEARCH<x>:TRIGger:A:BUS:I2C:DATA:VALue

This command sets or queries the binary data string used for I2C bus search to determine where to place a mark. The search number is specified by x. The search condition must be DATA or ADDRANDDATA.

**Conditions** Requires option 5-SREMBD or SUP5-SREMBD Triggering and Analysis application.

**Group** Search and Mark

**Syntax** SEARCH:SEARCH<x>:TRIGger:A:BUS:I2C:DATA:VALue <QString>  
SEARCH:SEARCH<x>:TRIGger:A:BUS:I2C:DATA:VALue?

**Arguments** <QString> specifies the data value. The valid characters are 0, 1, or X for binary format; and A-F, 0-9, and X for hexadecimal format.

**Examples** SEARCH:SEARCH1:TRIGGER:A:BUS:I2C:DATA:VALue "1001" sets the data value for I2C bus trigger search 1 to "1001".  
SEARCH:SEARCH2:TRIGGER:A:BUS:I2C:DATA:VALue? might return  
:SEARCH:SEARCH2:TRIGGER:A:BUS:I2C:DATA:VALue "XX", indicating that the data value for I2C bus trigger search is "XX" in hexadecimal format.

## SEARCH:SEARCH<x>:TRIGger:A:BUS:I3C:ADDRess:MODE

This command sets or queries the address mode for the specified I3C bus trigger search to determine where to place a search mark.

Requires purchase and installation of option SRI3C.

**Group** Search and Mark

**Syntax** SEARCH:SEARCH<x>:TRIGger:A:BUS:I3C:ADDRESS:MODE  
{ADDR10|ADDR7}  
SEARCH:SEARCH<x>:TRIGger:A:BUS:I3C:ADDRESS:MODE?

**Related Commands** [SEARCH:SEARCH<x>:TRIGger:A:BUS:I3C:ADDRESS:VALue](#)

**Arguments** Search<x> specifies the search number.

ADDR10 specifies the address mode as ADDR10.

ADDR7 specifies the address mode as ADDR7.

**Examples** SEARCH:SEARCH1:TRIGGER:A:BUS:I3C:ADDRESS:MODE ADDR10 sets the address mode for I3C bus trigger Search 1 to ADDR10.

SEARCH:SEARCH2:TRIGGER:A:BUS:I3C:ADDRESS:MODE? might return  
SEARCH:SEARCH2:TRIGGER:A:BUS:I3C:ADDRESS:MODE ADDR7, indicating that the address mode for I3C bus trigger Search 2 is set to ADDR7.

## SEARCH:SEARCH<x>:TRIGger:A:BUS:I3C:ADDRESS:VALue

This command sets or queries the I3C address value for which to search, to determine where to place a search mark.

Requires purchase and installation of option SRI3C.

**Group** Search and Mark

**Syntax** SEARCH:SEARCH<x>:TRIGger:A:BUS:I3C:ADDRESS:VALue <Qstring>  
SEARCH:SEARCH<x>:TRIGger:A:BUS:I3C:ADDRESS:VALue?

**Related Commands** [SEARCH:SEARCH<x>:TRIGger:A:BUS:I3C:ADDRESS:MODE](#)

**Arguments** Search<x> specifies the search number.

<Qstring> specifies the address value for the specified Search <x>. This is either a 7-bit or 10-bit value depending on the address mode. The valid characters are

0-9, A-F, and X for Hexadecimal address format; and 0, 1, and X (don't care) for Binary address format.

**Examples** SEARCH:SEARCH2:TRIGGER:A:BUS:I3C:ADDRESS:VALUE "01XXXXX" sets the address value to "01XXXXX" when the mode is ADDR7 and the format is binary.

SEARCH:SEARCH1:TRIGGER:A:BUS:I3C:ADDRESS:VALUE? might return SEARCH:SEARCH1:TRIGGER:A:BUS:I3C:ADDRESS:VALUE "XX", indicating that the address value is "XX" when the address mode is set to ADDR7 and the address format is hexadecimal.

## SEARCH:SEARCH<x>:TRIGger:A:BUS:I3C:BCR:VALue

This command sets or queries the binary field string used for the I3C search if the trigger condition is BCR.

Requires purchase and installation of option SRI3C.

**Group** Search and Mark

**Syntax** SEARCH:SEARCH<x>:TRIGger:A:BUS:I3C:BCR:VALue <Qstring>  
SEARCH:SEARCH<x>:TRIGger:A:BUS:I3C:BCR:VALue?

**Arguments** Search<x> specifies the search number.  
<Qstring> specifies the value for which to search. The valid characters are 0, 1, or X for Binary format; and 0-9, A-F, and X for Hexadecimal format.

**Examples** SEARCH:SEARCH1:TRIGGER:A:BUS:I3C:BCR:VALue "1001" sets the BCR value for I3C bus Search 1 to 1001.  
SEARCH:SEARCH2:TRIGGER:A:BUS:I3C:BCR:VALue? might return SEARCH:SEARCH2:TRIGGER:A:BUS:I3C:BCR:VALue "1001", indicating that the BCR value for I3C bus Search 2 is 1001 in hexadecimal format.

## SEARCH:SEARCH<x>:TRIGger:A:BUS:I3C:BCRTYPE:VALue

This command sets or queries the binary field string used for the I3C bus search if the trigger condition is BCRTYPE.

Requires purchase and installation of option SRI3C.

<b>Group</b>	Search and Mark
<b>Syntax</b>	SEARCH:SEARCH<x>:TRIGger:A:BUS:I3C:BCRType:VALue <Qstring> SEARCH:SEARCH<x>:TRIGger:A:BUS:I3C:BCRType:VALue?
<b>Arguments</b>	Search<x> specifies the search number.  <Qstring> specifies the data value for which to search. The valid characters are 0, 1, or X for Binary format; and 0-9, A-F, and X for Hexadecimal format.
<b>Examples</b>	SEARCH:SEARCH1:TRIGGER:A:BUS:I3C:BCRType:VALue "1001" sets the DCR Type value for I3C bus Search 1 to "1001".  SEARCH:SEARCH2:TRIGGER:A:BUS:I3C:BCRType:VALue? might return SEARCH:SEARCH2:TRIGGER:A:BUS:I3C:BCRType:VALue "1001", indicating that the BCR Type value for I3C bus Search 2 is "1001" in hexadecimal format.

## SEARCH:SEARCH<x>:TRIGger:A:BUS:I3C:BPACKets

This command sets or queries the I3C Broadcast Packets search to Broadcast or Response.

Requires purchase and installation of option SRI3C.

<b>Group</b>	Search and Mark
<b>Syntax</b>	SEARCH:SEARCH<x>:TRIGger:A:BUS:I3C:BPACKets {RESPonse BROadcast} SEARCH:SEARCH<x>:TRIGger:A:BUS:I3C:BPACKets?
<b>Arguments</b>	Search<x> specifies the search number.  RESPonse specifies the broadcast address mode as Response.  BROadcast specifies the broadcast address mode as Broadcast.
<b>Examples</b>	SEARCH:SEARCH1:TRIGGER:A:BUS:I3C:BPACKets RESPONSE sets the broadcast packets type for I3C bus Search 1 to Response.  SEARCH:SEARCH2:TRIGGER:A:BUS:I3C:BPACKets? might return SEARCH:SEARCH2:TRIGGER:A:BUS:I3C:BPACKets RESPONSE, indicating that the broadcast packets type for I3C bus Search 2 is set to Response.

## SEARCH:SEARCH<x>:TRIGger:A:BUS:I3C:BRGTID:VALue

This command sets or queries the binary field string used for the I3C trigger if the trigger condition is SETBRGTGT packet ID.

Requires purchase and installation of option SRI3C.

**Group** Search and Mark

**Syntax** SEARCH:SEARCH<x>:TRIGger:A:BUS:I3C:BRGTID:VALue <Qstring>  
SEARCH:SEARCH<x>:TRIGger:A:BUS:I3C:BRGTID:VALue?

**Arguments** Search<x> specifies the search number.  
  
<Qstring> specifies the value for which to search. The valid characters are 0, 1, or X for Binary format; and 0-9, A-F, and X for Hexadecimal format.

**Examples** SEARCH:SEARCH1:TRIGGER:A:BUS:I3C:BRGTID:VALue "1001" sets the Brgtgt search value for I3C bus Search 1 to 1001.  
  
SEARCH:SEARCH2:TRIGGER:A:BUS:I3C:BRGTID:VALue? might return SEARCH:SEARCH2:TRIGGER:A:BUS:I3C:BRGTID:VALue "9A", indicating that the Brgtgt search value for I3C bus trigger Search 2 is 9A in hexadecimal format.

## SEARCH:SEARCH<x>:TRIGger:A:BUS:I3C:CCODE:VALue

This command sets or queries the binary field string used for the I3C trigger if the trigger condition is SETBRGTGT packet ID.

Requires purchase and installation of option SRI3C.

**Group** Search and Mark

**Syntax** SEARCH:SEARCH<x>:TRIGger:A:BUS:I3C:CCODE:VALue <Qstring>  
SEARCH:SEARCH<x>:TRIGger:A:BUS:I3C:CCODE:VALue?

**Arguments** Search<x> specifies the search number.  
  
<Qstring> specifies the value for which to search. The valid characters are 0, 1, or X for Binary format; and A-F, 0-9, and X for Hexadecimal format.



**Examples**     `SEARCH:SEARCH1:TRIGGER:A:BUS:I3C:CCODE:VALUE "1001"` sets the command code value for I3C bus Search 1 to Binary 1001.

`SEARCH:SEARCH2:TRIGGER:A:BUS:I3C:CCODE:VALUE?` might return `SEARCH:SEARCH2:TRIGGER:A:BUS:I3C:CCODE:VALUE "1001"`, indicating that the command code value for I3C bus Search 2 is 1001 in hexadecimal format.

## SEARCH:SEARCH<x>:TRIGger:A:BUS:I3C:CONDition

This command sets or queries the trigger condition for the specified I3C bus trigger search to determine where to place a mark.

Requires purchase and installation of option SRI3C.

**Group**     Search and Mark

**Syntax**     `SEARCH:SEARCH<x>:TRIGger:A:BUS:I3C:CONDition`  
`{START|REPEATStart|ADDRESS|DATA|`  
`SDRDirect|SDRBroadcast|DDR|ERRORS|HOTJoin|`  
`DMSGEnd|BMSGEnd|HDRRestart|HDRExit}`  
`SEARCH:SEARCH<x>:TRIGger:A:BUS:I3C:CONDition?`

**Arguments**     `Search<x>` specifies the search number.

`START` specifies trigger condition as Start.

`REPEATStart` specifies trigger condition as Repeated Start.

`ADDRESS` specifies trigger condition as Address.

`DATA` specifies trigger condition as Data.

`SDRDirect` specifies trigger condition as I3C SDR Direct.

`SDRBroadcast` specifies trigger condition as I3C SDR Broadcast.

`DDR` specifies trigger condition as DDR.

`ERRORS` specifies trigger condition as Errors.

`HOTJoin` specifies trigger condition as Hot-Join.

`DMSGEnd` specifies trigger condition as Direct Message End.

`BMSGEnd` specifies trigger condition as Stop.

`HDRRestart` specifies trigger condition as HDR Restart.

`HDRExit` specifies trigger condition as HDR Exit.

- Examples**    `SEARCH:SEARCH3:TRIGGER:A:BUS:I3C:CONDITION START` sets the trigger condition for I3C bus trigger Search 3 to Start.
- `SEARCH:SEARCH1:TRIGGER:A:BUS:I3C:CONDITION?` might return `SEARCH:SEARCH1:TRIGGER:A:BUS:I3C:CONDITION ADDRESS`, indicating that the trigger condition for I3C bus trigger search 1 is set to Address.

## **SEARCH:SEARCH<x>:TRIGger:A:BUS:I3C:DATA:DIRection**

This command sets or queries the direction of the data for the I3C bus trigger search to determine where to place a mark.

Requires purchase and installation of option SRI3C.

- Group**        Search and Mark
- Syntax**        `SEARCH:SEARCH<x>:TRIGger:A:BUS:I3C:DATA:DIRection`  
                  `{NOCARE|READ|WRITE}`  
                  `SEARCH:SEARCH<x>:TRIGger:A:BUS:I3C:DATA:DIRection?`
- Arguments**    `Search<x>` specifies the search number.
- `NOCARE` specifies the data direction for which to search is Don't Care.
- `READ` specifies the data direction for which to search is Read.
- `WRITE` specifies the data direction for which to search is Write.
- Examples**        `SEARCH:SEARCH1:TRIGGER:A:BUS:I3C:DATA:DIRECTION READ` sets the data direction for I3C bus Search 1 to READ.
- `SEARCH:SEARCH2:TRIGGER:A:BUS:I3C:DATA:DIRECTION?` might return `SEARCH:SEARCH2:TRIGGER:A:BUS:I3C:DATA:DIRECTION NOCARE`, indicating that the data direction of the I3C bus Search 2 is Don't Care.

## **SEARCH:SEARCH<x>:TRIGger:A:BUS:I3C:DATA:SIZE**

This command sets or queries the length of the data string in bytes used for the specified I3C bus trigger search to determine where to place a mark.

Requires purchase and installation of option SRI3C.

- Group**        Search and Mark

<b>Syntax</b>	SEARCH:SEARCH<x>:TRIGger:A:BUS:I3C:DATA:SIZE <NR1> SEARCH:SEARCH<x>:TRIGger:A:BUS:I3C:DATA:SIZE?
<b>Arguments</b>	Search<x> specifies the search number.  <NR1> specifies the data size in bytes.
<b>Examples</b>	SEARCH:SEARCH4:TRIGGER:A:BUS:I3C:DATA:SIZE 1 sets the length of the data string for I3C bus Search 4 to 1 byte.  SEARCH:SEARCH1:TRIGGER:A:BUS:I3C:DATA:SIZE? might return SEARCH:SEARCH1:TRIGGER:A:BUS:I3C:DATA:SIZE 3, indicating that the length of the data string for I3C bus Search 1 is 3 bytes.

## SEARCH:SEARCH<x>:TRIGger:A:BUS:I3C:DATA:VALue

This command sets or queries the data value of the data token for the specified I3C bus trigger search to determine where to place a mark.

Requires purchase and installation of option SRI3C.

<b>Group</b>	Search and Mark
<b>Syntax</b>	SEARCH:SEARCH<x>:TRIGger:A:BUS:I3C:DATA:VALue <Qstring> SEARCH:SEARCH<x>:TRIGger:A:BUS:I3C:DATA:VALue?
<b>Arguments</b>	Search<x> specifies the search number.  <Qstring> specifies the data value. The valid characters are 0, 1, or X for Binary format; and A-F, 0-9, and X for Hexadecimal format.
<b>Examples</b>	SEARCH:SEARCH1:TRIGGER:A:BUS:I3C:DATA:VALUE "1001" sets the data value for I3C bus trigger Search 1 to 1001.  SEARCH:SEARCH2:TRIGGER:A:BUS:I3C:DATA:VALUE? might return SEARCH:SEARCH2:TRIGGER:A:BUS:I3C:DATA:VALUE "XX", indicating that the data value for I3C bus Search 2 is "XX" in hexadecimal format.

## SEARCH:SEARCH<x>:TRIGger:A:BUS:I3C:DCR:VALue

This command sets or queries the binary field string used for the I3C bus search if the trigger condition is DCR.

Requires purchase and installation of option SRI3C.

<b>Group</b>	Search and Mark
<b>Syntax</b>	SEARCH:SEARCH<x>:TRIGGER:A:BUS:I3C:DCR:VALUE <Qstring> SEARCH:SEARCH<x>:TRIGGER:A:BUS:I3C:DCR:VALUE?
<b>Arguments</b>	Search<x> specifies the search number.  <Qstring> specifies the value for which to search. The valid characters are 0, 1, or X for Binary format; and 0-9, A-F, and X for Hexadecimal format.
<b>Examples</b>	SEARCH:SEARCH1:TRIGGER:A:BUS:I3C:DCR:VALUE "1001" sets the DCR value for I3C bus Search 1 to 1001.  SEARCH:SEARCH2:TRIGGER:A:BUS:I3C:DCR:VALUE? might return SEARCH:SEARCH2:TRIGGER:A:BUS:I3C:DCR:VALUE "1001", indicating that the DCR value for I3C bus Search 2 is 1001 in hexadecimal format.

## SEARCH:SEARCH<x>:TRIGGER:A:BUS:I3C:DCRType:VALUE

This command sets or queries the binary field string used for the I3C bus search if the trigger condition is DCRTYPE.

Requires purchase and installation of option SRI3C.

<b>Group</b>	Search and Mark
<b>Syntax</b>	SEARCH:SEARCH<x>:TRIGGER:A:BUS:I3C:DCRType:VALUE <Qstring> SEARCH:SEARCH<x>:TRIGGER:A:BUS:I3C:DCRType:VALUE?
<b>Arguments</b>	Search<x> specifies the search number.  <Qstring> specifies the data value for which to search. The valid characters are 0, 1, or X for Binary format; and 0-9, A-F, and X for Hexadecimal format.
<b>Examples</b>	SEARCH:SEARCH1:TRIGGER:A:BUS:I3C:DCRType:VALUE "1001" sets the DCR Type value for I3C bus Search 1 to "1001".  SEARCH:SEARCH2:TRIGGER:A:BUS:I3C:DCRType:VALUE? might return SEARCH:SEARCH2:TRIGGER:A:BUS:I3C:DCRType:VALUE "1001", indicating that the DCR Type value for I3C bus Search 2 is "1001" in hexadecimal format.

## SEARCH:SEARCH<x>:TRIGger:A:BUS:I3C:DWORd:VALue

This command sets or queries the binary field string used for the I3C trigger if the trigger condition is DATAWORDS.

Requires purchase and installation of option SRI3C.

<b>Group</b>	Search and Mark
<b>Syntax</b>	SEARCH:SEARCH<x>:TRIGger:A:BUS:I3C:DWORd:VALue <Qstring> SEARCH:SEARCH<x>:TRIGger:A:BUS:I3C:DWORd:VALue?
<b>Arguments</b>	Search<x> specifies the search number.  <Qstring> specifies the value for which to search. The valid characters are 0, 1, or X for Binary format; and 0-9, A-F, and X for Hexadecimal format.
<b>Examples</b>	SEARCH:SEARCH1:TRIGGER:A:BUS:I3C:DWORd:VALue "1001" sets the data word value for I3C bus Search 1 to 1001.  SEARCH:SEARCH2:TRIGGER:A:BUS:I3C:DWORd:VALue? might return SEARCH:SEARCH2:TRIGGER:A:BUS:I3C:DWORd:VALue "1001", indicating that the <b>event byte</b> value for I3C bus Search 2 is 1001 in hexadecimal format.

## SEARCH:SEARCH<x>:TRIGger:A:BUS:I3C:ERRORTYPE

This command sets or queries the error type condition for the specified I3C bus search to determine where to place a mark.

Requires purchase and installation of option SRI3C.

<b>Group</b>	Search and Mark
<b>Syntax</b>	SEARCH:SEARCH<x>:TRIGger:A:BUS:I3C:ERRORTYPE {NACK TBIT PARity  BADDR DADDR PREamble CRC} SEARCH:SEARCH<x>:TRIGger:A:BUS:I3C:ERRORTYPE?
<b>Arguments</b>	Search<x> specifies the search number.  NACK specifies the error type on which to search as Missing Ack.  TBIT specifies the error type on which to search as T-Bit.  PARity specifies the error type on which to search as Parity.

BADDR specifies the error type on which to search as Broadcast Address.

DADDR specifies the error type on which to search as Dynamic Address.

PREAmble specifies the error type on which to search as Preamble.

CRC specifies the error type on which to search as CRC.

- Examples** SEARCH:SEARCH1:TRIGGER:A:BUS:I3C:ERRORTYPE NACK sets the error condition for I3C bus trigger Search 1 to Missing ack.
- SEARCH:SEARCH3:TRIGGER:A:BUS:I3C:ERRORTYPE? might return SEARCH:SEARCH3:TRIGGER:A:BUS:I3C:ERRORTYPE PARITY, indicating that the error condition for I3C bus trigger Search 3 is set to Parity.

## SEARCH:SEARCH<x>:TRIGger:A:BUS:I3C:EVENTBYTe:VALue

This command sets or queries the binary field string used for the I3C trigger if the trigger condition is EVENTBYTE.

Requires purchase and installation of option SRI3C.

**Group** Search and Mark

**Syntax** SEARCH:SEARCH<x>:TRIGger:A:BUS:I3C:EVENTBYTe:VALue <Qstring>  
SEARCH:SEARCH<x>:TRIGger:A:BUS:I3C:EVENTBYTe:VALue?

**Arguments** Search<x> specifies the search number.

<Qstring> specifies the value for which to search. The valid characters are 0, 1, or X for Binary format; and 0-9, A-F, and X for Hexadecimal format.

- Examples** SEARCH:SEARCH1:TRIGGER:A:BUS:I3C:EVENTBYTe:VALue "1001" sets the event byte value for I3C bus Search 1 to 1001.
- SEARCH:SEARCH2:TRIGGER:A:BUS:I3C:EVENTBYTe:VALue? might return SEARCH:SEARCH2:TRIGGER:A:BUS:I3C:EVENTBYTe:VALue "1001", indicating that the event byte value for I3C bus trigger Search 2 is 1001 in hexadecimal format.

## SEARCH:SEARCH<x>:TRIGger:A:BUS:I3C:FREQBYTe:VALue

This command sets or queries the binary field string used for the I3C trigger if the trigger condition is FREQUENCYBYTE.

Requires purchase and installation of option SRI3C.

<b>Group</b>	Search and Mark
<b>Syntax</b>	SEARCH:SEARCH<x>:TRIGger:A:BUS:I3C:FREQBYTe:VALue <Qstring> SEARCH:SEARCH<x>:TRIGger:A:BUS:I3C:FREQBYTe:VALue?
<b>Arguments</b>	Search<x> specifies the search number.  <Qstring> specifies the value for which to search. The valid characters are 0, 1, or X for Binary format; and 0-9, A-F, and X for Hexadecimal format.
<b>Examples</b>	SEARCH:SEARCH1:TRIGGER:A:BUS:I3C:FREQBYTe:VALue "1001" sets the frequency byte value for I3C bus Search 1 to 1001.  SEARCH:SEARCH2:TRIGGER:A:BUS:I3C:FREQBYTe:VALue? might return SEARCH:SEARCH2:TRIGGER:A:BUS:I3C:FREQBYTe:VALue "1001", indicating that the frequency byte value for I3C bus Search 2 is 1001 in hexadecimal format.

## SEARCH:SEARCH<x>:TRIGger:A:BUS:I3C:GSLsb:VALue

This command sets or queries the binary field string used for the I3C trigger if the trigger condition is GETSTATUSLSB.

Requires purchase and installation of option SRI3C.

<b>Group</b>	Search and Mark
<b>Syntax</b>	SEARCH:SEARCH<x>:TRIGger:A:BUS:I3C:GSLsb:VALue <Qstring> SEARCH:SEARCH<x>:TRIGger:A:BUS:I3C:GSLsb:VALue?
<b>Arguments</b>	Search<x> specifies the search number.  <Qstring> specifies the value for which to search. The valid characters are 0, 1, or X for Binary format; and 0-9, A-F, and X for Hexadecimal format.
<b>Examples</b>	SEARCH:SEARCH1:TRIGGER:A:BUS:I3C:GSLsb:VALue "1001" sets the GetStatus MSb value for I3C bus Search 1 to 1001.  SEARCH:SEARCH2:TRIGGER:A:BUS:I3C:GSLsb:VALue? might return SEARCH:SEARCH2:TRIGGER:A:BUS:I3C:GSLsb:VALue "1001", indicating that the GetStatus MSb value for I3C bus Search 2 is 1001 in hexadecimal format.

## SEARCH:SEARCH<x>:TRIGger:A:BUS:I3C:GSMsb:VALue

This command sets or queries the binary field string used for the I3C trigger if the trigger condition is GETSTATUSMSB.

Requires purchase and installation of option SRI3C.

<b>Group</b>	Search and Mark
<b>Syntax</b>	SEARCH:SEARCH<x>:TRIGger:A:BUS:I3C:GSMsb:VALue <Qstring> SEARCH:SEARCH<x>:TRIGger:A:BUS:I3C:GSMsb:VALue?
<b>Arguments</b>	Search<x> specifies the search number.  <Qstring> specifies the value for which to search. The valid characters are 0, 1, or X for Binary format; and 0-9, A-F, and X for Hexadecimal format.
<b>Examples</b>	SEARCH:SEARCH1:TRIGGER:A:BUS:I3C:GSMsb:VALue "1001" sets theGetStatus MSb value for I3C bus Search 1 to 1001.  SEARCH:SEARCH2:TRIGGER:A:BUS:I3C:GSMsb:VALue? might return SEARCH:SEARCH2:TRIGGER:A:BUS:I3C:GSMsb:VALue "1001", indicating that the GetStatus MSb value for I3C bus Search 2 is 1001 in hexadecimal format.

## SEARCH:SEARCH<x>:TRIGger:A:BUS:I3C:ID:VALue

This command sets or queries the binary field string used for the I3C search if the trigger condition is ENTDAAs packet ID.

Requires purchase and installation of option SRI3C.

<b>Group</b>	Search and Mark
<b>Syntax</b>	SEARCH:SEARCH<x>:TRIGger:A:BUS:I3C:ID:VALue <Qstring> SEARCH:SEARCH<x>:TRIGger:A:BUS:I3C:ID:VALue?
<b>Arguments</b>	Search<x> specifies the search number.  <Qstring> specifies the value for which to search. The valid characters are 0, 1, or X for Binary format; and 0-9, A-F, and X for Hexadecimal format.
<b>Examples</b>	SEARCH:SEARCH1:TRIGGER:A:BUS:I3C:ID:VALue "1001" sets the ID value for I3C bus trigger Search 1 to 1001.



SEARCH:SEARCH2:TRIGGER:A:BUS:I3C:ID:VALue? might return  
SEARCH:SEARCH2:TRIGGER:A:BUS:I3C:ID:VALue "1001", indicating that  
the ID value for I3C bus Search 2 is 1001 in hexadecimal format.

## SEARCH:SEARCH<x>:TRIGger:A:BUS:I3C:INACCBYTe:VALue

This command sets or queries the binary field string used for the I3C search if the trigger condition is INACCURACYBYTE.

Requires purchase and installation of option SRI3C.

<b>Group</b>	Search and Mark
<b>Syntax</b>	SEARCH:SEARCH<x>:TRIGger:A:BUS:I3C:INACCBYTe:VALue <Qstring> SEARCH:SEARCH<x>:TRIGger:A:BUS:I3C:INACCBYTe:VALue?
<b>Arguments</b>	Search<x> specifies the search number.  <Qstring> specifies the value for which to search. The valid characters are 0, 1, or X for Binary format; and 0-9, A-F, and X for Hexadecimal format.
<b>Examples</b>	SEARCH:SEARCH1:TRIGGER:A:BUS:I3C:INACCBYTe:VALue "1001" sets the inaccuracy byte value for I3C bus Search 1 to 1001.  SEARCH:SEARCH2:TRIGGER:A:BUS:I3C:INACCBYTe:VALue? might return SEARCH:SEARCH2:TRIGGER:A:BUS:I3C:INACCBYTe:VALue "1001", indicating that the inaccuracy byte value for I3C bus Search 2 is 1001 in hexadecimal format.

## SEARCH:SEARCH<x>:TRIGger:A:BUS:I3C:MAXREAD:VALue

This command sets or queries the binary field string used for the I3C trigger if the trigger condition is MAXREAD.

Requires purchase and installation of option SRI3C.

<b>Group</b>	Search and Mark
<b>Syntax</b>	SEARCH:SEARCH<x>:TRIGger:A:BUS:I3C:MAXREAD:VALue <Qstring> SEARCH:SEARCH<x>:TRIGger:A:BUS:I3C:MAXREAD:VALue?

<b>Arguments</b>	<p>Search&lt;x&gt; specifies the search number.</p> <p>&lt;Qstring&gt; specifies the value for which to search. The valid characters are 0, 1, or X for Binary format; and 0-9, A-F, and X for Hexadecimal format.</p>
<b>Examples</b>	<p>SEARCH:SEARCH1:TRIGGER:A:BUS:I3C:MAXREAD:VALue "1001" sets the Maximum Read value for I3C bus Search 1 to 1001.</p> <p>SEARCH:SEARCH4:TRIGGER:A:BUS:I3C:MAXREAD:VALue? might return SEARCH:SEARCH4:TRIGGER:A:BUS:I3C:MAXREAD:VALue "1001", indicating that the Maximum Read value for I3C bus Search 4 is 1001 in hexadecimal format.</p>

## SEARCH:SEARCH<x>:TRIGger:A:BUS:I3C:MAXRTURN:VALue

This command sets or queries the binary field string used for the I3C trigger if the trigger condition is MAXREADTURN.

Requires purchase and installation of option SRI3C.

<b>Group</b>	Search and Mark
<b>Syntax</b>	SEARCH:SEARCH<x>:TRIGger:A:BUS:I3C:MAXRTURN:VALue <Qstring> SEARCH:SEARCH<x>:TRIGger:A:BUS:I3C:MAXRTURN:VALue?
<b>Arguments</b>	<p>Search&lt;x&gt; specifies the search number.</p> <p>&lt;Qstring&gt; specifies the value for which to search. The valid characters are 0, 1, or X for Binary format; and 0-9, A-F, and X for Hexadecimal format.</p>
<b>Examples</b>	<p>SEARCH:SEARCH5:TRIGGER:A:BUS:I3C:MAXRTURN:VALue "1001" sets the Maximum Read Turnaround value for I3C bus Search 5 to 1001.</p> <p>SEARCH:SEARCH2:TRIGGER:A:BUS:I3C:MAXRTURN:VALue? might return SEARCH:SEARCH2:TRIGGER:A:BUS:I3C:MAXRTURN:VALue "1001", indicating that the Maximum Read Turnaround value for I3C bus Search 2 is 1001 in hexadecimal format.</p>

## SEARCH:SEARCH<x>:TRIGger:A:BUS:I3C:MAXWRITE:VALue

This command sets or queries the binary field string used for the I3C trigger if the trigger condition is MAXWRITE.

Requires purchase and installation of option SRI3C.

<b>Group</b>	Search and Mark
<b>Syntax</b>	SEARCH:SEARCH<x>:TRIGger:A:BUS:I3C:MAXWRITE:VALue <Qstring> SEARCH:SEARCH<x>:TRIGger:A:BUS:I3C:MAXWRITE:VALue?
<b>Arguments</b>	Search<x> specifies the search number.  <Qstring> specifies the value for which to search. The valid characters are 0, 1, or X for Binary format; and 0-9, A-F, and X for Hexadecimal format.
<b>Examples</b>	SEARCH:SEARCH1:TRIGGER:A:BUS:I3C:MAXWRITE:VALue "1001" sets the Maximum Write value for I3C bus Search 1 to 1001.  SEARCH:SEARCH2:TRIGGER:A:BUS:I3C:MAXWRITE:VALue? might return SEARCH:SEARCH2:TRIGGER:A:BUS:I3C:MAXWRITE:VALue "1001", indicating that the Maximum Write value for I3C bus Search 2 is 1001 in hexadecimal format.

## SEARCH:SEARCH<x>:TRIGger:A:BUS:I3C:PACKets

This command sets or queries the I3C Direct Packets to Direct or Response.

Requires purchase and installation of option SRI3C.

<b>Group</b>	Search and Mark
<b>Syntax</b>	SEARCH:SEARCH<x>:TRIGger:A:BUS:I3C:PACKets {RESPonse DIRect} SEARCH:SEARCH<x>:TRIGger:A:BUS:I3C:PACKets?
<b>Arguments</b>	Search<x> specifies the search number.  RESPonse specifies the packet address mode as Response.  DIRect specifies the packet address mode as Direct.
<b>Examples</b>	SEARCH:SEARCH3:TRIGGER:A:BUS:I3C:PACKets DIRect sets the packets for I3C bus Search 3 to Direct.  SEARCH:SEARCH2:TRIGGER:A:BUS:I3C:PACKets? might return SEARCH:SEARCH2:TRIGGER:A:BUS:I3C:PACKets RESPonse, indicating that the packets for I3C bus Search 2 is set to Response.

## SEARCH:SEARCH<x>:TRIGger:A:BUS:I3C:SADdress:VALue

This command sets or queries the binary field string used for the I3C bus search if the trigger condition is SLAVEADDRESS.

Requires purchase and installation of option SRI3C.

<b>Group</b>	Search and Mark
<b>Syntax</b>	SEARCH:SEARCH<x>:TRIGger:A:BUS:I3C:SADdress:VALue <QString> SEARCH:SEARCH<x>:TRIGger:A:BUS:I3C:SADdress:VALue?
<b>Arguments</b>	Search<x> specifies the search number.  <Qstring> specifies the address value for which to search. The valid characters are 0, 1, or X for Binary format; and A-F, 0-9, and X for Hexadecimal format.
<b>Examples</b>	SEARCH:SEARCH1:TRIGGER:A:BUS:I3C:SADdress:VALue "1001" sets the slave address value for I3C bus trigger search 1 to "1001".  SEARCH:SEARCH2:TRIGGER:A:BUS:I3C:SADdress:VALue? might return SEARCH:SEARCH2:TRIGGER:A:BUS:I3C:SADdress:VALue "1001", indicating that the slave address value for I3C bus Search 2 is 1001 in hexadecimal format.

## SEARCH:SEARCH<x>:TRIGger:A:BUS:I3C:SDR:BROADCASTPacket

This command sets or queries the SDR broadcast packets for the specified I3C bus trigger search to determine where to place a mark.

Requires purchase and installation of option SRI3C.

<b>Group</b>	Search and Mark
<b>Syntax</b>	SEARCH:SEARCH<x>:TRIGger:A:BUS:I3C:SDR: BROADCASTPacket {ENSLave DISLave ENTasx RSTDya  ENTRDya SETMwr1 SETMrd1 LSLave ENTRTSTMode EXTime>} SEARCH:SEARCH<x>:TRIGger:A:BUS:I3C:SDR:BROADCASTPacket?
<b>Arguments</b>	Search<x> specifies the search number.  ENSLave specifies the I3C broadcast packet type as Enable Slave.  DISLave specifies the I3C broadcast packet type as Disable Slave.

ENTasx specifies the I3C broadcast packet type as Enter Activity Stat.  
 RSTDya specifies the I3C broadcast packet type as Reset Dynamic Address.  
 ENTRDya specifies the I3C broadcast packet type as Reset Dynamic Address.  
 SETMwr1 specifies the I3C broadcast packet type as Set Max Write Length.  
 SETMrd1 specifies the I3C broadcast packet type as Set Max Read Length.  
 LSLave specifies the I3C broadcast packet type as Define List of Slaves.  
 ENTRTSTMode specifies the I3C broadcast packet type as Enter Test Mode Broadcast.  
 EXTime specifies the I3C broadcast packet type as Set Exchange Time.

**Examples** SEARCH:SEARCH1:TRIGGER:A:BUS:I3C:SDR:BROADCASTPacket ENSLave sets the trigger condition for I3C bus trigger search 1 to Enable Slave.  
 SEARCH:SEARCH1:TRIGGER:A:BUS:I3C:SDR:BROADCASTPacket? might return SEARCH:SEARCH5:TRIGGER:A:BUS:I3C:SDR:BROADCASTPacket ENRDYA, indicating that the trigger condition for I3C bus trigger Search 5 is set to Reset Dynamic Address.

## SEARCH:SEARCH<x>:TRIGger:A:BUS:I3C:SDR:DIRECTPacket

This command sets or queries the SDR direct packet types for the specified I3C bus trigger search to determine where to place a mark.

Requires purchase and installation of option SRI3C.

**Group** Search and Mark

**Syntax** SEARCH:SEARCH<x>:TRIGger:A:BUS:I3C:SDR:  
 DIRECTPacket {ENSLave|DISLave|ENTasx|RSTDya|  
 SETMwr1|SETMrd1|SEText|SETDya|SETNdya|GETMwr1|GETMrd1|  
 GETPrId|GETBusch|GETDevch|GETS1ave|ACCM|SETBrt|  
 MDATASpeed|HDRCapability}  
 SEARCH:SEARCH<x>:TRIGger:A:BUS:I3C:SDR:DIRECTPacket?

**Arguments** Search<x> specifies the search number.  
 ENSLave specifies the trigger condition as Enable Slave.  
 DISLave specifies the trigger condition as Disable Slave.  
 ENTasx specifies the trigger condition as Enter Activity State.  
 RSTDya specifies the trigger condition as Reset Dynamic Address.

SETMwr1 specifies the trigger condition as Set Max Write Length.  
SETMRd1 specifies the trigger condition as Set Max Read Length.  
SETExt specifies the trigger condition as Set Exchange Time.  
SETDya specifies the trigger condition as Set Dynamic Address.  
SETNdya specifies the trigger condition as Set New Dynamic Address.  
GETMwr1 specifies the trigger condition as Get Max Write Length.  
GETMRd1 specifies the trigger condition as Get Max Read Length.  
GETPri d specifies the trigger condition as Get Provisional ID.  
GETBUSch specifies the trigger condition as Get Provisional ID.  
GETDevch specifies the trigger condition as Get Dev Characteristics.  
GETS1ave specifies the trigger condition as Get Slave Current Status.  
ACCM specifies the trigger condition as Get Accept Mastership.  
SETBrt specifies the trigger condition as Set Bridge Direct Target.  
MDATASpeed specifies the trigger condition as Get Max Data Speed.  
HDRCapabi lity specifies the trigger condition as Get HDR Capability.

**Examples** SEARCH:SEARCH4:TRIGGER:A:BUS:I3C:SDR:DIRECTPacket ENSLave sets the trigger condition for I3C bus trigger Search 4 to Enable Slave.  
SEARCH:SEARCH1:TRIGGER:A:BUS:I3C:SDR:DIRECTPacket? might return SEARCH:SEARCH8:TRIGGER:A:BUS:I3C:SDR:DIRECTPacket ENTASX, indicating that the trigger condition for I3C bus Search 8 is set to Enter Activity State.

## SEARCH:SEARCH<x>:TRIGger:A:BUS:I3C:STATEBYTe:VALue

This command sets or queries the binary field string used for the I3C trigger if the trigger condition is STATEBYTE.

Requires purchase and installation of option SRI3C.

**Group** Search and Mark

**Syntax** SEARCH:SEARCH<x>:TRIGger:A:BUS:I3C:STATEBYTe:VALue <Qstring>  
SEARCH:SEARCH<x>:TRIGger:A:BUS:I3C:STATEBYTe:VALue?

- Arguments**    `Search<x>` specifies the search number.
- `<Qstring>` specifies the value for which to search. The valid characters are 0, 1, or X for Binary format; and 0-9, A-F, and X for Hexadecimal format.
- Examples**      `SEARCH:SEARCH1:TRIGGER:A:BUS:I3C:STATEBYTe:VALue "1001"` sets the state byte value for I3C bus Search 1 to 1001.
- `SEARCH:SEARCH2:TRIGGER:A:BUS:I3C:STATEBYTe:VALue?` might return `SEARCH:SEARCH2:TRIGGER:A:BUS:I3C:STATEBYTe:VALue "1001"`, indicating that the state byte value for I3C bus Search 2 is 1001 in hexadecimal format.

## **SEARCH:SEARCH<x>:TRIGger:A:BUS:I3C:STAtic:ADDRess**

This command sets or queries the binary field string used for the I3C search if the trigger condition is `STATICADDRESS`.

Requires purchase and installation of option `SRI3C`.

- Group**          Search and Mark
- Syntax**        `SEARCH:SEARCH<x>:TRIGger:A:BUS:I3C:STAtic:ADDRess <Qstring>`  
`SEARCH:SEARCH<x>:TRIGger:A:BUS:I3C:STAtic:ADDRess?`
- Arguments**    `Search<x>` specifies the search number.
- `<Qstring>` specifies the address value for which to search. The valid characters are 0, 1, or X for Binary format; and 0-9, A-F, and X for Hexadecimal format.
- Examples**      `SEARCH:SEARCH1:TRIGGER:A:BUS:I3C:STAtic:ADDRess "1001"` sets the address value for I3C bus trigger Search 1 to 1001.
- `SEARCH:SEARCH2:TRIGGER:A:BUS:I3C:STAtic:ADDRess?` might return `SEARCH:SEARCH2:TRIGGER:A:BUS:I3C:STAtic:ADDRess "1001"`, indicating that the address value for I3C bus trigger Search 2 is "1001" in hexadecimal format.

## **SEARCH:SEARCH<x>:TRIGger:A:BUS:I3C:SUPPORtBYTe:VALue**

This command sets or queries the binary field string used for the I3C trigger if the trigger condition is `SUPPORTEDBYTE`.

Requires purchase and installation of option `SRI3C`.

<b>Group</b>	Search and Mark
<b>Syntax</b>	SEARCH:SEARCH<x>:TRIGger:A:BUS:I3C:SUPPORTBYTe:VALue <Qstring> SEARCH:SEARCH<x>:TRIGger:A:BUS:I3C:SUPPORTBYTe:VALue?
<b>Arguments</b>	Search<x> specifies the search number.  <Qstring> specifies the value for which to search. The valid characters are 0, 1, or X for Binary format; and 0-9, A-F, and X for Hexadecimal format.
<b>Examples</b>	SEARCH:SEARCH1:TRIGGER:A:BUS:I3C:SUPPORTBYTe:VALue "1001" sets the supported byte value for I3C bus Search 1 to 1001.  SEARCH:SEARCH2:TRIGGER:A:BUS:I3C:SUPPORTBYTe:VALue? might return SEARCH:SEARCH2:TRIGGER:A:BUS:I3C:SUPPORTBYTe:VALue "1001", indicating that the supported byte value for I3C bus Search 2 is 1001 in hexadecimal format.

## SEARCH:SEARCH<x>:TRIGger:A:BUS:I3C:TESTMODE:VALue

This command sets or queries the binary field string used for the I3C trigger if the trigger condition is TESTMODE.

Requires purchase and installation of option SRI3C.

<b>Group</b>	Search and Mark
<b>Syntax</b>	SEARCH:SEARCH<x>:TRIGger:A:BUS:I3C:TESTMODE:VALue <Qstring> SEARCH:SEARCH<x>:TRIGger:A:BUS:I3C:TESTMODE:VALue?
<b>Arguments</b>	Search<x> specifies the search number.  <Qstring> specifies the value for which to search. The valid characters are 0, 1, or X for Binary format; and 0-9, A-F, and X for Hexadecimal format.
<b>Examples</b>	SEARCH:SEARCH1:TRIGGER:A:BUS:I3C:TESTMODE:VALue "1001" sets the test mode value for I3C bus Search 1 to 1001.  SEARCH:SEARCH2:TRIGGER:A:BUS:I3C:TESTMODE:VALue? might return SEARCH:SEARCH2:TRIGGER:A:BUS:I3C:TESTMODE:VALue "1001", indicating that the test mode value for I3C bus Search 2 is 1001 in hexadecimal format.



## SEARCH:SEARCH<x>:TRIGger:A:BUS:LIN:CONDition

This command sets or queries the condition for a LIN bus search. The search number is specified by x.

<b>Conditions</b>	Requires option 5-SRAUTO or SUP5-SRAUTO Triggering and Analysis application.
<b>Group</b>	Search and Mark
<b>Syntax</b>	SEARCH:SEARCH<x>:TRIGger:A:BUS:LIN:CONDition {DATA IDANDDATA ERROR IDentifier SLEEP SYNCfield WAKEup} SEARCH:SEARCH<x>:TRIGger:A:BUS:LIN:CONDition?
<b>Arguments</b>	Arguments are the available trigger conditions.
<b>Examples</b>	SEARCH:SEARCH1:TRIGger:A:BUS:LIN:CONDition DATA sets the trigger condition to data.  SEARCH:SEARCH1:TRIGger:A:BUS:LIN:CONDition? might return SEARCH:SEARCH1:TRIGGER:A:BUS:LIN:CONDITION SYNC, indicating the trigger condition is sync.

## SEARCH:SEARCH<x>:TRIGger:A:BUS:LIN:DATA:HIVALue

This command sets or queries the high data value string used in a LIN bus search. The search number is specified by x. The search condition must be DATA or IDANDDATA and the data qualifier must be INRANGE or OTRANGE.

<b>Group</b>	Search and Mark
<b>Syntax</b>	SEARCH:SEARCH<x>:TRIGger:A:BUS:LIN:DATA:HIVALue <QString> SEARCH:SEARCH<x>:TRIGger:A:BUS:LIN:DATA:HIVALue?
<b>Arguments</b>	<QString> is a quoted string of 1s, 0s, or Xs representing the binary data string to be used in a LIN search if the search condition is IDentifier or IDANDDATA (identifier and data).
<b>Examples</b>	SEARCH:SEARCH1:TRIGGER:A:BUS:LIN:DATA:HIVALUE? might return SEARCH:SEARCH1:TRIGGER:A:BUS:LIN:DATA:HIVALUE



<b>Arguments</b>	<NR1> specifies the data size.
<b>Examples</b>	<p>SEARCH:SEARCH1:TRIGger:A:BUS:LIN:DATA:SIZE 1.0 sets the data size to 1.</p> <p>SEARCH:SEARCH1:TRIGger:A:BUS:LIN:DATA:SIZE? might return SEARCH:SEARCH1:TRIGGER:A:BUS:LIN:DATA:SIZE 1, indicating the data size is 1.</p>

## SEARCH:SEARCH<x>:TRIGger:A:BUS:LIN:DATA:VALue

This command sets or queries the data string used for a LIN bus search. The search number is specified by x. The search condition must be DATA or IDANDDATA.

<b>Conditions</b>	Requires option 5-SRAUTO or SUP5-SRAUTO Triggering and Analysis application.
<b>Group</b>	Search and Mark
<b>Syntax</b>	<p>SEARCH:SEARCH&lt;x&gt;:TRIGger:A:BUS:LIN:DATA:VALue &lt;QString&gt;</p> <p>SEARCH:SEARCH&lt;x&gt;:TRIGger:A:BUS:LIN:DATA:VALue?</p>

**Arguments** <QString> specifies the data value.

<b>Examples</b>	<p>SEARCH:SEARCH2:TRIGger:A:BUS:LIN:DATA:VALue 1010 sets the data value to XXXXXX1010.</p> <p>SEARCH:SEARCH1:TRIGger:A:BUS:LIN:DATA:VALue? might return SEARCH:SEARCH1:TRIGGER:A:BUS:LIN:DATA:VALUE "XXXXXXXXXX", indicating that the data value is a don't care.</p>
-----------------	-----------------------------------------------------------------------------------------------------------------------------------------------------------------------------------------------------------------------------------------------------------------------

## SEARCH:SEARCH<x>:TRIGger:A:BUS:LIN:ERRTYPE

This command sets or queries the error type for a LIN bus search. The search number is specified by x. The search condition must be set to ERROR.

<b>Conditions</b>	Requires option 5-SRAUTO or SUP5-SRAUTO Triggering and Analysis application.
<b>Group</b>	Search and Mark

**Syntax** SEARCH:SEARCH<x>:TRIGger:A:BUS:LIN:ERRTYPE  
 {CHECKsum|PARity|SYNC}  
 SEARCH:SEARCH<x>:TRIGger:A:BUS:LIN:ERRTYPE?

**Arguments** CHECKsum specifies the error type is checksum.  
 PARity specifies the error type is parity.  
 SYNC specifies the error type is sync.

**Examples** SEARCH:SEARCH2:TRIGger:A:BUS:LIN:ERRTYPE Parity sets the error type to parity.  
 SEARCH:SEARCH2:TRIGger:A:BUS:LIN:ERRTYPE? might return :SEARCH:SEARCH2:TRIGGER:A:BUS:LIN:ERRTYPE SYNC, indicating that the error type is sync.

## SEARCH:SEARCH<x>:TRIGger:A:BUS:LIN:IDentifier:VALue

This command sets or queries the string used for a LIN bus identifier value. The search number is specified by x. The search condition must be IDENTIFIER or IDANDDATA.

**Conditions** Requires option 5-SRAUTO or SUP5-SRAUTO Triggering and Analysis application.

**Group** Search and Mark

**Syntax** SEARCH:SEARCH<x>:TRIGger:A:BUS:LIN:IDentifier:VALue  
 <QString>  
 SEARCH:SEARCH<x>:TRIGger:A:BUS:LIN:IDentifier:VALue?

**Arguments** <QString> specifies the identifier value.

**Examples** SEARCH:SEARCH1:TRIGger:A:BUS:LIN:IDentifier:VALue 1010 sets the identifier value to XX1010.  
 SEARCH:SEARCH1:TRIGger:A:BUS:LIN:IDentifier:VALue? might return SEARCH:SEARCH1:TRIGGER:A:BUS:LIN:IDENTIFIER:VALUE "XXXXXX", indicates the identifier value is don't care.

## SEARCH:SEARCH<x>:TRIGger:A:BUS:MANChester:CONDition

This command specifies a field or condition for an Manchester bus to search on. The search number is specified by x.

**Conditions** Requires the SR-MANCh Triggering and Analysis application.

**Group** Search and Mark

**Syntax** SEARCH:SEARCH<x>:TRIGger:A:BUS:MANChester:CONDition  
{SYNCBITS| HEADer| DATa| packetOffData| TRAIler| ERRors}  
SEARCH:SEARCH<x>:TRIGger:A:BUS:MANChester:CONDition?

**Related Commands** [BUS:B<x>:MANChester:DISplaymode](#)

**Arguments** SYNCBITS specifies Sync Bits symbols as the field within an Manchester frame to search on.

HEADer specifies header symbols as the field within an Manchester frame to search on.

DATa specifies data symbols as the field within an Manchester frame to search on.

packetOffData specifies the binary string used for Manchester triggering if the trigger condition is DATA.

TRAIler specifies trailer symbols as the field within an Manchester frame to search on.

ERRors specifies error symbols as the field within an Manchester frame to search on.

**Examples** SEARCH:SEARCH1:TRIGGER:A:BUS:MANChester:CONDition SYNCBITS specifies Sync Bit symbols as the field within an Manchester frame to search on.

SEARCH:SEARCH1:TRIGGER:A:BUS:MANChester:CONDition? might return :SEARCH:SEARCH1:TRIGGER:A:BUS:MANChester:CONDition SYNCBITS, indicating that Sync Bits is the currently specified field within an Manchester frame to search on.

## SEARCH:SEARCH<x>:TRIGger:A:BUS:MANChester:DATA:SIZE

This command specifies the number of bits per word for the specified Manchester bus. The search number is specified by x.

<b>Conditions</b>	Requires the SR-MANCH Triggering and Analysis application.
<b>Group</b>	Search and Mark
<b>Syntax</b>	SEARCH:SEARCH<x>:TRIGger:A:BUS:MANChester:DATA:SIZE <NR1> SEARCH:SEARCH<x>:TRIGger:A:BUS:MANChester:DATA:SIZE?
<b>Related Commands</b>	<a href="#">BUS:B&lt;x&gt;:MANChester:DISplaymode</a> , <a href="#">SEARCH:SEARCH&lt;x&gt;:TRIGger:A:BUS:MANChester:CONDition</a>
<b>Arguments</b>	Search<x> is the number of the search.  <NR1> specifies the data string in a valid format. The minimum and default values are 1. The maximum value is 5.
<b>Examples</b>	SEARCH:SEARCH1:TRIGger:A:BUS:MANChester:DATA:SIZE 2 sets the data string for Manchester bus trigger search 1 to 2 bits.  SEARCH:SEARCH1:TRIGger:A:BUS:MANChester:DATA:SIZE? might return :SEARCH:SEARCH1:TRIGger:A:BUS:MANChester:DATA:SIZE 2, indicating that the length of the data string for Manchester bus trigger search 1 is 2 bits.

## SEARCH:SEARCH<x>:TRIGger:A:BUS:MANChester:DATA:VALue

This command specifies the binary string used for Manchester triggering if the trigger condition is data when searching on an Manchester signal. The search condition needs to be set to data. The search number is specified by <x>.

<b>Conditions</b>	Requires the SR-MANCH Triggering and Analysis application.
<b>Group</b>	Search and Mark
<b>Syntax</b>	SEARCH:SEARCH<x>:TRIGger:A:BUS:MANChester:DATA:VALue <QString> SEARCH:SEARCH<x>:TRIGger:A:BUS:MANChester:DATA:VALue?
<b>Related Commands</b>	<a href="#">BUS:B&lt;x&gt;:MANChester:DISplaymode</a> , <a href="#">SEARCH:SEARCH&lt;x&gt;:TRIGger:A:BUS:MANChester:CONDition</a>
<b>Arguments</b>	<QString> is the data value.

**Examples**     `SEARCH:SEARCH1:TRIGger:A:BUS:MANChester:DATA:VALue`  
                   "00001000" specifies binary as the value to be used while searching.

`SEARCH:SEARCH1:TRIGger:A:BUS:MANChester:DATA:VALue?` might  
 return `:SEARCH:SEARCH1:TRIGger:A:BUS:MANChester:DATA:VALue`  
 "00001000", indicating that binary is the value to be used while searching.

## **SEARCH:SEARCH<x>:TRIGger:A:BUS:MANChester:ERRor:TYPE**

This command sets or queries the error to be used when searching on a Manchester signal. The search condition must be set to error. Parity error identifies odd and even parity. The search number is specified by <x>.

**Conditions**     Requires the SR-MANCh Triggering and Analysis application.

**Group**            Search and Mark

**Syntax**            `SEARCH:SEARCH<x>:TRIGger:A:BUS:MANChester:ERRor:TYPE`  
                   {MANChester|PARity}  
                   `SEARCH:SEARCH<x>:TRIGger:A:BUS:MANChester:ERRor:TYPE?`

**Related Commands**     [BUS:B<x>:MANChester:DISplaymode](#), [SEARCH:SEARCH<x>:TRIGger:A:BUS:MANChester:CONDition](#)

**Arguments**        MANChester sets the error type to Manchester.  
                   PARity sets the error type to parity.

**Examples**         `SEARCH:SEARCH1:TRIGger:A:BUS:MANChester:ERRor:TYPE`  
                   MANChester sets the error type to Manchester.

`SEARCH:SEARCH1:TRIGger:A:BUS:MANChester:ERRor:TYPE?` might  
 return `:SEARCH:SEARCH1:TRIGger:A:BUS:MANChester:ERRor:TYPE`  
 PARity, indicating the error type is parity.

## **SEARCH:SEARCH<x>:TRIGger:A:BUS:MANChester:HEADer:VALue**

This command specifies the binary string used for Manchester triggering if the trigger condition is header when searching on an Manchester signal. The search condition needs to be set to header. The search number is specified by <x>.

**Conditions**        Requires the SR-MANCh Triggering and Analysis application.

<b>Group</b>	Search and Mark
<b>Syntax</b>	SEARCH:SEARCH<x>:TRIGger:A:BUS:MANChesTer:HEADER:VALue <QString> SEARCH:SEARCH<x>:TRIGger:A:BUS:MANChesTer:HEADER:VALue?
<b>Related Commands</b>	<a href="#">BUS:B&lt;x&gt;:MANChesTer:DISPlaymode</a> , <a href="#">SEARCH:SEARCH&lt;x&gt;:TRIGger:A:BUS:MANChesTer:CONDition</a>
<b>Arguments</b>	<QString> is the header value.
<b>Examples</b>	SEARCH:SEARCH1:TRIGger:A:BUS:MANChesTer:DATA:VALue "00001000" specifies binary as the value to be used while searching.  SEARCH:SEARCH1:TRIGger:A:BUS:MANChesTer:DATA:VALue? might return :SEARCH:SEARCH1:TRIGger:A:BUS:MANChesTer:DATA:VALue "00001000", indicating the binary header value to be used while searching.

## SEARCH:SEARCH<x>:TRIGger:A:BUS:MANChesTer:packetOffData:VALue

This command specifies the binary string used for Manchester triggering if the trigger condition is DATA. The search number is specified by <x>.

<b>Conditions</b>	Requires the SR-MANCH Triggering and Analysis application.
<b>Group</b>	Search and Mark
<b>Syntax</b>	SEARCH:SEARCH<x>:TRIGger:A:BUS:MANChesTer:packetOffData: VALue <NR1> SEARCH:SEARCH<x>:TRIGger:A:BUS:MANChesTer:packetOffData: VALue?
<b>Related Commands</b>	<a href="#">BUS:B&lt;x&gt;:MANChesTer:DISPlaymode</a> , <a href="#">SEARCH:SEARCH&lt;x&gt;:TRIGger:A:BUS:MANChesTer:CONDition</a>
<b>Arguments</b>	<NR1> specifies the data string in a valid format.
<b>Examples</b>	SEARCH:SEARCH1:TRIGger:A:BUS:MANChesTerDATAOFF:VALue 1 specifies binary as the value to be used while searching.



SEARCH:SEARCH1:TRIGger:A:BUS:MANChesterDATAOFF:VALue? might return :SEARCH:SEARCH1:TRIGger:A:BUS:MANChesterDATAOFF:VALue 1, indicating the binary value to be used while searching.

## SEARCH:SEARCH<x>:TRIGger:A:BUS:MANChester:SYNC:VALue

This command specifies the binary string used for Manchester triggering if the trigger condition is Sync when searching on an Manchester signal. The search condition needs to be set to Sync. The search number is specified by <x>.

**Conditions** Requires the SR-MANCH Triggering and Analysis application.

**Group** Search and Mark

**Syntax** SEARCH:SEARCH<x>:TRIGger:A:BUS:MANChester:SYNC:VALue  
<Qstring>  
SEARCH:SEARCH<x>:TRIGger:A:BUS:MANChester:SYNC:VALue?

**Related Commands** [BUS:B<x>:MANChester:DISplaymode](#), [SEARCH:SEARCH<x>:TRIGger:A:BUS:MANChester:CONDition](#)

**Arguments** <QSTRING> specifies the data string in a valid format.

**Examples** SEARCH:SEARCH1:TRIGger:A:BUS:MANChesterDATAOFF:VALue "00001000" specifies binary as the value to be used while searching.

SEARCH:SEARCH1:TRIGger:A:BUS:MANChesterDATAOFF:VALue? might return SEARCH:SEARCH1:TRIGger:A:BUS:MANChesterDATAOFF:VALue "00001000", indicating the binary value to be used while searching.

## SEARCH:SEARCH<x>:TRIGger:A:BUS:MANChester:TRAILER:VALue

This command specifies the binary string used for Manchester triggering if the trigger condition is Trailer when searching on an Manchester signal. The search condition needs to be set to Trailer. The search number is specified by <x>.

**Conditions** Requires the SR-MANCH Triggering and Analysis application.

**Group** Search and Mark

<b>Syntax</b>	SEARCH:SEARCH<x>:TRIGger:A:BUS:MANChester:TRAILER:VALue <QString> SEARCH:SEARCH<x>:TRIGger:A:BUS:MANChester:TRAILER:VALue?
<b>Related Commands</b>	<a href="#">BUS:B&lt;x&gt;:MANChester:DISplaymode</a> , <a href="#">SEARCH:SEARCH&lt;x&gt;:TRIGger:A:BUS:MANChester:CONDition</a>
<b>Arguments</b>	<QString> specifies the data string in a valid format.
<b>Examples</b>	SEARCH:SEARCH1:TRIGger:A:BUS:MANChester:TRAILER:VALue "00001000" specifies binary as the value to be used while searching.  SEARCH:SEARCH1:TRIGger:A:BUS:MANChester:TRAILER:VALue? might return :SEARCH:SEARCH1:TRIGger:A:BUS:MANChester:TRAILER:VALue "00001000", indicating the binary value to be used while searching.

## SEARCH:SEARCH<x>:TRIGger:A:BUS:MDIO:ADDress:VALue

This command specifies the binary address string used for MDIO triggering if the trigger condition is address. The search number is specified by x.

<b>Conditions</b>	Requires option SR-MDIO.
<b>Group</b>	Search and Mark
<b>Syntax</b>	SEARCH:SEARCH<x>:TRIGger:A:BUS:MDIO:ADDress:VALue <QString> SEARCH:SEARCH<x>:TRIGger:A:BUS:MDIO:ADDress:VALue?
<b>Arguments</b>	<QString> is the address value. Default address value is XXXXXXXXXXXXXXXXXXXX.
<b>Examples</b>	SEARCH:SEARCH1:TRIGGER:A:BUS:MDIO:ADDress:VALue "XXXXXXXXXXXXXXXXXX" specifies address value as the field within a MDIO frame to search on.  SEARCH:SEARCH1:TRIGGER:A:BUS:MDIO:ADDress:VALue? might return :SEARCH:SEARCH1:TRIGGER:A:BUS:MDIO:ADDress:VALue "XXXXXXXXXXXXXXXXXX", indicating that data is the currently specified field within a MDIO frame to search on.

## SEARCH:SEARCH<x>:TRIGger:A:BUS:MDIO:CONDition

This command sets or queries the trigger condition for MDIO bus. The search number is specified by x.

<b>Conditions</b>	Requires option SR-MDIO.
<b>Group</b>	Search and Mark
<b>Syntax</b>	SEARCH:SEARCH<x>:TRIGger:A:BUS:MDIO:CONDition {STARTPACKet PHYSICALADDRESS REGISTERADDRESS DEVICETYPE DATA ADDRESS ERROR} SEARCH:SEARCH<x>:TRIGger:A:BUS:MDIO:CONDition?
<b>Arguments</b>	<p>STARTPACKet specifies STARTPACKet as the field within a MDIO frame to search on. This is the default trigger on condition.</p> <p>PHYSICALADDRESS specifies PHYSICALADDRESS as the field within a MDIO frame to search on.</p> <p>REGISTERADDRESS specifies REGISTERADDRESS as the field within a MDIO frame to search on.</p> <p>DEVICETYPE specifies DEVICETYPE as the field within a MDIO frame to search on.</p> <p>DATA specifies DATA as the field within a MDIO frame to search on.</p> <p>ADDRESS specifies ADDRESS as the field within a MDIO frame to search on.</p> <p>ERROR specifies ERROR as the field within a MDIO frame to search on.</p>
<b>Examples</b>	<p>SEARCH:SEARCH1:TRIGGER:A:BUS:MDIO:CONDition ERROR specifies ERROR as the field within a MDIO frame to search on.</p> <p>SEARCH:SEARCH1:TRIGGER:A:BUS:MDIO:CONDition? might return :SEARCH:SEARCH1:TRIGGER:A:BUS:MDIO:CONDition ERROR, indicating that ERROR is the currently specified field within a MDIO frame to search on.</p>

## SEARCH:SEARCH<x>:TRIGger:A:BUS:MDIO:DATA:VALue

This command specifies the binary data string used for MDIO triggering if the trigger condition is DATA. The search number is specified by x.

<b>Conditions</b>	Requires option SR-MDIO.
-------------------	--------------------------

<b>Group</b>	Search and Mark
<b>Syntax</b>	SEARCH:SEARCH<x>:TRIGGER:A:BUS:MDIO:DATA:VALue <QString> SEARCH:SEARCH<x>:TRIGGER:A:BUS:MDIO:DATA:VALue?
<b>Arguments</b>	<QString> is the data value. Default value is XXXXXXXXXXXXXXXXXXXX.
<b>Examples</b>	SEARCH:SEARCH1:TRIGGER:A:BUS:MDIO:DATA:VALue "XXXXXXXXXXXXXXXXXX" specifies data as the field within a MDIO frame to search on.  SEARCH:SEARCH1:TRIGGER:A:BUS:MDIO:DATA:VALue? might return :SEARCH:SEARCH1:TRIGGER:A:BUS:MDIO:DATA:VALue "XXXXXXXXXXXXXXXXXX", indicating that data is the currently specified field within a MDIO frame to search on.

## SEARCH:SEARCH<x>:TRIGGER:A:BUS:MDIO:DEVicetype:VALue

This command specifies the binary device type string used for MDIO triggering if the trigger condition is Device type. The search number is specified by x.

<b>Conditions</b>	Requires option SR-MDIO.
<b>Group</b>	Search and Mark
<b>Syntax</b>	SEARCH:SEARCH<x>:TRIGGER:A:BUS:MDIO:DEVicetype:VALue <QString> SEARCH:SEARCH<x>:TRIGGER:A:BUS:MDIO:DEVicetype:VALue?
<b>Arguments</b>	<QString> is the device type. Default value is XXXXX.
<b>Examples</b>	SEARCH:SEARCH1:TRIGGER:A:BUS:MDIO:DEVicetype:VALue "XXXXX" specifies device type as the field within a MDIO frame to search on.  SEARCH:SEARCH1:TRIGGER:A:BUS:MDIO:DEVicetype:VALue? might return :SEARCH:SEARCH1:TRIGGER:A:BUS:MDIO:DEVicetype:VALue "XXXXX", indicating that device type is the currently specified field within a MDIO frame to search on.

## SEARCH:SEARCH<x>:TRIGger:A:BUS:MDIO:ERRType

This command sets or queries the error type to be used when triggering on MDIO data. This applies when the MDIO bus trigger condition is set to ERRor. The search number is specified by x.

<b>Conditions</b>	Requires option SR-MDIO.
<b>Group</b>	Search and Mark
<b>Syntax</b>	SEARCH:SEARCH<x>:TRIGger:A:BUS:MDIO:ERRType {OPCODEERRor  DEVERRor  ANY} SEARCH:SEARCH<x>:TRIGger:A:BUS:MDIO:ERRType?
<b>Arguments</b>	OPCODEERRor specifies OPCODEERRor as the field within a MDIO frame to search on. This is the default trigger on condition.  DEVERRor specifies DEVERRor as the field within a MDIO frame to search on.  ANY specifies ANY as the field within a MDIO frame to search on.
<b>Examples</b>	SEARCH:SEARCH1:TRIGGER:A:BUS:MDIO:ERRType ANY specifies error type as the field within a MDIO frame to search on.  SEARCH:SEARCH1:TRIGGER:A:BUS:MDIO:ERRType? might return :SEARCH:SEARCH1:TRIGGER:A:BUS:MDIO:ERRType ANY, indicating that error type is the currently specified field within a MDIO frame to search on.

## SEARCH:SEARCH<x>:TRIGger:A:BUS:MDIO:OPCode:VALue

This command specifies the binary op-code string used for MDIO triggering if the trigger condition is op-code. The search number is specified by x.

<b>Conditions</b>	Requires option SR-MDIO.
<b>Group</b>	Search and Mark
<b>Syntax</b>	SEARCH:SEARCH<x>:TRIGger:A:BUS:MDIO:OPCode:VALue <QString> SEARCH:SEARCH<x>:TRIGger:A:BUS:MDIO:OPCode:VALue?
<b>Arguments</b>	<QString> is the op-code value. Default op-code value is XX.

**Examples**     `SEARCH:SEARCH1:TRIGGER:A:BUS:MDIO:OPCode:VALue "XX"` specifies op-code value as the field within a MDIO frame to search on.

`SEARCH:SEARCH1:TRIGGER:A:BUS:MDIO:OPCode:VALue?` might return `:SEARCH:SEARCH1:TRIGGER:A:BUS:MDIO:OPCode:VALue "XX"`, indicating that op-code value is the currently specified field within a MDIO frame to search on.

## **SEARCH:SEARCH<x>:TRIGger:A:BUS:MDIO:PHYSicaladdress:VALue**

This command specifies the binary physical address string used for MDIO triggering if the trigger condition is physical address. The search number is specified by x.

**Conditions**     Requires option SR-MDIO.

**Group**            Search and Mark

**Syntax**           `SEARCH:SEARCH<x>:TRIGger:A:BUS:MDIO:PHYSicaladdress:VALue <QString>`  
`SEARCH:SEARCH<x>:TRIGger:A:BUS:MDIO:PHYSicaladdress:VALue?`

**Arguments**       `<QString>` is the physical address value. Default physical address value is `XXXXX`.

**Examples**        `SEARCH:SEARCH1:TRIGGER:A:BUS:MDIO:PHYSicaladdress:VALue "XXXXX"` specifies physical address as the field within a MDIO frame to search on.

`SEARCH:SEARCH1:TRIGGER:A:BUS:MDIO:PHYSicaladdress:VALue?` might return `:SEARCH:SEARCH1:TRIGGER:A:BUS:MDIO:PHYSicaladdress:VALue "XXXXX"`, indicating that physical address is the currently specified field within a MDIO frame to search on.

## **SEARCH:SEARCH<x>:TRIGger:A:BUS:MDIO:REGisteraddress:VALue**

This command specifies the binary register address string used for MDIO triggering if the trigger condition is register address. The search number is specified by x.

**Conditions**       Requires option SR-MDIO.

<b>Group</b>	Search and Mark
<b>Syntax</b>	SEARCH:SEARCH<x>:TRIGger:A:BUS:MDIO:REGisteraddress:VALue <QString> SEARCH:SEARCH<x>:TRIGger:A:BUS:MDIO:REGisteraddress:VALue?
<b>Arguments</b>	<QString> is the register address value. Default register address value is XXXXX.
<b>Examples</b>	SEARCH:SEARCH1:TRIGGER:A:BUS:MDIO:REGisteraddress:VALue "XXXXX" specifies register address as the field within a MDIO frame to search on.  SEARCH:SEARCH1:TRIGGER:A:BUS:MDIO:REGisteraddress:VALue? might return :SEARCH:SEARCH1:TRIGGER:A:BUS:MDIO:REGisteraddress:VALue "XXXXX", indicating that register address is the currently specified field within a MDIO frame to search on.

## SEARCH:SEARCH<x>:TRIGger:A:BUS:MIL1553B:COMMAND:ADDRess:HIVALue

This command sets or queries the high value when searching on command word addresses for a MIL-STD-1553 bus. The search number is specified by x. The search condition must be set to COMMAND, and the address qualifier must be INrange or OUTrange.

<b>Conditions</b>	Requires option 5-SRAERO or SUP5-SRAERO Triggering and Analysis application.
<b>Group</b>	Search and Mark
<b>Syntax</b>	SEARCH:SEARCH<x>:TRIGger:A:BUS:MIL1553B:COMMAND:ADDRess: HIVALue <QString> SEARCH:SEARCH<x>:TRIGger:A:BUS:MIL1553B:COMMAND:ADDRess: HIVALue?
<b>Arguments</b>	<QString> is the address value.
<b>Examples</b>	SEARCH:SEARCH1:TRIGGER:A:BUS:MIL1553B:COMMAND:ADDRess:HIVALUE "X1000" sets the value to X1000.  SEARCH:SEARCH1:TRIGGER:A:BUS:MIL1553B:COMMAND:ADDRess:HIVALUE? might return "XXXXX", indicating that the value is XXXXX.

## SEARCH:SEARCH<x>:TRIGger:A:BUS:MIL1553B:COMMAND:ADDRess:QUALifier

This command sets or queries the qualifier to be used when searching on command word addresses for a MIL-STD-1553 bus. The search number is specified by x. The search condition must be set to COMMAND.

**Conditions** Requires option 5-SRAERO or SUP5-SRAERO Triggering and Analysis application.

**Group** Search and Mark

**Syntax** SEARCH:SEARCH<x>:TRIGger:A:BUS:MIL1553B:COMMAND:ADDRess:QUALifier {EQUAL|UNEQUAL|LESSTHAN|MORETHAN|LESSEQUAL|MOREEQUAL|INrange|OUTrange}  
SEARCH:SEARCH<x>:TRIGger:A:BUS:MIL1553B:COMMAND:ADDRess:QUALifier?

**Arguments** Arguments are the available address qualifiers.

**Examples** SEARCH:SEARCH1:TRIGGER:A:BUS:MIL1553B:COMMAND:ADDRESS:QUALIFIER LESSTHAN sets the address qualifier to less than.  
SEARCH:SEARCH1:TRIGGER:A:BUS:MIL1553B:COMMAND:ADDRESS:QUALIFIER? might return EQUAL, indicating that the address qualifier is set to equal.

## SEARCH:SEARCH<x>:TRIGger:A:BUS:MIL1553B:COMMAND:ADDRess:VALue

This command sets or queries the low value when searching on command word addresses for a MIL-STD-1553 bus. The search number is specified by x. The search condition must be set to COMMAND.

**Conditions** Requires option 5-SRAERO or SUP5-SRAERO Triggering and Analysis application.

**Group** Search and Mark

**Syntax** SEARCH:SEARCH<x>:TRIGger:A:BUS:MIL1553B:COMMAND:ADDRESS:VALue <Qstring>  
SEARCH:SEARCH<x>:TRIGger:A:BUS:MIL1553B:COMMAND:ADDRESS:VALue?



**Arguments** <QString> is the address value.

**Examples** SEARCH:SEARCH1:TRIGGER:A:BUS:MIL1553B:COMMAND:ADDRESS:VALUE "X1000" sets the value to X1000.

SEARCH:SEARCH1:TRIGGER:A:BUS:MIL1553B:COMMAND:ADDRESS:VALUE? might return "XXXXXX", indicating that the value is XXXXXX.

## SEARCH:SEARCH<x>:TRIGger:A:BUS:MIL1553B:COMMAND:COUNT

This command sets or queries the value of the command word "word count" field for a MIL-STD-1553 bus to search on. The search number is specified by x. The search condition must be set to COMMAND.

**Conditions** Requires option 5-SRAERO or SUP5-SRAERO Triggering and Analysis application.

**Group** Search and Mark

**Syntax** SEARCH:SEARCH<x>:TRIGger:A:BUS:MIL1553B:COMMAND:COUNT <QString>  
SEARCH:SEARCH<x>:TRIGger:A:BUS:MIL1553B:COMMAND:COUNT?

**Arguments** <QString> is the word count value.

**Examples** SEARCH:SEARCH1:TRIGGER:A:BUS:MIL1553B:COMMAND:COUNT "X1000" sets the value to X1000.

SEARCH:SEARCH1:TRIGGER:A:BUS:MIL1553B:COMMAND:COUNT? might return "XXXXXX", indicating that the value is XXXXXX.

## SEARCH:SEARCH<x>:TRIGger:A:BUS:MIL1553B:COMMAND:PARity

This command sets or queries the value of the command word parity bit for a MIL-STD-1553 bus to search on. The search number is specified by x. The search condition must be set to COMMAND.

**Conditions** Requires option 5-SRAERO or SUP5-SRAERO Triggering and Analysis application.

<b>Group</b>	Search and Mark
<b>Syntax</b>	SEARCH:SEARCH<x>:TRIGger:A:BUS:MIL1553B:COMMAND:PARity {ONE ZERO NOCARE} SEARCH:SEARCH<x>:TRIGger:A:BUS:MIL1553B:COMMAND:PARity?
<b>Arguments</b>	ONE filters command words to only match those where the parity bit has a value of 1.  ZERO filters command words to only match those where the parity bit has a value of 0.  NOCARE disables filtering of command words on the parity bit.
<b>Examples</b>	SEARCH:SEARCH1:TRIGGER:A:BUS:MIL1553B:COMMAND:PARITY ONE specifies filtering command words for those where the parity bit has a value of 1.  SEARCH:SEARCH1:TRIGGER:A:BUS:MIL1553B:COMMAND:PARITY? might return NOCARE, indicating that command words are not being filtered based on the parity bit value.

## SEARCH:SEARCH<x>:TRIGger:A:BUS:MIL1553B:COMMAND:SUBAddress

This command sets or queries the value of the command word subaddress field for a MIL-STD-1553 bus to search on. The search number is specified by x. The search condition must be set to COMMAND.

<b>Conditions</b>	Requires option 5-SRAERO or SUP5-SRAERO Triggering and Analysis application.
<b>Group</b>	Search and Mark
<b>Syntax</b>	SEARCH:SEARCH<x>:TRIGger:A:BUS:MIL1553B:COMMAND:SUBAddress <Qstring> SEARCH:SEARCH<x>:TRIGger:A:BUS:MIL1553B:COMMAND:SUBAddress?
<b>Arguments</b>	<Qstring> is the word count value.
<b>Examples</b>	SEARCH:SEARCH1:TRIGGER:A:BUS:MIL1553B:COMMAND:SUBADDRESS "X1000" sets the value to X1000.  SEARCH:SEARCH1:TRIGGER:A:BUS:MIL1553B:COMMAND:SUBADDRESS? might return "XXXXX", indicating that the value is XXXXX.

**SEARCH:SEARCH<x>:TRIGger:A:BUS:MIL1553B:COMMAND:TRBit**

This command sets or queries the value of the command word Transmit / Receive bit for a MIL-STD-1553 bus to search on. The search number is specified by x. The search condition must be set to COMMAND.

**Conditions** Requires option 5-SRAERO or SUP5-SRAERO Triggering and Analysis application.

**Group** Search and Mark

**Syntax** SEARCH:SEARCH<x>:TRIGger:A:BUS:MIL1553B:COMMAND:TRBit  
{RX|TX|X}  
SEARCH:SEARCH<x>:TRIGger:A:BUS:MIL1553B:COMMAND:TRBit?

**Arguments** RX filters command words to only match those that are receive packets.  
TX filters command words to only match those that are transmit packets.  
X disables filtering of command words on the R/T bit.

**Examples** SEARCH:SEARCH1:TRIGGER:A:BUS:MIL1553B:COMMAND:TRBIT TX  
specifies filtering command words for only transmit messages.  
  
SEARCH:SEARCH1:TRIGGER:A:BUS:MIL1553B:COMMAND:TRBIT? might  
return X, indicating that command words are not being filtered based on the R/T  
bit value.

**SEARCH:SEARCH<x>:TRIGger:A:BUS:MIL1553B:CONDition**

This command sets or queries the field or condition for a MIL-STD-1553 bus to search on. The search number is specified by x.

**Conditions** Requires option 5-SRAERO or SUP5-SRAERO Triggering and Analysis application.

**Group** Search and Mark

**Syntax** SEARCH:SEARCH<x>:TRIGger:A:BUS:MIL1553B:CONDition  
{SYNC|COMMAND|STATUS|DATA|ERROR}  
SEARCH:SEARCH<x>:TRIGger:A:BUS:MIL1553B:CONDition?

<b>Arguments</b>	<p>SYNC specifies a search for the sync pulse of any word.</p> <p>COMMAND specifies a search for a matching command word.</p> <p>STATUS specifies a search for a matching status word.</p> <p>DATA specifies a search for a matching data word.</p> <p>ERROR specifies a search for a specified error condition.</p>
<b>Examples</b>	<p>SEARCH:SEARCH1:TRIGGER:A:BUS:MIL1553B:CONDITION DATA specifies finding matching data word(s).</p> <p>SEARCH:SEARCH1:TRIGGER:A:BUS:MIL1553B:CONDITION? might return SYNC, indicating that the bus is being searched for sync pulses found in any word.</p>

## SEARCH:SEARCH<x>:TRIGger:A:BUS:MIL1553B:DATA:PARity

This command sets or queries the value of the command word parity bit for a MIL-STD-1553 bus to search on. The search number is specified by x. The search condition must be set to DATA.

<b>Conditions</b>	Requires option 5-SRAERO or SUP5-SRAERO Triggering and Analysis application.
<b>Group</b>	Search and Mark
<b>Syntax</b>	<pre>SEARCH:SEARCH&lt;x&gt;:TRIGger:A:BUS:MIL1553B:DATA:PARity {ONE ZERO NOCARE} SEARCH:SEARCH&lt;x&gt;:TRIGger:A:BUS:MIL1553B:DATA:PARity?</pre>
<b>Arguments</b>	<p>ONE filters data words to only match those where the parity bit has a value of 1.</p> <p>ZERO filters data words to only match those where the parity bit has a value of 0.</p> <p>NOCARE disables filtering of data words on the parity bit.</p>
<b>Examples</b>	<p>SEARCH:SEARCH1:TRIGGER:A:BUS:MIL1553B:DATA:PARITY ONE specifies filtering data words for those where the parity bit has a value of 1.</p> <p>SEARCH:SEARCH1:TRIGGER:A:BUS:MIL1553B:DATA:PARITY? might return NOCARE, indicating that data words are not being filtered based on the parity bit value.</p>

## SEARCH:SEARCH<x>:TRIGger:A:BUS:MIL1553B:DATA:VALue

This command sets or queries the value when searching on data words for a MIL-STD-1553 bus. The search number is specified by x. The search condition must be set to DATA.

<b>Conditions</b>	Requires option 5-SRAERO or SUP5-SRAERO Triggering and Analysis application.
<b>Group</b>	Search and Mark
<b>Syntax</b>	SEARCH:SEARCH<x>:TRIGger:A:BUS:MIL1553B:DATA:VALue <QString> SEARCH:SEARCH<x>:TRIGger:A:BUS:MIL1553B:DATA:VALue?
<b>Arguments</b>	<QString> is the data value.
<b>Examples</b>	SEARCH:SEARCH1:TRIGGER:A:BUS:MIL1553B:DATA:VALUE "XXXXXXXXXXXX1000" sets the value to XXXXXXXXXXXXXXX1000.  SEARCH:SEARCH1:TRIGGER:A:BUS:MIL1553B:DATA:VALUE? might return "XXXXXXXXXXXXXXXXXXXX", indicating that the value is XXXXXXXXXXXXXXXXXXXX.

## SEARCH:SEARCH<x>:TRIGger:A:BUS:MIL1553B:ERRTYPe

This command sets or queries the type of error condition for a MIL-STD-1553 bus to search on. The search number is specified by x. The search condition must be set to ERRor.

<b>Conditions</b>	Requires option 5-SRAERO or SUP5-SRAERO Triggering and Analysis application.
<b>Group</b>	Search and Mark
<b>Syntax</b>	SEARCH:SEARCH<x>:TRIGger:A:BUS:MIL1553B:ERRTYPe {PARity SYNC DATA} SEARCH:SEARCH<x>:TRIGger:A:BUS:MIL1553B:ERRTYPe?

**Arguments**    **PARity** specifies searching for an incorrectly calculated parity bit in any word.  
**SYNC** specifies searching for any sync pulse that does not transition in the middle of the pulse as required.  
**DATA** specifies searching for any non-contiguous data words.

**Examples**    **SEARCH:SEARCH1:TRIGGER:A:BUS:MIL1553B:ERRTYPE DATA** specifies searching for non-contiguous data words.  
**SEARCH:SEARCH1:TRIGGER:A:BUS:MIL1553B:ERRTYPE?** might return **PARITY**, indicating that the bus is being searched for parity errors in any word.

## **SEARCH:SEARCH<x>:TRIGger:A:BUS:MIL1553B:STATus:ADDRes:HIVALue**

This command sets or queries the high value when searching on status word addresses for a MIL-STD-1553 bus. The search number is specified by x. The search condition must be set to **STATus** and the address qualifier must be **INrange** or **OUTrange**.

**Conditions**    Requires option 5-SRAERO or SUP5-SRAERO Triggering and Analysis application.

**Group**        Search and Mark

**Syntax**        **SEARCH:SEARCH<x>:TRIGger:A:BUS:MIL1553B:STATus:ADDRes:HIVALue <QString>**  
**SEARCH:SEARCH<x>:TRIGger:A:BUS:MIL1553B:STATus:ADDRes:HIVALue?**

**Arguments**    **<QString>** is the address value.

**Examples**    **SEARCH:SEARCH1:TRIGGER:A:BUS:MIL1553B:STATus:ADDRes:HIVALUE "X1000"** sets the value to X1000.  
**SEARCH:SEARCH1:TRIGGER:A:BUS:MIL1553B:STATus:ADDRes:HIVALUE?** might return "XXXXX", indicating that the value is XXXXX.

## **SEARCH:SEARCH<x>:TRIGger:A:BUS:MIL1553B:STATus:ADDRes:QUALifier**

This command sets or queries the qualifier used when searching on status word addresses for a MIL-STD-1553 bus. The search number is specified by x. The search condition must be set to **STATus**.

<b>Conditions</b>	Requires option 5-SRAERO or SUP5-SRAERO Triggering and Analysis application.
<b>Group</b>	Search and Mark
<b>Syntax</b>	SEARCH:SEARCH<x>:TRIGger:A:BUS: MIL1553B:STATus:ADDRess:QUALifier {EQUAL UNEQUAL LESSthan MORethan LESSEQUAL MORREEQUAL  INrange OUTrange} SEARCH:SEARCH<x>:TRIGger:A:BUS:MIL1553B:STATus:ADDRess: QUALifier?
<b>Arguments</b>	Arguments are the available address qualifiers.
<b>Examples</b>	SEARCH:SEARCH1:TRIGGER:A:BUS:MIL1553B:STATUS:ADDRESS:QUALIFIER LESSTHAN sets the address qualifier to less than.  SEARCH:SEARCH1:TRIGGER:A:BUS:MIL1553B:STATUS:ADDRESS:QUALIFIER? might return EQUAL, indicating that the address qualifier is set to equal.

## SEARCH:SEARCH<x>:TRIGger:A:BUS:MIL1553B:STATus:ADDRess:VALue

This command sets or queries the low value when searching on status word addresses for a MIL-STD-1553 bus. The search number is specified by x. The search condition must be set to STATUS.

<b>Conditions</b>	Requires option 5-SRAERO or SUP5-SRAERO Triggering and Analysis application.
<b>Group</b>	Search and Mark
<b>Syntax</b>	SEARCH:SEARCH<x>:TRIGger:A:BUS:MIL1553B:STATus:ADDRess:VALue <QString> SEARCH:SEARCH<x>:TRIGger:A:BUS:MIL1553B:STATus:ADDRess: VALue?
<b>Arguments</b>	<QString> is the address value.
<b>Examples</b>	SEARCH:SEARCH1:TRIGGER:A:BUS:MIL1553B:STATUS:ADDRESS:VALUE "X1000" sets the value to X1000.

SEARCH:SEARCH1:TRIGGER:A:BUS:MIL1553B:STATUS:ADDRESS:VALUE?  
might return "XXXXX", indicating that the value is XXXXX.

## SEARCH:SEARCH<x>:TRIGger:A:BUS:MIL1553B:STATus:BIT:BCR

This command sets or queries the value of the broadcast command received bit (BCR bit, bit 15) in a status word for a MIL-STD-1553 bus to search on. The search number is specified by x. The search condition must be set to STATus.

<b>Conditions</b>	Requires option 5-SRAERO or SUP5-SRAERO Triggering and Analysis application.
<b>Group</b>	Search and Mark
<b>Syntax</b>	SEARCH:SEARCH<x>:TRIGger:A:BUS:MIL1553B:STATus:BIT:BCR {ONE ZERO NOCARE} SEARCH:SEARCH<x>:TRIGger:A:BUS:MIL1553B:STATus:BIT:BCR?
<b>Arguments</b>	ONE filters status words to only match those where the BCR bit has a value of 1. ZERO filters status words to only match those where the BCR bit has a value of 0. NOCARE disables filtering of status words on the BCR bit.
<b>Examples</b>	SEARCH:SEARCH1:TRIGGER:A:BUS:MIL1553B:STATUS:BIT:BCR ONE specifies filtering status words for those where the BCR bit has a value of 1.  SEARCH:SEARCH1:TRIGGER:A:BUS:MIL1553B:STATUS:BIT:BCR? might return NOCARE, indicating that status words are not being filtered based on the BCR bit value.

## SEARCH:SEARCH<x>:TRIGger:A:BUS:MIL1553B:STATus:BIT:BUSY

This command sets or queries the value of the busy bit (BUSY bit, bit 16) in a status word for a MIL-STD-1553 bus to search on. The search number is specified by x. The search condition must be set to STATus.

<b>Conditions</b>	Requires option 5-SRAERO or SUP5-SRAERO Triggering and Analysis application.
<b>Group</b>	Search and Mark



<b>Syntax</b>	SEARCH:SEARCH<x>:TRIGger:A:BUS:MIL1553B:STATus:BIT:BUSY {ONE ZERO NOCARE} SEARCH:SEARCH<x>:TRIGger:A:BUS:MIL1553B:STATus:BIT:BUSY?
<b>Arguments</b>	ONE filters status words to only match those where the BUSY bit has a value of 1. ZERO filters status words to only match those where the BUSY bit has a value of 0. NOCARE disables filtering of status words on the BUSY bit.
<b>Examples</b>	SEARCH:SEARCH1:TRIGGER:A:BUS:MIL1553B:STATUS:BIT:BUSY ONE specifies filtering status words for those where the BUSY bit has a value of 1.  SEARCH:SEARCH1:TRIGGER:A:BUS:MIL1553B:STATUS:BIT:BUSY? might return NOCARE, indicating that status words are not being filtered based on the BUSY bit value.

## SEARCH:SEARCH<x>:TRIGger:A:BUS:MIL1553B:STATus:BIT:DBCA

This command sets or queries the value of the dynamic bus control acceptance bit (DBCA bit, bit 18) in a status word for a MIL-STD-1553 bus to search on. The search number is specified by x. The search condition must be set to STATUS.

<b>Conditions</b>	Requires option 5-SRAERO or SUP5-SRAERO Triggering and Analysis application.
<b>Group</b>	Search and Mark
<b>Syntax</b>	SEARCH:SEARCH<x>:TRIGger:A:BUS:MIL1553B:STATus:BIT:DBCA {ONE ZERO NOCARE} SEARCH:SEARCH<x>:TRIGger:A:BUS:MIL1553B:STATus:BIT:DBCA?
<b>Arguments</b>	ONE filters status words to only match those where the DBCA bit has a value of 1. ZERO filters status words to only match those where the DBCA bit has a value of 0. NOCARE disables filtering of status words on the DBCA bit.
<b>Examples</b>	SEARCH:SEARCH1:TRIGGER:A:BUS:MIL1553B:STATUS:BIT:DBCA ONE specifies filtering status words for those where the DBCA bit has a value of 1.  SEARCH:SEARCH1:TRIGGER:A:BUS:MIL1553B:STATUS:BIT:DBCA? might return NOCARE, indicating that status words are not being filtered based on the DBCA bit value.

## SEARCH:SEARCH<x>:TRIGger:A:BUS:MIL1553B:STATus:BIT:INSTR

This command sets or queries the value of the instrumentation bit (INSTR bit, bit 10) in a status word for a MIL-STD-1553 bus to search on. The search number is specified by x. The search condition must be set to STATUS.

<b>Conditions</b>	Requires option 5-SRAERO or SUP5-SRAERO Triggering and Analysis application.
<b>Group</b>	Search and Mark
<b>Syntax</b>	SEARCH:SEARCH<x>:TRIGger:A:BUS:MIL1553B:STATus:BIT:INSTR {ONE ZERO NOCARE} SEARCH:SEARCH<x>:TRIGger:A:BUS:MIL1553B:STATus:BIT:INSTR?
<b>Arguments</b>	ONE filters status words to only match those where the INSTR bit has a value of 1. ZERO filters status words to only match those where the INSTR bit has a value of 0. NOCARE disables filtering of status words on the INSTR bit.
<b>Examples</b>	SEARCH:SEARCH1:TRIGGER:A:BUS:MIL1553B:STATus:BIT:INSTR ONE specifies filtering status words for those where the INSTR bit has a value of 1. SEARCH:SEARCH1:TRIGGER:A:BUS:MIL1553B:STATus:BIT:INSTR? might return NOCARE, indicating that status words are not being filtered based on the INSTR bit value.

## SEARCH:SEARCH<x>:TRIGger:A:BUS:MIL1553B:STATus:BIT:ME

This command sets or queries the value of the message error bit (ME bit, bit 9) in a status word for a MIL-STD-1553 bus to search on. The search number is specified by x. The search condition must be set to STATUS.

<b>Conditions</b>	Requires option 5-SRAERO or SUP5-SRAERO Triggering and Analysis application.
<b>Group</b>	Search and Mark
<b>Syntax</b>	SEARCH:SEARCH<x>:TRIGger:A:BUS:MIL1553B:STATus:BIT:ME {ONE ZERO NOCARE} SEARCH:SEARCH<x>:TRIGger:A:BUS:MIL1553B:STATus:BIT:ME?

**Arguments** ONE filters status words to only match those where the ME bit has a value of 1.  
 ZERO filters status words to only match those where the ME bit has a value of 0.  
 NOCARE disables filtering of status words on the ME bit.

**Examples** SEARCH:SEARCH1:TRIGGER:A:BUS:MIL1553B:STATUS:BIT:ME ONE specifies filtering status words for those where the ME bit has a value of 1.  
 SEARCH:SEARCH1:TRIGGER:A:BUS:MIL1553B:STATUS:BIT:ME? might return NOCARE, indicating that status words are not being filtered based on the ME bit value.

## SEARCH:SEARCH<x>:TRIGger:A:BUS:MIL1553B:STATus:BIT:SRQ

This command sets or queries the value of the status word service request bit (SRQ bit, bit 11) in a status word for a MIL-STD-1553 bus to search on. The search number is specified by x. The search condition must be set to STATUS.

**Conditions** Requires option 5-SRAERO or SUP5-SRAERO Triggering and Analysis application.

**Group** Search and Mark

**Syntax** SEARCH:SEARCH<x>:TRIGger:A:BUS:MIL1553B:STATus:BIT:SRQ  
 {ONE | ZERO | NOCARE}  
 SEARCH:SEARCH<x>:TRIGger:A:BUS:MIL1553B:STATus:BIT:SRQ?

**Arguments** ONE filters status words to only match those where the SRQ bit has a value of 1.  
 ZERO filters status words to only match those where the SRQ bit has a value of 0.  
 NOCARE disables filtering of status words on the SRQ bit.

**Examples** SEARCH:SEARCH1:TRIGGER:A:BUS:MIL1553B:STATUS:BIT:SRQ ONE specifies filtering status words to those where the SRQ bit has a value of 1.  
 SEARCH:SEARCH1:TRIGGER:A:BUS:MIL1553B:STATUS:BIT:SRQ? might return NOCARE, indicating that status words are not being filtered based on the SRQ bit value.

## SEARCH:SEARCH<x>:TRIGger:A:BUS:MIL1553B:STATus:BIT:SUBSF

This command sets or queries the value of the subsystem flag bit (SUBSF bit, bit 17) in a status word for a MIL-STD-1553 bus to search on. The search number is specified by x>. The search condition must be set to STATUS.

<b>Conditions</b>	Requires SR-AERO Triggering and Analysis application.
<b>Group</b>	Search and Mark
<b>Syntax</b>	SEARCH:SEARCH<x>:TRIGger:A:BUS:MIL1553B:STATus:BIT:SUBSF {ONE ZERO NOCARE} SEARCH:SEARCH<x>:TRIGger:A:BUS:MIL1553B:STATus:BIT:SUBSF?
<b>Arguments</b>	ONE filters status words to only match those where the SUBSF bit has a value of 1.  ZERO filters status words to only match those where the SUBSF bit has a value of 0.  NOCARE disables filtering of status words on the SUBSF bit.
<b>Examples</b>	SEARCH:SEARCH1:TRIGGER:A:BUS:MIL1553B:STATus:BIT:SUBSF ONE specifies filtering status words for those where the SUBSF bit has a value of 1.  SEARCH:SEARCH1:TRIGGER:A:BUS:MIL1553B:STATus:BIT:SUBSF? might return NOCARE, indicating that status words are not being filtered based on the SUBSF bit value.

## SEARCH:SEARCH<x>:TRIGger:A:BUS:MIL1553B:STATus:BIT:TF

This command sets or queries the value of the terminal flag bit (TF bit, bit 19) in a status word for a MIL-STD-1553 bus to search on. The search number is specified by x. The search condition must be set to STATUS.

<b>Conditions</b>	Requires option 5-SRAERO or SUP5-SRAERO Triggering and Analysis application.
<b>Group</b>	Search and Mark
<b>Syntax</b>	SEARCH:SEARCH<x>:TRIGger:A:BUS:MIL1553B:STATus:BIT:TF {ONE ZERO NOCARE} SEARCH:SEARCH<x>:TRIGger:A:BUS:MIL1553B:STATus:BIT:TF?

**Arguments** ONE filters status words to only match those where the TF bit has a value of 1.  
 ZERO filters status words to only match those where the TF bit has a value of 0.  
 NOCARE disables filtering of status words on the TF bit.

**Examples** SEARCH:SEARCH1:TRIGGER:A:BUS:MIL1553B:STATUS:BIT:TF ONE specifies filtering status words for those where the TF bit has a value of 1.  
 SEARCH:SEARCH1:TRIGGER:A:BUS:MIL1553B:STATUS:BIT:TF? might return NOCARE, indicating that status words are not being filtered based on the TF bit value.

## SEARCH:SEARCH<x>:TRIGger:A:BUS:MIL1553B:STATus:PARity

This command sets or queries the value of the status word parity bit for a MIL-STD-1553 bus to search on. The search number is specified by x. The search condition must be set to STATus.

**Conditions** Requires option 5-SRAERO or SUP5-SRAERO Triggering and Analysis application.

**Group** Search and Mark

**Syntax** SEARCH:SEARCH<x>:TRIGger:A:BUS:MIL1553B:STATus:PARity  
 {ONE | ZERO | NOCARE}  
 SEARCH:SEARCH<x>:TRIGger:A:BUS:MIL1553B:STATus:PARity?

**Arguments** ONE filters status words to only match those where the parity bit has a value of 1.  
 ZERO filters status words to only match those where the parity bit has a value of 0.  
 NOCARE disables filtering of status words on the parity bit.

**Examples** SEARCH:SEARCH1:TRIGGER:A:BUS:MIL1553B:STATUS:PARITY ONE specifies filtering status words for those where the parity bit has a value of 1.  
 SEARCH:SEARCH1:TRIGGER:A:BUS:MIL1553B:STATUS:PARITY? might return NOCARE, indicating that status words are not being filtered based on the parity bit value.

## SEARCH:SEARCH<x>:TRIGger:A:BUS:B:NRZ:CONDition

This command specifies a field or condition for an NRZ bus to search on. The search number is specified by x.

<b>Conditions</b>	Requires the SRNRZ Triggering and Analysis application.
<b>Group</b>	Search and Mark
<b>Syntax</b>	SEARCH:SEARCH<x>:TRIGger:A:BUS:B:NRZ:CONDition {DATA} SEARCH:SEARCH<x>:TRIGger:A:BUS:B:NRZ:CONDition?
<b>Related Commands</b>	<a href="#">SEARCH:SEARCH&lt;x&gt;:TRIGger:A:BUS:NRZ:DATA:SIZE</a>
<b>Arguments</b>	Search<x> is the number of the search.  DATA specifies the search condition as Data Characters.
<b>Examples</b>	SEARCH:SEARCH1:TRIGGER:A:BUS:NRZ:CONDition DATA specifies data as the field within an NRZ frame to search on.  SEARCH:SEARCH1:TRIGGER:A:BUS:NRZ:CONDITION? might return :SEARCH:SEARCH1:TRIGGER:A:BUS:NRZ:CONDITION DATA, indicating that DATA is the currently specified field within an NRZ frame to search on.

## SEARCH:SEARCH<x>:TRIGger:A:BUS:NRZ:DATA:SIZE

This command specifies the length of the data string, in bytes, to use when searching on the NRZ signal. The search condition needs to be set to DATA. The search number is specified by x.

<b>Conditions</b>	Requires the SRNRZ Triggering and Analysis application.
<b>Group</b>	Search and Mark
<b>Syntax</b>	SEARCH:SEARCH<x>:TRIGger:A:BUS:NRZ:DATA:SIZE <NR1> SEARCH:SEARCH<x>:TRIGger:A:BUS:NRZ:DATA:SIZE?
<b>Related Commands</b>	<a href="#">SEARCH:SEARCH&lt;x&gt;:TRIGger:A:BUS:B:NRZ:CONDition</a>

**Arguments** Search<x> is the number of the search.  
 <NR1> specifies the data string in a valid format. The minimum and default values are 1. The maximum value is 5.

**Examples** SEARCH:SEARCH1:TRIGGER:A:BUS:NRZ:DATA:SIZE 1 sets the data string for NRZ bus trigger search 1 to 1 byte.  
 SEARCH:SEARCH1:TRIGGER:A:BUS:NRZ:DATA:SIZE? might return :SEARCH:SEARCH1:TRIGGER:A:BUS:NRZ:DATA:SIZE 3, indicating that the length of the data string for NRZ bus trigger search 1 is 3 bytes.

## SEARCH:SEARCH<x>:TRIGger:A:BUS:NRZ:DATA:VALue

This command sets or queries the binary data value to be used when searching on a NRZ signal. The search condition must be set to DATA.

**Conditions** Requires the SRNRZ Triggering and Analysis application.

**Group** Search and Mark

**Syntax** SEARCH:SEARCH<x>:TRIGger:A:BUS:NRZ:DATA:VALue <QString>  
 SEARCH:SEARCH<x>:TRIGger:A:BUS:NRZ:DATA:VALue?

**Arguments** Search<x> is the number of the search.  
 <QString> specifies the data value in a valid format.

**Examples** SEARCH:SEARCH1:TRIGger:A:BUS:NRZ:DATA:VALue "1111" sets the data value to 1111.  
 SEARCH:SEARCH1:TRIGger:A:BUS:NRZ:DATA:VALue? might return :SEARCH:SEARCH1:TRIGGER:A:BUS:NRZ:DATA:VALUE "1010", indicating the data value is 1010.

## SEARCH:SEARCH<x>:TRIGger:A:BUS:ONEWIRE:COMManD:VALue

This command specifies the binary data string used for ONEWIRE triggering if the trigger condition is COMMAND.

**Conditions** Requires option SR-ONEWIRE.

<b>Group</b>	Search and Mark
<b>Syntax</b>	SEARCH:SEARCH<x>:TRIGGER:A:BUS:ONEWIRE:COMMAND:VALUE <QString> SEARCH:SEARCH<x>:TRIGGER:A:BUS:ONEWIRE:COMMAND:VALUE?
<b>Arguments</b>	Search<x> is the number of the search.  <QString> specifies the data value in a valid format. The default size and value for COMMAND is 8 bits and "XXXXXXXX".
<b>Examples</b>	SEARCH:SEARCH1:TRIGGER:A:BUS:ONEWIRE:COMMAND:VALUE "0111100111" sets the command value as "0111100111".  SEARCH:SEARCH1:TRIGGER:A:BUS:ONEWIRE:COMMAND:VALUE? might return :SEARCH:SEARCH1:TRIGGER:A:BUS:ONEWIRE:COMMAND:VALUE "0111100111", indicating that the command value is "0111100111".

## SEARCH:SEARCH<x>:TRIGGER:A:BUS:ONEWIRE:CONDITION

This command sets or queries the trigger condition for a ONEWIRE bus. MODE should be set to Overdrive for OVERDRIVEMATCH and OVERDRIVESKIP. MODE should be set to Standard for READROM, MATCHROM, SKIPROM, SEARCHROM, ALARMSEARCH. The search number is specified by x.

<b>Conditions</b>	Requires option SR-ONEWIRE.
<b>Group</b>	Search and Mark
<b>Syntax</b>	SEARCH:SEARCH<x>:TRIGGER:A:BUS:ONEWIRE:CONDITION {RESet  PREsence  COMMAND  DATA  READROM  MATCHROM  OVERDRIVEMATCH  SKIPROM  OVERDRIVESKIP  SEARCHROM  ALARMSEARCH  CRCERROR} SEARCH:SEARCH<x>:TRIGGER:A:BUS:ONEWIRE:CONDITION?
<b>Arguments</b>	Search<x> is the number of the search.  RESet specifies the search condition as RESet. Reset is the default trigger on condition.  PREsence specifies the search condition as PREsence.  COMMAND specifies the search condition as COMMAND.  DATA specifies the search condition as DATA.



READROM specifies the search condition as READROM.

MATCHROM specifies the search condition as MATCHROM.

SKIPROM specifies the search condition as SKIPROM.

SEARCHROM specifies the search condition as SEARCHROM.

ALARMSEARCH specifies the search condition as ALARMSEARCH.

CRCERROR specifies the search condition as CRCERROR.

**Examples** SEARCH:SEARCH1:TRIGGER:A:BUS:ONEWIRE:CONDITION DATA specifies data as the field within an ONEWIRE frame to search on.

SEARCH:SEARCH1:TRIGGER:A:BUS:ONEWIRE:CONDITION? might return :SEARCH:SEARCH1:TRIGGER:A:BUS:ONEWIRE:CONDITION DATA, indicating that DATA is the currently specified field within an ONEWIRE frame to search on.

## SEARCH:SEARCH<x>:TRIGGER:A:BUS:ONEWIRE:DATA:SIZE

This command specifies the length of the data string in bytes to be used for ONEWIRE triggering if the trigger condition is DATA. The search number is specified by x.

**Conditions** Requires the option SR-ONEWIRE.

**Group** Search and Mark

**Syntax** SEARCH:SEARCH<x>:TRIGGER:A:BUS:ONEWIRE:DATA:SIZE <NR1>  
SEARCH:SEARCH<x>:TRIGGER:A:BUS:ONEWIRE:DATA:SIZE?

**Arguments** Search<x> is the number of the search.

<NR1> specifies the data string in a valid format. The minimum and default values are 1. The maximum value is 5.

**Examples** SEARCH:SEARCH1:TRIGGER:A:BUS:ONEWIRE:DATA:SIZE 4 sets the data size value as 4.

SEARCH:SEARCH1:TRIGGER:A:BUS:ONEWIRE:DATA:SIZE? might return :SEARCH:SEARCH1:TRIGGER:A:BUS:ONEWIRE:DATA:SIZE 4, indicating that the data size value is 4.

## SEARCH:SEARCH<x>:TRIGger:A:BUS:ONEWIRE:DATA:VALue

This command specifies the binary data string used for ONEWIRE triggering if the trigger condition is DATA.

<b>Conditions</b>	Requires the option SR-ONEWIRE.
<b>Group</b>	Search and Mark
<b>Syntax</b>	SEARCH:SEARCH<x>:TRIGger:A:BUS:ONEWIRE:DATA:VALue <QString> SEARCH:SEARCH<x>:TRIGger:A:BUS:ONEWIRE:DATA:VALue?
<b>Arguments</b>	Search<x> is the number of the search.  <QString> specifies the data value in a valid format. The default size and value for DATA is 8 bits and "XXXXXXXX".
<b>Examples</b>	SEARCH:SEARCH1:TRIGGER:A:BUS:ONEWIRE:DATA:VALue "0111100111" sets the Data value as "0111100111".  SEARCH:SEARCH1:TRIGGER:A:BUS:ONEWIRE:DATA:VALue? might return :SEARCH:SEARCH1:TRIGGER:A:BUS:ONEWIRE:DATA:VALue "0111100111", indicating that the data value is "0111100111".

## SEARCH:SEARCH<x>:TRIGger:A:BUS:ONEWIRE:MATCHROM:FAMILYCODE

This command sets or queries the family code for Match ROM in ONEWIRE bus. MODE should be set to Standard.

<b>Conditions</b>	Requires the option SR-ONEWIRE.
<b>Group</b>	Search and Mark
<b>Syntax</b>	SEARCH:SEARCH<x>:TRIGger:A:BUS:ONEWIRE:MATCHROM:FAMILYCODE <QString> SEARCH:SEARCH<x>:TRIGger:A:BUS:ONEWIRE:MATCHROM:FAMILYCODE?
<b>Arguments</b>	Search<x> is the number of the search.  <QString> specifies the binary string used for Family Code triggering. The default size and value of family code for Match ROM is 8 bits and "XXXXXXXX".



## SEARCH:SEARCH<x>:TRIGger:A:BUS:ONEWIRE:OVERDRIVE:FAMILYCODE

This command sets or queries the Family Code for Overdrive Match ROM in ONEWIRE bus. MODE should be set to Overdrive.

<b>Conditions</b>	Requires the option SR-ONEWIRE.
<b>Group</b>	Search and Mark
<b>Syntax</b>	SEARCH:SEARCH<x>:TRIGger:A:BUS:ONEWIRE:OVERDRIVE:FAMILYCODE <QString> SEARCH:SEARCH<x>:TRIGger:A:BUS:ONEWIRE:OVERDRIVE:FAMILYCODE?
<b>Arguments</b>	Search<x> is the number of the search.  <QString> specifies the binary string used for Family Code triggering. The default size and value of family code for Overdrive match ROM is 8 bits and "XXXXXXXX".
<b>Examples</b>	SEARCH:SEARCH1:TRIGGER:A:BUS:ONEWIRE:OVERDRIVE:FAMILYCODE "11000011" specifies the binary string used for Family Code triggering if the trigger condition is Overdrive match ROM to "11000011".  SEARCH:SEARCH1:TRIGGER:A:BUS:ONEWIRE:OVERDRIVE:FAMILYCODE? might return :SEARCH:SEARCH1:TRIGGER:A:BUS:ONEWIRE:OVERDRIVE:FAMILYCODE "0111100111", indicating that the value of the family code set for Overdrive Match ROM is "0111100111".

## SEARCH:SEARCH<x>:TRIGger:A:BUS:ONEWIRE:OVERDRIVE:SERIALNUMBER

This command sets or queries the serial number for Overdrive Match ROM in ONEWIRE bus. MODE should be set to Overdrive.

<b>Conditions</b>	Requires the option SR-ONEWIRE.
<b>Group</b>	Search and Mark
<b>Syntax</b>	SEARCH:SEARCH<x>:TRIGger:A:BUS:ONEWIRE:OVERDRIVE: SERIALNUMBER <QString> SEARCH:SEARCH<x>:TRIGger:A:BUS:ONEWIRE:OVERDRIVE: SERIALNUMBER?

<b>Arguments</b>	<p>Search&lt;x&gt; is the number of the search.</p> <p>&lt;QString&gt; specifies the binary string used for Serial Number triggering. The default size and value of serial number for Overdrive match ROM is 48 bits and "XXXXXXXX XXXXXXXXXXX XXXXXXXXXXX XXXXXXXXXXX XXXXXXXXXXX XXXXXXXXXXX".</p>
<b>Examples</b>	<p>SEARCH:SEARCH1:TRIGGER:A:BUS:ONEWIRE:OVERDRIVE:SERIALNUMBER "11000010" specifies the binary string used for Serial Number triggering if the trigger condition is Overdrive match ROM and set it to "11000010".</p> <p>SEARCH:SEARCH1:TRIGGER:A:BUS:ONEWIRE:OVERDRIVE:SERIALNUMBER? might return :SEARCH:SEARCH1:TRIGGER:A:BUS:ONEWIRE:OVERDRIVE:SERIALNUMBER "0111100111", indicating that the value of the serial number set for Overdrive Match ROM is "0111100111".</p>

## SEARCH:SEARCH<x>:TRIGger:A:BUS:ONEWIRE:READROM:FAMILYCODE

This command sets or queries the family code for Read ROM in ONEWIRE bus. MODE should be set to Standard.

<b>Conditions</b>	Requires the option SR-ONEWIRE.
<b>Group</b>	Search and Mark
<b>Syntax</b>	<p>SEARCH:SEARCH&lt;x&gt;:TRIGger:A:BUS:ONEWIRE:READROM:FAMILYCODE &lt;QString&gt;</p> <p>SEARCH:SEARCH&lt;x&gt;:TRIGger:A:BUS:ONEWIRE:READROM:FAMILYCODE?</p>
<b>Arguments</b>	<p>Search&lt;x&gt; is the number of the search.</p> <p>&lt;QString&gt; specifies the binary string used for Family Code triggering. The default size and value of family code for Read ROM is 8 bits and "XXXXXXXX".</p>
<b>Examples</b>	<p>SEARCH:SEARCH1:TRIGGER:A:BUS:ONEWIRE:READROM:FAMILYCODE "11000000" specifies the binary string used for Family Code triggering if the trigger condition is READ ROM to "11000000".</p> <p>SEARCH:SEARCH1:TRIGGER:A:BUS:ONEWIRE:READROM:FAMILYCODE? might return :SEARCH:SEARCH1:TRIGGER:A:BUS:ONEWIRE:READROM:FAMILYCODE "0111100111", indicating that the value of the family code set for Read ROM is "0111100111".</p>



<b>Arguments</b>	<p>Search&lt;x&gt; is the number of the search.</p> <p>&lt;QString&gt; specifies the ROM code for Search ROM. The default size and value of ROM code for Search ROM is 64 bits and "XXXXXXXX XXXXXXXX XXXXXXXX XXXXXXXX XXXXXXXX XXXXXXXX XXXXXXXX".</p>
<b>Examples</b>	<p>SEARCH:SEARCH1:TRIGGER:A:BUS:ONEWIRE:SEARCHROM:ROMCODE "11011101" specifies the ROM code set for Search ROM as "11011101".</p> <p>SEARCH:SEARCH1:TRIGGER:A:BUS:ONEWIRE:SEARCHROM:ROMCODE? might return :SEARCH:SEARCH1:TRIGGER:A:BUS:ONEWIRE:SEARCHROM:ROMCODE "0111100111", indicating that the value of the ROM code set for Search ROM is "0111100111".</p>

## SEARCH:SEARCH<x>:TRIGger:A:BUS:PARAllel:DATA:VALue

This command sets or queries the binary data string used for a parallel bus search to determine where to place a mark. The search number is specified by x.

<b>Group</b>	Search and Mark
<b>Syntax</b>	<p>SEARCH:SEARCH&lt;x&gt;:TRIGger:A:BUS:PARAllel:DATA:VALue &lt;QString&gt;          SEARCH:SEARCH&lt;x&gt;:TRIGger:A:BUS:PARAllel:DATA:VALue?</p>
<b>Arguments</b>	<QString> specifies the data value in a valid format. Valid characters are 0-9,
<b>Examples</b>	<p>SEARCH:SEARCH2:TRIGGER:A:BUS:PARALLEL:DATA:VALUE "XXXXXXXX" sets the string data value to "XXXXXXXX" in binary format.</p> <p>SEARCH:SEARCH1:TRIGGER:A:BUS:PARALLEL:DATA:VALUE? might return SEARCH:SEARCH1:TRIGGER:A:BUS:PARALLEL:DATA:VALUE "XXXXXXXXXXXXXXXX10010", indicating that the data value string is set to "XXXXXXXXXXXXXXXX10010" in binary format.</p>

## SEARCH:SEARCH<x>:TRIGger:A:BUS:PSIFive:BLOCKDATA:VALue

This command sets or queries the binary block data string used for PSI5 triggering if the trigger condition is block id.

<b>Conditions</b>	Requires option SR-PSI5
-------------------	-------------------------

<b>Group</b>	Search and Mark
<b>Syntax</b>	SEARCH:SEARCH<x>:TRIGGER:A:BUS:PSIFIVE:BLOCKDATA:VALUE <QString> SEARCH:SEARCH<x>:TRIGGER:A:BUS:PSIFIVE:BLOCKDATA:VALUE?
<b>Arguments</b>	<QString> specifies the binary block data string.
<b>Examples</b>	SEARCH:SEARCH1:TRIGGER:A:BUS:PSIFIVE:BLOCKDATA:VALUE "1100001111" sets the block data value as the field within a PSI5 frame to search on.  SEARCH:SEARCH1:TRIGGER:A:BUS:PSIFIVE:BLOCKDATA:VALUE? might return :SEARCH:SEARCH1:TRIGGER:A:BUS:PSIFIVE:BLOCKDATA:VALUE "1100001111", indicating that the binary block data value is the currently "1100001111".

## SEARCH:SEARCH<x>:TRIGGER:A:BUS:PSIFIVE:CONDITION

This command sets or queries the trigger condition for an PSI5 bus. The search number is specified by x.

<b>Conditions</b>	Requires option SR-PSI5
<b>Group</b>	Search and Mark
<b>Syntax</b>	SEARCH:SEARCH<x>:TRIGGER:A:BUS:PSIFIVE:CONDITION {START STATUS DATA BLOCKID SENSORSTATUS ERRORS STARTBIT FUNCTIONCODE E SEARCH:SEARCH<x>:TRIGGER:A:BUS:PSIFIVE:CONDITION?
<b>Arguments</b>	START specifies the search condition as Start. This is the default trigger. STATUS specifies the search condition as Status. DATA specifies the search condition as Data. BLOCKID specifies the search condition as Block ID. SENSORSTATUS specifies the search condition as Sensor Status. ERRORS specifies the search condition as Errors. STARTBIT specifies the search condition as Start Bit. FUNCTIONCODE specifies the search condition as Function Code.



ECUDATa specifies the search condition as ECU Data.

SENSORADDRESS specifies the search condition as Sensor Address.

REGISTERADDRESS specifies the search condition as Register Address.

SENSORSTATUS specifies the search condition as Sensor Status.

CRCERROR specifies the search condition as CRC Error.

**Examples** SEARCH:SEARCH1:TRIGGER:A:BUS:PSIFIVE:CONDition START specifies start as the field within a PSI5 frame to search on.

SEARCH:SEARCH1:TRIGGER:A:BUS:PSIFIVE:CONDition? might return :SEARCH:SEARCH1:TRIGGER:A:BUS:PSIFIVE:CONDition START, indicating that start is the currently specified field within a PSI5 frame to search on.

## SEARCH:SEARCH<x>:TRIGger:A:BUS:PSIFIVE:DATA:ECU:SENSor:VALue

This command sets or queries the binary Data string used for PSI5 triggering if the trigger condition is Data in ECU to Sensor communication mode. The search number is specified by x.

**Conditions** Requires option SR-PSI5

**Group** Search and Mark

**Syntax** SEARCH:SEARCH<x>:TRIGger:A:BUS:PSIFIVE:DATA:ECU:SENSor:VALue <QString>  
SEARCH:SEARCH<x>:TRIGger:A:BUS:PSIFIVE:DATA:ECU:SENSor:VALue?

**Arguments** <QString> specifies the value of the data string. The valid characters are 0, 1, and X for values in binary format; and A-F, 0-9, and X for values in hexadecimal format.

**Examples** SEARCH:SEARCH1:TRIGger:A:BUS:B:PSIFIVE:DATA:ECU:SENSor:VALue "01111001" sets the data value as "01111001".

SEARCH:SEARCH1:TRIGger:A:BUS:B:PSIFIVE:DATA:ECU:SENSor:VALue? might return :SEARCH:SEARCH1:TRIGger:A:BUS:B:PSIFIVE:DATA:ECU:SENSor:VALue "0111100111", indicating that the data value is "0111100111".

## SEARCH:SEARCH<x>:TRIGger:A:BUS:PSIFive:DATA:REGion:A:VALue

This command sets or queries the binary data string used for PSI5 triggering if the trigger condition is data region A. The search number is specified by *x*.

<b>Conditions</b>	Requires option SR-PSI5
<b>Group</b>	Search and Mark
<b>Syntax</b>	SEARCH:SEARCH<x>:TRIGger:A:BUS:PSIFive:DATA:REGion:A:VALue <QString> SEARCH:SEARCH<x>:TRIGger:A:BUS:PSIFive:DATA:REGion:A:VALue?
<b>Arguments</b>	<QString> specifies the value of the data string. The valid characters are 0, 1, and X for values in binary format; and A-F, 0-9, and X for values in hexadecimal format.
<b>Examples</b>	SEARCH:SEARCH1:TRIGGER:A:BUS:PSIFive:DATA:REGion:A:VALue "0111100111" sets the data value as "0111100111".  SEARCH:SEARCH1:TRIGGER:A:BUS:PSIFive:DATA:REGion:A:VALue? might return :SEARCH:SEARCH1:TRIGGER:A:BUS:PSIFive:DATA:REGion:A:VALue "0111100111", indicating that the data value is "0111100111".

## SEARCH:SEARCH<x>:TRIGger:A:BUS:PSIFive:DATA:REGion:B:VALue

This command sets or queries the binary data string used for PSI5 triggering if the trigger condition is data region B. The search number is specified by *x*.

<b>Conditions</b>	Requires option SR-PSI5
<b>Group</b>	Search and Mark
<b>Syntax</b>	SEARCH:SEARCH<x>:TRIGger:A:BUS:PSIFive:DATA:REGion:B:VALue <QString> SEARCH:SEARCH<x>:TRIGger:A:BUS:PSIFive:DATA:REGion:B:VALue?
<b>Arguments</b>	<QString> specifies the value of the data string. The valid characters are 0, 1, and X for values in binary format; and A-F, 0-9, and X for values in hexadecimal format.

**Examples**    `SEARCH:SEARCH1:TRIGGER:A:BUS:PSIFIVE:DATA:REGION:B:VALUE "0111100111"` sets the data value as "0111100111".

`SEARCH:SEARCH1:TRIGGER:A:BUS:PSIFIVE:DATA:REGION:B:VALUE?` might return  
`:SEARCH:SEARCH1:TRIGGER:A:BUS:PSIFIVE:DATA:REGION:A:VALUE "0111100111"`, indicating that the data value is "0111100111".

## SEARCH:SEARCH<x>:TRIGger:A:BUS:PSIFIVE:DATABITS

This command sets or queries the binary register address string used for PSI5 triggering if the trigger condition is Data in ECU to Sensor communication mode. The search number is specified by x.

**Conditions**    Requires option SR-PSI5

**Group**        Search and Mark

**Syntax**        `SEARCH:SEARCH<x>:TRIGger:A:BUS:PSIFIVE:DATABITS {FOURBIT|EIGHTBIT|TWENTYBIT}`  
`SEARCH:SEARCH<x>:TRIGger:A:BUS:PSIFIVE:DATABITS?`

**Arguments**    `FOURBIT` specifies the data bit value as 4 bit.  
`EIGHTBIT` specifies the data bit value as 8 bit.  
`TWENTYBIT` specifies the data bit value as 20 bit.

**Examples**        `SEARCH:SEARCH1:TRIGGER:A:BUS:PSIFIVE:DATABITS FOURBIT` specifies sets data bit as 4 bit.

`SEARCH:SEARCH1:TRIGGER:A:BUS:PSIFIVE:DATBITS?` might return  
`:SEARCH:SEARCH1:TRIGGER:A:BUS:PSIFIVE:DATBITS EIGHTBIT`, indicating that the data bit is 8 bit.

## SEARCH:SEARCH<x>:TRIGger:A:BUS:PSIFIVE:ERRORTYPE

This command sets or queries the error type for an PSI5 bus. The search number is specified by x.

**Conditions**    Requires option SR-PSI5

<b>Group</b>	Search and Mark
<b>Syntax</b>	SEARCH:SEARCH<x>:TRIGger:A:BUS:PSIFIVE:ERRORTYPE {ANY PARi ty CRC RESPONSECODE} SEARCH:SEARCH<x>:TRIGger:A:BUS:PSIFIVE:ERRORTYPE?
<b>Arguments</b>	ANY specifies the error type value as any. This is the default value. PARi ty specifies the error type value as parity. CRC specifies the error type value as CRC. RESPONSECODE specifies the error type value as response code.
<b>Examples</b>	SEARCH:SEARCH1:TRIGGER:A:BUS:PSIFIVE:ERRORTYPE PARi ty specifies parity as the field within a PSI5 frame to search on. SEARCH:SEARCH1:TRIGGER:A:BUS:PSIFIVE:ERRORTYPE? might return :SEARCH:SEARCH1:TRIGGER:A:BUS:PSIFIVE:ERRORTYPE PARi ty, indicating that parity is the current specified field within a PSI5 frame to search on.

## SEARCH:SEARCH<x>:TRIGger:A:BUS:PSIFIVE:FUNCTIONCODETYPE

This command sets or queries the binary data string used for PSI5 triggering if the trigger condition is a Function Code. The search number is specified by x.

<b>Conditions</b>	Requires option SR-PSI5
<b>Group</b>	Search and Mark
<b>Syntax</b>	SEARCH:SEARCH<x>:TRIGger:A:BUS:PSIFIVE:FUNCTIONCODETYPE <QString> SEARCH:SEARCH<x>:TRIGger:A:BUS:PSIFIVE:FUNCTIONCODETYPE?
<b>Arguments</b>	<QString> specifies the value of the data string. The valid characters are 0, 1, and X for values in binary format; and A-F, 0-9, and X for values in hexadecimal format.
<b>Examples</b>	SEARCH:SEARCH1:TRIGGER:A:BUS:PSIFIVE:FUNCTIONCODETYPE "011" specifies function code as "011".

SEARCH:SEARCH1:TRIGGER:A:BUS:PSIFIVE:FUNCTIONCODETYPE? might return :SEARCH:SEARCH1:TRIGGER:A:BUS:PSIFIVE:FUNCTIONCODETYPE "011", indicating that Function Code Type is currently "011".

## SEARCH:SEARCH<x>:TRIGger:A:BUS:PSIFIVE:REGister:ADDRess:VALue

This command sets or queries the binary register address string used for PSI5 triggering if the trigger condition is Register Address. The search number is specified by x.

<b>Conditions</b>	Requires option SR-PSI5
<b>Group</b>	Search and Mark
<b>Syntax</b>	SEARCH:SEARCH<x>:TRIGger:A:BUS:PSIFIVE:REGister:ADDRess:VALue <QString> SEARCH:SEARCH<x>:TRIGger:A:BUS:PSIFIVE:REGister:ADDRess:VALue?
<b>Arguments</b>	<QString> specifies the value of the data string. The valid characters are 0, 1, and X for values in binary format; and A-F, 0-9, and X for values in hexadecimal format.
<b>Examples</b>	SEARCH:SEARCH1:TRIGger:A:BUS:B:PSIFIVE:REGister:ADDRess:VALue "0111100111" sets the register address value as "0111100111".  SEARCH:SEARCH1:TRIGger:A:BUS:B:PSIFIVE:REGister:ADDRess:VALue? might return :SEARCH:SEARCH1:TRIGger:A:BUS:B:PSIFIVE:REGister:ADDRess:VALue "011", indicating that the register address value is "011".

## SEARCH:SEARCH<x>:TRIGger:A:BUS:PSIFIVE:REGISTERADDRess

This command sets or queries the register address for PSI5 bus. The search number is specified by x.

<b>Conditions</b>	Requires option SR-PSI5
<b>Group</b>	Search and Mark

**Syntax** SEARCH:SEARCH<x>:TRIGger:A:BUS:PSIFIVE:REGISTERADDRESS  
 {TWOBIT|SIXBIT|EIGHTBIT}  
 SEARCH:SEARCH<x>:TRIGger:A:BUS:PSIFIVE:REGISTERADDRESS?

**Arguments** TWOBIT specifies the register address value as 2 bit. This is the default value.  
 SIXBIT specifies the register address value as 6 bit.  
 EIGHTBIT specifies the register address value as 8 bit.

**Examples** SEARCH:SEARCH1:TRIGGER:A:BUS:PSIFIVE:REGISTERADDRESS SIXBIT  
 specifies the register address as 6 bit as the field within a PSI5 frame to search on.  
 SEARCH:SEARCH1:TRIGGER:A:BUS:PSIFIVE:REGISTERADDRESS? might  
 return :SEARCH:SEARCH1:TRIGGER:A:BUS:PSIFIVE:REGISTERADDRESS  
 SIXBIT, indicating that register address as 6 bit is the currently specified field  
 within a PSI5 frame to search on.

## SEARCH:SEARCH<x>:TRIGger:A:BUS:PSIFIVE:SENSOR:ADDRESS:VALUE

This command sets or queries the binary sensor address string used for PSI5 triggering if the trigger condition is Sensor Address. The search number is specified by x.

**Conditions** Requires option SR-PSI5

**Group** Search and Mark

**Syntax** SEARCH:SEARCH<x>:TRIGger:A:BUS:PSIFIVE:SENSOR:ADDRESS:VALUE  
 <Qstring>  
 SEARCH:SEARCH<x>:TRIGger:A:BUS:PSIFIVE:SENSOR:ADDRESS:VALUE?

**Arguments** <Qstring> specifies the value of the data string. The valid characters are 0, 1, and X for values in binary format; and A-F, 0-9, and X for values in hexadecimal format.

**Examples** SEARCH:SEARCH1:TRIGGER:A:BUS:PSIFIVE:SENSOR:ADDRESS:VALUE  
 "101" specifies sensor address as "101".  
 SEARCH:SEARCH1:TRIGGER:A:BUS:PSIFIVE:SENSOR:ADDRESS:VALUE?  
 might return  
 :SEARCH:SEARCH1:TRIGGER:A:BUS:PSIFIVE:SENSOR:ADDRESS:VALUE  
 "101", indicating that the sensor address value is currently "101".

**SEARCH:SEARCH<x>:TRIGger:A:BUS:PSIFIVE:SENSORSTaTus:TYPe**

This command sets or queries the sensor status for PSI5 bus.

**Conditions** Requires option SR-PSI5

**Group** Search and Mark

**Syntax** SEARCH:SEARCH<x>:TRIGger:A:BUS:PSIFIVE:SENSORSTaTus:TYPe  
{READY|BUSY|DEFect|SERVICEMODE|UNLocked}  
SEARCH:SEARCH<x>:TRIGger:A:BUS:PSIFIVE:SENSORSTaTus:TYPe?

**Arguments** READY specifies the sensor status as ready. This is the default value.  
BUSY specifies the sensor status as busy.  
DEFect specifies the sensor status as defect.  
SERVICEMODE specifies the sensor status as service mode.  
UNLocked specifies the sensor status as unlocked.

**Examples** SEARCH:SEARCH1:TRIGGER:A:BUS:PSIFIVE:SENSORSTaTus:TYPe READY  
specifies ready as the field within a PSI5 frame to search on.  
SEARCH:SEARCH1:TRIGGER:A:BUS:PSIFIVE:SENSORSTaTus:TYPe? might  
return :SEARCH:SEARCH1:TRIGGER:A:BUS:PSIFIVE:SENSORSTaTus:TYPe  
READY, indicating that ready is the specified field within a PSI5 frame to search on.

**SEARCH:SEARCH<x>:TRIGger:A:BUS:PSIFIVE:STaTus:VALue**

This command sets or queries the binary status string used for PSI5 triggering if the trigger condition is status.

**Conditions** Requires option SR-PSI5

**Group** Search and Mark

**Syntax** SEARCH:SEARCH<x>:TRIGger:A:BUS:PSIFIVE:STaTus:VALue  
<QString>  
SEARCH:SEARCH<x>:TRIGger:A:BUS:PSIFIVE:STaTus:VALue?

**Arguments** <QString> specifies the value of the data string. The valid characters are 0, 1, and X for values in binary format; and A-F, 0-9, and X for values in hexadecimal format.

**Examples** SEARCH:SEARCH1:TRIGGER:A:BUS:PSIFIVE:STATUS:VALUE "10" specifies the status value as "10".

SEARCH:SEARCH1:TRIGGER:A:BUS:PSIFIVE:STATUS:VALUE? might return :SEARCH:SEARCH1:TRIGGER:A:BUS:PSIFIVE:STATUS:VALUE "10", indicating that the status value is 10.

## SEARCH:SEARCH<x>:TRIGger:A:BUS:RS232C:CONDition

This command sets or queries the condition for an RS232C bus search to determine where to place a mark. The search number is specified by x.

**Conditions** Requires option 5-SRCOMP or SUP5-SRCOMP Triggering and Analysis application.

**Group** Search and Mark

**Syntax** SEARCH:SEARCH<x>:TRIGger:A:BUS:RS232C:CONDition {DATA|EOP|PARITyerror|START}  
SEARCH:SEARCH<x>:TRIGger:A:BUS:RS232C:CONDition?

**Arguments** DATA specifies the search condition as Data.  
EOP specifies the search condition as End of Packet.  
PARITyerror specifies the search condition as Parity Error.  
START specifies the search condition as Start.

**Examples** SEARCH:SEARCH1:TRIGGER:A:BUS:RS232C:CONDITION DATA sets the search condition for RS232C bus trigger search 1 to Data.

SEARCH:SEARCH2:TRIGGER:A:BUS:RS232C:CONDITION? might return :SEARCH:SEARCH2:TRIGGER:A:BUS:RS232C:CONDITION EOP, indicating that the search condition for RS232C bus trigger search 2 is set to End of Packet.



## SEARCH:SEARCH<x>:TRIGger:A:BUS:RS232C:DATA:SIZE

This command sets or queries the length of the data string in bytes to be used for an RS232C bus search to determine where to place a mark when the search condition is Data. The search number is specified by x.

<b>Conditions</b>	Requires option 5-SRCOMP or SUP5-SRCOMP Triggering and Analysis application.
<b>Group</b>	Search and Mark
<b>Syntax</b>	SEARCH:SEARCH<x>:TRIGger:A:BUS:RS232C:DATA:SIZE <NR3> SEARCH:SEARCH<x>:TRIGger:A:BUS:RS232C:DATA:SIZE?
<b>Arguments</b>	<NR3> is the number of bits per word in the data string, from 1 to 8.
<b>Examples</b>	SEARCH:SEARCH1:TRIGGER:A:BUS:RS232C:DATA:SIZE 1 sets the number of bits per word in RS232C bus trigger search 1 data string to 1.  SEARCH:SEARCH2:TRIGGER:A:BUS:RS232C:DATA:SIZE? might return :SEARCH:SEARCH2:TRIGGER:A:BUS:RS232C:DATA:SIZE 8, indicating that the bits per word for RS232C bus trigger search 2 is set to 8.

## SEARCH:SEARCH<x>:TRIGger:A:BUS:RS232C:DATA:VALue

This command sets or queries the data string used for the specified RS232C bus trigger search to determine where to place a mark. The search condition must be Data. The search number is specified by x.

<b>Conditions</b>	Requires option 5-SRCOMP or SUP5-SRCOMP Triggering and Analysis application.
<b>Group</b>	Search and Mark
<b>Syntax</b>	SEARCH:SEARCH<x>:TRIGger:A:BUS:RS232C:DATA:VALue <QString> SEARCH:SEARCH<x>:TRIGger:A:BUS:RS232C:DATA:VALue?
<b>Arguments</b>	<QString> specifies the value of the data string. The valid characters are 0, 1, and X for values in binary format; and A-F, 0-9, and X for values in hexadecimal format.

**Examples**     `SEARCH:SEARCH1:TRIGGER:A:BUS:RS232C:DATA:VALUE "01"` sets the value of the data string for RS232C bus trigger search 1 to "01" when the format is hexadecimal.

`SEARCH:SEARCH1:TRIGGER:A:BUS:RS232C:DATA:VALUE?` might return `SEARCH:SEARCH1:TRIGGER:A:BUS:RS232C:DATA:VALUE "XXXXXXXX1"`, indicating that the data string value for RS232C bus trigger search 1 is set to "XXXXXXXX1" when the format is binary.

## SEARCH:SEARCH<x>:TRIGger:A:BUS:S8B10B:CONDition

This command sets or queries the type of data search for an 8B10B bus. The search number is specified by x.

**Conditions**     Requires the SR8B10b Triggering and Analysis application.

**Group**            Search and Mark

**Syntax**            `SEARCH:SEARCH<x>:TRIGger:A:BUS:S8B10B:CONDition`  
                           `{SYMBOLs|ERRORs}`  
                           `SEARCH:SEARCH<x>:TRIGger:A:BUS:S8B10B:CONDition?`

**Related Commands**     [SEARCH:SEARCH<x>:TRIGger:A:BUS:S8B10B:DISParity](#)  
                                   [SEARCH:SEARCH<x>:TRIGger:A:BUS:S8B10B:ERRor](#)  
                                   [SEARCH:SEARCH<x>:TRIGger:A:BUS:S8B10B:SYMBOL:CSYMVALue](#)  
                                   [SEARCH:SEARCH<x>:TRIGger:A:BUS:S8B10B:SYMBOL:EBITVALue](#)  
                                   [SEARCH:SEARCH<x>:TRIGger:A:BUS:S8B10B:SYMBOL:MODE](#)  
                                   [SEARCH:SEARCH<x>:TRIGger:A:BUS:S8B10B:SYMBOL:TBITVALue](#)  
                                   [SEARCH:SEARCH<x>:TRIGger:A:BUS:S8B10B:SYMBOL:TYPE](#)

**Arguments**        `Search<x>` is the number of the search.

`SYMBOLs` specifies the search condition as data or control.

`ERRORs` specifies the search condition as Symbol error or disparity error.

**Examples**        `SEARCH:SEARCH1:TRIGGER:A:BUS:S8B10B:CONDition SYMBOL` specifies Symbol as the field within an 8B10b frame to search on.

SEARCH:SEARCH1:TRIGGER:A:BUS:S8B10B:CONDITION? might return  
:SEARCH:SEARCH1:TRIGGER:A:BUS:S8B10B:CONDITION SYMBOL,  
indicating that SYMBOL is the currently specified field within an 8B10b frame  
to search on.

## SEARCH:SEARCH<x>:TRIGger:A:BUS:S8B10B:DISParity

This command sets or queries the disparity to be used when searching on a 8B10b signal. The search condition must be set to Symbols > 8-bit.

**Conditions** Requires the SR8B10b Triggering and Analysis application.

**Group** Search and Mark

**Syntax** SEARCH:SEARCH<x>:TRIGger:A:BUS:S8B10B:DISParity  
{POSITIVE|NEGAtive|EITHer}  
SEARCH:SEARCH<x>:TRIGger:A:BUS:S8B10B:DISParity?

**Related Commands** [SEARCH:SEARCH<x>:TRIGger:A:BUS:S8B10B:CONDition](#)

**Arguments** Search<x> is the Search identifier number.  
POSITIVE specifies searching for positive disparity.  
NEGAtive specifies searching for negative disparity.  
EITHer specifies searching for neutral or either positive/negative disparity.

**Examples** SEARCH:SEARCH1:TRIGger:A:BUS:S8B10B:DISParity POSITIVE sets  
the disparity to positive.

SEARCH:SEARCH1:TRIGger:A:BUS:S8B10B:DISParity? might return  
:SEARCH:SEARCH1:TRIGGER:A:BUS:S8B10B:DISParity POSITIVE,  
indicating the disparity is positive.

## SEARCH:SEARCH<x>:TRIGger:A:BUS:S8B10B:ERRor

This command sets or queries the error type to be used when searching on a 8B10b signal. The search condition must be set to Errors.

**Conditions** Requires the SR8B10b Triggering and Analysis application.

<b>Group</b>	Search and Mark
<b>Syntax</b>	SEARCH:SEARCH<x>:TRIGger:A:BUS:S8B10B:ERROR {SYMBOL DISParity} SEARCH:SEARCH<x>:TRIGger:A:BUS:S8B10B:ERROR?
<b>Related Commands</b>	<a href="#">SEARCH:SEARCH&lt;x&gt;:TRIGger:A:BUS:S8B10B:CONDition</a>
<b>Arguments</b>	Search<x> is the Search identifier number.  SYMBOL specifies searching for Symbol Errors.  DISParity specifies searching for Disparity Errors.
<b>Examples</b>	SEARCH:SEARCH1:TRIGger:A:BUS:S8B10B:ERROR DISParity sets the error type to Disparity.  SEARCH:SEARCH1:TRIGger:A:BUS:S8B10B:ERROR? might return :SEARCH:SEARCH1:TRIGGER:A:BUS:S8B10B:ERROR DISPARITY, indicating the Error type to be disparity.

## SEARCH:SEARCH<x>:TRIGger:A:BUS:S8B10B:SYMBOL:CSYMVALue

This command sets or queries the control symbol value to be used when searching on 8b10b signal. The default is all X's (don't care). The search condition needs to be set to Symbols. The search number is specified by x.

<b>Conditions</b>	Requires the SR8B10b Triggering and Analysis application.
<b>Group</b>	Search and Mark
<b>Syntax</b>	SEARCH:SEARCH<x>:TRIGger:A:BUS:S8B10B:SYMBOL:CSYMVALue <Qstring> SEARCH:SEARCH<x>:TRIGger:A:BUS:S8B10B:SYMBOL:CSYMVALue?
<b>Related Commands</b>	<a href="#">SEARCH:SEARCH&lt;x&gt;:TRIGger:A:BUS:S8B10B:CONDition</a>
<b>Arguments</b>	Search<x> is the Search identifier number.  <Qstring> specifies the 10 bit value.

**Examples** SEARCH:SEARCH1:TRIGger:A:BUS:S8B10B:SYMbo1:CSYMVALue "D28.5" specifies the value to be used while searching.

SEARCH:SEARCH1:TRIGger:A:BUS:S8B10B:SYMbo1:CSYMVALue? might return :SEARCH:SEARCH1:TRIGGER:A:BUS:S8B10B:SYMbo1:CSYMVALue "D28.5", indicating the value to be used while searching.

## SEARCH:SEARCH<x>:TRIGger:A:BUS:S8B10B:SYMbol:EBITVALue

This command specifies the 8 bit value to be used when searching on an 8b10b signal. The default is all X's (don't care). The search condition needs to be set to Symbols. The search number is specified by x.

**Conditions** Requires the SR8B10b Triggering and Analysis application.

**Group** Search and Mark

**Syntax** SEARCH:SEARCH<x>:TRIGger:A:BUS:S8B10B:SYMbo1:EBITVALue  
<Qstring>  
SEARCH:SEARCH<x>:TRIGger:A:BUS:S8B10B:SYMbo1:EBITVALue?

**Related Commands** [SEARCH:SEARCH<x>:TRIGger:A:BUS:S8B10B:CONDition](#)

**Arguments** Search<x> is the Search identifier number.  
<Qstring> specifies the 8 bit value.

**Examples** SEARCH:SEARCH1:TRIGger:A:BUS:S8B10B:SYMbo1:EBITVALue "00001000" specifies hexadecimal 08 as the value to be used while searching.

SEARCH:SEARCH1:TRIGger:A:BUS:S8B10B:SYMbo1:EBITVALue? might return :SEARCH:SEARCH1:TRIGGER:A:BUS:S8B10B:SYMbo1:EBITVALue "00001000", indicating the binary value and 08 as the hexadecimal value to be used while searching.

## SEARCH:SEARCH<x>:TRIGger:A:BUS:S8B10B:SYMbol:MODE

This command sets or queries the mode of data search to be used when searching on 8b10b signal. The search condition must be set to Symbols.

**Conditions** Requires the SR8B10b Triggering and Analysis application.

<b>Group</b>	Search and Mark
<b>Syntax</b>	SEARCH:SEARCH<x>:TRIGger:A:BUS:S8B10B:SYMbo1:MODE {EBIT TBIT SYMB} SEARCH:SEARCH<x>:TRIGger:A:BUS:S8B10B:SYMbo1:MODE?
<b>Related Commands</b>	<a href="#">SEARCH:SEARCH&lt;x&gt;:TRIGger:A:BUS:S8B10B:CONDition</a>
<b>Arguments</b>	<p>Search&lt;x&gt; is the number of the search.</p> <p>EBIT specifies searching for Eight Bit data.</p> <p>TBIT specifies searching for Ten bit data (6 bits and 4 bits combined). Only valid values are considered.</p> <p>SYMB specifies searching for symbol data with disparity. Takes only K and D with possible values..</p>
<b>Examples</b>	<p>SEARCH:SEARCH1:TRIGger:A:BUS:S8B10B:SYMbo1:MODE TBIT sets the symbol mode to tbit.</p> <p>SEARCH:SEARCH1:TRIGger:A:BUS:S8B10B:SYMbo1:MODE? might return :SEARCH:SEARCH1:TRIGGER:A:BUS:S8B10B:SYMbo1:MODE TBIT, indicating the symbol mode to be tbit.</p>

## SEARCH:SEARCH<x>:TRIGger:A:BUS:S8B10B:SYMBOL:TBITRDNeg

This command specifies the 10 bit RD negative value to be used when searching on an 8b10b signal. The default is all X's (don't care). The search condition needs to be set to Symbols. The search number is specified by x.

<b>Conditions</b>	Requires the SR8B10b Triggering and Analysis application.
<b>Group</b>	Search and Mark
<b>Syntax</b>	SEARCH:SEARCH<x>:TRIGger:A:BUS:S8B10B:SYMbo1:TBITRDNeg <Qstring> SEARCH:SEARCH<x>:TRIGger:A:BUS:S8B10B:SYMbo1:TBITRDNeg?
<b>Related Commands</b>	<a href="#">SEARCH:SEARCH&lt;x&gt;:TRIGger:A:BUS:S8B10B:CONDition</a>

<b>Arguments</b>	Search<x> is the Search identifier number. <Qstring> specifies the 10 bit RD negative value.
<b>Examples</b>	SEARCH:SEARCH1:TRIGger:A:BUS:S8B10B:SYMBOL:TBITRDNeg "0011101010" specifies hexadecimal 0EA as the value to be used while searching.  SEARCH:SEARCH1:TRIGger:A:BUS:S8B10B:SYMBOL:TBITRDNeg? might return :SEARCH:SEARCH1:TRIGGER:A:BUS:S8B10B:SYMBOL:TBITRDNeg "0011101010", indicating the binary value and 0EA as the hexadecimal value to be used while searching.

## SEARCH:SEARCH<x>:TRIGger:A:BUS:S8B10B:SYMBOL:TBITRDPos

This command specifies the 10 bit RD positive value to be used when searching on an 8b10b signal. The default is all X's (don't care). The search condition needs to be set to Symbols. The search number is specified by x.

<b>Conditions</b>	Requires the SR8B10b Triggering and Analysis application.
<b>Group</b>	Search and Mark
<b>Syntax</b>	SEARCH:SEARCH<x>:TRIGger:A:BUS:S8B10B:SYMBOL:TBITRDPos <QString> SEARCH:SEARCH<x>:TRIGger:A:BUS:S8B10B:SYMBOL:TBITRDPos?
<b>Related Commands</b>	<a href="#">SEARCH:SEARCH&lt;x&gt;:TRIGger:A:BUS:S8B10B:CONDition</a>
<b>Arguments</b>	Search<x> is the Search identifier number. <Qstring> specifies the 10 bit RD positive value.
<b>Examples</b>	SEARCH:SEARCH1:TRIGger:A:BUS:S8B10B:SYMBOL:TBITRDPos "0011101010" specifies hexadecimal 0EA as the value to be used while searching.  SEARCH:SEARCH1:TRIGger:A:BUS:S8B10B:SYMBOL:TBITRDPos? might return :SEARCH:SEARCH1:TRIGGER:A:BUS:S8B10B:SYMBOL:TBITRDPos "0011101010", indicating the binary value and 0EA as the hexadecimal value to be used while searching.

## SEARCH:SEARCH<x>:TRIGger:A:BUS:S8B10B:SYMBOL:TBITVALue

This command specifies the 10 bit value to be used when searching on an 8b10b signal. The default is all X's (don't care). The search condition needs to be set to Symbols. The search number is specified by x.

<b>Conditions</b>	Requires the SR8B10b Triggering and Analysis application.
<b>Group</b>	Search and Mark
<b>Syntax</b>	SEARCH:SEARCH<x>:TRIGger:A:BUS:S8B10B:SYMBOL:TBITVALue <QString> SEARCH:SEARCH<x>:TRIGger:A:BUS:S8B10B:SYMBOL:TBITVALue?
<b>Related Commands</b>	<a href="#">SEARCH:SEARCH&lt;x&gt;:TRIGger:A:BUS:S8B10B:CONDition</a>
<b>Arguments</b>	Search<x> is the Search identifier number.  <Qstring> specifies the 10 bit value.
<b>Examples</b>	SEARCH:SEARCH1:TRIGger:A:BUS:S8B10B:SYMBOL:TBITVALue "0011101010" specifies hexadecimal 0EA as the value to be used while searching.  SEARCH:SEARCH1:TRIGger:A:BUS:S8B10B:SYMBOL:TBITVALue? might return :SEARCH:SEARCH1:TRIGGER:A:BUS:S8B10B:SYMBOL:TBITVALue "0011101010", indicating the binary value and 0EA as the hexadecimal value to be used while searching.

## SEARCH:SEARCH<x>:TRIGger:A:BUS:S8B10B:SYMBOL:TYPE

This command sets or queries the type of symbol when searching on 8b10b signal. The search condition must be set to Symbols.

<b>Conditions</b>	Requires the SR8B10b Triggering and Analysis application.
<b>Group</b>	Search and Mark
<b>Syntax</b>	SEARCH:SEARCH<x>:TRIGger:A:BUS:S8B10B:SYMBOL:TYPE {DATA CONTRoL} SEARCH:SEARCH<x>:TRIGger:A:BUS:S8B10B:SYMBOL:TYPE?



**Related Commands**    [SEARCH:SEARCH<x>:TRIGger:A:BUS:S8B10B:CONDition](#)

**Arguments**    Search<x> is the number of the search.  
 DATA specifies searching for Data Symbols.  
 CONTro1 specifies searching for Control Symbols.

**Examples**    SEARCH:SEARCH1:TRIGger:A:BUS:S8B10B:SYMbo1:TYPE DATA sets the symbol type to data.  
 SEARCH:SEARCH1:TRIGger:A:BUS:S8B10B:SYMbo1:TYPE? might return :SEARCH:SEARCH1:TRIGGER:A:BUS:S8B10B:SYMbo1:TYPE DATA, indicating the symbol type to be data.

## SEARCH:SEARCH<x>:TRIGger:A:BUS:SDLC:ADDRESS:TYPE

This commands specifies the Address type in SDLC frame which can be Broadcast, No-Station and Address value can be specified.

**Conditions**    Requires option SR-SDLC.

**Group**    Search and Mark

**Syntax**    SEARCH:SEARCH<x>:TRIGger:A:BUS:SDLC:ADDRESS:TYPE  
 {BROadcast|NOSTATIon|STATIONADDR}  
 SEARCH:SEARCH<x>:TRIGger:A:BUS:SDLC:ADDRESS:TYPE?

**Arguments**    Search<x> is the number of the search.  
 BROadcast specifies the Broadcast as the field within a SDLC frame to search on. BROadcast is the default value.  
 NOSTATIon specifies the No-Station as the field within a SDLC frame to search on.  
 STATIONADDR specifies the Address as the field within a SDLC frame to search on.

**Examples**    SEARCH:SEARCH1:TRIGGER:A:BUS:SDLC:ADDRESS:TYPE BROadcast specifies the Address Type as the field within a SDLC frame to search on.

SEARCH:SEARCH1:TRIGGER:A:BUS:SDLC:ADDRESS:TYPE? might return  
:SEARCH:SEARCH1:TRIGGER:A:BUS:SDLC:ADDRESS:TYPE BROADCAST,  
indicating that the Address Type is specified as Broadcast.

## SEARCH:SEARCH<x>:TRIGGER:A:BUS:SDLC:CONDITION

This command sets or queries the trigger condition for a SDLC bus.

<b>Conditions</b>	Requires option SR-SDLC.
<b>Group</b>	Search and Mark
<b>Syntax</b>	SEARCH:SEARCH<x>:TRIGGER:A:BUS:SDLC:CONDITION {START  DATA  ABORT  ADDRESS  UNNUMBERED  INFORMATION  SUPERVISORY  ERRORS  END} SEARCH:SEARCH<x>:TRIGGER:A:BUS:SDLC:CONDITION?
<b>Arguments</b>	<p>Search&lt;x&gt; is the number of the search.</p> <p>START specifies start as the field within a SDLC frame to search on. The default Trigger on Condition is START.</p> <p>DATA specifies data as the field within a SDLC frame to search on.</p> <p>ABORT specifies abort as the field within a SDLC frame to search on.</p> <p>ADDRESS specifies address as the field within a SDLC frame to search on.</p> <p>UNNUMBERED specifies unnumbered as the field within a SDLC frame to search on.</p> <p>INFORMATION specifies information as the field within a SDLC frame to search on.</p> <p>SUPERVISORY specifies supervisory as the field within a SDLC frame to search on.</p> <p>ERRORS specifies errors as the field within a SDLC frame to search on.</p> <p>END specifies end as the field within a SDLC frame to search on.</p>
<b>Examples</b>	<p>SEARCH:SEARCH1:TRIGGER:A:BUS:SDLC:CONDITION START specifies start as the field within a SDLC frame to search on.</p> <p>SEARCH:SEARCH1:TRIGGER:A:BUS:SDLC:CONDITION? might return :SEARCH:SEARCH1:TRIGGER:A:BUS:SDLC:CONDITION START, indicating that start is the currently specified field within a SDLC frame to search on.</p>

## SEARCH:SEARCH<x>:TRIGger:A:BUS:SDLC:DATA:SIZE

This command specifies the length of the data string in bytes to be used for SDLC triggering if the trigger condition is DATA. The search number is specified by x.

<b>Conditions</b>	Requires option SR-SDLC.
<b>Group</b>	Search and Mark
<b>Syntax</b>	SEARCH:SEARCH<x>:TRIGger:A:BUS:SDLC:DATA:SIZE <NR3> SEARCH:SEARCH<x>:TRIGger:A:BUS:SDLC:DATA:SIZE?
<b>Arguments</b>	<NR3> is the length of the data string in bytes. The default Data size is 1, otherwise ranges between 1 to 5.
<b>Examples</b>	SEARCH:SEARCH1:TRIGGER:A:BUS:SDLC:DATA:SIZE 4 sets the data size value as 4.  SEARCH:SEARCH1:TRIGGER:A:BUS:SDLC:DATA:SIZE? might return :SEARCH:SEARCH1:TRIGGER:A:BUS:SDLC:DATA:SIZE 4, indicating that the data size value is 4.

## SEARCH:SEARCH<x>:TRIGger:A:BUS:SDLC:DATA:VALue

This command specifies the binary data string used for SDLC triggering if the trigger condition is DATA. The search number is specified by x.

<b>Conditions</b>	Requires option SR-SDLC.
<b>Group</b>	Search and Mark
<b>Syntax</b>	SEARCH:SEARCH<x>:TRIGger:A:BUS:SDLC:DATA:VALue <QString> SEARCH:SEARCH<x>:TRIGger:A:BUS:SDLC:DATA:VALue?
<b>Arguments</b>	<QString> specifies the value of the data string. The default value is XXXXXXXX .
<b>Examples</b>	SEARCH:SEARCH1:TRIGGER:A:BUS:SDLC:DATA:VALue "0111100111" sets the Data value as "0111100111".

SEARCH:SEARCH1:TRIGGER:A:BUS:SDLC:DATA:VALUE? might return  
:SEARCH:SEARCH1:TRIGGER:A:BUS:SDLC:DATA:VALUE "0111100111",  
indicating that the data value is "0111100111".

## SEARCH:SEARCH<x>:TRIGger:A:BUS:SDLC:ERROR:TYPE

This command sets or queries the Error Type in SDLC bus.

<b>Conditions</b>	Requires option SR-SDLC.
<b>Group</b>	Search and Mark
<b>Syntax</b>	SEARCH:SEARCH<x>:TRIGger:A:BUS:SDLC:ERROR:TYPE {FCS NUMERICORDER} SEARCH:SEARCH<x>:TRIGger:A:BUS:SDLC:ERROR:TYPE?
<b>Arguments</b>	Search<x> is the number of the search.  FCS sets FCS as the Error Type in SDLC bus. The default error type condition is FCS  NUMERICORDER sets NUMERICORDER as the Error Type in SDLC bus.
<b>Examples</b>	SEARCH:SEARCH1:TRIGGER:A:BUS:SDLC:ERROR:TYPE FCS specifies parity as the field within a FCS frame to search on.  SEARCH:SEARCH1:TRIGGER:A:BUS:SDLC:ERROR:TYPE? might return :SEARCH:SEARCH1:TRIGGER:A:BUS:SDLC:ERROR:TYPE FCS, indicating that FCS is the currently specified field within a FCS frame to search on.

## SEARCH:SEARCH<x>:TRIGger:A:BUS:SDLC:FRAME:TYPE

This command sets or queries the Frame Type in SDLC bus.

<b>Conditions</b>	Requires option SR-SDLC.
<b>Group</b>	Search and Mark
<b>Syntax</b>	SEARCH:SEARCH<x>:TRIGger:A:BUS:SDLC:FRAME:TYPE {COMMAND RESPONSE BOTH} SEARCH:SEARCH<x>:TRIGger:A:BUS:SDLC:FRAME:TYPE?

<b>Arguments</b>	<p>Search&lt;x&gt; is the number of the search.</p> <p>COMMAND sets Command as the Frame Type in SDLC bus. The default value of frame type for SDLC Unnumbered frame is Command.</p> <p>RESPONSE sets Response as the Frame Type in SDLC bus.</p> <p>BOTH sets both Command and Response as the Frame Type in SDLC bus.</p>
<b>Examples</b>	<p>SEARCH:SEARCH1:TRIGGER:A:BUS:SDLC:FRAME:TYPE RESPONSE specifies the frame type as Response.</p> <p>SEARCH:SEARCH1:TRIGGER:A:BUS:SDLC:FRAME:TYPE? might return :SEARCH:SEARCH1:TRIGGER:A:BUS:SDLC:FRAME:TYPE RESPONSE, indicating that frame type is Response for Unnumbered frames and accordingly packet list will change.</p>

## SEARCH:SEARCH<x>:TRIGger:A:BUS:SDLC:STADdress:VALue

This command specifies the binary Station Address string used for SDLC triggering if the trigger condition is Address. The search number is specified by x.

<b>Conditions</b>	Requires option SR-SDLC.
<b>Group</b>	Search and Mark
<b>Syntax</b>	<p>SEARCH:SEARCH&lt;x&gt;:TRIGger:A:BUS:SDLC:STADdress:VALue &lt;QString&gt;</p> <p>SEARCH:SEARCH&lt;x&gt;:TRIGger:A:BUS:SDLC:STADdress:VALue?</p>
<b>Related Commands</b>	<a href="#">SEARCH:SEARCH&lt;x&gt;:TRIGger:A:BUS:SDLC:ADDRess:TYPE</a>
<b>Arguments</b>	<QString> specifies the value of the data string. The default value is XXXXXXXX.
<b>Examples</b>	<p>SEARCH:SEARCH1:TRIGGER:A:BUS:SDLC:STADdress:VALue "0111100111" sets the Station Address value as "0111100111".</p> <p>SEARCH:SEARCH1:TRIGGER:A:BUS:SDLC:STADdress:VALue? might return :SEARCH:SEARCH1:TRIGGER:A:BUS:SDLC:STADdress:VALue "0111100111", indicating that the station address value is "0111100111".</p>

## SEARCH:SEARCH<x>:TRIGger:A:BUS:SDLC:SUPervisory:FRAMETYPe

This command sets or queries the Supervisory Frame Type in SDLC bus.

<b>Conditions</b>	Requires option SR-SDLC.
<b>Group</b>	Search and Mark
<b>Syntax</b>	SEARCH:SEARCH<x>:TRIGger:A:BUS:SDLC:SUPervisory:FRAMETYPe {RR RNR REJ} SEARCH:SEARCH<x>:TRIGger:A:BUS:SDLC:SUPervisory:FRAMETYPe?
<b>Arguments</b>	Search<x> is the number of the search.  RR sets the frame type as RR.  RNR sets the frame type as RNR.  REJ sets the frame type as REJ.
<b>Examples</b>	SEARCH:SEARCH1:TRIGGER:A:BUS:SDLC:SUPervisory:FRAMETYPe RNR specifies Receive Not Ready supervisory packet type.  SEARCH:SEARCH1:TRIGGER:A:BUS:SDLC:SUPervisory:FRAMETYPe? might return :SEARCH:SEARCH1:TRIGGER:A:BUS:SDLC:SUPervisory:FRAMETYPe RNR, indicating that RNR is the currently specified SDLC Supervisory Packet to search on.

## SEARCH:SEARCH<x>:TRIGger:A:BUS:SDLC:UNNumbered:FRAMETYPe

This command sets or queries the Unnumbered Frame Type in SDLC bus.

<b>Conditions</b>	Requires option SR-SDLC.
<b>Group</b>	Search and Mark
<b>Syntax</b>	SEARCH:SEARCH<x>:TRIGger:A:BUS:SDLC:UNNumbered:FRAMETYPe {UP UI SNRM SNRME REQDISconnect UACK REQSETINIT  DISCMODE FRAMEREJ TEST XID CONFigure BEACon} SEARCH:SEARCH<x>:TRIGger:A:BUS:SDLC:UNNumbered:FRAMETYPe?

**Related Commands**    [SEARCH:SEARCH<x>:TRIGger:A:BUS:SDLC:FRAMe:TYPE](#)

**Arguments**

Search<x> is the number of the search.

UP sets the Unnumbered Frame Type as UP.

UI sets the Unnumbered Frame Type as UI.

SNRM sets the Unnumbered Frame Type as SNRM.

SNRME sets the Unnumbered Frame Type as SNRME.

REQDISConnect sets the Unnumbered Frame Type as REQDISConnect.

UACK sets the Unnumbered Frame Type as UACK.

REQSETINIT sets the Unnumbered Frame Type as REQSETINIT.

DISCMODE sets the Unnumbered Frame Type as DISCMODE.

FRAMEREJ sets the Unnumbered Frame Type as FRAMEREJ.

TEST sets the Unnumbered Frame Type as TEST.

XID sets the Unnumbered Frame Type as XID.

CONFiGure sets the Unnumbered Frame Type as CONFiGure.

BEACon sets the Unnumbered Frame Type as BEACon.

**Examples**

SEARCH:SEARCH1:TRIGGER:A:BUS:SDLC:UNNumbered:FRAMETYPE SNRME specifies the frame type as SNRME.

SEARCH:SEARCH1:TRIGGER:A:BUS:SDLC:UNNumbered:FRAMETYPE? might return :SEARCH:SEARCH1:TRIGGER:A:BUS:SDLC:UNNumbered:FRAMETYPE SNRME, indicating that Unnumbered Frame type is SNRME when related command Frame Type is set as COMManD.

## SEARCH:SEARCH<x>:TRIGger:A:BUS:SENT:CONDition

This command sets or queries the search condition for a SENT bus.

**Conditions**    Requires option SRAUTOSEN.

**Group**    Search and Mark

**Syntax**    SEARCH:SEARCH<x>:TRIGger:A:BUS:SENT:CONDition  
 {START|FAST|SLOW|PAUSE|ERROR}  
 SEARCH:SEARCH<x>:TRIGger:A:BUS:SENT:CONDition?

<b>Arguments</b>	<p>SEARCH&lt;x&gt; is the number of the search.</p> <p>START specifies searching for start of packet.</p> <p>FAST specifies searching for fast channel data.</p> <p>SLOW specifies searching for slow channel data.</p> <p>PAUSE specifies searching for pause pulses.</p> <p>ERROR specifies searching on errors.</p>
<b>Examples</b>	<p>SEARCH:SEARCH1:TRIGGER:A:BUS:SENT:CONDITION SLOW specifies searching for slow channel packet.</p> <p>SEARCH:SEARCH1:TRIGGER:A:BUS:SENT:CONDITION? might return SEARCH:SEARCH1:TRIGGER:A:BUS:SENT:CONDITION PAUSE, indicating the search is set to find pause pulses.</p>

## SEARCH:SEARCH<x>:TRIGger:A:BUS:SENT:ERRType

This command sets or queries the error type to be used when searching on SENT data.

<b>Conditions</b>	<p>Requires option SRAUTOSEN.</p> <p>SENT bus trigger condition is set to ERROR.</p>
<b>Group</b>	Search and Mark
<b>Syntax</b>	<p>SEARCH:SEARCH&lt;x&gt;:TRIGger:A:BUS:SENT:ERRType {FRAMELENGTH CRC} SEARCH:SEARCH&lt;x&gt;:TRIGger:A:BUS:SENT:ERRType?</p>
<b>Related Commands</b>	<a href="#">SEARCH:SEARCH&lt;x&gt;:TRIGger:A:BUS:SENT:CONDition</a>
<b>Arguments</b>	<p>SEARCH&lt;x&gt; is the number of the search.</p> <p>FRAMELENGTH specifies searching for SENT frame length errors.</p> <p>CRC specifies searching for CRC errors.</p>
<b>Examples</b>	<p>SEARCH:SEARCH1:TRIGger:A:BUS:SENT:ERRType FRAMELENGTH sets the search to find SENT frame length errors.</p>



SEARCH:SEARCH1:TRIGger:A:BUS:SENT:ERRType? might return  
 SEARCH:SEARCH1:TRIGger:A:BUS:SENT:ERRType CRC to indicate the  
 search is set to find CRC errors.

## SEARCH:SEARCH<x>:TRIGger:A:BUS:SENT:ERRType:CRc

This command sets or queries the CRC error type to be used when searching on SENT data.

<b>Conditions</b>	Requires option SRAUTOSEN.  SENT bus trigger condition is set to ERRor and ERRType is set to CRc.
<b>Group</b>	Search and Mark
<b>Syntax</b>	SEARCH:SEARCH<x>:TRIGger:A:BUS:SENT:ERRType:CRc {FAST SLOW} SEARCH:SEARCH<x>:TRIGger:A:BUS:SENT:ERRType:CRc?

**Related Commands**    [SEARCH:SEARCH<x>:TRIGger:A:BUS:SENT:CONDition](#)  
[SEARCH:SEARCH<x>:TRIGger:A:BUS:SENT:ERRType](#)

**Arguments**    Search<x> is the number of the search.  
  
 FAST specifies searching for CRC errors only in the fast channel.  
  
 SLOW specifies searching for CRC errors only in the slow channel.

**Examples**    SEARCH:SEARCH1:TRIGGER:A:BUS:SENT:ERRType:CRc SLOW sets the  
 search to find SENT slow channel CRC errors.  
  
 SEARCH:SEARCH1:TRIGGER:A:BUS:SENT:ERRType:CRc? might return  
 SEARCH:SEARCH1:TRIGGER:A:BUS:SENT:ERRType:CRc FAST, indicating  
 that the SENT fast channel is being searched for CRC errors.

## SEARCH:SEARCH<x>:TRIGger:A:BUS:SENT:FAST:CHAN1A:HIVALue

This command sets or queries the high binary fast channel 1 value to use when searching on a SENT bus signal.

**Conditions**    Requires option SRAUTOSEN.  
  
 The SENT bus search condition must be set to FAST.

<b>Group</b>	Trigger
<b>Syntax</b>	SEARCH:SEARCH<x>:TRIGger:A:BUS:SENT:FAST:CHAN1A:HIVALue <QString> SEARCH:SEARCH<x>:TRIGger:A:BUS:SENT:FAST:CHAN1A:HIVALue?
<b>Related Commands</b>	<a href="#">SEARCH:SEARCH&lt;x&gt;:TRIGger:A:BUS:SENT:CONDition</a>
<b>Arguments</b>	Search<x> is the Search identifier number.  <Qstring> sets the Fast Channel 1 binary data high value.
<b>Examples</b>	SEARCH:SEARCH1:TRIGGER:A:BUS:SENT:FAST:CHAN1A:HIVALue "XXXXXXXXXXXX" sets the Fast Channel 1 high value on which to search to XXXXXXXXXXXX, or "don't care."  SEARCH:SEARCH1:TRIGGER:A:BUS:SENT:FAST:CHAN1A:HIVALue? might return SEARCH:SEARCH1:TRIGGER:A:BUS:SENT:FAST:CHAN1A:HIVALUE "0101XXXX1111", indicating the Fast Channel 1 high value on which to search is set to the binary value 0101XXXX1111.

## SEARCH:SEARCH<x>:TRIGger:A:BUS:SENT:FAST:CHAN1A:QUALifier

This command sets or queries the qualifier to be used when searching on SENT fast packet bus data for device channel 1.

<b>Conditions</b>	Requires option SRAUTOSEN  The SENT bus trigger condition must be set to FAST.
<b>Group</b>	Search and Mark
<b>Syntax</b>	SEARCH:SEARCH<x>:TRIGger:A:BUS:SENT:FAST:CHAN1A: QUALifier {Equal UNEQual LESSthan MOREthan  LESSEQual MOREEQual INrange OUTrange} SEARCH:SEARCH<x>:TRIGger:A:BUS:SENT:FAST:CHAN1A:QUALifier?
<b>Related Commands</b>	<a href="#">SEARCH:SEARCH&lt;x&gt;:TRIGger:A:BUS:SENT:CONDition</a>  <a href="#">SEARCH:SEARCH&lt;x&gt;:TRIGger:A:BUS:SENT:FAST:CHAN1A:VALue</a>

**Arguments**    Search<x> is the number of the search.  
                   EQUa1 specifies the qualifier as Equal.  
                   LESSEQUa1 specifies the qualifier as Less Than or Equal to.  
                   LESSThan specifies the qualifier as Less Than.  
                   MOREEQUa1 specifies the qualifier as More Than or Equal to.  
                   MOREThan specifies the qualifier as More Than.  
                   UNEQUa1 specifies the qualifier as Unequal.  
                   INrange sets the qualifier to inside a range.  
                   OUTrange sets the qualifier to outside a range.

**Examples**    SEARCH:SEARCH1:TRIGGER:A:BUS:SENT:FAST:CHAN1A:QUALIFIER  
                   UNEQUAL sets the fast channel 1 data qualifier to not equal for search 1.  
                   SEARCH:SEARCH3:TRIGGER:A:BUS:SENT:FAST:CHAN1A:QUALIFIER?  
                   might return  
                   SEARCH:SEARCH1:TRIGGER:A:BUS:SENT:FAST:CHAN1A:QUALIFIER  
                   MOREEQUAL to indicate that the fast channel 1 data qualifier is set  
                   to greater than or equal for search 3.

## SEARCH:SEARCH<x>:TRIGger:A:BUS:SENT:FAST:CHAN1A:VALue

This command sets or queries the binary fast channel 1 value to be used when searching on a SENT bus signal.

**Conditions**    Requires option SRAUTOSEN.  
                   The trigger condition must be set to FAST.

**Group**        Search and Mark

**Syntax**        SEARCH:SEARCH<x>:TRIGger:A:BUS:SENT:FAST:CHAN1A:VALue  
                   <Qstring>  
                   SEARCH:SEARCH<x>:TRIGger:A:BUS:SENT:FAST:CHAN1A:VALue?

**Related Commands**    [SEARCH:SEARCH<x>:TRIGger:A:BUS:SENT:CONDition](#)

**Arguments**    Search<x> is the number of the search.  
                   <Qstring> is the Fast Channel 1 binary value.

**Examples**      `SEARCH:SEARCH1:TRIGGER:A:BUS:SENT:FAST:CHAN1A:VALUE`  
"XXXXXXXXXXXX" sets the Fast Channel 1 value to XXXXXXXXXXXXX, or  
"don't care."  
  
`SEARCH:SEARCH1:TRIGGER:A:BUS:SENT:FAST:CHAN1A:VALUE?` might  
return `SEARCH:SEARCH1:TRIGGER:A:BUS:SENT:FAST:CHAN1A:VALUE`  
"0000XXXX1111" to indicate the binary value 0000XXXX1111.

## **SEARCH:SEARCH<x>:TRIGger:A:BUS:SENT:FAST:CHAN2B:HIVALue**

This command sets or queries the high binary fast channel 2 value to use when searching on a SENT bus signal.

**Conditions**      Requires option SRAUTOSEN.

The SENT bus search condition must be set to FAST.

**Group**            Trigger

**Syntax**            `SEARCH:SEARCH<x>:TRIGger:A:BUS:SENT:FAST:CHAN2B:HIVALue`  
`<Qstring>`  
`SEARCH:SEARCH<x>:TRIGger:A:BUS:SENT:FAST:CHAN2B:HIVALue?`

**Related Commands**    [SEARCH:SEARCH<x>:TRIGger:A:BUS:SENT:CONDition](#)

**Arguments**        `Search<x>` is the Search identifier number.  
  
`<Qstring>` sets the Fast Channel 2 high binary data value.

**Examples**        `SEARCH:SEARCH1:TRIGGER:A:BUS:SENT:FAST:CHAN2B:HIVALue`  
"100000000000" sets the Fast Channel 2 high value on which to search to  
100000000000.  
  
`SEARCH:SEARCH1:TRIGGER:A:BUS:SENT:FAST:CHAN2B:HIVALue?` might  
return `SEARCH:SEARCH1:TRIGGER:A:BUS:SENT:FAST:CHAN2B:HIVALUE`  
"0101XXXX1111", indicating the Fast Channel 2 high value on which to search is  
set to the binary value 0101XXXX1111.

## **SEARCH:SEARCH<x>:TRIGger:A:BUS:SENT:FAST:CHAN2B:QUALifier**

This command sets or queries the qualifier to be used when searching on SENT fast packet bus data for device channel 2.

<b>Conditions</b>	Requires option SRAUTOSEN The SENT bus trigger condition must be set to FAST.
<b>Group</b>	Search and Mark
<b>Syntax</b>	SEARCH:SEARCH<x>:TRIGger:A:BUS:SENT:FAST:CHAN2B:QUALifier {Equal UNEQual LESSthan MORethan LESSEQual MORREEQual INrange OUTrange} SEARCH:SEARCH<x>:TRIGger:A:BUS:SENT:FAST:CHAN2B:QUALifier?
<b>Related Commands</b>	<a href="#">SEARCH:SEARCH&lt;x&gt;:TRIGger:A:BUS:SENT:CONDition</a> <a href="#">SEARCH:SEARCH&lt;x&gt;:TRIGger:A:BUS:SENT:FAST:CHAN2B:VALue</a>
<b>Arguments</b>	Search<x> is the number of the search. EQUal specifies the qualifier as Equal. LESSEQUal specifies the qualifier as Less Than or Equal to. LESSThan specifies the qualifier as Less Than. MORREEQUal specifies the qualifier as More Than or Equal to. MORETHan specifies the qualifier as More Than. UNEQUal specifies the qualifier as Unequal. INrange sets the qualifier to inside a range. OUTrange sets the qualifier to outside a range.
<b>Examples</b>	SEARCH:SEARCH5:TRIGGER:A:BUS:SENT:FAST:CHAN2B:QUALIFIER UNEQUAL sets the fast channel 2 data qualifier to not equal for search 5.  SEARCH:SEARCH1:TRIGGER:A:BUS:SENT:FAST:CHAN2B:QUALIFIER? might return SEARCH:SEARCH1:TRIGGER:A:BUS:SENT:FAST:CHAN2B:QUALIFIER MORREEQUAL to indicate that the fast channel 2 data qualifier is set to greater than or equal for search 1.

## SEARCH:SEARCH<x>:TRIGger:A:BUS:SENT:FAST:CHAN2B:VALue

This command sets or queries the binary fast channel 2 value to be used when searching on a SENT bus signal.

<b>Conditions</b>	Requires option SRAUTOSEN. The trigger condition must be set to FAST.
<b>Group</b>	Search and Mark
<b>Syntax</b>	SEARCH:SEARCH<x>:TRIGger:A:BUS:SENT:FAST:CHAN2B:VALue <Qstring> SEARCH:SEARCH<x>:TRIGger:A:BUS:SENT:FAST:CHAN2B:VALue?
<b>Related Commands</b>	<a href="#">SEARCH:SEARCH&lt;x&gt;:TRIGger:A:BUS:SENT:CONDition</a>
<b>Arguments</b>	Search<x> is the number of the search. <Qstring> is the Fast Channel 2 binary value.
<b>Examples</b>	SEARCH:SEARCH1:TRIGGER:A:BUS:SENT:FAST:CHAN2B:VALUE "111111111111" sets the Fast Channel 2 value to 111111111111.  SEARCH:SEARCH1:TRIGGER:A:BUS:SENT:FAST:CHAN2B:VALUE? might return SEARCH:SEARCH1:TRIGGER:A:BUS:SENT:FAST:CHAN2B:VALUE "000000000000" to indicate the binary value 000000000000.

## SEARCH:SEARCH<x>:TRIGger:A:BUS:SENT:FAST:COUNTER:HIVALue

This command sets or queries the high binary fast message counter value to use when searching on a SENT bus signal.

<b>Conditions</b>	Requires option SRAUTOSEN. The SENT bus search condition must be set to FAST. The number of channels must be set to 1. The nibble count must be set to 6.
<b>Group</b>	Trigger
<b>Syntax</b>	SEARCH:SEARCH<x>:TRIGger:A:BUS:SENT:FAST:COUNTER:HIVALue <Qstring> SEARCH:SEARCH<x>:TRIGger:A:BUS:SENT:FAST:COUNTER:HIVALue?
<b>Related Commands</b>	<a href="#">SEARCH:SEARCH&lt;x&gt;:TRIGger:A:BUS:SENT:CONDition</a>

[BUS:B<x>:SENT:NUMCHANnel](#)

[BUS:B<x>:SENT:NIBBLECount](#)

**Arguments** Search<x> is the Search identifier number.  
 <Qstring> sets the Fast Channel 1 counter binary value.

**Examples** SEARCH:SEARCH1:TRIGGER:A:BUS:SENT:FAST:COUNTER:HIVALUE  
 "XXXXXXXX" sets the Fast Channel secure counter high value on which to search  
 to "don't care."  
 SEARCH:SEARCH4:TRIGGER:A:BUS:SENT:FAST:COUNTER:HIVALUE? might  
 return SEARCH:SEARCH4:TRIGGER:A:BUS:SENT:FAST:COUNTER:HIVALUE  
 "11110000" to indicate a binary value of 11110000 on which to search.

## SEARCH:SEARCH<x>:TRIGger:A:BUS:SENT:FAST:COUNTER:QUALifier

This command sets or queries the qualifier to be used when searching on SENT fast packet bus data for the secure format counter.

**Conditions** Requires option SRAUTOSEN  
 The SENT bus trigger condition must be set to FAST.

**Group** Search and Mark

**Syntax** SEARCH:SEARCH<x>:TRIGger:A:BUS:SENT:FAST:COUNTER:  
 QUALifier {EQual|UNEQual|LESSthan|MOREthan|  
 LESSEQual|MOREEQual|INrange|OUTrange}  
 SEARCH:SEARCH<x>:TRIGger:A:BUS:SENT:FAST:COUNTER:QUALifier?

**Related Commands** [SEARCH:SEARCH<x>:TRIGger:A:BUS:SENT:CONDition](#)  
[SEARCH:SEARCH<x>:TRIGger:A:BUS:SENT:FAST:COUNTER:VALue](#)

**Arguments** Search<x> is the number of the search.  
 EQual specifies the qualifier as Equal.  
 LESSEQual specifies the qualifier as Less Than or Equal to.  
 LESSThan specifies the qualifier as Less Than.  
 MOREEQual specifies the qualifier as More Than or Equal to.

MOREThan specifies the qualifier as More Than.

UNEQUAL specifies the qualifier as Unequal.

INrange sets the qualifier to inside a range.

OUTrange sets the qualifier to outside a range.

**Examples** SEARCH:SEARCH5:TRIGGER:A:BUS:SENT:FAST:COUNTER:QUALIFIER  
LESSThan sets the fast channel 2 data qualifier on search 5 to less than.

SEARCH:SEARCH1:TRIGGER:A:BUS:SENT:FAST:COUNTER:QUALIFIER?  
might return  
SEARCH:SEARCH1:TRIGGER:A:BUS:SENT:FAST:COUNTER:QUALIFIER  
EQUAL to indicate that the fast channel 2 data qualifier on search 1 is set to equal.

## SEARCH:SEARCH<x>:TRIGGER:A:BUS:SENT:FAST:COUNTER:VALUE

This command sets or queries the binary fast message counter value to be used when searching on a SENT bus signal.

**Conditions** Requires option SRAUTOSEN.  
The search condition must be set to FAST.  
The number of channels must be set to 1.  
The nibble count must be set to 6.

**Group** Search and Mark

**Syntax** SEARCH:SEARCH<x>:TRIGGER:A:BUS:SENT:FAST:COUNTER:VALUE  
<Qstring>  
SEARCH:SEARCH<x>:TRIGGER:A:BUS:SENT:FAST:COUNTER:VALUE?

**Related Commands** [SEARCH:SEARCH<x>:TRIGGER:A:BUS:SENT:CONDITION](#)  
[BUS:B<x>:SENT:NIBBLECOUNT](#)  
[BUS:B<x>:SENT:NUMCHANNEL](#)

**Arguments** Search<x> is the number of the search.  
<Qstring> is the Fast Channel 1 counter value.



**Examples**     `SEARCH:SEARCH1:TRIGGER:A:BUS:SENT:FAST:COUNTER:VALUE "XXXXXXXX"` sets the Fast Channel 1 secure counter value to "don't care."

`SEARCH:SEARCH1:TRIGGER:A:BUS:SENT:FAST:COUNTER:VALUE?` might return `SEARCH:SEARCH1:TRIGGER:A:BUS:SENT:FAST:COUNTER:VALUE "00001111"` to search for a binary counter value of 00001111.

## **SEARCH:SEARCH<x>:TRIGger:A:BUS:SENT:FAST:INVERTNIBble:VALue**

This command sets or queries the binary fast message inverted nibble value to be used when searching on a SENT bus signal.

**Conditions**     Requires option SRAUTOSEN.

The search condition must be set to FAST.

The number of channels must be set to 1.

The nibble count must be set to 6.

**Group**     Search and Mark

**Syntax**     `SEARCH:SEARCH<x>:TRIGger:A:BUS:SENT:FAST:INVERTNIBble:VALue <Qstring>`  
`SEARCH:SEARCH<x>:TRIGger:A:BUS:SENT:FAST:INVERTNIBble:VALue?`

**Related Commands**     [SEARCH:SEARCH<x>:TRIGger:A:BUS:SENT:CONDition](#)  
[BUS:B<x>:SENT:NIBBLECount](#)  
[BUS:B<x>:SENT:NUMCHANnel](#)

**Arguments**     Search<x> is the number of the search.

<Qstring> is the fast message inverted nibble binary value.

**Examples**     `TRIGGER:A:BUS:B1:SENT:FAST:INVERTNIBBLE:VALUE "XXXX"` sets the Fast Channel 1 secure inverted nibble value to "don't care."

`TRIGGER:A:BUS:B1:SENT:FAST:INVERTNIBBLE:VALUE?` might return `TRIGGER:A:BUS:B1:SENT:FAST:INVERTNIBBLE:VALUE "1111"` to search for a binary inverted nibble value of 1111.

## SEARCH:SEARCH<x>:TRIGger:A:BUS:SENT:FAST:STATus:VALue

This command sets or queries the binary status value to be used when searching on a SENT bus signal.

**Conditions** Requires option SRAUTOSEN.

The trigger condition must be set to FAST.

**Group** Search and Mark

**Syntax** SEARCH:SEARCH<x>:TRIGger:A:BUS:SENT:FAST:STATus:VALue  
<Qstring>  
SEARCH:SEARCH<x>:TRIGger:A:BUS:SENT:FAST:STATus:VALue?

**Related Commands** [SEARCH:SEARCH<x>:TRIGger:A:BUS:SENT:CONDition](#)

**Arguments** Search<x> is the number of the search.

<Qstring> is the binary status binary value.

**Examples** SEARCH:SEARCH1:TRIGGER:A:BUS:SENT:FAST:STATus:VALue "XXXX"  
sets the binary status value to XXXX.

SEARCH:SEARCH1:TRIGGER:A:BUS:SENT:FAST:STATus:VALue? might  
return SEARCH:SEARCH1:TRIGGER:A:BUS:SENT:FAST:STATus:VALue  
"1010" to indicate searching on a binary status value of 1010.

## SEARCH:SEARCH<x>:TRIGger:A:BUS:SENT:PAUSE:QUALifier

This command sets or queries the qualifier to be used when searching on SENT pause pulses.

**Conditions** Requires option SRAUTOSEN

The SENT bus trigger condition must be set to PAUSE.

**Group** Search and Mark

**Syntax** SEARCH:SEARCH<x>:TRIGger:A:BUS:SENT:PAUSE:  
QUALifier {EQUAL|UNEQUAL|LESSTHAN|MORETHAN|  
LESSEQUAL|MOREEQUAL|INRANGE|OUTRANGE}

SEARCH:SEARCH<x>:TRIGger:A:BUS:SENT:PAUSE:QUALifier?

**Related Commands**

[SEARCH:SEARCH<x>:TRIGger:A:BUS:SENT:CONDition](#)

[SEARCH:SEARCH<x>:TRIGger:A:BUS:SENT:PAUSE:TICKs:VALue](#)

[SEARCH:SEARCH<x>:TRIGger:A:BUS:SENT:PAUSE:TICKs:HIVALue](#)

**Arguments**

Search<x> is the number of the search.

EQUal specifies the qualifier as Equal.

INrange sets the qualifier to be within a range.

LESSEQUal sets the qualifier as Less Than or Equal to.

LESSThan sets the qualifier as Less Than.

MOREEQUal sets the qualifier as More Than or Equal to.

MOREThan sets the qualifier as More Than.

OUTrange sets the qualifier to be outside a range.

UNEQUal specifies the qualifier as Unequal.

**Examples**

SEARCH:SEARCH1:TRIGGER:A:BUS:SENT:PAUSE:QUALIFIER LESSTHAN sets the pause pulse qualifier to less than.

SEARCH:SEARCH1:TRIGGER:A:BUS:SENT:PAUSE:QUALIFIER? might return SEARCH:SEARCH1:TRIGGER:A:BUS:SENT:PAUSE:QUALIFIER INRANGE to indicate that the pause pulse qualifier is set to search inside the range of ticks low and ticks high.

## SEARCH:SEARCH<x>:TRIGger:A:BUS:SENT:PAUSE:TICKs:HIVALue

This command sets or queries the maximum number of pause clock ticks to be used when searching on a SENT bus signal.

**Conditions**

Requires option SRAUTOSEN.

The trigger condition must be set to PAUSE.

**Group**

Search and Mark

**Syntax**

SEARCH:SEARCH<x>:TRIGger:A:BUS:SENT:PAUSE:TICKs:HIVALue  
<NR1>

SEARCH:SEARCH<x>:TRIGger:A:BUS:SENT:PAUSE:TICKs:HIVALue?

**Related Commands** [SEARCH:SEARCH<x>:TRIGger:A:BUS:SENT:CONDition](#)

**Arguments** Search<x> is the number of the search.  
<NR1> is the maximum number of pause clock ticks to be used when searching.

**Examples** SEARCH:SEARCH1:TRIGGER:A:BUS:SENT:PAUSE:TICKS:HIVALUE 15 sets the maximum pause tick count for which to search to 15.  
SEARCH:SEARCH1:TRIGGER:A:BUS:SENT:PAUSE:TICKS:HIVALUE? might return SEARCH:SEARCH1:TRIGGER:A:BUS:SENT:PAUSE:TICKS:HIVALUE 20 to indicate the maximum number of pause ticks to search for is 20.

## SEARCH:SEARCH<x>:TRIGger:A:BUS:SENT:PAUSE:TICKs:VALue

This command sets or queries the minimum number of pause clock ticks to be used when searching on a SENT bus signal.

**Conditions** Requires option SRAUTOSEN.  
The trigger condition must be set to PAUSE.

**Group** Search and Mark

**Syntax** SEARCH:SEARCH<x>:TRIGger:A:BUS:SENT:PAUSE:TICKs:VALue <NR1>  
SEARCH:SEARCH<x>:TRIGger:A:BUS:SENT:PAUSE:TICKs:VALue?

**Related Commands** [SEARCH:SEARCH<x>:TRIGger:A:BUS:SENT:CONDition](#)

**Arguments** Search<x> is the number of the search.  
<NR1> is the minimum number of pause clock ticks to be used when searching.

**Examples** SEARCH:SEARCH1:TRIGGER:A:BUS:SENT:PAUSE:TICKS:VALUE 12 sets the minimum pause tick count on which to search to 12.  
SEARCH:SEARCH1:TRIGGER:A:BUS:SENT:PAUSE:TICKS:VALUE? might return SEARCH:SEARCH1:TRIGGER:A:BUS:SENT:PAUSE:TICKS:VALUE 15 to indicate the minimum number of pause ticks to search for is 15.

**SEARCH:SEARCH<x>:TRIGger:A:BUS:SENT:SLOW:DATA:HIVALue**

This command sets or queries the high binary Slow channel data value to use when searching on a SENT bus signal.

**Conditions** Requires option SRAUTOSEN.

The SENT bus search condition must be set to SLOW.

**Group** Trigger

**Syntax** SEARCH:SEARCH<x>:TRIGger:A:BUS:SENT:SLOW:DATA:HIVALue  
<QString>  
SEARCH:SEARCH<x>:TRIGger:A:BUS:SENT:SLOW:DATA:HIVALue?

**Related Commands** [SEARCH:SEARCH<x>:TRIGger:A:BUS:SENT:CONDition](#)

**Arguments** search<x> is the Search identifier number.

<Qstring> sets the binary Slow channel data value.

**Examples** SEARCH:SEARCH2:TRIGGER:A:BUS:SENT:SLOW:DATA:HIVALUE  
"XXXXXXXX" sets the Slow data high value on which to search to "don't care"  
for Search 2.

SEARCH:SEARCH1:TRIGGER:A:BUS:SENT:SLOW:DATA:HIVALUE? might  
return SEARCH:SEARCH1:TRIGGER:A:BUS:SENT:SLOW:DATA:HIVALUE  
"11110001", to indicate searching on slow data values that match 11110001.

**SEARCH:SEARCH<x>:TRIGger:A:BUS:SENT:SLOW:DATA:QUALifier**

This command sets or queries the qualifier to be used when searching on SENT slow packet bus data.

**Conditions** Requires option SRAUTOSEN.

The SENT bus trigger condition must be set to SLOW.

**Group** Search and Mark

**Syntax** SEARCH:SEARCH<x>:TRIGger:A:BUS:SENT:SLOW:DATA:QUALifier {EQua1|UNEQua1|LESSthan|MORethan|LESSEQua1|MOREEQua1|INrange|OUTrange}  
SEARCH:SEARCH<x>:TRIGger:A:BUS:SENT:SLOW:DATA:QUALifier?

**Related Commands** [SEARCH:SEARCH<x>:TRIGger:A:BUS:SENT:CONDition](#)  
[SEARCH:SEARCH<x>:TRIGger:A:BUS:SENT:SLOW:DATA:VALue](#)

**Arguments** Search<x> is the number of the search.  
EQua1 specifies the qualifier as Equal.  
LESSEQua1 sets the qualifier as Less Than or Equal to.  
LESSThan sets the qualifier as Less Than.  
MOREEQua1 sets the qualifier as More Than or Equal to.  
MORETHan sets the qualifier as More Than.  
UNEQua1 specifies the qualifier as Unequal.  
INrange sets the search qualifier to inside a range.  
OUTrange sets the search qualifier to outside a range.

**Examples** SEARCH:SEARCH1:TRIGGER:A:BUS:SENT:SLOW:DATA:QUALIFIER  
LESSEQUAL sets the slow channel data qualifier to less than or equal.  
SEARCH:SEARCH1:TRIGGER:A:BUS:SENT:SLOW:DATA:QUALIFIER? might return SEARCH:SEARCH1:TRIGGER:A:BUS:SENT:SLOW:DATA:QUALIFIER EQUAL to indicate that the slow channel data qualifier is set to equal.

## SEARCH:SEARCH<x>:TRIGger:A:BUS:SENT:SLOW:DATA:VALue

This command sets or queries the binary slow channel data value to be used when searching on a SENT bus signal.

**Conditions** Requires option SRAUTOSEN.  
The trigger condition must be set to SLOW.

**Group** Search and Mark

**Syntax** SEARCH:SEARCH<x>:TRIGger:A:BUS:SENT:SLOW:DATA:VALue <Qstring>

SEARCH:SEARCH<x>:TRIGger:A:BUS:SENT:SLOW:DATA:VALue?

**Related Commands** [SEARCH:SEARCH<x>:TRIGger:A:BUS:SENT:CONDition](#)

**Arguments** Search<x> is the number of the search.  
<Qstring> is the slow channel data binary value.

**Examples** SEARCH:SEARCH1:TRIGGER:A:BUS:SENT:SLOW:DATA:VALUE "XXXXXXXX" sets the slow data search value to "don't care."  
  
SEARCH:SEARCH1:TRIGGER:A:BUS:SENT:SLOW:DATA:VALUE? might return "XXXX1111", indicating the search is marking slow data values that match XXXX1111.

## SEARCH:SEARCH<x>:TRIGger:A:BUS:SENT:SLOW:IDentifier:VALue

This command sets or queries the binary slow identifier value to be used when searching on a SENT bus signal.

**Conditions** Requires option SRAUTOSEN.  
The trigger condition must be set to SLOW.

**Group** Search and Mark

**Syntax** SEARCH:SEARCH<x>:TRIGger:A:BUS:SENT:SLOW:IDentifier:VALue  
<Qstring>  
SEARCH:SEARCH<x>:TRIGger:A:BUS:SENT:SLOW:IDentifier:VALue?

**Related Commands** [SEARCH:SEARCH<x>:TRIGger:A:BUS:SENT:CONDition](#)

**Arguments** Search<x> is the number of the search.  
<Qstring> is the slow channel identifier binary value.

**Examples** SEARCH:SEARCH1:TRIGGER:A:BUS:SENT:SLOW:IDENTIFIER:VALUE "XXXX" sets the search identifier value to "don't care."  
  
SEARCH:SEARCH1:TRIGGER:A:BUS:SENT:SLOW:IDENTIFIER:VALUE? might return

SEARCH:SEARCH1:TRIGGER:A:BUS:SENT:SLOW:IDENTIFIER:VALUE  
"0001" indicating to search for the slow channel identifier value of 0001.

## SEARCH:SEARCH<x>:TRIGger:A:BUS:SMBUS:ADDRes:VALue

This command specifies the binary physical address string used for SMBUS triggering if the trigger condition is address.

<b>Conditions</b>	Requires option SR-SMBUS
<b>Group</b>	Search and Mark
<b>Syntax</b>	SEARCH:SEARCH<x>:TRIGger:A:BUS:SMBUS:ADDRes:VALue <Qstring> SEARCH:SEARCH<x>:TRIGger:A:BUS:SMBUS:ADDRes:VALue?
<b>Arguments</b>	Search<x> is the search identifier number.  <Qstring> specifies the address value as the field within a SMBUS frame to search on. The default value is XXXXXXXX.
<b>Examples</b>	SEARCH:SEARCH1:TRIGGER:A:BUS:SMBUS:ADDRes:VALue "1111111" specifies the address value as the field within a SMBUS frame to search on.  SEARCH:SEARCH1:TRIGGER:A:BUS:SMBUS:ADDRes:VALue? might return SEARCH:SEARCH1:TRIGGER:A:BUS:SMBUS:ADDRes:VALue "1111111", indicating the address value as "1111111" current specified within a SMBUS frame to search on.

## SEARCH:SEARCH<x>:TRIGger:A:BUS:SMBUS:COMManD:VALue

This command specifies the binary command code string used for SMBUS triggering if the trigger condition is command code.

<b>Conditions</b>	Requires option SR-SMBUS
<b>Group</b>	Search and Mark
<b>Syntax</b>	SEARCH:SEARCH<x>:TRIGger:A:BUS:SMBUS:COMManD:VALue <Qstring> SEARCH:SEARCH<x>:TRIGger:A:BUS:SMBUS:COMManD:VALue?



**Arguments** Search<x> is the search identifier number.  
 <Qstring> specifies the command value as the field within a SMBUS frame to search on. The default value is XXXXXXXX.

**Examples** SEARCH:SEARCH1:TRIGGER:A:BUS:SMBUS:COMMAND:VALUE "11011111" specifies the address value as the field within a SMBUS frame to search on.  
 SEARCH:SEARCH1:TRIGGER:A:BUS:SMBUS:COMMAND:VALUE? might return SEARCH:SEARCH1:TRIGGER:A:BUS:SMBUS:COMMAND:VALUE "11011111", indicating the command value as "11011111" current specified within a SMBUS frame to search on.

## SEARCH:SEARCH<x>:TRIGGER:A:BUS:SMBUS:CONDITION

This command sets or queries the trigger condition for a SMBUS bus.

**Conditions** Requires option SR-SMBUS

**Group** Search and Mark

**Syntax** SEARCH:SEARCH<x>:TRIGGER:A:BUS:SMBUS:CONDITION {START|REPEATSTART| ADDRESS| HOSTADDR| DEVICEADDR| COMMAND| DATA| UDIDDATA| ERROR| STOP| IDLE}  
 SEARCH:SEARCH<x>:TRIGGER:A:BUS:SMBUS:CONDITION?

**Arguments** Search<x> is the search number.  
 START sets the search condition to start. This is the default value.  
 REPEATSTART sets the search condition to repeat start.  
 ADDRESS sets the search condition to address.  
 HOSTADDR sets the search condition to host address.  
 DEVICEADDR sets the search condition to device address.  
 COMMAND sets the search condition to command.  
 DATA sets the search condition to data.  
 UDIDDATA sets the search condition to UDID data.  
 ERROR sets the search condition to error.  
 STOP sets the search condition to stop.  
 IDLE sets the search condition to idle.

**Examples** SEARCH:SEARCH1:TRIGGER:A:BUS:SMBUS:CONDition START specifies start as the event within a SMBUS frame to search on.

SEARCH:SEARCH1:TRIGGER:A:BUS:SMBUS:CONDition? might return :SEARCH:SEARCH1:TRIGGER:A:BUS:SMBUS:CONDition START, indicating that start is the currently specified event within a SMBUS frame to search on.

## SEARCH:SEARCH<x>:TRIGger:A:BUS:SMBUS:DATA:SIZE

This command specifies the length of the data string in bytes to be used for an SMBus trigger if the trigger condition is DATA.

**Conditions** Requires option SR-SMBUS

**Group** Search and Mark

**Syntax** SEARCH:SEARCH<x>:TRIGger:A:BUS:SMBUS:DATA:SIZE <NR1>  
SEARCH:SEARCH<x>:TRIGger:A:BUS:SMBUS:DATA:SIZE?

**Arguments** Search<x> is the search number.

NR1 sets the data size value. The valid range is 1 to 8. The default data size is 1.

**Examples** SEARCH:SEARCH1:TRIGGER:A:BUS:SMBUS:DATA:SIZE 4 sets the data size value as 4.

SEARCH:SEARCH1:TRIGGER:A:BUS:SMBUS:DATA:SIZE? might return :SEARCH:SEARCH1:TRIGGER:A:BUS:SMBUS:DATA:SIZE 4, indicating that the data size value is 4.

## SEARCH:SEARCH<x>:TRIGger:A:BUS:SMBUS:DATA:VALue

This command specifies the binary data string used for SMBus triggering if the trigger condition is DATA.

**Conditions** Requires option SR-SMBUS

**Group** Search and Mark

**Syntax** SEARCH:SEARCH<x>:TRIGger:A:BUS:SMBUS:DATA:VALue <Qstring>  
SEARCH:SEARCH<x>:TRIGger:A:BUS:SMBUS:DATA:VALue?

- Arguments**    Search<x> is the search identifier number.
- <Qstring> specifies the data value as the field within a SMBUS frame to search on. The default value is XXXXXXXX.
- Examples**     SEARCH:SEARCH1:TRIGGER:A:BUS:SMBUS:DATA:VALue "11001100" sets the data value as "11001100".
- SEARCH:SEARCH1:TRIGGER:A:BUS:SMBUS:DATA:VALue? might return :SEARCH:SEARCH1:TRIGGER:A:BUS:SMBUS:DATA:VALue "11001100", indicating that the data value is "11001100".

## SEARCH:SEARCH<x>:TRIGger:A:BUS:SMBUS:DEVICEADDR:VALue

This command specifies the binary physical address string is used for SMBUS triggering if the trigger condition is device address.

- Conditions**    Requires option SR-SMBUS
- Group**         Search and Mark
- Syntax**        SEARCH:SEARCH<x>:TRIGger:A:BUS:SMBUS:DEVICEADDR:VALue  
                  <Qstring>  
                  SEARCH:SEARCH<x>:TRIGger:A:BUS:SMBUS:DEVICEADDR:VALue?
- Arguments**    Search<x> is the search identifier number.
- <Qstring> specifies the device address value as the field within a SMBUS frame to search on. The default value is XXXXXXXX.
- Examples**     SEARCH:SEARCH1:TRIGGER:A:BUS:SMBUS:DEVICEADDR:VALue "0011111" specifies the device Address value as the field within a SMBUS frame to search on.
- SEARCH:SEARCH1:TRIGGER:A:BUS:SMBUS:DEVICEADDR:VALue? might return :SEARCH:SEARCH1:TRIGGER:A:BUS:SMBUS:DEVICEADDR:VALue "11001100", indicating the device address value is "0011111".

## SEARCH:SEARCH<x>:TRIGger:A:BUS:SMBUS:ERROR:TYPE

This command sets or queries the error type for a SMBus.

<b>Conditions</b>	Requires option SR-SMBUS
<b>Group</b>	Search and Mark
<b>Syntax</b>	SEARCH:SEARCH<x>:TRIGger:A:BUS:SMBUS:ERROR:TYPE {ANY ACK NACK PEC} SEARCH:SEARCH<x>:TRIGger:A:BUS:SMBUS:ERROR:TYPE?
<b>Arguments</b>	Search<x> is the search number.  ANY sets the error search type to ANY. This is the default value  ACK sets the error search type to ACK.  NACK sets the error search type to NACK.  PEC sets the error search type to PEC.
<b>Examples</b>	SEARCH:SEARCH1:TRIGGER:A:BUS:SMBUS:ERROR:TYPE ACK specifies ACK error as the field within a SMBus frame to search on.  SEARCH:SEARCH1:TRIGGER:A:BUS:SMBUS:ERROR:TYPE? might return :SEARCH:SEARCH1:TRIGGER:A:BUS:SMBUS:ERROR:TYPE ACK, indicating that ACK error is the currently specified field within a SMBus frame to search on.

## SEARCH:SEARCH<x>:TRIGger:A:BUS:SMBUS:FIELDBYTE

This command sets or queries the field byte for a SMBUS bus if trigger condition is UDID data.

<b>Conditions</b>	Requires option SR-SMBUS
<b>Group</b>	Search and Mark
<b>Syntax</b>	SEARCH:SEARCH<x>:TRIGger:A:BUS:SMBUS:FIELDBYTE {ONE TWO FOUR} SEARCH:SEARCH<x>:TRIGger:A:BUS:SMBUS:FIELDBYTE?
<b>Arguments</b>	Search<x> is the search number.  ONE sets the field byte size to 8 bits. This is the default value.  TWO sets the field byte size to 16 bits.  FOUR sets the field byte size to 32 bits.

- Examples**     `SEARCH:SEARCH1:TRIGGER:A:BUS:SMBUS:FIELDBYTE TWO` sets the field byte size as 16.
- `SEARCH:SEARCH1:TRIGGER:A:BUS:SMBUS:FIELDBYTE?` might return `:SEARCH:SEARCH1:TRIGGER:A:BUS:SMBUS:FIELDBYTE TWO`, indicating that the field byte size is 16.

## SEARCH:SEARCH<x>:TRIGger:A:BUS:SMBUS:UDIDDATA:VALue

This command specifies the binary data string used for SMBUS triggering if the trigger condition is UDID data.

- Conditions**     Requires option SR-SMBUS
- Group**            Search and Mark
- Syntax**            `SEARCH:SEARCH<x>:TRIGger:A:BUS:SMBUS:UDIDDATA:VALue`  
                           `{ONE|TWO|FOUR}`  
                           `SEARCH:SEARCH<x>:TRIGger:A:BUS:SMBUS:UDIDDATA:VALue?`
- Arguments**        `Search<x>` is the search identifier number.
- `<Qstring>` specifies the UDID data value as the field within a SMBUS frame to search on. The default value is `XXXXXXXX`.
- Examples**         `SEARCH:SEARCH1:TRIGGER:A:BUS:SMBUS:UDIDDATA:VALue "11001101"` sets the UDID data value as "11001100".
- `SEARCH:SEARCH1:TRIGGER:A:BUS:SMBUS:UDIDDATA:VALue?` might return `:SEARCH:SEARCH1:TRIGGER:A:BUS:SMBUS:UDIDDATA:VALue "11001101"`, indicating that the UDID data value is "11001101".

## SEARCH:SEARCH<x>:TRIGger:A:BUS:SOUrce

This command sets or queries the bus source for the bus search to determine where to place a mark. The search number is specified by x.

- Group**            Search and Mark
- Syntax**            `SEARCH:SEARCH<x>:TRIGger:A:BUS:SOUrce`  
                           `{B0|B1|B2|B3|B4|B5|B6|B7|B8|B9|B10| B11|B12|B13|B14|B15|B16}`  
                           `SEARCH:SEARCH<x>:TRIGger:A:BUS:SOUrce?`

- Arguments** B0–B16 specifies the bus source as a bus number from B01 to B16.
- Examples** SEARCH:SEARCH1:TRIGGER:A:BUS:SOURCE B1 sets the bus source for bus trigger search 1 to B1.
- SEARCH:SEARCH1:TRIGGER:A:BUS:SOURCE? might return  
SEARCH:SEARCH1:TRIGGER:A:BUS:SOURCE B15, indicating that the bus source for bus trigger search 1 is B15.

## SEARCH:SEARCH<x>:TRIGger:A:BUS:SPACEWIRE:CONDition

This command sets or queries the field or condition for which to search on a SpaceWire bus.

- Conditions** Requires option SR-SPACEWIRE
- This command affects most of the  
SEARCH:SEARCH<x>:TRIGger:A:BUS:B<x>:SPACEWIRE commands.
- Group** Search and Mark
- Syntax** SEARCH:SEARCH<x>:TRIGger:A:BUS:SPACEWIRE:CONDition  
{SYNC|DATA|ERRORs|CONTROLCode|CONTROLCHAR}  
SEARCH:SEARCH<x>:TRIGger:A:BUS:SPACEWIRE:CONDition?
- Arguments** Search<x> is the search number.
- SYNC sets the search condition to Synchronization.
- DATA sets the search condition to Data Characters.
- ERRORs sets the search condition to SpaceWire Bus Decode Errors.
- CONTROLCode sets the search condition to control code.
- CONTROLCHAR sets the search condition to control character.
- Examples** SEARCH:SEARCH1:TRIGGER:A:BUS:SPACEWIRE:CONDition SYNC sets Synchronization as the field within an SpaceWire frame to search on.
- SEARCH:SEARCH1:TRIGGER:A:BUS:SPACEWIRE:CONDITION? might return  
SEARCH:SEARCH1:TRIGGER:A:BUS:SPACEWIRE:CONDITION DATA, indicating that the data field is the currently specified field within an SpaceWire frame to search on.

**SEARCH:SEARCH<x>:TRIGger:A:BUS:SPACEWIRE:CONTROLCHARTYPE**

This command sets or queries the control character type to use when searching on a SpaceWire bus signal.

**Conditions** Requires option SR-SPACEWIRE

**Group** Search and Mark

**Syntax** SEARCH:SEARCH<x>:TRIGger:A:BUS:SPACEWIRE:CONTROLCHARTYPE  
{FCT|ESC|ENDOFPACKet}  
SEARCH:SEARCH<x>:TRIGger:A:BUS:SPACEWIRE:CONTROLCHARTYPE?

**Related Commands** [SEARCH:SEARCH<x>:TRIGger:A:BUS:SPACEWIRE:CONDition](#)

**Arguments** Search<x> is the search number.

FCT sets the control character type to Flow Control Token.

ESC sets the control character type to Escape.

ENDOFPACKet sets the control character type to End of Packet.

**Examples** SEARCH:SEARCH1:TRIGger:A:BUS:SPACEWIRE:CONTROLCHARTYPE FCT specifies Flow control token as the field on which to search within a SpaceWire frame.

SEARCH:SEARCH1:TRIGger:A:BUS:SPACEWIRE:CONTROLCHARTYPE? might return SEARCH:SEARCH1:TRIGger:A:BUS:SPACEWIRECONTROLCHARTYPE ESC.

**SEARCH:SEARCH<x>:TRIGger:A:BUS:SPACEWIRE:CONTROLCODETYPE**

This command sets or queries the control code type to use when searching on a SpaceWire bus signal.

**Conditions** Requires option SR-SPACEWIRE

**Group** Search and Mark

**Syntax** SEARCH:SEARCH<x>:TRIGger:A:BUS:SPACEWIRE:CONTROLCODETYPE  
{NULL|TIMECODE}

SEARCH:SEARCH<x>:TRIGger:A:BUS:SPACEWIRe:CONTROLCODETYPE?

**Related Commands** [SEARCH:SEARCH<x>:TRIGger:A:BUS:SPACEWIRe:CONDition](#)

**Arguments** Search<x> is the search number.  
 NULL sets the control code type to Null code.  
 TIMECODE sets the control code type to Time code (only varying part of Time code [6 bits] is considered for search).

**Examples** SEARCH:SEARCH1:TRIGger:A:BUS:SPACEWIRe:CONTROLCODETYPE NULL specifies Null as the field on which to search within an SpaceWire frame.  
 SEARCH:SEARCH1:TRIGger:A:BUS:SPACEWIRe:CONTROLCODETYPE? might return SEARCH:SEARCH1:TRIGger:A:BUS:SPACEWIReCONTROLCODETYPE TIMECODE.

## SEARCH:SEARCH<x>:TRIGger:A:BUS:SPACEWIRe:DATA:SIZE

This command sets or queries the length of the data string, in bytes, to use when searching on a SpaceWire bus signal. The search condition needs to be set to Data (see *Related Commands*).

**Conditions** Requires option SR-SPACEWIRE

**Group** Search and Mark

**Syntax** SEARCH:SEARCH<x>:TRIGger:A:BUS:SPACEWIRe:DATA:SIZE<NR1>  
 SEARCH:SEARCH<x>:TRIGger:A:BUS:SPACEWIRe:DATA:SIZE?

**Related Commands** [SEARCH:SEARCH<x>:TRIGger:A:BUS:SPACEWIRe:CONDition](#)

**Arguments** Search<x> is the search number.  
 NR1 is an integer value that specifies the number of contiguous data bytes to use when searching on the SpaceWire data field. The valid range is 1 to 10.

**Examples** SEARCH:SEARCH1:TRIGger:A:BUS:SPACEWIRe:DATA:SIZE 4 specifies 4 as the number of contiguous data bytes to use when searching on the SpaceWire data field.



SEARCH:SEARCH5:TRIGger:A:BUS:SPACEWIRE:DATA:SIZE? might return SEARCH:SEARCH5:TRIGger:A:BUS:SPACEWIRE:DATA:SIZE 10, indicating that Search 5 is set to use 10 contiguous data bytes searching on the SpaceWire data field.

## SEARCH:SEARCH<x>:TRIGger:A:BUS:SPACEWIRE:DATA:VALue

This command sets or queries the binary data value to be used when searching on an SpaceWire bus signal. The search condition must be set to Data (see *Related Commands*).

**Conditions** Requires option SR-SPACEWIRE

**Group** Search and Mark

**Syntax** SEARCH:SEARCH<x>:TRIGger:A:BUS:SPACEWIRE:DATA:VALue<Qstring>  
SEARCH:SEARCH<x>:TRIGger:A:BUS:SPACEWIRE:DATA:VALue?

**Related Commands** [SEARCH:SEARCH<x>:TRIGger:A:BUS:SPACEWIRE:CONDition](#)

**Arguments** Search<x> is the search number.  
QString specifies the binary data value to search for on a SpaceWire bus signal.

**Examples** SEARCH:SEARCH1:TRIGger:A:BUS:SPACEWIRE:DATA:VALue "101011"  
sets the data VALue to 101011.  
  
SEARCH:SEARCH5:TRIGger:A:BUS:SPACEWIRE:DATA:VALue? might return  
SEARCH:SEARCH5:TRIGger:A:BUS:SPACEWIRE:DATA:VALue "10101",  
indicating that Search 5 is set to look for binary data value 10101.

## SEARCH:SEARCH<x>:TRIGger:A:BUS:SPACEWIRE:ERRORType

This command sets or queries the error type for which to search on the SpaceWire bus signal.

**Conditions** Requires option SR-SPACEWIRE

**Group** Search and Mark

**Syntax** SEARCH:SEARCH<x>:TRIGger:A:BUS:SPACEWIRE:ERRORTYPE {EEP|ESC|PARity}  
SEARCH:SEARCH<x>:TRIGger:A:BUS:SPACEWIRE:ERRORTYPE?

**Related Commands** [SEARCH:SEARCH<x>:TRIGger:A:BUS:SPACEWIRE:CONDition](#)

**Arguments** Search<x> is the search number.  
EEP sets the error search type to Error end of packet.  
ESC sets the error search type to Escape error.  
PARity sets the error search type to Parity error.

**Examples** SEARCH:SEARCH1:TRIGGER:A:BUS:SPACEWIRE:ERRORTYPE EEP specifies Error end Of Packet as the field on which to search within a SpaceWire frame.  
SEARCH:SEARCH1:TRIGGER:A:BUS:SPACEWIRE:ERRORTYPE? might return SEARCH:SEARCH1:TRIGGER:A:BUS:SPACEWIRE:ERRORTYPE ESC, indicating that Escape Error is the currently specified field on which to search within a SpaceWire frame.

## SEARCH:SEARCH<x>:TRIGger:A:BUS:SPACEWIRE:TIMECode:VALue

This command sets or queries the binary data string used for SpaceWire search if the search condition is Time Code.

**Conditions** Requires option SR-SPACEWIRE

**Group** Search and Mark

**Syntax** SEARCH:SEARCH<x>:TRIGger:A:BUS:SPACEWIRE:TIMECode:VALue <Qstring>  
SEARCH:SEARCH<x>:TRIGger:A:BUS:SPACEWIRE:TIMECode:VALue?

**Related Commands** [SEARCH:SEARCH<x>:TRIGger:A:BUS:SPACEWIRE:CONDition](#)

**Arguments** Search<x> is the search number.  
QString sets the binary data value to be used when searching on an SpaceWire bus signal.

**Examples**    `SEARCH:SEARCH1:TRIGGER:A:BUS:B:SPACEWIRE:TIMECODE:VALUE "101011"` sets the timecode value to binary 101011.

`SEARCH:SEARCH1:TRIGGER:A:BUS:B:SPACEWIRE:TIMECODE:VALUE?` might return  
`SEARCH:SEARCH1:TRIGGER:A:BUS:B:SPACEWIRE:TIMECODE:VALUE "101011"`.

## SEARCH:SEARCH<x>:TRIGGER:A:BUS:SPI:CONDITION

This command sets or queries the search condition for an SPI bus search to determine where to place a mark. The search number is specified by x.

**Conditions**    Requires option 5-SRCOMP or SUP5-SRCOMP Triggering and Analysis application.

**Group**        Search and Mark

**Syntax**        `SEARCH:SEARCH<x>:TRIGGER:A:BUS:SPI:CONDITION {DATA|SS|STARTOFFRAME}`  
`SEARCH:SEARCH<x>:TRIGGER:A:BUS:SPI:CONDITION?`

**Arguments**    `DATA` specifies the trigger condition as Data.  
`SS` specifies the trigger condition as Slave Selection.  
`STARTOFFRAME` specifies the trigger condition as start of frame.

**Examples**        `SEARCH:SEARCH1:TRIGGER:A:BUS:SPI:CONDITION SS` sets the trigger condition for SPI bus trigger search 1 to SS.

`SEARCH:SEARCH1:TRIGGER:A:BUS:SPI:CONDITION?` might return  
`SEARCH:SEARCH1:TRIGGER:A:BUS:SPI:CONDITION DATA`, indicating that the trigger condition for SPI bus trigger search 1 is set to Data.

## SEARCH:SEARCH<x>:TRIGGER:A:BUS:SPI:DATA:SIZE

This command sets or queries the length of the data string in bytes used for the specified SPI bus trigger search to determine where to place a mark. The search condition must be DATA. The search number is specified by x.

**Conditions**    Requires option 5-SRCOMP or SUP5-SRCOMP Triggering and Analysis application.

<b>Group</b>	Search and Mark
<b>Syntax</b>	SEARCH:SEARCH<x>:TRIGger:A:BUS:SPI:DATA:SIZE <NR1> SEARCH:SEARCH<x>:TRIGger:A:BUS:SPI:DATA:SIZE?
<b>Arguments</b>	<NR1> specifies the number of contiguous data bytes.
<b>Examples</b>	SEARCH:SEARCH1:TRIGGER:A:BUS:SPI:DATA:SIZE 1 sets the length of the data string for SPI bus trigger search 1 to 1 byte.  SEARCH:SEARCH2:TRIGGER:A:BUS:SPI:DATA:SIZE? might return :SEARCH:SEARCH2:TRIGGER:A:BUS:SPI:DATA:SIZE 4, indicating that the length of the data string for SPI bus trigger search 2 is 4 bytes.

## SEARCH:SEARCH<x>:TRIGger:A:BUS:SPI:DATA:VALue

The command sets or queries the binary data string used for an SPI bus search to determine where to place a mark. The search number is specified by x. The search condition must be DATA.

<b>Conditions</b>	Requires option 5-SRCOMP or SUP5-SRCOMP Triggering and Analysis application.
<b>Group</b>	Search and Mark
<b>Syntax</b>	SEARCH:SEARCH<x>:TRIGger:A:BUS:SPI:DATA:VALue <QString> SEARCH:SEARCH<x>:TRIGger:A:BUS:SPI:DATA:VALue?
<b>Arguments</b>	<QString> specifies the data value in the specified valid format. The valid characters are 0, 1, and X for binary format; and A-F, 0-9, and X for hexadecimal format.
<b>Examples</b>	SEARCH:SEARCH1:TRIGGER:A:BUS:SPI:DATA:VALUE "00001111" sets the data value for SPI bus trigger search 1 to "00001111" in binary format.  SEARCH:SEARCH1:TRIGGER:A:BUS:SPI:DATA:VALUE? might return SEARCH:SEARCH1:TRIGGER:A:BUS:SPI:DATA:VALUE "11", indicating that the data value for SPI bus trigger search 1 is set to "11" in hexadecimal format.

## SEARCH:SEARCH<x>:TRIGger:A:BUS:SPI:SOURCEType

This command sets or queries trigger Source for SPI bus. The search number is specified by x.

<b>Conditions</b>	Requires option SR-SPI.
<b>Group</b>	Search and Mark
<b>Syntax</b>	SEARCH:SEARCH<x>:TRIGger:A:BUS:SPI:SOURCEType {MISo MOSi} SEARCH:SEARCH<x>:TRIGger:A:BUS:SPI:SOURCEType?
<b>Arguments</b>	MISo specifies the trigger source as MISo. The default search source type is MISo. MOSi specifies the trigger source as MOSi.
<b>Examples</b>	SEARCH:SEARCH1:TRIGGER:A:BUS:SPI:SOURCEType MOSi sets the trigger source for SPI bus trigger search 1 to MOSi.  SEARCH:SEARCH1:TRIGGER:A:BUS:SPI:SOURCEType? might return SEARCH:SEARCH1:TRIGGER:A:BUS:SPI:SOURCEType MOSi, indicating that the trigger source for SPI bus trigger search 1 is MOSi.

## SEARCH:SEARCH<x>:TRIGger:A:BUS:SPMI:CONDition

This command sets or queries the search condition for an SPMI bus.

<b>Conditions</b>	Requires option SRPM
<b>Group</b>	Search and Mark
<b>Syntax</b>	SEARCH:SEARCH<x>:TRIGger:A:BUS: SPMI:CONDition {SSC RESet SLEep  SHUTdown WAKEup MASTERREAd MASTERWRITe REGREAd REGWRITe  DEVICEDESCMASTERREAd DEVICEDESCSLAVEREAd EXTREGREAd  EXTREGWRITe LONGEXTREGREAd LONGEXTREGWRITe REGOWRITe  AUTHenticate TRANSferbusownership PARITyerror} SEARCH:SEARCH<x>:TRIGger:A:BUS:SPMI:CONDition?
<b>Arguments</b>	Search<x> is the search identifier number.  SSC specifies searching for the Sequence Start Condition.

RESet specifies searching for the Reset command sequence.

SLEEp specifies searching for the Sleep command sequence.

SHUTdown specifies searching for the Shutdown command sequence.

WAKEup specifies searching for the Wakeup command sequence.

MASTERREAd specifies searching for the Master Read command sequence.

MASTERWRITe specifies searching for the Master Write command sequence.

REGREAd specifies searching for the Register Read command sequence.

REGWRITe specifies searching for the Register Write command sequence.

DEVICEDESCMASTERREAd specifies searching for the Device Descriptor Block Master Read command sequence

DEVICEDESCSLAVEREAd specifies searching for the Device Descriptor Block Slave Read command sequence.

EXTREGREAd specifies triggering on the Extended Register Read command sequence.

EXTREGWRITe specifies searching for the Extended Register Write command sequence.

LONGEXTREGREAd specifies searching for the Extended Register Read Long command sequence.

LONGEXTREGWRITe specifies searching for the Extended Register Write Long command sequence.

REG0WRITe specifies searching for the Register 0 Write command sequence.

AUTHenticate specifies searching for the Authentication command sequence.

TRANSferbusownership specifies searching for the Transfer Bus Ownership (TBO) command sequence.

PARITyerror specifies searching for the parity errors.

**Examples**    `SEARCH:SEARCH4:TRIGger:A:BUS:SPMI:CONDITION SLEEP` specifies searching for a Sleep command sequence in search Search4.

`SEARCH:SEARCH2:TRIGger:A:BUS:SPMI:CONDITION?` might return `:SEARCH:SEARCH2:TRIGger:A:BUS:SPMI:CONDITION MASTERREAD`, indicating that search Search2 is searching for Master Read command sequences.

## **SEARCH:SEARCH<x>:TRIGger:A:BUS:SPMI:DATA:SIZE**

This command sets or queries the length of the data string, in bytes, to be used when searching on an SPMI bus signal.

<b>Conditions</b>	<p>Requires option SRPM.</p> <p>The Search condition must be set to EXTREGREAd, EXTREGWRItE, LONGEXTREGREAd, or LONGEXTREGWRItE.</p> <p>Note that this a floating point value. If the condition is set to REG0WRItE, the query return value will be a fractional value (0.875) because the data size is less than a byte.</p>
<b>Group</b>	Search and Mark
<b>Syntax</b>	<pre>SEARCH:SEARCH&lt;x&gt;:TRIGger:A:BUS:SPMI:DATA:SIZE &lt;NR2&gt; SEARCH:SEARCH&lt;x&gt;:TRIGger:A:BUS:SPMI:DATA:SIZE?</pre>
<b>Related Commands</b>	<p><a href="#">SEARCH:SEARCH&lt;x&gt;:TRIGger:A:BUS:SPMI:CONDition</a></p> <p><a href="#">SEARCH:SEARCH&lt;x&gt;:TRIGger:A:BUS:SPMI:DATA:VALue</a></p>
<b>Arguments</b>	<p>Search&lt;x&gt; is the Search identifier number.</p> <p>&lt;NR2&gt; is the size of the data string in bytes.</p>
<b>Examples</b>	<p>SEARCH:SEARCH2:TRIGger:A:BUS:SPMI:DATA:SIZE 1 sets the data size to 1 byte.</p> <p>SEARCH:SEARCH2:TRIGger:A:BUS:SPMI:DATA:SIZE? might return SEARCH:SEARCH2:TRIGger:A:BUS:SPMI:DATA:SIZE 4 to indicate the search data pattern has four bytes of data.</p>

## SEARCH:SEARCH<x>:TRIGger:A:BUS:SPMI:DATA:VALue

This command specifies the binary data string used for SPMI when the search condition is MASTERREAd, MASTERWRItE, REGREAd, REGWRItE, EXTREGREAd, EXTREGWRItE, LONGEXTREGREAd, LONGEXTREGWRItE, or REG0WRItE.

<b>Conditions</b>	Requires option SRPM
<b>Group</b>	Search and Mark
<b>Syntax</b>	<pre>SEARCH:SEARCH&lt;x&gt;:TRIGger:A:BUS:SPMI:DATA:VALue &lt;Qstring&gt; SEARCH:SEARCH&lt;x&gt;:TRIGger:A:BUS:SPMI:DATA:VALue?</pre>

**Related Commands**    [SEARCH:SEARCH<x>:TRIGger:A:BUS:SPMI:CONDition](#)

**Arguments**    Search<x> is the search identifier number.  
                   <Qstring> is the binary data string that identifies the data value for which to search.

**Examples**    SEARCH:SEARCH2:TRIGger:A:BUS:SPMI:DATA:VALUE "XXXXXXXX" sets the binary data value to "don't care" for Search 2.  
                   SEARCH:SEARCH2:TRIGger:A:BUS:SPMI:DATA:VALUE? might return SEARCH:SEARCH2:TRIGger:A:BUS:SPMI:DATA:VALUE "XXXX1111" to indicate Search 2 is searching for binary data value XXXX1111.

## SEARCH:SEARCH<x>:TRIGger:A:BUS:SPMI:MASTERADDRESS:VALUE

This command sets or queries the binary data string that identifies the master address used in SPMI when the search condition is MASTERREAD, MASTERWRITE, or DEVIDESCMasterRead.

**Conditions**    Requires option SRPM

**Group**    Search and Mark

**Syntax**    SEARCH:SEARCH<x>:TRIGger:A:BUS:SPMI:MASTERADDRESS:VALUE  
                   <Qstring>  
                   SEARCH:SEARCH<x>:TRIGger:A:BUS:SPMI:MASTERADDRESS:VALUE?

**Related Commands**    [SEARCH:SEARCH<x>:TRIGger:A:BUS:SPMI:CONDition](#)

**Arguments**    Search<x> is the search identifier number.  
                   <Qstring> is the binary data string that identifies the master address for which to search.

**Examples**    SEARCH:SEARCH2:TRIGger:A:BUS:SPMI:MASTERADDRESS:VALUE "XX" sets the binary master address on which to search to "don't care."  
                   SEARCH:SEARCH3:TRIGger:A:BUS:SPMI:MASTERADDRESS:VALUE? might return SEARCH:SEARCH3:TRIGger:A:BUS:SPMI:MASTERADDRESS:VALUE "11" to indicate that Search 3 is searching for binary master address 11.



## SEARCH:SEARCH<x>:TRIGger:A:BUS:SPMI:NORESPonse

This command sets or queries whether or not to search for No Response frames.

**Conditions** Requires option SRPM

**Group** Search and Mark

**Syntax** SEARCH:SEARCH<x>:TRIGger:A:BUS:SPMI:NORESPonse <Qstring>  
SEARCH:SEARCH<x>:TRIGger:A:BUS:SPMI:NORESPonse?

**Related Commands** [SEARCH:SEARCH<x>:TRIGger:A:BUS:SPMI:CONDition](#)

**Arguments** Search<x> is the search identifier number.  
  
<Qstring> is either "TRUE" or "FALSE" boolean value for searching on SPMI No Response frames.

**Examples** SEARCH:SEARCH6:TRIGger:A:BUS:SPMI:NORESPONSE TRUE sets Search 6 to look for No Response frames.

SEARCH:SEARCH4:TRIGger:A:BUS:SPMI:NORESPONSE? might return  
SEARCH:SEARCH4:TRIGger:A:BUS:SPMI:NORESPONSE FALSE to indicate that the Search 4 is not looking for No Response frames.

## SEARCH:SEARCH<x>:TRIGger:A:BUS:SPMI:REGISTERADDRess:VALue

This command sets or queries the binary data string that identifies the register address used in SPMI triggering if the trigger condition is MASTERREAd, MASTERWRItE, REGREAd, REGWRItE, EXTREGREAd, EXTREGWRItE, LONGEXTREGREAd, or LONGEXTREGWRItE.

**Conditions** Requires option SRPM

**Group** Search and Mark

**Syntax** SEARCH:SEARCH<x>:TRIGger:A:BUS:SPMI:REGISTERADDRess:VALue  
<Qstring>  
SEARCH:SEARCH<x>:TRIGger:A:BUS:SPMI:REGISTERADDRess:VALue?

**Related Commands**    [SEARCH:SEARCH<x>:TRIGger:A:BUS:SPMI:CONDition](#)

**Arguments**    Search<x> is the search identifier number.  
                   <Qstring> is the binary data string that identifies the register address for which to search.

**Examples**    SEARCH:SEARCH2:TRIGger:A:BUS:SPMI:REGISTERADDRESS:VALUE  
                   "XXXXXXXX" sets the binary register address to "don't care."  
                   SEARCH:SEARCH5:TRIGger:A:BUS:SPMI:REGISTERADDRESS:VALUE?  
                   might return  
                   SEARCH:SEARCH5:TRIGger:A:BUS:SPMI:REGISTERADDRESS:VALUE  
                   "XXXX1111" to indicate Search 5 is searching for binary register address is  
                   XXXX1111.

## SEARCH:SEARCH<x>:TRIGger:A:BUS:SPMI:SLAVEADDRESS:VALue

This command sets or queries the binary data string that identifies the slave address used in SPMI when the search condition is RESet, SLEEp, SHUTdown, WAKeup, AUTHenticate, REGREAd, REGWRItE, EXTREGREAd, EXTREGWRItE, LONGEXTREGREAd, LONGEXTREGWRItE, DEVIDESCSLAVEREAd, or REG0WRItE.

**Conditions**    Requires option SRPM

**Group**    Search and Mark

**Syntax**    SEARCH:SEARCH<x>:TRIGger:A:BUS:SPMI:SLAVEADDRESS:VALue  
                   <Qstring>  
                   SEARCH:SEARCH<x>:TRIGger:A:BUS:SPMI:SLAVEADDRESS:VALue?

**Related Commands**    [SEARCH:SEARCH<x>:TRIGger:A:BUS:SPMI:CONDition](#)

**Arguments**    Search<x> is the search identifier number.  
                   <Qstring> is the binary data string that identifies the slave address for which to search.

**Examples**    SEARCH:SEARCH3:TRIGger:A:BUS:SPMI:SLAVEADDRESS:VALUE "0011"  
                   sets the binary slave address to 0011 on Search 3.

SEARCH:SEARCH1:TRIGger:A:BUS:SPMI:SLAVEADDRESS:VALUE? might return SEARCH:SEARCH1:TRIGger:A:BUS:SPMI:SLAVEADDRESS:VALUE "1010" to indicate the binary slave address is 1010 for Search 1.

## SEARCH:SEARCH<x>:TRIGger:A:BUS:SVID:COMManD:RESPonse

This command sets or queries the command response of the respective command type for SVID bus.

**Conditions** Requires option SR-SVID

**Group** Search and Mark

**Syntax** SEARCH:SEARCH<x>:TRIGger:A:BUS:SVID:COMManD:RESPonse  
 {GETReg| GETRegvendor| GETRegtestcfg| SETFast| SETSlow| SETDecay| SETPs| SETRegaddr| SETRegdata| REGAddrvendor| REGDatavendor| REGAddrtestcfg| REGDatatestcfg| TESTmode| SETWp| GETRegpktrecent| GETRegpkta1ert| GETRegpktbody| GETRegvrent}  
 SEARCH:SEARCH<x>:TRIGger:A:BUS:SVID:COMManD:RESPonse?

**Arguments** Search<x> is the search identifier number.

GETReg specifies the search condition as GETReg. This is the default command response condition.

GETRegvvendor specifies the search condition as GETRegvvendor.

GETRegtestcfg specifies the search condition as GETRegtestcfg.

SETFast specifies the search condition as SETFast.

SETSlow specifies the search condition as SETSlow.

SETDecay specifies the search condition as SETDecay.

SETPs specifies the search condition as SETPs.

SETRegaddr specifies the search condition as SETRegaddr.

SETRegdata specifies the search condition as SETRegdata.

REGAddrvendor specifies the search condition as REGAddrvendor.

REGDatavendor specifies the search condition as REGDatavendor.

REGAddrtestcfg specifies the search condition as REGAddrtestcfg.

REGDatatestcfg specifies the search condition as REGDatatestcfg.

TESTmode specifies the search condition as TESTmode.

SETWp specifies the search condition as SETWp.

GETRegpktrecent specifies the search condition as GETRegpktrecent.

GETRegpkta1ert specifies the search condition as GETRegpkta1ert.

GETRegpktbad specifies the search condition as GETRegpktbad.

GETRegvrent specifies the search condition as GETRegvrent.

**Examples** SEARCH:SEARCH3:TRIGger:A:BUS:SVID:COMManD:RESPOse SETS1ow specifies setslow of set command as the field within a SVID frame to search on.

SEARCH:SEARCH1:TRIGger:A:BUS:SVID:COMManD:RESPOse? might return SEARCH:SEARCH1:TRIGger:A:BUS:SVID:COMManD:RESPOse SETS1ow, indicating that SETS1ow is the currently specified field within a SVID frame to search on.

## SEARCH:SEARCH<x>:TRIGger:A:BUS:SVID:COMManD:TYPE

This command sets or queries the command type for SVID bus.

**Conditions** Requires option SR-SVID

**Group** Search and Mark

**Syntax** SEARCH:SEARCH<x>:TRIGger:A:BUS:SVID:COMManD:TYPE {GET|SET|OPTional}  
SEARCH:SEARCH<x>:TRIGger:A:BUS:SVID:COMManD:TYPE?

**Arguments** Search<x> is the search identifier number.

GET specifies the search condition as GET. This is the default command type condition.

SET specifies the search condition as SET.

OPTional specifies the search condition as OPTional.

**Examples** SEARCH:SEARCH3:TRIGger:A:BUS:SVID:COMManD:TYPE SET specifies SET as the field within a SVID frame to search on.

SEARCH:SEARCH1:TRIGger:A:BUS:SVID:COMManD:TYPE? might return SEARCH:SEARCH1:TRIGger:A:BUS:SVID:COMManD:TYPE SET, indicating that SET is the currently specified field within a SVID frame to search on.

## SEARCH:SEARCH<x>:TRIGger:A:BUS:SVID:CONDition

This command sets or queries the trigger condition for SVID bus.

<b>Conditions</b>	Requires option SR-SVID
<b>Group</b>	Search and Mark
<b>Syntax</b>	SEARCH:SEARCH<x>:TRIGger:A:BUS:SVID:CONDition {STARTCONDition  SLAVEADDRESS  COMMAND  PAYLoad  ERRors} SEARCH:SEARCH<x>:TRIGger:A:BUS:SVID:CONDition?
<b>Arguments</b>	<p>Search&lt;x&gt; is the search identifier number.</p> <p>STARTCONDition specifies the search condition as STARTCONDition. This is the default trigger on condition.</p> <p>SLAVEADDRESS specifies the search condition as SLAVEADDRESS.</p> <p>COMMAND specifies the search condition as COMMAND.</p> <p>PAYLoad specifies the search condition as PAYLoad.</p> <p>ERRors specifies the search condition as ERRors.</p>
<b>Examples</b>	<p>SEARCH:SEARCH3:TRIGger:A:BUS:SVID:SVID:CONDition ERRors specifies ERRors as the field within a SVID frame to search on.</p> <p>SEARCH:SEARCH1:TRIGger:A:BUS:SVID:CONDition? might return SEARCH:SEARCH1:TRIGger:A:BUS:SVID:CONDition ERRors, indicating that ERRors is the currently specified field within a SVID frame to search on.</p>

## SEARCH:SEARCH<x>:TRIGger:A:BUS:SVID:ERRor:TYPE

This command sets or queries the error type for SVID bus.

<b>Conditions</b>	Requires option SR-SVID
<b>Group</b>	Search and Mark
<b>Syntax</b>	SEARCH:SEARCH<x>:TRIGger:A:BUS:SVID:ERRor:TYPE {ANY  NACK  REJect  MIXed  PARity} SEARCH:SEARCH<x>:TRIGger:A:BUS:SVID:ERRor:TYPE?

<b>Arguments</b>	<p>Search&lt;x&gt; is the search identifier number.</p> <p>ANY specifies the search condition as ANY. This is the default error type condition.</p> <p>NACK specifies the search condition as NACK.</p> <p>REJect specifies the search condition as REJect.</p> <p>MIXed specifies the search condition as MIXed.</p> <p>PARity specifies the search condition as PARity.</p>
<b>Examples</b>	<p>SEARCH:SEARCH3:TRIGger:A:BUS:SVID:SVID:ERROR:TYPE PARity specifies PARity as the field within a SVID frame to search on.</p> <p>SEARCH:SEARCH1:TRIGger:A:BUS:SVID:ERROR:TYPE? might return SEARCH:SEARCH1:TRIGger:A:BUS:SVID:ERROR:TYPE PARity, indicating that PARity is the currently specified field within a SVID frame to search on.</p>

## SEARCH:SEARCH<x>:TRIGger:A:BUS:SVID:PAYLoad:TYPE

This command sets or queries the payload type for SVID bus.

<b>Conditions</b>	Requires option SR-SVID
<b>Group</b>	Search and Mark
<b>Syntax</b>	SEARCH:SEARCH<x>:TRIGger:A:BUS:SVID:PAYLoad:TYPE {MASTER SLAVE EITHER} SEARCH:SEARCH<x>:TRIGger:A:BUS:SVID:PAYLoad:TYPE?
<b>Arguments</b>	<p>Search&lt;x&gt; is the search identifier number.</p> <p>MASTER specifies the search condition as MASTER. This is the default payload type condition.</p> <p>SLAVE specifies the search condition as SLAVE.</p> <p>EITHER specifies the search condition as EITHER.</p>
<b>Examples</b>	<p>SEARCH:SEARCH3:TRIGger:A:BUS:SVID:SVID:PAYLoad:TYPE SLAVE specifies SLAVE payload as the field within a SVID frame to search on.</p> <p>SEARCH:SEARCH1:TRIGger:A:BUS:SVID:PAYLoad:TYPE? might return SEARCH:SEARCH1:TRIGger:A:BUS:SVID:PAYLoad:TYPE PARity,</p>

indicating that SLAVE is the currently specified field within a SVID frame to search on.

## SEARCH:SEARCH<x>:TRIGger:A:BUS:SVID:PAYLoad:VALue

This command sets or queries the payload value to be used when search is on SVID bus.

<b>Conditions</b>	Requires option SR-SVID
<b>Group</b>	Search and Mark
<b>Syntax</b>	SEARCH:SEARCH<x>:TRIGger:A:BUS:SVID:PAYLoad:VALue <QString> SEARCH:SEARCH<x>:TRIGger:A:BUS:SVID:PAYLoad:VALue?
<b>Arguments</b>	Search<x> is the search identifier number.  <QString> specifies the data value in the specified valid format. The valid characters are 0, 1, and X for binary; for hexadecimal; and symbolic).
<b>Examples</b>	SEARCH:SEARCH1:TRIGGER:A:BUS:SVID:PAYLoad:VALue "XXXX" specifies the payload value as XXXX within a SVID frame to search on.  SEARCH:SEARCH1:TRIGGER:A:BUS:SVID:PAYLoad:VALue? might return SEARCH:SEARCH1:TRIGGER:A:BUS:SVID:PAYLoad:VALue "XXXX", indicating the payload value is XXXX within a SVID frame to search on.

## SEARCH:SEARCH<x>:TRIGger:A:BUS:SVID:SLAVE:ADDRESS

This command sets or queries the slave address to be used when search is on SVID bus.

<b>Conditions</b>	Requires option SR-SVID
<b>Group</b>	Search and Mark
<b>Syntax</b>	SEARCH:SEARCH<x>:TRIGger:A:BUS:SVID:SLAVE:ADDRESS <QString> SEARCH:SEARCH<x>:TRIGger:A:BUS:SVID:SLAVE:ADDRESS?

**Arguments**     `Search<x>` is the search identifier number.

`<QString>` specifies the data value in the specified valid format. The valid characters are 0, 1, and X for binary; for hexadecimal; and symbolic). the default address is `XXXX`.

**Examples**     `SEARCH:SEARCH1:TRIGGER:A:BUS:SVID:SLAVE:ADDRESS "XXXX"`  
specifies the pslave address as `XXXX` within a SVID frame to search on.

`SEARCH:SEARCH1:TRIGGER:A:BUS:SVID:SLAVE:ADDRESS?` might return  
`SEARCH:SEARCH1:TRIGGER:A:BUS:SVID:SLAVE:ADDRESS "XXXX"`,  
indicating the slave address is `XXXX` within a SVID frame to search on.

## **SEARCH:SEARCH<x>:TRIGger:A:BUS:USB:ADDRESS:HIVALue**

This command sets or queries the high binary address value used when searching on a USB bus signal to determine where to place a mark. The search number is specified by `x`. The search condition must be set to `TOKEN`.

The `VALue` and `HIVALue` set a range that the `INrange` and `OUTrange` qualifiers use to decide when to trigger. For example, if the `QUALIFER` is set to `INrange`, and the address is within the range set by `VALue` and `HIVALue`, then a trigger can be generated.

**Conditions**     Requires option 5-SRUSB2 or SUP5-SRUSB2 Triggering and Analysis application.

**Group**            Search and Mark

**Syntax**           `SEARCH:SEARCH<x>:TRIGger:A:BUS:USB:ADDRESS:HIVALue <QString>`  
`SEARCH:SEARCH<x>:TRIGger:A:BUS:USB:ADDRESS:HIVALue?`

**Related Commands**     [SEARCH:SEARCH<x>:TRIGger:A:BUS:USB:ADDRESS:VALue](#)

**Arguments**     `<QString>` specifies the data value in the specified valid format. The valid characters are 0, 1, and X for binary; for hexadecimal; and symbolic).

**Examples**     `SEARCH:SEARCH1:TRIGGER:A:BUS:USB:ADDRESS:HIVALUE`

`SEARCH:SEARCH1:TRIGGER:A:BUS:USB:ADDRESS:HIVALUE?` might return `SEARCH:SEARCH1:TRIGGER:A:BUS:USB:ADDRESS:HIVALUE "XX"`, indicating that the address value for normal token for USB bus trigger search 1 is set to `"XX,"` in hexadecimal format.



## SEARCH:SEARCH<x>:TRIGger:A:BUS:USB:ADDress:VALue

This command sets or queries the binary address value used for a USB bus search to determine where to place a mark. The search number is specified by x. The search condition must be set to TOKEN.

**Conditions** Requires option 5-SRUSB2 or SUP5-SRUSB2 Triggering and Analysis application.

**Group** Search and Mark

**Syntax** SEARCH:SEARCH<x>:TRIGger:A:BUS:USB:ADDress:VALue <QString>  
SEARCH:SEARCH<x>:TRIGger:A:BUS:USB:ADDress:VALue?

**Related Commands** [SEARCH:SEARCH<x>:TRIGger:A:BUS:USB:ADDress:HIVALue](#)

**Arguments** <QString> specifies the data value in the specified valid format. Valid characters are 0, 1, and X for binary; A-F, 0-9 and X for hexadecimal; and for symbolic.

**Examples** SEARCH:SEARCH1:TRIGGER:A:BUS:USB:ADDRESS:VALUE "1110000" sets the address value for the normal token for USB bus trigger search 1 to "1110000" in binary format.

SEARCH:SEARCH1:TRIGGER:A:BUS:USB:ADDRESS:VALUE? might return SEARCH:SEARCH1:TRIGGER:A:BUS:USB:ADDRESS:VALUE "11", indicating that the address value for normal token for USB bus trigger search 1 is set to "11" hexadecimal format.

## SEARCH:SEARCH<x>:TRIGger:A:BUS:USB:CONDition

This command sets or queries the search condition for a USB bus search to determine where to place a mark. The search number is specified by x.

**Conditions** Requires option 5-SRUSB2 or SUP5-SRUSB2 Triggering and Analysis application.

**Group** Search and Mark

**Syntax** SEARCH:SEARCH<x>:TRIGger:A:BUS:USB:CONDition  
{DATAPacket|EOP|ERROR|HANDSHAKEPacket|RESET|RESUME|  
SPECIALPacket|SUSPEND|SYNC|TOKENPacket}

SEARCH:SEARCH<x>:TRIGger:A:BUS:USB:CONDition?

- Arguments**
- DATAPacket specifies the search condition as Data Packet.
  - EOP specifies the search condition as End of Packet.
  - ERROR specifies the search condition as Error.
  - HANDSHAKEPacket specifies the search condition as Handshake Packet.
  - RESET specifies the search condition as Reset.
  - RESUME specifies the search condition as Resume.
  - SPECIALPacket specifies the search condition as Special Packet.
  - SUSPEND specifies the search condition as Suspend.
  - SYNC specifies the search condition as Sync.
  - TOKENPacket specifies the search condition as Token (Address) Packet.

- Examples**
- SEARCH:SEARCH1:TRIGGER:A:BUS:USB:CONDITION EOP sets the search condition for USB bus trigger search 1 to End of Packet.
- SEARCH:SEARCH1:TRIGGER:A:BUS:USB:CONDITION? might return  
SEARCH:SEARCH1:TRIGGER:A:BUS:USB:CONDITION SYNC, indicating that the search condition for USB bus trigger search 1 is set to Sync.

## SEARCH:SEARCH<x>:TRIGger:A:BUS:USB:DATA:HIVALue

This command sets or queries the high binary data value used with In Range and Out of Range qualifiers for a USB bus search to determine where to place a mark. The search number is specified by x. The search condition must be set to DATA.

- Conditions** Requires option 5-SRUSB2 or SUP5-SRUSB2 Triggering and Analysis application.
- Group** Search and Mark
- Syntax** SEARCH:SEARCH<x>:TRIGger:A:BUS:USB:DATA:HIVALue <QString>  
SEARCH:SEARCH<x>:TRIGger:A:BUS:USB:DATA:HIVALue?
- Arguments** <QString> specifies the data value in the specified valid format (binary, hexadecimal, or symbolic). The valid characters for binary are 0, 1, and X;

- Examples**     `SEARCH:SEARCH1:TRIGGER:A:BUS:USB:DATA:HIVALUE "XXXXX111"` sets the data value for USB bus trigger search 1 to "XXXXX111" in binary format.
- `SEARCH:SEARCH1:TRIGGER:A:BUS:USB:DATA:HIVALUE?` might return `SEARCH:SEARCH1:TRIGGER:A:BUS:USB:DATA:HIVALUE "11"`, indicating that the data value for USB bus trigger search 1 is set to "11" in hexadecimal format.

## SEARCH:SEARCH<x>:TRIGger:A:BUS:USB:DATA:OFFSet

This command sets the byte offset to look for a data pattern at, in bytes, to be used when searching on a USB bus signal. The search number is specified by x. The search condition must be set to DATA.

- Conditions**     Requires option 5-SRUSB2 or SUP5-SRUSB2 Triggering and Analysis application.
- Group**            Search and Mark
- Syntax**            `SEARCH:SEARCH<x>:TRIGger:A:BUS:USB:DATA:OFFSet <NR1>`  
`SEARCH:SEARCH<x>:TRIGger:A:BUS:USB:DATA:OFFSet?`
- Arguments**        <NR1> specifies the data offset in bytes.
- Examples**         `SEARCH:SEARCH1:TRIGGER:A:BUS:USB:DATA:OFFSET 5` sets the data offset for USB bus trigger search 1 to 5 bytes.
- `SEARCH:SEARCH1:TRIGGER:A:BUS:USB:DATA:OFFSET?` might return `SEARCH:SEARCH1:TRIGGER:A:BUS:USB:DATA:OFFSET DONTCARE`, indicating that the data offset for USB bus trigger search 1 is set to DONTCare.

## SEARCH:SEARCH<x>:TRIGger:A:BUS:USB:DATA:QUALifier

This command sets or queries the qualifier to be used when searching on a USB bus signal. The search condition must be set to IDANDDATA OR DATA. The search number is specified by x.

- Conditions**        Requires option 5-SRUSB2 or SUP5-SRUSB2 Triggering and Analysis application.
- Group**            Search and Mark

**Syntax** SEARCH:SEARCH<x>:TRIGger:A:BUS:USB:DATA:QUALifier {EQual|UNEQual|LESSThan|MOREthan|LESSEQual|MOREEQual|INrange|OUTrange}  
SEARCH:SEARCH<x>:TRIGger:A:BUS:USB:DATA:QUALifier?

**Arguments** EQual specifies the qualifier as Equal.  
INrange specifies the qualifier as Inside Range.  
LESSEQual specifies the qualifier as Less Than or Equal to.  
MOREEQual specifies the qualifier as More Than or Equal to.  
OUTrange specifies the qualifier as Out of Range.  
UNEQual specifies the qualifier as Unequal.  
LESSThan specifies the qualifier as Less Than.  
MOREThan specifies the qualifier as More Than.

**Examples** SEARCH:SEARCH1:TRIGger:A:BUS:USB:DATA:QUALifier INRANGE sets the qualifier to INRANGE.  
SEARCH:SEARCH1:TRIGger:A:BUS:USB:DATA:QUALifier? might return SEARCH:SEARCH1:TRIGGER:A:BUS:USB:DATA:QUALIFIER EQUAL indicating the qualifier is set to equal.

## SEARCH:SEARCH<x>:TRIGger:A:BUS:USB:DATA:SIZE

This command sets or queries the length of the data string, in bytes, used for a USB bus search to determine where to place a mark. The search number is specified by x. The search condition must be set to DATA.

**Conditions** Requires option 5-SRUSB2 or SUP5-SRUSB2 Triggering and Analysis application.

**Group** Search and Mark

**Syntax** SEARCH:SEARCH<x>:TRIGger:A:BUS:USB:DATA:SIZE <NR1>  
SEARCH:SEARCH<x>:TRIGger:A:BUS:USB:DATA:SIZE?

**Arguments** <NR1> specifies the data size in bytes.

- Examples**     `SEARCH:SEARCH1:TRIGGER:A:BUS:USB:DATA:SIZE 1` sets the size of the data string for USB bus trigger search 1 to 1 byte.
- `SEARCH:SEARCH1:TRIGGER:A:BUS:USB:DATA:SIZE?` might return `SEARCH:SEARCH1:TRIGGER:A:BUS:USB:DATA:SIZE 3`, indicating that the size of the data string for USB bus trigger search 1 is set to 3 bytes.

## SEARCH:SEARCH<x>:TRIGger:A:BUS:USB:DATA:TYPE

This command sets or queries the USB bus search type. The search number is specified by x.

- Conditions**     Requires option 5-SRUSB2 or SUP5-SRUSB2 Triggering and Analysis application.
- Group**            Search and Mark
- Syntax**            `SEARCH:SEARCH<x>:TRIGger:A:BUS:USB:DATA:TYPE`  
                           `{ANY|DATA0|DATA1|DATA2|MDATA}`  
                           `SEARCH:SEARCH<x>:TRIGger:A:BUS:USB:DATA:TYPE?`
- Arguments**        ANY specifies the data packet type as Any.  
                           DATA0 specifies the data packet type as DATA0.  
                           DATA1 specifies the data packet type as DATA1.  
                           DATA2 specifies the data packet type as DATA2.  
                           MDATA specifies the data packet type as MDATA.
- Examples**         `SEARCH:SEARCH1:TRIGGER:A:BUS:USB:DATA:TYPE ANY` sets the data packet type for USB bus trigger search 1 to ANY.
- `SEARCH:SEARCH2:TRIGGER:A:BUS:USB:DATA:TYPE?` might return `:SEARCH:SEARCH2:TRIGGER:A:BUS:USB:DATA:TYPE MDADA`, indicating that the packet type for USB bus trigger search 2 is set to MDATA.

## SEARCH:SEARCH<x>:TRIGger:A:BUS:USB:DATA:VALue

This command sets or queries the binary data value used for a USB bus search to determine where to place a mark. The search number is specified by x. The search condition must be set to DATA.

<b>Conditions</b>	Requires option 5-SRUSB2 or SUP5-SRUSB2 Triggering and Analysis application.
<b>Group</b>	Search and Mark
<b>Syntax</b>	SEARCH:SEARCH<x>:TRIGger:A:BUS:USB:DATA:VALue <QString> SEARCH:SEARCH<x>:TRIGger:A:BUS:USB:DATA:VALue?
<b>Arguments</b>	<QString> specifies the data value. The valid characters are 0, 1, and X for binary format; and A-F, 0-9, and X for hexadecimal format.
<b>Examples</b>	SEARCH:SEARCH1:TRIGGER:A:BUS:USB:DATA:VALUE "AB" sets the data value for data token for USB bus trigger search 1 to "AB" in hexadecimal format.  SEARCH:SEARCH1:TRIGGER:A:BUS:USB:DATA:VALUE? might return SEARCH:SEARCH1:TRIGGER:A:BUS:USB:DATA:VALUE "XXXXXXXX", indicating that the data value for data token for USB bus trigger search 1 is set to "XXXXXXXX" in binary format.

## SEARCH:SEARCH<x>:TRIGger:A:BUS:USB:ENDPoint:VALue

This command sets or queries the endpoint binary value used for a USB bus search to determine where to place a mark. The search number is specified by x. The search condition must be set to TOKEN.

<b>Conditions</b>	Requires option 5-SRUSB2 or SUP5-SRUSB2 Triggering and Analysis application.
<b>Group</b>	Search and Mark
<b>Syntax</b>	SEARCH:SEARCH<x>:TRIGger:A:BUS:USB:ENDPoint:VALue <QString> SEARCH:SEARCH<x>:TRIGger:A:BUS:USB:ENDPoint:VALue?
<b>Arguments</b>	<QString> specifies the data value in the specified valid format. The valid characters are 0, 1, and X for binary format; A-F, 0-9 and X for hexadecimal format.
<b>Examples</b>	SEARCH:SEARCH1:TRIGGER:A:BUS:USB:ENDPOINT:VALUE "1111" sets the endpoint value for normal token for USB bus trigger search 1 to "1111" in binary format.

SEARCH:SEARCH1:TRIGGER:A:BUS:USB:ENDPOINT:VALUE? might return SEARCH:SEARCH1:TRIGGER:A:BUS:USB:ENDPOINT:VALUE "1", indicating that the endpoint value for normal token for USB bus trigger search 1 is set to "1" in hexadecimal format.

## SEARCH:SEARCH<x>:TRIGger:A:BUS:USB:ERRTYPE

This command sets or queries the error type for a USB bus search to determine where to place a mark. The search number is specified by x.

<b>Conditions</b>	Requires option 5-SRUSB2 or SUP5-SRUSB2 Triggering and Analysis application.
<b>Group</b>	Search and Mark
<b>Syntax</b>	SEARCH:SEARCH<x>:TRIGger:A:BUS:USB:ERRTYPE {BITSTUFFing CRC5 CRC16 PID} SEARCH:SEARCH<x>:TRIGger:A:BUS:USB:ERRTYPE?
<b>Arguments</b>	BITSTUFFing specifies the error type as Bit Stuffing. CRC5 specifies the error type as Token CRC5 (Cyclic Redundancy Check 5). CRC16 specifies the error type as Data CRC16 (Cyclic Redundancy Check 16). PID specifies the error type as PID Check Bits.
<b>Examples</b>	SEARCH:SEARCH1:TRIGGER:A:BUS:USB:ERRTYPE CRC5 sets the error type for USB bus trigger search 1 to Token CRC5. SEARCH:SEARCH1:TRIGGER:A:BUS:USB:ERRTYPE? might return SEARCH:SEARCH1:TRIGGER:A:BUS:USB:ERRTYPE PID, indicating that the error type for USB bus trigger search 1 is set to PID Check Bits.

## SEARCH:SEARCH<x>:TRIGger:A:BUS:USB:HANDSHAKEType

This command sets or queries the handshake type for the specified USB bus trigger search to determine where to place a mark. The search number is specified by x.

<b>Conditions</b>	Requires option 5-SRUSB2 or SUP5-SRUSB2 Triggering and Analysis application.
-------------------	------------------------------------------------------------------------------

<b>Group</b>	Search and Mark
<b>Syntax</b>	SEARCH:SEARCH<x>:TRIGger:A:BUS:USB:HANDSHAKEType {ACK ANY NAK NYET STALL} SEARCH:SEARCH<x>:TRIGger:A:BUS:USB:HANDSHAKEType?
<b>Arguments</b>	ACK specifies the handshake type as Acknowledgement (positive) (XX10). ANY specifies the handshake type as Any (0010). NAK specifies the handshake type as Negative Acknowledgment (1010). NYET specifies the handshake type as No response Yet (0110). STALL specifies the handshake type as Stall (endpoint is halted or control pipe request not supported) (1110).
<b>Examples</b>	SEARCH:SEARCH1:TRIGGER:A:BUS:USB:HANDSHAKETYPE NAK sets the handshake type for USB bus trigger search 1 to NAK. SEARCH:SEARCH2:TRIGGER:A:BUS:USB:HANDSHAKETYPE? might return :SEARCH:SEARCH2:TRIGGER:A:BUS:USB:HANDSHAKETYPE NYET, indicating that the handshake type for USB bus trigger search 2 is set to NYET.

## SEARCH:SEARCH<x>:TRIGger:A:BUS:USB:SOFFRAMENUMber

This command sets or queries the frame number string to use for the Start of Frame for the specified USB bus trigger search to determine where to place a mark. The search number is specified by x. The search condition must be set to TOKEN.

<b>Conditions</b>	Requires option 5-SRUSB2 or SUP5-SRUSB2 Triggering and Analysis application.
<b>Group</b>	Search and Mark
<b>Syntax</b>	SEARCH:SEARCH<x>:TRIGger:A:BUS:USB:SOFFRAMENUMber <QString> SEARCH:SEARCH<x>:TRIGger:A:BUS:USB:SOFFRAMENUMber?
<b>Arguments</b>	<QString> specifies the frame number string for the Start of Frame in a valid format (binary, hexadecimal, or symbolic).



**Examples**     `SEARCH:SEARCH1:TRIGGER:A:BUS:USB:SOFFRAMENUMBER "1001"` sets the frame number string for the SOF for USB bus trigger search 1 to "1001" in symbolic format.

`SEARCH:SEARCH1:TRIGGER:A:BUS:USB:SOFFRAMENUMBER?` might return `SEARCH:SEARCH1:TRIGGER:A:BUS:USB:SOFFRAMENUMBER "xxxxxxx1001"`, indicating that the frame number string for the SOF for USB bus trigger search 1 is set to "XXXXXXXX1001" in binary format.

## SEARCH:SEARCH<x>:TRIGger:A:BUS:USB:SPECIALType

This command sets or queries the USB search type for the specified USB bus trigger search to determine where to place a mark. The search number is specified by x.

**Conditions**     Requires option 5-SRUSB2 or SUP5-SRUSB2 Triggering and Analysis application.

**Group**            Search and Mark

**Syntax**           `SEARCH:SEARCH<x>:TRIGger:A:BUS:USB:SPECIALType`  
                       `{ANY|ERROR|PING|PREAmbLe|RESERVED|SPLit}`  
                       `SEARCH:SEARCH<x>:TRIGger:A:BUS:USB:SPECIALType?`

**Arguments**      ANY specifies the PID value as Any (XX00).  
                       ERROR specifies the PID value as ERR (1100).  
                       PING specifies the PID value as PING (0100).  
                       PREAmbLe specifies the PID value as PRE (1100).  
                       RESERVED specifies the PID value as Reserved (0000).  
                       SPLit specifies the PID value as Split (1000).

**Examples**        `SEARCH:SEARCH1:TRIGGER:A:BUS:USB:SPECIALTYPE ERROR` sets the PID value for USB bus trigger search 1 to ERROR.

`SEARCH:SEARCH1:TRIGGER:A:BUS:USB:SPECIALTYPE?` might return `SEARCH:SEARCH1:TRIGGER:A:BUS:USB:SPECIALTYPE SPLIT`, indicating that the PID value for USB bus trigger search 1 is set to SPLIT.

## SEARCH:SEARCH<x>:TRIGger:A:BUS:USB:SPLIT:ET:VALue

This command sets or queries the Endpoint Type value for the specified USB bus trigger search on split token field to determine where to place a mark. The search number is specified by x.

<b>Conditions</b>	Requires option 5-SRUSB2 or SUP5-SRUSB2 Triggering and Analysis application.
<b>Group</b>	Search and Mark
<b>Syntax</b>	SEARCH:SEARCH<x>:TRIGger:A:BUS:USB:SPLIT:ET:VALue {BULK CONTROL NOCARE INTERRUPT ISOchronous} SEARCH:SEARCH<x>:TRIGger:A:BUS:USB:SPLIT:ET:VALue?
<b>Arguments</b>	BULK specifies the Endpoint Type value as Bulk (10). CONTROL specifies the Endpoint Type value as Control (00). NOCARE specifies the Endpoint Type value as Don't Care. INTERRUPT specifies the Endpoint Type value as Interrupt (11). ISOchronous specifies the Endpoint Type value as Isochronous (01).
<b>Examples</b>	SEARCH:SEARCH1:TRIGGER:A:BUS:USB:SPLIT:ET:VALUE BULK sets the Endpoint Type value for USB bus trigger search 1 to Bulk.  SEARCH:SEARCH1:TRIGGER:A:BUS:USB:SPLIT:ET:VALUE? might return SEARCH:SEARCH1:TRIGGER:A:BUS:USB:SPLIT:ET:VALUE DONTCARE, indicating that the Endpoint Type value for USB bus trigger search 1 is set to DONTCare.

## SEARCH:SEARCH<x>:TRIGger:A:BUS:USB:SPLIT:HUB:VALue

This command sets or queries the binary hub address value to be used when searching on a USB bus signal. The search number is specified by x. The search condition must be set to Special with packet type SPLIT.

<b>Conditions</b>	Requires option 5-SRUSB2 or SUP5-SRUSB2 Triggering and Analysis application.
<b>Group</b>	Search and Mark

<b>Syntax</b>	SEARCH:SEARCH<x>:TRIGger:A:BUS:USB:SPLIT:HUB:VALue <QString> SEARCH:SEARCH<x>:TRIGger:A:BUS:USB:SPLIT:HUB:VALue?
<b>Arguments</b>	<QString> specifies the hub address. The valid characters are .
<b>Examples</b>	SEARCH:SEARCH1:TRIGGER:A:BUS:USB:SPLIT:HUB:VALUE "1001" sets the hub address to "XXX1001".  SEARCH:SEARCH1:TRIGGER:A:BUS:USB:SPLIT:HUB:VALUE? might return SEARCH:SEARCH1:TRIGGER:A:BUS:USB:SPLIT:HUB:VALUE "XX" (for binary format), indicating that the hub address for the USB bus trigger search on split token field is "XX".

## SEARCH:SEARCH<x>:TRIGger:A:BUS:USB:SPLIT:PORT:VALue

This command sets or queries the binary port address used when searching on a USB bus signal. The search number is specified by x. The search condition must be set to Special with a packet type SPLIT.

<b>Conditions</b>	Requires option 5-SRUSB2 or SUP5-SRUSB2 Triggering and Analysis application.
<b>Group</b>	Search and Mark
<b>Syntax</b>	SEARCH:SEARCH<x>:TRIGger:A:BUS:USB:SPLIT:PORT:VALue <QString> SEARCH:SEARCH<x>:TRIGger:A:BUS:USB:SPLIT:PORT:VALue?
<b>Arguments</b>	<QString> specifies the port address in the valid format. The valid characters are
<b>Examples</b>	SEARCH:SEARCH1:TRIGGER:A:BUS:USB:SPLIT:PORT:VALUE "1111" sets the port address for USB bus trigger search 1 to "XXX1111" for binary format.  SEARCH:SEARCH1:TRIGGER:A:BUS:USB:SPLIT:PORT:VALUE? might return SEARCH:SEARCH1:TRIGGER:A:BUS:USB:SPLIT:PORT:VALUE "XX", indicating that the port address for USB hub trigger search 1 is set to "XX" in hexadecimal format.

## SEARCH:SEARCH<x>:TRIGger:A:BUS:USB:SPLIT:SC:VALue

This command sets or queries the Start/Complete value for the specified USB bus trigger on split token field search to determine where to place a mark. The search number is specified by x.

<b>Conditions</b>	Requires option 5-SRUSB2 or SUP5-SRUSB2 Triggering and Analysis application.
<b>Group</b>	Search and Mark
<b>Syntax</b>	SEARCH:SEARCH<x>:TRIGger:A:BUS:USB:SPLIT:SC:VALue {CSPLIT NOCARE SSPLIT} SEARCH:SEARCH<x>:TRIGger:A:BUS:USB:SPLIT:SC:VALue?
<b>Arguments</b>	CSPLIT specifies Complete (CSPLIT)(1) Start/Complete value. NOCARE specifies the Start/Complete value as Don't Care (X). SSPLIT specifies Start (SSPLIT) (0) Start/Complete value.
<b>Examples</b>	SEARCH:SEARCH1:TRIGGER:A:BUS:USB:SPLIT:SC:VALUE DONTCARE sets the Start/Complete value for USB bus trigger search 1 to DONTCare.  SEARCH:SEARCH2:TRIGGER:A:BUS:USB:SPLIT:SC:VALUE? might return :SEARCH:SEARCH2:TRIGGER:A:BUS:USB:SPLIT:SC:VALUE SSPLIT, indicating that the Start/Complete value for USB bus trigger search 2 is set to SSPLIT.

## SEARCH:SEARCH<x>:TRIGger:A:BUS:USB:SPLIT:SE:VALue

This command sets or queries the Start/End value for the specified USB bus trigger on split token field search to determine where to place a mark. The search number is specified by x.

<b>Conditions</b>	Requires option 5-SRUSB2 or SUP5-SRUSB2 Triggering and Analysis application.
<b>Group</b>	Search and Mark
<b>Syntax</b>	SEARCH:SEARCH<x>:TRIGger:A:BUS:USB:SPLIT:SE:VALue {NOCARE FULLSPEED ISOALL ISOEND ISOMID ISOSTART LOWSPEED} SEARCH:SEARCH<x>:TRIGger:A:BUS:USB:SPLIT:SE:VALue?

<b>Arguments</b>	<p>NOCARE specifies Don't Care (X) Start/End bit value.</p> <p>FULLSPEED specifies Control/Bulk/Interrupt Full Speed device (0X) Start/End bit value.</p> <p>ISOALL specifies Isochronous Data is All (11) Start/End bit value.</p> <p>ISOEND specifies Isochronous Data is End (01) Start/End bit value.</p> <p>ISOMID specifies Isochronous Data is Middle (00) Start/End bit value.</p> <p>ISOSTART specifies Isochronous Data is Start (10) Start/End bit value.</p> <p>LOWSPEED specifies Control/Bulk/Interrupt Low Speed device (1X) Start/End bit value.</p>
<b>Examples</b>	<p>SEARCH:SEARCH1:TRIGGER:A:BUS:USB:SPLIT:SE:VALUE ISOSTART sets the Start/End value for USB bus trigger on split token field search 1 to ISOSTART.</p> <p>SEARCH:SEARCH1:TRIGGER:A:BUS:USB:SPLIT:SE:VALUE? might return SEARCH:SEARCH1:TRIGGER:A:BUS:USB:SPLIT:SE:VALUE DONTCARE, indicating that the Start/End value for USB bus trigger on split token field search 1 is set to DONTCare.</p>

## SEARCH:SEARCH<x>:TRIGger:A:BUS:USB:TOKENType

This command sets or queries the token type used to search a USB bus signal. The search number is specified by x.

<b>Conditions</b>	Requires option 5-SRUSB2 or SUP5-SRUSB2 Triggering and Analysis application.
<b>Group</b>	Search and Mark
<b>Syntax</b>	<pre>SEARCH:SEARCH&lt;x&gt;:TRIGger:A:BUS:USB:TOKENType {ANY IN OUT SETUP SOF} SEARCH:SEARCH&lt;x&gt;:TRIGger:A:BUS:USB:TOKENType?</pre>
<b>Arguments</b>	<p>ANY specifies the token type as Any (XX01).</p> <p>IN specifies the token type as IN (1001).</p> <p>OUT specifies the token type as OUT (0001).</p> <p>SETUP specifies the token type as SETUP (1101).</p> <p>SOF specifies the token type as Start Of Frame (0101).</p>

**Examples**     `SEARCH:SEARCH1:TRIGGER:A:BUS:USB:TOKENTYPE IN` sets the token type for USB bus trigger search 1 to IN.

`SEARCH:SEARCH1:TRIGGER:A:BUS:USB:TOKENTYPE?` might return `SEARCH:SEARCH1:TRIGGER:A:BUS:USB:TOKENTYPE SOF`, indicating that the token type for USB bus trigger search 1 is set to Start Of Frame.

## **SEARCH:SEARCH<x>:TRIGger:A:DDRREAD:BURSTDETECTmethod**

This command sets or queries the DDRRead search burst detection method.

**Conditions**     Requires option 6-DBDDR3.

                     Requires a 6 Series MSO instrument.

                     Set the DDR Read standard (DDR3 or LPDDR3) before using this command. See Related Commands.

**Group**            Search and Mark

**Syntax**           `SEARCH:SEARCH<x>:TRIGger:A:DDRREAD:BURSTDETECTmethod`  
                     `{DQDQS|ChipSelect|LogicState}`  
                     `SEARCH:SEARCH<x>:TRIGger:A:DDRREAD:BURSTDETECTmethod?`

**Related Commands**     [SEARCH:SEARCH<x>:TRIGger:A:DDRREADWRITE:STANdard](#)

**Arguments**        `DQDQS` sets the burst detection method to `DQDQS`.

`ChipSelect` sets the burst detection method to `ChipSelect`.

`LogicState` sets the burst detection method to `LogicState`.

**Examples**         `SEARCH:SEARCH1:TRIGger:A:DDRREAD:BURSTDETECTmethod DQDQS` sets the burst detection method as DQ/DQS Phase alignment.

`SEARCH:SEARCH1:TRIGger:A:DDRREAD:BURSTDETECTmethod?` might return `SEARCH:SEARCH1:TRIGger:A:DDRREAD:BURSTDETECTmethod DQDQS` indicating that the DDR read burst detection method is `DQDQS`.

## **SEARCH:SEARCH<x>:TRIGger:A:DDRREAD:BURSTLatency**

This command sets or queries the DDR read logic state burst latency value.

<b>Conditions</b>	<p>Requires option 6-DBDDR3.</p> <p>Requires a 6 Series MSO instrument.</p> <p>Set the DDR Read standard (DDR3 or LPDDR3) before using this command. See Related Commands.</p> <p>Set burst detection method as "Logic State".</p>
<b>Group</b>	Search and Mark
<b>Syntax</b>	<pre>SEARCH:SEARCH&lt;x&gt;:TRIGger:A:DDRREAD:BURSTLatency &lt;NR3&gt; SEARCH:SEARCH&lt;x&gt;:TRIGger:A:DDRREAD:BURSTLatency?</pre>
<b>Related Commands</b>	<a href="#">SEARCH:SEARCH&lt;x&gt;:TRIGger:A:DDRREAD:BURSTDETECTmethod</a>
<b>Arguments</b>	<p>SEARCH&lt;x&gt; specifies the search number.</p> <p>NR3 sets the logic state burst latency value.</p>
<b>Examples</b>	<p>SEARCH:SEARCH1:TRIGger:A:DDRREAD:BURSTLatency 500E-3 sets the DDRREAD burst latency value of search 1 to .005.</p> <p>SEARCH:SEARCH3:TRIGger:A:DDRREAD:BURSTLatency? might return SEARCH:SEARCH3:TRIGger:A:DDRREAD:BURSTLatency 500E-3, indicating that the DDRREAD logic burst latency value is set to 500E-3 for search 3.</p>

## SEARCH:SEARCH<x>:TRIGger:A:DDRREAD:BURSTLENGTH

This command sets or queries the DDR read logic state burst length value.

<b>Conditions</b>	<p>Requires option 6-DBDDR3.</p> <p>Requires a 6 Series MSO instrument.</p> <p>Set the DDR Read standard (DDR3 or LPDDR3) before using this command. See Related Commands.</p> <p>Set burst detection method as "Logic State".</p>
<b>Group</b>	Search and Mark
<b>Syntax</b>	<pre>SEARCH:SEARCH&lt;x&gt;:TRIGger:A:DDRREAD:BURSTLENGTH &lt;NR1&gt; SEARCH:SEARCH&lt;x&gt;:TRIGger:A:DDRREAD:BURSTLENGTH?</pre>

**Related Commands**    [SEARCH:SEARCH<x>:TRIGger:A:DDRREAD:BURSTDETECTmethod](#)

**Arguments**    SEARCH<x> specifies the search number.  
NR1 sets the logic state burst length value.

**Examples**    SEARCH:SEARCH3:TRIGger:A:DDRREAD:BURSTLENGTH 10 sets the DDRREAD logic state burst length value of search 3 to 10 bursts.  
SEARCH:SEARCH1:TRIGger:A:DDRREAD:BURSTLENGTH? might return SEARCH:SEARCH1:TRIGger:A:DDRREAD:BURSTLENGTH 8, indicating that the DDRREAD logic state burst length value is set to 8 bursts for search 1.

## SEARCH:SEARCH<x>:TRIGger:A:DDRREAD:CSActive

This command sets or queries the DDR Read chip select active state.

**Conditions**    Requires option 6-DBDDR3.  
Requires a 6 Series MSO instrument.  
Set the DDR Read standard (DDR3 or LPDDR3) before using this command.  
See Related Commands.  
Set burst detection method as "Chip Select"

**Group**    Search and Mark

**Syntax**    SEARCH:SEARCH<x>:TRIGger:A:DDRREAD:CSActive {LOW|HIGH}  
SEARCH:SEARCH<x>:TRIGger:A:DDRREAD:CSActive?

**Related Commands**    [SEARCH:SEARCH<x>:TRIGger:A:DDRREAD:BURSTDETECTmethod](#)

**Arguments**    SEARCH<x> specifies the search number.  
LOW sets the DDR read chip select active state to low.  
HIGH sets the DDR read chip select active state to high.

**Examples**    SEARCH:SEARCH2:TRIGger:A:DDRREAD:CSActive LOW sets the DDRREAD chip select active to LOW for search 2.



SEARCH:SEARCH4:TRIGger:A:DDRREAD:CSActive? might return  
SEARCH:SEARCH4:TRIGger:A:DDRREAD:CSActive HIGH, indicating the  
DDRREAD chip select active value for search 4 is set to HIGH.

## SEARCH:SEARCH<x>:TRIGger:A:DDRREAD:CSLevel

This command sets or queries the DDR Read chip select level value.

<b>Conditions</b>	Requires option 6-DBDDR3. Requires a 6 Series MSO instrument. Set the DDR Read standard (DDR3 or LPDDR3) before using this command. See Related Commands. Set burst detection method as "Chip Select"
<b>Group</b>	Search and Mark
<b>Syntax</b>	SEARCH:SEARCH<x>:TRIGger:A:DDRREAD:CSLevel <NR3> SEARCH:SEARCH<x>:TRIGger:A:DDRREAD:CSLevel?
<b>Related Commands</b>	<a href="#">SEARCH:SEARCH&lt;x&gt;:TRIGger:A:DDRREAD:BURSTDETECTmethod</a> <a href="#">SEARCH:SEARCH&lt;x&gt;:TRIGger:A:DDRREAD:CSMode</a>
<b>Arguments</b>	SEARCH<x> specifies the search number. NR3 sets the DDR read chip select level value.
<b>Examples</b>	SEARCH:SEARCH2:TRIGger:A:DDRREAD:CSLevel 2.8E-3 sets the DDRREAD chip select level value to 2.8E-3  SEARCH:SEARCH5:TRIGger:A:DDRREAD:CSLevel? might return SEARCH:SEARCH5:TRIGger:A:DDRREAD:CSLevel 2.8E-3, indicating DDRREAD search chip select level value for search 5 is set to 2.8E-3

## SEARCH:SEARCH<x>:TRIGger:A:DDRREAD:CSMode

This command sets or queries the DDR Read chip select mode.

<b>Conditions</b>	Requires option 6-DBDDR3. Requires a 6 Series MSO instrument.
-------------------	------------------------------------------------------------------

Set the DDR Read standard (DDR3 or LPDDR3) before using this command.  
See Related Commands.

Set burst detection method as "Chip Select"

**Group** Search and Mark

**Syntax** SEARCH:SEARCH<x>:TRIGger:A:DDRREAD:CSMode {Auto|Manual}  
SEARCH:SEARCH<x>:TRIGger:A:DDRREAD:CSMode?

**Related Commands** [SEARCH:SEARCH<x>:TRIGger:A:DDRREAD:BURSTDETECTmethod](#)

**Arguments** SEARCH<x> specifies the search number.

Auto sets the DDR read chip select mode to auto.

Manual sets the DDR read chip select mode to manual. Use the Related Commands to set the Reference levels when in Manual mode.

**Examples** SEARCH:SEARCH2:TRIGger:A:DDRREAD:CSMode MANUAL sets the DDRREAD search chip select mode to Manual for search 2.  
SEARCH:SEARCH3:TRIGger:A:DDRREAD:CSMode? might return SEARCH:SEARCH3:TRIGger:A:DDRREAD:CSMode Manual, indicating that the DDRREAD search 3 chip select mode is set to manual.

## SEARCH:SEARCH<x>:TRIGger:A:DDRREAD:CSSource

This command sets or queries the DDR Read search chip select source.

**Conditions** Requires option 6-DBDDR3.

Requires a 6 Series MSO instrument.

Set the DDR Read standard (DDR3 or LPDDR3) before using this command.  
See Related Commands.

Set burst detection method as "Chip Select".

**Group** Search and Mark

**Syntax** SEARCH:SEARCH<x>:TRIGger:A:DDRREAD:CSSource  
{S<x>\_Ch<x>\_D<x>|CH<x>|CH<x>\_D<x>|Math<x>|REF<x>|REF<x>\_D<x>}  
SEARCH:SEARCH<x>:TRIGger:A:DDRREAD:CSSource?

**Related Commands**    [SEARCH:SEARCH<x>:TRIGger:A:DDRREAD:BURSTDETECTmethod](#)

**Arguments**

SEARCH<x> specifies the search number.

S<x>\_Ch<x>\_D<x> specifies is the remote scope number, the analog channel and the digital channel.

CH<x> specifies channel <x> as the DDR read chip select source for the specified search <x>.

CH<x>\_D<x> specifies digital waveform <x> of channel <x> as the DDR read strobe source for the specified search <x>.

Math<x> specifies math waveform <x> as the DDR read chip select source for the specified search <x>.

REF<x> specifies reference waveform <x> as the DDR read chip select source for the specified search <x>.

REF<x>\_D<x> specifies digital waveform <x> of reference waveform <x> as the DDR read strobe source for the specified search <x>.

**Examples**

SEARCH:SEARCH5:TRIGger:A:DDRREAD:CSSource CH2 sets the search 5 chip select source waveform to CH2 for DDR Read search.

SEARCH:SEARCH3:TRIGger:A:DDRREAD:CSSource? might return SEARCH:SEARCH3:TRIGger:A:DDRREAD:CSSource CH2, indicating that Channel 2 waveform is the source for the DDRRead chip select source of search 3.

## SEARCH:SEARCH<x>:TRIGger:A:DDRREAD:DATARate

This command sets or queries the DDR read search data rate for DDR3 and LPDDR3 standards of the specified search.

**Conditions**

Requires option 6-DBDDR3.

Requires a 6 Series MSO instrument.

Set the DDR Read standard (DDR3 or LPDDR3) before using this command. See Related Commands.

**Group**    Search and Mark

**Syntax**

SEARCH:SEARCH<x>:TRIGger:A:DDRREAD:DATARate {333|800|1066|1200|1333|1466|1600|1866|2133}  
SEARCH:SEARCH<x>:TRIGger:A:DDRREAD:DATARate?

<b>Related Commands</b>	<a href="#">SEARCH:SEARCH&lt;x&gt;:TRIGger:A:DDRREAD:STANdard</a>
<b>Arguments</b>	<p>333–2133 sets the data rate to the specified value.</p> <p>The DDR3 standard supports the following data rates: 800 1066 1333 1600 1866 2133.</p> <p>The LPDDR3 standard supports the following data rates: 333 800 1066 1200 1333 1466 1600 1866 2133.</p>
<b>Examples</b>	<p>SEARCH:SEARCH2:TRIGger:A:DDRREAD:DATARate 1333 sets the data rate to 1333 for DDR read Search 2.</p> <p>SEARCH:SEARCH1:TRIGger:A:DDRREAD:DATARate? might return SEARCH:SEARCH1:TRIGger:A:DDRREAD:DATARate 800 indicating that the data rate for DDR read Search 1 is 800.</p>

## SEARCH:SEARCH<x>:TRIGger:A:DDRREAD:DATASource

This command sets or queries the DDR read data source when the search type is DDR READ.

<b>Conditions</b>	<p>Requires option 6-DBDDR3</p> <p>Requires 6 Series MSO instrument</p> <p>Load a reference waveform on the instrument before using this command to set the search data source to a reference waveform.</p>
<b>Group</b>	Search and Mark
<b>Syntax</b>	<pre>SEARCH:SEARCH&lt;x&gt;:TRIGger:A:DDRREAD:DATASource {CH&lt;x&gt; CH&lt;x&gt;_D&lt;x&gt; Math&lt;x&gt; REF&lt;x&gt; REF&lt;x&gt;_D&lt;x&gt;} SEARCH:SEARCH&lt;x&gt;:TRIGger:A:DDRREAD:DATASource?</pre>
<b>Arguments</b>	<p>CH&lt;x&gt; specifies channel &lt;x&gt; as the DDR read data source for the specified search &lt;x&gt;.</p> <p>CH&lt;x&gt;_D&lt;x&gt; specifies digital waveform &lt;x&gt; of channel &lt;x&gt; as the DDR read data source for the specified search &lt;x&gt;.</p> <p>Math&lt;x&gt; specifies math waveform &lt;x&gt; as the DDR read data source for the specified search &lt;x&gt;.</p> <p>REF&lt;x&gt; specifies reference waveform &lt;x&gt; as the DDR read data source for the specified search &lt;x&gt;.</p>

REF<x>\_D<x> specifies digital waveform <x> of reference waveform <x> as the DDR read data source for the specified search <x>.

**Examples** SEARCH:SEARCH1:TRIGGER:A:DDRREAD:DATASource CH2 sets the source waveform for the A trigger to Channel 2.

SEARCH:SEARCH1:TRIGGER:A:DDRREAD:DATASource? might return SEARCH:SEARCH1:TRIGGER:A:DDRREAD:DATASource REF1, indicating that the Reference waveform 1 DDR read trigger data is the source for search 1.

## SEARCH:SEARCH<x>:TRIGger:A:DDRREAD:HYSteresis

This command sets or queries the DDR read hysteresis reference level value, when the search type is DDR READ.

**Conditions** Requires option 6-DBDDR3.  
Requires a 6 Series MSO instrument.  
Set the DDR read reference level mode to Manual before using this command.  
See Related Commands.

**Group** Search and Mark

**Syntax** SEARCH:SEARCH<x>:TRIGger:A:DDRREAD:HYSteresis <NR3>  
SEARCH:SEARCH<x>:TRIGger:A:DDRREAD:HYSteresis?

**Related Commands** [SEARCH:SEARCH<x>:TRIGger:A:DDRREAD:REFLEVELMode](#)

**Arguments** NR3 sets the DDR read search hysteresis percent value in the range of 0% to 50%.

**Examples** SEARCH:SEARCH2:TRIGger:A:DDRREAD:HYSteresis 15 sets the DDR read search hysteresis value to 15%.

SEARCH:SEARCH1:TRIGger:A:DDRREAD:HYSteresis? might return SEARCH:SEARCH1:TRIGger:A:DDRREAD:HYSteresis 10, indicating that the DDR read search hysteresis value is set to 10%.

## SEARCH:SEARCH<x>:TRIGger:A:DDRREAD:LOGIC1SOUrce:SYMBol

This command sets or queries the DDR read logic source 1 symbol.

<b>Conditions</b>	Requires option 6-DBDDR3. Requires a 6 Series MSO instrument. Set the DDR Read standard (DDR3 or LPDDR3) before using this command. See Related Commands. Set burst detection method as "Logic State".
<b>Group</b>	Search and Mark
<b>Syntax</b>	SEARCH:SEARCH<x>:TRIGger:A:DDRREAD:LOGIC1SOURCE:SYMBOL {H L X} SEARCH:SEARCH<x>:TRIGger:A:DDRREAD:LOGIC1SOURCE:SYMBOL?
<b>Related Commands</b>	<a href="#">SEARCH:SEARCH&lt;x&gt;:TRIGger:A:DDRREAD:BURSTDETECTmethod</a>
<b>Arguments</b>	SEARCH<x> specifies the search number. H sets the logic source 1 symbol to H (High). L sets the logic source 1 symbol to L (Low). X sets the logic source 1 symbol to X (Don't care).
<b>Examples</b>	SEARCH:SEARCH3:TRIGger:A:DDRREAD:LOGIC1SOURCE:SYMBOL X sets the DDRREAD logic source 1 symbol of search 3 to X (don't care).  SEARCH:SEARCH1:TRIGger:A:DDRREAD:LOGIC1SOURCE:SYMBOL? might return SEARCH:SEARCH1:TRIGger:A:DDRREAD:LOGIC1SOURCE:SYMBOL L, indicating that the DDRREAD logic source 1 symbol is set to Low for search 1.

## SEARCH:SEARCH<x>:TRIGger:A:DDRREAD:LOGIC2SOURCE:SYMBOL

This command sets or queries the DDR read logic source 2 symbol.

<b>Conditions</b>	Requires option 6-DBDDR3. Requires a 6 Series MSO instrument. Set the DDR Read standard (DDR3 or LPDDR3) before using this command. See Related Commands. Set burst detection method as "Logic State".
<b>Group</b>	Search and Mark

**Syntax** SEARCH:SEARCH<x>:TRIGger:A:DDRREAD:LOGIC2SOURCE:SYMBOL  
{H|L|X}  
SEARCH:SEARCH<x>:TRIGger:A:DDRREAD:LOGIC2SOURCE:SYMBOL?

**Related Commands** [SEARCH:SEARCH<x>:TRIGger:A:DDRREAD:BURSTDETECTmethod](#)

**Arguments** SEARCH<x> specifies the search number.  
H sets the logic source 2 symbol to H (High).  
L sets the logic source 2 symbol to L (Low).  
X sets the logic source 2 symbol to X (Don't care).

**Examples** SEARCH:SEARCH3:TRIGger:A:DDRREAD:LOGIC2SOURCE:SYMBOL X sets the DDRREAD logic source 2 symbol of search 3 to X (don't care)  
SEARCH:SEARCH1:TRIGger:A:DDRREAD:LOGIC2SOURCE:SYMBOL? might return SEARCH:SEARCH1:TRIGger:A:DDRREAD:LOGIC2SOURCE:SYMBOL L, indicating that the DDRREAD logic source 2 symbol is set to Low for search 1.

## SEARCH:SEARCH<x>:TRIGger:A:DDRREAD:LOGIC3SOURCE:SYMBOL

This command sets or queries the DDR read logic source 3 symbol.

**Conditions** Requires option 6-DBDDR3.  
Requires a 6 Series MSO instrument.  
Set the DDR Read standard (DDR3 or LPDDR3) before using this command.  
See Related Commands.  
Set burst detection method as "Logic State".

**Group** Search and Mark

**Syntax** SEARCH:SEARCH<x>:TRIGger:A:DDRREAD:LOGIC3SOURCE:SYMBOL  
{H|L|X}  
SEARCH:SEARCH<x>:TRIGger:A:DDRREAD:LOGIC3SOURCE:SYMBOL?

**Related Commands** [SEARCH:SEARCH<x>:TRIGger:A:DDRREAD:BURSTDETECTmethod](#)

<b>Arguments</b>	SEARCH<x> specifies the search number. H sets the logic source 3 symbol to H (High). L sets the logic source 3 symbol to L (Low). X sets the logic source 3 symbol to X (Don't care).
<b>Examples</b>	SEARCH:SEARCH3:TRIGger:A:DDRREAD:LOGIC3SOURCE:SYMBOL X sets the DDRREAD logic source 3 symbol of search 3 to X (don't care)  SEARCH:SEARCH1:TRIGger:A:DDRREAD:LOGIC3SOURCE:SYMBOL? might return SEARCH:SEARCH1:TRIGger:A:DDRREAD:LOGIC3SOURCE:SYMBOL L, indicating that the DDRREAD logic source 3 symbol is set to Low for search 1.

## SEARCH:SEARCH<x>:TRIGger:A:DDRREAD:LOGIC4SOURCE:SYMBOL

This command sets or queries the DDR read logic source 4 symbol.

<b>Conditions</b>	Requires option 6-DBDDR3. Requires a 6 Series MSO instrument. Set the DDR Read standard (DDR3 or LPDDR3) before using this command. See Related Commands. Set burst detection method as "Logic State".
<b>Group</b>	Search and Mark
<b>Syntax</b>	SEARCH:SEARCH<x>:TRIGger:A:DDRREAD:LOGIC4SOURCE:SYMBOL {H L X} SEARCH:SEARCH<x>:TRIGger:A:DDRREAD:LOGIC4SOURCE:SYMBOL?
<b>Related Commands</b>	<a href="#">SEARCH:SEARCH&lt;x&gt;:TRIGger:A:DDRREAD:BURSTDETECTmethod</a>
<b>Arguments</b>	SEARCH<x> specifies the search number. H sets the logic source 4 symbol to H (High). L sets the logic source 4 symbol to L (Low). X sets the logic source 4 symbol to X (Don't care).
<b>Examples</b>	SEARCH:SEARCH3:TRIGger:A:DDRREAD:LOGIC4SOURCE:SYMBOL X sets the DDRREAD logic source 4 symbol of search 3 to X (don't care)



SEARCH:SEARCH1:TRIGger:A:DDRREAD:LOGIC4SOURCE:SYMBOL? might return SEARCH:SEARCH1:TRIGger:A:DDRREAD:LOGIC4SOURCE:SYMBOL L, indicating that the DDRREAD logic source 4 symbol is set to Low for search 1.

## SEARCH:SEARCH<x>:TRIGger:A:DDRREAD:MARgin

This command sets or queries the DDR read margin reference level value, when the search type is DDR READ.

**Conditions** Requires option 6-DBDDR3.  
Requires a 6 Series MSO instrument.  
Set the DDR read reference level mode to Manual before using this command. See Related Commands.

**Group** Search and Mark

**Syntax** SEARCH:SEARCH<x>:TRIGger:A:DDRREAD:MARgin <NR3>  
SEARCH:SEARCH<x>:TRIGger:A:DDRREAD:MARgin?

**Related Commands** [SEARCH:SEARCH<x>:TRIGger:A:DDRREAD:REFLEVELMode](#)

**Arguments** NR3 sets the DDR read search margin percent value in the range of 0% to 100%.

**Examples** SEARCH:SEARCH2:TRIGger:A:DDRREAD:MARgin 12 sets the DDR read search margin value to 12%.  
SEARCH:SEARCH1:TRIGger:A:DDRREAD:MARgin? might return SEARCH:SEARCH1:TRIGger:A:DDRREAD:MARgin 10, indicating that the DDR read search margin value is set to 10%.

## SEARCH:SEARCH<x>:TRIGger:A:DDRREAD:MAXCAS

This command sets or queries the DDR read chip maximum Column Access Strobe (CAS) value.

**Conditions** Requires option 6-DBDDR3.  
Requires a 6 Series MSO instrument.  
Set the DDR Read standard (DDR3 or LPDDR3) before using this command. See Related Commands.

Set burst detection method as "Chip Select"

**Group** Search and Mark

**Syntax** SEARCH:SEARCH<x>:TRIGger:A:DDRREAD:MAXCAS <NR3>  
SEARCH:SEARCH<x>:TRIGger:A:DDRREAD:MAXCAS?

**Related Commands** [SEARCH:SEARCH<x>:TRIGger:A:DDRREAD:BURSTDETECTmethod](#)

**Arguments** SEARCH<x> specifies the search number.  
NR3 sets the DDR read chip select CAS maximum value.

**Examples** EARCH:SEARCH1:TRIGger:A:DDRREAD:MAXCas 3.8E-3 sets the DDR read chip select CAS maximum value to 3.8 milliseconds for search 1.  
SEARCH:SEARCH7:TRIGger:A:DDRREAD:MAXCas? might return  
SEARCH:SEARCH7:TRIGger:A:DDRREAD:MAXCas 3.8E-3, indicating that the DDR read chip select CAS maximum value is set to 3.8 milliseconds for search 7.

## SEARCH:SEARCH<x>:TRIGger:A:DDRREAD:MINCas

This command sets or queries the DDR read chip minimum Column Access Strobe (CAS) value.

**Conditions** Requires option 6-DBDDR3.  
Requires a 6 Series MSO instrument.

Set the DDR Read standard (DDR3 or LPDDR3) before using this command.  
See Related Commands.

Set burst detection method as "Chip Select"

**Group** Search and Mark

**Syntax** SEARCH:SEARCH<x>:TRIGger:A:DDRREAD:MINCas <NR3>  
SEARCH:SEARCH<x>:TRIGger:A:DDRREAD:MINCas?

**Related Commands** [SEARCH:SEARCH<x>:TRIGger:A:DDRREAD:BURSTDETECTmethod](#)

**Arguments** SEARCH<x> specifies the search number.  
NR3 sets the DDR read chip select CAS minimum value.

**Examples** SEARCH:SEARCH1:TRIGger:A:DDRREAD:MINCas 3.8E-3 sets the DDR read chip select CAS minimum value to 3.8 milliseconds for search 1.  
SEARCH:SEARCH7:TRIGger:A:DDRREAD:MINCas? might return SEARCH:SEARCH7:TRIGger:A:DDRREAD:MINCas 3.8E-3, indicating that the DDR read chip select CAS minimum value is set to 3.8 milliseconds for search 7.

## SEARCH:SEARCH<x>:TRIGger:A:DDRREAD:POSTAMBLE:LENGTH

This command sets or queries the DDR read postamble length when the search type is DDR READ.

**Conditions** Requires option 6-DBDDR3.  
Requires a 6 Series MSO instrument.

**Group** Search and Mark

**Syntax** SEARCH:SEARCH<x>:TRIGger:A:DDRREAD:POSTAMBLE:LENGTH {500E-3|500E-1.5|500E-1}  
SEARCH:SEARCH<x>:TRIGger:A:DDRREAD:POSTAMBLE:LENGTH?

**Arguments** 500E-1.5 sets the postamble length to 1.5 tCK (number of clock cycles).  
500E-1 sets the postamble length to 1 tCK (number of clock cycles).  
500E-3 sets the postamble length to 0.5 tCK (number of clock cycles).

**Examples** SEARCH:SEARCH2:TRIGger:A:DDRREAD:POSTAMBLE:LENGTH 500E-3 sets the DDR read postamble length for Search 2 to 0.5 tCK.  
SEARCH:SEARCH1:TRIGger:A:DDRREAD:POSTAMBLE:LENGTH? might return SEARCH:SEARCH1:TRIGger:A:DDRREAD:POSTAMBLE:LENGTH 500E-1, indicating that the read postamble length for Search 1 is set to 1 tCK.

## SEARCH:SEARCH<x>:TRIGger:A:DDRREAD:PREAMBLE:TYPE

This command sets or queries the DDR read preamble type when the search type is DDR READ.

<b>Conditions</b>	Requires option 6-DBDDR3. Requires a 6 Series MSO instrument.
<b>Group</b>	Search and Mark
<b>Syntax</b>	SEARCH:SEARCH<x>:TRIGger:A:DDRREAD:PREAMBLE:TYPE {STATIC DYNAMIC} SEARCH:SEARCH<x>:TRIGger:A:DDRREAD:PREAMBLE:TYPE?
<b>Arguments</b>	STATIC sets the DDR Read preamble type to Static. DYNAMIC sets the DDR Read preamble type to Dynamic.
<b>Examples</b>	SEARCH:SEARCH2:TRIGger:A:DDRREAD:PREAMBLE:TYPE STATIC sets the DDR read preamble type to Static for Search 2.  SEARCH:SEARCH4:TRIGger:A:DDRREAD:PREAMBLE:TYPE? might return SEARCH:SEARCH4:TRIGger:A:DDRREAD:PREAMBLE:TYPE DYNAMIC, indicating that the DDR read preamble type for Search 4 is set to dynamic mode.

## SEARCH:SEARCH<x>:TRIGger:A:DDRREAD:REFLevel:DATA:HIGH

This command sets or queries the DDR read data high reference level value, when the search type is DDR READ.

<b>Conditions</b>	Requires option 6-DBDDR3. Requires a 6 Series MSO instrument. Set the DDR read reference level mode to Manual before using this command. See Related Commands.
<b>Group</b>	Search and Mark
<b>Syntax</b>	SEARCH:SEARCH<x>:TRIGger:A:DDRREAD:REFLevel:DATA:HIGH <NR3> SEARCH:SEARCH<x>:TRIGger:A:DDRREAD:REFLevel:DATA:HIGH?
<b>Related Commands</b>	<a href="#">SEARCH:SEARCH&lt;x&gt;:TRIGger:A:DDRREAD:REFLEVELMode</a>
<b>Arguments</b>	NR3 sets the DDR read search data high reference value.

**Examples** SEARCH:SEARCH2:TRIGger:A:DDRREAD:REFLevel:DATA:HIGH 3.8E-3 sets the DDR read search data high reference value.

SEARCH:SEARCH1:TRIGger:A:DDRREAD:REFLevel:DATA:HIGH? might return SEARCH:SEARCH1:TRIGger:A:DDRREAD:REFLevel:DATA:HIGH 50E-3, indicating that the DDR read search data high reference value is set to 50E-3.

## SEARCH:SEARCH<x>:TRIGger:A:DDRREAD:REFLevel:DATA:LOW

This command sets or queries the DDR read data low reference level value, when the search type is DDR READ.

**Conditions** Requires option 6-DBDDR3.  
Requires a 6 Series MSO instrument.  
Set the DDR read reference level mode to Manual before using this command.  
See Related Commands.

**Group** Search and Mark

**Syntax** SEARCH:SEARCH<x>:TRIGger:A:DDRREAD:REFLevel:DATA:LOW <NR3>  
SEARCH:SEARCH<x>:TRIGger:A:DDRREAD:REFLevel:DATA:LOW?

**Related Commands** [SEARCH:SEARCH<x>:TRIGger:A:DDRREAD:REFLEVELMode](#)

**Arguments** NR3 sets the DDR read search data low reference value.

**Examples** SEARCH:SEARCH2:TRIGger:A:DDRREAD:REFLevel:DATA:LOW 3.8E-3 sets the DDR read search data low reference value.

SEARCH:SEARCH1:TRIGger:A:DDRREAD:REFLevel:DATA:LOW? might return SEARCH:SEARCH1:TRIGger:A:DDRREAD:REFLevel:DATA:LOW 50E-3, indicating that the DDR read search data low reference value is set to 50E-3.

## SEARCH:SEARCH<x>:TRIGger:A:DDRREAD:REFLevel:DATA:MID

This command sets or queries the DDR read data mid reference level value, when the search type is DDR READ.

**Conditions** Requires option 6-DBDDR3.

Requires a 6 Series MSO instrument.

Set the DDR read reference level mode to Manual before using this command.  
See Related Commands.

**Group** Search and Mark

**Syntax** SEARCH:SEARCH<x>:TRIGger:A:DDRREAD:REFLeve1:DATA:MID <NR3>  
SEARCH:SEARCH<x>:TRIGger:A:DDRREAD:REFLeve1:DATA:MID?

**Related Commands** [SEARCH:SEARCH<x>:TRIGger:A:DDRREAD:REFLEVELMode](#)

**Arguments** NR3 sets the DDR read search data mid reference value.

**Examples** SEARCH:SEARCH2:TRIGger:A:DDRREAD:REFLeve1:DATA:MID 3.8E-3 sets the DDR read search data mid reference value.

SEARCH:SEARCH1:TRIGger:A:DDRREAD:REFLeve1:DATA:MID? might return SEARCH:SEARCH1:TRIGger:A:DDRREAD:REFLeve1:DATA:MID 50E-3, indicating that the DDR read search data mid reference value is set to 50E-3.

## SEARCH:SEARCH<x>:TRIGger:A:DDRREAD:REFLevel:STROBE:HIGH

This command sets or queries the DDR read reference level strobe high value, when the search type is DDR READ.

**Conditions** Requires option 6-DBDDR3.

Requires a 6 Series MSO instrument.

Set the DDR read reference level mode to Manual before using this command.  
See Related Commands.

**Group** Search and Mark

**Syntax** SEARCH:SEARCH<x>:TRIGger:A:DDRREAD:REFLeve1:STROBE:HIGH <NR3>  
SEARCH:SEARCH<x>:TRIGger:A:DDRREAD:REFLeve1:STROBE:HIGH?

**Related Commands** [SEARCH:SEARCH<x>:TRIGger:A:DDRREAD:REFLEVELMode](#)

<b>Arguments</b>	NR3 sets the DDR read search strobe high value.
<b>Examples</b>	<p>SEARCH:SEARCH2:TRIGger:A:DDRREAD:REFLevel:STROBE:HIGH 3.8E-3 sets the DDR read search strobe high value.</p> <p>SEARCH:SEARCH1:TRIGger:A:DDRREAD:REFLevel:STROBE:HIGH? might return SEARCH:SEARCH1:TRIGger:A:DDRREAD:REFLevel:STROBE:HIGH 50E-3, indicating that the DDR read search strobe high value is set to 50E-3.</p>

## SEARCH:SEARCH<x>:TRIGger:A:DDRREAD:REFLevel:STROBE:LOW

This command sets or queries the DDR read reference level strobe low value, when the search type is DDR READ.

<b>Conditions</b>	<p>Requires option 6-DBDDR3.</p> <p>Requires a 6 Series MSO instrument.</p> <p>Set the DDR read reference level mode to Manual before using this command. See Related Commands.</p>
<b>Group</b>	Search and Mark
<b>Syntax</b>	<p>SEARCH:SEARCH&lt;x&gt;:TRIGger:A:DDRREAD:REFLevel:STROBE:LOW &lt;NR3&gt;</p> <p>SEARCH:SEARCH&lt;x&gt;:TRIGger:A:DDRREAD:REFLevel:STROBE:LOW?</p>

**Related Commands** [SEARCH:SEARCH<x>:TRIGger:A:DDRREAD:REFLEVELMode](#)

<b>Arguments</b>	NR3 sets the DDR read search strobe low reference value.
<b>Examples</b>	<p>SEARCH:SEARCH2:TRIGger:A:DDRREAD:REFLevel:STROBE:LOW 3.8E-3 sets the DDR read search strobe low reference value.</p> <p>SEARCH:SEARCH1:TRIGger:A:DDRREAD:REFLevel:STROBE:LOW? might return SEARCH:SEARCH1:TRIGger:A:DDRREAD:REFLevel:STROBE:MID 50E-3, indicating that the DDR read search strobe low reference value is set to 50E-3.</p>

## SEARCH:SEARCH<x>:TRIGger:A:DDRREAD:REFLevel:STROBE:MID

This command sets or queries the DDR read reference level strobe mid value, when the search type is DDR READ.

<b>Conditions</b>	Requires option 6-DBDDR3. Requires a 6 Series MSO instrument. Set the DDR read reference level mode to Manual before using this command. See Related Commands.
<b>Group</b>	Search and Mark
<b>Syntax</b>	SEARCH:SEARCH<x>:TRIGger:A:DDRREAD:REFLeve1:STROBE:MID <NR3> SEARCH:SEARCH<x>:TRIGger:A:DDRREAD:REFLeve1:STROBE:MID?
<b>Related Commands</b>	<a href="#">SEARCH:SEARCH&lt;x&gt;:TRIGger:A:DDRREAD:REFLEVELMode</a>
<b>Arguments</b>	NR3 sets the DDR read search strobe mid reference value.
<b>Examples</b>	SEARCH:SEARCH2:TRIGger:A:DDRREAD:REFLeve1:STROBE:MID 3.8E-3 sets the DDR read search strobe mid reference value.  SEARCH:SEARCH1:TRIGger:A:DDRREAD:REFLeve1:STROBE:MID? might return SEARCH:SEARCH1:TRIGger:A:DDRREAD:REFLeve1:STROBE:MID 50E-3, indicating that the DDR read search strobe mid reference value is set to 50E-3.

## SEARCH:SEARCH<x>:TRIGger:A:DDRREAD:REFLEVELMode

This command sets or queries the DDR read reference level mode to auto or manual, when the search type is DDR READ.

<b>Conditions</b>	Requires option 6-DBDDR3. Requires a 6 Series MSO instrument.
<b>Group</b>	Search and Mark
<b>Syntax</b>	SEARCH:SEARCH<x>:TRIGger:A:DDRREAD:REFLEVELMode {AUTO MANUAL} SEARCH:SEARCH<x>:TRIGger:A:DDRREAD:REFLEVELMode?
<b>Related Commands</b>	<a href="#">SEARCH:SEARCH&lt;x&gt;:TRIGger:A:DDRREAD:REFLevel:DATA:HIGH</a> <a href="#">SEARCH:SEARCH&lt;x&gt;:TRIGger:A:DDRREAD:REFLevel:DATA:LOW</a>



## SEARCH:SEARCH<x>:TRIGger:A:DDRREAD:REFLevel:DATA:MID

- Arguments** AUTO sets the DDR read reference level mode to auto.  
 MANUAL sets the DDR read reference level mode to manual. Use the Related Commands to set the Reference levels when in Manual mode.
- Examples** SEARCH:SEARCH3:TRIGger:A:DDRREAD:REFLEVELMode MANUAL sets the DDR read search reference level mode to Manual for Search 3.  
 SEARCH:SEARCH1:TRIGger:A:DDRREAD:REFLEVELMode? might return SEARCH:SEARCH1:TRIGger:A:DDRREAD:REFLEVELMode MANUAL, indicating that the DDR read search reference level mode set to automatic for Search 1.

## SEARCH:SEARCH<x>:TRIGger:A:DDRREAD:STANdard

This command sets or queries the DDR read search standard as DDR3 or LPDDR3.

- Conditions** Requires option 6-DBDDR3  
 Requires 6 Series MSO instrument
- Group** Search and Mark
- Syntax** SEARCH:SEARCH<x>:TRIGger:A:DDRREAD:STANdard {DDR3|LPDDR3}  
 SEARCH:SEARCH<x>:TRIGger:A:DDRREAD:STANdard?
- Arguments** DDR3 sets the DDR read search standard as DDR3.  
 LPDDR3 sets the DDR read search standard as LPDDR3.
- Examples** SEARCH:SEARCH2:TRIGger:A:DDRREAD:STANdard DDR3 sets the DDR standard to DDR3 for DDR read Search 2.  
 SEARCH:SEARCH5:TRIGger:A:DDRREAD:STANdard? might return SEARCH:SEARCH5:TRIGger:A:DDRREAD:STANdard LPDDR3, indicating that the DDR standard is set to LPDDR3 for DDR read Search 5.

## SEARCH:SEARCH<x>:TRIGger:A:DDRREAD:STROBESource

This command sets or queries the DDR read strobe source when the search type is DDR READ.

<b>Conditions</b>	<p>Requires option 6-DBDDR3</p> <p>Requires 6 Series MSO instrument</p> <p>Load a reference waveform on the instrument before using this command to set the search data source to a reference waveform.</p>
<b>Group</b>	Search and Mark
<b>Syntax</b>	<pre>SEARCH:SEARCH&lt;x&gt;:TRIGger:A:DDRREAD:STROBESource {CH&lt;x&gt; CH&lt;x&gt;_D&lt;x&gt; Math&lt;x&gt; REF&lt;x&gt; REF&lt;x&gt;_D&lt;x&gt;} SEARCH:SEARCH&lt;x&gt;:TRIGger:A:DDRREAD:STROBESource?</pre>
<b>Arguments</b>	<p>CH&lt;x&gt; specifies channel &lt;x&gt; as the DDR read strobe trigger source for the specified search &lt;x&gt;.</p> <p>CH&lt;x&gt;_D&lt;x&gt; specifies digital waveform &lt;x&gt; of channel &lt;x&gt; as the DDR read strobe trigger source for the specified search &lt;x&gt;.</p> <p>Math&lt;x&gt; specifies math waveform &lt;x&gt; as the DDR read strobe trigger source for the specified search &lt;x&gt;.</p> <p>REF&lt;x&gt; specifies reference waveform &lt;x&gt; as the DDR read strobe trigger source for the specified search &lt;x&gt;.</p> <p>REF&lt;x&gt;_D&lt;x&gt; specifies digital waveform &lt;x&gt; of reference waveform &lt;x&gt; as the DDR read strobe trigger source for the specified search &lt;x&gt;.</p>
<b>Examples</b>	<pre>SEARCH:SEARCH3:TRIGGER:A:DDRREAD:STROBESource MAT25</pre> sets the Search 3 source waveform to Math 2 for the DDR read strobe search. <p> </p> <pre>SEARCH:SEARCH1:TRIGGER:A:DDRREAD:STROBESource?</pre> might return <pre>SEARCH:SEARCH1:TRIGGER:A:DDRREAD:STROBESource CH3</pre> , indicating that the Channel 3 waveform is the source for the DDR read strobe of Search 1.

## SEARCH:SEARCH<x>:TRIGger:A:DDRREAD:TOLERance

This command sets or queries the DDR read logic state tolerance value.

<b>Conditions</b>	<p>Requires option 6-DBDDR3.</p> <p>Requires a 6 Series MSO instrument.</p> <p>Set the DDR Read standard (DDR3 or LPDDR3) before using this command. See Related Commands.</p> <p>Set burst detection method as "Logic State".</p>
-------------------	------------------------------------------------------------------------------------------------------------------------------------------------------------------------------------------------------------------------------------

<b>Group</b>	Search and Mark
<b>Syntax</b>	SEARCH:SEARCH<x>:TRIGger:A:DDRREAD:TOLERance <NR3> SEARCH:SEARCH<x>:TRIGger:A:DDRREAD:TOLERance?
<b>Related Commands</b>	<a href="#">SEARCH:SEARCH&lt;x&gt;:TRIGger:A:DDRREAD:BURSTDETECTmethod</a>
<b>Arguments</b>	SEARCH<x> specifies the search number. NR3 sets the logic state tolerance value.
<b>Examples</b>	SEARCH:SEARCH3:TRIGger:A:DDRREAD:TOLERance 400E-3 sets the DDRREAD logic state tolerance value of search 3 to .004. SEARCH:SEARCH1:TRIGger:A:DDRREAD:TOLERance? might return SEARCH:SEARCH1:TRIGger:A:DDRREAD:TOLERance 500E-3, indicating that the DDRREAD logic state tolerance value is set to 500E-3 for search 1.

## SEARCH:SEARCH<x>:TRIGger:A:DDRREADWRITE:BURSTDETECTmethod

This command sets or queries the DDR Read/Write search burst detection method.

<b>Conditions</b>	Requires option 6-DBDDR3. Requires a 6 Series MSO instrument. Set the DDR Read standard (DDR3 or LPDDR3) before using this command. See Related Commands.
<b>Group</b>	Search and Mark
<b>Syntax</b>	SEARCH:SEARCH<x>:TRIGger:A:DDRREADWRITE:BURSTDETECTmethod {DQDQS ChipSelect LogicState} SEARCH:SEARCH<x>:TRIGger:A:DDRREADWRITE:BURSTDETECTmethod?
<b>Related Commands</b>	<a href="#">SEARCH:SEARCH&lt;x&gt;:TRIGger:A:DDRREADWRITE:STANdard</a>
<b>Arguments</b>	DQDQS sets the read/write burst detection method to DQDQS. ChipSelect sets the read/write burst detection method to ChipSelect. LogicState sets the read/write burst detection method to LogicState.

**Examples** SEARCH:SEARCH1:TRIGger:A:DDRREADWRITE:BURSTDETECTmethod  
DQDQS sets the burst detection method as Logic state + burst latency

SEARCH:SEARCH1:TRIGger:A:DDRREADWRITE:BURSTDETECTmethod?  
might return  
SEARCH:SEARCH1:TRIGger:A:DDRREADWRITE:BURSTDETECTmethod  
LogicState, indicating that the DDR ReadWrite burst detection  
method is Logic state + burst latency.

## SEARCH:SEARCH<x>:TRIGger:A:DDRREADWRITE:BURSTLatency

This command sets or queries the DDR read/write logic state burst latency value.

**Conditions** Requires option 6-DBDDR3.  
Requires a 6 Series MSO instrument.  
Set the DDR Read standard (DDR3 or LPDDR3) before using this command.  
See Related Commands.  
Set burst detection method as "Logic State".

**Group** Search and Mark

**Syntax** SEARCH:SEARCH<x>:TRIGger:A:DDRREADWRITE:BURSTLatency <NR3>  
SEARCH:SEARCH<x>:TRIGger:A:DDRREADWRITE:BURSTLatency?

**Related Commands** [SEARCH:SEARCH<x>:TRIGger:A:DDRREADWRITE:BURSTDETECTmethod](#)

**Arguments** SEARCH<x> specifies the search number.  
NR3 sets the logic state burst latency value.

**Examples** SEARCH:SEARCH1:TRIGger:A:DDRREADWRITE:BURSTLatency 500E-3 sets  
the DDRREADWRITE burst latency value of search 1 to .005.

SEARCH:SEARCH3:TRIGger:A:DDRREADWRITE:BURSTLatency? might  
return SEARCH:SEARCH3:TRIGger:A:DDRREADWRITE:BURSTLatency  
500E-3, indicating that the DDRREADWRITE logic burst latency value is set  
to 500E-3 for search 3.

## SEARCH:SEARCH<x>:TRIGger:A:DDRREADWRITE:BURSTLENGTH

This command sets or queries the DDR read/write logic state burst length value.

**Conditions** Requires option 6-DBDDR3.  
 Requires a 6 Series MSO instrument.  
 Set the DDR Read standard (DDR3 or LPDDR3) before using this command.  
 See Related Commands.  
 Set burst detection method as "Logic State".

**Group** Search and Mark

**Syntax** SEARCH:SEARCH<x>:TRIGger:A:DDRREADWRITE:BURSTLENGTH <NR1>  
 SEARCH:SEARCH<x>:TRIGger:A:DDRREADWRITE:BURSTLENGTH?

**Related Commands** [SEARCH:SEARCH<x>:TRIGger:A:DDRREADWRITE:BURSTDETECTmethod](#)

**Arguments** SEARCH<x> specifies the search number.  
 NR1 sets the logic state burst length value.

**Examples** SEARCH:SEARCH3:TRIGger:A:DDRREADWRITE:BURSTLENGTH 10 sets the DDRREADWRITE logic state burst length value of search 3 to 10 bursts.  
 SEARCH:SEARCH1:TRIGger:A:DDRREADWRITE:BURSTLENGTH? might return SEARCH:SEARCH1:TRIGger:A:DDRREADWRITE:BURSTLENGTH 8, indicating that the DDRREADWRITE logic state burst length value is set to 8 bursts for search 1.

## SEARCH:SEARCH<x>:TRIGger:A:DDRREADWRITE:CSActive

This command sets or queries the DDR Read/Write chip select active state.

**Conditions** Requires option 6-DBDDR3.  
 Requires a 6 Series MSO instrument.  
 Set the DDR Read standard (DDR3 or LPDDR3) before using this command.  
 See Related Commands.  
 Set burst detection method as "Chip Select"

**Group** Search and Mark

<b>Syntax</b>	<code>SEARCH:SEARCH&lt;x&gt;:TRIGger:A:DDRREADWRITE:CSActive {LOW HIGH}</code> <code>SEARCH:SEARCH&lt;x&gt;:TRIGger:A:DDRREADWRITE:CSActive?</code>
<b>Related Commands</b>	<a href="#">SEARCH:SEARCH&lt;x&gt;:TRIGger:A:DDRREADWRITE:BURSTDETECTmethod</a>
<b>Arguments</b>	<code>SEARCH&lt;x&gt;</code> specifies the search number.  LOW sets the DDR read/write chip select active state to low.  HIGH sets the DDR read/write chip select active state to high.
<b>Examples</b>	<code>SEARCH:SEARCH2:TRIGger:A:DDRREADWRITE:CSActive LOW</code> sets the DDRREADWRITE chip select active to LOW.  <code>SEARCH:SEARCH4:TRIGger:A:DDRREADWRITE:CSActive?</code> might return <code>SEARCH:SEARCH4:TRIGger:A:DDRREADWRITE:CSActive HIGH</code> , indicating the DDRREADWRITE search chip select active value for search 4 is set to HIGH.

## SEARCH:SEARCH<x>:TRIGger:A:DDRREADWRITE:CSLevel

This command sets or queries the DDR Read/Write chip select level value.

<b>Conditions</b>	Requires option 6-DBDDR3.  Requires a 6 Series MSO instrument.  Set the DDR Read standard (DDR3 or LPDDR3) before using this command. See Related Commands.  Set burst detection method as "Chip Select"
<b>Group</b>	Search and Mark
<b>Syntax</b>	<code>SEARCH:SEARCH&lt;x&gt;:TRIGger:A:DDRREADWRITE:CSLevel &lt;NR3&gt;</code> <code>SEARCH:SEARCH&lt;x&gt;:TRIGger:A:DDRREADWRITE:CSLevel?</code>
<b>Related Commands</b>	<a href="#">SEARCH:SEARCH&lt;x&gt;:TRIGger:A:DDRREADWRITE:BURSTDETECTmethod</a>  <a href="#">SEARCH:SEARCH&lt;x&gt;:TRIGger:A:DDRREADWRITE:CSMode</a>
<b>Arguments</b>	<code>SEARCH&lt;x&gt;</code> specifies the search number.  NR3 sets the DDR read/write chip select level value.

- Examples**     `SEARCH:SEARCH2:TRIGger:A:DDRREADWRITE:CSLevel 2.8E-3` sets the DDR read/write chip select level value to 2.8E-3.
- `SEARCH:SEARCH4:TRIGger:A:DDRREADWRITE:CSLevel?` might return `SEARCH:SEARCH4:TRIGger:A:DDRREADWRITE:CSLevel 2.8E-3`, indicating the DDR read/write search chip select level value for search 4 is set to 2.8E-3.

## SEARCH:SEARCH<x>:TRIGger:A:DDRREADWRITE:CSMode

This command sets or queries the DDR read/write chip select mode.

- Conditions**     Requires option 6-DBDDR3.
- Requires a 6 Series MSO instrument.
- Set the DDR Read standard (DDR3 or LPDDR3) before using this command. See Related Commands.
- Set burst detection method as "Chip Select"
- Group**            Search and Mark
- Syntax**           `SEARCH:SEARCH<x>:TRIGger:A:DDRREADWRITE:CSMode {Auto|Manual}`  
`SEARCH:SEARCH<x>:TRIGger:A:DDRREADWRITE:CSMode?`
- Related Commands**     [SEARCH:SEARCH<x>:TRIGger:A:DDRREADWRITE:BURSTDETECTmethod](#)
- Arguments**        `SEARCH<x>` specifies the search number.
- `Auto` sets the DDR read/write chip select mode to auto.
- `Manual` sets the DDR read/write chip select mode to manual. Use the Related Commands to set the Reference levels when in Manual mode.
- Examples**         `SEARCH:SEARCH4:TRIGger:A:DDRREADWRITE:CSMode AUTO` sets the DDR read/write search chip select mode to Auto for search 4.
- `SEARCH:SEARCH3:TRIGger:A:DDRREADWRITE:CSMode?` might return `SEARCH:SEARCH3:TRIGger:A:DDRREADWRITE:CSMode Manual`, indicating that the DDR read/write chip select mode is set to manual for search 3.

## SEARCH:SEARCH<x>:TRIGger:A:DDRREADWRITE:CSSource

This command sets or queries the DDR Read/Write search chip select source.

<b>Conditions</b>	<p>Requires option 6-DBDDR3.</p> <p>Requires a 6 Series MSO instrument.</p> <p>Set the DDR Read standard (DDR3 or LPDDR3) before using this command. See Related Commands.</p> <p>Set burst detection method as "Chip Select".</p>
<b>Group</b>	Search and Mark
<b>Syntax</b>	<pre>SEARCH:SEARCH&lt;x&gt;:TRIGger:A:DDRREADWRITE:CSSource {S&lt;x&gt;_Ch&lt;x&gt;_D&lt;x&gt; CH&lt;x&gt; CH&lt;x&gt;_D&lt;x&gt; Math&lt;x&gt; REF&lt;x&gt; REF&lt;x&gt;_D&lt;x&gt;} SEARCH:SEARCH&lt;x&gt;:TRIGger:A:DDRREADWRITE:CSSource?</pre>
<b>Related Commands</b>	<a href="#">SEARCH:SEARCH&lt;x&gt;:TRIGger:A:DDRREADWRITE:BURSTDETECTmethod</a>
<b>Arguments</b>	<p>SEARCH&lt;x&gt; specifies the search number.</p> <p>S&lt;x&gt;_Ch&lt;x&gt;_D&lt;x&gt; specifies is the remote scope number, the analog channel and the digital channel.</p> <p>CH&lt;x&gt; specifies channel &lt;x&gt; as the DDR read/write chip select source for the specified search &lt;x&gt;.</p> <p>CH&lt;x&gt;_D&lt;x&gt; specifies digital waveform &lt;x&gt; of channel &lt;x&gt; as the DDR read/write strobe source for the specified search &lt;x&gt;.</p> <p>Math&lt;x&gt; specifies math waveform &lt;x&gt; as the DDR read/write chip select source for the specified search &lt;x&gt;.</p> <p>REF&lt;x&gt; specifies reference waveform &lt;x&gt; as the DDR read/write chip select source for the specified search &lt;x&gt;.</p> <p>REF&lt;x&gt;_D&lt;x&gt; specifies digital waveform &lt;x&gt; of reference waveform &lt;x&gt; as the DDR read/write strobe source for the specified search &lt;x&gt;.</p>
<b>Examples</b>	<p>SEARCH:SEARCH3:TRIGger:A:DDRREADWRITE:CSSource CH2 sets the search 3 chip select source waveform to CH2 for the specified DDR read/write search.</p> <p>SEARCH:SEARCH1:TRIGger:A:DDRREADWRITE:CSSource? might return SEARCH:SEARCH1:TRIGger:A:DDRREADWRITE:CSSource CH2, indicating that the Channel 2 waveform is the source for the DDR read/write chip select source of search 1.</p>



## SEARCH:SEARCH<x>:TRIGger:A:DDRREADWRITE:DATARate

This command sets or queries the DDR read/write data rate for DDR3 and LPDDR3 standards of the specified search.

**Conditions** Requires option 6-DBDDR3.  
Requires a 6 Series MSO instrument.  
Set the DDR Read/Write standard (DDR3 or LPDDR3) before using this command. See Related Commands.

**Group** Search and Mark

**Syntax** SEARCH:SEARCH<x>:TRIGger:A:DDRREADWRITE:DATARate  
{333|800|1066|1200|1333|1466|1600|1866|2133}  
SEARCH:SEARCH<x>:TRIGger:A:DDRREADWRITE:DATARate?

**Related Commands** [SEARCH:SEARCH<x>:TRIGger:A:DDRREADWRITE:STANdard](#)

**Arguments** 333–2133 sets the data rate to the specified value.  
The DDR3 standard supports the following data rates:  
800|1066|1333|1600|1866|2133.  
The LPDDR3 standard supports the following data rates:  
333|800|1066|1200|1333|1466|1600|1866|2133.

**Examples** SEARCH:SEARCH2:TRIGger:A:DDRREADWRITE:DATARate 1333 sets the data rate to 1333 for DDR read Search 2.  
SEARCH:SEARCH5:TRIGger:A:DDRREADWRITE:DATARate? might return SEARCH:SEARCH5:TRIGger:A:DDRREADWRITE:DATARate 1466 indicating that the data rate for DDR read Search 5 is 1466.

## SEARCH:SEARCH<x>:TRIGger:A:DDRREADWRITE:DATASource

This command sets or queries the DDR read/write data source when the search type is DDR READWRITE.

**Conditions** Requires option 6-DBDDR3  
Requires 6 Series MSO instrument

Load a reference waveform on the instrument before using this command to set the search data source to a reference waveform.

<b>Group</b>	Search and Mark
<b>Syntax</b>	SEARCH:SEARCH<x>:TRIGger:A:DDRREADWRITE:DATASource {CH<x> CH<x>_D<x> Math<x> REF<x> REF<x>_D<x>} SEARCH:SEARCH<x>:TRIGger:A:DDRREADWRITE:DATASource?
<b>Arguments</b>	<p>CH&lt;x&gt; specifies channel &lt;x&gt; as the DDR read/write data source for the specified search &lt;x&gt;.</p> <p>CH&lt;x&gt;_D&lt;x&gt; specifies digital waveform &lt;x&gt; of channel &lt;x&gt; as the DDR read/write data source for the specified search &lt;x&gt;.</p> <p>Math&lt;x&gt; specifies math waveform &lt;x&gt; as the DDR read/write data source for the specified search &lt;x&gt;.</p> <p>REF&lt;x&gt; specifies reference waveform &lt;x&gt; as the DDR read/write data source for the specified search &lt;x&gt;.</p> <p>REF&lt;x&gt;_D&lt;x&gt; specifies digital waveform &lt;x&gt; of reference waveform &lt;x&gt; as the DDR read/write data source for the specified search &lt;x&gt;.</p>
<b>Examples</b>	<p>SEARCH:SEARCH3:TRIGGER:A:DDRREADWRITE:DATASource CH2 sets the source waveform of Search 3 to Channel 2 for the DDR read/write search.</p> <p>SEARCH:SEARCH1:TRIGGER:A:DDRREADWRITE:DATASource? might return SEARCH:SEARCH1:TRIGGER:A:DDRREADWRITE:DATASource CH2, indicating that the Channel 2 waveform is the source for the DDR read/write data of Search 1.</p>

## SEARCH:SEARCH<x>:TRIGger:A:DDRREADWRITE:HYSteresis

This command sets or queries the DDR read/write hysteresis reference level value, when the search type is DDR READWRITE.

<b>Conditions</b>	<p>Requires option 6-DBDDR3.</p> <p>Requires a 6 Series MSO instrument.</p> <p>Set the DDR read/write reference level mode to Manual before using this command. See Related Commands.</p>
<b>Group</b>	Search and Mark

**Syntax** SEARCH:SEARCH<x>:TRIGger:A:DDRREADWRITE:HYSteresis <NR3>  
SEARCH:SEARCH<x>:TRIGger:A:DDRREADWRITE:HYSteresis?

**Related Commands** [SEARCH:SEARCH<x>:TRIGger:A:DDRREADWRITE:REFLEVELMode](#)

**Arguments** NR3 sets the DDR read/write search hysteresis percent value in the range of 0% to 50%.

**Examples** SEARCH:SEARCH2:TRIGger:A:DDRREADWRITE:HYSteresis 10 sets the DDR read/write search hysteresis value to 10%.

SEARCH:SEARCH1:TRIGger:A:DDRREAWRITE:HYSteresis? might return SEARCH:SEARCH1:TRIGger:A:DDRREADWRITE:HYSteresis 5, indicating that the DDR read/write search hysteresis value is set to 5%.

## SEARCH:SEARCH<x>:TRIGger:A:DDRREADWRITE:LOGIC1SOUrcE:SYMBol

This command sets or queries the DDR read/write logic source 1 symbol.

**Conditions** Requires option 6-DBDDR3.  
Requires a 6 Series MSO instrument.  
Set the DDR Read standard (DDR3 or LPDDR3) before using this command.  
See Related Commands.  
Set burst detection method as "Logic State".

**Group** Search and Mark

**Syntax** SEARCH:SEARCH<x>:TRIGger:A:DDRREADWRITE:LOGIC1SOUrcE:SYMBol  
{H|L|X}  
SEARCH:SEARCH<x>:TRIGger:A:DDRREADWRITE:LOGIC1SOUrcE:SYMBol?

**Related Commands** [SEARCH:SEARCH<x>:TRIGger:A:DDRREADWRITE:BURSTDETECTmethod](#)

**Arguments** SEARCH<x> specifies the search number.  
H sets the logic source 1 symbol to H (High).  
L sets the logic source 1 symbol to L (Low).  
X sets the logic source 1 symbol to X (Don't care).

**Examples**     `SEARCH:SEARCH3:TRIGger:A:DDRREADWRITE:LOGIC1SOURCE:SYMBOL X`  
sets the DDRREADWRITE logic source 1 symbol of search 3 to X (don't care)

`SEARCH:SEARCH1:TRIGger:A:DDRREADWRITE:LOGIC1SOURCE:SYMBOL?`  
might return  
`SEARCH:SEARCH1:TRIGger:A:DDRREADWRITE:LOGIC1SOURCE:SYMBOL L,`  
indicating that the DDRREADWRITE logic source 1 symbol is set to Low  
for search 1.

## **SEARCH:SEARCH<x>:TRIGger:A:DDRREADWRITE:LOGIC2SOURCE:SYMBOL**

This command sets or queries the DDR read/write logic source 2 symbol.

**Conditions**     Requires option 6-DBDDR3.  
Requires a 6 Series MSO instrument.  
Set the DDR Read standard (DDR3 or LPDDR3) before using this command.  
See Related Commands.  
Set burst detection method as "Logic State".

**Group**            Search and Mark

**Syntax**           `SEARCH:SEARCH<x>:TRIGger:A:DDRREADWRITE:LOGIC2SOURCE:SYMBOL`  
`{H|L|X}`  
`SEARCH:SEARCH<x>:TRIGger:A:DDRREADWRITE:LOGIC2SOURCE:SYMBOL?`

**Related Commands**     [SEARCH:SEARCH<x>:TRIGger:A:DDRREADWRITE:BURSTDETECTmethod](#)

**Arguments**        `SEARCH<x>` specifies the search number.  
H sets the logic source 2 symbol to H (High).  
L sets the logic source 2 symbol to L (Low).  
X sets the logic source 2 symbol to X (Don't care).

**Examples**     `SEARCH:SEARCH3:TRIGger:A:DDRREADWRITE:LOGIC2SOURCE:SYMBOL X`  
sets the DDRREADWRITE logic source 2 symbol of search 3 to X (don't care)

`SEARCH:SEARCH1:TRIGger:A:DDRREADWRITE:LOGIC2SOURCE:SYMBOL?`  
might return  
`SEARCH:SEARCH1:TRIGger:A:DDRREADWRITE:LOGIC2SOURCE:SYMBOL L,`  
indicating that the DDRREADWRITE logic source 2 symbol is set to Low  
for search 1.

**SEARCH:SEARCH<x>:TRIGger:A:DDRREADWRITE:LOGIC3SOURCE:SYMBOL**

This command sets or queries the DDR read/write logic source 3 symbol.

<b>Conditions</b>	<p>Requires option 6-DBDDR3.</p> <p>Requires a 6 Series MSO instrument.</p> <p>Set the DDR Read standard (DDR3 or LPDDR3) before using this command. See Related Commands.</p> <p>Set burst detection method as "Logic State".</p>
<b>Group</b>	Search and Mark
<b>Syntax</b>	<pre>SEARCH:SEARCH&lt;x&gt;:TRIGger:A:DDRREADWRITE:LOGIC3SOURCE:SYMBOL {H L X} SEARCH:SEARCH&lt;x&gt;:TRIGger:A:DDRREADWRITE:LOGIC3SOURCE:SYMBOL?</pre>
<b>Related Commands</b>	<a href="#">SEARCH:SEARCH&lt;x&gt;:TRIGger:A:DDRREADWRITE:BURSTDETECTmethod</a>
<b>Arguments</b>	<p>SEARCH&lt;x&gt; specifies the search number.</p> <p>H sets the logic source 3 symbol to H (High).</p> <p>L sets the logic source 3 symbol to L (Low).</p> <p>X sets the logic source 3 symbol to X (Don't care).</p>
<b>Examples</b>	<pre>SEARCH:SEARCH3:TRIGger:A:DDRREADWRITE:LOGIC3SOURCE:SYMBOL X sets the DDRREADWRITE logic source 3 symbol of search 3 to X (don't care)  SEARCH:SEARCH1:TRIGger:A:DDRREADWRITE:LOGIC3SOURCE:SYMBOL? might return SEARCH:SEARCH1:TRIGger:A:DDRREADWRITE:LOGIC3SOURCE:SYMBOL L, indicating that the DDRREADWRITE logic source 3 symbol is set to Low for search 1.</pre>

**SEARCH:SEARCH<x>:TRIGger:A:DDRREADWRITE:LOGIC4SOURCE:SYMBOL**

This command sets or queries the DDR read/write logic source 4 symbol.

<b>Conditions</b>	<p>Requires option 6-DBDDR3.</p> <p>Requires a 6 Series MSO instrument.</p>
-------------------	-----------------------------------------------------------------------------

Set the DDR Read standard (DDR3 or LPDDR3) before using this command.  
See Related Commands.

Set burst detection method as "Logic State".

**Group** Search and Mark

**Syntax** SEARCH:SEARCH<x>:TRIGger:A:DDRREADWRITE:LOGIC4SOURCE:SYMBOL  
{H|L|X}  
SEARCH:SEARCH<x>:TRIGger:A:DDRREADWRITE:LOGIC4SOURCE:SYMBOL?

**Related Commands** [SEARCH:SEARCH<x>:TRIGger:A:DDRREADWRITE:BURSTDETECTmethod](#)

**Arguments** SEARCH<x> specifies the search number.  
H sets the logic source 4 symbol to H (High).  
L sets the logic source 4 symbol to L (Low).  
X sets the logic source 4 symbol to X (Don't care).

**Examples** SEARCH:SEARCH3:TRIGger:A:DDRREADWRITE:LOGIC4SOURCE:SYMBOL X  
sets the DDRREADWRITE logic source 4 symbol of search 3 to X (don't care)  
SEARCH:SEARCH1:TRIGger:A:DDRREADWRITE:LOGIC4SOURCE:SYMBOL?  
might return  
SEARCH:SEARCH1:TRIGger:A:DDRREADWRITE:LOGIC4SOURCE:SYMBOL L,  
indicating that the DDRREADWRITE logic source 4 symbol is set to Low  
for search 1.

## SEARCH:SEARCH<x>:TRIGger:A:DDRREADWRITE:MARGIN

This command sets or queries the DDR read/write margin reference level value,  
when the search type is DDR READWRITE.

**Conditions** Requires option 6-DBDDR3.  
Requires a 6 Series MSO instrument.  
Set the DDR read/write reference level mode to Manual before using this  
command. See Related Commands.

**Group** Search and Mark

**Syntax** SEARCH:SEARCH<x>:TRIGger:A:DDRREADWRITE:MARgin <NR3>  
SEARCH:SEARCH<x>:TRIGger:A:DDRREADWRITE:MARgin?

**Related Commands** [SEARCH:SEARCH<x>:TRIGger:A:DDRREADWRITE:REFLEVELMode](#)

**Arguments** NR3 sets the DDR read/write search margin percent value in the range of 0% to 100%.

**Examples** SEARCH:SEARCH2:TRIGger:A:DDRREADWRITE:MARgin 15 sets the DDR read/write search margin value to 15%.

SEARCH:SEARCH1:TRIGger:A:DDRREADWRITE:MARgin? might return SEARCH:SEARCH1:TRIGger:A:DDRREADWRITE:MARgin 10, indicating that the DDR read/write search margin value is set to 10%.

## SEARCH:SEARCH<x>:TRIGger:A:DDRREADWRITE:MAXCAS

This command sets or queries the DDR read/write chip maximum Column Access Strobe (CAS) value.

**Conditions** Requires option 6-DBDDR3.  
Requires a 6 Series MSO instrument.  
Set the DDR Read standard (DDR3 or LPDDR3) before using this command. See Related Commands.  
Set burst detection method as "Chip Select"

**Group** Search and Mark

**Syntax** SEARCH:SEARCH<x>:TRIGger:A:DDRREADWRITE:MAXCAS <NR3>  
SEARCH:SEARCH<x>:TRIGger:A:DDRREADWRITE:MAXCAS?

**Related Commands** [SEARCH:SEARCH<x>:TRIGger:A:DDRREADWRITE:BURSTDETECTmethod](#)

**Arguments** SEARCH<x> specifies the search number.  
NR3 sets the DDR read chip select CAS maximum value.

**Examples** SEARCH:SEARCH1:TRIGger:A:DDRREADWRITE:MAXCAS 3.8E-3 sets the DDR read chip select CAS maximum value to 3.8 milliseconds for search 1.

SEARCH:SEARCH5:TRIGger:A:DDRREADWRITE:MAXCAS? might return  
SEARCH:SEARCH5:TRIGger:A:DDRREADWRITE:MAXCAS 2.1E-3, indicating  
that the DDR read chip select CAS maximum value is set to 2.1 milliseconds  
for search 5.

## SEARCH:SEARCH<x>:TRIGger:A:DDRREADWRITE:MINCas

This command sets or queries the DDR read/write chip minimum Column Access Strobe (CAS) value.

<b>Conditions</b>	Requires option 6-DBDDR3. Requires a 6 Series MSO instrument. Set the DDR Read standard (DDR3 or LPDDR3) before using this command. See Related Commands. Set burst detection method as "Chip Select"
<b>Group</b>	Search and Mark
<b>Syntax</b>	SEARCH:SEARCH<x>:TRIGger:A:DDRREADWRITE:MINCas <NR3> SEARCH:SEARCH<x>:TRIGger:A:DDRREADWRITE:MINCas?
<b>Related Commands</b>	<a href="#">SEARCH:SEARCH&lt;x&gt;:TRIGger:A:DDRREADWRITE:BURSTDETECTmethod</a>
<b>Arguments</b>	SEARCH<x> specifies the search number. NR3 sets the DDR read chip select CAS minimum value.
<b>Examples</b>	SEARCH:SEARCH1:TRIGger:A:DDRREADWRITE:MINCas 3.8E-3 sets the DDR read chip select CAS minimum value to 3.8 milliseconds for search 1. SEARCH:SEARCH5:TRIGger:A:DDRREADWRITE:MINCas? might return SEARCH:SEARCH5:TRIGger:A:DDRREADWRITE:MINCas 2.1E-3, indicating that the DDR read chip select CAS minimum value is set to 2.1 milliseconds for search 5.

## SEARCH:SEARCH<x>:TRIGger:A:DDRREADWRITE:POSTAMBLE:LENGth

This command sets or queries the DDR read/write postamble length when the search type is DDR READWRITE.



<b>Conditions</b>	Requires option 6-DBDDR3. Requires a 6 Series MSO instrument.
<b>Group</b>	Search and Mark
<b>Syntax</b>	SEARCH:SEARCH<x>:TRIGger:A:DDRREADWRITE:POSTAMBLE:LENGTH {500E-3 1.5 1} SEARCH:SEARCH<x>:TRIGger:A:DDRREADWRITE:POSTAMBLE:LENGTH?
<b>Arguments</b>	500E-1.5 sets the postamble length to 1.5 tCK (number of clock cycles). 500E-1 sets the postamble length to 1 tCK (number of clock cycles). 500E-3 sets the postamble length to 0.5 tCK (number of clock cycles).
<b>Examples</b>	SEARCH:SEARCH3:TRIGger:A:DDRREADWRITE:POSTAMBLE:LENGTH 500E-1.5 sets the DDR read/write postamble length for Search 3 to 1.5 tCK.  SEARCH:SEARCH2:TRIGger:A:DDRREADWRITE:POSTAMBLE:LENGTH? might return SEARCH:SEARCH2:TRIGger:A:DDRREADWRITE:POSTAMBLE:LENGTH 500E-1, indicating that the read/write postamble length for Search 2 is set to 1 tCK.

## SEARCH:SEARCH<x>:TRIGger:A:DDRREADWRITE:PREAMBLE:TYPE

This command sets or queries the DDR read/write preamble type when the search type is DDR READWRITE.

<b>Conditions</b>	Requires option 6-DBDDR3. Requires a 6 Series MSO instrument.
<b>Group</b>	Search and Mark
<b>Syntax</b>	SEARCH:SEARCH<x>:TRIGger:A:DDRREADWRITE:PREAMBLE:TYPE {STATIC DYNAMIC} SEARCH:SEARCH<x>:TRIGger:A:DDRREADWRITE:PREAMBLE:TYPE?
<b>Arguments</b>	STATIC sets the DDR Read/Write preamble type to Static. DYNAMIC sets the DDR Read/Write preamble type to Dynamic.

**Examples**     `SEARCH:SEARCH2:TRIGger:A:DDRREADWRITE:PREAMBLE:TYPE STATIC`  
sets the search 2 DDR read preamble type to Static.

`SEARCH:SEARCH5:TRIGger:A:DDRREADWRITE:PREAMBLE:TYPE?` might  
return `SEARCH:SEARCH5:TRIGger:A:DDRREADWRITE:PREAMBLE:TYPE`  
`DYNAMIC`, indicating that the DDR read/write preamble type for Search 5 is set  
to dynamic mode.

## **SEARCH:SEARCH<x>:TRIGger:A:DDRREADWRITE:REFLevel:DATA:HIGH**

This command sets or queries the DDR read/write data high reference level value,  
when the search type is DDR READWRITE.

**Conditions**     Requires option 6-DBDDR3.  
Requires a 6 Series MSO instrument.  
Set the DDR read/write reference level mode to Manual before using this  
command. See Related Commands.

**Group**           Search and Mark

**Syntax**           `SEARCH:SEARCH<x>:TRIGger:A:DDRREADWRITE:REFLevel:DATA:HIGH`  
`<NR3>`  
`SEARCH:SEARCH<x>:TRIGger:A:DDRREADWRITE:REFLevel:DATA:HIGH?`

**Related Commands**     [SEARCH:SEARCH<x>:TRIGger:A:DDRREADWRITE:REFLEVELMode](#)

**Arguments**        NR3 sets the DDR read/write search data high reference value.

**Examples**        `SEARCH:SEARCH2:TRIGger:A:DDRREADWRITE:REFLevel:DATA:HIGH`  
`3.8E-3` sets the DDR read/write search data high reference value.

`SEARCH:SEARCH1:TRIGger:A:DDRREADWRITE:REFLevel:DATA:HIGH?`  
might return  
`SEARCH:SEARCH1:TRIGger:A:DDRREADWRITE:REFLevel:DATA:HIGH`  
`50E-3`, indicating that the DDR read/write search data high reference value is  
set to 50E-3.

## **SEARCH:SEARCH<x>:TRIGger:A:DDRREADWRITE:REFLevel:DATA:LOW**

This command sets or queries the DDR read/write data low reference level value,  
when the search type is DDR READWRITE.

<b>Conditions</b>	<p>Requires option 6-DBDDR3.</p> <p>Requires a 6 Series MSO instrument.</p> <p>Set the DDR read/write reference level mode to Manual before using this command. See Related Commands.</p>
<b>Group</b>	Search and Mark
<b>Syntax</b>	<pre>SEARCH:SEARCH&lt;x&gt;:TRIGger:A:DDRREADWRITE:REFLevel:DATA:LOW &lt;NR3&gt; SEARCH:SEARCH&lt;x&gt;:TRIGger:A:DDRREADWRITE:REFLevel:DATA:LOW?</pre>
<b>Related Commands</b>	<a href="#">SEARCH:SEARCH&lt;x&gt;:TRIGger:A:DDRREADWRITE:REFLEVELMode</a>
<b>Arguments</b>	NR3 sets the DDR read/write search data low reference value.
<b>Examples</b>	<pre>SEARCH:SEARCH2:TRIGger:A:DDRREADWRITE:REFLevel:DATA:LOW 3.8E-3</pre> <p>sets the DDR read/write search data low reference value.</p> <pre>SEARCH:SEARCH1:TRIGger:A:DDRREADWRITE:REFLevel:DATA:LOW? 50E-3</pre> <p>might return SEARCH:SEARCH1:TRIGger:A:DDRREADWRITE:REFLevel:DATA:LOW 50E-3, indicating that the DDR read/write search data low reference value is set to 50E-3.</p>

## SEARCH:SEARCH<x>:TRIGger:A:DDRREADWRITE:REFLevel:DATA:MID

This command sets or queries the DDR read/write data mid reference level value, when the search type is DDR READWRITE.

<b>Conditions</b>	<p>Requires option 6-DBDDR3.</p> <p>Requires a 6 Series MSO instrument.</p> <p>Set the DDR read/write reference level mode to Manual before using this command. See Related Commands.</p>
<b>Group</b>	Search and Mark
<b>Syntax</b>	<pre>SEARCH:SEARCH&lt;x&gt;:TRIGger:A:DDRREADWRITE:REFLevel:DATA:MID &lt;NR3&gt; SEARCH:SEARCH&lt;x&gt;:TRIGger:A:DDRREADWRITE:REFLevel:DATA:MID?</pre>

**Related Commands** [SEARCH:SEARCH<x>:TRIGger:A:DDRREADWRITE:REFLEVELMode](#)

**Arguments** NR3 sets the DDR read/write search data mid reference value.

**Examples** SEARCH:SEARCH2:TRIGger:A:DDRREADWRITE:REFLeve1:DATA:MID 3.8E-3 sets the DDR read/write search data mid reference value.

SEARCH:SEARCH1:TRIGger:A:DDRREAWRITE:REFLeve1:DATA:MID? might return SEARCH:SEARCH1:TRIGger:A:DDRREADWRITE:REFLeve1:DATA:MID 50E-3, indicating that the DDR read/write search data mid reference value is set to 50E-3.

## SEARCH:SEARCH<x>:TRIGger:A:DDRREADWRITE:REFLevel:STROBE:HIGH

This command sets or queries the DDR read/write reference level strobe high value, when the search type is DDR READWRITE.

**Conditions** Requires option 6-DBDDR3.  
Requires a 6 Series MSO instrument.

Set the DDR read/write reference level mode to Manual before using this command. See Related Commands.

**Group** Search and Mark

**Syntax** SEARCH:SEARCH<x>:TRIGger:A:DDRREADWRITE:REFLeve1:STROBE:HIGH <NR3>  
SEARCH:SEARCH<x>:TRIGger:A:DDRREADWRITE:REFLeve1:STROBE:HIGH?

**Related Commands** [SEARCH:SEARCH<x>:TRIGger:A:DDRREADWRITE:REFLEVELMode](#)

**Arguments** NR3 sets the DDR read search strobe high value.

**Examples** SEARCH:SEARCH2:TRIGger:A:DDRREADWRITE:REFLeve1:STROBE:HIGH 3.8E-3 sets the DDR read/write search strobe high value.

SEARCH:SEARCH1:TRIGger:A:DDRREADWRITE:REFLeve1:STROBE:HIGH? might return  
SEARCH:SEARCH1:TRIGger:A:DDRREADWRITE:REFLeve1:STROBE:HIGH 50E-3, indicating that the DDR read/write search strobe high value is set to 50E-3.

**SEARCH:SEARCH<x>:TRIGger:A:DDRREADWRITE:REFLevel:STROBE:LOW**

This command sets or queries the DDR read/write reference level strobe low value, when the search type is DDR READWRITE.

<b>Conditions</b>	Requires option 6-DBDDR3. Requires a 6 Series MSO instrument. Set the DDR read/write reference level mode to Manual before using this command. See Related Commands.
<b>Group</b>	Search and Mark
<b>Syntax</b>	SEARCH:SEARCH<x>:TRIGger:A:DDRREADWRITE:REFLevel:STROBE:LOW <NR3> SEARCH:SEARCH<x>:TRIGger:A:DDRREADWRITE:REFLevel:STROBE:LOW?
<b>Related Commands</b>	<a href="#">SEARCH:SEARCH&lt;x&gt;:TRIGger:A:DDRREADWRITE:REFLEVELMode</a>
<b>Arguments</b>	NR3 sets the DDR read/write search strobe low reference value.
<b>Examples</b>	SEARCH:SEARCH2:TRIGger:A:DDRREADWRITE:REFLevel:STROBE:LOW 3.8E-3 sets the DDR read/write search strobe low reference value.  SEARCH:SEARCH1:TRIGger:A:DDRREADWRITE:REFLevel:STROBE:LOW? might return SEARCH:SEARCH1:TRIGger:A:DDRREADWRITE:REFLevel:STROBE:LOW 50E-3, indicating that the DDR read/write search strobe low reference value is set to 50E-3.

**SEARCH:SEARCH<x>:TRIGger:A:DDRREADWRITE:REFLevel:STROBE:MID**

This command sets or queries the DDR read/write reference level strobe mid value, when the search type is DDR READWRITE.

<b>Conditions</b>	Requires option 6-DBDDR3. Requires a 6 Series MSO instrument. Set the DDR read/write reference level mode to Manual before using this command. See Related Commands.
-------------------	----------------------------------------------------------------------------------------------------------------------------------------------------------------------------

<b>Group</b>	Search and Mark
<b>Syntax</b>	SEARCH:SEARCH<x>:TRIGger:A:DDRREADWRITE:REFLeve1:STROBE:MID <NR3> SEARCH:SEARCH<x>:TRIGger:A:DDRREADWRITE:REFLeve1:STROBE:MID?
<b>Related Commands</b>	<a href="#">SEARCH:SEARCH&lt;x&gt;:TRIGger:A:DDRREADWRITE:REFLEVELMode</a>
<b>Arguments</b>	NR3 sets the DDR read/write search strobe mid reference value.
<b>Examples</b>	SEARCH:SEARCH2:TRIGger:A:DDRREADWRITE:REFLeve1:STROBE:MID 3.8E-3 sets the DDR read/write search strobe mid reference value.  SEARCH:SEARCH1:TRIGger:A:DDRREADWRITE:REFLeve1:STROBE:MID? might return SEARCH:SEARCH1:TRIGger:A:DDRREADWRITE:REFLeve1:STROBE:MID 50E-3, indicating that the DDR read/write search strobe mid reference value is set to 50E-3.

## SEARCH:SEARCH<x>:TRIGger:A:DDRREADWRITE:REFLEVELMode

This command sets or queries the DDR read/write reference level mode to auto or manual, when the search type is DDR READWRITE.

<b>Conditions</b>	Requires option 6-DBDDR3. Requires a 6 Series MSO instrument.
<b>Group</b>	Search and Mark
<b>Syntax</b>	SEARCH:SEARCH<x>:TRIGger:A:DDRREADWRITE:REFLEVELMode {AUTO MANUAL} SEARCH:SEARCH<x>:TRIGger:A:DDRREADWRITE:REFLEVELMode?
<b>Related Commands</b>	<a href="#">SEARCH:SEARCH&lt;x&gt;:TRIGger:A:DDRREAD:REFLevel:DATA:HIGH</a> <a href="#">SEARCH:SEARCH&lt;x&gt;:TRIGger:A:DDRREAD:REFLevel:DATA:LOW</a> <a href="#">SEARCH:SEARCH&lt;x&gt;:TRIGger:A:DDRREAD:REFLevel:DATA:MID</a>

<b>Arguments</b>	AUTO sets the DDR read/write reference level mode to auto.  MANUAL sets the DDR read/write reference level mode to manual. Use the Related Commands to set the Reference levels when in Manual mode.
<b>Examples</b>	SEARCH:SEARCH3:TRIGger:A:DDRREADWRITE:REFLEVELMode MANUAL sets the DDR read/write search reference level mode to Manual for Search 3.  SEARCH:SEARCH1:TRIGger:A:DDRREADWRITE:REFLEVELMode? might return SEARCH:SEARCH1:TRIGger:A:DDRREADWRITE:REFLEVELMode MANUAL, indicating that the DDR read/write search reference level mode set to automatic for Search 1.

## SEARCH:SEARCH<x>:TRIGger:A:DDRREADWRITE:STANdard

This command sets or queries the DDR read/write search standard as DDR3 or LPDDR3.

<b>Conditions</b>	Requires option 6-DBDDR3.  Requires a 6 Series MSO instrument.
<b>Group</b>	Search and Mark
<b>Syntax</b>	SEARCH:SEARCH<x>:TRIGger:A:DDRREADWRITE:STANdard {DDR3 LPDDR3} SEARCH:SEARCH<x>:TRIGger:A:DDRREADWRITE:STANdard?
<b>Arguments</b>	DDR3 sets the DDR read/write search standard as DDR3.  LPDDR3 sets the DDR read/write search standard as LPDDR3.
<b>Examples</b>	SEARCH:SEARCH2:TRIGger:A:DDRREADWRITE:STANdard DDR3 sets the DDR standard to DDR3 for DDR read/write Search 2.  SEARCH:SEARCH2:TRIGger:A:DDRREADWRITE:STANdard? might return SEARCH:SEARCH2:TRIGger:A:DDRREADWRITE:STANdard LPDDR3 indicating that the DDR standard is set to LPDDR3 for DDR read/write Search 2.

## SEARCH:SEARCH<x>:TRIGger:A:DDRREADWRITE:STROBESource

This command sets or queries the DDR readwrite strobe source when the search type is DDR READWRITE.

<b>Conditions</b>	<p>Requires option 6-DBDDR3.</p> <p>Requires a 6 Series MSO instrument.</p> <p>Load a reference waveform on the instrument before using this command to set the search data source to a reference waveform.</p>
<b>Group</b>	Search and Mark
<b>Syntax</b>	<pre>SEARCH:SEARCH&lt;x&gt;:TRIGger:A:DDRREADWRITE:STROBESource {CH&lt;x&gt; CH&lt;x&gt;_D&lt;x&gt; Math&lt;x&gt; REF&lt;x&gt; REF&lt;x&gt;_D&lt;x&gt;} SEARCH:SEARCH&lt;x&gt;:TRIGger:A:DDRREADWRITE:STROBESource?</pre>
<b>Arguments</b>	<p>CH&lt;x&gt; specifies channel &lt;x&gt; as the DDR read/write strobe source for the specified search &lt;x&gt;.</p> <p>CH&lt;x&gt;_D&lt;x&gt; specifies digital waveform &lt;x&gt; of channel &lt;x&gt; as the DDR read/write strobe source for the specified search &lt;x&gt;.</p> <p>Math&lt;x&gt; specifies math waveform &lt;x&gt; as the DDR read/write strobe source for the specified search &lt;x&gt;.</p> <p>REF&lt;x&gt; specifies reference waveform &lt;x&gt; as the DDR read/write strobe source for the specified search &lt;x&gt;.</p> <p>REF&lt;x&gt;_D&lt;x&gt; specifies digital waveform &lt;x&gt; of reference waveform &lt;x&gt; as the DDR read/write strobe source for the specified search &lt;x&gt;.</p>
<b>Examples</b>	<p>SEARCH:SEARCH5:TRIGGER:A:DDRREADWRITE:STROBESource CH8 sets the Search 5 source waveform to Channel 8 for the DDR read/write strobe search.</p> <p>SEARCH:SEARCH1:TRIGGER:A:DDRREADWRITE:STROBESource? might return SEARCH:SEARCH1:TRIGGER:A:DDRREADWRITE:STROBESource CH3, indicating that the Channel 3 waveform is the source for the DDR read/write strobe of Search 1.</p>

## SEARCH:SEARCH<x>:TRIGger:A:DDRREADWRITE:TOLERance

This command sets or queries the DDR read/write logic state tolerance value.

<b>Conditions</b>	<p>Requires option 6-DBDDR3.</p> <p>Requires a 6 Series MSO instrument.</p> <p>Set the DDR Read standard (DDR3 or LPDDR3) before using this command. See Related Commands.</p>
-------------------	--------------------------------------------------------------------------------------------------------------------------------------------------------------------------------



Set burst detection method as "Logic State".

**Group** Search and Mark

**Syntax** SEARCH:SEARCH<x>:TRIGger:A:DDRREADWRITE:TOLERance <NR3>  
SEARCH:SEARCH<x>:TRIGger:A:DDRREADWRITE:TOLERance?

**Related Commands** [SEARCH:SEARCH<x>:TRIGger:A:DDRREADWRITE:BURSTDETECTmethod](#)

**Arguments** SEARCH<x> specifies the search number.  
NR3 sets the logic state tolerance value.

**Examples** SEARCH:SEARCH1:TRIGger:A:DDRREADWRITE:TOLERance 400E-3 sets the DDRREADWRITE logic state tolerance value of search 1 to .004.  
SEARCH:SEARCH3:TRIGger:A:DDRREADWRITE:TOLERance? might return SEARCH:SEARCH3:TRIGger:A:DDRREADWRITE:TOLERance 500E-3, indicating that the DDRREADWRITE logic state tolerance value is set to 500E-3 for search 3.

## SEARCH:SEARCH<x>:TRIGger:A:DDRWRITE:BURSTDETECTmethod

This command sets or queries the DDRWRITE search burst detection method.

**Conditions** Requires option 6-DBDDR3.  
Requires a 6 Series MSO instrument.  
Set the DDR Read standard (DDR3 or LPDDR3) before using this command.  
See Related Commands.

**Group** Search and Mark

**Syntax** SEARCH:SEARCH<x>:TRIGger:A:DDRWRITE:BURSTDETECTmethod  
{DQDQS|Chipselect|LogicState}  
SEARCH:SEARCH<x>:TRIGger:A:DDRWRITE:BURSTDETECTmethod?

**Related Commands** [SEARCH:SEARCH<x>:TRIGger:A:DDRREADWRITE:STANdard](#)

<b>Arguments</b>	DQDQS sets the write burst detection method to DQDQS. ChipSelect sets the write burst detection method to ChipSelect. LogicState sets the write burst detection method to LogicState.
<b>Examples</b>	SEARCH:SEARCH1:TRIGGER:A:DDRWRITE:BURSTDETECTmethod ChipSelect sets the burst detection method as ChipSelect, Latency + DQ/DQS Phase alignment.  SEARCH:SEARCH1:TRIGGER:A:DDRWRITE:BURSTDETECTmethod? might return SEARCH:SEARCH1:TRIGGER:A:DDRWRITE:BURSTDETECTmethod ChipSelect, indicating that the DDR Write burst detection method is ChipSelect.

## SEARCH:SEARCH<x>:TRIGGER:A:DDRWRITE:BURSTLatency

This command sets or queries the DDR write logic state burst latency value.

<b>Conditions</b>	Requires option 6-DBDDR3. Requires a 6 Series MSO instrument. Set the DDR Read standard (DDR3 or LPDDR3) before using this command. See Related Commands. Set burst detection method as "Logic State".
<b>Group</b>	Search and Mark
<b>Syntax</b>	SEARCH:SEARCH<x>:TRIGGER:A:DDRWRITE:BURSTLatency <NR3> SEARCH:SEARCH<x>:TRIGGER:A:DDRWRITE:BURSTLatency?
<b>Related Commands</b>	<a href="#">SEARCH:SEARCH&lt;x&gt;:TRIGGER:A:DDRWRITE:BURSTDETECTmethod</a>
<b>Arguments</b>	SEARCH<x> specifies the search number. NR3 sets the logic state burst latency value.
<b>Examples</b>	SEARCH:SEARCH1:TRIGGER:A:DDRWRITE:BURSTLatency 500E-3 sets the burst latency value of search 1 to .005.  SEARCH:SEARCH3:TRIGGER:A:DDRWRITE:BURSTLatency? might return SEARCH:SEARCH3:TRIGGER:A:DDRWRITE:BURSTLatency 500E-3, indicating that the DDRWRITE logic burst latency value is set to 500E-3 for search 3.

## SEARCH:SEARCH<x>:TRIGger:A:DDRWRITE:BURSTLENGTH

This command sets or queries the DDR write logic state burst length value.

<b>Conditions</b>	<p>Requires option 6-DBDDR3.</p> <p>Requires a 6 Series MSO instrument.</p> <p>Set the DDR Read standard (DDR3 or LPDDR3) before using this command. See Related Commands.</p> <p>Set burst detection method as "Logic State".</p>
<b>Group</b>	Search and Mark
<b>Syntax</b>	<pre>SEARCH:SEARCH&lt;x&gt;:TRIGger:A:DDRWRITE:BURSTLENGTH &lt;NR1&gt; SEARCH:SEARCH&lt;x&gt;:TRIGger:A:DDRWRITE:BURSTLENGTH?</pre>
<b>Related Commands</b>	<a href="#">SEARCH:SEARCH&lt;x&gt;:TRIGger:A:DDRWRITE:BURSTDETECTmethod</a>
<b>Arguments</b>	<p>SEARCH&lt;x&gt; specifies the search number.</p> <p>NR1 sets the logic state burst length value.</p>
<b>Examples</b>	<p>SEARCH:SEARCH3:TRIGger:A:DDRWRITE:BURSTLENGTH 10 sets the DDRWRITE logic state burst length value of search 3 to 10 bursts.</p> <p>SEARCH:SEARCH1:TRIGger:A:DDRWRITE:BURSTLENGTH? might return SEARCH:SEARCH1:TRIGger:A:DDRWRITE:BURSTLENGTH 8, indicating that the DDRWRITE logic state burst length value is set to 8 bursts for search 1.</p>

## SEARCH:SEARCH<x>:TRIGger:A:DDRWRITE:CSActive

This command sets or queries the DDR write chip select active state.

<b>Conditions</b>	<p>Requires option 6-DBDDR3.</p> <p>Requires a 6 Series MSO instrument.</p> <p>Set the DDR Read standard (DDR3 or LPDDR3) before using this command. See Related Commands.</p> <p>Set burst detection method as "Chip Select"</p>
-------------------	-----------------------------------------------------------------------------------------------------------------------------------------------------------------------------------------------------------------------------------

<b>Group</b>	Search and Mark
<b>Syntax</b>	SEARCH:SEARCH<x>:TRIGger:A:DDRWRITE:CSActive {LOW HIGH} SEARCH:SEARCH<x>:TRIGger:A:DDRWRITE:CSActive?
<b>Related Commands</b>	<a href="#">SEARCH:SEARCH&lt;x&gt;:TRIGger:A:DDRWRITE:BURSTDETECTmethod</a>
<b>Arguments</b>	SEARCH<x> specifies the search number. LOW sets the DDR write chip select active state to low. HIGH sets the DDR write chip select active state to high.
<b>Examples</b>	SEARCH:SEARCH2:TRIGger:A:DDRWRITE:CSActive LOW sets the DDRWRITE chip select active state to LOW for search 2. SEARCH:SEARCH4:TRIGger:A:DDRWRITE:CSActive? might return SEARCH:SEARCH4:TRIGger:A:DDRWRITE:CSActive HIGH, indicating the DDRWRITE chip select active state for search 4 is set to HIGH.

## SEARCH:SEARCH<x>:TRIGger:A:DDRWRITE:CSLevel

This command sets or queries the DDR Write chip select level value.

<b>Conditions</b>	Requires option 6-DBDDR3. Requires a 6 Series MSO instrument. Set the DDR Read standard (DDR3 or LPDDR3) before using this command. See Related Commands. Set burst detection method as "Chip Select"
<b>Group</b>	Search and Mark
<b>Syntax</b>	SEARCH:SEARCH<x>:TRIGger:A:DDRWRITE:CSLevel <NR3> SEARCH:SEARCH<x>:TRIGger:A:DDRWRITE:CSLevel?
<b>Related Commands</b>	<a href="#">SEARCH:SEARCH&lt;x&gt;:TRIGger:A:DDRWRITE:BURSTDETECTmethod</a> <a href="#">SEARCH:SEARCH&lt;x&gt;:TRIGger:A:DDRWRITE:CSMode</a>

<b>Arguments</b>	SEARCH<x> specifies the search number. NR3 sets the DDR write chip select level value.
<b>Examples</b>	SEARCH:SEARCH2:TRIGger:A:DDRWRITE:CSLevel 2.8E-3 sets the DDR write chip select level value to 2.8E-3  SEARCH:SEARCH5:TRIGger:A:DDRWRITE:CSLevel? might return SEARCH:SEARCH5:TRIGger:A:DDRWRITE:CSLevel 2.8E-3, indicating the DDR write search chip select level value for search 5 is set to 2.8E-3

## SEARCH:SEARCH<x>:TRIGger:A:DDRWRITE:CSMode

This command sets or queries the DDR Write chip select mode.

<b>Conditions</b>	Requires option 6-DBDDR3. Requires a 6 Series MSO instrument. Set the DDR Read standard (DDR3 or LPDDR3) before using this command. See Related Commands. Set burst detection method as "Chip Select"
<b>Group</b>	Search and Mark
<b>Syntax</b>	SEARCH:SEARCH<x>:TRIGger:A:DDRWRITE:CSMode {Auto Manual} SEARCH:SEARCH<x>:TRIGger:A:DDRWRITE:CSMode?
<b>Related Commands</b>	<a href="#">SEARCH:SEARCH&lt;x&gt;:TRIGger:A:DDRWRITE:BURSTDETECTmethod</a>
<b>Arguments</b>	SEARCH<x> specifies the search number. Auto sets the DDR write chip select mode to auto. Manual sets the DDR write chip select mode to manual. Use the Related Commands to set the Reference levels when in Manual mode.
<b>Examples</b>	SEARCH:SEARCH2:TRIGger:A:DDRWRITE:CSMode MANUAL sets the DDR write search chip select mode to Manual for search 2.  SEARCH:SEARCH3:TRIGger:A:DDRWRITE:CSMode? might return SEARCH:SEARCH3:TRIGger:A:DDRWRITE:CSMode Manual, indicating that the DDR write search 3 chip select mode is set to manual.

## SEARCH:SEARCH<x>:TRIGger:A:DDRWRITE:CSSource

This command sets or queries the DDR Write search chip select source.

<b>Conditions</b>	Requires option 6-DBDDR3. Requires a 6 Series MSO instrument. Set the DDR Read standard (DDR3 or LPDDR3) before using this command. See Related Commands.
<b>Group</b>	Search and Mark
<b>Syntax</b>	SEARCH:SEARCH<x>:TRIGger:A:DDRWRITE:CSSource {S<x>_Ch<x>_D<x> CH<x> CH<x>_D<x> Math<x> REF<x> REF<x>_D<x>} SEARCH:SEARCH<x>:TRIGger:A:DDRWRITE:CSSource?
<b>Related Commands</b>	<a href="#">SEARCH:SEARCH&lt;x&gt;:TRIGger:A:DDRWRITE:BURSTDETECTmethod</a>
<b>Arguments</b>	SEARCH<x> specifies the search number.  S<x>_Ch<x>_D<x> specifies is the remote scope number, the analog channel and the digital channel.  CH<x> specifies channel <x> as the DDR write chip select source for the specified search <x>.  CH<x>_D<x> specifies digital waveform <x> of channel <x> as the DDR write strobe source for the specified search <x>.  Math<x> specifies math waveform <x> as the DDR write chip select source for the specified search <x>.  REF<x> specifies reference waveform <x> as the DDR write chip select source for the specified search <x>.  REF<x>_D<x> specifies digital waveform <x> of reference waveform <x> as the DDR write strobe source for the specified search <x>.
<b>Examples</b>	SEARCH:SEARCH5:TRIGger:A:DDRWRITE:CSSource CH2 sets the search 5 chip select source waveform to CH2 for DDR write search.  SEARCH:SEARCH1:TRIGger:A:DDRWRITE:CSSource? might return SEARCH:SEARCH1:TRIGger:A:DDRWRITE:CSSource CH2, indicating that the Channel 2 waveform is the source for the DDR write chip select source of search 1.

## SEARCH:SEARCH<x>:TRIGger:A:DDRWRITE:DATARate

This command sets or queries the DDR write search data rate for DDR3 and LPDDR3 standards of the specified search.

**Conditions** Requires option 6-DBDDR3.  
Requires a 6 Series MSO instrument.  
Set the DDR Write standard (DDR3 or LPDDR3) before using this command.  
See Related Commands.

**Group** Search and Mark

**Syntax** SEARCH:SEARCH<x>:TRIGger:A:DDRWRITE:DATARate  
{333|800|1066|1200|1333|1466|1600|1866|2133}  
SEARCH:SEARCH<x>:TRIGger:A:DDRWRITE:DATARate?

**Related Commands** [SEARCH:SEARCH<x>:TRIGger:A:DDRWRITE:STANdard](#)

**Arguments** 333–2133 sets the data rate to the specified value.  
The DDR3 standard supports the following data rates:  
800|1066|1333|1600|1866|2133.  
The LPDDR3 standard supports the following data rates:  
333|800|1066|1200|1333|1466|1600|1866|2133.

**Examples** SEARCH:SEARCH2:TRIGger:A:DDRWRITE:DATARate 1333 sets the data rate to 1333 for DDR read Search 2.  
SEARCH:SEARCH7:TRIGger:A:DDRWRITE:DATARate? might return  
SEARCH:SEARCH7:TRIGger:A:DDRWRITE:DATARate 1466 indicating that the data rate for DDR read Search 7 is 1466.

## SEARCH:SEARCH<x>:TRIGger:A:DDRWRITE:DATASource

This command sets or queries the DDR write data source when the search type is DDR Write.

**Conditions** Requires option 6-DBDDR3  
Requires 6 Series MSO instrument

Load a reference waveform on the instrument before using this command to set the search data source to a reference waveform.

**Group** Search and Mark

**Syntax** SEARCH:SEARCH<x>:TRIGger:A:DDRWRITE:DATASource  
 {CH<x>|CH<x>\_D<x>|Math<x>|REF<x>|REF<x>\_D<x>}  
 SEARCH:SEARCH<x>:TRIGger:A:DDRWRITE:DATASource?

**Arguments** CH<x> specifies channel <x> as the DDR write data source for the specified search <x>.

CH<x>\_D<x> specifies digital waveform <x> of channel <x> as the DDR write data source for the specified search <x>.

Math<x> specifies math waveform <x> as the DDR write data source for the specified search <x>.

REF<x> specifies reference waveform <x> as the DDR write data source for the specified search <x>.

REF<x>\_D<x> specifies digital waveform <x> of reference waveform <x> as the DDR write data source for the specified search <x>.

**Examples** SEARCH:SEARCH1:TRIGGER:A:WRITE:DATASource CH2 sets the search 1 source waveform to Channel 2 for the DDR write search.

SEARCH:SEARCH1:TRIGGER:A:DDRWRITE:DATASource? might return SEARCH:SEARCH1:TRIGGER:A:DDRWRITE:DATASource RMATH3, indicating that the Math 1 waveform DDR write trigger data is the source for search 1.

## SEARCH:SEARCH<x>:TRIGger:A:DDRWRITE:HYSteresis

This command sets or queries the DDR write hysteresis reference level value, when the search type is DDR WRITE.

**Conditions** Requires option 6-DBDDR3.

Requires a 6 Series MSO instrument.

Set the DDR write reference level mode to Manual before using this command. See Related Commands.

**Group** Search and Mark



**Syntax** SEARCH:SEARCH<x>:TRIGger:A:DDRWRITE:HYSteresis <NR3>  
SEARCH:SEARCH<x>:TRIGger:A:DDRWRITE:HYSteresis?

**Related Commands** [SEARCH:SEARCH<x>:TRIGger:A:DDRWRITE:REFLEVELMode](#)

**Arguments** NR3 sets the DDR write search hysteresis percent value in the range of 0% to 50%.

**Examples** SEARCH:SEARCH2:TRIGger:A:DDRWRITE:HYSteresis 7 sets the DDR write search hysteresis value to 7%.

SEARCH:SEARCH1:TRIGger:A:DDRWRITE:HYSteresis? might return  
SEARCH:SEARCH1:TRIGger:A:DDRWRITE:HYSteresis 10, indicating that the DDR write search hysteresis value is set to 10%.

## SEARCH:SEARCH<x>:TRIGger:A:DDRWRITE:LOGIC1SOUrce:SYMBol

This command sets or queries the DDR write logic source 1 symbol.

**Conditions** Requires option 6-DBDDR3.

Requires a 6 Series MSO instrument.

Set the DDR Read standard (DDR3 or LPDDR3) before using this command.  
See Related Commands.

Set burst detection method as "Logic State".

**Group** Search and Mark

**Syntax** SEARCH:SEARCH<x>:TRIGger:A:DDRWRITE:LOGIC1SOUrce:SYMBol  
{H|L|X}  
SEARCH:SEARCH<x>:TRIGger:A:DDRWRITE:LOGIC1SOUrce:SYMBol?

**Related Commands** [SEARCH:SEARCH<x>:TRIGger:A:DDRWRITE:BURSTDETECTmethod](#)

**Arguments** SEARCH<x> specifies the search number.

H sets the logic source 1 symbol to H (High).

L sets the logic source 1 symbol to L (Low).

X sets the logic source 1 symbol to X (Don't care).

**Examples** SEARCH:SEARCH3:TRIGger:A:DDRWRITE:LOGIC1SOURCE:SYMBOL X sets the DDRWRITE logic source 1 symbol of search 3 to X (don't care)

SEARCH:SEARCH1:TRIGger:A:DDRWRITE:LOGIC1SOURCE:SYMBOL? might return SEARCH:SEARCH1:TRIGger:A:DDRWRITE:LOGIC1SOURCE:SYMBOL L, indicating that the DDRWRITE logic source 1 symbol is set to Low for search 1.

## SEARCH:SEARCH<x>:TRIGger:A:DDRWRITE:LOGIC2SOURCE:SYMBOL

This command sets or queries the DDR write logic source 2 symbol.

**Conditions** Requires option 6-DBDDR3.  
Requires a 6 Series MSO instrument.  
Set the DDR Read standard (DDR3 or LPDDR3) before using this command. See Related Commands.  
Set burst detection method as "Logic State".

**Group** Search and Mark

**Syntax** SEARCH:SEARCH<x>:TRIGger:A:DDRWRITE:LOGIC2SOURCE:SYMBOL  
{H|L|X}  
SEARCH:SEARCH<x>:TRIGger:A:DDRWRITE:LOGIC2SOURCE:SYMBOL?

**Related Commands** [SEARCH:SEARCH<x>:TRIGger:A:DDRWRITE:BURSTDETECTmethod](#)

**Arguments** SEARCH<x> specifies the search number.  
H sets the logic source 2 symbol to H (High).  
L sets the logic source 2 symbol to L (Low).  
X sets the logic source 2 symbol to X (Don't care).

**Examples** SEARCH:SEARCH3:TRIGger:A:DDRWRITE:LOGIC2SOURCE:SYMBOL X sets the DDRWRITE logic source 2 symbol of search 3 to X (don't care)

SEARCH:SEARCH1:TRIGger:A:DDRWRITE:LOGIC2SOURCE:SYMBOL? might return SEARCH:SEARCH1:TRIGger:A:DDRWRITE:LOGIC2SOURCE:SYMBOL L, indicating that the DDRWRITE logic source 2 symbol is set to Low for search 1.

**SEARCH:SEARCH<x>:TRIGger:A:DDRWRITE:LOGIC3SOUrce:SYMBol**

This command sets or queries the DDR write logic source 3 symbol.

<b>Conditions</b>	<p>Requires option 6-DBDDR3.</p> <p>Requires a 6 Series MSO instrument.</p> <p>Set the DDR Read standard (DDR3 or LPDDR3) before using this command. See Related Commands.</p> <p>Set burst detection method as "Logic State".</p>
<b>Group</b>	Search and Mark
<b>Syntax</b>	<pre>SEARCH:SEARCH&lt;x&gt;:TRIGger:A:DDRWRITE:LOGIC3SOUrce:SYMBol {H L X} SEARCH:SEARCH&lt;x&gt;:TRIGger:A:DDRWRITE:LOGIC3SOUrce:SYMBol?</pre>
<b>Related Commands</b>	<a href="#">SEARCH:SEARCH&lt;x&gt;:TRIGger:A:DDRWRITE:BURSTDETECTmethod</a>
<b>Arguments</b>	<p>SEARCH&lt;x&gt; specifies the search number.</p> <p>H sets the logic source 3 symbol to H (High).</p> <p>L sets the logic source 3 symbol to L (Low).</p> <p>X sets the logic source 3 symbol to X (Don't care).</p>
<b>Examples</b>	<p>SEARCH:SEARCH3:TRIGger:A:DDRWRITE:LOGIC3SOUrce:SYMBol X sets the DDRWRITE logic source 3 symbol of search 3 to X (don't care)</p> <p>SEARCH:SEARCH1:TRIGger:A:DDRWRITE:LOGIC3SOUrce:SYMBol? might return SEARCH:SEARCH1:TRIGger:A:DDRWRITE:LOGIC3SOUrce:SYMBol L, indicating that the DDRWRITE logic source 3 symbol is set to Low for search 1.</p>

**SEARCH:SEARCH<x>:TRIGger:A:DDRWRITE:LOGIC4SOUrce:SYMBol**

This command sets or queries the DDR write logic source 4 symbol.

<b>Conditions</b>	<p>Requires option 6-DBDDR3.</p> <p>Requires a 6 Series MSO instrument.</p> <p>Set the DDR Read standard (DDR3 or LPDDR3) before using this command. See Related Commands.</p>
-------------------	------------------------------------------------------------------------------------------------------------------------------------------------------------------------------------

Set burst detection method as "Logic State".

**Group** Search and Mark

**Syntax** SEARCH:SEARCH<x>:TRIGger:A:DDRWRITE:LOGIC4SOURCE:SYMBOL  
{H|L|X}  
SEARCH:SEARCH<x>:TRIGger:A:DDRWRITE:LOGIC4SOURCE:SYMBOL?

**Related Commands** [SEARCH:SEARCH<x>:TRIGger:A:DDRWRITE:BURSTDETECTmethod](#)

**Arguments** SEARCH<x> specifies the search number.  
H sets the logic source 4 symbol to H (High).  
L sets the logic source 4 symbol to L (Low).  
X sets the logic source 4 symbol to X (Don't care).

**Examples** SEARCH:SEARCH3:TRIGger:A:DDRWRITE:LOGIC4SOURCE:SYMBOL X sets the DDRWRITE logic source 4 symbol of search 3 to X (don't care)  
SEARCH:SEARCH1:TRIGger:A:DDRWRITE:LOGIC4SOURCE:SYMBOL? might return SEARCH:SEARCH1:TRIGger:A:DDRWRITE:LOGIC4SOURCE:SYMBOL L, indicating that the DDRWRITE logic source 4 symbol is set to Low for search 1.

## SEARCH:SEARCH<x>:TRIGger:A:DDRWRITE:MARgin

This command sets or queries the DDR write margin reference level value, when the search type is DDR WRITE.

**Conditions** Requires option 6-DBDDR3.  
Requires a 6 Series MSO instrument.

Set the DDR write reference level mode to Manual before using this command.  
See Related Commands.

**Group** Search and Mark

**Syntax** SEARCH:SEARCH<x>:TRIGger:A:DDRWRITE:MARgin <NR3>  
SEARCH:SEARCH<x>:TRIGger:A:DDRWRITE:MARgin?

**Related Commands** [SEARCH:SEARCH<x>:TRIGger:A:DDRWRITE:REFLEVELMode](#)

**Arguments** NR3 sets the DDR write search margin percent value in the range of 0% to 100%.

**Examples** SEARCH:SEARCH2:TRIGger:A:DDRWRITE:MARGin 11 sets the DDR write search margin value to 11%.

SEARCH:SEARCH1:TRIGger:A:DDRWRITE:MARGin? might return SEARCH:SEARCH1:TRIGger:A:DDRWRITE:MARGin 5, indicating that the DDR write search margin value is set to 5%.

## SEARCH:SEARCH<x>:TRIGger:A:DDRWRITE:MAXCAS

This command sets or queries the DDR write chip select maximum Column Access Strobe (CAS) value.

**Conditions** Requires option 6-DBDDR3.

Requires a 6 Series MSO instrument.

Set the DDR Read standard (DDR3 or LPDDR3) before using this command. See Related Commands.

Set burst detection method as "Chip Select".

**Group** Search and Mark

**Syntax** SEARCH:SEARCH<x>:TRIGger:A:DDRWRITE:MAXCAS <NR3>  
SEARCH:SEARCH<x>:TRIGger:A:DDRWRITE:MAXCAS?

**Related Commands** [SEARCH:SEARCH<x>:TRIGger:A:DDRWRITE:BURSTDETECTmethod](#)

**Arguments** SEARCH<x> specifies the search number.

NR3 sets the DDR write chip select CAS maximum value.

**Examples** SEARCH:SEARCH1:TRIGger:A:DDRWRITE:MAXCAS 3.8E-3 sets the DDR write chip select CAS maximum value to 3.8 milliseconds for search 1.

SEARCH:SEARCH2:TRIGger:A:DDRWRITE:MAXCAS? might return SEARCH:SEARCH2:TRIGger:A:DDRWRITE:MAXCAS 3.8E-3, indicating that the DDR write chip select CAS maximum value is set to 3.8 milliseconds for search 2.

## SEARCH:SEARCH<x>:TRIGger:A:DDRWRITE:MINCas

This command sets or queries the DDR write chip select minimum Column Access Strobe (CAS) value.

**Conditions** Requires option 6-DBDDR3.  
Requires a 6 Series MSO instrument.  
Set the DDR Read standard (DDR3 or LPDDR3) before using this command. See Related Commands.  
Set burst detection method as "Chip Select".

**Group** Search and Mark

**Syntax** SEARCH:SEARCH<x>:TRIGger:A:DDRWRITE:MINCas <NR3>  
SEARCH:SEARCH<x>:TRIGger:A:DDRWRITE:MINCas?

**Related Commands** [SEARCH:SEARCH<x>:TRIGger:A:DDRWRITE:BURSTDETECTmethod](#)

**Arguments** SEARCH<x> specifies the search number.  
NR3 sets the DDR write chip select CAS minimum value.

**Examples** SEARCH:SEARCH1:TRIGger:A:DDRWRITE:MINCas 3.8E-3 sets the DDR write chip select CAS minimum value to 3.8 milliseconds for search 1.  
SEARCH:SEARCH2:TRIGger:A:DDRWRITE:MINCas? might return SEARCH:SEARCH2:TRIGger:A:DDRWRITE:MINCas 3.8E-3, indicating that the DDR write chip select CAS minimum value is set to 3.8 milliseconds for search 2.

## SEARCH:SEARCH<x>:TRIGger:A:DDRWRITE:POSTAMBLE:LENGth

This command sets or queries the DDR write postamble length when the search type is DDR WRITE.

**Conditions** Requires option 6-DBDDR3.  
Requires a 6 Series MSO instrument.

**Group** Search and Mark

<b>Syntax</b>	SEARCH:SEARCH<x>:TRIGger:A:DDRWRITE:POSTAMBLE:LENGTH {500E-3 1.5 1} SEARCH:SEARCH<x>:TRIGger:A:DDRWRITE:POSTAMBLE:LENGTH?
<b>Arguments</b>	500E-1.5 sets the postamble length to 1.5 tCK (number of clock cycles). 500E-1 sets the postamble length to 1 tCK (number of clock cycles). 500E-3 sets the postamble length to 0.5 tCK (number of clock cycles).
<b>Examples</b>	SEARCH:SEARCH6:TRIGger:A:DDRWRITE:POSTAMBLE:LENGTH 500E-3 sets the DDR write postamble length for Search 6 to 0.5 tCK.  SEARCH:SEARCH2:TRIGger:A:DDRWRITE:POSTAMBLE:LENGTH? might return SEARCH:SEARCH2:TRIGger:A:DDRWRITE:POSTAMBLE:LENGTH 500E-1, indicating that the write postamble length for Search 2 is set to 1 tCK.

## SEARCH:SEARCH<x>:TRIGger:A:DDRWRITE:PREAMBLE:TYPE

This command sets or queries the DDR write preamble type when the search type is DDR WRITE.

<b>Conditions</b>	Requires option 6-DBDDR3. Requires a 6 Series MSO instrument.
<b>Group</b>	Search and Mark
<b>Syntax</b>	SEARCH:SEARCH<x>:TRIGger:A:DDRWRITE:PREAMBLE:TYPE {STATIC DYNAMIC} SEARCH:SEARCH<x>:TRIGger:A:DDRWRITE:PREAMBLE:TYPE?
<b>Arguments</b>	STATIC sets the DDR Write preamble type to Static. DYNAMIC sets the DDR Write preamble type to Dynamic.
<b>Examples</b>	SEARCH:SEARCH1:TRIGger:A:DDRWRITE:PREAMBLE:TYPE STATIC sets the DDR write preamble type to Static for Search 1.  SEARCH:SEARCH4:TRIGger:A:DDRWRITE:PREAMBLE:TYPE? might return SEARCH:SEARCH4:TRIGger:A:DDRWRITE:PREAMBLE:TYPE DYNAMIC, indicating that the DDR write preamble type for Search 4 is set to dynamic mode.

## SEARCH:SEARCH<x>:TRIGger:A:DDRWRITE:REFLevel:DATA:HIGh

This command sets or queries the DDR write data high reference level value, when the search type is DDR WRITE.

**Conditions** Requires option 6-DBDDR3.

Requires a 6 Series MSO instrument.

Set the DDR write reference level mode to Manual before using this command. See Related Commands.

**Group** Search and Mark

**Syntax** SEARCH:SEARCH<x>:TRIGger:A:DDRWRITE:REFLevel:DATA:HIGh <NR3>  
SEARCH:SEARCH<x>:TRIGger:A:DDRWRITE:REFLevel:DATA:HIGh?

**Related Commands** [SEARCH:SEARCH<x>:TRIGger:A:DDRWRITE:REFLEVELMode](#)

**Arguments** NR3 sets the DDR read search data high reference value.

**Examples** SEARCH:SEARCH2:TRIGger:A:DDRWRITE:REFLevel:DATA:HIGh 3.8E-3 sets the DDR write search data high reference value.

SEARCH:SEARCH1:TRIGger:A:DDRWRITE:REFLevel:DATA:HIGh? might return SEARCH:SEARCH1:TRIGger:A:DDRWRITE:REFLevel:DATA:HIGh 50E-3, indicating that the DDR write search data high reference value is set to 50E-3.

## SEARCH:SEARCH<x>:TRIGger:A:DDRWRITE:REFLevel:DATA:LOW

This command sets or queries the DDR write data low reference level value, when the search type is DDR WRITE.

**Conditions** Requires option 6-DBDDR3.

Requires a 6 Series MSO instrument.

Set the DDR write reference level mode to Manual before using this command. See Related Commands.

**Group** Search and Mark



**Syntax** SEARCH:SEARCH<x>:TRIGger:A:DDRWRITE:REFLevel:DATA:LOW <NR3>  
SEARCH:SEARCH<x>:TRIGger:A:DDRWRITE:REFLevel:DATA:LOW?

**Related Commands** [SEARCH:SEARCH<x>:TRIGger:A:DDRWRITE:REFLEVELMode](#)

**Arguments** NR3 sets the DDR read search data low reference value.

**Examples** SEARCH:SEARCH2:TRIGger:A:DDRWRITE:REFLevel:DATA:LOW 3.8E-3  
sets the DDR write search data low reference value.

SEARCH:SEARCH1:TRIGger:A:DDRWRITE:REFLevel:DATA:LOW? might  
return SEARCH:SEARCH1:TRIGger:A:DDRWRITE:REFLevel:DATA:LOW  
50E-3, indicating that the DDR write search data low reference value is set to  
50E-3.

## SEARCH:SEARCH<x>:TRIGger:A:DDRWRITE:REFLevel:DATA:MID

This command sets or queries the DDR write data mid reference level value,  
when the search type is DDR WRITE.

**Conditions** Requires option 6-DBDDR3.

Requires a 6 Series MSO instrument.

Set the DDR write reference level mode to Manual before using this command.  
See Related Commands.

**Group** Search and Mark

**Syntax** SEARCH:SEARCH<x>:TRIGger:A:DDRWRITE:REFLevel:DATA:MID <NR3>  
SEARCH:SEARCH<x>:TRIGger:A:DDRWRITE:REFLevel:DATA:MID?

**Related Commands** [SEARCH:SEARCH<x>:TRIGger:A:DDRWRITE:REFLEVELMode](#)

**Arguments** NR3 sets the DDR read search data mid reference value.

**Examples** SEARCH:SEARCH2:TRIGger:A:DDRWRITE:REFLevel:DATA:MID 3.8E-3  
sets the DDR write search data mid reference value.

SEARCH:SEARCH1:TRIGger:A:DDRWRITE:REFLevel:DATA:MID? might  
return SEARCH:SEARCH1:TRIGger:A:DDRWRITE:REFLevel:DATA:MID

50E-3, indicating that the DDR write search data mid reference value is set to 50E-3.

## SEARCH:SEARCH<x>:TRIGger:A:DDRWRITE:REFLevel:STROBE:HIGH

This command sets or queries the DDR write reference level strobe high value, when the search type is DDR WRITE.

**Conditions** Requires option 6-DBDDR3.  
Requires a 6 Series MSO instrument.  
Set the DDR write reference level mode to Manual before using this command. See Related Commands.

**Group** Search and Mark

**Syntax** SEARCH:SEARCH<x>:TRIGger:A:DDRWRITE:REFLevel:STROBE:HIGH  
<NR3>  
SEARCH:SEARCH<x>:TRIGger:A:DDRWRITE:REFLevel:STROBE:HIGH?

**Related Commands** [SEARCH:SEARCH<x>:TRIGger:A:DDRWRITE:REFLEVELMode](#)

**Arguments** NR3 sets the DDR write search strobe high value.

**Examples** SEARCH:SEARCH2:TRIGger:A:DDRWRITE:REFLevel:STROBE:HIGH  
3.8E-3 sets the DDR write search strobe high value.  
SEARCH:SEARCH1:TRIGger:A:DDRWRITE:REFLevel:STROBE:HIGH? might  
return SEARCH:SEARCH1:TRIGger:A:DDRWRITE:REFLevel:STROBE:HIGH  
50E-3, indicating that the DDR write search strobe high value is set to 50E-3.

## SEARCH:SEARCH<x>:TRIGger:A:DDRWRITE:REFLevel:STROBE:LOW

This command sets or queries the DDR write reference level strobe low value, when the search type is DDR WRITE.

**Conditions** Requires option 6-DBDDR3.  
Requires a 6 Series MSO instrument.  
Set the DDR write reference level mode to Manual before using this command. See Related Commands.

**Group** Search and Mark

**Syntax** SEARCH:SEARCH<x>:TRIGger:A:DDRWRITE:REFLeve1:STROBE:LOW  
<NR3>  
SEARCH:SEARCH<x>:TRIGger:A:DDRWRITE:REFLeve1:STROBE:LOW?

**Related Commands** [SEARCH:SEARCH<x>:TRIGger:A:DDRWRITE:REFLEVELMode](#)

**Arguments** NR3 sets the DDR read search strobe low reference value.

**Examples** SEARCH:SEARCH2:TRIGger:A:DDRWRITE:REFLeve1:STROBE:LOW 3.8E-3  
sets the DDR write search strobe low reference value.

SEARCH:SEARCH1:TRIGger:A:DDRWRITE:REFLeve1:STROBE:LOW? might  
return SEARCH:SEARCH1:TRIGger:A:DDRWRITE:REFLeve1:STROBE:LOW  
50E-3, indicating that the DDR write search strobe low reference value is set  
to 50E-3.

## SEARCH:SEARCH<x>:TRIGger:A:DDRWRITE:REFLeve1:STROBE:MID

This command sets or queries the DDR write reference level strobe mid value, when the search type is DDR WRITE.

**Conditions** Requires option 6-DBDDR3.  
Requires a 6 Series MSO instrument.  
Set the DDR write reference level mode to Manual before using this command.  
See Related Commands.

**Group** Search and Mark

**Syntax** SEARCH:SEARCH<x>:TRIGger:A:DDRWRITE:REFLeve1:STROBE:MID  
<NR3>  
SEARCH:SEARCH<x>:TRIGger:A:DDRWRITE:REFLeve1:STROBE:MID?

**Related Commands** [SEARCH:SEARCH<x>:TRIGger:A:DDRWRITE:REFLEVELMode](#)

**Arguments** NR3 sets the DDR read search strobe mid reference value.

**Examples**     `SEARCH:SEARCH2:TRIGger:A:DDRWRITE:REFLeve1:STROBE:MID 3.8E-3`  
sets the DDR write search strobe mid reference value.

`SEARCH:SEARCH1:TRIGger:A:DDRWRITE:REFLeve1:STROBE:MID?` might  
return `SEARCH:SEARCH1:TRIGger:A:DDRWRITE:REFLeve1:STROBE:MID`  
`50E-3`, indicating that the DDR write search strobe mid reference value is set  
to `50E-3`.

## **SEARCH:SEARCH<x>:TRIGger:A:DDRWRITE:REFLEVELMode**

This command sets or queries the DDR write reference level mode to auto or manual, when the search type is DDR WRITE.

**Conditions**     Requires option 6-DBDDR3.  
Requires a 6 Series MSO instrument.

**Group**     Search and Mark

**Syntax**     `SEARCH:SEARCH<x>:TRIGger:A:DDRWRITE:REFLEVELMode`  
`{AUTO|MANUAL}`  
`SEARCH:SEARCH<x>:TRIGger:A:DDRWRITE:REFLEVELMode?`

**Related Commands**     [SEARCH:SEARCH<x>:TRIGger:A:DDRREAD:REFLevel:DATA:HIGH](#)  
[SEARCH:SEARCH<x>:TRIGger:A:DDRREAD:REFLevel:DATA:LOW](#)  
[SEARCH:SEARCH<x>:TRIGger:A:DDRREAD:REFLevel:DATA:MID](#)

**Arguments**     `AUTO` sets the DDR write reference level mode to auto.  
`MANUAL` sets the DDR write reference level mode to manual. Use the Related  
Commands to set the Reference levels when in Manual mode.

**Examples**     `SEARCH:SEARCH3:TRIGger:A:DDRWRITE:REFLEVELMode MANUAL` sets the  
DDR write search reference level mode to Manual for Search 3.

`SEARCH:SEARCH1:TRIGger:A:DDRWRITE:REFLEVELMode?` might return  
`SEARCH:SEARCH1:TRIGger:A:DDRWRITE:REFLEVELMode MANUAL`,  
indicating that the DDR write search reference level mode set to automatic for  
Search 1.

## SEARCH:SEARCH<x>:TRIGger:A:DDRWRITE:STANdard

This command sets or queries the DDR write search standard as DDR3 or LPDDR3.

<b>Conditions</b>	Requires option 6-DBDDR3 Requires 6 Series MSO instrument
<b>Group</b>	Search and Mark
<b>Syntax</b>	SEARCH:SEARCH<x>:TRIGger:A:DDRWRITE:STANdard {DDR3 LPDDR3} SEARCH:SEARCH<x>:TRIGger:A:DDRWRITE:STANdard?
<b>Arguments</b>	DDR3 sets the DDR write search standard as DDR3. LPDDR3 sets the DDR write search standard as LPDDR3.
<b>Examples</b>	SEARCH:SEARCH2:TRIGger:A:DDRWRITE:STANdard DDR3 sets the DDR standard to DDR3 for DDR write Search 2.  SEARCH:SEARCH5:TRIGger:A:DDRWRITE:STANdard? might return SEARCH:SEARCH5:TRIGger:A:DDRWRITE:STANdard LPDDR3 indicating that the DDR standard is set to LPDDR3 for DDR write Search 5.

## SEARCH:SEARCH<x>:TRIGger:A:DDRWRITE:STROBESource

This command sets or queries the DDR write strobe source when the search type is DDR Write.

<b>Conditions</b>	Requires option 6-DBDDR3 Requires 6 Series MSO instrument  Load a reference waveform on the instrument before using this command to set the search data source to a reference waveform.
<b>Group</b>	Search and Mark
<b>Syntax</b>	SEARCH:SEARCH<x>:TRIGger:A:DDRWRITE:STROBESource {CH<x> CH<x>_D<x> Math<x> REF<x> REF<x>_D<x>} SEARCH:SEARCH<x>:TRIGger:A:DDRWRITE:STROBESource?

**Arguments**

CH<x> specifies channel <x> as the DDR write strobe source for the specified search <x>.

CH<x>\_D<x> specifies digital waveform <x> of channel <x> as the DDR write strobe source for the specified search <x>.

Math<x> specifies math waveform <x> as the DDR write strobe source for the specified search <x>.

REF<x> specifies reference waveform <x> as the DDR write strobe source for the specified search <x>.

REF<x>\_D<x> specifies digital waveform <x> of reference waveform <x> as the DDR write strobe source for the specified search <x>.

**Examples**

SEARCH:SEARCH2:TRIGGER:A:DDRWRITE:STROBESource MATH4 sets the Search 2 source waveform to Math 4 for the DDR write strobe search.

SEARCH:SEARCH1:TRIGGER:A:DDRWRITE:STROBESource? might return SEARCH:SEARCH1:TRIGGER:A:DDRWRITE:STROBESource CH3, indicating that the Channel 3 waveform is the source for the DDR write strobe of Search 1.

## SEARCH:SEARCH<x>:TRIGger:A:DDRWRITE:TOLERance

This command sets or queries the DDR write logic state tolerance value.

**Conditions**

Requires option 6-DBDDR3.

Requires a 6 Series MSO instrument.

Set the DDR Read standard (DDR3 or LPDDR3) before using this command. See Related Commands.

Set burst detection method as "Logic State".

**Group** Search and Mark

**Syntax**

SEARCH:SEARCH<x>:TRIGger:A:DDRWRITE:TOLERance <NR3>  
SEARCH:SEARCH<x>:TRIGger:A:DDRWRITE:TOLERance?

**Related Commands** [SEARCH:SEARCH<x>:TRIGger:A:DDRWRITE:BURSTDETECTmethod](#)

**Arguments**

SEARCH<x> specifies the search number.

NR3 sets the logic state tolerance value.

- Examples**    `SEARCH:SEARCH3:TRIGger:A:DDRWRITE:TOLERance 400E-3` sets the DDRWRITE logic state tolerance value of search 3 to .004.
- `SEARCH:SEARCH1:TRIGger:A:DDRWRITE:TOLERance?` might return `SEARCH:SEARCH1:TRIGger:A:DDRWRITE:TOLERance 500E-3`, indicating that the DDRWRITE logic state tolerance value is set to 500E-3 for search 1.

## SEARCH:SEARCH<x>:TRIGger:A:EDGE:SLOpe

This command sets or queries the slope for an edge trigger search to determine where to place a mark. The search number is specified by x.

- Group**    Search and Mark
- Syntax**    `SEARCH:SEARCH<x>:TRIGger:A:EDGE:SLOpe {RISe|FALL|EITHer}`  
`SEARCH:SEARCH<x>:TRIGger:A:EDGE:SLOpe?`
- Arguments**    `RISe` specifies a rising edge.  
`FALL` specifies a falling edge.  
`EITHer` specifies either rising or falling edge.
- Examples**    `SEARCH:SEARCH1:TRIGGER:A:EDGE:SLOPE RISE` sets the slope for search 1 to rise.
- `SEARCH:SEARCH1:TRIGGER:A:EDGE:SLOPE?` might return `SEARCH:SEARCH1:TRIGGER:A:EDGE:SLOPE RISE`, indicating that the slope for the trigger for search 1 is rise.

## SEARCH:SEARCH<x>:TRIGger:A:EDGE:SOUrce

This command sets or queries the source waveform for an edge trigger search to determine where to place a mark. The search number is specified by x.

- Group**    Search and Mark
- Syntax**    `SEARCH:SEARCH<x>:TRIGger:A:EDGE:SOUrce`  
`{S<x>_Ch<x>_D<x>|CH<x>|CH<x>_D<x>|MATH<x>|REF<x>|REF<x>_D<x>}`  
`SEARCH:SEARCH<x>:TRIGger:A:EDGE:SOUrce?`

**Arguments** S<x>\_Ch<x>\_D<x> specifies is the remote scope number, the analog channel and the digital channel.

CH<x> specifies one input channel as the source, where the channel number is specified by x.

CH<x>\_D<x> specifies a digital reference waveform as the source waveform for the specified search.

MATH<x> specifies the math waveform as the search source, where the math number is specified by x.

REF<x> specifies the reference waveform as the search source, where the reference number is specified by x.

REF<x>\_D<x> specifies a digital reference waveform as the source waveform for the specified search.

**Examples** SEARCH:SEARCH1:TRIGGER:A:EDGE:SOURCE CH2 sets the source waveform for the A trigger to Channel 2.

SEARCH:SEARCH1:TRIGGER:A:EDGE:SOURCE? might return  
SEARCH:SEARCH1:TRIGGER:A:EDGE:SOURCE CH2, indicating that the Channel 2 edge trigger is the source for search 1.

## SEARCH:SEARCH<x>:TRIGger:A:EDGE:THReshold

This command sets or queries the source threshold level for an edge trigger search to determine where to place a mark. The search number is specified by x.

**Group** Search and Mark

**Syntax** SEARCH:SEARCH<x>:TRIGger:A:EDGE:THReshold <NR3>  
SEARCH:SEARCH<x>:TRIGger:A:EDGE:THReshold?

**Arguments** <NR3> is the source threshold level for an edge trigger search.

**Examples** SEARCH:SEARCH1:TRIGger:A:EDGE:THReshold 50.0e-3 sets the threshold to 50 mV.

SEARCH:SEARCH1:TRIGger:A:EDGE:THReshold? might return  
SEARCH:SEARCH1:TRIGGER:A:EDGE:THRESHOLD 0.0E+0 indicating the threshold is 0.0 V.



## SEARCH:SEARCH<x>:TRIGger:A:LOGIc:CLOCK:THReshold

This command sets or queries the logic clock threshold for a logic trigger search to determine where to place a mark. The search number is specified by x.

<b>Group</b>	Search and Mark
<b>Syntax</b>	SEARCH:SEARCH<x>:TRIGger:A:LOGIc:CLOCK:THReshold <NR3> SEARCH:SEARCH<x>:TRIGger:A:LOGIc:CLOCK:THReshold?
<b>Arguments</b>	<NR3> is the logic clock threshold.
<b>Examples</b>	SEARCH:SEARCH1:TRIGger:A:LOGIc:CLOCK:THReshold 50.0e-3 sets the threshold to 50 mV.  SEARCH:SEARCH1:TRIGger:A:LOGIc:CLOCK:THReshold? might return SEARCH:SEARCH1:TRIGGER:A:LOGIC:CLOCK:THRESHOLD 0.0E+0 indicating the threshold is set to 0.0 V.

## SEARCH:SEARCH<x>:TRIGger:A:LOGIc:DELTAtime

This command specifies the Logic search delta time value. The time value is used as part of the Logic search condition to determine if the duration of a logic pattern meets the specified time constraints. The search number is specified by x.

<b>Group</b>	Search and Mark
<b>Syntax</b>	SEARCH:SEARCH<x>:TRIGger:A:LOGIc:DELTAtime <NR3> SEARCH:SEARCH<x>:TRIGger:A:LOGIc:DELTAtime?
<b>Arguments</b>	<NR3> is delta time value.
<b>Examples</b>	SEARCH:SEARCH1:TRIGger:A:LOGIc:DELTAtime 1.5e-9 sets the delta time to 1.5 ns.  SEARCH:SEARCH1:TRIGger:A:LOGIc:DELTAtime? might return SEARCH:SEARCH1:TRIGGER:A:LOGIC:DELTAIME 1.0000E-9 indicating the delta time is 1.0 ns.

## SEARCH:SEARCH<x>:TRIGger:A:LOGic:FUNCTion

This command sets or queries the logic operator for a pattern or state trigger search to determine where to place a mark. The search number is specified by x.

<b>Group</b>	Search and Mark
<b>Syntax</b>	SEARCH:SEARCH<x>:TRIGger:A:LOGic:FUNCTion {AND NAND NOR OR} SEARCH:SEARCH<x>:TRIGger:A:LOGic:FUNCTion?
<b>Arguments</b>	AND places a mark if all conditions are true. NAND places a mark if any of the conditions are false. NOR places a mark if all conditions are false. OR places a mark if any of the conditions are true.
<b>Examples</b>	SEARCH:SEARCH1:TRIGGER:A:LOGIC:FUNCTION AND sets the trigger a logic function for search 1 to AND.  SEARCH:SEARCH1:TRIGGER:A:LOGIC:FUNCTION? might return SEARCH:SEARCH1:TRIGGER:A:LOGIC:FUNCTION NOR, indicating that the logic function for search 1 is set to NOR.

## SEARCH:SEARCH<x>:TRIGger:A:LOGic:INPUT:CLOCK:SOURce

This command specifies or queries the channel to use as the clock source for logic trigger. The search number is specified by x.

<b>Group</b>	Search and Mark
<b>Syntax</b>	SEARCH:SEARCH<x>:TRIGger:A:LOGic:INPUT:CLOCK:SOURce {S<x>_Ch<x>_D CH<x> CH<x>_D<x> REF<x>_D<x>} SEARCH:SEARCH<x>:TRIGger:A:LOGic:INPUT:CLOCK:SOURce?
<b>Arguments</b>	S<x>_Ch<x>_D<x> specifies is the remote scope number, the analog channel and the digital channel.  CH<x> specifies one input channel as the source, where the channel number is specified by x.  CH<x>_D<x> specifies a digital reference waveform as the source waveform for the specified search.

REF<x>\_D<x> specifies a digital reference waveform as the source waveform for the specified search.

**Examples** SEARCH:SEARCH1:TRIGger:A:LOGic:INPUT:CLOCK:SOURce CH2 sets the clock source to channel 2.

SEARCH:SEARCH1:TRIGger:A:LOGic:INPUT:CLOCK:SOURce? might return SEARCH:SEARCH1:TRIGGER:A:LOGIC:INPUT:CLOCK:SOURCE UNDEFINED indicating the clock source is not defined.

## SEARCH:SEARCH<x>:TRIGger:A:LOGic:LEVel:CH<x>

This command sets or queries the voltage level to use for logic trigger search. The search number is specified by x.

**Group** Search and Mark

**Syntax** SEARCH:SEARCH<x>:TRIGger:A:LOGic:LEVel:CH<x> <NR3>  
SEARCH:SEARCH<x>:TRIGger:A:LOGic:LEVel:CH<x>?

**Arguments** <NR3> is the voltage level to use for logic trigger search.

**Examples** SEARCH:SEARCH1:TRIGger:A:LOGic:LEVel:CH2 50.0e-3 sets the level to 50 mV.

SEARCH:SEARCH1:TRIGger:A:LOGic:LEVel:CH2? might return SEARCH:SEARCH1:TRIGGER:A:LOGIC:LEVEL:CH2 0.0E+0 indicating the level is set to 0.0 V.

## SEARCH:SEARCH<x>:TRIGger:A:LOGic:LEVel:MATH<x>

This command sets the voltage level to use for logic trigger search. The search number is specified by x.

**Group** Search and Mark

**Syntax** SEARCH:SEARCH<x>:TRIGger:A:LOGic:LEVel:MATH<x> <NR3>  
SEARCH:SEARCH<x>:TRIGger:A:LOGic:LEVel:MATH<x>?

**Arguments** <NR3> is the voltage level to use for logic trigger search.

**Examples** SEARCH:SEARCH1:TRIGger:A:LOGic:LEVe1:MATH1 50.0e-3 sets the level to 50.0 mV.

SEARCH:SEARCH1:TRIGger:A:LOGic:LEVe1:MATH1? might return SEARCH:SEARCH1:TRIGGER:A:LOGIC:LEVEL:MATH1 0.0E+0 indicating the level is set to 0.0 V.

## SEARCH:SEARCH<x>:TRIGger:A:LOGic:LEVe1:REF<x>

This command sets the voltage level to use for logic trigger search. The search number is specified by x.

**Group** Search and Mark

**Syntax** SEARCH:SEARCH<x>:TRIGger:A:LOGic:LEVe1:REF<x> <NR3>  
SEARCH:SEARCH<x>:TRIGger:A:LOGic:LEVe1:REF<x>?

**Arguments** <NR3> is the voltage level to use for logic trigger search.

**Examples** SEARCH:SEARCH1:TRIGger:A:LOGic:LEVe1:REF1 50.0e-3 sets the level to 50.0 mV.

SEARCH:SEARCH1:TRIGger:A:LOGic:LEVe1:REF1? might return SEARCH:SEARCH1:TRIGGER:A:LOGIC:LEVEL:REF1 0.0E+0 indicating the level is set to 0.0 V.

## SEARCH:SEARCH<x>:TRIGger:A:LOGic:LOGICPattern:CH<x>

This command sets or queries the conditions used for generating an A logic pattern, with respect to the defined input pattern, and identifies the time that the selected pattern may be true and still generate the trigger. The search number is specified by x.

**Group** Search and Mark

**Syntax** SEARCH:SEARCH<x>:TRIGger:A:LOGic:LOGICPattern:CH<x> {H|L|X}  
SEARCH:SEARCH<x>:TRIGger:A:LOGic:LOGICPattern:CH<x>?

**Arguments** H specifies triggering when the pattern is high.  
L specifies triggering when the pattern is low.

X specifies triggering when the pattern is high or low.

**Examples**     `SEARCH:SEARCH1:TRIGGER:A:LOGIC:LOGICPattern:CH2 H` sets the channel 2 pattern to a high.

`SEARCH:SEARCH1:TRIGGER:A:LOGIC:LOGICPattern:CH2?` might return `SEARCH:SEARCH1:TRIGGER:A:LOGIC:LOGICPATTERN:CH2 X` indicating channel 2 is a don't care.

## **SEARCH:SEARCH<x>:TRIGGER:A:LOGIC:LOGICPattern:CH<x>\_D<x>**

This command sets or queries the conditions used for generating an A logic pattern, with respect to the defined input pattern, and identifies the time that the selected pattern may be true and still generate the trigger. The search number is specified by x.

**Group**     Search and Mark

**Syntax**     `SEARCH:SEARCH<x>:TRIGGER:A:LOGIC:LOGICPattern:CH<x>_D<x>`  
                   {H|L|X}  
                   `SEARCH:SEARCH<x>:TRIGGER:A:LOGIC:LOGICPattern:CH<x>_D<x>?`

**Arguments**     H specifies triggering when the pattern is high.  
                   L specifies triggering when the pattern is low.  
                   X specifies triggering when the pattern is high or low.

**Examples**     `SEARCH:SEARCH1:TRIGGER:A:LOGIC:LOGICPattern:CH1_D1 H` sets the channel patter to a high.

`SEARCH:SEARCH1:TRIGGER:A:LOGIC:LOGICPattern:CH1_D1?` might return `SEARCH:SEARCH1:TRIGGER:A:LOGIC:LOGICPATTERN:CH1_D1 X` indicating the channel patter is a don't care.

## **SEARCH:SEARCH<x>:TRIGGER:A:LOGIC:LOGICPattern:MATH<x>**

This command sets or queries the conditions used for generating an A logic pattern, with respect to the defined input pattern, and identifies the time that the selected pattern may be true and still generate the trigger. The search number is specified by x.

**Group**     Search and Mark

**Syntax** SEARCH:SEARCH<x>:TRIGger:A:LOGic:LOGICPattern:MATH<x>  
 {H|L|X}  
 SEARCH:SEARCH<x>:TRIGger:A:LOGic:LOGICPattern:MATH<x>?

**Arguments** H specifies triggering when the pattern is high.  
 L specifies triggering when the pattern is low.  
 X specifies triggering when the pattern is high or low.

**Examples** SEARCH:SEARCH1:TRIGger:A:LOGic:LOGICPattern:MATH1 H sets the pattern to a high.  
 SEARCH:SEARCH1:TRIGger:A:LOGic:LOGICPattern:MATH1? might return  
 SEARCH:SEARCH1:TRIGGER:A:LOGIC:LOGICPATTERN:MATH1 X indicating the pattern is a don't care.

## SEARCH:SEARCH<x>:TRIGger:A:LOGic:LOGICPattern:REF<x>

This command sets or queries the conditions used for generating an A logic pattern, with respect to the defined input pattern, and identifies the time that the selected pattern may be true and still generate the trigger. The search number is specified by x.

**Group** Search and Mark

**Syntax** SEARCH:SEARCH<x>:TRIGger:A:LOGic:LOGICPattern:REF<x> {H|L|X}  
 SEARCH:SEARCH<x>:TRIGger:A:LOGic:LOGICPattern:REF<x>?

**Arguments** H specifies triggering when the pattern is high.  
 L specifies triggering when the pattern is low.  
 X specifies triggering when the pattern is high or low.

**Examples** SEARCH:SEARCH1:TRIGger:A:LOGic:LOGICPattern:REF1 H sets the pattern to a high.  
 SEARCH:SEARCH1:TRIGger:A:LOGic:LOGICPattern:REF1? might return  
 SEARCH:SEARCH1:TRIGGER:A:LOGIC:LOGICPATTERN:REF1 X indicating the pattern is a don't care.

## SEARCH:SEARCH<x>:TRIGger:A:LOGIc:POLarity

This command sets or queries the polarity for the clock channel when Use Clock Edge is set to Yes for Logic search type. The search number is specified by x.

<b>Group</b>	Search and Mark
<b>Syntax</b>	SEARCH:SEARCH<x>:TRIGger:A:LOGIc:POLarity {POSitive NEGative EITHer} SEARCH:SEARCH<x>:TRIGger:A:LOGIc:POLarity?
<b>Arguments</b>	POSitive specifies using the positive clock edge. NEGative specifies using negative clock edge. EITHer specifies using either the positive or negative clock edge.
<b>Examples</b>	SEARCH:SEARCH1:TRIGger:A:LOGIc:POLarity NEGATIVE sets the polarity to negative.  SEARCH:SEARCH1:TRIGger:A:LOGIc:POLarity? might return SEARCH:SEARCH1:TRIGGER:A:LOGIC:POLARITY POSITIVE indicating the polarity is set to positive.

## SEARCH:SEARCH<x>:TRIGger:A:LOGIc:USEClOCKedge

This command specifies whether or not Logic search uses a clock source. The search number is specified by x.

<b>Group</b>	Search and Mark
<b>Syntax</b>	SEARCH:SEARCH<x>:TRIGger:A:LOGIc:USEClOCKedge {OFF ON 0 1} SEARCH:SEARCH<x>:TRIGger:A:LOGIc:USEClOCKedge?
<b>Arguments</b>	OFF specifies not to use the clock source. ON specifies to use the clock source. 0 specifies not to use the clock source. 1 specifies to use the clock source.
<b>Examples</b>	SEARCH:SEARCH1:TRIGger:A:LOGIc:USEClOCKedge ON specifies to use the clock source.

SEARCH:SEARCH1:TRIGGER:A:LOGIC:USECLOCKEDGE? might return  
SEARCH:SEARCH1:TRIGGER:A:LOGIC:USECLOCKEDGE 0 indicating not to use  
the clock source.

## SEARCH:SEARCH<x>:TRIGGER:A:LOGIC:WHEN

This command sets or queries the condition for generating an A or B logic search with respect to the defined input pattern.

**Group** Search and Mark

**Syntax** SEARCH:SEARCH<x>:TRIGGER:A:LOGIC:WHEN  
{TRUE|FALSE|MOREthan|LESSThan|EQUAL|UNEQUAL}  
SEARCH:SEARCH<x>:TRIGGER:A:LOGIC:WHEN?

**Arguments** TRUE searches on an input value that is true.  
FALSE searches on an input value that is false.  
MOREthan searches on an input value that is greater than a set value.  
LESSThan searches on an input value that is less than a set value.  
EQUAL searches on an input value that is equal to a set value.  
UNEQUAL searches on an input value that is not equal to a set value.

**Examples** SEARCH:SEARCH1:TRIGGER:A:LOGIC:WHEN FALSE specifies a search on an input value that is false.  
SEARCH:SEARCH1:TRIGGER:A:LOGIC:WHEN? might return  
SEARCH:SEARCH1:TRIGGER:A:LOGIC:WHEN TRUE indicating a search on an input value that is true.

## SEARCH:SEARCH<x>:TRIGGER:A:PULSEWIDTH:HIGHLIMIT

This command specifies the upper limit to use, in seconds, when searching for a pulse whose duration is inside or outside a range of two values. The search number is specified by x.

**Group** Search and Mark

**Syntax** SEARCH:SEARCH<x>:TRIGGER:A:PULSEWIDTH:HIGHLIMIT <NR3>  
SEARCH:SEARCH<x>:TRIGGER:A:PULSEWIDTH:HIGHLIMIT?



<b>Arguments</b>	<NR3> is the upper limit to use, in seconds, when searching for a pulse.
<b>Examples</b>	SEARCH:SEARCH1:TRIGger:A:PULSEwidth:HIGHLimit 2.5e-9 sets the high limit to 2.5 ns.  SEARCH:SEARCH1:TRIGger:A:PULSEwidth:HIGHLimit? might return SEARCH:SEARCH1:TRIGGER:A:PULSEWIDTH:HIGHLIMIT 2.0000E-9 indicating the pulse width high limit is 2.0 ns.

## SEARCH:SEARCH<x>:TRIGger:A:PULSEwidth:LOGICQUALification

This command specifies whether or not to use logic qualification for a pulse width search. The search number is specified by x.

<b>Group</b>	Search and Mark
<b>Syntax</b>	SEARCH:SEARCH<x>:TRIGger:A:PULSEwidth:LOGICQUALification {ON OFF} SEARCH:SEARCH<x>:TRIGger:A:PULSEwidth:LOGICQUALification?
<b>Arguments</b>	ON specifies to use logic qualification.  OFF specifies not to use logic qualification.
<b>Examples</b>	SEARCH:SEARCH1:TRIGger:A:PULSEwidth:LOGICQUALification ON turns on logic qualification.  SEARCH:SEARCH1:TRIGger:A:PULSEwidth:LOGICQUALification? might return SEARCH:SEARCH1:TRIGGER:A:PULSEWIDTH:LOGICQUALIFICATION OFF indicating logic qualification is off.

## SEARCH:SEARCH<x>:TRIGger:A:PULSEwidth:LOWLimit

This command specifies the lower limit to use, in seconds, when searching for a pulse whose duration is inside or outside a range of two values. The search number is specified by x.

<b>Group</b>	Search and Mark
<b>Syntax</b>	SEARCH:SEARCH<x>:TRIGger:A:PULSEwidth:LOWLimit <NR3> SEARCH:SEARCH<x>:TRIGger:A:PULSEwidth:LOWLimit?

- Arguments** <NR3> is the lower limit to use, in seconds, when searching for a pulse.
- Examples** SEARCH:SEARCH1:TRIGger:A:PULSEwidth:LOWLimit 0.5e-9 sets the low limit to 0.5 ns.
- SEARCH:SEARCH1:TRIGger:A:PULSEwidth:LOWLimit? might return  
SEARCH:SEARCH1:TRIGGER:A:PULSEWIDTH:LOWLIMIT 1.0000E-9  
indicating the low limit is 2.0 ns.

## SEARCH:SEARCH<x>:TRIGger:A:PULSEwidth:POLarity

This command specifies the polarity for a pulse width search. The search number is specified by x.

- Group** Search and Mark
- Syntax** SEARCH:SEARCH<x>:TRIGger:A:PULSEwidth:POLarity  
{POSitive|NEGative}  
SEARCH:SEARCH<x>:TRIGger:A:PULSEwidth:POLarity?
- Arguments** POSitive specifies positive polarity for a pulse width search.  
NEGative specifies negative polarity for a pulse width search.
- Examples** SEARCH:SEARCH1:TRIGger:A:PULSEwidth:POLarity NEGATIVE sets the polarity to negative.
- SEARCH:SEARCH1:TRIGger:A:PULSEwidth:POLarity? might return  
SEARCH:SEARCH1:TRIGGER:A:PULSEWIDTH:POLARITY POSITIVE  
indicating the polarity is positive.

## SEARCH:SEARCH<x>:TRIGger:A:PULSEwidth:SOURce

This command sets and queries the source for the pulse width search input. The search number is specified by x.

- Group** Search and Mark
- Syntax** SEARCH:SEARCH<x>:TRIGger:A:PULSEwidth:SOURce  
{S<x>\_Ch<x>\_D|CH<x>|CH<x>\_D<x>|REF<x>|REF<x>\_D<x>}  
SEARCH:SEARCH<x>:TRIGger:A:PULSEwidth:SOURce?

**Arguments** S<x>\_Ch<x>\_D<x> specifies is the remote scope number, the analog channel and the digital channel.

CH<x> specifies one input channel as the source, where the channel number is specified by x.

CH<x>\_D<x> specifies a digital reference waveform as the source waveform for the specified search.

REF<x> specifies the reference waveform as the search source, where the reference number is specified by x.

REF<x>\_D<x> specifies a digital reference waveform as the source waveform for the specified search.

**Examples** SEARCH:SEARCH1:TRIGger:A:PULSEwidth:SOURce CH1 sets the source to channel 1.

SEARCH:SEARCH1:TRIGger:A:PULSEwidth:SOURce? might return SEARCH:SEARCH1:TRIGGER:A:PULSEWIDTH:SOURCE CH2 indicating channel 2 is the source.

## SEARCH:SEARCH<x>:TRIGger:A:PULSEWidth:THReshold

Sets or queries the source threshold level for a pulse width trigger search to determine where to place a mark. The search number is specified by x.

**Group** Search and Mark

**Syntax** SEARCH:SEARCH<x>:TRIGger:A:PULSEwidth:THReshold <NR3>  
SEARCH:SEARCH<x>:TRIGger:A:PULSEwidth:THReshold?

**Arguments** <NR3> is the source threshold level for a pulse width trigger search.

**Examples** SEARCH:SEARCH1:TRIGger:A:PULSEwidth:THReshold 1.0e-9 sets to 1.0 V.

SEARCH:SEARCH1:TRIGger:A:PULSEwidth:THReshold? might return SEARCH:SEARCH1:TRIGGER:A:PULSEWIDTH:THRESHOLD 0.0E+0 indicating the threshold is 0.0 V.

## SEARCH:SEARCH<x>:TRIGger:A:PULSEWidth:WHEn

This command specifies to search for a pulse with a width (duration) that is less than, greater than, equal to, or unequal to a specified value (set using SEARCH:A:PULSEwidth:WIDTH), OR whose SEARCH:A:PULSEwidth:LOWLimit and SEARCH:A:PULSEwidth:HIGHLimit). The search number is specified by x.

**Group** Search and Mark

**Syntax** SEARCH:SEARCH<x>:TRIGger:A:PULSEwidth:WHEn  
{LESSthan|MOREthan|EQua|UNEQua|WITHin|OUTSide}  
SEARCH:SEARCH<x>:TRIGger:A:PULSEwidth:WHEn?

**Arguments** LESSthan causes a search when a pulse is detected with a width less than the time set by the SEARCH:A:PULSEWidth:WIDTH command.

MOREthan causes a search when a pulse is detected with a width greater than the time set by the SEARCH:A:PULSEWidth:WIDTH command.

EQua causes a search when a pulse is detected with a width equal to the time period specified in SEARCH:A:PULSEWidth:WIDTH within a  $\pm 5\%$  tolerance.

UNEQua causes a search when a pulse is detected with a width greater than or less than (but not equal) the time period specified in SEARCH:A:PULSEWidth:WIDTH within a  $\pm 5\%$  tolerance.

WITHin causes a search when a pulse is detected that is within a range set by two values.

OUTSide causes a search when a pulse is detected that is outside of a range set by two values.

**Examples** SEARCH:SEARCH1:TRIGger:A:PULSEwidth:WHEn Outside causes a search when a pulse is detected that is outside the set range.

SEARCH:SEARCH1:TRIGger:A:PULSEwidth:WHEn? might return  
SEARCH:SEARCH1:TRIGGER:A:PULSEWIDTH:WHEN WITHIN indicating that a search will occur when a pulse is detected that is within a set range.

## SEARCH:SEARCH<x>:TRIGger:A:RUNT:LOGICQUALification

This command specifies whether or not to use logic qualification for a runt search. The search number is specified by x.

**Group** Search and Mark

<b>Syntax</b>	SEARCH:SEARCH<x>:TRIGger:A:RUNT:LOGICQUALification {ON OFF} SEARCH:SEARCH<x>:TRIGger:A:RUNT:LOGICQUALification?
<b>Arguments</b>	ON specifies to use logic qualification for a runt search. OFF specifies not to use logic qualification for a runt search.
<b>Examples</b>	SEARCH:SEARCH1:TRIGger:A:RUNT:LOGICQUALification ON turns on logic qualification. SEARCH:SEARCH1:TRIGger:A:RUNT:LOGICQUALification? might return SEARCH:SEARCH1:TRIGGER:A:RUNT:LOGICQUALIFICATION OFF indicating logic qualification is off.

## SEARCH:SEARCH<x>:TRIGger:A:RUNT:POLarity

This command specifies the polarity for the runt search. The search number is specified by x.

<b>Group</b>	Search and Mark
<b>Syntax</b>	SEARCH:SEARCH<x>:TRIGger:A:RUNT:POLarity {POSitive NEGative EITher} SEARCH:SEARCH<x>:TRIGger:A:RUNT:POLarity?
<b>Arguments</b>	POSitive specifies using positive polarity for the runt search. NEGative specifies using negative polarity for the runt search. EITher specifies using either positive or negative polarity for the runt search.
<b>Examples</b>	SEARCH:SEARCH1:TRIGger:A:RUNT:POLarity NEGATIVE specifies using negative polarity for the runt search. SEARCH:SEARCH1:TRIGger:A:RUNT:POLarity? might return SEARCH:SEARCH1:TRIGGER:A:RUNT:POLARITY POSITIVE indicating the polarity is set to positive.

## SEARCH:SEARCH<x>:TRIGger:A:RUNT:SOURce

This command sets and queries the source for the Runt search input. The search number is specified by x.

<b>Group</b>	Search and Mark
<b>Syntax</b>	SEARCH:SEARCH<x>:TRIGger:A:RUNT:SOURce {CH<x> REF<x>} SEARCH:SEARCH<x>:TRIGger:A:RUNT:SOURce?
<b>Arguments</b>	CH<x> specifies one input channel as the source, where the channel number is specified by x.  REF<x> specifies the reference waveform as the search source, where the reference number is specified by x.
<b>Examples</b>	SEARCH:SEARCH1:TRIGger:A:RUNT:SOURce CH1 sets the source to channel 1.  SEARCH:SEARCH1:TRIGger:A:RUNT:SOURce? might return SEARCH:SEARCH1:TRIGGER:A:RUNT:SOURCE CH2 indicating the source is set to channel 2.

## SEARCH:SEARCH<x>:TRIGger:A:RUNT:THReshold:HIGH

This command sets or queries the source threshold HIGH level for a runt trigger search to determine where to place a mark.

<b>Group</b>	Search and Mark
<b>Syntax</b>	SEARCH:SEARCH<x>:TRIGger:A:RUNT:THReshoId:HIGH <NR3> SEARCH:SEARCH<x>:TRIGger:A:RUNT:THReshoId:HIGH?
<b>Arguments</b>	<NR3> is the source threshold HIGH level for a runt trigger search.
<b>Examples</b>	SEARCH:SEARCH1:TRIGger:A:RUNT:THReshoId:HIGH 50.0E-3 sets the high threshold to 50 mV.  SEARCH:SEARCH1:TRIGger:A:RUNT:THReshoId:HIGH? might return SEARCH:SEARCH1:TRIGGER:A:RUNT:THRESHOLD:HIGH 0.0E+0 indicating the high threshold is 0.0 V.

## SEARCH:SEARCH<x>:TRIGger:A:RUNT:THReshold:LOW

Sets or queries the source threshold LOW level for a runt trigger search to determine where to place a mark. The search number is specified by x.

<b>Group</b>	Search and Mark
<b>Syntax</b>	SEARCH:SEARCH<x>:TRIGger:A:RUNT:THReshoId:LOW <NR3> SEARCH:SEARCH<x>:TRIGger:A:RUNT:THReshoId:LOW?
<b>Arguments</b>	<NR3> is the source threshold LOW level for a runt trigger search.
<b>Examples</b>	SEARCH:SEARCH1:TRIGger:A:RUNT:THReshoId:LOW 50.0e-3 sets the threshold to 50 mV.  SEARCH:SEARCH1:TRIGger:A:RUNT:THReshoId:LOW? might return SEARCH:SEARCH1:TRIGGER:A:RUNT:THRESHOLD:LOW 0.0E+0 indicating the threshold is 0.0 V.

## SEARCH:SEARCH<x>:TRIGger:A:RUNT:WHEn

This command sets or queries the condition setting for a runt trigger search to determine where to place a mark. The search number is specified by x.

<b>Group</b>	Search and Mark
<b>Syntax</b>	SEARCH:SEARCH<x>:TRIGger:A:RUNT:WHEn {OCCURS LESSthan MOREthan EQuaI}NOTEQuaI} SEARCH:SEARCH<x>:TRIGger:A:RUNT:WHEn?
<b>Arguments</b>	<p>LESSthan argument sets the instrument to search if the a runt pulse is detected with width less than the time set by the SEARCH:SEARCH&lt;x&gt;:TRIGger:A:RUNT:WIDth command.</p> <p>MOREthan argument sets the instrument to search if the a runt pulse is detected with width more than the time set by the SEARCH:SEARCH&lt;x&gt;:TRIGger:A:RUNT:WIDth command.</p> <p>EQuaI argument sets the instrument to search when the pattern is true for a time period equal to the time period specified in SEARCH:SEARCH&lt;x&gt;:TRIGger:A:RUNT:WIDth within a <math>\pm 5\%</math> tolerance.</p> <p>NOTEQuaI argument sets the instrument to search when the pattern is true for a time period greater than or less than (but not equal) the time period specified in SEARCH:SEARCH&lt;x&gt;:TRIGger:A:RUNT:WIDth within a <math>\pm 5\%</math> tolerance.</p> <p>OCCURS argument specifies a search event if a runt of any detectable width occurs.</p>

- Examples**     `SEARCH:SEARCH1:TRIGGER:A:RUNT:WHEN MORETHAN` sets the instrument to trigger when a runt pulse is detected with width wider than the time set by the `SEARCH:SEARCH<x>:TRIGger:A:RUNT:WIDTH` command.
- `SEARCH:SEARCH1:TRIGGER:A:RUNT:WHEN?` might return `SEARCH:SEARCH1:TRIGGER:A:RUNT:WHEN OCCURS`, indicating that a mark is placed if a runt trigger event occurs.

## SEARCH:SEARCH<x>:TRIGger:A:RUNT:WIDTH

This command sets or queries the width setting for a runt trigger search to determine where to place a mark. The search number is specified by x.

- Group**     Search and Mark
- Syntax**     `SEARCH:SEARCH<x>:TRIGger:A:RUNT:WIDTH <NR3>`  
`SEARCH:SEARCH<x>:TRIGger:A:RUNT:WIDTH?`
- Arguments**     `<NR3>` specifies the minimum width in seconds.
- Examples**     `SEARCH:SEARCH1:TRIGGER:A:RUNT:WIDTH 400E-12` sets the runt trigger minimum width for search 1 to 0.4 nanoseconds.
- `SEARCH:SEARCH1:TRIGGER:A:RUNT:WIDTH?` might return `SEARCH:SEARCH1:TRIGGER:A:RUNT:WIDTH 500.0000E-12`, indicating that the runt trigger minimum width for search 1 is set to 0.5 nanoseconds.

## SEARCH:SEARCH<x>:TRIGger:A:SETHold:CLOCK:EDGE

This command sets or queries the clock slope setting for a setup/hold trigger search to determine where to place a mark. The search number is specified by x.

- Group**     Search and Mark
- Syntax**     `SEARCH:SEARCH<x>:TRIGger:A:SETHold:CLOCK:EDGE {FALL|RISE}`  
`SEARCH:SEARCH<x>:TRIGger:A:SETHold:CLOCK:EDGE?`
- Arguments**     `FALL` specifies the polarity as the clock falling edge.  
`RISe` specifies the polarity as the clock rising edge.



**Examples**     `SEARCH:SEARCH1:TRIGGER:A:SETHOLD:CLOCK:EDGE FALL` sets the setup/hold trigger clock slope polarity for search 1 to falling edge.

`SEARCH:SEARCH1:TRIGGER:A:SETHOLD:CLOCK:EDGE?` might return `SEARCH:SEARCH1:TRIGGER:A:SETHOLD:CLOCK:EDGE RISE`, indicating that the setup/hold trigger clock slope polarity for search 1 is set to rising edge.

## SEARCH:SEARCH<x>:TRIGger:A:SETHold:CLOCK:SOURce

This command sets or queries the clock source setting for a setup/hold trigger search to determine where to place a mark. The search number is specified by x.

**Group**     Search and Mark

**Syntax**     `SEARCH:SEARCH<x>:TRIGger:A:SETHold:CLOCK:SOURce`  
`{S<x>_Ch<x>_D<x> | CH<x> | CH<x>_D<x> | MATH<x> | REF<x> | REF<x>_D<x>}`  
`SEARCH:SEARCH<x>:TRIGger:A:SETHold:CLOCK:SOURce`  
`SEARCH:SEARCH<x>:TRIGger:A:SETHold:CLOCK:SOURce?`

**Arguments**     `S<x>_Ch<x>_D<x>` specifies is the remote scope number, the analog channel and the digital channel.

`CH<x>` specifies an input channel as the source, where `<x> = 1, 2, 3, 4, 5, 6, 7, or 8`, depending on the number of channels in your instrument.

`CH<x>_D<x>` specifies a digital waveform as the setup and hold clock source waveform for the specified search.

`MATH<x>` specifies the math waveform as the search source, where `<x> = ≥1`.

`REF<x>` specifies the reference waveform as the search source, where `<x> = ≥1`.

`REF<x>_D<x>` specifies a digital reference waveform as the setup and hold clock source waveform for the specified search.

**Examples**     `SEARCH:SEARCH1:TRIGGER:A:SETHOLD:CLOCK:SOURCE MATH1` sets the setup/hold trigger clock source setting for search 1 to MATH1.

`SEARCH:SEARCH1:TRIGGER:A:SETHOLD:CLOCK:SOURCE?` might return `SEARCH:SEARCH1:TRIGGER:A:SETHOLD:CLOCK:SOURCE CH1`, indicating that the setup/hold trigger clock source setting for search 1 is set to CH1.

## SEARCH:SEARCH<x>:TRIGger:A:SETHold:CLOCK:THReshold

This command sets or queries the clock threshold setting for a setup/hold trigger search to determine where to place a mark. The search number is specified by x.

<b>Group</b>	Search and Mark
<b>Syntax</b>	SEARCH:SEARCH<x>:TRIGGER:A:SETHold:CLOCK:THRESHold <NR3> SEARCH:SEARCH<x>:TRIGGER:A:SETHold:CLOCK:THRESHold?
<b>Arguments</b>	<NR3> the clock threshold setting for a setup/hold trigger search.
<b>Examples</b>	SEARCH:SEARCH1:TRIGGER:A:SETHOLD:CLOCK:THRESHOLD -1.3 sets the setup/hold trigger clock threshold setting for search 1 to -1.3 volts. SEARCH:SEARCH1:TRIGGER:A:SETHOLD:CLOCK:THRESHOLD? might return SEARCH:SEARCH1:TRIGGER:A:SETHOLD:CLOCK:THRESHOLD -1.3000, indicating that the setup/hold trigger clock threshold setting for search 1 is set to -1.3 volts.  ** CANNOT USE LocalCmd HERE BECAUSE OF VARIABLES **

## SEARCH:SEARCH<x>:TRIGGER:A:SETHold:HOLDTime

This command sets or queries the hold time setting for a setup/hold trigger search to determine where to place a mark. The search number is specified by x.

<b>Group</b>	Search and Mark
<b>Syntax</b>	SEARCH:SEARCH<x>:TRIGGER:A:SETHold:HOLDTime <NR3> SEARCH:SEARCH<x>:TRIGGER:A:SETHold:HOLDTime?
<b>Arguments</b>	<NR3> specifies the hold time setting in seconds. Positive values for hold time occur after the clock edge. Negative values occur before the clock edge.
<b>Examples</b>	SEARCH:SEARCH1:TRIGGER:A:SETHOLD:HOLDTIME 400E-12 sets the setup/hold trigger hold time setting for search 1 to 400 ps.  SEARCH:SEARCH1:TRIGGER:A:SETHOLD:HOLDTIME? might return SEARCH:SEARCH1:TRIGGER:A:SETHOLD:HOLDTIME 500.0000E-12, indicating that the setup/hold trigger hold time setting for search 1 is set to 0.5 ns.

## SEARCH:SEARCH<x>:TRIGGER:A:SETHold:LEVel:CH<x>

This command sets or queries the voltage level to use for setup & hold trigger search. The search number is specified by x.

<b>Group</b>	Search and Mark
<b>Syntax</b>	SEARCH:SEARCH<x>:TRIGger:A:SETHold:LEVEl:CH<x> <NR3> SEARCH:SEARCH<x>:TRIGger:A:SETHold:LEVEl:CH<x>?
<b>Arguments</b>	<NR3> the voltage level to use for setup & hold trigger search.
<b>Examples</b>	SEARCH:SEARCH1:TRIGger:A:SETHold:LEVEl:CH1 50.0e-3 sets the level to 50.0 mV.  SEARCH:SEARCH1:TRIGger:A:SETHold:LEVEl:CH1? might return SEARCH:SEARCH1:TRIGGER:A:SETHOLD:LEVEL:CH1 0.0E+0 indicating the level is 0.0 V.

## SEARCH:SEARCH<x>:TRIGger:A:SETHold:LEVEl:MATH<x>

This command sets or queries the voltage level to use for setup & hold trigger search. The search number is specified by x.

<b>Group</b>	Search and Mark
<b>Syntax</b>	SEARCH:SEARCH<x>:TRIGger:A:SETHold:LEVEl:MATH<x> <NR3> SEARCH:SEARCH<x>:TRIGger:A:SETHold:LEVEl:MATH<x>?
<b>Arguments</b>	<NR3> isi the voltage level to use for setup & hold trigger search.
<b>Examples</b>	SEARCH:SEARCH1:TRIGger:A:SETHold:LEVEl:MATH1 50.0e-3 sets the level to 50.0 mV.  SEARCH:SEARCH1:TRIGger:A:SETHold:LEVEl:MATH1? might return SEARCH:SEARCH1:TRIGGER:A:SETHOLD:LEVEL:MATH1 0.0E+0 indicating the level is 0.0 V.

## SEARCH:SEARCH<x>:TRIGger:A:SETHold:LEVEl:REF<x>

This command sets or queries the voltage level to use for setup & hold trigger search. The search number is specified by x.

<b>Group</b>	Search and Mark
--------------	-----------------

**Syntax** SEARCH:SEARCH<x>:TRIGger:A:SETHold:LEVEl:REF<x> <NR3>  
SEARCH:SEARCH<x>:TRIGger:A:SETHold:LEVEl:REF<x>?

**Arguments** <NR3> is the voltage level to use for setup & hold trigger search.

**Examples** SEARCH:SEARCH1:TRIGger:A:SETHold:LEVEl:REF1 50.0e-3 sets the level to 50.0 mV.  
SEARCH:SEARCH1:TRIGger:A:SETHold:LEVEl:REF1? might return SEARCH:SEARCH1:TRIGGER:A:SETHOLD:LEVEL:REF1 0.0E+0 indicating the level is 0.0 V.

## SEARCH:SEARCH<x>:TRIGger:A:SETHold:LOGICPattern:CH<x>

This command sets or queries the conditions used for generating an A logic pattern, with respect to the defined input pattern, and identifies the time that the selected pattern may be true and still generate the trigger. The search number is specified by x.

**Group** Search and Mark

**Syntax** SEARCH:SEARCH<x>:TRIGger:A:SETHold:LOGICPattern:CH<x>  
{INCLUDE|DONTInclude}  
SEARCH:SEARCH<x>:TRIGger:A:SETHold:LOGICPattern:CH<x>?

**Arguments** INCLUDE specifies including the specified channel SETHOLD inputs in the specified search.  
DONTInclude specifies not including the specified channel SETHOLD inputs in the specified search.

**Examples** SEARCH:SEARCH1:TRIGger:A:SETHold:LOGICPattern:CH1 INCLUDE specifies including the specified channel SETHOLD inputs in the specified search.  
SEARCH:SEARCH1:TRIGger:A:SETHold:LOGICPattern:CH1? might return SEARCH:SEARCH1:TRIGGER:A:SETHOLD:LOGICPATTERN:CH1 DONTINCLUDE indicating the specified channel SETHOLD inputs will not be included in the specified search.

## SEARCH:SEARCH<x>:TRIGger:A:SETHold:LOGICPattern:CH<x>\_D<x>

This command sets or queries the conditions used for generating an A logic pattern, with respect to the defined input pattern, and identifies the time that the

selected pattern may be true and still generate the trigger. The search number is specified by x.

<b>Group</b>	Search and Mark
<b>Syntax</b>	SEARCH:SEARCH<x>:TRIGger:A:SETHold:LOGICPattern:CH<x>_D<x> {INCLude DONTInCLude} SEARCH:SEARCH<x>:TRIGger:A:SETHold:LOGICPattern:CH<x>_D<x>?
<b>Arguments</b>	INCLude specifies including the specified digital channel SETHOLD inputs in the specified search.  DONTInCLude specifies not including the specified digital channel SETHOLD inputs in the specified search.
<b>Examples</b>	SEARCH:SEARCH1:TRIGger:A:SETHold:LOGICPattern:CH1_D0 INCLUDE specifies including the specified digital channel SETHOLD inputs in the specified search.  SEARCH:SEARCH1:TRIGger:A:SETHold:LOGICPattern:CH1_D0? might return SEARCH:SEARCH1:TRIGGER:A:SETHOLD:LOGICPATTERN:CH1_D0 DONTINCLUDE indicating the specified digital channel SETHOLD inputs will not be included in the specified search.

## SEARCH:SEARCH<x>:TRIGger:A:SETHold:LOGICPattern:MATH<x>

This command sets or queries the conditions used for generating an A logic pattern, with respect to the defined input pattern, and identifies the time that the selected pattern may be true and still generate the trigger. The search number is specified by x.

<b>Group</b>	Search and Mark
<b>Syntax</b>	SEARCH:SEARCH<x>:TRIGger:A:SETHold:LOGICPattern:MATH<x> {INCLude DONTInCLude} SEARCH:SEARCH<x>:TRIGger:A:SETHold:LOGICPattern:MATH<x>?
<b>Arguments</b>	INCLude specifies including the specified math SETHOLD inputs in the specified search.  DONTInCLude specifies not including the specified math SETHOLD inputs in the specified search.

**Examples**     `SEARCH:SEARCH1:TRIGger:A:SETHold:LOGICPattern:MATH1 INCLUDE` specifies including the specified math SETHOLD inputs in the specified search.

`SEARCH:SEARCH1:TRIGger:A:SETHold:LOGICPattern:MATH1?` might return `SEARCH:SEARCH1:TRIGGER:A:SETHOLD:LOGICPATTERN:MATH1 DONTINCLUDE` indicating the specified math SETHOLD inputs will not be included in the specified search.

## **SEARCH:SEARCH<x>:TRIGger:A:SETHold:LOGICPattern:REF<x>**

This command sets and returns the conditions used for generating an A logic pattern, with respect to the defined input pattern, and identifies the time that the selected pattern may be true and still generate the trigger. The search number is specified by x.

**Group**     Search and Mark

**Syntax**     `SEARCH:SEARCH<x>:TRIGger:A:SETHold:LOGICPattern:REF<x>`  
                  `{INCLUDE|DONTInclude}`  
                  `SEARCH:SEARCH<x>:TRIGger:A:SETHold:LOGICPattern:REF<x>?`

**Arguments**     `INCLUDE` specifies including the specified reference SETHOLD inputs in the specified search.

`DONTInclude` specifies not including the specified reference SETHOLD inputs in the specified search.

**Examples**     `SEARCH:SEARCH1:TRIGger:A:SETHold:LOGICPattern:REF1 INCLUDE` specifies including the specified reference SETHOLD inputs in the specified search.

`SEARCH:SEARCH1:TRIGger:A:SETHold:LOGICPattern:REF1?` might return `SEARCH:SEARCH1:TRIGGER:A:SETHOLD:LOGICPATTERN:REF1 DONTINCLUDE` indicating the specified reference SETHOLD inputs will not be included in the specified search.

## **SEARCH:SEARCH<x>:TRIGger:A:SETHold:SETTime**

This command sets or queries the setup time setting for a setup/hold trigger search to determine where to place a mark. The search number is specified by x.

**Group**     Search and Mark

<b>Syntax</b>	SEARCH:SEARCH<x>:TRIGger:A:SETHold:SETTime <NR3> SEARCH:SEARCH<x>:TRIGger:A:SETHold:SETTime?
<b>Arguments</b>	<NR3> specifies the setup time for setup and hold violation triggering.
<b>Examples</b>	SEARCH:SEARCH1:TRIGGER:A:SETHOLD:SETTIME 2E-9 sets the setup/hold trigger setup time setting for search 1 to 2 ns.  SEARCH:SEARCH1:TRIGGER:A:SETHOLD:SETTIME? might return SEARCH:SEARCH1:TRIGGER:A:SETHOLD:SETTIME 1.0000E-9, indicating that the setup/hold trigger setup time setting for search 1 is set to 1.0 ns.

## SEARCH:SEARCH<x>:TRIGger:A:STATE

This command sets or queries the enabled state of the search. The search number is specified by x.

<b>Group</b>	Search and Mark
<b>Syntax</b>	SEARCH:SEARCH<x>:TRIGger:A:STATE {<NR1> OFF ON} SEARCH:SEARCH<x>:TRIGger:A:STATE?
<b>Arguments</b>	<NR1> = 1 enables the search. Any other character disables the search.  ON enables the search. OFF disables the search.
<b>Examples</b>	SEARCH:SEARCH1:TRIGger:A:STATE OFF disables the search.  SEARCH:SEARCH1:TRIGger:A:STATE? might return SEARCH:SEARCH1:TRIGGER:A:STATE 1 indicating search 1 is enabled.

## SEARCH:SEARCH<x>:TRIGger:A:STOPAcq

This command sets or queries whether acquisitions are stopped when a search hit is found. The search number is specified by x.

<b>Group</b>	Search and Mark
<b>Syntax</b>	SEARCH:SEARCH<x>:TRIGger:A:STOPAcq {<NR1> OFF ON} SEARCH:SEARCH<x>:TRIGger:A:STOPAcq?

<b>Arguments</b>	<p>&lt;x&gt; is the number of the search on which to enable or disable the stop acquisition function.</p> <p>&lt;NR1&gt; = 1 enables stopping when a search hit is found. Any other character disables the feature.</p> <p>ON enables stopping when a search hit is found.</p> <p>OFF disables stopping on a search hit.</p>
<b>Examples</b>	<p>SEARCH:SEARCH1:TRIGger:A:STOPAcq ON enables stopping when a search hit is found.</p> <p>SEARCH:SEARCH3:TRIGger:A:STOPAcq? might return :SEARCH:SEARCH3:TRIGGER:A:STOPACQ 1 indicating acquisitions are stopped when a search hit is found on search number 3.</p>

## SEARCH:SEARCH<x>:TRIGger:A:TIMEOut:LOGICQUALification

This command specifies whether or not to use logic qualification for a timeout search. The search number is specified by x.

<b>Group</b>	Search and Mark
<b>Syntax</b>	SEARCH:SEARCH<x>:TRIGger:A:TIMEOut:LOGICQUALification {ON OFF} SEARCH:SEARCH<x>:TRIGger:A:TIMEOut:LOGICQUALification?
<b>Arguments</b>	<p>ON specifies to use logic qualification.</p> <p>OFF specifies not to use logic qualification.</p>
<b>Examples</b>	<p>SEARCH:SEARCH1:TRIGger:A:TIMEOut:LOGICQUALification ON specifies to use logic qualification.</p> <p>SEARCH:SEARCH1:TRIGger:A:TIMEOut:LOGICQUALification? might return SEARCH:SEARCH1:TRIGGER:A:TIMEOUT:LOGICQUALIFICATION OFF indicating logic qualification is off.</p>

## SEARCH:SEARCH<x>:TRIGger:A:TIMEOut:POLarity

The polarity to be used for a Timeout search. The search number is specified by x.

<b>Group</b>	Search and Mark
--------------	-----------------



<b>Syntax</b>	SEARCH:SEARCH<x>:TRIGger:A:TIMEOut:POLArity {STAYSHigh STAYSLow EITHer} SEARCH:SEARCH<x>:TRIGger:A:TIMEOut:POLArity?
<b>Arguments</b>	STAYSHigh specifies the polarity stays HIGH. STAYSLow specifies the polarity stays LOW. EITHer specifies the polarity stays HIGH or stays LOW.
<b>Examples</b>	SEARCH:SEARCH1:TRIGger:A:TIMEOut:POLArity STAYSLow specifies the polarity stays LOW. SEARCH:SEARCH1:TRIGger:A:TIMEOut:POLArity? might return SEARCH:SEARCH1:TRIGGER:A:TIMEOUT:POLARITY STAYSHIGH indicating the polarity stays HIGH.

## SEARCH:SEARCH<x>:TRIGger:A:TIMEOut:SOUrce

This command sets and queries the source for timeout search input. The search number is specified by x.

<b>Group</b>	Search and Mark
<b>Syntax</b>	SEARCH:SEARCH<x>:TRIGger:A:TIMEOut:SOUrce {S<x>_Ch<x>_D<x> CH<x> CH<x>_D<x> MATH<x> REF<x> REF<x>_D<x>} SEARCH:SEARCH<x>:TRIGger:A:TIMEOut:SOUrce?
<b>Arguments</b>	S<x>_Ch<x>_D<x> specifies is the remote scope number, the analog channel and the digital channel. CH<x> specifies one input channel as the source, where the channel number is specified by x. CH<x>_D<x> specifies a digital reference waveform as the source waveform for the specified search. MATH<x> specifies the math waveform as the search source, where the math number is specified by x. REF<x> specifies the reference waveform as the search source, where the reference number is specified by x. REF<x>_D<x> specifies a digital reference waveform as the source waveform for the specified search.

**Examples**    `SEARCH:SEARCH1:TRIGger:A:TIMEOut:SOURce`  
`SEARCH:SEARCH1:TRIGger:A:TIMEOut:SOURce?` might return  
`SEARCH:SEARCH1:TRIGGER:A:TIMEOUT:SOURCE CH1_D0` indicating  
CH1\_D0 is the source.

## **SEARCH:SEARCH<x>:TRIGger:A:TIMEOut:THReshold**

Sets or queries the source threshold level for a timeout trigger search to determine where to place a mark. The search number is specified by x.

**Group**    Search and Mark

**Syntax**    `SEARCH:SEARCH<x>:TRIGger:A:TIMEOut:THReshold <NR3>`  
`SEARCH:SEARCH<x>:TRIGger:A:TIMEOut:THReshold?`

**Arguments**    <NR3> is the source threshold level for a timeout trigger search.

**Examples**    `SEARCH:SEARCH1:TRIGger:A:TIMEOut:THReshold 50.0e-3` sets the  
threshold to 50.0 mV.  
`SEARCH:SEARCH1:TRIGger:A:TIMEOut:THReshold?` might return  
`SEARCH:SEARCH1:TRIGGER:A:TIMEOUT:THRESHOLD 0.0E+0` indicating  
the threshold is 0.0 V.

## **SEARCH:SEARCH<x>:TRIGger:A:TIMEOut:TIME**

This command sets or queries the time setting for a timeout trigger search to determine where to place a mark. The search number is specified by x.

**Group**    Search and Mark

**Syntax**    `SEARCH:SEARCH<x>:TRIGger:A:TIMEOut:TIME <NR3>`  
`SEARCH:SEARCH<x>:TRIGger:A:TIMEOut:TIME?`

**Arguments**    <NR3> is the time in seconds.

**Examples**    `SEARCH:SEARCH1:TRIGGER:A:TIMEOUT:TIME 400E-9` sets the timeout  
trigger time setting for search 1 to 400 ns.

SEARCH:SEARCH1:TRIGGER:A:TIMEOUT:TIME? might return  
 SEARCH:SEARCH1:TRIGGER:A:TIMEOUT:TIME 500.0000E-12, indicating  
 that the timeout trigger time setting for search 1 is set to 500 ns.

## SEARCH:SEARCH<x>:TRIGger:A:TRANSition:DELTATime

This command sets or queries the transition time setting for a transition trigger search to determine where to place a mark. The search number is specified by x.

<b>Group</b>	Search and Mark
<b>Syntax</b>	SEARCH:SEARCH<x>:TRIGger:A:TRANSition:DELTATime <NR3> SEARCH:SEARCH<x>:TRIGger:A:TRANSition:DELTATime?
<b>Arguments</b>	<NR3> specifies the transition time in seconds.
<b>Examples</b>	SEARCH:SEARCH1:TRIGGER:A:TIMEOUT:TIME 400E-9 sets the transition trigger time setting for search 1 to 400 ns.  SEARCH:SEARCH1:TRIGGER:A:TRANSITION:DELTATIME? might return SEARCH:SEARCH1:TRIGGER:A:TRANSITION:DELTATIME 500.0000E-12, indicating that the transition trigger time setting for search 1 is set to 500 ps.

## SEARCH:SEARCH<x>:TRIGger:A:TRANSition:LOGICQUALification

This command specifies whether or not to use logic qualification for a transition search. The search number is specified by x.

<b>Group</b>	Search and Mark
<b>Syntax</b>	SEARCH:SEARCH<x>:TRIGger:A:TRANSition:LOGICQUALification {ON OFF} SEARCH:SEARCH<x>:TRIGger:A:TRANSition:LOGICQUALification?
<b>Arguments</b>	ON specifies to use logic qualification for a transition search.  OFF specifies not to use logic qualification for a transition search.
<b>Examples</b>	SEARCH:SEARCH1:TRIGger:A:TRANSition:LOGICQUALification ON specifies to use logic qualification for a transition search.

SEARCH:SEARCH1:TRIGger:A:TRANSition:LOGICQUALification? might return SEARCH:SEARCH1:TRIGGER:A:TRANSITION:LOGICQUALIFICATION OFF indicating logic qualification is off.

## SEARCH:SEARCH<x>:TRIGger:A:TRANSition:POLarity

This command specifies the polarity for the transition search. The search number is specified by x.

<b>Group</b>	Search and Mark
<b>Syntax</b>	SEARCH:SEARCH<x>:TRIGger:A:TRANSition:POLarity {POSitive NEGative EITher} SEARCH:SEARCH<x>:TRIGger:A:TRANSition:POLarity?
<b>Arguments</b>	EITher places a mark on a transition of either polarity. NEGative places a mark on a transition of negative polarity. POSitive places a mark on a transition of positive polarity.
<b>Examples</b>	SEARCH:SEARCH1:TRIGger:A:TRANSition:POLarity NEGATIVE places a mark on a transition of negative polarity. SEARCH:SEARCH1:TRIGger:A:TRANSition:POLarity? might return SEARCH:SEARCH1:TRIGGER:A:TRANSITION:POLARITY POSITIVE indicating the polaity is positive.

## SEARCH:SEARCH<x>:TRIGger:A:TRANSition:SOURce

This command sets and queries the source for the transition search input. The search number is specified by x.

<b>Group</b>	Search and Mark
<b>Syntax</b>	SEARCH:SEARCH<x>:TRIGger:A:TRANSition:SOURce {S<x>_Ch<x> CH<x> MATH<x> REF<x>} SEARCH:SEARCH<x>:TRIGger:A:TRANSition:SOURce?
<b>Arguments</b>	S<x>_Ch<x> specifies is the remote scope number, and the analog channel. CH<x> specifies one input channel as the source.

MATH<x> specifies the math waveform as the source.

REF<x> specifies the reference waveform as the source.

**Examples** SEARCH:SEARCH1:TRIGger:A:TRANSition:SOURce CH1 sets the source to channel 1.  
SEARCH:SEARCH1:TRIGger:A:TRANSition:SOURce? might return SEARCH:SEARCH1:TRIGGER:A:TRANSITION:SOURCE CH2 indicating channel 2 is the source.

## SEARCH:SEARCH<x>:TRIGger:A:TRANSition:THReshold:HIGH

Sets or queries the source threshold HIGH level for a transition trigger search to determine where to place a mark. The search number is specified by x.

**Group** Search and Mark

**Syntax** SEARCH:SEARCH<x>:TRIGger:A:TRANSition:THReshold:HIGH <NR3>  
SEARCH:SEARCH<x>:TRIGger:A:TRANSition:THReshold:HIGH?

**Arguments** <NR3> the source threshold HIGH level for a transition trigger search.

**Examples** SEARCH:SEARCH1:TRIGger:A:TRANSition:THReshold:HIGH 50.0e-3 sets the high threshold to 50.0 mV.  
SEARCH:SEARCH1:TRIGger:A:TRANSition:THReshold:HIGH? might return SEARCH:SEARCH1:TRIGGER:A:TRANSITION:THRESHOLD:HIGH 0.0E+0 indicating the high threshold is 0.0 V.

## SEARCH:SEARCH<x>:TRIGger:A:TRANSition:THReshold:LOW

Sets or queries the source threshold LOW level for a transition trigger search to determine where to place a mark. The search number is specified by x.

**Group** Search and Mark

**Syntax** SEARCH:SEARCH<x>:TRIGger:A:TRANSition:THReshold:LOW <NR3>  
SEARCH:SEARCH<x>:TRIGger:A:TRANSition:THReshold:LOW?

**Arguments** <NR3> is the source threshold LOW level for a transition trigger search.

**Examples**     `SEARCH:SEARCH1:TRIGGER:A:TRANSITION:THRESHOLD:LOW -50.0e-3`  
sets the LOW threshold to -50.0 mV.

`SEARCH:SEARCH1:TRIGGER:A:TRANSITION:THRESHOLD:LOW?` might return  
`SEARCH:SEARCH1:TRIGGER:A:TRANSITION:THRESHOLD:LOW 0.0E+0`  
indicating the LOW threshold is 0.0 V.

## **SEARCH:SEARCH<x>:TRIGGER:A:TRANSITION:WHEN**

This command sets or queries the condition setting for a transition trigger search to determine where to place a mark. The search number is specified by x.

**Group**     Search and Mark

**Syntax**     `SEARCH:SEARCH<x>:TRIGGER:A:TRANSITION:WHEN`  
`{FASTERthan|SLOWERthan|EQUAL|UNEQUAL}`  
`SEARCH:SEARCH<x>:TRIGGER:A:TRANSITION:WHEN?`

**Arguments**     `FASTERthan` sets the trigger to occur when the transitioning signal is faster than the set volts/second rate.

`SLOWERthan` sets the trigger to occur when the transitioning signal is slower than the set volts/second rate.

`EQUAL` sets the trigger to occur when the transitioning signal is equal to the set volts/second rate.

`UNEQUAL` sets the trigger to occur when the transitioning signal is not equal to the set volts/second rate.

**Examples**     `SEARCH:SEARCH1:TRIGGER:A:TRANSITION:WHEN SLOWERTHAN` sets the transition trigger condition setting for search 1 to SLOWERTHAN.

`SEARCH:SEARCH1:TRIGGER:A:TRANSITION:WHEN?` might return  
`SEARCH:SEARCH1:TRIGGER:A:TRANSITION:WHEN FASTERTHAN`, indicating that the transition trigger condition setting for search 1 is set to FASTERTHAN.

## **SEARCH:SEARCH<x>:TRIGGER:A:TYPE**

This command sets or queries the trigger type setting for a search to determine where to place a mark. The search number is specified by x.

**Group**     Search and Mark

<b>Syntax</b>	<pre>SEARCH:SEARCH&lt;x&gt;:TRIGger:A:TYPE {EDGE RUNT TRANSition PULSEwidth TIMEOut LOGic  SETHold WINDow Bus DDRRead DDRREADwrite DDRwrite} SEARCH:SEARCH&lt;x&gt;:TRIGger:A:TYPE?</pre>
<b>Arguments</b>	<p>EDGE triggers when the source input signal amplitude crosses the specified level in the direction given by the slope.</p> <hr/> <p><b>NOTE.</b> <i>Some trigger types are optional.</i></p> <hr/> <p>RUNT triggers when a pulse crosses the first preset voltage threshold but does not cross the second preset threshold before recrossing the first. The thresholds are set with the SEARCH:SEARCH&lt;x&gt;:TRIGger:A:RUNt:HIGH and SEARCH:SEARCH&lt;x&gt;:TRIGger:A:RUNt:LOW THRESHOLD commands.</p> <p>TRANSition triggers when a pulse crosses both thresholds in the same direction as the specified polarity and the transition time between the two threshold crossings is greater or less than the specified time delta.</p> <p>PULSEwidth triggers on input signal source pulses that are inside or outside of the given time range specified by SEARCH:SEARCH&lt;x&gt;:TRIGger:A:LOGic:PATtern:WHEn:LESSLimit and SEARCH:SEARCH&lt;x&gt;:TRIGger:A:LOGic:PATtern:WHEn:MORELimit. The polarity is selected using the SEARCH:SEARCH&lt;x&gt;:TRIGger:A:RUNt:POLarity command.</p> <p>TIMEOut triggers on an input signal source that stays above, stays below, or stays either above or below the trigger level for a given time.</p> <p>LOGic specifies that a search occurs when specified conditions are met, and is controlled by the SEARCH:A:LOGic commands.</p> <p>SETHold triggers on a functional pattern combination of one to three data sources at the time of the clock transition.</p> <p>WINDow triggers on an input signal source that enters or exits the horizontal band defined by the two trigger levels.</p> <p>Bus specifies that a search occurs when a communications signal is found.</p> <p>DDRRead triggers on a DDR Read event.</p> <p>DDRREADwrite triggers on a DDR Read or Write event.</p> <p>DDRwrite triggers on a DDR Write event.</p>
<b>Examples</b>	<pre>SEARCH:SEARCH1:TRIGGER:A:TYPE RUNT sets the trigger type setting for search 1 to RUNT.</pre>

SEARCH:SEARCH1:TRIGGER:A:TYPE? might return  
SEARCH:SEARCH1:TRIGGER:A:TYPE EDGE, indicating that the trigger type  
setting for search 1 is set to EDGE.

## SEARCH:SEARCH<x>:TRIGger:A:WINDow:CROSSIng

This command sets or queries the window trigger threshold crossing of the selected trigger Source. The threshold crossing selection is only effective when :TRIGger:A:WINDow:WHEN is INSIDEGreater or OUTSIDEGreater. The search number is specified by x.

**Group** Search and Mark

**Syntax** SEARCH:SEARCH<x>:TRIGger:A:WINDow:CROSSIng  
{UPPER|LOWER|EITHER|NONE}

**Arguments** UPPER if :TRIGger:A:WINDow:WHEN is INSIDEGreater, the instrument triggers when the signal remains between the upper and lower thresholds for longer than the time limit (:TRIGger:A:WINDow:WIDTH) and then exits through the upper threshold. If :TRIGger:A:WINDow:WHEN is OUTSIDEGreater, the instrument triggers when the signal remains above the upper threshold for longer than the time limit (:TRIGger:A:WINDow:WIDTH) and then crosses downward through the upper threshold.

LOWER if :TRIGger:A:WINDow:WHEN is INSIDEGreater, the instrument triggers when the signal remains between the upper and lower thresholds for longer than the time limit (:TRIGger:A:WINDow:WIDTH) and then exits through the lower threshold. If :TRIGger:A:WINDow:WHEN is OUTSIDEGreater, the instrument triggers when the signal remains below the lower threshold for longer than the time limit (:TRIGger:A:WINDow:WIDTH) and then crosses upwards through the lower threshold.

EITHER if :TRIGger:A:WINDow:WHEN is INSIDEGreater, the instrument triggers when the signal remains between the upper and lower thresholds for longer than the time limit (:TRIGger:A:WINDow:WIDTH) and then exits through either the upper or lower threshold. If :TRIGger:A:WINDow:WHEN is OUTSIDEGreater, the instrument triggers when the signal remains either above the upper threshold or below the lower threshold for longer than the time limit (:TRIGger:A:WINDow:WIDTH) and then crosses a threshold.

NONE if :TRIGger:A:WINDow:WHEN is INSIDEGreater, the instrument triggers when the signal remains between the upper and lower thresholds for longer than the time limit (:TRIGger:A:WINDow:WIDTH) without crossing through either the upper or lower threshold. If :TRIGger:A:WINDow:WHEN is OUTSIDEGreater, the instrument triggers when the signal remains outside the upper and lower



thresholds for longer than the time limit (:TRIGger:A:WINDow:WIDTH) without crossing through either the upper or lower threshold.

**Examples** SEARCH:SEARCH1:TRIGger:A:WINDow:CROSSIng LOWER sets the CROSSING to LOWER.

SEARCH:SEARCH1:TRIGger:A:WINDow:CROSSIng? might return SEARCH:SEARCH1:TRIGGER:A:WINDOW:CROSSING UPPER indicating that CROSSING is set to UPPER.

## SEARCH:SEARCH<x>:TRIGger:A:WINDow:LOGICQUALification

This command specifies or queries whether or not to use logic qualification for a window search. The search number is specified by x.

**Group** Search and Mark

**Syntax** SEARCH:SEARCH<x>:TRIGger:A:WINDow:LOGICQUALification  
{ON|OFF}  
SEARCH:SEARCH<x>:TRIGger:A:WINDow:LOGICQUALification?

**Arguments** ON specifies to use logic qualification for a window search.  
OFF specifies not to us logic qualification for a window search.

**Examples** SEARCH:SEARCH1:TRIGger:A:WINDow:LOGICQUALification ON turns ON logic qualification for a window search.

SEARCH:SEARCH1:TRIGger:A:WINDow:LOGICQUALification? might return SEARCH:SEARCH1:TRIGGER:A:WINDOW:LOGICQUALIFICATION OFF indicating logic qualification is off.

## SEARCH:SEARCH<x>:TRIGger:A:WINDow:POLarity

This command sets or queries the window trigger threshold crossing of the selected trigger Source. The search number is specified by x.

**Group** Search and Mark

**Syntax** SEARCH:SEARCH<x>:TRIGger:A:WINDow:POLarity  
{UPPer|LOWer|EITHer|NONE}  
SEARCH:SEARCH<x>:TRIGger:A:WINDow:POLarity?

<b>Arguments</b>	<p><b>UPPER</b> specifies that the instrument triggers when the signal remains above the upper threshold for longer than the time limit and then crosses downward through the upper threshold.</p> <p><b>LOWER</b> specifies that the instrument triggers when the signal remains below the lower threshold for longer than the time limit and then crosses upwards through the lower threshold.</p> <p><b>EITHER</b> specifies that the instrument triggers when the signal remains either above the upper threshold or below the lower threshold for longer than the time limit and then crosses a threshold.</p> <p><b>NONE</b> specifies that the instrument triggers when the signal remains outside the upper and lower thresholds for longer than the time limit without crossing through either the upper or lower threshold.</p>
<b>Examples</b>	<p><code>SEARCH:SEARCH1:TRIGGER:A:WINDOW:POLARITY LOWER</code> sets the polarity to lower.</p> <p><code>SEARCH:SEARCH1:TRIGGER:A:WINDOW:POLARITY?</code> might return <code>SEARCH:SEARCH1:TRIGGER:A:WINDOW:POLARITY UPPER</code> indicating the polarity is set to upper.</p>

## SEARCH:SEARCH<x>:TRIGGER:A:WINDOW:SOURCE

This command sets and queries the source for the window search input. The search number is specified by x.

<b>Group</b>	Search and Mark
<b>Syntax</b>	<p><code>SEARCH:SEARCH&lt;x&gt;:TRIGGER:A:WINDOW:SOURCE</code>  <code>{S&lt;x&gt;_Ch&lt;x&gt; CH&lt;x&gt; MATH&lt;x&gt; REF&lt;x&gt;}</code>  <code>SEARCH:SEARCH&lt;x&gt;:TRIGGER:A:WINDOW:SOURCE?</code></p>
<b>Arguments</b>	<p><code>S&lt;x&gt;_Ch&lt;x&gt;</code> specifies is the remote scope number, and the analog channel.</p> <p><code>CH&lt;x&gt;</code> specifies one input channel as the source.</p> <p><code>MATH&lt;x&gt;</code> specifies the math waveform as the source.</p> <p><code>REF&lt;x&gt;</code> specifies the reference waveform as the source.</p>
<b>Examples</b>	<p><code>SEARCH:SEARCH1:TRIGGER:A:WINDOW:SOURCE CH2</code> sets the source to channel 2.</p>

SEARCH:SEARCH1:TRIGger:A:WINDow:SOuRce? might return  
 SEARCH:SEARCH1:TRIGGER:A:WINDOW:SOURCE CH3 indicating the source  
 is channel 3.

## SEARCH:SEARCH<x>:TRIGger:A:WINDow:THReshold:HIGH

This command sets or queries the source threshold HIGH level for a transition trigger search to determine where to place a mark. The search number is specified by x.

<b>Group</b>	Search and Mark
<b>Syntax</b>	SEARCH:SEARCH<x>:TRIGger:A:WINDow:THReshoId:HIGH <NR3> SEARCH:SEARCH<x>:TRIGger:A:WINDow:THReshoId:HIGH?
<b>Arguments</b>	<NR3> is the source threshold HIGH level for a transition trigger search.
<b>Examples</b>	SEARCH:SEARCH1:TRIGger:A:WINDow:THReshoId:HIGH 50.0e-3 sets the high threshold to 50.0 mV.  SEARCH:SEARCH1:TRIGger:A:WINDow:THReshoId:HIGH? might return SEARCH:SEARCH1:TRIGGER:A:WINDOW:THRESHOLD:HIGH 0.0E+0 indicating the high threshold is 0.0 V.

## SEARCH:SEARCH<x>:TRIGger:A:WINDow:THReshold:LOW

This command sets or queries the source threshold LOW level for a transition trigger search to determine where to place a mark. The search number is specified by x.

<b>Group</b>	Search and Mark
<b>Syntax</b>	SEARCH:SEARCH<x>:TRIGger:A:WINDow:THReshoId:LOW <NR3> SEARCH:SEARCH<x>:TRIGger:A:WINDow:THReshoId:LOW?
<b>Arguments</b>	<NR3> the source threshold LOW level for a transition trigger search
<b>Examples</b>	SEARCH:SEARCH1:TRIGger:A:WINDow:THReshoId:LOW -50.0e-3 sets the low threshold to -50.0 mV.

SEARCH:SEARCH1:TRIGger:A:WINDow:THResho1d:LOW? might return  
SEARCH:SEARCH1:TRIGGER:A:WINDOW:THRESHOLD:LOW 0.0E+0 indicating  
the low threshold is 0.0 V.

## SEARCH:SEARCH<x>:TRIGger:A:WINDow:WHEn

This command sets or queries the window search event. The search number is specified by x.

**Group** Search and Mark

**Syntax** SEARCH:SEARCH<x>:TRIGger:A:WINDow:WHEn  
{ENTERSWindow|EXITSWindow| INSIDEGreater|OUTSIDEGreater}  
SEARCH:SEARCH<x>:TRIGger:A:WINDow:WHEn?

**Arguments** ENTERSWindow specifies a window search when the signal enters the window.  
EXITSWindow specifies a window search when the signal exits the window.  
OUTSIDEGreater specifies a search when the signal leaves the window defined by the threshold levels for the time specified by Width.  
INSIDEGreater specifies a search when the signal enters the window defined by the threshold levels for the time specified by Width.

**Examples** SEARCH:SEARCH1:TRIGger:A:WINDow:WHEn EXITSWINDOW specifies a window search when the signal exits the window.  
SEARCH:SEARCH1:TRIGger:A:WINDow:WHEn? might return  
SEARCH:SEARCH1:TRIGGER:A:WINDOW:WHEn ENTERSWINDOW indicating a window search when the signal enters the window.

## SEARCH:SEARCH<x>:TRIGger:A:WINDow:WIDTh

This command sets or queries the width setting for a window trigger search to determine where to place a mark. The search number is specified by x.

**Group** Search and Mark

**Syntax** SEARCH:SEARCH<x>:TRIGger:A:WINDow:WIDTh <NR3>  
SEARCH:SEARCH<x>:TRIGger:A:WINDow:WIDTh?

**Arguments** <NR3> specifies the minimum width in seconds.  
ECL specifies a preset high level of -1.3 V and TTL specifies a preset high level of +1.4V.

**Examples** SEARCH:SEARCH1:TRIGGER:A:WINDOW:WIDTH 400E-12 sets the window trigger width setting for search 1 to 0.4 ns.  
SEARCH:SEARCH1:TRIGGER:A:WINDOW:WIDTH? might return SEARCH:SEARCH1:TRIGGER:A:WINDOW:WIDTH 500.0000E-12, indicating that the window trigger width setting for search 1 is set to 0.5 ns.

## SEARCH:SElected

This command sets or queries the selected search, for example SEARCH1. The search number is specified by x.

**Group** Search and Mark

**Syntax** SEARCH:SElected SEARCH1

**Arguments** SEARCH1 is the specified search.

**Examples** SEARCH:SElected SEARCH1 specifies a search 1 search.  
SEARCH:SElected? might return :SEARCH:SElected SEARCH1 indicating search 1 is selected.

## SEARCHTABLE (No Query Form)

This command adds or deletes a new search event table in an Option 5-WIN (Microsoft Windows 10 OS) TekExpress compliance testing application.

**Group** Search and Mark

**Syntax** SEARCHTABLE {ADDNew|DElete} <qstring>

**Arguments** ADDNew adds a new search events table in the display area.  
DElete removes a displayed search events table from the display area.  
<qstring> contains the name of the search table.

**Examples**     SEARCHTABLE:ADDNew "SEARCHTABLE1" adds the SEARCHTABLE1 in the display area.

                  SEARCHTABLE:DELeTe "SEARCHTABLE1" removes the SEARCHTABLE1 from the display area.

## SET? (Query Only)

This query-only command returns the commands that list the instrument settings, except for configuration information for the calibration values. You can use these commands to return the instrument to the state it was in when you made the SET? query. The SET? query always returns command headers, regardless of the setting of the [HEADer](#) command. This is because the returned commands are intended to be sent back to the instrument as a command string. The [VERBose](#) command can still be used to specify whether the returned headers should be abbreviated or full-length.

This command is identical to the [\\*LRN?](#) command.

**Group**        Miscellaneous

**Syntax**       SET?

**Related Commands**     [HEADer](#)  
                               [\\*LRN?](#)  
                               [VERBose](#)

**Examples**     SET? might return the following response: :ACQUIRE:STOPAFTER  
 RUNSTOP;STATE 1;MODE SAMPLE;NUMENV 10;NUMAVG 16;REPET  
 1;:FASTACQ:STATE 0;:APPLICATION:GPKNOB1:ACTIVE  
 0;:APPLICATION:GPKNOB2:ACTIVE 0;:APPLICATION:WINDOW:HEIGHT  
 236;WIDTH 640;:APPLICATION:SCOPEAPP:STATE  
 RUNNING;WINDOW FULLSCREEN;:APPLICATION:EXTAPP:STATE  
 NOTRUNNING;:AUXOUT:SOURCE ATRIGGER;EDGE FALLING;:CMDBATCH  
 1;:HEADER 1;:LOCK NONE;:ROSC:SOURCE INTERNAL;:VERBOSE  
 1;:ALIAS:STATE 0;:DISPLAY:CLOCK 1;COLOR:PALETTE  
 NORMAL;MATHCOLOR DEFAULT;REFCOLOR DEFAULT;:DISPLAY:FILTER  
 SINX;FORMAT YT;GRATICULE FULL;INTENSITY:WAVEFORM  
 75.0000;AUTOBRIGHT 1;:DISPLAY:PERSISTENCE  
 OFF;STYLE VECTORS;TRIGBAR SHORT;TRIGT 1;VARPERSIST  
 500.0000E-3;PORT FILE;:DIAG:LEVEL SUBSYS;:TRIGGER:A:MODE  
 AUTO;TYPE EDGE;LEVEL 0.0000;HOLDOFF:BY DEFAULT;TIME  
 1.5000E-6;:TRIGGER:A:EDGE:SOURCE CH1;COUPLING DC;SLOPE RISE;.

## SOCKETServer:ENable

This command enables or disables the socket server which supports a telnet or other TCPIP socket connection to send commands and queries to the instrument. The default state is enabled.

**Group** Miscellaneous

**Syntax** SOCKETServer:ENable {0|1|OFF|ON}  
SOCKETServer:ENable?

**Arguments** 1 enables the socket server. If the state is 0 (disabled) and this command is sent to enable the socket server when the port is in use by another service, then the error event code 221 (Settings conflict) is posted to the event queue and the socket server remains disabled. In this case, select a different port number and attempt to enable the socket server again.

0 disables the socket server.

ON enables the socket server.

OFF disables the socket server.

**Examples** SOCKETSERVER:ENABLE On enables the socket server.

SOCKETSERVER:ENABLE? might return :SOCKETSERVER:ENABLE 1 indicating the socket server is enabled.

## SOCKETServer:PORT

This command sets the TCPIP port for the socket server connection.

**Group** Miscellaneous

**Syntax** SOCKETServer:PORT <NR1>  
SOCKETServer:PORT?

**Arguments** <NR1> is the TCPIP port for the socket server connection.

If the socket server is enabled and the port specified is in use by another service, then the error event code 221 (Settings conflict) is posted to the event queue and the socket server remains in its current state (i.e. enabled/disabled and port address remain unchanged).

Similarly, if any sessions are active when the port is changed, this same error event may be posted to the event queue and the port will remain unchanged. In this case, exit all current sessions and send the :SOCKETServer:PORT command again.

**Examples** SOCKETSERVER:PORT 4000 sets the socket server port number to 4000.  
SOCKETSERVER:PORT? might return :SOCKETSERVER:PORT 4000 indicating that the port number is 4000.

## SOCKETServer:PROTOCOL

This command sets or queries the protocol for the socket server.

**Group** Miscellaneous

**Syntax** SOCKETServer:PROTOCOL {TERMiNaL|NONE}  
SOCKETServer:PROTOCOL?

**Arguments** TERMiNaL specifies terminal protocol for the socket server. When set to TERMiNaL, a session startup message is sent to the socket and a command prompt is provided.  
NONE disables the terminal features, allowing the server to be used for raw socket transactions, such as with a VISA socket server. The default setting is NONE.

**Examples** SOCKETSERVER:PROTOCOL NONE sets the protocol to none.  
SOCKETSERVER:PROTOCOL? might return :SOCKETSERVER:PROTOCOL TERMINAL indicating the protocol is set to terminal.

## \*SRE

The \*SRE (Service Request Enable) command sets and queries the bits in the Service Request Enable Register. For more information, refer to Registers.

**Group** Status and Error

**Syntax** \*SRE <NR1>  
\*SRE?



**Related Commands**

\*CLS  
 DESE  
 \*ESE  
 \*ESR?  
 EVENT?  
 EVMsg?  
 FACtory  
 \*STB?

**Arguments**

<NR1> is a value in the range from 0 through 255. The binary bits of the SRER are set according to this value. Using an out-of-range value causes an execution error. The power-on default for SRER is 0 if \*PSC is 1. If \*PSC is 0, the SRER maintains the previous power cycle value through the current power cycle.

**Examples**

\*SRE 48 sets the bits in the SRER to binary 00110000.  
 \*SRE? might return 32, showing that the bits in the SRER have the binary value of 00100000.

**\*STB? (Query Only)**

The \*STB? (Read Status Byte) query returns the contents of the Status Byte Register (SBR) using the Master Summary Status (MSS) bit. For more information, refer to Registers.

**Group**

Status and Error

**Syntax**

\*STB?

**Related Commands**

\*CLS  
 DESE  
 \*ESE  
 \*ESR?  
 EVENT?  
 EVMsg?  
 FACtory

[\\*SRE](#)

**Returns** <NR1>

**Examples** \*STB? might return 96, showing that the SBR contains the binary value 01100000.

## SV:CH<x>:SElect:SPECTrogram

This command sets or queries whether the spectrogram plot for the specified channel is displayed in the Spectrum View.

**Group** Spectrum View

**Syntax** SV:CH<x>:SElect:SPECTrogram {ON|OFF}  
SV:CH<x>:SElect:SPECTrogram?

**Arguments** CH<x> specifies the channel number.

ON turns on spectrogram.

OFF turns off spectrogram.

**Examples** SV:CH4:SElect:SPECTrogram ON turns on spectrogram.

SV:CH4:SElect:SPECTrogram? might return  
:SV:CH4:SElect:SPECTrogram OFF, indicating that spectrogram is off.

## SV:LOCKCenter

This command sets or queries whether the Center Frequency setting is locked across all channels in the Spectrum View.

**Group** Spectrum View

**Syntax** SV:LOCKCenter {ON|1|OFF|0}  
SV:LOCKCenter?

**Related Commands** [REMOTE:S<x>\\_CH<x>:SV:CENTERFrequency](#)

**Arguments** ON, 1 sets all spectrum traces channels in the Spectrum View window to use the same center frequency value. When the center frequency of any channel is changed, the center frequency of all other channels is automatically changed to match that value.

OFF, 0 enables use of different center frequency values for each spectrum trace channel. The center frequencies of all channels are independent.

**Examples** SV:LOCKCenter ON locks all spectrum trace channels to the same center frequency.

SV:LOCKCenter? might return 0, which indicates that each spectrum trace channel may have an independent center frequency setting.

## SV:LOCKspectrum

This command sets or queries whether the Spectrum Time value is locked across all spectrum trace channels in the Spectrum View.

**Group** Spectrum View

**Syntax** SV:LOCKspectrum {ON|1|OFF|0}  
SV:LOCKspectrum?

**Related Commands** [REMOTE:S<x>\\_CH<x>:SV:POSition](#)

**Arguments** ON, 1 sets all spectrum traces channels in the Spectrum View window to use the same Spectrum Time value. When the Spectrum Time of any channel is changed, the Spectrum Time of all other channels is automatically changed to match that value.

OFF, 0 enables use of different Spectrum Time values for each spectrum trace channel. The Spectrum Time of all channels are independent.

**Examples** SV:LOCKspectrum ON sets all spectrum trace channels to use the same spectrum time.

SV:LOCKspectrum? might return 0, which indicates each channel may have an independent Spectrum Time setting.

## SV:MARKER:PEAK:EXCURsion

This command sets or queries the minimum peak excursion value, in dB, for the Spectrum View trace peak markers.

Peak excursion refers to the minimum amount a spectrum signal needs to fall in amplitude between marked peaks to be considered another valid peak. If the peak excursion value is low, more peaks will tend to qualify as valid peaks and have associated markers. If the peak excursion value is high, fewer peaks will have associated markers.

**Group** Spectrum View

**Syntax** SV:MARKER:PEAK:EXCURsion <NR3>  
SV:MARKER:PEAK:EXCURsion?

**Arguments** <NR3> specifies the peak marker excursion value in dB. The range of values is 0.0 dB to 200.0 dB.

**Examples** SV:MARKER:PEAK:EXCURsion 12 sets the peak excursion value to 12 dB.  
SV:MARKER:PEAK:EXCURsion? might return 30.00, indicating that a peak must exceed 30 dB change from other marked peaks to be marked with a peak indicator icon.

## SV:MARKER:PEAK:MAXimum

This command sets or queries the maximum number of Spectrum View peak markers that can be placed on spectrum traces.

the Spectrum View window can show between 1 and 11 peak markers on all spectrum traces. The default is 5. To turn on the peak markers, use the command SV:MARKER:PEAK:STATE. The actual number of peak markers may be less than the maximum, depending on the threshold and excursion values and the spectral content of the RF signal. If more peaks than the maximum are detected that meet the threshold and excursion criteria, only the highest amplitude peaks will have markers placed on them.

**Group** Spectrum View

**Syntax** SV:MARKER:PEAK:MAXimum <NR1>  
SV:MARKER:PEAK:MAXimum?

**Related Commands** [SV:MARKER:PEAK:STATE](#)

**Arguments** <NR1> is an integer value that specifies the maximum number of peak markers to display on spectrum traces. The range of values is 1 to 11.

**Examples** `SV:MARKER:PEAK:MAXimum 3` sets the maximum number of peaks that can have markers to three.

`SV:MARKER:PEAK:MAXimum?` might return 7, indicating that the maximum number of peaks that can have markers is set to seven.

## SV:MARKER:PEAK:STATE

This command sets or queries showing peak markers on spectrum traces in the Spectrum View window.

There are up to 11 markers. The maximum number of markers can be set using the command `SV:MARKER:PEAK:MAXimum`. The peak markers find amplitude peaks based upon threshold and excursion settings (set with the `SV:MARKER:PEAK:EXCURsion` and `SV:MARKER:PEAK:THReshold` commands.) Each peak marker has a readout associated with it. These can be absolute or delta readouts (set with the `SV:MARKER:TYPE` command.)

**Group** Spectrum View

**Syntax** `SV:MARKER:PEAK:STATE {CH<x>}`  
`SV:MARKER:PEAK:STATE?`

**Related Commands** [SV:MARKER:PEAK:MAXimum](#)

[SV:MARKER:PEAK:EXCURsion](#)

[SV:MARKER:PEAK:THReshold](#)

[SV:MARKER:TYPE](#)

**Arguments** ON, 1 enables showing peak marker icons on spectrum trace waveforms.  
 OFF, 0 disables showing peak marker icons on spectrum trace waveforms.

**Examples** `SV:MARKER:PEAK:STATE 1` turns the peak markers on.

`SV:MARKER:PEAK:STATE?` might return 0, indicating that peak markers are turned off.

## SV:MARKER:PEAK:THReshold

This command sets or queries the minimum peak threshold value required to mark a peak. Only peaks with an amplitude greater than the threshold value will qualify for peak marker placement. Applies to all spectrum traces, and to each trace in its own vertical units.

**Group** Spectrum View

**Syntax** SV:MARKER:PEAK:THReshold <NR3>  
SV:MARKER:PEAK:THReshold?

**Related Commands** [SV:S<x>\\_CH<x>:UNIts](#)

**Arguments** <NR3> specifies the peak marker threshold value. The range of values is -200.0 to 200.0.

**Examples** SV:MARKER:PEAK:THReshold -40 sets the peak marker threshold to -40 dBm.  
SV:MARKER:PEAK:THReshold? might return -50.00, indicating that only peaks with an amplitude greater than -50 dBm qualify for peak marker placement.

## SV:MARKER:PEAKS:AMPLITUDE? (Query Only)

This command queries the peak amplitudes for the Spectrum View trace peak markers.

**Group** Spectrum View

**Syntax** SV:MARKER:PEAKS:AMPLITUDE?

**Returns** Returns the peak amplitudes in a comma separated list.

**Examples** SV:MARKER:PEAKS:AMPLITUDE? might return  
"-59.9311294555664, -67.5772018432617, -66.0407104492188, -69.4306945800781,  
indicating that a peak amplitudes are -59.9311294555664, -67.5772018432617,  
-66.0407104492188, -69.4306945800781, and -62.5529403686523.

## SV:MARKER:PEAKS:FREQUENCY? (Query Only)

This command queries the peak frequencies for the Spectrum View trace peak markers.

**Group** Spectrum View

**Syntax** SV:MARKER:PEAKS:FREQUENCY?

**Returns** Returns the peak frequencies in a comma separated list.

**Examples** SV:MARKER:PEAKS:FREQUENCY? might return "781.2605289757411E+6,906.0288915094338E+6,946.8286725067385E+6,1.026059214960E+9,1.1718855289757E+9", indicating that a peak frequencies are 781.2605289757411E+6, 906.0288915094338E+6, 946.8286725067385E+6, and 1.026059214960E+9,1.1718855289757E+9.

## SV:MARKER:REFERENCE (No Query Form)

This command sets the Center Frequency of the currently selected Spectrum View channel to the frequency indicated by the Reference Marker, in effect moving the Reference Marker to the center of the screen.

**Group** Spectrum View

**Syntax** SV:MARKER:REFERENCE

**Related Commands** [SV:S<x>\\_CH<x>:UNITS](#)

**Examples** SV:MARKER:REFERENCE moves the Reference Marker location to the center of the screen.

## SV:MARKER:REFERENCE:AMPLITUDE? (Query Only)

This command queries the amplitude (vertical) value of the Reference Marker in user-set units. This value indicates the absolute amplitude of the Reference Marker, regardless of whether the other markers are manual or automatic.

**Group** Spectrum View

**Syntax** SV:MARKER:REFERENCE:AMPLITUDE?

**Related Commands** SV:S<x>\_CH<x>:UNIts

**Returns** <NR3> specifies the amplitude of the Reference Marker.

**Examples** SV:MARKER:REFERENCE:AMPLITUDE? might return -65.6218, indicating an amplitude value of -65.6218 dBm.

## SV:MARKER:REFERENCE:FREQUENCY? (Query Only)

This command queries the frequency of the Reference Marker, in Hz, when the Spectrum View trace markers are on.

**Group** Spectrum View

**Syntax** SV:MARKER:REFERENCE:FREQUENCY?

**Returns** <NR3> specifies the frequency of the Reference Marker.

**Examples** SV:MARKER:REFERENCE:FREQUENCY? might return 1.6830E+9, indicating that the Reference Marker frequency is 1.683 GHz.

## SV:MARKER:TYPE

This command sets or queries the peak marker type (either DELTA or ABSolute).

An Absolute marker shows the frequency and amplitude at the location of the marker. A Delta marker shows the frequency and amplitude of the marker relative to the Reference Marker. The Reference Marker shows the absolute frequency and amplitude, regardless of this command. The marker amplitude measurements are in dBm for Absolute, or in dBc (dB below carrier amplitude) for Delta.

**Group** Spectrum View

**Syntax** SV:MARKER:TYPE {DELta|ABSolute}  
SV:MARKER:TYPE?



<b>Arguments</b>	<p><b>DELTA</b> specifies to display the frequency and amplitude of the peak markers relative to the Reference Marker. The relative amplitude is in dBc (dB below carrier amplitude); the relative frequency is in Hz.</p> <p><b>ABSOLUTE</b> specifies to display the actual frequency and amplitude of each peak marker. The absolute amplitude is in user-set units; the absolute frequency is in Hz.</p>
<b>Examples</b>	<p><code>SV:MARKER:TYPE DELTA</code> changes the marker type to Delta.</p> <p><code>SV:MARKER:TYPE?</code> might return <b>ABSOLUTE</b>, indicating that the peak markers are measuring the absolute values of the spectrum trace at those positions.</p>

## SV:RF\_PHASE:REFERENCE:MASTER

This command sets or queries the channel used as the Master Phase Reference.

<b>Conditions</b>	Requires option SV-RFVT
<b>Group</b>	Spectrum View
<b>Syntax</b>	<p><code>SV:RF_PHASE:REFERENCE:MASTER {CH&lt;x&gt; NONE}</code>  <code>SV:RF_PHASE:REFERENCE:MASTER?</code></p>
<b>Arguments</b>	<p><b>CH&lt;x&gt;</b> sets the specified channel as the Master Phase Reference source.</p> <p><b>NONE</b> indicates that there is no Master Phase Reference.</p>
<b>Examples</b>	<p><code>SV:RF_PHASE:REFERENCE:MASTER CH3</code> sets the Master Phase Reference source to Channel 3.</p> <p><code>SV:RF_PHASE:REFERENCE:MASTER?</code> might return  <code>SV:RF_PHASE:REFERENCE:MASTER NONE</code>, indicating that there is no Master Phase Reference.</p>

## SV:S<x>\_CH<x>:RF\_AVERAGE:NUMAVG

This command sets or queries the number of acquisitions to be used when creating the Average trace for the specified spectrum trace channel in the Spectrum View. The Average spectrum trace shows the average of values from multiple acquisitions at each trace point. **S<x>** is the remote scope number and **Ch<x>** is the channel number to use as the Spectrum View source.

<b>Group</b>	Spectrum View
<b>Syntax</b>	SV:S<x>_CH<x>:RF_AVErage:NUMAVg <NR1> SV:S<x>_CH<x>:RF_AVErage:NUMAVg?
<b>Arguments</b>	<NR1> specifies the number of acquisitions to average. The range is 2 - 512, in exponential increments.
<b>Examples</b>	SV:S1_CH1:RF_AVErage:NUMAVg 100 sets the number of acquisitions to use for the Average spectrum trace of Scope 1 channel 2 to 128 (the closest power of 2 increment).  SV:S1_CH2:RF_AVErage:NUMAVg? might return 16, indicating that the number of averages for the Scope 1 channel 2 Average spectrum trace is set to 16.

## SV:S<x>\_CH<x>:RF\_MAGnitude:FORMat

This command sets or queries the format of the Magnitude vs. Time trace for the specified channel. S<x> is the remote scope number and Ch<x> is the channel number to use as the Spectrum View source.

<b>Conditions</b>	Requires option SV-RFVT
<b>Group</b>	Spectrum View
<b>Syntax</b>	SV:S<x>_CH<x>:RF_MAGnitude:FORMat {AMPLINear   POWLINear   POWLOG} SV:S<x>_CH<x>:RF_MAGnitude:FORMat?
<b>Related Commands</b>	<a href="#">DISplay:WAVEView&lt;x&gt;:RF_PHASE&lt;x&gt;:VERTical:POSition</a>
<b>Arguments</b>	AMPLINear (Amplitude (linear)) sets the magnitude in Volts with square root conversion of linear power values.  POWLINear (Power (linear)) sets the magnitude in Watts with direct use of linear power values.  POWLOG (Power (log)) sets the magnitude in dB using log conversion of linear power values.

**Examples** `SV:S1_CH2:RF_MAGNitude:FORMat AMPLINear` sets the Scope 1 Channel 2 Magnitude vs. Time trace to be shown with linear power values.

`SV:S1_CH1:RF_MAGNitude:FORMat?` might return `SV:S1_CH1:RF_MAGNitude:FORMat POWLOG`, indicating that the Scope 1 Channel 1 Magnitude vs. Time trace is displayed with log power values.

## SV:S<x>\_CH<x>:RF\_PHASE:REFERENCE:DEGREES

This command sets or queries the channel Phase Reference value in degrees. S<x> is the remote scope number and Ch<x> is the channel number to use as the Spectrum View source.

**Conditions** Requires option SV-RFVT

**Group** Spectrum View

**Syntax** `SV:S<x>_CH<x>:RF_PHASE:REFERENCE:DEGREES <NR3>`  
`SV:S<x>_CH<x>:RF_PHASE:REFERENCE:DEGREES?`

**Related Commands** [SV:S<x>\\_CH<x>:RF\\_PHASE:REFERENCE:TIME](#), [SV:S<x>\\_CH<x>:RF\\_PHASE:REFERENCE:POSITION](#), [SV:RF\\_PHASE:REFERENCE:MASTER](#)

**Arguments** NR3 is the Phase Reference value, in degrees. This indicates a fixed phase value at the phase time set by `SV:S<x>_CH<x>:RF_PHASE:REFERENCE:TIME`. If CH<x> is the master phase reference, then the value is used to calculate the phase values of all other channels.

**Examples** `SV:S1_CH1:RF_PHASE:REFERENCE:DEGREES 25` sets the Phase Reference value to 25 degrees.

`SV:S1_CH2:RF_PHASE:REFERENCE:DEGREES?` might return `SV:S1_CH2:RF_PHASE:REFERENCE:DEGREES 0`, indicating that the Phase Reference value is 0 degrees.

## SV:S<x>\_CH<x>:RF\_PHASE:REFERENCE:POSITION

This command sets or queries whether the channel Phase Reference is located at the Trigger position or at the Cursor A position. S<x> is the remote scope number and Ch<x> is the channel number to use as the Spectrum View source.

<b>Conditions</b>	Requires option SV-RFVT
<b>Group</b>	Spectrum View
<b>Syntax</b>	SV:S<x>_CH<x>:RF_PHASE:REFerence:POSition {TRIGger CURSor} SV:S<x>_CH<x>:RF_PHASE:REFerence:POSition?
<b>Related Commands</b>	<a href="#">SV:S&lt;x&gt;_CH&lt;x&gt;:RF_PHASE:REFerence:TIME</a> , <a href="#">SV:S&lt;x&gt;_CH&lt;x&gt;:RF_PHASE:REFerence:DEGrees</a> , <a href="#">SV:RF_PHASE:REFerence:MASTer</a>
<b>Arguments</b>	TRIGger sets the Phase Reference location to the Trigger position.  CURSor sets the channel Phase Reference location to the phase time set by SV:S<x>_CH<x>:RF_PHASE:REFerence:TIME, which defaults to the Cursor A position.
<b>Examples</b>	SV:S1_CH1:RF_PHASE:REFerence:POSition TRIGger sets the Phase Reference location to the Trigger position.  SV:S1_H2:RF_PHASE:REFerence:POSition? might return SV:CH2:RF_PHASE:REFerence:POSition CURSor, indicating that the Phase Reference location is at the Cursor A position.

## SV:S<x>\_CH<x>:RF\_PHASE:REFerence:TIME

This command sets or queries the channel Phase Reference time in seconds. S<x> is the remote scope number and Ch<x> is the channel number to use as the Spectrum View source.

<b>Conditions</b>	Requires option SV-RFVT
<b>Group</b>	Spectrum View
<b>Syntax</b>	SV:S<x>_CH<x>:RF_PHASE:REFerence:TIME <NR3> SV:S<x>_CH<x>:RF_PHASE:REFerence:TIME?
<b>Related Commands</b>	<a href="#">SV:S&lt;x&gt;_CH&lt;x&gt;:RF_PHASE:REFerence:DEGrees</a> , <a href="#">SV:S&lt;x&gt;_CH&lt;x&gt;:RF_PHASE:REFerence:POSition</a> , <a href="#">SV:RF_PHASE:REFerence:MASTer</a>

**Arguments** NR3 is the Phase Reference time, in seconds. This indicates the time at which the phase value set by `SV:S<x>_CH<x>:RF_PHASE:REFERENCE:DEGREES` is applied. If the phase position set by `SV:S<x>_CH<x>:RF_PHASE:REFERENCE:POSITION` is TRIGGER, then the phase time is fixed at 0 seconds and cannot be changed. If the phase position is CURSOR, then the phase time may be set to any value, and is initialized to the position of Cursor A. If CH<x> is the master phase reference, then the time is used to calculate the phase values of all other channels.

**Examples** `SV:S1_CH1:RF_PHASE:REFERENCE:TIME 25e-9` sets the Phase Reference time to 25 ns.

`SV:S1_CH1:RF_PHASE:REFERENCE:TIME?` might return  
`SV:S1_CH1:RF_PHASE:REFERENCE:TIME 0`, indicating that the Phase Reference time is 0 seconds.

## SV:S<x>\_CH<x>:RF\_PHASE:WRAP:DEGREES

This command sets or queries the Phase Wrap limit for the Phase vs. Time trace for the specified channel. S<x> is the remote scope number and Ch<x> is the channel number to use as the Spectrum View source.

**Conditions** Requires option SV-RFVT

**Group** Spectrum View

**Syntax** `SV:S<x>_CH<x>:RF_PHASE:WRAP:DEGREES <NR3>`  
`SV:S<x>_CH<x>:RF_PHASE:WRAP:DEGREES?`

**Arguments** CH<x> is the channel number of the Phase vs. Time trace.

NR3 sets the number of wrap degrees, from 180 degrees to infinity. When Phase Wrap is enabled, the phase values in the Phase vs Time waveform are constrained to be within  $\pm$  the specified limit. Phase values below or above the limit are wrapped by repeatedly adding or subtracting 360 degrees until they are within range.

**Examples** `SV:S1_CH2:RF_PHASE:WRAP:DEGREES 200` sets the Phase Wrap limit for the open 1 Channel 2 Phase vs. Time trace to 200 degrees.

`SV:S1_CH2:RF_PHASE:WRAP:DEGREES?` might return  
`SV:S1_CH2:RF_PHASE:WRAP:DEGREES 210`, indicating that the Phase Wrap limit for the Scope 1 Channel 2 Phase vs. Time trace is 210 degrees.

## SV:S<x>\_CH<x>:RF\_PHASE:WRAP:STATE

This command sets or queries whether Phase Wrap is applied to the Phase vs. Time trace for the specified channel. S<x> is the remote scope number and Ch<x> is the channel number to use as the Spectrum View source.

<b>Conditions</b>	Requires option SV-RFVT
<b>Group</b>	Spectrum View
<b>Syntax</b>	SV:S<x>_CH<x>:RF_PHASE:WRAP:STATE {ON OFF} SV:S<x>_CH<x>:RF_PHASE:WRAP:STATE?
<b>Arguments</b>	ON enables applying phase wrap on the specified Phase vs. Time channel trace. OFF disables applying phase wrap on the specified Phase vs. Time channel trace.
<b>Examples</b>	SV:S1_CH1:RF_PHASE:WRAP:STATE ON turns on (enables) Phase Wrap for the Scope 1 Channel 1 Channel 5 Phase vs. Time trace.  SV:S1_CH1:RF_PHASE:WRAP:STATE? might return SV:CH1:RF_PHASE:WRAP:STATE OFF, indicating that Phase Wrap is turned off (disabled) for the Scope 1 Channel 1 Phase vs. Time trace.

## SV:S<x>\_CH<x>:SElect:RF\_AVErage

This command sets or queries whether the Average trace is displayed for the specified spectrum trace channel in the Spectrum View. S<x> is the remote scope number and Ch<x> is the channel number to use as the Spectrum View source.

<b>Group</b>	Spectrum View
<b>Syntax</b>	SV:S<x>_CH<x>:SElect:RF_AVErage {ON 1 OFF 0} SV:S<x>_CH<x>:SElect:RF_AVErage?
<b>Arguments</b>	ON, 1 enables the display of the Average trace for the specified spectrum trace channel.  OFF, 0 disables the display of the Average trace for the specified spectrum trace channel.

**Examples** `SV:S1_CH3:SElect:RF_AVErAge ON` turns on the display of the Average trace for the Scope 1 channel 3 spectrum trace.

`SV:S1_CH3:SElect:RF_AVErAge?` might return 0, indicating that the Average trace for the Scope 1 channel 3 spectrum trace is turned off.

## **SV:S<x>\_CH<x>:SElect:RF\_FREQUency**

This command sets or queries whether the Frequency vs. Time trace for the specified channel is displayed in the Waveform View. S<x> is the remote scope number and Ch<x> is the channel number to use as the Spectrum View source.

**Conditions** Requires option SV-RFVT

**Group** Spectrum View

**Syntax** `SV:S<x>_CH<x>:SElect:RF_FREQUency {ON|OFF}`  
`SV:S<x>_CH<x>:SElect:RF_FREQUency?`

**Arguments** ON enables display of the Frequency vs. Time trace.  
 OFF disables display of the Frequency vs. Time trace.

**Examples** `SV:S1_CH4:SElect:RF_FREQUency ON` turns on display of the Scope 1 Channel 4 Frequency vs. Time trace.

`SV:S1_CH4:SElect:RF_FREQUency?` might return  
`SV:CH1:SElect:RF_FREQUency OFF`, indicating that the Scope 1 Channel 4 Frequency vs. Time trace is not displayed.

## **SV:S<x>\_CH<x>:SElect:RF\_MAGnitide**

This command sets or queries whether the Magnitude vs. Time trace for the specified channel is displayed in the Waveform View. S<x> is the remote scope number and Ch<x> is the channel number to use as the Spectrum View source.

**Conditions** Requires option SV-RFVT

**Group** Spectrum View

**Syntax**    `SV:S<x>_CH<x>:SElect:RF_MAGnitude {ON|OFF}`  
`SV:S<x>_CH<x>:SElect:RF_MAGnitude?`

**Arguments**    ON enables display of the Magnitude vs. Time trace.  
OFF disables display of the Magnitude vs. Time trace.

**Examples**    `SV:S1_CH4:SElect:RF_MAGnitude ON` turns on (enables) display of the Scope 1 Channel 4 Magnitude vs. Time trace.  
`SV:S1_CH4:SElect:RF_MAGnitude?` might return  
`SV:CH1:SElect:RF_MAGnitude OFF`, indicating that the Scope 1 Channel 4 Magnitude vs. Time trace is not displayed.

## **SV:S<x>\_CH<x>:SElect:RF\_MAXHold**

This command sets or queries whether the Max Hold trace is displayed for the specified spectrum trace channel in the Spectrum View. S<x> is the remote scope number and Ch<x> is the channel number to use as the Spectrum View source.

**Group**    Spectrum View

**Syntax**    `SV:S<x>_CH<x>:SElect:RF_MAXHo1d {ON|1|OFF|0}`  
`SV:S<x>_CH<x>:SElect:RF_MAXHo1d?`

**Arguments**    ON, 1 enables the display of the Max Hold trace for the specified spectrum trace channel.  
OFF, 0 disables the display of the Max Hold trace for the specified spectrum trace channel.

**Examples**    `SV:S1_CH3:SElect:RF_MAXHo1d ON` turns on the display of the Max Hold trace for the Scope 1 channel 3 spectrum trace.  
`SV:S1_CH3:SElect:RF_MAXHo1d?` might return 1, indicating that the Max Hold trace for the Scope 1 channel 3 spectrum trace is displayed.

## **SV:S<x>\_CH<x>:SElect:RF\_MINHold**

This command sets or queries whether the Min Hold trace is displayed for the specified spectrum trace channel in the Spectrum View. S<x> is the remote scope number and Ch<x> is the channel number to use as the Spectrum View source.



<b>Group</b>	Spectrum View
<b>Syntax</b>	SV:S<x>_CH<x>:SElect:RF_MINHo1d {ON 1 OFF 0} SV:S<x>_CH<x>:SElect:RF_MINHo1d?
<b>Arguments</b>	ON, 1 enables the display of the Min Hold trace for the specified spectrum trace channel.  OFF, 0 disables the display of the Min Hold trace for the specified spectrum trace channel.
<b>Examples</b>	SV:S1_CH2:SElect:RF_MINHo1d ON turns on the display of the Min Hold trace for the Scope 1 channel 2 spectrum trace.  SV:S1_CH2:SElect:RF_MINHo1d? might return 0, indicating that the Min Hold trace for the Scope 1 channel 2 spectrum trace is turned off.

## SV:S<x>\_CH<x>:SElect:RF\_NORMal

This command sets or queries whether the Normal trace is displayed for the specified spectrum trace channel in the Spectrum View. S<x> is the remote scope number and Ch<x> is the channel number to use as the Spectrum View source.

<b>Group</b>	Spectrum View
<b>Syntax</b>	SV:S<x>_CH<x>:SElect:RF_NORMal {ON 1 OFF 0} SV:S<x>_CH<x>:SElect:RF_NORMal?
<b>Arguments</b>	ON, 1 enables the display of the Normal trace for the specified spectrum trace channel.  OFF, 0 disables the display of the Normal trace for the specified spectrum trace channel.
<b>Examples</b>	SV:S1_CH3:SElect:RF_NORMal ON turns on the display of the Average trace for the Scope 1 channel 3 spectrum trace.  SV:S1_CH3:SElect:RF_NORMal? might return 0, indicating that the Average trace for the Scope 1 channel 3 spectrum trace is turned off.

## SV:S<x>\_CH<x>:SElect:RF\_PHASE

This command sets or queries whether the Phase vs. Time trace for the specified channel is displayed in the Waveform View. S<x> is the remote scope number and Ch<x> is the channel number to use as the Spectrum View source.

<b>Conditions</b>	Requires option SV-RFVT
<b>Group</b>	Spectrum View
<b>Syntax</b>	SV:S<x>_CH<x>:SElect:RF_PHASE {ON OFF} SV:S<x>_CH<x>:SElect:RF_PHASE?
<b>Arguments</b>	ON enables display of the Phase vs. Time trace. OFF disables display of the Phase vs. Time trace.
<b>Examples</b>	SV:S1_CH4:SElect:RF_PHASE ON turns on (enables) display of the Scope 1 Channel 4 Phase vs. Time trace. SV:S1_CH4:SElect:RF_PHASE? might return SV:S1_CH4:SElect:RF_PHASE OFF, indicating that the Scope 1 Channel 4 Phase vs. Time trace is not displayed.

## SV:S<x>\_CH<x>:SElect:SPECTrogram

This command sets or queries whether the spectrogram plot for the specified channel is displayed in the Spectrum View.

<b>Conditions</b>	Requires option SV-RFVT
<b>Group</b>	Remote Scope
<b>Syntax</b>	SV:S<x>_CH<x>:SElect:SPECTrogram {ON OFF} SV:S<x>_CH<x>:SElect:SPECTrogram?
<b>Arguments</b>	S<x> is the remote scope number and CH<x> specifies the analog channel as source. ON turns on spectrogram. OFF turns of spectrogram.

**Examples** `SV:S1_CH1:SElect:SPECTrogram ON` turns on spectrogram.  
`SV:S1_CH1:SElect:SPECTrogram?` might return  
`SV:S1_CH1:SElect:SPECTrogram OFF`, indicating that spectrogram is off.

## SV:S<x>\_CH<x>:SELTrace

This command sets or queries the spectrum trace type to show for the specified channel in the Spectrum View. Each channel's spectrum trace can display up to four traces; a Normal trace (default), a Max Hold trace, a Min Hold trace and an Average trace. S<x> is the remote scope number and Ch<x> is the channel number to use as the Spectrum View source.

**Group** Spectrum View

**Syntax** `SV:S<x>_CH<x>:SELTrace {NORMal|MAXHold|MINHold|AVERage}`  
`SV:S<x>_CH<x>:SELTrace?`

**Arguments** `NORMal` selects the Normal trace for the specified spectrum trace channel. If the specified spectrum trace channel does not have a Normal trace, this command is ignored.

`MAXHold` selects the Max Hold trace for the specified spectrum trace channel. If the specified spectrum trace channel does not have a Max Hold trace, this command is ignored.

`MINHold` selects the Min Hold trace for the specified spectrum trace channel. If the specified spectrum trace channel does not have a Min Hold trace, this command is ignored.

`AVERage` selects the Average trace for the specified spectrum trace channel. If the specified spectrum trace channel does not have an Average trace, this command is ignored.

**Examples** `SV:S1_CH1:SELTrace MAXhold` selects the Max Hold trace of the Scope 1 channel 1 spectrum trace in the Spectrum View.

`SV:S1_CH1:SELTrace?` might return `AVE`, indicating that the Average trace of the Scope 1 channel 1 spectrum trace is currently selected in the Spectrum View.

## SV:S<x>\_CH<x>:SQUELCH:STATE

This command sets or queries whether Squelch is enabled for the RF vs Time traces for the specified channel. The frequency vs. time and phase vs. time traces aren't meaningful when the transmitting signal is turned off, as they just show

broadband noise that clutters up the display. With squelch, a threshold may be defined for the magnitude vs. time trace to indicate when the transmitter is on/off. Then the frequency and phase vs. time traces are shown only when the magnitude vs. time trace is above the threshold and they are blanked out when it's below the threshold. S<x> is the remote scope number and Ch<x> is the channel number to use as the Spectrum View source.

<b>Conditions</b>	Requires option SV-RFVT
<b>Group</b>	Spectrum View
<b>Syntax</b>	SV:S<x>_CH<x>:SQUELCH:STATE {ON OFF} SV:S<x>_CH<x>:SQUELCH:STATE?
<b>Related Commands</b>	<a href="#">SV:S&lt;x&gt;_CH&lt;x&gt;:SQUELCH:THReshold</a>
<b>Arguments</b>	ON enables (turns on) Squelch calculations. OFF disables (turns off) Squelch calculations.
<b>Examples</b>	SV:S1_CH6:SQUELCH:STATE ON turns on Squelch calculations for the RF vs. Time traces of Scope 1 Channel 6.  SV:S1_CH6:SQUELCH:STATE? might return SV:S1_CH6:SQUELCH:STATE OFF, indicating that Squelch calculations are turned off for the RF vs. Time traces of Scope 1 Channel 6.

## SV:S<x>\_CH<x>:SQUELCH:THReshold

This command sets or queries the Squelch threshold value for the RF vs Time traces for the specified channel. S<x> is the remote scope number and Ch<x> is the channel number to use as the Spectrum View source.

<b>Conditions</b>	Requires option SV-RFVT
<b>Group</b>	Spectrum View
<b>Syntax</b>	SV:S<x>_CH<x>:SQUELCH:THReshold <NR3> SV:S<x>_CH<x>:SQUELCH:THReshold?

**Related Commands** [SV:S<x>\\_CH<x>:SQUELCH:STATE](#)

**Arguments** NR3 sets the threshold value, in volts, applied to the Magnitude vs. Time trace that determines whether or not to show the Frequency and Phase vs. Time traces for the same channel.

**Examples** `SV:S1_CH5:SQUELCH:THRESHOLD 0.5` sets the Squelch Threshold value to 0.5 volts for the RF vs Time traces of Scope 1 Channel 5.

`SV:S1_CH5:SQUELCH:THRESHOLD?` might return `SV:S1_CH5:SQUELCH:THRESHOLD 1.25`, indicating a Squelch Threshold value of 1.25 Volts for the RF vs. Time traces of Scope 1 Channel 5.

## SV:S<x>\_CH<x>:UNITS

This command sets or queries the absolute logarithmic amplitude vertical scale units to show in the specified spectrum trace remote scope channel of the Spectrum View. S<x> is the remote scope number and Ch<x> is the channel number to use as the Spectrum View source.

**Group** Spectrum View

**Syntax** `SV:S<x>_CH<x>:UNITS {DBM|DBUW|DBMV|DBUV|DBMA|DBUA}`  
`SV:S<x>_CH<x>:UNITS?`

**Arguments** DBM specifies Decibel milliwatts (dBm).  
 DBUW specifies Decibel microwatts (dBμW).  
 DBMV specifies Decibel millivolts (dBmV).  
 DBUV specifies Decibel microvolts (dBμV).  
 DBMA specifies Decibel milliamperes (dBmA).  
 DBUA specifies Decibel microamperes (dBμA).

**Examples** `SV:S1_CH2:UNITS DBUV` sets the units to be used for the Scope 1 channel 2 spectrum trace to decibel microvolts.

`SV:S1_CH2:UNITS?` might return `DBM`, indicating that the vertical units for the Scope 1 channel 2 spectrum trace are decibel milliwatts.

## SV:SPECTrogram:CSCale:MAX

This command sets or queries the maximum color scale value. Maximum must be > Minimum. If the user is adjusting Maximum down to the point where it would be the same as Minimum, then Minimum begins decrementing as needed to stay 1 dB below Maximum.

<b>Conditions</b>	Requires option SV-RFVT.
<b>Group</b>	Spectrum View
<b>Syntax</b>	SV:SPECTrogram:CSCale:MAX <NR3> SV:SPECTrogram:CSCale:MAX?
<b>Related Commands</b>	<a href="#">SV:S&lt;x&gt;_CH&lt;x&gt;:SElect:SPECTrogram</a>
<b>Arguments</b>	<NR3> sets the maximum color scale value. The default value is 0.0 and the valid range is -169.0 to 100.0.
<b>Examples</b>	SV:SPECTROGRAM:CSCALE:MAX 0 sets the color scale max value to 0.  SV:SPECTROGRAM:CSCALE:MAX? might return :SV:SPECTrogram:CSCale:MAX 0, indicating that the color scale max value is 0.

## SV:SPECTrogram:CSCale:MIN

This command sets or queries the minimum color scale value. Minimum must be < Maximum. If the user is adjusting Minimum up to the point where it would be the same as Minimum, then Maximum begins incrementing as needed to stay 1 dB above minimum.

<b>Conditions</b>	Requires option SV-RFVT.
<b>Group</b>	Spectrum View
<b>Syntax</b>	SV:SPECTrogram:CSCale:MIN <NR3> SV:SPECTrogram:CSCale:MIN?
<b>Related Commands</b>	<a href="#">SV:S&lt;x&gt;_CH&lt;x&gt;:SElect:SPECTrogram</a>

- Arguments** <NR3> sets the maximum color scale value. The default value is 0.0 and the valid range is -169.0 to 100.0.
- Examples** SV:SPECTROGRAM:CSCALE:MIN -100.0 sets the color scale min value to -100.0.  
SV:SPECTROGRAM:CSCALE:MIN? might return  
:SV:SPECTrogram:CSCaLe:MAX -100.0, indicating that the color scale min value is -100.0.

## SV:SPECTrogram:CURSor:A

This command sets or queries whether the spectrum trace at cursor A position is selected or not.

- Conditions** Requires option SV-RFVT.
- Group** Spectrum View
- Syntax** SV:SPECTrogram:CURSor:A {1|0|ON|OFF}  
SV:SPECTrogram:CURSor:A?

**Related Commands** [SV:S<x>\\_CH<x>:SElect:SPECTrogram](#)

- Arguments** 1 turns on the spectrum trace for cursor A position.  
0 turns off the spectrum trace for cursor A position. Off is the default.  
ON turns on the spectrum trace for cursor A position.  
OFF turns off the spectrum trace for cursor A position. Off is the default.

- Examples** SV:SPECTROGRAM:CURSOR:A ON turns on the spectrum trace for cursor A position.  
SV:SPECTROGRAM:CURSOR:A? might return :SV:SPECTrogram:CURSor:A OFF, indicating that the spectrum trace for cursor A position is turned off.

## SV:SPECTrogram:CURSor:B

This command sets or queries whether the spectrum trace at cursor B position is selected or not.

<b>Conditions</b>	Requires option SV-RFVT.
<b>Group</b>	Spectrum View
<b>Syntax</b>	SV:SPECTrogram:CURSOR:B {1 0 ON OFF} SV:SPECTrogram:CURSOR:B?
<b>Related Commands</b>	<a href="#">SV:S&lt;x&gt;_CH&lt;x&gt;:SElect:SPECTrogram</a>
<b>Arguments</b>	1 turns on the spectrum trace for cursor B position. 0 turns off the spectrum trace for cursor B position. Off is the default. ON turns on the spectrum trace for cursor B position. OFF turns off the spectrum trace for cursor B position. Off is the default.
<b>Examples</b>	SV:SPECTROGRAM:CURSOR:B ON turns on the spectrum trace for cursor B position. SV:SPECTROGRAM:CURSOR:B? might return :SV:SPECTrogram:CURSOR:B OFF, indicating that the spectrum trace for cursor B position is turned off.

## TIME

This command sets the time in the form *hh:mm:ss* where hh refers to a two-digit hour number, mm refers to a two-digit minute number from 01 to 60, and ss refers to a two-digit second number from 01 to 60.

<b>Conditions</b>	Time can only be changed in increments of 1 hour maximum. There is a 24-hour total time change limit. Time changes cannot cross the 00:00:00 boundary. On Linux, if an internet connection is present, any time changes are automatically overridden by the NTP server. This also resets the 24-hour time change limit. On Windows, this command only succeeds if the scope application was started with administrator privileges.
<b>Group</b>	Miscellaneous
<b>Syntax</b>	TIME <QString> TIME?



**Related Commands**    [DATE?](#)

**Arguments**    <QString> is a quoted string representing the desired time.

**Examples**    `TIME "13:02:10"` sets the time to 1:02 p.m. and 10 seconds.  
`TIME?` might return `:TIME "14:05:17"`, indicating the current time is set to 2:05 p.m. and 17 seconds.

## TIME:ZONE

This command sets the time zone to the one specified.

**Group**    Miscellaneous

**Syntax**    `TIME:ZONE <QString>`  
`TIME:ZONE?`

**Arguments**    <QString> is a quoted string representing the desired time zone.

**Examples**    `TIME:ZONE "America/Yellowknife"` sets the time zone to UTC delta -7.  
`TIME:ZONE?` might return `:TIME:ZONE "America/Los_Angeles"`.

## TIME:ZONE:UTCDELTA

This command sets or queries the time zone using the difference between the desired time zone and UTC.

**Group**    Miscellaneous

**Syntax**    `TIME:ZONE:UTCDELTA <NR3>`  
`TIME:ZONE:UTCDELTA?`

**Arguments**    <NR3> is the specified number of hours difference between the desired time zone and UTC which is equivalent to GMT. The deltas supported are: -12.00, -11.00, -10.00, -9.30, -9.00, -8.30, -8.00, -7.00, -6.00, -5.00, -4.00, -3.30, -3.00, -2.00, -1.00, 0.0, 1.00, 2.00, 3.00, 3.30, 4.00, 4.30, 5.00, 5.30, 6.00, 6.30, 7.00, 8.00, 9.00, 9.30, 10.00, 10.30, 11.00, 11.30, 12.00

**Examples**    `TIME:ZONE:UTCDELTA -7.0e0` sets the time zone to America/Yellowknife.  
`TIME:ZONE:UTCDELTA?` might return `:TIME:ZONE:UTCDELTA -8.0000`.

## TOTaluptime? (Query Only)

Total number of hours the instrument has been turned on since the NV memory was last programmed, usually during the initial manufacturing process.

**Group**    Miscellaneous

**Syntax**    `TOTaluptime?`

**Returns**    The total number of hours the instrument has been turned on since the NV memory was last programmed.

**Examples**    `TOTALUPTIME?` might return `:TOTALUPTIME 756` indicating the up time is 756 minutes.

## TRIGger:{A|B}:EDGE:COUPling

This command sets or queries the type of coupling for the edge trigger. This command is equivalent to selecting Edge from the Trigger Type drop-down in the Trigger setup context menu, and choosing from the Coupling drop-down list.

**Group**    Trigger

**Syntax**    `TRIGger:{A|B}:EDGE:COUPling {DC|HFRej|LFRej|NOISerej}`  
`TRIGger:{A|B}:EDGE:COUPling?`

**Related Commands**    [TRIGger:{A|B}:EDGE:SOUrce](#)  
[TRIGger:{A|B}:EDGE:SLOpe](#)

**Arguments**    DC selects DC trigger coupling, which passes all input signals to the trigger circuitry.

HFRej coupling attenuates signals above 50 kHz before passing the signals to the trigger circuitry.

LFREj coupling attenuates signals below 80 kHz before passing the signals to the trigger circuitry.

NOISErej coupling provides stable triggering by increasing the trigger hysteresis. Increased hysteresis reduces the trigger sensitivity to noise but can require greater trigger signal amplitude.

**Examples** TRIGGER:A:EDGE:COUPLING DC sets the A edge trigger coupling to DC.

TRIGGER:A:EDGE:COUPLING? might return :TRIGGER:A:EDGE:COUPLING DC, indicating that the A edge trigger coupling is set to DC.

## TRIGger:{A|B}:EDGE:SLOpe

This command sets or queries the slope for the edge trigger. This command is equivalent to selecting Edge from the Trigger Type drop-down in the Trigger setup context menu, and then choosing the desired Slope. This command is also equivalent to pressing the front-panel Slope button.

**Group** Trigger

**Syntax** TRIGger:{A|B}:EDGE:SLOpe {RISe|FALL|EITHer}  
TRIGger:{A|B}:EDGE:SLOpe?

**Related Commands** [TRIGger:{A|B}:EDGE:SOUrce](#)  
[TRIGger:{A|B}:EDGE:COUPling](#)

**Arguments** RISE specifies to trigger on the rising or positive edge of a signal.  
FALL specifies to trigger on the falling or negative edge of a signal.  
EITHER specifies to trigger on either the rising or falling edge of a signal.

**Examples** TRIGGER:A:EDGE:SLOPE RISE sets the A edge trigger slope to positive, which triggers on the rising edge of the signal.

TRIGGER:A:EDGE:SLOPE? might return :TRIGGER:A:EDGE:SLOPE FALL, indicating that the A edge trigger slope is negative.

## TRIGger:{A|B}:EDGE:SOURce

This command sets or queries the source for the edge trigger. For instruments that have an Auxiliary Input (such as the MSO58LP), AUXiliary can be selected as trigger source.

**Group** Trigger

**Syntax** TRIGger:{A|B}:EDGE:SOURce {CH<x>|CH<x>\_D<y>|LINE|AUXiliary}  
TRIGger:{A|B}:EDGE:SOURce?

**Related Commands** [TRIGger:{A|B}:EDGE:SLOpe](#)  
[TRIGger:{A|B}:EDGE:COUPling](#)

**Arguments** CH<x> specifies an analog channel as the edge trigger source.  
CH<x>\_D<y> specifies a digital channel as the edge trigger source.  
LINE specifies AC line voltage, and is a valid source when B trigger is inactive.  
AUXiliary specifies the Auxiliary Input.

**Examples** TRIGGER:A:EDGE:SOURCE CH2 sets the A edge trigger source to input channel 2.  
TRIGGER:A:EDGE:SOURCE? might return :TRIGGER:A:EDGE:SOURCE CH1, indicating that the A edge trigger source is set to input channel 1.

## TRIGger:{A|B}:LEVel:CH<x>

This command sets or queries the CH<x> trigger level for an Edge, Pulse Width, Runt or Rise/Fall (Transition and Slew Rate) trigger when triggering on an analog channel waveform. Each channel can have an independent trigger level. The <x> is the channel number.

**Group** Trigger

**Syntax** TRIGger:{A|B}:LEVel:CH<x> <NR3>  
TRIGger:{A|B}:LEVel:CH<x>?

**Arguments** <NR3> specifies the trigger level in user units (usually volts).

**Examples** TRIGGER:A:LEVEL:CH1 1.5 sets the A trigger level for Channel 1 to 1.5 V.  
 TRIGGER:A:LEVEL:CH2? might return :TRIGGER:A:LEVEL:CH2  
 1.3000E+00, indicating that the A trigger level for Channel 2 is set to 1.3 V.

## TRIGger:{A|B}:TYPE

This command sets or queries the type of A or B trigger.

**Group** Trigger

**Syntax** TRIGger:{A|B}:TYPE {EDGE|WIDTH|TIMEOut|RUNT|WINDOW|LOGIC|  
 SETHold|TRANSITION|BUS}  
 TRIGger:{A|B}:TYPE?

**Arguments** EDGE is a normal trigger. A trigger event occurs when a signal passes through a specified voltage level in a specified direction and is controlled by the TRIGger:A:EDGE commands.

WIDTH specifies that the trigger occurs when a pulse with a specified width is found.

TIMEOut specifies that a trigger occurs when a pulse with the specified timeout is found.

RUNT specifies that a trigger occurs when a pulse with the specified parameters is found.

WINDOW specifies that a trigger occurs when a signal with the specified window parameters is found.

LOGIC specifies that a trigger occurs when specified conditions are met and is controlled by the TRIGger:{A|B}:LOGIC commands.

SETHold specifies that a trigger occurs when a signal is found that meets the setup and hold parameters.

TRANSITION specifies that a trigger occurs when a specified pulse is found that meets the transition trigger parameters.

BUS specifies that a trigger occurs when a signal is found that meets the specified bus setup parameters.

**Examples** TRIGGER:A:TYPE EDGE sets the A trigger type to EDGE.  
 TRIGGER:A:TYPE? might return :TRIGGER:A:TYPE RUNT indicating that the A trigger type is a runt trigger.

## \*TST? (Query Only)

Tests (self-test) the interface and returns a 0.

**Group** Miscellaneous

**Syntax** \*TST?

**Examples** \*TST? always returns 0.

## UNDO (No Query Form)

Reverts the instrument settings to a state before the previous command or user interface action.

**Group** Miscellaneous

**Syntax** UNDO

**Examples** UNDO reverts the instrument settings to a state before the previous command or user interface action.

## VERBose

This command sets or queries the Verbose state that controls the length of keywords on query responses. Keywords can be both headers and arguments.

---

**NOTE.** *This command does not affect IEEE Std 488.2-1987 Common Commands (those starting with an asterisk).*

---

**Group** Miscellaneous

**Syntax** VERBose {<NR1>|OFF|ON}  
VERBose?

**Related Commands** [HEADer](#)  
[\\*LRN?](#)

## SET?

<b>Arguments</b>	<p>&lt;NR1&gt; = 0 disables Verbose, any other value enables Verbose.</p> <p>OFF sets the Verbose state to false, which returns minimum-length keywords for applicable setting queries.</p> <p>ON sets the Verbose state to true, which returns full-length keywords for applicable setting queries.</p> <p>A 0 returns minimum-length keywords for applicable setting queries; any other value returns full-length keywords.</p>
<b>Examples</b>	<p>VERBOSE ON sets the Verbose state to true and return the full length keyword for the applicable setting queries.</p> <p>VERBOSE? might return :VERBOSE OFF, indicating that the Verbose state is set to false and return the minimum-length keywords for the applicable setting queries.</p> <p>With :HEADer ON and :VERBOse ON, the :ACQui re:MODE? query might return: :ACQUIRE:MODE SAMPLE</p> <p>With :HEADer ON and :VERBOse OFF, the :ACQui re:MODE? query might return: :ACQ:MOD SAM</p> <p>With :HEADer OFF and :VERBOse ON, the :ACQui re:MODE? query might return: SAMPLE</p> <p>With :HEADer OFF and :VERBOse OFF, the :ACQui re:MODE? query might return: SAM</p>

## VERTical:DESKew:FROM:CUSTOMPROPAGation

This command sets or queries a target (FROM) delay that you can specify when the propagation delay of the target (FROM) probe used for deskew cannot be detected automatically.

<b>Group</b>	Vertical
<b>Syntax</b>	<pre>VERTical:DESKew:FROM:CUSTOMPROPAGation &lt;NR3&gt; VERTical:DESKew:FROM:CUSTOMPROPAGation?</pre>
<b>Arguments</b>	<p>&lt;NR3&gt; is a target (FROM) delay that you can specify when the propagation delay of the target (FROM) probe used for deskew cannot be detected automatically.</p>

**Examples**    `VERTICAL:DESKEW:FROM:CUSTOMPROPAGATION 0.25e-9` sets the custom delay to 250 ps.

`VERTICAL:DESKEW:FROM:CUSTOMPROPAGATION?` might return  
`:VERTICAL:DESKEW:FROM:CUSTOMPROPAGATION 0.0E+0` indicating the custom delay is 0.0 s.

## VERTical:DESKew:FROM:SOURce

This command sets or queries the source channel for performing channel-to-channel deskew adjustment. Sources can be any of the analog channels.

**Group**    Vertical

**Syntax**    `VERTical:DESKew:FROM:SOURce CH<x>`  
`VERTical:DESKew:FROM:SOURce?`

**Arguments**    The vertical deskew source.

**Examples**    `VERTICAL:DESKEW:FROM:SOURCE CH1` sets channel 1 as the from source.

`VERTICAL:DESKEW:FROM:SOURCE?` might return  
`:VERTICAL:DESKew:FROM:SOURCE CH2` indicating channel 2 is the from source.

## VERTical:DESKew:STATIC (No Query Form)

This command executes static deskew using the deskew settings.

**Group**    Vertical

**Syntax**    `VERTical:DESKew:STATIC EXECute`

**Arguments**    `EXECute` will execute static deskew using the deskew settings.

**Examples**    `VERTICAL:DESKEW:STATIC EXECUTE` will execute static deskew using the deskew settings.



## VERTical:DESKew:TO:CUSTOMPROPAGation

This command sets or queries a target (TO) delay that can be specified by the user when the propagation delay of the target (TO) probe used for deskew cannot be detected automatically.

<b>Group</b>	Vertical
<b>Syntax</b>	VERTical:DESKew:TO:CUSTOMPROPAGation <NR3>
<b>Arguments</b>	<NR3> is a target (TO) delay that can be specified by the user when the propagation delay of the target (TO) probe used for deskew cannot be detected automatically.
<b>Examples</b>	<p>VERTICAL:DESKew:TO:CUSTOMPROPAGATION 0.25e-9 sets the custom propagation to 250 ps.</p> <p>VERTICAL:DESKew:TO:CUSTOMPROPAGATION? might return :VERTICAL:DESKew:TO:CUSTOMPROPAGATION 0.0E+0 indicating the custom propagation is set to 0.0 ns.</p>

## VERTical:DESKew:TO:SOURce

This command sets or queries the target channel for performing channel-to-channel deskew adjustment. Target sources can be any of the live analog channels.

<b>Group</b>	Vertical
<b>Syntax</b>	<p>VERTical:DESKew:TO:SOURce CH&lt;x&gt;</p> <p>VERTical:DESKew:TO:SOURce?</p>
<b>Arguments</b>	Arguments are the live analog channels.
<b>Examples</b>	<p>VERTICAL:DESKew:TO:SOURCE CH4 sets the deskew to source is channel 4.</p> <p>VERTICAL:DESKew:TO:SOURCE? might return :VERTICAL:DESKew:TO:SOURCE CH2 indicating the deskew to source is channel 2.</p>

## VISual:AREA<x>:ASPEctratio

Sets or queries whether the aspect ratio of the specified Visual Trigger area is locked.

**Group** Trigger

**Syntax** VISual:AREA<x>:ASPEctratio {ON|OFF|<NR1>}  
VISual:AREA<x>:ASPEctratio?

**Arguments** Area<x> specifies the integer number of a Visual Trigger area.

ON locks the aspect ratio of the specified Visual Trigger area. The aspect ratio is kept constant when the height or width of the area changes.

OFF unlocks the aspect ratio of the specified Visual Trigger area.

<NR1> is an integer number. 1 locks the aspect ratio of the specified Visual Trigger area; any other value unlocks the aspect ratio of the specified Visual Trigger area

**Examples** VISual:AREA6:ASPEctratio ON locks the aspect ratio of area 6.

VISual:AREA2:ASPEctratio? might return VISual:AREA2:ASPEctratio OFF,. indicating that the aspect ratio of area 2 is not locked.

## VISual:AREA<x>:FLIP:HORizontal (No Query Form)

Flips the specified Visual Trigger area horizontally around its center point.

**Group** Trigger

**Syntax** VISual:AREA<x>:FLIP:HORizontal

**Related Commands** [VISual:AREA<x>:FLIP:VERTical](#)

**Arguments** Area<x> specifies the integer number of a Visual Trigger area.

**Examples** VISual:AREA1:FLIP:HORizontal horizontally flips area 1.

## VISual:AREA<x>:FLIP:VERTical (No Query Form)

Flips the specified Visual Trigger area vertically around its center point.

**Group** Trigger

**Syntax** VISual:AREA<x>:FLIP:VERTical

**Related Commands** [VISual:AREA<x>:FLIP:HORizontal](#)

**Arguments** Area<x> specifies the integer number of a Visual Trigger area.

**Examples** VISual:AREA8:FLIP:VERTical vertically flips area 8.

## VISual:AREA<x>:HEIGht

Sets or queries the height of the specified Visual Trigger area.

**Group** Trigger

**Syntax** VISual:AREA<x>:HEIGht <NR3>  
VISual:AREA<x>:HEIGht?

**Arguments** Area<x> specifies the integer number of a Visual Trigger area.  
<NR3> specifies the height of the Visual Trigger area in amplitude.

**Examples** VISual:AREA51:HEIGht 3.5 sets the height of area 51 to 3.5 (volts or Amps).  
VISual:AREA4:HEIGht? might return VISual:AREA4:HEIGht 15, indicating that the height of area 4 is 15.

## VISual:AREA<x>:HITType

Sets or queries the area hit logic true condition for the specified Visual Trigger area.

**Group** Trigger

**Syntax** VISual:AREA<x>:HITType {IN|OUT|DONTcare}  
VISual:AREA<x>:HITType?

**Arguments** Area<x> specifies the integer number of a Visual Trigger area.

IN specifies that the waveform must intrude anywhere into the specified area to be true.

OUT specifies that the waveform must not intrude anywhere into the specified area to be true.

DONTcare sets the area to a don't care state, causing the area to be ignored. This is useful when you are developing a Visual Trigger condition and need to change the hit logic type of an area while keeping the area.

**Examples** VISual:AREA2:HITType OUT sets the area 2 hit type to OUT.

VISual:AREA5:HITType? might return VISual:AREA5:HITType IN, indicating that the waveform must intrude into area 5 to be true.

## VISual:AREA<x>:RESET (No Query Form)

Sets the specified Visual Trigger area shape to a default-sized triangle.

**Group** Trigger

**Syntax** VISual:AREA<x>:RESET

**Arguments** Area<x> specifies the integer number of a Visual Trigger area.

**Examples** VISual:AREA2:RESET changes area 2 to a default triangle shape.

## VISual:AREA<x>:ROTation

Sets or queries the rotation angle of the specified Visual Trigger area.

**Group** Trigger

**Syntax** VISual:AREA<x>:ROTation <NR3>  
VISual:AREA<x>:ROTation?

<b>Arguments</b>	Area<x> specifies the integer number of a Visual Trigger area.  <NR3> specifies the rotation angle of the Visual Trigger area, in positive degrees from 0 to 360. Zero degrees is referenced from when the area was created.
<b>Examples</b>	VISua1:AREA2:ROtation 45 rotates Visual Trigger area 2 by 45 degrees.  VISua1:AREA1:ROtation? might return VISua1:AREA1:ROtation -60, indicating that area 4 rotation position is minus 60 degrees.

## VISua1:AREA<x>:SHAPE

Sets or queries the current shape of the area.

<b>Group</b>	Trigger
<b>Syntax</b>	VISua1:AREA<x>:SHAPE {TRIAnGLE RECTAnGLE TRAPezoid HEXAgon} VISua1:AREA<x>:SHAPE?
<b>Arguments</b>	Area<x> specifies the integer number of a Visual Trigger area.  TRIAnGLE sets the specified area to a triangular shape (three vertices). If the area does not exist, the instrument creates a new triangular area with the specified area number.  RECTAnGLE sets the specified area to a rectangular shape (four vertices, right angles at each corner). If the area does not exist, the instrument creates a new triangular area with the specified area number.  TRAPezoid sets the specified area to a trapezoidal shape (four vertices, two parallel sides). If the area does not exist, the instrument creates a new triangular area with the specified area number.  HEXAgon sets the specified area to a hexagonal shape (six vertices). If the area does not exist, the instrument creates a new hexagonal area with the specified area number.
<b>Returns</b>	CUSTOM indicates that the shape is a custom-created shape, or the positions of one or more vertices of a standard shape have been changed.
<b>Examples</b>	VISua1:AREA1:SHAPE Hexagon sets area 1 to be a hexagonal shape, or creates a new area 1 hexagonal shape if the specified area does not exist.  VISua1:AREA2:SHAPE? might return VISua1:AREA2:SHAPE CUSTOM, indicating that area 2 is a custom shape.

## VISual:AREA<x>:SOURce

Sets or queries the signal source for the specified Visual Trigger area. The source can only be an analog channel.

**Group** Trigger

**Syntax** VISual:AREA<x>:SOURce {CH1|CH2|CH3|CH4|CH5|CH6|CH7|CH8}  
VISual:AREA<x>:SOURce?

**Arguments** Area<x> specifies the integer number of a Visual Trigger area.  
CH1 through CH8 sets the source channel number for the specified area.

**Examples** VISual:AREA1:SOURce CH3 sets the source channel number for area 1 to Channel 3.  
VISual:AREA6:SOURce? might return VISual:AREA6:SOURce CH8, indicating that the source for area 6 is Channel 8.

## VISual:AREA<x>:VERTICES

Sets or queries the X and Y vertex coordinate values for all vertices of the specified Visual Trigger area. Vertex values must be set in pairs.

**Group** Trigger

**Syntax** VISual:AREA<x>:VERTICES "<NR3>, <NR3>, <NR3>, <NR3>, <NR3>,"  
<NR3> [, <NR3>, <NR3>, ...]"  
VISual:AREA<x>:VERTICES?

**Arguments** Area<x> specifies the integer number of a Visual Trigger area.  
<NR3>, <NR3> specifies the X, Y coordinate pair of each vertex in an area. The first value is X (time) and the second value is Y (amplitude). There must be a minimum of three vertex pairs to create an area. If the specified area exists, the area is changed to the shape specified in the arguments. If the specified area does not exist, a new area is created and assigned the specified vertices.

**Examples** VISual:AREA3:VERTICES  
"400E-9,1,400E-9,0.5,600E-9,0.5,600E-9,1" sets or creates area 3 as a rectangle that is 200 ns wide by 500 mV high.

VISual:AREA3:VERTICES? might return VISual:AREA3:VERTICES "171.1E-9, -141.7E-3, 321.1E-9, -141.7E-3, 283.6E-9, 1.708, 208.6E-9, 1.708", indicating that area 3 is defined as a trapezoid that is 150 ns wide by 1.85 V high.

## VISual:AREA<x>:WIDTH

Sets or queries the width of the specified Visual Trigger area.

<b>Group</b>	Trigger
<b>Syntax</b>	VISual:AREA<x>:WIDTH <NR3> VISual:AREA<x>:WIDTH?
<b>Arguments</b>	Area<x> specifies the integer number of a Visual Trigger area. <NR3> specifies the width of the Visual Trigger area in seconds.
<b>Examples</b>	VISual:AREA5:WIDTH 0.0000045 sets the width of area 5 to 4.5 $\mu$ s. VISual:AREA3:WIDTH? might return VISual:AREA3:WIDTH 0.000016, indicating that the width of area 3 is 16 $\mu$ s.

## VISual:AREA<x>:XPOSITION

Sets or queries the horizontal (X-axis) center position of the specified Visual Trigger area.

<b>Group</b>	Trigger
<b>Syntax</b>	VISual:AREA<x>:XPOSITION <NR3> VISual:AREA<x>:XPOSITION?
<b>Arguments</b>	Area<x> specifies the integer number of a Visual Trigger area. <NR3> specifies the horizontal position of the center of the Visual Trigger area, in seconds.
<b>Examples</b>	VISual:AREA1:XPOSITION -6.9e-6 sets the horizontal center of area 1 to be -6.9 $\mu$ s from the trigger point.

VISual:AREA3:XPOSITION? might return VISual:AREA3:XPOSITION 8.0e-6, indicating that the center of area 3 is 8  $\mu$ s from the trigger point.

## VISual:AREA<x>:YPOSITION

Sets or queries the vertical (Y-axis) center position of the specified Visual Trigger area.

**Group** Trigger

**Syntax** VISual:AREA<x>:YPOSITION <NR3>  
VISual:AREA<x>:YPOSITION?

**Arguments** Area<x> specifies the integer number of a Visual Trigger area.  
  
<NR3> specifies the vertical position of the center of the Visual Trigger area, in amplitude (volts, amps).

**Examples** VISual:AREA1:YPOSITION 0.5 sets the vertical center of area 1 to be 500 mV.  
  
VISual:AREA3:YPOSITION? might return VISual:AREA3:YPOSITION 2, indicating that the vertical center of area 3 is 2 volts.

## VISual:DELETEALL (No Query Form)

Deletes all Visual Trigger areas.

**Group** Trigger

**Syntax** VISual:DELETEALL

**Examples** VISUAL:DELETEALL deletes all Visual Trigger areas.

## VISual:ENABLE

Sets or queries the status (on or off) of the Visual Trigger mode.

**Group** Trigger



<b>Syntax</b>	<code>VISual:ENABle {ON OFF &lt;NR1&gt;}</code> <code>VISual:ENABle?</code>
<b>Arguments</b>	<p>ON enables the Visual Trigger mode.</p> <p>OFF disables the Visual Trigger mode.</p> <p>&lt;NR1&gt; is an integer number. 0 turns off the Visual Trigger mode; any other value enables Visual Trigger mode.</p>
<b>Examples</b>	<p><code>VISual:ENABle ON</code> enables the Visual Trigger function.</p> <p><code>VISual:ENABle?</code> might return <code>VISual:ENABle OFF</code>, indicating that Visual Trigger mode is not enabled.</p>

## VISual:EQUation

Sets or queries the Visual Trigger area combination logic equation.

<b>Group</b>	Trigger
<b>Syntax</b>	<code>VISual:EQUation &lt;Qstring&gt;</code> <code>VISual:EQUation?</code>
<b>Arguments</b>	<p>&lt;Qstring&gt; defines the Visual Trigger area combination logic equation. The equation is made up of area names (A&lt;x&gt;) combined with logic operators AND, OR, or XOR (&amp;,  , ^). It may also contain parentheses for grouping. The equation must be true to have a valid Visual Trigger event and display a waveform. Each area's true state depends on the area's condition setting (In, Out or Don't Care).</p>
<b>Examples</b>	<p><code>VISual:EQUation "(A1 &amp; A2)   A3"</code> sets the combined area logic such that both areas 1 and 2 must be true, or area 3 must be true, to have a valid Visual Trigger event and display a waveform.</p> <p><code>VISual:EQUation?</code> might return <code>VISual:EQUation "A1 &amp; A2 &amp; A3 &amp; A4"</code>, indicating that the area combination logic equation requires that areas 1 through 4 must be true to have a valid Visual Trigger event.</p>

## VISual:SHOWAREas

Shows or hides all Visual Trigger areas.

<b>Group</b>	Trigger
<b>Syntax</b>	<code>VISual:SHOWAREas {ON OFF &lt;NR1&gt;}</code> <code>VISual:SHOWAREas?</code>
<b>Arguments</b>	<p>ON shows all Visual Trigger areas.</p> <p>OFF hides all Visual Trigger areas.</p> <p>&lt;NR1&gt; is an integer number. 0 hides all Visual Trigger areas; any other value shows all Visual Trigger areas.</p>
<b>Examples</b>	<p><code>VISual:SHOWAREas OFF</code> hides all Visual Trigger areas.</p> <p><code>VISual:SHOWAREas?</code> might return <code>VISual:SHOWAREas ON</code>, indicating that Visual Trigger areas are displayed on the screen.</p>

## VISual:SHOWCRiteria

Sets or queries display of the area names and hit criteria for all visual trigger areas.

<b>Group</b>	Trigger
<b>Syntax</b>	<code>VISual:SHOWCRiteria {ON OFF &lt;NR1&gt;}</code> <code>VISual:SHOWCRiteria?</code>
<b>Arguments</b>	<p>ON enables display of the area name and hit criteria labels (In, Out, Don't care icons) of all Visual Trigger areas.</p> <p>OFF hides the area name and hit criteria labels (In, Out, Don't care icons) of all Visual Trigger areas.</p> <p>&lt;NR1&gt; is an integer number. 0 hides the area name and hit criteria of all Visual Trigger areas; any other value enables displaying the area name and hit criteria of all Visual Trigger areas.</p>
<b>Examples</b>	<p><code>VISual:SHOWCRiteria OFF</code> hides the name and hit criteria labels of all Visual Trigger areas.</p> <p><code>VISual:SHOWCRiteria?</code> might return <code>VISual:SHOWCRiteria ON</code>, indicating that the name and hit criteria labels of all Visual Trigger areas are displayed.</p>

## VISual:SHOWEquation

Shows or hides the Visual Trigger area combination logic equation.

**Group** Trigger

**Syntax** VISual:SHOWEquation {ON|OFF|<NR1>}  
VISual:SHOWEquation?

**Arguments** ON shows the Visual Trigger area combination logic equation.  
OFF hides the Visual Trigger area combination logic equation.  
<NR1> is an integer number. 0 hides the area combination logic equation; any other value displays the area combination logic equation.

**Examples** VISual:SHOWEquation ON shows the Visual Trigger area combination logic equation.  
VISual:SHOWEquation? might return VISual:SHOWEquation OFF, indicating that the Visual Trigger area combination logic equation is not displayed on the screen.

## \*WAI (No Query Form)

The \*WAI (Wait) command (no query form) prevents the instrument from executing further commands or queries until all pending commands that generate an OPC message are complete. This command allows you to synchronize the operation of the instrument with your application program. For more information, refer to Synchronization Methods.

**Group** Status and Error

**Syntax** \*WAI

**Related Commands** [BUSY?](#)  
[\\*OPC](#)

**Examples** \*WAI prevents the instrument from executing any further commands or queries until all pending commands that generate an OPC message are complete.

## WAVFrm? (Query Only)

This query-only command provides the Tektronix standard waveform query which returns the waveform preamble followed by the waveform data for the source specified by :DATA:SOURce using the :DATA settings for encoding, width, and so forth.

**Group** Waveform Transfer

**Syntax** WAVFrm?

**Related Commands** [CURVe?](#)  
[DATA:SOURce](#)  
[WFMOupre?](#)

**Examples** WAVFRM? might return the waveform data as: WFMOUTPRE:BIT\_NR 8;BN\_FMT RI;BYT\_NR 1; BYT\_OR MSB;ENCDG ASC;NR\_PT 500;PT\_FMT Y; PT\_ORDER LINEAR;PT\_OFF 0;XINCR 400.0000E-12; XZERO 0.0000;XUNIT "s";YMULT 4.0000E-3; YOFF 0.0000;YZERO 0.0000;YUNIT "V"; WFID "Ch1,DC coupling, 100.0mV/div, 200.0ns/div, 5000 points,Samp1 mode".

## WFMOupre? (Query Only)

This query-only command queries the waveform formatting data for the waveform specified by the [DATA:SOURce](#) command. The preamble components are considered to be of two types; formatting and interpretation. The formatting components are: ENCDg, BN\_Fmt, BYT\_Or, BYT\_Nr, BIT\_Nr. The interpretation components are derived from the DATA:SOURce specified waveform.

**Group** Waveform Transfer

**Syntax** WFMOupre?

**Examples** WFMOUTPRE? might return the waveform formatting data as: WFMOUTPRE:BYT\_NR 2;BIT\_NR 16;ENCDG BINARY;BN\_FMT RI;BYT\_OR MSB;WFID "Ch1, DC coupling, 200.0mV/div, 10.00us/div, 1250 points, Sample mode";NR\_PT 1000;PT\_FMT Y;XUNIT "s";XINCR 80.0000E-9;XZERO

```
0.0000;PT_OFF 625;YUNIT "V";YMULT 31.2500E-6;YOFF
0.0000;YZERO 0.0000;NR_FR 3.
```

## WFMOutpre:ASC\_Fmt? (Query Only)

This query returns the format for ASCII data transferred from the instrument. No command form is provided as the format is determined by the data source type. Some waveforms are normalized vector data where the data points are 8-byte doubles in floating point format whereas other formats are 1-byte or 2-byte integers.

**Group** Waveform Transfer

**Syntax** WFMOutpre:ASC\_Fmt?

**Related Commands** [DATA:SOURce](#)  
[WFMOutpre:BN\\_Fmt](#)  
[WFMOutpre:ENCdg](#)

**Returns** FP represents floating point ASCII data. The waveforms are normalized vector data where the data points are 8-byte doubles in floating point format.

INTEGER represents signed integer ASCII data. The waveform data are 1-byte or 2-byte integers.

**Examples** WFMOutpre:ASC\_Fmt? might return WFMOUTPRE:ASC\_FMT INTEGER indicating the ASCII format is integer.

## WFMOutpre:BIT\_Nr

This command sets and queries the number of bits per waveform point that outgoing waveforms contain, as specified by the [DATA:SOURce](#) command. Note that values will be constrained according to the underlying waveform data. This specification is only meaningful when [WFMOutpre:ENCdg](#) is set to BIN and [WFMOutpre:BN\\_Fmt](#) is set to either RI or RP.

**Group** Waveform Transfer

<b>Syntax</b>	WFMOutpre:BIT_Nr <NR1> WFMOutpre:BIT_Nr?
<b>Related Commands</b>	<a href="#">DATA:SOURce</a> <a href="#">WFMOutpre:BN_Fmt</a> <a href="#">WFMOutpre:ENCdg</a>
<b>Arguments</b>	<NR1> number of bits per data point can be 8 or 16.
<b>Examples</b>	WFMOUTPRE:BIT_NR 16 sets the number of bits per waveform point to 16 for incoming RI and RP binary format data.  WFMOUTPRE:BIT_NR? might return WFMOUTPRE:BIT_NR 8, indicating that outgoing RI or RP binary format data uses 8 bits per waveform point.

## WFMOutpre:BN\_Fmt

This command sets or queries the format of binary data for outgoing waveforms specified by the [DATA:SOURce](#) command.

<b>Group</b>	Waveform Transfer
<b>Syntax</b>	WFMOutpre:BN_Fmt {RI RP FP} WFMOutpre:BN_Fmt?
<b>Related Commands</b>	<a href="#">DATA:SOURce</a>
<b>Arguments</b>	RI specifies signed integer data point representation. RP specifies positive integer data point representation. FP specifies floating point representation.
<b>Examples</b>	WFMOUTPRE:BN_FMT FP specifies that outgoing waveform data will be in single-precision binary floating point format.  WFMOUTPRE:BN_FMT? might return WFMOUTPRE:BN_FMT RI, indicating that the outgoing waveform data is currently in signed integer format.

## WFMOutpre:BYT\_Nr

This command sets or queries the binary field data width (bytes per point) for the waveform specified by the [DATA:SOURce](#) command. Note that values will be constrained according to the underlying waveform data. This specification is only meaningful when [WFMOutpre:ENCdg](#) is set to BIN, and [WFMOutpre:BN\\_Fmt](#) is set to either RI or RP.

**Group** Waveform Transfer

**Syntax** WFMOutpre:BYT\_Nr <NR1>  
WFMOutpre:BYT\_Nr?

**Related Commands** [DATA:SOURce](#)  
[WFMOutpre:BN\\_Fmt](#)  
[WFMOutpre:ENCdg](#)

**Arguments** <NR1> is the number of bytes per data point and can be 1, 2 or 8. A value of 1 or 2 bytes per waveform point indicates channel data; 8 bytes per waveform point indicate pixel map (fast acquisition) data.

**Examples** WFMOUTPRE:BYT\_NR 1 sets the number of bytes per outgoing waveform data point to 1, which is the default setting.  
WFMOUTPRE:BYT\_NR? might return WFMOUTPRE:BYT\_NR 2, indicating that there are 2 bytes per outgoing waveform data point.

## WFMOutpre:BYT\_Or

This command sets or queries which byte of binary waveform data is transmitted first, during a waveform data transfer, when data points require more than one byte. This specification only has meaning when [WFMOutpre:ENCdg](#) is set to BIN.

**Group** Waveform Transfer

**Syntax** WFMOutpre:BYT\_Or {LSB|MSB}  
WFMOutpre:BYT\_Or?

**Related Commands** [WFMOutpre:ENCdg](#)

- Arguments**    LSB specifies that the least significant byte will be transmitted first.  
                  MSB specifies that the most significant byte will be transmitted first.
- Examples**     WFMOUTPRE:BYT\_OR MSB sets the most significant outgoing byte of waveform data to be transmitted first.
- WFMOUTPRE:BYT\_OR? might return WFMOUTPRE:BYT\_OR LSB, indicating that the least significant data byte will be transmitted first.

## WFMOutpre:CENTERFREQUENCY? (Query Only)

This query returns the center frequency of the outgoing waveform. The center frequency is a precise frequency at the center of the display of the frequency domain graticule. In many applications, it is a carrier frequency.

- Group**        Waveform Transfer
- Syntax**      WFMOutpre:CENTERFREQUENCY?
- Related Commands**    [DATA:SOURce](#)
- Returns**      Returns the center frequency of the outgoing waveform, in Hertz.
- Examples**     WFMOutpre:CENTERFREQUENCY? might return  
                  WFMOutpre:CENTERFREQUENCY 1.0E+9, indicating a center frequency of 1 GHz.

## WFMOutpre:DOMAIN? (Query Only)

This query returns the domain of the outgoing waveform, either TIME or FREQUENCY. If the domain is TIME, it indicates that the data is to be treated as integer information. If the domain is FREQUENCY, it indicates that the data is to be treated as floating point information.

- Group**        Waveform Transfer
- Syntax**      WFMOutpre:DOMAIN?



<b>Related Commands</b>	<a href="#">DATA:SOURce</a> <a href="#">WFMOutpre:BN_Fmt</a> <a href="#">WFMOutpre:ENCdg</a>
<b>Returns</b>	Returns the domain of the outgoing waveform.
<b>Examples</b>	<p>WFMOUTPRE:DOMAIN? might return WFMOUTPRE:DOMAIN TIME, indicating that the outgoing waveform is a time domain trace.</p> <p>WFMOutpre:DOMain? might return WFMOutpre:DOMain FREQuency, indicating that the outgoing waveform is one of the four Spectrum View frequency domain traces (CH&lt;x&gt;_SV_NORMAl, CH&lt;x&gt;_SV_AVErage, CH&lt;x&gt;_SV_MINHOLD, or CH&lt;x&gt;_SV_MAXHOLD).</p>

## WFMOutpre:ENCdg

This command sets or queries the type of encoding for outgoing waveforms.

<b>Group</b>	Waveform Transfer
<b>Syntax</b>	WFMOutpre:ENCdg {ASCIi BINary} WFMOutpre:ENCdg?
<b>Related Commands</b>	<a href="#">DATA:ENCdg</a> <a href="#">WFMOutpre:BYT_Nr</a> <a href="#">WFMOutpre:BYT_Or</a> <a href="#">WFMOutpre:BIT_Nr</a> <a href="#">WFMOutpre:BN_Fmt</a>
<b>Arguments</b>	<p>ASCIi specifies that the outgoing data is to be in ASCII format. Waveforms internally stored as integers will be sent as &lt;NR1&gt; numbers, while those stored as floating point will be sent as &lt;NR3&gt; numbers.</p> <p>BINary specifies that outgoing data is to be in a binary format whose further specification is determined by <a href="#">WFMOutpre:BYT_Nr</a>, <a href="#">WFMOutpre:BIT_Nr</a>, <a href="#">WFMOutpre:BN_Fmt</a> and <a href="#">WFMOutpre:BYT_Or</a>.</p>
<b>Examples</b>	WFMOUTPRE:ENCDG ASCIi specifies that the outgoing waveform data will be sent in ASCII format.

WFMOU

```
PRE:ENCDG?
```

 might return `WFMOU

```
PRE:ENCDG
```

 BINARY`, indicating that outgoing waveform data will be sent in binary format.

## WFMOU ``` pre:NR_Pt? ``` (Query Only)

This query-only command returns the number of points for the `DATA:SOURCE` waveform that will be transmitted in response to a `CURVe??` query.

**Group** Waveform Transfer

**Syntax** `WFMOU

```
pre:NR_Pt?
````

**Related Commands** [CURVe?](#)  
[DATA](#)  
[DATA:START](#)  
[DATA:STOP](#)  
[SAVe:WAVEform](#)

**Examples** `WFMOU

```
PRE:NR_PT?
```` might return `WFMOU

```
PRE:NR_PT
```

 5000`, indicating that there are 5000 data points to be sent.

## WFMOU ``` pre:PT_Fmt? ``` (Query Only)

This query-only command returns the point format for the waveform specified by the `DATA:SOURCE` command. The format specifies a set of equations describing how the scale factors in the preamble are used to give meaning to the `CURVe?` data points.

An error is reported if the `DATA:SOURCE` waveform does not exist.

**Group** Waveform Transfer

**Syntax** `WFMOU

```
pre:PT_Fmt?
````

**Related Commands** [CURVe?](#)  
[DATA:SOURCE](#)

**Examples** `WFMOUtpRE:PT_FMT?` might return `WFMOuTPre:PT_Fmt ENV`, indicating that the waveform data is a series of min-max pairs.

## WFMOuTPre:PT\_Off? (Query Only)

This query-only command returns the trigger point relative to [DATA:STARt](#) for the waveform specified by the [DATA:SOUrce](#) command.

---

**NOTE.** *This returned value is the point immediately following the actual trigger.*

---

**Group** Waveform Transfer

**Syntax** `WFMOuTPre:PT_Off?`

**Related Commands** [DATA:SOUrce](#)  
[DATA:STARt](#)  
[WFMOuTPre:XZEro?](#)

**Examples** `WFMOUtpRE:PT_Off?` might return `WFMOUtpRE:PT_Off 251` specifying that the trigger actually occurred between points 250 and 251.

## WFMOuTPre:PT\_ORder? (Query Only)

This query-only command specifies whether the source waveform is Fast Acquisition. A Fast Acquisition waveform is stored as a 500 (vertical) by 1000 (horizontal) point bitmap. Each point represents display intensity for that screen location. Only `CURVe?` query functions are allowed on Fast Acquisition waveforms. When the `WFMOuTPre:PT_ORder?` query returns `Row`, this indicates that the source is a Fast Acquisition waveform (and that each of 1000 possible horizontal columns being transmitted contains 500 vertical points. Note: 500 might vary based on how many channels enabled from same FastAcq group.) and waveform points are transmitted in the following order: left to right; then top to bottom.

When the `WFMOuTPre:PT_ORder?` query returns `Linear`, this indicates that the source is not a Fast Acquisition waveform (and that each horizontal column being sent contains only one vertical point). Note that waveform points are transmitted in the following order: top to bottom, then left to right.

**Group** Waveform Transfer

**Syntax** WFMOutpre:PT\_Order?

**Related Commands** [DATA:SOURce](#)

**Examples** WFMOUTPRE:PT\_ORDER? might return WFMOUTPRE:PT\_Order ROW, specifying that the waveform designated by the DATA:SOURce waveform is a Fast Acquisition waveform and CURve? is returning the PIXmap data for that source.

WFMOUTPRE:PT\_ORDER? might return WFMOUTPRE:PT\_Order LINEAR, specifying that the source waveform is a non-Fast Acquisition waveform and CURve? is returning the Vector data for that source.

## WFMOutpre:RESample

This command sets or queries the resampling of outgoing waveform data. This command is equivalent to setting DATA:RESample. Setting the WFMOutpre:RESample value causes the corresponding DATA value to be updated and vice versa.

**Group** Waveform Transfer

**Syntax** WFMOutpre:RESample <NR1>  
WFMOutpre:RESample?

**Related Commands** [DATA:RESample](#)

**Arguments** <NR1> is the resampling rate. The default value is 1, which means every sample is returned. A value of 2 returns every other sample, while a value of 3 returns every third sample, and so on.

**Examples** WFMOUTPRE:RESAMPLE 1 sets the resampling to return all waveform data samples.

WFMOUTPRE:RESAMPLE? might return WFMOUTPRE:RESAMPLE 4, indicating that every fourth sample of the waveform data is returned.

## WFMOutpre:SPAN? (Query Only)

This query returns the frequency span of the outgoing waveform. The span is the range of frequencies you can observe around the center frequency.

**Group** Waveform Transfer

**Syntax** WFMOupre:SPAN?

**Related Commands** [DATA:SOURce](#)

**Returns** Returns the frequency span of the outgoing waveform, in Hertz.

**Examples** RF:SPAN? might return RF:SPAN 10.0000E+6, indicating the span is 10 MHz.

## WFMOupre:WFId? (Query Only)

This query-only command returns a string describing several aspects of the acquisition parameters for the waveform specified by the [DATA:SOURce](#) command.

An error is reported if the [DATA:SOURce](#) waveform does not exist.

**Group** Waveform Transfer

**Syntax** WFMOupre:WFId?

**Related Commands** [DATA:SOURce](#)

**Returns** <QString> contains the following comma-separated fields documented in the following tables:

**Table 2-47: Waveform Suffixes**

| Field    | Description                                                                                                         | Examples                                         |
|----------|---------------------------------------------------------------------------------------------------------------------|--------------------------------------------------|
| Source   | The source identification string as it appears in the front panel scale factor readouts.                            | "CH1-8"<br>"Math<x>"<br>"Ref<x>"                 |
| Coupling | A string describing the vertical coupling of the waveform (the Source1 waveform in the case of Dual Waveform Math). | "AC coupling"<br>"DC coupling"<br>"GND coupling" |

**Table 2-47: Waveform Suffixes (cont.)**

| <b>Field</b>     | <b>Description</b>                                                                                                                                                     | <b>Examples</b>                                                                                                                                          |
|------------------|------------------------------------------------------------------------------------------------------------------------------------------------------------------------|----------------------------------------------------------------------------------------------------------------------------------------------------------|
| Vert Scale       | A string containing the vertical scale factor of the unzoomed waveform. The numeric portion will always be four digits. The examples cover all known internal units.   | "100.0 mV/div"<br>"20.00 dB/div"<br>"45.00 deg/div"<br>"785.4 mrad/div"<br>"500.0 $\mu$ Vs/div"<br>"10.00 kV/s/div"<br>"200.0 mV/div"<br>"50.00 unk/div" |
| Horiz Scale      | A string containing the horizontal scale factor of the unzoomed waveform. The numeric portion will always be four digits. The examples cover all known internal units. | "100 ms/div"<br>"10.00 kHz/div"<br>"50.00 c/div"                                                                                                         |
| Record Length    | A string containing the number of waveform points available in the entire record. The numeric portion is given as an integer.                                          | "500 points"<br>"500000 points"                                                                                                                          |
| Acquisition Mode | A string describing the mode used to acquire the waveform.                                                                                                             | "Sample mode"<br>"Pk Detect mode"<br>"Hi Res mode"<br>"Envelope mode"<br>"Average mode"                                                                  |
| Center Frequency | A string containing the center frequency value of the waveform.                                                                                                        | "2.400GHz"                                                                                                                                               |
| Span             | A string containing the frequency span value of the waveform.                                                                                                          | "20.00MHz"                                                                                                                                               |
| Reference Level  | A string containing the reference level value of the waveform.                                                                                                         | "1.000mW"                                                                                                                                                |

**Examples** WFMOUTPRE:WFID? might return WFMOUTPRE:WFID "Ch1, DC coupling,100.0mVolts/div,500.0 $\mu$ s/div,500 points, Hi Res mode".

## WFMOutpre:WFMTYPE? (Query Only)

This query returns the type of the outgoing waveform.

The type of waveform that is being transferred in turn determines in which window it will display on the instrument screen: (the Waveform View window or Spectrum View window). Both the Analog and RF\_TD arguments specify the time domain window; the RF\_RD argument specifies the frequency domain window.

**Group** Waveform Transfer

**Syntax** `WFMOutpre:WFMTYPE?`

**Related Commands** [DATA:SOURce](#)

**Returns** Returns the type of the outgoing waveform:  
 ANALOG indicates a Channel or Math waveform.  
 SV\_FD indicates a Spectrum View RF frequency domain waveform.  
 RF\_TD indicates an RF time domain waveform.

**Examples** `WFMOutpre:WFMTYPE?` might return `WFMOutpre:WFMTYPE CH<x>_SV_FD`, which indicates that the outgoing waveform is an RF frequency domain waveform (`CH<x>_SV_AVErge`, `CH<x>_SV_MAXHold`, `CH<x>_SV_MINHold`, or `CH<x>_SV_NORMal`).

## WFMOutpre:XINcr? (Query Only)

This query-only command returns the horizontal point spacing in units of `WFMOutpre:XUNit` for the waveform specified by the [DATA:SOURce](#) command. This value corresponds to the sampling interval.

An error is reported if the `DATA:SOURce` waveform does not exist.

**Group** Waveform Transfer

**Syntax** `WFMOutpre:XINcr?`

**Related Commands** [DATA:SOURce](#)  
[WFMOutpre:XUNit?](#)

**Examples** `WFMOUTPRE:XINCR?` might return `WFMOUTPRE:XINCR 10.0000E-6`, indicating that the horizontal sampling interval is 10  $\mu$ s/point (500  $\mu$ s/div).

## WFMOutpre:XUNit? (Query Only)

This query-only command returns the horizontal units for the waveform specified by the [DATA:SOURce](#) command.

An error is reported if the `DATA:SOURce` waveform does not exist.

|                         |                                                                                                                         |
|-------------------------|-------------------------------------------------------------------------------------------------------------------------|
| <b>Group</b>            | Waveform Transfer                                                                                                       |
| <b>Syntax</b>           | WFMOUtpre:XUNit?                                                                                                        |
| <b>Related Commands</b> | <a href="#">DATA:SOURce</a>                                                                                             |
| <b>Examples</b>         | WFMOUtpre:XUNIT? might return WFMOUtpre:XUNIT "HZ", indicating that the horizontal units for the waveform are in Hertz. |

## WFMOUtpre:XZEro? (Query Only)

This query-only command returns the sub-sample time between the trigger sample (designated by PT\_OFF) and the occurrence of the actual trigger for the waveform specified by the [DATA:SOURce](#) command. This value is in units of WFMOUtpre:XUNit.

An error is reported if the [DATA:SOURce](#) waveform does not exist.

---

**NOTE.** During steady state operation, when all control changes have settled and triggers are arriving on a regular basis, this is the only part of the preamble that changes on each acquisition.

---

|                         |                                                                                                                                           |
|-------------------------|-------------------------------------------------------------------------------------------------------------------------------------------|
| <b>Group</b>            | Waveform Transfer                                                                                                                         |
| <b>Syntax</b>           | WFMOUtpre:XZEro?                                                                                                                          |
| <b>Related Commands</b> | <a href="#">DATA:SOURce</a><br><a href="#">WFMOUtpre:XUNit?</a>                                                                           |
| <b>Examples</b>         | WFMOUtpre:XZERO? might return WFMOUtpre:XZERO 5.6300E-9, indicating that the trigger actually occurred 5.63 ns before the trigger sample. |

## WFMOUtpre:YMUIt? (Query Only)

This query-only command returns the vertical scale factor per digitizing level in units specified by WFMOUtpre:YUNit for the waveform specified by the [DATA:SOURce](#) command. For those formats in which [WFMOUtpre:BYT\\_Nr](#) is important (all non-floating point formats), WFMOUtpre:YMUIt? must take the location of the binary point implied by BYT\_NR into consideration.



An error is reported if the `DATA:SOURce` waveform does not exist.

**Group** Waveform Transfer

**Syntax** `WFMOutpre:YMULT?`

**Related Commands** [DATA:SOURce](#)

**Examples** `WFMOUTPRE:YMULT?` might return `WFMOUTPRE:YMULT 4.0000E-3`, indicating that the vertical scale for the corresponding waveform is 100 mV/div.

## WFMOutpre:YOFF? (Query Only)

This query-only command returns the vertical offset of the source specified by [DATA:SOURce](#). For this instrument family, the value returned is always 0.0 as the offset is combined with the `:YZERO` value.

An error is reported if the [DATA:SOURce](#) waveform does not exist.

**Group** Waveform Transfer

**Syntax** `WFMOutpre:YOFF?`

**Related Commands** [DATA:SOURce](#)  
[WFMOutpre:BYT\\_Nr](#)

**Examples** `WFMOUTPRE:YOFF?` might return `WFMOUTPRE:YOFF -50.0000E+0`, indicating that the position indicator for the waveform was 50 digitizing levels (2 divisions) below center screen.

## WFMOutpre:YUNit? (Query Only)

This query-only command returns the vertical units for the waveform specified by the [DATA:SOURce](#) command.

An error is reported if the `DATA:SOURce` waveform does not exist.

**Group** Waveform Transfer

**Syntax** WFMOutpre:YUNit?

**Related Commands** [DATA:SOURce](#)

**Examples** WFMOUTPRE:YUNIT? might return WFMOUTPRE:YUNIT "dB", indicating that the vertical units for the waveform are measured in decibels.

## WFMOutpre:YZero? (Query Only)

This query-only command returns the combined vertical position and offset for the source waveform specified by [DATA:SOURce](#). This represents a departure from previous instruments where the :YZero value represented the vertical position in vertical units and the :YOff value represented the vertical offset in digitizing levels. For this instrument family, the value of :YOff is always 0.0.

An error is reported if the [DATA:SOURce](#) waveform does not exist.

**Group** Waveform Transfer

**Syntax** WFMOutpre:YZero?

**Related Commands** [DATA:SOURce](#)  
[WFMOutpre:YUNit?](#)

**Examples** WFMOUTPRE:YZERO? might return WFMOUTPRE:YZERO -100.0000E-3, indicating that vertical offset is set to -100 mV.

# Status and Events

The instrument provides a status and event reporting system for the Ethernet and USB interfaces. This system informs you of certain significant events that occur within the instrument.

The instrument status handling system consists of five 8-bit registers and two queues for each interface. The remaining Status subtopics describe these registers and components. They also explain how the event handling system operates.

## Registers

- Overview** The registers in the event handling system fall into two functional groups:
- Status Registers contain information about the status of the instrument. They include the Standard Event Status Register (SESR).
  - Enable Registers determine whether selected types of events are reported to the Status Registers and the Event Queue. They include the Device Event Status Enable Register (DESER), the Event Status Enable Register (ESER), and the Service Request Enable Register (SRER).

**Status Registers** The Standard Event Status Register (SESR) and the Status Byte Register (SBR) record certain types of events that may occur while the instrument is in use. IEEE Std 488.2-1987 defines these registers.

Each bit in a Status Register records a particular type of event, such as an execution error or message available. When an event of a given type occurs, the instrument sets the bit that represents that type of event to a value of one. (You can disable bits so that they ignore events and remain at zero. See Enable Registers). Reading the status registers tells you what types of events have occurred.

**The Standard Event Status Register (SESR).** The SESR records eight types of events that can occur within the instrument. Use the \*ESR? query to read the SESR register. Reading the register clears the bits of the register so that the register can accumulate information about new events.

---

**NOTE.** TekVISA applications use SESR bit 6 to respond to any of several events, including some front panel actions.

---

|     |     |     |     |     |     |     |     |
|-----|-----|-----|-----|-----|-----|-----|-----|
| 7   | 6   | 5   | 4   | 3   | 2   | 1   | 0   |
| PON | URQ | CME | EXE | DDE | QYE | RQC | OPC |

Figure 3-1: The Standard Event Status Register (SESR)

**Table 3-1: SESR Bit Functions**

| Bit     | Function |                                                                                                                                                  |
|---------|----------|--------------------------------------------------------------------------------------------------------------------------------------------------|
| 7 (MSB) | PON      | Power On. Shows that the instrument was powered on. On completion, the diagnostic self tests also set this bit.                                  |
| 6       | URQ      | User Request. Indicates that an application event has occurred. *See note.                                                                       |
| 5       | CME      | Command Error. Shows that an error occurred while the instrument was parsing a command or query.                                                 |
| 4       | EXE      | Execution Error. Shows that an error executing a command or query.                                                                               |
| 3       | DDE      | Device Error. Shows that a device error occurred.                                                                                                |
| 2       | QYE      | Query Error. Either an attempt was made to read the Output Queue when no data was present or pending, or that data in the Output Queue was lost. |
| 1       | RQC      | Request Control. This is not used.                                                                                                               |
| 0 (LSB) | OPC      | operation complete. Shows that the operation is complete. This bit is set when all pending operations complete following an *OPC command.        |

**The Status Byte Register (SBR).** Records whether output is available in the Output Queue, whether the instrument requests service, and whether the SESR has recorded any events.

Use a Serial Poll or the \*STB? query to read the contents of the SBR. The bits in the SBR are set and cleared depending on the contents of the SESR, the Event Status Enable Register (ESER), and the Output Queue. When you use a Serial Poll to obtain the SBR, bit 6 is the RQS bit. When you use the \*STB? query to obtain the SBR, bit 6 is the MSS bit. Reading the SBR does not clear the bits.

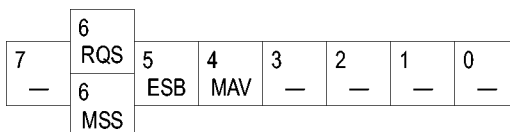

**Figure 3-2: The Status Byte Register (SBR)**

**Table 3-2: SBR Bit Functions**

| Bit     | Function |                                                                                                               |
|---------|----------|---------------------------------------------------------------------------------------------------------------|
| 7 (MSB) | —        | Not used.                                                                                                     |
| 6       | RQS      | Request Service. Obtained from a serial poll. Shows that the instrument requests service from the controller. |
| 6       | MSS      | Master Status Summary. Obtained from *STB? query. Summarizes the ESB and MAV bits in the SBR.                 |
| 5       | ESB      | Event Status Bit. Shows that status is enabled and present in the SESR.                                       |

**Table 3-2: SBR Bit Functions (cont.)**

| Bit | Function                                                                   |
|-----|----------------------------------------------------------------------------|
| 4   | MAV Message Available. Shows that output is available in the Output Queue. |
| 3   | ———— Not used.                                                             |
| 2   | ———— Not used.                                                             |
| 1-0 | ———— Not used.                                                             |

### Enable Registers

DESER, ESER, and SRER allow you to select which events are reported to the Status Registers and the Event Queue. Each Enable Register acts as a filter to a Status Register (the DESER also acts as a filter to the Event Queue) and can prevent information from being recorded in the register or queue.

Each bit in an Enable Register corresponds to a bit in the Status Register it controls. In order for an event to be reported to a bit in the Status Register, the corresponding bit in the Enable Register must be set to one. If the bit in the Enable Register is set to zero, the event is not recorded.

Various commands set the bits in the Enable Registers. The Enable Registers and the commands used to set them are described below.

**The Device Event Status Enable Register (DESER).** This register controls which types of events are reported to the SESR and the Event Queue. The bits in the DESER correspond to those in the SESR.

Use the DESE command to enable and disable the bits in the DESER. Use the DESE? query to read the DESER.

|     |     |     |     |     |     |     |     |
|-----|-----|-----|-----|-----|-----|-----|-----|
| 7   | 6   | 5   | 4   | 3   | 2   | 1   | 0   |
| PON | URQ | CME | EXE | DDE | QYE | RQC | OPC |

**Figure 3-3: The Device Event Status Enable Register (DESER)**

**The Event Status Enable Register (ESER).** This register controls which types of events are summarized by the Event Status Bit (ESB) in the SBR. Use the \*ESE command to set the bits in the ESER. Use the \*ESE? query to read it.

|     |     |     |     |     |     |     |     |
|-----|-----|-----|-----|-----|-----|-----|-----|
| 7   | 6   | 5   | 4   | 3   | 2   | 1   | 0   |
| PON | URQ | CME | EXE | DDE | QYE | RQC | OPC |

**Figure 3-4: The Event Status Enable Register (ESER)**

**The Service Request Enable Register (SRER).** This register controls which bits in the SBR generate a Service Request and are summarized by the Master Status Summary (MSS) bit.

Use the \*SRE command to set the SRER. Use the \*SRE? query to read the register. The RQS bit remains set to one until either the Status Byte Register is read with a Serial Poll or the MSS bit changes back to a zero.

|   |   |     |     |   |   |   |   |
|---|---|-----|-----|---|---|---|---|
| 7 | 6 | 5   | 4   | 3 | 2 | 1 | 0 |
| — | — | ESB | MAV | — | — | — | — |

Figure 3-5: The Service Request Enable Register (SRER)

**\*PSC Command** The \*PSC command controls the Enable Registers contents at power-on. Sending \*PSC 1 sets the Enable Registers at power on as follows:

- DESER 255 (equivalent to a DESe 255 command)
- ESER 0 (equivalent to an \*ESE 0 command)
- SRER 0 (equivalent to an \*SRE 0 command)

Sending \*PSC 0 lets the Enable Registers maintain their values in nonvolatile memory through a power cycle.

---

**NOTE.** To enable the PON (Power On) event to generate a Service Request, send \*PSC 0, use the DESe and \*ESE commands to enable PON in the DESER and ESER, and use the \*SRE command to enable bit 5 in the SRER. Subsequent power-on cycles will generate a Service Request.

---

## Queues

The \*PSC command controls the Enable Registers contents at power-on. Sending \*PSC 1 sets the Enable Registers at power on as follows:

**Output Queue** The instrument stores query responses in the Output Queue and empties this queue each time it receives a new command or query message after an <EOM>. The controller must read a query response before it sends the next command (or query) or it will lose responses to earlier queries.



---

**CAUTION.** When a controller sends a query, an <EOM>, and a second query, the instrument normally clears the first response and outputs the second while reporting a Query Error (QYE bit in the ESER) to indicate the lost response. A fast controller, however, may receive a part or all of the first response as well. To avoid this situation, the controller should always read the response immediately after sending any terminated query message or send a DCL (Device Clear) before sending the second query.

---

**Event Queue** The Event Queue stores detailed information on up to 33 events. If than 32 events stack up in the Event Queue, the 32nd event is replaced by event code 350, "Queue Overflow."

Read the Event Queue with the `EVENT?` query (which returns only the event number), with the `EVMSG?` query (which returns the event number and a text description of the event), or with the `ALLEV?` query (which returns all the event numbers along with a description of the event). Reading an event removes it from the queue.

Before reading an event from the Event Queue, you must use the `*ESR?` query to read the summary of the event from the SESR. This makes the events summarized by the `*ESR?` read available to the `EVENT?` and `EVMSG?` queries, and empties the SESR.

Reading the SESR erases any events that were summarized by previous `*ESR?` reads but not read from the Event Queue. Events that follow an `*ESR?` read are put in the Event Queue but are not available until `*ESR?` is used again.

## Event Handling Sequence

The following figure shows how to use the status and event handling system. In the explanation that follows, numbers in parentheses refer to numbers in the figure.

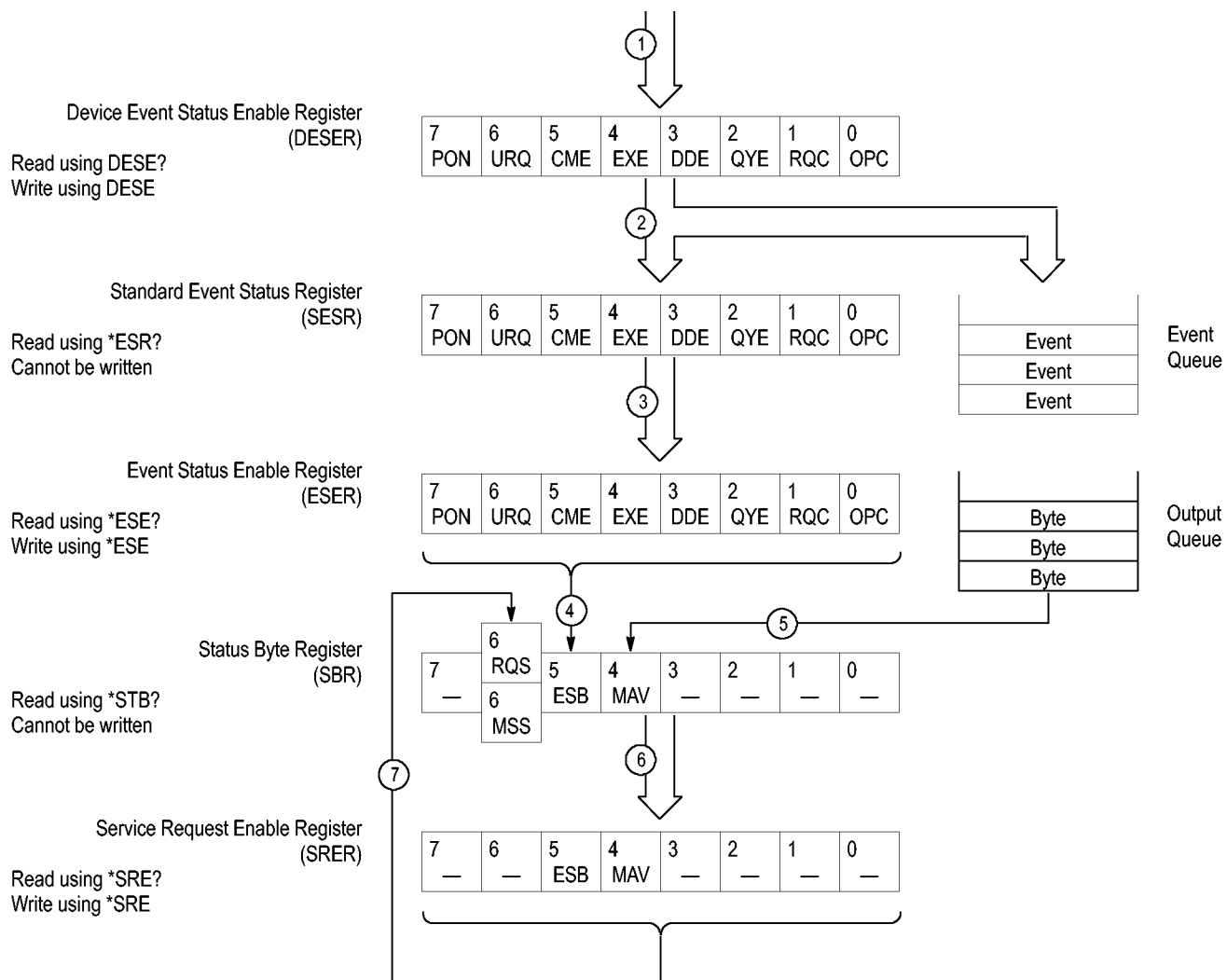

Figure 3-6: Status and Event Handling Process

When an event occurs, a signal is sent to the DESER (1). If that type of event is enabled in the DESER (that is, if the bit for that event type is set to 1), the appropriate bit in the SESR is set to one, and the event is recorded in the Event Queue (2). If the corresponding bit in the ESER is also enabled (3), then the ESB bit in the SBR is set to one (4).

When output is sent to the Output Queue, the MAV bit in the SBR is set to one (5).

When a bit in the SBR is set to one and the corresponding bit in the SRER is enabled (6), the MSS bit in the SBR is set to one and a service request is generated (7).



## Synchronization Methods

**Overview** Although most commands are completed almost immediately after being received by the instrument, some commands start a process that requires time. For example, once a single sequence acquisition command is executed, depending upon the applied signals and trigger settings, it may take an extended period of time before the acquisition is complete. Rather than remain idle while the operation is in process, the instrument will continue processing other commands. This means that some operations will not be completed in the order that they were sent. Furthermore, sometimes the result of an operation depends upon the result of an earlier operation. A first operation must complete before the next one is processed.

In order to handle these situations, the instrument status and event reporting system allows you to synchronize the operation of the instrument with your application program, using the Operation Complete function. Note, however, that only some operations are able to take advantage of this function; a table is provided below of commands that support this.

The following commands are used to synchronize the instrument functions using Operation Complete. See examples of how to use these commands later on in this section:

**\*OPC** — sending the \*OPC command will set bit 0 of the SESR (Standard Events Status Register). The bit will only be set high when all pending operations that generate an OPC message have finished execution. (The SESR is queried using \*ESR?) The \*OPC? query form returns 1 only when all operations have completed, or a device clear is received.

**\*WAI** — prevents the instrument from executing further commands or queries until all pending commands that generate an OPC message are complete.

**BUSY?** — returns the status of operations: 1 means there are pending operations, 0 means that all pending operations are complete.

---

**NOTE.** *Some OPC operations may require an extended period of time to complete or may never complete. For example, a single sequence acquisition may never complete when no trigger event occurs. You should be aware of these conditions and tailor your program accordingly by:*

— *setting the timeout sufficiently for the anticipated maximum time for the operation and*

— *handle a timeout appropriately by querying the SESR (\*ESR?) and event queue (EVMsg? or ALLEv?).*

---

**NOTE.** The \*OPC command form can also be used to cause an SRQ to be generated upon completion of all pending operations. This requires that the ESB (Event Status Bit, bit 5) of the SRER (Service Request Enable Register) is set, and the OPC bit (bit 0) of the DESR (Device Event Status Enable Register) and the ESER (Event Status Enable Register) are set. (The SRER is set/queried using \*SRE. The DESR is set/queried using DESE. The ESER is set/queried using \*ESE.)

Only a subset of instrument operations support the Operation Complete function (OPC):

**Table 3-3: instrument operations that can generate OPC**

| Command                                              | Conditions                                                               |
|------------------------------------------------------|--------------------------------------------------------------------------|
| ACQuire:STATE <non-zero NR1>  ON RUN                 | Only when in single sequence acquisition mode                            |
| :AUTOset < EXECute >                                 |                                                                          |
| CALibrate:INTERNAI                                   |                                                                          |
| CALibrate:INTERNAI:START                             |                                                                          |
| CALibrate:FACTory START                              |                                                                          |
| CALibrate:FACTory CONTInue                           |                                                                          |
| CALibrate:FACTory PREVIOUS                           |                                                                          |
| CH<x>:PRObe:AUTOZero EXECute                         |                                                                          |
| CH<x>:PRObe:DEGAUss EXECute                          |                                                                          |
| DIAG:STATE EXECute                                   |                                                                          |
| FACTory                                              |                                                                          |
| MEASUrement:MEAS<x> :RESUlts                         | When used in single sequence acquisition mode or during waveform recall. |
| RECAI:SETUp (<file as quoted string> FACTory)        |                                                                          |
| RECAI:WAVEform <.ISF or .CSV file >,< REF<x> >       |                                                                          |
| :RF:REFLevel AUTO                                    |                                                                          |
| *RST                                                 |                                                                          |
| SAVe:IMAGe <file as quoted string>                   |                                                                          |
| SAVe:SETUp <file as quoted string>                   |                                                                          |
| SAVe:WAVEform < source wfm > , (< REF<x> > < file >) |                                                                          |
| TRIGger:A SETLevel                                   |                                                                          |

### Example of Acquiring and Measuring a Single-Sequence Waveform

For example, a typical application might involve acquiring a single-sequence waveform and then taking a measurement on the acquired waveform. You could use the following command sequence to do this:

```

/** Set up conditional acquisition */
ACQUIRE:STATE OFF
DISPLAY:WAVEVIEW1:CH1:STATE 1
HORIZONTAL:RECORDLENGTH 1000
ACQUIRE:MODE SAMPLE
ACQUIRE:STOPAFTER SEQUENCE
/** Acquire waveform data */
ACQUIRE:STATE ON
/** Set up the measurement parameters */
MEASUREMENT:MEAS1:TYPE AMPLITUDE
MEASUREMENT:MEAS1:SOURCE CH1
/** Take amplitude measurement */
MEASUREMENT:MEAS1:RESULTS:CURRENTACQ:MEAN?
    
```

The acquisition of the waveform requires extended processing time. It may not finish before the instrument takes an amplitude measurement (see the following figure). This can result in an incorrect amplitude value.

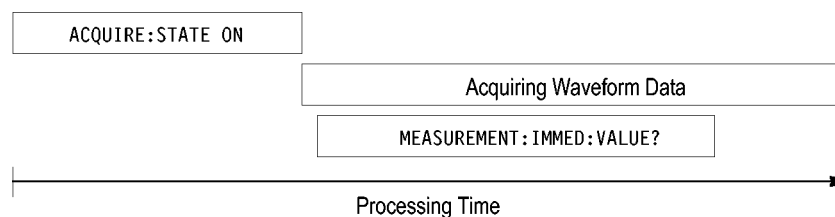

Figure 3-7: Command Processing Without Using Synchronization

To ensure the instrument completes waveform acquisition before taking the measurement on the acquired data, you can synchronize the program using \*WAI, BUSY, \*OPC, and \*OPC?.

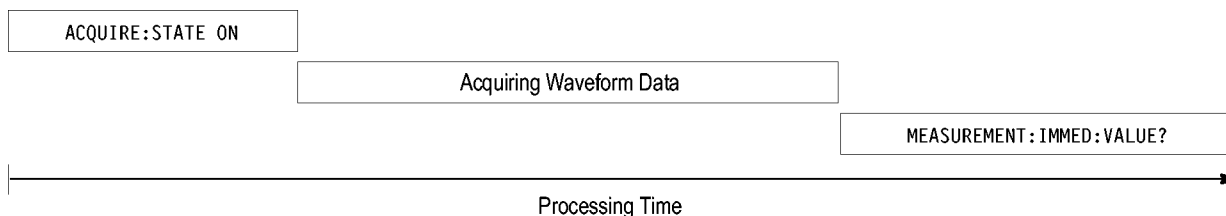

Figure 3-8: Processing Sequence With Synchronization

### Example of Using the \*OPC Command

If the corresponding status registers are enabled, the \*OPC command sets the OPC bit in the Standard Event Status Register (SESR) when an operation is complete. You achieve synchronization by using this command with either a serial poll or service request handler.

**Serial Poll Method:** Enable the OPC bit in the Device Event Status Enable Register (DESER) and the Event Status Enable Register (ESER) using the DESE and \*ESE commands.

When the operation is complete, the OPC bit in the Standard Event Status Register (SESR) will be enabled and the Event Status Bit (ESB) in the Status Byte Register will be enabled.

The same command sequence using the \*OPC command for synchronization with serial polling looks like this:

```
/* Set up conditional acquisition */
ACQUIRE:STATE OFF
DISPLAY:WAVEVIEW1:CH1:STATE 1
HORIZONTAL:RECORDLENGTH 1000
ACQUIRE:MODE SAMPLE
ACQUIRE:STOPAFTER SEQUENCE
/* Enable the status registers */
DESE 1
*ESE 1
*SRE 0
/* Acquire waveform data */
ACQUIRE:STATE ON
/* Set up the measurement parameters on the channel we're
about to sequence */
MEASUREMENT:MEAS1:TYPE AMPLITUDE
MEASUREMENT:MEAS1:SOURCE CH1
/* wait until the acquisition is complete before taking the
measurement. */
*OPC
while serial poll = 0, keep looping
/* Take amplitude measurement */
MEASUREMENT:MEAS1:RESULTS:CURRENTACQ:MEAN?
```

This technique requires less bus traffic than did looping on BUSY.

**Service Request Method:** Enable the OPC bit in the Device Event Status Enable Register (DESER) and the Event Status Enable Register (ESER) using the DESE and \*ESE commands.

You can also enable service requests by setting the ESB bit in the Service Request Enable Register (SRER) using the \*SRE command. When the operation is complete, the instrument will generate a Service Request.

The same command sequence using the \*OPC command for synchronization looks like this

```
/* Set up conditional acquisition */
ACQUIRE:STATE OFF
DISPLAY:WAVEVIEW1:CH1:STATE 1
HORIZONTAL:RECORDLENGTH 1000
```

```

ACQUIRE:MODE SAMPLE
ACQUIRE:STOPAFTER SEQUENCE
/* Enable the status registers */
DESE 1
*ESE 1
*SRE 32

/* Set up the measurement parameters on the channel we're
about to sequence */ :MEASUREMENT:MEAS1:TYPE AMPLITUDE
:MEASUREMENT:MEAS1:SOURCE CH1
/* Acquire waveform data */
ACQUIRE:STATE ON
/* wait until the acquisition is complete before taking the
measurement*/
*OPC

```

The program can now do different tasks such as talk to other devices. The SRQ, when it comes, interrupts those tasks and returns control to this task.

```

/* Take amplitude measurement */
MEASUREMENT:MEAS1:RESULTS:CURRENTACQ:MEAN?

```

### Example of Using the \*OPC? Query

The \*OPC? query places a 1 in the Output Queue once an operation that generates an OPC message is complete. The \*OPC? query does not return until all pending OPC operations have completed. Therefore, your time-out must be set to a time at least as long as the longest expected time for the operations to complete.

The same command sequence using the \*OPC? query for synchronization looks like this:

```

/* Set up single sequence acquisition */
ACQUIRE:STATE OFF
DISPLAY:WAVEVIEW1:CH1:STATE 1
HORIZONTAL:RECORDLENGTH 1000
ACQUIRE:MODE SAMPLE
ACQUIRE:STOPAFTER SEQUENCE
/* Set up the measurement parameters on the channel we're
about to sequence */
MEASUREMENT:MEAS1:TYPE AMPLITUDE
MEASUREMENT:MEAS1:SOURCE CH1
/* Acquire waveform data */
ACQUIRE:STATE ON
/* wait until the acquisition is complete before taking the
measurement*/
*OPC?

```

Wait for read from Output Queue.

```

/* Take amplitude measurement */
MEASUREMENT:MEAS1:RESULTS:CURRENTACQ:MEAN?

```

This is the simplest approach. It requires no status handling or loops. However, you must set the controller time-out for longer than the acquisition operation.

### Example of Using the \*WAI Command

The \*WAI command forces completion of previous commands that generate an OPC message. No commands after the \*WAI are processed before the OPC message(s) are generated

The same command sequence using the \*WAI command for synchronization looks like this:

```

/* Set up conditional acquisition */
ACQUIRE:STATE OFF
DISPLAY:WAVEVIEW1:CH1:STATE 1
HORIZONTAL:RECORDLENGTH 1000
ACQUIRE:MODE SAMPLE
ACQUIRE:STOPAFTER SEQUENCE
/* Set up the measurement parameters on the channel we're
about to sequence */
MEASUREMENT:MEAS1:TYPE AMPLITUDE
MEASUREMENT:MEAS1:SOURCE CH1
/* Acquire waveform data */
ACQUIRE:STATE ON
/* wait until the acquisition is complete before taking
the measurement*/
*/
*WAI
/* Take amplitude measurement */
MEASUREMENT:MEAS1:RESULTS:CURRENTACQ:MEAN?
    
```

The controller can continue to write commands to the input buffer of the instrument, but the commands will not be processed by the instrument until all in-process OPC operations are complete. If the input buffer becomes full, the controller will be unable to write commands to the buffer. This can cause a time-out.

### Example of Using the BUSY? Query

The BUSY? query allows you to find out whether the instrument is busy processing a command that has an extended processing time such as single-sequence acquisition.

The same command sequence, using the BUSY? query for synchronization, looks like this:

```

/* Set up conditional acquisition */
ACQUIRE:STATE OFF
DISPLAY:WAVEVIEW1:CH1:STATE 1
HORIZONTAL:RECORDLENGTH 1000
ACQUIRE:MODE SAMPLE
ACQUIRE:STOPAFTER SEQUENCE
    
```

```

/* Acquire waveform data */
ACQUIRE:STATE ON
/* Set up the measurement parameters */
MEASUREMENT:IMMED:TYPE AMPLITUDE
MEASUREMENT:IMMED:SOURCE CH1
/* wait until the acquisition is complete before taking
the measurement */
while BUSY? keep looping
/* Take amplitude measurement */
MEASUREMENT:IMMED:VALUE?

```

This sequence lets you create your own wait loop rather than using the \*WAI command. The BUSY? query helps you avoid time-outs caused by writing too many commands to the input buffer. The controller is still tied up though, and the repeated BUSY? query will result in bus traffic.

### Reference waveforms

Measurements on references also support OPC when used in conjunction with a :RECALL:WAVEFORM command.

```

/* Load the waveform file */
:RECALL:WAVEFORM "C:/Digital8.wfm",REF1
*OPC?
/* Set up the measurement parameters on the reference */
:MEASUREMENT:MEAS1:TYPE PERIOD
:MEASUREMENT:MEAS1:SOURCE REF1
*OPC?
/* wait for read from Output Queue. */
/* Take amplitude measurement */
:MEASUREMENT:MEAS1:RESULTS:CURRENTACQ:MEAN?

```

### Messages

The information contained in the topics above covers all the programming interface messages the instrument generates in response to commands and queries.

For most messages, a secondary message from the instrument gives detail about the cause of the error or the meaning of the message. This message is part of the message string and is separated from the main message by a semicolon.

Each message is the result of an event. Each type of event sets a specific bit in the SESR and is controlled by the equivalent bit in the DESER. Thus, each message is associated with a specific SESR bit. In the message tables, the associated SESR bit is specified in the table title, with exceptions noted with the error message text.

### No Event

The following table shows the messages when the system has no events or status to report. These have no associated SESR bit.

**Table 3-4: No Event Messages**

| <b>Code</b> | <b>Message</b>                                |
|-------------|-----------------------------------------------|
| 0           | No events to report; queue empty              |
| 1           | No events to report; new events pending *ESR? |

**Command Error**

The following table shows the command error messages generated by improper syntax. Check that the command is properly formed and that it follows the rules in the section on command Syntax.

**Table 3-5: Command Error Messages (CME Bit 5)**

| <b>Code</b> | <b>Message</b>               |
|-------------|------------------------------|
| 100         | Command error                |
| 101         | Invalid character            |
| 102         | Syntax error                 |
| 103         | Invalid separator            |
| 104         | Data type error              |
| 105         | GET not allowed              |
| 108         | Parameter not allowed        |
| 109         | Missing parameter            |
| 110         | Command header error         |
| 112         | Program mnemonic too long    |
| 113         | Undefined header             |
| 120         | Numeric data error           |
| 121         | Invalid character in numeric |
| 123         | Exponent too large           |
| 124         | Too many digits              |
| 130         | Suffix error                 |
| 131         | Invalid suffix               |
| 134         | Suffix too long              |
| 140         | Character data error         |
| 141         | Invalid character data       |
| 144         | Character data too long      |
| 150         | String data error            |
| 151         | Invalid string data          |
| 152         | String data too long         |
| 160         | Block data error             |
| 161         | Invalid block data           |
| 170         | Command expression error     |
| 171         | Invalid expression           |



**Execution Error** The following table lists the execution errors that are detected during execution of a command.

**Table 3-6: Execution Error Messages (EXE Bit 4)**

| <b>Code</b> | <b>Message</b>                                          |
|-------------|---------------------------------------------------------|
| 200         | Execution error                                         |
| 221         | Settings conflict                                       |
| 222         | Data out of range                                       |
| 224         | Illegal parameter value                                 |
| 241         | Hardware missing                                        |
| 250         | Mass storage error                                      |
| 251         | Missing mass storage                                    |
| 252         | Missing media                                           |
| 253         | Corrupt media                                           |
| 254         | Media full                                              |
| 255         | Directory full                                          |
| 256         | File name not found                                     |
| 257         | File name error                                         |
| 258         | Media protected                                         |
| 259         | File name too long                                      |
| 280         | Program error                                           |
| 282         | Insufficient network printer information                |
| 283         | Network printer not responding                          |
| 284         | Network printer server not responding                   |
| 286         | Program runtime error                                   |
| 287         | Future use                                              |
| 2200        | Measurement error, Measurement system error             |
| 2201        | Measurement error, Zero period                          |
| 2202        | Measurement error, No period, second waveform           |
| 2203        | Measurement error, No period, second waveform           |
| 2204        | Measurement error, Low amplitude, second waveform       |
| 2205        | Measurement error, Low amplitude, second waveform       |
| 2206        | Measurement error, Invalid gate                         |
| 2207        | Measurement error, Measurement overflow                 |
| 2208        | Measurement error, No backwards Mid Ref crossing        |
| 2209        | Measurement error, No second Mid Ref crossing           |
| 2210        | Measurement error, No Mid Ref crossing, second waveform |
| 2211        | Measurement error, No backwards Mid Ref crossing        |
| 2212        | Measurement error, No negative crossing                 |

Table 3-6: Execution Error Messages (EXE Bit 4) (cont.)

| Code | Message                                                 |
|------|---------------------------------------------------------|
| 2213 | Measurement error, No positive crossing                 |
| 2214 | Measurement error, No crossing, target waveform         |
| 2215 | Measurement error, No crossing, second waveform         |
| 2216 | Measurement error, No crossing, target waveform         |
| 2217 | Measurement error, Constant waveform                    |
| 2219 | Measurement error, No valid edge - No arm sample        |
| 2220 | Measurement error, No valid edge - No arm cross         |
| 2221 | Measurement error, No valid edge - No trigger cross     |
| 2222 | Measurement error, No valid edge - No second cross      |
| 2223 | Measurement error, Waveform mismatch                    |
| 2224 | Measurement error, WAIT calculating                     |
| 2225 | Measurement error, No waveform to measure               |
| 2226 | Measurement error, Null Waveform                        |
| 2227 | Measurement error, Positive and Negative Clipping       |
| 2228 | Measurement error, Positive Clipping                    |
| 2229 | Measurement error, Negative Clipping                    |
| 2230 | Measurement error, High Ref < Low Ref                   |
| 2231 | Measurement error, No statistics available              |
| 2233 | Requested waveform is temporarily unavailable           |
| 2235 | Math error, invalid math description                    |
| 2240 | Invalid password                                        |
| 2241 | Waveform requested is invalid                           |
| 2244 | Source waveform is not active                           |
| 2245 | Saveref error, selected channel is turned off           |
| 2250 | Reference error, the reference waveform file is invalid |
| 2253 | Reference error, too many points received               |
| 2254 | Reference error, too few points received                |
| 2259 | File too big                                            |
| 2270 | Alias error                                             |
| 2271 | Alias syntax error                                      |
| 2273 | Illegal alias label                                     |
| 2276 | Alias expansion error                                   |
| 2277 | Alias redefinition not allowed                          |
| 2278 | Alias header not found                                  |
| 2285 | TekSecure(R) Pass                                       |
| 2286 | TekSecure(R) Fail                                       |
| 2500 | Setup error, file does not look like a setup file       |

Table 3-6: Execution Error Messages (EXE Bit 4) (cont.)

| Code | Message                                                        |
|------|----------------------------------------------------------------|
| 2501 | Setup warning, could not recall all values from external setup |
| 2620 | Mask error, too few points received                            |
| 2760 | Mark limit reached                                             |
| 2761 | No mark present                                                |
| 2762 | Search copy failed                                             |

**Device Error** The following table lists the device errors that can occur during instrument operation. These errors may indicate that the instrument needs repair.

Table 3-7: Device Error Messages (DDE Bit 3)

| Code | Message                 |
|------|-------------------------|
| 310  | System error            |
| 311  | Memory error            |
| 312  | PUD memory lost         |
| 314  | Save/recall memory lost |

**System Event** The following table lists the system event messages. These messages are generated whenever certain system conditions occur.

Table 3-8: System Event Messages

| Code | Message                                                      |
|------|--------------------------------------------------------------|
| 400  | Query event                                                  |
| 401  | Power on (PON bit 7 set)                                     |
| 402  | Operation complete (OPC bit 0 set)                           |
| 403  | User request (URQ bit 6 set)                                 |
| 404  | Power fail (DDE bit 3 set)                                   |
| 405  | Request control                                              |
| 410  | Query INTERRUPTED (QYE bit 2 set)                            |
| 420  | Query UNTERMINATED (QYE bit 2 set)                           |
| 430  | Query DEADLOCKED (QYE bit 2 set)                             |
| 440  | Query UNTERMINATED after indefinite response (QYE bit 2 set) |
| 468  | Knob/Keypad value changed                                    |
| 472  | Application variable changed                                 |

**Execution Warning** The following table lists warning messages that do not interrupt the flow of command execution. They also notify you of possible unexpected results.

**Table 3-9: Execution Warning Messages (EXE Bit 4)**

| <b>Code</b> | <b>Message</b>                                  |
|-------------|-------------------------------------------------|
| 528         | Parameter out of range                          |
| 532         | Curve data too long, Curve truncated            |
| 533         | Curve error, Preamble values are inconsistent   |
| 540         | Measurement warning, Uncertain edge             |
| 541         | Measurement warning, Low signal amplitude       |
| 542         | Measurement warning, Unstable histogram         |
| 543         | Measurement warning, Low resolution             |
| 544         | Measurement warning, Uncertain edge             |
| 545         | Measurement warning, Invalid in minmax          |
| 546         | Measurement warning, Need 3 edges               |
| 547         | Measurement warning, Clipping positive/negative |
| 548         | Measurement warning, Clipping positive          |
| 549         | Measurement warning, Clipping negative          |

**Table 3-10: Execution Warning Messages (EXE Bit 4)**

| <b>Code</b> | <b>Message</b>                                  |
|-------------|-------------------------------------------------|
| 540         | Measurement warning                             |
| 541         | Measurement warning, Low signal amplitude       |
| 542         | Measurement warning, Unstable histogram         |
| 543         | Measurement warning, Low resolution             |
| 544         | Measurement warning, Uncertain edge             |
| 545         | Measurement warning, Invalid min max            |
| 546         | Measurement warning, Need 3 edges               |
| 547         | Measurement warning, Clipping positive/negative |
| 548         | Measurement warning, Clipping positive          |
| 549         | Measurement warning, Clipping negative          |

**Internal Warning**

The following table shows internal errors that indicate an internal fault in the instrument.

**Table 3-11: Internal Warning Messages**

| <b>Code</b> | <b>Message</b>                 |
|-------------|--------------------------------|
| 630         | Internal warning, 50Ω overload |

# Appendix A: Character Set

| B7<br>B6<br>B5<br>BITS<br>B4 B3 B2 B1 | 0 0 0   |                       | 0 0 1 |                       | 0 1 0              |                     | 0 1 1 |                   | 1 0 0      |   | 1 0 1 |   | 1 1 0      |   | 1 1 1 |                                    |
|---------------------------------------|---------|-----------------------|-------|-----------------------|--------------------|---------------------|-------|-------------------|------------|---|-------|---|------------|---|-------|------------------------------------|
|                                       | CONTROL |                       |       |                       | NUMBERS<br>SYMBOLS |                     |       |                   | UPPER CASE |   |       |   | LOWER CASE |   |       |                                    |
| 0 0 0 0                               | 0       | NUL                   | 20    | DLE                   | 40                 | SP                  | 60    | 0                 | 100        | @ | 120   | P | 140        | , | 160   | p                                  |
| 0 0 0 1                               | 1       | GTL<br>SOH            | 21    | LL0<br>DC1            | 41                 | !                   | 61    | 1                 | 101        | A | 121   | Q | 141        | a | 161   | q                                  |
| 0 0 1 0                               | 2       | STX                   | 22    | DC2                   | 42                 | "                   | 62    | 2                 | 102        | B | 122   | R | 142        | b | 162   | r                                  |
| 0 0 1 1                               | 3       | ETX                   | 23    | DC3                   | 43                 | #                   | 63    | 3                 | 103        | C | 123   | S | 143        | c | 163   | s                                  |
| 0 1 0 0                               | 4       | SDC<br>EOT            | 24    | DCL<br>DC4            | 44                 | \$                  | 64    | 4                 | 104        | D | 124   | T | 144        | d | 164   | t                                  |
| 0 1 0 1                               | 5       | PPC<br>ENQ            | 25    | PPU<br>NAK            | 45                 | %                   | 65    | 5                 | 105        | E | 125   | U | 145        | e | 165   | u                                  |
| 0 1 1 0                               | 6       | ACK                   | 26    | SYN                   | 46                 | &                   | 66    | 6                 | 106        | F | 126   | V | 146        | f | 166   | v                                  |
| 0 1 1 1                               | 7       | BEL                   | 27    | ETB                   | 47                 | '                   | 67    | 7                 | 107        | G | 127   | W | 147        | g | 167   | w                                  |
| 1 0 0 0                               | 8       | GET<br>BS             | 30    | SPE<br>CAN            | 50                 | (                   | 70    | 8                 | 110        | H | 130   | X | 150        | h | 170   | x                                  |
| 1 0 0 1                               | 9       | TCT<br>HT             | 31    | SPD<br>EM             | 51                 | )                   | 71    | 9                 | 111        | I | 131   | Y | 151        | i | 171   | y                                  |
| 1 0 1 0                               | 10      | LF                    | 32    | SUB                   | 52                 | *                   | 72    | :                 | 112        | J | 132   | Z | 152        | j | 172   | z                                  |
| 1 0 1 1                               | 11      | VT                    | 33    | ESC                   | 53                 | +                   | 73    | ;                 | 113        | K | 133   | [ | 153        | k | 173   | {                                  |
| 1 1 0 0                               | 12      | FF                    | 34    | FS                    | 54                 | ,                   | 74    | <                 | 114        | L | 134   | \ | 154        | l | 174   |                                    |
| 1 1 0 1                               | 13      | CR                    | 35    | GS                    | 55                 | -                   | 75    | =                 | 115        | M | 135   | ] | 155        | m | 175   | }                                  |
| 1 1 1 0                               | 14      | SO                    | 36    | RS                    | 56                 | .                   | 76    | >                 | 116        | N | 136   | ^ | 156        | n | 176   | ~                                  |
| 1 1 1 1                               | 15      | SI                    | 37    | US                    | 57                 | /                   | 77    | ?                 | 117        | O | 137   | _ | 157        | o | 177   | RUBOUT<br>(DEL)                    |
|                                       |         | ADDRESSED<br>COMMANDS |       | UNIVERSAL<br>COMMANDS |                    | LISTEN<br>ADDRESSES |       | TALK<br>ADDRESSES |            |   |       |   |            |   |       | SECONDARY ADDRESSES<br>OR COMMANDS |

## KEY

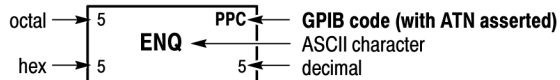

## Tektronix

REF: ANSI STD X3.4-1977  
IEEE STD 488.1-1987  
ISO STD 646-2973



# Appendix B: Reserved Words

This is a list of reserved words for your instrument. Capital letters identify the required minimum spelling.

|          |               |                    |                   |
|----------|---------------|--------------------|-------------------|
| *CAL     | ACCM          | AN                 | AUTOMATIC         |
| *CLS     | ACCOMMONMODE  | ANALOG             | AUTOset           |
| *DDT     | ACDC          | ANALOG             | AUTOset           |
| *ESE     | ACDCRMS       | ANALYSISMethod     | DPMAutoSet        |
| *ESR     | ACK           | ANALYZEmode        | AUTOset DPMPReset |
| *IDN     | ACKMISS       | AND                | AUXLevel          |
| *LRN     | ACKNOWLEDge   | ANNOTate           | AUXiliary         |
| *OPC     | ACKnum        | ANOISEDensity      | AUXout            |
| *OPT     | ACQ           | ANY                | AVAILable         |
| *PSC     | ACQDURATION   | ANYError           | Average           |
| *PUD     | ACquire       | AOffset            | AVG               |
| *RST     | ACquisition   | APOSITION          | AVPOSITION        |
| *SRE     | ACRMS         | APPID              | AXPOSITION        |
| *STB     | ACTION        | APPPWR             | AYPOSITION        |
| *TRG     | ACTONEvent    | APPPWRSUM          | Auto              |
| *TST     | ACTive        | APPLY              | B                 |
| *WAI     | ADD           | ARbitrary          | B0                |
| 0        | ADDMEAS       | AREA               | B1                |
| 1        | ADDNew        | AREA<t;x>          | B10               |
| 1066     | ADDR10        | AREAofcrosssection | B11               |
| 1200     | ADDR7         | ARINC429           | B12               |
| 128      | ADDRANDDATA   | ARINC429A          | B13               |
| 1333     | ADDRESS       | ARROW              | B14               |
| 1466     | ADDress       | ASCII              | B15               |
| 15       | ADDress       | ASCIi              | B16               |
| 1600     | ADVanced      | ASC_Fmt            | B2                |
| 1866     | AFG           | ASCIi              | B3                |
| 2133     | AGND          | ASIC               | B4                |
| 333      | AHPOSITION    | ASORuce            | B5                |
| 500E1    | ALARMSEARCh   | ASPEctratio        | B6                |
| 500E15   | ALERT         | ATRIGger           | B7                |
| 500E3    | ALIAS         | AUDio              | B8                |
| 7        | ALL           | AUNIts             | B9                |
| 8        | ALLAcqs       | AUTHenticate       | BACA              |
| 800      | ALLBits       | AUTO               | BACKLight         |
| 9        | ALLEv         | AUTODim            | BACKWARD          |
| A        | ALLTHResholds | AUTOETHERnet       | BADDR             |
| AB       | ALWAYS        | AUTOINCrement      | BADGE             |
| ABC      | AM14          | AUTORange          | BADGe             |
| ABCB     | AMPL          | AUTORbw            | BANDwidth         |
| ABORT    | AMPLINear     | AUTOSAVEPITIMEOUT  | BANDwidth         |
| ABOrt    | AMPLITUDE     | AUTOSAVEUITIMEOUT  | BASE              |
| ABSOLUTE | AMPLitude     | AUTOScale          | BASETop           |
| ABSolute | AMPMode       | AUTOset            | BASic             |
| AC       | AMP[1-10]val  | AUTOZero           | BATHTUB           |
| ACBC     | AMPITUDE      | AUTOfit            | BATHtub           |

|                 |                   |                     |                 |
|-----------------|-------------------|---------------------|-----------------|
| BC              | BRSBit            | CH2                 | COMPRESSION     |
| BCR             | BSOURCE           | CH3                 | COMPensate      |
| BCRType         | BULK              | CH4                 | COMPLete        |
| BDIFFBP         | BUNITS            | CH5                 | COMPosition     |
| BEACon          | BURSTDETECTmethod | CH6                 | COMPression     |
| BER             | BURSTEDGTYPE      | CH7                 | CONDENRG        |
| BHPOSITION      | BURSTLENGTH       | CH8                 | CONDLOSS        |
| BIAS            | BURSTLatency      | CHAN1A              | CONDition       |
| BIN             | BURSTWIDTH        | CHAN2B              | CONFIGuration   |
| BINARY          | BURST             | CHANwidth           | CONFIGure       |
| BINary          | BUS               | CHX                 | CONFigure       |
| BIT             | BUSANDWAVEFORM    | Channe1             | CONNECTSTATUS   |
| BITAMPLITUDE    | BUSTABLE          | CHecksum            | CONNECT         |
| BITCfmode       | BUSTURNAROUND     | CH<lt;x>            | CONNECTed       |
| BITDelay        | BUSY              | CH<lt;x>_DALL       | CONSTAmplitude  |
| BITEnd          | BUSx              | CH<lt;x>_D<lt;x>    | CONSTANTCLOCK   |
| BITHIGH         | BVPOSITION        | CHX                 | CONSTCLOCKMODE  |
| BITLOW          | BXPOSITION        | CHX_DALL            | CONSTant        |
| BITORDER        | BY                | CHX_Dx              | CONTROL         |
| BITOrder        | BYPOSITION        | CHX_Dy              | CONTROLCHARTYPE |
| BITPERIOD       | BYT_Nr            | CLASSA              | CONTROLCODETYPE |
| BITPcnt         | BYT_Or            | CLASSB              | CONTROLMESSAGE  |
| BITRate         | BYTE              | CLASSC              | CONTRol         |
| BITS            | Block             | CLASSD              | CONTInuous      |
| BITSTUFFing     | B<lt;x>           | CLASS               | CONTRol         |
| BITStart        | B<lt;x>PSIFIVE    | CLEAR               | COPY            |
| BITType         | Bpeak             | CLEAr               | COUNT           |
| BIT_Nr          | Br                | CLIPPING            | COUNTER         |
| BIT<lt;n>SOURCE | Bus               | CLOCK               | COUNT           |
| BJT             | Bx                | CLOCKBITSPERCHANNEL | COUPLing        |
| BLACKMANHarris  | C                 | CLOCKFrequency      | COUNT           |
| BLACKmanharris  | CA                | CLOCKMultiplier     | CPHY            |
| BLANKingtime    | CALLOUTS          | CLOCKRecovery       | CR              |
| BLOCKDATA       | CALLOUT<lt;x>     | CLOCKSOURCE         | CRC             |
| BLOCKid         | CALibrate         | CLOCK               | CRC16           |
| BLUe            | CAN               | CLOCKSOURCE         | CRC5            |
| BM              | CAN2X             | CLRESPONSE          | CRCERRor        |
| BMP             | CANH              | CMETHOD             | CRCHeader       |
| BMSGEnd         | CANL              | CN                  | CRCTrailer      |
| BN              | CAPACITANCE       | COFFSet             | CREATOR         |
| BNOISE          | CARDIac           | COLOR               | CROSSIng        |
| BN_Fmt          | CATaLog           | COLOROFF            | CSActive        |
| BOFFSet         | CB                | COLORON             | CSI             |
| BOLD            | CCODE             | COLORy              | CSIBLANK        |
| BOOKMARK        | CCOUNT            | COLOR               | CSINULL         |
| BOOKMark        | CCRESUlts         | COLORs              | CSLevel         |
| BOTH            | CCYCLes           | COMM                | CSMode          |
| BPACKets        | CENTERFREQUENCY   | COMMAND             | CSPLIT          |
| BPOSITION       | CENTERFrequency   | COMMONMODE          | CSSource        |
| BRGTID          | CGND              | COMMONMode          | CSYMLue         |
| BRINGtovieW     | CGS               | COMMand             | CURRENT         |
| BROADCASTPacket | CH                | COMMENTS            | CURRent         |
| BROadcast       | CH1               | COMPRESSEDPSStream  | CURRentacq      |



|                    |               |                      |                |
|--------------------|---------------|----------------------|----------------|
| CURSOR             | DATATHRESHold | DDRWRITE             | DISPLAYUnits   |
| CURSOR1            | DATE          | DDRWrite             | DISParity      |
| CURSOR<t;x>        | DATA          | DDT                  | DISPlaystat    |
| CURSor             | DBCA          | DECIMAL              | DISabled       |
| CURSors            | DBM           | DECode               | DISPlay        |
| CURVe              | DBMA          | DEFect               | DISPlaymode    |
| CURrent            | DBMV          | DEFine               | DIVide         |
| CUSTOM             | DBUA          | DEFinedby            | DIVisions      |
| CUSTOMLIMITSFile   | DBUV          | DEGAUSS              | DJ             |
| CUSTOMPROPAGation  | DBUW          | DEGrees              | DJDD           |
| CUSTOMTABLe        | DC            | DELAY                | DJDIRAC        |
| CUSTOm             | DCD           | DELETE               | DMINus         |
| CWD                | DCDC          | DELETEALL            | DMSGEnd        |
| CYCLE              | DCP1W2        | DELEte               | DNS            |
| CYCLEAmp           | DCPWR         | DELIMiter            | DNFFSet        |
| CYCLEBase          | DCR           | DELTA                | DOMAINname     |
| CYCLECount         | DCREJ         | DELTATime            | DOMain         |
| CYCLEMAX           | DCRType       | DELTA                | DONTInClude    |
| CYCLEMin           | DCSLONGWRITE  | DELTatime            | DONTcare       |
| CYCLEMode          | DCSLONGREAD   | DELaY                | DOTsonly       |
| CYCLEPKPK          | DCSR          | DELeTe               | DOUBLE         |
| CYCLETop           | DCSSRR        | DELeTeqstring        | DPHY           |
| CYCLEcount         | DCSSW         | DELta                | DPLUS          |
| CYCLEmode          | DDJ           | DESE                 | DPMOVERSHOOT   |
| ChIpSelect         | DDR           | DESKEW               | DPMRIPPLE      |
| Chx_Dx             | DDR3          | DESKeW               | DPMTURNOFFTIME |
| ClockEdge          | DDRAOS        | DEST                 | DPMTURNONTIME  |
| Current            | DDRAOSPERTCK  | DESTination          | DPMUNDERSHOOT  |
| D                  | DDRAOSPERUI   | DESTinationaddr      | DPlus          |
| DADDR              | DDRAUS        | DESTinationport      | DQ0            |
| DAMPing            | DDRAUSPERTCK  | DEVErRor             | DQDQS          |
| DATA               | DDRAUSPERUI   | DEVIceChirp          | DRIVE          |
| DATA0              | DDRHOIDDIFF   | DEVIceDESCMASTERREAD | DRive          |
| DATA1              | DDRREAD       | DEVIceDESCSLAVEREAD  | DSI            |
| DATA2              | DDRREADWRITE  | DEVIceTYPE           | DSIBLANK       |
| DATAA              | DDRREADWrite  | DEVIceType           | DSINULL        |
| DATAB              | DDRRead       | DEVIcetype           | Duty           |
| DATABITS           | DDRSETUPDIFF  | DHCPbootp            | DVBYDT         |
| DATABITS           | DDRTCHABS     | DIAG                 | DVDT           |
| DATABits           | DDRTCAVERAGE  | DIBYDT               | DVM            |
| DATAFORMat         | DDRTCKAVERAGE | DIDT                 | DWORD          |
| DATAFORMat         | DDRTCLABS     | DIFF                 | DYNAMIC        |
| DATAFormat         | DDRTCLAVERAGE | DIFFerential         | DYNAMIC        |
| DATAMINUS          | DDRTDQSK      | DIGGRPlt;x>          | DYNRange       |
| DATAMINUSTHRESHOLD | DDRTERRMN     | DIR                  | DeLtaB         |
| DATAMINUSTHRESHold | DDRTERRN      | DIRECTPacket         | DeLtaH         |
| DATAPLUS           | DDRTJITCC     | DIRacmodel           | Dlt;x>         |
| DATAPLUSTHRESHold  | DDRTJITDUTY   | DIREct               | EACHCLOCKCYCLE |
| DATAPacket         | DDRTJITPER    | DIREction            | EBIT           |
| DATAPath           | DDRTJPST      | DISCMODE             | EBITVALue      |
| DATARATE           | DDRTRPRE      | DISCrete             | ECC            |
| DATARate           | DDRTWPRE      | DISLave              | ECL            |
| DATASource         | DDRVIXAC      | DISPLAY              | ECU            |

|                |                   |              |                 |
|----------------|-------------------|--------------|-----------------|
| ECUDATa        | EOp               | EYERender    | FIFTy           |
| ECUSENSor      | EQua1             | EYEWIDTHBER  | FIFTyhz         |
| ECUSOURce      | EQUation          | EYEhistogram | FIFTy           |
| EDECAY         | EQua1             | Efficiency1  | FILE            |
| EDGE           | EQua1NOTEQua1     | Efficiency2  | FILEDest        |
| EDGEInCre      | ERISe             | Efficiency3  | FILEFormat      |
| EDGEQUALONE    | ERROR             | Equa1s       | FILEName        |
| EDGEQUALTWO    | ERRORREPort       | Execute      | FILESYSTEM      |
| EDGEQUALifier  | ERRORTYPe         | F1MAG        | FILESystem      |
| EDGES          | ERROR             | F2           | FILTERRANGEFROM |
| EDGESOURce     | ERRTYPe           | F3MAG        | FILTERRANGETO   |
| EDGESource     | ERRTYPe           | F4           | FILTER          |
| EDGEType       | ERRType           | F8           | FILTERs         |
| EDGE<lt;x>     | ERRor             | FACTory      | FILEpath        |
| EDGE           | ERRors            | FAIL         | FIRST           |
| EFFICIENCY     | ESCAPEMODE        | FAILCount    | FIVE            |
| Efficiency     | ESIBit            | FALL         | FIVEHundred     |
| EIGHTBIT       | ET                | FALLHigh     | FIXED           |
| EIGHTHUNDREdHz | ETHERNET          | FALLING      | FIXed           |
| EITHER         | ETHERnet          | FALLLow      | FLATNESS        |
| EITHer         | ETHernet          | FALLMid      | FLATTOP2        |
| EITHer         | EUSB              | FALLSLEWRATE | FLATtop2        |
| EMBEDDED       | EVEN              | FALLTIME     | FLAG            |
| ENABLe         | EVENT             | FALLing      | FLEXRAY         |
| ENABle         | EVENTBYTe         | FALSe        | FLEXray         |
| ENABled        | EVENTS            | FALLing      | FLIP            |
| ENCdg          | EVENTtable        | FAMILYCODE   | FLYBACK         |
| ENCoding       | EVERY             | FAST         | FOLDER          |
| END            | EVMsg             | FASTAcq      | FONT            |
| ENDPoint       | EVQty             | FASTERthan   | FONTSize        |
| ENDSEARCh      | EXCURsion         | FASTer       | FORCEDRange     |
| ENDtime        | EXECUTEQUEue      | FASTframe    | FORCE           |
| ENET           | EXECute           | Fast         | FORMError       |
| ENET100        | EXITSwindow       | FBD1         | FORMat          |
| ENET1000       | EXPLICITCLOCK     | FBD2         | FORward         |
| ENgineering    | EXPLICITCLOCKMODE | FBD3         | FOUR            |
| ENHANCED4      | EXPORTRaw         | FC1063       | FOURBIT         |
| ENHANCED8      | EXTAtten          | FC133        | FOURHUNDREDHZ   |
| ENSLave        | EXTDBatten        | FC2125       | FOURHUNDREdHz   |
| ENTERSWindow   | EXTENDED          | FC266        | FOURHundred     |
| ENTRDya        | EXTENDED          | FC4250       | FOURTEENten     |
| ENTRTSTMode    | EXTENDuis         | FC531        | FP              |
| ENTasx         | EXTREGREAD        | FC8500       | FPANel          |
| ENVeloPe       | EXTREGWRite       | FCS          | FPBinary        |
| ENABle         | EXTUnits          | FCSError     | FRAME           |
| EOF            | EXTended          | FD           | FRAMECONTRol    |
| EOFTYPE        | EXTernal          | FDBITS       | FRAMEEND        |
| EOP            | EXTime            | FDISO        | FRAMEID         |
| EOPBITS        | EYEDIAGRAM        | FDNONISO     | FRAMELEngth     |
| EOT            | EYEHIGH           | FFT          | FRAMEREJ        |
| EOTP           | EYELOW            | FIBREchanne1 | FRAMESTART      |
| EOTPDATa       | EYEMASK           | FIFTY        | FRAMETYPe       |
| EOW            | EYERENDER         | FIFTYHZ      | FRAMETYPe       |

|                      |                 |                 |                   |
|----------------------|-----------------|-----------------|-------------------|
| FRAMeType            | GETSlave        | HIGHLimit       | IMAGinary         |
| FRAMING              | GLoBa1          | HIGHPass        | IMDA              |
| FRAMe                | GLoBa1ref       | HIGHREFVo1tage  | IMDAACQTREND      |
| FRAMe                | GLONGREAD       | HIGHTIME        | IMDADQ0           |
| FREFerence           | GLONGWRITE      | HIGHZ           | IMDAEFFICIENCY    |
| FREQ                 | GLoBa1          | HIRes           | IMDAHARMONICS     |
| FREQBYTE             | GM              | HISTOGRAM       | IMDAINPUTCURRENT  |
| FREQUENCY            | GMT             | HIStory         | IMDAINPUTPOWER    |
| FREQ[1-10]Va1        | GPKNOB1         | HITDMVALue      | IMDAINPUTVOLTAGE  |
| FREQ[1-11]Va1        | GPKNOB2         | HITS            | IMDALINERIPPLE    |
| FREQuency            | GR              | HITType         | IMDAPHASORDIAGRAM |
| FROM                 | GRATICULE       | HIVALue         | IMDAPLOTDisplay   |
| FROMEDGESEARCHDIRect | GRATicule       | HOLD            | IMDAPOWERQUALITY  |
| FROMLeve1            | GRATicule       | HOLDTime        | IMDASWITCHRIPPLE  |
| FROMSearch           | GREATERthan     | HOLDoff         | IMDATIMETREND     |
| FROMSymbol           | GREen           | HOMEDir         | IMPEDANCE         |
| FROMedge             | GRIDTYPE        | HORDER          | IMPEDance         |
| FRame                | GRIDlines       | HORIZontalscale | IN                |
| FULL                 | GRId            | HORZ            | INACCBYTE         |
| FULLSPEED            | GROUPDe1ay      | HORZPOS         | INCLUDEREFs       |
| FULLScreen           | GSLSb           | HORZScale       | INCLUde           |
| FUL1                 | GSMSb           | HORizonta1      | INCLUde           |
| FUNCTIONCODETYPE     | GSP             | HOSTChirp       | INDBits           |
| FUNCTIONCODE         | GSRR            | HOTJoin         | INDEPENDENT       |
| FUNcTion             | GSW             | HS              | INDUCT            |
| FUNDCURRent          | H               | HSOURce         | INDUCTANCE        |
| FW1394BS1600B        | HAMMING         | HSYNCEND        | INDEX             |
| FW1394BS400B         | HANDSHAKEPacket | HSYNCSTART      | INFILTErs         |
| FW1394BS800B         | HANDSHAKEType   | HUB             | INFINITE          |
| False                | HANNing         | HUNDRDBASETx    | INFMAXimum        |
| GAIN                 | HARMONICS       | HUNDred         | INFMINimum        |
| GAINCROSSOVERFREQ    | HARMONICSCLass  | HYSTEResis      | INFPersist        |
| GAP                  | HARMONICSSOURce | HYSTEResis      | INFORMATION       |
| GATESource           | HARMONICSStd    | Hc              | INIT              |
| GATEWay              | HARMONICSUNits  | Hmax            | INPUT             |
| GATing               | HAVERSINE       | I2C             | INPUTCAP          |
| GAUSSian             | HBArs           | I2S             | INPUTLeve1        |
| GAUSSian             | HDRCapability   | I3C             | INPUTMode         |
| GENIPADDRESS         | HDRExit         | IBA2500         | INPUTPower        |
| GENERator            | HDRRestart      | IBA_GEN2        | INPUTSource       |
| GET                  | HEADER          | ICFACTOR        | INPUTType         |
| GETBusch             | HEADer          | ID              | INPWR             |
| GETDevch             | HEIGHT          | IDANDDATA       | INPWRSUM          |
| GETMRd1              | HEIGHTBER       | IDFORmat        | INPUt             |
| GETMwr1              | HEIGHT          | IDLE            | INRUSH            |
| GETPrid              | HEX             | IDLETime        | INRUSHcurrent     |
| GETReg               | HEXAgon         | IDLe            | INSIDEGreater     |
| GETRegpktalert       | HFRej           | IDentifier      | INSIDERange       |
| GETRegpktbad         | HI              | IEC             | INSTR             |
| GETRegpktrecent      | HID             | IEEE519         | INSTa11           |
| GETRegtestcfg        | HIGH            | ILEVELAbs       | INTENSITY         |
| GETRegvender         | HIGHLeve1       | ILEVELPct       | INTERNAL          |
| GETRegvrent          | HIGHLeve1       | IMAGE           | INTERPRatio       |

|               |                    |                 |                   |
|---------------|--------------------|-----------------|-------------------|
| INTERRUPT     | LAYout             | LONGEXTREGWRite | MASTERREAD        |
| INTERNAL      | LDIR               | LOOP            | MASTERWRITE       |
| INTERp        | LEFT               | LOOPBandwidth   | MASTer            |
| INTERNAL      | LENGTH             | LORENTz         | MATCHROM          |
| INVERTColor   | LENGth             | LOW             | MATH              |
| INVERTNIBble  | LESSEQual          | LOWDATAMINus    | MATHArbfl<lt;x>   |
| INVERTed      | LESSLimit          | LOWDATAPLUS     | MATHFFTview<lt;n> |
| INVERTed      | LESSThan           | LOWERFREquency  | MATHFFTview<lt;x> |
| INVert        | LESSThan           | LOWLeve1        | MATHFFTx          |
| INVerted      | LEVELUNIts         | LOWLimit        | MATH<lt;x>        |
| INputs        | LEVe1              | LOWPass         | MATHx             |
| INrange       | LF                 | LOWREFVo1tage   | MATlab            |
| IO            | LFREquency         | LOWSPEED        | MAX               |
| IOUT1SOURCE   | LFRej              | LOWTHRESHo1d    | MAXCAS            |
| IOUT2SOURCE   | LIC                | LOWTIME         | MAXCycle          |
| IOUT3SOURCE   | LICENSE            | LOWER           | MAXFRames         |
| IPADDRESS     | LICense            | LOWERthresho1d  | MAXHo1d           |
| IPHeader      | LIMIT              | LP              | MAXIMUM           |
| IPOWER        | LIMITCount         | LPDDR3          | MAXPSRR           |
| IPVFOUR       | LIMit              | LPDT            | MAXPSRRFREQ       |
| IRMS          | LIN                | LPS666          | MAXREAD           |
| IRipple       | LINE               | LPTHRESHo1d     | MAXRETSIZE        |
| ISCLOCKED     | LINEAR             | LPYCBCR24       | MAXRTURN          |
| ISOALL        | LINEAr             | LRIPPKPK        | MAXSamplerate     |
| ISOEND        | LINEEND            | LRIPRMS         | MAXTIME           |
| ISOMID        | LINEFREQUENCY      | LSB             | MAXVo1tage        |
| ISOSTART      | LINERIPPLE         | LSlave          | MAXWRITE          |
| ISOURce       | LINESTART          | LXI             | MAXimum           |
| ISOURce       | LINESelected       | LogicState      | MDATA             |
| ISOchronous   | LINear             | MAC             | MDATASpeed        |
| ITALIC        | LIST               | MACADDRESS      | MDIO              |
| ITALic        | LJ                 | MACLEngth       | ME                |
| ITEM          | LOAD               | MAG             | MEAN              |
| IVSINTEGRALV  | LOCKCenter         | MAGLOSS         | MEANAUTOCalculate |
| IVSINTV       | LOCKRJ             | MAGNETICLOSS    | MEANhistogram     |
| InputPwr      | LOCKRJValue        | MAGNITUDE       | MEAS              |
| Inrange       | LOCKspectrum       | MAGNitude       | MEAS1             |
| J2            | LOCK               | MAGPROPERTY     | MEASRange         |
| J9            | LOG                | MAINWindow      | MEASTAB1e         |
| JITTERMODE    | LOGARITHM          | MAIn            | MEASU             |
| JITTERSUMMARY | LOGIC              | MANChester      | MEASUREAT         |
| JITTERSummary | LOGIC1SOURCE       | MANUAL          | MEASUREMENT       |
| JITTERmodel   | LOGIC2SOURCE       | MANua1          | MEAS<lt;x>        |
| JPG           | LOGIC3SOURCE       | MARKER          | MEASured          |
| JTFBandwidth  | LOGIC4SOURCE       | MARGin          | MEASurement       |
| KAISERBesse1  | LOGIC5SOURCE       | MASK            | MEASx             |
| KAISerbesse1  | LOGICPattern       | MASKFail        | MEDian            |
| L             | LOGICQUALification | MASKHit         | MEDium            |
| L2LTOL2N      | LOGICSource        | MASKOffset      | MEMORY            |
| LABELANDDATA  | LOGIC              | MASKPass        | MESSaging         |
| LABe1         | LOGic              | MASKfile        | METHod            |
| LAN           | LONG               | MASK<lt;x>      | MID               |
| LATCH         | LONGEXTREGREAD     | MASTERADDRESS   | MIDRef            |

|                  |                   |                   |                     |
|------------------|-------------------|-------------------|---------------------|
| MIL              | NEGAtive          | NUMOUTputs        | OUTPUT4             |
| MIL1553B         | NEGAtive          | NUMSEQUence       | OUTPUT4SOURce       |
| MIN              | NETWOrKCONFig     | NWIDTH            | OUTPUT4VOLTage      |
| MINCas           | NEWpass           | NWIDTTH           | OUTPUT5             |
| MINCYcle         | NEXt              | NYET              | OUTPUT5SOURce       |
| MINHOld          | NIBBLECount       | None              | OUTPUT5VOLTage      |
| MINIMUM          | NIBBLE            | OC1               | OUTPUT6             |
| MINImum          | NO                | OC12              | OUTPUT6SOURce       |
| MINMax           | NOCARE            | OC3               | OUTPUT6VOLTage      |
| MINPSRR          | NOISEAdd          | OC48              | OUTPUT7             |
| MINPSRRFREQ      | NOISErej          | OCCURS            | OUTPUT7SOURce       |
| MINUI            | NOISE             | ODD               | OUTPUT7VOLTage      |
| MINimum          | NOMINALOFFset     | ODDEven           | OUTPUTSource        |
| MISo             | NOMinal           | OFF               | OUTPUTType          |
| MIXED            | NOMinalfreq       | OFF1              | OUTPUT<lt;n>VOLTage |
| MIXEDASCII       | NONE              | OFFSet            | OUTPWR              |
| MIXEDHEX         | NONTRANSition     | ON                | OUTPWRSUM           |
| MIXed            | NOne              | ONCE              | OUTPut              |
| MKDir            | NOPARity          | ONE               | OUTSIDEGreater      |
| MODE             | NOR               | ONEOVERDELTAVALUE | OUTSIDErange        |
| MODEHistogram    | NORESPonse        | ONEPAIRI          | OUTSOURCE           |
| MODE             | NORMALColor       | ONEPAIRV          | OUTWIRing           |
| MODEl            | NORMAl            | ONEPAIRVI         | OUTrange            |
| MODulo           | NORMAl            | ONEWIRE           | OUTSide             |
| MOREEQua         | NOSTATION         | ONFAIL            | OVERDRIVEMATCH      |
| MOREEQuAl        | NOTE              | OPCODEERRor       | OVERDRIVESKIP       |
| MOREEQuAlINrange | NOTEQuAls         | OPCode            | OVERDRIVE           |
| MORELimit        | NOVERSHOOT        | OPERating         | OVERLoad            |
| MOREThan         | NOne              | OPPOSITEas        | OVERride            |
| MOREthan         | NPERIOD           | OPTIMIZAtion      | OVERlay             |
| MOSFET           | NPJ               | OPTIMize          | OVERdrive           |
| MOSi             | NPULSE            | OPTIONALPARAM     | OVERlay             |
| MOUNT            | NPULSEWIDTH       | OPTION            | Output1Pwr          |
| MOVEABLE         | NR1               | OPTIONAl          | Output2Pwr          |
| MSB              | NR2               | OR                | Output3Pwr          |
| MULTiply         | NR3               | OUT               | P1W2V1I1            |
| MULTipleframes   | NRZ               | OUTEDGEQUALifier  | P1W3V2I2            |
| Manual           | NR_Pt             | OUTFILTERs        | P3W3                |
| Math<lt;x>       | NTIMES            | OUTL2LTOL2N       | P3W3V2I2            |
| Mathx            | NTIMES            | OUTLINESelected   | P3W3V3I3            |
| N                | NULL              | OUTPUT            | P3W4                |
| NACK             | NULLFRDynamic     | OUTPUT1           | PACKET              |
| NAK              | NULLFRStatic      | OUTPUT1SOURce     | PACKets             |
| NAME             | NULl              | OUTPUT1Type       | PALETTE             |
| NAME             | NUMACQs           | OUTPUT1VOLTage    | PANKNOB             |
| NAND             | NUMACq            | OUTPUT2           | PARityerror         |
| NAND             | NUMAVg            | OUTPUT2SOURce     | PARAllel            |
| NATIVE           | NUMBER            | OUTPUT2Type       | PARity              |
| NAVigate         | NUMBins           | OUTPUT2VOLTage    | PASSFAILEnabled     |
| NDUTY            | NUMCHANnel        | OUTPUT3           | PASSFAILHIGHlimit   |
| NDUTYCYCLE       | NUMERICORDER      | OUTPUT3SOURce     | PASSFAILLimit       |
| NDuTy            | NUMFRAMESACquired | OUTPUT3Type       | PASSFAILLOWlimit    |
| NDuty            | NUMOFOutputs      | OUTPUT3VOLTage    | PASSFAILMARGin      |

|                    |                   |                |            |
|--------------------|-------------------|----------------|------------|
| PASSFAILWHEN       | PLL               | PRIOD          | RATE19K    |
| PASSWord           | PLOT              | PROBEControl   | RATE1K     |
| PATTERNDETECTION   | PLOTData          | PROBECal       | RATE1M     |
| PATTERNLength      | PLOTVIEW<t;x>     | PROBEFunc      | RATE20K    |
| PATTERNType        | PLOTVIEWx         | PROFile        | RATE250K   |
| PATtern            | PLOTview<t;n>     | PROTOcol       | RATE25K    |
| PAUSE              | PLOTview<t;x>     | PROTOcol       | RATE2K     |
| PAUSEPULSe         | PLOT<t;x>         | PROTocol       | RATE2M     |
| PAUSE              | PLOTx             | PRObe          | RATE300    |
| PAYLength          | PM                | PSIFive        | RATE31K    |
| PAYLOAD            | PNG               | PSRR           | RATE33K    |
| PAYLength          | PNJUNCTION        | PTYPE          | RATE38K    |
| PAYLoad            | POHCL             | PT_Fmt         | RATE3M     |
| PAYload            | POHCM             | PT_Off         | RATE400K   |
| PCIE_GEN1          | POHCS             | PULSEWIDTH     | RATE4K     |
| PCIE_GEN2          | POINT             | PULSEwidth     | RATE4M     |
| PCIE_GEN3          | POINTS            | PULSe          | RATE500K   |
| PCIExpress         | POLARITY          | PULSe          | RATE50K    |
| PDUTTY             | POLarity          | PWIDTH         | RATE5M     |
| PDUTY              | POPulation        | PWRFACTOR      | RATE62K    |
| PDUTYCYCLE         | PORT              | PWRFREQ        | RATE68K    |
| PEAK               | PORTConfiguration | PWRUpstatus    | RATE6M     |
| PEAKCURRENT        | PORTReset         | ParalBlockgt   | RATE7M     |
| PEAKVOLTage        | POSITIVE          | Permeability   | RATE800K   |
| PEAKdetect         | POST              | QFACTOR        | RATE83K    |
| PERCent            | POSTAMBLE         | QString        | RATE8M     |
| PERFREQ            | POSITION          | QStringNR1     | RATE921K   |
| PERIOD             | POSitive          | QStringQString | RATE92K    |
| PERIOD             | POVERSHOOT        | QTAG           | RATE9K     |
| PERSistence        | POWERFACTOR       | QTAGGING       | RATE9M     |
| PERSource          | POWERQUALITY      | QUALifier      | RATED      |
| PFACTOR            | POWERRating       | QUALifier      | RAW10      |
| PFC                | POWERx            | Qstring        | RAW12      |
| PHASE              | POWLINear         | RADIans        | RAW14      |
| PHASECROSSOVERFREQ | POWLOG            | RAIL17         | RAW16      |
| PHASENOISE         | Power             | RAILNUM        | RAW20      |
| PHASEONE           | Power<t;x>        | RAMP           | RAW6       |
| PHASETHREE         | PPD               | RAMPtime       | RAW7       |
| PHASETWO           | PPS101010         | RANDom         | RAW8       |
| PHASOR             | PPS121212         | RAP            | RBW        |
| PHASE              | PPS565            | RAPDATA        | RBWMode    |
| PHYSICALADDRESS    | PPS666            | RATE100K       | RCURRENT   |
| PHYSicaladdress    | PPS888            | RATE10K        | RDS        |
| PICPARAMeter       | PPULSE            | RATE10M        | RDSON      |
| PID                | PPULSEWIDTH       | RATE115K       | RDSON      |
| PING               | PREAMBLE          | RATE11M        | READ       |
| PIXELNUMBER        | PRESET            | RATE125K       | READFile   |
| PIXELVALue         | PRESS             | RATE12M        | READROM    |
| PIXel              | PREViewstate      | RATE13M        | READout    |
| PJ                 | PREVIOUS          | RATE14M        | READY      |
| PK2PK              | PREamble          | RATE153K       | REAL       |
| PK2Pk              | PREsence          | RATE15M        | RECALL     |
| PKPK               | PRIMARYTURNS      | RATE16M        | RECALLmask |

|                     |                     |                 |                 |
|---------------------|---------------------|-----------------|-----------------|
| RECORD              | REQuESted           | RMS             | SCRAmBlIng      |
| RECORDLength        | RERUN               | RNR             | SDATa           |
| RECOrdlength        | RESAMPLE            | ROLL            | SDI             |
| RECTANGLE           | RESAMPLERate        | ROLOCATION      | SDIDATA         |
| RECTANGular         | RESERVed            | ROMCODe         | SDIDATASSM      |
| RECTangle           | RESET               | ROSc            | SDLC            |
| RECTangular         | RESEtTRIGger        | ROtAtion        | SDR             |
| RED                 | RESOLution          | RP              | SDRBroadcast    |
| REF                 | RESPONSECODe        | RPBinary        | SDRDirect       |
| REFERENCE           | RESPonse            | RR              | SE              |
| REFFFTView<lt;n>    | RESPonsetime        | RRBDisplaystate | SEARCH          |
| REFFFTView<lt;x>    | RESUME              | RS232C          | SEARCH1         |
| REFFFTX             | RESUlT              | RSTDYa          | SEARCHOPTION    |
| REFLEVELMode        | RESUlTs             | RUN             | SEARCHROM       |
| REFLeve1            | RESample            | RUNStOp         | SEARCHSource    |
| REFLeve1s           | RESet               | RUNT            | SEARCHTABle     |
| REFLeve1s<lt;x>     | RESistance          | RUNt            | SEARCHTable     |
| REFMode             | RF_AVErage          | RWINADDR        | SEARCH<lt;x>    |
| REFOUT              | RF_FREQuency        | RX              | SEARCHtotrigger |
| REFVOLTAGE<lt;n>Val | RF_FREQuency<lt;x>  | S8B10B          | SEARCHx>        |
| REFVo1tage          | RF_MAGNitude        | SADDRESS        | SEARCH          |
| REFerence           | RF_MAGNitude<lt;x>  | SAME            | SEC1SOURCE      |
| REF<lt;x>           | RF_MAXHold          | SAMEas          | SEC1TURNS       |
| REF<lt;x>_DALL      | RF_MINHold          | SAMPLERate      | SEC2SOURCE      |
| REF<lt;x>_D<lt;x>   | RF_NORMAl           | SAMPLEpoint     | SEC2TURNS       |
| REFX                | RF_PHASE            | SAMplE          | SEC3SOURCE      |
| REFX_DX             | RF_PHASE<lt;x>      | SAS12_NOSSC     | SEC3TURNS       |
| REGOWRite           | RFvsTime            | SAS12_SSC       | SEC4SOURCE      |
| REGAddrtestcfg      | RGB444              | SAS15_NOSSC     | SEC4TURNS       |
| REGAddrvndor        | RGB555              | SAS15_SSC       | SEC5SOURCE      |
| REGDatatestcfg      | RGB565              | SAS3_NOSSC      | SEC5TURNS       |
| REGDatavndor        | RGB666              | SAS3_SSC        | SEC6SOURCE      |
| REGISTERADDRESS     | RGB888              | SAS6_NOSSC      | SEC6TURNS       |
| REGREAd             | RI                  | SAS6_SSC        | SECOND          |
| REGWRite            | RIBinary            | SATA_GEN1       | SECONds         |
| REGion              | RIGht               | SATA_GEN2       | SECPhase        |
| REGister            | RI0125              | SATA_GEN3       | SECVo1t         |
| REGisteraddress     | RI0250              | SAVEIMAGE       | SECWINDings     |
| REJ                 | RI03125             | SAVEON          | SECONds         |
| REJect              | RIPPLEFREQ<lt;n>Val | SAVEONEVent     | SEG<lt;x>       |
| REM                 | RISE                | SAVEWAVEform    | SEG<lt;x>COUNT  |
| REMOte              | RISEHigh            | SAVE            | SEG<lt;y>       |
| REName              | RISELow             | SAVEmask        | SELECTED        |
| REPEATERHOST        | RISEMid             | SC              | SELECTIONtype   |
| REPEATERPERIPHERAL  | RISESLEWRATE        | SCALE           | SELTrace        |
| REPEATStart         | RISETIME            | SCALERATIO      | SELEct          |
| REPEATstart         | RISING              | SCALE           | SELEcted        |
| REPOrt              | RISe                | SCALE           | SENSORADDRESS   |
| REPWR               | RISing              | SCIENTific      | SENSORECU       |
| REPWRSUM            | RJ                  | SCLk            | SENSORSTATUS    |
| REPeating           | RJDD                | SCOPEApp REBOOT | SENSOr          |
| REQDISConnect       | RJDIRAC             | SCRAMBLING      | SENT            |
| REQSETINIT          | RMDir               | SCREEN          | SEQSEtUp        |

|                 |                |                |                 |
|-----------------|----------------|----------------|-----------------|
| SEQnum          | SIXTEENeight   | SPECTrum       | STOPACQ         |
| SEquence        | SIXTYHZ        | SPI            | STOPAcq         |
| SERIALNUMBER    | SIXTYhz        | SPLIT          | STOPAfter       |
| SERVICE         | SIXty          | SPLITMODE      | STOPFREquency   |
| SERVICEMODE     | SIZE           | SPLit          | STOPFrequency   |
| SERVICENAME     | SIZEe          | SPMI           | STROBE          |
| SERnumber       | SKEW           | SPREADSheet    | STROBESource    |
| SESSion         | SKIPROM        | SPace          | STRObe          |
| SET             | SLAVE          | SQUELCH        | STRObe          |
| SETBrt          | SLAVEADDRESS   | SQUare         | SType           |
| SETDecay        | SLAVE          | SRBinary       | STYle           |
| SETDya          | SLEEP          | SRJ            | STandard        |
| SETFast         | SLEWRATEMethod | SRPbinary      | STop            |
| SETHOLDLogicval | SLEep          | SRQ            | SUBAddress      |
| SETHold         | SLOW           | SS             | SUBGROUP        |
| SETLevel        | SLOWERthan     | SSC            | SUBNETMask      |
| SETMrdl         | SLOWER         | SSCFREQDEV     | SUBSF           |
| SETMwr1         | SLOpe          | SSCMODRATE     | SUBTYpe         |
| SETNdya         | SMPS           | SSCPROFILE     | SUBtract        |
| SETPs           | SNap           | SSM            | SUMFrame        |
| SETRegaddr      | SNRM           | SSPLIT         | SUPPORTBYTe     |
| SETRegdata      | SNRME          | STADDRESS      | SUPpress        |
| SETSlow         | SOA            | STALL          | SUPervisory     |
| SETTime         | SOAHITSCNT     | STANDARD       | SUSPEND         |
| SETUP           | SOCKETServer   | STANDARD       | SV              |
| SETUp           | SOF            | START          | SVID            |
| SETWp           | SOFFRAMENUMber | STARTBIT       | SWITCHING       |
| SEText          | SOT            | STARTCONDition | SWITCHINGLOSS   |
| SEVEN           | SOURCE         | STARTFREQUEncy | SWITCHINGRIPPLE |
| SFD             | SOURCEEDGEType | STARTFREquency | SWL             |
| SFPbinary       | SOURCEList     | STARTFrequency | SWLCONFIGType   |
| SHAPE           | SOURCEType     | STARTPACKet    | SWRIPPKPK       |
| SHORT           | SOURCES        | STARTOffframe  | SWRIPRMS        |
| SHOWAREas       | SOURCE         | STARTtime      | SYMB            |
| SHOWCRiteria    | SOURce         | STARTUp        | SYMBOL          |
| SHOUEquation    | SOURceaddr     | STARTUpnosync  | SYMBOL          |
| Short           | SOURcelt;x>    | START          | SYMBOLs         |
| SHUTDOWN        | SOURceport     | STATE          | SYMMetry        |
| SHUTdown        | SOW            | STATEBYTe      | SYNC            |
| SI              | SPACEWIRE      | STATIC         | SYNCBITS        |
| SIGNAL          | SPAN           | STATIONADDR    | SYNCFrame       |
| SIGNALFREQUENCY | SPANABovebw    | STATIStics     | SYNCMODE        |
| SIGNALType      | SPANBELowdc    | STATUS         | SYNCSEARCh      |
| SIGNALType      | SPANRBWRatio   | STATE          | SYNCTHRESHold   |
| SIGNAl          | SPEC           | STATic         | SYNCfield       |
| SignAl          | SPECIALPacket  | STATus         | SYSTEM          |
| SINC            | SPECIALType    | STAYSHigh      | Start           |
| SINE            | SPECTRAL       | STAYSLow       | Stop            |
| SINGLE          | SPECTRALBUJ    | STAcKed        | String          |
| SINX            | SPECTRUM       | STANDard       | Symbol          |
| SIX             | SPECTRAL       | STDDev         | TARGETBER       |
| SIXBIT          | SPECViewlt;x>  | STEPRESPONSE   | TBIT            |
| SIXFIFTYhz      | SPECTral       | STOP           | TBITRDNeg       |



|                    |                      |                 |               |
|--------------------|----------------------|-----------------|---------------|
| TBITRDPos          | TOLERance            | TYPe            | VERTSCALE     |
| TBITVALue          | TOLerance            | TotalEfficiency | VERTical      |
| TCKAVG             | TOLevel              | True            | VERsion       |
| TCPHeader          | TONENRG              | U               | VGLeve1       |
| TDM                | TONLOSS              | UACK            | VIEW          |
| TDMVALue           | TOOTHGAP             | UI              | VIEWStyle     |
| TEKEXponential     | TOP                  | ULPS            | VIEWType      |
| TEKSecure          | TOSymbol             | UNDERLine       | VISIBility    |
| TEMPerature        | TOTAL                | UNDERline       | VISua1        |
| TENBASET           | TOTALEFFiciency      | UNDO            | VLEVELAbs     |
| TENNinety          | TOTALuptime          | UNEQual         | VLEVELPct     |
| TERMinal           | TOUCHSCREEN          | UNINSTALL       | VOLTAGE       |
| TERmination        | TRACK                | UNIQUE          | VOLTage       |
| TEST               | TRAILER              | UNITINTERVAL    | VOUT1SOURCE   |
| TESTCONNECTION     | TRANSFERbusownership | UNITIntervals   | VOUT2SOURCE   |
| TESTMODE           | TRANSITION           | UNITIntervals   | VOUT3SOURCE   |
| TESTmode           | TRANSITION           | UNITS           | VRMS          |
| TEST               | TRANstion            | UNIts           | VSOURCE       |
| TEXT               | TRAPezoid            | UNLock          | VSOURCE       |
| TF                 | TRAIler              | UNLocked        | VSYNCEnd      |
| THDF               | TRBit                | UNMOUNT         | VSYNcSTART    |
| THDR               | TRIAngle             | UNNumbered      | VTERM         |
| THIRD              | TRIGLeve1            | UNWRap          | VUNIT         |
| THREE              | TRIGger              | UP              | WAITTime      |
| THREEPHASEAUTOset  | TRIGgertosearch<!    | UPDatenow       | WAKEup        |
| THREESIXtyhz       | TRPWR                | UPPERFREQuency  | WAKEup        |
| THRESHo1d          | TRPWRSUM             | UPPer           | WAVEFORM      |
| THRESHo1d          | TRUEPWR              | UPPerthreshold  | WAVEVIEW1     |
| TICKTIME           | TRUe                 | USAGe           | WAVEview      |
| TICKTOLerance      | TRAck                | USB             | WAVEview1t;x> |
| TICKS              | TTL                  | USB3            | WAVEview1t;y> |
| TIE                | TTLENRG              | USBDevice       | WAVEform      |
| TIEHISTOGRAM       | TTLLOSS              | USBTmc          | WAVEforms     |
| TIESPECTRUM        | TURN                 | USECLockedge    | WAVFrm        |
| TIETIMETREND       | TURNOfftime          | USECLockedge    | WEIGHt        |
| TIMECode           | TURNON               | USEGLOBAL       | WFID          |
| TIMEOUTSIDELEVEL   | TURNONTIME           | USEREIGHTB      | WFMOutpre     |
| TIMEOut            | TURNONtime           | UTCDELTA        | WFMTYPE       |
| TIMEStamp          | TWELVEtwelve         | V               | WHEN          |
| TIMETOMAX          | TWENTYBIT            | V1X             | WIDTH         |
| TIMETOMIN          | TWENTyeighty         | V2X             | WIDTHBER      |
| TIMETREND          | TWENTYfive           | VALUe           | WIDTh         |
| TIMINGMode         | TWO                  | VALidate        | WINDOW        |
| TIME               | TWOBIT               | VALue           | WINDOWLENgth  |
| TJBER              | TWOCLOCKCYCLES       | VARpersist      | WINSCALE      |
| TNTRATIO           | TWOFifty             | VBars           | WINDow        |
| TO                 | TWOTHousand          | VCESat          | WIRing        |
| TOEDGESEARCHDIRECT | TX                   | VCFactor        | WIThin        |
| TOEdge             | TXRX                 | VDIFFXOVR       | WORD          |
| TOFFENRG           | TXRXTHRESHo1d        | VECTors         | WORDCOUNT     |
| TOFFLOSS           | TYPE                 | VERBose         | WORDSIZE      |
| TOKENPacket        | TYPE1                | VERTICES        | WORDSe1       |
| TOKENType          | TYPE2                | VERTPOS         | WORDSize      |



# Appendix C: Factory Defaults

## Default Setup

The following table lists the default values for each command.

**NOTE.** Find the most up-to-date default values for your instrument and software by performing a TekSecure command, saving the instrument setup and looking at the instrument or setup file.

Table C-1: Default Values

| Item                                    | Description  |
|-----------------------------------------|--------------|
| ACQUIRE:FASTACQ:PALETTE                 | TEMPERATURE  |
| ACQUIRE:FASTACQ:STATE                   | 0            |
| ACQUIRE:MAGNIVU                         | 0            |
| ACQUIRE:MODE                            | SAMPLE       |
| ACQUIRE:NUMAVG                          | 16           |
| ACQUIRE:NUMENV                          | INFINITE     |
| ACQUIRE:STATE                           | 1            |
| ACQUIRE:STOPAFTER                       | RUNSTOP      |
| ACTONEVENT:ACTION:AUXOUT:STATE          | 0            |
| ACTONEVENT:ACTION:EMAIL:SETUP:TOADDRESS | "TestString" |
| ACTONEVENT:ACTION:EMAIL:STATE           | 0            |
| ACTONEVENT:ACTION:PRINT:STATE           | 0            |
| ACTONEVENT:ACTION:SAVEIMAGE:STATE       | 0            |
| ACTONEVENT:ACTION:SAVEWFM:STATE         | 0            |
| ACTONEVENT:ACTION:SRQ:STATE             | 0            |
| ACTONEVENT:ACTION:STOPACQ:STATE         | 1            |
| ACTONEVENT:ACTION:VISUAL:STATE          | 0            |
| ACTONEVENT:EVENTTYPE                    | NONE         |
| ACTONEVENT:NUMACQS                      | 1            |
| ACTONEVENT:REPEATCOUNT                  | 1.0000       |
| AFG:AMPLITUDE                           | 500.0000E-3  |
| AFG:ARBITRARY:EMEM:POINTS:ENCDG         | ASCII        |
| AFG:FREQUENCY                           | 100.0E+3     |
| AFG:FUNCTION                            | SINE         |
| AFG:HIGLEVEL                            | 250.0000E-3  |
| AFG:LEVELPRESET                         | USER         |
| AFG:LOWLEVEL                            | -250.0000E-3 |

Table C-1: Default Values (cont.)

| Item                            | Description         |
|---------------------------------|---------------------|
| AFG:NOISEADD:PERCENT            | 0.0E+0              |
| AFG:NOISEADD:STATE              | 0                   |
| AFG:OFFSET                      | 0.0E+0              |
| AFG:OUTPUT:LOAD:IMPEDANCE       | HIGHZ               |
| AFG:PERIOD                      | 9.99999999999916E-6 |
| AFG:PHASE                       | 0.0E+0              |
| AFG:PULSE:WIDTH                 | 1.0E-6              |
| AFG:RAMP:SYMMETRY               | 50.0000             |
| AFG:SQUARE:DUTY                 | 50.0000             |
| ALIAS:STATE                     | 0                   |
| APPLICATION:TYPE                | POWER               |
| AUXOUT:EDGE                     | RISING              |
| AUXOUT:SOURCE                   | ATRIGGER            |
| BUS:B1:AUDIO:BITDELAY           | 1                   |
| BUS:B1:AUDIO:BITORDER           | MSB                 |
| BUS:B1:AUDIO:CHANNEL:SIZE       | 24                  |
| BUS:B1:AUDIO:CLOCK:POLARITY     | RISE                |
| BUS:B1:AUDIO:CLOCK:SOURCE       | CH1                 |
| BUS:B1:AUDIO:DATA:POLARITY      | NORMAL              |
| BUS:B1:AUDIO:DATA:SIZE          | 24                  |
| BUS:B1:AUDIO:DISPLAY:FORMAT     | SIGNEDDECIMAL       |
| BUS:B1:AUDIO:FRAME:SIZE         | 8                   |
| BUS:B1:AUDIO:FRAMESYNC:POLARITY | RISE                |
| BUS:B1:AUDIO:FRAMESYNC:SOURCE   | CH2                 |
| BUS:B1:AUDIO:TYPE               | I2S                 |
| BUS:B1:AUDIO:WORDSEL:POLARITY   | NORMAL              |
| BUS:B1:AUDIO:WORDSEL:SOURCE     | CH2                 |
| BUS:B1:CAN:BITRATE              | 500000              |
| BUS:B1:CAN:FD:BITRATE           | 4000000             |
| BUS:B1:CAN:FD:STANDARD          | ISO                 |
| BUS:B1:CAN:PROBE                | CANH                |
| BUS:B1:CAN:SAMPLEPOINT          | 50                  |
| BUS:B1:CAN:SOURCE               | CH1                 |
| BUS:B1:CAN:STANDARD             | CAN2X               |
| BUS:B1:DISPLAY:FORMAT           | HEXADECIMAL         |
| BUS:B1:DISPLAY:TYPE             | BUS                 |
| BUS:B1:FLEXRAY:BITRATE          | 10000000            |

Table C-1: Default Values (cont.)

| Item                                 | Description |
|--------------------------------------|-------------|
| BUS:B1:FLEXRAY:CHANNEL               | A           |
| BUS:B1:FLEXRAY:SIGNAL                | BDIFFBP     |
| BUS:B1:FLEXRAY:SOURCE                | CH1         |
| BUS:B1:I2C:ADDRESS:RWINCLUDE         | 0           |
| BUS:B1:I2C:CLOCK:SOURCE              | CH1         |
| BUS:B1:I2C:DATA:SOURCE               | CH2         |
| BUS:B1:LABEL                         | "Parallel"  |
| BUS:B1:LIN:BITRATE                   | 19200       |
| BUS:B1:LIN:IDFORMAT                  | NOPARITY    |
| BUS:B1:LIN:POLARITY                  | NORMAL      |
| BUS:B1:LIN:SAMPLEPOINT               | 50          |
| BUS:B1:LIN:SOURCE                    | CH1         |
| BUS:B1:LIN:STANDARD                  | V2X         |
| BUS:B1:MIL1553B:POLARITY             | NORMAL      |
| BUS:B1:MIL1553B:RESPONSETIME:MAXIMUM | 12.0000E-6  |
| BUS:B1:MIL1553B:RESPONSETIME:MINIMUM | 4.0000E-6   |
| BUS:B1:MIL1553B:SOURCE               | CH1         |
| BUS:B1:PARALLEL:BIT0:SOURCE          | D0          |
| BUS:B1:PARALLEL:BIT10:SOURCE         | D10         |
| BUS:B1:PARALLEL:BIT11:SOURCE         | D11         |
| BUS:B1:PARALLEL:BIT12:SOURCE         | D12         |
| BUS:B1:PARALLEL:BIT13:SOURCE         | D13         |
| BUS:B1:PARALLEL:BIT14:SOURCE         | D14         |
| BUS:B1:PARALLEL:BIT15:SOURCE         | D15         |
| BUS:B1:PARALLEL:BIT16:SOURCE         | CH1         |
| BUS:B1:PARALLEL:BIT17:SOURCE         | CH2         |
| BUS:B1:PARALLEL:BIT18:SOURCE         | CH3         |
| BUS:B1:PARALLEL:BIT19:SOURCE         | CH4         |
| BUS:B1:PARALLEL:BIT1:SOURCE          | D1          |
| BUS:B1:PARALLEL:BIT2:SOURCE          | D2          |
| BUS:B1:PARALLEL:BIT3:SOURCE          | D3          |
| BUS:B1:PARALLEL:BIT4:SOURCE          | D4          |
| BUS:B1:PARALLEL:BIT5:SOURCE          | D5          |
| BUS:B1:PARALLEL:BIT6:SOURCE          | D6          |
| BUS:B1:PARALLEL:BIT7:SOURCE          | D7          |
| BUS:B1:PARALLEL:BIT8:SOURCE          | D8          |
| BUS:B1:PARALLEL:BIT9:SOURCE          | D9          |

Table C-1: Default Values (cont.)

| Item                            | Description  |
|---------------------------------|--------------|
| BUS:B1:PARALLEL:CLOCK:EDGE      | RISING       |
| BUS:B1:PARALLEL:CLOCK:ISCLOCKED | NO           |
| BUS:B1:PARALLEL:CLOCK:SOURCE    | CH1          |
| BUS:B1:PARALLEL:WIDTH           | 16           |
| BUS:B1:POSITION                 | 0.0E+0       |
| BUS:B1:RS232C:BITRATE           | 9600         |
| BUS:B1:RS232C:DATABITS          | 8            |
| BUS:B1:RS232C:DELIMITER         | LF           |
| BUS:B1:RS232C:DISPLAYMODE       | FRAME        |
| BUS:B1:RS232C:PARITY            | NONE         |
| BUS:B1:RS232C:POLARITY          | NORMAL       |
| BUS:B1:RS232C:RX:SOURCE         | OFF          |
| BUS:B1:RS232C:TX:SOURCE         | CH1          |
| BUS:B1:SPI:BITORDER             | MSB          |
| BUS:B1:SPI:CLOCK:POLARITY       | RISE         |
| BUS:B1:SPI:CLOCK:SOURCE         | CH1          |
| BUS:B1:SPI:DATA:IN:POLARITY     | HIGH         |
| BUS:B1:SPI:DATA:IN:SOURCE       | OFF          |
| BUS:B1:SPI:DATA:OUT:POLARITY    | HIGH         |
| BUS:B1:SPI:DATA:OUT:SOURCE      | CH3          |
| BUS:B1:SPI:DATA:SIZE            | 8            |
| BUS:B1:SPI:FRAMING              | SS           |
| BUS:B1:SPI:IDLETIME             | 5.0000E-6    |
| BUS:B1:SPI:SELECT:POLARITY      | LOW          |
| BUS:B1:SPI:SELECT:SOURCE        | CH2          |
| BUS:B1:STATE                    | 0            |
| BUS:B1:TYPE                     | PARALLEL     |
| BUS:B1:USB:BITRATE              | FULL         |
| BUS:B1:USB:PROBE                | DIFFERENTIAL |
| BUS:B1:USB:SOURCE:DIFFERENTIAL  | CH1          |
| BUS:B1:USB:SOURCE:DMINUS        | CH2          |
| BUS:B1:USB:SOURCE:DPLUS         | CH1          |
| BUS:B2:AUDIO:BITDELAY           | 1            |
| BUS:B2:AUDIO:BITORDER           | MSB          |
| BUS:B2:AUDIO:CHANNEL:SIZE       | 24           |
| BUS:B2:AUDIO:CLOCK:POLARITY     | RISE         |
| BUS:B2:AUDIO:CLOCK:SOURCE       | CH1          |

Table C-1: Default Values (cont.)

| Item                                 | Description   |
|--------------------------------------|---------------|
| BUS:B2:AUDIO:DATA:POLARITY           | NORMAL        |
| BUS:B2:AUDIO:DATA:SIZE               | 24            |
| BUS:B2:AUDIO:DISPLAY:FORMAT          | SIGNEDDECIMAL |
| BUS:B2:AUDIO:FRAME:SIZE              | 8             |
| BUS:B2:AUDIO:FRAMESYNC:POLARITY      | RISE          |
| BUS:B2:AUDIO:FRAMESYNC:SOURCE        | CH2           |
| BUS:B2:AUDIO:TYPE                    | I2S           |
| BUS:B2:AUDIO:WORDSEL:POLARITY        | NORMAL        |
| BUS:B2:AUDIO:WORDSEL:SOURCE          | CH2           |
| BUS:B2:CAN:BITRATE                   | 500000        |
| BUS:B2:CAN:FD:BITRATE                | 4000000       |
| BUS:B2:CAN:FD:STANDARD               | ISO           |
| BUS:B2:CAN:PROBE                     | CANH          |
| BUS:B2:CAN:SAMPLEPOINT               | 50            |
| BUS:B2:CAN:SOURCE                    | CH1           |
| BUS:B2:CAN:STANDARD                  | CAN2X         |
| BUS:B2:DISPLAY:FORMAT                | HEXADECIMAL   |
| BUS:B2:DISPLAY:TYPE                  | BUS           |
| BUS:B2:FLEXRAY:BITRATE               | 10000000      |
| BUS:B2:FLEXRAY:CHANNEL               | A             |
| BUS:B2:FLEXRAY:SIGNAL                | BDIFFBP       |
| BUS:B2:FLEXRAY:SOURCE                | CH1           |
| BUS:B2:I2C:ADDRESS:RWINCLUDE         | 0             |
| BUS:B2:I2C:CLOCK:SOURCE              | CH1           |
| BUS:B2:I2C:DATA:SOURCE               | CH2           |
| BUS:B2:LABEL                         | "Parallel"    |
| BUS:B2:LIN:BITRATE                   | 19200         |
| BUS:B2:LIN:IDFORMAT                  | NOPARITY      |
| BUS:B2:LIN:POLARITY                  | NORMAL        |
| BUS:B2:LIN:SAMPLEPOINT               | 50            |
| BUS:B2:LIN:SOURCE                    | CH1           |
| BUS:B2:LIN:STANDARD                  | V2X           |
| BUS:B2:MIL1553B:POLARITY             | NORMAL        |
| BUS:B2:MIL1553B:RESPONSETIME:MAXIMUM | 12.0000E-6    |
| BUS:B2:MIL1553B:RESPONSETIME:MINIMUM | 4.0000E-6     |
| BUS:B2:MIL1553B:SOURCE               | CH1           |
| BUS:B2:PARALLEL:BIT0:SOURCE          | D0            |

Table C-1: Default Values (cont.)

| Item                            | Description |
|---------------------------------|-------------|
| BUS:B2:PARALLEL:BIT10:SOURCE    | D10         |
| BUS:B2:PARALLEL:BIT11:SOURCE    | D11         |
| BUS:B2:PARALLEL:BIT12:SOURCE    | D12         |
| BUS:B2:PARALLEL:BIT13:SOURCE    | D13         |
| BUS:B2:PARALLEL:BIT14:SOURCE    | D14         |
| BUS:B2:PARALLEL:BIT15:SOURCE    | D15         |
| BUS:B2:PARALLEL:BIT16:SOURCE    | CH1         |
| BUS:B2:PARALLEL:BIT17:SOURCE    | CH2         |
| BUS:B2:PARALLEL:BIT18:SOURCE    | CH3         |
| BUS:B2:PARALLEL:BIT19:SOURCE    | CH4         |
| BUS:B2:PARALLEL:BIT1:SOURCE     | D1          |
| BUS:B2:PARALLEL:BIT2:SOURCE     | D2          |
| BUS:B2:PARALLEL:BIT3:SOURCE     | D3          |
| BUS:B2:PARALLEL:BIT4:SOURCE     | D4          |
| BUS:B2:PARALLEL:BIT5:SOURCE     | D5          |
| BUS:B2:PARALLEL:BIT6:SOURCE     | D6          |
| BUS:B2:PARALLEL:BIT7:SOURCE     | D7          |
| BUS:B2:PARALLEL:BIT8:SOURCE     | D8          |
| BUS:B2:PARALLEL:BIT9:SOURCE     | D9          |
| BUS:B2:PARALLEL:CLOCK:EDGE      | RISING      |
| BUS:B2:PARALLEL:CLOCK:ISCLOCKED | NO          |
| BUS:B2:PARALLEL:CLOCK:SOURCE    | CH1         |
| BUS:B2:PARALLEL:WIDTH           | 16          |
| BUS:B2:POSITION                 | 0.0E+0      |
| BUS:B2:RS232C:BITRATE           | 9600        |
| BUS:B2:RS232C:DATABITS          | 8           |
| BUS:B2:RS232C:DELIMITER         | LF          |
| BUS:B2:RS232C:DISPLAYMODE       | FRAME       |
| BUS:B2:RS232C:PARITY            | NONE        |
| BUS:B2:RS232C:POLARITY          | NORMAL      |
| BUS:B2:RS232C:RX:SOURCE         | OFF         |
| BUS:B2:RS232C:TX:SOURCE         | CH1         |
| BUS:B2:SPI:BITORDER             | MSB         |
| BUS:B2:SPI:CLOCK:POLARITY       | RISE        |
| BUS:B2:SPI:CLOCK:SOURCE         | CH1         |
| BUS:B2:SPI:DATA:IN:POLARITY     | HIGH        |
| BUS:B2:SPI:DATA:IN:SOURCE       | OFF         |



Table C-1: Default Values (cont.)

| Item                           | Description  |
|--------------------------------|--------------|
| BUS:B2:SPI:DATA:OUT:POLARITY   | HIGH         |
| BUS:B2:SPI:DATA:OUT:SOURCE     | CH3          |
| BUS:B2:SPI:DATA:SIZE           | 8            |
| BUS:B2:SPI:FRAMING             | SS           |
| BUS:B2:SPI:IDLETIME            | 5.0000E-6    |
| BUS:B2:SPI:SELECT:POLARITY     | LOW          |
| BUS:B2:SPI:SELECT:SOURCE       | CH2          |
| BUS:B2:STATE                   | 0            |
| BUS:B2:TYPE                    | PARALLEL     |
| BUS:B2:USB:BITRATE             | FULL         |
| BUS:B2:USB:PROBE               | DIFFERENTIAL |
| BUS:B2:USB:SOURCE:DIFFERENTIAL | CH1          |
| BUS:B2:USB:SOURCE:DMINUS       | CH2          |
| BUS:B2:USB:SOURCE:DPLUS        | CH1          |
| BUS:LOWERTHRESHOLD:CH1         | 0.0E+0       |
| BUS:LOWERTHRESHOLD:CH2         | 0.0E+0       |
| BUS:LOWERTHRESHOLD:CH3         | 0.0E+0       |
| BUS:LOWERTHRESHOLD:CH4         | 0.0E+0       |
| BUS:LOWERTHRESHOLD:MATH        | 0.0E+0       |
| BUS:LOWERTHRESHOLD:REF1        | 0.0E+0       |
| BUS:LOWERTHRESHOLD:REF2        | 0.0E+0       |
| BUS:LOWERTHRESHOLD:REF3        | 0.0E+0       |
| BUS:LOWERTHRESHOLD:REF4        | 0.0E+0       |
| BUS:UPPERTHRESHOLD:CH1         | 800.0000E-3  |
| BUS:UPPERTHRESHOLD:CH2         | 800.0000E-3  |
| BUS:UPPERTHRESHOLD:CH3         | 800.0000E-3  |
| BUS:UPPERTHRESHOLD:CH4         | 800.0000E-3  |
| BUS:UPPERTHRESHOLD:MATH        | 0.0E+0       |
| BUS:UPPERTHRESHOLD:REF1        | 0.0E+0       |
| BUS:UPPERTHRESHOLD:REF2        | 0.0E+0       |
| BUS:UPPERTHRESHOLD:REF3        | 0.0E+0       |
| BUS:UPPERTHRESHOLD:REF4        | 0.0E+0       |
| CH1:AMPSVIAVOLTS:ENABLE        | 0            |
| CH1:AMPSVIAVOLTS:FACTOR        | 10.0000      |
| CH1:BANDWIDTH                  | 1.0000E+9    |
| CH1:COUPLING                   | DC           |
| CH1:DESKEW                     | 0.0E+0       |

Table C-1: Default Values (cont.)

| Item                    | Description |
|-------------------------|-------------|
| CH1:INVERT              | 0           |
| CH1:LABEL               | ""          |
| CH1:OFFSET              | 0.0E+0      |
| CH1:POSITION            | 0.0E+0      |
| CH1:PROBE:FORCEDRANGE   | 0.0E+0      |
| CH1:PROBE:GAIN          | 1.0000      |
| CH1:PROBE:PROPDELAY     | 0.0E+0      |
| CH1:SCALE               | 100.0000E-3 |
| CH1:TERMINATION         | 1.0000E+6   |
| CH1:YUNITS              | "V"         |
| CH2:AMPSVIAVOLTS:ENABLE | 0           |
| CH2:AMPSVIAVOLTS:FACTOR | 10.0000     |
| CH2:BANDWIDTH           | 1.0000E+9   |
| CH2:COUPLING            | DC          |
| CH2:DESKEW              | 0.0E+0      |
| CH2:INVERT              | 0           |
| CH2:LABEL               | ""          |
| CH2:OFFSET              | 0.0E+0      |
| CH2:POSITION            | 0.0E+0      |
| CH2:PROBE:FORCEDRANGE   | 0.0E+0      |
| CH2:PROBE:GAIN          | 1.0000      |
| CH2:PROBE:PROPDELAY     | 0.0E+0      |
| CH2:SCALE               | 100.0000E-3 |
| CH2:TERMINATION         | 1.0000E+6   |
| CH2:YUNITS              | "V"         |
| CH3:AMPSVIAVOLTS:ENABLE | 0           |
| CH3:AMPSVIAVOLTS:FACTOR | 10.0000     |
| CH3:BANDWIDTH           | 1.0000E+9   |
| CH3:COUPLING            | DC          |
| CH3:DESKEW              | 0.0E+0      |
| CH3:INVERT              | 0           |
| CH3:LABEL               | ""          |
| CH3:OFFSET              | 0.0E+0      |
| CH3:POSITION            | 0.0E+0      |
| CH3:PROBE:FORCEDRANGE   | 0.0E+0      |
| CH3:PROBE:GAIN          | 1.0000      |
| CH3:PROBE:PROPDELAY     | 0.0E+0      |

Table C-1: Default Values (cont.)

| Item                              | Description |
|-----------------------------------|-------------|
| CH3:SCALE                         | 100.0000E-3 |
| CH3:TERMINATION                   | 1.0000E+6   |
| CH3:YUNITS                        | "V"         |
| CH4:AMPSVIAVOLTS:ENABLE           | 0           |
| CH4:AMPSVIAVOLTS:FACTOR           | 10.0000     |
| CH4:BANDWIDTH                     | 1.0000E+9   |
| CH4:COUPLING                      | DC          |
| CH4:DESKEW                        | 0.0E+0      |
| CH4:INVERT                        | 0           |
| CH4:LABEL                         | ""          |
| CH4:OFFSET                        | 0.0E+0      |
| CH4:POSITION                      | 0.0E+0      |
| CH4:PROBE:FORCEDRANGE             | 0.0E+0      |
| CH4:PROBE:GAIN                    | 1.0000      |
| CH4:PROBE:PROPDELAY               | 0.0E+0      |
| CH4:SCALE                         | 100.0000E-3 |
| CH4:TERMINATION                   | 1.0000E+6   |
| CH4:YUNITS                        | "V"         |
| CURSOR:FUNCTION                   | OFF         |
| CURSOR:HBARS:POSITION1            | 0.0E+0      |
| CURSOR:HBARS:POSITION2            | 0.0E+0      |
| CURSOR:HBARS:UNITS                | BASE        |
| CURSOR:MODE                       | INDEPENDENT |
| CURSOR:SOURCE                     | AUTO        |
| CURSOR:VBARS:POSITION1            | -12.00E-6   |
| CURSOR:VBARS:POSITION2            | 12.00E-6    |
| CURSOR:VBARS:UNITS                | SECONDS     |
| CURSOR:XY:READOUT                 | RECTANGULAR |
| CURSOR:XY:RECTANGULAR:X:POSITION1 | 0.0E+0      |
| CURSOR:XY:RECTANGULAR:X:POSITION2 | 0.0E+0      |
| CURSOR:XY:RECTANGULAR:Y:POSITION1 | 0.0E+0      |
| CURSOR:XY:RECTANGULAR:Y:POSITION2 | 0.0E+0      |
| D0:LABEL                          | ""          |
| D0:POSITION                       | 80.0000E-3  |
| D0:THRESHOLD                      | 1.4000      |
| D10:LABEL                         | ""          |
| D10:POSITION                      | 80.0000E-3  |

Table C-1: Default Values (cont.)

| Item          | Description |
|---------------|-------------|
| D10:THRESHOLD | 1.4000      |
| D11:LABEL     | ""          |
| D11:POSITION  | 80.0000E-3  |
| D11:THRESHOLD | 1.4000      |
| D12:LABEL     | ""          |
| D12:POSITION  | 80.0000E-3  |
| D12:THRESHOLD | 1.4000      |
| D13:LABEL     | ""          |
| D13:POSITION  | 80.0000E-3  |
| D13:THRESHOLD | 1.4000      |
| D14:LABEL     | ""          |
| D14:POSITION  | 80.0000E-3  |
| D14:THRESHOLD | 1.4000      |
| D15:LABEL     | ""          |
| D15:POSITION  | 80.0000E-3  |
| D15:THRESHOLD | 1.4000      |
| D1:LABEL      | ""          |
| D1:POSITION   | 80.0000E-3  |
| D1:THRESHOLD  | 1.4000      |
| D2:LABEL      | ""          |
| D2:POSITION   | 80.0000E-3  |
| D2:THRESHOLD  | 1.4000      |
| D3:LABEL      | ""          |
| D3:POSITION   | 80.0000E-3  |
| D3:THRESHOLD  | 1.4000      |
| D4:LABEL      | ""          |
| D4:POSITION   | 80.0000E-3  |
| D4:THRESHOLD  | 1.4000      |
| D5:LABEL      | ""          |
| D5:POSITION   | 80.0000E-3  |
| D5:THRESHOLD  | 1.4000      |
| D6:LABEL      | ""          |
| D6:POSITION   | 80.0000E-3  |
| D6:THRESHOLD  | 1.4000      |
| D7:LABEL      | ""          |
| D7:POSITION   | 80.0000E-3  |
| D7:THRESHOLD  | 1.4000      |

Table C-1: Default Values (cont.)

| Item                                       | Description  |
|--------------------------------------------|--------------|
| D8:LABEL                                   | ""           |
| D8:POSITION                                | 80.0000E-3   |
| D8:THRESHOLD                               | 1.4000       |
| D9:LABEL                                   | ""           |
| D9:POSITION                                | 80.0000E-3   |
| D9:THRESHOLD                               | 1.4000       |
| DATA:DESTINATION                           | REF1         |
| DATA:ENCDG                                 | RIBINARY     |
| DATA:SOURCE                                | CH1          |
| DATA:START                                 | 1            |
| DATA:STOP                                  | 10000        |
| DESKEW:DISPLAY                             | 1            |
| DISPLAY:CLOCK                              | 1            |
| DISPLAY:DIGITAL:ACTIVITY                   | 0            |
| DISPLAY:DIGITAL:HEIGHT                     | MEDIUM       |
| DISPLAY:GRATICULE                          | FULL         |
| DISPLAY:INTENSITY:BACKLIGHT                | HIGH         |
| DISPLAY:INTENSITY:BACKLIGHT:AUTODIM:ENABLE | 1            |
| DISPLAY:INTENSITY:BACKLIGHT:AUTODIM:TIME   | 60           |
| DISPLAY:INTENSITY:GRATICULE                | 75           |
| DISPLAY:INTENSITY:WAVEFORM                 | 35           |
| DISPLAY:PERSISTENCE                        | 0.0E+0       |
| DISPLAY:STYLE:DOTSONLY                     | 0            |
| DISPLAY:TRIGFREQUENCY                      | 0            |
| DISPLAY:XY                                 | OFF          |
| DISPLAY:XY:WITHYT                          | 0            |
| DVM:AUTORANGE                              | 0            |
| DVM:DISPLAYSTYLE                           | FULL         |
| DVM:MODE                                   | OFF          |
| DVM:SOURCE                                 | CH1          |
| EMAIL:SETUP:FROMADDRESS                    | "TestString" |
| EMAIL:SETUP:HOSTALIASNAME                  | "TestString" |
| EMAIL:SETUP:SMTPLGIN                       | "TestString" |
| EMAIL:SETUP:SMTPPORT                       | 25           |
| EMAIL:SETUP:SMTPSERVER                     | "TestString" |
| FASTACQ:STATE                              | 0            |
| HEADER                                     | 0            |

Table C-1: Default Values (cont.)

| Item                              | Description                     |
|-----------------------------------|---------------------------------|
| HISTOGRAM:BOXPCNT                 | 20.0000,20.0000,80.0000,80.0000 |
| HISTOGRAM:DISPLAY                 | LINEAR                          |
| HISTOGRAM:MODE                    | OFF                             |
| HISTOGRAM:SOURCE                  | CH1                             |
| HORIZONTAL:DELAY:MODE             | 1                               |
| HORIZONTAL:DELAY:TIME             | 0.0E+0                          |
| HORIZONTAL:POSITION               | 50.0000                         |
| HORIZONTAL:RECORDLENGTH           | 10000                           |
|                                   | 4.0000E-6                       |
| LOCK                              | NONE                            |
| MARKER:M1:FREQUENCY:ABSOLUTE      | 0.0E+0                          |
| MARKER:M2:FREQUENCY:ABSOLUTE      | 0.0E+0                          |
| MARKER:MANUAL                     | 0                               |
| MARKER:PEAK:EXCURSION             | 30.0000                         |
| MARKER:PEAK:MAXIMUM               | 5                               |
| MARKER:PEAK:STATE                 | 1                               |
| MARKER:PEAK:THRESHOLD             | -50.0000                        |
| MARKER:TYPE                       | ABSOLUTE                        |
| MATH:AUTOSCALE                    | 1                               |
| MATH:DEFINE                       | "CH1+CH2"                       |
| MATH:HORIZONTAL:POSITION          | 50.0000                         |
| MATH:                             | 4.0000E-6                       |
| MATH:HORIZONTAL:UNITS             | "s"                             |
| MATH:LABEL                        | ""                              |
| MATH:SPECTRAL:MAG                 | DB                              |
| MATH:SPECTRAL:WINDOW              | HANNING                         |
| MATH:TYPE                         | DUAL                            |
| MATH:VERTICAL:POSITION            | 0.0E+0                          |
| MATH:VERTICAL:SCALE               | 100.0000E-3                     |
| MATH:VERTICAL:UNITS               | "V"                             |
| MATHVAR:VAR1                      | 0.0E+0                          |
| MATHVAR:VAR2                      | 0.0E+0                          |
| MEASUREMENT:GATING                | SCREEN                          |
| MEASUREMENT:IMMED:DELAY:DIRECTION | FORWARDS                        |
| MEASUREMENT:IMMED:DELAY:EDGE1     | RISE                            |
| MEASUREMENT:IMMED:DELAY:EDGE2     | RISE                            |
| MEASUREMENT:IMMED:SOURCE1         | CH1                             |

Table C-1: Default Values (cont.)

| Item                               | Description |
|------------------------------------|-------------|
| MEASUREMENT:IMMED:SOURCE2          | CH2         |
| MEASUREMENT:IMMED:TYPE             | PERIOD      |
| MEASUREMENT:INDICATORS:STATE       | OFF         |
| MEASUREMENT:MEAS1:DELAY:DIRECTION  | FORWARDS    |
| MEASUREMENT:MEAS1:DELAY:EDGE1      | RISE        |
| MEASUREMENT:MEAS1:DELAY:EDGE2      | RISE        |
| MEASUREMENT:MEAS1:SOURCE1          | CH1         |
| MEASUREMENT:MEAS1:SOURCE2          | CH2         |
| MEASUREMENT:MEAS1:STATE            | 0           |
| MEASUREMENT:MEAS1:TYPE             | PERIOD      |
| MEASUREMENT:MEAS2:DELAY:DIRECTION  | FORWARDS    |
| MEASUREMENT:MEAS2:DELAY:EDGE1      | RISE        |
| MEASUREMENT:MEAS2:DELAY:EDGE2      | RISE        |
| MEASUREMENT:MEAS2:SOURCE1          | CH1         |
| MEASUREMENT:MEAS2:SOURCE2          | CH2         |
| MEASUREMENT:MEAS2:STATE            | 0           |
| MEASUREMENT:MEAS2:TYPE             | PERIOD      |
| MEASUREMENT:MEAS3:DELAY:DIRECTION  | FORWARDS    |
| MEASUREMENT:MEAS3:DELAY:EDGE1      | RISE        |
| MEASUREMENT:MEAS3:DELAY:EDGE2      | RISE        |
| MEASUREMENT:MEAS3:SOURCE1          | CH1         |
| MEASUREMENT:MEAS3:SOURCE2          | CH2         |
| MEASUREMENT:MEAS3:STATE            | 0           |
| MEASUREMENT:MEAS3:TYPE             | PERIOD      |
| MEASUREMENT:MEAS4:DELAY:DIRECTION  | FORWARDS    |
| MEASUREMENT:MEAS4:DELAY:EDGE1      | RISE        |
| MEASUREMENT:MEAS4:DELAY:EDGE2      | RISE        |
| MEASUREMENT:MEAS4:SOURCE1          | CH1         |
| MEASUREMENT:MEAS4:SOURCE2          | CH2         |
| MEASUREMENT:MEAS4:STATE            | 0           |
| MEASUREMENT:MEAS4:TYPE             | PERIOD      |
| MEASUREMENT:METHOD                 | AUTO        |
| MEASUREMENT:REFLEVEL:ABSOLUTE:HIGH | 0.0E+0      |
| MEASUREMENT:REFLEVEL:ABSOLUTE:LOW  | 0.0E+0      |
| MEASUREMENT:REFLEVEL:ABSOLUTE:MID1 | 0.0E+0      |
| MEASUREMENT:REFLEVEL:ABSOLUTE:MID2 | 0.0E+0      |
| MEASUREMENT:REFLEVEL:METHOD        | PERCENT     |

Table C-1: Default Values (cont.)

| Item                              | Description   |
|-----------------------------------|---------------|
| MEASUREMENT:REFLEVEL:PERCENT:HIGH | 90.0000       |
| MEASUREMENT:REFLEVEL:PERCENT:LOW  | 10.0000       |
| MEASUREMENT:REFLEVEL:PERCENT:MID1 | 50.0000       |
| MEASUREMENT:REFLEVEL:PERCENT:MID2 | 50.0000       |
| MEASUREMENT:STATISTICS:MODE       | ALL           |
| MEASUREMENT:STATISTICS:WEIGHTING  | 32            |
| MESSAGE:BOX                       | 167,67,167,83 |
| MESSAGE:SHOW                      | ""            |
| MESSAGE:STATE                     | 0             |
| PICTBRIDGE:DATEPRINT              | DEFLT         |
| PICTBRIDGE:IDPRINT                | OFF           |
| PICTBRIDGE:IMAGESIZE              | DEFLT         |
| PICTBRIDGE:PAPERSIZE              | DEFLT         |
| PICTBRIDGE:PAPERTYPE              | DEFLT         |
| PICTBRIDGE:PRINTQUAL              | DEFLT         |
| REF1:HORIZONTAL:DELAY:TIME        | 16.0000E-6    |
| REF1:                             | 4.0000E-6     |
| REF1:VERTICAL:POSITION            | 0.0E+0        |
| REF1:VERTICAL:SCALE               | 100.0000E-3   |
| REF2:HORIZONTAL:DELAY:TIME        | 16.0000E-6    |
| REF2:                             | 4.0000E-6     |
| REF2:VERTICAL:POSITION            | 0.0E+0        |
| REF2:VERTICAL:SCALE               | 100.0000E-3   |
| REF3:HORIZONTAL:DELAY:TIME        | 16.0000E-6    |
| REF3:                             | 4.0000E-6     |
| REF3:VERTICAL:POSITION            | 0.0E+0        |
| REF3:VERTICAL:SCALE               | 100.0000E-3   |
| REF4:HORIZONTAL:DELAY:TIME        | 16.0000E-6    |
| REF4:                             | 4.0000E-6     |
| REF4:VERTICAL:POSITION            | 0.0E+0        |
| REF4:VERTICAL:SCALE               | 100.0000E-3   |
| ROSC:SOURCE                       | INTERNAL      |
| SAVE:ASSIGN:TYPE                  | WAVEFORM      |
| SAVE:IMAGE:FILEFORMAT             | PNG           |
| SAVE:IMAGE:INKSAVER               | 1             |
| SAVE:IMAGE:LAYOUT                 | PORTRAIT      |
| SAVE:WAVEFORM                     | WFM           |



Table C-1: Default Values (cont.)

| Item                                                         | Description                    |
|--------------------------------------------------------------|--------------------------------|
| SAVE:WAVEFORM:GATING                                         | NONE                           |
| SEARCH:SEARCH1:STATE                                         | 0                              |
| SEARCH:SEARCH1:TRIGGER:A:BUS:B1:AUDIO:CONDITION              | SOF                            |
| SEARCH:SEARCH1:TRIGGER:A:BUS:B1:AUDIO:DATA:HIVALUE           | "XXXXXXXXXXXXXXXXXXXXXXXXXXXX" |
| SEARCH:SEARCH1:TRIGGER:A:BUS:B1:AUDIO:DATA:OFFSET            | 0                              |
| SEARCH:SEARCH1:TRIGGER:A:BUS:B1:AUDIO:DATA:QUALIFIER         | EQUAL                          |
| SEARCH:SEARCH1:TRIGGER:A:BUS:B1:AUDIO:DATA:VALUE             | "XXXXXXXXXXXXXXXXXXXXXXXXXXXX" |
| SEARCH:SEARCH1:TRIGGER:A:BUS:B1:AUDIO:DATA:WORD              | EITHER                         |
| SEARCH:SEARCH1:TRIGGER:A:BUS:B1:CAN:CONDITION                | SOF                            |
| SEARCH:SEARCH1:TRIGGER:A:BUS:B1:CAN:DATA:DIRECTION           | NOCARE                         |
| SEARCH:SEARCH1:TRIGGER:A:BUS:B1:CAN:DATA:OFFSET              | 0                              |
| SEARCH:SEARCH1:TRIGGER:A:BUS:B1:CAN:DATA:QUALIFIER           | EQUAL                          |
| SEARCH:SEARCH1:TRIGGER:A:BUS:B1:CAN:DATA:SIZE                | 1                              |
| SEARCH:SEARCH1:TRIGGER:A:BUS:B1:CAN:DATA:VALUE               | "XXXXXXXX"                     |
| SEARCH:SEARCH1:TRIGGER:A:BUS:B1:CAN:FD:BRSBIT                | X                              |
| SEARCH:SEARCH1:TRIGGER:A:BUS:B1:CAN:FD:ESIBIT                | X                              |
| SEARCH:SEARCH1:TRIGGER:A:BUS:B1:CAN:FRAMETYPE                | DATA                           |
| SEARCH:SEARCH1:TRIGGER:A:BUS:B1:CAN:IDENTIFIER:MODE          | STANDARD                       |
| SEARCH:SEARCH1:TRIGGER:A:BUS:B1:CAN:IDENTIFIER:VALUE         | "XXXXXXXXXX"                   |
| SEARCH:SEARCH1:TRIGGER:A:BUS:B1:FLEXRAY:CONDITION            | SOF                            |
| SEARCH:SEARCH1:TRIGGER:A:BUS:B1:FLEXRAY:CYCLECOUNT:HIVALUE   | "XXXXXX"                       |
| SEARCH:SEARCH1:TRIGGER:A:BUS:B1:FLEXRAY:CYCLECOUNT:QUALIFIER | EQUAL                          |
| SEARCH:SEARCH1:TRIGGER:A:BUS:B1:FLEXRAY:CYCLECOUNT:VALUE     | "XXXXXX"                       |
| SEARCH:SEARCH1:TRIGGER:A:BUS:B1:FLEXRAY:DATA:HIVALUE         | "XXXXXXXX"                     |
| SEARCH:SEARCH1:TRIGGER:A:BUS:B1:FLEXRAY:DATA:OFFSET          | -1                             |
| SEARCH:SEARCH1:TRIGGER:A:BUS:B1:FLEXRAY:DATA:QUALIFIER       | EQUAL                          |
| SEARCH:SEARCH1:TRIGGER:A:BUS:B1:FLEXRAY:DATA:SIZE            | 1                              |
| SEARCH:SEARCH1:TRIGGER:A:BUS:B1:FLEXRAY:DATA:VALUE           | "XXXXXXXX"                     |
| SEARCH:SEARCH1:TRIGGER:A:BUS:B1:FLEXRAY:EOFTYPE              | STATIC                         |
| SEARCH:SEARCH1:TRIGGER:A:BUS:B1:FLEXRAY:ERRTYPE              | CRCHEADER                      |
| SEARCH:SEARCH1:TRIGGER:A:BUS:B1:FLEXRAY:FRAMEID:HIVALUE      | "XXXXXXXXXX"                   |
| SEARCH:SEARCH1:TRIGGER:A:BUS:B1:FLEXRAY:FRAMEID:QUALIFIER    | EQUAL                          |
| SEARCH:SEARCH1:TRIGGER:A:BUS:B1:FLEXRAY:FRAMEID:VALUE        | "XXXXXXXXXX"                   |
| SEARCH:SEARCH1:TRIGGER:A:BUS:B1:FLEXRAY:FRAMETYPE            | NORMAL                         |
| SEARCH:SEARCH1:TRIGGER:A:BUS:B1:FLEXRAY:HEADER:CRC           | "XXXXXXXXXX"                   |
| SEARCH:SEARCH1:TRIGGER:A:BUS:B1:FLEXRAY:HEADER:CYCLECOUNT    | "XXXXXX"                       |
| SEARCH:SEARCH1:TRIGGER:A:BUS:B1:FLEXRAY:HEADER:FRAMEID       | "XXXXXXXXXX"                   |

Table C-1: Default Values (cont.)

| Item                                                               | Description            |
|--------------------------------------------------------------------|------------------------|
| SEARCH:SEARCH1:TRIGGER:A:BUS:B1:FLEXRAY:HEADER:INDBITS             | "XXXXX"                |
| SEARCH:SEARCH1:TRIGGER:A:BUS:B1:FLEXRAY:HEADER:PAYLENGTH           | "XXXXXXXX"             |
| SEARCH:SEARCH1:TRIGGER:A:BUS:B1:I2C:ADDRESS:MODE                   | ADDR7                  |
| SEARCH:SEARCH1:TRIGGER:A:BUS:B1:I2C:ADDRESS:TYPE                   | USER                   |
| SEARCH:SEARCH1:TRIGGER:A:BUS:B1:I2C:ADDRESS:VALUE                  | "XXXXXXXX"             |
| SEARCH:SEARCH1:TRIGGER:A:BUS:B1:I2C:CONDITION                      | START                  |
| SEARCH:SEARCH1:TRIGGER:A:BUS:B1:I2C:DATA:DIRECTION                 | NO CARE                |
| SEARCH:SEARCH1:TRIGGER:A:BUS:B1:I2C:DATA:SIZE                      | 1                      |
| SEARCH:SEARCH1:TRIGGER:A:BUS:B1:I2C:DATA:VALUE                     | "XXXXXXXXX"            |
| SEARCH:SEARCH1:TRIGGER:A:BUS:B1:LIN:CONDITION                      | SYNCFIELD              |
| SEARCH:SEARCH1:TRIGGER:A:BUS:B1:LIN:DATA:HIVALUE                   | "XXXXXXXXX"            |
| SEARCH:SEARCH1:TRIGGER:A:BUS:B1:LIN:DATA:QUALIFIER                 | EQUAL                  |
| SEARCH:SEARCH1:TRIGGER:A:BUS:B1:LIN:DATA:SIZE                      | 1                      |
| SEARCH:SEARCH1:TRIGGER:A:BUS:B1:LIN:DATA:VALUE                     | "XXXXXXXXX"            |
| SEARCH:SEARCH1:TRIGGER:A:BUS:B1:LIN:ERRTYPE                        | SYNC                   |
| SEARCH:SEARCH1:TRIGGER:A:BUS:B1:LIN:IDENTIFIER:VALUE               | "XXXXXX"               |
| SEARCH:SEARCH1:TRIGGER:A:BUS:B1:MIL1553B:COMMAND:ADDRESS:HIVALUE   | "XXXXX"                |
| SEARCH:SEARCH1:TRIGGER:A:BUS:B1:MIL1553B:COMMAND:ADDRESS:QUALIFIER | EQUAL                  |
| SEARCH:SEARCH1:TRIGGER:A:BUS:B1:MIL1553B:COMMAND:ADDRESS:VALUE     | "XXXXX"                |
| SEARCH:SEARCH1:TRIGGER:A:BUS:B1:MIL1553B:COMMAND:COUNT             | "XXXXX"                |
| SEARCH:SEARCH1:TRIGGER:A:BUS:B1:MIL1553B:COMMAND:PARITY            | X                      |
| SEARCH:SEARCH1:TRIGGER:A:BUS:B1:MIL1553B:COMMAND:SUBADDRESS        | "XXXXX"                |
| SEARCH:SEARCH1:TRIGGER:A:BUS:B1:MIL1553B:COMMAND:TRBIT             | X                      |
| SEARCH:SEARCH1:TRIGGER:A:BUS:B1:MIL1553B:CONDITION                 | SYNC                   |
| SEARCH:SEARCH1:TRIGGER:A:BUS:B1:MIL1553B:DATA:PARITY               | X                      |
| SEARCH:SEARCH1:TRIGGER:A:BUS:B1:MIL1553B:DATA:VALUE                | "XXXXXXXXXXXXXXXXXXXX" |
| SEARCH:SEARCH1:TRIGGER:A:BUS:B1:MIL1553B:ERRTYPE                   | PARITY                 |
| SEARCH:SEARCH1:TRIGGER:A:BUS:B1:MIL1553B:STATUS:ADDRESS:HIVALUE    | "XXXXX"                |
| SEARCH:SEARCH1:TRIGGER:A:BUS:B1:MIL1553B:STATUS:ADDRESS:QUALIFIER  | EQUAL                  |
| SEARCH:SEARCH1:TRIGGER:A:BUS:B1:MIL1553B:STATUS:ADDRESS:VALUE      | "XXXXX"                |
| SEARCH:SEARCH1:TRIGGER:A:BUS:B1:MIL1553B:STATUS:BIT:BCR            | X                      |
| SEARCH:SEARCH1:TRIGGER:A:BUS:B1:MIL1553B:STATUS:BIT:BUSY           | X                      |
| SEARCH:SEARCH1:TRIGGER:A:BUS:B1:MIL1553B:STATUS:BIT:DBCA           | X                      |
| SEARCH:SEARCH1:TRIGGER:A:BUS:B1:MIL1553B:STATUS:BIT:INSTR          | X                      |
| SEARCH:SEARCH1:TRIGGER:A:BUS:B1:MIL1553B:STATUS:BIT:ME             | X                      |
| SEARCH:SEARCH1:TRIGGER:A:BUS:B1:MIL1553B:STATUS:BIT:SRQ            | X                      |
| SEARCH:SEARCH1:TRIGGER:A:BUS:B1:MIL1553B:STATUS:BIT:SUSBF          | X                      |

Table C-1: Default Values (cont.)

| Item                                                    | Description                  |
|---------------------------------------------------------|------------------------------|
| SEARCH:SEARCH1:TRIGGER:A:BUS:B1:MIL1553B:STATUS:BIT:TF  | X                            |
| SEARCH:SEARCH1:TRIGGER:A:BUS:B1:MIL1553B:STATUS:PARITY  | X                            |
| SEARCH:SEARCH1:TRIGGER:A:BUS:B1:MIL1553B:TIME:LESSLIMIT | 4.0000E-6                    |
| SEARCH:SEARCH1:TRIGGER:A:BUS:B1:MIL1553B:TIME:MORELIMIT | 12.0000E-6                   |
| SEARCH:SEARCH1:TRIGGER:A:BUS:B1:MIL1553B:TIME:QUALIFIER | MORETHAN                     |
| SEARCH:SEARCH1:TRIGGER:A:BUS:B1:PARALLEL:VALUE          | "XXXXXXXXXXXXXXXXXX"         |
| SEARCH:SEARCH1:TRIGGER:A:BUS:B1:RS232C:CONDITION        | TXSTART                      |
| SEARCH:SEARCH1:TRIGGER:A:BUS:B1:RS232C:RX:DATA:SIZE     | 1                            |
| SEARCH:SEARCH1:TRIGGER:A:BUS:B1:RS232C:RX:DATA:VALUE    | "XXXXXXXX"                   |
| SEARCH:SEARCH1:TRIGGER:A:BUS:B1:RS232C:TX:DATA:SIZE     | 1                            |
| SEARCH:SEARCH1:TRIGGER:A:BUS:B1:RS232C:TX:DATA:VALUE    | "XXXXXXXX"                   |
| SEARCH:SEARCH1:TRIGGER:A:BUS:B1:SPI:CONDITION           | SS                           |
| SEARCH:SEARCH1:TRIGGER:A:BUS:B1:SPI:DATA:MISO:VALUE     | "XXXXXXXX"                   |
| SEARCH:SEARCH1:TRIGGER:A:BUS:B1:SPI:DATA:MOSI:VALUE     | "XXXXXXXX"                   |
| SEARCH:SEARCH1:TRIGGER:A:BUS:B1:SPI:DATA:SIZE           | 1                            |
| SEARCH:SEARCH1:TRIGGER:A:BUS:B1:USB:ADDRESS:HIVALUE     | "XXXXXXXX"                   |
| SEARCH:SEARCH1:TRIGGER:A:BUS:B1:USB:ADDRESS:VALUE       | "XXXXXXXX"                   |
| SEARCH:SEARCH1:TRIGGER:A:BUS:B1:USB:CONDITION           | SYNC                         |
| SEARCH:SEARCH1:TRIGGER:A:BUS:B1:USB:DATA:HIVALUE        | "XXXXXXXX"                   |
| SEARCH:SEARCH1:TRIGGER:A:BUS:B1:USB:DATA:OFFSET         | -1                           |
| SEARCH:SEARCH1:TRIGGER:A:BUS:B1:USB:DATA:SIZE           | 1                            |
| SEARCH:SEARCH1:TRIGGER:A:BUS:B1:USB:DATA:TYPE           | ANY                          |
| SEARCH:SEARCH1:TRIGGER:A:BUS:B1:USB:DATA:VALUE          | "XXXXXXXX"                   |
| SEARCH:SEARCH1:TRIGGER:A:BUS:B1:USB:ENDPOINT:VALUE      | "XXXX"                       |
| SEARCH:SEARCH1:TRIGGER:A:BUS:B1:USB:ERRTYPE             | PID                          |
| SEARCH:SEARCH1:TRIGGER:A:BUS:B1:USB:HANDSHAKETYPE       | ANY                          |
| SEARCH:SEARCH1:TRIGGER:A:BUS:B1:USB:QUALIFIER           | EQUAL                        |
| SEARCH:SEARCH1:TRIGGER:A:BUS:B1:USB:SOFFRAMENUMBER      | "XXXXXXXXXXXX"               |
| SEARCH:SEARCH1:TRIGGER:A:BUS:B1:USB:SPECIALTYPE         | ANY                          |
| SEARCH:SEARCH1:TRIGGER:A:BUS:B1:USB:TOKENTYPE           | ANY                          |
| SEARCH:SEARCH1:TRIGGER:A:BUS:B2:AUDIO:CONDITION         | SOF                          |
| SEARCH:SEARCH1:TRIGGER:A:BUS:B2:AUDIO:DATA:HIVALUE      | "XXXXXXXXXXXXXXXXXXXXXXXXXX" |
| SEARCH:SEARCH1:TRIGGER:A:BUS:B2:AUDIO:DATA:OFFSET       | 0                            |
| SEARCH:SEARCH1:TRIGGER:A:BUS:B2:AUDIO:DATA:QUALIFIER    | EQUAL                        |
| SEARCH:SEARCH1:TRIGGER:A:BUS:B2:AUDIO:DATA:VALUE        | "XXXXXXXXXXXXXXXXXXXXXXXXXX" |
| SEARCH:SEARCH1:TRIGGER:A:BUS:B2:AUDIO:DATA:WORD         | EITHER                       |
| SEARCH:SEARCH1:TRIGGER:A:BUS:B2:CAN:CONDITION           | SOF                          |

Table C-1: Default Values (cont.)

| Item                                                         | Description    |
|--------------------------------------------------------------|----------------|
| SEARCH:SEARCH1:TRIGGER:A:BUS:B2:CAN:DATA:DIRECTION           | NOCARE         |
| SEARCH:SEARCH1:TRIGGER:A:BUS:B2:CAN:DATA:OFFSET              | 0              |
| SEARCH:SEARCH1:TRIGGER:A:BUS:B2:CAN:DATA:QUALIFIER           | EQUAL          |
| SEARCH:SEARCH1:TRIGGER:A:BUS:B2:CAN:DATA:SIZE                | 1              |
| SEARCH:SEARCH1:TRIGGER:A:BUS:B2:CAN:DATA:VALUE               | "XXXXXXXX"     |
| SEARCH:SEARCH1:TRIGGER:A:BUS:B2:CAN:FD:BRSBIT                | X              |
| SEARCH:SEARCH1:TRIGGER:A:BUS:B2:CAN:FD:ESIBIT                | X              |
| SEARCH:SEARCH1:TRIGGER:A:BUS:B2:CAN:FRAMETYPE                | DATA           |
| SEARCH:SEARCH1:TRIGGER:A:BUS:B2:CAN:IDENTIFIER:MODE          | STANDARD       |
| SEARCH:SEARCH1:TRIGGER:A:BUS:B2:CAN:IDENTIFIER:VALUE         | "XXXXXXXXXXXX" |
| SEARCH:SEARCH1:TRIGGER:A:BUS:B2:FLEXRAY:CONDITION            | SOF            |
| SEARCH:SEARCH1:TRIGGER:A:BUS:B2:FLEXRAY:CYCLECOUNT:HIVALUE   | "XXXXXX"       |
| SEARCH:SEARCH1:TRIGGER:A:BUS:B2:FLEXRAY:CYCLECOUNT:QUALIFIER | EQUAL          |
| SEARCH:SEARCH1:TRIGGER:A:BUS:B2:FLEXRAY:CYCLECOUNT:VALUE     | "XXXXXX"       |
| SEARCH:SEARCH1:TRIGGER:A:BUS:B2:FLEXRAY:DATA:HIVALUE         | "XXXXXXXX"     |
| SEARCH:SEARCH1:TRIGGER:A:BUS:B2:FLEXRAY:DATA:OFFSET          | -1             |
| SEARCH:SEARCH1:TRIGGER:A:BUS:B2:FLEXRAY:DATA:QUALIFIER       | EQUAL          |
| SEARCH:SEARCH1:TRIGGER:A:BUS:B2:FLEXRAY:DATA:SIZE            | 1              |
| SEARCH:SEARCH1:TRIGGER:A:BUS:B2:FLEXRAY:DATA:VALUE           | "XXXXXXXX"     |
| SEARCH:SEARCH1:TRIGGER:A:BUS:B2:FLEXRAY:EOFTYPE              | STATIC         |
| SEARCH:SEARCH1:TRIGGER:A:BUS:B2:FLEXRAY:ERRTYPE              | CRCHEADER      |
| SEARCH:SEARCH1:TRIGGER:A:BUS:B2:FLEXRAY:FRAMEID:HIVALUE      | "XXXXXXXXXXXX" |
| SEARCH:SEARCH1:TRIGGER:A:BUS:B2:FLEXRAY:FRAMEID:QUALIFIER    | EQUAL          |
| SEARCH:SEARCH1:TRIGGER:A:BUS:B2:FLEXRAY:FRAMEID:VALUE        | "XXXXXXXXXXXX" |
| SEARCH:SEARCH1:TRIGGER:A:BUS:B2:FLEXRAY:FRAMETYPE            | NORMAL         |
| SEARCH:SEARCH1:TRIGGER:A:BUS:B2:FLEXRAY:HEADER:CRC           | "XXXXXXXXXXXX" |
| SEARCH:SEARCH1:TRIGGER:A:BUS:B2:FLEXRAY:HEADER:CYCLECOUNT    | "XXXXXX"       |
| SEARCH:SEARCH1:TRIGGER:A:BUS:B2:FLEXRAY:HEADER:FRAMEID       | "XXXXXXXXXXXX" |
| SEARCH:SEARCH1:TRIGGER:A:BUS:B2:FLEXRAY:HEADER:INDBITS       | "XXXXXX"       |
| SEARCH:SEARCH1:TRIGGER:A:BUS:B2:FLEXRAY:HEADER:PAYLENGTH     | "XXXXXX"       |
| SEARCH:SEARCH1:TRIGGER:A:BUS:B2:I2C:ADDRESS:MODE             | ADDR7          |
| SEARCH:SEARCH1:TRIGGER:A:BUS:B2:I2C:ADDRESS:TYPE             | USER           |
| SEARCH:SEARCH1:TRIGGER:A:BUS:B2:I2C:ADDRESS:VALUE            | "XXXXXX"       |
| SEARCH:SEARCH1:TRIGGER:A:BUS:B2:I2C:CONDITION                | START          |
| SEARCH:SEARCH1:TRIGGER:A:BUS:B2:I2C:DATA:DIRECTION           | NOCARE         |
| SEARCH:SEARCH1:TRIGGER:A:BUS:B2:I2C:DATA:SIZE                | 1              |
| SEARCH:SEARCH1:TRIGGER:A:BUS:B2:I2C:DATA:VALUE               | "XXXXXXXX"     |

Table C-1: Default Values (cont.)

| Item                                                               | Description          |
|--------------------------------------------------------------------|----------------------|
| SEARCH:SEARCH1:TRIGGER:A:BUS:B2:LIN:CONDITION                      | SYNCFIELD            |
| SEARCH:SEARCH1:TRIGGER:A:BUS:B2:LIN:DATA:HIVALUE                   | "XXXXXXXX"           |
| SEARCH:SEARCH1:TRIGGER:A:BUS:B2:LIN:DATA:QUALIFIER                 | EQUAL                |
| SEARCH:SEARCH1:TRIGGER:A:BUS:B2:LIN:DATA:SIZE                      | 1                    |
| SEARCH:SEARCH1:TRIGGER:A:BUS:B2:LIN:DATA:VALUE                     | "XXXXXXXX"           |
| SEARCH:SEARCH1:TRIGGER:A:BUS:B2:LIN:ERRTYPE                        | SYNC                 |
| SEARCH:SEARCH1:TRIGGER:A:BUS:B2:LIN:IDENTIFIER:VALUE               | "XXXXXX"             |
| SEARCH:SEARCH1:TRIGGER:A:BUS:B2:MIL1553B:COMMAND:ADDRESS:HIVALUE   | "XXXXX"              |
| SEARCH:SEARCH1:TRIGGER:A:BUS:B2:MIL1553B:COMMAND:ADDRESS:QUALIFIER | EQUAL                |
| SEARCH:SEARCH1:TRIGGER:A:BUS:B2:MIL1553B:COMMAND:ADDRESS:VALUE     | "XXXXX"              |
| SEARCH:SEARCH1:TRIGGER:A:BUS:B2:MIL1553B:COMMAND:COUNT             | "XXXXX"              |
| SEARCH:SEARCH1:TRIGGER:A:BUS:B2:MIL1553B:COMMAND:PARITY            | X                    |
| SEARCH:SEARCH1:TRIGGER:A:BUS:B2:MIL1553B:COMMAND:SUBADDRESS        | "XXXXX"              |
| SEARCH:SEARCH1:TRIGGER:A:BUS:B2:MIL1553B:COMMAND:TRBIT             | X                    |
| SEARCH:SEARCH1:TRIGGER:A:BUS:B2:MIL1553B:CONDITION                 | SYNC                 |
| SEARCH:SEARCH1:TRIGGER:A:BUS:B2:MIL1553B:DATA:PARITY               | X                    |
| SEARCH:SEARCH1:TRIGGER:A:BUS:B2:MIL1553B:DATA:VALUE                | "XXXXXXXXXXXXXXXXXX" |
| SEARCH:SEARCH1:TRIGGER:A:BUS:B2:MIL1553B:ERRTYPE                   | PARITY               |
| SEARCH:SEARCH1:TRIGGER:A:BUS:B2:MIL1553B:STATUS:ADDRESS:HIVALUE    | "XXXXX"              |
| SEARCH:SEARCH1:TRIGGER:A:BUS:B2:MIL1553B:STATUS:ADDRESS:QUALIFIER  | EQUAL                |
| SEARCH:SEARCH1:TRIGGER:A:BUS:B2:MIL1553B:STATUS:ADDRESS:VALUE      | "XXXXX"              |
| SEARCH:SEARCH1:TRIGGER:A:BUS:B2:MIL1553B:STATUS:BIT:BCR            | X                    |
| SEARCH:SEARCH1:TRIGGER:A:BUS:B2:MIL1553B:STATUS:BIT:BUSY           | X                    |
| SEARCH:SEARCH1:TRIGGER:A:BUS:B2:MIL1553B:STATUS:BIT:DBCA           | X                    |
| SEARCH:SEARCH1:TRIGGER:A:BUS:B2:MIL1553B:STATUS:BIT:INSTR          | X                    |
| SEARCH:SEARCH1:TRIGGER:A:BUS:B2:MIL1553B:STATUS:BIT:ME             | X                    |
| SEARCH:SEARCH1:TRIGGER:A:BUS:B2:MIL1553B:STATUS:BIT:SRQ            | X                    |
| SEARCH:SEARCH1:TRIGGER:A:BUS:B2:MIL1553B:STATUS:BIT:SBSF           | X                    |
| SEARCH:SEARCH1:TRIGGER:A:BUS:B2:MIL1553B:STATUS:BIT:TF             | X                    |
| SEARCH:SEARCH1:TRIGGER:A:BUS:B2:MIL1553B:STATUS:PARITY             | X                    |
| SEARCH:SEARCH1:TRIGGER:A:BUS:B2:MIL1553B:TIME:LESSLIMIT            | 4.0000E-6            |
| SEARCH:SEARCH1:TRIGGER:A:BUS:B2:MIL1553B:TIME:MORELIMIT            | 12.0000E-6           |
| SEARCH:SEARCH1:TRIGGER:A:BUS:B2:MIL1553B:TIME:QUALIFIER            | MORETHAN             |
| SEARCH:SEARCH1:TRIGGER:A:BUS:B2:PARALLEL:VALUE                     | "XXXXXXXXXXXXXXXXXX" |
| SEARCH:SEARCH1:TRIGGER:A:BUS:B2:RS232C:CONDITION                   | TXSTART              |
| SEARCH:SEARCH1:TRIGGER:A:BUS:B2:RS232C:RX:DATA:SIZE                | 1                    |
| SEARCH:SEARCH1:TRIGGER:A:BUS:B2:RS232C:RX:DATA:VALUE               | "XXXXXXXX"           |

Table C-1: Default Values (cont.)

| Item                                                 | Description    |
|------------------------------------------------------|----------------|
| SEARCH:SEARCH1:TRIGGER:A:BUS:B2:RS232C:TX:DATA:SIZE  | 1              |
| SEARCH:SEARCH1:TRIGGER:A:BUS:B2:RS232C:TX:DATA:VALUE | "XXXXXXXX"     |
| SEARCH:SEARCH1:TRIGGER:A:BUS:B2:SPI:CONDITION        | SS             |
| SEARCH:SEARCH1:TRIGGER:A:BUS:B2:SPI:DATA:MISO:VALUE  | "XXXXXXXX"     |
| SEARCH:SEARCH1:TRIGGER:A:BUS:B2:SPI:DATA:MOSI:VALUE  | "XXXXXXXX"     |
| SEARCH:SEARCH1:TRIGGER:A:BUS:B2:SPI:DATA:SIZE        | 1              |
| SEARCH:SEARCH1:TRIGGER:A:BUS:B2:USB:ADDRESS:HIVALUE  | "XXXXXXXX"     |
| SEARCH:SEARCH1:TRIGGER:A:BUS:B2:USB:ADDRESS:VALUE    | "XXXXXXXX"     |
| SEARCH:SEARCH1:TRIGGER:A:BUS:B2:USB:CONDITION        | SYNC           |
| SEARCH:SEARCH1:TRIGGER:A:BUS:B2:USB:DATA:HIVALUE     | "XXXXXXXX"     |
| SEARCH:SEARCH1:TRIGGER:A:BUS:B2:USB:DATA:OFFSET      | -1             |
| SEARCH:SEARCH1:TRIGGER:A:BUS:B2:USB:DATA:SIZE        | 1              |
| SEARCH:SEARCH1:TRIGGER:A:BUS:B2:USB:DATA:TYPE        | ANY            |
| SEARCH:SEARCH1:TRIGGER:A:BUS:B2:USB:DATA:VALUE       | "XXXXXXXX"     |
| SEARCH:SEARCH1:TRIGGER:A:BUS:B2:USB:ENDPOINT:VALUE   | "XXXX"         |
| SEARCH:SEARCH1:TRIGGER:A:BUS:B2:USB:ERRTYPE          | PID            |
| SEARCH:SEARCH1:TRIGGER:A:BUS:B2:USB:HANDSHAKETYPE    | ANY            |
| SEARCH:SEARCH1:TRIGGER:A:BUS:B2:USB:QUALIFIER        | EQUAL          |
| SEARCH:SEARCH1:TRIGGER:A:BUS:B2:USB:SOFFRAMENUMBER   | "XXXXXXXXXXXX" |
| SEARCH:SEARCH1:TRIGGER:A:BUS:B2:USB:SPECIALTYPE      | ANY            |
| SEARCH:SEARCH1:TRIGGER:A:BUS:B2:USB:TOKENTYPE        | ANY            |
| SEARCH:SEARCH1:TRIGGER:A:BUS:SOURCE                  | B1             |
| SEARCH:SEARCH1:TRIGGER:A:EDGE:SLOPE                  | RISE           |
| SEARCH:SEARCH1:TRIGGER:A:EDGE:SOURCE                 | CH1            |
| SEARCH:SEARCH1:TRIGGER:A:LEVEL                       | 0.0E+0         |
| SEARCH:SEARCH1:TRIGGER:A:LEVEL:CH1                   | 0.0E+0         |
| SEARCH:SEARCH1:TRIGGER:A:LEVEL:CH2                   | 0.0E+0         |
| SEARCH:SEARCH1:TRIGGER:A:LEVEL:CH3                   | 0.0E+0         |
| SEARCH:SEARCH1:TRIGGER:A:LEVEL:CH4                   | 0.0E+0         |
| SEARCH:SEARCH1:TRIGGER:A:LEVEL:MATH                  | 0.0E+0         |
| SEARCH:SEARCH1:TRIGGER:A:LEVEL:REF1                  | 0.0E+0         |
| SEARCH:SEARCH1:TRIGGER:A:LEVEL:REF2                  | 0.0E+0         |
| SEARCH:SEARCH1:TRIGGER:A:LEVEL:REF3                  | 0.0E+0         |
| SEARCH:SEARCH1:TRIGGER:A:LEVEL:REF4                  | 0.0E+0         |
| SEARCH:SEARCH1:TRIGGER:A:LOGIC:FUNCTION              | AND            |
| SEARCH:SEARCH1:TRIGGER:A:LOGIC:INPUT:CH1             | X              |
| SEARCH:SEARCH1:TRIGGER:A:LOGIC:INPUT:CH2             | X              |

Table C-1: Default Values (cont.)

| Item                                              | Description |
|---------------------------------------------------|-------------|
| SEARCH:SEARCH1:TRIGGER:A:LOGIC:INPUT:CH3          | X           |
| SEARCH:SEARCH1:TRIGGER:A:LOGIC:INPUT:CH4          | X           |
| SEARCH:SEARCH1:TRIGGER:A:LOGIC:INPUT:CLOCK:EDGE   | RISE        |
| SEARCH:SEARCH1:TRIGGER:A:LOGIC:INPUT:CLOCK:SOURCE | NONE        |
| SEARCH:SEARCH1:TRIGGER:A:LOGIC:INPUT:D0           | X           |
| SEARCH:SEARCH1:TRIGGER:A:LOGIC:INPUT:D1           | X           |
| SEARCH:SEARCH1:TRIGGER:A:LOGIC:INPUT:D10          | X           |
| SEARCH:SEARCH1:TRIGGER:A:LOGIC:INPUT:D11          | X           |
| SEARCH:SEARCH1:TRIGGER:A:LOGIC:INPUT:D12          | X           |
| SEARCH:SEARCH1:TRIGGER:A:LOGIC:INPUT:D13          | X           |
| SEARCH:SEARCH1:TRIGGER:A:LOGIC:INPUT:D14          | X           |
| SEARCH:SEARCH1:TRIGGER:A:LOGIC:INPUT:D15          | X           |
| SEARCH:SEARCH1:TRIGGER:A:LOGIC:INPUT:D2           | X           |
| SEARCH:SEARCH1:TRIGGER:A:LOGIC:INPUT:D3           | X           |
| SEARCH:SEARCH1:TRIGGER:A:LOGIC:INPUT:D4           | X           |
| SEARCH:SEARCH1:TRIGGER:A:LOGIC:INPUT:D5           | X           |
| SEARCH:SEARCH1:TRIGGER:A:LOGIC:INPUT:D6           | X           |
| SEARCH:SEARCH1:TRIGGER:A:LOGIC:INPUT:D7           | X           |
| SEARCH:SEARCH1:TRIGGER:A:LOGIC:INPUT:D8           | X           |
| SEARCH:SEARCH1:TRIGGER:A:LOGIC:INPUT:D9           | X           |
| SEARCH:SEARCH1:TRIGGER:A:LOGIC:INPUT:MATH         | X           |
| SEARCH:SEARCH1:TRIGGER:A:LOGIC:INPUT:REF1         | X           |
| SEARCH:SEARCH1:TRIGGER:A:LOGIC:INPUT:REF2         | X           |
| SEARCH:SEARCH1:TRIGGER:A:LOGIC:INPUT:REF3         | X           |
| SEARCH:SEARCH1:TRIGGER:A:LOGIC:INPUT:REF4         | X           |
| SEARCH:SEARCH1:TRIGGER:A:LOGIC:PATTERN:INPUT:D0   | X           |
| SEARCH:SEARCH1:TRIGGER:A:LOGIC:PATTERN:INPUT:D1   | X           |
| SEARCH:SEARCH1:TRIGGER:A:LOGIC:PATTERN:INPUT:D10  | X           |
| SEARCH:SEARCH1:TRIGGER:A:LOGIC:PATTERN:INPUT:D11  | X           |
| SEARCH:SEARCH1:TRIGGER:A:LOGIC:PATTERN:INPUT:D12  | X           |
| SEARCH:SEARCH1:TRIGGER:A:LOGIC:PATTERN:INPUT:D13  | X           |
| SEARCH:SEARCH1:TRIGGER:A:LOGIC:PATTERN:INPUT:D14  | X           |
| SEARCH:SEARCH1:TRIGGER:A:LOGIC:PATTERN:INPUT:D15  | X           |
| SEARCH:SEARCH1:TRIGGER:A:LOGIC:PATTERN:INPUT:D2   | X           |
| SEARCH:SEARCH1:TRIGGER:A:LOGIC:PATTERN:INPUT:D3   | X           |
| SEARCH:SEARCH1:TRIGGER:A:LOGIC:PATTERN:INPUT:D4   | X           |
| SEARCH:SEARCH1:TRIGGER:A:LOGIC:PATTERN:INPUT:D5   | X           |

Table C-1: Default Values (cont.)

| Item                                                  | Description |
|-------------------------------------------------------|-------------|
| SEARCH:SEARCH1:TRIGGER:A:LOGIC:PATTERN:INPUT:D6       | X           |
| SEARCH:SEARCH1:TRIGGER:A:LOGIC:PATTERN:INPUT:D7       | X           |
| SEARCH:SEARCH1:TRIGGER:A:LOGIC:PATTERN:INPUT:D8       | X           |
| SEARCH:SEARCH1:TRIGGER:A:LOGIC:PATTERN:INPUT:D9       | X           |
| SEARCH:SEARCH1:TRIGGER:A:LOGIC:PATTERN:WHEN           | TRUE        |
| SEARCH:SEARCH1:TRIGGER:A:LOGIC:PATTERN:WHEN:LESSLIMIT | 8.0000E-9   |
| SEARCH:SEARCH1:TRIGGER:A:LOGIC:PATTERN:WHEN:MORELIMIT | 8.0000E-9   |
| SEARCH:SEARCH1:TRIGGER:A:LOGIC:THRESHOLD:CH1          | 0.0E+0      |
| SEARCH:SEARCH1:TRIGGER:A:LOGIC:THRESHOLD:CH2          | 0.0E+0      |
| SEARCH:SEARCH1:TRIGGER:A:LOGIC:THRESHOLD:CH3          | 0.0E+0      |
| SEARCH:SEARCH1:TRIGGER:A:LOGIC:THRESHOLD:CH4          | 0.0E+0      |
| SEARCH:SEARCH1:TRIGGER:A:LOGIC:THRESHOLD:MATH         | 0.0E+0      |
| SEARCH:SEARCH1:TRIGGER:A:LOGIC:THRESHOLD:REF1         | 0.0E+0      |
| SEARCH:SEARCH1:TRIGGER:A:LOGIC:THRESHOLD:REF2         | 0.0E+0      |
| SEARCH:SEARCH1:TRIGGER:A:LOGIC:THRESHOLD:REF3         | 0.0E+0      |
| SEARCH:SEARCH1:TRIGGER:A:LOGIC:THRESHOLD:REF4         | 0.0E+0      |
| SEARCH:SEARCH1:TRIGGER:A:LOWERTHRESHOLD:CH1           | 0.0E+0      |
| SEARCH:SEARCH1:TRIGGER:A:LOWERTHRESHOLD:CH2           | 0.0E+0      |
| SEARCH:SEARCH1:TRIGGER:A:LOWERTHRESHOLD:CH3           | 0.0E+0      |
| SEARCH:SEARCH1:TRIGGER:A:LOWERTHRESHOLD:CH4           | 0.0E+0      |
| SEARCH:SEARCH1:TRIGGER:A:LOWERTHRESHOLD:MATH          | 0.0E+0      |
| SEARCH:SEARCH1:TRIGGER:A:LOWERTHRESHOLD:REF1          | 0.0E+0      |
| SEARCH:SEARCH1:TRIGGER:A:LOWERTHRESHOLD:REF2          | 0.0E+0      |
| SEARCH:SEARCH1:TRIGGER:A:LOWERTHRESHOLD:REF3          | 0.0E+0      |
| SEARCH:SEARCH1:TRIGGER:A:LOWERTHRESHOLD:REF4          | 0.0E+0      |
| SEARCH:SEARCH1:TRIGGER:A:PULSEWIDTH:HIGHLIMIT         | 12.0000E-9  |
| SEARCH:SEARCH1:TRIGGER:A:PULSEWIDTH:LOWLIMIT          | 8.0000E-9   |
| SEARCH:SEARCH1:TRIGGER:A:PULSEWIDTH:POLARITY          | POSITIVE    |
| SEARCH:SEARCH1:TRIGGER:A:PULSEWIDTH:WHEN              | LESSTHAN    |
| SEARCH:SEARCH1:TRIGGER:A:PULSEWIDTH:WIDTH             | 8.0000E-9   |
| SEARCH:SEARCH1:TRIGGER:A:RUNT:POLARITY                | POSITIVE    |
| SEARCH:SEARCH1:TRIGGER:A:RUNT:WHEN                    | OCCURS      |
| SEARCH:SEARCH1:TRIGGER:A:RUNT:WIDTH                   | 8.0000E-9   |
| SEARCH:SEARCH1:TRIGGER:A:SETHOLD:CLOCK:EDGE           | RISE        |
| SEARCH:SEARCH1:TRIGGER:A:SETHOLD:CLOCK:SOURCE         | CH1         |
| SEARCH:SEARCH1:TRIGGER:A:SETHOLD:CLOCK:THRESHOLD      | 0.0E+0      |
| SEARCH:SEARCH1:TRIGGER:A:SETHOLD:DATA:SOURCE          | NONE        |



Table C-1: Default Values (cont.)

| Item                                                | Description                    |
|-----------------------------------------------------|--------------------------------|
| SEARCH:SEARCH1:TRIGGER:A:SETHOLD:DATA:THRESHOLD     | 9.91E+37                       |
| SEARCH:SEARCH1:TRIGGER:A:SETHOLD:HOLDTIME           | 8.0000E-9                      |
| SEARCH:SEARCH1:TRIGGER:A:SETHOLD:SETTIME            | 8.0000E-9                      |
| SEARCH:SEARCH1:TRIGGER:A:SETHOLD:THRESHOLD:CH1      | 0.0E+0                         |
| SEARCH:SEARCH1:TRIGGER:A:SETHOLD:THRESHOLD:CH2      | 0.0E+0                         |
| SEARCH:SEARCH1:TRIGGER:A:SETHOLD:THRESHOLD:CH3      | 0.0E+0                         |
| SEARCH:SEARCH1:TRIGGER:A:SETHOLD:THRESHOLD:CH4      | 0.0E+0                         |
| SEARCH:SEARCH1:TRIGGER:A:SETHOLD:THRESHOLD:MATH     | 0.0E+0                         |
| SEARCH:SEARCH1:TRIGGER:A:SETHOLD:THRESHOLD:REF1     | 0.0E+0                         |
| SEARCH:SEARCH1:TRIGGER:A:SETHOLD:THRESHOLD:REF2     | 0.0E+0                         |
| SEARCH:SEARCH1:TRIGGER:A:SETHOLD:THRESHOLD:REF3     | 0.0E+0                         |
| SEARCH:SEARCH1:TRIGGER:A:SETHOLD:THRESHOLD:REF4     | 0.0E+0                         |
| SEARCH:SEARCH1:TRIGGER:A:TIMEOUT:POLARITY           | STAYSHIGH                      |
| SEARCH:SEARCH1:TRIGGER:A:TIMEOUT:TIME               | 8.0000E-9                      |
| SEARCH:SEARCH1:TRIGGER:A:TRANSITION:DELTATIME       | 8.0000E-9                      |
| SEARCH:SEARCH1:TRIGGER:A:TRANSITION:POLARITY        | POSITIVE                       |
| SEARCH:SEARCH1:TRIGGER:A:TRANSITION:WHEN            | SLOWER                         |
| SEARCH:SEARCH1:TRIGGER:A:TYPE                       | EDGE                           |
| SEARCH:SEARCH1:TRIGGER:A:UPPERTHRESHOLD:CH1         | 800.0000E-3                    |
| SEARCH:SEARCH1:TRIGGER:A:UPPERTHRESHOLD:CH2         | 800.0000E-3                    |
| SEARCH:SEARCH1:TRIGGER:A:UPPERTHRESHOLD:CH3         | 800.0000E-3                    |
| SEARCH:SEARCH1:TRIGGER:A:UPPERTHRESHOLD:CH4         | 800.0000E-3                    |
| SEARCH:SEARCH1:TRIGGER:A:UPPERTHRESHOLD:MATH        | 800.0000E-3                    |
| SEARCH:SEARCH1:TRIGGER:A:UPPERTHRESHOLD:REF1        | 800.0000E-3                    |
| SEARCH:SEARCH1:TRIGGER:A:UPPERTHRESHOLD:REF2        | 800.0000E-3                    |
| SEARCH:SEARCH1:TRIGGER:A:UPPERTHRESHOLD:REF3        | 800.0000E-3                    |
| SEARCH:SEARCH1:TRIGGER:A:UPPERTHRESHOLD:REF4        | 800.0000E-3                    |
| SEARCH:SEARCH<x>:TRIGGER:A:BUS:B<x>:CAN:DATA:OFFSet | 0                              |
| SEARCH:SEARCH<x>:TRIGGER:A:BUS:B<x>:CAN:FD:BRSBIT   | X                              |
| SEARCH:SEARCH<x>:TRIGGER:A:BUS:B<x>:CAN:FD:ESIBIT   | X                              |
| TRIGGER:A:BUS:B1:AUDIO:CONDITION                    | SOF                            |
| TRIGGER:A:BUS:B1:AUDIO:DATA:HIVALUE                 | "XXXXXXXXXXXXXXXXXXXXXXXXXXXX" |
| TRIGGER:A:BUS:B1:AUDIO:DATA:OFFSET                  | 0                              |
| TRIGGER:A:BUS:B1:AUDIO:DATA:QUALIFIER               | EQUAL                          |
| TRIGGER:A:BUS:B1:AUDIO:DATA:VALUE                   | "XXXXXXXXXXXXXXXXXXXXXXXXXXXX" |
| TRIGGER:A:BUS:B1:AUDIO:DATA:WORD                    | EITHER                         |
| TRIGGER:A:BUS:B1:CAN:CONDITION                      | SOF                            |

Table C-1: Default Values (cont.)

| Item                                          | Description    |
|-----------------------------------------------|----------------|
| TRIGGER:A:BUS:B1:CAN:DATA:DIRECTION           | NO CARE        |
| TRIGGER:A:BUS:B1:CAN:DATA:OFFSET              | 0              |
| TRIGGER:A:BUS:B1:CAN:DATA:QUALIFIER           | EQUAL          |
| TRIGGER:A:BUS:B1:CAN:DATA:SIZE                | 1              |
| TRIGGER:A:BUS:B1:CAN:DATA:START               | 0.0E+0         |
| TRIGGER:A:BUS:B1:CAN:FD:BRSBIT                | X              |
| TRIGGER:A:BUS:B1:CAN:FD:ESIBIT                | X              |
| TRIGGER:A:BUS:B1:CAN:DATA:VALUE               | "XXXXXXXX"     |
| TRIGGER:A:BUS:B1:CAN:FRAMETYPE                | DATA           |
| TRIGGER:A:BUS:B1:CAN:IDENTIFIER:MODE          | STANDARD       |
| TRIGGER:A:BUS:B1:CAN:IDENTIFIER:VALUE         | "XXXXXXXXXXXX" |
| TRIGGER:A:BUS:B1:FLEXRAY:CONDITION            | SOF            |
| TRIGGER:A:BUS:B1:FLEXRAY:CYCLECOUNT:HIVALUE   | "XXXXXX"       |
| TRIGGER:A:BUS:B1:FLEXRAY:CYCLECOUNT:QUALIFIER | EQUAL          |
| TRIGGER:A:BUS:B1:FLEXRAY:CYCLECOUNT:VALUE     | "XXXXXX"       |
| TRIGGER:A:BUS:B1:FLEXRAY:DATA:HIVALUE         | "XXXXXXXX"     |
| TRIGGER:A:BUS:B1:FLEXRAY:DATA:OFFSET          | -1             |
| TRIGGER:A:BUS:B1:FLEXRAY:DATA:QUALIFIER       | EQUAL          |
| TRIGGER:A:BUS:B1:FLEXRAY:DATA:SIZE            | 1              |
| TRIGGER:A:BUS:B1:FLEXRAY:DATA:VALUE           | "XXXXXXXX"     |
| TRIGGER:A:BUS:B1:FLEXRAY:EOFTYPE              | STATIC         |
| TRIGGER:A:BUS:B1:FLEXRAY:ERRTYPE              | CRCHEADER      |
| TRIGGER:A:BUS:B1:FLEXRAY:FRAMEID:HIVALUE      | "XXXXXXXXXXXX" |
| TRIGGER:A:BUS:B1:FLEXRAY:FRAMEID:QUALIFIER    | EQUAL          |
| TRIGGER:A:BUS:B1:FLEXRAY:FRAMEID:VALUE        | "XXXXXXXXXXXX" |
| TRIGGER:A:BUS:B1:FLEXRAY:FRAMETYPE            | NORMAL         |
| TRIGGER:A:BUS:B1:FLEXRAY:HEADER:CRC           | "XXXXXXXXXXXX" |
| TRIGGER:A:BUS:B1:FLEXRAY:HEADER:CYCLECOUNT    | "XXXXXX"       |
| TRIGGER:A:BUS:B1:FLEXRAY:HEADER:FRAMEID       | "XXXXXXXXXXXX" |
| TRIGGER:A:BUS:B1:FLEXRAY:HEADER:INDBITS       | "XXXXX"        |
| TRIGGER:A:BUS:B1:FLEXRAY:HEADER:PAYLENGTH     | "XXXXXX"       |
| TRIGGER:A:BUS:B1:I2C:ADDRESS:MODE             | ADDR7          |
| TRIGGER:A:BUS:B1:I2C:ADDRESS:TYPE             | USER           |
| TRIGGER:A:BUS:B1:I2C:ADDRESS:VALUE            | "XXXXXX"       |
| TRIGGER:A:BUS:B1:I2C:CONDITION                | START          |
| TRIGGER:A:BUS:B1:I2C:DATA:DIRECTION           | NO CARE        |
| TRIGGER:A:BUS:B1:I2C:DATA:SIZE                | 1              |

Table C-1: Default Values (cont.)

| Item                                  | Description                    |
|---------------------------------------|--------------------------------|
| TRIGGER:A:BUS:B1:I2C:DATA:START       | 0.0E+0                         |
| TRIGGER:A:BUS:B1:I2C:DATA:VALUE       | "XXXXXXXX"                     |
| TRIGGER:A:BUS:B1:LIN:CONDITION        | SYNCFIELD                      |
| TRIGGER:A:BUS:B1:LIN:DATA:HIVALUE     | "XXXXXXXX"                     |
| TRIGGER:A:BUS:B1:LIN:DATA:QUALIFIER   | EQUAL                          |
| TRIGGER:A:BUS:B1:LIN:DATA:SIZE        | 1                              |
| TRIGGER:A:BUS:B1:LIN:DATA:VALUE       | "XXXXXXXX"                     |
| TRIGGER:A:BUS:B1:LIN:ERRTYPE          | SYNC                           |
| TRIGGER:A:BUS:B1:LIN:IDENTIFIER:VALUE | "XXXXXX"                       |
| TRIGGER:A:BUS:B1:PARALLEL:VALUE       | "XXXXXXXXXXXXXXXXXXXX"         |
| TRIGGER:A:BUS:B1:RS232C:CONDITION     | TXSTART                        |
| TRIGGER:A:BUS:B1:RS232C:RX:DATA:SIZE  | 1                              |
| TRIGGER:A:BUS:B1:RS232C:RX:DATA:VALUE | "XXXXXXXX"                     |
| TRIGGER:A:BUS:B1:RS232C:TX:DATA:SIZE  | 1                              |
| TRIGGER:A:BUS:B1:RS232C:TX:DATA:VALUE | "XXXXXXXX"                     |
| TRIGGER:A:BUS:B1:SPI:CONDITION        | SS                             |
| TRIGGER:A:BUS:B1:SPI:DATA:IN:VALUE    | "XXXXXXXX"                     |
| TRIGGER:A:BUS:B1:SPI:DATA:OUT:VALUE   | "XXXXXXXX"                     |
| TRIGGER:A:BUS:B1:SPI:DATA:SIZE        | 1                              |
| TRIGGER:A:BUS:B1:SPI:DATA:START       | 0.0E+0                         |
| TRIGGER:A:BUS:B1:USB:ADDRESS:HIVALUE  | "XXXXXXXX"                     |
| TRIGGER:A:BUS:B1:USB:ADDRESS:VALUE    | "XXXXXXXX"                     |
| TRIGGER:A:BUS:B1:USB:CONDITION        | SYNC                           |
| TRIGGER:A:BUS:B1:USB:DATA:HIVALUE     | "XXXXXXXX"                     |
| TRIGGER:A:BUS:B1:USB:DATA:OFFSET      | -1                             |
| TRIGGER:A:BUS:B1:USB:DATA:SIZE        | 1                              |
| TRIGGER:A:BUS:B1:USB:DATA:TYPE        | ANY                            |
| TRIGGER:A:BUS:B1:USB:DATA:VALUE       | "XXXXXXXX"                     |
| TRIGGER:A:BUS:B1:USB:ENDPOINT:VALUE   | "XXXX"                         |
| TRIGGER:A:BUS:B1:USB:ERRTYPE          | PID                            |
| TRIGGER:A:BUS:B1:USB:HANDSHAKETYPE    | ANY                            |
| TRIGGER:A:BUS:B1:USB:QUALIFIER        | EQUAL                          |
| TRIGGER:A:BUS:B1:USB:SOFFRAMENUMBER   | "XXXXXXXXXXXX"                 |
| TRIGGER:A:BUS:B1:USB:SPECIALTYPE      | ANY                            |
| TRIGGER:A:BUS:B1:USB:TOKENTYPE        | ANY                            |
| TRIGGER:A:BUS:B2:AUDIO:CONDITION      | SOF                            |
| TRIGGER:A:BUS:B2:AUDIO:DATA:HIVALUE   | "XXXXXXXXXXXXXXXXXXXXXXXXXXXX" |

Table C-1: Default Values (cont.)

| Item                                          | Description                    |
|-----------------------------------------------|--------------------------------|
| TRIGGER:A:BUS:B2:AUDIO:DATA:OFFSET            | 0                              |
| TRIGGER:A:BUS:B2:AUDIO:DATA:QUALIFIER         | EQUAL                          |
| TRIGGER:A:BUS:B2:AUDIO:DATA:VALUE             | "XXXXXXXXXXXXXXXXXXXXXXXXXXXX" |
| TRIGGER:A:BUS:B2:AUDIO:DATA:WORD              | EITHER                         |
| TRIGGER:A:BUS:B2:CAN:CONDITION                | SOF                            |
| TRIGGER:A:BUS:B2:CAN:DATA:DIRECTION           | NOCARE                         |
| TRIGGER:A:BUS:B2:CAN:DATA:OFFSET              | 0                              |
| TRIGGER:A:BUS:B2:CAN:DATA:QUALIFIER           | EQUAL                          |
| TRIGGER:A:BUS:B2:CAN:DATA:SIZE                | 1                              |
| TRIGGER:A:BUS:B2:CAN:DATA:START               | 0.0E+0                         |
| TRIGGER:A:BUS:B2:CAN:DATA:VALUE               | "XXXXXXXX"                     |
| TRIGGER:A:BUS:B2:CAN:FD:BRBUT                 | X                              |
| TRIGGER:A:BUS:B2:CAN:FD:ESIBIT                | X                              |
| TRIGGER:A:BUS:B2:CAN:FRAMETYPE                | DATA                           |
| TRIGGER:A:BUS:B2:CAN:IDENTIFIER:MODE          | STANDARD                       |
| TRIGGER:A:BUS:B2:CAN:IDENTIFIER:VALUE         | "XXXXXXXXXXXX"                 |
| TRIGGER:A:BUS:B2:FLEXRAY:CONDITION            | SOF                            |
| TRIGGER:A:BUS:B2:FLEXRAY:CYCLECOUNT:HIVALUE   | "XXXXXX"                       |
| TRIGGER:A:BUS:B2:FLEXRAY:CYCLECOUNT:QUALIFIER | EQUAL                          |
| TRIGGER:A:BUS:B2:FLEXRAY:CYCLECOUNT:VALUE     | "XXXXXX"                       |
| TRIGGER:A:BUS:B2:FLEXRAY:DATA:HIVALUE         | "XXXXXXXX"                     |
| TRIGGER:A:BUS:B2:FLEXRAY:DATA:OFFSET          | -1                             |
| TRIGGER:A:BUS:B2:FLEXRAY:DATA:QUALIFIER       | EQUAL                          |
| TRIGGER:A:BUS:B2:FLEXRAY:DATA:SIZE            | 1                              |
| TRIGGER:A:BUS:B2:FLEXRAY:DATA:VALUE           | "XXXXXXXX"                     |
| TRIGGER:A:BUS:B2:FLEXRAY:EOFTYPE              | STATIC                         |
| TRIGGER:A:BUS:B2:FLEXRAY:ERRTYPE              | CRCHEADER                      |
| TRIGGER:A:BUS:B2:FLEXRAY:FRAMEID:HIVALUE      | "XXXXXXXXXXXX"                 |
| TRIGGER:A:BUS:B2:FLEXRAY:FRAMEID:QUALIFIER    | EQUAL                          |
| TRIGGER:A:BUS:B2:FLEXRAY:FRAMEID:VALUE        | "XXXXXXXXXXXX"                 |
| TRIGGER:A:BUS:B2:FLEXRAY:FRAMETYPE            | NORMAL                         |
| TRIGGER:A:BUS:B2:FLEXRAY:HEADER:CRC           | "XXXXXXXXXXXX"                 |
| TRIGGER:A:BUS:B2:FLEXRAY:HEADER:CYCLECOUNT    | "XXXXXX"                       |
| TRIGGER:A:BUS:B2:FLEXRAY:HEADER:FRAMEID       | "XXXXXXXXXXXX"                 |
| TRIGGER:A:BUS:B2:FLEXRAY:HEADER:INDBITS       | "XXXXXX"                       |
| TRIGGER:A:BUS:B2:FLEXRAY:HEADER:PAYLENGTH     | "XXXXXX"                       |
| TRIGGER:A:BUS:B2:I2C:ADDRESS:MODE             | ADDR7                          |

Table C-1: Default Values (cont.)

| Item                                  | Description          |
|---------------------------------------|----------------------|
| TRIGGER:A:BUS:B2:I2C:ADDRESS:TYPE     | USER                 |
| TRIGGER:A:BUS:B2:I2C:ADDRESS:VALUE    | "XXXXXXXX"           |
| TRIGGER:A:BUS:B2:I2C:CONDITION        | START                |
| TRIGGER:A:BUS:B2:I2C:DATA:DIRECTION   | NOCARE               |
| TRIGGER:A:BUS:B2:I2C:DATA:SIZE        | 1                    |
| TRIGGER:A:BUS:B2:I2C:DATA:START       | 0.0E+0               |
| TRIGGER:A:BUS:B2:I2C:DATA:VALUE       | "XXXXXXXX"           |
| TRIGGER:A:BUS:B2:LIN:CONDITION        | SYNCFIELD            |
| TRIGGER:A:BUS:B2:LIN:DATA:HIVALUE     | "XXXXXXXX"           |
| TRIGGER:A:BUS:B2:LIN:DATA:QUALIFIER   | EQUAL                |
| TRIGGER:A:BUS:B2:LIN:DATA:SIZE        | 1                    |
| TRIGGER:A:BUS:B2:LIN:DATA:VALUE       | "XXXXXXXX"           |
| TRIGGER:A:BUS:B2:LIN:ERRTYPE          | SYNC                 |
| TRIGGER:A:BUS:B2:LIN:IDENTIFIER:VALUE | "XXXXXX"             |
| TRIGGER:A:BUS:B2:PARALLEL:VALUE       | "XXXXXXXXXXXXXXXXXX" |
| TRIGGER:A:BUS:B2:RS232C:CONDITION     | TXSTART              |
| TRIGGER:A:BUS:B2:RS232C:RX:DATA:SIZE  | 1                    |
| TRIGGER:A:BUS:B2:RS232C:RX:DATA:VALUE | "XXXXXXXX"           |
| TRIGGER:A:BUS:B2:RS232C:TX:DATA:SIZE  | 1                    |
| TRIGGER:A:BUS:B2:RS232C:TX:DATA:VALUE | "XXXXXXXX"           |
| TRIGGER:A:BUS:B2:SPI:CONDITION        | SS                   |
| TRIGGER:A:BUS:B2:SPI:DATA:IN:VALUE    | "XXXXXXXX"           |
| TRIGGER:A:BUS:B2:SPI:DATA:OUT:VALUE   | "XXXXXXXX"           |
| TRIGGER:A:BUS:B2:SPI:DATA:SIZE        | 1                    |
| TRIGGER:A:BUS:B2:SPI:DATA:START       | 0.0E+0               |
| TRIGGER:A:BUS:B2:USB:ADDRESS:HIVALUE  | "XXXXXXXX"           |
| TRIGGER:A:BUS:B2:USB:ADDRESS:VALUE    | "XXXXXXXX"           |
| TRIGGER:A:BUS:B2:USB:CONDITION        | SYNC                 |
| TRIGGER:A:BUS:B2:USB:DATA:HIVALUE     | "XXXXXXXX"           |
| TRIGGER:A:BUS:B2:USB:DATA:OFFSET      | -1                   |
| TRIGGER:A:BUS:B2:USB:DATA:SIZE        | 1                    |
| TRIGGER:A:BUS:B2:USB:DATA:TYPE        | ANY                  |
| TRIGGER:A:BUS:B2:USB:DATA:VALUE       | "XXXXXXXX"           |
| TRIGGER:A:BUS:B2:USB:ENDPOINT:VALUE   | "XXXX"               |
| TRIGGER:A:BUS:B2:USB:ERRTYPE          | PID                  |
| TRIGGER:A:BUS:B2:USB:HANDSHAKETYPE    | ANY                  |
| TRIGGER:A:BUS:B2:USB:QUALIFIER        | EQUAL                |

Table C-1: Default Values (cont.)

| Item                                | Description    |
|-------------------------------------|----------------|
| TRIGGER:A:BUS:B2:USB:SOFFRAMENUMBER | "XXXXXXXXXXXX" |
| TRIGGER:A:BUS:B2:USB:SPECIALTYPE    | ANY            |
| TRIGGER:A:BUS:B2:USB:TOKENTYPE      | ANY            |
| TRIGGER:A:BUS:B<x>:CAN:DATA:OFFSet  | 0              |
| TRIGGER:A:BUS:B<x>:CAN:FD:BRSBIT    | X              |
| TRIGGER:A:BUS:B<x>:CAN:FD:ESIBIT    | X              |
| TRIGGER:A:BUS:SOURCE                | B1             |
| TRIGGER:A:EDGE:COUPLING             | DC             |
| TRIGGER:A:EDGE:SLOPE                | RISE           |
| TRIGGER:A:EDGE:SOURCE               | CH1            |
| TRIGGER:A:HOLDOFF:TIME              | 20.0000E-9     |
| TRIGGER:A:LEVEL                     | 0.0E+0         |
| TRIGGER:A:LEVEL:CH1                 | 0.0E+0         |
| TRIGGER:A:LEVEL:CH2                 | 0.0E+0         |
| TRIGGER:A:LEVEL:CH3                 | 0.0E+0         |
| TRIGGER:A:LEVEL:CH4                 | 0.0E+0         |
| TRIGGER:A:LEVEL:D0                  | 1.4000         |
| TRIGGER:A:LEVEL:D1                  | 1.4000         |
| TRIGGER:A:LEVEL:D10                 | 1.4000         |
| TRIGGER:A:LEVEL:D11                 | 1.4000         |
| TRIGGER:A:LEVEL:D12                 | 1.4000         |
| TRIGGER:A:LEVEL:D13                 | 1.4000         |
| TRIGGER:A:LEVEL:D14                 | 1.4000         |
| TRIGGER:A:LEVEL:D15                 | 1.4000         |
| TRIGGER:A:LEVEL:D2                  | 1.4000         |
| TRIGGER:A:LEVEL:D3                  | 1.4000         |
| TRIGGER:A:LEVEL:D4                  | 1.4000         |
| TRIGGER:A:LEVEL:D5                  | 1.4000         |
| TRIGGER:A:LEVEL:D6                  | 1.4000         |
| TRIGGER:A:LEVEL:D7                  | 1.4000         |
| TRIGGER:A:LEVEL:D8                  | 1.4000         |
| TRIGGER:A:LEVEL:D9                  | 1.4000         |
| TRIGGER:A:LOGIC:CLASS               | LOGIC          |
| TRIGGER:A:LOGIC:FUNCTION            | AND            |
| TRIGGER:A:LOGIC:INPUT:CH1           | X              |
| TRIGGER:A:LOGIC:INPUT:CH2           | X              |
| TRIGGER:A:LOGIC:INPUT:CH3           | X              |

Table C-1: Default Values (cont.)

| Item                                   | Description |
|----------------------------------------|-------------|
| TRIGGER:A:LOGIC:INPUT:CH4              | X           |
| TRIGGER:A:LOGIC:INPUT:CLOCK:EDGE       | RISE        |
| TRIGGER:A:LOGIC:INPUT:CLOCK:SOURCE     | NONE        |
| TRIGGER:A:LOGIC:INPUT:D0               | X           |
| TRIGGER:A:LOGIC:INPUT:D1               | X           |
| TRIGGER:A:LOGIC:INPUT:D10              | X           |
| TRIGGER:A:LOGIC:INPUT:D11              | X           |
| TRIGGER:A:LOGIC:INPUT:D12              | X           |
| TRIGGER:A:LOGIC:INPUT:D13              | X           |
| TRIGGER:A:LOGIC:INPUT:D14              | X           |
| TRIGGER:A:LOGIC:INPUT:D15              | X           |
| TRIGGER:A:LOGIC:INPUT:D2               | X           |
| TRIGGER:A:LOGIC:INPUT:D3               | X           |
| TRIGGER:A:LOGIC:INPUT:D4               | X           |
| TRIGGER:A:LOGIC:INPUT:D5               | X           |
| TRIGGER:A:LOGIC:INPUT:D6               | X           |
| TRIGGER:A:LOGIC:INPUT:D7               | X           |
| TRIGGER:A:LOGIC:INPUT:D8               | X           |
| TRIGGER:A:LOGIC:INPUT:D9               | X           |
| TRIGGER:A:LOGIC:PATTERN:DELTATIME      | 8.0000E-9   |
| TRIGGER:A:LOGIC:PATTERN:WHEN           | TRUE        |
| TRIGGER:A:LOGIC:PATTERN:WHEN:LESSLIMIT | 8.0000E-9   |
| TRIGGER:A:LOGIC:PATTERN:WHEN:MORELIMIT | 8.0000E-9   |
| TRIGGER:A:LOGIC:THRESHOLD:CH1          | 0.0E+0      |
| TRIGGER:A:LOGIC:THRESHOLD:CH2          | 0.0E+0      |
| TRIGGER:A:LOGIC:THRESHOLD:CH3          | 0.0E+0      |
| TRIGGER:A:LOGIC:THRESHOLD:CH4          | 0.0E+0      |
| TRIGGER:A:LOGIC:THRESHOLD:D0           | 1.4000      |
| TRIGGER:A:LOGIC:THRESHOLD:D1           | 1.4000      |
| TRIGGER:A:LOGIC:THRESHOLD:D10          | 1.4000      |
| TRIGGER:A:LOGIC:THRESHOLD:D11          | 1.4000      |
| TRIGGER:A:LOGIC:THRESHOLD:D12          | 1.4000      |
| TRIGGER:A:LOGIC:THRESHOLD:D13          | 1.4000      |
| TRIGGER:A:LOGIC:THRESHOLD:D14          | 1.4000      |
| TRIGGER:A:LOGIC:THRESHOLD:D15          | 1.4000      |
| TRIGGER:A:LOGIC:THRESHOLD:D2           | 1.4000      |
| TRIGGER:A:LOGIC:THRESHOLD:D3           | 1.4000      |

Table C-1: Default Values (cont.)

| Item                           | Description |
|--------------------------------|-------------|
| TRIGGER:A:LOGIC:THRESHOLD:D4   | 1.4000      |
| TRIGGER:A:LOGIC:THRESHOLD:D5   | 1.4000      |
| TRIGGER:A:LOGIC:THRESHOLD:D6   | 1.4000      |
| TRIGGER:A:LOGIC:THRESHOLD:D7   | 1.4000      |
| TRIGGER:A:LOGIC:THRESHOLD:D8   | 1.4000      |
| TRIGGER:A:LOGIC:THRESHOLD:D9   | 1.4000      |
| TRIGGER:A:LOWERTHRESHOLD:CH1   | 0.0E+0      |
| TRIGGER:A:LOWERTHRESHOLD:CH2   | 0.0E+0      |
| TRIGGER:A:LOWERTHRESHOLD:CH3   | 0.0E+0      |
| TRIGGER:A:LOWERTHRESHOLD:CH4   | 0.0E+0      |
| TRIGGER:A:LOWERTHRESHOLD:D0    | 1.4000      |
| TRIGGER:A:LOWERTHRESHOLD:D1    | 1.4000      |
| TRIGGER:A:LOWERTHRESHOLD:D10   | 1.4000      |
| TRIGGER:A:LOWERTHRESHOLD:D11   | 1.4000      |
| TRIGGER:A:LOWERTHRESHOLD:D12   | 1.4000      |
| TRIGGER:A:LOWERTHRESHOLD:D13   | 1.4000      |
| TRIGGER:A:LOWERTHRESHOLD:D14   | 1.4000      |
| TRIGGER:A:LOWERTHRESHOLD:D15   | 1.4000      |
| TRIGGER:A:LOWERTHRESHOLD:D2    | 1.4000      |
| TRIGGER:A:LOWERTHRESHOLD:D3    | 1.4000      |
| TRIGGER:A:LOWERTHRESHOLD:D4    | 1.4000      |
| TRIGGER:A:LOWERTHRESHOLD:D5    | 1.4000      |
| TRIGGER:A:LOWERTHRESHOLD:D6    | 1.4000      |
| TRIGGER:A:LOWERTHRESHOLD:D7    | 1.4000      |
| TRIGGER:A:LOWERTHRESHOLD:D8    | 1.4000      |
| TRIGGER:A:LOWERTHRESHOLD:D9    | 1.4000      |
| TRIGGER:A:MODE                 | AUTO        |
| TRIGGER:A:PULSE:CLASS          | WIDTH       |
| TRIGGER:A:PULSEWIDTH:HIGHLIMIT | 12.0000E-9  |
| TRIGGER:A:PULSEWIDTH:LOWLIMIT  | 8.0000E-9   |
| TRIGGER:A:PULSEWIDTH:POLARITY  | POSITIVE    |
| TRIGGER:A:PULSEWIDTH:WHEN      | LESSTHAN    |
| TRIGGER:A:PULSEWIDTH:WIDTH     | 8.0000E-9   |
| TRIGGER:A:RUNT:POLARITY        | POSITIVE    |
| TRIGGER:A:RUNT:WHEN            | OCCURS      |
| TRIGGER:A:RUNT:WIDTH           | 8.0000E-9   |
| TRIGGER:A:SETHOLD:CLOCK:EDGE   | RISE        |



Table C-1: Default Values (cont.)

| Item                              | Description |
|-----------------------------------|-------------|
| TRIGGER:A:SETHOLD:CLOCK:SOURCE    | CH1         |
| TRIGGER:A:SETHOLD:CLOCK:THRESHOLD | 0.0E+0      |
| TRIGGER:A:SETHOLD:DATA:SOURCE     | NONE        |
| TRIGGER:A:SETHOLD:DATA:THRESHOLD  | 9.91E+37    |
| TRIGGER:A:SETHOLD:HOLDTIME        | 8.0000E-9   |
| TRIGGER:A:SETHOLD:SETTIME         | 8.0000E-9   |
| TRIGGER:A:SETHOLD:THRESHOLD:CH1   | 0.0E+0      |
| TRIGGER:A:SETHOLD:THRESHOLD:CH2   | 0.0E+0      |
| TRIGGER:A:SETHOLD:THRESHOLD:CH3   | 0.0E+0      |
| TRIGGER:A:SETHOLD:THRESHOLD:CH4   | 0.0E+0      |
| TRIGGER:A:SETHOLD:THRESHOLD:D0    | 1.4000      |
| TRIGGER:A:SETHOLD:THRESHOLD:D1    | 1.4000      |
| TRIGGER:A:SETHOLD:THRESHOLD:D10   | 1.4000      |
| TRIGGER:A:SETHOLD:THRESHOLD:D11   | 1.4000      |
| TRIGGER:A:SETHOLD:THRESHOLD:D12   | 1.4000      |
| TRIGGER:A:SETHOLD:THRESHOLD:D13   | 1.4000      |
| TRIGGER:A:SETHOLD:THRESHOLD:D14   | 1.4000      |
| TRIGGER:A:SETHOLD:THRESHOLD:D15   | 1.4000      |
| TRIGGER:A:SETHOLD:THRESHOLD:D2    | 1.4000      |
| TRIGGER:A:SETHOLD:THRESHOLD:D3    | 1.4000      |
| TRIGGER:A:SETHOLD:THRESHOLD:D4    | 1.4000      |
| TRIGGER:A:SETHOLD:THRESHOLD:D5    | 1.4000      |
| TRIGGER:A:SETHOLD:THRESHOLD:D6    | 1.4000      |
| TRIGGER:A:SETHOLD:THRESHOLD:D7    | 1.4000      |
| TRIGGER:A:SETHOLD:THRESHOLD:D8    | 1.4000      |
| TRIGGER:A:SETHOLD:THRESHOLD:D9    | 1.4000      |
| TRIGGER:A:TIMEOUT:POLARITY        | STAYSHIGH   |
| TRIGGER:A:TIMEOUT:TIME            | 8.0000E-9   |
| TRIGGER:A:TRANSITION:DELTATIME    | 8.0000E-9   |
| TRIGGER:A:TRANSITION:POLARITY     | POSITIVE    |
| TRIGGER:A:TRANSITION:WHEN         | SLOWER      |
| TRIGGER:A:TYPE                    | EDGE        |
| TRIGGER:A:UPPERTHRESHOLD:CH1      | 800.0000E-3 |
| TRIGGER:A:UPPERTHRESHOLD:CH2      | 800.0000E-3 |
| TRIGGER:A:UPPERTHRESHOLD:CH3      | 800.0000E-3 |
| TRIGGER:A:UPPERTHRESHOLD:CH4      | 800.0000E-3 |
| TRIGGER:B:BY                      | TIME        |

Table C-1: Default Values (cont.)

| Item                         | Description |
|------------------------------|-------------|
| TRIGGER:B:EDGE:COUPLING      | DC          |
| TRIGGER:B:EDGE:SLOPE         | RISE        |
| TRIGGER:B:EDGE:SOURCE        | CH1         |
| TRIGGER:B:EVENTS:COUNT       | 1           |
| TRIGGER:B:LEVEL              | 0.0E+0      |
| TRIGGER:B:LEVEL:CH1          | 0.0E+0      |
| TRIGGER:B:LEVEL:CH2          | 0.0E+0      |
| TRIGGER:B:LEVEL:CH3          | 0.0E+0      |
| TRIGGER:B:LEVEL:CH4          | 0.0E+0      |
| TRIGGER:B:LEVEL:D0           | 1.4000      |
| TRIGGER:B:LEVEL:D1           | 1.4000      |
| TRIGGER:B:LEVEL:D10          | 1.4000      |
| TRIGGER:B:LEVEL:D11          | 1.4000      |
| TRIGGER:B:LEVEL:D12          | 1.4000      |
| TRIGGER:B:LEVEL:D13          | 1.4000      |
| TRIGGER:B:LEVEL:D14          | 1.4000      |
| TRIGGER:B:LEVEL:D15          | 1.4000      |
| TRIGGER:B:LEVEL:D2           | 1.4000      |
| TRIGGER:B:LEVEL:D3           | 1.4000      |
| TRIGGER:B:LEVEL:D4           | 1.4000      |
| TRIGGER:B:LEVEL:D5           | 1.4000      |
| TRIGGER:B:LEVEL:D6           | 1.4000      |
| TRIGGER:B:LEVEL:D7           | 1.4000      |
| TRIGGER:B:LEVEL:D8           | 1.4000      |
| TRIGGER:B:LEVEL:D9           | 1.4000      |
| TRIGGER:B:LOWERTHRESHOLD:CH1 | 0.0E+0      |
| TRIGGER:B:LOWERTHRESHOLD:CH2 | 0.0E+0      |
| TRIGGER:B:LOWERTHRESHOLD:CH3 | 0.0E+0      |
| TRIGGER:B:LOWERTHRESHOLD:CH4 | 0.0E+0      |
| TRIGGER:B:LOWERTHRESHOLD:D0  | 1.4000      |
| TRIGGER:B:LOWERTHRESHOLD:D1  | 1.4000      |
| TRIGGER:B:LOWERTHRESHOLD:D10 | 1.4000      |
| TRIGGER:B:LOWERTHRESHOLD:D11 | 1.4000      |
| TRIGGER:B:LOWERTHRESHOLD:D12 | 1.4000      |
| TRIGGER:B:LOWERTHRESHOLD:D13 | 1.4000      |
| TRIGGER:B:LOWERTHRESHOLD:D14 | 1.4000      |
| TRIGGER:B:LOWERTHRESHOLD:D15 | 1.4000      |

Table C-1: Default Values (cont.)

| Item                           | Description |
|--------------------------------|-------------|
| TRIGGER:B:LOWERTHRESHOLD:D2    | 1.4000      |
| TRIGGER:B:LOWERTHRESHOLD:D3    | 1.4000      |
| TRIGGER:B:LOWERTHRESHOLD:D4    | 1.4000      |
| TRIGGER:B:LOWERTHRESHOLD:D5    | 1.4000      |
| TRIGGER:B:LOWERTHRESHOLD:D6    | 1.4000      |
| TRIGGER:B:LOWERTHRESHOLD:D7    | 1.4000      |
| TRIGGER:B:LOWERTHRESHOLD:D8    | 1.4000      |
| TRIGGER:B:LOWERTHRESHOLD:D9    | 1.4000      |
| TRIGGER:B:STATE                | 0           |
| TRIGGER:B:TIME                 | 8.0000E-9   |
| TRIGGER:B:TYPE                 | EDGE        |
| VERBOSE                        | 1           |
| VIDPIC:AUTOCONTRAST            | 1           |
| VIDPIC:AUTOCONTRAST:UPDATERATE | 20          |
| ZOOM:MODE                      | 0           |
| ZOOM:ZOOM1:POSITION            | 50.0000     |
| ZOOM:ZOOM1:SCALE               | 4.0000E-6   |
| ZOOM:ZOOM1:STATE               | 0           |



# Appendix D: Waveform Transfer (WFMOutpre? and CURVe? Query) Examples

Here are several examples of command sequences using the WFMOutpre? and CURVe? queries to transfer data from the instrument to a PC, with different data sources, including Analog, Digital waveforms. Each command sequence example is followed by an explanation of the returned WFMOutpre? results. The WFMOutpre? values act as settings that apply to the CURVe query data being transferred.

---

**NOTE.** In order to guarantee that the waveform data returned from CURVe? queries of multiple waveforms are correlated to the same acquisition, you should use single sequence acquisition mode to acquire the waveform data from a single acquisition. Single sequence acquisition mode is enabled using SEQUENCE.

---

## Example 1: Analog Waveform (Channels 1–4)

Goal: Transfer 10,000 points of analog channel waveform data from the instrument to a PC.

| Command                 | Comment                                                                                                                                                                                                                                                                                                                                                                                                                                                                                                                              |
|-------------------------|--------------------------------------------------------------------------------------------------------------------------------------------------------------------------------------------------------------------------------------------------------------------------------------------------------------------------------------------------------------------------------------------------------------------------------------------------------------------------------------------------------------------------------------|
| :DATA:SOURce CH1        |                                                                                                                                                                                                                                                                                                                                                                                                                                                                                                                                      |
| :DATA:START 1           |                                                                                                                                                                                                                                                                                                                                                                                                                                                                                                                                      |
| :DATA:STOP 10000        |                                                                                                                                                                                                                                                                                                                                                                                                                                                                                                                                      |
| :WFMOutpre:ENCdg BINARY |                                                                                                                                                                                                                                                                                                                                                                                                                                                                                                                                      |
| :WFMOutpre:BYT_Nr 1     |                                                                                                                                                                                                                                                                                                                                                                                                                                                                                                                                      |
| :HEADer 1               |                                                                                                                                                                                                                                                                                                                                                                                                                                                                                                                                      |
| :WFMOutpre?             | Returns the following values. Each value represents the current settings that a CURVe? query will use to format the data that will be transferred from the instrument to a PC or other device (see next table for explanations):<br><br>:WFMOUTPRE:BYT_NR 1;BIT_NR 8;ENCDG BINARY;BN_FMT RI;BYT_OR MSB;WFID "Ch1, DC coupling, 100.0mV/div, 4.000us/div, 10000 points, Sample mode";NR_PT 10000;PT_FMT Y;PT_ORDER LINEAR;XUNIT "s";XINCR 4.0000E-9;XZERO 139.9999E-12;PT_OFF 5000;YUNIT "v";YMULT 4.0000E-3;YOFF 0.0E+0;YZERO 0.0E+0 |
| :CURVe?                 | Returns 10,000 data points:<br><br>:CURVe #510000<10,000 binary bytes of waveform data.>                                                                                                                                                                                                                                                                                                                                                                                                                                             |

---

**NOTE.** You can also use the WAVFrm? query, which concatenates the WFMOutpre? and CURVe? queries.

---

| WFMOupre? Query results                                                      | Explanation                                                                                                                                                                                                                                                                                                                                                                                                                                  |
|------------------------------------------------------------------------------|----------------------------------------------------------------------------------------------------------------------------------------------------------------------------------------------------------------------------------------------------------------------------------------------------------------------------------------------------------------------------------------------------------------------------------------------|
| BYT_NR 1                                                                     | This value specifies the number of bytes per data point in the waveform data. To change this value automatically, use the <a href="#">WFMOupre:BYT_Nr</a> command. Note that changing this value automatically changes the BIT_NR value accordingly. (This value can also be set using the command.)                                                                                                                                         |
| BIT_NR 8                                                                     | This value specifies the number of bits per data point in the waveform data. To change this value, use the <a href="#">WFMOupre:BIT_Nr</a> command. Note that changing this value automatically changes the BYT_NR value accordingly.                                                                                                                                                                                                        |
| ENCDG BINARY                                                                 | This value specifies the encoding of the waveform data. To change this value (the other possibility is ASCii), use the <a href="#">WFMOupre:ENCdg</a> command. (This value can also be set using the <a href="#">DATA:ENCdg</a> command, which provides the ability to set the <a href="#">WFMOupre:ENCdg</a> , <a href="#">WFMOupre:BN_Fmt</a> , and <a href="#">WFMOupre:BYT_Or</a> values using a single command.)                        |
| BN_FMT RI                                                                    | This value specifies the binary format, which in this case is RI (signed integer). To change this value (the other possibility is RP or positive integer), use the <a href="#">WFMOupre:BN_Fmt</a> command. Note: this field is not applicable for ASCii encoding.                                                                                                                                                                           |
| BYT_OR MSB                                                                   | This value specifies the byte order for the BINARY encoding, which in this case is MSB (most significant byte first). To change this value to LSB, use the <a href="#">WFMOupre:BYT_Or</a> command. Note: this field is not applicable for ASCii encoding.                                                                                                                                                                                   |
| WFID "Ch1, DC coupling, 100.0mv/div, 4.000us/div, 10000 points, Sample mode" | This quoted string represents information about the source waveform that would be returned by a <a href="#">WFMOupre:WFid?</a> query.                                                                                                                                                                                                                                                                                                        |
| NR_PT 10000                                                                  | This value indicates the number of data points in the waveform record to be transferred using the CURVE? query. (If you would like to determine only this value, use the <a href="#">WFMOupre:NR_Pt?</a> query.) Note: this value is typically equal to the full record length, but you also have the option to transfer only a portion of the record length by using the <a href="#">DATA:START</a> and <a href="#">DATA:STOP</a> commands. |
| PT_FMT Y                                                                     | This value indicates the format of the data points in the waveform record. In this case, the value represents YT format. This is query only – the returned values can be Y for YT format or ENV for envelope format (min/max pairs). (If you would like to determine only this value, use the <a href="#">WFMOupre:PT_Fmt?</a> query.)                                                                                                       |
| PT_ORDER LINEAR                                                              | This value is LINEAR or ROW.                                                                                                                                                                                                                                                                                                                                                                                                                 |
| XUNIT "s"                                                                    | This value indicates the units of the x-axis of the waveform record. This is determined by the horizontal settings for the waveform source. Typically, this value is "s", representing seconds. When using the math waveform as a source, the value can be "s" or "Hz". This is query only. (If you would like to determine only this value, use the <a href="#">WFMOupre:XUNit?</a> query.)                                                 |
| XINCR 4.0000E-9                                                              | This value indicates the time, in seconds, or frequency, in hertz, between data points in the waveform record. This is query only. (If you would like to determine only this value, use the <a href="#">WFMOupre:XINcr?</a> query.)                                                                                                                                                                                                          |
| XZERO 139.9999E-12                                                           | This value indicates the sub-sample time between the trigger sample (designated by PT_OFF) and the occurrence of the actual trigger in the waveform record. The value is in units of <a href="#">WFMOupre:XUNit</a> . This is query only. (If you would like to determine only this value, use the <a href="#">WFMOupre:XZEro?</a> query.)                                                                                                   |
| PT_OFF 5000                                                                  | This value indicates the data point immediately following the trigger point relative to <a href="#">DATA:START</a> in the waveform record. This is a query only. (If you would like to determine only this value, use the <a href="#">WFMOupre:PT_Off?</a> query.)                                                                                                                                                                           |



| WFMOupre? Query results                                              | Explanation                                                                                                                                                                                                                                                                                                                                                                                                                                                  |
|----------------------------------------------------------------------|--------------------------------------------------------------------------------------------------------------------------------------------------------------------------------------------------------------------------------------------------------------------------------------------------------------------------------------------------------------------------------------------------------------------------------------------------------------|
| WFMOUPRE:BYT_Nr 1                                                    | This value specifies the number of bytes per data point in the waveform data. To change this value automatically, use the <a href="#">WFMOupre:BYT_Nr</a> command. Note that changing this value automatically changes the BIT_Nr value accordingly. (This value can also be set using the <a href="#">DATA:WIDTH</a> command.)                                                                                                                              |
| BIT_Nr 8                                                             | This value specifies the number of bits per data point in the waveform data. To change this value, use the <a href="#">WFMOupre:BIT_Nr</a> command. Note that changing this value automatically changes the BYT_Nr value accordingly.                                                                                                                                                                                                                        |
| ENCDG ASCII                                                          | This value specifies the encoding of the waveform data. To change this value (the other possibility is BINARY), use the <a href="#">WFMOupre:ENCDg</a> command. (This value can also be set using the <a href="#">DATA:ENCDg</a> command, which provides the ability to set the <a href="#">WFMOupre:ENCDg</a> , <a href="#">WFMOupre:BN_Fmt</a> , and <a href="#">WFMOupre:BYT_Or</a> values using a single command.)                                       |
| BN_FMT RI                                                            | This value specifies the binary format, which in this case is RI (signed integer). To change this value (the other possibility is RP or positive integer), use the <a href="#">WFMOupre:BN_Fmt</a> command. Note: this field is not applicable for ASCII encoding.                                                                                                                                                                                           |
| BYT_OR MSB                                                           | This value specifies the byte order for the BINARY encoding, which in this case is MSB (most significant byte first, also known as IBM format). To change this value to LSB, use the <a href="#">WFMOupre:BYT_Or</a> command. Note: this field is not applicable for ASCII encoding.                                                                                                                                                                         |
| WFID "D5, unknown coupling, 100.0us/div, 10000 points, Digital mode" | This quoted string represents information about the source waveform that would be returned by a <a href="#">WFMOupre:WFID?</a> query. It cannot be changed.                                                                                                                                                                                                                                                                                                  |
| NR_PT 25                                                             | This value indicates the number of data points in the waveform record to be transferred using the <a href="#">CURVE?</a> query. (If you would like to determine only this value, use the <a href="#">WFMOupre:NR_Pt?</a> query.) Note: this value is typically equal to the full record length, but you also have the option to transfer only a portion of the record length by using the <a href="#">DATA:STARt</a> and <a href="#">DATA:STOP</a> commands. |
| PT_FMT Y                                                             | This value indicates the format of the data points in the waveform record. In this case, the value represents YT format. This is query only. (If you would like to determine only this value, use the <a href="#">WFMOupre:PT_Fmt?</a> query.)                                                                                                                                                                                                               |
| PT_ORDER LINEAR                                                      | This value is always <a href="#">LINEar</a> .                                                                                                                                                                                                                                                                                                                                                                                                                |
| XUNIT "s"                                                            | This value indicates the units of the x-axis of the waveform record. This is determined by the horizontal settings for the waveform source. Typically, this value is "s", representing seconds. When using the math waveform as a source, the value can be "s" or "Hz". This is query only. (If you would like to determine only this value, use the <a href="#">WFMOupre:XUNit?</a> query.)                                                                 |
| XINCR 100.0000E-9                                                    | This value indicates the time, in seconds, or frequency, in hertz, between data points in the waveform record. This is query only. (If you would like to determine only this value, use the <a href="#">WFMOupre:XINcr?</a> query.)                                                                                                                                                                                                                          |
| XZERO 155.000E-12                                                    | This value indicates the sub-sample time between the trigger sample (designated by <a href="#">PT_OFF</a> ) and the occurrence of the actual trigger in the waveform record. The value is in units of <a href="#">WFMOupre:XUNit</a> . This is query only. (If you would like to determine only this value, use the <a href="#">WFMOupre:XZEro?</a> query.)                                                                                                  |
| PT_OFF 5000                                                          | This value indicates the data point immediately following the trigger point relative to <a href="#">DATA:STARt</a> in the waveform record. (If you would like to determine only this value, use the <a href="#">WFMOupre:PT_Off?</a> query.)                                                                                                                                                                                                                 |



| WFMOUtpre? Query results | Explanation                                                                                                                                                                                                                                                                                                                    |
|--------------------------|--------------------------------------------------------------------------------------------------------------------------------------------------------------------------------------------------------------------------------------------------------------------------------------------------------------------------------|
| YUNIT "State"            | This value indicates the vertical units of data points in the waveform record. This can be any of several string values, depending upon the vertical units of the source waveform – in this case, State. This is query only. (If you would like to determine only this value, use the <a href="#">WFMOUtpre:YUNit?</a> query.) |
| YMULT 1.0000             | This value indicates the multiplying factor to convert the data point values from digitizing levels to the units specified by the <code>WFMOUtpre:YUNit</code> command. This is query only. (If you would like to determine only this value, use the <a href="#">WFMOUtpre:YMUIt?</a> query.)                                  |
| YOFF 0.0E+0              | This value indicates the vertical position of the source waveform in digitizing levels. There are 25 digitizing levels per vertical division. This is query only. (If you would like to determine only this value, use the <a href="#">WFMOUtpre:YOFF?</a> query.)                                                             |
| YZERO 0.0E+0             | This value indicates the vertical offset of the source waveform in units specified by the <code>WFMOUtpre:YUNit</code> command. This is query only. (If you would like to determine only this value, use the <a href="#">WFMOUtpre:YZero?</a> query.)                                                                          |

### Example 3: Digital with 4 Bytes Per Point and Zoom Off

Goal: Transfer 25 points of Digital data from the instrument to a PC using 4 bytes per point and Zoom off.

| Command                             | Comment                                                                                                                                                                                                                                                                                                                                                                                                                                                                                                                                                    |
|-------------------------------------|------------------------------------------------------------------------------------------------------------------------------------------------------------------------------------------------------------------------------------------------------------------------------------------------------------------------------------------------------------------------------------------------------------------------------------------------------------------------------------------------------------------------------------------------------------|
| <code>:DATA:SOURce CH1_D1</code>    |                                                                                                                                                                                                                                                                                                                                                                                                                                                                                                                                                            |
| <code>:ACQuire:MAGnivu 0</code>     |                                                                                                                                                                                                                                                                                                                                                                                                                                                                                                                                                            |
| <code>:DATA:START 1</code>          |                                                                                                                                                                                                                                                                                                                                                                                                                                                                                                                                                            |
| <code>:DATA:STOP 25</code>          |                                                                                                                                                                                                                                                                                                                                                                                                                                                                                                                                                            |
| <code>:WFMOUtpre:ENCdg ASCii</code> |                                                                                                                                                                                                                                                                                                                                                                                                                                                                                                                                                            |
| <code>:WFMOUtpre:BYT_Nr 4</code>    |                                                                                                                                                                                                                                                                                                                                                                                                                                                                                                                                                            |
| <code>:HEADer 1</code>              |                                                                                                                                                                                                                                                                                                                                                                                                                                                                                                                                                            |
| <code>:VERBose 1</code>             |                                                                                                                                                                                                                                                                                                                                                                                                                                                                                                                                                            |
| <code>:WFMOUtpre?</code>            | Returns the following values. Each value represents the current settings that a <code>CURVe?</code> query will use to format the data that will be transferred from the instrument to a PC or other device (see next table for explanations):<br><br><code>:WFMOUtpre:BYT_Nr 4;BIT_Nr 32;ENCdg ASCII;BN_FMT RI;BYT_OR MSB;WFID "Digital, unknown coupling, 100.0us/div, 10000 points, Digital mode";NR_PT 25;PT_FMT Y;PT_ORDER LINEAR;XUNIT "s";XINCR 100.0000E-9;XZERO 155.000E-12;PT_OFF 5000;YUNIT "State";YMULT 1.0000;YOFF 0.0E+0;YZERO 0.0E+0</code> |
| <code>:CURVe?</code>                | Returns the following values. Each value represents a data point:<br><br><code>:CURVe<br/>FB386,FB366,FB3E6,FB366,FB3E6,FB32E,FB3A2,FB32E,FB3AA,FB366,FB3EA,FB366,FB3E2,FB36,FB3E6,FB366,FB3E6,FB346,FB3C6,FB346,FB3C6,FB34E,FB3C2,FB34E,FB3CA</code>                                                                                                                                                                                                                                                                                                      |

---

**NOTE.** The returned hexadecimal data values are formatted without leading zeroes. For example, a 4-byte digital value of FB386 should be interpreted as 000FB386.

---



---

**NOTE.** You can also use the *WAVFrm?* query, which concatenates the *WFMOupre?* and *CURVe?* queries.

---

| WFMOupre? Query results                                                   | Explanation                                                                                                                                                                                                                                                                                                                                                                                                                                                  |
|---------------------------------------------------------------------------|--------------------------------------------------------------------------------------------------------------------------------------------------------------------------------------------------------------------------------------------------------------------------------------------------------------------------------------------------------------------------------------------------------------------------------------------------------------|
| WFMOUPRE:BYT_NR 4                                                         | This value specifies the number of bytes per data point in the waveform data. To change this value automatically, use the <a href="#">WFMOupre:BYT_Nr</a> command. Note that changing this value automatically changes the BIT_NR value accordingly. (This value can also be set using the <a href="#">DATA:WIDTH</a> command.)                                                                                                                              |
| BIT_NR 32                                                                 | This value specifies the number of bits per data point in the waveform data. To change this value, use the <a href="#">WFMOupre:BIT_Nr</a> command. Note that changing this value automatically changes the BYT_NR value accordingly.                                                                                                                                                                                                                        |
| ENCDG ASCII                                                               | This value specifies the encoding of the waveform data. To change this value (the other possibility is BINARY), use the <a href="#">WFMOupre:ENCDg</a> command. (This value can also be set using the <a href="#">DATA:ENCDg</a> command, which provides the ability to set the <a href="#">WFMOupre:ENCDg</a> , <a href="#">WFMOupre:BN_Fmt</a> , and <a href="#">WFMOupre:BYT_Or</a> values using a single command.)                                       |
| BN_FMT RI                                                                 | This value specifies the binary format, which in this case is RI (signed integer). To change this value (the other possibility is RP or positive integer), use the <a href="#">WFMOupre:BN_Fmt</a> command. Note: this field is not applicable for ASCII encoding.                                                                                                                                                                                           |
| BYT_OR MSB                                                                | This value specifies the byte order for the BINARY encoding, which in this case is MSB (most significant byte first, also known as IBM format). To change this value to LSB, use the <a href="#">WFMOupre:BYT_Or</a> command. Note: this field is not applicable for ASCII encoding.                                                                                                                                                                         |
| WFID "Digital, unknown coupling, 100.0us/div, 10000 points, Digital mode" | This quoted string represents information about the source waveform that would be returned by a <a href="#">WFMOupre:WFID?</a> query. It cannot be changed.                                                                                                                                                                                                                                                                                                  |
| NR_PT 25                                                                  | This value indicates the number of data points in the waveform record to be transferred using the <a href="#">CURVE?</a> query. (If you would like to determine only this value, use the <a href="#">WFMOupre:NR_Pt?</a> query.) Note: this value is typically equal to the full record length, but you also have the option to transfer only a portion of the record length by using the <a href="#">DATA:START</a> and <a href="#">DATA:STOP</a> commands. |
| PT_FMT Y                                                                  | This value indicates the format of the data points in the waveform record. In this case, the value represents YT format. This is query only – the returned values can be Y for YT format or ENV for envelope format (min/max pairs). (If you would like to determine only this value, use the <a href="#">WFMOupre:PT_Fmt?</a> query.)                                                                                                                       |
| PT_ORDER LINEAR                                                           | This value is always LINEar.                                                                                                                                                                                                                                                                                                                                                                                                                                 |
| XUNIT "s"                                                                 | This value indicates the units of the x-axis of the waveform record. This is determined by the horizontal settings for the waveform source. For live channels, this value is "s", representing seconds. When using the math waveform as a source, the value can be "s" or "Hz". This is query only. (If you would like to determine only this value, use the <a href="#">WFMOupre:XUNIT?</a> query.)                                                         |

| WFMOUtpre? Query results | Explanation                                                                                                                                                                                                                                                                                                                    |
|--------------------------|--------------------------------------------------------------------------------------------------------------------------------------------------------------------------------------------------------------------------------------------------------------------------------------------------------------------------------|
| XINCR 100.0000E-9        | This value indicates the time, in seconds, or frequency, in hertz, between data points in the waveform record. This is query only. (If you would like to determine only this value, use the <a href="#">WFMOUtpre:XINcr?</a> query.)                                                                                           |
| XZERO 155.000E-12        | This value indicates the sub-sample time between the trigger sample (designated by PT_OFF) and the occurrence of the actual trigger in the waveform record. The value is in units of WFMOUtpre:XUNit. This is query only. (If you would like to determine only this value, use the <a href="#">WFMOUtpre:XZEro?</a> query.)    |
| PT_OFF 5000              | This value indicates the data point immediately following the trigger point relative to DATA:START in the waveform record. (If you would like to determine only this value, use the <a href="#">WFMOUtpre:PT_Off?</a> query.)                                                                                                  |
| YUNIT "State"            | This value indicates the vertical units of data points in the waveform record. This can be any of several string values, depending upon the vertical units of the source waveform – in this case, State. This is query only. (If you would like to determine only this value, use the <a href="#">WFMOUtpre:YUNit?</a> query.) |
| YMULT 1.0000             | This value indicates the multiplying factor to convert the data point values from digitizing levels to the units specified by the WFMOUtpre:YUNit command. This is query only. (If you would like to determine only this value, use the <a href="#">WFMOUtpre:YMUIt?</a> query.)                                               |
| YOFF 0.0E+0              | This value indicates the vertical position of the source waveform in digitizing levels. There are 25 digitizing levels per vertical division. This is query only. (If you would like to determine only this value, use the <a href="#">WFMOUtpre:YOff?</a> query.)                                                             |
| YZERO 0.0E+0             | This value indicates the vertical offset of the source waveform in units specified by the WFMOUtpre:YUNit command. This is query only. (If you would like to determine only this value, use the <a href="#">WFMOUtpre:YZEro?</a> query.)                                                                                       |

## Example 4: Digital with 8 Bytes Per Point and Zoom Off

Goal: Transfer 25 points of Digital data from the instrument to a PC using 8 bytes per point and Zoom off.

| Command                | Comment |
|------------------------|---------|
| :DATA:SOURce CH1_D1    |         |
| :ACQuire:MAGnivu 0     |         |
| :DATA:START 1          |         |
| :DATA:STOP 25          |         |
| :WFMOUtpre:ENCdg ASCii |         |
| :WFMOUtpre:BYT_Nr 8    |         |
| :HEADer 1              |         |
| :VERBose 1             |         |



| WFMOUtpre? Query results                                                  | Explanation                                                                                                                                                                                                                                                                                                                                                                                                                                                |
|---------------------------------------------------------------------------|------------------------------------------------------------------------------------------------------------------------------------------------------------------------------------------------------------------------------------------------------------------------------------------------------------------------------------------------------------------------------------------------------------------------------------------------------------|
| WFID "Digital, unknown coupling, 100.0us/div, 10000 points, Digital mode" | This quoted string represents information about the source waveform that would be returned by a <code>WFMOUtpre:WFID?</code> query. It cannot be changed.                                                                                                                                                                                                                                                                                                  |
| NR_PT 25                                                                  | This value indicates the number of data points in the waveform record to be transferred using the <code>CURVe?</code> query. (If you would like to determine only this value, use the <a href="#">WFMOUtpre:NR_Pt?</a> query.) Note: this value is typically equal to the full record length, but you also have the option to transfer only a portion of the record length by using the <a href="#">DATA:START</a> and <a href="#">DATA:STOP</a> commands. |
| PT_FMT Y                                                                  | This value indicates the format of the data points in the waveform record. In this case, the value represents YT format. This is query only – the returned values can be Y for YT format or ENV for envelope format (min/max pairs). (If you would like to determine only this value, use the <a href="#">WFMOUtpre:PT_Fmt?</a> query.)                                                                                                                    |
| PT_ORDER LINEAR                                                           | This value is always <code>LINEAR</code> .                                                                                                                                                                                                                                                                                                                                                                                                                 |
| XUNIT "s"                                                                 | This value indicates the units of the x-axis of the waveform record. This is determined by the horizontal settings for the waveform source. Typically, this value is "s", representing seconds. When using the math waveform as a source, the value can be "s" or "Hz". This is query only. (If you would like to determine only this value, use the <a href="#">WFMOUtpre:XUNit?</a> query.)                                                              |
| XINCR 100.0000E-9                                                         | This value indicates the time, in seconds, or frequency, in hertz, between data points in the waveform record. This is query only. (If you would like to determine only this value, use the <a href="#">WFMOUtpre:XINcr?</a> query.)                                                                                                                                                                                                                       |
| XZERO 155.000E-12                                                         | This value indicates the sub-sample time between the trigger sample (designated by <code>PT_OFF</code> ) and the occurrence of the actual trigger in the waveform record. The value is in units of <code>WFMOUtpre:XUNit</code> . This is query only. (If you would like to determine only this value, use the <a href="#">WFMOUtpre:XZEro?</a> query.)                                                                                                    |
| PT_OFF 5000                                                               | This value indicates the data point immediately following the trigger point relative to <code>DATA:START</code> in the waveform record. (If you would like to determine only this value, use the <a href="#">WFMOUtpre:PT_Off?</a> query.)                                                                                                                                                                                                                 |
| YUNIT "State"                                                             | This value indicates the vertical units of data points in the waveform record. This can be any of several string values, depending upon the vertical units of the source waveform – in this case, State. This is query only. (If you would like to determine only this value, use the <a href="#">WFMOUtpre:YUNit?</a> query.)                                                                                                                             |
| YMULT 1.0000                                                              | This value indicates the multiplying factor to convert the data point values from digitizing levels to the units specified by the <code>WFMOUtpre:YUNit</code> command. This is query only. (If you would like to determine only this value, use the <a href="#">WFMOUtpre:YMUlt?</a> query.)                                                                                                                                                              |
| YOFF 0.0E+0                                                               | This value indicates the vertical position of the source waveform in digitizing levels. There are 25 digitizing levels per vertical division. This is query only. (If you would like to determine only this value, use the <a href="#">WFMOUtpre:YOFF?</a> query.)                                                                                                                                                                                         |
| YZERO 0.0E+0                                                              | This value indicates the vertical offset of the source waveform in units specified by the <code>WFMOUtpre:YUNit</code> command. This is query only. (If you would like to determine only this value, use the <a href="#">WFMOUtpre:YZEro?</a> query.)                                                                                                                                                                                                      |

## Example 5: Digital with 4 Bytes Per Point and Zoom On

Goal: Transfer 25 points of Digital data from the instrument to a PC using 4 bytes per point and Zoom on.

| Command               | Comment                                                                                                                                                                                                                                                                                                                                                                                                                                                                                                                       |
|-----------------------|-------------------------------------------------------------------------------------------------------------------------------------------------------------------------------------------------------------------------------------------------------------------------------------------------------------------------------------------------------------------------------------------------------------------------------------------------------------------------------------------------------------------------------|
| :DATA:SOURce CH1_D1   |                                                                                                                                                                                                                                                                                                                                                                                                                                                                                                                               |
| :ACQuire:MAGnivu 1    |                                                                                                                                                                                                                                                                                                                                                                                                                                                                                                                               |
| :DATA:START 1         |                                                                                                                                                                                                                                                                                                                                                                                                                                                                                                                               |
| :DATA:STOP 25         |                                                                                                                                                                                                                                                                                                                                                                                                                                                                                                                               |
| :WFMOupre:ENCdg ASCii |                                                                                                                                                                                                                                                                                                                                                                                                                                                                                                                               |
| :WFMOupre:BYT_Nr 4    |                                                                                                                                                                                                                                                                                                                                                                                                                                                                                                                               |
| :HEADer 1             |                                                                                                                                                                                                                                                                                                                                                                                                                                                                                                                               |
| :VERBose 1            |                                                                                                                                                                                                                                                                                                                                                                                                                                                                                                                               |
| :WFMOupre?            | Returns the following values. Each value represents the current settings that a CURVe? query will use to format the data that will be transferred from the instrument to a PC or other device (see next table for explanations):<br><br>:WFMOUPRE:BYT_NR 4;BIT_NR 32;ENCDG ASCII;BN_FMT RI;BYT_OR MSB;WFID "Digital, unknown coupling, 100.0us/div, 10000 points, Digital mode";NR_PT 25;PT_FMT Y;PT_ORDER LINEAR;XUNIT "s";XINCR 1.2121E-9;XZERO 155.000E-12;PT_OFF 5000;YUNIT "State";YMULT 1.0000;YOFF 0.0E+0;YZERO 0.0E+0 |
| :CURVe?               | Returns the following values. Each value represents a data point:<br><br>:CURVE<br>FB6E6, FB666, FB6E6, FB666, FB666, FB6E6, FB666, FB6E6, FB666, FB666, FB6E6, FB666, FB6E6, FB666, FB666, FB6E6, FB666, FB666, FB6E6, FB666, FB666                                                                                                                                                                                                                                                                                          |

**NOTE.** The returned hexadecimal data values are formatted without leading zeroes.

**NOTE.** You can also use the *WAVFrm?* query, which concatenates the *WFMOupre?* and *CURVe?* queries.

| WFMOupre? Query results | Explanation                                                                                                                                                                                                                                                                                                                     |
|-------------------------|---------------------------------------------------------------------------------------------------------------------------------------------------------------------------------------------------------------------------------------------------------------------------------------------------------------------------------|
| WFMOUPRE:BYT_NR 4       | This value specifies the number of bytes per data point in the waveform data. To change this value automatically, use the <a href="#">WFMOupre:BYT_Nr</a> command. Note that changing this value automatically changes the BIT_NR value accordingly. (This value can also be set using the <a href="#">DATA:WIDTH</a> command.) |
| BIT_NR 32               | This value specifies the number of bits per data point in the waveform data. To change this value, use the <a href="#">WFMOupre:BIT_Nr</a> command. Note that changing this value automatically changes the BYT_NR value accordingly.                                                                                           |

| WFMOupre? Query results                                                   | Explanation                                                                                                                                                                                                                                                                                                                                                                                                                                  |
|---------------------------------------------------------------------------|----------------------------------------------------------------------------------------------------------------------------------------------------------------------------------------------------------------------------------------------------------------------------------------------------------------------------------------------------------------------------------------------------------------------------------------------|
| ENCDG ASCII                                                               | This value specifies the encoding of the waveform data. To change this value (the other possibility is BINARY), use the <a href="#">WFMOupre:ENCDg</a> command. (This value can also be set using the <a href="#">DATA:ENCDg</a> command, which provides the ability to set the <a href="#">WFMOupre:ENCDg</a> , <a href="#">WFMOupre:BN_Fmt</a> , and <a href="#">WFMOupre:BYT_Or</a> values using a single command.)                       |
| BN_FMT RI                                                                 | This value specifies the binary format, which in this case is RI (signed integer). To change this value (the other possibility is RP or positive integer), use the <a href="#">WFMOupre:BN_Fmt</a> command. Note: this field is not applicable for ASCII encoding.                                                                                                                                                                           |
| BYT_OR MSB                                                                | This value specifies the byte order for the BINARY encoding, which in this case is MSB (most significant byte first, also known as IBM format). To change this value to LSB, use the <a href="#">WFMOupre:BYT_Or</a> command. Note: this field is not applicable for ASCII encoding.                                                                                                                                                         |
| WFID "Digital, unknown coupling, 100.0us/div, 10000 points, Digital mode" | This quoted string represents information about the source waveform that would be returned by a <a href="#">WFMOupre:WFID?</a> query. It cannot be changed.                                                                                                                                                                                                                                                                                  |
| NR_PT 25                                                                  | This value indicates the number of data points in the waveform record to be transferred using the CURVE? query. (If you would like to determine only this value, use the <a href="#">WFMOupre:NR_Pt?</a> query.) Note: this value is typically equal to the full record length, but you also have the option to transfer only a portion of the record length by using the <a href="#">DATA:START</a> and <a href="#">DATA:STOP</a> commands. |
| PT_FMT Y                                                                  | This value indicates the format of the data points in the waveform record. In this case, the value represents YT format. This is query only – the returned values can be Y for YT format or ENV for envelope format (min/max pairs). (If you would like to determine only this value, use the <a href="#">WFMOupre:PT_Fmt?</a> query.)                                                                                                       |
| PT_ORDER LINEAR                                                           | This value is always LINEar.                                                                                                                                                                                                                                                                                                                                                                                                                 |
| XUNIT "s"                                                                 | This value indicates the units of the x-axis of the waveform record. This is determined by the horizontal settings for the waveform source. Typically, this value is "s", representing seconds. When using the math waveform as a source, the value can be "s" or "Hz". This is query only. (If you would like to determine only this value, use the <a href="#">WFMOupre:XUNit?</a> query.)                                                 |
| XINCR 1.2121E-9                                                           | This value indicates the time, in seconds, or frequency, in hertz, between data points in the waveform record. This is query only. (If you would like to determine only this value, use the <a href="#">WFMOupre:XINcr?</a> query.)                                                                                                                                                                                                          |
| XZERO 155.000E-12                                                         | This value indicates the sub-sample time between the trigger sample (designated by PT_OFF) and the occurrence of the actual trigger in the waveform record. The value is in units of <a href="#">WFMOupre:XUNit</a> . This is query only. (If you would like to determine only this value, use the <a href="#">WFMOupre:XZEro?</a> query.)                                                                                                   |
| PT_OFF 5000                                                               | This value indicates the data point immediately following the trigger point relative to <a href="#">DATA:START</a> in the waveform record. (If you would like to determine only this value, use the <a href="#">WFMOupre:PT_Off?</a> query.)                                                                                                                                                                                                 |
| YUNIT "State"                                                             | This value indicates the vertical units of data points in the waveform record. This can be any of several string values, depending upon the vertical units of the source waveform – in this case, State. This is query only. (If you would like to determine only this value, use the <a href="#">WFMOupre:YUNit?</a> query.)                                                                                                                |
| YMULT 1.0000                                                              | This value indicates the multiplying factor to convert the data point values from digitizing levels to the units specified by the <a href="#">WFMOupre:YUNit</a> command. This is query only. (If you would like to determine only this value, use the <a href="#">WFMOupre:YMUlt?</a> query.)                                                                                                                                               |

| WFMOupre? Query results | Explanation                                                                                                                                                                                                                                                       |
|-------------------------|-------------------------------------------------------------------------------------------------------------------------------------------------------------------------------------------------------------------------------------------------------------------|
| YOFF 0.0E+0             | This value indicates the vertical position of the source waveform in digitizing levels. There are 25 digitizing levels per vertical division. This is query only. (If you would like to determine only this value, use the <a href="#">WFMOupre:YOFF?</a> query.) |
| YZERO 0.0E+0            | This value indicates the vertical offset of the source waveform in units specified by the <code>WFMOupre:YUNIT</code> command. This is query only. (If you would like to determine only this value, use the <a href="#">WFMOupre:YZero?</a> query.)               |

## Example 6: RF Frequency Domain Waveform

Goal: Transfer 5 points of RF frequency domain data from the instrument to a PC using 8 bytes per point.

**NOTE.** A frequency domain waveform used in data transfer from the instrument to a PC or other device may be one of the four RF frequency domain traces or the Spectrum Math waveform.

| Command                    | Comment                                                                                                                                                                                                                                                                                                                                                                                                                                                                                                                                                                                                                                                                                       |
|----------------------------|-----------------------------------------------------------------------------------------------------------------------------------------------------------------------------------------------------------------------------------------------------------------------------------------------------------------------------------------------------------------------------------------------------------------------------------------------------------------------------------------------------------------------------------------------------------------------------------------------------------------------------------------------------------------------------------------------|
| :DATA:SOURce CH1_SV_NORMal |                                                                                                                                                                                                                                                                                                                                                                                                                                                                                                                                                                                                                                                                                               |
| :DATA:STARt 495            |                                                                                                                                                                                                                                                                                                                                                                                                                                                                                                                                                                                                                                                                                               |
| :DATA:STOP 505             |                                                                                                                                                                                                                                                                                                                                                                                                                                                                                                                                                                                                                                                                                               |
| :WFMOupre:ENCDg ASCii      |                                                                                                                                                                                                                                                                                                                                                                                                                                                                                                                                                                                                                                                                                               |
| :WFMOupre:BYT_Nr 8         |                                                                                                                                                                                                                                                                                                                                                                                                                                                                                                                                                                                                                                                                                               |
| :HEADer 1                  |                                                                                                                                                                                                                                                                                                                                                                                                                                                                                                                                                                                                                                                                                               |
| :VERBose 1                 |                                                                                                                                                                                                                                                                                                                                                                                                                                                                                                                                                                                                                                                                                               |
| :WFMOupre?                 | Returns the following values. Each value represents the current settings that a CURVe? query will use to format the data that will be transferred from the instrument to a PC or other device (see next table for explanations):<br>:WFMOUPRE:BYT_NR 8;BIT_NR 64;ENCDG ASCII;BN_FMT FP;BYT_OR MSB;WFID "RF_NORMAL, unknown coupling, 10.00w/div, 200.0MHz/div, 1001 points, Sample mode, Center Freq: 2.400GHz, Span: 2.000GHz, Reference Level: 1.000mw";NR_PT 21;PT_FMT Y;PT_ORDER LINEAR;XUNIT "Hz";XINCR 2.0000E+6;XZERO 1.4000E+9;PT_OFF 0;YUNIT "w";YMULT 1.5625E-3;YOFF 0.0E+0;YZERO 0.0E+0;DOMAIN FREQUENCY;WFMTYPE RF_FD;CENTERFREQUENCY 2.4000E+9;SPAN 2.0000E+9;REFLEVEL 1.0000E-3 |
| :CURVe?                    | Returns the following values. Each value represents a data point:<br>:CURVE<br>2.43108E-10,1.62648E-10,2.78478E-10,4.15163E-10,7.66223E-10,7.63905E-10,3.68375E-10,3.42668E-10,3.06422E-10,1.81561E-10,2.0223E-10,4.24327E-10,1.95298E-10,2.1304E-10,9.41791E-11,4.56513E-10,4.33067E-10,6.57215E-11,1.65388E-10,9.09116E-10,5.39507E-10                                                                                                                                                                                                                                                                                                                                                      |



| WFMOupre? Query results                                                                                                                                     | Explanation                                                                                                                                                                                                                                                                                                                                                                |
|-------------------------------------------------------------------------------------------------------------------------------------------------------------|----------------------------------------------------------------------------------------------------------------------------------------------------------------------------------------------------------------------------------------------------------------------------------------------------------------------------------------------------------------------------|
| BYT_NR 8                                                                                                                                                    | This value specifies the number of bytes per data point in the waveform data. This value is fixed for RF frequency domain traces.                                                                                                                                                                                                                                          |
| BIT_NR 64                                                                                                                                                   | This value specifies the number of bits per data point in the waveform data. This value is fixed for RF frequency domain traces.                                                                                                                                                                                                                                           |
| ENCDG ASCII                                                                                                                                                 | This value specifies the encoding of the waveform data. To change this value (the other possibility for RF frequency domain traces is FPBINARY), use the WFMOupre:ENCDg command. This value can also be set using the DATa:ENCDg command.                                                                                                                                  |
| BN_FMT FP                                                                                                                                                   | This value specifies the binary format, which in this case is FP (floating point). This value is fixed for RF frequency domain traces. Note: This field is not applicable for ASCII encoding.                                                                                                                                                                              |
| BYT_OR MSB                                                                                                                                                  | This value specifies the byte order for the BINARY encoding, which in this case is MSB (most significant byte first, also known as IBM format). To change this value to LSB, use the WFMOupre:BYT_Or command. Note: This field is not applicable for ASCII encoding.                                                                                                       |
| WFID "CH1_SV_NORMal, unknown coupling, 10.00W/div, 200.0MHz/div, 1001 points, Sample mode, Center Freq: 2.400GHz, Span: 2.000GHz, Reference Level: 1.000mW" | This quoted string represents information about the source waveform that would be returned by a WFMOupre:WFId? Query. It cannot be changed.                                                                                                                                                                                                                                |
| NR_PT 21                                                                                                                                                    | This value indicates the number of data points in the waveform record. (If you would like to determine only this value, use the WFMOupre:NR_Pt? query.) Note: This value is typically equal to the full record length of the RF frequency domain trace, but you also have the option to transfer only a portion of the record using the DATs:START and DATa:STOP commands. |
| PT_FMT Y                                                                                                                                                    | This value indicates the format of the data points in the waveform record. In this case, the value represents YF (Amplitude vs. Frequency) format. This is query only. (If you would like to determine only this value, use the WFMOupre:PT_Fmt? query.)                                                                                                                   |
| PT_ORDER LINEAR .                                                                                                                                           | This value is always LINear                                                                                                                                                                                                                                                                                                                                                |
| XUNIT "Hz"                                                                                                                                                  | This value indicates the units of the x-axis of the waveform record. This value is always "Hz" for RF frequency domain traces. This is query only. (If you would like to determine only this value, use the WFMOupre:XUNit? query.)                                                                                                                                        |
| XINCR 2.0000E+6                                                                                                                                             | This value indicates the frequency, in hertz, between data points in the waveform record. This is query only. (If you would like to determine only this value, use the WFMOupre:XINcr? query.)                                                                                                                                                                             |
| XZERO 1.4000E+9                                                                                                                                             | This value indicates the frequency, in hertz, of the first data point in the waveform record. This frequency is relative to the time of the trigger, which is always 0. This XZEro frequency can be negative. This is query only. (If you would like to determine only this value, use the WFMOupre:XZEro? query.)                                                         |
| PT_OFF 0                                                                                                                                                    | This is a query provided only for compatibility with other Tektronix instruments. The returned value is always 0. (If you would like to determine only this value, use the WFMOupre:PT_Off? query.)                                                                                                                                                                        |
| YUNIT "W"                                                                                                                                                   | This value indicates the units of data points in the waveform record. This value depends on the vertical units of the source waveform – in this case, watts. This is query only. (If you would like to determine only this value, use the WFMOupre:YUNit? query.)                                                                                                          |
| YMULT 1.5625E-3                                                                                                                                             | This value indicates the multiplying factor to convert the data point values to the units specified by the:WFMOupre:YUNit command. This is query only. (If you would like to determine only this value, use the WFMOupre:YMUlt? query.)                                                                                                                                    |

|                           |                                                                                                                                                                                                                                                                                                                                                                                                                                                    |
|---------------------------|----------------------------------------------------------------------------------------------------------------------------------------------------------------------------------------------------------------------------------------------------------------------------------------------------------------------------------------------------------------------------------------------------------------------------------------------------|
| YOFF 0.0E+0               | This value indicates the vertical position of the source waveform. This value is unused for RF frequency domain traces and is always 0.                                                                                                                                                                                                                                                                                                            |
| YZERO 0.0E+0              | This value indicates the vertical offset of the source waveform. This value is unused for RF frequency domain traces and is always 0.                                                                                                                                                                                                                                                                                                              |
| DOMAIN FREQUENCY          | This value indicates the domain in which the source waveform is displayed and stored. For RF time domain traces, the domain is Time and waveform transfer information is treated as integer information. For RF frequency domain traces, the domain is Frequency and waveform transfer information is treated as floating point information. This is query only. (If you would like to determine only this value, use the WFMOupre:DOMain? query.) |
| WFMTYPE RF_FD             | This value indicates the type of the source waveform. RF_FD indicates an RF frequency domain trace (frequency domain waveform). This is query only. (If you would like to determine only this value, use the WFMOupre:WFMTYPE? query.)                                                                                                                                                                                                             |
| CENTERFREQUENCY 2.4000E+9 | This value indicates the center frequency, in hertz, of the source waveform. This is query only. (If you would like to determine only this value, use the WFMOupre:CENTERFREQuency? query.)                                                                                                                                                                                                                                                        |
| SPAN 2.0000E+9            | This value indicates the frequency span, in hertz, of the source waveform. This is query only. (If you would like to determine only this value, use the WFMOupre:SPAN? query.)                                                                                                                                                                                                                                                                     |
| REFLEVEL 1.0000E-3        | This value indicates the reference level, in watts, of the source waveform. This is query only. (If you would like to determine only this value, use the WFMOupre:REFLEvel? query.)                                                                                                                                                                                                                                                                |

## Example 7: Baseband IQ Waveform

Goal: Transfer Baseband I and Q data from the instrument to a PC.

**NOTE.** Requires SV-RFVT option.

| Command                      | Comment                                                     |
|------------------------------|-------------------------------------------------------------|
| :DATA:SOURce CH1_BASEBAND_IQ |                                                             |
| :DATA:WIDth 2                | Set data width for every I,Q pair to 2.                     |
| :WFMOupre:ENCdg SRIBinary    | Request data LSB first.                                     |
| :WFMOupre:YMUlt?             | Apply 2*YMUlt scaling to I and Q samples returned by CURVe? |

| Command     | Comment                                                                                                                                                                                                                                                                                                                                                                                                                                                                                                                                                                                                                                                                                                                          |
|-------------|----------------------------------------------------------------------------------------------------------------------------------------------------------------------------------------------------------------------------------------------------------------------------------------------------------------------------------------------------------------------------------------------------------------------------------------------------------------------------------------------------------------------------------------------------------------------------------------------------------------------------------------------------------------------------------------------------------------------------------|
| :WFMOUtpre? | <p>Returns the following values. Each value represents the current settings that aCURVe? query will use to format the data that will be transferred from the instrument to a PC or other device:</p> <pre data-bbox="634 373 1458 667">:WFMOUtpre:BYT_NR 1;BIT_NR 8;:WFMOUtpre:ENCDG BINARY;BN_FMT RI;:WFMOUtpre:ASC_FMT INTEGER;BYT_OR MSB;:WFMOUtpre:WFID "CH1_SV_BASEBAND_IQ, 5062 points, Center Freq: 1GHz, Span: 312.5MHz";NR_PT 9;:WFMOUtpre:PT_FMT ENV;PT_ORDER LINEAR;:WFMOUtpre:XUNIT "s";XINCR 1.280E-9;:WFMOUtpre:XZERO 815.000E-12;PT_OFF 0;:WFMOUtpre:YUNIT "V";YMULT 8.0000E-3;:WFMOUtpre:YOFF 0.0E+0;YZERO0.0E+0;:WFMOUtpre:DOMAIN TIME;WFMTYPE F_TD;:WFMOUtpre:CENTERFREQUENCY 1.0000E+9;SPAN 312.5000E+6</pre> |
| :CURVe?     | <p>CURVe? will transmit NR_Pt points which are interleaved I and Q pairs. The result can be read from the binary buffer as uint16 to get I and Q pair values in "digitizing levels". Multiply the digitizing level value by 2*YMULT to get absolute I and Q point values.</p>                                                                                                                                                                                                                                                                                                                                                                                                                                                    |



# Appendix E: Search and Trigger Command Sequence Examples

The following are some example command sequences that show a variety of different searches and triggers. The commands in these sequences are not order-dependent.

To use these examples, connect channel 1, channel 2, channel 3 and channel 4 to the probe compensation signal located on the right hand side of the front panel.

The search and trigger command group sections contain more information on general search and trigger concepts. ,

## Example 1: Single Threshold Edge Search

Goal: Search the channel 2 waveform and place a mark at each instance where it crosses below a threshold of 1.4 volts.

| Command                                         | Comment                                                                                                                                                            |
|-------------------------------------------------|--------------------------------------------------------------------------------------------------------------------------------------------------------------------|
| *RST;:*OPC?                                     | Resets the instrument and waits for that operation to complete (approximately 1 to 5 seconds depending on the complexity of the previous setup).                   |
| display:waveview1:ch2:state 1                   | Turns the CH2 waveform on.                                                                                                                                         |
| :AUTOset EXECute>:*OPC?                         | Autosets the displayed waveform CH2 and waits for the auto setup to complete.                                                                                      |
| SEARCH:SEARCH1:TRIGger:A:TYPE EDGE              | Specifies that this will be an edge search (a mark will be placed when the source waveform passes through a specified threshold level in the specified direction). |
| SEARCH:SEARCH1:TRIGger:A:EDGE:SOURce CH2        | Specifies the CH2 waveform as the source waveform.                                                                                                                 |
| SEARCH:SEARCH1:TRIGger:A:LOWerthreshold:CH2 1.4 | Specifies 1.4 volts as the threshold level.                                                                                                                        |
| SEARCH:SEARCH1:TRIGger:A:EDGE:SLOpe FALL        | Specifies the falling edge as the direction.                                                                                                                       |
| SEARCH:SEARCH1:STATE 1                          | Turns the search on.                                                                                                                                               |
| SEARCH:SEARCH1:TOTal?                           | Returns 4, indicating that CH2 fell below the 1.4 volt threshold 4 times.                                                                                          |

## Example 2: Single Threshold Edge Trigger

Goal: Trigger on the channel 2 waveform when the waveform crosses below a threshold of 1.4 volts.

| Command                        | Comment                                                                          |
|--------------------------------|----------------------------------------------------------------------------------|
| *RST                           | Resets the instrument. Wait for the reset to complete (approximately 3 seconds). |
| :DISPLAY:WAVEVIEW1:CH2:STATE 1 | Turns the CH2 waveform on.                                                       |

| Command                           | Comment                                                                                                                                                          |
|-----------------------------------|------------------------------------------------------------------------------------------------------------------------------------------------------------------|
| :TRIGger:A:TYPE EDGE              | Specifies that this will be an edge trigger (trigger will occur when the source waveform passes through a specified threshold level in the specified direction). |
| :TRIGger:A:EDGE:SOURce CH2        | Specifies the CH2 waveform as the source waveform.                                                                                                               |
| :TRIGger:A:LOWerthreshold:CH2 1.4 | Specifies 1.4 volts as the threshold level.                                                                                                                      |
| :TRIGger:A:EDGE:SLOpe FALL        | Specifies as falling edge as the direction.                                                                                                                      |
| :TRIGger:STATE?                   | Should return TRIGGER, not AUTO.                                                                                                                                 |

### Example 3: Dual Threshold Runt Search

Goal: Search the channel 3 waveform for negative runt pulses and place a mark at each instance when the waveform drops below an upper threshold of 1.4 volts, but does not cross a lower threshold of -2 volts before re-crossing the upper threshold. The pulse width must be less than 600 microseconds.

| Command                                          | Comment                                                                                                                                                                               |
|--------------------------------------------------|---------------------------------------------------------------------------------------------------------------------------------------------------------------------------------------|
| *RST                                             | Resets the instrument. Wait for the reset to complete (approximately 3 seconds).                                                                                                      |
| :DISPLAY:WAVEVIEW1:CH3:STATE 1                   | Turns the CH3 waveform on.                                                                                                                                                            |
| :AUTOset EXECute                                 | Autosets the displayed waveform CH3. Wait for the autoset to complete (approximately 3 seconds).                                                                                      |
| SEARCH:SEARCH1:TRIGger:A:TYPE RUNT               | Specifies that this will be a runt search (a mark will be placed on a pulse amplitude that crosses one threshold but fails to cross a second threshold before re-crossing the first). |
| SEARCH:SEARCH1:TRIGger:A:EDGE:SOURce CH3         | Specifies to use channel 3 as the source waveform.                                                                                                                                    |
| SEARCH:SEARCH1:TRIGger:A:LOWerthreshold:CH3 -2   | Specifies to use -2 volts as the lower threshold.                                                                                                                                     |
| SEARCH:SEARCH1:TRIGger:A:UPPerthreshold: CH3 1.4 | Specifies to use 1.4 volts as the upper threshold.                                                                                                                                    |
| SEARCH:SEARCH1:TRIGger:A:RUNT:POLarity NEGative  | Specifies to search for when the runt polarity is negative.                                                                                                                           |
| SEARCH:SEARCH1:TRIGger:A:RUNT:WIDTH 600E-6       | Specifies a pulse width of 600E-6 seconds.                                                                                                                                            |
| SEARCH:SEARCH1:TRIGger:A:RUNT:WHEn LESSthan      | Specifies to search for when the pulse width is less than 600E-6 seconds.                                                                                                             |
| SEARCH:SEARCH1:STATE 1                           | Turns the search on.                                                                                                                                                                  |
| SEARCH:SEARCH1:TOTal?                            | Returns 3, indicating that 3 total negative runt pulses were less than 600E-6 seconds wide                                                                                            |

**NOTE.** You could use a similar command sequence with a transition type search.

## Example 4: Single Threshold Logic Search on Three Waveforms

Goal: Search the channel 1, 2 and 3 waveforms and place a mark at each instance when either channel 1 is above 1.4 volts, channel 2 is above 1.5 volts, or channel 3 is above 1.3 volts.

| Command                                          | Comment                                                                                                                                                                                                                                                                                               |
|--------------------------------------------------|-------------------------------------------------------------------------------------------------------------------------------------------------------------------------------------------------------------------------------------------------------------------------------------------------------|
| *RST                                             | Resets the instrument. Wait for the reset to complete (approximately 3 seconds).                                                                                                                                                                                                                      |
| :DISPLAY:WAVEVIEW1:CH1:STATE 1                   | Turns the CH1 waveform on.                                                                                                                                                                                                                                                                            |
| :DISPLAY:WAVEVIEW1:CH2:STATE 1                   | Turns the CH2 waveform on.                                                                                                                                                                                                                                                                            |
| :DISPLAY:WAVEVIEW1:CH3:STATE 1                   | Turns the CH3 waveform on.                                                                                                                                                                                                                                                                            |
| :AUTOset EXECute                                 | Autosets the displayed waveforms CH1, CH2 and CH3. Wait for the autose to complete (approximately 3 seconds).                                                                                                                                                                                         |
| SEARCH:SEARCH1:TRIGger:A:TYPE LOGic              | Specifies that this will be a logic search (a mark will be placed when all channels transition to the specified state).                                                                                                                                                                               |
| SEARCH:SEARCH1:TRIGger:A:LOGic:INPut:CH1 HIGH    | Specifies the Boolean logic criteria for channel 1; in this case, high.                                                                                                                                                                                                                               |
| SEARCH:SEARCH1:TRIGger:A:LOGic:INPut:CH2 HIGH    | Specifies the Boolean logic criteria for channel 2; in this case, high.                                                                                                                                                                                                                               |
| SEARCH:SEARCH1:TRIGger:A:LOGic:INPut:CH3 HIGH    | Specifies the Boolean logic criteria for channel 3; in this case, high.                                                                                                                                                                                                                               |
| SEARCH:SEARCH1:TRIGger:A:LOGic:THReshold:CH1 1.4 | Specifies to use 1.4 volts as the threshold for CH1.                                                                                                                                                                                                                                                  |
| SEARCH:SEARCH1:TRIGger:A:LOGic:THReshold:CH2 1.5 | Specifies to use 1.5 volts as the threshold for CH2.                                                                                                                                                                                                                                                  |
| SEARCH:SEARCH1:TRIGger:A:LOGic:THReshold:CH3 1.3 | Specifies to use 1.3 volts as the threshold for CH3.                                                                                                                                                                                                                                                  |
| SEARCH:SEARCH1:TRIGger:A:LOGic:PATtern:WHEn TRUE | Specifies the condition for generating a logic pattern search; in this case, true.                                                                                                                                                                                                                    |
| SEARCH:SEARCH1:TRIGger:A:LOGic:FUNCTION OR       | Specifies the logic operator for the logic search; in this case, OR.                                                                                                                                                                                                                                  |
| SEARCH:SEARCH1:STATE 1                           | Turns the search on.                                                                                                                                                                                                                                                                                  |
| SEARCH:SEARCH1:TOTal?                            | Returns 3 or 4, indicating 3 or 4 times when one of channels 1, 2 or 3 became high.<br><br>Note: Depending upon the number of transitions displayed, you may get 3 or 4 search marks for this example. If you get 3 search marks, try adjusting the horizontal position until you see 4 search marks. |





---

# Appendix F: Remote Scope Command Examples

## Acquire single acquisition

Add Scope1 and connect to Scope1  
Add Period and TIE measurements on s1\_ch1  
Add Eye Diagram plot  
Acquire Channel - Single acquisition  
Generate report  
Disconnect and Delete Scope1

**Socket** :REMOTE:COMMInter Socket  
:Remote:addnew SCOPE1  
:REMOTE:SCOPE1:IPADDRESS "ScopeIP"

**VISA - Network** :REMOTE:COMMInter Visa  
:Remote:addnew SCOPE1  
:REMOTE:SCOPE1:VISACONNECTIONTYPE Network  
:REMOTE:SCOPE1:IPADDRESS "ScopeIP"

**VISA - USB** :REMOTE:COMMInter Visa  
:Remote:addnew SCOPE1  
:REMOTE:SCOPE1:VISACONNECTIONTYPE USB  
:REMOTE:USBDESCRIPTORS usb0

**Additional Commands** :REMOTE:SCOPE1:CONNECT 1  
:MEASUREMENT:ADDMEAS PERIOD  
:MEASUREMENT:ADDMEAS TIE  
:MEASUREMENT:MEAS1:SOURCE S1\_Ch1  
:MEASUREMENT:MEAS2:SOURCE S1\_Ch1  
:PLOT:PLOT1:SOURCE "Meas2"  
:PLOT:PLOT1:TYPE EYEDIAGRAM  
:REMOTE:ACQUIRE 1  
:SAVE:REPORT "D:/Report.pdf"  
:REMOTE:SCOPE1:DISCONNECT  
:Remote:delete "scope1"

## Save Remote channel to ref

Add Scope1 and connect to Scope1 Save S1\_ch1 as Ref1 Recall Ref1 Add Period and TIE measurements on recalled Ref1 Add Eye Diagram plot Generate report Disconnect and Delete Scope1

**Socket** :REMOTE:COMMInter Socket  
 :Remote:addnew SCOPE1  
 :REMOTE:SCOPE1:IPADDRESS "ScopeIP"

**VISA - Network** :REMOTE:COMMInter Visa  
 :Remote:addnew SCOPE1  
 :REMOTE:SCOPE1:VISACONNECTIONtype Network  
 :REMOTE:SCOPE1:IPADDRESS "ScopeIP"

**VISA - USB** :REMOTE:COMMInter Visa  
 :Remote:addnew SCOPE1  
 :REMOTE:SCOPE1:VISACONNECTIONtype USB  
 :REMOTE:USBDESCRIPTORS usb0

**Additional Commands** :REMOTE:SCOPE1:CONNECT 1  
 :FILESYSTEM:CWD?  
 :SAVE:WAVEFORM s1\_ch1, "Tek\_S1\_ch1.wfm"  
 :REF:ADDNEW "Ref1"  
 :RECALL:WAVEFORM "Tek\_S1\_ch1.wfm", Ref1  
 :MEASUREMENT:ADDMEAS PERIOD  
 :MEASUREMENT:ADDMEAS TIE  
 :MEASUREMENT:MEAS1:SOURCE Ref1  
 :MEASUREMENT:MEAS2:SOURCE Ref1  
 :PLOT:PLOT1:SOURCE "Meas2"  
 :PLOT:PLOT1:TYPE EYEDIAGRAM  
 :SAVE:REPORT "D:/Report.pdf"  
 :REMOTE:SCOPE1:DISCONNECT

```
:Remote:delete "scope1"
```

## Continuous Acquisition

Add Scope1 and connect to Scope1 Add Period and TIE measurements on s1\_ch1  
 Add Eye Diagram plot Set the Acq Method to Continuous Start/Stop Continuous  
 Acquisition Generate report Disconnect and Delete Scope1

```
Socket :REMOTE:COMMInter Socket
:Remote:addnew SCOPE1
:REMOTE:SCOPE1:IPADDRESS "ScopeIP"
```

```
VISA - Network :REMOTE:COMMInter Visa
:Remote:addnew SCOPE1
:REMOTE:SCOPE1:VISACONNECTIONTYPE Network
:REMOTE:SCOPE1:IPADDRESS "ScopeIP"
```

```
VISA - USB :REMOTE:COMMInter Visa
:Remote:addnew SCOPE1
:REMOTE:SCOPE1:VISACONNECTIONTYPE USB
:REMOTE:USBDESCRIPTORS usb0
```

```
Additional Commands :REMOTE:SCOPE1:CONNECT 1
:MEASUREMENT:ADDMEAS PERIOD
:MEASUREMENT:ADDMEAS TIE
:MEASUREMENT:MEAS1:SOURCE S1_Ch1
:MEASUREMENT:MEAS2:SOURCE S1_Ch1
:PLOT:PLOT1:SOURCE "Meas2"
:PLOT:PLOT1:TYPE EYEDIAGRAM
:REMOTE:ACQMETHOD CONTINUOUS
:REMOTE:RUNSTOP RUN
:REMOTE:RUNSTOP Stop
:SAVE:REPORT "D:/Report.pdf"
```

```
:REMOTE:SCOPE1:Disconnect
:Remote:delete "scope1"
```

## Act on Timer event (DataLogging)

Add Scope1 and connect to Scope1 Add Period and TIE measurements on s1\_ch1  
 Add Eye Diagram plot Enable Save Image, Save measurement results and Save  
 Waveform Act on timer event option Set the Timer interval and timer count Start  
 Data logging Disconnect and Delete Scope1

**Socket** :REMOTE:COMMInter Socket  
 :Remote:addnew SCOPE1 :  
 REMOTE:SCOPE1:IPADDRESS "ScopeIP"

**VISA - Network** :REMOTE:COMMInter Visa  
 :Remote:addnew SCOPE1  
 :REMOTE:SCOPE1:VISACONNECTIONTYPE Network  
 :REMOTE:SCOPE1:IPADDRESS "ScopeIP"

**VISA - USB** :REMOTE:COMMInter Visa  
 :Remote:addnew SCOPE1  
 :REMOTE:SCOPE1:VISACONNECTIONTYPE USB  
 :REMOTE:USBDESCRIPTORS usb0

**Additional Commands** :REMOTE:SCOPE1:CONNECT 1  
 :MEASUREMENT:ADDMEAS PERIOD  
 :MEASUREMENT:ADDMEAS TIE  
 :MEASUREMENT:MEAS1:SOURCE S1\_Ch1  
 :MEASUREMENT:MEAS2:SOURCE S1\_Ch1  
 :PLOT:PLOT1:SOURCE "Meas2"  
 :PLOT:PLOT1:TYPE EYEDIAGRAM  
 :ACTONEVENT:TIMER:ACTION:SAVEIMAGE:STATE 1  
 :ACTONEVENT:TIMER:ACTION:SAVEMWAVEFORM:STATE 1  
 :ACTONEVENT:TIMER:ACTION:SAVETABLE:STATE 1

```
:ACTONEVent:TIMERInterval 10
:ACTONEVent:TIMERCOUNT 2
:REMOTE:LOGGING Start
:REMOTE:SCOPE1:Disconnect
:Remote:delete "scope1"
```

## Waveform Transfer

Query remote source waveform data.

**Socket** :REMOTE:COMMInter Socket  
:Remote:addnew SCOPE1  
:REMOTE:SCOPE1:IPADDRESS "ScopeIP"

**VISA - Network** :REMOTE:COMMInter Visa  
:Remote:addnew SCOPE1  
:REMOTE:SCOPE1:VISACONNECTIONtype Network  
:REMOTE:SCOPE1:IPADDRESS "ScopeIP"

**VISA - USB** :REMOTE:COMMInter Visa  
:Remote:addnew SCOPE1  
:REMOTE:SCOPE1:VISACONNECTIONtype USB  
:REMOTE:USBDESCRIPTORS usb0

**Additional Commands** :REMOTE:SCOPE1:CONNECT 1  
:DATA:SOURCE S1\_CH1 :DATA:START 1  
:DATA:STOP 10000  
:WFMPRE:ENCODING BINARY  
:WFMPRE:BYTES 2  
:HEADER 1  
:WFMPRE?  
:CURVE?



---

# Glossary

## **ASCII**

Acronym for the American Standard Code for Information Interchange. Controllers transmit commands to the instrument using ASCII character encoding.

## **Address**

A 7-bit code that identifies an instrument on the communication bus. The digitizing instrument must have a unique address for the controller to recognize and transmit commands to it.

## **Backus-Naur Form (BNF)**

A standard notation system for command syntax diagrams. The syntax diagrams in this manual use BNF notation.

## **Controller**

A computer or other device that sends commands to and accepts responses from the digitizing instrument.

## **EOI**

A mnemonic referring to the control line End or Identify. One of the two possible end-of-message terminators.

## **EOM**

A generic acronym referring to the end-of-message terminator. The end-of-message terminator can be either an EOI or the ASCII code for line feed (LF).

## **Equivalent-Time sampling (ET)**

A sampling mode in which the instrument acquires signals over many repetitions of the event. This instrument uses a type of equivalent time sampling called random equivalent time sampling. It utilizes an internal clock that runs asynchronously with respect to the input signal and the signal trigger. The instrument takes samples continuously, independent of the trigger position, and displays them based on the time difference between the sample and the trigger. Although the samples are taken sequentially in time, they are random with respect to the trigger.

## **Real-Time sampling**

A sampling mode where the instrument samples fast enough to completely fill a waveform record from a single trigger event. Use real-time sampling to capture single-shot or transient events.

## **IEEE**

An acronym for the Institute for Electrical and Electronic Engineers.

## **Serial poll**

A device on the bus can request service from the Controller by asserting the SRQ line. When a controller acknowledges the SRQ, it serial polls each device on the bus to determine which device on the bus requested service. Any device requesting service returns a status byte indicating it needs to be serviced and then

unasserts the SRQ line. Devices not requiring service return a status byte that indicates they do not need servicing.

**TEKSecure**

A Tektronix custom command that initializes both waveform and setup memories. This overwrites any previously stored data.



# Index

## A

ACTONEVnt:ENable, 2-137  
ACTONEVnt:NUMSAVES?, 2-137  
ACTONEVnt:TIMER:ACTION:SAVEIMAGE:  
STATE, 2-137  
ACTONEVnt:TIMER:ACTION:SAVETable:  
STATE, 2-138  
ACTONEVnt:TIMER:ACTION:SAVEWAVEform:  
STATE, 2-139  
ACTONEVnt:TIMERCount, 2-139  
ACTONEVnt:TIMERInterval, 2-140  
ACTONEVnt:Type?, 2-140  
ALias, 2-141  
ALias:CATalog?, 2-141  
ALias:DEFine, 2-141  
ALias:DELEte, 2-142  
ALias:DELEte:ALL, 2-143  
ALias:DELEte:NAME, 2-143  
ALias:STATE, 2-144  
ALLEv?, 2-144  
AUTOSAVEPITIMEOUT, 2-145  
AUTOSAVEUITIMEOUT, 2-145

## B

BUS:ADDNew, 2-145  
BUS:B<x>:ARINC429A:BITRate, 2-146  
BUS:B<x>:ARINC429A:BITRate:CUSTom, 2-147  
BUS:B<x>:ARINC429A:DATAFORmat, 2-147  
BUS:B<x>:ARINC429A:POLARITY, 2-148  
BUS:B<x>:ARINC429A:SOURce, 2-148  
BUS:B<x>:ARINC429A:THRESHold, 2-149  
BUS:B<x>:AUDio:BITDelay, 2-150  
BUS:B<x>:AUDio:BITOrder, 2-150  
BUS:B<x>:AUDio:CLOCK:POLarity, 2-151  
BUS:B<x>:AUDio:CLOCK:SOURce, 2-151  
BUS:B<x>:AUDio:CLOCK:THRESHold, 2-152  
BUS:B<x>:AUDio:DATA:POLarity, 2-153  
BUS:B<x>:AUDio:DATA:SIZE, 2-153  
BUS:B<x>:AUDio:DATA:SOURce, 2-154  
BUS:B<x>:AUDio:DATA:THRESHold, 2-155  
BUS:B<x>:AUDio:DATA:WORDSize, 2-156  
BUS:B<x>:AUDio:FRAME:  
CLOCKBITSPERCHANNEL, 2-156

BUS:B<x>:AUDio:FRAME:SIZE, 2-157  
BUS:B<x>:AUDio:TYPE, 2-157  
BUS:B<x>:AUDio:WORDSel:POLarity, 2-158  
BUS:B<x>:AUDio:WORDSel:SOURce, 2-158  
BUS:B<x>:AUDio:WORDSel:THRESHold, 2-159  
BUS:B<x>:AUTOETHERnet:  
DATAMINUSTHRESHOLD, 2-160  
BUS:B<x>:AUTOETHERnet:  
DATAPLUSTHRESHold, 2-161  
BUS:B<x>:AUTOETHERnet:  
LOWDATAMINus, 2-161  
BUS:B<x>:AUTOETHERnet:  
LOWDATAPLUS, 2-162  
BUS:B<x>:AUTOETHERnet:  
LOWTHRESHold, 2-163  
BUS:B<x>:AUTOETHERnet:SIGNALTYpe, 2-163  
BUS:B<x>:AUTOETHERnet:SOURce, 2-164  
BUS:B<x>:AUTOETHERnet:SOURce:  
DMINus, 2-165  
BUS:B<x>:AUTOETHERnet:SOURce:DPLUs, 2-165  
BUS:B<x>:AUTOETHERnet:THRESHold, 2-166  
BUS:B<x>:AUTOETHERnet:TYPE, 2-167  
BUS:B<x>:CAN:BITRate, 2-167  
BUS:B<x>:CAN:BITRate:VALue, 2-168  
BUS:B<x>:CAN:FD:BITRate, 2-169  
BUS:B<x>:CAN:FD:BITRate:CUSTom, 2-169  
BUS:B<x>:CAN:SAMPLEpoint, 2-170  
BUS:B<x>:CAN:SIGNal, 2-170  
BUS:B<x>:CAN:SOURce, 2-171  
BUS:B<x>:CAN:STANDard, 2-172  
BUS:B<x>:CAN:THRESHold, 2-172  
BUS:B<x>:CPHY:A:DATA:THRESHold, 2-173  
BUS:B<x>:CPHY:A:LP:THRESHold, 2-173  
BUS:B<x>:CPHY:A:SOURce, 2-174  
BUS:B<x>:CPHY:AB:SOURce, 2-175  
BUS:B<x>:CPHY:AB:THRESHold, 2-175  
BUS:B<x>:CPHY:AGND:SOURce, 2-176  
BUS:B<x>:CPHY:AGND:THRESHold, 2-176  
BUS:B<x>:CPHY:B:DATA:THRESHold, 2-177  
BUS:B<x>:CPHY:B:SOURce, 2-178  
BUS:B<x>:CPHY:BC:SOURce, 2-178  
BUS:B<x>:CPHY:BC:THRESHold, 2-179  
BUS:B<x>:CPHY:BITRate, 2-179  
BUS:B<x>:CPHY:C:DATA:THRESHold, 2-180

- BUS:B<x>:CPHY:C:LP:THRESHold, 2-180
- BUS:B<x>:CPHY:C:SOUrce, 2-181
- BUS:B<x>:CPHY:CA:SOUrce, 2-182
- BUS:B<x>:CPHY:CA:THReshold, 2-182
- BUS:B<x>:CPHY:CGND:SOUrce, 2-183
- BUS:B<x>:CPHY:CGND:THReshold, 2-184
- BUS:B<x>:CPHY:LP:DIRectiOn, 2-184
- BUS:B<x>:CPHY:SIGNALTYpe, 2-185
- BUS:B<x>:CPHY:SUBTYPe, 2-185
- BUS:B<x>:CXPI:BITRate, 2-186
- BUS:B<x>:CXPI:REC:THReshold, 2-186
- BUS:B<x>:CXPI:SOUrce, 2-187
- BUS:B<x>:DISPlay:FORMat, 2-188
- BUS:B<x>:DISPlay:LAYout, 2-188
- BUS:B<x>:DPHY:CLOCK:SOUrce, 2-189
- BUS:B<x>:DPHY:CLOCK:THRESHold, 2-190
- BUS:B<x>:DPHY:DMINus:
  - DATATHRESHold, 2-190
- BUS:B<x>:DPHY:DMINus:LPTHRESHold, 2-191
- BUS:B<x>:DPHY:DMINus:SOUrce, 2-191
- BUS:B<x>:DPHY:DPlus:DATATHRESHold, 2-192
- BUS:B<x>:DPHY:DPlus:LPTHRESHold, 2-193
- BUS:B<x>:DPHY:DPlus:SOUrce, 2-193
- BUS:B<x>:DPHY:LP:DIRectiOn, 2-194
- BUS:B<x>:DPHY:PROToCol:TYPe, 2-195
- BUS:B<x>:DPHY:SIGNAL:ENCoding, 2-195
- BUS:B<x>:ESPI:ALERt:POLarity, 2-196
- BUS:B<x>:ESPI:ALERt:SOUrce, 2-196
- BUS:B<x>:ESPI:ALERt:THReshold, 2-197
- BUS:B<x>:ESPI:ALERTVIEW, 2-197
- BUS:B<x>:ESPI:CHIPSElect:POLarity, 2-198
- BUS:B<x>:ESPI:CHIPSElect:SOUrce, 2-198
- BUS:B<x>:ESPI:CHIPSElect:THReshold, 2-199
- BUS:B<x>:ESPI:CLOCK:POLarity, 2-200
- BUS:B<x>:ESPI:CLOCK:SOUrce, 2-200
- BUS:B<x>:ESPI:CLOCK:THReshold, 2-201
- BUS:B<x>:ESPI:DATAONE:POLarity, 2-201
- BUS:B<x>:ESPI:DATAONE:SOUrce, 2-202
- BUS:B<x>:ESPI:DATAONE:THReshold, 2-202
- BUS:B<x>:ESPI:DATATWO:POLarity, 2-203
- BUS:B<x>:ESPI:DATATWO:SOUrce, 2-203
- BUS:B<x>:ESPI:DATATWO:THReshold, 2-204
- BUS:B<x>:ESPI:IOMODE, 2-205
- BUS:B<x>:ETHERCAT:
  - DATAMINUSTHRESHold, 2-205
- BUS:B<x>:ETHERCAT:
  - DATAPLUSTHRESHold, 2-206
- BUS:B<x>:ETHERCAT:SIGNALTYpe, 2-206
- BUS:B<x>:ETHERCAT:SOUrce:DIFF, 2-207
- BUS:B<x>:ETHERCAT:SOUrce:DMINus, 2-208
- BUS:B<x>:ETHERCAT:SOUrce:DPLUs, 2-208
- BUS:B<x>:ETHERCAT:THRESHold, 2-209
- BUS:B<x>:ETHERnet:
  - DATAMINUSTHRESHold, 2-210
- BUS:B<x>:ETHERnet:
  - DATAPLUSTHRESHold, 2-210
- BUS:B<x>:ETHERnet:IPVFOUR, 2-211
- BUS:B<x>:ETHERnet:LOWTHRESHold, 2-212
- BUS:B<x>:ETHERnet:QTAGGING, 2-212
- BUS:B<x>:ETHERnet:SIGNALTYpe, 2-213
- BUS:B<x>:ETHERnet:SOUrce, 2-213
- BUS:B<x>:ETHERnet:SOUrce:DMINus, 2-214
- BUS:B<x>:ETHERnet:SOUrce:DPLUs, 2-215
- BUS:B<x>:ETHERnet:THRESHold, 2-215
- BUS:B<x>:ETHERnet:TYPe, 2-216
- BUS:B<x>:EUSB:BITRate, 2-217
- BUS:B<x>:EUSB:DATAMINUS:DATA:
  - THRESHold, 2-217
- BUS:B<x>:EUSB:DATAMINUSTHRESHold, 2-218
- BUS:B<x>:EUSB:DATAPLUS:DATA:
  - THRESHold, 2-218
- BUS:B<x>:EUSB:DATAPLUSTHRESHold, 2-219
- BUS:B<x>:EUSB:LOWTHRESHold, 2-220
- BUS:B<x>:EUSB:OPERating:MODE, 2-220
- BUS:B<x>:EUSB:SIGNALTYpe, 2-221
- BUS:B<x>:EUSB:SOUrce:DIFF, 2-221
- BUS:B<x>:EUSB:SOUrce:DMINus, 2-222
- BUS:B<x>:EUSB:SOUrce:DPLUs, 2-223
- BUS:B<x>:EUSB:THRESHold, 2-223
- BUS:B<x>:FLEXray:BITRate, 2-224
- BUS:B<x>:FLEXray:BITRate:CUSTom, 2-224
- BUS:B<x>:FLEXray:CHannel, 2-225
- BUS:B<x>:FLEXray:LOWTHRESHold, 2-225
- BUS:B<x>:FLEXray:SIGNAL, 2-226
- BUS:B<x>:FLEXray:SOUrce, 2-227
- BUS:B<x>:FLEXray:SOUrce:TXRX, 2-227
- BUS:B<x>:FLEXray:THRESHold, 2-228
- BUS:B<x>:FLEXray:TXRXTHRESHold, 2-229
- BUS:B<x>:I2C:CLOCK:SOUrce, 2-229
- BUS:B<x>:I2C:CLOCK:THReshold, 2-230
- BUS:B<x>:I2C:DATA:SOUrce, 2-231
- BUS:B<x>:I2C:DATA:THReshold, 2-231
- BUS:B<x>:I2C:RWINADDR, 2-232
- BUS:B<x>:I3C:CLOCK:SOUrce, 2-233

- BUS:B<x>:I3C:CLOCK:THRESHold, 2-233
- BUS:B<x>:I3C:DATA:SOURce, 2-234
- BUS:B<x>:I3C:DATA:THRESHold, 2-235
- BUS:B<x>:LABEL:COLor, 2-235
- BUS:B<x>:LABEL:FONT:BOLD, 2-236
- BUS:B<x>:LABEL:FONT:ITALic, 2-237
- BUS:B<x>:LABEL:FONT:SIZE, 2-237
- BUS:B<x>:LABEL:FONT:TYPE, 2-238
- BUS:B<x>:LABEL:FONT:UNDERline, 2-238
- BUS:B<x>:LABEL:name, 2-239
- BUS:B<x>:LABEL:XPOS, 2-239
- BUS:B<x>:LABEL:YPOS, 2-240
- BUS:B<x>:LIN:BITRate, 2-240
- BUS:B<x>:LIN:BITRate:CUSTom, 2-241
- BUS:B<x>:LIN:IDFORmat, 2-241
- BUS:B<x>:LIN:POLarity, 2-242
- BUS:B<x>:LIN:SAMPLEpoint, 2-242
- BUS:B<x>:LIN:SOURce, 2-243
- BUS:B<x>:LIN:SOURce:THRESHold, 2-244
- BUS:B<x>:LIN:STANDard, 2-244
- BUS:B<x>:MANChester:BITORDER, 2-245
- BUS:B<x>:MANChester:BITRate, 2-245
- BUS:B<x>:MANChester:DISplaymode, 2-246
- BUS:B<x>:MANChester:HEADer:LENGth, 2-246
- BUS:B<x>:MANChester:IDLE:BITS, 2-247
- BUS:B<x>:MANChester:parity, 2-248
- BUS:B<x>:MANChester:SOURce, 2-248
- BUS:B<x>:MANChester:START:INDex, 2-249
- BUS:B<x>:MANChester:SYNC:SIZE, 2-249
- BUS:B<x>:MANChester:THRESHold, 2-250
- BUS:B<x>:MANChester:TOLerance, 2-251
- BUS:B<x>:MANChester:TRAILer:LENGth, 2-251
- BUS:B<x>:MANChester:TRANStion:ZERo, 2-252
- BUS:B<x>:MANChester:WORD:COUNT, 2-252
- BUS:B<x>:MANChester:WORDSIZE, 2-253
- BUS:B<x>:MDIO:CLOCK:SOURce, 2-254
- BUS:B<x>:MDIO:CLOCK:THRESHold, 2-254
- BUS:B<x>:MDIO:DATA:SOURce, 2-255
- BUS:B<x>:MDIO:DATA:THRESHold, 2-255
- BUS:B<x>:MIL1553B:LOWTHRESHold, 2-256
- BUS:B<x>:MIL1553B:POLarity, 2-257
- BUS:B<x>:MIL1553B:RESPonsetime:
  - MAXimum, 2-257
- BUS:B<x>:MIL1553B:RESPonsetime:
  - MINimum, 2-258
- BUS:B<x>:MIL1553B:SOURce, 2-259
- BUS:B<x>:MIL1553B:THRESHold, 2-259
- BUS:B<x>:NRZ:BITOrder, 2-260
- BUS:B<x>:NRZ:BITRate, 2-261
- BUS:B<x>:NRZ:POLarity, 2-261
- BUS:B<x>:NRZ:SOURce, 2-262
- BUS:B<x>:NRZ:SPMI:VERsion, 2-262
- BUS:B<x>:NRZ:THRESHold, 2-263
- BUS:B<x>:ONEWIRE:DATA:SOURce, 2-264
- BUS:B<x>:ONEWIRE:DATA:THRESHold, 2-264
- BUS:B<x>:ONEWIRE:MODE, 2-265
- BUS:B<x>:PARAllel:ALLTHRESHolds, 2-266
- BUS:B<x>:PARAllel:ALLTHRESHolds:APPLY, 2-266
- BUS:B<x>:PARAllel:BIT<n>SOURce, 2-267
- BUS:B<x>:PARAllel:BIT<n>SOURce:
  - THRESHold, 2-267
- BUS:B<x>:PARAllel:CLOCK:EDGE, 2-268
- BUS:B<x>:PARAllel:CLOCK:ISCLOCKED, 2-269
- BUS:B<x>:PARAllel:CLOCK:SOURce, 2-269
- BUS:B<x>:PARAllel:CLOCK:SOURce:
  - THRESHold, 2-270
- BUS:B<x>:PSIFIVE:BITPERiod, 2-271
- BUS:B<x>:PSIFIVE:BITRate, 2-271
- BUS:B<x>:PSIFIVE:COMM:DIRection, 2-272
- BUS:B<x>:PSIFIVE:DATAA, 2-272
- BUS:B<x>:PSIFIVE:DATAB, 2-273
- BUS:B<x>:PSIFIVE:DATAFORMAt, 2-273
- BUS:B<x>:PSIFIVE:ECUSOURce, 2-274
- BUS:B<x>:PSIFIVE:FRAMECONTrol, 2-274
- BUS:B<x>:PSIFIVE:MESSAging, 2-275
- BUS:B<x>:PSIFIVE:SOURce, 2-275
- BUS:B<x>:PSIFIVE:STATus, 2-276
- BUS:B<x>:PSIFIVE:SYNCMODE, 2-277
- BUS:B<x>:PSIFIVE:SYNCTHRESHold, 2-277
- BUS:B<x>:PSIFIVE:THRESHold, 2-278
- BUS:B<x>:RS232C:BITRate, 2-278
- BUS:B<x>:RS232C:BITRate:CUSTom, 2-279
- BUS:B<x>:RS232C:DATABits, 2-279
- BUS:B<x>:RS232C:DELIMiter, 2-280
- BUS:B<x>:RS232C:DISplaymode, 2-281
- BUS:B<x>:RS232C:PARity, 2-281
- BUS:B<x>:RS232C:POLarity, 2-282
- BUS:B<x>:RS232C:SOURce, 2-283
- BUS:B<x>:RS232C:SOURce:THRESHold, 2-283
- BUS:B<x>:S8B10B:BITRate, 2-284
- BUS:B<x>:S8B10B:SOURce, 2-284
- BUS:B<x>:S8B10B:THRESHold, 2-285
- BUS:B<x>:SDLC:BITRate, 2-286
- BUS:B<x>:SDLC:DATA:SOURce, 2-286

BUS:B<x>:SDLC:DATA:THReshold, 2-287  
 BUS:B<x>:SDLC:ENCoding, 2-287  
 BUS:B<x>:SDLC:MODulo, 2-288  
 BUS:B<x>:SENT:CHANWidth, 2-288  
 BUS:B<x>:SENT:NIBBLECount, 2-289  
 BUS:B<x>:SENT:NUMCHANnel, 2-290  
 BUS:B<x>:SENT:PAUSEPULSe, 2-290  
 BUS:B<x>:SENT:POLARITY, 2-291  
 BUS:B<x>:SENT:SLOW, 2-291  
 BUS:B<x>:SENT:SOUrce, 2-292  
 BUS:B<x>:SENT:THRESHold, 2-293  
 BUS:B<x>:SENT:TICKTIME, 2-293  
 BUS:B<x>:SENT:TICKTOlerance, 2-294  
 BUS:B<x>:SMBUS:CLOCK:SOUrce, 2-294  
 BUS:B<x>:SMBUS:CLOCK:THReshold, 2-295  
 BUS:B<x>:SMBUS:DATA:SOUrce, 2-296  
 BUS:B<x>:SMBUS:DATA:THReshold, 2-296  
 BUS:B<x>:SMBUS:PEC:VALUe, 2-297  
 BUS:B<x>:SPACEWIRE:BITRate, 2-298  
 BUS:B<x>:SPACEWIRE:DATA:SOUrce, 2-298  
 BUS:B<x>:SPACEWIRE:DATA:THReshold, 2-299  
 BUS:B<x>:SPACEWIRE:DECode:TYPe, 2-300  
 BUS:B<x>:SPACEWIRE:STRobe:SOUrce, 2-300  
 BUS:B<x>:SPACEWIRE:STRobe:THReshold, 2-301  
 BUS:B<x>:SPACEWIRE:SYNC, 2-302  
 BUS:B<x>:SPACEWIRE:SYNC:COUnt, 2-302  
 BUS:B<x>:SPACEWIRE:SYNC:PATtern, 2-303  
 BUS:B<x>:SPACEWIRE:SYNC:VALUe, 2-303  
 BUS:B<x>:SPI:BITOrder, 2-304  
 BUS:B<x>:SPI:CLOCK:POLarity, 2-304  
 BUS:B<x>:SPI:CLOCK:SOUrce, 2-305  
 BUS:B<x>:SPI:CLOCK:THReshold, 2-306  
 BUS:B<x>:SPI:DATA:POLarity, 2-306  
 BUS:B<x>:SPI:DATA:SIZE, 2-307  
 BUS:B<x>:SPI:DATA:SOUrce, 2-308  
 BUS:B<x>:SPI:DATA:THReshold, 2-308  
 BUS:B<x>:SPI:FRAMING, 2-309  
 BUS:B<x>:SPI:IDLETime, 2-309  
 BUS:B<x>:SPI:MISo:DATA:POLarity, 2-310  
 BUS:B<x>:SPI:MISo:INPut, 2-311  
 BUS:B<x>:SPI:MISo:THReshold, 2-311  
 BUS:B<x>:SPI:MOSi:DATA:POLarity, 2-312  
 BUS:B<x>:SPI:MOSi:INPut, 2-312  
 BUS:B<x>:SPI:MOSi:THReshold, 2-313  
 BUS:B<x>:SPI:NUMBER:INputs, 2-314  
 BUS:B<x>:SPI:SElect:POLarity, 2-314  
 BUS:B<x>:SPI:SElect:SOUrce, 2-315

BUS:B<x>:SPI:SElect:THReshold, 2-316  
 BUS:B<x>:SPMI:SCLk:SOUrce, 2-316  
 BUS:B<x>:SPMI:SCLk:THReshold, 2-317  
 BUS:B<x>:SPMI:SDATA:SOUrce, 2-318  
 BUS:B<x>:SPMI:SDATA:THReshold, 2-318  
 BUS:B<x>:SVID:ALERT:SOUrce, 2-319  
 BUS:B<x>:SVID:ALERT:THReshold, 2-320  
 BUS:B<x>:SVID:CLOCK:SOUrce, 2-320  
 BUS:B<x>:SVID:CLOCK:THReshold, 2-321  
 BUS:B<x>:SVID:DATA:SOUrce, 2-321  
 BUS:B<x>:SVID:DATA:THReshold, 2-322  
 BUS:B<x>:TYPe, 2-323  
 BUS:B<x>:USB:BITRate, 2-324  
 BUS:B<x>:USB:DATAMINUSTHRESHold, 2-324  
 BUS:B<x>:USB:DATAPLUSTHRESHold, 2-325  
 BUS:B<x>:USB:LOWTHRESHold, 2-325  
 BUS:B<x>:USB:SIGNALTYpe, 2-326  
 BUS:B<x>:USB:SOUrce, 2-326  
 BUS:B<x>:USB:SOUrce:DMINus, 2-327  
 BUS:B<x>:USB:SOUrce:DPLUs, 2-328  
 BUS:B<x>:USB:THRESHold, 2-329  
 BUS:DELeTe, 2-329  
 BUS:LIST?, 2-330  
 BUSTABLE:ADDNew, 2-330  
 BUSTABLE:DELeTe, 2-331  
 BUSTABLE:LIST?, 2-331  
 BUSY?, 2-331

## C

CALLOUTS:CALLOUT<x>, 2-332  
 CALLOUTS:CALLOUT<x>:BOOKMark:  
     SOURCE, 2-332  
 CALLOUTS:CALLOUT<x>:BOOKMark:  
     XPOS, 2-333  
 CALLOUTS:CALLOUT<x>:COLOR, 2-333  
 CALLOUTS:CALLOUT<x>:DISPLAYPOsition:  
     X, 2-334  
 CALLOUTS:CALLOUT<x>:DISPLAYPOsition:  
     Y, 2-334  
 CALLOUTS:CALLOUT<x>:FONT:BOLD, 2-334  
 CALLOUTS:CALLOUT<x>:FONT:ITALIC, 2-335  
 CALLOUTS:CALLOUT<x>:FONT:SIZE, 2-335  
 CALLOUTS:CALLOUT<x>:FONT:TYPe, 2-336  
 CALLOUTS:CALLOUT<x>:FONT:  
     UNDERLine, 2-336  
 CALLOUTS:CALLOUT<x>:TEXT, 2-337  
 CALLOUTS:CALLOUT<x>:TYPe, 2-337

CH<x>?, 2-338  
 CH<x>:BANDwidth, 2-338  
 CH<x>:BANDwidth:FILTer:OPTIMIZAtion, 2-339  
 CH<x>\_D<x>:LABel:COLor, 2-360  
 CH<x>\_D<x>:LABel:FONT:BOLD, 2-360  
 CH<x>\_D<x>:LABel:FONT:ITALic, 2-361  
 CH<x>\_D<x>:LABel:FONT:SIZE, 2-361  
 CH<x>\_D<x>:LABel:FONT:TYPE, 2-362  
 CH<x>\_D<x>:LABel:FONT:UNDERline, 2-362  
 CH<x>\_D<x>:LABel:NAME, 2-363  
 CH<x>\_DALL:LABel:COLor, 2-356  
 CH<x>\_DALL:LABel:FONT:BOLD, 2-357  
 CH<x>\_DALL:LABel:FONT:ITALic, 2-357  
 CH<x>\_DALL:LABel:FONT:SIZE, 2-358  
 CH<x>\_DALL:LABel:FONT:TYPE, 2-358  
 CH<x>\_DALL:LABel:FONT:UNDERline, 2-359  
 CH<x>\_DALL:LABel:NAME, 2-359  
 CH<x>:DITHERrange, 2-339  
 CH<x>:INVert, 2-340  
 CH<x>:PRObe?, 2-340  
 CH<x>:PRObe:AUTOZero, 2-341  
 CH<x>:PRObe:COMPensate, 2-341  
 CH<x>:PRObe:DEGAUSS, 2-342  
 CH<x>:PRObe:DEGAUSS:STATE?, 2-342  
 CH<x>:PRObe:FORCEDRange, 2-343  
 CH<x>:PRObe:GAIN?, 2-343  
 CH<x>:PRObe:ID?, 2-343  
 CH<x>:PRObe:ID:SERnumber?, 2-344  
 CH<x>:PRObe:ID:TYPE?, 2-344  
 CH<x>:PRObe:INPUTMode, 2-345  
 CH<x>:PRObe:INPUTMode:AOFFSet, 2-345  
 CH<x>:PRObe:INPUTMode:BOFFSet, 2-346  
 CH<x>:PRObe:INPUTMode:COFFSet, 2-346  
 CH<x>:PRObe:INPUTMode:DOFFSet, 2-347  
 CH<x>:PRObe:RESistance?, 2-348  
 CH<x>:PRObe:SELFCal, 2-348  
 CH<x>:PRObe:SELFCal:State?, 2-348  
 CH<x>:PRObe:SET, 2-349  
 CH<x>:PRObe:STATus?, 2-349  
 CH<x>:PRObe:UNIts?, 2-350  
 CH<x>:PROBECal?, 2-350  
 CH<x>:PROBECOnTrol, 2-351  
 CH<x>:PROBEFunc:EXTAtten, 2-352  
 CH<x>:PROBEFunc:EXTDBatten, 2-352  
 CH<x>:PROBEFunc:EXTUnits, 2-353  
 CH<x>:PROBEFunc:EXTUnits:STATE, 2-353  
 CH<x>:SCALERATio, 2-354

CH<x>:SV:SPANABovebw?, 2-354  
 CH<x>:SV:SPANBELowdc?, 2-355  
 CH<x>:TERmination, 2-355  
 CH<x>:VTERm:BIAS, 2-356  
 \*CLS, 2-363  
 Command Groups, 2-11  
 CONFIGuration:ANALog:BANDWidth?, 2-364  
 CURVe?, 2-365  
 CURVEStream?, 2-367  
 CUSTOMTABLE:ADDNew, 2-369  
 CUSTOMTABLE:DELeTe, 2-369  
 CUSTOMTABLE:LIST?, 2-370

## D

DATA, 2-370  
 DATA:ENCdG, 2-371  
 DATA:FRAMEStARt, 2-373  
 DATA:FRAMEStOP, 2-373  
 DATA:MODE, 2-374  
 DATA:RESAmple, 2-374  
 DATA:SOUrce, 2-375  
 DATA:SOUrce:AVAILAbLe?, 2-376  
 DATA:StARt, 2-377  
 DATA:StOP, 2-377  
 DATA:WIDth, 2-378  
 DATE?, 2-379  
 DESE, 2-379  
 DISPlay?, 2-380  
 DISPlay:{CH<x>|Math<x>|REF<x>}:  
   INVERTColor, 2-381  
 DISPlay:{CH<x>|Math<x>|REF<x>}:  
   NORMALColor, 2-382  
 DISPlay:COLors, 2-382  
 DISPlay:GLObal:B<x>:STATE, 2-383  
 DISPlay:GLObal:CH<x>:STATE, 2-383  
 DISPlay:GLObal:MATH<x>:STATE, 2-384  
 DISPlay:GLObal:PLOT<x>:STATE, 2-385  
 DISPlay:GLObal:REF<x>:STATE, 2-385  
 DISPlay:INTENSITy?, 2-386  
 DISPlay:INTENSITy:BACKLight, 2-386  
 DISPlay:INTENSITy:BACKLight:AUTODim:  
   ENAbLe, 2-387  
 DISPlay:INTENSITy:BACKLight:AUTODim:  
   TIME, 2-387  
 DISPlay:MATHFFTView<n>:CURSor:  
   ROLOCATION, 2-388  
 DISPlay:MATHFFTView<x>:AUTOScale, 2-389

- DISplay:MATHFFTView<x>:CURSor:  
ASOURce?, 2-389
- DISplay:MATHFFTView<x>:CURSor:  
BSOURce?, 2-390
- DISplay:MATHFFTView<x>:CURSor:DDT?, 2-390
- DISplay:MATHFFTView<x>:CURSor:  
FUNCTion, 2-390
- DISplay:MATHFFTView<x>:CURSor:HBArs:  
APOSition, 2-391
- DISplay:MATHFFTView<x>:CURSor:HBArs:  
AUNIts?, 2-392
- DISplay:MATHFFTView<x>:CURSor:HBArs:  
BPOSition, 2-392
- DISplay:MATHFFTView<x>:CURSor:HBArs:  
BUNIts?, 2-392
- DISplay:MATHFFTView<x>:CURSor:HBArs:  
DELTA?, 2-393
- DISplay:MATHFFTView<x>:CURSor:MODE, 2-393
- DISplay:MATHFFTView<x>:CURSor:  
ONEOVERDELTAVALUE?, 2-394
- DISplay:MATHFFTView<x>:CURSor:SCREEN:  
AXPOSition, 2-394
- DISplay:MATHFFTView<x>:CURSor:SCREEN:  
AYPOSition, 2-395
- DISplay:MATHFFTView<x>:CURSor:SCREEN:  
BXPOSition, 2-395
- DISplay:MATHFFTView<x>:CURSor:SCREEN:  
BYPOSition, 2-396
- DISplay:MATHFFTView<x>:CURSor:STATE, 2-396
- DISplay:MATHFFTView<x>:CURSor:VBArS:  
APOSition, 2-397
- DISplay:MATHFFTView<x>:CURSor:VBArS:  
AUNIts?, 2-397
- DISplay:MATHFFTView<x>:CURSor:VBArS:  
BPOSition, 2-398
- DISplay:MATHFFTView<x>:CURSor:VBArS:  
BUNIts?, 2-398
- DISplay:MATHFFTView<x>:CURSor:VBArS:  
DELTA?, 2-399
- DISplay:MATHFFTView<x>:CURSor:WAVEform:  
APOSition, 2-399
- DISplay:MATHFFTView<x>:CURSor:WAVEform:  
BPOSition, 2-400
- DISplay:MATHFFTView<x>:GRIDlines, 2-400
- DISplay:MATHFFTView<x>:MATH:MATH<x>:  
STATE, 2-401
- DISplay:MATHFFTView<x>:XAXIS:SCALE, 2-401
- DISplay:MATHFFTView<x>:YAXIS:SCALE, 2-402
- DISplay:MATHFFTView<x>:ZOOM:XAXIS:  
FROM, 2-402
- DISplay:MATHFFTView<x>:ZOOM:XAXIS:  
TO, 2-403
- DISplay:MATHFFTView<x>:ZOOM:YAXIS:  
FROM, 2-403
- DISplay:MATHFFTView<x>:ZOOM:YAXIS:  
TO, 2-404
- DISplay:PERSistence, 2-404
- DISplay:PERSistence:RESET, 2-405
- DISplay:PLOTView<n>:CURSor:  
ROLOCATION, 2-405
- DISplay:PLOTView<x>:AUTOScale, 2-406
- DISplay:PLOTView<x>:CURSor:ASOURce?, 2-407
- DISplay:PLOTView<x>:CURSor:BSOURce?, 2-407
- DISplay:PLOTView<x>:CURSor:DDT?, 2-407
- DISplay:PLOTView<x>:CURSor:FUNCTion, 2-408
- DISplay:PLOTView<x>:CURSor:HBArs:  
APOSition, 2-408
- DISplay:PLOTView<x>:CURSor:HBArs:  
AUNIts?, 2-409
- DISplay:PLOTView<x>:CURSor:HBArs:  
BPOSition, 2-409
- DISplay:PLOTView<x>:CURSor:HBArs:  
BUNIts?, 2-410
- DISplay:PLOTView<x>:CURSor:HBArs:  
DELTA?, 2-410
- DISplay:PLOTView<x>:CURSor:MODE, 2-411
- DISplay:PLOTView<x>:CURSor:  
ONEOVERDELTAVALUE?, 2-411
- DISplay:PLOTView<x>:CURSor:SCREEN:  
AXPOSition, 2-412
- DISplay:PLOTView<x>:CURSor:SCREEN:  
AYPOSition, 2-412
- DISplay:PLOTView<x>:CURSor:SCREEN:  
BXPOSition, 2-413
- DISplay:PLOTView<x>:CURSor:SCREEN:  
BYPOSition, 2-413
- DISplay:PLOTView<x>:CURSor:  
SPLITMODE, 2-414
- DISplay:PLOTView<x>:CURSor:STATE, 2-414
- DISplay:PLOTView<x>:CURSor:VBArS:  
APOSition, 2-415
- DISplay:PLOTView<x>:CURSor:VBArS:  
BPOSition, 2-415

- DISplay:PLOTView<x>:CURSor:VBArS:  
   DELTA?, 2-416  
 DISplay:PLOTView<x>:CURSor:VBArS:  
   UNIts?, 2-416  
 DISplay:PLOTView<x>:CURSor:WAVEform:  
   APOSition, 2-417  
 DISplay:PLOTView<x>:CURSor:WAVEform:  
   BPOSition, 2-417  
 DISplay:PLOTView<x>:GRIDlines, 2-418  
 DISplay:PLOTVIEW<x>:XAXIS:SCALE, 2-419  
 DISplay:PLOTVIEW<x>:YAXIS:SCALE, 2-419  
 DISplay:PLOTView<x>:ZOOM:XAXIS:  
   FROM, 2-420  
 DISplay:PLOTView<x>:ZOOM:XAXIS:TO, 2-420  
 DISplay:PLOTView<x>:ZOOM:YAXIS:  
   FROM, 2-421  
 DISplay:PLOTView<x>:ZOOM:YAXIS:TO, 2-421  
 DISplay:REFFFTView<x>:AUTOScale, 2-422  
 DISplay:REFFFTView<x>:CURSor:  
   ASOURce?, 2-422  
 DISplay:REFFFTView<x>:CURSor:  
   BSOURce?, 2-423  
 DISplay:REFFFTView<x>:CURSor:DDT?, 2-423  
 DISplay:REFFFTView<x>:CURSor:  
   FUNction, 2-423  
 DISplay:REFFFTView<x>:CURSor:HBArs:  
   APOSition, 2-424  
 DISplay:REFFFTView<x>:CURSor:HBArs:  
   AUNIts?, 2-425  
 DISplay:REFFFTView<x>:CURSor:HBArs:  
   BPOSition, 2-425  
 DISplay:REFFFTView<x>:CURSor:HBArs:  
   BUNIts?, 2-425  
 DISplay:REFFFTView<x>:CURSor:HBArs:  
   DELTA?, 2-426  
 DISplay:REFFFTView<x>:CURSor:MODE, 2-426  
 DISplay:REFFFTView<x>:CURSor:  
   ONEOVERDELTAVALUE?, 2-427  
 DISplay:REFFFTView<x>:CURSor:  
   ROLOCATION, 2-427  
 DISplay:REFFFTView<x>:CURSor:SCREEN:  
   AXPOSition, 2-428  
 DISplay:REFFFTView<x>:CURSor:SCREEN:  
   AYPOSition, 2-428  
 DISplay:REFFFTView<x>:CURSor:SCREEN:  
   BXPOSition, 2-429  
 DISplay:REFFFTView<x>:CURSor:SCREEN:  
   BYPOSition, 2-429  
 DISplay:REFFFTView<x>:CURSor:  
   SPLITMODE, 2-430  
 DISplay:REFFFTView<x>:CURSor:STATE, 2-430  
 DISplay:REFFFTView<x>:CURSor:VBArS:  
   APOSition, 2-431  
 DISplay:REFFFTView<x>:CURSor:VBArS:  
   BPOSition, 2-431  
 DISplay:REFFFTView<x>:CURSor:VBArS:  
   DELTA?, 2-432  
 DISplay:REFFFTView<x>:CURSor:VBArS:  
   UNIts?, 2-432  
 DISplay:REFFFTView<x>:CURSor:WAVEform:  
   AHPOSition?, 2-433  
 DISplay:REFFFTView<x>:CURSor:WAVEform:  
   APOSition, 2-433  
 DISplay:REFFFTView<x>:CURSor:WAVEform:  
   AVPOSition?, 2-434  
 DISplay:REFFFTView<x>:CURSor:WAVEform:  
   BHPOSition?, 2-434  
 DISplay:REFFFTView<x>:CURSor:WAVEform:  
   BPOSition, 2-434  
 DISplay:REFFFTView<x>:CURSor:WAVEform:  
   BVPOSition?, 2-435  
 DISplay:REFFFTView<x>:GRIDlines, 2-435  
 DISplay:REFFFTView<x>:REF:REF<x>:  
   STATE, 2-436  
 DISplay:REFFFTView<x>:XAXIS:SCALE, 2-436  
 DISplay:REFFFTView<x>:ZOOM:XAXIS:  
   FROM, 2-437  
 DISplay:REFFFTView<x>:ZOOM:XAXIS:TO, 2-437  
 DISplay:REFFFTView<x>:ZOOM:YAXIS:  
   FROM, 2-438  
 DISplay:REFFFTView<x>:ZOOM:YAXIS:TO, 2-438  
 DISplay:SELEct:BUS, 2-439  
 DISplay:SELEct:MATH, 2-439  
 DISplay:SELEct:REFerence, 2-440  
 DISplay:SELEct:SOURce, 2-440  
 DISplay:SELEct:SPEcView<x>:SOURce, 2-441  
 DISplay:SELEct:VIEW, 2-441  
 DISplay:SELEct:WAVEView<x>:SOURce, 2-441  
 DISplay:SPEcView<x>:CURSor:CURSOR:  
   ANOISEDensity?, 2-442  
 DISplay:SPEcView<x>:CURSor:CURSOR:  
   ASOURce, 2-443

- DISplay:SPECView<x>:CURSor:CURSOR:  
BNOISE?, 2-443
- DISplay:SPECView<x>:CURSor:CURSOR:  
BSOURce, 2-444
- DISplay:SPECView<x>:CURSor:CURSOR:HBArs:  
APOSITION, 2-444
- DISplay:SPECView<x>:CURSor:CURSOR:HBArs:  
AUNIts?, 2-445
- DISplay:SPECView<x>:CURSor:CURSOR:HBArs:  
BPOSITION, 2-445
- DISplay:SPECView<x>:CURSor:CURSOR:HBArs:  
BUNIts?, 2-446
- DISplay:SPECView<x>:CURSor:CURSOR:  
READout, 2-446
- DISplay:SPECView<x>:CURSor:CURSOR:  
SPLITMODE, 2-447
- DISplay:SPECView<x>:CURSor:CURSOR:  
STATE, 2-447
- DISplay:SPECView<x>:CURSor:CURSOR:VBArS:  
APOSITION, 2-448
- DISplay:SPECView<x>:CURSor:CURSOR:VBArS:  
BPOSITION, 2-448
- DISplay:SPECView<x>:CURSor:CURSOR:VBArS:  
UNIts?, 2-449
- DISplay:SPECView<x>:CURSor:CURSOR:  
WAVEform:APOSITION, 2-449
- DISplay:SPECView<x>:CURSor:CURSOR:  
WAVEform:BPOSITION, 2-450
- DISplay:SPECView<x>:GRATICule, 2-451
- DISplay:SPECView<x>:HORZ, 2-451
- DISplay:SPECView<x>:INTENSITy:  
GRATICule, 2-452
- DISplay:SPECView<x>:INTENSITy:  
WAVEform, 2-452
- DISplay:SPECView<x>:VIEWStyle, 2-453
- DISplay:VARpersist, 2-453
- DISplay:WAVEform, 2-454
- DISplay:WAVEView:CURSor:CURSOR1:  
ROLOCATION, 2-454
- DISplay:WAVEView:GRIDTYPE, 2-455
- DISplay:WAVEView<x>:BUS:B<x>:STATE, 2-455
- DISplay:WAVEView<x>:BUS:B<x>:VERTical:  
POSITION, 2-456
- DISplay:WAVEView<x>:CH<x>\_D<x>:  
STATE, 2-459
- DISplay:WAVEView<x>:CH<x>\_DALL:  
STATE, 2-458
- DISplay:WAVEView<x>:CH<x>\_DALL:VERTical:  
POSITION, 2-459
- DISplay:WAVEView<x>:CH<x>:STATE, 2-456
- DISplay:WAVEView<x>:CH<x>:VERTical:  
POSITION, 2-457
- DISplay:WAVEView<x>:CH<x>:VERTical:  
SCALE, 2-458
- DISplay:WAVEView<x>:CURSor?, 2-460
- DISplay:WAVEView<x>:CURSor:CURSOR:  
WAVEform:ALL:Values?, 2-473
- DISplay:WAVEView<x>:CURSor:CURSOR:  
WAVEform:AVPOSITION?, 2-474
- DISplay:WAVEView<x>:CURSor:CURSOR:  
WAVEform:BVPOSITION?, 2-476
- DISplay:WAVEView<x>:CURSor:  
CURSOR<x>?, 2-460
- DISplay:WAVEView<x>:CURSor:CURSOR<x>:  
ASOURce, 2-461
- DISplay:WAVEView<x>:CURSor:CURSOR<x>:  
BSOURce, 2-462
- DISplay:WAVEView<x>:CURSor:CURSOR<x>:  
DDT?, 2-462
- DISplay:WAVEView<x>:CURSor:CURSOR<x>:  
FUNCTION, 2-463
- DISplay:WAVEView<x>:CURSor:CURSOR<x>:  
HBArs:APOSITION, 2-464
- DISplay:WAVEView<x>:CURSor:CURSOR<x>:  
HBArs:AUNIts?, 2-464
- DISplay:WAVEView<x>:CURSor:CURSOR<x>:  
HBArs:BPOSITION, 2-465
- DISplay:WAVEView<x>:CURSor:CURSOR<x>:  
HBArs:BUNIts?, 2-465
- DISplay:WAVEView<x>:CURSor:CURSOR<x>:  
HBArs:DELTA?, 2-466
- DISplay:WAVEView<x>:CURSor:CURSOR<x>:  
MODE, 2-466
- DISplay:WAVEView<x>:CURSor:CURSOR<x>:  
ONEOVERDELTAVALUE?, 2-467
- DISplay:WAVEView<x>:CURSor:CURSOR<x>:  
SCREEN:AXPOSITION, 2-468
- DISplay:WAVEView<x>:CURSor:CURSOR<x>:  
SCREEN:AYPOSITION, 2-468
- DISplay:WAVEView<x>:CURSor:CURSOR<x>:  
SCREEN:BXPOSITION, 2-469
- DISplay:WAVEView<x>:CURSor:CURSOR<x>:  
SCREEN:BYPOSITION, 2-469



- DISplay:WAVEView<x>:CURSor:CURSOR<x>:  
   SPLITMODE, 2-470  
 DISplay:WAVEView<x>:CURSor:CURSOR<x>:  
   STATE, 2-471  
 DISplay:WAVEView<x>:CURSor:CURSOR<x>:  
   VBArS:APOsition, 2-471  
 DISplay:WAVEView<x>:CURSor:CURSOR<x>:  
   VBArS:BPOsition, 2-472  
 DISplay:WAVEView<x>:CURSor:CURSOR<x>:  
   VBArS:DELTA?, 2-472  
 DISplay:WAVEView<x>:CURSor:CURSOR<x>:  
   VBArS:UNItS?, 2-473  
 DISplay:WAVEView<x>:CURSor:CURSOR<x>:  
   WAVEform:APOsition, 2-474  
 DISplay:WAVEView<x>:CURSor:CURSOR<x>:  
   WAVEform:BPOsition, 2-475  
 DISplay:WAVEView<x>:FILTer, 2-476  
 DISplay:WAVEView<x>:GRATicule, 2-477  
 DISplay:WAVEView<x>:INTENSITy:  
   GRATicule, 2-477  
 DISplay:WAVEView<x>:INTENSITy:  
   WAVEform, 2-478  
 DISplay:WAVEView<x>:MATH:MATH<x>:  
   AUTOScale, 2-478  
 DISplay:WAVEView<x>:MATH:MATH<x>:  
   STATE, 2-479  
 DISplay:WAVEView<x>:MATH:MATH<x>:  
   VERTical:POsition, 2-479  
 DISplay:WAVEView<x>:MATH:MATH<x>:  
   VERTical:SCALE, 2-480  
 DISplay:WAVEView<x>:PLOT:PLOT<x>:  
   AUTOScale, 2-480  
 DISplay:WAVEView<x>:PLOT:PLOT<x>:  
   STATE, 2-481  
 DISplay:WAVEView<x>:PLOT:PLOT<x>:VERTical:  
   POsition, 2-482  
 DISplay:WAVEView<x>:PLOT:PLOT<x>:VERTical:  
   SCALE, 2-482  
 DISplay:WAVEView<x>:REF:REF<x>:  
   STATE, 2-483  
 DISplay:WAVEView<x>:REF:REF<x>:VERTical:  
   POsition, 2-483  
 DISplay:WAVEView<x>:REF:REF<x>:VERTical:  
   SCALE, 2-484  
 DISplay:WAVEView<x>:RF\_FREQUency<x>:  
   VERTical:POsition, 2-484  
 DISplay:WAVEView<x>:RF\_FREQUency<x>:  
   VERTical:SCALE, 2-485  
 DISplay:WAVEView<x>:RF\_MAGNitude<x>:  
   VERTical:POsition, 2-485  
 DISplay:WAVEView<x>:RF\_MAGNitude<x>:  
   VERTical:SCALE, 2-486  
 DISplay:WAVEView<x>:RF\_PHASe<x>:VERTical:  
   POsition, 2-487  
 DISplay:WAVEView<x>:RF\_PHASe<x>:VERTical:  
   SCALE, 2-487  
 DISplay:WAVEView<x>:STYle, 2-488  
 DISplay:WAVEView<x>:VIEWStYle, 2-488  
 DISplay:WAVEView<x>:ZOOM?, 2-489  
 DISplay:WAVEView<x>:ZOOM:ZOOM<x>?, 2-490  
 DISplay:WAVEView<x>:ZOOM:ZOOM<x>:  
   HORizontal:POsition, 2-490  
 DISplay:WAVEView<x>:ZOOM:ZOOM<x>:  
   HORizontal:SCALE, 2-491  
 DISplay:WAVEView<x>:ZOOM:ZOOM<x>:  
   HORizontal:WINSCALE, 2-492  
 DISplay:WAVEView<x>:ZOOM:ZOOM<x>:  
   STATE, 2-492  
 DISplay:WAVEView<x>:ZOOM:ZOOM<x>:  
   VERTical:POsition, 2-493  
 DISplay:WAVEView<x>:ZOOM:ZOOM<x>:  
   VERTical:SCALE, 2-494  
 DISplay:WAVEView<y>:REF:REF<x>:  
   FRAME, 2-494  
 DISplay:WAVEView<y>:REF<x>\_DALL:  
   FRAME, 2-495
- ## E
- \*ESE, 2-495
  - \*ESR?, 2-496
  - EVENT?, 2-497
  - EVMsg?, 2-497
  - EVQty?, 2-498
  - EYEMASK:MASK<x>:COUNt:HITs?, 2-498
  - EYEMASK:MASK<x>:COUNt:SEG<y>:  
   HITs?, 2-499
  - EYEMASK:MASK<x>:CREATor?, 2-500
  - EYEMASK:MASK<x>:ENABled, 2-500
  - EYEMASK:MASK<x>:MASKfile, 2-501
  - EYEMASK:MASK<x>:MASKOffSet:HORizontal:  
   AUTOfit?, 2-502
  - EYEMASK:MASK<x>:TEST:SAMple:  
   THREShold, 2-502

EYEMASK:MASK<x>:TEST:STATUS?, 2-503

## F

FACTory, 2-503  
 FILESYS:COLLECTLOGFILES, 2-504  
 FILESystem?, 2-505  
 FILESystem:COPy, 2-505  
 FILESystem:CWD, 2-506  
 FILESystem:DELEte, 2-507  
 FILESystem:DIR?, 2-507  
 FILESystem:HOMEDir?, 2-508  
 FILESystem:LDIR?, 2-508  
 FILESystem:MKDir, 2-509  
 FILESystem:MOUNT:DRIVE, 2-509  
 FILESystem:MOUNT:TEKDrive, 2-510  
 FILESystem:READFile, 2-511  
 FILESystem:REName, 2-512  
 FILESystem:RMDir, 2-512  
 FILESystem:TEKDrive:CODE?, 2-513  
 FILESystem:TEKDrive:CODE:EXPIrytime?, 2-513  
 FILESystem:TEKDrive:CODE:STATus?, 2-513  
 FILESystem:UNMOUNT:DRive, 2-514  
 FILESystem:UNMOUNT:TEKDrive, 2-514  
 FILESystem:WRITEFile, 2-515

## H

HEADer, 2-515  
 HISTogram:ADDNew, 2-516  
 HISTogram:DELEte, 2-517  
 HISTogram:DELETEALL, 2-517  
 HISTogram:HISTogram<x>:BOX, 2-517  
 HISTogram:HISTogram<x>:BSTate, 2-518  
 HISTogram:HISTogram<x>:DATA?, 2-518  
 HISTogram:HISTogram<x>:DISPlay, 2-519  
 HISTogram:HISTogram<x>:FUNctioN, 2-519  
 HISTogram:HISTogram<x>:MEASurement:  
   COUNT, 2-520  
 HISTogram:HISTogram<x>:MEASurement:  
   HITS, 2-520  
 HISTogram:HISTogram<x>:MEASurement:  
   MAX, 2-521  
 HISTogram:HISTogram<x>:MEASurement:  
   MEAN, 2-521  
 HISTogram:HISTogram<x>:MEASurement:  
   MEDian, 2-522

HISTogram:HISTogram<x>:MEASurement:  
   MIN, 2-523  
 HISTogram:HISTogram<x>:MEASurement:  
   MODE, 2-523  
 HISTogram:HISTogram<x>:MEASurement:  
   ONESigma, 2-524  
 HISTogram:HISTogram<x>:MEASurement:  
   PHITs, 2-524  
 HISTogram:HISTogram<x>:MEASurement:  
   PK2PK, 2-525  
 HISTogram:HISTogram<x>:MEASurement:  
   RESUIts?, 2-525  
 HISTogram:HISTogram<x>:MEASurement:  
   STDDev, 2-527  
 HISTogram:HISTogram<x>:MEASurement:  
   THRSigma, 2-527  
 HISTogram:HISTogram<x>:MEASurement:  
   TWOSigma, 2-528  
 HISTogram:HISTogram<x>:SAVE, 2-528  
 HISTogram:HISTogram<x>:SIZE, 2-529  
 HISTogram:HISTogram<x>:SOUrce, 2-529  
 HISTogram:HISTogram<x>:STATE, 2-530  
 HISTogram:HISTogram<x>:TRANSparency, 2-530  
 HISTogram:LIST?, 2-531  
 HORizontal:DELay:MODE, 2-531  
 HORizontal:DELay:TIME, 2-532  
 HORizontal:MODE, 2-532  
 HORizontal:MODE:MANual:CONFIGure, 2-533  
 HORizontal:POSition, 2-533  
 HORizontal:SAMPLERate, 2-534  
 HORizontal:SCALE, 2-534

## I

ID?, 2-535  
 \*IDN?, 2-535

## L

LICense?, 2-536  
 LICense:APPID?, 2-536  
 LICense:COUNT?, 2-537  
 LICense:ERRor?, 2-537  
 LICense:GMT?, 2-538  
 LICense:HID?, 2-538  
 LICense:INSTall, 2-539  
 LICense:ITEM?, 2-539  
 LICense:LIST?, 2-539

License:UNINSTALL?, 2-536  
 License:VALidate?, 2-540  
 \*LRN?, 2-540

## M

MAINWindow:BADGe:BRINgtoview, 2-541  
 MAINWindow:FONTSize, 2-542  
 MAINWindow:RRBDisplaystate, 2-542  
 MASK:DELeTe, 2-542  
 MASK:MASK<x>:COUNT?, 2-543  
 MASK:MASK<x>:COUNT:HITS?, 2-543  
 MASK:MASK<x>:DEFinedby, 2-544  
 MASK:MASK<x>:DISPlay, 2-545  
 MASK:MASK<x>:LIST?, 2-545  
 MASK:MASK<x>:SEG<x>:COUNT:HITS?, 2-546  
 MASK:MASK<x>:SEG<x>:POINTS, 2-546  
 MASK:MASK<x>:SOURce, 2-547  
 MASK:MASK<x>:TEST:CTHReshold, 2-547  
 MASK:MASK<x>:TEST:STATE, 2-548  
 MASK:MASK<x>:TEST:STATUS?, 2-549  
 MASK:MASK<x>:TEST:THReshold, 2-549  
 MASK:MASK<x>:TOLerance:HABSolute, 2-550  
 MASK:MASK<x>:TOLerance:HORizontal, 2-550  
 MASK:MASK<x>:TOLerance:UPDatenow, 2-551  
 MASK:MASK<x>:TOLerance:VABSolute, 2-552  
 MASK:MASK<x>:TOLerance:VERTical, 2-552  
 MASK:MASK<x>:TTYPe, 2-553  
 MASK:TEST:WAVEforms, 2-554  
 MATH:ADDNew, 2-554  
 MATH:DELeTe, 2-555  
 MATH:LIST?, 2-555  
 MATH:MATH<x>:ARINC429A:  
   SUPPortedfields, 2-556  
 MATH:MATH<x>:AUDIO:SUPPortedfields, 2-556  
 MATH:MATH<x>:AUTOETHERnet:  
   SUPPortedfields, 2-557  
 MATH:MATH<x>:AVG:MODE, 2-557  
 MATH:MATH<x>:AVG:WEIGht, 2-558  
 MATH:MATH<x>:CAN:SUPPortedfields, 2-558  
 MATH:MATH<x>:CXPI:SUPPortedfields, 2-559  
 MATH:MATH<x>:DEFine, 2-559  
 MATH:MATH<x>:ESPI:SUPPortedfields, 2-560  
 MATH:MATH<x>:ETHERCAT:  
   SUPPortedfields, 2-560  
 MATH:MATH<x>:ETHERnet:  
   SUPPortedfields, 2-561  
 MATH:MATH<x>:EUSB:SUPPortedfields, 2-562  
 MATH:MATH<x>:FILTer:CFReq, 2-562  
 MATH:MATH<x>:FILTer:DELay, 2-563  
 MATH:MATH<x>:FILTer:DESIGN, 2-563  
 MATH:MATH<x>:FILTer:HCFReq, 2-564  
 MATH:MATH<x>:FILTer:INFo?, 2-564  
 MATH:MATH<x>:FILTer:LCFReq, 2-565  
 MATH:MATH<x>:FILTer:LOAD, 2-565  
 MATH:MATH<x>:FILTer:LOAD:RESPonse, 2-566  
 MATH:MATH<x>:FILTer:ORDER, 2-566  
 MATH:MATH<x>:FILTer:PRIPple, 2-567  
 MATH:MATH<x>:FILTer:RESPonse, 2-567  
 MATH:MATH<x>:FILTer:ROFactor, 2-568  
 MATH:MATH<x>:FILTer:SATTenuation, 2-568  
 MATH:MATH<x>:FILTer:SAVe, 2-569  
 MATH:MATH<x>:FILTer:SAVe:RESPonse, 2-569  
 MATH:MATH<x>:FILTer:SDEViation, 2-570  
 MATH:MATH<x>:FILTer:SDURation, 2-570  
 MATH:MATH<x>:FILTer:SOURce, 2-571  
 MATH:MATH<x>:FILTer:SYMBols, 2-572  
 MATH:MATH<x>:FILTer:TWIDth, 2-572  
 MATH:MATH<x>:FILTer:TYPe, 2-573  
 MATH:MATH<x>:FLEXray:SUPPortedfields, 2-573  
 MATH:MATH<x>:FUNCTion, 2-574  
 MATH:MATH<x>:GATING, 2-576  
 MATH:MATH<x>:I2C:SUPPortedfields, 2-574  
 MATH:MATH<x>:I3C:SUPPortedfields, 2-575  
 MATH:MATH<x>:INTERpolation, 2-575  
 MATH:MATH<x>:LABel:COLor, 2-576  
 MATH:MATH<x>:LABel:FONT:BOLD, 2-577  
 MATH:MATH<x>:LABel:FONT:ITALic, 2-577  
 MATH:MATH<x>:LABel:FONT:SIZE, 2-578  
 MATH:MATH<x>:LABel:FONT:TYPe, 2-578  
 MATH:MATH<x>:LABel:FONT:UNDERline, 2-579  
 MATH:MATH<x>:LABel:NAME, 2-579  
 MATH:MATH<x>:LABel:XPOS, 2-580  
 MATH:MATH<x>:LABel:YPOS, 2-580  
 MATH:MATH<x>:LIN:SUPPortedfields, 2-581  
 MATH:MATH<x>:MDIO:SUPPortedfields, 2-581  
 MATH:MATH<x>:MIL1553B:  
   SUPPortedfields, 2-582  
 MATH:MATH<x>:ONEWIRE:  
   SUPPortedfields, 2-582  
 MATH:MATH<x>:PARAllel:SUPPortedfields, 2-583  
 MATH:MATH<x>:PSIFive:SUPPortedfields, 2-583  
 MATH:MATH<x>:RS232C:SUPPortedfields, 2-584  
 MATH:MATH<x>:SDLC:SUPPortedfields, 2-584  
 MATH:MATH<x>:SENT:SUPPortedfields, 2-585

- MATH:MATH<x>:SIGNeddata, 2-585  
MATH:MATH<x>:SMBUS:SUPPortedfields, 2-586  
MATH:MATH<x>:SOUrce<x>, 2-586  
MATH:MATH<x>:SPACEWIRe:  
    SUPPortedfields, 2-587  
MATH:MATH<x>:SPECTral:HORZ, 2-588  
MATH:MATH<x>:SPECTral:MAG, 2-588  
MATH:MATH<x>:SPECTral:PHASE, 2-589  
MATH:MATH<x>:SPECTral:SOUrce, 2-589  
MATH:MATH<x>:SPECTral:SUPPpress, 2-590  
MATH:MATH<x>:SPECTral:SUPPpress:  
    VALue, 2-590  
MATH:MATH<x>:SPECTral:TYPE, 2-591  
MATH:MATH<x>:SPECTral:UNWRap, 2-592  
MATH:MATH<x>:SPECTral:UNWRap:  
    DEGrees, 2-592  
MATH:MATH<x>:SPECTral:WINDow, 2-593  
MATH:MATH<x>:SPI:SUPPortedfields, 2-594  
MATH:MATH<x>:SPMI:SUPPortedfields, 2-594  
MATH:MATH<x>:SVID:SUPPortedfields, 2-595  
MATH:MATH<x>:TYPe, 2-595  
MATH:MATH<x>:USB:SUPPortedfields, 2-596  
MATH:MATH<x>:VUNIT, 2-597  
MATHArbft<x>:FILEpath, 2-597  
MEASTABLE:ADDNew, 2-598  
MEASTABLE:DELETE, 2-598  
MEASU:MEAS1:SUBGROUP:RESULts:ALLAcqs:  
    MAXimum?, 2-598  
MEASU:MEAS1:SUBGROUP:RESULts:ALLAcqs:  
    MEAN?, 2-599  
MEASU:MEAS1:SUBGROUP:RESULts:ALLAcqs:  
    MINimum?, 2-600  
MEASU:MEAS1:SUBGROUP:RESULts:ALLAcqs:  
    PK2PK?, 2-600  
MEASU:MEAS1:SUBGROUP:RESULts:ALLAcqs:  
    POPulation?, 2-601  
MEASU:MEAS1:SUBGROUP:RESULts:ALLAcqs:  
    STDDev?, 2-602  
MEASU:MEAS1:SUBGROUP:RESULts:  
    CURRentacq:MAXimum?, 2-602  
MEASU:MEAS1:SUBGROUP:RESULts:  
    CURRentacq:MEAN?, 2-603  
MEASU:MEAS1:SUBGROUP:RESULts:  
    CURRentacq:MINimum?, 2-605  
MEASU:MEAS1:SUBGROUP:RESULts:  
    CURRentacq:PK2PK?, 2-605  
MEASU:MEAS1:SUBGROUP:RESULts:  
    CURRentacq:POPulation?, 2-606  
MEASU:MEAS1:SUBGROUP:RESULts:  
    CURRentacq:STDDev?, 2-607  
MEASUrement?: 2-607  
MEASUrement:ADDMEAS , 2-608  
MEASUrement:ADDNew, 2-617  
MEASUrement:ANNOtate, 2-618  
MEASUrement:AUTOset, 2-618  
MEASUrement:CH<x>:REFLevels:ABSolute:  
    FALLHigh, 2-619  
MEASUrement:CH<x>:REFLevels:ABSolute:  
    FALLLow, 2-619  
MEASUrement:CH<x>:REFLevels:ABSolute:  
    FALLMid, 2-620  
MEASUrement:CH<x>:REFLevels:ABSolute:  
    HYSTeresis, 2-620  
MEASUrement:CH<x>:REFLevels:ABSolute:  
    RISEHigh, 2-621  
MEASUrement:CH<x>:REFLevels:ABSolute:  
    RISELow, 2-621  
MEASUrement:CH<x>:REFLevels:ABSolute:  
    RISEMid, 2-622  
MEASUrement:CH<x>:REFLevels:ABSolute:  
    TYPE, 2-622  
MEASUrement:CH<x>:REFLevels:BASETop, 2-623  
MEASUrement:CH<x>:REFLevels:METHod, 2-624  
MEASUrement:CH<x>:REFLevels:PERCent:  
    FALLHigh, 2-624  
MEASUrement:CH<x>:REFLevels:PERCent:  
    FALLLow, 2-625  
MEASUrement:CH<x>:REFLevels:PERCent:  
    FALLMid, 2-625  
MEASUrement:CH<x>:REFLevels:PERCent:  
    HYSTeresis, 2-626  
MEASUrement:CH<x>:REFLevels:PERCent:  
    RISEHigh, 2-626  
MEASUrement:CH<x>:REFLevels:PERCent:  
    RISELow, 2-627  
MEASUrement:CH<x>:REFLevels:PERCent:  
    RISEMid, 2-627  
MEASUrement:CH<x>:REFLevels:PERCent:  
    TYPE, 2-628  
MEASUrement:CLOCKRecovery:ADVanced:  
    METHod, 2-628  
MEASUrement:CLOCKRecovery:  
    CLOCKFrequency, 2-629

- MEASUrement:CLOCKRecovery:
  - CLOCKMultiplier, 2-629
- MEASUrement:CLOCKRecovery:
  - CONSTCLOCKMODE, 2-630
- MEASUrement:CLOCKRecovery:DAMPing, 2-631
- MEASUrement:CLOCKRecovery:DATAPath, 2-631
- MEASUrement:CLOCKRecovery:DATARate, 2-632
- MEASUrement:CLOCKRecovery:
  - EXPLICITCLOCKMODE, 2-632
- MEASUrement:CLOCKRecovery:
  - JTFBandwidth, 2-633
- MEASUrement:CLOCKRecovery:
  - LOOPBandwidth, 2-633
- MEASUrement:CLOCKRecovery:
  - MEANAUTOCalculate, 2-634
- MEASUrement:CLOCKRecovery:METHod, 2-634
- MEASUrement:CLOCKRecovery:MODEL, 2-635
- MEASUrement:CLOCKRecovery:
  - NOMINALOFFset, 2-635
- MEASUrement:CLOCKRecovery:
  - NOMINALOFFset:SELECTIONtype, 2-636
- MEASUrement:CLOCKRecovery:STAndard, 2-636
- MEASUrement:DELEte , 2-637
- MEASUrement:DELETEALL , 2-637
- MEASUrement:DIRacmodel, 2-638
- MEASUrement:DISPLAYUnits, 2-638
- MEASUrement:EDGE<x>, 2-639
- MEASUrement:EYERENDER, 2-639
- MEASUrement:FILTers:BLANKingtime, 2-640
- MEASUrement:FILTers:HIGHPass:FREQ, 2-640
- MEASUrement:FILTers:HIGHPass:SPEC, 2-640
- MEASUrement:FILTers:LOWPass:FREQ, 2-641
- MEASUrement:FILTers:LOWPass:SPEC, 2-641
- MEASUrement:FILTers:RAMptime, 2-642
- MEASUrement:GATing, 2-642
- MEASUrement:GATing:ACTive, 2-643
- MEASUrement:GATing:ENDtime, 2-644
- MEASUrement:GATing:HYSTeresis, 2-644
- MEASUrement:GATing:LOGICSource, 2-645
- MEASUrement:GATing:MIDRef, 2-645
- MEASUrement:GATing:SEARCHSource, 2-646
- MEASUrement:GATing:STARTtime, 2-646
- MEASUrement:HIGHLEVel:CONFIGuration, 2-647
- MEASUrement:HIGHLEVel:EDGEQUALifier, 2-647
- MEASUrement:HIGHLEVel:INLOWPass:
  - FREQ, 2-648
- MEASUrement:HIGHLEVel:INLOWPass:
  - SPEC, 2-648
- MEASUrement:HIGHLEVel:L2LTOL2N, 2-649
- MEASUrement:HIGHLEVel:LINESelected, 2-649
- MEASUrement:HIGHLEVel:
  - OUTEDGEQUALifier, 2-650
- MEASUrement:HIGHLEVel:OUTL2LTOL2N, 2-651
- MEASUrement:HIGHLEVel:
  - OUTLINESelected, 2-652
- MEASUrement:HIGHLEVel:OUTLOWPass:
  - FREQ, 2-650
- MEASUrement:HIGHLEVel:OUTLOWPass:
  - SPEC, 2-651
- MEASUrement:HIGHLEVel:OUTSOURCE, 2-652
- MEASUrement:HIGHLEVel:OUTWIRing, 2-653
- MEASUrement:HIGHLEVel:SOURCE, 2-654
- MEASUrement:HIGHLEVel:WIRing, 2-654
- MEASUrement:INTERp, 2-655
- MEASUrement:JITTermodel, 2-656
- MEASUrement:LIST?, 2-656
- MEASUrement:LOCKRJ, 2-656
- MEASUrement:LOCKRJValue, 2-657
- MEASUrement:MATH<x>:REFLevels:ABSolute:
  - FALLHigh, 2-657
- MEASUrement:MATH<x>:REFLevels:ABSolute:
  - FALLLow, 2-658
- MEASUrement:MATH<x>:REFLevels:ABSolute:
  - FALLMid, 2-658
- MEASUrement:MATH<x>:REFLevels:ABSolute:
  - HYSTeresis, 2-659
- MEASUrement:MATH<x>:REFLevels:ABSolute:
  - RISEHigh, 2-659
- MEASUrement:MATH<x>:REFLevels:ABSolute:
  - RISELow, 2-660
- MEASUrement:MATH<x>:REFLevels:ABSolute:
  - RISEMid, 2-661
- MEASUrement:MATH<x>:REFLevels:ABSolute:
  - TYPE, 2-661
- MEASUrement:MATH<x>:REFLevels:
  - BASETop, 2-662
- MEASUrement:MATH<x>:REFLevels:
  - METHod, 2-662
- MEASUrement:MATH<x>:REFLevels:PERCent:
  - FALLHigh, 2-663
- MEASUrement:MATH<x>:REFLevels:PERCent:
  - FALLLow, 2-664

- MEASUREMENT:MATH<x>:REFLEVELS:PERCENT:  
FALLMid, 2-664
- MEASUREMENT:MATH<x>:REFLEVELS:PERCENT:  
HYSTERESIS, 2-665
- MEASUREMENT:MATH<x>:REFLEVELS:PERCENT:  
RISEHigh, 2-665
- MEASUREMENT:MATH<x>:REFLEVELS:PERCENT:  
RISELow, 2-666
- MEASUREMENT:MATH<x>:REFLEVELS:PERCENT:  
RISEMID, 2-666
- MEASUREMENT:MATH<x>:REFLEVELS:PERCENT:  
TYPE, 2-667
- MEASUREMENT:MEAS?:STLTYpe, 2-787
- MEASUREMENT:MEAS<x>:BER, 2-669
- MEASUREMENT:MEAS<x>:BER:  
TARGETBER, 2-670
- MEASUREMENT:MEAS<x>:BIN, 2-670
- MEASUREMENT:MEAS<x>:BITCfmode, 2-671
- MEASUREMENT:MEAS<x>:BITEnd, 2-671
- MEASUREMENT:MEAS<x>:BITPent, 2-672
- MEASUREMENT:MEAS<x>:BITStart, 2-672
- MEASUREMENT:MEAS<x>:BITType, 2-673
- MEASUREMENT:MEAS<x>:BURSTEDGTYPe, 2-673
- MEASUREMENT:MEAS<x>:CCRESULTS:ALLAcqs:  
MAXimum?, 2-674
- MEASUREMENT:MEAS<x>:CCRESULTS:ALLAcqs:  
MEAN?, 2-674
- MEASUREMENT:MEAS<x>:CCRESULTS:ALLAcqs:  
MINimum?, 2-675
- MEASUREMENT:MEAS<x>:CCRESULTS:ALLAcqs:  
PK2PK?, 2-675
- MEASUREMENT:MEAS<x>:CCRESULTS:ALLAcqs:  
POPulation?, 2-675
- MEASUREMENT:MEAS<x>:CCRESULTS:ALLAcqs:  
STDDev?, 2-676
- MEASUREMENT:MEAS<x>:CCRESULTS:  
CURRENTAcq:MAXimum?, 2-676
- MEASUREMENT:MEAS<x>:CCRESULTS:  
CURRENTAcq:MEAN?, 2-677
- MEASUREMENT:MEAS<x>:CCRESULTS:  
CURRENTAcq:MINimum?, 2-677
- MEASUREMENT:MEAS<x>:CCRESULTS:  
CURRENTAcq:PK2PK?, 2-677
- MEASUREMENT:MEAS<x>:CCRESULTS:  
CURRENTAcq:POPulation?, 2-678
- MEASUREMENT:MEAS<x>:CCRESULTS:  
CURRENTAcq:STDDev?, 2-678
- MEASUREMENT:MEAS<x>:CLOCKRECOVERY:  
ADVanced:METhod, 2-679
- MEASUREMENT:MEAS<x>:CLOCKRECOVERY:  
CLOCKFrequency, 2-679
- MEASUREMENT:MEAS<x>:CLOCKRECOVERY:  
CLOCKMultiplier, 2-680
- MEASUREMENT:MEAS<x>:CLOCKRECOVERY:  
CONSTCLOCKMODE, 2-680
- MEASUREMENT:MEAS<x>:CLOCKRECOVERY:  
DAMPing, 2-681
- MEASUREMENT:MEAS<x>:CLOCKRECOVERY:  
DATAPath, 2-681
- MEASUREMENT:MEAS<x>:CLOCKRECOVERY:  
DATARate, 2-682
- MEASUREMENT:MEAS<x>:CLOCKRECOVERY:  
EXPLICITCLOCKMODE, 2-682
- MEASUREMENT:MEAS<x>:CLOCKRECOVERY:  
GLOBal, 2-683
- MEASUREMENT:MEAS<x>:CLOCKRECOVERY:  
JTFBandwidth, 2-684
- MEASUREMENT:MEAS<x>:CLOCKRECOVERY:  
LOOPBandwidth, 2-684
- MEASUREMENT:MEAS<x>:CLOCKRECOVERY:  
MEANAUTOCalculate, 2-685
- MEASUREMENT:MEAS<x>:CLOCKRECOVERY:  
METhod, 2-685
- MEASUREMENT:MEAS<x>:CLOCKRECOVERY:  
MODEl, 2-686
- MEASUREMENT:MEAS<x>:CLOCKRECOVERY:  
NOMINALOFFset, 2-686
- MEASUREMENT:MEAS<x>:CLOCKRECOVERY:  
NOMINALOFFset:SELECTIONtype, 2-687
- MEASUREMENT:MEAS<x>:CLOCKRECOVERY:  
STANDARD, 2-687
- MEASUREMENT:MEAS<x>:COMMONMODE:  
FILTERS:STATE, 2-688
- MEASUREMENT:MEAS<x>:COMMONMODE:  
SOURCEs, 2-689
- MEASUREMENT:MEAS<x>:COVER, 2-689
- MEASUREMENT:MEAS<x>:  
CUSTOMLIMITSFile, 2-690
- MEASUREMENT:MEAS<x>:CYCLEmode, 2-690
- MEASUREMENT:MEAS<x>:DELAY:EDGE<x>, 2-691
- MEASUREMENT:MEAS<x>:DISPLAYstat:  
ENABLE, 2-692
- MEASUREMENT:MEAS<x>:EDGE<x>, 2-698
- MEASUREMENT:MEAS<x>:EDGEIncr, 2-692

- MEASUrement:MEAS<x>:EDGEQUALifier, 2-693  
 MEASUrement:MEAS<x>:EDGEQUALONE, 2-693  
 MEASUrement:MEAS<x>:EDGEQUALTWO, 2-694  
 MEASUrement:MEAS<x>:EDGES:  
     FROMLevel, 2-694  
 MEASUrement:MEAS<x>:EDGES:LEVel, 2-695  
 MEASUrement:MEAS<x>:EDGES:  
     LOWERFREQuency, 2-695  
 MEASUrement:MEAS<x>:EDGES:N, 2-696  
 MEASUrement:MEAS<x>:EDGES:  
     SLEWRATEMethod, 2-696  
 MEASUrement:MEAS<x>:EDGES:TOLevel, 2-697  
 MEASUrement:MEAS<x>:EDGES:  
     UPPERFREQuency, 2-698  
 MEASUrement:MEAS<x>:EEQUal, 2-699  
 MEASUrement:MEAS<x>:FAILCount?, 2-699  
 MEASUrement:MEAS<x>:  
     FILTERRANGEFROM, 2-700  
 MEASUrement:MEAS<x>:  
     FILTERRANGETO, 2-700  
 MEASUrement:MEAS<x>:FILTErs:  
     BLANKingtime, 2-701  
 MEASUrement:MEAS<x>:FILTErs:GLOBal, 2-701  
 MEASUrement:MEAS<x>:FILTErs:HIGHPass:  
     FREQ, 2-702  
 MEASUrement:MEAS<x>:FILTErs:HIGHPass:  
     SPEC, 2-702  
 MEASUrement:MEAS<x>:FILTErs:LOWPass:  
     FREQ, 2-703  
 MEASUrement:MEAS<x>:FILTErs:LOWPass:  
     SPEC, 2-703  
 MEASUrement:MEAS<x>:FILTErs:  
     RAMPtime, 2-704  
 MEASUrement:MEAS<x>:FREQ, 2-704  
 MEASUrement:MEAS<x>:FROMedge, 2-705  
 MEASUrement:MEAS<x>:  
     FROMEDGESEARCHDIRect, 2-706  
 MEASUrement:MEAS<x>:FROMSymbol:  
     LOGIC2SOUrce, 2-706  
 MEASUrement:MEAS<x>:FROMSymbol:  
     LOGIC3SOUrce, 2-707  
 MEASUrement:MEAS<x>:FROMSymbol:  
     LOGIC4SOUrce, 2-708  
 MEASUrement:MEAS<x>:FROMSymbol:  
     LOGIC5SOUrce, 2-708  
 MEASUrement:MEAS<x>:FROMSymbol:  
     MEASUREAT, 2-709  
 MEASUrement:MEAS<x>:FUNDCURRent, 2-710  
 MEASUrement:MEAS<x>:GATing, 2-711  
 MEASUrement:MEAS<x>:GATing:ACTive, 2-711  
 MEASUrement:MEAS<x>:GATing:ENDtime, 2-712  
 MEASUrement:MEAS<x>:GATing:GLOBal, 2-712  
 MEASUrement:MEAS<x>:GATing:  
     HYSTeresis, 2-713  
 MEASUrement:MEAS<x>:GATing:  
     LOGICSource, 2-714  
 MEASUrement:MEAS<x>:GATing:MIDRef, 2-714  
 MEASUrement:MEAS<x>:GATing:  
     SEARCHSource, 2-715  
 MEASUrement:MEAS<x>:GATing:  
     STARTtime, 2-715  
 MEASUrement:MEAS<x>:GLOBalref, 2-716  
 MEASUrement:MEAS<x>:  
     HARMONICSCLass, 2-716  
 MEASUrement:MEAS<x>:  
     HARMONICSSOURce, 2-717  
 MEASUrement:MEAS<x>:HARMONICSStd, 2-717  
 MEASUrement:MEAS<x>:  
     HARMONICSUNits, 2-718  
 MEASUrement:MEAS<x>:HIGHLEVel:  
     CONFIGuration, 2-718  
 MEASUrement:MEAS<x>:HIGHLEVel:  
     L2LTOL2N, 2-719  
 MEASUrement:MEAS<x>:HIGHLEVel:  
     LINESelected , 2-719  
 MEASUrement:MEAS<x>:HIGHLEVel:  
     OUTL2LTOL2N, 2-720  
 MEASUrement:MEAS<x>:HIGHLEVel:  
     OUTLINESelected, 2-720  
 MEASUrement:MEAS<x>:HIGHLEVel:  
     OUTWIRing, 2-721  
 MEASUrement:MEAS<x>:HIGHLEVel:  
     USEGLOBAL, 2-722  
 MEASUrement:MEAS<x>:HIGHLEVel:  
     WIRing, 2-722  
 MEASUrement:MEAS<x>:HIGHREFVoltage, 2-723  
 MEASUrement:MEAS<x>:HLEVel:OUTPut:  
     UGLobal, 2-723  
 MEASUrement:MEAS<x>:HTORque, 2-724  
 MEASUrement:MEAS<x>:HVOLtage, 2-724  
 MEASUrement:MEAS<x>:IDLETime, 2-725  
 MEASUrement:MEAS<x>:INPUTLEVel, 2-725  
 MEASUrement:MEAS<x>:INPUTPower, 2-726

- MEASUREMENT:MEAS<x>:JITTERSummary:  
DCD, 2-727
- MEASUREMENT:MEAS<x>:JITTERSummary:  
DDJ, 2-727
- MEASUREMENT:MEAS<x>:JITTERSummary:  
DJDD, 2-728
- MEASUREMENT:MEAS<x>:JITTERSummary:  
EYEWIDTHBER, 2-728
- MEASUREMENT:MEAS<x>:JITTERSummary:  
NPJ, 2-729
- MEASUREMENT:MEAS<x>:JITTERSummary:  
PJ, 2-729
- MEASUREMENT:MEAS<x>:JITTERSummary:  
RJDD, 2-730
- MEASUREMENT:MEAS<x>:JITTERSummary:  
TIE, 2-730
- MEASUREMENT:MEAS<x>:JITTERSummary:  
TJBER, 2-731
- MEASUREMENT:MEAS<x>:LABEL, 2-731
- MEASUREMENT:MEAS<x>:LINESelected, 2-732
- MEASUREMENT:MEAS<x>:LOWREFVoltage, 2-732
- MEASUREMENT:MEAS<x>:LTORque, 2-733
- MEASUREMENT:MEAS<x>:LTYPe, 2-733
- MEASUREMENT:MEAS<x>:LUNITs, 2-734
- MEASUREMENT:MEAS<x>:LVOLtage, 2-734
- MEASUREMENT:MEAS<x>:MAXCurrenT, 2-735
- MEASUREMENT:MEAS<x>:MAXCycle, 2-736
- MEASUREMENT:MEAS<x>:MAXGVoltage, 2-736
- MEASUREMENT:MEAS<x>:MAXVoltage, 2-737
- MEASUREMENT:MEAS<x>:MEASRange:  
GLOBal, 2-737
- MEASUREMENT:MEAS<x>:MEASRange:  
MAX, 2-738
- MEASUREMENT:MEAS<x>:MEASRange:MIN, 2-738
- MEASUREMENT:MEAS<x>:MEASRange:  
STATE, 2-739
- MEASUREMENT:MEAS<x>:MECH:EINDexz, 2-739
- MEASUREMENT:MEAS<x>:MECH:GRATio, 2-740
- MEASUREMENT:MEAS<x>:MECH:MUNits, 2-741
- MEASUREMENT:MEAS<x>:MECH:PPAirs, 2-741
- MEASUREMENT:MEAS<x>:MECH:PPRotation, 2-742
- MEASUREMENT:MEAS<x>:MECH:STYPe, 2-742
- MEASUREMENT:MEAS<x>:MINCycle, 2-743
- MEASUREMENT:MEAS<x>:ODDEVen, 2-744
- MEASUREMENT:MEAS<x>:OFILters:LOWPass:  
FREQ, 2-744
- MEASUREMENT:MEAS<x>:OFILters:LOWPass:  
SPEC, 2-745
- MEASUREMENT:MEAS<x>:OSANgle, 2-745
- MEASUREMENT:MEAS<x>:  
OUTEDGEQUALifer, 2-746
- MEASUREMENT:MEAS<x>:OUTFILters:LOWPass:  
FREQ, 2-747
- MEASUREMENT:MEAS<x>:OUTFILters:LOWPass:  
SPEC, 2-747
- MEASUREMENT:MEAS<x>:  
OUTPUT<n>VOLtagE, 2-748
- MEASUREMENT:MEAS<x>:  
PASSFAILENabled, 2-748
- MEASUREMENT:MEAS<x>:  
PASSFAILHIGHlimit, 2-749
- MEASUREMENT:MEAS<x>:PASSFAILLIMIT, 2-749
- MEASUREMENT:MEAS<x>:  
PASSFAILLOWlimit, 2-750
- MEASUREMENT:MEAS<x>:  
PASSFAILMARGin, 2-751
- MEASUREMENT:MEAS<x>:PASSFAILWHEN, 2-751
- MEASUREMENT:MEAS<x>:  
PATTERNDETECTION, 2-752
- MEASUREMENT:MEAS<x>:PATTERNLENgth, 2-753
- MEASUREMENT:MEAS<x>:PATTERNTYPe, 2-753
- MEASUREMENT:MEAS<x>:PCOUNt, 2-754
- MEASUREMENT:MEAS<x>:PERFREQ:EDGE, 2-754
- MEASUREMENT:MEAS<x>:POLarity, 2-755
- MEASUREMENT:MEAS<x>:POPulation:  
GLOBal, 2-755
- MEASUREMENT:MEAS<x>:POPulation:LIMIT:  
STATE, 2-756
- MEASUREMENT:MEAS<x>:POPulation:LIMIT:  
VALue, 2-756
- MEASUREMENT:MEAS<x>:POWERFACTor, 2-757
- MEASUREMENT:MEAS<x>:PREGion, 2-757
- MEASUREMENT:MEAS<x>:PWIDth, 2-758
- MEASUREMENT:MEAS<x>:REDGe, 2-758
- MEASUREMENT:MEAS<x>:REFLevels:ABSolute:  
FALLHigh, 2-759
- MEASUREMENT:MEAS<x>:REFLevels<x>:  
ABSolute:FALLLow, 2-760
- MEASUREMENT:MEAS<x>:REFLevels<x>:  
ABSolute:FALLMid, 2-760
- MEASUREMENT:MEAS<x>:REFLevels<x>:  
ABSolute:HYSteresis, 2-761



- MEASUrement:MEAS<x>:REFLevels<x>:  
ABSolute:RISEHigh, 2-761
- MEASUrement:MEAS<x>:REFLevels<x>:  
ABSolute:RISELow, 2-762
- MEASUrement:MEAS<x>:REFLevels<x>:  
ABSolute:RISEMid, 2-762
- MEASUrement:MEAS<x>:REFLevels<x>:  
ABSolute:TYPE, 2-763
- MEASUrement:MEAS<x>:REFLevels<x>:  
BASETop, 2-763
- MEASUrement:MEAS<x>:REFLevels<x>:  
METHod, 2-764
- MEASUrement:MEAS<x>:REFLevels<x>:PERCent:  
FALLHigh, 2-765
- MEASUrement:MEAS<x>:REFLevels<x>:PERCent:  
FALLLow, 2-765
- MEASUrement:MEAS<x>:REFLevels<x>:PERCent:  
FALLMid, 2-766
- MEASUrement:MEAS<x>:REFLevels<x>:PERCent:  
HYSTeresis, 2-767
- MEASUrement:MEAS<x>:REFLevels<x>:PERCent:  
RISEHigh, 2-767
- MEASUrement:MEAS<x>:REFLevels<x>:PERCent:  
RISELow, 2-768
- MEASUrement:MEAS<x>:REFLevels<x>:PERCent:  
RISEMid, 2-768
- MEASUrement:MEAS<x>:REFLevels<x>:PERCent:  
TYPE, 2-769
- MEASUrement:MEAS<x>:REFMode, 2-769
- MEASUrement:MEAS<x>:REFVoltage, 2-770
- MEASUrement:MEAS<x>:  
REFVOLTAGE<n>Val, 2-770
- MEASUrement:MEAS<x>:RESUlts:ALLAcqs:  
MAXimum?, 2-771
- MEASUrement:MEAS<x>:RESUlts:ALLAcqs:  
MEAN?, 2-771
- MEASUrement:MEAS<x>:RESUlts:ALLAcqs:  
MINimum?, 2-772
- MEASUrement:MEAS<x>:RESUlts:ALLAcqs:  
PK2PK?, 2-772
- MEASUrement:MEAS<x>:RESUlts:ALLAcqs:  
POPulation?, 2-773
- MEASUrement:MEAS<x>:RESUlts:ALLAcqs:  
STDDev?, 2-773
- MEASUrement:MEAS<x>:RESUlts:CURRentacq:  
MAXimum?, 2-774
- MEASUrement:MEAS<x>:RESUlts:CURRentacq:  
MEAN?, 2-774
- MEASUrement:MEAS<x>:RESUlts:CURRentacq:  
MINimum?, 2-775
- MEASUrement:MEAS<x>:RESUlts:CURRentacq:  
PK2PK?, 2-775
- MEASUrement:MEAS<x>:RESUlts:CURRentacq:  
POPulation?, 2-775
- MEASUrement:MEAS<x>:RESUlts:CURRentacq:  
STDDev?, 2-776
- MEASUrement:MEAS<x>:RESUlts:HISTory:  
MAXimum?, 2-776
- MEASUrement:MEAS<x>:RESUlts:HISTory:  
MEAN?, 2-777
- MEASUrement:MEAS<x>:RESUlts:HISTory:  
MINimum?, 2-777
- MEASUrement:MEAS<x>:RESUlts:HISTory:  
PK2PK?, 2-778
- MEASUrement:MEAS<x>:RESUlts:HISTory:  
POPulation?, 2-778
- MEASUrement:MEAS<x>:RESUlts:HISTory:  
STDDev?, 2-779
- MEASUrement:MEAS<x>:  
RIPPLEFREQ<n>Val, 2-779
- MEASUrement:MEAS<x>:SEQUence, 2-780
- MEASUrement:MEAS<x>:  
SIGNALFREQUency, 2-780
- MEASUrement:MEAS<x>:SIGNALType, 2-781
- MEASUrement:MEAS<x>:SLABs, 2-781
- MEASUrement:MEAS<x>:SLPCt, 2-782
- MEASUrement:MEAS<x>:SLTYPe, 2-782
- MEASUrement:MEAS<x>:  
SMOOTHINGFILTER, 2-783
- MEASUrement:MEAS<x>:SOURCE, 2-783
- MEASUrement:MEAS<x>:SOURce<x>, 2-784
- MEASUrement:MEAS<x>:SSC:NOMinalfreq, 2-785
- MEASUrement:MEAS<x>:SSC:NOMinalfreq:  
SELECTIONtype, 2-785
- MEASUrement:MEAS<x>:STATUS?, 2-786
- MEASUrement:MEAS<x>:STLABs, 2-786
- MEASUrement:MEAS<x>:STLPct, 2-787
- MEASUrement:MEAS<x>:STYPe, 2-788
- MEASUrement:MEAS<x>:SUNits, 2-788
- MEASUrement:MEAS<x>:TCKAVG, 2-789
- MEASUrement:MEAS<x>:TCONstant, 2-789
- MEASUrement:MEAS<x>:TIMINGMode, 2-791
- MEASUrement:MEAS<x>:TMETHod, 2-790

- MEASUREMENT:MEAS<x>:TOEdge, 2-791
- MEASUREMENT:MEAS<x>:
  - TOEDGESEARCHDIRect, 2-792
- MEASUREMENT:MEAS<x>:TOSymbol:
  - LOGIC2SOURCE, 2-792
- MEASUREMENT:MEAS<x>:TOSymbol:
  - LOGIC3SOURCE, 2-793
- MEASUREMENT:MEAS<x>:TOSymbol:
  - LOGIC4SOURCE, 2-794
- MEASUREMENT:MEAS<x>:TOSymbol:
  - LOGIC5SOURCE, 2-795
- MEASUREMENT:MEAS<x>:TOSymbol:
  - MEASUREAT, 2-795
- MEASUREMENT:MEAS<x>:TRANSITION, 2-796
- MEASUREMENT:MEAS<x>:TYPE, 2-797
- MEASUREMENT:MEAS<x>:WAITTime, 2-807
- MEASUREMENT:MEAS<x>:WINDOWLENGTH, 2-807
- MEASUREMENT:MEAS<x>:XUNIT?, 2-808
- MEASUREMENT:MEAS<x>:YUNIT?, 2-808
- MEASUREMENT:MEASRange:MAX, 2-668
- MEASUREMENT:MEASRange:MIN, 2-668
- MEASUREMENT:MEASRange:STATE, 2-669
- MEASUREMENT:MECH:EINDEX, 2-808
- MEASUREMENT:MECH:GRATIO, 2-809
- MEASUREMENT:MECH:MUNITS, 2-809
- MEASUREMENT:MECH:PPAIRS, 2-810
- MEASUREMENT:MECH:PPROTATION, 2-811
- MEASUREMENT:MECH:SOURCE<x>, 2-811
- MEASUREMENT:MECH:STYPE, 2-812
- MEASUREMENT:MINUI, 2-812
- MEASUREMENT:POPULATION:LIMIT:STATE, 2-813
- MEASUREMENT:POPULATION:LIMIT:VALUE, 2-813
- MEASUREMENT:REF<x>:REFLEVELS:ABSOLUTE:
  - FALLHigh, 2-824
- MEASUREMENT:REF<x>:REFLEVELS:ABSOLUTE:
  - FALLLow, 2-825
- MEASUREMENT:REF<x>:REFLEVELS:ABSOLUTE:
  - FALLMid, 2-825
- MEASUREMENT:REF<x>:REFLEVELS:ABSOLUTE:
  - HYSTeresis, 2-826
- MEASUREMENT:REF<x>:REFLEVELS:ABSOLUTE:
  - RISEHigh, 2-826
- MEASUREMENT:REF<x>:REFLEVELS:ABSOLUTE:
  - RISELow, 2-827
- MEASUREMENT:REF<x>:REFLEVELS:ABSOLUTE:
  - RISEMid, 2-827
- MEASUREMENT:REF<x>:REFLEVELS:ABSOLUTE:
  - TYPE, 2-828
- MEASUREMENT:REF<x>:REFLEVELS:
  - BASETop, 2-828
- MEASUREMENT:REF<x>:REFLEVELS:METHOd, 2-829
- MEASUREMENT:REF<x>:REFLEVELS:PERCENT:
  - FALLHigh, 2-830
- MEASUREMENT:REF<x>:REFLEVELS:PERCENT:
  - FALLLow, 2-830
- MEASUREMENT:REF<x>:REFLEVELS:PERCENT:
  - FALLMid, 2-831
- MEASUREMENT:REF<x>:REFLEVELS:PERCENT:
  - HYSTeresis, 2-831
- MEASUREMENT:REF<x>:REFLEVELS:PERCENT:
  - RISEHigh, 2-832
- MEASUREMENT:REF<x>:REFLEVELS:PERCENT:
  - RISELow, 2-832
- MEASUREMENT:REF<x>:REFLEVELS:PERCENT:
  - RISEMid, 2-833
- MEASUREMENT:REF<x>:REFLEVELS:PERCENT:
  - TYPE, 2-833
- MEASUREMENT:REFLEVELS:ABSOLUTE:
  - FALLHigh, 2-814
- MEASUREMENT:REFLEVELS:ABSOLUTE:
  - FALLLow, 2-814
- MEASUREMENT:REFLEVELS:ABSOLUTE:
  - FALLMid, 2-815
- MEASUREMENT:REFLEVELS:ABSOLUTE:
  - HYSTeresis, 2-815
- MEASUREMENT:REFLEVELS:ABSOLUTE:
  - RISEHigh, 2-816
- MEASUREMENT:REFLEVELS:ABSOLUTE:
  - RISELow, 2-816
- MEASUREMENT:REFLEVELS:ABSOLUTE:
  - RISEMid, 2-817
- MEASUREMENT:REFLEVELS:ABSOLUTE:TYPE, 2-817
- MEASUREMENT:REFLEVELS:BASETop, 2-818
- MEASUREMENT:REFLEVELS:JITTERMODE, 2-818
- MEASUREMENT:REFLEVELS:METHOd, 2-819
- MEASUREMENT:REFLEVELS:MODE, 2-819
- MEASUREMENT:REFLEVELS:PERCENT:
  - FALLHigh, 2-820
- MEASUREMENT:REFLEVELS:PERCENT:
  - FALLLow, 2-820
- MEASUREMENT:REFLEVELS:PERCENT:
  - FALLMid, 2-821

MEASUREMENT:REFLEVELS:PERCENT:  
 HYSTERESIS, 2-821  
 MEASUREMENT:REFLEVELS:PERCENT:  
 RISEHIGH, 2-822  
 MEASUREMENT:REFLEVELS:PERCENT:  
 RISELOW, 2-822  
 MEASUREMENT:REFLEVELS:PERCENT:  
 RISEMID, 2-823  
 MEASUREMENT:REFLEVELS:PERCENT:TYPE, 2-823  
 MEASUREMENT:REFLEVELS:TYPE, 2-824  
 MEASUREMENT:RESULTS:HISTORY:START, 2-834  
 MEASUREMENT:RESULTS:HISTORY:STOP, 2-835  
 MEASUREMENT:STATISTICS:CYCLEMODE, 2-835  
 MEASUREMENT:WBG:PDEVICE, 2-836

## O

\*OPC, 2-836  
 \*OPT?, 2-837

## P

PAUSE, 2-838  
 PEAKSTABLE:ADDNEW, 2-838  
 PEAKSTABLE:DELETE, 2-838  
 PEAKSTABLE:LIST?, 2-839  
 PEAKSTABLE:TABLE<x>:FRESOLUTION, 2-839  
 PLOT:ADDNEW, 2-840  
 PLOT:DELETE, 2-840  
 PLOT:LIST?, 2-840  
 PLOT:PLOT<x>:BATHTUB:BER, 2-841  
 PLOT:PLOT<x>:BATHTUB:XAXISUNITS, 2-841  
 PLOT:PLOT<x>:BITTYPE, 2-841  
 PLOT:PLOT<x>:EXPORTRAW?, 2-842  
 PLOT:PLOT<x>:EXTENDUIS, 2-843  
 PLOT:PLOT<x>:EYERENDER, 2-843  
 PLOT:PLOT<x>:IMDA:MEAS, 2-844  
 PLOT:PLOT<x>:IMDAPLOTDISPLAY, 2-845  
 PLOT:PLOT<x>:LABEL:COLOR, 2-846  
 PLOT:PLOT<x>:LABEL:FONT:BOLD, 2-846  
 PLOT:PLOT<x>:LABEL:FONT:ITALIC, 2-847  
 PLOT:PLOT<x>:LABEL:FONT:SIZE, 2-847  
 PLOT:PLOT<x>:LABEL:FONT:TYPE, 2-848  
 PLOT:PLOT<x>:LABEL:FONT:UNDERLINE, 2-848  
 PLOT:PLOT<x>:LABEL:NAME, 2-849  
 PLOT:PLOT<x>:LABEL:XPOS, 2-849  
 PLOT:PLOT<x>:LABEL:YPOS, 2-849  
 PLOT:PLOT<x>:MASK?, 2-850

PLOT:PLOT<x>:MASKOFFSET:HORIZONTAL:  
 AUTOFIT, 2-850  
 PLOT:PLOT<x>:MASKOFFSET:PERCENTUI:  
 FROM, 2-851  
 PLOT:PLOT<x>:MASKOFFSET:PERCENTUI:  
 TO, 2-852  
 PLOT:PLOT<x>:NUMBINS, 2-851  
 PLOT:PLOT<x>:PTYPE, 2-852  
 PLOT:PLOT<x>:RAILNUM, 2-853  
 PLOT:PLOT<x>:SOURCE<x>, 2-853  
 PLOT:PLOT<x>:SPECTRUM:BASE, 2-854  
 PLOT:PLOT<x>:SPECTRUM:DYNRANGE, 2-854  
 PLOT:PLOT<x>:TYPE, 2-855  
 POWER:ADDNEW, 2-856  
 POWER:DELETE, 2-856  
 POWER:POWER<x>:AUTOSSET, 2-857  
 POWER:POWER<x>:CLRESPONSE:  
 AMP[1-10]VAL, 2-857  
 POWER:POWER<x>:CLRESPONSE:  
 AMPMODE, 2-858  
 POWER:POWER<x>:CLRESPONSE:  
 ANALYSISMETHOD, 2-859  
 POWER:POWER<x>:CLRESPONSE:  
 AUTORBW, 2-859  
 POWER:POWER<x>:CLRESPONSE:  
 CONNECTSTATUS?, 2-860  
 POWER:POWER<x>:CLRESPONSE:  
 CONSTAMPLITUDE, 2-860  
 POWER:POWER<x>:CLRESPONSE:  
 FREQ[1-11]VAL, 2-861  
 POWER:POWER<x>:CLRESPONSE:GENERATOR, 2-862  
 POWER:POWER<x>:CLRESPONSE:  
 GENIPADDRESS, 2-863  
 POWER:POWER<x>:CLRESPONSE:  
 IMPEDANCE, 2-863  
 POWER:POWER<x>:CLRESPONSE:  
 INPUTSOURCE, 2-864  
 POWER:POWER<x>:CLRESPONSE:MON, 2-865  
 POWER:POWER<x>:CLRESPONSE:  
 OUTPUTSOURCE, 2-865  
 POWER:POWER<x>:CLRESPONSE:PPD, 2-866  
 POWER:POWER<x>:CLRESPONSE:  
 STARTFREQUENCY, 2-866  
 POWER:POWER<x>:CLRESPONSE:  
 STOPFREQUENCY, 2-867  
 POWER:POWER<x>:CLRESPONSE:  
 TESTCONNECTION, 2-868

- POWer:POWer<x>:CYCLEAmp:
  - INPUTSOurce, 2-868
- POWer:POWer<x>:CYCLEBase:
  - INPUTSOurce, 2-869
- POWer:POWer<x>:CYCLEMAX:
  - INPUTSOurce, 2-869
- POWer:POWer<x>:CYCLEMin:
  - INPUTSOurce, 2-870
- POWer:POWer<x>:CYCLEPKPK:
  - INPUTSOurce, 2-871
- POWer:POWer<x>:CYCLETop:
  - INPUTSOurce, 2-871
- POWer:POWer<x>:DIDT:INPUTSOurce, 2-872
- POWer:POWer<x>:DIDT:
  - SOURCEEDGEType, 2-873
- POWer:POWer<x>:DVDT:INPUTSOurce, 2-873
- POWer:POWer<x>:DVDT:
  - SOURCEEDGEType, 2-874
- POWer:POWer<x>:EFFICIENCY:INPUTType, 2-874
- POWer:POWer<x>:EFFICIENCY:
  - IOUT1SOurce, 2-875
- POWer:POWer<x>:EFFICIENCY:
  - IOUT2SOurce, 2-876
- POWer:POWer<x>:EFFICIENCY:
  - IOUT3SOurce, 2-876
- POWer:POWer<x>:EFFICIENCY:ISOurce, 2-877
- POWer:POWer<x>:EFFICIENCY:
  - NUMOFOutputs, 2-878
- POWer:POWer<x>:EFFICIENCY:
  - OUTPUT1Type, 2-879
- POWer:POWer<x>:EFFICIENCY:
  - OUTPUT2Type, 2-879
- POWer:POWer<x>:EFFICIENCY:
  - OUTPUT3Type, 2-880
- POWer:POWer<x>:EFFICIENCY:
  - OUTPUTType, 2-881
- POWer:POWer<x>:EFFICIENCY:
  - VOUT1SOurce, 2-881
- POWer:POWer<x>:EFFICIENCY:
  - VOUT2SOurce, 2-882
- POWer:POWer<x>:EFFICIENCY:
  - VOUT3SOurce, 2-883
- POWer:POWer<x>:EFFICIENCY:VSOurce, 2-884
- POWer:POWer<x>:FREQUENCY:EDGe, 2-884
- POWer:POWer<x>:FREQUENCY:
  - INPUTSOurce, 2-885
- POWer:POWer<x>:GATing, 2-886
- POWer:POWer<x>:GATing:GLOBal, 2-886
- POWer:POWer<x>:HARMONICS:CLASs, 2-887
- POWer:POWer<x>:HARMONICS:CLFile, 2-887
- POWer:POWer<x>:HARMONICS:CMETHod, 2-888
- POWer:POWer<x>:HARMONICS:
  - FUNDCURRent, 2-889
- POWer:POWer<x>:HARMONICS:HORDer, 2-889
- POWer:POWer<x>:HARMONICS:HSOURce, 2-890
- POWer:POWer<x>:HARMONICS:IPOWer, 2-890
- POWer:POWer<x>:HARMONICS:ISOURce, 2-891
- POWer:POWer<x>:HARMONICS:
  - LINEFREQUEncy, 2-891
- POWer:POWer<x>:HARMONICS:ODDEVen, 2-892
- POWer:POWer<x>:HARMONICS:PFACtor, 2-893
- POWer:POWer<x>:HARMONICS:
  - POWERRating, 2-893
- POWer:POWer<x>:HARMONICS:RCURRent, 2-894
- POWer:POWer<x>:HARMONICS:STANDard, 2-894
- POWer:POWer<x>:HARMONICS:
  - STARTFREQUEncy, 2-895
- POWer:POWer<x>:HARMONICS:UNITs, 2-896
- POWer:POWer<x>:HARMONICS:VSOURce, 2-896
- POWer:POWer<x>:IMPEDANCE:
  - AMP[1-10]Val, 2-897
- POWer:POWer<x>:IMPEDANCE:AMPMode, 2-897
- POWer:POWer<x>:IMPEDANCE:
  - ANALYSISMETHod, 2-898
- POWer:POWer<x>:IMPEDANCE:AUTORbw, 2-899
- POWer:POWer<x>:IMPEDANCE:
  - CONNECTSTATus?, 2-899
- POWer:POWer<x>:IMPEDANCE:
  - CONSTAMPLitude, 2-900
- POWer:POWer<x>:IMPEDANCE:
  - FREQ[1-10]Val, 2-900
- POWer:POWer<x>:IMPEDANCE:GENerator, 2-901
- POWer:POWer<x>:IMPEDANCE:
  - GENIPADDress, 2-902
- POWer:POWer<x>:IMPEDANCE:
  - IMPEDANCE, 2-902
- POWer:POWer<x>:IMPEDANCE:
  - INPUTSOurce, 2-903
- POWer:POWer<x>:IMPEDANCE:
  - OUTPUTSOurce, 2-903
- POWer:POWer<x>:IMPEDANCE:PPD, 2-904
- POWer:POWer<x>:IMPEDANCE:
  - STARTFREQUEncy, 2-905

- POWer:POWer<x>:IMPEDANCE:  
     STOPFREQuency, 2-905  
 POWer:POWer<x>:IMPEDANCE:  
     TESTCONNecion, 2-906  
 POWer:POWer<x>:INDUCTANCE:  
     EDGESource, 2-907  
 POWer:POWer<x>:INDUCTANCE:ISOUrce, 2-907  
 POWer:POWer<x>:INDUCTANCE:VSOURce, 2-908  
 POWer:POWer<x>:INPUTCAP:ISOURce, 2-909  
 POWer:POWer<x>:INPUTCAP:  
     PEAKCURRent, 2-910  
 POWer:POWer<x>:INPUTCAP:  
     PEAKVOLTage, 2-910  
 POWer:POWer<x>:INPUTCAP:VSOURce, 2-911  
 POWer:POWer<x>:INRUSHcurrent:  
     INPUTSOurce, 2-912  
 POWer:POWer<x>:INRUSHcurrent:  
     PEAKCURRent, 2-912  
 POWer:POWer<x>:IVSINTEGRALV:  
     ISOURce, 2-913  
 POWer:POWer<x>:IVSINTEGRALV:  
     VSOURce, 2-914  
 POWer:POWer<x>:LABel, 2-914  
 POWer:POWer<x>:LINERIPPLE:  
     INPUTSOurce, 2-915  
 POWer:POWer<x>:LINERIPPLE:  
     LFREQuency, 2-915  
 POWer:POWer<x>:MAGNETICLOSS:  
     ISOURce, 2-916  
 POWer:POWer<x>:MAGNETICLOSS:  
     VSOURce, 2-917  
 POWer:POWer<x>:MAGPROPERTY:  
     AREAofcrosssection, 2-917  
 POWer:POWer<x>:MAGPROPERTY:  
     EDGESOURce, 2-918  
 POWer:POWer<x>:MAGPROPERTY:  
     ISOURce, 2-919  
 POWer:POWer<x>:MAGPROPERTY:LENgth, 2-920  
 POWer:POWer<x>:MAGPROPERTY:  
     PRIMARYTURNs, 2-920  
 POWer:POWer<x>:MAGPROPERTY:  
     SEC1SOURce, 2-921  
 POWer:POWer<x>:MAGPROPERTY:  
     SEC1TURNs, 2-922  
 POWer:POWer<x>:MAGPROPERTY:  
     SEC2SOURce, 2-923  
 POWer:POWer<x>:MAGPROPERTY:  
     SEC2TURNs, 2-924  
 POWer:POWer<x>:MAGPROPERTY:  
     SEC3SOURce, 2-924  
 POWer:POWer<x>:MAGPROPERTY:  
     SEC3TURNs, 2-925  
 POWer:POWer<x>:MAGPROPERTY:  
     SEC4SOURce, 2-926  
 POWer:POWer<x>:MAGPROPERTY:  
     SEC4TURNs, 2-927  
 POWer:POWer<x>:MAGPROPERTY:  
     SEC5SOURce, 2-928  
 POWer:POWer<x>:MAGPROPERTY:  
     SEC5TURNs, 2-929  
 POWer:POWer<x>:MAGPROPERTY:  
     SEC6SOURce, 2-929  
 POWer:POWer<x>:MAGPROPERTY:  
     SEC6TURNs, 2-930  
 POWer:POWer<x>:MAGPROPERTY:  
     SECPhase, 2-931  
 POWer:POWer<x>:MAGPROPERTY:  
     SECVolt, 2-932  
 POWer:POWer<x>:MAGPROPERTY:  
     SECWINDings, 2-932  
 POWer:POWer<x>:MAGPROPERTY:UNITs, 2-933  
 POWer:POWer<x>:MAGPROPERTY:  
     VSOURce, 2-934  
 POWer:POWer<x>:NDUTYCYCLE:  
     EDGEType, 2-935  
 POWer:POWer<x>:NDUTYCYCLE:  
     INPUTSOurce, 2-935  
 POWer:POWer<x>:NPULSEWIDTH:  
     INPUTSOurce, 2-936  
 POWer:POWer<x>:PDUTYCYCLE:  
     EDGEType, 2-937  
 POWer:POWer<x>:PDUTYCYCLE:  
     INPUTSOurce, 2-937  
 POWer:POWer<x>:PERIOD:EDGe, 2-938  
 POWer:POWer<x>:PERIOD:INPUTSOurce, 2-938  
 POWer:POWer<x>:POWERQUALITY:  
     CCYCLes, 2-939  
 POWer:POWer<x>:POWERQUALITY:  
     FREFeRence, 2-939  
 POWer:POWer<x>:POWERQUALITY:  
     ISOURce, 2-940  
 POWer:POWer<x>:POWERQUALITY:STYPe, 2-940

- POWer:POWer<x>:POWERQUALITY:  
VSOURce, 2-941
- POWer:POWer<x>:PPULSEWIDTH:  
INPUTSOurce, 2-942
- POWer:POWer<x>:PRESET, 2-942
- POWer:POWer<x>:PSRR:AMP[1-10]Val, 2-943
- POWer:POWer<x>:PSRR:AMPMode, 2-943
- POWer:POWer<x>:PSRR:ANALYSISMethod, 2-944
- POWer:POWer<x>:PSRR:AUTORbw, 2-945
- POWer:POWer<x>:PSRR:  
CONNECTSTATus?, 2-945
- POWer:POWer<x>:PSRR:CONSTAMplitude, 2-946
- POWer:POWer<x>:PSRR:FREQ[1-11]Val, 2-946
- POWer:POWer<x>:PSRR:GENerator, 2-948
- POWer:POWer<x>:PSRR:GENIPADdress, 2-948
- POWer:POWer<x>:PSRR:IMPEDance, 2-949
- POWer:POWer<x>:PSRR:INPUTSOurce, 2-950
- POWer:POWer<x>:PSRR:OUTPUTSOurce, 2-950
- POWer:POWer<x>:PSRR:PPD, 2-951
- POWer:POWer<x>:PSRR:STARTFREQuency, 2-951
- POWer:POWer<x>:PSRR:STOPFREQuency, 2-952
- POWer:POWer<x>:PSRR:TESTCONNection, 2-952
- POWer:POWer<x>:RDSON:DEVICEType, 2-953
- POWer:POWer<x>:RDSON:ISOURce, 2-954
- POWer:POWer<x>:RDSON:VSOURce, 2-954
- POWer:POWer<x>:REFLevels:ABSolute:  
FALLHigh, 2-955
- POWer:POWer<x>:REFLevels:ABSolute:  
FALLLow, 2-956
- POWer:POWer<x>:REFLevels:ABSolute:  
FALLMid, 2-956
- POWer:POWer<x>:REFLevels:ABSolute:  
HYSTeresis, 2-957
- POWer:POWer<x>:REFLevels:ABSolute:  
RISEHigh, 2-957
- POWer:POWer<x>:REFLevels:ABSolute:  
RISELow, 2-958
- POWer:POWer<x>:REFLevels:ABSolute:  
RISEMid, 2-959
- POWer:POWer<x>:REFLevels:ABSolute:  
TYPE, 2-959
- POWer:POWer<x>:REFLevels:BASETop, 2-960
- POWer:POWer<x>:REFLevels:METHod, 2-960
- POWer:POWer<x>:REFLevels:PERCent:  
FALLHigh, 2-961
- POWer:POWer<x>:REFLevels:PERCent:  
FALLLow, 2-961
- POWer:POWer<x>:REFLevels:PERCent:  
FALLMid, 2-962
- POWer:POWer<x>:REFLevels:PERCent:  
HYSTeresis, 2-963
- POWer:POWer<x>:REFLevels:PERCent:  
RISEHigh, 2-963
- POWer:POWer<x>:REFLevels:PERCent:  
RISELow, 2-964
- POWer:POWer<x>:REFLevels:PERCent:  
RISEMid, 2-964
- POWer:POWer<x>:REFLevels:PERCent:  
TYPE, 2-965
- POWer:POWer<x>:RESUlts:ALLAcqs:  
MAXimum?, 2-966
- POWer:POWer<x>:RESUlts:ALLAcqs:  
MEAN?, 2-968
- POWer:POWer<x>:RESUlts:ALLAcqs:  
MINimum?, 2-970
- POWer:POWer<x>:RESUlts:ALLAcqs:  
PK2PK?, 2-972
- POWer:POWer<x>:RESUlts:ALLAcqs:  
POPulation?, 2-975
- POWer:POWer<x>:RESUlts:ALLAcqs:  
STDDev?, 2-977
- POWer:POWer<x>:RESUlts:CURRentacq:  
F1MAG?, 2-979
- POWer:POWer<x>:RESUlts:CURRentacq:  
F3MAG?, 2-979
- POWer:POWer<x>:RESUlts:CURRentacq:  
FREQUENCY?, 2-980
- POWer:POWer<x>:RESUlts:CURRentacq:  
IRMS?, 2-980
- POWer:POWer<x>:RESUlts:CURRentacq:  
MAXimum?, 2-981
- POWer:POWer<x>:RESUlts:CURRentacq:  
MEAN?, 2-983
- POWer:POWer<x>:RESUlts:CURRentacq:  
MINimum?, 2-985
- POWer:POWer<x>:RESUlts:CURRentacq:  
PK2PK?, 2-987
- POWer:POWer<x>:RESUlts:CURRentacq:  
POHCL?, 2-989
- POWer:POWer<x>:RESUlts:CURRentacq:  
POHCM?, 2-990
- POWer:POWer<x>:RESUlts:CURRentacq:  
POHCS?, 2-990

- POWer:POWer<x>:RESUlts:CURRentacq:  
POPULation?, 2-990
- POWer:POWer<x>:RESUlts:CURRentacq:  
RMS?, 2-993
- POWer:POWer<x>:RESUlts:CURRentacq:  
STATUS?, 2-993
- POWer:POWer<x>:RESUlts:CURRentacq:  
STDDev?, 2-994
- POWer:POWer<x>:RESUlts:CURRentacq:  
THDF?, 2-996
- POWer:POWer<x>:RESUlts:CURRentacq:  
THDR?, 2-996
- POWer:POWer<x>:RESUlts:CURRentacq:  
TRPWR?, 2-997
- POWer:POWer<x>:RESUlts:CURRentacq:  
VRMS?, 2-997
- POWer:POWer<x>:SEQSEtUp, 2-998
- POWer:POWer<x>:SEQUence, 2-998
- POWer:POWer<x>:SOA:ISOURce, 2-999
- POWer:POWer<x>:SOA:POINT, 2-999
- POWer:POWer<x>:SOA:RECALLmask, 2-1000
- POWer:POWer<x>:SOA:RECALLmask:  
FILEName, 2-1000
- POWer:POWer<x>:SOA:SAVemask, 2-1001
- POWer:POWer<x>:SOA:SAVemask:  
AUTOINCrement, 2-1001
- POWer:POWer<x>:SOA:SAVemask:  
FILEName, 2-1002
- POWer:POWer<x>:SOA:SAVemask:FOLDer, 2-1002
- POWer:POWer<x>:SOA:VSOURce, 2-1003
- POWer:POWer<x>:SWITCHINGLOSS:  
DEVICEType, 2-1003
- POWer:POWer<x>:SWITCHINGLOSS:  
GATESource, 2-1004
- POWer:POWer<x>:SWITCHINGLOSS:  
ILEVELAbs, 2-1004
- POWer:POWer<x>:SWITCHINGLOSS:  
ILEVELPct, 2-1005
- POWer:POWer<x>:SWITCHINGLOSS:  
ISOURce, 2-1006
- POWer:POWer<x>:SWITCHINGLOSS:  
LEVELUNIts, 2-1006
- POWer:POWer<x>:SWITCHINGLOSS:  
RDSOn, 2-1007
- POWer:POWer<x>:SWITCHINGLOSS:  
SWLCONFIGType, 2-1007
- POWer:POWer<x>:SWITCHINGLOSS:  
VCESat, 2-1008
- POWer:POWer<x>:SWITCHINGLOSS:  
VGLevel, 2-1009
- POWer:POWer<x>:SWITCHINGLOSS:  
VLEVELAbs, 2-1009
- POWer:POWer<x>:SWITCHINGLOSS:  
VLEVELPct, 2-1010
- POWer:POWer<x>:SWITCHINGLOSS:  
VSOURce, 2-1010
- POWer:POWer<x>:SWITCHINGRIPPLE:  
INPUTSOurce, 2-1011
- POWer:POWer<x>:SWITCHINGRIPPLE:  
LFREQuency, 2-1012
- POWer:POWer<x>:TURNOFFtime:  
FREQuency, 2-1012
- POWer:POWer<x>:TURNOFFtime:  
INPUTLEVel, 2-1013
- POWer:POWer<x>:TURNOFFtime:  
INPUTSOurce, 2-1013
- POWer:POWer<x>:TURNOFFtime:  
MAXTIME, 2-1014
- POWer:POWer<x>:TURNOFFtime:  
MAXVoltage, 2-1015
- POWer:POWer<x>:TURNOFFtime:  
NUMOUTputs, 2-1015
- POWer:POWer<x>:TURNOFFtime:  
OUTPUT1SOURce, 2-1017
- POWer:POWer<x>:TURNOFFtime:  
OUTPUT1VOLTage, 2-1017
- POWer:POWer<x>:TURNOFFtime:  
OUTPUT2SOURce, 2-1018
- POWer:POWer<x>:TURNOFFtime:  
OUTPUT2VOLTage, 2-1019
- POWer:POWer<x>:TURNOFFtime:  
OUTPUT3SOURce, 2-1019
- POWer:POWer<x>:TURNOFFtime:  
OUTPUT3VOLTage, 2-1020
- POWer:POWer<x>:TURNOFFtime:  
OUTPUT4SOURce, 2-1021
- POWer:POWer<x>:TURNOFFtime:  
OUTPUT4VOLTage, 2-1021
- POWer:POWer<x>:TURNOFFtime:  
OUTPUT5SOURce, 2-1022
- POWer:POWer<x>:TURNOFFtime:  
OUTPUT5VOLTage, 2-1023

POWer:POWer<x>:TURNOFFtime:  
 OUTPUT6SOURce, 2-1024  
 POWer:POWer<x>:TURNOFFtime:  
 OUTPUT6VOLTage, 2-1024  
 POWer:POWer<x>:TURNOFFtime:  
 OUTPUT7SOURce, 2-1025  
 POWer:POWer<x>:TURNOFFtime:  
 OUTPUT7VOLTage, 2-1026  
 POWer:POWer<x>:TURNOFFtime:TYPE, 2-1026  
 POWer:POWer<x>:TURNONtime:  
 FREQuency, 2-1027  
 POWer:POWer<x>:TURNONtime:  
 INPUTLEVel, 2-1028  
 POWer:POWer<x>:TURNONtime:  
 INPUTSOurce, 2-1028  
 POWer:POWer<x>:TURNONtime:  
 MAXTIME, 2-1029  
 POWer:POWer<x>:TURNONtime:  
 MAXVoltage, 2-1029  
 POWer:POWer<x>:TURNONtime:  
 NUMOUTputs, 2-1030  
 POWer:POWer<x>:TURNONtime:  
 OUTPUT1SOURce, 2-1031  
 POWer:POWer<x>:TURNONtime:  
 OUTPUT1VOLTage, 2-1032  
 POWer:POWer<x>:TURNONtime:  
 OUTPUT2SOURce, 2-1033  
 POWer:POWer<x>:TURNONtime:  
 OUTPUT2VOLTage, 2-1033  
 POWer:POWer<x>:TURNONtime:  
 OUTPUT3SOURce, 2-1034  
 POWer:POWer<x>:TURNONtime:  
 OUTPUT3VOLTage, 2-1035  
 POWer:POWer<x>:TURNONtime:  
 OUTPUT4SOURce, 2-1035  
 POWer:POWer<x>:TURNONtime:  
 OUTPUT4VOLTage, 2-1036  
 POWer:POWer<x>:TURNONtime:  
 OUTPUT5SOURce, 2-1037  
 POWer:POWer<x>:TURNONtime:  
 OUTPUT5VOLTage, 2-1037  
 POWer:POWer<x>:TURNONtime:  
 OUTPUT6SOURce, 2-1038  
 POWer:POWer<x>:TURNONtime:  
 OUTPUT6VOLTage, 2-1039  
 POWer:POWer<x>:TURNONtime:  
 OUTPUT7SOURce, 2-1040

POWer:POWer<x>:TURNONtime:  
 OUTPUT7VOLTage, 2-1040  
 POWer:POWer<x>:TURNONtime:TYPE, 2-1041  
 POWer:POWer<x>:TYPE, 2-1042  
 \*PSC, 2-1042  
 \*PUD, 2-1043

## R

RECALL:MASK, 2-1044  
 RECALL:SESSion, 2-1044  
 RECALL:SETUp, 2-1045  
 RECALL:WAVEform, 2-1046  
 REF:ADDNew, 2-1046  
 REF:DELeTe, 2-1047  
 REF:LIST?, 2-1047  
 REF:REF<x>:DESKew, 2-1048  
 REF:REF<x>:LAbel:COLor, 2-1048  
 REF:REF<x>:LAbel:FONT:BOLD, 2-1048  
 REF:REF<x>:LAbel:FONT:ITALic, 2-1049  
 REF:REF<x>:LAbel:FONT:SIZE, 2-1049  
 REF:REF<x>:LAbel:FONT:TYPE, 2-1050  
 REF:REF<x>:LAbel:FONT:UNDERline, 2-1050  
 REF:REF<x>:LAbel:NAME, 2-1051  
 REF:REF<x>:LAbel:XPOS, 2-1051  
 REF:REF<x>:LAbel:YPOS, 2-1052  
 REF:REF<x>:SOURce, 2-1052  
 REF<x>\_D<x>:LAbel:COLor, 2-1057  
 REF<x>\_D<x>:LAbel:FONT:BOLD, 2-1057  
 REF<x>\_D<x>:LAbel:FONT:ITALic, 2-1058  
 REF<x>\_D<x>:LAbel:FONT:SIZE, 2-1058  
 REF<x>\_D<x>:LAbel:FONT:TYPE, 2-1059  
 REF<x>\_D<x>:LAbel:FONT:UNDERline, 2-1059  
 REF<x>\_D<x>:LAbel:NAME, 2-1060  
 REF<x>\_D<x>:LAbel:XPOS, 2-1060  
 REF<x>\_D<x>:LAbel:YPOS, 2-1061  
 REF<x>\_DALL:LAbel:COLor, 2-1053  
 REF<x>\_DALL:LAbel:FONT:BOLD, 2-1053  
 REF<x>\_DALL:LAbel:FONT:ITALic, 2-1054  
 REF<x>\_DALL:LAbel:FONT:SIZE, 2-1054  
 REF<x>\_DALL:LAbel:FONT:TYPE, 2-1055  
 REF<x>\_DALL:LAbel:FONT:UNDERline, 2-1055  
 REF<x>\_DALL:LAbel:NAME, 2-1056  
 REF<x>\_DALL:LAbel:XPOS, 2-1056  
 REF<x>\_DALL:LAbel:YPOS, 2-1056  
 REM, 2-1061  
 REMOTE:ACQMethod, 2-1063  
 REMOTE:ACQStatus?, 2-1062



- REMOTE:ACQUIRE, 2-1061
  - REMOTE:ADDNew, 2-1062
  - REMOTE:COMMInter, 2-1063
  - REMOTE:CONTROL, 2-1064
  - REMOTE:DELEte, 2-1064
  - REMOTE:LOGGING, 2-1065
  - REMOTE:NUMAcq?, 2-1065
  - REMOTE:S<x>\_CH<x>:DIGGRP:D<x>:
    - THReshold, 2-1066
  - REMOTE:S<x>\_CH<x>:DIGGRP:
    - THReshold, 2-1066
  - REMOTE:S<x>\_CH<x>:PROBETYPe?, 2-1067
  - REMOTE:S<x>\_CH<x>:SElect:DIGGRP:
    - Dall, 2-1068
  - REMOTE:S<x>\_CH<x>:STAtE, 2-1068
  - REMOTE:S<x>\_CH<x>:SV:
    - CENTERFrequency, 2-1065
  - REMOTE:S<x>\_CH<x>:SV:POSition, 2-1067
  - REMOTE:S<x>\_CH<x>:SV:
    - STARTFrequency?, 2-1069
  - REMOTE:S<x>\_CH<x>:SV:STAtE, 2-1069
  - REMOTE:S<x>\_CH<x>:SV:
    - STOPFrequency?, 2-1070
  - REMOTE:S<x>\_DCH<x>:D<x>:THReshold, 2-1070
  - REMOTE:S<x>\_DCH<x>:
    - GROUP<x>THReshold, 2-1071
  - REMOTE:S<x>\_DCH<x>:SElect:DAll, 2-1071
  - REMOTE:SCOPE<x>:BANDWidth?, 2-1073
  - REMOTE:SCOPE<x>:CONNECT, 2-1073
  - REMOTE:SCOPE<x>:
    - CONNECTIONMessage?, 2-1073
  - REMOTE:SCOPE<x>:CONNECTIONStAtE?, 2-1074
  - REMOTE:SCOPE<x>:DISCONNECT, 2-1074
  - REMOTE:SCOPE<x>:HORizontal:FASTframe:
    - COUNT?, 2-1074
  - REMOTE:SCOPE<x>:HORizontal:FASTframe:
    - MAXFrames?, 2-1075
  - REMOTE:SCOPE<x>:HORizontal:FASTframe:
    - SELECTED?, 2-1075
  - REMOTE:SCOPE<x>:HORizontal:FASTframe:
    - STAtE?, 2-1076
  - REMOTE:SCOPE<x>:HORizontal:FASTframe:
    - SUMFrame?, 2-1076
  - REMOTE:SCOPE<x>:HORizontal:FASTframe:
    - SUMFrame:STAtE?, 2-1077
  - REMOTE:SCOPE<x>:IPADdress, 2-1077
  - REMOTE:SCOPE<x>:MODELname?, 2-1078
  - REMOTE:SCOPE<x>:PORT, 2-1078
  - REMOTE:SCOPE<x>:SCREen:CAPtUre, 2-1079
  - REMOTE:SCOPE<x>:StAtE?, 2-1079
  - REMOTE:SCOPE<x>:SYNC, 2-1080
  - REMOTE:SCOPE<x>:
    - VISACONNectioNtype, 2-1080
  - REMOTE:SEquence:CURrent?, 2-1072
  - REMOTE:SEquence:NUMSEquence, 2-1072
  - REMOTE:SV:RBW, 2-1081
  - REMOTE:SV:RBWMode, 2-1081
  - REMOTE:SV:SPAN, 2-1082
  - REMOTE:SV:SPANRBWRatio, 2-1082
  - REMOTE:SV:WINDOW, 2-1083
  - REMOTE:USBDEscriptors, 2-1084
  - \*RST, 2-1084
- S**
- S<x>\_CH<x>:BANDwidth:ACTUAl?, 2-1086
  - S<x>\_CH<x>:CLIPping?, 2-1086
  - S<x>\_CH<x>:COUPLing, 2-1087
  - S<x>\_CH<x>:DESKew, 2-1087
  - S<x>\_CH<x>:LABel:COLor, 2-1088
  - S<x>\_CH<x>:LABel:FONT:BOLD, 2-1088
  - S<x>\_CH<x>:LABel:FONT:ITALic, 2-1089
  - S<x>\_CH<x>:LABel:FONT:SIZE, 2-1089
  - S<x>\_CH<x>:LABel:FONT:TYPE, 2-1090
  - S<x>\_CH<x>:LABel:FONT:UNDERline, 2-1090
  - S<x>\_CH<x>:LABel:NAME, 2-1091
  - S<x>\_CH<x>:LABel:XPOS, 2-1091
  - S<x>\_CH<x>:LABel:YPOS, 2-1092
  - S<x>\_CH<x>:OFFSet, 2-1092
  - S<x>\_CH<x>:POSition, 2-1093
  - S<x>\_CH<x>:SCAle, 2-1093
  - SAVe:EVENTtable:BUS, 2-1093
  - SAVe:EVENTtable:CUSTom, 2-1094
  - SAVe:EVENTtable:CUSTom:COMMENTS, 2-1094
  - SAVe:EVENTtable:CUSTom:DATAFormat, 2-1095
  - SAVe:EVENTtable:CUSTom:
    - INCLUDEREFs, 2-1095
  - SAVe:EVENTtable:MEASUrement, 2-1096
  - SAVe:EVENTtable:PEAKS, 2-1097
  - SAVe:EVENTtable:SEARCHTable, 2-1097
  - SAVe:IMAGe, 2-1098
  - SAVe:IMAGe:COMPosition, 2-1098
  - SAVe:IMAGe:VIEWTYpe, 2-1099
  - SAVe:PLOTData, 2-1099
  - SAVe:REPOrt, 2-1100

- SAVe:REPOrt:COMMeNts, 2-1101
- SAVe:SESSion, 2-1101
- SAVe:SETUp, 2-1102
- SAVe:SETUp:INCLUDEREFs, 2-1103
- SAVe:WAVEform, 2-1103
- SAVe:WAVEform:GATing, 2-1105
- SAVe:WAVEform:GATing:RESAMPLERate, 2-1106
- SAVe:WAVEform:SOURCELIst?, 2-1106
- SAVEONEVent:FILEDest, 2-1106
- SAVEONEVent:FILENAME, 2-1107
- SAVEONEVent:IMAGE:FILEFormat, 2-1107
- SAVEONEVent:WAVEform:FILEFormat, 2-1108
- SAVEONEVent:WAVEform:SOUrce, 2-1109
- SCOPEApp REBOOT, 2-1109
- SEARCH:ADDNew, 2-1110
- SEARCH:DELeTe, 2-1110
- SEARCH:DELETEALL, 2-1110
- SEARCH:LIST?, 2-1111
- SEARCH:SEARCH<x>:COpy, 2-1111
- SEARCH:SEARCH<x>:NAVigate, 2-1111
- SEARCH:SEARCH<x>:TOTAL?, 2-1112
- SEARCH:SEARCH<x>:TRIGger:A:BUS:  
ARINC429A:CONDition, 2-1112
- SEARCH:SEARCH<x>:TRIGger:A:BUS:  
ARINC429A:DATA:HIVALue, 2-1113
- SEARCH:SEARCH<x>:TRIGger:A:BUS:  
ARINC429A:DATA:QUALifier, 2-1114
- SEARCH:SEARCH<x>:TRIGger:A:BUS:  
ARINC429A:DATA:VALue, 2-1114
- SEARCH:SEARCH<x>:TRIGger:A:BUS:  
ARINC429A:ERRTYPe, 2-1115
- SEARCH:SEARCH<x>:TRIGger:A:BUS:  
ARINC429A:LABel:HIVALue, 2-1116
- SEARCH:SEARCH<x>:TRIGger:A:BUS:  
ARINC429A:LABel:QUALifier, 2-1116
- SEARCH:SEARCH<x>:TRIGger:A:BUS:  
ARINC429A:LABel:VALue, 2-1117
- SEARCH:SEARCH<x>:TRIGger:A:BUS:  
ARINC429A:SDI:VALue, 2-1117
- SEARCH:SEARCH<x>:TRIGger:A:BUS:  
ARINC429A:SSM:VALue, 2-1118
- SEARCH:SEARCH<x>:TRIGger:A:BUS:AUDio:  
CONDition, 2-1119
- SEARCH:SEARCH<x>:TRIGger:A:BUS:AUDio:  
DATA:HITDMVALue, 2-1119
- SEARCH:SEARCH<x>:TRIGger:A:BUS:AUDio:  
DATA:HIVALue, 2-1120
- SEARCH:SEARCH<x>:TRIGger:A:BUS:AUDio:  
DATA:OFFSet, 2-1120
- SEARCH:SEARCH<x>:TRIGger:A:BUS:AUDio:  
DATA:QUALifier, 2-1121
- SEARCH:SEARCH<x>:TRIGger:A:BUS:AUDio:  
DATA:TDMVALue, 2-1122
- SEARCH:SEARCH<x>:TRIGger:A:BUS:AUDio:  
DATA:VALue, 2-1122
- SEARCH:SEARCH<x>:TRIGger:A:BUS:AUDio:  
DATA:WORD, 2-1123
- SEARCH:SEARCH<x>:TRIGger:A:BUS:  
AUTOETHERnet:CONDition, 2-1124
- SEARCH:SEARCH<x>:TRIGger:A:BUS:  
AUTOETHERnet:DATA:HIVALue, 2-1125
- SEARCH:SEARCH<x>:TRIGger:A:BUS:  
AUTOETHERnet:DATA:OFFSet, 2-1125
- SEARCH:SEARCH<x>:TRIGger:A:BUS:  
AUTOETHERnet:DATA:SIZE, 2-1126
- SEARCH:SEARCH<x>:TRIGger:A:BUS:  
AUTOETHERnet:DATA:VALue, 2-1127
- SEARCH:SEARCH<x>:TRIGger:A:BUS:  
AUTOETHERnet:IPHeader:DESTinationaddr:  
VALue, 2-1128
- SEARCH:SEARCH<x>:TRIGger:A:BUS:  
AUTOETHERnet:IPHeader:PROTOcol:  
VALue, 2-1129
- SEARCH:SEARCH<x>:TRIGger:A:BUS:  
AUTOETHERnet:IPHeader:SOUrceaddr:  
VALue, 2-1129
- SEARCH:SEARCH<x>:TRIGger:A:BUS:  
AUTOETHERnet:MAC:ADDRess:DESTination:  
VALue, 2-1130
- SEARCH:SEARCH<x>:TRIGger:A:BUS:  
AUTOETHERnet:MAC:ADDRess:SOUrce:  
VALue, 2-1131
- SEARCH:SEARCH<x>:TRIGger:A:BUS:  
AUTOETHERnet:MAC:LENgth:  
HIVALue, 2-1132
- SEARCH:SEARCH<x>:TRIGger:A:BUS:  
AUTOETHERnet:MAC:LENgth:VALue, 2-1133
- SEARCH:SEARCH<x>:TRIGger:A:BUS:  
AUTOETHERnet:QTAG:VALue, 2-1134
- SEARCH:SEARCH<x>:TRIGger:A:BUS:  
AUTOETHERnet:QUALifier, 2-1134
- SEARCH:SEARCH<x>:TRIGger:A:BUS:  
AUTOETHERnet:TCPHeader:ACKnum:  
VALue, 2-1135

- SEARCH:SEARCH<x>:TRIGger:A:BUS:  
AUTOETHERnet:TCPHeader:DESTinationport:  
VALue, 2-1136
- SEARCH:SEARCH<x>:TRIGger:A:BUS:  
AUTOETHERnet:TCPHeader:SEQnum:  
VALue, 2-1137
- SEARCH:SEARCH<x>:TRIGger:A:BUS:  
AUTOETHERnet:TCPHeader:SOUrceport:  
VALue, 2-1138
- SEARCH:SEARCH<x>:TRIGger:A:BUS:B:NRZ:  
CONDition, 2-1328
- SEARCH:SEARCH<x>:TRIGger:A:BUS:CAN:  
CONDition, 2-1139
- SEARCH:SEARCH<x>:TRIGger:A:BUS:CAN:  
DATa:DIRection, 2-1139
- SEARCH:SEARCH<x>:TRIGger:A:BUS:CAN:  
DATa:OFFSet, 2-1140
- SEARCH:SEARCH<x>:TRIGger:A:BUS:CAN:  
DATa:QUALifier, 2-1141
- SEARCH:SEARCH<x>:TRIGger:A:BUS:CAN:  
DATa:SIZE, 2-1141
- SEARCH:SEARCH<x>:TRIGger:A:BUS:CAN:  
DATa:VALue, 2-1142
- SEARCH:SEARCH<x>:TRIGger:A:BUS:CAN:  
ERRType, 2-1142
- SEARCH:SEARCH<x>:TRIGger:A:BUS:CAN:FD:  
BRSBit, 2-1143
- SEARCH:SEARCH<x>:TRIGger:A:BUS:CAN:FD:  
ESIBit, 2-1144
- SEARCH:SEARCH<x>:TRIGger:A:BUS:CAN:  
FRAMeType, 2-1144
- SEARCH:SEARCH<x>:TRIGger:A:BUS:CAN:  
IDentifier:MODE, 2-1145
- SEARCH:SEARCH<x>:TRIGger:A:BUS:CAN:  
IDentifier:VALue, 2-1146
- SEARCH:SEARCH<x>:TRIGger:A:BUS:CPHY:  
BLUe:VALue, 2-1146
- SEARCH:SEARCH<x>:TRIGger:A:BUS:CPHY:  
CONDition, 2-1147
- SEARCH:SEARCH<x>:TRIGger:A:BUS:CPHY:  
DATa:SIZE, 2-1148
- SEARCH:SEARCH<x>:TRIGger:A:BUS:CPHY:  
DATa:VALue, 2-1148
- SEARCH:SEARCH<x>:TRIGger:A:BUS:CPHY:  
ERRor:TYPE, 2-1149
- SEARCH:SEARCH<x>:TRIGger:A:BUS:CPHY:  
ESCAPEMODE:COMMand, 2-1149
- SEARCH:SEARCH<x>:TRIGger:A:BUS:CPHY:  
GREen:VALue, 2-1150
- SEARCH:SEARCH<x>:TRIGger:A:BUS:CPHY:  
MODE:TYPE, 2-1151
- SEARCH:SEARCH<x>:TRIGger:A:BUS:CPHY:  
PACKets:LIST, 2-1151
- SEARCH:SEARCH<x>:TRIGger:A:BUS:CPHY:  
PACKets:TYPE, 2-1154
- SEARCH:SEARCH<x>:TRIGger:A:BUS:CPHY:  
PIXel:NUMBer, 2-1155
- SEARCH:SEARCH<x>:TRIGger:A:BUS:CPHY:  
PIXel:SEARCHOPTion, 2-1156
- SEARCH:SEARCH<x>:TRIGger:A:BUS:CPHY:  
RED:VALue, 2-1156
- SEARCH:SEARCH<x>:TRIGger:A:BUS:CPHY:  
SYMBOL:SIZE, 2-1157
- SEARCH:SEARCH<x>:TRIGger:A:BUS:CPHY:  
SYMBOL:VALue, 2-1157
- SEARCH:SEARCH<x>:TRIGger:A:BUS:CPHY:  
WORD:SIZE, 2-1158
- SEARCH:SEARCH<x>:TRIGger:A:BUS:CPHY:  
WORD:VALue, 2-1158
- SEARCH:SEARCH<x>:TRIGger:A:BUS:CPHY:  
WORDCOUNT:VALue, 2-1159
- SEARCH:SEARCH<x>:TRIGger:A:BUS:CPHY:  
YCBCR:CB, 2-1160
- SEARCH:SEARCH<x>:TRIGger:A:BUS:CPHY:  
YCBCR:CR, 2-1160
- SEARCH:SEARCH<x>:TRIGger:A:BUS:CPHY:  
YCBCR:Y, 2-1161
- SEARCH:SEARCH<x>:TRIGger:A:BUS:CPHY:  
YUV:U, 2-1161
- SEARCH:SEARCH<x>:TRIGger:A:BUS:CPHY:  
YUV:V, 2-1162
- SEARCH:SEARCH<x>:TRIGger:A:BUS:CPHY:  
YUV:Y, 2-1162
- SEARCH:SEARCH<x>:TRIGger:A:BUS:CXPI:  
CONDition, 2-1163
- SEARCH:SEARCH<x>:TRIGger:A:BUS:CXPI:  
COUNter:VALue, 2-1164
- SEARCH:SEARCH<x>:TRIGger:A:BUS:CXPI:  
DATa:SIZE, 2-1164
- SEARCH:SEARCH<x>:TRIGger:A:BUS:CXPI:  
DATa:VALue, 2-1165
- SEARCH:SEARCH<x>:TRIGger:A:BUS:CXPI:  
DLC:VALue, 2-1165

- SEARCH:SEARCH<x>:TRIGger:A:BUS:CXPI:  
ERROR:TYPe, 2-1166
- SEARCH:SEARCH<x>:TRIGger:A:BUS:CXPI:  
EXTDLC:VALue, 2-1167
- SEARCH:SEARCH<x>:TRIGger:A:BUS:CXPI:  
FRAMe:TYPe, 2-1167
- SEARCH:SEARCH<x>:TRIGger:A:BUS:CXPI:  
FRAMEID:VALue, 2-1168
- SEARCH:SEARCH<x>:TRIGger:A:BUS:CXPI:  
NETMN:SLEePIND, 2-1169
- SEARCH:SEARCH<x>:TRIGger:A:BUS:CXPI:  
NETMN:WAKEUPIND, 2-1169
- SEARCH:SEARCH<x>:TRIGger:A:BUS:DPHY:  
BLUe:VALue, 2-1170
- SEARCH:SEARCH<x>:TRIGger:A:BUS:DPHY:  
CONDition, 2-1170
- SEARCH:SEARCH<x>:TRIGger:A:BUS:DPHY:  
DATa:SIZE, 2-1171
- SEARCH:SEARCH<x>:TRIGger:A:BUS:DPHY:  
DATa:VALue, 2-1172
- SEARCH:SEARCH<x>:TRIGger:A:BUS:DPHY:  
ERRor:TYPe, 2-1172
- SEARCH:SEARCH<x>:TRIGger:A:BUS:DPHY:  
ESCAPEMODE:COMManD, 2-1173
- SEARCH:SEARCH<x>:TRIGger:A:BUS:DPHY:  
GREen:VALue, 2-1174
- SEARCH:SEARCH<x>:TRIGger:A:BUS:DPHY:  
MODE:TYPe, 2-1174
- SEARCH:SEARCH<x>:TRIGger:A:BUS:DPHY:  
PACKets:LIST, 2-1175
- SEARCH:SEARCH<x>:TRIGger:A:BUS:DPHY:  
PACKets:TYPe, 2-1178
- SEARCH:SEARCH<x>:TRIGger:A:BUS:DPHY:  
PIXel:NUMBer, 2-1179
- SEARCH:SEARCH<x>:TRIGger:A:BUS:DPHY:  
PIXel:SEARCHOPTion, 2-1179
- SEARCH:SEARCH<x>:TRIGger:A:BUS:DPHY:  
RED:VALue, 2-1180
- SEARCH:SEARCH<x>:TRIGger:A:BUS:DPHY:  
WORDCOUNt:VALue, 2-1180
- SEARCH:SEARCH<x>:TRIGger:A:BUS:DPHY:  
YCBCR:CB, 2-1181
- SEARCH:SEARCH<x>:TRIGger:A:BUS:DPHY:  
YCBCR:CR, 2-1182
- SEARCH:SEARCH<x>:TRIGger:A:BUS:DPHY:  
YCBCR:Y, 2-1182
- SEARCH:SEARCH<x>:TRIGger:A:BUS:DPHY:  
YUV:U, 2-1183
- SEARCH:SEARCH<x>:TRIGger:A:BUS:DPHY:  
YUV:V, 2-1183
- SEARCH:SEARCH<x>:TRIGger:A:BUS:DPHY:  
YUV:Y, 2-1184
- SEARCH:SEARCH<x>:TRIGger:A:BUS:ESPI:  
ADDRes:VALue, 2-1184
- SEARCH:SEARCH<x>:TRIGger:A:BUS:ESPI:  
COMMAND:OPCode, 2-1185
- SEARCH:SEARCH<x>:TRIGger:A:BUS:ESPI:  
CONDition, 2-1186
- SEARCH:SEARCH<x>:TRIGger:A:BUS:ESPI:  
CYCLETYPe, 2-1187
- SEARCH:SEARCH<x>:TRIGger:A:BUS:ESPI:  
DATa:SIZE, 2-1189
- SEARCH:SEARCH<x>:TRIGger:A:BUS:ESPI:  
DATa:VALue, 2-1189
- SEARCH:SEARCH<x>:TRIGger:A:BUS:ESPI:  
ERRor:TYPe, 2-1190
- SEARCH:SEARCH<x>:TRIGger:A:BUS:ESPI:  
LENGth:VALue, 2-1190
- SEARCH:SEARCH<x>:TRIGger:A:BUS:ESPI:  
PHASe, 2-1191
- SEARCH:SEARCH<x>:TRIGger:A:BUS:ESPI:  
RESPCYCLE:TYPe, 2-1192
- SEARCH:SEARCH<x>:TRIGger:A:BUS:ESPI:  
SMBUS:DESTination:ADDRes, 2-1193
- SEARCH:SEARCH<x>:TRIGger:A:BUS:ESPI:  
SMBUS:SLAVe:ADDRes, 2-1193
- SEARCH:SEARCH<x>:TRIGger:A:BUS:ESPI:  
STATus:VALue, 2-1194
- SEARCH:SEARCH<x>:TRIGger:A:BUS:ESPI:TAG:  
VALue, 2-1194
- SEARCH:SEARCH<x>:TRIGger:A:BUS:ESPI:  
VIRTUALWIRe:COUNt:VALue, 2-1195
- SEARCH:SEARCH<x>:TRIGger:A:BUS:ESPI:  
VIRTUALWIRe:DATa:VALue, 2-1195
- SEARCH:SEARCH<x>:TRIGger:A:BUS:ESPI:  
VIRTUALWIRe:INDex:VALue, 2-1196
- SEARCH:SEARCH<x>:TRIGger:A:BUS:ESPI:  
VIRTUALWIRe:RESPonse:VALue, 2-1197
- SEARCH:SEARCH<x>:TRIGger:A:BUS:  
ETHERCAT:ADDRESSMODE, 2-1197
- SEARCH:SEARCH<x>:TRIGger:A:BUS:  
ETHERCAT:CNTNV:VALue, 2-1198

SEARCH:SEARCH<x>:TRIGger:A:BUS:  
   ETHERCAT:COMMANDTYPe, 2-1198  
 SEARCH:SEARCH<x>:TRIGger:A:BUS:  
   ETHERCAT:CONDition, 2-1199  
 SEARCH:SEARCH<x>:TRIGger:A:BUS:  
   ETHERCAT:CYC:VALue, 2-1200  
 SEARCH:SEARCH<x>:TRIGger:A:BUS:  
   ETHERCAT:DATA:SIZE, 2-1201  
 SEARCH:SEARCH<x>:TRIGger:A:BUS:  
   ETHERCAT:DATA:VALue, 2-1202  
 SEARCH:SEARCH<x>:TRIGger:A:BUS:  
   ETHERCAT:DATAGRAM, 2-1202  
 SEARCH:SEARCH<x>:TRIGger:A:BUS:  
   ETHERCAT:DATAGRAMHEADer, 2-1203  
 SEARCH:SEARCH<x>:TRIGger:A:BUS:  
   ETHERCAT:DATAGRAMHEADer:  
   LENGth, 2-1203  
 SEARCH:SEARCH<x>:TRIGger:A:BUS:  
   ETHERCAT:DESTINATIONADDRess:  
   VALue, 2-1204  
 SEARCH:SEARCH<x>:TRIGger:A:BUS:  
   ETHERCAT:DEVICEADDRess, 2-1205  
 SEARCH:SEARCH<x>:TRIGger:A:BUS:  
   ETHERCAT:ERRor:REPLY:SERVice:  
   DATA, 2-1205  
 SEARCH:SEARCH<x>:TRIGger:A:BUS:  
   ETHERCAT:FRAMETYPe, 2-1206  
 SEARCH:SEARCH<x>:TRIGger:A:BUS:  
   ETHERCAT:HASH:VALue, 2-1207  
 SEARCH:SEARCH<x>:TRIGger:A:BUS:  
   ETHERCAT:HEADer:LENGth, 2-1207  
 SEARCH:SEARCH<x>:TRIGger:A:BUS:  
   ETHERCAT:IDENtification:VALue, 2-1208  
 SEARCH:SEARCH<x>:TRIGger:A:BUS:  
   ETHERCAT:IDX:VALue, 2-1208  
 SEARCH:SEARCH<x>:TRIGger:A:BUS:  
   ETHERCAT:INDEx:VALue, 2-1209  
 SEARCH:SEARCH<x>:TRIGger:A:BUS:  
   ETHERCAT:IPDESTination:ADDRess:  
   VALue, 2-1210  
 SEARCH:SEARCH<x>:TRIGger:A:BUS:  
   ETHERCAT:IPSOURce:ADDRess:  
   VALue, 2-1210  
 SEARCH:SEARCH<x>:TRIGger:A:BUS:  
   ETHERCAT:IRQ:VALue, 2-1211  
 SEARCH:SEARCH<x>:TRIGger:A:BUS:  
   ETHERCAT:LEN:VALue, 2-1212  
 SEARCH:SEARCH<x>:TRIGger:A:BUS:  
   ETHERCAT:LOGICALADDRess:  
   VALue, 2-1212  
 SEARCH:SEARCH<x>:TRIGger:A:BUS:  
   ETHERCAT:MAILbox, 2-1213  
 SEARCH:SEARCH<x>:TRIGger:A:BUS:  
   ETHERCAT:MAILbox:ADDRess:VALue, 2-1213  
 SEARCH:SEARCH<x>:TRIGger:A:BUS:  
   ETHERCAT:MAILbox:CNT:VALue, 2-1214  
 SEARCH:SEARCH<x>:TRIGger:A:BUS:  
   ETHERCAT:MAILbox:DETail, 2-1215  
 SEARCH:SEARCH<x>:TRIGger:A:BUS:  
   ETHERCAT:MAILbox:HEADer, 2-1215  
 SEARCH:SEARCH<x>:TRIGger:A:BUS:  
   ETHERCAT:MAILBOXTYPe, 2-1216  
 SEARCH:SEARCH<x>:TRIGger:A:BUS:  
   ETHERCAT:NETWork:VARiable, 2-1217  
 SEARCH:SEARCH<x>:TRIGger:A:BUS:  
   ETHERCAT:NETWork:VARiable:  
   HEADer, 2-1218  
 SEARCH:SEARCH<x>:TRIGger:A:BUS:  
   ETHERCAT:NETWORKVARiable:DATA:  
   SIZE, 2-1218  
 SEARCH:SEARCH<x>:TRIGger:A:BUS:  
   ETHERCAT:NETWORKVARiable:DATA:  
   VALue, 2-1219  
 SEARCH:SEARCH<x>:TRIGger:A:BUS:  
   ETHERCAT:OFFSet:VALue, 2-1220  
 SEARCH:SEARCH<x>:TRIGger:A:BUS:  
   ETHERCAT:POSition:VALue, 2-1220  
 SEARCH:SEARCH<x>:TRIGger:A:BUS:  
   ETHERCAT:PROTOCOLTYPe, 2-1221  
 SEARCH:SEARCH<x>:TRIGger:A:BUS:  
   ETHERCAT:PUBID:VALue, 2-1221  
 SEARCH:SEARCH<x>:TRIGger:A:BUS:  
   ETHERCAT:QUALity:VALue, 2-1222  
 SEARCH:SEARCH<x>:TRIGger:A:BUS:  
   ETHERCAT:SERVice:DATA:LENGth, 2-1223  
 SEARCH:SEARCH<x>:TRIGger:A:BUS:  
   ETHERCAT:SERVice:DATA:SIZE, 2-1223  
 SEARCH:SEARCH<x>:TRIGger:A:BUS:  
   ETHERCAT:SERVice:DATA:VALue, 2-1224  
 SEARCH:SEARCH<x>:TRIGger:A:BUS:  
   ETHERCAT:SOURCEADDRess:VALue, 2-1224  
 SEARCH:SEARCH<x>:TRIGger:A:BUS:  
   ETHERCAT:SRC:PORT:VALue, 2-1225

- SEARCH:SEARCH<x>:TRIGger:A:BUS:  
ETHERCAT:TCI:VALue, 2-1226
- SEARCH:SEARCH<x>:TRIGger:A:BUS:  
ETHERCAT:WKC:VALue, 2-1226
- SEARCH:SEARCH<x>:TRIGger:A:BUS:  
ETHERnet:CONDition, 2-1227
- SEARCH:SEARCH<x>:TRIGger:A:BUS:  
ETHERnet:DATA:HIVALue, 2-1228
- SEARCH:SEARCH<x>:TRIGger:A:BUS:  
ETHERnet:DATA:OFFSet, 2-1229
- SEARCH:SEARCH<x>:TRIGger:A:BUS:  
ETHERnet:DATA:QUALifier, 2-1229
- SEARCH:SEARCH<x>:TRIGger:A:BUS:  
ETHERnet:DATA:SIZE, 2-1230
- SEARCH:SEARCH<x>:TRIGger:A:BUS:  
ETHERnet:DATA:VALue, 2-1231
- SEARCH:SEARCH<x>:TRIGger:A:BUS:  
ETHERnet:IPHeader:DESTinationadr:  
VALue, 2-1232
- SEARCH:SEARCH<x>:TRIGger:A:BUS:  
ETHERnet:IPHeader:PROTOcol:VALue, 2-1232
- SEARCH:SEARCH<x>:TRIGger:A:BUS:  
ETHERnet:IPHeader:SOURceaddr:  
VALue, 2-1233
- SEARCH:SEARCH<x>:TRIGger:A:BUS:  
ETHERnet:MAC:ADDRess:DESTination:  
VALue, 2-1234
- SEARCH:SEARCH<x>:TRIGger:A:BUS:  
ETHERnet:MAC:ADDRess:SOURce:  
VALue, 2-1235
- SEARCH:SEARCH<x>:TRIGger:A:BUS:  
ETHERnet:MAC:LENgth:HIVALue, 2-1236
- SEARCH:SEARCH<x>:TRIGger:A:BUS:  
ETHERnet:MAC:LENgth:VALue, 2-1236
- SEARCH:SEARCH<x>:TRIGger:A:BUS:  
ETHERnet:QTAG:VALue, 2-1237
- SEARCH:SEARCH<x>:TRIGger:A:BUS:  
ETHERnet:TCPHeader:ACKnum:VALue, 2-1238
- SEARCH:SEARCH<x>:TRIGger:A:BUS:  
ETHERnet:TCPHeader:DESTinationport:  
VALue, 2-1238
- SEARCH:SEARCH<x>:TRIGger:A:BUS:  
ETHERnet:TCPHeader:SEQnum:VALue, 2-1239
- SEARCH:SEARCH<x>:TRIGger:A:BUS:  
ETHERnet:TCPHeader:SOURceport:  
VALue, 2-1240
- SEARCH:SEARCH<x>:TRIGger:A:BUS:EUSB:  
ADDRess:HIVALue, 2-1241
- SEARCH:SEARCH<x>:TRIGger:A:BUS:EUSB:  
ADDRess:VALue, 2-1241
- SEARCH:SEARCH<x>:TRIGger:A:BUS:EUSB:  
CONDition, 2-1242
- SEARCH:SEARCH<x>:TRIGger:A:BUS:EUSB:  
DATA:HIVALue, 2-1243
- SEARCH:SEARCH<x>:TRIGger:A:BUS:EUSB:  
DATA:OFFSet, 2-1244
- SEARCH:SEARCH<x>:TRIGger:A:BUS:EUSB:  
DATA:QUALifier, 2-1244
- SEARCH:SEARCH<x>:TRIGger:A:BUS:EUSB:  
DATA:SIZE, 2-1245
- SEARCH:SEARCH<x>:TRIGger:A:BUS:EUSB:  
DATA:TYPE, 2-1246
- SEARCH:SEARCH<x>:TRIGger:A:BUS:EUSB:  
DATA:VALue, 2-1246
- SEARCH:SEARCH<x>:TRIGger:A:BUS:EUSB:  
DATABITS:SIZE, 2-1247
- SEARCH:SEARCH<x>:TRIGger:A:BUS:EUSB:  
ENDPoint:VALue, 2-1248
- SEARCH:SEARCH<x>:TRIGger:A:BUS:EUSB:  
ENDSEARCh, 2-1249
- SEARCH:SEARCH<x>:TRIGger:A:BUS:EUSB:  
EOP:DATABITS:SIZE, 2-1249
- SEARCH:SEARCH<x>:TRIGger:A:BUS:EUSB:  
EOP:QUALifier, 2-1250
- SEARCH:SEARCH<x>:TRIGger:A:BUS:EUSB:  
EOPBITS:MAX:SIZE, 2-1251
- SEARCH:SEARCH<x>:TRIGger:A:BUS:EUSB:  
EOPBITS:MIN:SIZE, 2-1251
- SEARCH:SEARCH<x>:TRIGger:A:BUS:EUSB:  
ERRType, 2-1248
- SEARCH:SEARCH<x>:TRIGger:A:BUS:EUSB:  
HANDSHAKEType, 2-1252
- SEARCH:SEARCH<x>:TRIGger:A:BUS:EUSB:  
RAP:ADDRess:VALue, 2-1253
- SEARCH:SEARCH<x>:TRIGger:A:BUS:EUSB:  
RAP:COMMand, 2-1253
- SEARCH:SEARCH<x>:TRIGger:A:BUS:EUSB:  
RAP:DATA:VALue, 2-1254
- SEARCH:SEARCH<x>:TRIGger:A:BUS:EUSB:  
RAP:OPTion, 2-1255
- SEARCH:SEARCH<x>:TRIGger:A:BUS:EUSB:  
SOFFRAMENUMber, 2-1255

- SEARCH:SEARCH<x>:TRIGger:A:BUS:EUSB:  
SPECIALType, 2-1256
- SEARCH:SEARCH<x>:TRIGger:A:BUS:EUSB:  
SPLit:ET:VALue, 2-1256
- SEARCH:SEARCH<x>:TRIGger:A:BUS:EUSB:  
SPLit:HUB:VALue, 2-1257
- SEARCH:SEARCH<x>:TRIGger:A:BUS:EUSB:  
SPLit:PORT:VALue, 2-1258
- SEARCH:SEARCH<x>:TRIGger:A:BUS:EUSB:  
SPLit:SC:VALue, 2-1258
- SEARCH:SEARCH<x>:TRIGger:A:BUS:EUSB:  
SPLit:SE:VALue, 2-1259
- SEARCH:SEARCH<x>:TRIGger:A:BUS:EUSB:  
SYNC:QUALifier, 2-1260
- SEARCH:SEARCH<x>:TRIGger:A:BUS:EUSB:  
SYNCBITS:MAX:SIZE, 2-1261
- SEARCH:SEARCH<x>:TRIGger:A:BUS:EUSB:  
SYNCBITS:MIN:SIZE, 2-1261
- SEARCH:SEARCH<x>:TRIGger:A:BUS:EUSB:  
SYNCSEARCh, 2-1262
- SEARCH:SEARCH<x>:TRIGger:A:BUS:EUSB:  
TOKENType, 2-1262
- SEARCH:SEARCH<x>:TRIGger:A:BUS:  
FLEXRAY:CONDition, 2-1263
- SEARCH:SEARCH<x>:TRIGger:A:BUS:  
FLEXRAY:CYCLEcount:HIVALue, 2-1264
- SEARCH:SEARCH<x>:TRIGger:A:BUS:  
FLEXRAY:CYCLEcount:QUALifier, 2-1264
- SEARCH:SEARCH<x>:TRIGger:A:BUS:  
FLEXRAY:CYCLEcount:VALue, 2-1265
- SEARCH:SEARCH<x>:TRIGger:A:BUS:  
FLEXRAY:DATA:HIVALue, 2-1265
- SEARCH:SEARCH<x>:TRIGger:A:BUS:  
FLEXRAY:DATA:OFFSet, 2-1266
- SEARCH:SEARCH<x>:TRIGger:A:BUS:  
FLEXRAY:DATA:QUALifier, 2-1267
- SEARCH:SEARCH<x>:TRIGger:A:BUS:  
FLEXRAY:DATA:SIZE, 2-1267
- SEARCH:SEARCH<x>:TRIGger:A:BUS:  
FLEXRAY:DATA:VALue, 2-1268
- SEARCH:SEARCH<x>:TRIGger:A:BUS:  
FLEXRAY:EOFTYPE, 2-1268
- SEARCH:SEARCH<x>:TRIGger:A:BUS:  
FLEXRAY:ERRTYPE, 2-1269
- SEARCH:SEARCH<x>:TRIGger:A:BUS:  
FLEXRAY:FRAMEID:HIVALue, 2-1270
- SEARCH:SEARCH<x>:TRIGger:A:BUS:  
FLEXRAY:FRAMEID:QUALifier, 2-1270
- SEARCH:SEARCH<x>:TRIGger:A:BUS:  
FLEXRAY:FRAMEID:VALue, 2-1271
- SEARCH:SEARCH<x>:TRIGger:A:BUS:  
FLEXRAY:FRAMEType, 2-1271
- SEARCH:SEARCH<x>:TRIGger:A:BUS:  
FLEXRAY:HEADER:CRC, 2-1272
- SEARCH:SEARCH<x>:TRIGger:A:BUS:  
FLEXRAY:HEADER:CYCLECount, 2-1272
- SEARCH:SEARCH<x>:TRIGger:A:BUS:  
FLEXRAY:HEADER:FRAMEID, 2-1273
- SEARCH:SEARCH<x>:TRIGger:A:BUS:  
FLEXRAY:HEADER:INDBits, 2-1273
- SEARCH:SEARCH<x>:TRIGger:A:BUS:  
FLEXRAY:HEADER:PAYLENGth, 2-1274
- SEARCH:SEARCH<x>:TRIGger:A:BUS:I2C:  
ADDRess:MODE, 2-1275
- SEARCH:SEARCH<x>:TRIGger:A:BUS:I2C:  
ADDRess:VALue, 2-1275
- SEARCH:SEARCH<x>:TRIGger:A:BUS:I2C:  
CONDition, 2-1276
- SEARCH:SEARCH<x>:TRIGger:A:BUS:I2C:DATA:  
DIRection, 2-1277
- SEARCH:SEARCH<x>:TRIGger:A:BUS:I2C:DATA:  
SIZE, 2-1277
- SEARCH:SEARCH<x>:TRIGger:A:BUS:I2C:DATA:  
VALue, 2-1278
- SEARCH:SEARCH<x>:TRIGger:A:BUS:I3C:  
ADDRess:MODE, 2-1278
- SEARCH:SEARCH<x>:TRIGger:A:BUS:I3C:  
ADDRess:VALue, 2-1279
- SEARCH:SEARCH<x>:TRIGger:A:BUS:I3C:BCR:  
VALue, 2-1280
- SEARCH:SEARCH<x>:TRIGger:A:BUS:I3C:  
BCRType:VALue, 2-1280
- SEARCH:SEARCH<x>:TRIGger:A:BUS:I3C:  
BPACKets, 2-1281
- SEARCH:SEARCH<x>:TRIGger:A:BUS:I3C:  
BRGTID:VALue, 2-1282
- SEARCH:SEARCH<x>:TRIGger:A:BUS:I3C:  
CCODE:VALue, 2-1282
- SEARCH:SEARCH<x>:TRIGger:A:BUS:I3C:  
CONDition, 2-1283
- SEARCH:SEARCH<x>:TRIGger:A:BUS:I3C:DATA:  
DIRection, 2-1284

- SEARCH:SEARCH<x>:TRIGger:A:BUS:I3C:DATA:SIZE, 2-1284
- SEARCH:SEARCH<x>:TRIGger:A:BUS:I3C:DATA:VALue, 2-1285
- SEARCH:SEARCH<x>:TRIGger:A:BUS:I3C:DCR:VALue, 2-1285
- SEARCH:SEARCH<x>:TRIGger:A:BUS:I3C:DCRType:VALue, 2-1286
- SEARCH:SEARCH<x>:TRIGger:A:BUS:I3C:DWORD:VALue, 2-1287
- SEARCH:SEARCH<x>:TRIGger:A:BUS:I3C:ERRORTYPE, 2-1287
- SEARCH:SEARCH<x>:TRIGger:A:BUS:I3C:EVENTBYTE:VALue, 2-1288
- SEARCH:SEARCH<x>:TRIGger:A:BUS:I3C:FREQBYTE:VALue, 2-1288
- SEARCH:SEARCH<x>:TRIGger:A:BUS:I3C:GSLsb:VALue, 2-1289
- SEARCH:SEARCH<x>:TRIGger:A:BUS:I3C:GSMsb:VALue, 2-1290
- SEARCH:SEARCH<x>:TRIGger:A:BUS:I3C:ID:VALue, 2-1290
- SEARCH:SEARCH<x>:TRIGger:A:BUS:I3C:INACCBYTE:VALue, 2-1291
- SEARCH:SEARCH<x>:TRIGger:A:BUS:I3C:MAXREAD:VALue, 2-1291
- SEARCH:SEARCH<x>:TRIGger:A:BUS:I3C:MAXRTURN:VALue, 2-1292
- SEARCH:SEARCH<x>:TRIGger:A:BUS:I3C:MAXWRITE:VALue, 2-1292
- SEARCH:SEARCH<x>:TRIGger:A:BUS:I3C:PACKets, 2-1293
- SEARCH:SEARCH<x>:TRIGger:A:BUS:I3C:SADDRESS:VALue, 2-1294
- SEARCH:SEARCH<x>:TRIGger:A:BUS:I3C:SDR:BROADCASTPacket, 2-1294
- SEARCH:SEARCH<x>:TRIGger:A:BUS:I3C:SDR:DIRECTPacket, 2-1295
- SEARCH:SEARCH<x>:TRIGger:A:BUS:I3C:STATEBYTE:VALue, 2-1296
- SEARCH:SEARCH<x>:TRIGger:A:BUS:I3C:STATic:ADDRESS, 2-1297
- SEARCH:SEARCH<x>:TRIGger:A:BUS:I3C:SUPPORTBYTE:VALue, 2-1297
- SEARCH:SEARCH<x>:TRIGger:A:BUS:I3C:TESTMODE:VALue, 2-1298
- SEARCH:SEARCH<x>:TRIGger:A:BUS:LIN:CONDition, 2-1299
- SEARCH:SEARCH<x>:TRIGger:A:BUS:LIN:DATA:HIVALue, 2-1299
- SEARCH:SEARCH<x>:TRIGger:A:BUS:LIN:DATA:QUALifier, 2-1300
- SEARCH:SEARCH<x>:TRIGger:A:BUS:LIN:DATA:SIZE, 2-1300
- SEARCH:SEARCH<x>:TRIGger:A:BUS:LIN:DATA:VALue, 2-1301
- SEARCH:SEARCH<x>:TRIGger:A:BUS:LIN:ERRType, 2-1301
- SEARCH:SEARCH<x>:TRIGger:A:BUS:LIN:IDentifier:VALue, 2-1302
- SEARCH:SEARCH<x>:TRIGger:A:BUS:MANChester:CONDition, 2-1303
- SEARCH:SEARCH<x>:TRIGger:A:BUS:MANChester:DATA:SIZE, 2-1303
- SEARCH:SEARCH<x>:TRIGger:A:BUS:MANChester:DATA:VALue, 2-1304
- SEARCH:SEARCH<x>:TRIGger:A:BUS:MANChester:ERRor:TYPE, 2-1305
- SEARCH:SEARCH<x>:TRIGger:A:BUS:MANChester:HEADER:VALue, 2-1305
- SEARCH:SEARCH<x>:TRIGger:A:BUS:MANChester:packetOffData:VALue, 2-1306
- SEARCH:SEARCH<x>:TRIGger:A:BUS:MANChester:SYNC:VALue, 2-1307
- SEARCH:SEARCH<x>:TRIGger:A:BUS:MANChester:TRAILER:VALue, 2-1307
- SEARCH:SEARCH<x>:TRIGger:A:BUS:MDIO:ADDRESS:VALue, 2-1308
- SEARCH:SEARCH<x>:TRIGger:A:BUS:MDIO:CONDition, 2-1309
- SEARCH:SEARCH<x>:TRIGger:A:BUS:MDIO:DATA:VALue, 2-1309
- SEARCH:SEARCH<x>:TRIGger:A:BUS:MDIO:DEVicetype:VALue, 2-1310
- SEARCH:SEARCH<x>:TRIGger:A:BUS:MDIO:ERRType, 2-1311
- SEARCH:SEARCH<x>:TRIGger:A:BUS:MDIO:OPCode:VALue, 2-1311
- SEARCH:SEARCH<x>:TRIGger:A:BUS:MDIO:PHYSicaladdress:VALue, 2-1312
- SEARCH:SEARCH<x>:TRIGger:A:BUS:MDIO:REGisteraddress:VALue, 2-1312



- SEARCH:SEARCH<x>:TRIGger:A:BUS:  
MIL1553B:COMMAND:ADDRESS:  
HIVALue, 2-1313
- SEARCH:SEARCH<x>:TRIGger:A:BUS:  
MIL1553B:COMMAND:ADDRESS:  
QUALifier, 2-1314
- SEARCH:SEARCH<x>:TRIGger:A:BUS:  
MIL1553B:COMMAND:ADDRESS:  
VALue, 2-1314
- SEARCH:SEARCH<x>:TRIGger:A:BUS:  
MIL1553B:COMMAND:COUNT, 2-1315
- SEARCH:SEARCH<x>:TRIGger:A:BUS:  
MIL1553B:COMMAND:PARity, 2-1315
- SEARCH:SEARCH<x>:TRIGger:A:BUS:  
MIL1553B:COMMAND:SUBADDRESS, 2-1316
- SEARCH:SEARCH<x>:TRIGger:A:BUS:  
MIL1553B:COMMAND:TRBit, 2-1317
- SEARCH:SEARCH<x>:TRIGger:A:BUS:  
MIL1553B:CONDITION, 2-1317
- SEARCH:SEARCH<x>:TRIGger:A:BUS:  
MIL1553B:DATA:PARity, 2-1318
- SEARCH:SEARCH<x>:TRIGger:A:BUS:  
MIL1553B:DATA:VALue, 2-1319
- SEARCH:SEARCH<x>:TRIGger:A:BUS:  
MIL1553B:ERRTYPe, 2-1319
- SEARCH:SEARCH<x>:TRIGger:A:BUS:  
MIL1553B:STATUS:ADDRESS:HIVALue, 2-1320
- SEARCH:SEARCH<x>:TRIGger:A:BUS:  
MIL1553B:STATUS:ADDRESS:QUALifier, 2-1320
- SEARCH:SEARCH<x>:TRIGger:A:BUS:  
MIL1553B:STATUS:ADDRESS:VALue, 2-1321
- SEARCH:SEARCH<x>:TRIGger:A:BUS:  
MIL1553B:STATUS:BIT:BCR, 2-1322
- SEARCH:SEARCH<x>:TRIGger:A:BUS:  
MIL1553B:STATUS:BIT:BUSY, 2-1322
- SEARCH:SEARCH<x>:TRIGger:A:BUS:  
MIL1553B:STATUS:BIT:DBCA, 2-1323
- SEARCH:SEARCH<x>:TRIGger:A:BUS:  
MIL1553B:STATUS:BIT:INSTR, 2-1324
- SEARCH:SEARCH<x>:TRIGger:A:BUS:  
MIL1553B:STATUS:BIT:ME, 2-1324
- SEARCH:SEARCH<x>:TRIGger:A:BUS:  
MIL1553B:STATUS:BIT:SRQ, 2-1325
- SEARCH:SEARCH<x>:TRIGger:A:BUS:  
MIL1553B:STATUS:BIT:SBSF, 2-1326
- SEARCH:SEARCH<x>:TRIGger:A:BUS:  
MIL1553B:STATUS:BIT:TF, 2-1326
- SEARCH:SEARCH<x>:TRIGger:A:BUS:  
MIL1553B:STATUS:PARity, 2-1327
- SEARCH:SEARCH<x>:TRIGger:A:BUS:NRZ:  
DATA:SIZE, 2-1328
- SEARCH:SEARCH<x>:TRIGger:A:BUS:NRZ:  
DATA:VALue, 2-1329
- SEARCH:SEARCH<x>:TRIGger:A:BUS:  
ONEWIRE:COMMAND:VALue, 2-1329
- SEARCH:SEARCH<x>:TRIGger:A:BUS:  
ONEWIRE:CONDITION, 2-1330
- SEARCH:SEARCH<x>:TRIGger:A:BUS:  
ONEWIRE:DATA:SIZE, 2-1331
- SEARCH:SEARCH<x>:TRIGger:A:BUS:  
ONEWIRE:DATA:VALue, 2-1332
- SEARCH:SEARCH<x>:TRIGger:A:  
BUS:ONEWIRE:MATCHROM:  
FAMILYCODE, 2-1332
- SEARCH:SEARCH<x>:TRIGger:A:  
BUS:ONEWIRE:MATCHROM:  
SERIALNUMBER, 2-1333
- SEARCH:SEARCH<x>:TRIGger:A:BUS:  
ONEWIRE:OVERDRIVE:FAMILYCODE, 2-1334
- SEARCH:SEARCH<x>:TRIGger:A:  
BUS:ONEWIRE:OVERDRIVE:  
SERIALNUMBER, 2-1334
- SEARCH:SEARCH<x>:TRIGger:A:BUS:  
ONEWIRE:READROM:FAMILYCODE, 2-1335
- SEARCH:SEARCH<x>:TRIGger:  
A:BUS:ONEWIRE:READROM:  
SERIALNUMBER, 2-1336
- SEARCH:SEARCH<x>:TRIGger:A:BUS:  
ONEWIRE:SEARCHROM:ROMCODE, 2-1336
- SEARCH:SEARCH<x>:TRIGger:A:BUS:PARallel:  
DATA:VALue, 2-1337
- SEARCH:SEARCH<x>:TRIGger:A:BUS:PSIFIVE:  
BLOCKDATA:VALue, 2-1337
- SEARCH:SEARCH<x>:TRIGger:A:BUS:PSIFIVE:  
CONDITION, 2-1338
- SEARCH:SEARCH<x>:TRIGger:A:BUS:PSIFIVE:  
DATA:ECU:SENSOR:VALue, 2-1339
- SEARCH:SEARCH<x>:TRIGger:A:BUS:PSIFIVE:  
DATA:REGION:A:VALue, 2-1340
- SEARCH:SEARCH<x>:TRIGger:A:BUS:PSIFIVE:  
DATA:REGION:B:VALue, 2-1340
- SEARCH:SEARCH<x>:TRIGger:A:BUS:PSIFIVE:  
DATABITS, 2-1341

- SEARCH:SEARCH<x>:TRIGger:A:BUS:PSIFIVE:ERRORType, 2-1341
- SEARCH:SEARCH<x>:TRIGger:A:BUS:PSIFIVE:FUNCTIONCODEType, 2-1342
- SEARCH:SEARCH<x>:TRIGger:A:BUS:PSIFIVE:REGister:ADDRess:VALue, 2-1343
- SEARCH:SEARCH<x>:TRIGger:A:BUS:PSIFIVE:REGISTERADDRess, 2-1343
- SEARCH:SEARCH<x>:TRIGger:A:BUS:PSIFIVE:SENSor:ADDRess:VALue, 2-1344
- SEARCH:SEARCH<x>:TRIGger:A:BUS:PSIFIVE:SENSORSTATus:Type, 2-1345
- SEARCH:SEARCH<x>:TRIGger:A:BUS:PSIFIVE:STATus:VALue, 2-1345
- SEARCH:SEARCH<x>:TRIGger:A:BUS:RS232C:CONDition, 2-1346
- SEARCH:SEARCH<x>:TRIGger:A:BUS:RS232C:DATA:SIZE, 2-1347
- SEARCH:SEARCH<x>:TRIGger:A:BUS:RS232C:DATA:VALue, 2-1347
- SEARCH:SEARCH<x>:TRIGger:A:BUS:S8B10B:CONDition, 2-1348
- SEARCH:SEARCH<x>:TRIGger:A:BUS:S8B10B:DISParity, 2-1349
- SEARCH:SEARCH<x>:TRIGger:A:BUS:S8B10B:ERRor, 2-1349
- SEARCH:SEARCH<x>:TRIGger:A:BUS:S8B10B:SYMBol:CSYMVALue, 2-1350
- SEARCH:SEARCH<x>:TRIGger:A:BUS:S8B10B:SYMBol:EBITVALue, 2-1351
- SEARCH:SEARCH<x>:TRIGger:A:BUS:S8B10B:SYMBol:MODE, 2-1351
- SEARCH:SEARCH<x>:TRIGger:A:BUS:S8B10B:SYMBol:TBITRDNeg, 2-1352
- SEARCH:SEARCH<x>:TRIGger:A:BUS:S8B10B:SYMBol:TBITRDPos, 2-1353
- SEARCH:SEARCH<x>:TRIGger:A:BUS:S8B10B:SYMBol:TBITVALue, 2-1354
- SEARCH:SEARCH<x>:TRIGger:A:BUS:S8B10B:SYMBol:Type, 2-1354
- SEARCH:SEARCH<x>:TRIGger:A:BUS:SDLC:ADDRess:Type, 2-1355
- SEARCH:SEARCH<x>:TRIGger:A:BUS:SDLC:CONDition, 2-1356
- SEARCH:SEARCH<x>:TRIGger:A:BUS:SDLC:DATA:SIZE, 2-1357
- SEARCH:SEARCH<x>:TRIGger:A:BUS:SDLC:DATA:VALue, 2-1357
- SEARCH:SEARCH<x>:TRIGger:A:BUS:SDLC:ERROR:Type, 2-1358
- SEARCH:SEARCH<x>:TRIGger:A:BUS:SDLC:FRAME:Type, 2-1358
- SEARCH:SEARCH<x>:TRIGger:A:BUS:SDLC:STADDRess:VALue, 2-1359
- SEARCH:SEARCH<x>:TRIGger:A:BUS:SDLC:SUPERvisory:FRAMEType, 2-1360
- SEARCH:SEARCH<x>:TRIGger:A:BUS:SDLC:UNNumbered:FRAMEType, 2-1360
- SEARCH:SEARCH<x>:TRIGger:A:BUS:SENT:CONDition, 2-1361
- SEARCH:SEARCH<x>:TRIGger:A:BUS:SENT:ERRType, 2-1362
- SEARCH:SEARCH<x>:TRIGger:A:BUS:SENT:ERRType:CRC, 2-1363
- SEARCH:SEARCH<x>:TRIGger:A:BUS:SENT:FAST:CHAN1A:HIVALue, 2-1363
- SEARCH:SEARCH<x>:TRIGger:A:BUS:SENT:FAST:CHAN1A:QUALifier, 2-1364
- SEARCH:SEARCH<x>:TRIGger:A:BUS:SENT:FAST:CHAN1A:VALue, 2-1365
- SEARCH:SEARCH<x>:TRIGger:A:BUS:SENT:FAST:CHAN2B:HIVALue, 2-1366
- SEARCH:SEARCH<x>:TRIGger:A:BUS:SENT:FAST:CHAN2B:QUALifier, 2-1366
- SEARCH:SEARCH<x>:TRIGger:A:BUS:SENT:FAST:CHAN2B:VALue, 2-1367
- SEARCH:SEARCH<x>:TRIGger:A:BUS:SENT:FAST:COUNTER:HIVALue, 2-1368
- SEARCH:SEARCH<x>:TRIGger:A:BUS:SENT:FAST:COUNTER:QUALifier, 2-1369
- SEARCH:SEARCH<x>:TRIGger:A:BUS:SENT:FAST:COUNTER:VALue, 2-1370
- SEARCH:SEARCH<x>:TRIGger:A:BUS:SENT:FAST:INVERTNIBble:VALue, 2-1371
- SEARCH:SEARCH<x>:TRIGger:A:BUS:SENT:FAST:STATus:VALue, 2-1372
- SEARCH:SEARCH<x>:TRIGger:A:BUS:SENT:PAUSE:QUALifier, 2-1372
- SEARCH:SEARCH<x>:TRIGger:A:BUS:SENT:PAUSE:TICKs:HIVALue, 2-1373
- SEARCH:SEARCH<x>:TRIGger:A:BUS:SENT:PAUSE:TICKs:VALue, 2-1374

SEARCH:SEARCH<x>:TRIGger:A:BUS:SENT:  
SLOW:DATA:HIVALue, 2-1375

SEARCH:SEARCH<x>:TRIGger:A:BUS:SENT:  
SLOW:DATA:QUALifier, 2-1375

SEARCH:SEARCH<x>:TRIGger:A:BUS:SENT:  
SLOW:DATA:VALue, 2-1376

SEARCH:SEARCH<x>:TRIGger:A:BUS:SENT:  
SLOW:IDentifier:VALue, 2-1377

SEARCH:SEARCH<x>:TRIGger:A:BUS:SMBUS:  
ADDRess:VALue, 2-1378

SEARCH:SEARCH<x>:TRIGger:A:BUS:SMBUS:  
COMManD:VALue, 2-1378

SEARCH:SEARCH<x>:TRIGger:A:BUS:SMBUS:  
CONDition, 2-1379

SEARCH:SEARCH<x>:TRIGger:A:BUS:SMBUS:  
DATa:SIZE, 2-1380

SEARCH:SEARCH<x>:TRIGger:A:BUS:SMBUS:  
DATa:VALue, 2-1380

SEARCH:SEARCH<x>:TRIGger:A:BUS:SMBUS:  
DEVICEADDR:VALue, 2-1381

SEARCH:SEARCH<x>:TRIGger:A:BUS:SMBUS:  
ERRor:TYPE, 2-1381

SEARCH:SEARCH<x>:TRIGger:A:BUS:SMBUS:  
FIELDBYTE, 2-1382

SEARCH:SEARCH<x>:TRIGger:A:BUS:SMBUS:  
UDIDDATA:VALue, 2-1383

SEARCH:SEARCH<x>:TRIGger:A:BUS:  
SOUrce, 2-1383

SEARCH:SEARCH<x>:TRIGger:A:BUS:  
SPACEWIRE:CONDition, 2-1384

SEARCH:SEARCH<x>:TRIGger:A:BUS:  
SPACEWIRE:CONTROLCHARTYPE, 2-1385

SEARCH:SEARCH<x>:TRIGger:A:BUS:  
SPACEWIRE:CONTROLCODETYPE, 2-1385

SEARCH:SEARCH<x>:TRIGger:A:BUS:  
SPACEWIRE:DATa:SIZE, 2-1386

SEARCH:SEARCH<x>:TRIGger:A:BUS:  
SPACEWIRE:DATa:VALue, 2-1387

SEARCH:SEARCH<x>:TRIGger:A:BUS:  
SPACEWIRE:ERRORTYPE, 2-1387

SEARCH:SEARCH<x>:TRIGger:A:BUS:  
SPACEWIRE:TIMECode:VALue, 2-1388

SEARCH:SEARCH<x>:TRIGger:A:BUS:SPI:  
CONDition, 2-1389

SEARCH:SEARCH<x>:TRIGger:A:BUS:SPI:DATa:  
SIZE, 2-1389

SEARCH:SEARCH<x>:TRIGger:A:BUS:SPI:DATa:  
VALue, 2-1390

SEARCH:SEARCH<x>:TRIGger:A:BUS:SPI:  
SOURCETYPE, 2-1391

SEARCH:SEARCH<x>:TRIGger:A:BUS:SPMI:  
CONDition, 2-1391

SEARCH:SEARCH<x>:TRIGger:A:BUS:SPMI:  
DATa:SIZE, 2-1392

SEARCH:SEARCH<x>:TRIGger:A:BUS:SPMI:  
DATa:VALue, 2-1393

SEARCH:SEARCH<x>:TRIGger:A:BUS:SPMI:  
MASTERADDRess:VALue, 2-1394

SEARCH:SEARCH<x>:TRIGger:A:BUS:SPMI:  
NORESPonse, 2-1395

SEARCH:SEARCH<x>:TRIGger:A:BUS:SPMI:  
REGISTERADDRess:VALue, 2-1395

SEARCH:SEARCH<x>:TRIGger:A:BUS:SPMI:  
SLAVEADDRess:VALue, 2-1396

SEARCH:SEARCH<x>:TRIGger:A:BUS:SVID:  
COMManD:RESPonse, 2-1397

SEARCH:SEARCH<x>:TRIGger:A:BUS:SVID:  
COMManD:TYPE, 2-1398

SEARCH:SEARCH<x>:TRIGger:A:BUS:SVID:  
CONDition, 2-1399

SEARCH:SEARCH<x>:TRIGger:A:BUS:SVID:  
ERRor:TYPE, 2-1399

SEARCH:SEARCH<x>:TRIGger:A:BUS:SVID:  
PAYLoad:TYPE, 2-1400

SEARCH:SEARCH<x>:TRIGger:A:BUS:SVID:  
PAYLoad:VALue, 2-1401

SEARCH:SEARCH<x>:TRIGger:A:BUS:SVID:  
SLAVE:ADDRESS, 2-1401

SEARCH:SEARCH<x>:TRIGger:A:BUS:USB:  
ADDRess:HIVALue, 2-1402

SEARCH:SEARCH<x>:TRIGger:A:BUS:USB:  
ADDRess:VALue, 2-1403

SEARCH:SEARCH<x>:TRIGger:A:BUS:USB:  
CONDition, 2-1403

SEARCH:SEARCH<x>:TRIGger:A:BUS:USB:  
DATa:HIVALue, 2-1404

SEARCH:SEARCH<x>:TRIGger:A:BUS:USB:  
DATa:OFFSet, 2-1405

SEARCH:SEARCH<x>:TRIGger:A:BUS:USB:  
DATa:QUALifier, 2-1405

SEARCH:SEARCH<x>:TRIGger:A:BUS:USB:  
DATa:SIZE, 2-1406

- SEARCH:SEARCH<x>:TRIGger:A:BUS:USB:  
DATA:TYPE, 2-1407
- SEARCH:SEARCH<x>:TRIGger:A:BUS:USB:  
DATA:VALue, 2-1407
- SEARCH:SEARCH<x>:TRIGger:A:BUS:USB:  
ENDPoint:VALue, 2-1408
- SEARCH:SEARCH<x>:TRIGger:A:BUS:USB:  
ERRType, 2-1409
- SEARCH:SEARCH<x>:TRIGger:A:BUS:USB:  
HANDSHAKType, 2-1409
- SEARCH:SEARCH<x>:TRIGger:A:BUS:USB:  
SOFFRAMENUMber, 2-1410
- SEARCH:SEARCH<x>:TRIGger:A:BUS:USB:  
SPECIALType, 2-1411
- SEARCH:SEARCH<x>:TRIGger:A:BUS:USB:  
SPLIT:ET:VALue, 2-1412
- SEARCH:SEARCH<x>:TRIGger:A:BUS:USB:  
SPLIT:HUB:VALue, 2-1412
- SEARCH:SEARCH<x>:TRIGger:A:BUS:USB:  
SPLIT:PORT:VALue, 2-1413
- SEARCH:SEARCH<x>:TRIGger:A:BUS:USB:  
SPLIT:SC:VALue, 2-1414
- SEARCH:SEARCH<x>:TRIGger:A:BUS:USB:  
SPLIT:SE:VALue, 2-1414
- SEARCH:SEARCH<x>:TRIGger:A:BUS:USB:  
TOKENType, 2-1415
- SEARCH:SEARCH<x>:TRIGger:A:DDRREAD:  
BURSTDETECTmethod, 2-1416
- SEARCH:SEARCH<x>:TRIGger:A:DDRREAD:  
BURSTLatency, 2-1416
- SEARCH:SEARCH<x>:TRIGger:A:DDRREAD:  
BURSTLENGTH, 2-1417
- SEARCH:SEARCH<x>:TRIGger:A:DDRREAD:  
CSActive, 2-1418
- SEARCH:SEARCH<x>:TRIGger:A:DDRREAD:  
CSLevel, 2-1419
- SEARCH:SEARCH<x>:TRIGger:A:DDRREAD:  
CSMode, 2-1419
- SEARCH:SEARCH<x>:TRIGger:A:DDRREAD:  
CSSource, 2-1420
- SEARCH:SEARCH<x>:TRIGger:A:DDRREAD:  
DATARate, 2-1421
- SEARCH:SEARCH<x>:TRIGger:A:DDRREAD:  
DATASource, 2-1422
- SEARCH:SEARCH<x>:TRIGger:A:DDRREAD:  
HYSteresis, 2-1423
- SEARCH:SEARCH<x>:TRIGger:A:DDRREAD:  
LOGIC1SOURCE:SYMBOL, 2-1423
- SEARCH:SEARCH<x>:TRIGger:A:DDRREAD:  
LOGIC2SOURCE:SYMBOL, 2-1424
- SEARCH:SEARCH<x>:TRIGger:A:DDRREAD:  
LOGIC3SOURCE:SYMBOL, 2-1425
- SEARCH:SEARCH<x>:TRIGger:A:DDRREAD:  
LOGIC4SOURCE:SYMBOL, 2-1426
- SEARCH:SEARCH<x>:TRIGger:A:DDRREAD:  
MARGin, 2-1427
- SEARCH:SEARCH<x>:TRIGger:A:DDRREAD:  
MAXCAS, 2-1427
- SEARCH:SEARCH<x>:TRIGger:A:DDRREAD:  
MINCas, 2-1428
- SEARCH:SEARCH<x>:TRIGger:A:DDRREAD:  
POSTAMBLE:LENGTH, 2-1429
- SEARCH:SEARCH<x>:TRIGger:A:DDRREAD:  
PREAMBLE:TYPE, 2-1429
- SEARCH:SEARCH<x>:TRIGger:A:DDRREAD:  
REFLevel:DATA:HIGH, 2-1430
- SEARCH:SEARCH<x>:TRIGger:A:DDRREAD:  
REFLevel:DATA:LOW, 2-1431
- SEARCH:SEARCH<x>:TRIGger:A:DDRREAD:  
REFLevel:DATA:MID, 2-1431
- SEARCH:SEARCH<x>:TRIGger:A:DDRREAD:  
REFLevel:STROBE:HIGH, 2-1432
- SEARCH:SEARCH<x>:TRIGger:A:DDRREAD:  
REFLevel:STROBE:LOW, 2-1433
- SEARCH:SEARCH<x>:TRIGger:A:DDRREAD:  
REFLevel:STROBE:MID, 2-1433
- SEARCH:SEARCH<x>:TRIGger:A:DDRREAD:  
REFLEVELMode, 2-1434
- SEARCH:SEARCH<x>:TRIGger:A:DDRREAD:  
STANDARD, 2-1435
- SEARCH:SEARCH<x>:TRIGger:A:DDRREAD:  
STROBESource, 2-1435
- SEARCH:SEARCH<x>:TRIGger:A:DDRREAD:  
TOLERance, 2-1436
- SEARCH:SEARCH<x>:TRIGger:  
A:DDRREADWRITE:  
BURSTDETECTmethod, 2-1437
- SEARCH:SEARCH<x>:TRIGger:A:  
DDRREADWRITE:BURSTLatency, 2-1438
- SEARCH:SEARCH<x>:TRIGger:A:  
DDRREADWRITE:BURSTLENGTH, 2-1438
- SEARCH:SEARCH<x>:TRIGger:A:  
DDRREADWRITE:CSActive, 2-1439

- SEARCH:SEARCH<x>:TRIGger:A:  
DDRREADWRITE:CSLevel, 2-1440
- SEARCH:SEARCH<x>:TRIGger:A:  
DDRREADWRITE:CSMode, 2-1441
- SEARCH:SEARCH<x>:TRIGger:A:  
DDRREADWRITE:CSSource, 2-1441
- SEARCH:SEARCH<x>:TRIGger:A:  
DDRREADWRITE:DATARate, 2-1443
- SEARCH:SEARCH<x>:TRIGger:A:  
DDRREADWRITE:DATASource, 2-1443
- SEARCH:SEARCH<x>:TRIGger:A:  
DDRREADWRITE:HYSteresis, 2-1444
- SEARCH:SEARCH<x>:TRIGger:A:  
DDRREADWRITE:LOGIC1SOUrce:  
SYMBOL, 2-1445
- SEARCH:SEARCH<x>:TRIGger:A:  
DDRREADWRITE:LOGIC2SOUrce:  
SYMBOL, 2-1446
- SEARCH:SEARCH<x>:TRIGger:A:  
DDRREADWRITE:LOGIC3SOUrce:  
SYMBOL, 2-1447
- SEARCH:SEARCH<x>:TRIGger:A:  
DDRREADWRITE:LOGIC4SOUrce:  
SYMBOL, 2-1447
- SEARCH:SEARCH<x>:TRIGger:A:  
DDRREADWRITE:MARGIN, 2-1448
- SEARCH:SEARCH<x>:TRIGger:A:  
DDRREADWRITE:MAXCAS, 2-1449
- SEARCH:SEARCH<x>:TRIGger:A:  
DDRREADWRITE:MINCas, 2-1450
- SEARCH:SEARCH<x>:TRIGger:A:  
DDRREADWRITE:POSTAMBLE:  
LENGTH, 2-1450
- SEARCH:SEARCH<x>:TRIGger:A:  
DDRREADWRITE:PREAMBLE:TYPE, 2-1451
- SEARCH:SEARCH<x>:TRIGger:A:  
DDRREADWRITE:REFLevel:DATA:  
HIGH, 2-1452
- SEARCH:SEARCH<x>:TRIGger:A:  
DDRREADWRITE:REFLevel:DATA:  
LOW, 2-1452
- SEARCH:SEARCH<x>:TRIGger:A:  
DDRREADWRITE:REFLevel:DATA:  
MID, 2-1453
- SEARCH:SEARCH<x>:TRIGger:A:  
DDRREADWRITE:REFLevel:STROBE:  
HIGH, 2-1454
- SEARCH:SEARCH<x>:TRIGger:A:  
DDRREADWRITE:REFLevel:STROBE:  
LOW, 2-1455
- SEARCH:SEARCH<x>:TRIGger:A:  
DDRREADWRITE:REFLevel:STROBE:  
MID, 2-1455
- SEARCH:SEARCH<x>:TRIGger:A:  
DDRREADWRITE:REFLEVELMode, 2-1456
- SEARCH:SEARCH<x>:TRIGger:A:  
DDRREADWRITE:STANdard, 2-1457
- SEARCH:SEARCH<x>:TRIGger:A:  
DDRREADWRITE:STROBESource, 2-1457
- SEARCH:SEARCH<x>:TRIGger:A:  
DDRREADWRITE:TOLERance, 2-1458
- SEARCH:SEARCH<x>:TRIGger:A:DDRWRITE:  
BURSTDETECTmethod, 2-1459
- SEARCH:SEARCH<x>:TRIGger:A:DDRWRITE:  
BURSTLatency, 2-1460
- SEARCH:SEARCH<x>:TRIGger:A:DDRWRITE:  
BURSTLENGTH, 2-1461
- SEARCH:SEARCH<x>:TRIGger:A:DDRWRITE:  
CSActive, 2-1461
- SEARCH:SEARCH<x>:TRIGger:A:DDRWRITE:  
CSLevel, 2-1462
- SEARCH:SEARCH<x>:TRIGger:A:DDRWRITE:  
CSMode, 2-1463
- SEARCH:SEARCH<x>:TRIGger:A:DDRWRITE:  
CSSource, 2-1464
- SEARCH:SEARCH<x>:TRIGger:A:DDRWRITE:  
DATARate, 2-1465
- SEARCH:SEARCH<x>:TRIGger:A:DDRWRITE:  
DATASource, 2-1465
- SEARCH:SEARCH<x>:TRIGger:A:DDRWRITE:  
HYSteresis, 2-1466
- SEARCH:SEARCH<x>:TRIGger:A:DDRWRITE:  
LOGIC1SOUrce:SYMBOL, 2-1467
- SEARCH:SEARCH<x>:TRIGger:A:DDRWRITE:  
LOGIC2SOUrce:SYMBOL, 2-1468
- SEARCH:SEARCH<x>:TRIGger:A:DDRWRITE:  
LOGIC3SOUrce:SYMBOL, 2-1469
- SEARCH:SEARCH<x>:TRIGger:A:DDRWRITE:  
LOGIC4SOUrce:SYMBOL, 2-1469
- SEARCH:SEARCH<x>:TRIGger:A:DDRWRITE:  
MARGIN, 2-1470
- SEARCH:SEARCH<x>:TRIGger:A:DDRWRITE:  
MAXCAS, 2-1471

- SEARCH:SEARCH<x>:TRIGger:A:DDRWRITE:  
MINCas, 2-1472
- SEARCH:SEARCH<x>:TRIGger:A:DDRWRITE:  
POSTAMBLE:LENGth, 2-1472
- SEARCH:SEARCH<x>:TRIGger:A:DDRWRITE:  
PREAMBLE:TYPE, 2-1473
- SEARCH:SEARCH<x>:TRIGger:A:DDRWRITE:  
REFLevel:DATA:HIGH, 2-1474
- SEARCH:SEARCH<x>:TRIGger:A:DDRWRITE:  
REFLevel:DATA:LOW, 2-1474
- SEARCH:SEARCH<x>:TRIGger:A:DDRWRITE:  
REFLevel:DATA:MID, 2-1475
- SEARCH:SEARCH<x>:TRIGger:A:DDRWRITE:  
REFLevel:STROBE:HIGH, 2-1476
- SEARCH:SEARCH<x>:TRIGger:A:DDRWRITE:  
REFLevel:STROBE:LOW, 2-1476
- SEARCH:SEARCH<x>:TRIGger:A:DDRWRITE:  
REFLevel:STROBE:MID, 2-1477
- SEARCH:SEARCH<x>:TRIGger:A:DDRWRITE:  
REFLEVELMode, 2-1478
- SEARCH:SEARCH<x>:TRIGger:A:DDRWRITE:  
STANdard, 2-1479
- SEARCH:SEARCH<x>:TRIGger:A:DDRWRITE:  
STROBESource, 2-1479
- SEARCH:SEARCH<x>:TRIGger:A:DDRWRITE:  
TOLERance, 2-1480
- SEARCH:SEARCH<x>:TRIGger:A:EDGE:  
SLOpe, 2-1481
- SEARCH:SEARCH<x>:TRIGger:A:EDGE:  
SOUrce, 2-1481
- SEARCH:SEARCH<x>:TRIGger:A:EDGE:  
THReshold, 2-1482
- SEARCH:SEARCH<x>:TRIGger:A:LOGIc:CLOCK:  
THReshold, 2-1483
- SEARCH:SEARCH<x>:TRIGger:A:LOGIc:  
DELtAtime, 2-1483
- SEARCH:SEARCH<x>:TRIGger:A:LOGIc:  
FUNction, 2-1484
- SEARCH:SEARCH<x>:TRIGger:A:LOGIc:INPUT:  
CLOCK:SOUrce, 2-1484
- SEARCH:SEARCH<x>:TRIGger:A:LOGIc:LEVel:  
CH<x>, 2-1485
- SEARCH:SEARCH<x>:TRIGger:A:LOGIc:LEVel:  
MATH<x>, 2-1485
- SEARCH:SEARCH<x>:TRIGger:A:LOGIc:LEVel:  
REF<x>, 2-1486
- SEARCH:SEARCH<x>:TRIGger:A:LOGIc:  
LOGICPattern:CH<x>, 2-1486
- SEARCH:SEARCH<x>:TRIGger:A:LOGIc:  
LOGICPattern:CH<x>\_D<x>, 2-1487
- SEARCH:SEARCH<x>:TRIGger:A:LOGIc:  
LOGICPattern:MATH<x>, 2-1487
- SEARCH:SEARCH<x>:TRIGger:A:LOGIc:  
LOGICPattern:REF<x>, 2-1488
- SEARCH:SEARCH<x>:TRIGger:A:LOGIc:  
POLarity, 2-1489
- SEARCH:SEARCH<x>:TRIGger:A:LOGIc:  
USEClOCKedge, 2-1489
- SEARCH:SEARCH<x>:TRIGger:A:LOGIc:  
WHEn, 2-1490
- SEARCH:SEARCH<x>:TRIGger:A:PULSEWidth:  
HIGHLimit, 2-1490
- SEARCH:SEARCH<x>:TRIGger:A:PULSEWidth:  
LOGICQUALification, 2-1491
- SEARCH:SEARCH<x>:TRIGger:A:PULSEWidth:  
LOWLimit, 2-1491
- SEARCH:SEARCH<x>:TRIGger:A:PULSEWidth:  
POLarity, 2-1492
- SEARCH:SEARCH<x>:TRIGger:A:PULSEWidth:  
SOUrce, 2-1492
- SEARCH:SEARCH<x>:TRIGger:A:PULSEWidth:  
THReshold, 2-1493
- SEARCH:SEARCH<x>:TRIGger:A:PULSEWidth:  
WHEn, 2-1494
- SEARCH:SEARCH<x>:TRIGger:A:RUNT:  
LOGICQUALification, 2-1494
- SEARCH:SEARCH<x>:TRIGger:A:RUNT:  
POLarity, 2-1495
- SEARCH:SEARCH<x>:TRIGger:A:RUNT:  
SOUrce, 2-1495
- SEARCH:SEARCH<x>:TRIGger:A:RUNT:  
THReshold:HIGH, 2-1496
- SEARCH:SEARCH<x>:TRIGger:A:RUNT:  
THReshold:LOW, 2-1496
- SEARCH:SEARCH<x>:TRIGger:A:RUNT:  
WHEn, 2-1497
- SEARCH:SEARCH<x>:TRIGger:A:RUNT:  
WIDth, 2-1498
- SEARCH:SEARCH<x>:TRIGger:A:SETHold:  
CLOCK:EDGE, 2-1498
- SEARCH:SEARCH<x>:TRIGger:A:SETHold:  
CLOCK:SOUrce, 2-1499

SEARCH:SEARCH<x>:TRIGger:A:SETHold:  
  CLOCK:THReshold, 2-1499  
SEARCH:SEARCH<x>:TRIGger:A:SETHold:  
  HOLDTime, 2-1500  
SEARCH:SEARCH<x>:TRIGger:A:SETHold:  
  LEVel:CH<x>, 2-1500  
SEARCH:SEARCH<x>:TRIGger:A:SETHold:  
  LEVel:MATH<x>, 2-1501  
SEARCH:SEARCH<x>:TRIGger:A:SETHold:  
  LEVel:REF<x>, 2-1501  
SEARCH:SEARCH<x>:TRIGger:A:SETHold:  
  LOGICPattern:CH<x>, 2-1502  
SEARCH:SEARCH<x>:TRIGger:A:SETHold:  
  LOGICPattern:CH<x>\_D<x>, 2-1502  
SEARCH:SEARCH<x>:TRIGger:A:SETHold:  
  LOGICPattern:MATH<x>, 2-1503  
SEARCH:SEARCH<x>:TRIGger:A:SETHold:  
  LOGICPattern:REF<x>, 2-1504  
SEARCH:SEARCH<x>:TRIGger:A:SETHold:  
  SETTime, 2-1504  
SEARCH:SEARCH<x>:TRIGger:A:STATE, 2-1505  
SEARCH:SEARCH<x>:TRIGger:A:  
  STOPAcq, 2-1505  
SEARCH:SEARCH<x>:TRIGger:A:TIMEOut:  
  LOGICQUALification, 2-1506  
SEARCH:SEARCH<x>:TRIGger:A:TIMEOut:  
  POLarity, 2-1506  
SEARCH:SEARCH<x>:TRIGger:A:TIMEOut:  
  SOUrce, 2-1507  
SEARCH:SEARCH<x>:TRIGger:A:TIMEOut:  
  THReshold, 2-1508  
SEARCH:SEARCH<x>:TRIGger:A:TIMEOut:  
  TIME, 2-1508  
SEARCH:SEARCH<x>:TRIGger:A:TRANSition:  
  DELTATime, 2-1509  
SEARCH:SEARCH<x>:TRIGger:A:TRANSition:  
  LOGICQUALification, 2-1509  
SEARCH:SEARCH<x>:TRIGger:A:TRANSition:  
  POLarity, 2-1510  
SEARCH:SEARCH<x>:TRIGger:A:TRANSition:  
  SOUrce, 2-1510  
SEARCH:SEARCH<x>:TRIGger:A:TRANSition:  
  THReshold:HIGH, 2-1511  
SEARCH:SEARCH<x>:TRIGger:A:TRANSition:  
  THReshold:LOW, 2-1511  
SEARCH:SEARCH<x>:TRIGger:A:TRANSition:  
  WHEn, 2-1512  
SEARCH:SEARCH<x>:TRIGger:A:TYPE, 2-1512  
SEARCH:SEARCH<x>:TRIGger:A:WINdow:  
  CROSSIng, 2-1514  
SEARCH:SEARCH<x>:TRIGger:A:WINdow:  
  LOGICQUALification, 2-1515  
SEARCH:SEARCH<x>:TRIGger:A:WINdow:  
  POLarity, 2-1515  
SEARCH:SEARCH<x>:TRIGger:A:WINdow:  
  SOUrce, 2-1516  
SEARCH:SEARCH<x>:TRIGger:A:WINdow:  
  THReshold:HIGH, 2-1517  
SEARCH:SEARCH<x>:TRIGger:A:WINdow:  
  THReshold:LOW, 2-1517  
SEARCH:SEARCH<x>:TRIGger:A:WINdow:  
  WHEn, 2-1518  
SEARCH:SEARCH<x>:TRIGger:A:WINdow:  
  WIDth, 2-1518  
SEARCH:SElected, 2-1519  
SEARCHTABLE, 2-1519  
SET?, 2-1520  
SOCKETServer:ENable, 2-1521  
SOCKETServer:PORT, 2-1521  
SOCKETServer:PROTOCol, 2-1522  
\*SRE, 2-1522  
\*STB?, 2-1523  
SV:CH<x>:SElect:SPECTrogram, 2-1524  
SV:LOCKCenter, 2-1524  
SV:LOCKspectrum, 2-1525  
SV:MARKER:PEAK:EXCURsion, 2-1526  
SV:MARKER:PEAK:MAXimum, 2-1526  
SV:MARKER:PEAK:STATE, 2-1527  
SV:MARKER:PEAK:THReshold, 2-1528  
SV:MARKER:PEAKS:AMPLITUDE?, 2-1528  
SV:MARKER:PEAKS:FREQuency?, 2-1529  
SV:MARKER:REFERence, 2-1529  
SV:MARKER:REFERence:AMPLITUDE?, 2-1529  
SV:MARKER:REFERence:FREQuency?, 2-1530  
SV:MARKER:TYPE, 2-1530  
SV:RF\_PHASE:REFERence:MASTer, 2-1531  
SV:S<x>\_CH<x>:RF\_AVErAge:NUMAVg, 2-1531  
SV:S<x>\_CH<x>:RF\_MAGnitude:FORMat, 2-1532  
SV:S<x>\_CH<x>:RF\_PHASE:REFERence:  
  DEGrees, 2-1533  
SV:S<x>\_CH<x>:RF\_PHASE:REFERence:  
  POSITION, 2-1533  
SV:S<x>\_CH<x>:RF\_PHASE:REFERence:  
  TIME, 2-1534

SV:S<x>\_CH<x>:RF\_PHASE:WRAP:  
 DEGrees, 2-1535  
 SV:S<x>\_CH<x>:RF\_PHASE:WRAP:STATE, 2-1536  
 SV:S<x>\_CH<x>:SElect:RF\_AVErAge, 2-1536  
 SV:S<x>\_CH<x>:SElect:RF\_FREQuency, 2-1537  
 SV:S<x>\_CH<x>:SElect:RF\_MAGNitude, 2-1537  
 SV:S<x>\_CH<x>:SElect:RF\_MAXHold, 2-1538  
 SV:S<x>\_CH<x>:SElect:RF\_MINHold, 2-1538  
 SV:S<x>\_CH<x>:SElect:RF\_NORMal, 2-1539  
 SV:S<x>\_CH<x>:SElect:RF\_PHASE, 2-1540  
 SV:S<x>\_CH<x>:SElect:SPEctrogram, 2-1540  
 SV:S<x>\_CH<x>:SELTrace, 2-1541  
 SV:S<x>\_CH<x>:SQUELCH:STATE, 2-1541  
 SV:S<x>\_CH<x>:SQUELCH:THReshold, 2-1542  
 SV:S<x>\_CH<x>:UNIts, 2-1543  
 SV:SPEctrogram:CSCale:MAX, 2-1544  
 SV:SPEctrogram:CSCale:MIN, 2-1544  
 SV:SPEctrogram:CURSor:A, 2-1545  
 SV:SPEctrogram:CURSor:B, 2-1545

**T**

TIME, 2-1546  
 TIME:ZONE, 2-1547  
 TIME:ZONE:UTCDELTA, 2-1547  
 TOTaluptime?, 2-1548  
 TRIGger:{A|B}:EDGE:COUPling, 2-1548  
 TRIGger:{A|B}:EDGE:SLOpe, 2-1549  
 TRIGger:{A|B}:EDGE:SOUrce, 2-1550  
 TRIGger:{A|B}:LEVel:CH<x>, 2-1550  
 TRIGger:{A|B}:TYPe, 2-1551  
 \*TST?, 2-1552

**U**

UNDO, 2-1552

**V**

VERBose, 2-1552  
 VERTical:DESKew:FROM:  
 CUSTOMPROPAGation, 2-1553  
 VERTical:DESKew:FROM:SOUrce, 2-1554  
 VERTical:DESKew:STATIC, 2-1554  
 VERTical:DESKew:TO:  
 CUSTOMPROPAGation, 2-1555  
 VERTical:DESKew:TO:SOUrce, 2-1555  
 VISual:AREA<x>:ASPEctratio, 2-1556

VISual:AREA<x>:FLIP:HORizontal, 2-1556  
 VISual:AREA<x>:FLIP:VERTical, 2-1557  
 VISual:AREA<x>:HEIGHt, 2-1557  
 VISual:AREA<x>:HITType, 2-1557  
 VISual:AREA<x>:RESET, 2-1558  
 VISual:AREA<x>:ROTation, 2-1558  
 VISual:AREA<x>:SHAPE, 2-1559  
 VISual:AREA<x>:SOUrce, 2-1560  
 VISual:AREA<x>:VERTICES, 2-1560  
 VISual:AREA<x>:WIDTH, 2-1561  
 VISual:AREA<x>:XPOsition, 2-1561  
 VISual:AREA<x>:YPOsition, 2-1562  
 VISual:DELETEALL, 2-1562  
 VISual:ENable, 2-1562  
 VISual:EQUation, 2-1563  
 VISual:SHOWAREas, 2-1563  
 VISual:SHOWCRiteria, 2-1564  
 VISual:SHOWEQuation, 2-1565

**W**

\*WAI, 2-1565  
 WAVFrm?, 2-1566  
 WFMOutpre?, 2-1566  
 WFMOutpre:ASC\_Fmt?, 2-1567  
 WFMOutpre:BIT\_Nr, 2-1567  
 WFMOutpre:BN\_Fmt, 2-1568  
 WFMOutpre:BYT\_Nr, 2-1569  
 WFMOutpre:BYT\_Or, 2-1569  
 WFMOutpre:CENTERFREQuency?, 2-1570  
 WFMOutpre:DOMain?, 2-1570  
 WFMOutpre:ENCdg, 2-1571  
 WFMOutpre:NR\_Pt?, 2-1572  
 WFMOutpre:PT\_Fmt?, 2-1572  
 WFMOutpre:PT\_Off?, 2-1573  
 WFMOutpre:PT\_ORder?, 2-1573  
 WFMOutpre:RESample, 2-1574  
 WFMOutpre:SPAN?, 2-1574  
 WFMOutpre:WFId?, 2-1575  
 WFMOutpre:WFMTYPe?, 2-1576  
 WFMOutpre:XINcr?, 2-1577  
 WFMOutpre:XUNit?, 2-1577  
 WFMOutpre:XZEro?, 2-1578  
 WFMOutpre:YMUlt?, 2-1578  
 WFMOutpre:YOFf?, 2-1579  
 WFMOutpre:YUNit?, 2-1579  
 WFMOutpre:YZEro?, 2-1580