



**Tektronix PPG & PED Series
Pattern Generator & Error Detector Installation & Safety
Instructions**



071-3413-00



Tektronix PPG & PED Series Pattern Generator & Error Detector Installation & Safety Instructions

Register now!

Click the following link to protect your product.

▶ www.tektronix.com/register

www.tek.com

071-3413-00

Copyright © Tektronix. All rights reserved. Licensed software products are owned by Tektronix or its subsidiaries or suppliers, and are protected by national copyright laws and international treaty provisions.

Tektronix products are covered by U.S. and foreign patents, issued and pending. Information in this publication supersedes that in all previously published material. Specifications and price change privileges reserved.

TEKTRONIX and TEK are registered trademarks of Tektronix, Inc.

Contacting Tektronix

Tektronix, Inc.
14150 SW Karl Braun Drive
P.O. Box 500
Beaverton, OR 97077
USA

For product information, sales, service, and technical support:

- In North America, call 1-800-833-9200.
- Worldwide, visit www.tek.com to find contacts in your area.

Warranty

Tektronix warrants that this product will be free from defects in materials and workmanship for a period of one (1) year from the date of shipment. If any such product proves defective during this warranty period, Tektronix, at its option, either will repair the defective product without charge for parts and labor, or will provide a replacement in exchange for the defective product. Parts, modules and replacement products used by Tektronix for warranty work may be new or reconditioned to like new performance. All replaced parts, modules and products become the property of Tektronix.

In order to obtain service under this warranty, Customer must notify Tektronix of the defect before the expiration of the warranty period and make suitable arrangements for the performance of service. Customer shall be responsible for packaging and shipping the defective product to the service center designated by Tektronix, with shipping charges prepaid. Tektronix shall pay for the return of the product to Customer if the shipment is to a location within the country in which the Tektronix service center is located. Customer shall be responsible for paying all shipping charges, duties, taxes, and any other charges for products returned to any other locations.

This warranty shall not apply to any defect, failure or damage caused by improper use or improper or inadequate maintenance and care. Tektronix shall not be obligated to furnish service under this warranty a) to repair damage resulting from attempts by personnel other than Tektronix representatives to install, repair or service the product; b) to repair damage resulting from improper use or connection to incompatible equipment; c) to repair any damage or malfunction caused by the use of non-Tektronix supplies; or d) to service a product that has been modified or integrated with other products when the effect of such modification or integration increases the time or difficulty of servicing the product.

THIS WARRANTY IS GIVEN BY TEKTRONIX WITH RESPECT TO THE PRODUCT IN LIEU OF ANY OTHER WARRANTIES, EXPRESS OR IMPLIED. TEKTRONIX AND ITS VENDORS DISCLAIM ANY IMPLIED WARRANTIES OF MERCHANTABILITY OR FITNESS FOR A PARTICULAR PURPOSE. TEKTRONIX' RESPONSIBILITY TO REPAIR OR REPLACE DEFECTIVE PRODUCTS IS THE SOLE AND EXCLUSIVE REMEDY PROVIDED TO THE CUSTOMER FOR BREACH OF THIS WARRANTY. TEKTRONIX AND ITS VENDORS WILL NOT BE LIABLE FOR ANY INDIRECT, SPECIAL, INCIDENTAL, OR CONSEQUENTIAL DAMAGES IRRESPECTIVE OF WHETHER TEKTRONIX OR THE VENDOR HAS ADVANCE NOTICE OF THE POSSIBILITY OF SUCH DAMAGES.

[W2 – 15AUG04]

Table of Contents

Important safety information	ii
General safety summary	ii
Service safety summary	iv
Terms in this manual	iv
Symbols and terms on the product	v
Preface	vii
Operating requirements	1
Environmental requirements	1
Ventilation requirements	1
Power requirements	1
Installation	3
Power on the instrument	3
Power off the instrument	3
Controls and connectors	5
PPG1251 Front panel controls and connectors	5
PPG160x, PPG3000, PPG3200 Front panel controls and connectors	5
PPG4001 Front panel controls and connectors	6
PED3200 & PED4000 Front panel controls and connectors	6
PPG1251 & PPG4001 Rear panel controls and connectors	7
PPG160x, PPG3000, PPG3200 Rear panel controls and connectors	7
PED3200 & PED4000 Rear panel controls and connectors	8
Cleaning	9
Clean the flat panel display	9
Clean the exterior surfaces	9
Compliance information	11
EMC compliance	11
Safety compliance	12
Environmental considerations	13

Important safety information

This manual contains information and warnings that must be followed by the user for safe operation and to keep the product in a safe condition.

To safely perform service on this product, additional information is provided at the end of this section. (See page iv, *Service safety summary*.)

General safety summary

Use the product only as specified. Review the following safety precautions to avoid injury and prevent damage to this product or any products connected to it. Carefully read all instructions. Retain these instructions for future reference.

Comply with local and national safety codes.

For correct and safe operation of the product, it is essential that you follow generally accepted safety procedures in addition to the safety precautions specified in this manual.

The product is designed to be used by trained personnel only.

Only qualified personnel who are aware of the hazards involved should remove the cover for repair, maintenance, or adjustment.

Before use, always check the product with a known source to be sure it is operating correctly.

This product is not intended for detection of hazardous voltages.

Use personal protective equipment to prevent shock and arc blast injury where hazardous live conductors are exposed.

When incorporating this equipment into a system, the safety of that system is the responsibility of the assembler of the system.

To avoid fire or personal injury

Use proper power cord. Use only the power cord specified for this product and certified for the country of use.

Do not use the provided power cord for other products.

Ground the product. This product is grounded through the grounding conductor of the power cord. To avoid electric shock, the grounding conductor must be connected to earth ground. Before making connections to the input or output terminals of the product, make sure that the product is properly grounded.

Do not disable the power cord grounding connection.

Power disconnect. The power cord disconnects the product from the power source. See instructions for the location. Do not position the equipment so that

it is difficult to operate the power cord; it must remain accessible to the user at all times to allow for quick disconnection if needed.

Observe all terminal ratings. To avoid fire or shock hazard, observe all ratings and markings on the product. Consult the product manual for further ratings information before making connections to the product.

Do not apply a potential to any terminal, including the common terminal, that exceeds the maximum rating of that terminal.

The measuring terminals on this product are not rated for connection to mains or Category II, III, or IV circuits.

Do not operate without covers. Do not operate this product with covers or panels removed, or with the case open. Hazardous voltage exposure is possible.

Avoid exposed circuitry. Do not touch exposed connections and components when power is present.

Do not operate with suspected failures. If you suspect that there is damage to this product, have it inspected by qualified service personnel.

Disable the product if it is damaged. Do not use the product if it is damaged or operates incorrectly. If in doubt about safety of the product, turn it off and disconnect the power cord. Clearly mark the product to prevent its further operation.

Examine the exterior of the product before you use it. Look for cracks or missing pieces.

Use only specified replacement parts.

Use proper fuse. Use only the fuse type and rating specified for this product.

Wear eye protection. Wear eye protection if exposure to high-intensity rays or laser radiation exists.

Do not operate in wet/damp conditions. Be aware that condensation may occur if a unit is moved from a cold to a warm environment.

Do not operate in an explosive atmosphere.

Keep product surfaces clean and dry. Remove the input signals before you clean the product.

Provide proper ventilation. Refer to the installation instructions in the manual for details on installing the product so it has proper ventilation.

Slots and openings are provided for ventilation and should never be covered or otherwise obstructed. Do not push objects into any of the openings.

Provide a safe working environment. Always place the product in a location convenient for viewing the display and indicators.

Avoid improper or prolonged use of keyboards, pointers, and button pads. Improper or prolonged keyboard or pointer use may result in serious injury.

Be sure your work area meets applicable ergonomic standards. Consult with an ergonomics professional to avoid stress injuries.

Use care when lifting and carrying the product. This product is provided with handles for lifting and carrying.

Service safety summary

The *Service safety summary* section contains additional information required to safely perform service on the product. Only qualified personnel should perform service procedures. Read this *Service safety summary* and the *General safety summary* before performing any service procedures.

To avoid electric shock. Do not touch exposed connections.

Do not service alone. Do not perform internal service or adjustments of this product unless another person capable of rendering first aid and resuscitation is present.

Disconnect power. To avoid electric shock, switch off the product power and disconnect the power cord from the mains power before removing any covers or panels, or opening the case for servicing.

Use care when servicing with power on. Dangerous voltages or currents may exist in this product. Disconnect power, remove battery (if applicable), and disconnect test leads before removing protective panels, soldering, or replacing components.

Verify safety after repair. Always recheck ground continuity and mains dielectric strength after performing a repair.

Terms in this manual

These terms may appear in this manual:



WARNING. *Warning statements identify conditions or practices that could result in injury or loss of life.*



CAUTION. *Caution statements identify conditions or practices that could result in damage to this product or other property.*

Symbols and terms on the product

These terms may appear on the product:

- DANGER indicates an injury hazard immediately accessible as you read the marking.
- WARNING indicates an injury hazard not immediately accessible as you read the marking.
- CAUTION indicates a hazard to property including the product.



When this symbol is marked on the product, be sure to consult the manual to find out the nature of the potential hazards and any actions which have to be taken to avoid them. (This symbol may also be used to refer the user to ratings in the manual.)

The following symbol(s) may appear on the product:



CAUTION
Refer to Manual



Protective Ground
(Earth) Terminal

Preface

This document provides the minimum required safety and compliance information for the Tektronix PatternPro® Pattern Generator (PPG) and PatternPro® Error Detector (PED) products. It includes high-level operating requirements, installation information, high-level descriptions of instrument controls and connectors, and other information for the individual products.

The Tektronix PatternPro high-performance pattern generators offer single and multi-channel configurations capable of data rates up to 32 Gb/s. With optional jitter insertion, these instruments offer a flexible, cost effective and easy to use test solution supporting high speed applications such as 100 Gigabit Ethernet, 32G Fibre channel, PAM4, DP-QPSK testing, and a broad range of receiver test applications.

The Tektronix PED PatternPro series programmable error detectors offer single and two-channel standalone configurations capable of BER measurement at data rates up to 40 Gb/s. They support either PRBS or user-defined data patterns, with simple to use automatic or manual alignment of input clock and data, and pattern synchronization.

Tektronix recommends that you read the Important safety information at the beginning of this document before installing and using the PPG and PED series instruments.

For more detailed information on your Tektronix PPG and PED series instruments, please refer to the documents listed below. These documents are downloadable from the Tektronix Web Site at www.tektronix.com.

- PPG1251 PatternPro Pattern Generator User Manual
- PPG1600, PPG3000, PPG3200 Series PatternPro Pattern Generator User Manual
- PPG4001 PatternPro Pattern Generator User Manual
- PED3200 & PED4000 Series PatternPro Programmable Error Detector User Manual

Operating requirements

Environmental requirements

The following table describes the maximum operating environmental ratings for your instrument.

Table 1: Maximum operating environmental considerations

Feature	Description
Temperature	40 °C (104 °F)
Humidity	80% for temperatures up to 31 °C (88 °F) decreasing linearly to 50% at 40 °C (104 °F)
Altitude	2000 m (6562 ft.)

Ventilation requirements

The unit has fans in the rear, as well as cooling vents on the bottom and side panels to keep it from overheating.



CAUTION. *Inadequate ventilation can damage the instrument; to avoid damaging the instrument, observe the following precautions:*

Do not block the cooling vents.

Do not position any devices adjacent to the instrument that force air (heated or unheated) into or onto the instrument surfaces or cooling vents. This additional airflow could compromise performance.

When rack mounting the instrument, ensure there is adequate airflow around the instrument rear, sides, and bottom to ensure proper cooling. Adequate airflow enables air temperatures within approximately one inch of the instrument surfaces to remain within specified limits under all operating conditions.

Power requirements



CAUTION. *Operating the instrument on an incorrect line voltage can cause damage, possibly voiding the warranty. To avoid this, operate the instrument with the correct line voltage.*

The instrument operate from a single-phase line voltage listed in the following table. Line voltage and line frequency are automatically sensed; there are no switches to set. Check to ensure the operating voltage in your area is compatible.

Table 2: Power requirements

Item	Description
Voltage	100 V to 240 V
Frequency	50 Hz to 60 Hz
Power	
PPG1251, PPG1601, PPG1602, PPG3001, PPG3002, PPG3201, PPG3202, PPG4001, PED3201, PED4001, PED3202, PED4002	360 W, maximum
PPG1604, PPG3004, PPG3204	720 W, maximum
Power Fuse	
PPG1251, PPG1601, PPG1602, PPG3001, PPG3002, PPG3201, PPG3202, PPG4001, PED3201, PED4001, PED3202, PED4002	T 2A 250V
PPG1604, PPG3004, PPG3204	T 4A 250V

The power cord supplied with the instrument contains a separate ground for use with grounded outlets. When proper connections are made, the instrument chassis is connected to power line ground through the ground wire in the power cord providing protection against electric shock.

Installation

Before installing the instrument, verify that you have received all of the standard and optional accessories for the instrument.

Determine the best location for the instrument. The instrument is designed to operate on a bench or cart in the normal position (on the front feet).

Before connecting the power cord, review the *Operating requirements* in the previous section of this document.

Power on the instrument

1. Connect the power cord to the rear of the instrument and to a properly grounded power source
2. Momentarily push the front panel on/off switch and observe the following:
 - The green light on the switch turns on.
 - The instrument goes through the start-up sequence.
 - The Main menu displays on the screen.

Power off the instrument

To power off the instrument, push the front panel on/off switch.

The instrument goes through the shut-down sequence and the green light on the switch turns off.

Controls and connectors

This section provides a high-level description of the control and connectors on the instrument. The actual location of some of the controls and connectors may vary depending on the instrument model.

PPG1251 Front panel controls and connectors

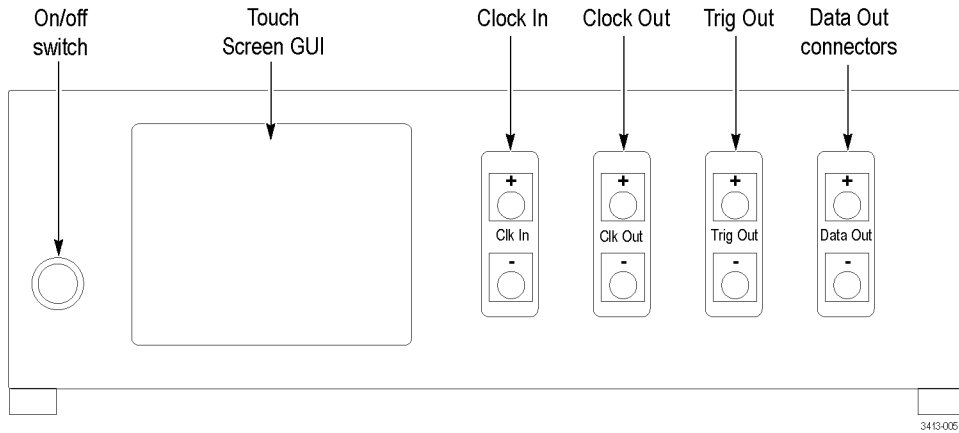

PPG160x, PPG3000, PPG3200 Front panel controls and connectors

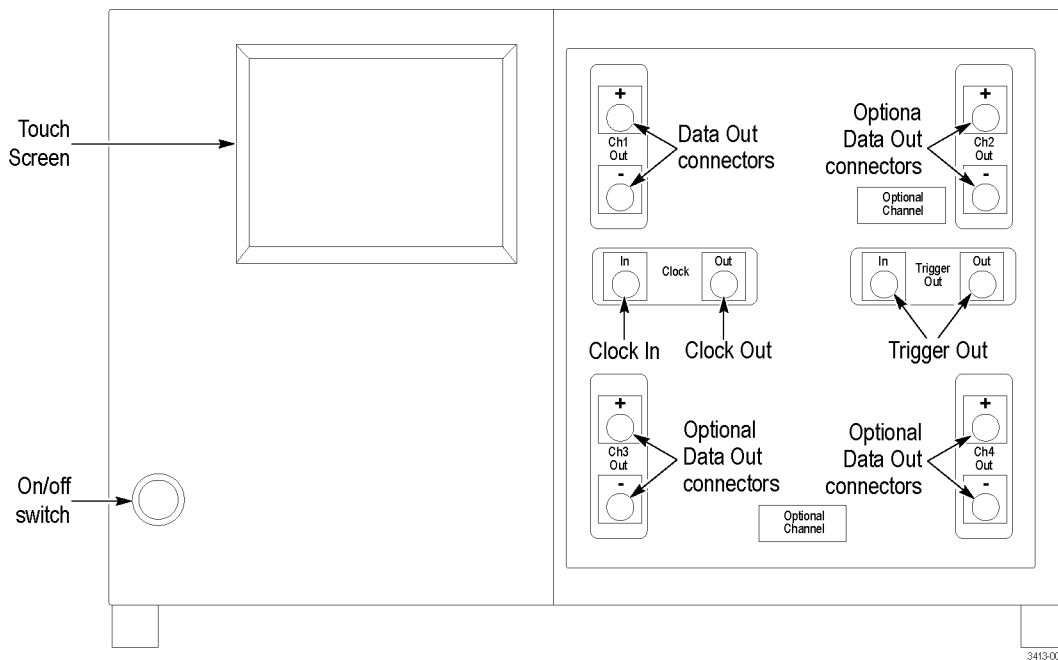

PPG4001 Front panel controls and connectors

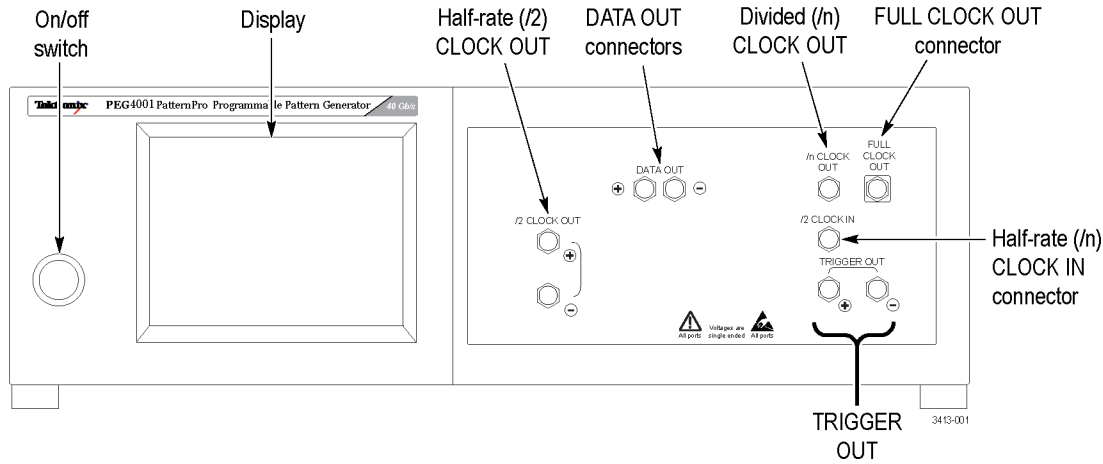

PED3200 & PED4000 Front panel controls and connectors

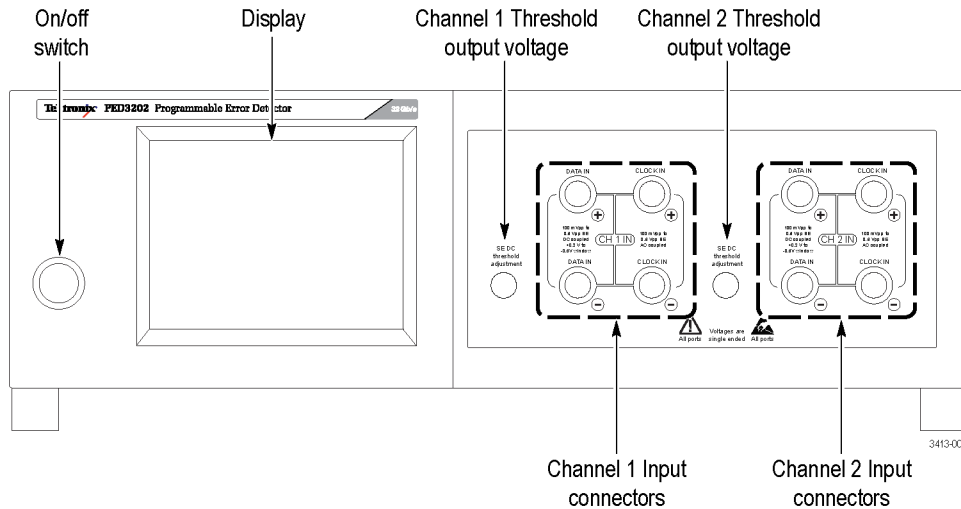

PPG1251 & PPG4001 Rear panel controls and connectors

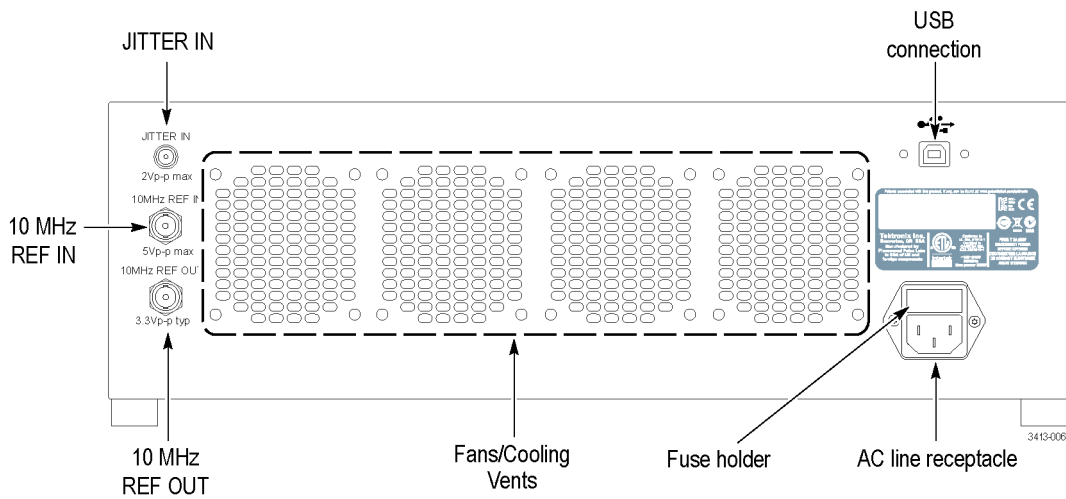

PPG160x, PPG3000, PPG3200 Rear panel controls and connectors

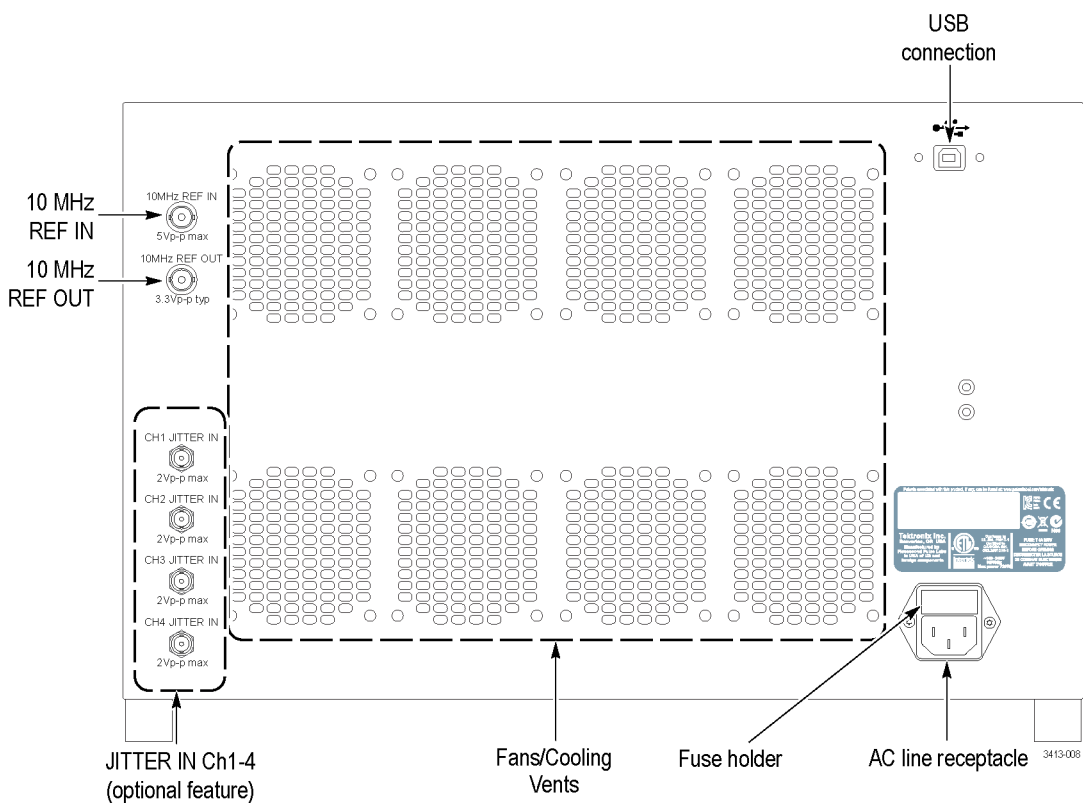

PED3200 & PED4000 Rear panel controls and connectors

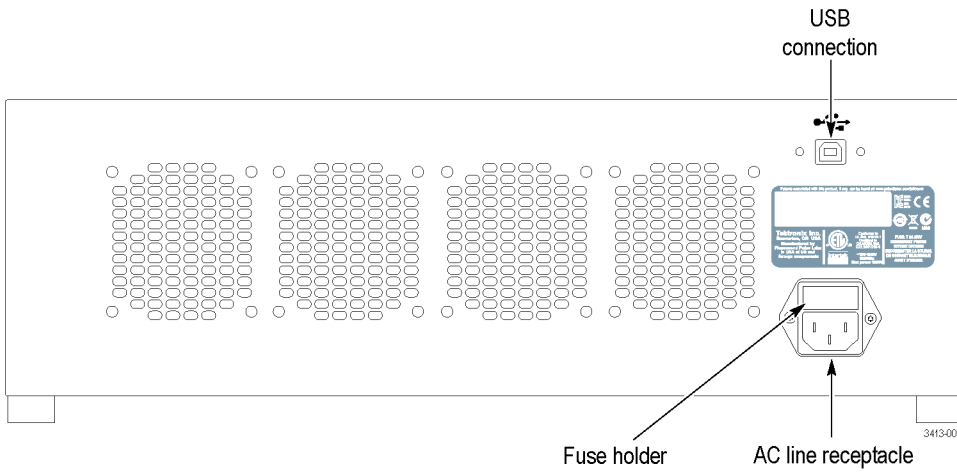

Cleaning

Periodic cleaning reduces instrument breakdown and increases reliability. Clean the instrument as needed, based on the operating environment. Dirty conditions may require more frequent cleaning than computer room conditions.

Clean the flat panel display

The flat panel display is a soft plastic display and must be treated with care during cleaning.



CAUTION. *Improper cleaning agents or methods can damage the flat panel display.*

- Do not use abrasive cleaners or commercial glass cleaners to clean the display surface.
- Do not spray liquids directly on the display surface.
- Do not scrub the display with excessive force.
- Avoid getting moisture inside the instrument while cleaning the display; use only enough solution to dampen the wipe.
- Clean the flat panel display surface by gently rubbing the display with a cleanroom wipe (such as Wypall Medium Duty Wipes, #05701, available from Kimberly-Clark Corporation).
- If the display is very dirty, moisten the wipe with distilled water or a 75% isopropyl alcohol solution and gently rub the display surface. Avoid using excess force or you may damage the plastic display surface.

Clean the exterior surfaces

Clean the exterior surfaces with a dry, lint-free cloth or a soft-bristle brush. If dirt remains, use a cloth or swab dampened with a 75% isopropyl alcohol solution. A swab is useful for cleaning in narrow spaces around the controls and connectors. Do not use abrasive compounds on any part of the instrument.

To avoid damaging the instrument follow these precautions:

- Avoid getting moisture inside the instrument during external cleaning and use only enough solution to dampen the cloth or swab.
- Do not wash the front-panel power switch. Cover the switch while washing the instrument.

- Use only deionized water when cleaning. Use a 75% isopropyl alcohol solution as a cleanser and rinse with deionized water.
- Do not use chemical cleaning agents; they may damage the instrument. Avoid chemicals that contain benzene, toluene, xylene, acetone, or similar solvents.

Compliance information

This section lists the EMC (electromagnetic compliance), safety, and environmental standards with which the instrument complies.

EMC compliance

EC Declaration of Conformity – EMC

Meets intent of Directive 2004/108/EC for Electromagnetic Compatibility. Compliance was demonstrated to the following specifications as listed in the Official Journal of the European Communities:

EN 61326-1. EMC requirements for electrical equipment for measurement, control, and laboratory use.^{1 2 3}

- CISPR 11. Radiated and conducted emissions, Group 1, Class A
- IEC 61000-4-2. Electrostatic discharge immunity
- IEC 61000-4-3. RF electromagnetic field immunity
- IEC 61000-4-4. Electrical fast transient / burst immunity
- IEC 61000-4-5. Power line surge immunity
- IEC 61000-4-6. Conducted RF immunity
- IEC 61000-4-11. Voltage dips and interruptions immunity

EN 61000-3-2. AC power line harmonic emissions

EN 61000-3-3. Voltage changes, fluctuations, and flicker

European contact.

Tektronix UK, Ltd.
Western Peninsula
Western Road
Bracknell, RG12 1RF
United Kingdom

¹ This product is intended for use in nonresidential areas only. Use in residential areas may cause electromagnetic interference.

² Emissions which exceed the levels required by this standard may occur when this equipment is connected to a test object.

³ For compliance with the EMC standards listed here, high quality shielded interface cables should be used.

**Australia / New Zealand
Declaration of
Conformity – EMC**

Complies with the EMC provision of the Radiocommunications Act per the following standard, in accordance with ACMA:

- CISPR 11. Radiated and Conducted Emissions, Group 1, Class A, in accordance with EN 61326-1.

Australia / New Zealand contact.

Baker & McKenzie
Level 27, AMP Centre
50 Bridge Street
Sydney NSW 2000, Australia

Safety compliance

This section lists the safety standards with which the product complies and other safety compliance information.

**EU declaration of
conformity – low voltage**

Compliance was demonstrated to the following specification as listed in the Official Journal of the European Union:

Low Voltage Directive 2006/95/EC.

- EN 61010-1. Safety Requirements for Electrical Equipment for Measurement, Control, and Laboratory Use – Part 1: General Requirements.

**U.S. nationally recognized
testing laboratory listing**

- UL 61010-1. Safety Requirements for Electrical Equipment for Measurement, Control, and Laboratory Use – Part 1: General Requirements.

Canadian certification

- CAN/CSA-C22.2 No. 61010-1. Safety Requirements for Electrical Equipment for Measurement, Control, and Laboratory Use – Part 1: General Requirements.

Additional compliances

- IEC 61010-1. Safety Requirements for Electrical Equipment for Measurement, Control, and Laboratory Use – Part 1: General Requirements.

Pollution degree rating

Pollution degree 2 (as defined in IEC 61010-1). Rated for indoor, dry location use only.

**Mains overvoltage
category rating**

The mains power supply circuits for these products are rated for overvoltage category II (as defined in IEC 61010-1).

Environmental considerations

This section provides information about the environmental impact of the product.

Product end-of-life handling

Observe the following guidelines when recycling an instrument or component:

Equipment recycling. Production of this equipment required the extraction and use of natural resources. The equipment may contain substances that could be harmful to the environment or human health if improperly handled at the product's end of life. To avoid release of such substances into the environment and to reduce the use of natural resources, we encourage you to recycle this product in an appropriate system that will ensure that most of the materials are reused or recycled appropriately.



This symbol indicates that this product complies with the applicable European Union requirements according to Directives 2012/19/EU and 2006/66/EC on waste electrical and electronic equipment (WEEE) and batteries. For information about recycling options, check the Support/Service section of the Tektronix Web site (www.tektronix.com).

Restriction of hazardous substances

This product is classified as an industrial monitoring and control instrument, and is not required to comply with the substance restrictions of the recast RoHS Directive 2011/65/EU until July 22, 2017.

