

WFM2300 and WFM2200A
Multiformat Multistandard Portable Waveform Monitors
User Manual



WFM2300 and WFM2200A
Multiformat Multistandard Portable Waveform Monitors
User Manual

This document supports software version 2.11.X and above.

Copyright © Tektronix. All rights reserved. Licensed software products are owned by Tektronix or its subsidiaries or suppliers, and are protected by national copyright laws and international treaty provisions. Tektronix products are covered by U.S. and foreign patents, issued and pending. Information in this publication supersedes that in all previously published material. Specifications and price change privileges reserved.

TEKTRONIX and TEK are registered trademarks of Tektronix, Inc.

Contacting Tektronix

Tektronix, Inc.
14150 SW Karl Braun Drive
P.O. Box 500
Beaverton, OR 97077
USA

For product information, sales, service, and technical support:

- In North America, call 1-800-833-9200.
- Worldwide, visit www.tektronix.com to find contacts in your area.

Warranty

Tektronix warrants that this product will be free from defects in materials and workmanship for a period of one (1) year from the date of shipment. If any such product proves defective during this warranty period, Tektronix, at its option, either will repair the defective product without charge for parts and labor, or will provide a replacement in exchange for the defective product. Parts, modules and replacement products used by Tektronix for warranty work may be new or reconditioned to like new performance. All replaced parts, modules and products become the property of Tektronix.

In order to obtain service under this warranty, Customer must notify Tektronix of the defect before the expiration of the warranty period and make suitable arrangements for the performance of service. Customer shall be responsible for packaging and shipping the defective product to the service center designated by Tektronix, with shipping charges prepaid. Tektronix shall pay for the return of the product to Customer if the shipment is to a location within the country in which the Tektronix service center is located. Customer shall be responsible for paying all shipping charges, duties, taxes, and any other charges for products returned to any other locations.

This warranty shall not apply to any defect, failure or damage caused by improper use or improper or inadequate maintenance and care. Tektronix shall not be obligated to furnish service under this warranty a) to repair damage resulting from attempts by personnel other than Tektronix representatives to install, repair or service the product; b) to repair damage resulting from improper use or connection to incompatible equipment; c) to repair any damage or malfunction caused by the use of non-Tektronix supplies; or d) to service a product that has been modified or integrated with other products when the effect of such modification or integration increases the time or difficulty of servicing the product.

THIS WARRANTY IS GIVEN BY TEKTRONIX WITH RESPECT TO THE PRODUCT IN LIEU OF ANY OTHER WARRANTIES, EXPRESS OR IMPLIED. TEKTRONIX AND ITS VENDORS DISCLAIM ANY IMPLIED WARRANTIES OF MERCHANTABILITY OR FITNESS FOR A PARTICULAR PURPOSE. TEKTRONIX' RESPONSIBILITY TO REPAIR OR REPLACE DEFECTIVE PRODUCTS IS THE SOLE AND EXCLUSIVE REMEDY PROVIDED TO THE CUSTOMER FOR BREACH OF THIS WARRANTY. TEKTRONIX AND ITS VENDORS WILL NOT BE LIABLE FOR ANY INDIRECT, SPECIAL, INCIDENTAL, OR CONSEQUENTIAL DAMAGES IRRESPECTIVE OF WHETHER TEKTRONIX OR THE VENDOR HAS ADVANCE NOTICE OF THE POSSIBILITY OF SUCH DAMAGES.

[W2 – 15AUG04]

Table of Contents

Important safety information	xi
General safety summary	xi
Service safety summary	xiii
Terms in the manual	xiii
Terms on the product	xiv
Symbols on the product	xiv
Preface	xv

Getting started

Introduction	1
Product description	1
Key features	2
Options and optional accessories	4
Instrument options	4
Optional accessories	5
International power cord options	5
Service options	6
Installation	6
Power requirements	7
Connect power	8
Power-on and power-off procedures	12
Tripod installation	15
SFP module installation	15
Video system installation	17
To test cable margins (WFM2300 only)	19
To measure A/V delay or propagation time (Option AVDP only)	20
Configure the network interface	20
Configure the IP address	20
Enable the Web remote interface	22
Configure and enable SNMP control	22
Incoming inspection	24
Basic turn on and self test	24
Front panel test	24
Fan test	25
Storing or shipping the instrument	25
To repackage the Li-Ion battery pack for shipment	25

To repack the instrument for shipment	26
---	----

Getting acquainted with your instrument

Front-panel controls	27
Three levels of control	27
Scope of controls	27
Layout and usage	28
Online help	31
To navigate online help	31
Instrument display	32
Supported displays	32
To select a display	32
Display limitation	33
Pop-up menus	33
To set display parameters	33
DISPLAY SELECT button	34
Status bar	38
Signal inputs	41
SDI signals	41
Multi In signals	41
ASI transport streams (WFM2300 Option ASI only)	41
External reference signals	41
Dual link signals	42
Connectors	43
Connector configuration	43
Signal outputs	44
SDI video output	44
AES audio output	45
A/V delay or propagation time signal output (Option AVDP only)	46
SFP module receiver - transceiver (Option SFP only)	46

Display modes

ANC Data display (Option DATA only)	48
To access the ANC Data display	48
Elements of the ANC Data display	48
Measure pop-up menu (ANC Data display)	50
CONFIG menu	50
To configure the Watch List	51

Arrowhead display	51
To access the Arrowhead display	51
Elements of the Arrowhead display	52
Gamut pop-up menu (Arrowhead display)	53
CONFIG menu	53
ASI PID List display (WFM2300 Option ASI only)	54
To access the ASI PID List display	54
Elements of the ASI PID List display	54
Detected ASI stream types	57
Measure pop-up menu (ASI PID List display)	58
CONFIG menu	58
Audio display	59
To access the Audio display	59
Elements of the Audio display	59
Above-bar warning messages	60
In-bar warning messages	60
Audio pop-up menu	61
CONFIG menu	64
To adjust audio volume	64
Audio Generator Status display	65
To access the Audio Generator Status display	65
Elements of the Audio Generator Status display	65
Generator pop-up menu (Audio Generator Status display)	67
CONFIG menu	70
Dolby E metadata configuration (Option DBE only)	70
Dolby E generated formats (Option DBE only)	71
Dolby E loudness measurements	76
AV Delay Measurement display (Option AVDP only)	78
To access the AV Delay display	78
Elements of the AV Delay display	79
Measure pop-up menu (AV Delay display)	79
CONFIG menu	80
Bowtie display	81
To access the Bowtie display	81
Elements of the Bowtie display	81
Measure pop-up menu (Bowtie display)	82
CONFIG menu	83
To position the Bowtie trace	83

Datalist display (Option DATA only)	83
To access the Datalist display	83
Elements of the Datalist display	84
Datalist color coding	84
Finding SAV and EAV in the active video stream	85
Measure pop-up menu (Datalist display)	85
CONFIG menu	86
Diagnostics Monitor display	86
To access the Diagnostics Monitor display	86
Elements of the Diagnostics Monitor display	86
Generator pop-up menu (Diagnostics Monitor display)	89
CONFIG menu	89
Diamond display	90
To access the Diamond display	90
Elements of the Diamond display	90
Gamut pop-up menu (Diamond display)	91
CONFIG menu	91
External Reference Waveform display	92
To access the External Reference Waveform display	92
Elements of the External Reference Waveform display	92
Waveform pop-up menu (External Reference Waveform display)	93
CONFIG menu	93
To position the External Reference Waveform trace	93
Eye display (WFM2300 only)	94
Elements of the Eye display	95
Eye display pop-up menu	95
Usage notes	96
Jitter display (WFM2300 only)	96
Elements of the Jitter display	97
High-Pass filter	97
Lightning display	98
To access the Lightning display	99
Elements of the Lightning display	99
Vector pop-up menu (Lightning display)	100
CONFIG menu	100
To position the Lightning trace	100
LTC Waveform display	101
To access the LTC Waveform display	101
Elements of the LTC Waveform display	101

Waveform pop-up menu (LTC Waveform display)	102
CONFIG menu	102
To position the LTC waveform trace	102
Picture display	103
To access the Picture display	103
Elements of the Picture display	103
Picture pop-up menu	104
CONFIG menu	105
Split Diamond display	106
To access the Split Diamond display	106
Elements of the Split Diamond display	106
Gamut pop-up menu (Split Diamond display)	107
CONFIG menu	107
Status displays	108
To select a status display	108
AES Channel Status display	109
Alarm Status display	110
ARIB Status displays	112
Audio Control Packet display	112
Audio Session display	115
Auxiliary Data Status display	118
Dolby Audio Status display	121
Error Log display	123
SFP Module Status display (Option SFP or Option SFP-HDMI)	126
SDI Status display (WFM2300 only)	128
Video Session display	131
Timing Measure display	136
To access the Timing Measure display	136
Elements of the Timing Measure display	136
Measure pop-up menu (Timing Measure display)	137
Timing displays for simple versus complex timing	139
Vector display	140
To access the Vector display	140
Elements of the Vector display	141
Vector pop-up menu	142
CONFIG menu	143
To position the Vector trace	143
Video Generator Status display	144
To access the Video Generator Status display	144

Elements of the Video Generator Status display	144
Generator pop-up menu (Video Generator Status display)	145
CONFIG menu	147
Waveform display	148
To access the Waveform display	148
Elements of the Waveform display	148
Waveform pop-up menu (Waveform display)	149
CONFIG menu	151
MAG, GAIN, SWEEP, and CURSOR buttons	151
To position the Waveform trace	152

Functions

Gain, sweep, and magnification	153
To set the gain	153
To set the sweep rate	154
To set the horizontal (sweep) magnification	155
Measurement cursors (Waveform display only)	156
Cursor types	156
To display and adjust the cursors	156
Display capture (freeze)	158
Remote screen capture	158
Line Select	159
Audio volume and source adjustment	160
To adjust the audio volume	160
To select the audio source	161
Presets	161
Preset groups	161
To save presets	162
To rename groups or presets	162
To recall presets	163
To export presets to a USB device	163
To import presets from a USB device	165
Alarms	166
Possible alarm responses	166
To set allowed alarm responses	167
To set alarm responses globally	167
To enable alarms	168
To set limits or qualifications	168
Monitoring alarms	169

Alarm descriptions	169
Software upgrades	
Before you begin	179
Software upgrade overview	180
USB software installation	181
Network software installation	182
Verify the software and installed options	184
Software installation troubleshooting	185
Monitoring the SDI physical layer (WFM2300 only)	
Display types	187
Configuring physical layer settings	188
To set SMPTE 259-292-425 alarm thresholds	189
To configure physical layer alarms	190
To make eye measurements	190
Eye measurement set up	191
To make manual eye measurements	191
To manually measure aberrations	192
To manually measure rise time using variable gain	193
To make automatic eye measurements	194
To make jitter measurements	194
To manually measure jitter	196
Taking cable loss measurements	197
Checking chroma-luma delay	
Check chroma/luma delay using the Lightning display	199
Checking gamut	
To set up gamut checks	202
Checking RGB gamut	202
Usage notes	204
Checking composite gamut	205
Usage notes	205
Checking luma gamut	206
Automating gamut checks	206

ARIB content displays

To enable the ARIB content displays	208
ARIB Status display	208
ARIB STD-B 39 display	209
ARIB STD-B 37 display and status screens	211
ARIB STD-B 35 display and status screens	213
ARIB TR-B 23 (1) display and status screens	215
ARIB TR-B 23 (2) display and status screens	216
ARIB TR-B 22 display and status screens	218

Audio monitoring

To configure embedded audio inputs and alarms	221
To display an audio input	222
To check audio level and phase	222
To check audio level	222
To check audio phase	223
Usage notes	224
To monitor embedded 16-channel audio	225
To configure audio inputs for embedded 16-channel audio	225
To set the audio input for embedded 16-channel audio	225
To quickly select channels 1-8 or 9-16 of the embedded audio	226
To check surround sound	227
Elements of the surround sound display	228
Usage notes	229

Closed captioning (CC) teletext AFD and safe area compliance

Monitoring CC and teletext	231
To configure CC and teletext	231
To view CC status and subtitles	232
To display CC	233
Usage notes	234
Monitoring for safe area compliance	234
To configure safe area graticules	234
To display safe area graticules	235
Usage notes	235
Monitoring for AFD compliance	236
To configure AFD graticules	236

Remote Web interface

Web browser	237
Java applet	238
Java application	238
Network access	239
SNMP control	239
General information	240
Screen resolution	240
Multiple clients	240
Screen capture	240
Web interface and SNMP command conflicts	240

Application examples

Timing a Studio: Using the traditional method	241
Timing a Studio: Using the timing display method	242
To use the timing display to time a signal to a reference	243
Timing a Studio: Timing multiple inputs to a router	244
To time the inputs to a router	244
Usage notes	245
Troubleshooting cable problems	246

Important safety information

This manual contains information and warnings that must be followed by the user for safe operation and to keep the product in a safe condition.

To safely perform service on this product, see the *Service safety summary* that follows the *General safety summary*.

General safety summary

Use the product only as specified. Review the following safety precautions to avoid injury and prevent damage to this product or any products connected to it. Carefully read all instructions. Retain these instructions for future reference.

Comply with local and national safety codes.

For correct and safe operation of the product, it is essential that you follow generally accepted safety procedures in addition to the safety precautions specified in this manual.

The product is designed to be used by trained personnel only.

Only qualified personnel who are aware of the hazards involved should remove the cover for repair, maintenance, or adjustment.

Before use, always check the product with a known source to be sure it is operating correctly.

While using this product, you may need to access other parts of a larger system. Read the safety sections of the other component manuals for warnings and cautions related to operating the system.

When incorporating this equipment into a system, the safety of that system is the responsibility of the assembler of the system.

To avoid fire or personal injury

Use proper power cord. Use only the power cord specified for this product and certified for the country of use. Do not use the provided power cord for other products.

Power disconnect. The power cord disconnects the product from the power source. See instructions for the location. Do not position the equipment so that it is difficult to operate the power cord; it must remain accessible to the user at all times to allow for quick disconnection if needed.

Use proper AC adapter. Use only the AC adapter specified for this product.

Do not operate without covers. Do not operate this product with covers or panels removed, or with the case open. Hazardous voltage exposure is possible.

Do not operate with suspected failures. If you suspect that there is damage to this product, have it inspected by qualified service personnel.

Disable the product if it is damaged. Do not use the product if it is damaged or operates incorrectly. If in doubt about safety of the product, turn it off and disconnect the power cord. Clearly mark the product to prevent its further operation.

Examine the exterior of the product before you use it. Look for cracks or missing pieces.

Use only specified replacement parts.

Replace batteries properly. Replace batteries only with the specified type and rating.

Recharge batteries properly. Recharge batteries for the recommended charge cycle only.

Do not operate in wet/damp conditions. Be aware that condensation may occur if a unit is moved from a cold to a warm environment.

Do not operate in an explosive atmosphere.

Keep product surfaces clean and dry. Remove the input signals before you clean the product.

Provide proper ventilation. Refer to the manual's installation instructions for details on installing the product so it has proper ventilation.

Slots and openings are provided for ventilation and should never be covered or otherwise obstructed. Do not push objects into any of the openings.

Provide a safe working environment. Always place the product in a location convenient for viewing the display and indicators.

Be sure your work area meets applicable ergonomic standards. Consult with an ergonomics professional to avoid stress injuries.

Service safety summary

The *Service safety summary* section contains additional information required to safely perform service on the product. Only qualified personnel should perform service procedures. Read this *Service safety summary* and the *General safety summary* before performing any service procedures.

To avoid electric shock.

Do not service alone. Do not perform internal service or adjustments of this product unless another person capable of rendering first aid and resuscitation is present.

Disconnect power. To avoid electric shock, switch off the product power and disconnect the power cord from the mains power before removing any covers or panels, or opening the case for servicing.

Use care when servicing with power on. Dangerous voltages or currents may exist in this product. Disconnect power, remove battery (if applicable), and disconnect test leads before removing protective panels, soldering, or replacing components.

Terms in the manual

These terms may appear in this manual:



WARNING. *Warning statements identify conditions or practices that could result in injury or loss of life.*



CAUTION. *Caution statements identify conditions or practices that could result in damage to this product or other property.*

Terms on the product

These terms may appear on the product:

- DANGER indicates an injury hazard immediately accessible as you read the marking.
- WARNING indicates an injury hazard not immediately accessible as you read the marking.
- CAUTION indicates a hazard to property including the product.

Symbols on the product



When this symbol is marked on the product, be sure to consult the manual to find out the nature of the potential hazards and any actions which have to be taken to avoid them. (This symbol may also be used to refer the user to ratings in the manual.)

The following symbols may appear on the product:



Preface

This manual contains the following information to help you use the Tektronix WFM2300 and WFM2200A Multiformat Multistandard Waveform Monitors:

- How to set up various waveform displays for monitoring SD-SDI, HD-SDI, and 3 Gb/s SDI video signals.
- How to set up audio displays to monitor embedded AES/EBU audio signals.
- How to set up parameters for monitoring auxiliary data, ancillary data, closed captions, and timecode.
- How to freeze video data.
- How to set up error logging and alarms.
- How to operate the instrument remotely.
- How to navigate instrument menus.
- How to operate the instrument front panel.

Product documentation

The following table lists the user documentation that is available for your product. You can always find the most updated documentation and software for your product on the Tektronix Web site at www.tektronix.com/downloads.

Table 1: Product documentation

To read about	Use these documents	Tektronix part number
Installation and safety	Installation and Safety Instructions Provides installation, safety, general specifications, and compliance information. This is a printed manual and is also available on the Web at www.tektronix.com/downloads .	071-3205-XX
Instrument operation	User Manual (this manual) Provides in-depth descriptions of instrument operation. Available on the Web at www.tektronix.com/downloads .	077-0864-XX
Content-sensitive help topics	Online Help Provides detailed information about instrument operation. The help is available by pressing the HELP button on the front panel of the instrument. You can also access the online help topics using the remote Web interface. See Remote Web interface on page 237.	NA
Specifications and procedures for checking instrument performance	Specifications and Performance Verification Technical Reference Provides physical, electrical, and environmental specifications along with functional checks and performance verification procedures. Available on the Web at www.tektronix.com/downloads .	077-0867-XX

To read about	Use these documents	Tektronix part number
Information about declassifying the instrument	Declassification and Security Instructions Provides detailed information about how to sanitize the instrument. Available on the Web at www.tektronix.com/downloads .	077-0869-XX
Information about the WFM200BA battery pack	WFM200BA Rechargeable Battery Pack Instructions Provides safety, operating, and recycling information for the Lithium-Ion battery pack. This is a printed manual and is also available on the Web at www.tektronix.com/downloads .	075-1041-XX
Information about the WFM200BC battery charger	WFM200BC External Battery Charger Instructions Provides safety and operating information for the optional, external battery charger. This is a printed manual and is also available on the Web at www.tektronix.com/downloads .	075-1042-XX

Conventions used in this manual

The following icon is used throughout this manual:

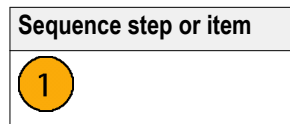

Getting started

Introduction

Your instrument was shipped with a printed Installation and Safety Instructions manual which includes safety, compliance, and operating requirements along with power-on, installation, and accessories information. That manual is also available online at www.tektronix.com/downloads. This User manual contains information about operating the instrument.

This chapter will help you set up and begin to use the instrument. It is divided into the following four sections:

- *Product description* describes your instrument and provides a list of key features.
- *Options and optional accessories* lists the options and optional accessories which are available for the instrument.
- *Network installation* describes how to set up your instrument for use on an Ethernet network.
- *Incoming inspection* provides a procedure for verifying the basic operation and functionality of your instrument.

Product description

The WFM2300 and WFM2200A Multiformat Multistandard Waveform Monitors are portable baseband video monitors offering uncompromised monitoring quality for field applications with a large 6.5 inch high-brightness, low-power consumption LED backlit display, and weighing in at less than 4.4 lbs (2 kg).

These instruments provide an array of basic monitoring tools for video (SD, HD, Dual Link, and optional 3G) and audio (Embedded and AES) signals. You can configure the instrument for a full screen or quad-tile display, which allows you to see all of the necessary signal information at a glance. The ANC Data Inspector, Data list, and closed caption decode features are invaluable for troubleshooting problems within the ancillary data space. The WFM2300 with Option ASI can monitor MPEG2 transport streams.

You can use the Tektronix patented Timing display and the external reference waveform display to assist in ensuring correct video timing and troubleshooting timing problems. The instrument includes a color bar and pathological video signal generator for troubleshooting signal paths and equipment.

A range of accessories can expand the versatility of each model for field operations such as production setup and troubleshooting. These instruments can also be powered by the supplied rechargeable/replaceable Li-Ion battery pack or the supplied 100-240 V AC adapter, which provides 19 VDC to the instrument.

Key features The following key features make these instruments easy to use, flexible, and effective tools.

Table 2: Key features

Item	Description
Flexible tile displays: Full and Quad Tile	<p>Quad Tile (4-Tile): View four measurement displays at once, one in each tile.</p> <p>In Quad Tile mode, the high-resolution LED display provides four concurrent views of a monitored signal (with a maximum of two trace displays at once). The instrument also provides the flexibility to configure each of the four display tiles independently, enabling you to quickly check the integrity of a signal.</p> <p>Full: View the active display full screen.</p>
Presets	Customizable presets allow you to quickly save and recall commonly used configurations.
Digital support	Support for digital applications.
Fully digital processing	Fully Digital Processing allows for accurate, repeatable, drift-free operation that surpasses traditional analog designs.
Video and audio test signal generation	<p>Multi-rate signal generation, including a pathological signal, provides engineers with a simple signal source for quick signal path verification during system and/or equipment setup and troubleshooting.</p> <p>You can genlock the signal output with the external reference input signal and you can enable the Moving Picture function on the output signal.</p> <p>Option DBE supports Dolby E test stream generation for embedded and AES outputs, which provides easy access to Dolby E audio reference and test signals within modern broadcast facilities. These signals include test tones at different levels (– 18 dB, –20 dB and Multi-tone) with frame rates compatible with the respective video signals.</p>
Waveform display	Traditional waveform displays allow signals to be overlaid or paraded.
Vector display	Vector display with Composite and Component Compass Rose Graticules, and gain, sweep, and magnification controls. Traditional and Lightning Vector displays are available. The latter visualizes both luma and chroma amplitudes, and quantifies inter-channel timing.
Infinite Persistence	All trace displays can also be set, tile by tile, to Infinite Persistence. This mode traces waveforms over time on the same display, providing a visual history of the trace.
Gamut monitoring	Arrowhead, Spearhead, Diamond, and Split Diamond displays offer user-selectable gamut thresholds so that you can set monitoring limits appropriate to a specific operation. Gamut monitoring is fully integrated with the alarm logging and reporting capabilities.
LTC waveform display	Longitudinal Time Code (LTC) is monitored in a frame rate display to allow observation of amplitude and noise, and verify LTC is locked to the video.

Item	Description
External Reference Waveform display	The External Reference waveform display check the external reference signal integrity, including its shape and amplitude. This display is independent of the input video signal.
Audio monitoring	Surround Sound display of audio signals and phase relationships of normal channel pairs.
	16-channel embedded AES/EBU audio simultaneous monitoring support with Multichannel Surround Sound ¹ display, flexible Lissajous display, and two channel AES/EBU BNC input monitoring. The Lissajous display lets you monitor a user-specified pairing of channel inputs.
	Support and options for viewing and monitoring both levels of normal channel pairs for embedded audio signals.
	Support for audio control packet coding and many popular audio scales, including BBC scales.
Auxiliary data monitoring	Support for monitoring auxiliary data including data conforming to ARIB standards and CEA608, CEA708, AFD, and CGMS-A.
Timing display	A Tektronix proprietary display that simplifies measuring the timing difference between two signals. Using the Timing display enables you to easily compare and correct the timing between two signals.
Audio/Video delay and propagation time measurements (Option AVDP only)	Support for an out-of-service A/V delay measurement to ensure system integrity and facilitate A/V delay compliance.
	Support for a propagation time measurement that measures the time between video signals leaving and returning to the instrument. This measurement allows the facility engineer to align the timing of the multiple incoming videos, check the delay of a CODEC system and/or a video signal path, including the satellite feed.
MPEG2 transport stream monitoring (WFM2300 Option ASI only)	Support for monitoring an ASI MPEG2 transport stream including an Eye pattern measurement, ASI signal polarity, MPEG2 PID Tree display, TS bit rate, TS packet size, continuity counter error detection, and error logging.
Closed Captioning support (Option DATA only)	Support for simultaneous decode and display in multiple languages of CC standards (CEA 608 (VBI), CEA 608 (ANC), CEA (608/708), CEA 708, TeletextB (VBI), TeletextB OP47 SDP (ANC), and TeletextB OP47 Multi (ANC)) with caption text and V-chip information overlaid on the picture (monitor mode). There are also settings for missing or incorrectly inserted closed captioning.
Picture area	Support for standard and custom Safe Graticules for Picture displays that look for incorrect placements of graphics, logos, Black events, and Frozen events. Two Safe Area graticules and Safe Title graticules are supported.
Status screens	Status screens provide content status at a glance.
Error tracking	Configurable alarms and error logging.
Remote control	Full remote control for complete installation flexibility.

¹ Audio Surround Sound Display licensed from Radio Technische Werkstätten GmbH and Co. KG (RTW).

Item	Description
Data List display	Examines the contents of all digital formats, structures, and transports and displays the data without any interpolation.
Ancillary data inspector	Allows you to monitor all ancillary data present in a signal.

Options and optional accessories

Your instrument may have been ordered with one or more of the options listed in this section.

Instrument options

The following options are available for your instrument:

Table 3: Instrument options

Option	Description
3G	Adds support for 3G-SDI (Level A and Level B) signal formats
ASI	Adds support for ASI signal format
AVDP	Adds out-of-service A/V delay measurement and propagation time measurement
DATA	Adds Ancillary Data monitoring (including decoding of 708 and 608 Closed Captions, Teletext and OP47 Subtitles, AFD, and CGMS-A), and ANC Data Inspector
DBE	Add Dolby E analysis (including Metadata display, peak level indication, and Dolby E timing measurement) and Dolby E test signals (user-configurable parameters include: Tone (-18 dB, -20 dB and Multitone), Configuration (8x1 mono, 4x2 stereo, surround 5.1, 5.1+2 and 7.1), Metadata, and Dolby E audio frame start location)
LOUD	Add Audio Loudness monitoring capabilities including Loudness Meter
SFP	Add Optical input/output SDI module support (includes one SFP module); an SFP module is available for additional purchase (Tektronix part number 119-8280-00)
SFP-HDMI	Adds HDMI input module support (includes one SFP module), not HDCP compliant; an SFP module is available for additional purchase (Tektronix part number 119-8475-00)

Check the installed options. When the instrument is powered on, you can check which options are installed on your instrument by performing the following steps:

1. Press the **CONFIG** button on the front panel.
2. Use the General knob to navigate to **Utilities**.
3. Press the right arrow button to navigate to the **Utilities** submenu and select **View Instrument Options**. The menu box on the right side of the display shows the installed options.

Optional accessories You can purchase any of the following accessories for your instrument.

Table 4: Optional accessories

Accessory	Description
WFM200BA	Additional Li-Ion rechargeable battery pack. The instrument is shipped with one WFM200BA rechargeable battery pack.
WFM200BC	External battery charger for the WFM200BA rechargeable battery pack.
WFM200FSC	Soft carrying case to protect the instrument with room for the instrument, AC adapter, and battery pack(s).

International power cord options

The instrument was shipped with an AC adapter and one of the following power cord options. Power cords for use in North America are UL listed and CSA certified. Cords for use in areas other than North America are approved by at least one authority acceptable in the country to which the product is shipped.

Table 5: Power cord options

Option	Description
A0	North America power
A1	Universal EUR power
A2	United Kingdom power
A3	Australia power
A5	Switzerland power
A6	Japan power
A10	China power
A11	India power
A12	Brazil power
A99 ¹	No power cord

¹ When ordering the A99 option, it is the responsibility of the end user to be sure that a certified power cord, for the country or region in which it is installed, is used with this instrument.

Service options You can add any or all of the following service options to any instrument. See *Instrument options* on page 4.

Table 6: Service options

Option	Description
C3	Calibration Service 3 Years
C5	Calibration Service 5 Years
D1	Calibration Data Report
D3	Calibration Data Report 3 years (with option C3)
D5	Calibration Data Report 5 Years (with Opt. C5)
G3	Complete Care 3 Years (includes loaner, scheduled calibration, and more)
G5	Complete Care 5 Years (includes loaner, scheduled calibration, and more)
R3	Repair Service 3 Years (including warranty)
R5	Repair Service 5 Years (including warranty)
R3DW	Repair Service Coverage 3 Years (includes product warranty period). 3-year period starts at time of customer instrument purchase. This option is available if the instrument is within product warranty. It is not available once instrument exits warranty period.
R5DW	Repair Service Coverage 5 Years (includes product warranty period). 5-year period starts at time of customer instrument purchase. This option is available if the instrument is within product warranty. It is not available once instrument exits warranty period.

Installation

Your handheld instrument is shipped in a fully enclosed metal chassis with a protective rubber boot. A flange with a threaded hole is provided on the bottom panel for use with a tripod mount.

If you need to install your instrument in a custom application, such as a console, be sure to provide adequate airflow and make sure the intake air to the side vents does not exceed 40 °C. Do not block or restrict the ventilating holes. See the *WFM2300 and WFM2200A Specifications and Performance Verification Technical Reference* for the complete operating specifications.



CAUTION. *To prevent risk of fire, adequate airflow must be maintained. Failure to provide adequate airflow to the instrument could cause the instrument to shut down. Inadequate airflow includes placing the instrument in any small, enclosed room that lacks a ventilation system, such as a closet. If the airflow is restricted or blocked and the instrument does not shut down, the risk of fire is increased and the instrument could be permanently damaged.*

Power requirements

This instrument is designed to be powered by a 19 VDC input or by the WFM200BA Lithium-Ion rechargeable battery pack. However, the instrument will operate from any regulated DC voltage between 11 V and 20 V. Input voltages below 18.5 V should not be used while the WFM200BA battery pack is installed, as the battery pack will discharge until it is below the input voltage level.

AC power. When the instrument operates from an external AC adapter, the following power requirements apply:



WARNING. *Fire can cause personal injury and/or property damage. To prevent risk of fire, when using an external DC source other than the provided AC adapter, make sure that it has a suitable current limiting device (such as a fuse).*

- A single-phase power source with one current-carrying conductor at or near earth-ground (the neutral conductor).
- The power source frequency must be 50 or 60 Hz, the operating voltage range must be from 100 to 240 VAC, continuous. The typical power draw is 27 W. However, if you are operating the instrument and charging a battery at the same time, the typical power doubles to 54 W.



WARNING. *To reduce risk of fire and shock, make sure the mains supply voltage fluctuations do not exceed 10% of the operating voltage range.*

- Systems with both current-carrying conductors live with respect to ground (such as phase-to-phase in multiphase systems) are not recommended as power sources.

NOTE. *Only the line conductor is fused for over-current protection. The fuse is internal and not user replaceable. Do not attempt to replace the fuse. If you suspect the fuse has blown, return the unit to an authorized service center for repair.*

- Use the proper power cord with the AC adapter. See [International power cord options](#) on page 5.

NOTE. *See the WFM2300 and WFM2200A Specifications and Performance Verification Technical Reference for additional information on power and environmental requirements.*

Battery power. This instrument can be powered by a Lithium-Ion rechargeable battery pack. One WFM200BA battery pack is provided with the instrument. If needed, you can purchase additional battery packs.

NOTE. *For optimum performance, charge the battery pack completely before using it for the first time or after prolonged storage.*

When installed, the battery pack will charge whenever the supplied AC adapter is connected, whether the instrument is On, Off, or in Standby mode. The charging rate is unaffected by instrument operation.

If you are using the WFM200BA battery pack to power the instrument, read the following battery safety notices. See the *WFM200BA Rechargeable Battery Pack Instructions* for information about how to properly operate and maintain the battery pack.



CAUTION. *To avoid damage to the battery pack, use only the waveform monitor or the optional WFM200BC battery charger to charge the battery pack. Do not connect any other voltage source to the battery pack.*

To avoid overheating of the battery pack during charging, do not exceed the allowable ambient temperature of 0 to 40 °C. The battery pack will stop charging if it gets too hot.

The temperature at which the battery pack will stop charging varies depending on the charging current and the battery heat dissipation characteristics. This is particularly true when the instrument is being operated while the battery pack is charging. The actual battery-charging temperature limit may be lower than 40 °C.

Connect power

This section provides procedures for installing the power cord and installing the battery pack.

Power cord installation. Connect the AC adapter to the power connector on the instrument top panel as shown below.

NOTE. *If a battery pack is installed in the instrument, it will automatically charge whenever the supplied AC adapter is connected, whether the instrument is On, Off, or in Standby mode.*

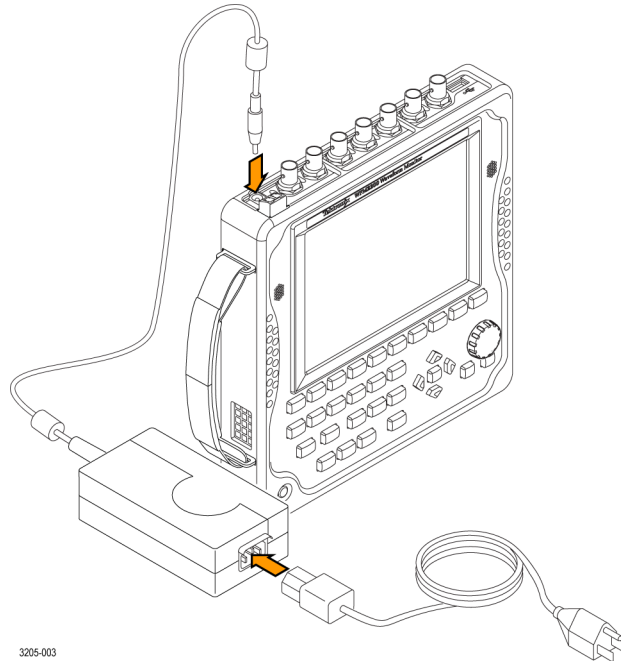

3205-003

Battery pack installation. The waveform monitor is shipped with a WFM200BA Lithium-Ion rechargeable battery pack. Perform the following steps to install the battery pack.

NOTE. For optimum performance, charge the battery pack completely before using it for the first time or after prolonged storage.

The battery pack can be installed, removed, or replaced while the instrument is turned on and operating with the AC adapter.

See the WFM200BA Rechargeable Battery Pack Instructions for more information about the battery pack.

1. On the rear panel of the instrument, remove the cover for the battery compartment:
 - a. Use your fingers or a coin to turn the battery cover screw counterclockwise until the cover is loose.
 - b. Lift away the battery cover.
2. Insert the WFM200BA battery pack into the battery compartment as shown below.

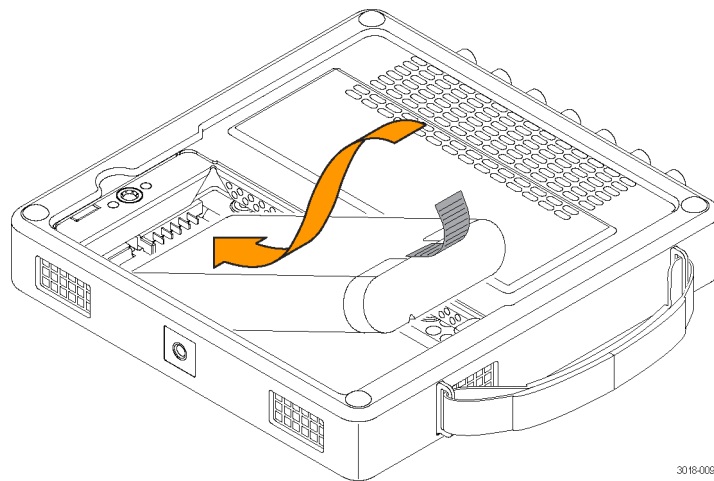

3. Secure the battery pack tab as shown below.

Fold the end of the tab between the battery pack and the chassis

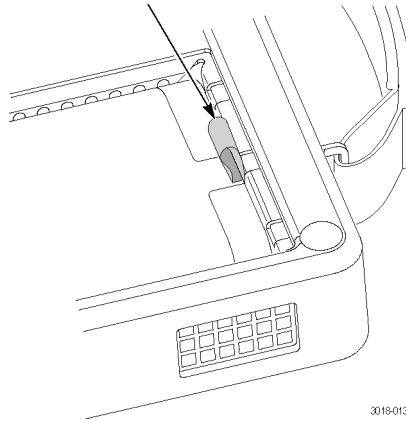

3018-013

4. Replace the battery compartment cover:
 - a. Insert the three tabs on the battery cover into the chassis slots as shown below.

Insert the three tabs into the chassis slots

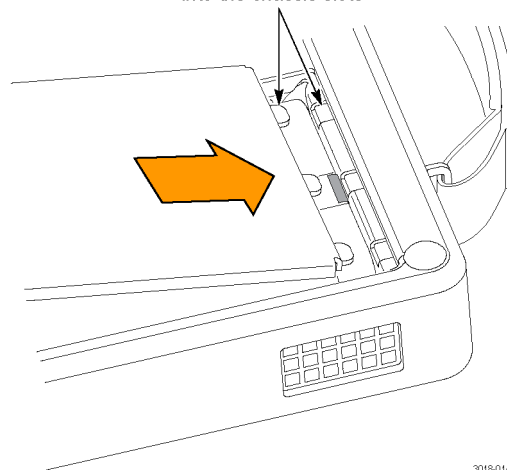

3018-014

- b. Close the battery cover and then use your fingers or a coin to turn the battery cover screw clockwise to secure the cover as shown below.

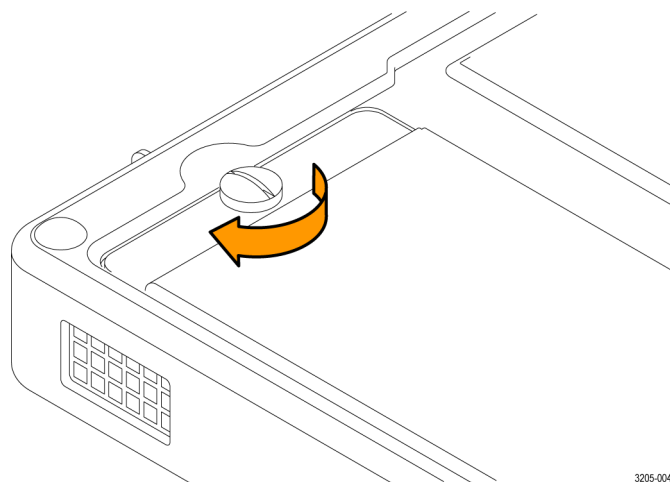

Power-on and power-off procedures

This section provides procedures for powering the instrument on and off.

Power-on procedure. Perform the following steps to power on the instrument:

1. Connect power to the instrument:
 - **AC adapter:** Connect the AC adapter to the power connector on the instrument. See [Power cord installation](#) on page 9.
 - **Battery pack:** Install the WFM200BA battery pack. See [Battery pack installation](#) on page 10.
2. Press the Power button on the instrument front panel to turn the instrument on.
3. If you are powering the instrument using only the battery pack, check the power level before operating the instrument. See [Battery charge level indicators](#) on page 14.

Power-off procedure. There are two methods for powering off the instrument:

- Press the Power button on the front panel. This opens the Power off or Standby dialog box where you can use the arrows buttons to select from the following actions:

NOTE. *When you press the Power button, you must make a selection in the Power off or Standby dialog box within 5 seconds or the instrument will automatically power off.*

- **Power off.** This is the default selection. You can press the **SEL** button to immediately power off the instrument or you can wait 5 seconds for the instrument to automatically power off.
- **Standby.** Use the arrow buttons to select Standby to put the instrument in Standby mode. In Standby mode, the instrument consumes less power than when it is turned on and also takes less time to turn back on than when the instrument is turned completely off.
- **Cancel.** Use the arrow buttons to select Cancel if you want to cancel the power-off operation.
- Press and hold the Power button for 5 seconds and then release the button to immediately power off the instrument.

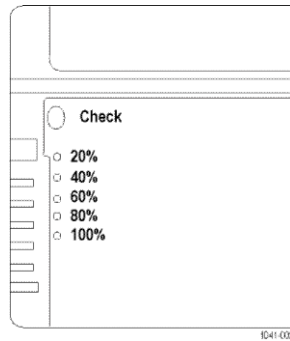

NOTE. *To remove power completely from the instrument, disconnect the AC adapter from the power connector and remove any installed battery pack.*

Battery charge level indicators. When the WFM200BA battery pack is not installed in the instrument, you can check the charge level by pressing the Check button on the back of the battery pack. LEDs will illuminate to indicate the amount of charge remaining in increments of approximately 20%.

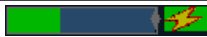
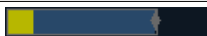

When a battery pack is installed in the instrument, an LED is illuminated on the top panel of the instrument next to the power connector and beneath the battery icon. The charge level meter is shown on the bottom right of the status bar. The following table shows examples of the meter icons.

Table 7: Battery charge-level meter icons

Item	Description
	Battery fully charged, AC adapter plugged in
	Battery partially charged, AC adapter plugged in and charging
	Battery level low, AC adapter not plugged in
	Battery level critically low, AC adapter not plugged in

Tripod installation

The bottom panel provides a 1/4-20 threaded hole that can be used to mount the instrument on a camera tripod as shown below.

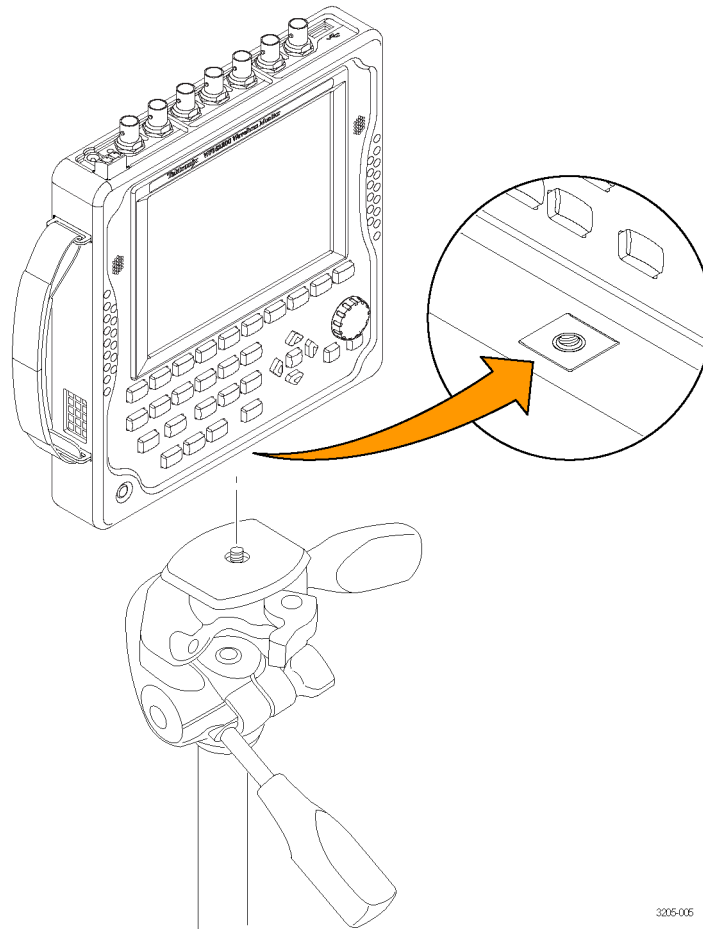

3205-005

SFP module installation

There are two SFP modules available:

- With Option SFP, you receive an SFP module for monitoring or outputting optical SDI signals.
- With Option SFP-HDMI, you receive an SFP module for monitoring HDMI signals.

To install the SFP module, you will first need to remove the plug from the SFP connector. Insert the SFP module into the SFP connector on the top-panel of the waveform monitor as shown below (optical SFP module shown). The module will latch into place when fully inserted.

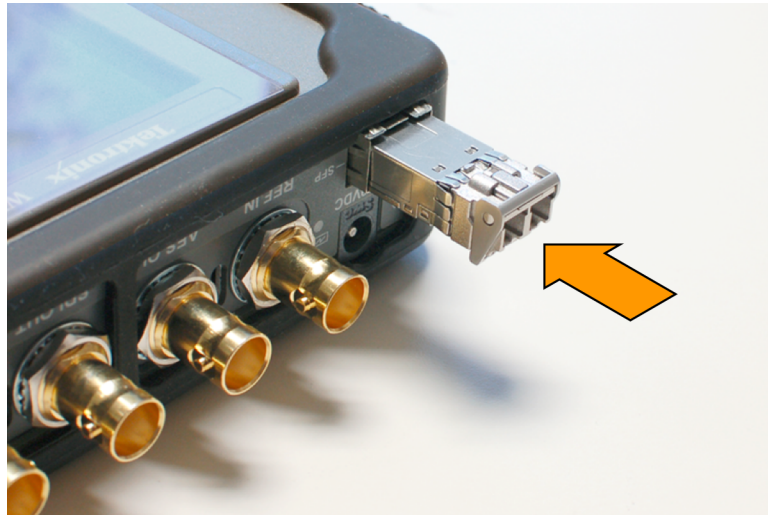

3205-011

SFP module removal. To remove the SFP module, lift up on the latch and then pull the module out of the SFP connector as shown below (optical SFP module shown).



3205-010

SFP module transportation. The SFP module should be removed from the waveform monitor while the instrument is being transported.



CAUTION. To prevent static damage to the SFP module while you are transporting the waveform monitor, always transport the SFP module in a anti-static bag or container.

Video system installation

The instrument can operate almost anywhere in the distribution system where serial digital system monitoring is needed.

Line termination. The line termination of the signal inputs are as follows:

- **SDI A and REF IN:** Each input has a 75 Ω internal termination.
- **MULTI IN:** The input auto-terminates based on the type of input signal.
- **SFP (optional):** The termination of the optional SFP input is determined by the installed module. No termination occurs for optical inputs.

Compatibility of BNC center pins. Most BNC connectors for video equipment, whether 50 Ω or 75 Ω , use a 50 Ω standard center pin. Some laboratory 75 Ω BNC connectors use a smaller diameter center pin. The BNC connectors on the instrument are designed to work with the 50 Ω standard (large diameter) center pins.

Do not use connectors or terminators with the smaller center pins. They could cause intermittent connections.

To monitor the video bit stream of a serial receiver. Route an incoming serial signals into the SDI A or MULTI IN input on the instrument.

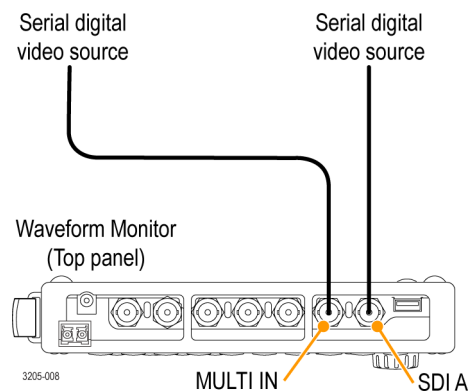

NOTE. See the WFM2300 and WFM2200A Specifications and Performance Verification Technical Reference for the maximum allowed cable lengths.

To monitor the embedded audio signal in a serial digital video stream. Route the incoming serial signal into the SDI A or MULTI IN input on the instrument.

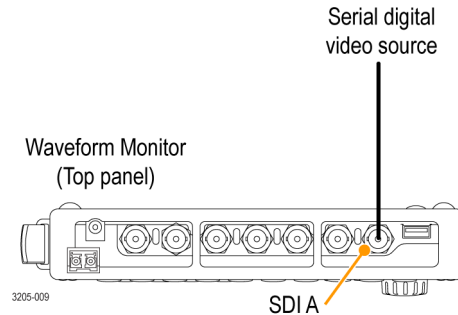

To monitor the external reference signal. Route the incoming reference signal into the REF IN input on the instrument.

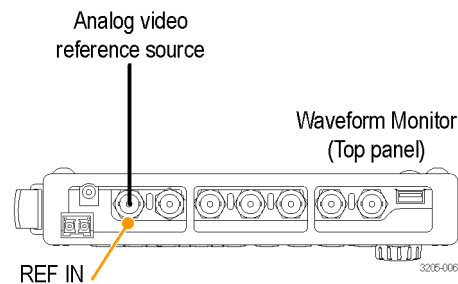

To genlock the SDI output test signal to the external reference signal. To genlock the SDI output test signal to the external reference signal, use the **CONFIG > Video/Gen Outputs > Test Signal Genlock** menu to enable the genlock function and to configure the genlock vertical and horizontal timing offsets. The Generator Status display and the Status Bar indicate the status of the genlock function.

**To test cable margins
(WFM2300 only)**

Stress loop connections for a monitored signal. To test the cable margins for a monitored signal, route the incoming signal input to one of the STRESS LOOP connectors. Route a cable from the other connector of the STRESS LOOP to the SDI A input as shown below.

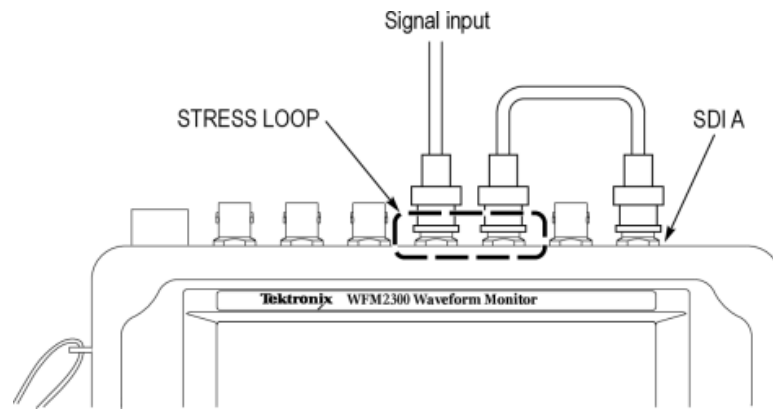

Stress loop connections for a generated signal. To test the cable margins for a generated signal, route the SDI OUT signal to one of the STRESS LOOP connectors. Route a cable from the other connector of the STRESS LOOP to your video system as shown below.

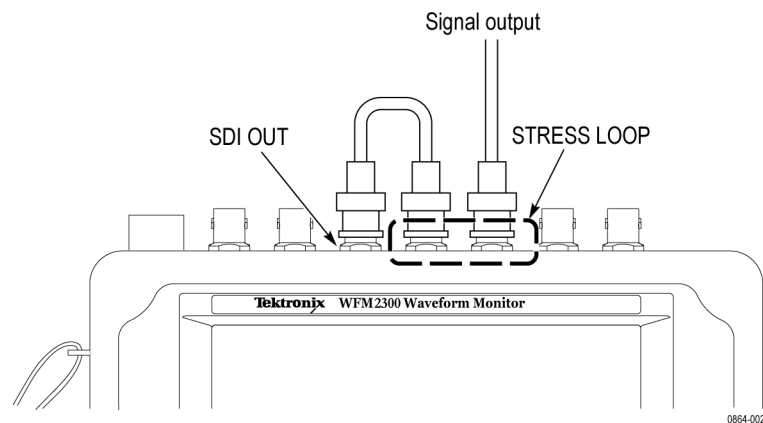

To measure A/V delay or propagation time (Option AVDP only)

To measure A/V delay or propagation time in a video system, route the SDI OUT signal to your video system input and route the video system output to the SDI A input connector as shown below.

The instrument must be set to AV Delay mode and the desired AV Timing mode must be selected (AV Delay or Propagation) in order for the proper signal to be generated and the measurement to be made.

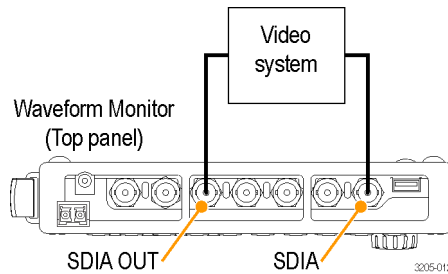

Configure the network interface

An Ethernet connection to the instrument is required for some instrument functions such as the following:

- Accessing the remote interface of the instrument
- Remotely controlling the instrument using SNMP commands
- Upgrading the instrument software

Configure the IP address

Perform the following steps to configure the IP address of the instrument:

1. Make one of the following Ethernet connections:
 - If you have a local Ethernet network, connect the instrument and computer to the network.
 - If you do not have a local Ethernet network, connect the computer directly to the instrument using an Ethernet cable. The instrument has an auto-crossover feature, so you do not need a crossover cable. You can also use a network HUB connection between the PC and the instrument.
2. Press the Power button to power on the instrument.

3. Assign the instrument an IP address:

NOTE. *When the instrument is connected to your local network, the instrument must be assigned a valid IP address to operate on your network. The instrument is shipped with a default IP address of 192.168.1.1, but the address will usually not be valid on your local network.*

The network addresses of the instrument can be assigned either manually or automatically using DHCP. If your network does not use DHCP, you will have to manually enter the address for the instrument. In that case, contact your local LAN administrator to obtain the valid network addresses.

Alternatively, when you connect the computer directly to the instrument using an Ethernet cable, you can manually assign the instrument any IP address that is compatible with the IP address for the Ethernet interface of the computer.

- a. Press the **CONFIG** button on the front panel.
- b. Navigate to **Network Settings > IP Config Mode**.
- c. Set the IP configuration mode:
 - If you connected the instrument to your local network, select either **Manual** or **DHCP** as directed by your LAN administrator.
 - If you connected the instrument directly to your computer, select **Manual**.
- d. If you set the IP configuration mode to Manual, perform one of the following tasks:
 - If you connected the instrument to your local Ethernet network, enter the IP address, subnet mask, and gateway address as directed by your LAN administrator.
 - If you connected the instrument directly to your computer, enter an IP address that is compatible with the IP address for the Ethernet interface of the computer. For example, if the IP address of the computer is 199.55.142.12, then set the IP address of the instrument to 199.55.142.x, where $x \neq 0, 12, \text{ or } 255$.

Set the subnet mask to the same value used by the computer. Set the gateway address to be the address of the computer.

NOTE. *If you selected DHCP mode, the network automatically assigns the instrument an IP address. DHCP typically requires several seconds to assign the network address.*

- e. Press the **CONFIG** button on the front panel to close the menus.

Enable the Web remote interface

Before you can access the instrument using a Web browser, the Web remote interface of the instrument must be enabled. Optionally, you can create a password which would then be required to gain access to the instrument using a Web browser. See *Enable the Web remote interface* on page 22.

NOTE. *The instrument is shipped with the Web remote interface disabled and no password required to gain access to the instrument using a Web browser.*

Perform the following steps to enable the Web remote interface:

1. Press the **CONFIG** button.
2. Navigate to **Network Settings > Web Enable**.
3. Select **On** to enable the Web remote interface.
4. To create a password that would be required to gain remote access to the instrument using a Web browser, perform the following steps:
 - a. Navigate to **Web Password** and press the right-arrow key to change the menu focus to the submenu. This opens the Web Password display.
 - b. Use the left/right arrow keys to move the highlight to the desired box in the password. Use the up/down arrow keys or the knob to change the text in each box as required.
 - c. To accept, clear, or cancel your changes, move the highlight to the respective selection box and press the **SEL** button.
5. Press the **CONFIG** button on the front panel to close the menu display.

Configure and enable SNMP control

If you intend to use SNMP commands to remotely control the instrument (SNMP control is primarily intended for access through automation systems), you must enable SNMP and configure the SNMP parameters of the instrument.

NOTE. *The `wfm_mon.mib` and `wfm2300.mib` files contain the SNMP OIDs for the WFM2300 and WFM2200A waveform monitors. These files can be downloaded from the home page of the Web remote interface.*

Perform the following steps to configure and enable SNMP control:

1. Press the **CONFIG** button and navigate to the **Network Settings** submenu.
2. Set the Public Community string as follows. This string is effectively a password and is required before SNMP commands can read values from the instrument. The default string value is “public”.
 - a. Navigate to **SNMP Public Community**, and then press the right arrow key to open the SNMP Public Community edit box.
 - b. Use the left and right arrow keys to move the highlight to each box in the string. For each box in the string, use the up and down arrow keys to change the entry as required for your installation.
 - c. To accept, clear, or cancel the changes, select the appropriate selection box and press the **SEL** button.
3. Set the Private Community string as follows. This string is effectively a password and is required before SNMP commands can read or write changes into the instrument. The default string value is “private”.
 - a. Navigate to **SNMP Private Community**, and then press the right arrow key to open the SNMP Private Community edit box.
 - b. Use the left and right arrow keys to move the highlight to each box in the string. For each box in the string, use the up and down arrow keys to change the entry as required for your installation.
 - c. To accept, clear, or cancel the changes, select the appropriate selection box and press the **SEL** button.
4. Set the SNMP trap addresses as follows. You can configure up to four IP addresses to which SNMP traps are sent through SNMP when error conditions are detected.

NOTE. *The default value for the SNMP trap addresses is all zeroes, which disables the trap outputs.*

- a. Navigate to **SNMP Trap Address 1**, and then press the right arrow key to open the SNMP Trap Address edit box.
 - b. Use the left and right arrow keys to move the highlight to each box in the address. For each box in the address, use the up and down arrow keys to change the entry as required for your installation.
 - c. To accept, clear, or cancel the changes, select the appropriate selection box and press the **SEL** button.
 - d. Repeat steps a through c for the other three SNMP trap addresses as required for your installation.
5. Navigate to **SNMP Enable** and press the right arrow key to select **On**. This setting turns SNMP remote access to the instrument on and off.

6. Navigate to **SNMP Trap Enable** and press the right arrow key to select **On**. This setting turns the traps that are sent out from the instrument through SNMP on and off.
7. Press the **CONFIG** button on the front panel to close the menu display.

Incoming inspection

The incoming inspection procedures are basic optional procedures to check the functionality of your instrument. These procedures require no external equipment.

For a more robust inspection, see the performance verification procedures in the *WFM2300 and WFM2200A Specifications and Performance Verification Technical Reference*.

Basic turn on and self test

1. Connect power to the instrument. See [Connect power](#) on page 8.
2. Turn the instrument on. See [Power-on procedure](#) on page 12.
3. After about 30 seconds, the power-on diagnostic page should appear on the screen.
4. Verify that all self tests pass. Any failures are shown in red.

NOTE. *Although the results of the power-on diagnostics are erased from the screen during the power-on process, you can view the results by selecting or by viewing them on the instrument Web page.*

5. After the diagnostics are finished, the instrument state is restored. When the progress indicator in the status bar is finished, the instrument has finished initializing.

Front panel test

1. Reset the instrument settings to the Factory Presets:
 - a. Press and hold the **PRESET** button to open the Preset menu.
 - b. Select **Recall Preset > Recall Factory Preset**, and then press the **SEL** button. Wait for the process to complete as indicated by the progress indicator.
2. Press the **HELP** button to display the instrument help.
3. Press each of the front panel buttons, one at a time, except for the **Power** and **HELP** buttons.

Each button should flash as you press it. Most buttons will show help text related to that button in the right pane of the help screen. Some buttons, such as the presets, all show the same information, so you may need to alternate between preset buttons and another button to see the text change. The navigation keys (the four arrow keys and the SEL button) do not show help text. They are used to navigate the help panes and content.

4. Press the right arrow key until the Help Contents pane in the upper-left corner is highlighted.
5. Turn the knob and verify that the selector box moves up and down the list of topics.
6. Press the **HELP** button to exit the help.

Fan test You should be able to hear the fans and feel air coming out of the back of the instrument. At low temperatures, the fans will turn slowly and be very quiet.

Storing or shipping the instrument



CAUTION. To prevent damage to the Li-Ion battery pack and the instrument, observe the following precautions when storing or shipping the instrument:

- Do not store the battery pack in the instrument when the instrument is not in use.
 - Remove the battery pack before shipping the instrument.
-

To repack the Li-Ion battery pack for shipment

See the *WFM200BA Rechargeable Battery Pack Instructions* that was supplied with the battery pack for information about handling, storing, shipping, and recycling Li-Ion battery packs.



CAUTION. To prevent damage to the Li-Ion battery pack, use the original packaging when shipping the battery pack and ensure that the package labeling and documentation meets all of the requirements for shipping Li-Ion batteries under the IATA Dangerous Goods Regulations.

To repack the instrument for shipment

Use the following instructions to prepare your instrument for shipment to a Tektronix, Inc., Service Center:



CAUTION. *Remove the battery pack when transporting or storing the instrument in an enclosed container.*

1. Attach a tag to the instrument showing: the owner, complete address and phone number of someone at your firm who can be contacted, the instrument serial number, and a description of the required service.
2. Package the instrument in the original packaging materials. You can contact Tektronix to obtain replacement packaging.

If you cannot use the original packaging materials to package the instrument, follow these directions:

- a. Obtain a carton of corrugated cardboard having inside dimensions six or more inches greater than the dimensions of the instrument. Use a shipping carton that has a test strength of at least 250 pounds (113.5 kg).
 - b. Surround the module with a protective (anti-static) bag.
 - c. Pack dunnage or urethane form between the instrument and the carton. If using Styrofoam kernels, overfill the box and compress the kernels by closing the lid. There should be three inches of tightly packed cushioning on all sides of the instrument.
3. Seal the carton with shipping tape, industrial stapler, or both.

Getting acquainted with your instrument

Front-panel controls

NOTE. *Some of the controls that are covered in this section are option-dependent. For a list of the options that are installed on your instrument, press the button. In the Configuration menu, select the submenu. The entry lists the options installed on your instrument.*

Three levels of control

You control the instrument on three levels:

- **Frequently changed settings.** The front panel buttons control the most commonly changed parameters, such as which measurement appears in each tile. Use the knob and navigation buttons to adjust levels and make selections.
- **Tile-specific settings.** Pop-up menus control parameters that are specific to the tile in which they are displayed. The pop-up menus control less frequently changed parameters such as the waveform display mode (for example, changing the waveform display mode from RGB to YPbPr). To display a pop-up menu, press and hold the desired button for about two seconds.
- **Instrument-wide settings.** The parameters in the Configuration menu are instrument-wide settings. The configuration menu controls settings that are changed only occasionally, such as changing waveform color or setting the network address.

Scope of controls

Some controls are global and affect all tiles, while other controls only affect the active tile. Generally speaking, if a control is configured by front panel buttons or by a pop-up menu, it is tile specific. (Exceptions are the Input and Ref buttons, and all audio and generator features, each of which are global.)

If a control is configured by the Configuration menu, the selections are always global. The settings in the Display, Main, and Preset menus are also global.

The Capture button can be either global or tile specific depending on the setting in the Configuration menu (Display Settings > Freeze Affects).

Layout and usage

The primary front panel elements shown below are described in the table that follows. The Description / usage procedure column in the table refers you to a procedure in this manual that explains how to use the element. If there is no page reference, the information given explains the basic function of the element.

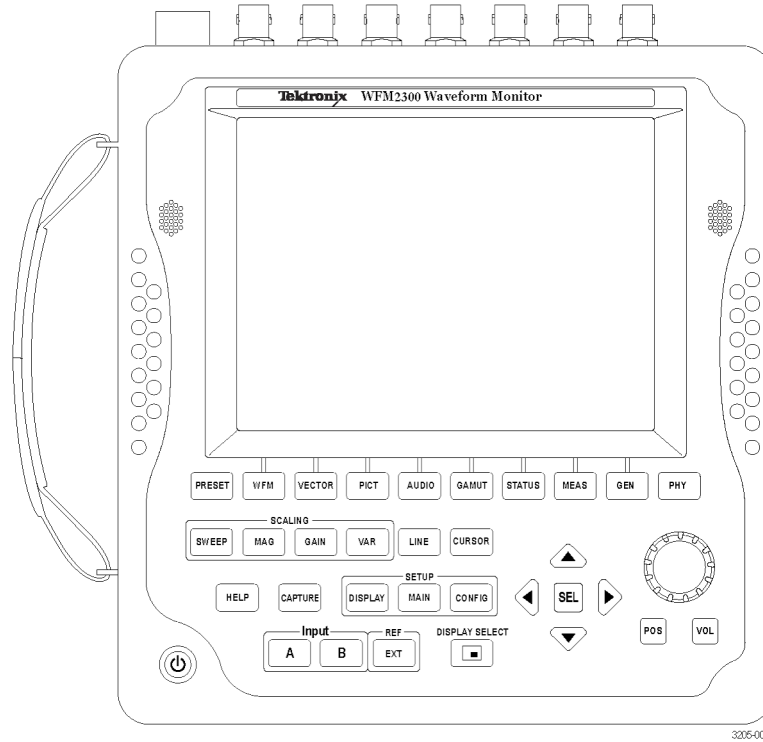

NOTE. The PHY button is only available on the WFM2300.

Control element or group	Description / usage procedure
PRESET	Press to save or recall presets using the bezel buttons. Press and hold to access the Preset menu. See Presets on page 161.
Measurement buttons (WFM, VECTOR, PICT, AUDIO, GAMUT, STATUS, MEAS, GEN, PHY)	Press these buttons to select one of the instrument displays. See To select a display on page 32.
Scaling buttons (SWEEP, MAG, GAIN, VAR)	Press these buttons to select how the signal trace is displayed. See Gain, sweep, and magnification on page 153.
LINE	Press this button to enable or disable the Line Select mode. When enabled, use the General knob and arrow buttons to select which line and field to display. In the Datalist display, press the SEL button to toggle between line and sample select. See Line Select on page 159.

Control element or group	Description / usage procedure
CURSOR	Press this button to enable or disable the measurement cursors. When enabled, use the General knob and the arrow buttons to adjust the cursor positions. Press and hold to access the Cursor pop-up menu. See Measurement cursors (Waveform display only) on page 156.
HELP	Press this button to display context-sensitive online help for the selected display mode or menu item. Use the General knob and the arrow buttons to navigate the online help content. When online help is displayed, you can press most of the front panel buttons to access information about those buttons. See To navigate online help on page 31.
CAPTURE	Press this button to capture an image of the selected display. Press and hold to access the Capture pop-up menu where you can compare a captured display image with the live display. See Display capture (freeze) on page 158.
Setup buttons (DISPLAY, MAIN, CONFIG)	Press the DISPLAY button to access menu selections to adjust various display levels, to enable the Infinite Persistence mode, and to save a copy of the instrument display to a device connected to the USB port. Press the MAIN button to access menu selections to select the tile display mode, to check the USB port status, and to configure the function of the Display Select button (selecting a display or turning the Thumbnail view on/off). Press the CONFIG button to access menu selections to configure various instrument parameters, to check for installed options, to set network parameters, to perform a system upgrade, and more.
Input selection buttons (A, B)	Press these buttons to select which video input to monitor: SDI 1A or MULTI IN 1B. See Signal inputs on page 41.
Reference button (EXT)	Press the EXT button to toggle the synchronization source between the internal reference signal or the analog video reference signal connected to the REF IN input. See To monitor the external reference signal on page 18 and To use the timing display to time a signal to a reference on page 243.

Control element or group	Description / usage procedure
DISPLAY SELECT / Thumbnail button	Press this button to move the tile selection from one tile to another. Press and hold to toggle between Full Screen and 4-Tile display modes. The default setting for this button is as a tile select button. You can configure this button using the MAIN button menu to toggle the thumbnail view of the picture on and off in the selected tile. The position of the thumbnail is determined automatically.
Arrow keys and SEL button	Press the up/down/left/right arrow keys to navigate between menu panes and selections or to increment/decrement values. Press the SEL button to set the selected parameter.
General knob	Turn the General knob to select or adjust a parameter and to navigate through a menu or online help. When the General knob is enabled, a knob icon appears next to the enabled parameter to indicate which parameter is controlled by the knob.
POS	Press the POS (position) button, and then use the General knob to position traces on the Waveform, Vector, Lightning, and Bowtie displays. Use the up/down arrow buttons for finer adjustments and use the left/right arrow buttons to switch between horizontal and vertical adjustments.
VOL	<p>Press the VOL (volume) button, and then use the General knob and the up/down arrow buttons to adjust the volume. When the Audio tile is selected and no menus are active, the General knob controls the volume. When monitoring high-amplitude audio, volume levels over 90% may cause audio clipping.</p> <div style="display: flex; align-items: center;">  <p>WARNING. To prevent risk of hearing damage, always turn down the headphone audio level before connecting a headphone into the headphone jack. Sound levels and impedance can vary between headphones.</p> </div>
Power button	<p>Press to put the instrument in Standby mode or to turn the power on or off. See Power-on and power-off procedures on page 12.</p> <p>NOTE. The Power button does not remove power from the instrument.</p>

Online help

Press the **HELP** button to access the instrument online help. Use the online help when you have questions about buttons, features, or operations related to your instrument. The online help is:

- Context-sensitive. The topic displayed depends on what is displayed in the active tile when the online help is selected or what control is operated after help is selected.
- Navigable. The Contents and Topic Selector panes, with links within the topics, provide access to topics.



Figure 1: Instrument online help

To navigate online help

1. Press the **HELP** button to open online help.
2. Press the right arrow key to navigate to the one of the three panes: **Help Contents**, **Help Index**, or the right-side pane that contains the topic content related to the front panel button you press while help is activated or the links in the help files and menus you use.
3. Use the General knob or the up/down arrow keys to highlight an entry in the Contents (entries never change) or the Index, or to highlight a link in the topic pane.
4. Press the **SEL** button to select the highlighted item.
5. Press the **HELP** button again to exit online help.

Instrument display

This instrument uses Quad Tile, which is a flexible, four-tiled display that can show four tiles at one time or a single, full-screen sized tile. The instrument also provides the flexibility to configure each of the four display tiles independently, enabling you to quickly check the integrity of a signal.

Supported displays

This instrument supports the displays listed below. For detailed information about each of the displays, see [Display modes](#) on page 47.

NOTE. *Some displays require a specific option to be installed. For example, the ANC Data display is not accessible unless you have Option DATA. See [Options and optional accessories](#) on page 4.*

- Waveform: YPbPr, YRGB, RGB, SDI → Composite or XYZ
- Vector: Normal, SDI → Composite, Lightning
- Gamut: Arrowhead, Diamond, Split Diamond
- Measure: Timing, Datalist, Bowtie, ANC Data, AV Delay, ASI PID List (WFM2300 only)
- Status: Error Log, Alarm Status, Video Session, Audio Session, Dolby Status, Audio Control, AES Channel Status, Auxiliary Data Status, SDI Status, SDI/ASI Status (WFM2300 only), SFP Status
- Audio: Phase, Surround
- Picture: Picture frame (on/off) and various closed caption and safe area graticules
- Generator: Generator Status, Diagnostics Monitor
- Phy (WFM2300 only): Eye, Jitter

To select a display

Push a front panel button corresponding to the display that you want to view and one of the following selected displays will appear:

- **WFM:** display of video waveform, Longitudinal Time Code (LTC) waveform, or External Reference waveform
- **VECTOR:** display of vector and lightning plots of color signals
- **PICT:** display of the picture generated by the video signal
- **AUDIO:** display of levels (meters), phase (plot), and surround sound for monitoring audio signals
- **GAMUT:** display of one of four views for checking the gamut of an SDI signal
- **STATUS:** display of extensive views of signal status

- **MEAS:** display of various measurements, including timing, audio video delay, propagation time, ANC data, and Data List
- **GEN:** display of status and configuration of the video generator and audio generator or view information from the Diagnostics Monitor
- **PHY (WFM2300 only):** display of Eye display, Jitter display, and Litter Meter, and access to SDI Stress Loop amplitude parameter and Jitter HP filter settings.

Display limitation

The instrument is capable of showing only two of the following displays at a time: Waveform, Vector, Lightning, Arrowhead, Diamond, Split Diamond, Bowtie, Datalist, Eye, and Timing Measure. A warning messages appears when you try to open more than two of these displays.

Pop-up menus

All pop-up menus are displayed by pressing and holding the specified display button for three seconds. To hide a pop-up menu, press the specified button again. Pop-up menus appear in the active tile and, in general, control only settings specific that tile. A pop-up menu will not appear if it is not appropriate for the current instrument setting.

To set display parameters

Use the pop-up menus to set up the measurements that you display.

1. Select a tile by pressing the **Display Select** button.
2. Press and hold a display button and the display and the pop-up menu for that display appears.

NOTE. *The selections in a pop-up menu can change depending on settings.*

3. Use the right and left keys to move between menu panels. The instrument surrounds the panel selected with a blue border.
4. Use the up and down arrow keys to select parameters in a menu.

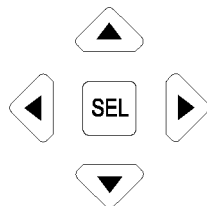

0253-007

Figure 2: Navigate menus using the arrow keys and select button

5. Navigate through the menu and make your selections.

DISPLAY SELECT button

You can configure the DISPLAY SELECT button to function in one of the following two modes:

- **Tile selection.** Select one of the four tiles while in 4-tile mode and change from 4-tile to full-screen mode and back again.
- **Thumbnail view.** Toggle on or off the thumbnail view of the picture display in the Waveform, Vector, or Gamut displays. The Waveform, Vector, or Gamut display must be in full-screen mode to activate the thumbnail view.

Button configuration. Perform the following steps to configure the function of the DISPLAY SELECT button:

1. Press the **MAIN** button to display the Main menu.
2. Navigate to **Display Select**.
3. Press the right arrow key to select **Thumb** or **Tile Sel**.
4. Press the **MAIN** button to close the Main menu.

Tile selection mode. When the DISPLAY SELECT button is configured for tile selection, the button functions as follows:

- In 4-tile mode, press the DISPLAY SELECT button to move the active tile selection to the next tile. The selected (active) tile is outlined in blue. The tile numbers and their associated quadrants are shown below.

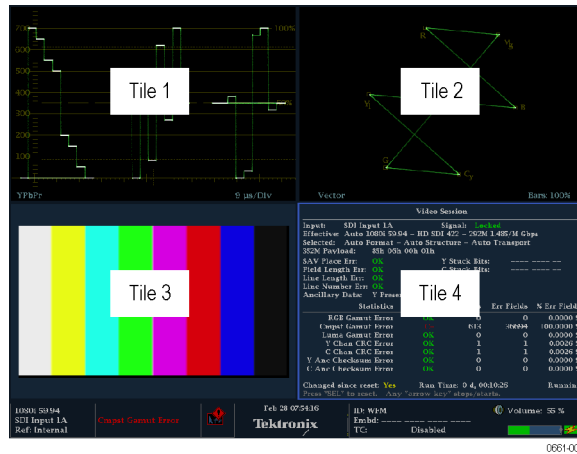

Figure 3: Display quadrants and related tile numbers

- In full screen mode, press the DISPLAY SELECT button to change the display to the next tile. In full screen mode, the same four displays are available as in 4-tile mode.
- Press and hold the DISPLAY SELECT button to toggle between 4-tile and full screen mode. The selected (active) tile in 4-tile mode is the tile expanded to full screen mode.

NOTE. You can also use the Main menu to toggle between 4-tile and full screen mode and to select the active tile.

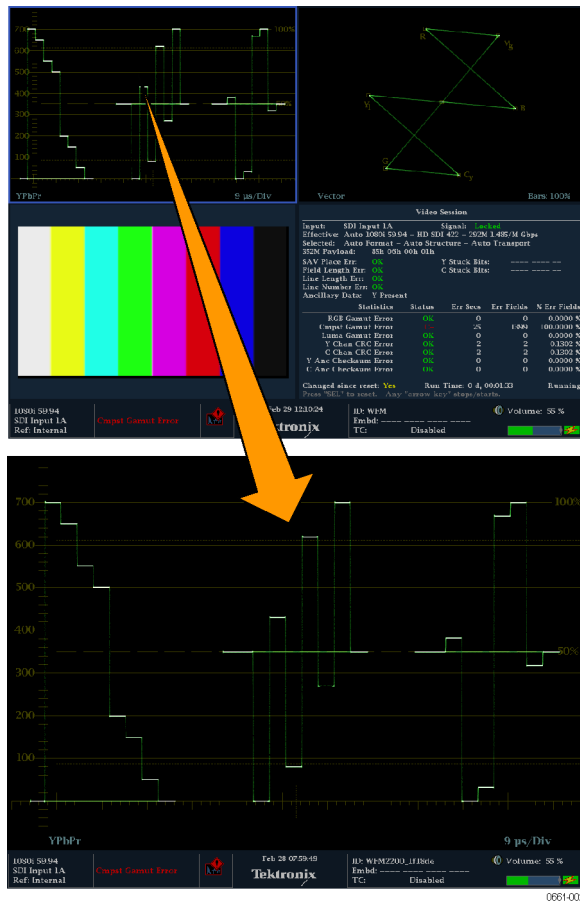

Figure 4: Changing from 4-tile to full-screen view

Thumbnail view mode. When the DISPLAY SELECT button is configured for Thumbnail view and the thumbnail view is enabled, the button functions as follows:

NOTE. When the Display Select setting is set to Thumbnail in the Main menu, pressing the DISPLAY SELECT button will toggle the thumbnail view on and off. This is equivalent to toggling the CONFIG > Display Settings > Thumbnail setting. The thumbnail view is not shown when the Picture display is visible in any tile.

- In full screen or 4-tile mode with no Picture display in any tile, press the DISPLAY SELECT button to toggle the thumbnail view of the picture display on and off. The button stays illuminated when the thumbnail view is turned on.
- In 4-tile mode, the placement of the thumbnail view is determined automatically. However, the placement is usually in the highest numbered tile containing a trace display, and then on status displays.

The following figure shows a full screen Waveform display with the thumbnail view enabled. In full screen mode, the thumbnail is always positioned in the lower right region of the display.

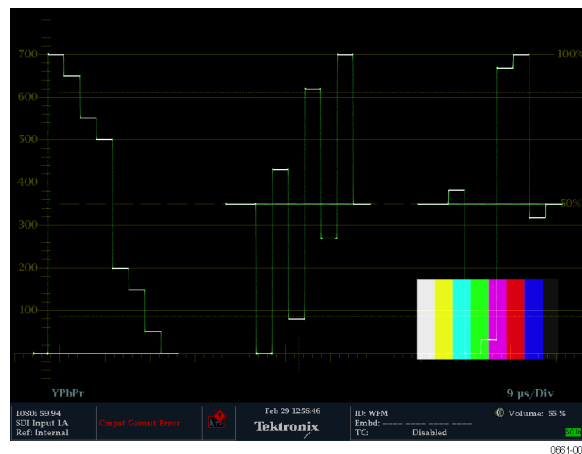

Figure 5: Thumbnail view in Waveform display

Status bar The Status bar is located on the bottom of the instrument display and shows instrument status, the type of signal being monitored, some alarms associated with that signal, and other information.

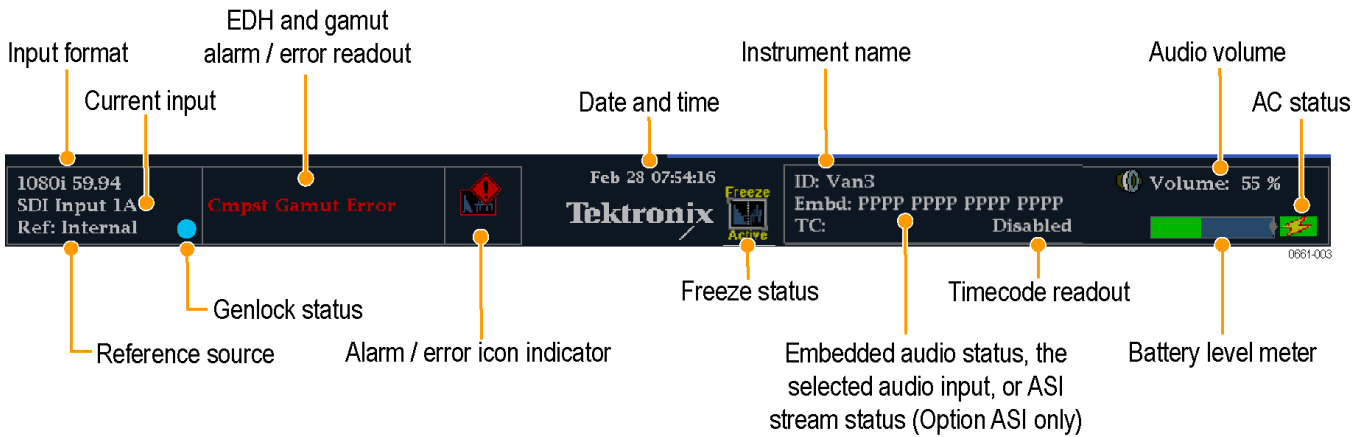







Figure 6: Elements of the Status bar

Status display element	Description
Input format	Text indicating the format of the signal or whether the signal is missing or unlocked. For ASI transport stream inputs (Option ASI only), the format readout is "ASI."
Current input	Text indicating the selected SDI input: <ul style="list-style-type: none"> ■ SDI 1A or MUTLI IN 1B for standard SDI signals ■ 1DL for dual link signals
Reference source	Text indicating the source of the current reference. When the reference source is set to internal, "Internal" is always displayed. When the reference source is set to external, the text indicates the reference format (such as NTSC) or whether the reference is missing or unlocked.
Genlock status	Icon indicating the status of the reference signal used for the genlock output of the SDI test signal. The color of the icon indicates the status: <ul style="list-style-type: none"> ■ Blue indicates that genlock is currently not enabled for the SDI output signal. ■ Green indicates that genlock is currently enabled and locked to the SDI output signal. ■ Red indicates that genlock is currently enabled but is not locked to the SDI output signal. ■ Yellow indicates that genlock is currently enabled but a lock is still being acquired for the SDI output signal.

Status display element	Description
EDH and gamut alarm/error readouts	<p>Readouts indicating that EDH or gamut errors are present. The following readouts appear only if the alarms have been enabled for screen text/icon notification in the CONFIG menu:</p> <ul style="list-style-type: none"> ■ EDH Error: This readout appears when EDH errors are present. ■ RGB Gamut Error: This readout appears when RGB gamut errors are present. ■ Cmpst Gamut Error: This readout appears when Composite gamut (Arrowhead) errors are present. ■ RGB and Cmpst Gamut: This readout appears when both RGB and Composite Gamut errors are present at the same time. ■ Luma Gamut Error: This readout appears when Luma errors are present.
Alarm/error icon indicator	An icon that appears when alarms that have been configured for screen text/icon notification in the CONFIG menu occur. The icon will also appear when alarms are active but have been muted or disabled.
Date and time	A readout of the instrument date and time (set in CONFIG > Utilities).
Instrument name	A readout showing the name assigned to the instrument in the CONFIG > Network Settings menu.
Audio status or ASI status	An up to 32-character string indicating the selected audio input (AES A) or the embedded audio channel status, when embedded audio is the selected input. In the latter case, each character shows the status of a specific channel: – for not present and P for present. For ASI transport stream inputs (Option ASI only), displays the stream status including the packet size (204 or 188 bytes), the ASI polarity (positive or negative), and the bit rate of the stream.
Timecode readout	A readout showing the selected time-code value. Also indicates if the time code is disabled.
Audio volume	A readout showing the audio volume setting in the CONFIG > Audio Inputs/Outputs menu.
Battery level meter	When a battery pack is installed, a meter showing the battery charge level is displayed. See Battery charge level indicators on page 14.
AC status	An icon that indicates whether the AC adapter is plugged in and/or charging the battery pack. See Battery charge level indicators on page 14.

Status bar icons. The following table describes the Status bar icons.

Icon	Description
	<p>Warning - Appears when an error or an alarm that is mapped to the user interface triggers.</p>
	<p>Alarms Muted - Appears when the alarms are muted from the STATUS pop-up menu.</p>
	<p>Remote Access - Appears when the instrument is accessed from the network. For example, when sending commands to the instrument from the remote interface.</p>
	<p>Alarms Disabled - This text appears in the Status Bar when Alarms are disabled from the Configuration menu.</p>
	<p>Freeze Active - Appears when the tiles are frozen or captured.</p>
	<p>Battery Low - This icon appears only when the instrument is using a battery pack as the power source. This icon appears when the battery has less than 10 minutes of operating power remaining. The icon turns from yellow to red when instrument shutdown is imminent due to low battery power.</p>

Signal inputs

SDI signals

Connect an SDI (3G, HD, or SD) signal to the SDI A input on the top panel of the instrument. See also [Video system installation](#) on page 17.

Use the CONFIG menu to set the parameters for monitoring the signals, such as thresholds, alarms monitored, and audio source.

Optical SDI signals. With Option SFP, connect an optical SDI signal to the SFP module installed on the top panel of the instrument. See also [Video system installation](#) on page 17.

HDMI SDI signals.

With Option SFP-HDMI, connect an HDMI SDI signal to the SFP module installed on the top panel of the instrument. See also [Video system installation](#) on page 17.

Multi In signals

Connect an SDI (3G, HD, or SD) signal, AES audio signal, LTC timecode, or ASI (Option ASI only) signal to the MUTLI IN input on the top panel of the instrument.

Use the CONFIG menu to set the parameters for monitoring the signals, such as thresholds, alarms monitored, and audio source.

ASI transport streams (WFM2300 Option ASI only)

Connect an ASI transport stream to the SDI A or MULTI IN connectors on the top of the instrument. See also [Video system installation](#) on page 17.

Use the CONFIG menu to set the parameters for monitoring the transport stream, such as alarms monitored.

External reference signals

The reference input is internally terminated in 75 Ω . Reference signals can be analog video Black Burst or Tri-level sync.

After you connect the appropriate reference signal to the EXT REF connector, press the **EXT REF** button to change the signal reference to external. The EXT button illuminates when External reference is selected. See also [Video system installation](#) on page 17.

You can select which signal format to lock to by pressing the **CONFIG** button and selecting **External Ref**. The default setting is Auto.

View the reference signal. You can use the waveform display to view the signal connected to the EXT REF connector. Press the **WFM** button to open the waveform display pop-up menu, and then select **Display Type > Ref Waveform**.

Genlock function. You can enable the SDI output test signal to genlock to the external reference signal by pressing the **CONFIG** button and selecting **Video/Gen Outputs > Test Signal Genlock > Enable**. You can also use the CONFIG menu to set the vertical and horizontal timing offsets used by the genlock function. The genlock status icon in the Status Bar indicates the genlock status. See *Status bar icons* on page 40.

Dual link signals

The inputs for dual link signals are the same as for SDI signals. Dual Link monitoring allows you to set up your instrument to monitor higher resolution signals than can be monitored using the traditional single link input. Dual link signals are combined in the instrument and then shown as a single signal on a waveform or other display.

The instrument will automatically detect properly formatted dual link signals which contain a SMPTE352 VPID in both links as required by SMPTE 372. In this case, set the format, structure, and transport settings in the CONFIG > SDI Input submenu to Auto to enable automatic detection of dual link signals.

If the SMPTE352 VPID is missing, the instrument may be forced into dual link input mode by manually selecting the appropriate sample structure and transport settings in the CONFIG > SDI Input submenu. Use the Video Session display (**STATUS > Display Type > Video Session**) to verify proper configuration.

Alpha Channel information is visible if present and is available in RGB and YCbCr display modes, but not in YRGB mode. The following figure is an example of how the signal components appear.



Figure 7: Placement of dual link information in the Waveform display

Connectors

See the *WFM2300 and WFM2200A Installation and Safety Instructions* that shipped with your product for descriptions of the connector functions.

See the *WFM2300 and WFM2200A Specifications and Performance Verification Technical Reference* for the complete connector specifications.

Both documents are available in electronic format on the Tektronix Web site at www.tektronix.com/downloads.

Connector configuration

After you have connected a signal source to your instrument, there are several menus to use to set up your signal:

- **CONFIG > SDI Input:** select how SDI inputs are displayed. The instrument can automatically detect the input format, sample structure, and SDI transport type (or you can specify these manually).

You can also choose to not display the EAV, SAV, and ANC data; set chroma alignment; select the NTSC setup level; select HD colorimetry; and set the dual link threshold.

- **Input A or B:** Press the Input A or Input B button to view the video signal connected to the SDI A or MUTLI IN input connector. The button for the selected input (A or B) is illuminated.

When Option 3G is installed and you are monitoring a 2xHD 3 Gb/s SDI signal (as defined by SMPTE 425), you can press and hold the associated input button to open a pop-up menu where you can select which stream in the signal to monitor. Possible menu options include the following:

- **SDI Input 1A (or Multi In 1B, SFP Input 2A, or SFP Input 2B):** Displays the 2 HD streams of a 3 Gb/s 2xHD signal together in an overlaid trace. For Picture displays, the image will be the average of both pictures.
- **SDI Input 1A.1 (or Multi In 1B.1, SFP Input 2A.1, or SFP Input 2B.1):** Displays only the first of the 2 HD streams of a 3 Gb/s 2xHD signal.
- **SDI Input 1A.2 (or Multi In 1B.2, SFP Input 2A.2, or SFP Input 2B.2):** Displays only the second of the 2 HD streams of a 3 Gb/s 2xHD signal.
- **Multi In Type:** Allows you to choose SDI, AES, or LTC as the stream type for the Multi input. Select the stream type from the **CONFIG > Input Mode > MULTI IN Signal** menu.
- **CONFIG > External Reference:** select how the external reference signal is detected. The instrument can automatically detect the input format or you can specify which format you want detected.

- **CONFIG > Video/Gen Outputs, CONFIG > Audio/Gen Outputs, and GEN** pop-up menu:
 - For the SDI video output, select the signal type and format, enable moving picture mode, enable the AV Timing mode for AV Delay or Propagation Delay measurements (Option AVDP only), enable genlock and configure the genlock offsets, and enable embedded audio groups. Option 3G is required to generate 3 Gb/s SDI signals.
 - For the AES audio output and for the embedded audio in the SDI video output, select the frequency, amplitude, and bitdepth. When Option DBE is installed, you can enable a Dolby E program output and configure the metadata.
- **CONFIG > Audio Inputs/Outputs** : select the embedded audio signal channel, format, and mapping, and set the volume for the instrument speakers and headphone output.

Signal outputs

SDI video output

This instrument can generate SD-SDI and HD-SDI signals using the SDI OUT connector. With Option 3G installed, it can also generate a 3 Gb/s SDI test signal.

The following signals can be generated in Level A and Level B:

- 100% Color Bar
- 75% Color Bar
- Pathological Signal
- SMPTE EG1 Color Bars
- SMPTE EG432-1 Color Bars
- SMPTE RP219 Color Bars
- 0% Flat Field
- 50% Flat Field
- 100% Flat Field
- 5-Step Staircase
- 10-Step Staircase
- Checkerboard
- Clean Aperture
- Production Aperture
- Convergence
- Pluge and Luma Reference

- SMPTE 303M Color Reference
- ChromaDuMonde
- Multiburst
- Y Multiburst

For more information about these signals, see the appropriate SMPTE standard.

The following illustration shows signal connections for testing a device. After you connect the signals, use **CONFIG > Video/Gen Outputs** submenu or the **GEN** pop-up menu to select the test signal pattern, level, and format you want to generate.

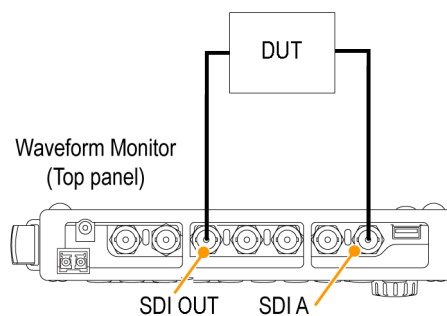

Figure 8: Video signal generation connection

Genlock function. You can enable the SDI output signal to genlock to the external reference signal by pressing the **CONFIG** button and selecting **Video/Gen Outputs > Test Signal Genlock > Enable**. You can also use the **CONFIG** menu to set the vertical and horizontal timing offsets used by the genlock function. The genlock status icon in the Status Bar indicates the genlock status. See [Status bar icons](#) on page 40.

AES audio output

This instrument can generate the following AES audio signals:

- Test signal: AES test tones with user-configurable frequency, amplitude, and bitdepth.
- AES out: loopthrough output of the signal on the MULTI IN connector.
- Audio output: output of the embedded audio in the video signal being output on the SDI OUT connector.

The following illustration shows signal connections for testing a device. After you connect the signals, use **CONFIG > Audio/Gen Outputs** submenu or the **GEN** pop-up menu to select the AES audio signal type that you want to generate.

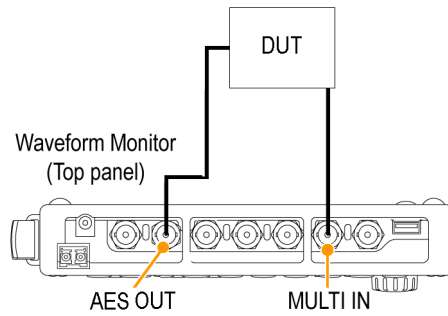
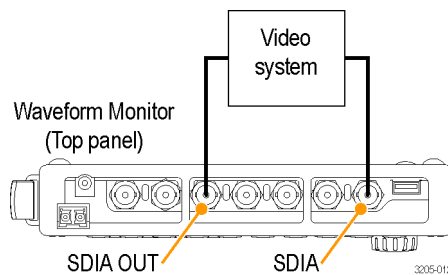

Figure 9: AES audio signal generation connection

A/V delay or propagation time signal output (Option AVDP only)

This instrument can generate a test signal to measure A/V delay or propagation time in a video system. The following illustration shows signal connections for making these measurements.

After you connect the signals, use the **CONFIG > Video/Gen Outputs** submenu or the **GEN** pop-up menu to select the type of measurement signal you want to generate.



SFP module receiver - transceiver (Option SFP only)

This instrument has an optical SDI input and output compliant to SMPTE297. Most SFP modules have directional arrows located above their ports. These arrows indicate how you should configure the SFP. The instrument will store the configuration for each SFP module installed by the module's vendor name and part number, so that when you reinstall a recognized module, the related configuration will be automatically applied.

You can configure the module from the **CONFIG > Input Mode > SFP Module Config** menu. When installing a module for the first time, select from the following configuration options:

- **None:** Not configured.
- **Sole Tx:** Select to enable the SFP module as a single channel transmitter.
- **Sole Rx:** Select to enable the SFP module as a single channel receiver.
- **Transceiver:** Select to enable the SFP module as a transceiver.
- **Dual Tx:** Select to enable the SFP module as dual transmitters.
- **Dual Rx:** Select to enable the SFP modules as dual receivers.

Display modes

This section describes each of the available display modes. The displays are listed in alphabetical order:

- *ANC Data display (Option DATA only)* on page 48
- *Arrowhead display* on page 51
- *ASI PID List display (WFM2300 Option ASI only)* on page 54
- *Audio display* on page 59
- *Audio Generator Status display* on page 65
- *AV Delay Measurement display (Option AVDP only)* on page 78
- *Bowtie display* on page 81
- *Datalist display (Option DATA only)* on page 83
- *Diamond display* on page 90
- *External Reference Waveform display* on page 92
- *Eye display (WFM2300 only)* on page 94
- *Jitter display (WFM2300 only)* on page 96
- *Lightning display* on page 98
- *LTC Waveform display* on page 101
- *Picture display* on page 103
- *Split Diamond display* on page 106
- Status displays:
 - *AES Channel Status display* on page 109
 - *Alarm Status display* on page 110
 - *ARIB Status displays* on page 112
 - *Audio Control Packet display* on page 112
 - *Audio Session display* on page 115
 - *Auxiliary Data Status display* on page 118
 - *Dolby Audio Status display* on page 121
 - *Error Log display* on page 123
 - *SDI Status display (WFM2300 only)* on page 128
 - *SFP Module Status display (Option SFP or Option SFP-HDMI)* on page 126
 - *Video Session display* on page 131
- *Timing Measure display* on page 136
- *Vector display* on page 140

- [Video Generator Status display](#) on page 144
- [Waveform display](#) on page 148

ANC Data display (Option DATA only)

The ANC (Ancillary) Data display is available only on instruments with Option DATA installed. This display allows you to more closely examine all of the ANC data in a signal.

The ANC Data Inspector is part of the ANC Data display. This ancillary monitoring feature allows you to see all ancillary data present in a signal. The instrument continually monitors the signal and tells you when changes in the presence of data occur.

When Watch List mode is activated, the instrument displays the presence and status of ANC data types you have selected in the Watch List. This allows you to focus on the ANC data types that are important to you.

To access the ANC Data display

1. Press and hold the **MEAS** button to open the Measure pop-up menu.
2. Use the arrow keys to select **Display Type > ANC Data DISP..**
3. Press the **MEAS** button to close the pop-up menu.

Elements of the ANC Data display

ANC Data Inspector				
Name	DID/SDID	Presence	Status	Location
S299M Ctrl Grp 2	E2/--	Present	OK	Field 2 / Line 8
S299M Ctrl Grp 1	E3/--	Present	OK	Field 2 / Line 8
S299M Aud Grp 2	E6/--	Present	OK	Field 2 / Line 66
S299M Aud Grp 1	E7/--	Present	OK	Field 2 / Line 66
S334-1 CDP(708)	61/01	Present	OK	Field 1 / Line 4

Detail		View Mode: Watch List		Time Elapsed Since Last Reset: 0 d, 00:01:09												
Format: SMPTE 334M CDP (708B)				Presence: Present												
DID: 61 (161)	Type: 2	Field: 1	Line: 4	Sample: --												
SDID: 1 (101)	DC: 82 (152)	Link: --	Stream: Y													
Exp/Act Chksum: 1b4 / 1b4		Error: OK														
000	296	269	152	14f	277	151	110	272	1f4	2fc	173	1e9	1fd	180	180	2ff
016	143	222	1fe	173	269	1fe	200	200	2fa	200	200	2fa	200	200	2fa	200
032	200	2fa	200	200	2fa	200	200	2fa	200	200	2fa	200	200	2fa	200	200

Figure 10: ANC Data display (full screen mode)

The ANC Data display includes two sections:

- **ANC Data Inspector** - This section of the display appears both in quad-tile and full screen display modes. Select a data type in this section to view the user data in the Detail section.
- **Detail** - This section of the display appears only in full screen mode and shows the user data for the data type selected in the ANC Data Inspector. You can expand the Detail area to show more data by pressing the MAG button.

The following information is available on the ANC Data display in full screen mode:

- **DID:** Data Identifier of the requested packet; permissible values range from 1 to 0xFF (255) inclusive.
- **Type:** Type of the ANC Data packet; either Type 1 packet (DID greater than or equal to 0x80), or Type 2 packet (DID less than 0x80), as defined by SMPTE 291M; Type 1 packets do not have a SDID field, instead they have a DBN field; the "actual value" (with parity bits added) is displayed in parentheses.
- **SDID:** Secondary Data Identifier of the requested packet; permissible values range from 0 through 0xFF (255) inclusive; this field only appears when a Type 2 packet is selected; the "actual value" (with parity bits added) is displayed in parentheses (mutually exclusive with DBN field).
- **DBN:** Data Block Number of the acquired packet; values range from 0 to 0xFF; the "actual value" (with parity bits added) is displayed in parenthesis (mutually exclusive with SDID field).
- **DC:** Data Count word of the acquired packet; the number of User Data words is displayed in decimal; the "actual value" (with parity bits added) is displayed in parenthesis, in hexadecimal.
- **Field:** The field of the video from which the packet was acquired; for progressive formats, 1 is displayed.
- **Line:** The line of the video (within the field) from which the packet was acquired.
- **Stream:** For HD (SMPTE 292M), indicates whether the ancillary packet was acquired from the Y or C data streams; for SD, "N/A" is displayed.
- **Status:** Indicates whether packet(s) of the desired type are present in the video; also indicates Checksum or CRC errors.
- **Checksum:** Indicates the checksum word that was recovered from the acquired packet.
- **Should be:** Indicates the checksum work computed by the instrument, based on data of the packet.
- **Format:** Indicates the name of the ancillary data type or standard.
- **User Data Words:** Contains the payload of the ancillary packet, displayed in hexadecimal; all 10 bits are displayed.

**Measure pop-up menu
(ANC Data display)**

Press and hold the MEAS button to open the Measure pop-up menu. The pop-up menu enables you to configure the display type and configure display parameters for the different display types. The following menu selections are available:

Display type. Select from the following display types:

- **Timing Measure** - Displays a Tektronix proprietary view that enables you to easily compare and correct the timing between two signals. See [Timing Measure display](#) on page 136.
- **Datalist (Option DATA only)** - Displays the content of all digital signal formats, structures, and transports (SD, HD, 3G, dual link, 4:2:2, 4:4:4, and others) except for composite signals. See [Datalist display \(Option DATA only\)](#) on page 83 .
- **Bowtie** - Displays the interchannel timing between Y Pb and Y Pr. See [Bowtie display](#) on page 81.
- **ANC Data (Option DATA only)** - Displays all of the ANC data in a video signal.
- **AV Delay (Option AVDP only)** - Displays results of the AV Delay and Propagation Time measurements. See [AV Delay Measurement display \(Option AVDP only\)](#) on page 78.
- **ASI PID List Disp. (WFM2300 Option ASI only)** - For MPEG2 transport stream inputs, displays the MPEG TS PID tree with each stream element having an LED icon to indicate the status of the element. See [ASI PID List display \(WFM2300 Option ASI only\)](#) on page 54.

All sessions reset. Select this option and press the SEL button to globally reset all of the displayed ANC Data display sessions. The session time is set to zero and all errors (if present) are reset.

View mode. Select the view mode:

- **All** - Displays all of the ANC data types present in the video signal.
- **Watch list** - Displays only the ANC data types selected by the user in the Watch List. See [To configure the Watch List](#) on page 51.

CONFIG menu

Use the CONFIG menu to set the following ANC Data display parameters:

- Use the **ANC Data Display > User ANC Types** settings to define the ANC data types by name and DID/SDID values.
- Use the **ANC Data Display > Config Watch List** selection to select which ANC data types will be displayed. See [To configure the Watch List](#) on page 51.
- Use the **Aux Data Settings** selections to define the ANC data types by name and DID/SDID values.
- Use the menu selections under **Alarms** to enable the alarms for various types of ANC data errors.

To configure the Watch List

The Watch List allows you to limit the data types viewed in the ANC Data display to only the types you specify. To configure the Watch List, perform the following steps:

1. Press the **CONFIG** button and select **ANC Data Display**.
2. Select **Config Watch List** from the menu.
3. Press the **SEL** button and a table of data types appears.
4. Check the boxes next to the data types you want to view in the ANC Data Inspector. Use the **SELECT ALL** and **CLEAR ALL** boxes to quickly select or clear all data types.
5. When you are finished selecting the data types, navigate to the **Return** box and press the **SEL** button.
6. Press the **CONFIG** button to dismiss the menu.
7. Press and hold the **MEAS** button and select **Display Type** and then **ANC Data Display** from the pop-up menu.

You can now view the data types you checked in the Watch List.

Arrowhead display

The Arrowhead display is a Tektronix proprietary display that shows gamut violations of the SDI input if translated into the Composite domain (NTSC and PAL). For more information about using the gamut-checking displays:

- See [Diamond display](#) on page 90
- See [Split Diamond display](#) on page 106
- See [Checking gamut](#) on page 201
- See the *Preventing Illegal Colors* application note available on the Tektronix Web site (www.tektronix.com)

To access the Arrowhead display

1. Press and hold the **GAMUT** button to open the Gamut pop-up menu.
2. Use the arrow keys to select **Display Type > Arrowhead**.
3. Press the **GAMUT** button to close the pop-up menu.

Elements of the Arrowhead display

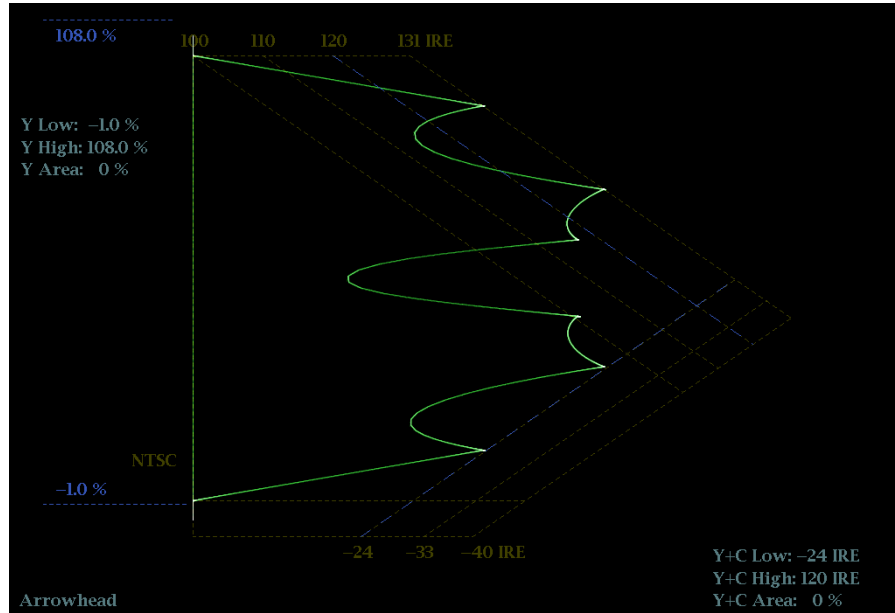

Figure 11: Arrowhead display

- **High threshold:** Shows the currently specified high threshold (Arrowhead NTSC Max or Arrowhead PAL Max) setting in the CONFIG > Gamut Thresholds menu.
- **Low threshold:** Shows the currently specified low threshold (Arrowhead NTSC Min or Arrowhead PAL Min) setting in the CONFIG > Gamut Thresholds menu.
- **Gamut display type:** Shows the selected Gamut display type - Arrowhead, Diamond, or Split Diamond.
- **Threshold indicators:** Indicates the threshold settings using blue dashed lines.
- **Luma minimum:** Shows the currently specified minimum luma threshold (Luma Min) setting in the CONFIG > Gamut Thresholds menu.
- **Luma maximum:** Shows the currently specified maximum luma threshold (Luma Max) setting in the CONFIG > Gamut Thresholds menu.
- **Y Area and Y+C Area:** Shows the specified percentage of the total image pixels that can be outside the current luma (Y) and gamut (Y+C) limits and not generate error reports.
- **Field and line numbers:** Shows the currently selected video field and line numbers when Line Select mode is enabled. See [Line Select](#) on page 159.

**Gamut pop-up menu
(Arrowhead display)**

Press and hold the GAMUT button to open the Gamut pop-up menu. The pop-up menu enables you to select the from the following Tektronix proprietary gamut displays:

- **Arrowhead** - Displays gamut violations of the SDI input if translated into the Composite domain (NTSC and PAL).
- **Diamond** - Displays gamut violations of the SDI input if translated to the RGB color space. See [Diamond display](#) on page 90.
- **Split Diamond** - Like the Diamond display, displays gamut violations of the SDI input if translated to the RGB color space. However, the Split Diamond display offsets the two halves of the Diamond display to allow you to better see negative RGB gamut errors. See [Split Diamond display](#) on page 106.

CONFIG menu

Use the CONFIG menu to set the following Arrowhead display parameters:

- Use the menu selections under **Gamut Thresholds** to set the minimum and maximum gamut limits for composite signals derived from the SDI signal, set the minimum and maximum luma levels, specify the percentage of the total image pixels that can be outside the current gamut or luma limits and not generate error reports, and reset the gamut and luma limits to default values.
- Use the menu selections under **Alarms > Video Content** to enable the alarms for the Arrowhead display.
- Set the **Graticules & Readouts > Gamut Readouts** setting to **On** or **Off** to turn on or off the readouts on the display.
- Use the menu selections under **Display Settings** to set various general display parameters which affect all applicable display modes such as waveform intensity and graticule color.

ASI PID List display (WFM2300 Option ASI only)

The ASI PID List display is available only on WFM2300 instruments with Option ASI installed. For MPEG2 transport stream inputs, this display allows you to view and navigate the MPEG TS PID tree with each stream element having an LED icon to indicate the status of the element. The Status Bar shows the TS packet size (188/204 byte per packet), ASI polarity, TS bit rate, and also indicates whether TS Sync Loss, Continuity Counter, or Sync Byte errors have occurred as described in ETSI TR 101 290.

This display helps engineers identify the structure of the transport stream and determine potential issues with the signal. Sync byte errors and continuity counter errors are logged in the error report to help users investigate intermittent issues. The instrument also performs Eye pattern measurement on the ASI stream to ensure signal quality in the physical layer.

To access the ASI PID List display

1. Press and hold the **MEAS** button to open the Measure pop-up menu.
2. Use the arrow keys to select **Display Type > ASI PID List Disp.**
3. Press the **MEAS** button to close the pop-up menu.

Elements of the ASI PID List display

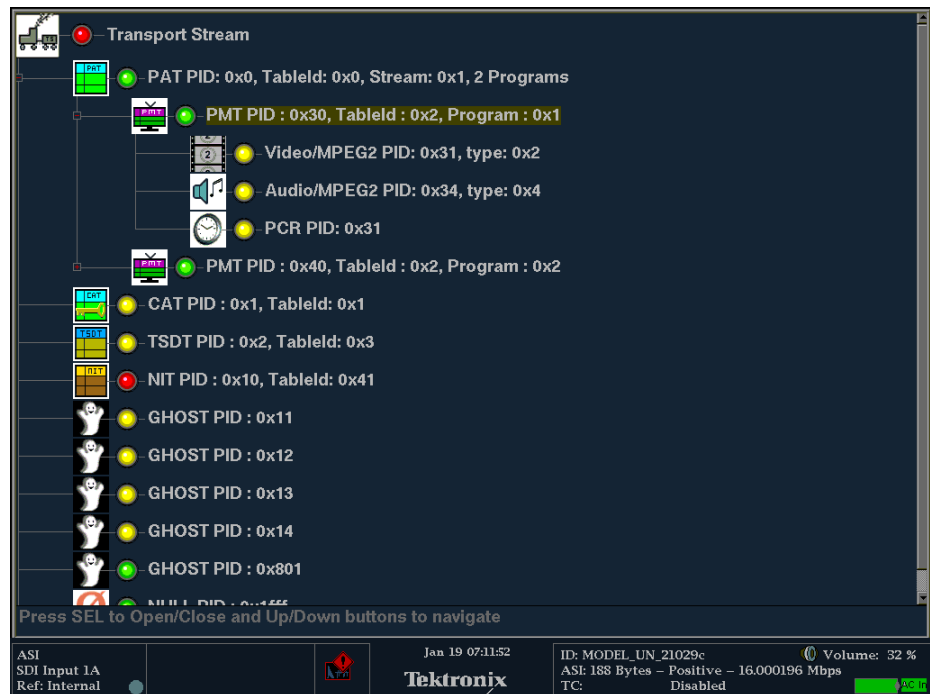















Figure 12: ASI PID List display

- **Hierarchy display:** The ASI transport stream is displayed in a hierarchal structure to show the interrelationship of the components in the stream. Additional information about each stream component such as PID and Table ID numbers is displayed next to each icon.

The “+” symbol displayed to the left of some icons indicates that the item includes lower-level transport stream components that are not displayed. The symbol changes to “-” when the lower level components are displayed. To expand the hierarchy, use the Up/Down arrow buttons to select the desired upper-level icon and press the SEL button. To collapse the selected upper-level icon, press the SEL button.

- **Stream component icons:** The hierarchy display contains icons as described in the following table. The specific icons you may encounter depends on the format of the transport stream.

Icon	Element type	Icon text
	Transport Stream (TS) This icon represents all transport stream packets that make up the stream.	For the TS icon, the following text is displayed: <ul style="list-style-type: none"> ■ Transport Stream
	Non TS Data stream other than transport stream format.	For the Non TS icon, the following text is displayed: <ul style="list-style-type: none"> ■ No Transport Stream Detected
	Transport Stream Description Table (TSDT) One or more transport packets with a PID value of 0x02 and a table_id value of 0x03.	For the TSDT icon, the following text is displayed: <ul style="list-style-type: none"> ■ PID: Shows the PID value of the TSDT ■ TableID: Shows the table_id value of the TSDT
	Program Association Table (PAT) One or more transport packets with a PID value and table_id value of 0x00.	For the PAT icon, the following text is displayed: <ul style="list-style-type: none"> ■ PID: Shows the PID value of the PAT ■ Table: Shows the table_id value of the PAT ■ Stream: Shows the transport_stream_id value of the PAT ■ Programs: Shows the number of programs contained in the transport stream
	Program Map Table (PMT) One or more transport packets with a PID value specified by the program_map_PID in the PAT and a table_id value of 0x02.	For the PMT icon, the following text is displayed: <ul style="list-style-type: none"> ■ PID: Shows the PID value of the PMT ■ TableID: Shows the table_id value of the PMT ■ Program: Shows the program number associated with the PMT
	Network Information Table (NIT) One or more transport packets with a PID value specified by the network_PID in the PAT.	For the NIT icon, the following text is displayed: <ul style="list-style-type: none"> ■ PID: Shows the PID value of the NIT ■ TableID: Shows the table_id value of the NIT
	Conditional Access Table (CAT) One or more transport packets with a PID value of 0x01 and a table_id value of 0x0001.	For the CAT icon, the following text is displayed: <ul style="list-style-type: none"> ■ PID: Shows the PID value of the CAT ■ TableID: Shows the table_id value of the CAT

Icon	Element type	Icon text
	Program Clock Reference (PCR) One or more transport packets with a PID value specified by the PCR_PID in the PMT and a PCR_flag value of 1.	For the PCR icon, the following text is displayed: <ul style="list-style-type: none"> ■ PID: Shows the PID value of the PCR
	Video Elementary Stream One or more transport packets with a PID value specified by the elementary_PID in the PMT and a stream_type value of 0x01 or 0x02.	For the Video Elementary Stream icon, the following text is displayed: <ul style="list-style-type: none"> ■ PID: Shows the PID value of the video elementary stream ■ Type: Shows the type of the video elementary stream (0x01 or 0x02)
	Audio Elementary Stream One or more transport packets with a PID value specified by the elementary_PID in the PMT and a stream_type value of 0x03, 0x04, or 0x11.	For the Audio Elementary Stream icon, the following text is displayed: <ul style="list-style-type: none"> ■ PID: Shows the PID value of the audio elementary stream ■ Type: Shows the type of the audio elementary stream (0x03 or 0x04)
	Data Stream One or more transport packets with a PID value specified by the elementary_PID in the PMT and a stream_type value of other than 0x01-0x05, 0x08, and 0x0F (in ATSC format, 0x81).	For the Data Stream icon, the following text is displayed: <ul style="list-style-type: none"> ■ PID: Shows the PID value of the data stream ■ Type: Shows the type of the data stream
	Digital Storage Media Command and Control (DSM-CC) One or more transport packets with a PID value specified by the elementary_PID in the PMT and a stream_type value of 0x08.	For the DSM-CC icon, the following text is displayed: <ul style="list-style-type: none"> ■ PID: Shows the PID value of the data DSM-CC ■ Type: Shows the type of the DSM-CC
	GHOST One or more transport packets with a PID value not specified in the PSI or Private Section PID file when the transport stream is downloaded.	For the GHOST icon, the following text is displayed: <ul style="list-style-type: none"> ■ PID: Shows the PID value of the GHOST
	NULL One or more transport packets with a PID value of 0x1FFF.	For the NULL icon, the following text is displayed: <ul style="list-style-type: none"> ■ PID: Shows the PID value of the NULL

- **Status LEDs:** Each element in the ASI transport stream has a status LED to indicate the status of the associated stream element as follows:
 - A green LED icon indicates that no errors have been detected in the element since the monitoring session was started or since the last session reset.
 - The LED icon turns red for 5 seconds when an error is detected.
 - After 5 seconds of an error-free condition, a red LED icon turns yellow to indicate that an error occurred in the past. The LED turns red again if another error is detected.

Use the Error Log display to view reported errors. See [Error Log display](#) on page 123.

Detected ASI stream types The following table lists the ASI stream types detected by the instrument.

NOTE. In order for the instrument to lock to an ASI signal, the bit rate of the ASI signal should be at least 200 k bits/sec.

Table 8: Detected ASI stream types

Stream type	Description	Stream type	Description
0x0	Reserved	0x21	JPEG 2000 Video
0x1	MPEG 1 Video	0x22	Reserved
0x2	MPEG 2 Video	0x23	Reserved
0x3	MPEG 1 Audio	0x24	HEVC (H.265) Video
0x4	MPEG 2 Audio	0x25	Reserved
0x5	Private Sections	0x26	Reserved
0x6	PES Private Data	0x27	HEVC (H.265) Video
0x7	Video/MHEG	0x28 to 0x7F	Reserved
0x8	Annex A DSM-CC	0x80	DigiCipher 2
0x9	ITU-T Rec. H.222.1	0x81	Dolby AC-3 Audio
0xA	DSM_CC/MPE	0x82	User Private
0xB	DSM_CC U-N Messages	0x83	SCTE Isochronous Data
0xC	DSM_CC Descriptors	0x84 to 0x86	User Private
0xD	DSM_CC Sections	0x87	Dolby E-AC-3 Audio
0xE	MPEG 2 Auxiliary	0x88	SMPTE/MS VC-1 Video
0xF	Advanced Audio Codec (AAC)	0x89 to 0x8F	User Private
0x10	MPEG 4 Video	0x90	Time Slice/Fwd Err Corr
0x11	MPEG 4 Audio	0x91 to 0xE5	User Private
0x12	Flex MUX Stream	0xE6	MS WM9 Audio
0x13	Flex MUX Stream	0xE7	User Private
0x14 to 0x19	Reserved	0xEA	MS WM9 Video
0x1A	IPMP Stream	0xEB	MS WM9 Video
0x1B	H.264 Video	0xEC to 0xFF	User Private
0x1C to 0x20	Reserved		

**Measure pop-up menu
(ASI PID List display)**

Select from the following display types:

- **Timing Measure** - Displays a Tektronix proprietary view that enables you to easily compare and correct the timing between two signals. See [Timing Measure display](#) on page 136.
- **Datalist (Option DATA only)** - Displays the content of all digital signal formats, structures, and transports (SD, HD, 3G, dual link, 4:2:2, 4:4:4, and others) except for composite signals. See [Datalist display \(Option DATA only\)](#) on page 83 .
- **Bowtie** - Displays the interchannel timing between Y Pb and Y Pr. See [Bowtie display](#) on page 81.
- **ANC Data (Option DATA only)** - Displays all of the ANC data in a video signal. See [ANC Data display \(Option DATA only\)](#) on page 48.
- **AV Delay (Option AVDP only)** - Displays results of the AV Delay and Propagation Time measurements. See [AV Delay Measurement display \(Option AVDP only\)](#) on page 78.
- **ASI PID List Disp. (WFM2300 Option ASI only)** - For MPEG2 transport stream inputs, displays the MPEG TS PID tree with each stream element having an LED icon to indicate the status of the element.

CONFIG menu

Use the CONFIG menu to set the following ASI monitoring parameters:

- Set the **Input Mode > MULTI IN Signal** setting to **SDI/ASI** to monitor ASI input signals on the MULTI IN connector.
- Set the **SDI Input > SDI Transport Type** setting to **Auto** or **ASI** to monitor ASI input signals.
- Use the settings under **Alarms > ASI Input** to configure the ASI signal alarms.

Audio display

The Audio display provides level meters and a phase display for monitoring audio signals. The level meters and correlation meters are always shown. When you choose to show the Phase plot (also known as Lissajous) or Surround Sound displays, the left part of the Audio tile displays the level meters and the right part the Phase or Surround Sound display.

To access the Audio display

1. Press and hold the **AUDIO** button to open the Audio pop-up menu.
2. Use the arrow keys to select the AUX display mode:
 - **Off** - Turns off the auxiliary display (Phase or Surround), which allows the level meters to occupy the complete viewing area.
 - **Phase display** - Displays a plot of the audio phase in either 2-channel XY or Lissajous Sound Stage modes.
 - **Surround display** - Displays a plot of the channel levels in a surround-sound listening environment.
3. Press the **AUDIO** button to close the pop-up menu.

Elements of the Audio display

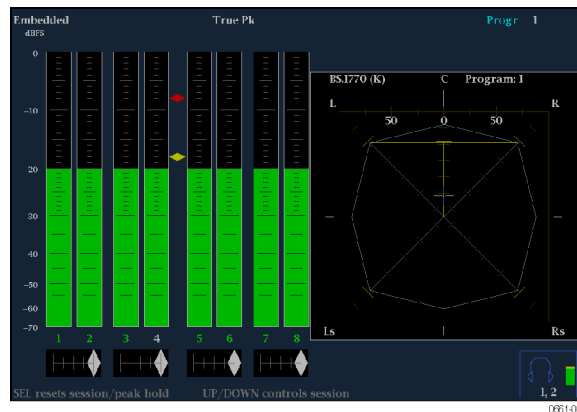

Figure 13: Audio display (Surround mode)

- **Level meters:** Shows the audio levels. (See [To check audio level](#) on page 222) The response of the level meters is determined by the ballistics setting in the CONFIG > Digital Audio Displays menu.
- **Phase or Surround Display:** Select between the Phase display, where the phase of a selected pair of channels is plotted against an X-Y or sound-stage plot, and the Surround display, where all the channels' levels display in positions matching their place in a surround-sound listening environment. See [To check audio phase](#) on page 223 and [To check surround sound](#) on page 227
- **Audio source/setup:** Displays the selected audio input and related setup information, such as Listening Mode when in Surround display. See [Audio monitoring](#) on page 221.

- **Level meter labels:** Identifies the signal in each meter bar. The labels vary according to whether the audio sources to the level meter bars are normal channel pairs, surround channels, or Dolby sources (the Dolby source labels include Dolby type).
- **Level meter ballistics readouts:** Displays the selected dynamic response characteristic.
- **Axes:** Shows the orientation of the two audio signals when displaying phase; shows the orientation and amplitudes of the sound field when displaying surround sound. (Axes are selectable for an X-Y or Soundstage plot.)
- **Phase correlation meters:** Displays the phase correlation between the two-channel bars under which it appears. The meter of the pair selected for the Phase display also appears in the Phase display. See [To check audio phase](#) on page 223.
- **Test level and Peak program level indicators:** Diamond-shaped markers between the level bars indicate the configurable limits set up for the display. Above the Test level, the bar displays in a yellow color. Above the Peak level, the bar displays in a red color. Test level is also known as Reference level or Line-up level.
- **Level meter scale and units:** By default, the units are in dB relative to full scale (dBFS) for digital inputs and dB relative to 0.775 Volts (dBu) for analog inputs. The 0 dB mark is digital Full scale for digital inputs and 0 dBu for analog inputs. You may also set the 0 dB mark to either the Peak Program level or the Test level.

Above-bar warning messages

This instrument displays warning messages above the level meter bars. The warning messages that can appear above the bars as follows:

- **Clip.** The number of consecutive samples equals or exceeds the # Samples for Clip setting.
- **Over.** The signal is at or above the specified Over Level for a time exceeding the Duration for Over setting.

In-bar warning messages

This instrument displays warning messages within the level meter bars. The warning messages that can appear are shown below in order of priority.

- **UNLOCKED.** The instrument is not locked to an incoming signal on the indicated input channel. Data cannot be decoded and all data and other errors are ignored. This means that if an AES input is selected, nothing recognizable is present on the input, or if embedded audio is selected, the VIDEO input is unrecognizable.
- **AES PARITY.** The incoming subframe does not have even parity as specified by the digital audio standards. The data sample is unreliable and is ignored. The level meters and Lissajous display treat the sample as a zero sample.

- **AES CRC ERROR.** The CRC code in the AES channel status packet is incorrect. Sometimes the CRC code is set to zero, indicating that the signal is missing; when this is the case, this message is not displayed.
- **MUTE.** The number of consecutive all-zero samples equals or exceeds the # Samples for Mute setting.
- **SILENCE.** The signal is at or below the specified Silence Level for a time exceeding the Duration for Silence setting.
- **DISABLED.** Indicates that an audio bar is not active.
- **AES V BIT.** Indicates that the Validity bit is set high for one or more data samples. In the AES/EBU standard, a set Validity bit indicates that the sample is not suitable for conversion to audio.

When the Ignore Validity Bit setting is set to On in the CONFIG > Digital Audio Displays submenu (the default value), the Validity bit is ignored and the audio sample as treated as normal audio. When the Ignore Validity Bit setting is set to Off, then the Validity bit value is used to mute the audio when the bit value is high.

- **NO AUDIO.** Indicates that an AES or embedded input has the Non audio bit set.
- **NOT PRESENT.** Indicates that an audio channel is not present in the current audio input.
- **DOLBY D.** Indicates an AES or embedded input is DOLBY Digital (not plus).
- **DOLBY D+.** Indicates an AES or embedded input is DOLBY Digital Plus.
- **DOLBY E.** Indicates an AES or embedded input is DOLBY E.

Audio pop-up menu

Press and hold the AUDIO button to open the Audio pop-up menu. The Audio pop-up menu enables you to select the audio input source and specify whether one of the auxiliary displays (audio phase or surround-sound) appears to the right of the level meter display. Some of the menu selections depend on the selected audio input source and which auxiliary display is enabled.

Audio input. When you select one of the following audio input sources other than Follows Video, the Audio display monitors the selected input regardless of which video input is active.

NOTE. Use the CONFIG menu to select the mapping of audio input channels to level bars, the meter type, and the Follows Video mapping of audio to video.

- **Follows Video** - Sets the audio source to be from the audio source configured for selected video input in the CONFIG > Audio Inputs/Outputs > Video to Audio Map submenu. If you select a different video input, the audio source then changes to the audio source configured for that video input.
- **AES A** - Sets the audio source to be from the AES audio input.
- **Embedded** - Sets the audio source to be from the embedded audio on the currently selected video input. Select which eight audio channels are shown in the level meters by configuring the Bar to Input Map settings in the CONFIG > Audio Inputs/Outputs submenus for the Embedded A, Embedded B, or Embedded Dual Link selections.
- **Emb. 16-Ch** - Sets the audio source to be from the embedded audio on the currently selected video input. This mode displays level meters for all 16 channels in the embedded audio, but does not display the correlation meters nor the Phase or Surround Sound auxiliary displays.

NOTE. When the audio input source is set to Emb. 16-Ch, Emb. 1-8, or Emb. 9-16, you can use the left/right arrow keys to quickly toggle through these three audio input sources.

- **Emb. 1-8** - Sets the audio source to be from the first eight channels in the embedded audio on the currently selected video input. This mode displays the correlation meters for the first eight channels and displays the Phase or Surround Sound auxiliary displays when they are enabled.
- **Emb. 9-16** - Sets the audio source to be from the second eight channels in the embedded audio on the currently selected video input. This mode displays the correlation meters for the second eight channels and displays the Phase or Surround Sound auxiliary displays when they are enabled.

Auxiliary display. Select from the following auxiliary displays:

- **Off** - Disables the auxiliary display, which allows the level meters to occupy the complete viewing area in the Audio display.
- **Phase Display** - Sets the auxiliary display to show a 2-channel phase display. A phase display is also called a Lissajous display. Use the Phase Style menu selection to choose the plot style of the phase display.
- **Surround Dp.** - Sets the auxiliary display to show a multichannel surround sound display. Use the Dominance Indicator menu selection to turn the dominance indicator on and off.

NOTE. *The Audio Surround Sound display is courtesy of Radio-Technische Werkstätten GmbH & Co. KG (RTW) of Cologne, Germany.*

Phase style. When Phase Display is selected as the auxiliary display, you can select from the following display styles:

- **Liss Snd Stage** - Displays the L and R axes rotated at 45 degrees in the Lissajous Sound Stage style.
- **X-Y** - Displays the L and R axes in the vertical and horizontal positions respectively.

Dominance indicator. When Surround Display is selected as the auxiliary display, use this menu selection to turn the dominance indicator on and off. When on, it indicates the location of the dominant sound in the surround sound image using a cross-hairs pointer.

Phase-Headphone pair. Select which audio pairs are mapped to the headphone jack and to the phase display. When you select **Custom**, you can specify individual channels for the input pair using the Custom Phase A and Custom Phase B menu selections.

Audio program. Select which program (1-8) in the embedded audio to monitor. This setting affects the Audio display only under the following conditions:

- When the bar format for the selected embedded audio source (Embedded A, Embedded B, or Embedded Dual Link) is set to Program (Surround) in the CONFIG > Audio Inputs/Outputs submenu.
- When the selected surround sound type contains more than one program. The type of surround sound is selected in the CONFIG > Audio Inputs/Outputs > Program Cfg submenu.

CONFIG menu

Use the CONFIG menu to set the following Audio display parameters:

- Use the menu selections under **Digital Audio Displays** to configure various audio display parameters such as meter type, ballistic characteristics, peak program level, meter scaling, alarm thresholds, correlation speed, and turning the Lissajous AGC mode on and off.
- Use the menu selections under **Audio Inputs/Outputs** to configure audio input and output parameters such as selecting which channels are active on each audio input port, selecting how each audio port is displayed, selecting the audio output source, selecting which channels to de-embed from the SDI video, configuring the “map” of active audio for each video input, and adjusting the speaker and headphone volume.

If Option 3G is installed, 3G Level A signals use the Embedded A or B settings as appropriate. Dual Link and 3G Level B signals use the Embedded Dual Link settings.

- Use the menu selections under **Alarms > Audio Content** and **Alarms > AES/Embedded** to enable various audio alarms.

To adjust audio volume

You can use any of the following methods to adjust the volume of the audio played out on the instrument speakers or the headphone jack:



WARNING. *To prevent the risk of hearing damage, always turn down the audio volume before connecting headphones to the instrument. Sound levels and impedance can vary between different headphones.*

- When the Audio display is selected and no menus are active, turn the General knob.
- When a display mode other than Audio is selected, press the **VOL** button and then use the General knob or the up/down arrow keys.
- Select the **CONFIG > Audio Inputs/Outputs > Headphone Volume** submenu item and then use the General knob or the up/down arrow keys.
- At any time, press and hold the **VOL** button to toggle audio muting. A red “X” appears over the speaker icon in the Status Bar when audio is muted.

NOTE. *When monitoring high-amplitude audio, volume levels over 90% may cause audio clipping.*

Audio Generator Status display

The Audio Generator Status display shows the status of audio signals being generated by the instrument.

To access the Audio Generator Status display

1. Press and hold the **GEN** button to open the Generator pop-up menu.
2. Use the arrow keys to select **Display Type > Audio Generator**.
3. Press the **GEN** button to close the pop-up menu.

Elements of the Audio Generator Status display



Figure 14: Audio Generator Status display

The following audio signal generator status elements appear on the display:

- **Embedded Audio:** Shows which embedded audio groups are turned on in the video signal output when the SDI Output setting is Test Signal.
- **AES Output:** Shows whether the AES output is turned off, is set to be a test tone signal, is set to be a Dolby E test signal (Option DBE only), is set to be a loopout of the AES input signal, or is set to be the embedded audio from the selected video input.
- **Tone Frequency:** Shows the test tone audio frequencies for channel 1 and channel 2 when the AES Output setting is Test Tone.
- **Tone Amplitude:** Shows the test tone audio amplitudes for channel 1 and channel 2 when the AES Output setting is Test Tone.
- **Tone Bitdepth:** Shows the test tone audio bitdepth (20 bit or 24 bit) when the AES Output setting is Test Tone.

NOTE. *The above tone frequency, amplitude, and bitdepth settings are used in both the AES audio output and in the embedded audio of the SDI video output. The same audio channel pair is duplicated to all pairs of embedded audio.*

The following Dolby E audio status elements appear on the display only when Option DBE is installed:

- **Dolby E Stream:** Shows which embedded audio channels have Dolby E content turned on in the video signal output when the SDI Output setting is Test Signal.
- **DE Prog Config:** Shows the Dolby E program configuration setting.
- **DE Bitdepth:** Shows the Dolby E bitdepth setting.
- **DE Audio Level:** Shows the Dolby E audio level setting.
- **DE Frame Rate:** Shows the Dolby E frame rate setting.
- **DE Start Pos:** Shows the Dolby E signal start position setting and the starting line number for the currently selected video format.
- **DE Dialnorm:** Shows the Dolby E metadata dialnorm setting.
- **DE Line Mode:** Shows the Dolby E metadata line mode setting.
- **DE RF Mode:** Shows the Dolby E metadata RF mode setting.
- **DE CenMix Lev:** Shows the Dolby E metadata center downmix level setting.
- **DE Surr Mix Lev:** Shows the Dolby E metadata surround downmix level setting.
- **DE Dmix Pref:** Shows the Dolby E metadata downmix preferred setting.
- **DE LtRt CMix Lev:** Shows the Dolby E metadata LtRt center mix level setting.
- **DE LtRt SMix Lev:** Shows the Dolby E metadata LtRt surround mix level setting.
- **DE LoRo CMix Lev:** Shows the Dolby E metadata LoRo center mix level setting.
- **DE LoRo SMix Lev:** Shows the Dolby E metadata LoRo surround mix level setting.

Generator pop-up menu (Audio Generator Status display)

Press and hold the GEN button to open the Generator pop-up menu. The pop-up menu provides a shortcut to the same settings controlled in the CONFIG > Video/Gen Outputs and CONFIG > Audio/Gen Outputs menus. The following menu selections are available:

Display Type. Select from the following display types:

- **Video Generator** – Displays the status of video signals being generated by the instrument. See *Video Generator Status display* on page 144.
- **Audio Generator** – Displays the status of audio signals being generated by the instrument.
- **Diagnostics Monitor** – Displays the status of various instrument diagnostics. See *Diagnostics Monitor display* on page 86.

Embedded Audio. When the SDI Output setting is Test Signal, selects which embedded audio groups are enabled in the video output signal (groups 1 through 4).

AES Output. Sets the AES audio output to be off, a test tone signal, a Dolby E program test signal, a loopout of the AES audio input, or a loopout of the embedded audio from the selected video input signal.

Audio Frequency. When the AES Output setting is Test Signal, sets the frequency of the test tone output for channels 1 and 2.

Audio Amplitude. When the AES Output setting is Test Signal, sets the amplitude of the test tone output for channels 1 and 2.

Audio Bitdepth. When the AES Output setting is Test Signal, sets the bitdepth of the test tone output to 20 bit or 24 bit.

Dolby E Stream. When Option DBE is installed, sets which audio pairs are enabled for Dolby E program content.

DE Program Config. When Option DBE is installed, sets the program configuration of the Dolby E signal. This parameter controls both the number of programs in the stream as well as how the eight audio channels are allocated to the programs. You can select from 5.1+2 / 20b, 5.1 / 20b, 5.1 / 16b, 7.1 / 20b, 4x2 / 20b, and 8x1 / 20b.

DE Audio Level. When Option DBE is installed, sets the level of the Dolby E signal to -18 dBFS, -20 dBFS, or Multi Tone.

DE Start Position. When Option DBE is installed, sets the starting position of the Dolby E signal to Ideal, Early, Late, or Custom. The line numbers for the starting position varies depending on the format of the video signal. See the Dolby Web site (www.dolby.com) for information about the starting line position for each video format.

When you select Custom, you can set a custom start position. The line numbers for the custom starting position varies depending on the format of the video signal. For 3G fast-progressive formats, the custom start line can be in the range of 22 to 140. Level A signals will support all of the line numbers in that range; Level B signals will support only even numbers in that range. For HD and SD signals, the custom start line can be in the range of 11 to 70.

DE Metadata. When Option DBE is installed, sets the Dolby E metadata parameters. Select this item and press the SEL button to access the Dolby E Metadata submenu. The submenu allows you to set the following Dolby E metadata parameters:



CAUTION. Use caution when changing the Dolby E metadata values. Changing the metadata does not change the encoded audio. Changing the metadata values from default values may cause the signal to not decode correctly. See [Dolby E metadata configuration \(Option DBE only\)](#) on page 70.

- **Dialnorm.** Sets the dialnorm value for the Dolby E signal. This value should represent the long term weighted average level of the dialog within a program. A Dolby Digital decoder will use this parameter to determine what level shift to apply to the audio that will normalize the decoder output. This allows different content to be automatically normalized by the decoder, provided that the dialnorm value is set correctly.
You can set a value between -1 dB and -31 dB. The default values are -23 dB for -20 dBFS signal levels and -24 dB for -18 dBFS signal levels.
- **Line Mode.** Sets the line mode compression profile for the Dolby E signal. Line mode compression is typically used in decoders with either six or two channel line level outputs. You can select Film Standard, Film Light, Music Standard, Music Light, Speech, or Disable.
- **RF Mode.** Sets the RF mode compression profile for the Dolby E signal. RF mode compression is typically used in decoders with two channel RF modulated outputs. You can select Film Standard, Film Light, Music Standard, Music Light, Speech, or Disable.
- **Cen Mix Lev.** Sets the center downmix level of the Dolby E signal. This parameter indicates what level shift should be applied to the center channel before adding it to the left and right channels when downmixing to a stereo output. This parameter is used when extended BSI parameters are not active. You can select -3.0 dB, -4.5 dB, or -6.0 dB.
- **Surr Mix Lev.** Sets the surround downmix level of the Dolby E signal. This parameter indicates what level shift should be applied to the surround channels before adding them to the left and right channels when downmixing to a stereo output. This parameter is used when extended BSI parameters are not active. You can select -3.0 dB, -6.0 dB, or 0.0 dB.
- **Downmix Pref.** Sets the preferred downmix of the Dolby E signal. This parameter is used in consumer decoders that have stereo outputs. This parameter is part of the extended BSI. You can select NI (Not Indicated), LtRt, or LoRo.
- **LtRt CenMix Lev.** Sets the LtRt center mix level of the Dolby E signal. This parameter indicates what level shift should be applied to the center channel before adding it to the left and right channels when downmixing to an LtRt output. This parameter is part of the extended BSI. You can select $+3.0$ dB, $+1.5$ dB, 0.0 dB, -1.5 dB, -3.0 dB, -4.5 dB, -6.0 dB, or Infinite.
- **LtRt Surr Mix Lev.** Sets the LtRt surround mix level of the Dolby E signal. This parameter indicates what level shift should be applied to the surround channels before adding them to the left and right channels when downmixing to an LtRt output. This parameter is part of the extended BSI. You can select $+3.0$ dB, $+1.5$ dB, 0.0 dB, -1.5 dB, -3.0 dB, -4.5 dB, -6.0 dB, or Infinite.

- **LoRt Cen Mix Lev.** Sets the LoRo center mix level of the Dolby E signal. This parameter indicates what level shift should be applied to the center channel before adding it to the left and right channels when downmixing to an LoRo output. This parameter is part of the extended BSI. You can select +3.0 dB, +1.5 dB, 0.0 dB, -1.5 dB, -3.0 dB, -4.5 dB, -6.0 dB, or Infinite.
- **LoRo Surr Mix Lev.** Sets the LoRo surround mix level of the Dolby E signal. This parameter indicates what level shift should be applied to the surround channels before adding them to the left and right channels when downmixing to an LoRo output. This parameter is part of the extended BSI. You can select +3.0 dB, +1.5 dB, 0.0 dB, -1.5 dB, -3.0 dB, -4.5 dB, -6.0 dB, or Infinite.
- **Frame Rate.** Sets the video frame rate associated with the Dolby E signal. You can select 23.98 fps, 24 fps, 25 fps, 29.97 fps, or 30 fps.
- **DE Meta. Set Default.** Resets the Dolby E metadata to the default values.

DE Meta. Set Default. When Option DBE is installed, resets the Dolby E metadata to the default values.

CONFIG menu

The settings controlled in the Generator Status pop-up menu are duplicated in the CONFIG > Video/Gen Outputs and the CONFIG > Audio/Gen Outputs menus. Changes made in the Generator Status pop-up menu immediately appear in the CONFIG > Outputs and the CONFIG > Audio/Gen Outputs menu selections.

Dolby E metadata configuration (Option DBE only)

NOTE. Use caution when changing the Dolby E metadata values. Changing the metadata does not change the encoded audio. Changing the metadata values from default values may cause the signal to not decode correctly.

When you configure the Dolby E metadata, depending on your selections, other metadata values may change or be limited as follows:

Program setting. The Program setting is the primary metadata control. When you select a program type, the metadata is set according to that program type.

For example, if you set the Dolby E program to 5.1, the Dolby E bit depth setting remains as it is and the user interface for the bit depth control shows both 16-bits and 20-bits as being available.

Frame rate setting. If you change the Dolby E frame rate setting, it does not affect the actual audio data being streamed out by the generator, and it does not change the rate at which this data is being streamed or the video frame rate itself.

Dolby E generated formats (Option DBE only)

The tables on the following pages list the Dolby E generated formats according to frame rate.

Table 9: Dolby E generated formats – 23.98 Hz frame rate

Dolby E program	Dolby E level	Signal levels and frequencies							
		Program 1 M1	Program 2 M2	Program 3 M3	Program 4 M4	Program 5 M5	Program 6 M6	Program 7 M7	Program 8 M8
8x1		Program 1 M1	Program 2 M2	Program 3 M3	Program 4 M4	Program 5 M5	Program 6 M6	Program 7 M7	Program 8 M8
	-20 dBFS	-20 dBFS 2.398 kHz	-20 dBFS 2.398 kHz	-20 dBFS 2.398 kHz	-20 dBFS 2.398 kHz	-20 dBFS 2.398 kHz	-20 dBFS 2.398 kHz	-20 dBFS 2.398 kHz	-20 dBFS 2.398 kHz
	-18 dBFS	-18 dBFS 2.398 kHz	-18 dBFS 2.398 kHz	-18 dBFS 2.398 kHz	-18 dBFS 2.398 kHz	-18 dBFS 2.398 kHz	-18 dBFS 2.398 kHz	-18 dBFS 2.398 kHz	-18 dBFS 2.398 kHz
	Multitone	-18 dBFS 119.9 Hz	-20 dBFS 239.8 Hz	-22 dBFS 359.7 Hz	-24 dBFS 479.5 Hz	-26 dBFS 599.4 Hz	-28 dBFS 1198.8 Hz	-30 dBFS 1798.2 Hz	-32 dBFS 2397.6 Hz
7.1		Program 1 L	Program 1 C	Program 1 R	Program 1 Ls	Program 1 Rs	Program 1 LFE	Program 1 Lb	Program 1 Rb
	-20 dBFS	-20 dBFS 2.398 kHz	-20 dBFS 2.398 kHz	-20 dBFS 2.398 kHz	-20 dBFS 2.398 kHz	-20 dBFS 2.398 kHz	-20 dBFS 240 Hz	-20 dBFS 2.398 kHz	-20 dBFS 2.398 kHz
	-18 dBFS	-18 dBFS 2.398 kHz	-18 dBFS 2.398 kHz	-18 dBFS 2.398 kHz	-18 dBFS 2.398 kHz	-18 dBFS 2.398 kHz	-18 dBFS 240 Hz	-18 dBFS 2.398 kHz	-18 dBFS 2.398 kHz
	Multitone	-18 dBFS 239.8 Hz	-20 dBFS 359.7 Hz	-22 dBFS 479.5 Hz	-24 dBFS 599.4 Hz	-26 dBFS 1198.8 Hz	-28 dBFS 119.9 Hz	-30 dBFS 1798.2 Hz	-32 dBFS 2397.6 Hz
5.1+2		Program 1 L	Program 1 C	Program 1 R	Program 1 Ls	Program 1 Rs	Program 1 LFE	Program 1 Lt	Program 1 Rt
	-20 dBFS	-20 dBFS 2.398 kHz	-20 dBFS 2.398 kHz	-20 dBFS 2.398 kHz	-20 dBFS 2.398 kHz	-20 dBFS 2.398 kHz	-20 dBFS 240 Hz	-20 dBFS 2.398 kHz	-20 dBFS 2.398 kHz
	-18 dBFS	-18 dBFS 2.398 kHz	-18 dBFS 2.398 kHz	-18 dBFS 2.398 kHz	-18 dBFS 2.398 kHz	-18 dBFS 2.398 kHz	-18 dBFS 240 Hz	-18 dBFS 2.398 kHz	-18 dBFS 2.398 kHz
	Multitone	-18 dBFS 239.8 Hz	-20 dBFS 359.7 Hz	-22 dBFS 479.5 Hz	-24 dBFS 599.4 Hz	-26 dBFS 1198.8 Hz	-28 dBFS 119.9 Hz	-30 dBFS 1798.2 Hz	-32 dBFS 2397.6 Hz
5.1		Program 1 L	Program 1 C	Program 1 R	Program 1 Ls	Program 1 Rs	Program 1 LFE		
	-20 dBFS	-20 dBFS 2.398 kHz	-20 dBFS 2.398 kHz	-20 dBFS 2.398 kHz	-20 dBFS 2.398 kHz	-20 dBFS 2.398 kHz	-20 dBFS 240 Hz		
	-18 dBFS	-18 dBFS 2.398 kHz	-18 dBFS 2.398 kHz	-18 dBFS 2.398 kHz	-18 dBFS 2.398 kHz	-18 dBFS 2.398 kHz	-18 dBFS 240 Hz		
	Multitone	-18 dBFS 239.8 Hz	-20 dBFS 359.7 Hz	-22 dBFS 479.5 Hz	-24 dBFS 599.4 Hz	-26 dBFS 1198.8 Hz	-28 dBFS 119.9 Hz		
4x2		Program 1 L1	Program 1 R1	Program 2 L2	Program 2 R2	Program 3 L3	Program 3 R3	Program 4 L4	Program 4 R4
	-20 dBFS	-20 dBFS 2.398 kHz	-20 dBFS 2.398 kHz	-20 dBFS 2.398 kHz	-20 dBFS 2.398 kHz	-20 dBFS 2.398 kHz	-20 dBFS 2.398 kHz	-20 dBFS 2.398 kHz	-20 dBFS 2.398 kHz
	-18 dBFS	-18 dBFS 2.398 kHz	-18 dBFS 2.398 kHz	-18 dBFS 2.398 kHz	-18 dBFS 2.398 kHz	-18 dBFS 2.398 kHz	-18 dBFS 2.398 kHz	-18 dBFS 2.398 kHz	-18 dBFS 2.398 kHz
	Multitone	-18 dBFS 119.9 Hz	-20 dBFS 239.8 Hz	-22 dBFS 359.7 Hz	-24 dBFS 479.5 Hz	-26 dBFS 599.4 Hz	-28 dBFS 1198.8 Hz	-30 dBFS 1798.2 Hz	-32 dBFS 2397.6 Hz

Table 10: Dolby E generated formats – 24 Hz frame rate

Dolby E program	Dolby E level	Signal levels and frequencies							
		Program 1 M1	Program 2 M2	Program 3 M3	Program 4 M4	Program 5 M5	Program 6 M6	Program 7 M7	Program 8 M8
8x1		Program 1 M1	Program 2 M2	Program 3 M3	Program 4 M4	Program 5 M5	Program 6 M6	Program 7 M7	Program 8 M8
	-20 dBFS	-20 dBFS 2.400 kHz	-20 dBFS 2.400 kHz	-20 dBFS 2.400 kHz	-20 dBFS 2.400 kHz	-20 dBFS 2.400 kHz	-20 dBFS 2.400 kHz	-20 dBFS 2.400 kHz	-20 dBFS 2.400 kHz
	-18 dBFS	-18 dBFS 2.400 kHz	-18 dBFS 2.400 kHz	-18 dBFS 2.400 kHz	-18 dBFS 2.400 kHz	-18 dBFS 2.400 kHz	-18 dBFS 2.400 kHz	-18 dBFS 2.400 kHz	-18 dBFS 2.400 kHz
	Multitone	-18 dBFS 120 Hz	-20 dBFS 240 Hz	-22 dBFS 360 Hz	-24 dBFS 480 Hz	-26 dBFS 600 Hz	-28 dBFS 1200 Hz	-30 dBFS 1800 Hz	-32 dBFS 2400 Hz
7.1		Program 1 L	Program 1 C	Program 1 R	Program 1 Ls	Program 1 Rs	Program 1 LFE	Program 1 Lb	Program 1 Rb
	-20 dBFS	-20 dBFS 2.400 kHz	-20 dBFS 2.400 kHz	-20 dBFS 2.400 kHz	-20 dBFS 240 Hz	-20 dBFS 2.400 kHz	-20 dBFS 2.400 kHz	-20 dBFS 2.400 kHz	-20 dBFS 2.400 kHz
	-18 dBFS	-18 dBFS 2.400 kHz	-18 dBFS 2.400 kHz	-18 dBFS 2.400 kHz	-18 dBFS 240 Hz	-18 dBFS 2.400 kHz	-18 dBFS 2.400 kHz	-18 dBFS 2.400 kHz	-18 dBFS 2.400 kHz
	Multitone	-18 dBFS 240 Hz	-20 dBFS 360 Hz	-22 dBFS 480 Hz	-24 dBFS 600 Hz	-26 dBFS 1200 Hz	-28 dBFS 120 Hz	-30 dBFS 1800 Hz	-32 dBFS 2400 Hz
5.1+2		Program 1 L	Program 1 C	Program 1 R	Program 1 Ls	Program 1 Rs	Program 1 LFE	Program 1 Lt	Program 1 Rt
	-20 dBFS	-20 dBFS 2.400 kHz	-20 dBFS 2.400 kHz	-20 dBFS 2.400 kHz	-20 dBFS 240 Hz	-20 dBFS 2.400 kHz	-20 dBFS 2.400 kHz	-20 dBFS 2.400 kHz	-20 dBFS 2.400 kHz
	-18 dBFS	-18 dBFS 2.400 kHz	-18 dBFS 2.400 kHz	-18 dBFS 2.400 kHz	-18 dBFS 240 Hz	-18 dBFS 2.400 kHz	-18 dBFS 2.400 kHz	-18 dBFS 2.400 kHz	-18 dBFS 2.400 kHz
	Multitone	-18 dBFS 240 Hz	-20 dBFS 360 Hz	-22 dBFS 480 Hz	-24 dBFS 600 Hz	-26 dBFS 1200 Hz	-28 dBFS 120 Hz	-30 dBFS 1800 Hz	-32 dBFS 2400 Hz
5.1		Program 1 L	Program 1 C	Program 1 R	Program 1 Ls	Program 1 Rs	Program 1 LFE		
	-20 dBFS	-20 dBFS 2.400 kHz	-20 dBFS 2.400 kHz	-20 dBFS 2.400 kHz	-20 dBFS 2.400 kHz	-20 dBFS 2.400 kHz	-20 dBFS 240 Hz		
	-18 dBFS	-18 dBFS 2.400 kHz	-18 dBFS 2.400 kHz	-18 dBFS 2.400 kHz	-18 dBFS 2.400 kHz	-18 dBFS 2.400 kHz	-18 dBFS 240 Hz		
	Multitone	-18 dBFS 240 Hz	-20 dBFS 360 Hz	-22 dBFS 480 Hz	-24 dBFS 600 Hz	-26 dBFS 1200 Hz	-28 dBFS 120 Hz		
4x2		Program 1 L1	Program 1 R1	Program 2 L2	Program 2 R2	Program 3 L3	Program 3 R3	Program 4 L4	Program 4 R4
	-20 dBFS	-20 dBFS 2.400 kHz	-20 dBFS 2.400 kHz	-20 dBFS 2.400 kHz	-20 dBFS 2.400 kHz	-20 dBFS 2.400 kHz	-20 dBFS 2.400 kHz	-20 dBFS 2.400 kHz	-20 dBFS 2.400 kHz
	-18 dBFS	-18 dBFS 2.400 kHz	-18 dBFS 2.400 kHz	-18 dBFS 2.400 kHz	-18 dBFS 2.400 kHz	-18 dBFS 2.400 kHz	-18 dBFS 2.400 kHz	-18 dBFS 2.400 kHz	-18 dBFS 2.400 kHz
	Multitone	-18 dBFS 120 Hz	-20 dBFS 240 Hz	-22 dBFS 360 Hz	-24 dBFS 480 Hz	-26 dBFS 600 Hz	-28 dBFS 1200 Hz	-30 dBFS 1800 Hz	-32 dBFS 2400 Hz

Table 11: Dolby E generated formats – 25 Hz frame rate

Dolby E program	Dolby E level	Signal levels and frequencies							
		Program 1 M1	Program 2 M2	Program 3 M3	Program 4 M4	Program 5 M5	Program 6 M6	Program 7 M7	Program 8 M8
8x1		Program 1 M1	Program 2 M2	Program 3 M3	Program 4 M4	Program 5 M5	Program 6 M6	Program 7 M7	Program 8 M8
	-20 dBFS	-20 dBFS 1.0 kHz	-20 dBFS 1.0 kHz	-20 dBFS 1.0 kHz	-20 dBFS 1.0 kHz	-20 dBFS 1.0 kHz	-20 dBFS 1.0 kHz	-20 dBFS 1.0 kHz	-20 dBFS 1.0 kHz
	-18 dBFS	-18 dBFS 1.0 kHz	-18 dBFS 1.0 kHz	-18 dBFS 1.0 kHz	-18 dBFS 1.0 kHz	-18 dBFS 1.0 kHz	-18 dBFS 1.0 kHz	-18 dBFS 1.0 kHz	-18 dBFS 1.0 kHz
	Multitone	-18 dBFS 125 Hz	-20 dBFS 250 Hz	-22 dBFS 350 Hz	-24 dBFS 475 Hz	-26 dBFS 600 Hz	-28 dBFS 1200 Hz	-30 dBFS 1800 Hz	-32 dBFS 2400 Hz
7.1		Program 1 L	Program 1 C	Program 1 R	Program 1 Ls	Program 1 Rs	Program 1 LFE	Program 1 Lb	Program 1 Rb
	-20 dBFS	-20 dBFS 1.0 kHz	-20 dBFS 1.0 kHz	-20 dBFS 1.0 kHz	-20 dBFS 1.0 kHz	-20 dBFS 1.0 kHz	-20 dBFS 240 Hz	-20 dBFS 1.0 kHz	-20 dBFS 1.0 kHz
	-18 dBFS	-18 dBFS 1.0 kHz	-18 dBFS 1.0 kHz	-18 dBFS 1.0 kHz	-18 dBFS 1.0 kHz	-18 dBFS 1.0 kHz	-18 dBFS 240 Hz	-18 dBFS 1.0 kHz	-18 dBFS 1.0 kHz
	Multitone	-18 dBFS 250 Hz	-20 dBFS 350 Hz	-22 dBFS 475 Hz	-24 dBFS 600 Hz	-26 dBFS 1200 Hz	-28 dBFS 125 Hz	-30 dBFS 1800 Hz	-32 dBFS 2400 Hz
5.1+2		Program 1 L	Program 1 C	Program 1 R	Program 1 Ls	Program 1 Rs	Program 1 LFE	Program 1 Lt	Program 1 Rt
	-20 dBFS	-20 dBFS 1.0 kHz	-20 dBFS 1.0 kHz	-20 dBFS 1.0 kHz	-20 dBFS 1.0 kHz	-20 dBFS 1.0 kHz	-20 dBFS 240 Hz	-20 dBFS 1.0 kHz	-20 dBFS 1.0 kHz
	-18 dBFS	-18 dBFS 1.0 kHz	-18 dBFS 1.0 kHz	-18 dBFS 1.0 kHz	-18 dBFS 1.0 kHz	-18 dBFS 1.0 kHz	-18 dBFS 240 Hz	-18 dBFS 1.0 kHz	-18 dBFS 1.0 kHz
	Multitone	-18 dBFS 250 Hz	-20 dBFS 350 Hz	-22 dBFS 475 Hz	-24 dBFS 600 Hz	-26 dBFS 1200 Hz	-28 dBFS 125 Hz	-30 dBFS 1800 Hz	-32 dBFS 2400 Hz
5.1		Program 1 L	Program 1 C	Program 1 R	Program 1 Ls	Program 1 Rs	Program 1 LFE		
	-20 dBFS	-20 dBFS 1.0 kHz	-20 dBFS 1.0 kHz	-20 dBFS 1.0 kHz	-20 dBFS 1.0 kHz	-20 dBFS 1.0 kHz	-20 dBFS 240 Hz		
	-18 dBFS	-18 dBFS 1.0 kHz	-18 dBFS 1.0 kHz	-18 dBFS 1.0 kHz	-18 dBFS 1.0 kHz	-18 dBFS 1.0 kHz	-18 dBFS 240 Hz		
	Multitone	-18 dBFS 250 Hz	-20 dBFS 350 Hz	-22 dBFS 475 Hz	-24 dBFS 600 Hz	-26 dBFS 1200 Hz	-28 dBFS 125 Hz		
4x2		Program 1 L1	Program 1 R1	Program 2 L2	Program 2 R2	Program 3 L3	Program 3 R3	Program 4 L4	Program 4 R4
	-20 dBFS	-20 dBFS 1.0 kHz	-20 dBFS 1.0 kHz	-20 dBFS 1.0 kHz	-20 dBFS 1.0 kHz	-20 dBFS 1.0 kHz	-20 dBFS 1.0 kHz	-20 dBFS 1.0 kHz	-20 dBFS 1.0 kHz
	-18 dBFS	-18 dBFS 1.0 kHz	-18 dBFS 1.0 kHz	-18 dBFS 1.0 kHz	-18 dBFS 1.0 kHz	-18 dBFS 1.0 kHz	-18 dBFS 1.0 kHz	-18 dBFS 1.0 kHz	-18 dBFS 1.0 kHz
	Multitone	-18 dBFS 125 Hz	-20 dBFS 250 Hz	-22 dBFS 350 Hz	-24 dBFS 475 Hz	-26 dBFS 600 Hz	-28 dBFS 1200 Hz	-30 dBFS 1800 Hz	-32 dBFS 2400 Hz

Table 12: Dolby E generated formats – 29.97 Hz frame rate

Dolby E program	Dolby E level	Signal levels and frequencies							
		Program 1 M1	Program 2 M2	Program 3 M3	Program 4 M4	Program 5 M5	Program 6 M6	Program 7 M7	Program 8 M8
8x1		Program 1 M1	Program 2 M2	Program 3 M3	Program 4 M4	Program 5 M5	Program 6 M6	Program 7 M7	Program 8 M8
	-20 dBSF	-20 dBFS 2.997 kHz	-20 dBFS 2.997 kHz	-20 dBFS 2.997 kHz	-20 dBFS 2.997 kHz	-20 dBFS 2.997 kHz	-20 dBFS 2.997 kHz	-20 dBFS 2.997 kHz	-20 dBFS 2.997 kHz
	-18 dBSF	-18 dBFS 2.997 kHz	-18 dBFS 2.997 kHz	-18 dBFS 2.997 kHz	-18 dBFS 2.997 kHz	-18 dBFS 2.997 kHz	-18 dBFS 2.997 kHz	-18 dBFS 2.997 kHz	-18 dBFS 2.997 kHz
	Multitone	-18 dBFS 119.9 Hz	-20 dBFS 239.8 Hz	-22 dBFS 359.7 Hz	-24 dBFS 479.5 Hz	-26 dBFS 599.4 Hz	-28 dBFS 1198.8 Hz	-30 dBFS 1798.2 Hz	-32 dBFS 2397.6 Hz
7.1		Program 1 L	Program 1 C	Program 1 R	Program 1 Ls	Program 1 Rs	Program 1 LFE	Program 1 Lb	Program 1 Rb
	-20 dBSF	-20 dBFS 2.997 kHz	-20 dBFS 2.997 kHz	-20 dBFS 2.997 kHz	-20 dBFS 2.997 kHz	-20 dBFS 2.997 kHz	-20 dBFS 240 Hz	-20 dBFS 2.997 kHz	-20 dBFS 2.997 kHz
	-18 dBSF	-18 dBFS 2.997 kHz	-18 dBFS 2.997 kHz	-18 dBFS 2.997 kHz	-18 dBFS 2.997 kHz	-18 dBFS 2.997 kHz	-18 dBFS 240 Hz	-18 dBFS 2.997 kHz	-18 dBFS 2.997 kHz
	Multitone	-18 dBFS 239.8 Hz	-20 dBFS 359.7 Hz	-22 dBFS 479.5 Hz	-24 dBFS 599.4 Hz	-26 dBFS 1198.8 Hz	-28 dBFS 119.9 Hz	-30 dBFS 1798.2 Hz	-32 dBFS 2397.6 Hz
5.1+2		Program 1 L	Program 1 C	Program 1 R	Program 1 Ls	Program 1 Rs	Program 1 LFE	Program 1 Lt	Program 1 Rt
	-20 dBSF	-20 dBFS 2.997 kHz	-20 dBFS 2.997 kHz	-20 dBFS 2.997 kHz	-20 dBFS 2.997 kHz	-20 dBFS 2.997 kHz	-20 dBFS 240 Hz	-20 dBFS 2.997 kHz	-20 dBFS 2.997 kHz
	-18 dBSF	-18 dBFS 2.997 kHz	-18 dBFS 2.997 kHz	-18 dBFS 2.997 kHz	-18 dBFS 2.997 kHz	-18 dBFS 2.997 kHz	-18 dBFS 240 Hz	-18 dBFS 2.997 kHz	-18 dBFS 2.997 kHz
	Multitone	-18 dBFS 239.8 Hz	-20 dBFS 359.7 Hz	-22 dBFS 479.5 Hz	-24 dBFS 599.4 Hz	-26 dBFS 1198.8 Hz	-28 dBFS 119.9 Hz	-30 dBFS 1798.2 Hz	-32 dBFS 2397.6 Hz
5.1		Program 1 L	Program 1 C	Program 1 R	Program 1 Ls	Program 1 Rs	Program 1 LFE		
	-20 dBSF	-20 dBFS 2.997 kHz	-20 dBFS 2.997 kHz	-20 dBFS 2.997 kHz	-20 dBFS 2.997 kHz	-20 dBFS 2.997 kHz	-20 dBFS 240 Hz		
	-18 dBSF	-18 dBFS 2.997 kHz	-18 dBFS 2.997 kHz	-18 dBFS 2.997 kHz	-18 dBFS 2.997 kHz	-18 dBFS 2.997 kHz	-18 dBFS 240 Hz		
	Multitone	-18 dBFS 239.8 Hz	-20 dBFS 359.7 Hz	-22 dBFS 479.5 Hz	-24 dBFS 599.4 Hz	-26 dBFS 1198.8 Hz	-28 dBFS 119.9 Hz		
4x2		Program 1 L1	Program 1 R1	Program 2 L2	Program 2 R2	Program 3 L3	Program 3 R3	Program 4 L4	Program 4 R4
	-20 dBSF	-20 dBFS 2.997 kHz	-20 dBFS 2.997 kHz	-20 dBFS 2.997 kHz	-20 dBFS 2.997 kHz	-20 dBFS 2.997 kHz	-20 dBFS 2.997 kHz	-20 dBFS 2.997 kHz	-20 dBFS 2.997 kHz
	-18 dBSF	-18 dBFS 2.997 kHz	-18 dBFS 2.997 kHz	-18 dBFS 2.997 kHz	-18 dBFS 2.997 kHz	-18 dBFS 2.997 kHz	-18 dBFS 2.997 kHz	-18 dBFS 2.997 kHz	-18 dBFS 2.997 kHz
	Multitone	-18 dBFS 119.9 Hz	-20 dBFS 239.8 Hz	-22 dBFS 359.7 Hz	-24 dBFS 479.5 Hz	-26 dBFS 599.4 Hz	-28 dBFS 1198.8 Hz	-30 dBFS 1798.2 Hz	-32 dBFS 2397.6 Hz

Table 13: Dolby E generated formats – 30 Hz frame rate

Dolby E program	Dolby E level	Signal levels and frequencies							
		Program 1 M1	Program 2 M2	Program 3 M3	Program 4 M4	Program 5 M5	Program 6 M6	Program 7 M7	Program 8 M8
8x1		Program 1 M1	Program 2 M2	Program 3 M3	Program 4 M4	Program 5 M5	Program 6 M6	Program 7 M7	Program 8 M8
	-20 dBFS	-20 dBFS 3.0 kHz	-20 dBFS 3.0 kHz	-20 dBFS 3.0 kHz	-20 dBFS 3.0 kHz	-20 dBFS 3.0 kHz	-20 dBFS 3.0 kHz	-20 dBFS 3.0 kHz	-20 dBFS 3.0 kHz
	-18 dBFS	-18 dBFS 3.0 kHz	-18 dBFS 3.0 kHz	-18 dBFS 3.0 kHz	-18 dBFS 3.0 kHz	-18 dBFS 3.0 kHz	-18 dBFS 3.0 kHz	-18 dBFS 3.0 kHz	-18 dBFS 3.0 kHz
	Multitone	-18 dBFS 120 Hz	-20 dBFS 240 Hz	-22 dBFS 360 Hz	-24 dBFS 480 Hz	-26 dBFS 600 Hz	-28 dBFS 1200 Hz	-30 dBFS 1800 Hz	-32 dBFS 2400 Hz
7.1		Program 1 L	Program 1 C	Program 1 R	Program 1 Ls	Program 1 Rs	Program 1 LFE	Program 1 Lb	Program 1 Rb
	-20 dBFS	-20 dBFS 3.0 kHz	-20 dBFS 3.0 kHz	-20 dBFS 3.0 kHz	-20 dBFS 3.0 kHz	-20 dBFS 3.0 kHz	-20 dBFS 240 Hz	-20 dBFS 3.0 kHz	-20 dBFS 3.0 kHz
	-18 dBFS	-18 dBFS 3.0 kHz	-18 dBFS 3.0 kHz	-18 dBFS 3.0 kHz	-18 dBFS 3.0 kHz	-18 dBFS 3.0 kHz	-18 dBFS 240 Hz	-18 dBFS 3.0 kHz	-18 dBFS 3.0 kHz
	Multitone	-18 dBFS 240 Hz	-20 dBFS 360 Hz	-22 dBFS 480 Hz	-24 dBFS 600 Hz	-26 dBFS 1200 Hz	-28 dBFS 120 Hz	-30 dBFS 1800 Hz	-32 dBFS 2400 Hz
5.1+2		Program 1 L	Program 1 C	Program 1 R	Program 1 Ls	Program 1 Rs	Program 1 LFE	Program 1 Lt	Program 1 Rt
	-20 dBFS	-20 dBFS 3.0 kHz	-20 dBFS 3.0 kHz	-20 dBFS 3.0 kHz	-20 dBFS 3.0 kHz	-20 dBFS 3.0 kHz	-20 dBFS 240 Hz	-20 dBFS 3.0 kHz	-20 dBFS 3.0 kHz
	-18 dBFS	-18 dBFS 3.0 kHz	-18 dBFS 3.0 kHz	-18 dBFS 3.0 kHz	-18 dBFS 3.0 kHz	-18 dBFS 3.0 kHz	-18 dBFS 240 Hz	-18 dBFS 3.0 kHz	-18 dBFS 3.0 kHz
	Multitone	-18 dBFS 240 Hz	-20 dBFS 360 Hz	-22 dBFS 480 Hz	-24 dBFS 600 Hz	-26 dBFS 1200 Hz	-28 dBFS 120 Hz	-30 dBFS 1800 Hz	-32 dBFS 2400 Hz
5.1		Program 1 L	Program 1 C	Program 1 R	Program 1 Ls	Program 1 Rs	Program 1 LFE		
	-20 dBFS	-20 dBFS 3.0 kHz	-20 dBFS 3.0 kHz	-20 dBFS 3.0 kHz	-20 dBFS 3.0 kHz	-20 dBFS 3.0 kHz	-20 dBFS 240 Hz		
	-18 dBFS	-18 dBFS 3.0 kHz	-18 dBFS 3.0 kHz	-18 dBFS 3.0 kHz	-18 dBFS 3.0 kHz	-18 dBFS 3.0 kHz	-18 dBFS 240 Hz		
	Multitone	-18 dBFS 240 Hz	-20 dBFS 360 Hz	-22 dBFS 480 Hz	-24 dBFS 600 Hz	-26 dBFS 1200 Hz	-28 dBFS 120 Hz		
4x2		Program 1 L1	Program 1 R1	Program 2 L2	Program 2 R2	Program 3 L3	Program 3 R3	Program 4 L4	Program 4 R4
	-20 dBFS	-20 dBFS 3.0 kHz	-20 dBFS 3.0 kHz	-20 dBFS 3.0 kHz	-20 dBFS 3.0 kHz	-20 dBFS 3.0 kHz	-20 dBFS 3.0 kHz	-20 dBFS 3.0 kHz	-20 dBFS 3.0 kHz
	-18 dBFS	-18 dBFS 3.0 kHz	-18 dBFS 3.0 kHz	-18 dBFS 3.0 kHz	-18 dBFS 3.0 kHz	-18 dBFS 3.0 kHz	-18 dBFS 3.0 kHz	-18 dBFS 3.0 kHz	-18 dBFS 3.0 kHz
	Multitone	-18 dBFS 120 Hz	-20 dBFS 240 Hz	-22 dBFS 360 Hz	-24 dBFS 480 Hz	-26 dBFS 600 Hz	-28 dBFS 1200 Hz	-30 dBFS 1800 Hz	-32 dBFS 2400 Hz

Dolby E loudness measurements

The following tables list the Dolby E loudness measurements for each program. The measurements were made with a Tektronix WFM8000 Series waveform monitor using the ATSC A/85 2013 Loudness preset.

Dialnorm values of -23 dB and -24 dB are used by default within the instrument, depending on the Dolby E level setting. If you want to use the measured loudness values instead of the default dialnorm values, you can enter them by adjusting the Dolby E metadata dialnorm setting. If you want to continue using these measured loudness values, use the PRESET menu to create a preset with the specific values you want.

Table 14: Dolby E loudness measurements – 23.98 and 24 Hz frame rates

Dolby E program	Dolby E level	Loudness measurement values (LKFS)							
		Program 1	Program 2	Program 3	Program 4	Program 5	Program 6	Program 7	Program 8
8x1	-20 dBSF	-20.2	-20.2	-20.2	-20.2	-20.2	-20.2	-20.2	-20.2
	-18 dBSF	-18.2	-18.2	-18.2	-18.2	-18.2	-18.2	-18.2	-18.2
	Multitone	-22.5	-23.9	-25.7	-27.6	-29.6	-30.5	-31.0	-32.2
7.1	-20 dBSF	-11.3							
	-18 dBSF	-9.3							
	Multitone	-17.2							
5.1+2	-20 dBSF	-12.6	-17.2						
	-18 dBSF	-10.6	-15.2						
	Multitone	-17.5	-28.5						
5.1	-20 dBSF	-12.6							
	-18 dBSF	-10.6							
	Multitone	-17.5							
4x2	-20 dBSF	-17.2	-17.2	-17.2	-17.2				
	-18 dBSF	-15.2	-15.2	-15.2	-15.2				
	Multitone	-20.1	-23.6	-27.0	-28.5				

Table 15: Dolby E loudness measurements – 25 Hz frame rate

Dolby E program	Dolby E level	Loudness measurement values (LKFS)							
		Program 1	Program 2	Program 3	Program 4	Program 5	Program 6	Program 7	Program 8
8x1	-20 dBSF	-23.0	-23.0	-23.0	-23.0	-23.0	-23.0	-23.0	-23.0
	-18 dBSF	-21.0	-21.0	-21.0	-21.0	-21.0	-21.0	-21.0	-21.0
	Multitone	-22.5	-23.9	-25.7	-27.6	-29.6	-30.5	-31.0	-32.2
7.1	-20 dBSF	-14.1							
	-18 dBSF	-12.1							
	Multitone	-17.2							
5.1+2	-20 dBSF	-15.4	-20.0						
	-18 dBSF	-13.4	-18.0						
	Multitone	-17.5	-28.5						
5.1	-20 dBSF	-15.4							
	-18 dBSF	-13.4							
	Multitone	-17.5							
4x2	-20 dBSF	-20.0	-20.0	-20.0	-20.0				
	-18 dBSF	-18.0	-18.0	-18.0	-18.0				
	Multitone	-20.1	-23.6	-27.0	-28.5				

Table 16: Dolby E loudness measurements – 29.97 and 30 Hz frame rates

Dolby E program	Dolby E level	Loudness measurement values (LKFS)							
		Program 1	Program 2	Program 3	Program 4	Program 5	Program 6	Program 7	Program 8
8x1	-20 dBSF	-19.9	-19.9	-19.9	-19.9	-19.9	-19.9	-19.9	-19.9
	-18 dBSF	-17.9	-17.9	-17.9	-17.9	-17.9	-17.9	-17.9	-17.9
	Multitone	-22.5	-23.9	-25.7	-27.6	-29.6	-30.5	-31.0	-32.2
7.1	-20 dBSF	-11.0							
	-18 dBSF	-9.0							
	Multitone	-17.2							
5.1+2	-20 dBSF	-12.3	-16.9						
	-18 dBSF	-10.3	-14.9						
	Multitone	-17.5	-28.5						
5.1	-20 dBSF	-12.3							
	-18 dBSF	-10.3							
	Multitone	-17.5							
4x2	-20 dBSF	-16.9	-16.9	-16.9	-16.9				
	-18 dBSF	-14.9	-14.9	-14.9	-14.9				
	Multitone	-20.1	-23.6	-27.0	-28.5				

AV Delay Measurement display (Option AVDP only)

The AV Delay Measurement display provides two measurements. The measurements can be run only one at a time and require the instrument to be out of service. In each measurement mode, a special signal is output from the SDI OUT connector.

AV Delay: Measures the duration that a video system advances or delays the audio signal relative to the video content. The measurement allows facility engineers to ensure system integrity and facilitate A/V delay compliance.

In AV Delay mode, the video and audio on the SDI OUT signal are continuously cycled between being on for 0.5 seconds then set to black and muted for 4.5 seconds.

Propagation Time: Measures how long it takes signal to pass through a video system. The measurement allows facility engineers to align the timing of the multiple incoming videos, check the delay of a CODEC system and/or a video signal path, including the satellite feed.

In Propagation mode, the video and audio on the SDI OUT signal are continuously cycled between being on for 0.5 seconds then set to black and muted for 9.5 seconds.

NOTE. *The amount of time that the AV Delay or Propagation Time signal cycles on and off varies slightly depending on the format of the SDI test signal output.*

The A/V delay and propagation time can be measured up to the test signal interval.

The Propagation Time measurement measures the delay of video signal path, not the audio signal path.

To access the AV Delay display

1. Press and hold the **MEAS** button to open the Measure pop-up menu.
2. Use the arrow keys to select **Display Type > AV Delay**.
3. Press the **MEAS** button to close the pop-up menu.

Elements of the AV Delay display



Figure 15: AV Delay display

The AV Delay measurement is displayed in both numeric and graphical formats.

- **AV Delay bar:** Shows the timing relative to audio.
- **Measured AV Delay:** Shows the timing difference measurement.
- **Manual Offset:** Shows the manual offset value.
- **Adjusted AV Delay:** Shows the adjusted timing difference.
- **Propagation Time:** Shows the propagation time measurement.

Measure pop-up menu (AV Delay display)

Press and hold the MEAS button to open the Measure pop-up menu. The pop-up menu enables you to configure the display type and configure display parameters for the different display types. The following menu selections are available:

Display type. Select from the following display types:

- **Timing Measure** - Displays a Tektronix proprietary view that enables you to easily compare and correct the timing between two signals. See [Timing Measure display](#) on page 136.
- **Datalist (Option DATA only)** - Displays the content of all digital signal formats, structures, and transports (SD, HD, 3G, dual link, 4:2:2, 4:4:4, and others) except for composite signals. See [Datalist display \(Option DATA only\)](#) on page 83.
- **Bowtie** - Displays the interchannel timing between Y Pb and Y Pr. See [Bowtie display](#) on page 81.
- **ANC Data (Option DATA only)** - Displays all of the ANC data in a video signal. See [ANC Data display \(Option DATA only\)](#) on page 48.
- **AV Delay (Option AVDP only)** - Displays results of AV Delay and Propagation Time measurements.
- **ASI PID List Disp. (WFM2300 Option ASI only)** - For MPEG2 transport stream inputs, displays the MPEG TS PID tree with each stream element having an LED icon to indicate the status of the element. See [ASI PID List display \(WFM2300 Option ASI only\)](#) on page 54.

AV Delay Enable. Enables or disables the delay measurement. However, if the AV Timing Mode is set to AV Delay or Propagation, the instrument will still be outputting the measurement signal on the SDI OUT connector.

Clear Offset. Clears the saved offset from the AV Delay measurement.

Save Offset. When making AV Delay measurements only, saves the measurement time of the current input as an offset to the measurement display. This saved time becomes the zero point for additional AV Delay measurements.

AV Timing Mode. Select from the following timing modes:

- **Off** - Turns off the AV Delay or Propagation timing signal on the SDI OUT connector.
- **AV Delay** - Turns on the AV Delay signal on the SDI OUT connector.
- **Propagation** - Turns on the Propagation timing signal on the SDI OUT connector.

CONFIG menu

Use the **Video/Gen Outputs > AV Timing Mode** setting to select the desired mode: **Off**, **AV Delay**, or **Propagation**. When you select AV Delay or Propagation, the associated measurement signal is output from the SDI OUT connector.

Bowtie display

The Bowtie display allows you to look at interchannel timing between Y Pb and Y Pr. The left side of the display compares Y and Pb; the right side compares Y and Pr. The Bowtie display requires a test signal with slightly differing frequencies on the chroma channels than on the luma channel.

If the bowtie patterns have a sharp null, and the null is at the center of each line, the relative amplitudes and interchannel timing are correct. Interchannel timing errors will move the position of the null:

- A relative amplitude error will decrease the depth of the null
- An incomplete null combined with an offset from center indicates both amplitude and timing problems between the channels being compared

To access the Bowtie display

1. Press and hold the **MEAS** button to open the Measure pop-up menu.
2. Use the arrow keys to select **Display Type > Bowtie**.
3. Press the **MEAS** button to close the pop-up menu.

Elements of the Bowtie display

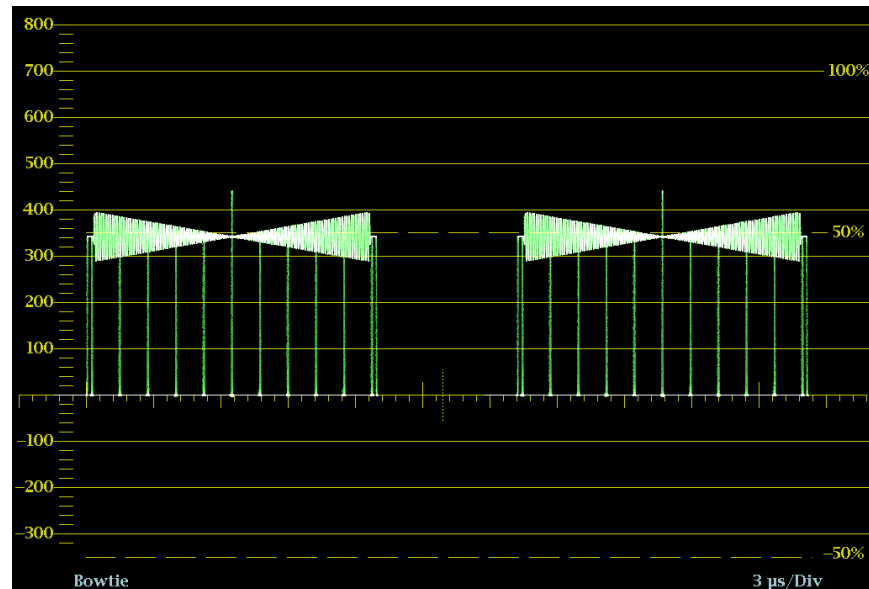

Figure 16: Bowtie display

- **Display:** Shows the display type as Bowtie.
- **Y-axis units:** The units for the y-axis depend on the test signal and the signal format.
- **X-axis units:** Shows the x-axis in microseconds/divisions.

- **H and V positions:** When you press the POS button to adjust the position of the waveform, a position readout appears with a knob icon to indicate whether the horizontal or vertical position is the focus of the General knob.
- **Field and line numbers:** Shows the currently selected video field and line numbers when Line Select mode is enabled. See [Line Select](#) on page 159.

Measure pop-up menu (Bowtie display)

Press and hold the MEAS button to open the Measure pop-up menu. The pop-up menu enables you to configure the display type and configure display parameters for the different display types. The following menu selections are available:

Display type. Select from the following display types:

- **Timing Measure** - Displays a Tektronix proprietary view that enables you to easily compare and correct the timing between two signals. See [Timing Measure display](#) on page 136.
- **Datalist (Option DATA only)** - Displays the content of all digital signal formats, structures, and transports (SD, HD, 3G, dual link, 4:2:2, 4:4:4, and others) except for composite signals. See [Datalist display \(Option DATA only\)](#) on page 83.
- **Bowtie** - Displays the interchannel timing between Y Pb and Y Pr.
- **ANC Data (Option DATA only)** - Displays all of the ANC data in a video signal. See [ANC Data display \(Option DATA only\)](#) on page 48.
- **AV Delay (Option AVDP only)** - Displays results of AV Delay and Propagation Time measurements. See [AV Delay Measurement display \(Option AVDP only\)](#) on page 78.
- **ASI PID List Disp. (WFM2300 Option ASI only)** - For MPEG2 transport stream inputs, displays the MPEG TS PID tree with each stream element having an LED icon to indicate the status of the element. See [ASI PID List display \(WFM2300 Option ASI only\)](#) on page 54.

Parade overlay. Select how the waveform appears by selecting **Parade** or **Overlay**.

Center waveform. Select this option to cancel any horizontal or vertical position adjustments and restore the trace to the default position.

- CONFIG menu** Use the CONFIG menu to set the following Bowtie display parameters:
- Set the **Graticules & Readouts > Waveform Readouts** setting to **On** or **Off** to turn on or off the readouts on the display.
 - Use the menu selections under **Display Settings** to set various general display parameters which affect all applicable display modes such as waveform intensity, graticule color, and enabling the thumbnail view.

- To position the Bowtie trace** To adjust the position of the trace on the Bowtie display:
1. Press the **POS** button.
 2. Press the left or right arrow key to enable horizontal or vertical adjustments. The knob icon appears next to the selected adjustment readout.
 3. Turn the General knob or use the up/down arrow keys to adjust the position of the waveform.
 4. Press the **POS** button to turn off the position adjustment mode.

Datalist display (Option DATA only)

The Datalist display allows you to see SD, HD, or 3G (Option 3G only) data without any interpolation. The Datalist tool examines the contents of all digital formats, structures, and transports (SD, HD, dual-link, 3 Gb/s, 4:2:2, 4:4:4, and others). Datalist works for all signals except composite signals (analog NTSC and analog PAL). From the display screen, you can select and isolate specific lines and words from the video or data stream.

- To access the Datalist display**
1. Press and hold the **MEAS** button to open the Measure pop-up menu.
 2. Use the arrow keys to select **Display Type > Datalist Display**.
 3. Press the **MEAS** button to close the pop-up menu.

Elements of the Datalist display

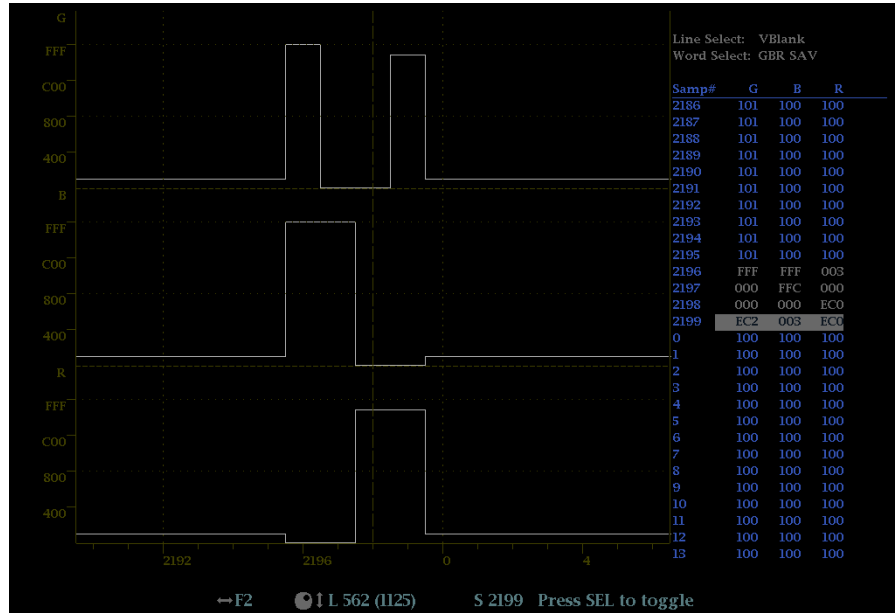

Figure 17: Datalist display

Use the navigation text on the bottom of the display screen to select line and sample items using the arrow keys and the General knob.

- **Line Select:** Shows which line is selected; press the **SEL** button to switch between Line Select and Word Select.
- **Word Select:** Shows which word is selected; press the **SEL** button to switch between Line Select and Word Select.
- **Samp#:** Shows the sample number.
- **Y0, Cb, Cr, Y1:** These labels change based on the signal, but they show the line number for each component.

Datalist color coding

Different fields of the data stream are shown in different colors:

- **Green:** Active video data.
- **Blue:** Data in horizontal or vertical blanking intervals.
- **White:** EAV and SAV packets; other reserved values such as the XYZ word.
- **Yellow:** Data outside the nominal allowed values.
- **Red:** Data with illegal values.

Finding SAV and EAV in the active video stream

From anywhere in the video stream, press the **CURSOR** button once to immediately jump to the EAV of the selected line. Press the button again to jump to the SAV of the same line. This allows you to move quickly to the beginning of the ANC data, which is right after the EAV.

Measure pop-up menu (Datalist display)

Press and hold the MEAS button to open the Measure pop-up menu. The pop-up menu enables you to configure the display type and configure display parameters for the different display types. The following menu selections are available:

Display type. Select from the following display types:

- **Timing Measure** - Displays a Tektronix proprietary view that enables you to easily compare and correct the timing between two signals. See [Timing Measure display](#) on page 136.
- **Datalist (Option DATA only)** - Displays the content of all digital signal formats, structures, and transports (SD, HD, 3G, dual link, 4:2:2, 4:4:4, and others) except for composite signals.
- **Bowtie** - Displays the interchannel timing between Y Pb and Y Pr. See [Bowtie display](#) on page 81.
- **ANC Data (Option DATA only)** - Displays all of the ANC data in a video signal. See [ANC Data display \(Option DATA only\)](#) on page 48.
- **AV Delay (Option AVDP only)** - Displays results of AV Delay and Propagation Time measurements. See [AV Delay Measurement display \(Option AVDP only\)](#) on page 78.
- **ASI PID List Disp. (WFM2300 Option ASI only)** - For MPEG2 transport stream inputs, displays the MPEG TS PID tree with each stream element having an LED icon to indicate the status of the element. See [ASI PID List display \(WFM2300 Option ASI only\)](#) on page 54.

Trace type. Select from the following trace types (Video is the default setting):

- **Video** - This mode shows the data similar to the video YPbPr display in Waveform mode, but without interpolation. The Y, Cb, and Cr traces are offset vertically to separate them, but are aligned temporally. You can select to turn on or off individual component traces of the display.
- **Data** - For an SD signal, this mode shows the data in the same sequence as it occurs in the serial domain. You see a sample of Y, then of Cb, then of Y' (Y prime), and then of Cr. Then the sequence repeats. The Y sample is the co-sited sample and the Y' sample is the isolated luma sample.

For an HD signal, this mode splits the serial input into a Y channel and a multiplexed Cb/Cr channel. The intent is to show the data in the same block structure as it occurs in the serial domain, even though it is displayed as 8 or 10-bit values.

Trace Y, Trace Cb, and Trace Cr. When the Trace Type is set to Video, use these selections to turn on or off the individual component traces of the display.

Format. Set the data format to Hexadecimal, Decimal, or Binary. The default data format is Hexadecimal.

CONFIG menu

Use the CONFIG menu to set the following Datalist display parameters:

- Use the menu selections under **Display Settings** to set various general display parameters which affect all applicable display modes such as readout intensity and graticule color.
- Use the menu selections under **Aux Data Settings** to set various data parameters.
- Use the menu selections under **Alarms** to enable various alarms that will highlight data as errors.

Diagnostics Monitor display

The Diagnostics Monitor display shows the status of various instrument diagnostics. Use the up and down arrow keys to navigate through the different pages of the display.

To access the Diagnostics Monitor display

1. Press and hold the **GEN** button to open the Generator pop-up menu.
2. Use the arrow keys to select **Display Type > Diag Monitor**.
3. Press the **GEN** button to close the pop-up menu.

Elements of the Diagnostics Monitor display

Diagnostics Info					Page 1 of 4
Fan Speed (rpm):		9557			9782
Low:		9557			9677
High:		9591			9800
Temperature	Last	Low	High	Average	
Main Board Ambient	56 C	26 C	56 C	53 C	
CPU Chip	64 C	35 C	65 C	64 C	
Fan Inlet Ambient	48 C	25 C	48 C	47 C	
FPGA Ambient	47 C	23 C	47 C	46 C	
CPU Ambient – from FPGA board	54 C	25 C	55 C	54 C	
DSP Chip	57 C	27 C	58 C	57 C	
DSY Chip	52 C	28 C	52 C	51 C	

Session Start at 03/03/2014 15:03:33 Run Time: 0 days, 00:02:51
 Press "SEL" to reset. Up and Down key to change page.

No Signal Mar 03 15:00:25 ID: WFM Volume: 32 %
SDI Input 1A Tektronix Audio Input: AES A
Ref: Internal ESCAPE TC: Disabled

Figure 18: Diagnostics Monitor display (page 1)



Figure 19: Diagnostics Monitor display (page 2)



Figure 20: Diagnostics Monitor display (page 3)

Diagnostics Info		Page 4 of 4	
External Power & Battery Information			
AC power:	ON	Status:	Charging
Temperature:	24 C		
Voltage:	15122 mV	Current:	1499 mA
Design Voltage:	14400 mV	Average Current:	1498 mA
Remaining Capacity:	3090 mAh		
Relative Capacity:	51 %	Absolute Capacity:	51 %
Full Charge Capacity:	6143 mAh	Design Capacity:	6140 mAh
Time to Empty:	N/A	Average Time to Empty:	N/A
Average Time to Full:	191 min		
Charge Voltage:	16800 mV	Charge Current:	1500 mA

Session Start at 03/14/2012 06:39:25 Run Time: 0 days, 00:03:25
 Press "SEL" to reset. Up and Down key to change page.

0661-013

Figure 21: Diagnostics Monitor display (page 4)

Elements on all pages. There are four pages to the Diagnostics Monitor display. The following information appears on all pages of the display:

- **Session Start:** Shows the date and time of the instrument when the Diagnostic Monitor session started. This start time applies to all of the pages in the Diagnostics Monitor display.
- **Run Time:** Shows the amount of time that has elapsed since the Diagnostic Monitor session was started. This run time applies to all of the pages in the Diagnostics Monitor display.

Elements on page 1. The following instrument diagnostic information appears on page 1 of the display: See *Diagnostics Monitor display* on page 86.

- **Fan Speed (rpm):** Shows the current speed of both internal fans and the high and low speed measurements for each fan since the instrument was turned on.
- **Temperatures:** Shows the last, low, high, and average temperatures for various internal components.

Elements on pages 2 and 3. The following instrument diagnostic information appears on pages 2 and 3 of the display: See *Diagnostics Monitor display* on page 86.

- **Power Supply Voltages:** Shows the last, low, high, and average power supply voltages for various internal components.

Elements on page 4. The following instrument diagnostic information appears on page 4 of the display: See *Diagnostics Monitor display* on page 86.

- **External Power & Battery Information:** Shows the status of various parameters related to the operation of the battery pack. If a battery pack is not installed in the instrument, the Status readout shows “Not Present” and the diagnostic parameters will list “N/A” as the status.

Generator pop-up menu (Diagnostics Monitor display)

Press and hold the GEN button to open the Generator pop-up menu. The following menu selections are available:

Display type. Select from the following display types:

- **Video Generator Status** – Displays the status of video signals being generated by the instrument. See *Video Generator Status display* on page 144.
- **Audio Generator Status** – Displays the status of audio signals being generated by the instrument. See *Audio Generator Status display* on page 65.
- **Diagnostics Monitor** – Displays the status of various instrument diagnostics.

CONFIG menu

The diagnostic information that is viewed from the Diagnostics Monitor displays is different than the diagnostics that are run when the instrument is powered on. You can use the CONFIG menu to view and configure the following Diagnostics Log parameters:

- Use the **Alarms > System and Diagnostics** setting to enable an alarm for a hardware fault.
- Use the menu selection under **Utilities** to run diagnostics, to set how the diagnostics log responds when full, to view the diagnostics log, and to configure custom diagnostics.

Diamond display

The Diamond display is a Tektronix proprietary display that shows gamut violations of the SDI input if translated to the RGB color space. For more information about using the gamut-checking displays:

- See *Arrowhead display* on page 51
- See *Split Diamond display* on page 106
- See *Checking gamut* on page 201
- See the *Preventing Illegal Colors* application note available on the Tektronix Web site (www.tektronix.com)

To access the Diamond display

1. Press and hold the **GAMUT** button to open the Gamut pop-up menu.
2. Use the arrow keys to select **Display Type > Diamond**.
3. Press the **GAMUT** button to close the pop-up menu.

Elements of the Diamond display

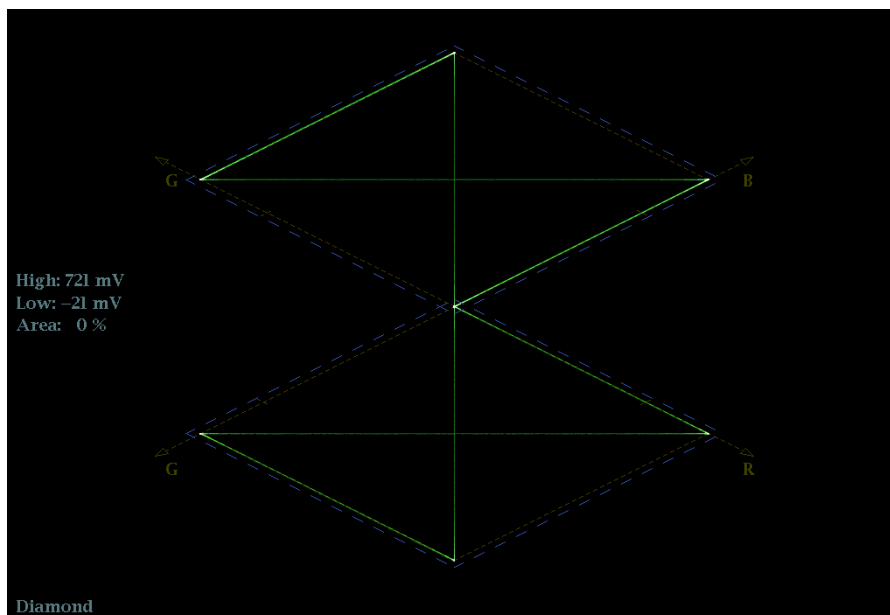

Figure 22: Diamond display

- **High threshold:** Shows the currently specified Diamond High threshold setting in the CONFIG > Gamut Thresholds menu.
- **Low threshold:** Shows the currently specified Diamond Low threshold setting in the CONFIG > Gamut Thresholds menu.
- **Gamut display type:** Shows the selected Gamut display type - Arrowhead, Diamond, or Split Diamond.
- **Threshold indicators:** Indicates the threshold settings using blue dashed lines.

- **Y Area:** Shows the specified percentage of the total image pixels that can be outside the current gamut limits and not generate error reports.
- **Field and line numbers:** Shows the currently selected video field and line numbers when Line Select mode is enabled. See [Line Select](#) on page 159.

Gamut pop-up menu (Diamond display)

Press and hold the GAMUT button to open the Gamut pop-up menu. The pop-up menu enables you to select the from the following Tektronix proprietary gamut displays:

- **Arrowhead** - Displays gamut violations of the SDI input if translated into the Composite domain (NTSC and PAL). See [Arrowhead display](#) on page 51.
- **Diamond** - Displays gamut violations of the SDI input if translated to the RGB color space.
- **Split Diamond** - Like the Diamond display, displays gamut violations of the SDI input if translated to the RGB color space. However, the Split Diamond display offsets the two halves of the Diamond display to allow you to better see negative RGB gamut errors. See [Split Diamond display](#) on page 106.

CONFIG menu

Use the CONFIG menu to set the following Diamond display parameters:

- Use the menu selections under **Gamut Thresholds** to set the minimum and maximum gamut limits for composite signals derived from the SDI signal, set the minimum and maximum luma levels, specify the percentage of the total image pixels that can be outside the current gamut or luma limits and not generate error reports, and reset the gamut and luma limits to default values.
- Use the menu selections under **Alarms > Video Content** to enable the alarms for the Diamond display.
- Set the **Graticules & Readouts > Gamut Readouts** setting to **On** or **Off** to turn on or off the readouts on the display.
- Use the menu selections under **Display Settings** to set various general display parameters which affect all applicable display modes such as waveform intensity and graticule color.

External Reference Waveform display

The External Reference Waveform display allows you to check the integrity of the reference signal on the EXT REF connector, including its shape and amplitude. This display is independent of the input video signal. See also [External reference signals](#) on page 41.

To access the External Reference Waveform display

1. Press and hold the **WFM** button to open the Waveform pop-up menu.
2. Use the arrow keys to select **Display Type > Ref Waveform**.
3. Press the **WFM** button to close the pop-up menu.

Elements of the External Reference Waveform display

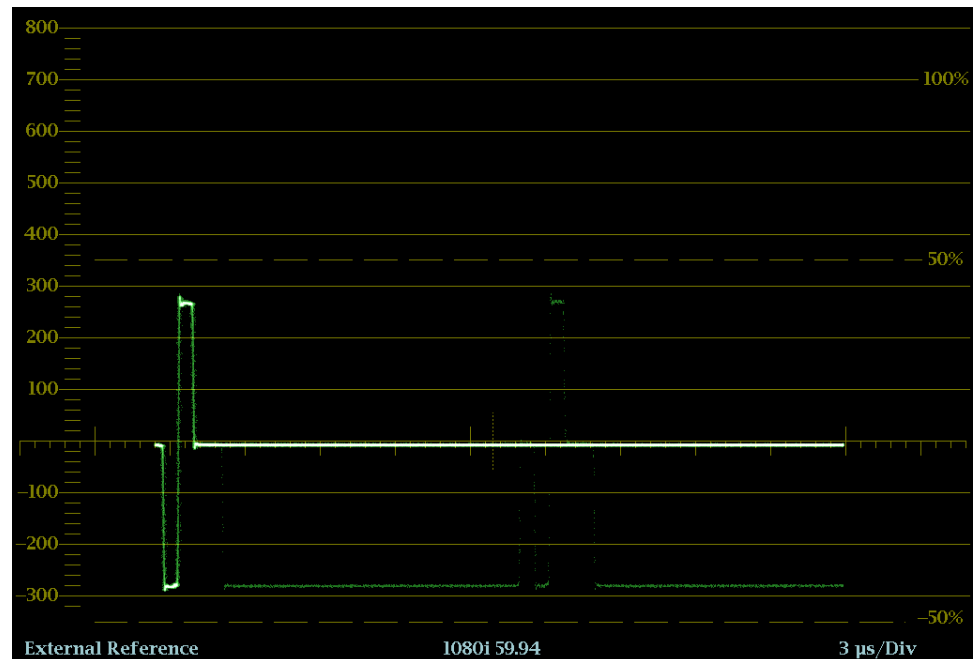

Figure 23: External Reference Waveform display (tri-level sync signal)

- **Display:** Shows the display type as External Reference.
- **Y-axis units:** Shows the y-axis units in millivolts per division.
- **X-axis units:** Shows the x-axis in milliseconds or microseconds per division depending on the sweep setting.
- **V Gain:** When you press the GAIN or VAR buttons to change the gain setting, a V Gain readout appears.
- **H and V positions:** When you press the POS button to adjust the position of the waveform, a position readout appears with a knob icon to indicate whether the horizontal or vertical position is the focus of the General knob.

Waveform pop-up menu (External Reference Waveform display)

Press and hold the WFM button to open the Waveform pop-up menu. The pop-up menu enables you to configure the display type and to center the waveform. The following menu selections are available:

Display type. Select from the following display types:

- **Waveform** - Displays a voltage versus time plot of the selected SDI input signal (SDI A or SDI B). See *Waveform display* on page 148.
- **LTC Waveform** - Displays a voltage versus time plot of the LTC input signal (LTC IN). See *LTC Waveform display* on page 101.
- **Ref Waveform** - Displays a voltage versus time plot of the external reference input signal (REF IN).

Center waveform. Select this option to cancel any horizontal or vertical position adjustments and restore the trace to the default position. This puts the baseline at the zero graticule.

CONFIG menu

Use the CONFIG menu to set the following External Reference Waveform display parameters:

- Set the **External Reference > Lock to Format** setting to **Auto** or select the expected format from the list.
- Set the **Alarms > Reference Input** settings as desired.
- Set the **Graticules & Readouts > SDI Waveform Graticules** setting to **Normal** or **Percent** to set the measurement units for the vertical axis.
- Set the **Graticules & Readouts > Waveform Readouts** setting to **On** or **Off** to turn on or off the readouts on the display.
- Use the menu selections under **Display Settings** to set various general display parameters which affect all applicable display modes such as waveform intensity and graticule color.

To position the External Reference Waveform trace

To adjust the position of the trace on the External Reference Waveform display:

1. Press the **POS** button.
2. Press the left or right arrow key to enable horizontal or vertical adjustments. The knob icon appears next to the selected adjustment readout.
3. Turn the General knob or use the up/down arrow keys to adjust the position of the waveform.
4. Press the **POS** button to turn off the position adjustment mode.

Eye display (WFM2300 only)

The Eye display is accessible from the **PHY** button on the front panel of your WFM2300 instrument. This display presents an eye pattern diagram of the SDI input, which lets you verify electrical characteristics of the SDI transport layer. Measure analog characteristics of the SDI input on the eye pattern using the graticule or voltage and time cursors.

With Option ASI, the instrument also performs the Eye pattern measurement on the ASI signal to ensure signal quality in the physical layer.

A jitter thermometer in the Eye display graphically relates the jitter measurement to alarm limits, and readouts display jitter magnitude. When displaying the Eye waveform in a single, full-screen tile, the measurement results and a histogram display are included with the Eye waveform.

NOTE. See *Monitoring the SDI Physical Layer* for information about taking Eye measurements.

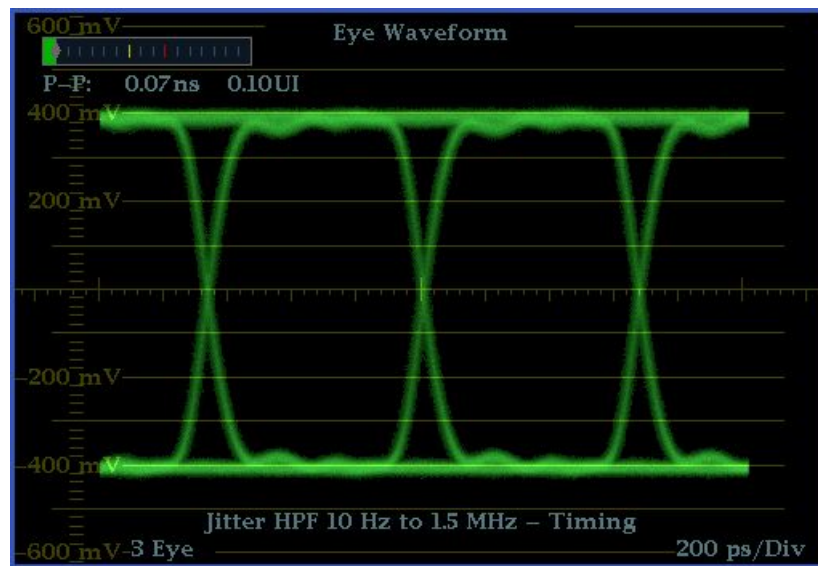

Figure 24: WFM2300 Eye display from 4-tile mode (no histogram)

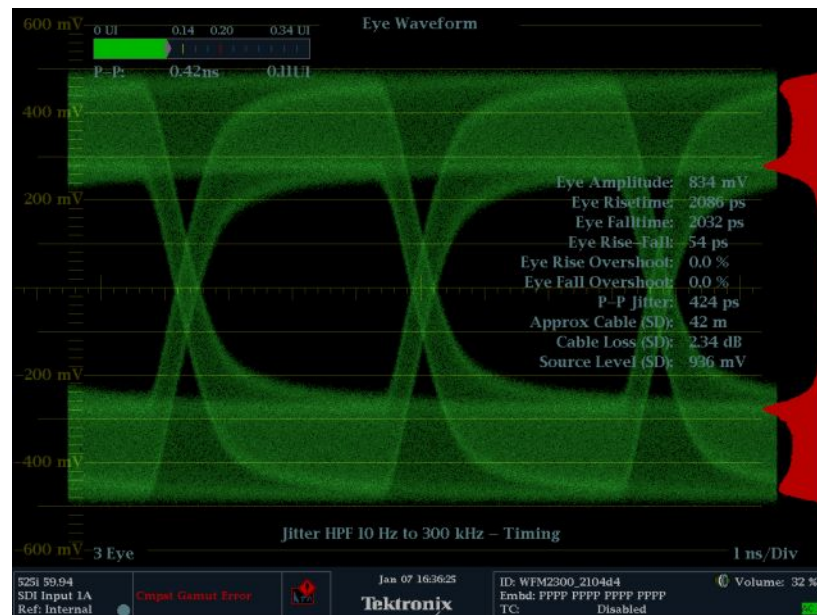

Figure 25: WFM2300 Eye display in single tile mode (full-screen) with histogram

Elements of the Eye display

- **Link:** Shows from which link the signal is originating.
- **Eye Pattern:** Displays a waveform you can use for SDI transport verification and analysis.
- **Jitter Thermometer:** Displays jitter value and relates it to alarm limits.
- **Cursor Readouts:** Provide for direct measurements of amplitude and time on the Eye.
- **Eye Pattern Type:** Either 3 Eye, or 10 Eye (SD)/20 Eye (HD). The latter types can help reveal when jitter at the parallel word rate is present.
- **Jitter HPF:** Indicates the setting for the Jitter High Pass Filter, set in the CONFIG menu.

Eye display pop-up menu

The Eye pop-up menu allows you to choose from two display types: Eye and Jitter. It allows you to do the following:

- **Jitter1 HP Filter:** Select the HP filter to be Timing, Align, 10 Hz, 100 Hz, 1 kHz, 10 kHz, or 100 kHz.
- **Center Waveform:** Press the **SEL** button to center the waveform.
- **Jitter Meter:** Select to not display the jitter meter or readout (Off), Meter Only, Readout Only, or Meter and Readout.
- **Enable Measure:** Press the **SEL** button to enable eye measurement.

- **Display Type:** Select from Eye or Jitter display.
- **SDI Stress Loop Amp:** Press the **SEL** button and use the General knob to adjust the level of the added interfering signal in the Stress Loop. Range is 0 mV to 300 mV.

Usage notes

The SDI Stress Loop Amplitude can also be set from the **CONFIG > Video/Gen Outputs** menu. This setting allows you to set the interfering signal amplitude from 0 mV to 300 mV. The **STRESS LOOP** connectors on the top panel of the instrument are a bi-directional passive signal path equivalent to approximately 20 meters of Belden 1694A cable. In addition, a 20 MHz variable amplitude interfering signal is available. The combination provides simple margin testing for an SDI link.

Jitter display (WFM2300 only)

The Jitter Display is accessible from the **PHY** button on WFM2300 instruments. It can be used after you have configured the instrument for Eye measurements. This display shows you the wave shape of the jitter and allows you to view additional time-domain information, such as whether there are jitter components that are synchronous or nearly synchronous to the video line or frame. You can also set alarms on various parameters. See also [To make jitter measurements](#) on page 194.



Figure 26: The Jitter display parameters as shown in a single tile when the instrument is in 4-tile mode

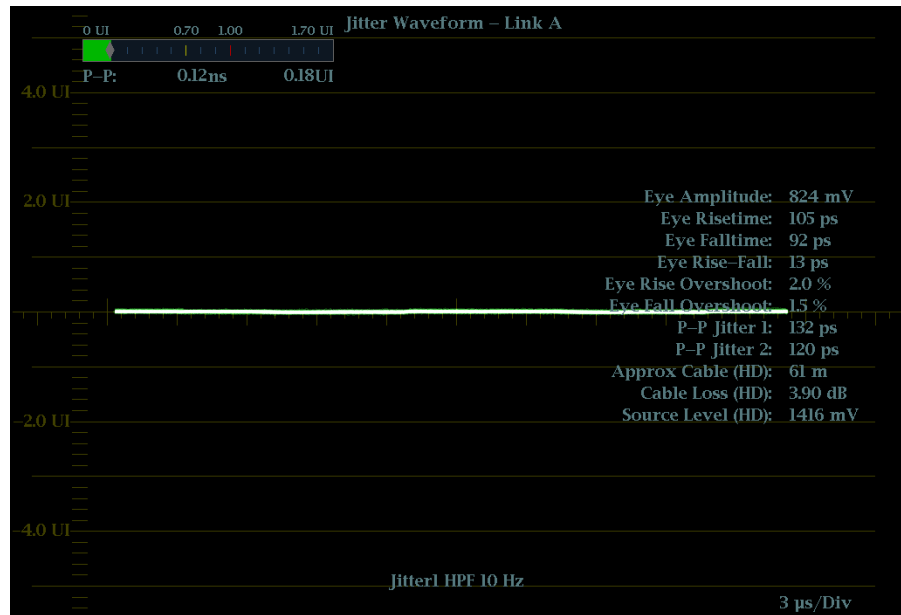

Figure 27: The Jitter display parameters as shown when the instrument is in single-tile mode

Elements of the Jitter display

- **Jitter Waveshape:** Displays the jitter wave shape (the image to the right shows no jitter). This shape is modified by the high-pass filter (HPF) setting.
- **Jitter Thermometer:** Displays jitter value and relates it to alarm limits.
- **Jitter HPF:** Indicates the setting for the Jitter High Pass Filter, set in the CONFIG menu.

High-Pass filter

The high-pass filter bandwidth setting allows you to show only jitter terms above the selected filter frequency. When you select a filter setting, depending on the active input signal, you select the jitter measurement type (Timing, Alignment, or neither, as defined by the SMPTE standard).

To choose the Jitter high-pass filter, use the Measurement pop-up menu and choose one of the following settings for the Jitter HP Filter entry:

Setting	Description
Timing	Sets the detector high-pass filter to 10 Hz. This is the correct value for measuring timing jitter for both SD and HD signals.
Align	Sets the detector high-pass filter to 1 kHz, as specified by SMTPE, for SD signals; and to 100 kHz for HD signals. These are the correct values for measuring alignment jitter.
10 Hz, 100 Hz, 1 kHz, 10 kHz, 100 kHz	Sets the detector high-pass filter to the selected value.

NOTE. For instructions on how to take jitter measurements, see *Monitoring the SDI Physical Layer*.

Lightning display

The Lightning display is a Tektronix proprietary display that plots the Pr and Pb signals against luminance. As shown below, Y versus Pb is plotted in the top half of the display and Y versus Pr is plotted in the bottom half.

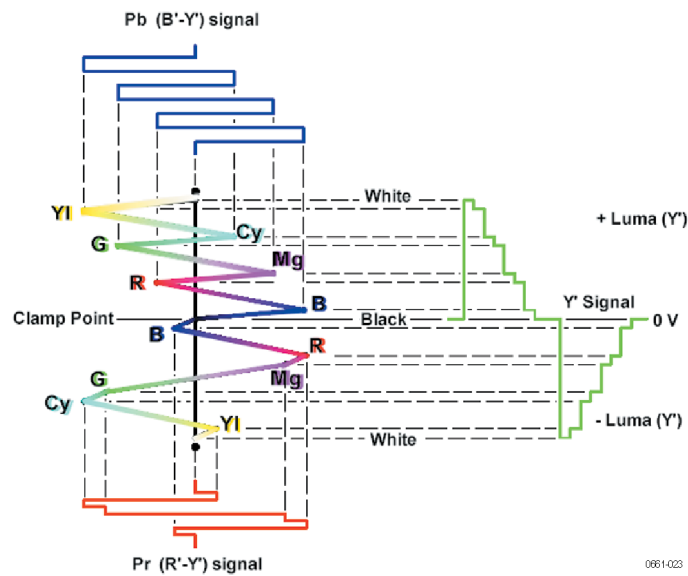

Figure 28: Construction of the Lightning display

This display is useful for checking chroma and luma gain, and for checking chroma to luma delay using the timing marks that show errors in the green to magenta transition on a color bar signal.

You can set the color bar targets to 75% or 100% and center the trace within the tile.

The related Vector display plots the Pr signal on the vertical axis and the Pb signal on the horizontal axis, which is useful for looking at hue and amplitude of the colors, but does not show luminance information. See also [Vector display](#) on page 140.

To access the Lightning display

1. Press and hold the **VECTOR** button to open the Vector pop-up menu.
2. Use the arrow keys to select **Display Type > Lightning**.
3. Press the **VECTOR** button to close the pop-up menu.

Elements of the Lightning display

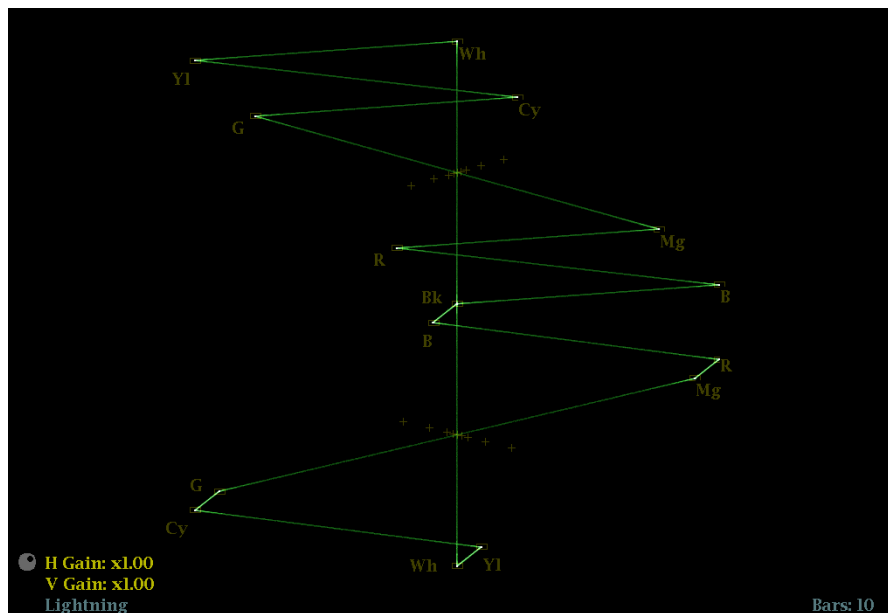

Figure 29: Lightning display

The following elements appear on the display:

- **V Gain:** Shows the current vertical gain setting when the gain is other than 1x. Press the GAIN button to toggle the vertical gain between 1x and the most recently selected vertical gain value. Press and hold the GAIN button to select fixed gain settings (1x, 2x, 5x, or 10x) or to enable VAR Gain mode. If you enable VAR Gain mode in the Gain pop-up menu or by pressing the VAR button, you can adjust the vertical gain using the General knob.
- **H Gain:** Shows the current horizontal gain setting when the gain is other than 1x. Press the MAG button to toggle the horizontal gain between 1x and the most recently selected horizontal gain value. Press and hold the MAG button to select fixed gain settings (2x, 5x, or 10x) or to enable VAR H Gain mode. If you enable Variable H Gain mode, you can adjust the horizontal gain using the General knob.
- **Display Type:** The selected display, either Lightning or Vector.
- **Bar Target Setting:** The bar target setting, either 75% or 100%.
- **H and V positions:** When you press the POS button to adjust the position of the waveform, a position readout appears with a knob icon to indicate whether the horizontal or vertical position is the focus of the General knob.
- **Field and line numbers:** Shows the currently selected video field and line numbers when Line Select mode is enabled. See [Line Select](#) on page 159.

Vector pop-up menu (Lightning display)

Press and hold the VECTOR button to open the Vector pop-up menu. The pop-up menu enables you to specify the display type and display mode, to set the bar targets, and to center the waveform in the display. The following menu selections are available:

Display type. Select from the following display types:

- **Vector** – The Vector display shows a plot of the Pr signal on the vertical axis and the Pb signal on the horizontal axis. This display is useful for looking at hue and amplitude of the colors, but does not show luminance information. See *Vector display* on page 140.
- **Lightning** – This Tektronix proprietary display shows the same Pr and Pb color signals as in the Vector mode, but they are plotted against luminance.

Bar targets. To select which scaling (75% or 100%) will be used in the current tile for either the Vector or Lightning display.

Center waveform. Select this option to cancel any horizontal or vertical position adjustments and restore the trace to the default position at the center of the tile.

CONFIG menu

Use the CONFIG menu to set the following Lightning display parameters:

- Set the **SDI Input > HD Colorimetry** setting to **Auto**, **ITU 709-2**, or **SMPTE 240M** to set the expected colorimetry in HD signals.
- Set the **Graticules & Readouts > Vector Readouts** setting to **On** or **Off** to turn on or off the readouts on the display.
- Use the menu selections under **Display Settings** to set various general display parameters which affect all applicable display modes such as waveform intensity and graticule color.

To position the Lightning trace

To adjust the position of the trace on the Lightning display:

1. Press the **POS** button.
2. Press the left or right arrow key to enable horizontal or vertical adjustments. The knob icon appears next to the selected adjustment readout.
3. Turn the General knob or use the up/down arrow keys to adjust the position of the waveform.
4. Press the **POS** button to turn off the position adjustment mode.

LTC Waveform display

The LTC (Longitudinal Time Code) Waveform display is a frame rate display of the signal on the LTC IN connector to allow observation of amplitude, synchronization, and phase. The displayed waveform is basically a 2-field sweep and corresponds to a video frame. The LTC phase should remain consistent relative to the frames that it is supposed to count.

To access the LTC Waveform display

1. Press and hold the **WFM** button to open the Waveform pop-up menu.
2. Use the arrow keys to select **Display Type > LTC Waveform**.
3. Press the **WFM** button to close the pop-up menu.

Elements of the LTC Waveform display

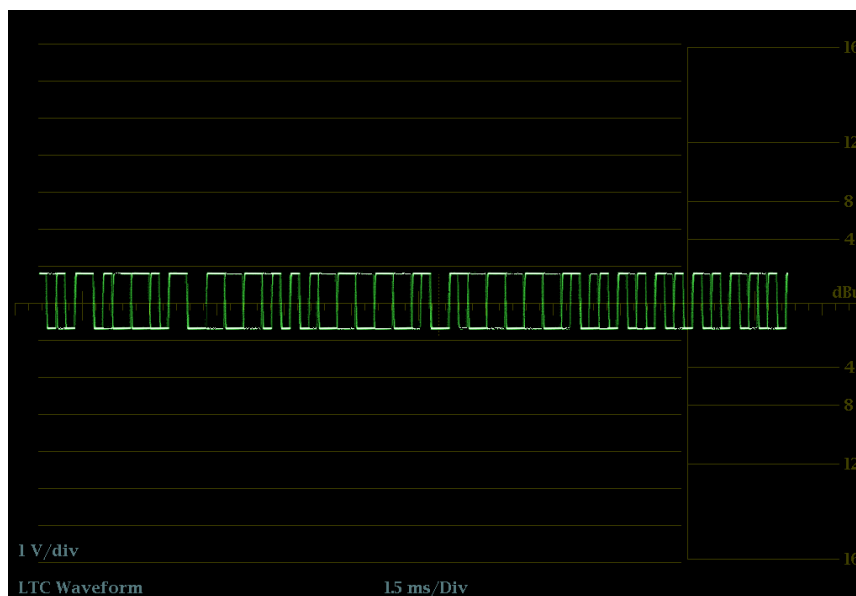

Figure 30: LTC Waveform display

- **Display:** Shows the display type as LTC Waveform.
- **Y-axis units:** Shows the y-axis units in volts/divisions.
- **X-axis units:** Shows the x-axis in milliseconds/divisions.
- **V Gain:** When you press the GAIN or VAR buttons to change the gain setting, a V Gain readout appears.
- **H and V positions:** When you press the POS button to adjust the position of the waveform, a position readout appears with a knob icon to indicate whether the horizontal or vertical position is the focus of the General knob.

Waveform pop-up menu (LTC Waveform display)

Press and hold the WFM button to open the Waveform pop-up menu. The pop-up menu enables you to configure the display type and to center the waveform. The following menu selections are available:

Display type. Select from the following display types:

- **Waveform** - Displays a voltage versus time plot of the selected SDI input signal (SDI A or SDI B). See also *Waveform display* on page 148.
- **LTC Waveform** - Displays a voltage versus time plot of the LTC input signal (LTC IN).
- **Ref Waveform** - Displays a voltage versus time plot of the external reference input signal (REF IN). See also *External Reference Waveform display* on page 92.

Center waveform. Select this option to cancel any horizontal or vertical position adjustments and restore the trace to the default position.

CONFIG menu

Use the CONFIG menu to set the following LTC Waveform display parameters:

- Set the **Graticules & Readouts > Waveform Readouts** setting to **On** or **Off** to turn on or off the readouts on the Waveform display.
- Use the menu selections under **Display Settings** to set various general display parameters which affect all applicable display modes such as waveform intensity, graticule color, and enabling the thumbnail view.
- Set the **Alarms > Timecode** settings as desired to enable timecode alarms.
- Set the **Aux Data Setting > Timecode Source** selection as appropriate for the type of timecode signal you are using.

To position the LTC waveform trace

To adjust the position of the trace on the LTC Waveform display:

1. Press the **POS** button.
2. Press the left or right arrow key to enable horizontal or vertical adjustments. The knob icon appears next to the selected adjustment readout.
3. Turn the General knob or use the up/down arrow keys to adjust the position of the waveform.
4. Press the **POS** button to turn off the position adjustment mode.

Picture display

The Picture display shows the picture generated by the selected video signal. You can choose to display the picture with or without a picture frame, VChip ratings, closed captioning (CC), teletext, and safe area graticules.

For more information, see [Closed captioning \(CC\) teletext AFD and safe area compliance](#) on page 231.

To access the Picture display

Press the PICT button to display a picture of the selected video input signal.

Elements of the Picture display

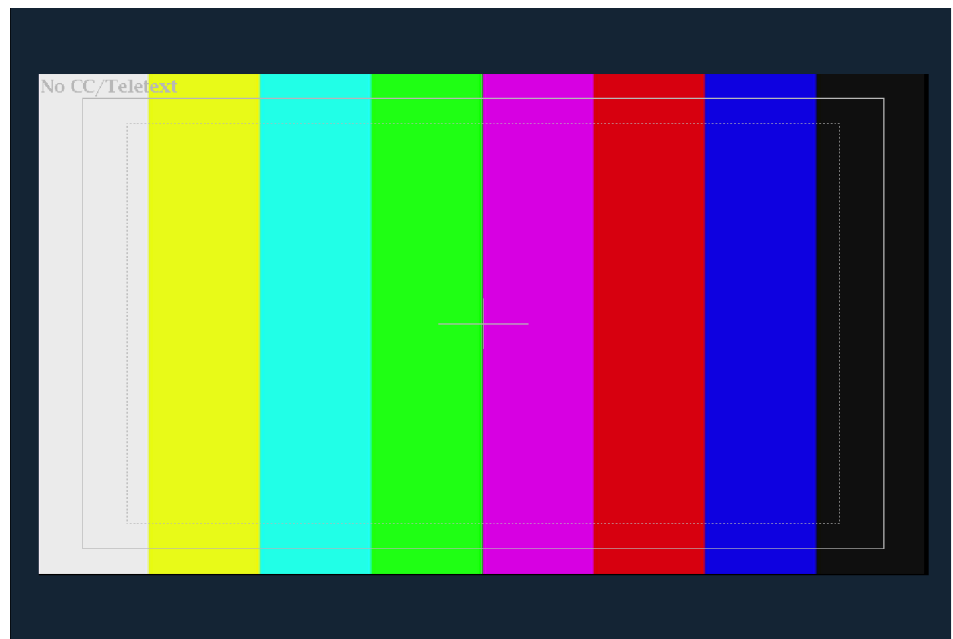

Figure 31: Picture display of color bars signal with Safe Area and Picture Center graticules enabled

- **Picture** – In full-screen mode, there is no cropping. Pictures are decimated horizontally and vertically to obtain the correct aspect ratio. This decimation may introduce minor artifacts in some images and may be more evident on a sweep signal.

In Quad Tile display mode, the picture is decimated to fit in the space available. For example, for 525-line signals, 12 lines are cropped (6 at the top and 6 at the bottom) to make the image fit.

- **VChip rating:** Displays detected VChip ratings from any of these systems: MPAA (US), TV (US), Canadian English, and Canadian French. VChip information is labeled CA (Content Advisory).

- **Safe Action area and Safe Title area graticules** – When enabled, Safe Action and Safe Title area graticules are displayed to show the safe areas of the picture to aid in monitoring for incorrect placement of graphics, logos, and other branding elements to ensure that they do not obscure text of essential action. The graticule areas indicate the maximum image area within which all significant action or titles should be contained.

The graticule sizes are defined by the selected standard (SMPTE, BBC, or ARIB B-4) and the selected aspect ratio (Auto, 4x3, 14x9, 16x9, or Custom). Custom settings will override the aspect ratio of the monitored input. You can display up to four safe area graticules (two Safe Action and two Safe Title) at a time. You can specify up to two custom safe area graticules.

- **Picture Center graticule** – When enabled, shows the center of the picture image.
- **AFD graticules** – When enabled, AFD (Active Format Descriptor) graticules are displayed if AFD is included in the signal. When AFD is not included in the signal, the message “AFD: Not Detected” is displayed.
- **Line Select cursor** – When the Picture Line Select Cursor is enabled in the CONFIG > Graticules & Readouts menu, the cursor highlights the selected line in the picture when Line Select mode is enabled.
- **Closed Caption Text and Teletext content:** Displays closed captioning or Teletext, configurable to decode to the following Closed Caption and Teletext standards. When no content is detected, the message “No CC/Teletext” is displayed.
 - For SD: CEA-608-line-21, TeletextB VBI (625), CEA-608 (ANC), CEA-608 (708), CEA-708, TeletextB VBI, TeletextB OP47 SDP (ANC), and TeletextB OP47 Multi (ANC)
 - For HD and 3G: CEA-608 (ANC), CEA-608 (708), CEA-708, TeletextB VBI, TeletextB OP47 SDP (ANC), and TeletextB OP47 Multi (ANC)
- **Field and line numbers:** Shows the currently selected video field and line numbers when Line Select mode is enabled. See also [Line Select](#) on page 159.

Picture pop-up menu

Press and hold the PICT button to open the Picture pop-up menu. The pop-up menu enables you to display Safe Area, AFD, and Picture Center graticules and to display Closed Caption and Teletext content.

- **Picture Frame:** Turns the Picture Frame display On or Off. When turned on, only the active video portion of the signal is displayed. When turned off, the elements of the signal that are outside of the active video signal such as user data, embedded audio, and the vertical interval are visible.
- **CC/Teletext Format:** Select the format of the closed caption content in the video signal. You can select from Off, Auto, CEA608, CEA708, and WST.

- **CEA608 CC Services:** If you are monitoring CEA 608 content, select the channel that you want to monitor. You can select from CC Channel 1 through 4 and Txt Channel 1 through 4.
- **CEA708 CC Services:** If you are monitoring CEA 708 content, select the service that you want to monitor. You can select from Service 1 through 6.
- **TtxtB Page:** If you are monitoring Teletext B content, select the page number that you want to monitor.
- **Safe Area Action 1/2, Safe Area Title 1/2:** Set the aspect ratio of the selected Safe Area Action or Safe Area Title graticule. Select from Off, Auto, 4x3, 14x9, 16x9, Custom_1, and Custom_2. Use the Custom Safe Action/Title settings in the CONFIG > Graticules & Readouts menu to define the custom safe areas.
- **AFD Graticules:** If AFD is included in the signal, use this setting to turn AFD graticules on or off.
- **Picture Center Grat:** Turns the graticule showing the center of the picture on or off.

CONFIG menu

Use the CONFIG menu to set the following Picture display parameters:

- Use the **Graticules & Readouts > Safe Area Graticule Standard** selections to select the standard used for Safe Action and Safe Title area graticules.
- Use the **Graticules & Readouts > Custom Safe Action/Title** selections to set the dimensions and offset for the custom Safe Action and Safe Title area graticules.
- Use the **Graticules & Readouts > Picture Line Select Cursor** setting to turn on or off the highlight of the selected line in the picture when Line Select mode is enabled.
- Use the **Graticules & Readouts > Picture Readouts** setting to turn on or off the readouts and graticules on the Picture display.
- Set the **Aux Data Settings > CEA 608 Settings** selections as appropriate if you are monitoring video with CEA 608 closed caption content.
- Set the **Aux Data Settings > CEA 708 Settings** selections as appropriate if you are monitoring video with CEA 708 closed caption content.
- Set the **Aux Data Settings > Teletext B Settings** selections as appropriate if you are monitoring video with Teletext B content.
- Use the menu selections under **Display Settings** to set various general display parameters which affect all applicable display modes such as waveform intensity, graticule color, and enabling the thumbnail view of the Picture display in the Waveform, Vector, or Gamut displays. See also [DISPLAY SELECT button](#) on page 34.

Split Diamond display

Like the Diamond display, the Split Diamond display is a Tektronix proprietary display that shows gamut violations of the SDI input if translated to the RGB color space. For more information about using the gamut-checking displays:

- See *Arrowhead display* on page 51
- See *Diamond display* on page 90
- See *Checking gamut* on page 201
- See the *Preventing Illegal Colors* application note available on the Tektronix Web site (www.tektronix.com)

To access the Split Diamond display

1. Press and hold the **GAMUT** button to open the Gamut pop-up menu.
2. Use the arrow keys to select **Display Type > Split Diamond**.
3. Press the **GAMUT** button to close the pop-up menu.

Elements of the Split Diamond display

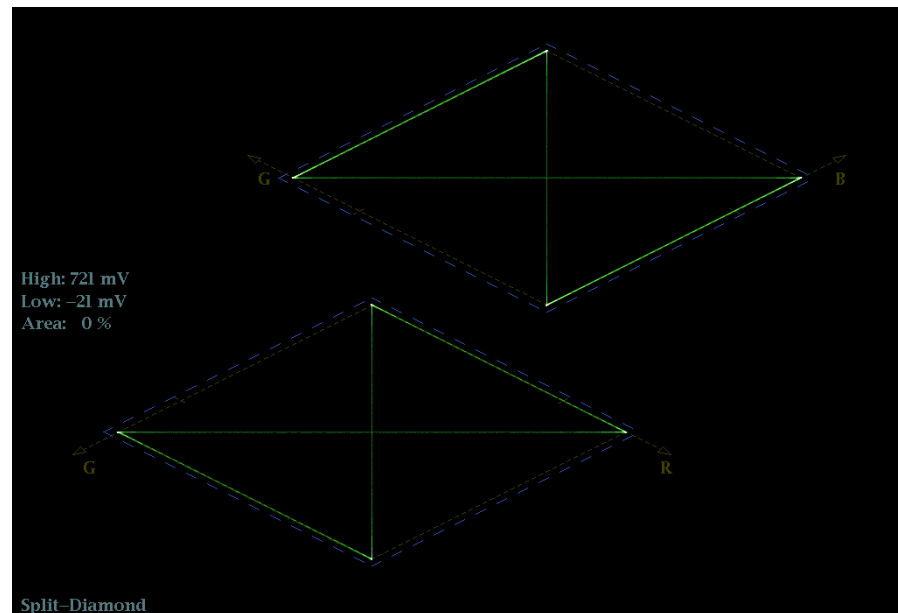

Figure 32: Split Diamond display

- **High threshold:** Shows the currently specified Diamond High threshold setting in the CONFIG > Gamut Thresholds menu.
- **Low threshold:** Shows the currently specified Diamond Low threshold setting in the CONFIG > Gamut Thresholds menu.
- **Gamut display type:** Shows the selected Gamut display type - Arrowhead, Diamond, or Split Diamond.
- **Threshold indicators:** Indicates the threshold settings using blue dashed lines.

- **Y Area:** Shows the specified percentage of the total image pixels that can be outside the current gamut limits and not generate error reports.
- **Field and line numbers:** Shows the currently selected video field and line numbers when Line Select mode is enabled. See also [Line Select](#) on page 159.

Gamut pop-up menu (Split Diamond display)

Press and hold the GAMUT button to open the Gamut pop-up menu. The pop-up menu enables you to select the from the following Tektronix proprietary gamut displays:

- **Arrowhead** - Displays gamut violations of the SDI input if translated into the Composite domain (NTSC and PAL). See also [Arrowhead display](#) on page 51.
- **Diamond** - Displays gamut violations of the SDI input if translated to RGB color space. See also [Diamond display](#) on page 90.
- **Split Diamond** - Like the Diamond display, displays gamut violations of the SDI input if translated to the RGB color space. However, the Split Diamond display offsets the two halves of the Diamond display to allow you to better see negative RGB gamut errors.

CONFIG menu

Use the CONFIG menu to set the following Split Diamond display parameters:

- Use the menu selections under **Gamut Thresholds** to set the minimum and maximum gamut limits for composite signals derived from the SDI signal, set the minimum and maximum luma levels, specify the percentage of the total image pixels that can be outside the current gamut or luma limits and not generate error reports, and reset the gamut and luma limits to default values.
- Use the menu selections under **Alarms > Video Content** to enable the alarms for the Split Diamond display.
- Set the **Graticules & Readouts > Gamut Readouts** setting to **On** or **Off** to turn on or off the readouts on the display.
- Use the menu selections under **Display Settings** to set various general display parameters which affect all applicable display modes such as waveform intensity and graticule color.

Status displays

The Status display provides several text views that show the status of the signal. You can view current alarms and errors (those occurring now and within the last few seconds), a history of errors and alarms (up to 10,000 entries), video error statistics or audio error statistics. You can display a different Status display type in all four tiles.

To select a status display

1. Press and hold the **STATUS** button to open the Status pop-up menu.
2. Use the arrow keys to select one of the following displays:
 - **Display Type > AES Channel Status** – Displays the status of the specified audio channels in the specified format. See [AES Channel Status display](#) on page 109.
 - **Display Type > Alarm Status** – Displays the current status of alarms. See [Alarm Status display](#) on page 110.
 - **ARIB Display > display mode** – Displays the selected ARIB status display. See [ARIB Status displays](#) on page 112.
 - **Display Type > Audio Control** – Displays the metadata encoded in the audio control packet. See [Audio Control Packet display](#) on page 112.
 - **Display Type > Audio Session** – Displays several performance parameters which provide an overview of the audio input signal. See [Audio Session display](#) on page 115.
 - **Display Type > Auxiliary Data Status** – Displays the status of the auxiliary data in the video signal such as closed caption, teletext, AFD, and V-chip rating. See [Auxiliary Data Status display](#) on page 118.
 - **Display Type > Dolby Status** – Displays the Dolby metadata from the VANC in the currently monitored SDI input. See [Dolby Audio Status display](#) on page 121.
 - **Display Type > Error Log** – Displays a log of the error events that have been detected since the instrument was turned on or since the log was last reset. You can view all of the errors or just the errors for the selected input and save the log to a USB memory device. See [Error Log display](#) on page 123.
 - **Display Type > Video Session** – Displays several performance parameters which provide an overview of the video input signal. See [Video Session display](#) on page 131.
3. Press the **STATUS** button to close the pop-up menu.

AES Channel Status display

The AES Channel Status display presents the AES channel status packet content from the select channel pair. The data can be presented in binary, XMSN (transmission order) binary, hexadecimal, or text (interpreted) format.

AES Channel Status				
Format:	Text	Audio Input:		Embedded A
Field Name		Ch L(1)	Ch R(2)	
Channel use		professional	professional	
Linear PCM Ident		PCM	PCM	
Emphasis		no emphasis	no emphasis	
Locking of source		locked	locked	
Sample frequency		48 kHz	48 kHz	
Channel mode		2-channel	2-channel	
User bits mode		192-bit blocks	192-bit blocks	
AUX bits use		main audio	main audio	
Audio word length		24/24 bits	24/24 bits	
Alignment level		not indicated	not indicated	
Reference signal		not a ref.	not a ref.	
Origin		A1-1	A1-2	
Destination				
Sample number		0	0	
Time of day		00:00:00	00:00:00	
Block CRC (should be)		01001100	01100110	
Block CRC (computed)		01001100 (OK)	01100110 (OK)	

0661015

Figure 33: AES Channel Status display

Elements of the AES Channel Status display.

- **Format:** Shows the format of the data in the display.
- **Audio Input:** Shows the selected audio input.
- **Field Name:** Lists the field names of the various data in the AES channel status packet.
- **Ch number columns:** Lists the content for the various data in the AES channel status packet for each of the selected channels.

Status pop-up menu (AES Channel Status display). Press and hold the STATUS button to open the Status pop-up menu. The following menu selections are available:

- **Display Type and ARIB Display:** Use the arrow keys to select the display type. See [To select a status display](#) on page 108.
- **Channels:** Use the arrow keys to select the channel pair to display:
 - Channels 1 & 2 (L and R)
 - Channels 3 & 4 (C and LFE)
 - Channels 5 & 6 (Ls and Rs)
 - Channels 7 & 8 (Lo and Ro)
- **Format:** Use the arrow keys to select the format of the data display. Select from Text, Hex, Binary, or XMSN Binary formats.

CONFIG menu. Use the CONFIG menu to set the following audio parameters:

- Use the menu selections under **Digital Audio Displays** to configure various audio display parameters such as meter type, ballistic characteristics, peak program level, meter scaling, alarm thresholds, correlation speed, and turning the Lissajous AGC mode on and off.
- Use the menu selections under **Audio Inputs/Outputs** to configure audio input and output parameters such as selecting which channels are active on each audio input port, selecting how each audio port is displayed, selecting the audio output source, selecting which channels to de-embed from the SDI video, configuring the “map” of active audio for each video input, and adjusting the speaker and headphone volume.

If Option 3G is installed, 3G Level A signals use the Embedded A or B settings as appropriate. 3G Level B signals use the Embedded Dual Link settings.

- Use the menu selections under **Alarms > Audio Content** and **Alarms > AES/Embedded** to enable various audio alarms.

Alarm Status display

The Alarm Status display shows the current status of all triggered alarms for the currently selected video and audio inputs, and indicates whether or not they have been enabled. Use the arrow keys to navigate through the different pages of the display.

Alarm	Alarm Status		Page 2 of 4
	Status	Additional Information	
Embed Aud Missing	Error7890123456789012	
Embed Aud Chksum	OK		
Embed Aud Parity	OK		
Audio Cntl Pkt Missing	OK		
Audio CRC Error	OK		
Audio Valid Bit	OK		
Audio Parity Error	OK		
Audio Clip	OK		
Audio Over Level	OK		
Audio Mute	OK		
Audio Silence	OK		
Audio Channel Loud	OK		
Audio Program Loud	OK		
Audio Session Loud	OK		
Audio Program Quiet	OK		
Audio Session Quiet	Error	12-----	
Dialnorm mismatch	OK		
Timecode Vitc Missing	Error		
Timecode Vitc Invalid	OK		
Timecode Ltc Missing	Error		
Timecode Ltc Invalid	OK		
Timecode Anc VITC Missing	OK		
Timecode Anc VITC Invalid	Error	VITC Field Invalid, Dropframe mismatch	
Timecode Anc LTC Missing	OK		
Timecode Anc LTC Invalid	Error	Dropframe mismatch,	
Arrow Left, Up – Previous page, Right, Down – Next page.			

Figure 34: Alarm Status display

Elements of the Alarm Status display.

- **Alarm:** Lists the alarms that have been triggered (**white** text indicates the alarm is being logged, **gray** text indicates that the alarm is not being logged).
- **Status:** Shows the status of the error:
 - **OK** – Indicates that the alarm is not being triggered or has not occurred in the five seconds.
 - **Error** – Indicates that the alarm is occurring or has occurred in the last five seconds.
 - **Green text** – Indicates that an error occurred but has cleared.
 - **Yellow text** – Indicates that an error occurred in the last five seconds but has cleared.
 - **Red text** – Indicates that an error is currently active.
 - **Gray text** – Indicates that an alarm has been generated but the alarm was not enabled for logging.
- **Additional Information:** Provides explanatory information about the error, if available. For example, if an Audio Signal Loss alarm is triggered, the text 123–678 may appear. These numbers indicate that the audio channels mapped to level meter bars 1,2,3,6,7, and 8 triggered the alarm.

Status pop-up menu (Alarm Status display). Press and hold the STATUS button to open the Status pop-up menu. The following menu selections are available:

- **Display Type and ARIB Display:** Use the arrow keys to select a status display. See [To select a status display](#) on page 108.
- **Mute Alarms:** Mutes alarms for all of the Status display types. An Alarms Muted icon appears in the Status Bar. See [Status bar icons](#) on page 40.

CONFIG menu. Use the CONFIG menu to set various parameters that will generate error reports in the Error Log status display. Some of those parameters are listed below.

- Use the menu selections under **Gamut Thresholds** to set the minimum and maximum gamut limits for composite signals derived from the SDI signal, set the minimum and maximum luma levels, and specify the percentage of the total image pixels that can be outside the current gamut or luma limits and not generate error reports.
- Use the menu selections under **Alarms** to enable various alarms that will be reported in the log.
- Use the menu selections under **Aux Data Settings** to set various expected data parameters.
- Use the menu selections under **Display Settings** to set various general display parameters which affect all applicable display modes such as waveform intensity and graticule color.

ARIB Status displays

Use the ARIB Status displays to check for the presence and status of ARIB-based information encoding. The instrument supports TR-B.22, TR-B.23-1, TR-B.23-2, B.35, B.37, and B.39 ARIB standards.

To view the ARIB content displays, you must first enable them using the **CONFIG > Aux Data Settings > ARIB Content Display** setting.

For detailed information about ARIB displays, see [ARIB content displays](#) on page 207.

Audio Control Packet display

The Audio Control Packet display allows you to view information on audio frame number, sampling frequency, active channels, and relative audio-to-video delay of each channel, as encoded in the audio control packet metadata.

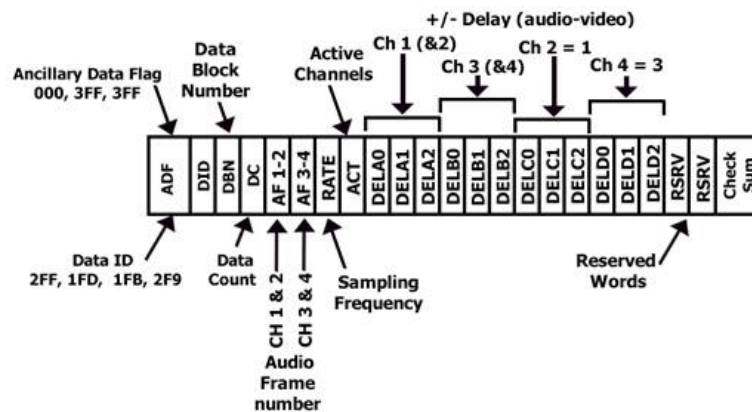

Figure 35: Format of the Audio Control Packet

For SD signals, transmission of audio control packets is optional for 48 kHz synchronous operation and required for all other modes of operation (since it contains the information as to what mode is being used). Where frequent switching is planned, receiving equipment can be designed to add or drop a sample following a switch in the four out of five cases where the sequence is broken.

The challenge in such a system is to detect that a switch has occurred. This can be facilitated by use of the data block number in the ancillary data format structure and by including an optional frame counter with the unused bits in the audio frame number word of the audio control packet.

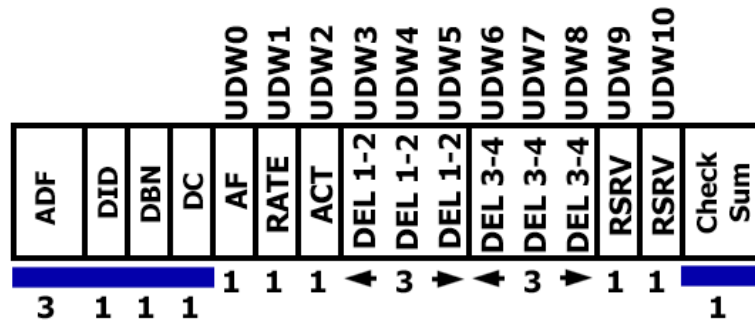

Figure 36: Structure of the audio control packet

For HD signals, the audio control packet carries additional information used in the process of decoding the audio data and has a similar structure to standard definition.

Audio Control Packet Display				
	Group 1	Group 2	Group 3	Group 4
DID:	0xe3 (1e3)	0xe2 (2e2)	0xe1 (2e1)	0xe0 (1e0)
Data Block:	0x00 (200)	0x00 (200)	0x00 (200)	0x00 (200)
Data Count:	11	11	11	11
Field / Line	F1 / L9	F1 / L9	F1 / L9	F1 / L9
Checksum:	0x101	0x1fd	0x1fc	0x2fc
Should Be:	0x101	0x1fd	0x1fc	0x2fc
Channel	Audio Frame	Rate (kHz)	Active Chan	Delay
1-2, 3-4	4	Sync 48	1-2, 3-4	—
5-6, 7-8	1	Sync 48	5-6, 7-8	—
9-10, 11-12	1	Sync 48	9-10, 11-12	—
13-14, 15-16	2	Sync 48	13-14, 15-16	—

0661016

Figure 37: Audio Control Packet display

Elements of the Audio Control Packet display. The elements of the Audio Control Packet display vary depending on the monitored signal.

- **Group 1 through n:** Shows the audio group number of the audio control packet to be used for decoding.
- **DID:** Shows the Data Identifier of the ancillary data packet for the audio control packet. For specific information about permissible DID values, view the help file in your instrument: while the Audio Control display is active in a tile, press the HELP button and follow the link at the bottom of the page to *Audio Control Packet Display Elements*.
- **Data Block:** Always 200h for HD. If SD is present, this increments by 1 when consecutive data for each DID is present, or when data blocks within a common data ID are to be linked.
- **Data Count:** 10Bh for HD. For SD, the data count represents the number of user data words to follow, up to a maximum of 255 words.
- **Field/Line:** Shows the field of the audio from which the packet was acquired. The line of the audio (within the field) from which the packet was acquired.
- **Checksum:** Shows the checksum word that was recovered from the acquired packet.
- **Should be:** Shows the checksum word computed by the instrument, based on the packet data.
- **Channel:** Shows the specific channel(s) to which the Audio Frame, Rate (kHz), Active Chan, and Delay Samples data apply. The AES stream allows up to 16 channels of audio data, and every 4 channels are transmitted together as an audio group.
- **Audio Frame:** Audio frame (AF) number data provide a sequential numbering of video frames that indicate where they fall in the progression of the non-integer number of samples per video frame (audio frame sequence). The first number of the sequence is always 1 and the final number is equal to the length of the audio frame sequence. An audio frame value of one or more zeroes indicates that frame numbering is not available.
- **Rate (kHz):** Shows the audio sampling rate.
- **Active Chan:** Shows whether the audio channel is active or inactive.
- **Delay Samples:** Shows the amount of accumulated audio processing delay relative to video, measured in audio sample intervals.

Status pop-up menu (Audio Control Packet display). Press and hold the STATUS button to open the Status pop-up menu. The following menu selections are available:

- **Display Type and ARIB Display:** Use the arrow keys to select a status display. See [To select a status display](#) on page 108.
- **Mute Alarms:** Mutes alarms for all of the Status display types. An Alarms Muted icon appears in the Status Bar. See [Status bar icons](#) on page 40.

CONFIG menu. Use the CONFIG menu to set the following audio parameters:

- Use the menu selections under **Digital Audio Displays** to configure various audio display parameters such as meter type, ballistic characteristics, peak program level, meter scaling, alarm thresholds, correlation speed, and turning the Lissajous AGC mode on and off.
- Use the menu selections under **Audio Inputs/Outputs** to configure audio input and output parameters such as selecting which channels are active on each audio input port, selecting how each audio port is displayed, selecting the audio output source, selecting which channels to de-embed from the SDI video, configuring the “map” of active audio for each video input, and adjusting the speaker and headphone volume.

If Option 3G is installed, 3G Level A signals use the Embedded A or B settings as appropriate. 3G Level B signals use the Embedded Dual Link settings.

- Use the menu selections under **Alarms > Audio Content** and **Alarms > AES/Embedded** to enable various audio alarms.

Audio Session display

The Audio Session display contains several performance parameters that you can display to see an overview of the audio input signal. This instrument maintains a running audio status session.

Audio Session								
Audio Input:	Embedded A		Signal Loss:					
AES Output	AES							
Channel	L	R	C	Lfe	Is	Rs	L2	R2
Clip	0	0	0	0	0	0	0	0
Over	0	0	0	0	0	0	0	0
Mute	0	0	0	0	0	0	0	0
Silence	0	0	0	0	0	0	0	0
Peak (dBFS)	-20.0	-20.0	-20.0	-20.0	-20.0	-20.0	-20.0	-20.0
High (dBFS)	-20.0	-20.0	-20.0	-20.0	-20.0	-20.0	-20.0	-20.0
Active bits	24	24	24	24	24	24	24	24

Changed since reset: **No** Run Time: 0 d, 00:27:04 Running

Press "SEL" to reset. Any "arrow key" stops/starts.

0661017

Figure 38: Audio Session display

Elements of the Audio Session display.

- **Audio Input:** Shows the selected input source.
- **Signal Loss:** Indicates the level meter bars (1-8) that have triggered a signal loss alarm. Dashes indicate that no alarm was triggered.
- **AES Output:** Shows the
- **Data Collect:** Indicates the status of error collection as Running or Stopped.
- **Channel:** This row aligns the channel number with the status readouts that appear below the row.
- **Clip:** The number of CLIPs detected during the session. (Only displayed for digital audio feeds.)
- **Over:** The number of OVERs detected during the session. (Only displayed for digital audio feeds.)
- **Mute:** The number of MUTEs detected during the session.
- **Silence:** The number of SILENCES detected during the session.
- **Peak (dBFS):** The True Peak signal level measured on the channel.
- **High (dBFS):** The highest signal level measured by the signal level meter. The level meter response is based on the Ballistics setting. If ballistics is set to True Peak, this readout is the same as the Peak readout.
- **Active Bits:** The number of active bits in the channel. For SD Embedded Audio the maximum is 20 bits.
- **Smpl Rate:** The sample rate of the channel pair.
- **Changed Since Last Reset:** Either Yes or No. Indicates whether an error has occurred since the last reset.

Status pop-up menu (Audio Session display). Press and hold the STATUS button to open the Status pop-up menu. The following menu selections are available:

NOTE. *To reset, stop, or start an individual audio or video session, select the tile in which it is displayed and use the SEL button, right arrow key, and left arrow key, respectively. Remember that the STATUS pop-up menu must be closed. Otherwise, the button and key presses will navigate through that menu.*

- **Display Type and ARIB Display:** Use the arrow keys to select a status display. See [To select a status display](#) on page 108.
- **Mute Alarms:** Mutes alarms for all Status display types.
- **All Sessions Reset:** Globally resets any and all audio sessions displayed in all panes, regardless of the display and session from which it is executed.
- **All Sessions Start:** Globally starts any and all stopped audio sessions displayed in all panes, regardless of the display and session from which it is executed.
- **All Sessions Stop:** Globally stops any and all stopped audio sessions displayed in all panes, regardless of the display and session from which it is executed.

CONFIG menu. Use the CONFIG menu to set the following audio parameters:

- Use the menu selections under **Digital Audio Displays** to configure various audio display parameters such as meter type, ballistic characteristics, peak program level, meter scaling, alarm thresholds, correlation speed, and turning the Lissajous AGC mode on and off.
- Use the menu selections under **Audio Inputs/Outputs** to configure audio input and output parameters such as selecting which channels are active on each audio input port, selecting how each audio port is displayed, selecting the audio output source, selecting which channels to de-embed from the SDI video, configuring the “map” of active audio for each video input, and adjusting the speaker and headphone volume.

If Option 3G is installed, 3G Level A signals use the Embedded A or B settings as appropriate. 3G Level B signals use the Embedded Dual Link settings.

- Use the menu selections under **Alarms > Audio Content** and **Alarms > AES/Embedded** to enable various audio alarms.

Auxiliary Data Status display

The Auxiliary Data Status display allows you to view closed-caption, teletext, video index, AFD, WSS, V-chip related status, and other ancillary data present on monitored signals.

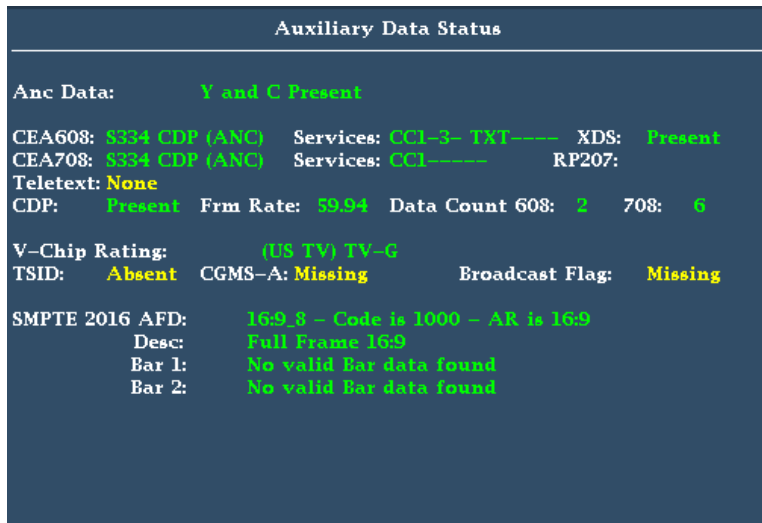

Figure 39: Auxiliary Data Status display

Elements of the Auxiliary Data Status display.

- **Ancillary Data Present:** Indicates if ANC data is present in the SDI stream.
- **CC/Teletext Type:** Indicates the Closed Caption or Teletext type in use, with the element turning red if an error is detected or the type is missing. Possible values are CEA-608 (VBI), CEA-608 (ANC), CEA-608 (708), CEA-708, Teletext B (WST) / VBI, Teletext B (WST) / OP47 SDP, Teletext B (WST) / OP47 Multi. If the CC type data is present, but is either late or early, the error message is displayed in yellow.
- **CEA 608:** Indicates the number and type of services present in the closed caption data CEA608 format. If a service has no activity for 30 seconds, it is considered missing.
- **CEA 708:** Indicates the number and type of services present on closed caption data in CEA708 format. If a service has no activity for 30 seconds, it is considered missing.
- **RP207:** Indicates the presence of Program Description Data.
- **Teletext:** Detects the location and line numbers for which teletext information is present.
- **CDP:** Indicates the presence of Caption Distribution Packets and provides information on frame rate and data count of 608 and 708 packets. Note that packet 608 typically has 4 data words and packet 708 has up to 46 data words, depending on the frame rate as defined in SMPTE 334.
- **V-Chip Rating:** Detects ratings from: MPAA (US), TV (US), Canadian English, and Canadian French systems.
- **Transmission Signal Identifier (TSID):** Indicates if the TSID is present in the SDI stream. If missing, "Not Detected" will display; otherwise, the TSID is displayed as a hexadecimal number.
- **Copy Generation Management System-Analog (CGMS-A):** Indicates if the CGMS-A is present in the signal. If missing, "Not Detected" will display; otherwise, the CGMS-A value is displayed.
- **Broadcast Flag:** Indicates if a broadcast flag was detected or not.
- **Timecode (TC) Flags:** Indicates the timecode status. The drop frame (DF) is 0 when drop frame compensation is being performed normally. DF is 1 when the count is not drop frame compensated. The color frame (CF) status is 0 when there is no relationship between the CF sequence and the time address. CF is 1 when CF ID is applied to the time address.
- **Pol:** Indicates the biphase polarity correction.
- **BG Flags:** Indicates the binary group (BG) values and whether they are specified. The readout will display a number from 0 to 7. For example, bit 0 is BGF0, bit 1 is BGF1, and bit 2 is BGF2.
- **BG Data:** Indicates the binary group (BG) data value.
- **Wide Screen Signaling (WSS):** Indicates if the WSS is present. The supported formats include Composite PAL and 625-line SD. The WSS data

is displayed with the hexadecimal byte value and its description. WSS decoding conforms to standard ITU-BT.1119-2.

- **Active Format Description (AFD):** Indicates if the SMPTE 2016-1 and 3 Format for Active Format Description and Bar Data is present. The AFD data is displayed with the hexadecimal byte value and its description. AFD decoding conforms to standard SMPTE 2016 1-3.
- **Video Index Scanning B2-B0:** Shows the Video Index Scanning System information. Conforms to SMPTE RP186-2008 Class 1.1. Data Octet 1. Scanning System provides information about the total number of lines, field rate, and aspect ratio.
- **Video Index AFD/ARD B6-B3:** Shows the Video Index binary value of Bits 6 to Bits 3 that are used to define the Active Format Descriptor. Conforms to SMPTE RP186-2008 Class 1.1. or ARDSPEC 1. See the instrument online help for a detailed description of codes: while the Aux Data Status display is active in a tile, press the HELP button.

Status pop-up menu (Auxiliary Data Status display). Press and hold the STATUS button to open the Status pop-up menu. The following menu selections are available:

- **Display Type and ARIB Display:** Use the arrow keys to select a status display. See *To select a status display* on page 108.
- **Mute Alarms:** Mutes alarms for all Status display types.
- **Reset ANC Data:** Resets any and all Auxiliary Data Status sessions displayed in all panes, regardless of the display and session from which it is executed.

CONFIG menu. Use the CONFIG menu to set the following Auxiliary Data Status display parameters:

- Use the **Aux Data Settings** selections to define the ANC data types by name and DID/SDID values.
- Use the menu selections under **Alarms** to enable the alarms for various types of ANC data errors.

Dolby Audio Status display

You can view Dolby metadata from the currently monitored SDI input. Select to view the metadata from the VANC.

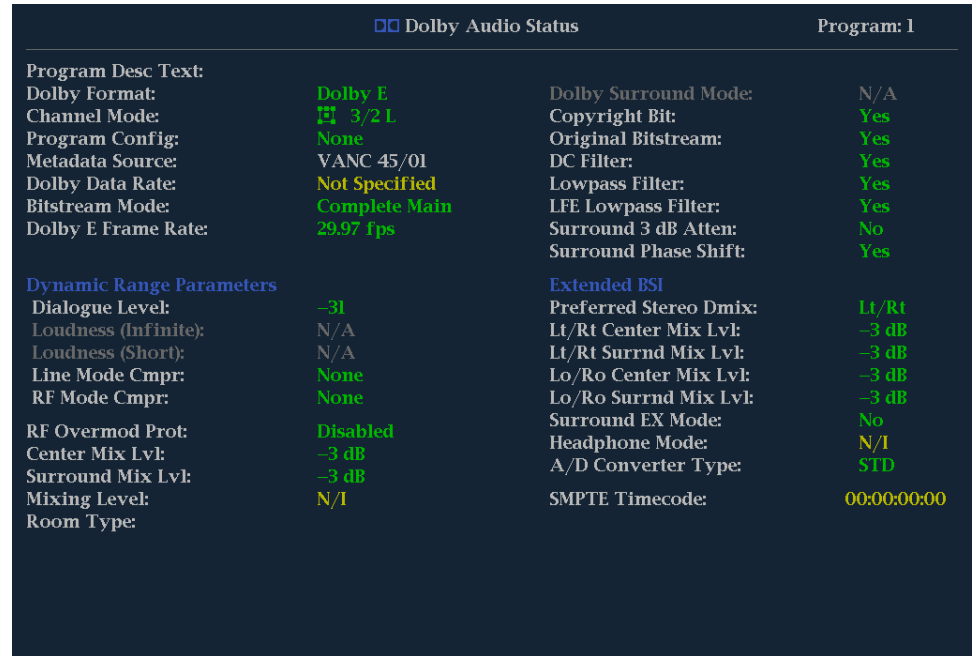

Figure 40: Dolby Audio Status display

Elements of the Dolby Audio Status display. The following is a list of some of the elements that show on the Dolby Audio Status display. Some elements apply only to Dolby type E. If Dolby type D is detected, these elements display with their names grayed out and with a value of N/A. For a complete list of the elements that might appear, see the instrument online help by pressing the **HELP** button when the Dolby Audio Status display is active in a tile.

- **Program Description Text:** A 32-character ASCII text field used by the program author to describe the audio program; for example, the name of the program (Movie Channel Promo), the program source (Football Main Feed), or the program language (Danish).
- **Dolby Format:** Indicates the Dolby Format. This indicator is also tied to the Dolby Format Error/Alarm: if the Alarm is asserted, the Dolby Format is displayed in red.
- **Channel Mode (or Audio Coding mode):** Indicates the active channels within the encoded bit stream, representing it in a ratio, X/Y, where X is the number of front channels (Left, Center, Right) and Y is the number of rear (Surround) channels. If the LFE Channel is present, an L is appended at the end of the channel mode.
- **Program Configuration:** Determines how the audio channels are grouped within a Dolby E bitstream. Up to eight channels can be grouped together in individual programs, where each program contains its own metadata.
- **Dolby Source:** Indicates the instrument input from which the Dolby Content is sourced.
- **Dolby Data Rate:** For Dolby D, indicates the encoded data rate; for Dolby E, indicates the data rate that would be used to encode a Dolby Digital bitstream.
- **Dolby Sample Rate:** Indicates the sample rate of the decoded Dolby Digital bitstream.
- **Bitstream Mode:** Describes the audio service contained within the Dolby Digital bitstream. A complete audio program may consist of a main audio service (a complete mix of all the program audio), an associated audio service comprising a complete mix, or a main service combined with an associated service. For more information about possible values, see the instrument online help; when the Dolby Status display is active in a tile, press the HELP button.
- **Dolby E Frame Rate:** Indicates the Dolby E frame rate. If Dolby Frame Rate is not the same as the video Frame Rate, the rate value is displayed in red.
- **Dolby E Frame Loc:** Displays the location (line number and sample number) of the SMPTE337 pre-amble. Also displays the Dolby E sync words one and two for bit depths of 16, 20, and 24.
- **Dolby PA Alignment:** Indicates an alignment error between the left and right Dolby channels.

- **Dialog Level:** Represents the long-term, A-weighted average level of dialog within a presentation, LAeq.

Status pop-up menu (Dolby Audio Status display). Press and hold the STATUS button to open the Status pop-up menu. The following menu selections are available:

- **Display Type and ARIB Display:** Use the arrow keys to select a status display. See *To select a status display* on page 108.
- **Mute Alarms:** Mutes alarms for all Status display types.
- **VANC Ch Pair DID:** Sets the VANC Dolby metadata source to 45h (Std) or 50h.
- **VANC Ch Pair SDID:** Sets which channel pair in the embedded audio is associated with the VANC Dolby metadata.
- **Dolby E Program:** Selects the Dolby E program number to be displayed (1 through 8).

Error Log display

The Error Log display shows a log of the error events that have been detected since the instrument was turned on or since the log was last reset. You can view all of the errors or just the errors for the selected input and save the log to a USB memory device.

Active Log		Filter: All	11/12/2010	Page 4 of 4
Source	Error Status	Timecode	Time	
✓	Audio Mute		14:37:27	
✓	SDI 1A RGB Gamut Error (r---b)		14:37:28	
✓	SDI 1A Composite Gamut Error (C-)		14:37:28	
^	SDI 1A C Anc Parity Error (Error)		14:37:28	
^	Audio CRC Error (123456-----)		14:37:28	
^	SDI 1A C Anc Parity Error (Error)		14:37:28	
^	SDI 1A Field Length Error (Strm 1&2 Error)		14:37:28	
✓	SDI 1A C Anc Parity Error (Error)		14:37:28	
^	SDI 1A Embed Aud Parity (1234567890123456)		14:37:28	
✓	SDI 1A RGB Gamut Error (Rr---Bb)		14:37:28	
✓	SDI 1A Luma Gamut Error		14:37:28	
✓	SDI 1A RGB Gamut Error		14:37:29	
^	Audio Mute (1234-----)		14:37:29	
✓	SDI 1A Y Anc Parity Error (OK)		14:37:29	
✓	SDI 1A C Anc Parity Error (OK)		14:37:29	
✓	Audio Signal Loss		14:37:30	
✓	SDI 1A Audio Session Loud (l-----)		14:38:37	
✓	SDI 1A Audio Session Loud (l-----)		14:38:37	

Arrow Left – Previous, Right – Next, Up – First, Down – Last.

Figure 41: Error Log display

Elements of the Error Log display. Across the top of the display screen, the following items are shown:

- **Log status:** Shows that the currently viewed log is active (**Active Log**) or that logging has stopped (**Active Log (Stopped)**).
- **Filter:** Shows the currently selected error filter. *All* means that all errors from all inputs and channels are being shown. You can also select to view errors by input or channel.
- **Date:** Shows the date, according to the internal clock of the instrument, that the error occurred. The date is displayed as month/day/year.
- **Page:** Shows which page of the log you are viewing out of the total number of pages in the log.

The Error Log display is divided into the following columns:

- **Entry type (icon):** An icon is displayed next to each log entry to provide a quick indication of the entry type:
 - **“i”:** Identifies log entries that are informational in nature. These entries do not represent an error, but usually indicate changes in instrument state, such as a change in the video input source.
 - **Red Rising Waveform:** Indicates that an error has occurred.
 - **Green Falling Waveform:** Indicates that an error has cleared.
- **Source:** Shows the inputs on which the errors have occurred.
- **Error Status:** Shows the current state of the entry: **White** items are informational and identify a change in instrument state; **Green** items are errors that have cleared; **Red** items are triggered errors.
- **Timecode:** Shows the time, according to VITC or LTC in the signal, that the error occurred. In the case of ongoing errors, this shows the VITC/LTC at which the error first occurred.
- **Time:** Shows the time, according to the internal clock of the instrument, that the error occurred.

When an ASI transport stream is being monitored (WFM2300 Option ASI only) and a Continuity Count error occurs, the value "NG" will be displayed along with a number indicating the number of PIDs with errors.

Status pop-up menu (Error Log display). Press and hold the STATUS button to open the Status pop-up menu. The following menu selections are available:

- **Display Type and ARIB Display:** Use the arrow keys to select a status display. See *To select a status display* on page 108.
- **Mute Alarms:** Mutes alarms for all of the Status display types. An Alarms Muted icon appears in the Status Bar. See *Status bar icons* on page 40.
- **Logging Active:** Turns the logging function on or off. The logging status is shown at the top of the display. When turned on, “Active Log” is displayed. When turned off, Active Log (Stopped) is displayed.
- **Logging Reset:** Press the SEL button to clear all of the entries in the log. Use care when executing a reset because the log entries cannot be recovered after a reset has erased them.
- **Input/Channel:** Allows you to select to filter errors in the error log so that you can view them by channel or input.
- **Save to USB (ALL):** Saves the entire unfiltered error log to a USB memory device.
- **Save to USB (Sel.):** Saves only the filtered error log for the selected channel or input to a USB memory device.

CONFIG menu. Use the CONFIG menu to set various parameters that will generate error reports in the Error Log status display. Some of those parameters are listed below.

- Use the menu selections under **Gamut Thresholds** to set the minimum and maximum gamut limits for composite signals derived from the SDI signal, set the minimum and maximum luma levels, and specify the percentage of the total image pixels that can be outside the current gamut or luma limits and not generate error reports.
- Use the menu selections under **Alarms** to enable various alarms that will be reported in the log.
- Use the menu selections under **Aux Data Settings** to set various expected data parameters.
- Use the menu selections under **Display Settings** to set various general display parameters which affect all applicable display modes such as waveform intensity and graticule color.

**SFP Module Status display
(Option SFP or
Option SFP-HDMI)**

With Option SFP (optical) or Option SFP-HDMI (HDMI), the SFP Module Status display provides information about the installed SFP (Small Formfactor Pluggable) module.

For more detailed information about the values of each element, refer to “INF-8074i Specification for SFP (Small Formfactor Pluggable) Transceiver”, published by the SFF Committee and available at <ftp://ftp.seagate.com/sff>.

SFP Module Status			
Module Status:	MSA	Module Type:	Transceiver
Rx Power A:	-1.4575 dBm	Tx Power A:	-1.9791 dBm
Rx Power B:	N/A	Tx Power B:	N/A
Module ID:	82h – Vendor Specific	Module EXT_ID:	04h – SFP
Conn. Type:	07h – LC	Encoding:	03h – NRZ
XCVR Code:	0000000000000000h – Unknown		
Nominal Bitrate:	1eh – 3000Mbps	Length 9 Micron:	1e00h – 30km
Length 50 Micron:	00h – 0m	Length 62.5 Micron:	00h – 0m
Length Copper:	00h – 0m	Vendor Name:	GENNUM
Vendor OUI:	000adf	Vendor PN:	GO2929-31DM
Vendor Rev:	00h – 0	Wavelength:	051eh – 1310
Vendor SN:	Z114530FW	Mfg Date Code:	111207

Figure 42: SFP Module Status display

Elements of the SFP Module Status display. The following elements are shown in the SFP Module Status display. For more detailed information about the values of each element, refer to "INF-8074i Specification for SFP (Small Formfactor Pluggable) Transceiver," published by the SFF Committee and available at <ftp://ftp.seagate.com/sff>.

- **Module Status:** Shows if a module is installed or not and, if so, whether or not it is MSA. One of the following will be displayed: Not Installed (no SFP module inserted), MSA (module electrical pinout conforms to Multi-Source Agreement standard), Non-MSA (module has Video-specific electrical pinout).
- **Rx Power A:** SFP module internally measured receiver laser power in dBm units on channel A.
- **Rx Power B:** SFP module internally measured receiver laser power in dBm units on channel B.
- **Module Type:** Configuration for the currently inserted SFP module. This is set from the STATUS button popup menu in the SFP Config submenu.
- **Tx Power A:** SFP module internally measured transmitter laser power in dBm units on channel A.
- **Module ID:** Type of serial transceiver.
- **Conn. Type:** Code for connector type.
- **XCVR Code:** Code for electronic or optical interface compatibility.
- **Nominal Bitrate:** Nominal bit rate in units of 100 Mbps, rounded to the nearest 100 Mbps.
- **Length 50 Micron:** Specifies the link length supported by the SFP transceiver while operating in compliance with the applicable standards using 50 micron multi-mode fiber. Value shown in units of 10 meters (m).
- **Length Copper:** Specifies the link length supported by the SFP transceiver while operating in compliance with the applicable standards using copper cable. Value shown in meters (m).
- **Vendor OUI:** SFP transceiver vendor IEEE company ID.
- **Vendor Rev:** Revision level for part number provided by vendor (ASCII).
- **Vendor SN:** Vendor serial number for SFP.
- **Module EXT_ID:** Extended identifier of type of serial transceiver.
- **Encoding:** Value for the serial encoding algorithm. Defines information transfer rate.
- **Length 9 Micron:** Specifies the link length supported by the SFP transceiver while operating in compliance with the applicable standards using single mode fiber. Value shown in kilometers (km).
- **Length 62.5 Micron:** Specifies the link length supported by the SFP transceiver while operating in compliance with the applicable standards using 62.5 micron multi-mode fiber. Value shown in units of 10 meters (m).

- **Vendor Name:** Name of SFP vendor.
- **Vendor PN:** Vendor part number for SFP.
- **Wavelength:** Shows received or transmitted wavelength in nanometers (nm).
- **Mfg Date Code:** Vendor date of SFP manufacture.

Status pop-up menu (SFP Module Status display). Press and hold the STATUS button to open the Status pop-up menu. The following menu selections are available:

- **Display Type and ARIB Display:** Use the arrow keys to select a status display. See *To select a status display* on page 108.
- **SFP Config:** Sets the type of SFP module to None, Sole Transmitter, Sole Receiver, Transceiver, Dual Transmitters, or Dual Receivers.

CONFIG menu. Use the selections under **Input Mode > SFP Module Config** to set the type of SFP module to None, Sole Transmitter, Sole Receiver, Transceiver, Dual Transmitters, or Dual Receivers.

**SDI Status display
(WFM2300 only)**

With the WFM2300 waveform monitor, you can view two measurements of signal jitter and cable loss in both dB and meters of the selected cable type, and calculated source level. Automatic measurements of eye amplitude, rise time, fall time, overshoot, and rise-fall difference are also displayed.



Figure 43: SDI Status display

When Option ASI is installed, the display is renamed to SDI/ASI Status and when an ASI transport stream is being monitored, the display changes as shown below. The jitter measurements are replaced by ASI status readouts and the cable measurements are left blank.



Figure 44: SDI/ASI Status display

Elements of the SDI Status display. Some elements are option dependent.

- **Signal:** Shows whether the signal is locked or not and shows the format of the signal being monitored.
- **Jitter and Cable Loss Thermometers:** The horizontal bar graphs show your measured values. 0-70% of the of the threshold value is represented by a green area; 70-100% by a yellow area; 100-170% by a red area. The measured value is shown as a black diamond.
- **Jitter1 HP Filter:** Sets the jitter high pass filter for one of the two jitter engines that drive the EYE display. Selectable as: Timing (set to 10Hz); Align (auto set to default filter settings); 10Hz; 1kHz; 10kHz; 100kHz. Jitter1 settings appear in tile 1 and 2.
- **P-P:** Shows the peak-to-peak jitter measurement, in time units and UIs (unit intervals).
- **Cable Loss:** Shows the signal loss in dB, at the frequency specified in the Cable Loss field of the Physical Layer Settings selection available from the CONFIG button. This readout is blank when an ASI transport stream is being monitored (Option ASI only).
- **Approx Cable:** Shows the approximate length of cable, assuming a continuous run of cable of the specified type, as specified in the Cable Type field of the Physical Layer Settings selection available from the CONFIG button. This readout is blank when an ASI transport stream is being monitored (Option ASI only).
- **Source Level:** Shows the calculated launch amplitude of the signal source, assuming a continuous run of cable of the specified type, as specified in the Launch Amplitude fields of the Physical Layer Settings selection available from the CONFIG button. This readout is blank when an ASI transport stream is being monitored (Option ASI only).
- **Cable Type:** Shows the cable type used to connect the signal source to the instrument, as specified in the Cable Type field of the Physical Layer Settings selection available from the CONFIG button.
- **Eye Amplitude:** Shows the amplitude of the eye waveform.
- **Eye Risetime:** Shows the rise time of the eye waveform.
- **Eye Falltime:** Shows the fall time of the eye waveform.
- **Eye Rise-Fall:** Shows the delta between rise time and fall time of the eye waveform.
- **Eye Rise Overshoot:** Shows the percentage of rise time overshoot of the eye waveform.
- **Eye Fall Overshoot:** Shows the percentage of fall time overshoot of the eye waveform.
- **ASI Packet Size:** (Option ASI only) Shows the packet size in the transport stream (188 or 204 bytes). The readout shows "Unlocked" when the signal input is not ASI.

- **ASI Polarity:** (Option ASI only) Shows the ASI polarity (positive or negative). The readout shows "N/A" when the signal input is not ASI.
- **ASI TS Bit Rate:** (Option ASI only) Show the bit rate of the transport stream in Mbps.
- **ASI Sync Byte:** (Option ASI only) Shows the status of the sync byte error check.
- **ASI CC Error:** (Option ASI only) Shows the status of the continuity counter error check. When a Continuity Count error occurs, the value "NG" will be displayed in red along with a number indicating the number of PIDs with errors.

Status pop-up menu (SDI Status display). Press and hold the STATUS button to open the Status pop-up menu. The following menu selections are available:

- **Mute Alarms:** Mutes alarms for all Status display types.
- **Jitter1 HP Filter:** Select the filter type: Timing, Align, 10 Hz, 100 Hz, 1 kHz, 10 kHz, 100 kHz.

Video Session display

When an SDI signal is being monitored, the Video Session display shows several performance parameters, such as CRC values, that you can view to get an overview of the video input signal. This instrument maintains a running video status session.



Figure 45: Video Session display of an HD-SDI signal

When an ASI transport stream is being monitored (WFM2300 Option ASI only), the Video Session display shows whether or not the signal is locked.



Figure 46: Video Session display of an ASI transport stream (WFM2300 Option ASI only)

Elements of the Video Session display. The following elements are visible when an SDI signal is being monitored:

- **Input:** Shows the selected input source.
- **Signal:** Indicates whether the instrument is locked to the selected input.
- **Effective:** Shows, in order, the detected format, sample structure, and transport of the input signal.
- **Selected:** Shows, in order, the selected format, sample structure, and transport of the instrument.
- **352M payload:** Indicates the presence of a SMPTE 352M payload.
- **SAV Place Err:** Indicates whether a Start-of-Active-Video Placement Error has occurred.
- **Field Length Err:** Indicates whether a Field Length Error has occurred.
- **Line Length Err:** Indicates whether a Line Length Error has occurred.
- **Ancillary Data:** Indicates whether Ancillary Data is present in the video signal. The displayed values are either Present or None for SD signals, or Y and C Present and None for HD and 3 Gb/s signals.
- **F1 AP CRC:** For SD signals only, calculates and displays the active picture CRC (Cyclical Redundancy Check) for field one in hexadecimal. The instrument uses the SMPTE RP165 standard for error checking. For HD and 3 Gb/s signals, the CRCs change on every video line.
- **F2 AP CRC:** For SD signals only, calculates and displays the active picture CRC (Cyclical Redundancy Check) for field two in hexadecimal. The instrument uses the SMPTE RP165 standard for error checking. For HD and 3 Gb/s signals, the CRCs change on every video line.
- **Data Collect:** Shows the state of error gathering. The possible states are:
 - **Running:** Indicates errors are being gathered and displayed on the status page.
 - **Stopped:** Indicates errors are not being gathered. The status page is not being updated.
 - **Resetting:** Appears briefly after the SEL button is pressed to reset the statistics.
- **Runtime:** The time since the last reset occurred. Time is displayed as "DD, HH:MM:SS", where DD is the number of days, HH is the number of hours, MM is the number of minutes, and SS is the number of seconds.
- **Stuck Bits:** For SD signals only, displays which of the video bits are stuck. If the readout is "---- ---- --", then none of the bits are stuck.
- **Y Stuck Bits:** For HD signals only, displays which of the luminance video bits are stuck. If the readout is "---- ---- LL", then none of the bits are stuck. LL is displayed for the two unused bits.

- **C Stuck Bits:** For HD signals only, displays which of the chrominance video bits are stuck. If the readout is "---- ---- LL", then none of the bits are stuck. LL is displayed for the two unused bits.
- **EDH Error:** For SD signals only, indicates that there is an error in the EDH packet (checksum or parity) of the signal.
- **Statistics:** This section of the display shows the status and statistical values for certain errors. For information about the errors in this section, view the help file in your instrument: while the Video Session is active in a tile, press the HELP button.
- **Status:** Shows the status of the associated error as either OK, Invalid, Missing, or Error.
- **Err Secs:** The number of seconds, since the last reset, that contained at least one error.
- **Err Fields:** The number of fields, since the last reset, that contained at least one error.
- **% Err Fields:** Shows a calculated number showing the percentage of all fields since the last reset that contained at least one error.
- **Black Events:** Shows when a black frame has occurred within the video image. Settings configured in the CONFIG > Measurement Settings menu.
- **Frozen Events:** Shows when a frozen frame has occurred within the video image. Settings configured in the CONFIG > Measurement Settings menu.
- **Changed Since Reset:** Indicates if either the F1 or F2 AP CRC values have changed since the last reset.
- **Frozen:** This readout only appears when you press the CAPTURE button. It indicates that errors are being gathered, but are not being displayed on the Status page. This state is useful for looking at EDH (Error Detection and Handling) CRC (Cyclic Redundancy Check) values on live video.

The following elements are visible when an ASI transport stream is being monitored (WFM2300 Option ASI only):

- **Input:** Shows the selected input source.
- **Signal:** Indicates whether the instrument is locked to the selected input.
- **Effective:** Shows the detected format of the input signal.
- **Selected:** Shows the selected format of the instrument.

Status pop-up menu (Video Session display). Press and hold the STATUS button to open the Status pop-up menu. The following menu selections are available:

NOTE. *To reset, stop, or start an individual video or audio session, select the tile in which it is displayed and use the SEL button, right arrow key, and left arrow key, respectively. Remember that the STATUS pop-up menu must be closed; otherwise, the button and key presses will navigate through that menu.*

- **Display Type and ARIB Display:** Use the arrow keys to select a status display. See [To select a status display](#) on page 108.
- **Mute Alarms:** Mutes alarms for all of the Status display types. An Alarms Muted icon appears in the Status Bar. See [Status bar icons](#) on page 40.
- **All Sessions Reset:** Globally resets any and all video sessions displayed in all panes, regardless of the display and session from which it is executed.
- **All Sessions Start:** Globally starts any and all stopped video sessions displayed in all panes, regardless of the display and session from which it is executed.
- **All Sessions Stop:** Globally stops any and all stopped video sessions displayed in all panes, regardless of the display and session from which it is executed.

CONFIG menu. Use the CONFIG menu to set the following Video Session status display parameters:

- Use the menu selections under **SDI Input** to set various format, structure, and video signal parameters.
- Use the menu selections under **Alarms** to set various alarms related to video input, content, and format errors.
- Use the menu selections under **Display Settings** to set various general display parameters which affect all applicable display modes.

Timing Measure display

The Timing Measure display a Tektronix proprietary display that simplifies measuring the timing difference between the SDI video input signal and the analog video external reference signal as the timing is corrected. This display enables you to easily compare and correct the timing between two signals.

For this display to operate, signals must be connected to the selected video input and to the external reference input. Use the Waveform display to view the video input waveform and use the External Reference Waveform display to view the external reference signal. See also *Waveform display* on page 148 and *External Reference Waveform display* on page 92.

To access the Timing Measure display

1. Press and hold the **MEAS** button to open the Measure pop-up menu.
2. Use the arrow keys to select **Display Type > Timing Measure**.
3. Press the **MEAS** button to close the pop-up menu.

Elements of the Timing Measure display

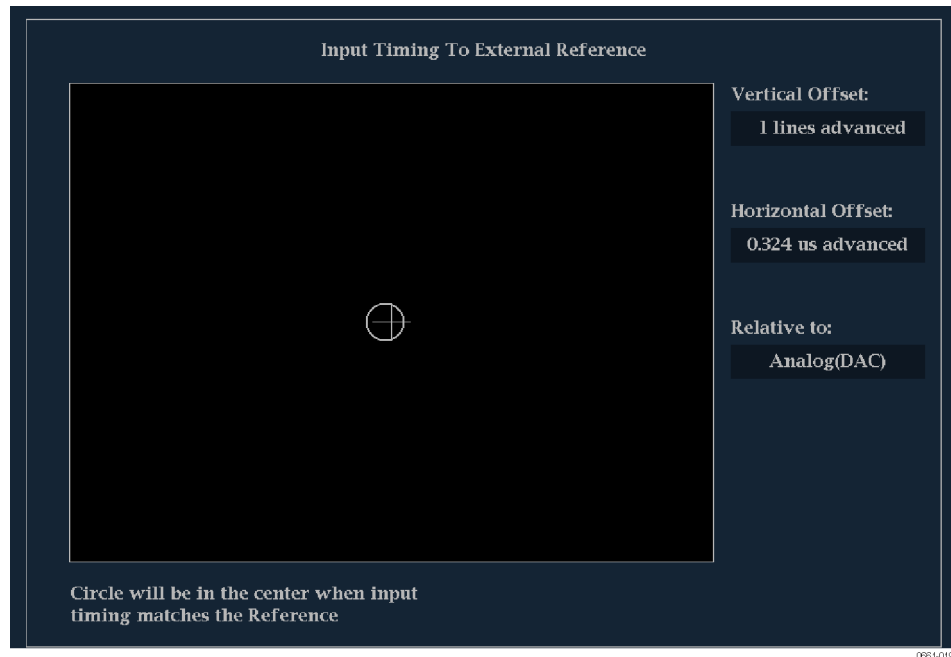

Figure 47: Timing Measure display

- **Input Signal Indicator:** A single circle representing timing of input signal relative to the reference. ¹
- **Reference Indicator:** A cross-hair indicator centered in the display represents the reference signal.

¹ More complex timing relationships display multiple circles. See *Timing displays for simple versus complex timing* on page 139.

- **Vertical Offset:** The timing difference between the reference and input signal.
- **Horizontal Offset:** The timing difference between the reference and input signal.
- **Relative to:** Indicates the chosen zero point for the timing display. ²
- **Link B to Link A:** Indicates the timing relationship between links of a Dual Link signal.

Measure pop-up menu (Timing Measure display)

Press and hold the MEAS button to open the Measure pop-up menu. The pop-up menu enables you to save a timing setting so that you can measure the timing between input or to match multiple inputs, and to specify the zero point of the timing display.

Save offset. Saves the timing of the current input as an offset to the timing display. This saved timing becomes the zero point for the saved offset mode of the timing display. This applies to both the cross-hair target in the middle of the display and the numeric readouts.

The Save Offset function allows you to measure the timing between inputs or to match multiple signals. Use the Relative To setting to select the definition for the zero timing offset.

NOTE. *You cannot save the timing offset if either the input or reference is missing or unlocked. You also cannot save a reference when in internal mode. Saving an offset in these conditions would lead to misleading results so it is not allowed by the instrument. A warning message appears on the screen if you attempt to save the offset when it is not allowed.*

² If you select *Saved Offset*, you can save the timing from one signal, and then display the timing relative to that saved offset.

Relative to. Sets the definition for the zero timing offset to one of the following. This selection changes both the numeric readouts and the target in the middle of the timing display.

- **Analog (DAC):** Means the timing offset of SD and HD SDI inputs are compensated for the delay of a nominal D to A converter. So after accounting for the DAC, the delay will be shown as zero when the two signals are timed down at the top panel of the instrument.

The DAC delay is not applied to composite or 3 Gb/s SDI inputs, so the Analog (DAC) and Serial (OH) settings are equivalent for these inputs.

- **Serial (OH):** Means the timing offset of the serial stream is considered to be zero when the “OH” sample of the scrambled serial stream is coincident with the appropriate sync edge of the analog reference connected to the instrument.

This setting is also allowed for composite inputs where this selection for zero timing means the reference sync points of the two signals will be coincident at the top panel of the instrument.

- **Saved Offset:** Means that the timing will be shown as zero offset when the input signal matches the timing of the signal that was present when the offset was saved using the Save Offset menu entry.

Display type. Select from the following display types:

- **Timing Measure** - Displays a Tektronix proprietary view that enables you to easily compare and correct the timing between two signals.
- **Datalist (Option DATA only)** - Displays the content of all digital signal formats, structures, and transports (SD, HD, 3G, dual link, 4:2:2, 4:4:4, and others) except for composite signals. See *Datalist display (Option DATA only)* on page 83.
- **Bowtie** - Displays the interchannel timing between Y Pb and Y Pr. See *Bowtie display* on page 81.
- **ANC Data (Option DATA only)** - Displays all of the ANC data in a video signal. See *ANC Data display (Option DATA only)* on page 48.
- **AV Delay (Option AVDP only)** - Displays results of AV Delay and Propagation Time measurements. See *AV Delay Measurement display (Option AVDP only)* on page 78.
- **ASI PID List Disp. (WFM2300 Option ASI only)** - For MPEG2 transport stream inputs, displays the MPEG TS PID tree with each stream element having an LED icon to indicate the status of the element. See *ASI PID List display (WFM2300 Option ASI only)* on page 54.

Timing displays for simple versus complex timing

The number of circles, with each representing a time offset, varies with the complexity of the timing between the reference and input signals.

Integer multiples of reference rates. If you are timing input signals with rates that are integer multiples of the reference rates, the instrument can measure the timing deterministically and displays the relationship as one circle (offset) relative to the cross-hair.

Such cases include timing an NTSC input (multiplier of 1) or a 525 SDI input whose frame time is 33.36 ms (multiplier of 2), against an NTSC reference, which has a frame time of 66.73 ms.

Non-integer multiples of reference rates. If you time input rates that are not integer multiples of the reference rates, the instrument cannot measure the timing deterministically, so it displays the relationships as several circles. Each circle represents a possible timing offset measurement relative to the reference cross-hair. Display emphasis is given to the circle that times closest to zero offset and the numerical readouts track this pair.

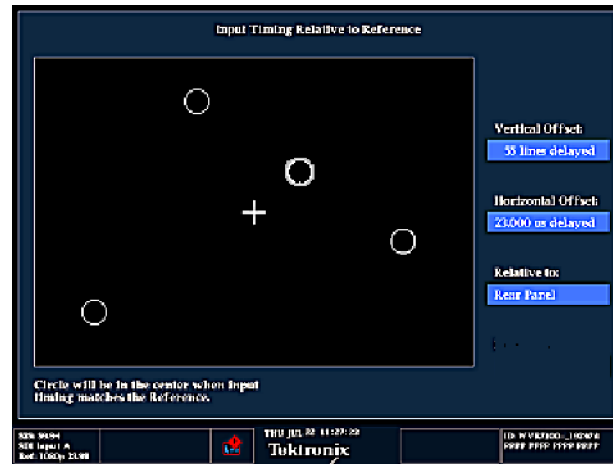
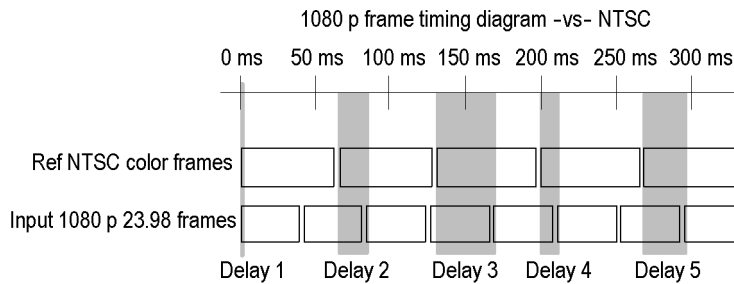

Figure 48: Timing display of non-integer multiples of reference rates

Non-deterministic cases include timing of slow rate inputs against fast frame-rate references or when timing video against film rates.

Multiple relationships. For a case where multiple relationships would display, consider an input of 1080p/23.98 Hz with a reference of NTSC/59.94 Hz:

- The different rates result in timing relationships between the signals that repeat once for every four fields of the input and five frames of the reference.
- Because this allows for five possible ways to measure timing between these two signals, the timing display shows four circles, with emphasis and readouts as previously described above.



Vector display

The Vector display is a plot of the Pr signal on the vertical axis and the Pb signal on the horizontal axis. This display is useful for looking at hue and amplitude of the colors, but does not show luminance information.

You can set the color bar targets to 75% or 100%, select which color is at the center of the display, and display the SDI signal as if it were a composite signal.

The related Lightning display plots the Pr and Pb color signals against luminance, which is useful for checking chroma and luma gain and for checking chroma to luma delay. See [Lightning display](#) on page 98.

To access the Vector display

1. Press and hold the **VECTOR** button to open the Vector pop-up menu.
2. Use the arrow keys to select **Display Type > Vector**.
3. Press the **VECTOR** button to close the pop-up menu.

Elements of the Vector display

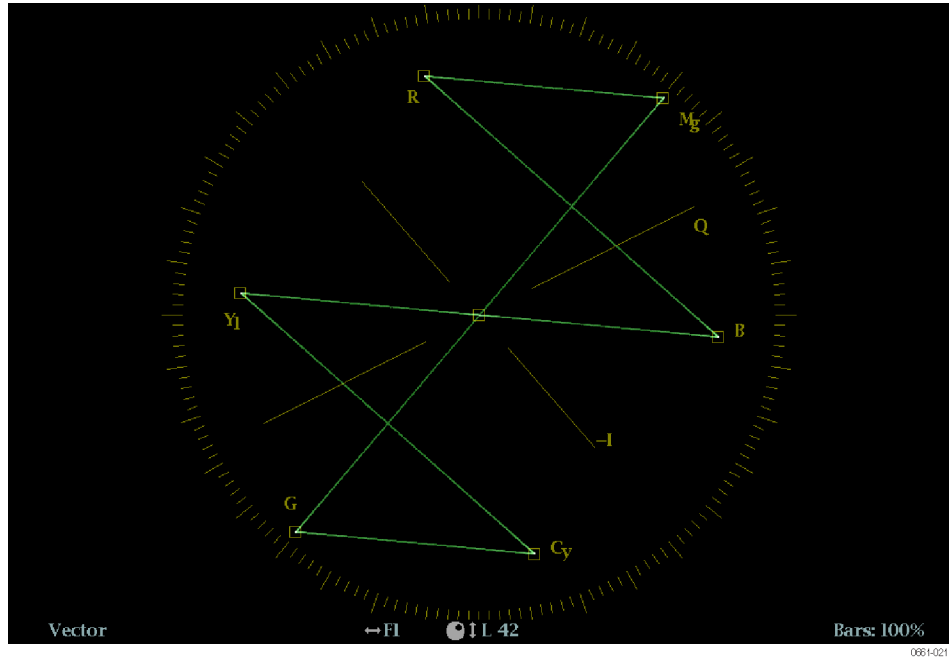

Figure 49: Vector display in Normal mode with the compass rose and I/Q axis graticules enabled

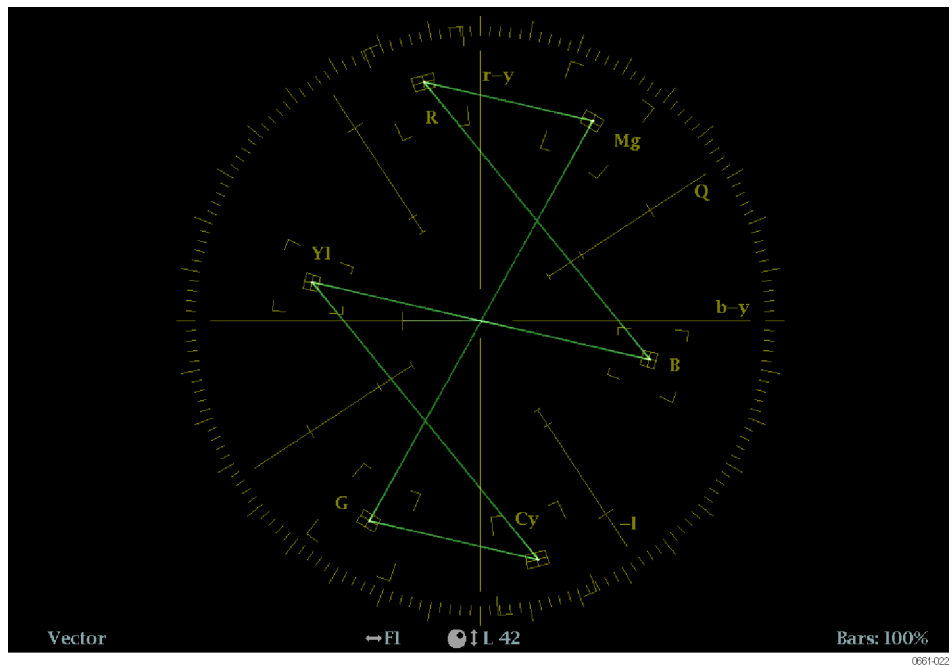

Figure 50: Vector display in Composite mode

The following elements appear on the display:

- **V Gain:** Shows the current gain setting when the gain is other than 1x. Press the GAIN button to toggle the vertical gain between 1x and the most recently selected gain value. Gain is applied equally in the horizontal and vertical directions.

Press and hold the GAIN button to select fixed gain settings (1x, 2x, 5x, or 10x) or to enable VAR Gain mode. If you enable VAR Gain mode in the Gain pop-up menu or by pressing the VAR button, you can adjust the gain using the General knob.

- **Display Type:** The selected display, either Lightning or Vector.
- **Bar Target Setting:** The bar target setting, either 75% or 100%.
- **Field and line numbers:** Shows the currently selected video field and line numbers when Line Select mode is enabled. See [Line Select](#) on page 159.
- **H and V positions:** When you press the POS button to adjust the position of the waveform, a position readout appears with a knob icon to indicate whether the horizontal or vertical position is the focus of the General knob.
- **Compass rose graticule:** When the Vector display mode is set to normal, the compass rose graticule appears only when it is enabled in the CONFIG > Graticules & Readouts submenu. When the Vector display mode is set to Composite, the compass rose graticule always appears.
- **I/Q axis graticule:** When the Vector display mode is set to normal, the I/Q axis graticule appears only when it is enabled in the CONFIG > Graticules & Readouts submenu. When the Vector display mode is set to Composite, the I/Q axis graticule always appears.

Vector pop-up menu

The Vector pop-up menu enables you to specify the display type and display mode (SDI inputs only), to set the bar targets, and to center the waveform in the display. The following menu selections are available:

Display type. Select from the following display types:

- **Vector** – The Vector display shows a plot of the Pr signal on the vertical axis and the Pb signal on the horizontal axis. This display is useful for looking at hue and amplitude of the colors, but does not show luminance information.
- **Lightning** – This Tektronix proprietary display shows the same Pr and Pb color signals as in the Vector mode, but they are plotted against luminance. The Lightning display is useful for checking chroma and luma gain, and for checking chroma to luma delay using the timing marks that show errors in the green to magenta transition on a color bar signal. See [Lightning display](#) on page 98.

Bar targets. Select which scaling (75% or 100%) will be used in the active tile for either the Vector or Lightning display.

Center on. To center the Vector display on a specific color, use the arrow keys to select the desired color. Select Black to restore the trace to the default position at the center of the tile.

Display mode. Select from the following compass rose display modes:

- **Normal** – Sets the compass rose and signal representations to component. The compass rose graticule must be turned on in the CONFIG > Graticules & Readouts menu before the compass rose will be visible in this mode.
- **SDI > Composite** – Sets the compass rose and signal representations to composite. The composite representation is independent from the Colorimetry in the signal source and provides a uniform representation of the hue shift.

CONFIG menu

Use the CONFIG menu to set the following Vector display parameters:

- Set the **SDI Input > HD Colorimetry** setting to **Auto**, **ITU 709-2**, or **SMPTE 240M** to set the expected colorimetry in HD signals.
- Set the **Graticules & Readouts > Vector I/Q Axis** setting to **On** or **Off** to turn on or off the I and Q axes on the display.
- Set the **Graticules & Readouts > Vector Compass Rose** setting to **On** or **Off** to turn on or off the compass rose display.
- Set the **Graticules & Readouts > Vector Readouts** setting to **On** or **Off** to turn on or off the readouts on the display.
- Use the menu selections under **Display Settings** to set various general display parameters which affect all applicable display modes such as waveform intensity and graticule color.

To position the Vector trace

To adjust the position of the trace on the Vector display:

1. Press the **POS** button.
2. Press the left or right arrow key to enable horizontal or vertical adjustments. The knob icon appears next to the selected adjustment readout. See also *Elements of the Waveform display* on page 148.
3. Turn the General knob or use the up/down arrow keys to adjust the position of the waveform.
4. Press the **POS** button to turn off the position adjustment mode.

Video Generator Status display

The Video Generator Status display shows the status of video signals being generated by the instrument.

To access the Video Generator Status display

1. Press and hold the **GEN** button to open the Generator pop-up menu.
2. Use the arrow keys to select **Display Type > Video Generator**.
3. Press the **GEN** button to close the pop-up menu.

Elements of the Video Generator Status display



Figure 51: Video Generator Status display

The following video signal generator status elements appear on the display:

- **Thumbnail picture:** Shows a thumbnail display of the picture generated by the output signal of the video generator.
- **SDI Output:** Shows whether the SDI output is set to be a test signal or a loopout of the selected SDI video input.
- **Test Signal Pattern:** Shows which test signal will be output when the SDI Output setting is Test Signal.
- **Test Signal Level:** Shows the signal level (A or B) that will be output when the SDI Output setting is Test Signal.
- **Test Signal Format:** Shows the signal format that will be output when the SDI Output setting is Test Signal.
- **Moving Picture Mode:** Shows whether the Moving Picture mode is turned on or off.

- **Moving Picture Rate:** Shows the frame and sample rate settings for the Moving Picture mode.
- **AV Timing Mode:** Shows the current AV Timing mode: Off, AV Delay, or Propagation.

The following genlock status elements appear on the display:

- **Genlock Status:** Shows the current status of the genlock function (Disable, Locked, or Unlocked).
- **Reference:** Shows the format of the external reference signal being used for the genlock function. Ext Missing is displayed when no external reference signal is detected.
- **Vertical Offset:** Shows the amount of offset (in video lines of the configured generator test signal video format) for the vertical timing of the output signal relative to the external reference signal.
- **Horizontal Offset:** Shows the amount of offset (in microseconds) for the horizontal timing of the output signal relative to the external reference signal.

Generator pop-up menu (Video Generator Status display)

Press and hold the GEN button to open the Generator pop-up menu. The pop-up menu provides a shortcut to the same settings controlled in the CONFIG > Video/Gen Outputs menu. The following menu selections are available:

Display type. Select from the following display types:

- **Video Generator Status** – Displays the status of video signals being generated by the instrument.
- **Audio Generator Status** – Displays the status of audio signals being generated by the instrument. [Audio Generator Status display](#) on page 65
- **Diagnostics Monitor** – Displays the status of various instrument diagnostics. See also [Diagnostics Monitor display](#) on page 86.

SDI output. Sets the SDI video output to be a test signal or a loopout of the selected SDI video input.

Signal pattern. When the SDI Output setting is Test Signal, selects one of the following signals to be output. For more information about these signals, see the appropriate SMPTE standard.

- 100% bar
- 75% bar
- Pathological
- SMPTE EG1 Bars
- EG432-1 Color Bar
- RP219 Color Bar
- 0% Flat Field
- 50% Flat Field
- 100% Flat Field
- 5-Step Staircase
- 10-Step Staircase
- Checkerboard
- Clean Aperture
- Production Aperture
- Convergence
- Pluge and luma
- SMPTE 303M Color Reference
- ChromaDuMonde
- Multiburst
- Y Multiburst

Signal level. When the SDI Output setting is Test Signal, selects the level of the output signal (Level A or Level B).

Signal format. When the SDI Output setting is Test Signal, selects the format of the output signal.

Genlock. Enables or disables whether the generator signal output is genlocked to the external reference input signal.

Genlock offset V. Sets the amount of offset (in video lines of the configured generator test signal video format) for the vertical timing of the output test signal relative to the external reference signal.

Genlock offset H. Sets the amount of offset (in microseconds) for the horizontal timing of the output test signal relative to the external reference signal.

Moving picture. When the SDI Output setting is Test Signal, turns the Moving Picture mode on and off.

NOTE. *The Moving Picture and the Moving Circle functions are mutually exclusive. Only one of these functions can be enabled at a time. For example, if you enable Moving Picture when Moving Circle is already enabled, Moving Circle is turned off automatically when Moving Picture is enabled.*

Per frames. When the SDI Output setting is Test Signal and the Moving Picture mode is on, sets the frame rate for the moving picture.

Moving samples. When the SDI Output setting is Test Signal and the Moving Picture mode is on, sets the sample rate for the moving picture.

AV Timing Mode. Sets the AV Timing mode to one of the following:

- **Off** - Turns off the AV Delay or Propagation timing signal on the SDI OUT connector.
- **AV Delay** - Turns on the AV Delay signal on the SDI OUT connector.
- **Propagation** - Turns on the Propagation timing signal on the SDI OUT connector.

CONFIG menu

The settings controlled in the Generator Status pop-up menu are duplicated in the CONFIG > Video/Gen Outputs menu. Changes made in the Generator Status pop-up menu immediately appear in the CONFIG > Video/Gen Outputs menu selections.

Waveform display

The Waveform display is a voltage versus time display of the SDI video signal. You can view the signal in line or field sweep, choose which SDI signal elements are displayed (RGB, YRGB, or YPbPr), and apply filters to the signal.

You can also display the SDI signal as if it were a composite signal and control (from the CONFIG menu) whether the EAV, SAV, and ANC data is included in the display.

To access the Waveform display

1. Press and hold the **WFM** button to open the Waveform pop-up menu.
2. Use the arrow keys to select **Display Type > Waveform**.
3. Press the **WFM** button to close the pop-up menu.

Elements of the Waveform display

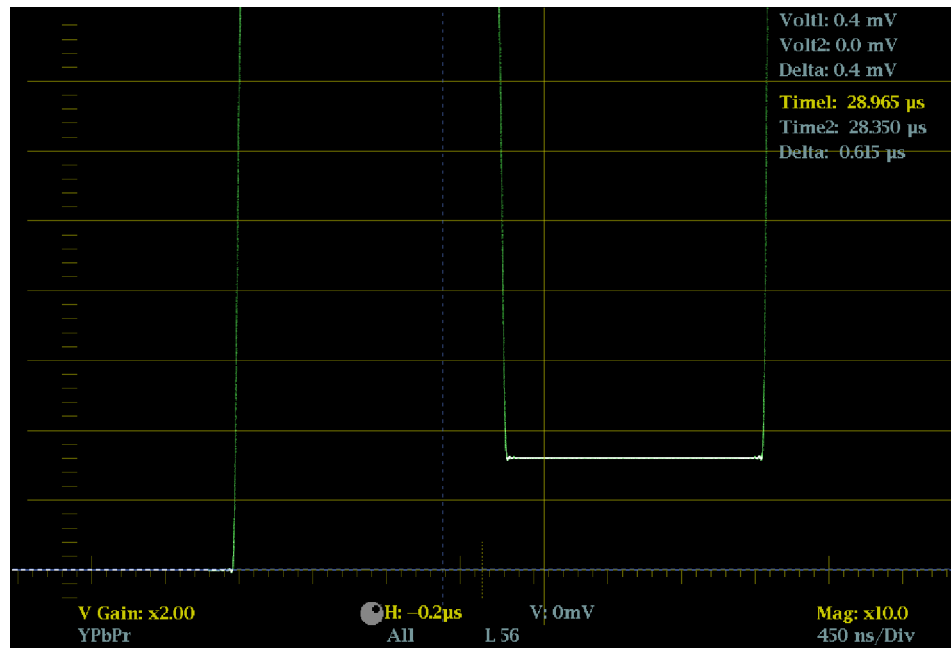

The following elements appear on the display:

- **V Gain:** Shows the current vertical gain setting when the gain is other than 1x. Press and hold the GAIN button to select a vertical gain setting. See also [MAG, GAIN, SWEEP, and CURSOR buttons](#) on page 151.
- **Mag:** Shows the current horizontal magnification factor when the magnification is other than 1x. Press and hold the MAG button to select a magnification factor. See also [MAG, GAIN, SWEEP, and CURSOR buttons](#) on page 151.

- **Horizontal axis units:** Shows the units for the tick marks on the 0 mV axis of the graticule. The axis units change depending on the sweep and magnification settings and the video input format.
- **Color space:** Shows the currently displayed waveform color space. Dashes (--) indicate components not displayed.
- **H and V positions:** When you press the POS button to adjust the position of the waveform trace, a position readout appears with a knob icon to indicate whether the horizontal or vertical position is the focus of the General knob.
- **Field and line numbers:** Shows the currently selected video field and line numbers when Line Select mode is enabled. See also [Line Select](#) on page 159.
- **Volt1, Volt2, Time1, Time2, and Delta:** Shows the current position of the voltage or time cursors and the distance between them when the cursors are enabled. See also [MAG, GAIN, SWEEP, and CURSOR buttons](#) on page 151.

Waveform pop-up menu (Waveform display)

Press and hold the WFM button to open the Waveform pop-up menu. The pop-up menu enables you to configure the display type, style, and mode used in the selected Waveform tile. The following menu selections are available:

Display type. Select from the following display types:

- **Waveform** - Displays a voltage versus time plot of the selected SDI input signal (SDI A or SDI B).
- **LTC Waveform** - Displays a voltage versus time plot of the LTC input signal (LTC IN). See [LTC Waveform display](#) on page 101.
- **Ref Waveform** - Displays a voltage versus time plot of the external reference input signal (REF IN). See [External Reference Waveform display](#) on page 92.

Display style. Select the style for how the SDI signal components are displayed:

- **Parade** - has all the components shown one beside the other.
- **Overlay** - has all the components drawn at the same location so that they appear one on top of the other.

Y, R, G, B components. Select to turn on or off the display of the individual video components: Luma (Y), Red (R), Green (G), or Blue (B).

Display mode. Select from the following display modes:

- **YPbPr** - Displays the SDI video input as Luma (Y) and color difference (Pb, Pr) components.
- **YRGB** - Displays the SDI video input as Luma (Y), Red (R), Green (G), and Blue (B) components.
- **RGB** - Displays the SDI video input as Red (R), Green (G), and Blue (B) components.
- **SDI > Composite** - Displays the SDI video input as if it is encoded into composite. The sync and burst in this mode are synthetic and convey no information about signal quality.

When viewing 525-line SDI input as a composite waveform in Line Select mode, both burst phases may appear when you would expect to see only one. This is because the line selection in SDI Mode is an odd/even selection, and composite signals are normally viewed with a one-of-four or one-of-eight line selection.

Filter. Select a filter to be applied to the video signal. This is useful for isolating a specific characteristic of the input. For example, to measure amplitude, you may want to use a Luma or Low pass filter to remove the high frequency components.

To choose a filter select one of the following filters from the Waveform menu:

- **Flat** - Display with the full available bandwidth.
- **Luma or Low Pass** - Display only the low-frequency part of the signal.

Center waveform. Select this option to cancel any horizontal or vertical position adjustments and restore the trace to the default position. This puts the baseline at the zero graticule.

CONFIG menu

Use the CONFIG menu to set the following Waveform display parameters:

- Set the **Graticules & Readouts > SDI Waveform Vertical Area** setting to **Normal** or **Max** to set the vertical limits of the display area.
- Set the **Graticules & Readouts > SDI Waveform Graticules** setting to **Normal** or **Percent** to set the measurement units for the vertical axis.
- Set the **Graticules & Readouts > Waveform Readouts** setting to **On** or **Off** to turn on or off the readouts on the Waveform display.
- Use the menu selections under **Display Settings** to set various general display parameters which affect all applicable display modes such as waveform intensity, graticule color, and enabling the thumbnail view.

MAG, GAIN, SWEEP, and CURSOR buttons

The MAG, GAIN, SWEEP, and CURSOR buttons provide functions that affect the display.

MAG button. Press the MAG button to toggle the magnification factor between 1x and the most recently selected magnification factor. Press and hold the MAG button to select fixed magnification factors (10x, 20x, 25x, or 50x) or to enable Best View mode.

In Best View mode, the horizontal magnification factor depends on the current sweep mode. For 1-field and 2-field modes, the magnification is optimized to show the blanking intervals. For 1-line and 2-line modes, the magnification is 20x or 25x to achieve a reasonable scale factor.

GAIN button. Press the GAIN button to toggle the vertical gain between 1x and the most recently selected vertical gain value. Press and hold the GAIN button to select fixed gain settings (1x, 2x, 5x, or 10x) or to enable Var Gain mode. If you enable VAR Gain mode in the Gain pop-up menu or by pressing the VAR button, you can adjust the vertical gain using the General knob.

SWEEP button. Press the SWEEP button to toggle the sweep between 1 Line and the most recently selected sweep mode. Press and hold the SWEEP button to select the display style (Parade or Overlay) and to select the sweep mode (1 Line, 2 Line, 1 Field, or 2 Field).

CURSOR button. Press the CURSOR button to toggle the measurement cursors on and off. Press and hold the CURSOR button to select the cursor style (Voltage, Time, or Voltage + Time) and to select the voltage cursor units (mV or %).

To position the Waveform trace

To adjust the position of the trace on the Waveform display:

1. Press the **POS** button.
2. Press the left or right arrow key to enable horizontal or vertical adjustments. The knob icon appears next to the selected adjustment readout. See also [Elements of the Waveform display](#) on page 148.
3. Turn the General knob or use the up/down arrow keys to adjust the position of the waveform.
4. Press the **POS** button to turn off the position adjustment mode.

Functions

This section describes the following functions of the instrument:

- Gain, sweep, and magnification
- Measurement cursors
- Display capture
- Line selection
- Audio volume and source adjustment
- Presets
- Software upgrades

Gain, sweep, and magnification

Select the gain, sweep, and magnification settings of a displayed trace using the GAIN, VAR, SWEEP, and MAG buttons. These front-panel buttons illuminate when the associated function is active.

NOTE. *The gain, sweep, and magnification functions do not apply to all of the display types. The applicable display types for each function are listed below.*

To set the gain

The gain function applies only to the Waveform, LTC Waveform, External Reference Waveform, Vector, Lightning, and Bowtie displays. The gain settings for each display type are independent of each other.

For the Vector display only, the gain is vertical and horizontal. For the other display modes, the gain is vertical only.

Gain is composed of both fixed and variable gain components. The effective gain is the fixed gain multiplied by the variable gain. Fixed gain affects both the trace and graticule. Variable gain affects only the trace.

The default gain setting is 1x. You can use the Gain pop-up menu to select one of the available fixed gain settings (such as 2x, 5x, and 10x) or you can enable variable gain mode and manually set the gain.

To select a fixed gain setting. Select a fixed gain setting by performing the following actions:

1. Press and hold the **GAIN** button to display the Gain pop-up menu.
2. Use the arrow keys to select **Gain Settings**, and then select one of the available fixed gain settings. The **GAIN** button stays illuminated when a fixed gain setting other than 1x is selected.
3. After you press the **GAIN** button to close the pop-up menu, you can then press the **GAIN** button again to toggle the gain between 1x and the last selected gain setting.

To select a variable gain setting. Select a variable gain setting by performing the following actions:

1. Enable variable gain using one of the following methods. The **VAR** button illuminates when variable gain is enabled.
 - Press the **VAR** button.
 - Press and hold the **GAIN** button to display the Gain pop-up menu. Use the arrow keys to select **VAR Gain > Enable**, and then press the **GAIN** button to close the pop-up menu.
2. Use the General knob or the up/down arrow keys to adjust the gain.
3. Press the **VAR** button to toggle the gain between the fixed gain setting and the selected variable gain setting.

NOTE. *When variable gain is enabled and a gain setting other than 1x is also selected (GAIN and VAR buttons are illuminated), the gain settings are multiplied together. For example, if variable gain is enabled and set to 1.2x, and a fixed gain of 5x is also selected, the displayed gain will be 6x (5 x 1.2). When both gain and variable gain are enabled, press the or buttons to toggle the portion of the gain associated with that button on and off.*

To set the sweep rate

The sweep function applies only to the Waveform, External Reference Waveform, and Bowtie displays. The sweep settings for each display type are independent of each other.

The default sweep setting is 1 Line. You can use the Sweep pop-up menu to select one of the available sweep settings:

1. Press and hold the **SWEEP** button to display the Sweep pop-up menu.
2. Use the arrow keys to select a line or field sweep. The available sweep options depend on which display mode is active.

For example, when the Waveform display is in Overlay mode, you can select from 1 Line, 2 Line, 1 Field, or 2 Field sweeps. When that same display is in Parade mode, only 1 Line and 1 Field sweeps are available.

3. After you press the **SWEEP** button to close the pop-up menu, you can press the **SWEEP** button again to toggle the sweep between 1 Line and the last selected sweep setting.

To set the horizontal (sweep) magnification

The magnification function applies only to the Waveform, Lightning, Bowtie, and ANC Data displays. The magnification settings for each display type are independent of each other.

Set the Waveform, Lightning, or Bowtie horizontal (sweep) magnification. The default magnification setting is 1x. Select a magnification setting by performing the following actions:

1. Press and hold the **MAG** button to display the Magnification pop-up menu.
2. Use the arrow keys to select a magnification setting. The available magnification options depend on which display mode is active:
 - For the Waveform and Bowtie displays, you can select from Best View, 10x, 20x, 25x, or 50x. The Best View setting optimizes the magnification for the selected sweep mode. For 2 Line and 2 Field sweeps, the magnification is optimized to show the blanking intervals. For 1 Line and 2 Line sweeps, the magnification is optimized to achieve a reasonable scale factor.
 - For the Lightning display, the magnification controls H Gain (horizontal gain). You can select from 2x, 5x, or 10x fixed magnifications and you can enable Variable H Gain and then use the General knob or the up/down arrow keys to adjust horizontal variable gain.
3. After you have selected a magnification setting, press the **MAG** button to close the pop-up menu.
4. You can now press the **MAG** button to toggle the magnification between 1x and the last selected magnification setting.

NOTE. For the Lightning display only, when variable H Gain is enabled and a magnification setting other than 1x is also selected, the magnification settings are multiplied together. For example, if variable H Gain is enabled and set to 1.2x, and a fixed magnification of 5x is also selected, the displayed H Gain magnification will be 6x (5×1.2).

Set the ANC data display magnification. When the ANC Data display is selected, press the **MAG** button to toggle the size of the user-data display area.

The magnification function for the ANC Data display allows you to see more of the user data at the bottom of the display or to see more of the listed data types at the top of the display.

Measurement cursors (Waveform display only)

The measurement cursors are available only for the Waveform display. The cursors enable you to accurately measure desired portions of the displayed waveform.

Cursor types

There are two types of measurement cursors:

- **Time:** There are two cursors for measuring time along the horizontal axis of the waveform.
- **Voltage:** There are two cursors for measuring voltage levels along the vertical axis of the waveform. You can set the units for the voltage cursors to be either millivolts or percentage. When the cursors units are set to percentage, you can set the current cursor position to be the 100% level.

The cursor readouts display the current position of each cursor and also the difference between them.

To display and adjust the cursors

Perform the following steps to display and adjust the measurement cursors in the Waveform display:

1. Select which cursors to display and set the cursor units:
 - a. Press and hold the **CURS**OR button to open the Cursor pop-up menu.
 - b. Use the arrow keys to set the **Cursor Style** to one of the following:
 - **Voltage:** Displays only the two voltage cursors.
 - **Time:** Displays only the two time cursors.
 - **Voltage + Time:** Displays both the voltage and time cursors.
 - a. For voltage cursors only, use the arrow keys to set the **Voltage Cursor Units** to one of the following:
 - **mV:** Sets the cursor units to millivolts.
 - **%:** Sets the cursors units to percentage.
 - a. Press the **CURS**OR button once to close the pop-up menu. The enabled measurement cursors will be displayed and the **CURS**OR button will remain illuminated.

- Use one of the following methods to select which measurement cursor to adjust. A knob icon appears next to the selected measurement cursor to indicate that the knob focus is set to that cursor.

NOTE. *If the knob icon does not appear next to a cursor measurement, press the CURSOR button to assign knob control to the cursors (make the cursors active).*

- If only voltage cursors are enabled or if only time cursors are enabled, press any arrow key to select between the two displayed measurement cursors.
 - If voltage cursors and time cursors are both enabled, press the up/down arrow keys to select between the two voltage cursors, and press the left/right arrow keys to select between the two time cursors.
- Turn the **GENERAL** knob to adjust the position of the selected cursor. The active cursor readout appears in yellow.

NOTE. *To quickly center the active cursor on screen, press and hold the button. If the voltage cursor units are set to percentage, you can use the Cursor pop-up menu to set the current position of the selected voltage cursor to be 100%.*

- Repeat steps 2 through 3 to adjust the position of the other enabled cursors.
- Read the cursor measurements in the Cursors readout.

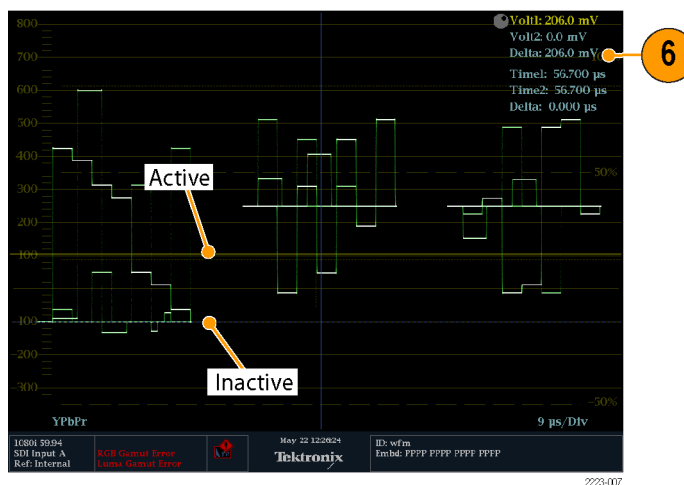

Figure 52: Using measurement cursors in the Waveform display

Display capture (freeze)

The capture (freeze) function essentially lets you take a snapshot of the display. Use the **CAPTURE** button to perform the following tasks:

- Freeze a single tile
- Freeze all tiles simultaneously

NOTE. *The frozen information is lost when the instrument power is cycled.*

Use the CONFIG > Display Settings > Freeze Affects submenu to configure the freeze function to capture all of the displayed tiles or to only capture the active (selected) tile.

The freeze function works in both 4-tile and full-screen modes but does not transfer when you change modes. For example, if you freeze a trace in 4-tile mode, the frozen image will not be shown if you go to full-screen mode. The image will still be available if you go back to 4-tile mode.

If you freeze an image in a tile and then switch that tile to another display mode (such as Vector), the frozen image is hidden. If you then change the tile back to the original display mode type, the frozen image will reappear.

NOTE. *For waveform displays, the captured image is shown in a different color to distinguish it from the live image. For all displays, the instrument continues to log error status in the background while the display is captured.*

Remote screen capture

You can also use the instrument remote interface to capture a snapshot of the instrument display or status bar in BMP or PNG formats. To connect to the remote interface, enter the IP address of the instrument into the URL address bar of a Web browser.

Before you can connect to the remote interface, use the CONFIG > Network Settings > Web Enable submenu to enable access to the remote interface.

Line Select

The Line Select function allows you to select which video line to view in the Waveform, Vector, Lightning, Arrowhead, Diamond, Split Diamond, Bowtie, and Datalist displays.

NOTE. *In the Picture display, the selected video line is highlighted in the picture image when the Picture Line Select Cursor is enabled in the CONFIG > Graticules & Readouts submenu.*

In full screen mode, when you enable Line Select and select a video line in one display (for example, the Waveform display), if you then select another applicable display type using the display-mode buttons (for example, the VECTOR button), the new display will automatically view the same video line. If you select another display mode using the DISPLAY SELECT button, you will have to enable Line Select for that display mode to view the same video line.

In 4-tile mode, you must enable Line Select for each applicable display type. When enabled, each applicable display type will show the same video line. If the Waveform display is set to field sweep and it is one of the display modes in a 4-tile display, the selected video line is highlighted in the field sweep when the Field Sweep Line Select Cursor is enabled in the CONFIG > Graticules & Readouts submenu.

Perform the following steps to select a video line to view:

1. Select the tile containing the display for which you want to enable Line Select.

NOTE. *Line Select mode can only be active on one tile at a time, but the line select brightup cursor does appear in other tiles and moves as you select lines in the active tile.*

2. Press the **LINE SEL** button to toggle Line Select on or off. When on, the tile displays the selected line information only.
3. Press the left or right arrow key to select **F1** (field 1), **F2** (field 2), or **All**. See also [Figure 53: Navigating line selection](#) on page 160.

NOTE. *For dual link signals in fast progressive video formats, use the arrow keys to select fields. In the Datalist display, press the button to toggle between Line Select and Sample Select.*

4. The line and field information will appear at the bottom of the display screen.
5. Use the General knob or the up/down arrow keys to select a video line to view.

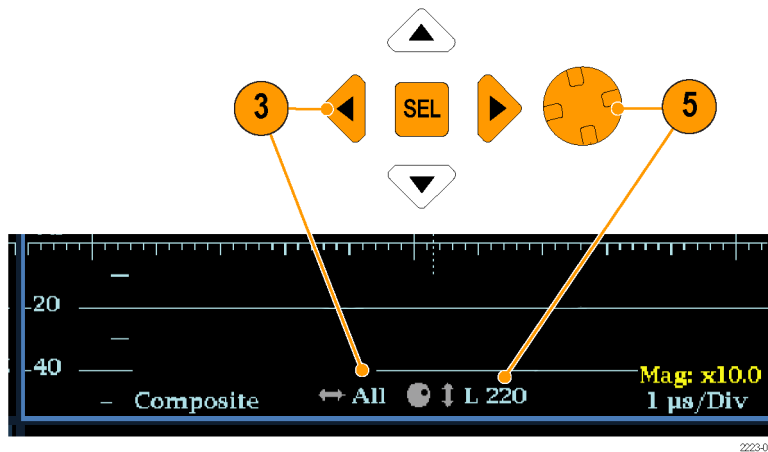

Figure 53: Navigating line selection

Audio volume and source adjustment

To listen to the audio in an input signal, the instrument provides internal speakers and a headphone jack, which is located on the right side panel. When headphones are connected to the instrument, the internal speakers are muted.



WARNING. To prevent the risk of hearing damage, always turn down the audio volume before connecting headphones to the headphone jack. Sound levels and impedance can vary between different headphones.

To adjust the audio volume

You can use any of the following methods to adjust the volume of the audio played out on the instrument speakers or the headphone jack:

- When the Audio display is selected and no menus are active, turn the General knob.
- When a display mode other than Audio is selected, press the **VOL** button and then use the General knob or the up/down arrow keys.
- Select the **CONFIG > Audio Inputs/Outputs > Headphone Volume** submenu item and then use the General knob or the up/down arrow keys.
- At any time, press and hold the **VOL** button to toggle audio muting. A red “X” appears over the speaker icon in the Status Bar when audio is muted.

NOTE. When monitoring high-amplitude audio, volume levels over 90% may cause audio clipping.

- To select the audio source** You can use the following methods to select the source of the audio played out on the instrument speakers or the headphone jack:
- When the audio input is embedded, press the **INPUT A** or **INPUT B** buttons to set the audio source to be from the SDI A or SDI B video input signal.
 - When the Audio display is selected, use the Audio pop-up menu to set the Audio Input source to be from the embedded audio on the selected video input or to be from the AES audio input.

Presets

Instrument setups can become complex as you tailor them to monitor various parameters. To save set up time and ensure consistency, you can save instrument setups as presets in your instrument. You can save and quickly access presets using the **PRESET** button on the instrument front-panel and from the instrument Web page.

All instrument settings except those set in the Utilities and Network Settings submenus of the Configuration menu are saved in a Preset. Settings that are not saved are those such as the clock setting, IP configuration, and network address. The following is an overview of the settings saved in a Preset:

- Measurement assigned to each tile
- Tile specific settings
- Input selection
- SDI Input settings
- External Reference settings
- Audio Displays settings
- Audio Inputs/Outputs settings
- Alarm settings
- Gamut thresholds
- Display settings
- Readout setting
- Graticule settings

- Preset groups** The instrument can store up to 32 separate instrument presets. The presets are divided into four groups, A through D, with each group containing 8 preset storage locations. By default, the presets are named after their storage location (A1 – A8, B1 – B8, C1 – C8, and D1 – D8).

When the instrument is in Preset mode, the display mode buttons under the LCD display (WFM, VECTOR, PICT, etc.) illuminate and serve as the selection buttons for the storage locations within the selected preset group. Also, the contents of the Status Bar are replaced by boxes representing each preset in the selected group. If a preset location in that group has been saved, the box representing that location contains the name of the saved preset. Preset locations that have not been saved are indicated by <empty> in blue text.

In Preset mode, only one group of presets can be displayed at a time. Use the Preset pop-up menu to select which preset group (A – D) will be displayed when the instrument is in Preset mode. You can use the Preset pop-up menu to directly access any preset group and location.

To save presets

Perform the following steps to save the current instrument settings as a preset:

1. Set up the instrument exactly as you want to have it configured. This includes setting the contents of each tile and the audio and video settings.
2. Press and hold the **PRESET** button to open the Preset pop-up menu.
3. Use the arrow keys to select **Save Preset** and then to navigate to the desired preset location. For example, select Save Preset > Select Group B > Save B1.
4. Press the **SEL** button to save the preset. A message displays that your preset is saved.
5. Press the **PRESET** button to close the pop-up menu.

NOTE. *Once you have saved various instrument configurations as presets on one instrument, you can export the saved presets to a USB device so that you can import them to another instrument.*

To rename groups or presets

By default, the preset groups are named A through D and each preset is named after the storage location (A1 – A8, B1 – B8, C1 – C8, and D1 – D8). To rename a preset group or a preset to a meaningful name, perform the following steps:

1. Press and hold the **PRESET** button to open the Preset pop-up menu.
2. Use the arrow keys to select **Rename Preset** and then to navigate to the desired group and preset location. For example, select Rename Preset > Select Group B > Rename B1.
3. Press the **SEL** button or the right arrow key to open the Rename Preset edit box.
4. Use the left/right arrow keys to select a character in the name, and then use the up/down arrow keys to set the value of the selected character. Repeat for each character in the name.
5. After you have edited the name, select the **Accept** box and press the **SEL** button.

6. Repeat steps 2 through 5 for each preset or group that you want to rename.
7. Press the **PRESET** button to close the pop-up menu.

To recall presets

There are three methods for recalling saved presets:

- Press the **PRESET** button, and then use the display mode buttons under the LCD display (WFM, VECTOR, PICT, etc.) to select a preset from the displayed preset group.
- Press and hold the **PRESET** button to open the Preset pop-up menu, and then use the arrow keys to select a saved preset from any of the four preset groups or to recall the factory default preset. Press the **SEL** button to activate the selected preset.
- Use the Preset pop-up menu to select which preset is activated when the instrument is powered on.

To configure the power on preset. Perform the following steps to select which instrument preset is activated when the instrument is powered on:

1. Press and hold the **PRESET** button to open the Preset pop-up menu.
2. Use the arrow keys to select **Power Up Setup**. The name of the currently selected power on preset is displayed in blue text.
3. Use the arrow keys to navigate to the desired preset. For example, select Power Up Setup > Select Group B > Select B1.

NOTE. You can select any saved preset from any of the four preset groups, or the factory default preset, or the last state of the instrument when it was powered down to be the power on preset.

4. Press the **SEL** button to select the preset. The name of the selected power on preset is displayed in blue text.
5. Press the **PRESET** button to close the pop-up menu.

To export presets to a USB device

Once you have saved various instrument configurations as presets on an instrument, you can export the saved presets to a USB device so that you can import them to another instrument.

The instrument saves the presets to the subfolder you specify in a root directory folder named WfmPrst on the USB device.

Perform the following steps to export the saved presets to a USB device:

1. Insert a USB memory device into the USB port located on the top panel of the instrument.
2. Check that the USB memory device mounted properly:
 - a. Press the **MAIN** button to open the Main pop-up menu.
 - b. Use the arrow keys to select **USB Status**, and then press the **SEL** button.
 - c. Check that the Device State is **Mounted**, and then press the **SEL** button.
 - d. Press the **MAIN** button to close the Main pop-up menu.
3. Press and hold the **PRESET** button to open the Preset pop-up menu.
4. Use the arrow keys to select **Export Presets** and then **Select Source**.
5. Select one of the following preset sources, and then press the **SEL** button to select the preset source.
 - **Select All:** Selects all of the presets in the instrument.
 - **Select Group A – D:** Selects all of the presets in the selected preset group.
 - **From Group A – D:** Selects a single preset from any of the four preset groups.
6. Use the arrow keys to select **Export Presets** and then **Select Dest**.
7. Select a folder on the USB memory device if one exists or create a new folder by selecting **Create USB Folder** and then using the Create USB Folder edit box to name the new folder.

NOTE. *The instrument saves the presets to the subfolder you specify in a root directory folder named WfmPrst on the USB device. If the WfmPrst folder does not exist on the USB device, no folders will be shown as available in the Preset menu. When you select Create USB Folder, the WfmPrst root directory is automatically created during the save process if the directory does not already exist on the USB device.*

After you specify a subfolder on the USB device, you must then select the appropriate preset destination folder. The list of available preset destination folders depend on the source settings.

8. In the same Select Dest submenu, navigate to the desired destination folder and press the **SEL** button.
9. Press the left arrow key and then the down arrow key to highlight **Copy**.
10. Press the **SEL** button. You should see a pop-up message that says **Preset Export Complete** after the copy-to-USB function is complete.

11. If you do not want to export any other presets at this time, select **Export Presets** and then select **USB Unmount**.



CAUTION.

To prevent a loss of data on the USB device, use the Main menu or the Preset pop-up menu to unmount the USB device before removing it from the instrument.

12. When the USB Unmount menu selected disappears, remove the USB memory device from the USB port on the instrument.
13. Press the **Preset** button to close the Preset pop-up menu.
14. Perform the import presets procedure to import the saved presets to another WFM2200 instrument. See also [To import presets from a USB device](#) on page 165.

To import presets from a USB device

After you have saved the presets from one instrument to a USB memory device, perform the following steps to import those saved presets to another instrument:

NOTE. *The instrument imports presets from subfolders in a root directory folder named *WfmPrst* on the USB device.*

1. Insert the USB memory device onto which you saved presets from one WFM2200 into the USB port of another WFM2200.
2. Check that the USB memory device mounted properly:
 - a. Press the **MAIN** button to open the Main pop-up menu.
 - b. Use the arrow keys to select **USB Status**, and then press the **SEL** button.
 - c. Check that the Device State is **Mounted**, and then press the **SEL** button.
 - d. Press the **MAIN** button to close the Main pop-up menu.
3. Press and hold the **Preset** button to open the Preset pop-up menu.
4. Use the arrow keys to select **Import Presets** and then **Select Source**.
5. Use the arrow keys to select **Select USB Folder** and then highlight the folder on the USB device that contains the presets exported from another WFM2200. Press the **SEL** button to select the preset folder.
6. Select from the following preset sources, and then press the **SEL** button to select the preset source.
 - **Select All:** Selects all of the presets in the USB folder.
 - **Select Group A – D:** Selects all of the presets in the USB folder from the selected preset group.
 - **From Group A – D:** Selects a single preset from any of the four preset groups.

7. Use the arrow keys to navigate to the **Select Dest** menu option and use the arrow keys to access the submenu.
8. Navigate to the preset group that matches the source preset group and press the **SEL** button.
9. Press the left arrow key and then the down arrow key and highlight **Copy**.
10. Press the **SEL** button. You should see a pop-up notice that says **Import Presets Complete**.
11. If you do not want to export any other presets at this time, select **Import Presets** and then select **USB Unmount**.



CAUTION.

To prevent a loss of data on the USB device, use the Main menu or the Preset pop-up menu to unmount the USB device before removing it from the instrument.

12. When the USB Unmount menu selected disappears, remove the USB memory device from the USB port on the instrument.
13. Press the **Preset** button to close the Preset pop-up menu.

Alarms

Alarms can be configured so that your instrument automatically monitors parameters and reports when those parameter limits are exceeded. The procedures that follow describe how to configure response types for individual alarms, how to enable them, and how to monitor them.

Alarms may need to be configured in the Configuration menu. They are initially set to factory defaults. Do the first procedure in this section (if alarm configuration is needed) before doing the audio monitoring procedures. (See also [Audio monitoring](#) on page 221.)

Possible alarm responses

For each available alarm, you can select up to four of the responses listed. If you do not select a notification method for an error, you will not be notified if that error occurs.

- **Screen Text/Icon.** An icon appears on the display. This notification method is disabled when the Configuration menu is open. This option also enables alarm reporting with color on the Status screen.
- **Logging.** The instrument makes an entry in the Event Log. See also [Status displays](#) on page 108.

- Beep. The instrument makes an audible alarm.
- SNMP Trap. The instrument sends an SNMP trap out the Ethernet port for a remote notification that an alarm condition occurred. You must enable and configure the instrument for SNMP control using the Network Settings submenu of the Configuration menu before SNMP traps can be sent. Refer to the *WFM and WVR Management Information Base (MIB) Technical Reference* for more information about using SNMP alarm notifications.

NOTE. Alarms can be monitored in the Alarm Status display.

To set allowed alarm responses

The following procedure allows you to select what type of alarm response you want for each alarm category:

1. From the CONFIG menu, select **Alarms**.
2. Navigate to the alarm category that you want to configure. For example, **Video Format**.
3. Note that the alarms in the category you select appear to the right as you highlight the alarm category. Press **SEL** to display a table that allows you to set the responses for individual alarms.
4. For each alarm listed in the table, select the box to place (or remove) an X in the box under each response that you want enabled (or disabled) for that alarm. See *Possible alarm responses* on page 166.
5. Navigate to highlight the **Return** box, and press the **SEL** button to return to the Configuration menu.

Repeat these steps to configure other alarm categories.

To set alarm responses globally

The following procedure allows you to set alarms for all alarm categories to the setting on the global mask:

1. From the CONFIG menu, select **Alarms**.
2. Navigate to **Set all Alarms to this Mask**.
3. Press **SEL** to display a table for setting the allowed responses for alarm settings to be applied to all alarm categories.
4. For each alarm listed in the table, select the box to place (or remove) an X in the box under each response that you want enabled (or disabled) for that alarm. *G-Possible.Alarm.Responses*
5. Navigate to highlight the **Return** box, and press the **SEL** button to return to the Configuration menu.

To enable alarms The channels for which you enable alarms trigger your previously defined alarm responses. See *To set allowed alarm responses* on page 167.

1. From the CONFIG menu, select **Enable Alarms** and toggle it to **On**. This turns on all alarms that are individually enabled and provides a quick way to switch them on and off without changing their individual settings.
2. Also, for Audio inputs, you must enable alarms individually by channels. To start, select **Audio Inputs/Outputs** in the CONFIG menu.
3. Select each input shown in the box to individually enable its alarms. AES A is shown selected.
4. For each of the AES, Analog, and Embedded inputs, select **Bar to Input Map** and press the **SEL** button to display the **Bar to Input map** menu.
5. Navigate to each box for each alarm that you want to allow. Press the **SEL** button to enable it (when enabled, there is an **X** in the box) or disable it (when disabled, the box is blank) for each channel displayed.
6. Select the **Return** box, and press the **SEL** button to return to the CONFIG menu.
7. For Dolby 1 - 4, you must also enable alarms individually. (Requires Option DPE.)
8. Select the **Dolby Fmt Expected**, **Dolby E Pgm Mask** and/or **Dolby Chan** and configure them as you want.

To set limits or qualifications Some alarms require setting a threshold or condition that triggers the alarm.

1. Select **Alarm Thresholds** in turn, for both the **Analog Audio Displays** and **Digital Audio Displays**.
2. For each selection in the previous step, set the following alarm thresholds that trigger an alarm when exceeded:
 - Clip Samples: number of consecutive samples at the all-high level.
 - Mute Samples: number of consecutive all-zero samples.
 - Silence Level: the level below which audio is considered not present.
 - Silence Duration: the length of audio silence time allowed.
 - Over Level: the too-loud audio level.
3. For Closed Caption related alarms, select **Aux Data Settings** and then the desired CC type.
4. Select the required services for the desired CC type and select the CC channels and/or Text channels for which you want to trigger the CC Services Missing Alarm.
5. For SDI Gamut display related alarms, select **Gamut Thresholds** and then the desired gamut thresholds.

Monitoring alarms

After defining and enabling alarms, you can quickly check if any error condition exists by looking (or listening) for the notification you defined (text, icon, logging, SNMP trap, beep). Selecting audible response (Beep) can help you notice alarms that you may miss if the notification is text or icon only. (See [Status bar icons](#) on page 40 and [To set allowed alarm responses](#) on page 167 for more information.)

To check the condition of a specific alarm, press the **STATUS** button. In the Status menu, select **Display Type** and then select **Alarm Status**. One or more of the following appear:

Indicator	Description
Disabled (gray)	Alarm is not selected for reporting, but still shows if the error is present.
OK (green)	Alarm is enabled for reporting and has not detected errors for at least 5 seconds.
Error (yellow)	Alarm condition cleared for less than 5 seconds.
Error (red)	Alarm triggered now.

NOTE. *To monitor alarms remotely, use a PC to monitor SNMP traps over the Ethernet port (the PC must have SNMP trap service installed). Before SNMP traps can be sent, you must enable and configure the instrument for SNMP control using the Network Settings submenu of the Configuration menu.*

Alarm descriptions

The following tables describe the alarms that may be set for the waveform monitors.

Table 17: Video content alarms

Alarm	Description
RGB Gamut Error	Indicates that the selected video input signal contains colors that violate the currently set limits for RGB gamut, which are specified by the Diamond gamut thresholds.
Composite Gamut Error	Indicates that the selected video input signal contains colors that violate the currently set limits for composite gamut, which are specified by the Arrowhead gamut thresholds.
Luma Gamut Error	Indicates that the selected video input signal contains luminance levels that violate the currently set limits for Luma gamut, which are specified by the Luma gamut thresholds.

Table 18: Video format alarms

Alarm	Description
Video Format Change	Indicates that a change occurred in the format of the selected video input signal.
Video Format Mismatch	Indicates that the signal format detected on the selected video input differs from the configured Input Format setting (which is set to a specific line rate rather than being set to Auto) or that the format detected differs from the setting specified in the SMPTE 352 payload identifier (if preset).
Video Not HD	Indicates that the selected SDI video input signal is not in HD format.
Dual Link Format Mismatch	Indicates that the detected format of the Dual Link signal does not match the Lock to Standard setting in the Dual Link submenu of the CONFIG menu.
SMPTE 352M (VPID) Error	Indicates that the SMPTE 352 payload (Format ID) is not present in the signal.
Line Length Error	Indicates that the length of a video line differs from that expected for the detected video format.
Field Length Error	Indicates that the length of a video field differs from that expected for the detected video format.
EAV Placement Error	Indicates that the location of the EAV (End of Active Video) timing reference signal differs from that expected for the detected video format.
SAV Placement Error	Indicates that the location of the SAV (Start of Active Video) timing reference signal differs from that expected for the detected video format.
Line Number Error	For HD signals, indicates that the encoded line number differs from the counted line number.

Table 19: Reference input alarms

Alarm	Description
Ref Format Mismatch	Indicates that the detected format of the external reference input does not match the Lock to Format setting in the Ext Ref submenu of the CONFIG menu.
Video Ref Mismatch	Indicates that the detected format of the external reference signal is not compatible with the input signal format as defined in the instrument specifications.
External Reference Missing	Indicates that no signal is detected on the external reference input when REF EXT is selected.
External Reference Unlocked	Indicates that the instrument cannot lock to the external reference signal when REF EXT is selected. This is usually due to a wrong or unsupported video standard.
Reference Genlock Unlocked	Indicates that the instrument cannot lock to the generated reference signal.

Table 20: Digital input alarms

Alarm	Description
Input Missing	Indicates that no signal is detected on the selected SDI input.
Input Unlocked	Indicates unable to lock to selected SDI input signal.
AP CRC Alarm	For SD signals, indicates that the RP165 AP (active picture) CRC embedded in the data stream differs from the calculated CRC value or that it has been marked as invalid in the EDH packet, indicating there are EDH errors in the active picture.
FF CRC Alarm	For SD signals, indicates that the RP165 FF (full field) CRC embedded in the data stream differs from the calculated CRC value that it has been marked as invalid in the EDH packet, indicating there are EDH errors in the full field.
EDH Alarm	For SD signals, indicates that EDH (error detection and handling) has detected an error.
Y Chan CRC Error	For HD signals, indicates that the embedded CRC value for a line's Y (luminance) samples differs from the calculated CRC, and therefore a transmission error has occurred.
C Chan CRC Error	For HD signals, indicates that the embedded CRC for a line's C (chrominance) samples differs from the calculated CRC, and therefore a transmission error has occurred.
Y Anc Checksum Error	For HD signals, indicates that the embedded checksum in a Y (luminance) ancillary data packet differs from the calculated checksum, and therefore a transmission error has occurred.
C Anc Checksum Error	For HD signals, indicates that the embedded checksum in a C (chrominance) ancillary data packet differs from the calculated checksum, and therefore a transmission error has occurred.
Y Anc Parity Error	For HD signals, indicates that the Y channel ancillary parity bit does not match the calculated parity bit value, and therefore a transmission error has occurred.
C Anc Parity Error	For HD signals, indicates that the C channel ancillary parity bit does not match the calculated parity bit value, and therefore a transmission error has occurred.
Dual Link Timing Error	For HD signals, indicates that the relative timing between Link A and Link B (of a dual link signal) exceeds the user-defined threshold.

Table 21: ASI input alarms (WFM2300 Option ASI)

Alarm	Description
TS Sync Loss	Indicates a loss of synchronization per ETSI TR 101 290 First Priority 1.1.
Sync Byte Error	Indicates that Sync_byte is not equal to 0x47 per ETSI TR 101 290 First Priority 1.2.
Continuity Counter Error	Indicates an incorrect packet order or that a packet occurs more than twice or that a packet is lost per ETSI TR 101 290 First Priority 1.4.

Table 22: Timecode alarms

Alarm	Description
LTC Invalid	Indicates that the LTC was lost for one frame but has reappeared.
LTC Missing	Indicates that a break or discontinuity in the LTC has occurred.
VITC Invalid	Indicates that the VITC was lost for one frame but has reappeared.
VITC Missing	Indicates that a break or discontinuity in the VITC has occurred.
Anc LTC Invalid	Indicates that the Ancillary Time Code was lost for one frame but has reappeared.
Anc LTC Missing	Indicates that a break or discontinuity in the Ancillary Time Code has occurred.
Anc VITC Invalid	Indicates that the Ancillary VITC was lost for one frame but has reappeared.
Anc VITC Missing	Indicates that a break or discontinuity in the Ancillary VITC has occurred.

Table 23: Audio content alarms

Alarm	Description
Audio Clip	Indicates that the number of times the audio level in each channel was at the digital code for the maximum amplitude has exceeded the threshold for the number of consecutive, full-scale digital audio samples specified by the Clip Samples setting in the CONFIG menu.
Audio Mute	Indicates that the number of times the audio level in each channel was at the digital code for the minimum amplitude has exceeded the threshold for the number of consecutive digital audio samples specified by the Mute Samples setting in the CONFIG menu.
Audio Over	Indicates that the audio level in each channel has exceeded the level specified by the Over Level setting in the CONFIG menu for more time than specified by the Over Duration setting in the CONFIG menu.
Audio Silence	Indicates that the audio level in each channel has fallen below the level specified by the Silence Level setting in the CONFIG menu for more time than specified by the Silence Duration setting in the CONFIG menu.
Audio Phase	Indicates that the audio channel pairs are considered to be out of phase as configured by the Phase Err Corr setting in the CONFIG menu (defines the percentage of correlation error) and by the Phase Err Duration setting in the CONFIG menu (sets the amount of time the error must occur before the alarm is triggered).
Audio Channel Loud	Indicates that the audio signal has exceeded the level specified by the Channel Loud setting in the CONFIG menu. The default value is set to 0 LKFS and can range from -30 to 0 LKFS.
Audio Program Loud	Indicates that the audio signal has exceeded the level specified by the Program Loud setting in the CONFIG menu. The default value is set to 0 LKFS and can range from -30 to 0 LKFS.
Audio Session Loud	Indicates that the infinite loudness lies outside the target range (Target Loudness setting + Target/DN Delta setting in the CONFIG menu).
Audio Program Quiet	Indicates that the audio signal has fallen below the level specified by the Program Quiet setting in the CONFIG menu and is considered too quiet. The default value is set to -36 LKFS and can range from -60 to 0 LKFS.
Audio Session Quiet	Indicates that the infinite loudness lies outside the target range (Target Loudness setting - Target/DN Delta setting in the CONFIG menu).
Dialnorm Mismatch	Indicates that the dialnorm (dialog normalization) level indicated in the Dolby Metadata does not match the specified Target Loudness setting in the CONFIG menu. The default value is set to -24 LKFS and can range from -31 to 0 LKFS.

Table 24: AES/Embedded audio alarms

Alarm	Description
Audio Signal Loss	Indicates that the instrument has lost the incoming audio signal on the indicated input channel.
AES CRC Error	Indicates that the AES channel status CRC as calculated by the instrument does not agree with the CRC embedded in the channel status bytes.
AES Validity Bit	Indicates that the Validity bit is set high for one or more AES audio samples. In the AES/EBU standard, a set validity bit indicates that the sample is not suitable for conversion to audio.
AES Parity Error	Indicates that the incoming subframe does not have an even parity bit as specified by the applicable digital audio standards. The data sample is considered unreliable and is ignored.
AES Z Preamble Error	Indicates that the Z-bit in the embedded audio packet is missing or does not occur every 192 frames.
Embed Audio Stream Missing	Indicates that no embedded audio stream is detected in the selected SDI input.
Embed Audio Checksum	Indicates that the checksum present in the embedded audio stream does not match the calculated checksum and is therefore invalid.
Embed Audio Parity	Indicates that the incoming subframe does not have an even parity bit as specified by the applicable digital audio standards. The data sample is considered unreliable and is ignored.
Embed Audio Control Missing	Indicates that the Audio Control Packet, which contains information on the audio frame number, sampling frequency, active channels, and relative audio-to-video delay of each channel, is not present in the signal.

Table 25: Dolby audio alarms

Alarm	Description
Dolby Format Mismatch	Indicates that the Dolby Content for the Dolby input being monitored does not match the Dolby Format (D or E) setting in the CONFIG menu for that input (one of Dolby 1 through Dolby 4). If the Dolby Format is set to AUTO in the CONFIG menu, this alarm indicates that the audio format at the Dolby input is not Dolby, but is instead PCM. This alarm is logged and appears in the Error Log of the STATUS display.
Dolby E Video Sync Error	For Option DPE only, indicates that the Dolby E stream frame rate for the Dolby input being monitored is not the same as the Video Frame rate of the active video input.
Dolby E Frame Location	Indicates that the timing relationship between the start of the video and the start of the Dolby E frame exceeds the SMPTE RDD6 specified threshold.
Dolby PA Alignment	Indicates an alignment error between the left and right Dolby channels.
Dolby CRC Error	Indicates a cyclic redundancy code (CRC) error has been detected in the Dolby content.

Table 26: Closed Captions/Teletext alarms

Alarm	Description
Closed Caption Missing	Indicates that one or more of the required Closed Caption (CC) formats (as set in the CONFIG menu) are not present in the selected video input signal. An empty stream consisting only of null data is considered valid.
CEA608 Service(s) Missing	Indicates that one or more of the services selected for the CEA608 Required Services setting in the CONFIG menu is not present in the current closed caption data stream.

Alarm	Description
CEA608 Protocol Error	<p>Indicates a data error in a CEA608 payload of a CC data stream, applying to all forms of CEA608 (Line 21 or ANC). Excludes errors in the CEA708 Caption Data Packet (CDP). Alarm message definitions:</p> <ul style="list-style-type: none"> ■ XDS on Field 1: Packets containing XDS were encountered in field 1 of the CEA608 data stream. ■ Bit 1 in Control Word Invalid: A control word was encountered where Bit 1 did not match the field. ■ Ctrl Char in Second Word: A control word was found in the second word of a two-byte CEA608 packet. ■ CC in F2 But Not F1: CEA608 packets are present in F2 but missing in F1. ■ CEA608 Parity Error: A parity error was encountered in the CEA608 data stream. ■ Multiple Errors: Multiple errors were detected.
CEA708 Service(s) Missing	<p>Indicates that one or more of the services selected for the CEA708 Required Services setting in the CONFIG menu is not present in the current closed caption data stream.</p>
CEA708 Protocol Error	<p>Indicates that a parity, checksum, or CRC error (or other similar error) is detected in a CEA708 payload of a CC data stream, applying to all forms of CEA708 (Line 21 or ANC). Alarm message definitions:</p> <ul style="list-style-type: none"> ■ CEA708 Sequence Error: A continuity error was detected at the CEA708 protocol layer. ■ CEA708 Reserved Word: A reserved field was not set to the proper default value. ■ CEA708 SVCI-6 Coding Error: Services 1 through 6 were incorrectly coded as an auxiliary service. ■ CEA708 Svc Block Truncated: The CEA708 service block does not fit in the CEA708 data packet. ■ CEA708 Bac Command: An invalid command was encountered.
WST Page(s) Missing	<p>Indicates that one or more of the selected for the Teletext Required Services in the CONFIG menu is not present in the current caption stream.</p>
WST Protocol Error	<p>Indicates that there is an error in a VBI WST signal or in the WST protocol layer. Alarm message definitions:</p> <ul style="list-style-type: none"> ■ Error in Magazine/Packet Index: A Hamming-code error was encountered in the first two bytes of a teletext packet. ■ Error in Packet 0 Data: A Hamming-code error was encountered in the header data in a "row 0" packet. ■ Parity Error in Text: A parity error was detected in the teletext data.
VBI (Line 21) CC Missing	<p>Indicates that the CEA608 VBI captions are missing in the selected video input signal. The alarm is not active for HD, DL, or 3G signals.</p>
VBI (WST) Missing	<p>Indicates that World System Teletext (WST) VBI teletext packets are not present for SD and composite signals.</p>
ANC (SMPTE 334M) CC Missing	<p>Indicates that there are no ANC (SMPTE334M) captions in the selected video input signal. The alarm is not active for analog signals.</p>

Alarm	Description
Caption Data Packet Error	<p>Indicates that the Parity, Checksum, or Protocol data are present in the CEA708 Caption Data Payload. Alarm message definitions:</p> <ul style="list-style-type: none"> ■ CDP Checksum Error: The checksum in the caption data packet was not correct. ■ CDP Packet Length Mismatch: The indicated packet length was too long and/or data was missing. ■ CDP Frame Rate Mismatch: The frame rate indicated in the CDP does not match the video. ■ CDP Marker Bits Invalid: One or more “market bits” fields in the CDP were incorrect. ■ Invalid CDP Header: The CDP header code was invalid or missing. ■ Invalid CDP Footer: The CDP footer code was invalid or missing. ■ CDP Frame Rate Invalid: The frame rate was incorrectly coded. ■ CDP Packet Sequence Error: A discontinuity was detected in the received CDP packet. ■ CDP Timcode Error: The SMPTE timecode embedded in the CDP was incorrectly formatted. ■ CDP Header Mismatch: A section that was marked as present in the header is missing, or a section that was marked as missing in the header is present. ■ CDP Data Mismatch: The number of CC_DATA sections is incorrect for the indicated format. ■ Multiple Errors: Multiple error were detected.
OP47 (Anc Teletext) Missing	<p>Indicates that the instrument did not find a valid Operational Practice 47 (SDP or multi) data packet in the ancillary data space of the HD signal.</p>
OP47 Protocol Error	<p>Indicates an error is detected in the OP47 protocol layer. This alarm is generated in the following cases:</p> <ul style="list-style-type: none"> ■ Embedded teletext packets out of sequence ■ Incorrect header or footer ■ Reserved field used ■ Encoded teletext run-in missing or corrupt ■ Packet corrupt or truncated (size of packet wrong) ■ Missing data ■ Continuity error ■ Checksum error
S2031 Missing	<p>Indicates that the instrument did not find a valid SMPTE 2031 ANC data packet in the ancillary data space.</p>
S2031 Protocol Error	<p>Indicates that an error was detected in the SMPTE 2031 protocol layer.</p>

Table 27: Metadata alarms

Alarm	Description
XDS Error (CEA608)	<p>Indicates that the Parity, Checksum, or Protocol data in an Extended Data Services packet is incorrect. Alarm message definitions:</p> <ul style="list-style-type: none"> ■ XDS on Field 1: XDS packets are transmitted on field 1 of the video (they are only permitted on field 2). ■ Invalid XDS Command: An improperly formatted XDS command was issued. ■ XDS Buffer Overflow: An XDS command with greater than 32 bytes of payload was encountered. ■ XDS Odd Packet Length: An XDS packet with odd length was encountered. ■ XDS Invalid Character: An invalid data byte was encountered in an XDS packet. ■ XDS Invalid Packet Length: The length of the packet is inappropriate for the packet type. ■ Multiple errors: More errors occurred than could be displayed.
V-Chip Presence Error	Indicates that the No Content advisory packet has been detected in the selected video input signal for at least 4 seconds, exceeding the recommended 3 second duration time for repeating V-Chip data.
V-Chip Format Error	Indicates that a content advisory packet contained illegal data or was formatted incorrectly.
TSID Missing	Indicates that the TSID (Transmission Signal Identifier) is missing in the video for 5 seconds.
TSID Format Error	Indicates that the TSID is present but does not match an allowed value.
SDI WSS Missing	Indicates that the WSS (Wide Screen Signalling) signal is missing in the 625-line SDI signal.
SMPTE 2016 AFD Missing	Indicates that the AFD (Active Format Descriptor) is missing in the SD or HD signal.
RP186 Video Index Info Missing	Indicates that the Video Index Information is missing in the 625-line SD signal.
Copyright Status Error	Indicates that a copyright status error is detected.
Copyright Status Change	Indicates that there was a change in the copyright status.
RP207 Protocol Error	Indicates that there is an error in the RP207 protocol layer.
Source ID Packet Error	Indicates that there is an error in the Source ID packet.
Source ID Packet Changed	Indicates that there is a change in the Source ID packet.

Table 28: Physical layer alarms

Alarm	Description
Jitter 1 Level	Indicates that the jitter level for the Jitter1 engine has exceeded the Jitter1 Level threshold (in unit intervals) as set in the CONFIG menu for the type of signal connected to the instrument (SD, HD, or 3G). The Jitter1 engine controls tiles 1 and 2.
Jitter 2 Level	Indicates that the jitter level for the Jitter2 engine has exceeded the Jitter2 Level threshold (in unit intervals) as set in the CONFIG menu for the type of signal connected to the instrument (SD, HD, or 3G). The Jitter2 engine controls tiles 3 and 4.

Alarm	Description
Cable Length	<p>Based on the Cable Type setting in the CONFIG menu, indicates that the length of the cable (in meters) connecting the signal source to the instrument exceeds the threshold for acceptable signal loss (cable loss) for the type of signal connected to the instrument (SD, HD, or 3G).</p> <p>NOTE. Most serial receivers and cable equalizers are specified in terms of cable length for Belden 8281 or 1694A. To evaluate the margin to those specifications, use 8281 or 1694A as the cable type and the measured cable attenuation will be scaled as if it was 8281 or 1694A. This allows direct comparison to the specification. You will need to set the cable type to one that is close to your actual cable only to measure the physical length of the cable.</p>
Cable Loss	<p>Indicates that the signal loss (in dB) due to the cable connecting the signal source to the instrument exceeds the threshold for acceptable signal loss (cable loss) for the type of signal connected to the instrument (SD, HD, or 3G).</p> <p>The threshold is 160 Hz minus the loss at 18 MHz. Cable loss is typically low at low frequencies and higher at high frequencies. Most SDI receivers have equalization circuits that add high frequency data to the SDI signal. In equalized eye mode, the instrument allows you to see how the equalized eye signal of the receiver might appear.</p>
Source Level	Indicates that the signal level has exceeded the Source Level Max or Source Level Min amplitude thresholds as set in the CONFIG menu.
Eye Unlocked	Indicates that the Eye circuit cannot lock to the SDI signal input. There is no configurable threshold for this alarm.
Eye Amplitude	Indicates that the Eye waveform amplitude has exceeded the Eye Amplitude Max or Eye Amplitude Min thresholds (in millivolts) as set in the CONFIG menu for the type of signal connected to the instrument (SD, HD, or 3G).
Eye Rise Time	Indicates that the Eye waveform rise time has exceeded the Eye Risetime Max or Eye Risetime Min thresholds (in picoseconds) as set in the CONFIG menu for the type of signal connected to the instrument (SD, HD, or 3G).
Eye Fall Time	Indicates that the Eye waveform fall time has exceeded the Eye Falltime Max or Eye Falltime Min thresholds (in picoseconds) as set in the CONFIG menu for the type of signal connected to the instrument (SD, HD, or 3G).
Eye Rise Overshoot	Indicates that the Eye waveform rise time overshoot has exceeded the Eye Rise Overshoot threshold (in percentage of Eye waveform amplitude) as set in the CONFIG menu for the type of signal connected to the instrument (SD, HD, or 3G).
Eye Fall Overshoot	Indicates that the Eye waveform fall time overshoot has exceeded the Eye Fall Overshoot threshold (in percentage of Eye waveform amplitude) as set in the CONFIG menu for the type of signal connected to the instrument (SD, HD, or 3G).
Eye Rise-Fall Delta	Indicates that the delta between the Eye waveform rise time and fall time has exceeded the Eye Rise-Fall Delta threshold (in picoseconds) as set in the CONFIG menu for the type of signal connected to the instrument (SD, HD, or 3G).

Table 29: System and diagnostics alarms

Alarm	Description
Hardware Fault	Indicates that there has been a hardware failure with the instrument and service is required. If this alarm occurs, power down the instrument and contact your local Tektronix service representative.

Software upgrades

Tektronix releases software updates for products to add new features and to fix software problems. You can find the latest software for your product at the Tektronix Web site (www.tektronix.com/software).

Before you begin

Perform the following steps to determine if the software on your instrument should be upgraded:

1. Power on the instrument.
2. Verify the current software version installed on the instrument:
 - a. Press the **CONFIG** button on the front panel.
 - b. Navigate to **Utilities > View HW/SW Version**.
 - c. In the Hardware and Software Versions display window, record the software version number of the instrument in the first column of the table in step 3.
3. Verify the latest version of software at the Tektronix Web site:
 - a. Use the Web browser on a computer to navigate to the following Tektronix Web site:
<http://www.tektronix.com/downloads>
 - b. On the Downloads Finder Web page, search by model number (such as WFM2200A) and filter by software and software type to locate the software-upgrade package for the instrument.
 - c. Note the latest version number of the software-upgrade package(s).

Existing WFM2200A software version number	Latest Web site software version number

4. If the latest software version at the Web site is the same as the version installed on your instrument, you do not need to upgrade the instrument software.
5. If the latest software version at the Web site is newer than the version on your instrument, download the latest version to your computer.

6. After the software package ZIP file is downloaded, extract the following files into the directory of your choice: transfer.exe and firmware.pkg.

NOTE. *If a readme.txt file is included in the software package, be sure to read the file before you upgrade the software.*

7. If the software in your instrument needs to be upgraded, verify which options are currently installed before you install the software. After you install the upgrade, you will verify that the new options are installed and that any previously installed options are still enabled.
 - a. Connect the instrument and computer to your local Ethernet network. See [Configure the network interface](#) on page 20.
 - b. Power on the instrument.
 - c. On the computer, open a Web browser.
 - d. In the URL address box, enter the IP address assigned to the instrument you are upgrading. For example, http://192.168.1.1. This opens the Tektronix WFM Remote Interface home page.
 - e. Click **Instrument Options**.
 - f. Make a note of the enabled options or print out the Active Options page.

Software upgrade overview

There are two methods for upgrading the instrument software covered in this section:

- Using a USB memory device
- Using an Ethernet network

The time required to complete the software upgrade is approximately 10 minutes.



CAUTION.

Once the instrument has started to erase internal flash, do not remove power from the instrument. If you do so, the instrument flash may be corrupted and you will have to run the recovery procedure. See [Software installation troubleshooting](#) on page 185.

NOTE. *To help ensure an uninterrupted upgrade process, fully charge the battery pack and connect the instrument to the AC adapter before you begin the upgrade.*

If power to the instrument is lost before it begins erasing the internal flash, you can restart the software upgrade after the instrument reboots. If the instrument displays only a blank screen after power is reapplied, see the troubleshooting section for help.

USB software installation

Use the following steps to upgrade the instrument software using a USB memory device.

1. Insert a USB memory device into a USB port of the computer containing the latest instrument software.
2. On the computer, navigate to the USB device.
3. On the USB device, create a directory named **WfmUpgrd**.



CAUTION.

To prevent upgrade failure, be sure to correctly name the upgrade directory. The directory name is case sensitive, with the “W” and the “U” in WfmUpgrd being upper case.

4. Open the WfmUpgrd directory and copy the firmware.pkg file from the downloaded ZIP file to the USB device. The USB device should have a directory path of **WfmUpgrd\firmware.pkg**.
5. Eject and safely remove the USB device from the computer.
6. Power on the instrument and wait for the instrument to fully boot up before inserting the USB device into the USB port on the top panel of the instrument .
7. Press the **CONFIG** front panel button.
8. Navigate to **Utilities > System Upgrade > Upgrade Options > USB Upgrade**.

NOTE. *If the instrument displays a message indicating that a USB device containing firmware was not detected, make sure you have the correct directory path on the USB device. Also, press the front panel button to verify that the USB device is properly mounted.*

If the instrument still does not recognize the USB device, attempt the procedure again using a different USB device from a well known brand that is 16 GB or less.

9. Press the **SEL** front panel button. This displays the System Software Upgrade from USB window.

10. Select **Continue** from the System Software Upgrade from USB window and press **SEL** to start the software upgrade. During the upgrade process, the instrument displays messages indicating the upgrade status.



CAUTION.

Once the instrument has started to erase internal flash, do not remove power from the instrument. If you do so, the instrument flash may be corrupted and you will have to run the recovery procedure. See [Software installation troubleshooting](#) on page 185.

11. If the instrument does not reboot at the completion of the software upgrade, press and hold the Power button for 5 seconds to turn off the instrument. Press the Power button again to turn on the instrument.
12. Remove the USB device after the upgrade is complete:



CAUTION.

To prevent a loss of data on the USB device, use the MAIN menu to unmount the USB device before removing it from the instrument.

- a. Press the **MAIN** front panel button.
- b. Navigate to **USB Unmount**, and then press the **SEL** button.
- c. Remove the USB device after the USB Unmount selection disappears from the MAIN menu.

Network software installation

Use the following steps to upgrade the instrument software using a network connection:

1. Connect the instrument and a Windows PC to your local Ethernet network or directly connect the instrument to a Windows PC. See [Configure the network interface](#) on page 20.
2. Power on the instrument.
3. Prepare the instrument for the software upgrade:
 - a. Press the **CONFIG** front panel button.
 - b. Navigate to **Utilities > System Upgrade > Upgrade Options > Network Upgrade**.
 - c. Press the **SEL** front panel button. Note the IP address of the instrument displayed in the System Software Upgrade window.
 - d. Select **Continue** from the System Software Upgrade window, and then press the **SEL** button to prepare the instrument to receive a software upgrade.

4. Perform the software upgrade:
 - a. On the PC, double-click the **transfer.exe** file to launch the transfer program.
 - b. Type the IP address or DNS name of the instrument you are upgrading, and then press **Enter**. This starts the software upgrade process.

**CAUTION.**

Once the instrument has started to erase internal flash, do not remove power from the instrument. If you do so, the instrument flash may be corrupted and you will have to run the recovery procedure. See [Software installation troubleshooting](#) on page 185.

NOTE. *The upgrade will not proceed until all of the software data is transferred to the instrument. Once the upgrade has started, the instrument will attempt to complete the upgrade even if it loses contact with transfer.exe. So that you can monitor the progress of the upgrade, it is suggested that you do not close the transfer.exe window until the transfer utility asks for another IP address.*

- c. After the instrument reboots, if you configured the network settings of the instrument for DHCP when you started this upgrade, navigate to CONFIG > Network Settings > IP Config Mode and select **DHCP**.

- d. After the upgrade process completes, the transfer utility displays **done**. The instrument then reboots after a few seconds.

```

C:\release\transfer.exe
Erasing Flash... done
Programming Flash... done
Verifying Flash Programming... done
Initializing LCD Driver Upgrade... done
ERROR: R-1d-U21 Update failure
Please enter DNS name or address of target instrument:
xxx.xxx.xxx.xxx
Socket shutdown failed for command socket: Connection reset by peer
Opened TCP connection to 134.62.84.154
Reading Firmware Data (1720742 bytes)... done
Reading Firmware Data (12691580 bytes)... done
Reading Firmware Data (13923388 bytes)... done
Reading Firmware Data (1658598 bytes)... done
Reading Firmware Data (2433 bytes)... done
Initializing Kernel Upgrade... done
Verifying Flash Programming... done
Initializing Application Upgrade... done
Verifying Flash Programming... done
Initializing Filesystem Upgrade... done
Verifying Flash Programming... done
Initializing LCD Driver Upgrade... done
Verifying Flash Programming... done
Initializing Splash Image Upgrade... done
Erasing Flash... done
Verifying Flash Programming... done
done.
Please enter DNS name or address of target instrument:

```

Figure 54: Sample of transfer.exe window after the upgrade is complete

5. If the instrument does not reboot at the completion of the software upgrade, press and hold the Power button for 5 seconds to turn off the instrument. Press the Power button again to turn on the instrument.

Verify the software and installed options

1. If the instrument did not reboot at the completion of the software upgrade, cycle the power to the instrument to cause it to reboot.
2. Press the **CONFIG** button on the front panel.
3. Navigate to **Utilities > View HW/SW Version**.
4. Verify that the software version number matches the version of the software-upgrade package you installed.
5. Navigate to **Utilities > View Options**.
6. Verify that the options that were enabled to the software upgrade are still enabled.

Software installation troubleshooting

If a power failure occurs during SW upgrade and the instrument has a blank screen when you reapply power, perform the following procedure.

1. Connect an Ethernet cable directly from your computer to the instrument. You must use a direct network connection.
2. Press and hold the Power button for 5 seconds to turn off the instrument.
3. Press and hold the ◀ (left arrow) key while you press the Power button.
4. The instrument will turn on and the default IP address of 192.168.1.1 will be set.
5. Set the IP address of your computer to 192.168.1.x, where $x \neq 0, 1, \text{ or } 255$.
6. Enter the IP address of the instrument (192.168.1.1) for the upgrade transfer application.
7. Start the upgrade process. When it is complete, the instrument should reboot. If it does not, cycle the power.



CAUTION.

To prevent upgrade failure, leave the instrument power on during the upgrade process. The upgrade process may take up to 15 minutes to complete.

If you continue to experience an upgrade problem, contact Tektronix customer support or your local Tektronix representative for assistance.

Monitoring the SDI physical layer (WFM2300 only)

The WFM2300 waveform monitor can use an eye pattern display, eye measurements, a jitter display, jitter detection and measurement, and an SDI status display to monitor and measure the SDI physical layer.

Display types

- **Eye Display** (See *Eye display (WFM2300 only)* on page 94). This display allows you to use voltage and time measurement cursors and their readouts to monitor amplitude and timing measurements on an Eye waveform. There is also a jitter thermometer in the Eye display that graphically relates the jitter measurement to alarm limits, and there are readouts that display jitter magnitude.

When displaying the Eye waveform in a single, full-screen tile, the measurement results and a histogram display are included with the Eye waveform.

- **Jitter Display** (See *Jitter display (WFM2300 only)* on page 96). With this display, you can view additional time-domain information that is useful in separating sources of jitter, whether they are within a single circuit on a circuit board, or from various pieces of equipment in a system. This includes jitter components that are synchronous or nearly synchronous to video line or video frame. These components appear as stationary or near-stationary artifacts in line or field sweeps and the wave shape of the jitter as modified by the high-pass filter setting.
- **SDI Status Display** (See *SDI Status display (WFM2300 only)* on page 128). This display shows measurements of signal jitter and cable loss in both dB and meters of the selected cable type, and calculated source level. Automatic measurements of eye amplitude, rise time, fall time, overshoot, and rise-fall difference are also displayed. The Jitter and Cable Loss thermometers graphically relate those measurements to their alarm limits.

Configuring physical layer settings

Before you use Eye or SDI Status displays to monitor the SDI physical layer, you must configure the Eye and physical layer settings. These are initially set to factory defaults.

To take measurements, select the input you want to monitor and then proceed with the following steps:

1. Press the **CONFIG** button to display the configuration menu.
2. Select **Physical Layer Settings**.
3. Select **Cable Type** and select the best match for the type of cable that is connecting the SDI signal to the instrument.
4. Select **Jitter1 HP Filter**. Select a high-pass filter value for the Jitter1 engine controlling the top two tiles of the instrument display.

NOTE. *The Timing filter selection sets the filter value to 10 Hz. The Alignment filter selection sets the filter value to 1 kHz for SD or 100 kHz for HD.*

5. Select **Source Level Max** and use the General knob to increase or decrease the setting.
6. Select **Source Level Min** and use the **General** knob to increase or decrease the setting.

NOTE. *The maximum value you can select is 1000 mV; the minimum value is 600 mV.*

To set SMPTE 259-292-425 alarm thresholds

1. To reset the SMPTE 259 (SD), SMPTE 292 (HD), and SMPTE 425 (3G) alarm thresholds back to the factory-default values, select **Reset Defaults** from the **CONFIG > Physical Layer Settings** menu and press **SEL**.
2. To reset only the SD thresholds, HD thresholds, or the 3G thresholds back to the factory-default values, select **SMPTE 259 (SD) Thresholds** or **SMPTE 292 (HD) Thresholds** or **SMPTE 425 (3G) Thresholds**, depending on which type of video signal you are monitoring.
3. Select **Reset Defaults** in the SMPTE submenu and press the **SEL** button.
4. To set custom threshold levels, select **SMPTE 259 (SD) Thresholds**, **SMPTE 292 (HD) Thresholds**, or **SMPTE 425 (3G) Thresholds** depending on which type of video signal you are monitoring.
5. Select **Jitter1 Level**. Use the **General** knob to increase or decrease the threshold level for the Jitter1 engine controlling the top two tiles of the instrument display. The maximum level you can enter is 4.00 UI; the minimum level is 0.10 UI.
6. Select **Cable Loss** to specify the threshold for signal loss (in dB) due to length of cable connecting the signal source to the instrument.
7. Use the General knob to increase or decrease the threshold level. The maximum level you can enter is 30.0 dB; the minimum level is 0.0 dB.
8. Select **Cable Length** to specify the threshold for the length of the cable (in meters) connecting the signal source to the instrument.
9. Use the General knob to increase or decrease the cable length setting. The maximum length you can enter is 300 meters; the minimum length is 0 meters.
10. Select **Eye Amplitude Max**. Use the General knob to increase or decrease the setting. The maximum amplitude you can enter is 1010 mV; the minimum amplitude is 700 mV.
11. Select **Eye Amplitude Min**. Use the General knob to increase or decrease the setting. The maximum amplitude you can enter is 10 mV below the current Eye Amplitude Max setting; the minimum amplitude is 530 mV.
12. Select **Eye Risetime Max**. Use the General knob to increase or decrease the setting. The rise time range for SD is 410 ps to 3000 ps. The rise time range for HD and 3G is 10 ps to 1000 ps.
13. Select **Eye Risetime Min**. Use the General knob to increase or decrease the setting.
14. Select **Eye Falltime Max**. Use the General knob to increase or decrease the setting. The fall time range for SD is 410 ps to 3000 ps. The fall time range for HD and 3G is 10 ps to 1000 ps.
15. Select **Eye Falltime Min**. Use the General knob to increase or decrease the setting.

16. Select **Eye Rise-Fall Delta**. Use the General knob to increase or decrease the setting. The maximum value you can enter is 1000 ps; the minimum value is 0 ps.
17. Select **Eye Rise Overshoot**. Use the General knob to increase or decrease the setting. The maximum value you can enter is 20%; the minimum value is 0%.
18. Select **Eye Fall Overshoot**. Use the General knob to increase or decrease the setting. The maximum value you can enter is 20%; the minimum value is 0%.

To configure physical layer alarms

NOTE. *You can read more about alarms in the Alarms section.*

1. From the CONFIG menu, select **Alarms > Physical Layer**.
2. Press the **SEL** button.
3. Use the arrow keys and the **SEL** button to mark the squares for the alarms you want to monitor.

To make eye measurements

After you have configured the instrument for eye measurements, you can have the instrument perform automatic eye measurements or you can use the cursors to perform manual waveform measurements. The following procedures explain how to conduct both measurement types.

NOTE. *If you use the measurement cursors to manually measure the eye waveform, you might get a different result than that shown in the automatic eye measurements readout. This is because the automatic amplitude measurement uses histograms to be minimally affected by overshoot, ringing, and noise on the signal. Similarly, the automatic rise time and fall time measurements use histograms to find the centers of the distributions of 20% and 80% crossings. The difference between manual and automatic measurements is usually insignificant for clean, symmetrical signals.*

Eye measurement set up

1. Configure your instrument to monitor the SDI physical layer. See [Configuring physical layer settings](#) on page 188.
2. Connect a serial video-signal to your instrument using a 75 Ω cable of two meters or less in length. Use high-quality, low-loss coaxial cable, such as Belden 1694A.
3. Select a tile and press the **PHY** button and select **Eye Display** from the **Display Type** submenu.
4. Press the **GAIN** button to display the gain menu, select **VAR Gain**, and turn the **GENERAL** knob until the vertical gain is x1.00.

To make manual eye measurements

NOTE. Use the button to change the sweep of the Eye display.

1. Perform the initial setup for eye measurements. See [Eye measurement set up](#) on page 191.
2. Press the **CURSOR** button to display the measurement cursors.
3. Position one voltage cursor at the top part of the waveform, ignoring any overshoot or undershoot on the rising or falling edges. (See the following image.)
4. Position one voltage cursor at the bottom part of the waveform, ignoring any overshoot or undershoot on the rising or falling edges. (See the following image.)
5. Note the amplitude of the eye waveform that is displayed in the Voltage Cursor readout. (See the following image.)

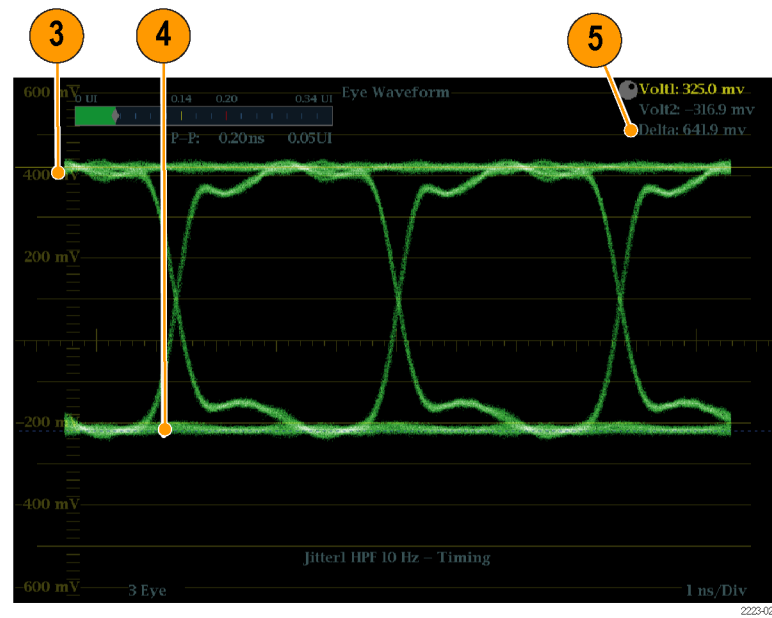

Figure 55: Eye measurement cursor placement

NOTE. Signal-source amplitudes outside $\pm 10\%$ of 800 mV can degrade receiver performance.

To manually measure aberrations

1. Perform the initial setup for eye measurements. See [Eye measurement set up](#) on page 191.
2. Press the **CURSOR** button to display the measurement cursors.
3. Position one voltage cursor at the peak of the overshoot at the top horizontal part of the waveform. (See the following image.)
4. Position the second voltage cursor at the bottom of the top line of the waveform. Include any ringing (the oscillation following overshoot) in the measurement. Essentially, you are measuring the thickness of the top line of the waveform. (See the following image.)
5. Note the amplitude of the aberration displayed in the Voltage Cursor readout. (See the following image.)
6. Perform the same voltage-cursor measurement on the bottom line thickness, including any undershoot and ringing.

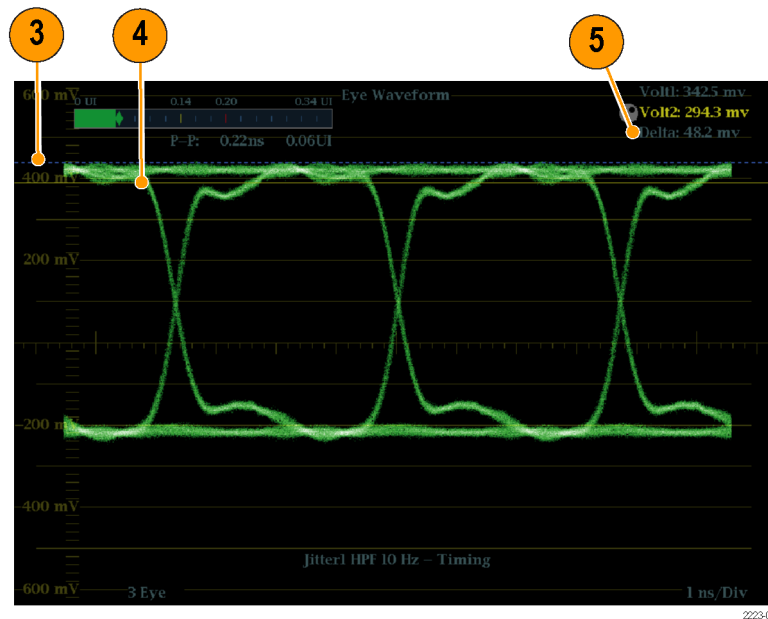

Figure 56: Using cursors to measure aberrations in the eye pattern

NOTE. Aberrations at the top or bottom line of the waveform should not exceed 10% of the signal amplitude. Automatic equalizer circuits in receivers may be sensitive to larger aberrations.

To manually measure rise time using variable gain

1. Perform the initial setup for eye measurements. See *Eye measurement set up* on page 191.
2. Press and hold the **GAIN** button to view the Gain pop-up menu and select **Enable** for **VAR Gain**. Press the **GAIN** button again to dismiss the pop-up menu.
3. Use the **General** knob to resize the waveform to 10 major divisions. Position the top and bottom of the waveform on graticule lines.
4. Press the **CURSOR** button to display the measurement cursors.
5. Position the first timing cursor at the crossing of the rising edge of the eye waveform and the graticule line two divisions above the bottom of the waveform. (See the following image.)
6. Position the second time cursor at the crossing of the rising edge of the eye waveform and the graticule line two divisions below the top of the waveform. (See the following image.)
7. Note the 20 – 80% rise time measurement displayed in the Delta time readout. (See the following image.)

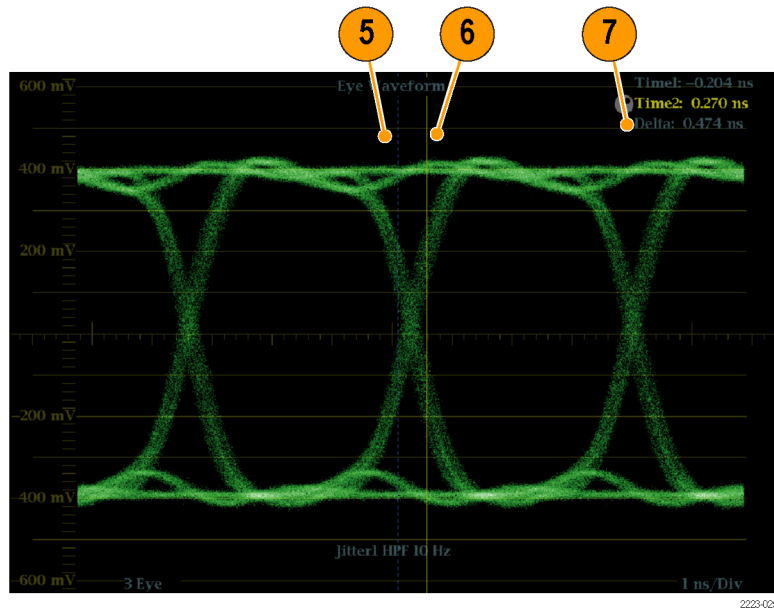

Figure 57: Measuring rise time using variable gain in the Eye display

To make automatic eye measurements

NOTE. *If you use the measurement cursors to manually measure the eye waveform, you might get a different result than that shown in the automatic eye measurements readout. This is because the automatic amplitude measurement uses histograms to be minimally affected by overshoot, ringing, and noise on the signal. Similarly, the automatic rise time and fall time measurements use histograms to find the centers of the distributions of 20% and 80% crossings. The difference between manual and automatic measurements is usually insignificant for clean, symmetrical signals.*

1. Perform the initial setup for eye measurements. See [Eye measurement set up](#) on page 191.
2. Press and hold the **STATUS** button to display the pop-up menu.
3. Select **Display Type** and then select **SDI Status**.
4. Note the Eye waveform measurements in the SDI Status display readouts. Automatic eye measurements (and a histogram of the Eye waveform) are also displayed in the Eye waveform display when expanded to the single, full-screen display.

To make jitter measurements

This section explains the procedures for taking jitter measurements. After you have configured the instrument for Eye or Jitter measurements, the instrument is also ready to take jitter measurements using one of the following displays:

- Measurement cursors on the Eye display
- SDI Status display
- Jitter display

NOTE. *Many jitter problems in systems have resulted from genlocking clocks to other references, such as the horizontal synchronization pulse. Reference jitter transferred by genlocks into a serial system is typically between 20 and several hundred Hertz. Also, the phase detection process used by the genlock can add noise, which results in jitter in the 10 Hz to 1 kHz range. Use the appropriate high-pass filter selection to include or reject genlock jitter from a measurement.*

The simplest way to measure jitter is to use the jitter readout and jitter thermometer in the Eye display or SDI Status display. These are derived from the jitter waveform. For more qualitative jitter information, use the Eye and Jitter displays to view the presence and magnitude of jitter and its potential for causing data errors as the eye closes. The Jitter display provides further analysis information including added time-domain information such as the wave shape of the jitter and whether there are jitter components that are synchronous or nearly synchronous to the video line or frame (these components appear as stationary or near-stationary artifacts in line or field sweeps).

Looking at jitter in both displays can help you separate jitter sources to determine whether they are within a single circuit on a circuit board or from various pieces of equipment in a system. If you are planning a composite D/A conversion, select the 10 Hz bandwidth filter to measure total broadband jitter.

The following image shows an example displaying a signal with a lot of jitter. In the first and second quadrants, the high-pass filter is set for 10 Hz so that all jitter above 10 Hz is displayed. In the third and fourth quadrants, the high-pass filter is set for 100 Hz, removing most of the 30 Hz jitter and leaving the spikes. Both Jitter displays are set for two-field sweep. The upper Eye display shows a fairly even jitter spread, which suggests a moderately uniform statistical distribution of jitter. This jitter is from a sine wave component. Notice that there is no indication of jitter spikes. In the lower Eye display, the jitter is of a low-density haze, which suggests a less uniform jitter distribution. This is indicated by the spikes.

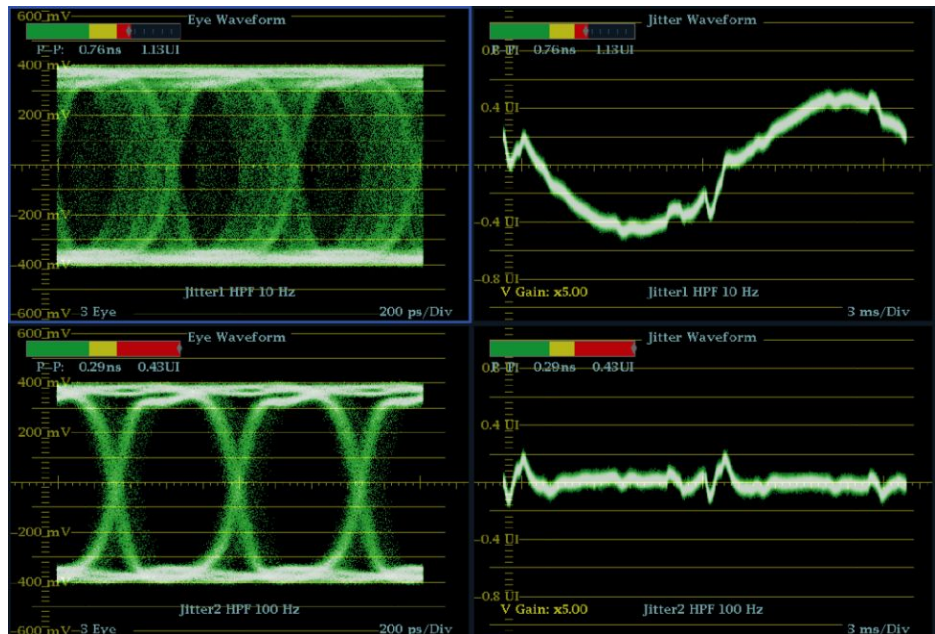

Figure 58: Measuring jitter

To manually measure jitter

NOTE. *If you use the measurement cursors to measure jitter, you may get a different result than that shown in the jitter thermometer for the following reasons: the internal peak detector does a better job of measuring jitter excursions than manually positioning the cursor; or the noise floor is removed from the jitter measurement readout but not from the cursor delta readout.*

1. Perform the initial setup for eye measurements. See [Eye measurement set up](#) on page 191.
2. Use the **SWEEP** button to select the 3 EYE mode, which shows peak jitter at each eye crossing.
3. Use the Eye pop-up menu to set the jitter high-pass filter to one of the following:
 - To measure timing jitter, select the 10 Hz filter for both SD and HD signals, or select the Timing filter.
 - To measure alignment jitter, select the 1 kHz filter for SD signals or select the 100 kHz filter for HD signals, or select the Align filter.
4. Press the **CURSOR** button to display the measurement cursors.
5. Position the first timing cursor at the left edge of the zero-crossing point of the eye waveform. (See the following image.)

NOTE. *If necessary, use the Gain and Sweep controls for better vertical and horizontal resolution.*

6. Position the second timing cursor at the right edge of the zero-crossing point of the eye waveform. (See the following image.)
7. Check that the Delta readout is less than the following:
 - SD Signals (per SMPTE 259M)
 - Timing jitter (10 Hz filter): 740 ps (0.2 unit intervals).
 - Alignment jitter (1 kHz filter): 740 ps (0.2 unit intervals).
 - HD Signals (per SMPTE 292)
 - Timing jitter (10 Hz filter): 673 ps (1.0 unit intervals).
 - Alignment jitter (100 kHz filter): 134 ps (0.2 unit intervals).
 - 3 Gb/s Signals (per SMPTE 424M)
 - Timing jitter (10 Hz filter): 673 ps (2.0 unit intervals).
 - Alignment jitter (100 kHz filter): 101 ps (0.3 unit intervals).

(See the following image.)

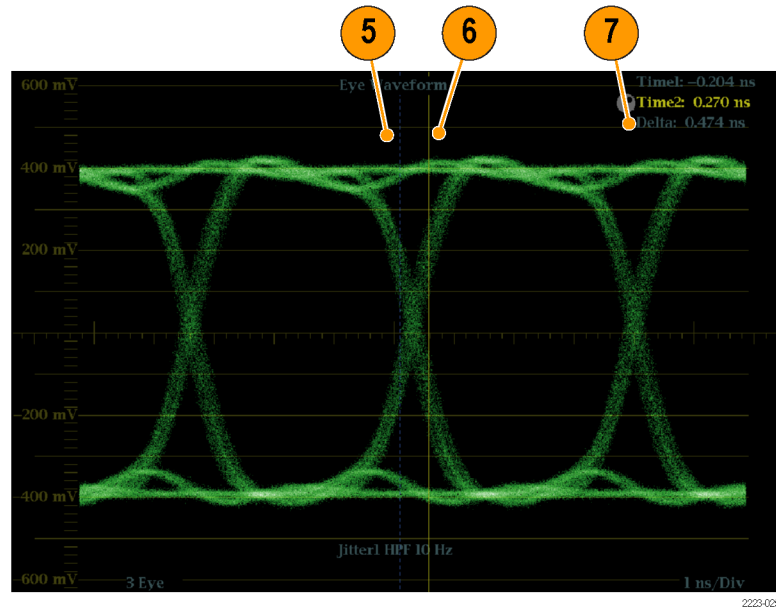

Figure 59: Using cursors to measure jitter

Taking cable loss measurements

After you have configured the instrument for eye measurements, you can take cable loss measurements using the SDI Status display.

NOTE. The accuracy of the Approx Cable (length) and Source Level readouts depends strongly on correctly setting the Cable Type and on the quality of the cable and connections in the signal path. These readouts are derived from the measured Cable Loss and the specified Cable Type. The Source Level readout of the SDI Status display indicates the calculated signal amplitude at the signal source, even when the signal level is greatly reduced at the instrument due to cable loss. Therefore, the automatic Eye Amplitude measurement may be significantly less than the indicated Source Level.

1. Perform the initial setup for eye measurements. See [Eye measurement set up](#) on page 191.
2. Press the **STATUS** button to select the Status display.
3. Press and hold the **STATUS** button to display the pop-up menu.
4. Use the arrow keys and the **SEL** button to select the SDI Status display.
5. Use the Cable Loss thermometer and readouts to monitor the cable loss. [Eye measurement set up](#) on page 191

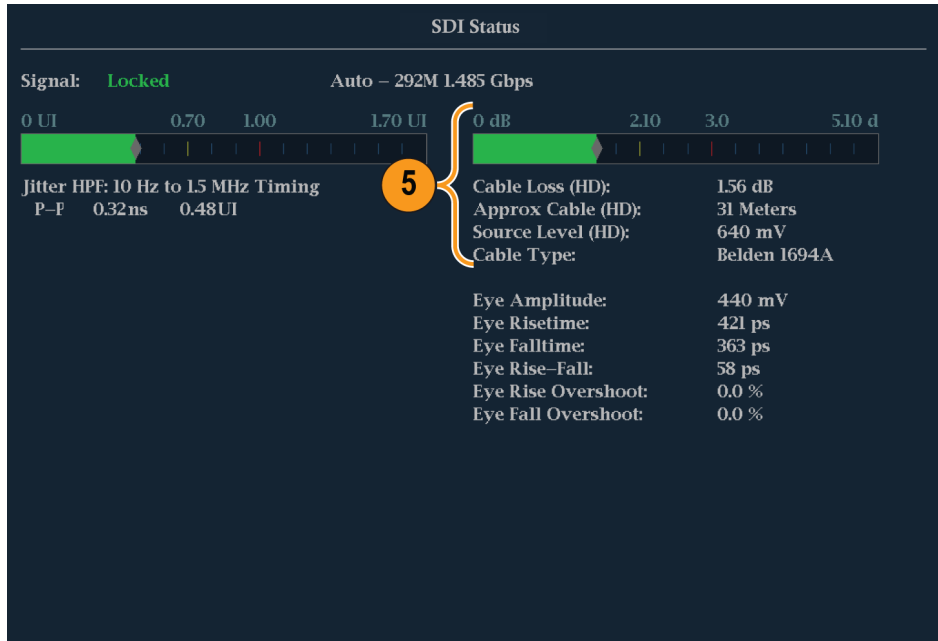

Figure 60: Cable loss information in the SDI Status display

Checking chroma-luma delay

The Lightning display can be used for interchannel timing measurements. If the color-difference signal is not coincident with luma, the transitions between the color dots will deviate from the center mark of a delay scale. The amount deviated represents the relative signal delay between luma and the color-difference signal.

Check chroma/luma delay using the Lightning display

Perform the following steps to check chroma/luma delay using the Lightning display:

1. Connect a color bar signal to the SDI A or SDI B input and then press the associated INPUT A or INPUT B button to select that video input to monitor.
2. Press and hold the **VECTOR** button to open the Vector pop-up menu.
3. In the Vector pop-up menu, set the **Display Type** to **Lightning**.
4. Set **Bar Targets** to match your input signal.
5. Select **Center Waveform** and press the **SEL** button to center the waveform.
6. Press the **VECTOR** button to close the pop-up menu.
7. Determine where transitions intersect the delay scales and derive the timing error in nanoseconds, as deflected from the center mark, using the following guidelines. (See the following image.)
 - The center mark of the nine marks spanning each green-magenta transition is the zero error point.
 - Alignment to a mark toward black means the color-difference signal lags with respect to luma.
 - Alignment to a mark toward white means the color-difference signal leads the luma signal.
 - The upper half of the display measures the Pb to Y timing; the bottom half measures the Pr to Y timing.

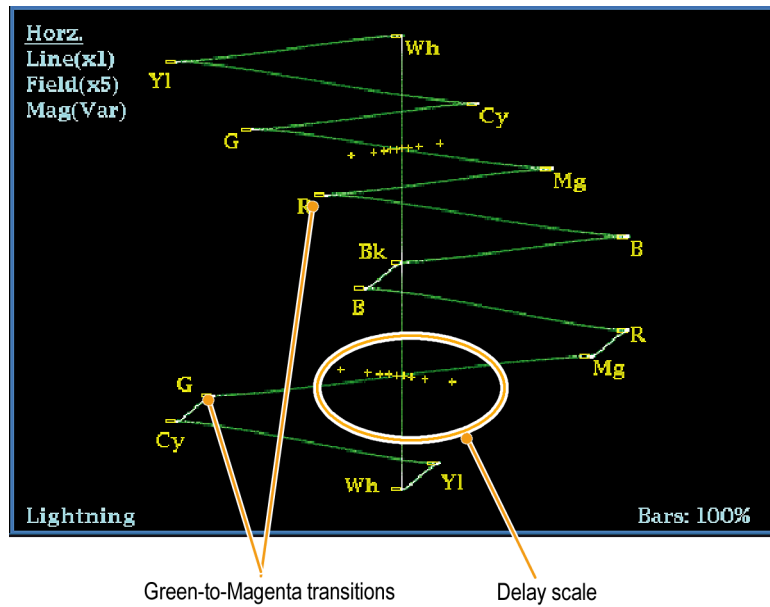

Figure 61: Determining transition intersections in the Lightning display

The + tic marks on the Lightning graticule indicate the timing errors shown in the following table:

Tic mark	SD Timing error (ns)	HD Timing error (ns)	1080p 50, 59.94, 60, 3Gbps (3 Gb/s and dual link formats) Timing error (ns)
0 marks	0	0	0
1st	20	2	1
2nd	40	5	2.5
3rd	74 ¹	13.5	6.75
4th	148 ²	27	13.5

¹ Luma sample
² Chroma sample

Checking gamut

Signals that are legal and valid in one signal representation may not be legal in another representation. Specifically, signals which are legal in the Digital YCbCr representation may not be legal if transcoded to RGB or encoded to NTSC / PAL. Any signal that fails this test is considered out of gamut.

You can set custom gamut thresholds using the CONFIG > Gamut Thresholds submenu or you can reset the gamut thresholds to default values.

Your instrument supports multiple displays and alarms to detect out-of-gamut signals. The flexible, tiled display allows you to simultaneously view several gamut measurements to learn which is most appropriate for a given application. The displays are and their uses follow:

- **Diamond display:** Checks that SDI signals conform to legal RGB gamut space.
- **Split Diamond display:** Separates the upper and lower diamonds to show excursions below black; otherwise it is identical to the Diamond display.
- **Arrowhead display:** Checks if an SDI signal is legal for composite color space.

The Diamond, Split Diamond, and Arrowhead displays have adjustable thresholds. If the signal goes outside the area defined by the thresholds, the signal is out of gamut. If these limits are exceeded, then the instrument can generate alarms if configured to do so.

For composite waveforms, the legal limit is simply the maximum level allowed for the combination of luma and chroma. This limit depends on the application. For example, a video tape machine may be able to record and play out signals with higher luma and chroma components than a transmitter.

To set up gamut checks

1. Connect a video signal to an SDI input on the rear panel.
2. Select a tile in which to view the Gamut Display and press and hold the **GAMUT** button.
3. In the Gamut pop-up menu, select from the following gamut display types:
 - Diamond – Use to detect, isolate, and correct RGB component gamut errors. See [Checking RGB gamut](#) on page 202.
 - Split Diamond – Use to reveal hard-to-find black gamut errors.
 - Arrowhead – Use to detect composite gamut errors, without employing a composite encoder.
4. Press the **GAMUT** button to dismiss the pop-up menu.
5. Press the **CONFIG** button and select **Gamut Thresholds**.
6. Set the thresholds as desired.

Checking RGB gamut

The Diamond display effectively shows how the R, G, and B signals relate and is a good tool for detecting gamut errors.

To form the Diamond display, the instrument converts the Y , P_b , and P_r components recovered from the serial signal to R, G, and B. To predictably display all three components, they must lie between peak white, 700 mV, and black, 0 V.

For a signal to be in gamut, all signal vectors must lie within the G-B and G-R diamonds. Conversely, if a signal vector extends outside the diamond, it is out of gamut. The direction of an excursion out of gamut indicates which signal is excessive. Errors in green amplitude affect both diamonds equally, while blue amplitude errors affect only the top diamond and red errors affect only the bottom diamond. (See following image.)

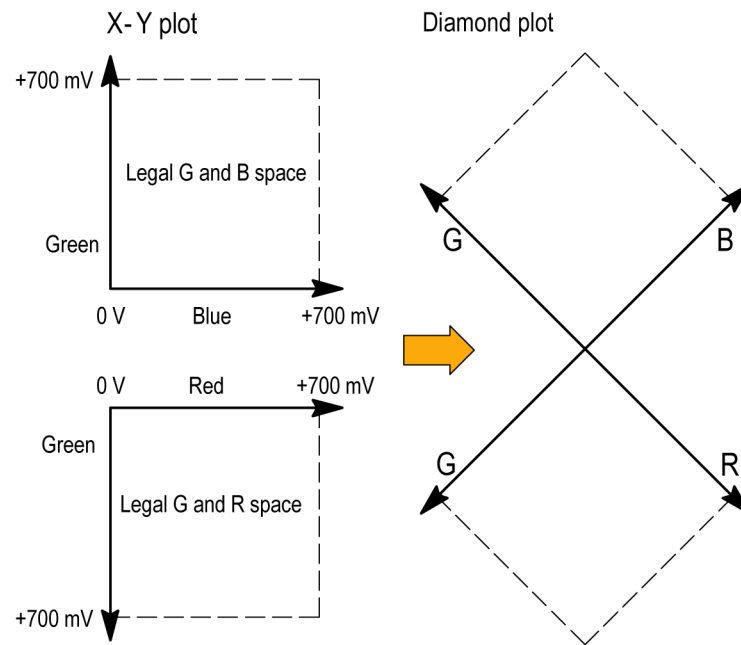

Figure 62: Diamond display plot

Set the thresholds for gamut. (See [To set up gamut checks](#) on page 202.) After selecting the **Diamond** display, compare the signal to the display to determine out-of-gamut components. Note the following:

- The intensity of a vector indicates its duration.
- A momentary out-of-gamut condition appears as a faint trace. Long duration violations show as a bright trace.

When evaluating out-of-gamut components, consider the following examples. (See the following image.)

- Example A:
 - R - Ok
 - $G > 700 \text{ mV}$
 - B - Ok
- Example B:
 - R - Ok
 - G - Ok
 - $B > 700 \text{ mV}$
- Example C:
 - R - Ok
 - G - Ok, 350 mV
 - $B < 0 \text{ mV}$

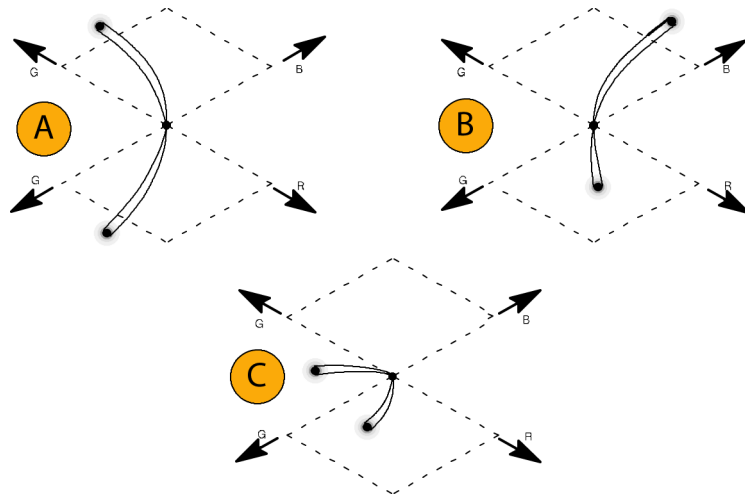

Figure 63: Out-of-gamut examples

Usage notes

As with the Lightning display, bending of the transitions indicates timing delays. When a color bar signal is applied, the vertical axis becomes an indicator of delay errors.

On the Diamond display, monochrome signals appear as vertical lines. Nonlinear component processing, such as from a gamma corrector that alters white balance, can cause deviations along the vertical axis.

To isolate gamut bright-ups, try the following:

- Use the **LINE SEL** button to select individual lines.
- Use the **PICT** display to examine the signal (turn on gamut bright-ups in the Display Settings submenu of the Configuration menu).
- Use the **Diamond Area** or **Arrowhead Area** settings (found in the Gamut Thresholds submenu of the Configuration menu) to specify a percentage of the image pixels to ignore for gamut violations. The Gamut bright-ups, however, will continue to indicate all Gamut violations.

Checking composite gamut

The Arrowhead gamut display plots luminance (Y) against chrominance (C) to check if the composite signal adheres to standard gamut. NTSC and PAL Arrowhead displays (75% Color bars) and indicates the values of the graticule lines. The arrowhead shape of the graticule results from overlaying the standard limits for luminance and luminance-plus-peak chrominance.

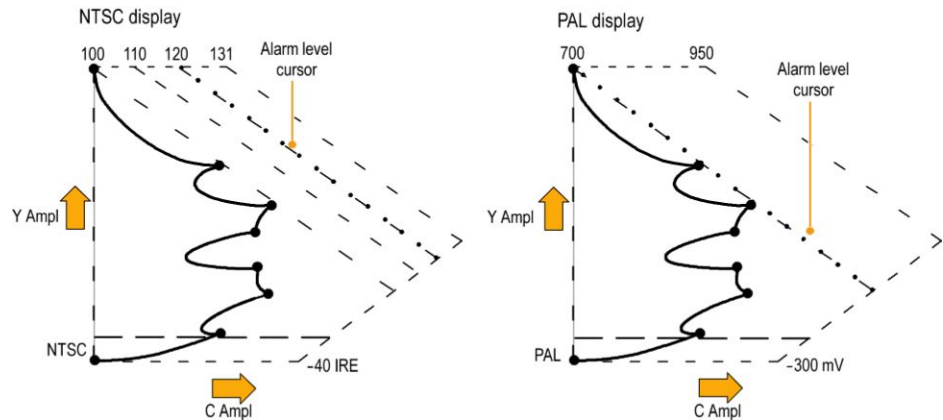

Figure 64: Arrowhead gamut display plots

Set the thresholds for gamut. (See [To set up gamut checks](#) on page 202.) After selecting the **Arrowhead** display, compare the signal to the display to determine out-of-gamut composite components. Note the following:

- Signals exceeding the luminance amplitude gamut extend above the top horizontal limit (top electronic graticule line).
- Signals exceeding the luminance plus peak chrominance amplitude gamut extend beyond the upper and lower diagonal limits.
- The bottom horizontal line shows the minimum allowed luminance level. 0 or 7.5 IRE for NTSC and 0 mV for PAL.

Usage notes

For a procedure to automate this check, see [Automating gamut checks](#) on page 206.

Checking luma gamut

Luma limit thresholds can be configured for identifying luma exceeding threshold limits. They apply to both the incoming SDI and to the Arrowhead representation of the SDI input as a composite signal. By defining these levels in percent, they automatically account for the presence or absence of setup. The thresholds are affected by your choice of set-up or no set-up for the Arrowhead display.

Set the thresholds for gamut. (See [To set up gamut checks](#) on page 202.) After selecting the **Arrowhead** display, compare the signal to the display to determine out-of-gamut luminance. Note the following:

- The adjustable thresholds are indicated by the dark blue horizontal graticule lines.
- The thresholds are defined in terms of percent of full scale.
- The range for the Upper limit is 90% to 108%.
- The range to the Lower Limit is -6% to +5%.

Another useful Arrowhead function is a measure of how well the active video signal is using the dynamic range of the video channel. A properly adjusted signal should be centered in the arrowhead graticule and have transitions that approach all the limits.

Automating gamut checks

You can use alarms to automatically monitor for out-of-gamut conditions.

1. Check that Gamut thresholds are configured as you want them. See [To set up gamut checks](#) on page 202.
2. Press the **CONFIG** button to display the Configuration menu.
3. Select **Alarms** and then **Video Content**. A dialog box appears where you can select for the various Video Content alarms.
4. Use the up/down arrow keys to move to each of the alarms that you want to set. Press the **SEL** button to toggle the alarm on (X) or off.
5. When you have configured the Alarms as you want them, move to the **Select here** box and select it.
6. Back in the Alarms menu, check that **Enable Alarms** is set to **On** before exiting the Alarms menu.

ARIB content displays

Your instrument supports conformance to ARIB data standards contained in the signal source. The ARIB content in the signal is shown in the following status displays:

- ARIB Status
- ARIB STD-B.39 Display
- ARIB STD-B.37 Display
- ARIB STD-B.35 Display
- ARIB TR-B.23 (1) Display
- ARIB TR-B.23 (2) Display
- ARIB TR-B.22 Display

The following DID and SDID values are defined for common types of ARIB-compliant data.

Table 30: DID and SDID values for common ARIB data types

Ancillary data type	DID value	SDID value
ARIB TR-B.22, Sub Information of transmitting materials	0x5F	0xE0
ARIB TR-B.23, Line 20 User Data - 1	0x5F	0xFC
ARIB TR-B.23, Line 20 User Data - 2	0x5F	0xFB
ARIB STD-B.35 Trigger Signal for Data Broadcasting	0x5F	0xFD
ARIB STD-B.37 Closed Captioning		
- Analog signal	0x5F	0xDD
- SD signal	0x5F	0xDE
- HD signal	0x5F	0xDF
ARIB STD-B.39 Inter Stationary Control Data		
- ARIB specification	0x5F	0xFE
- ITU specification	0x43	0x01

To enable the ARIB content displays

Before you can view the ARIB content displays, you must enable the ARIB displays using the CONFIG > Aux Data Settings > ARIB Content Display submenu.

ARIB Status display

The ARIB Status display is a status summary screen for the signal.

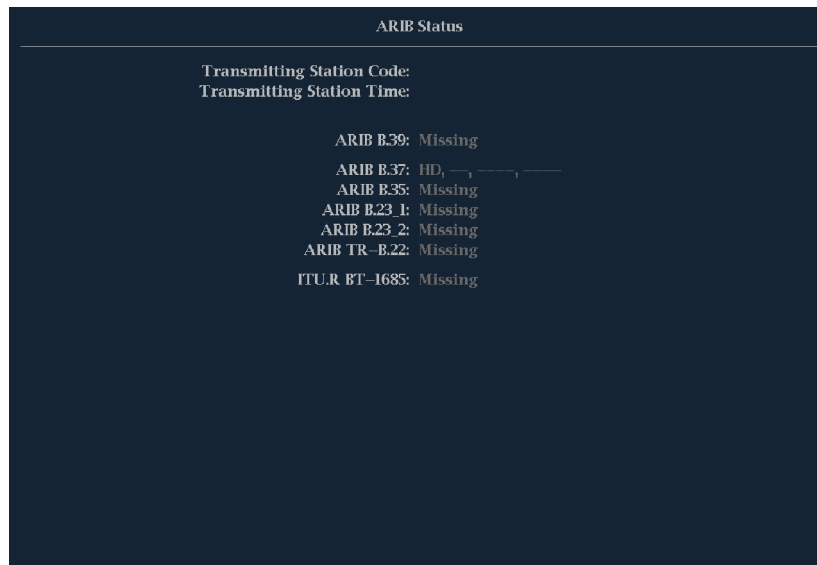

Figure 65: ARIB Status display, showing no ARIB data present

Use the ARIB Status display with the other specific ARIB Display screens to quickly determine if the data you are interested in is present in the signal. If the data is present, use the STATUS > ARIB Display menu to select the specific ARIB data packet type to view.

The ARIB Status display shows the presence (or absence) of each of the following supported standards (STD), technical reports (TR), or ITU standard:

- Transmitting station code (unique identification code of the transmitting station).
- Transmitting station time (time of broadcast from the transmitting station).
- ARIB STD-B.39 (inter-stationary control data).
- ARIB STD-B.37 (closed caption data).
- ARIB STD-B.35 (trigger signal data).
- ARIB TR-B.23 (1) (guidelines for inter-stationary control data transport, group 1).
- ARIB TR-B.23 (2) (guidelines for inter-stationary control data transport, group 2).

- ARIB TR-B.22 (guidelines for ancillary data transport).
- ITU.R BT-1685 (inter-stationary Control Data conveyed by ancillary data packets).

ARIB STD-B 39 display

The ARIB STD-B.39 display shows the decoded data for video signals using ancillary data compliant with ARIB STD-B.39. When this display is selected, the instrument searches the signal for ARIB STD-B.39 packets using the DID/SDID combinations defined by either the ITU or ARIB standards organizations.

```

ARIB B.39 Display
DID:      5f (25f) Type:      2 SDID:      fe (1fe) DC:      255 (2ff)
Field:
Status:   CHECKSUM Checksum:      x040 Should be:      x2ee
Format:   ARIB B.39 Inter-station Ctrl Data
          Inter-Station Ctrl Header 00000011 (x03)
          Transmitting Station Code  TEKテレビ
          Transmitting Station Time  2004/13/31 (Inv) 06:59:39.123
          Curr Video Mode            Unknown ?? x ?? 59.94 0.0
          Next Video Mode            Unknown 1920x1080 119.881 16x9
          Video Mode Countdown       002
          Curr Downmix/Audio Mode     [A-1/5QRT(2)]      S.2M (S+D)
          Next Downmix/Audio Mode     [A-1/2SQRT(2)]     3/2+S
          Audio Mode Countdown        003
          Trig Bits (Q8..Q1 Q16..Q9) 00000001 00000010
          Trig Bits (Q24..Q17 Q32..Q25) 00000100 00001000
          Trig Counter                016 032 064 128
          Trigr Countdown             017 033 065 129
          Status Bits (S8..S1 S16..S9) 01000100 10001000
          Error Correcting Code       x040 x040 x040 x040 x040 x040

```

```

ARIB Status
Transmitting Station Code  TEKテレビ
Transmitting Station Time  2004/13/31 (Inv) 06:59:39.123

ARIB B.39: OK
ARIB B.37: HD, SD, Analog, Mobile
ARIB B.35: Missing
ARIB B.23.1: Missing
ARIB B.23.2: Missing
ARIB TR-B.22: Missing
ITU.R BT-1685: Missing

```

Figure 66: ARIB STD-B.39 display (with the associated ARIB Status display)

The decoded ancillary data includes the following:

- DID - Data Identifier of the requested inter-stationary control packet; can be any of the following:
 - ARIB specification - 0x5F
 - ITU Specification - 0x43
- Type - Type of the ANC Data packet. For ARIB B.39, this is always a Type 2 packet (DID less than 0x80), as defined by SMPTE 291M. The actual value (with parity bits added) is displayed in parentheses.

- SDID - Secondary Data Identifier of the requested interstationary control packet; can be any of the following:
 - ARIB specification - 0xFE
 - ITU Specification - 0x01
- Line - The line of the video (within the field) from which the packet was acquired.
- Stream - For HD (SMPTE 292M, SMPTE 372, SMPTE 425), indicates whether the ancillary packet was acquired from the Y or C data streams. For SD, N/A is displayed.
- Status - Indicates whether packet(s) of the desired type are present in the video; also indicates Checksum or CRC errors.
- Checksum - Indicates the checksum word that was recovered from the acquired packet.
- Should be - Indicates the checksum word computed by the instrument, based on the packet data.
- Format - Indicates the name of the ancillary data type or standard.
- Inter-Station Ctrl Header - A header byte indicating packet continuity, and the presence or absence of the error correcting code.
- Transmitting Station Code - The name of the transmitting station. The instrument supports the display of Japanese characters.
- Transmitting Station Time - The broadcast time at the transmitting station.
- Current Video Mode - The video format of the current program.
- Next Video Mode - The video format of the next scheduled programming.
- Video Mode Countdown - A countdown timer indicating an upcoming change in video mode, which counts down from 254 (0xFE). A value of 0xFF indicates that no format change is pending within the next several seconds.
- Current Downmix/Audio Mode - Indicates the audio downmix and soundstage configuration of the current program.
- Next Downmix/Audio Mode - Indicates the audio downmix and soundstage configuration of the next scheduled program.
- Audio Mode Countdown - A countdown timer indicating an upcoming change in audio mode, which counts down from 254 (0xFE). A value of 0xFF indicates that no format change is pending within the next several seconds.
- Trigger Bits (Q8..Q1 Q16..Q9) - Together with trigger bits Q24..Q17 Q32..Q25, 32 bits that can be used to indicate changes in the program; usage is user-defined.
- Trigger Bits (Q24..Q17 Q32..Q25) - Together with trigger bits Q8..Q1 Q16..Q9; 32 bits that can be used to indicate changes in the program; usage is user-defined.

- Trigger Counter - Increments when bits Q1-Q4 go from 0 to 1. Wraps from 254 (0xFE) to zero. Value of 0xFF indicates the trigger counter is not used.
- Trigger Countdown - A countdown timer indicating an upcoming change in trigger bits Q1-Q4, which counts down from 254 (0xFE). A value of 0xFF indicates that no format change is pending within the next several seconds.
- Status Bits (S8..S1 S16..S9) - 16 user-defined status bits.
- Error Correcting Code - A six-word, Reed-Solomon error correcting code, which is used to verify the integrity of the ARIB B.39 or ITU-R BT. 1685 packet.

ARIB STD-B 37 display and status screens

The ARIB STD-B.37 display shows the decoded data for video signals using ancillary data compliant with ARIB STD-B.37. When this display is selected, the instrument searches the signal for ARIB STD-B.37 packets using the DID/SDID combinations defined by ARIB.

ARIB B.37 Display				
DID:	5f (25f)	-- (---)	-- (---)	-- (---)
SDID:	df (idf)	-- (---)	-- (---)	-- (---)
DC:	255 (2ff)	---	---	---
Field / Line	1 19	---	---	---
Format:	ARIB B.37 CC (HD)	No ARIB B.37	No ARIB B.37	No ARIB B.37
Chksum:	x1fe	---	---	---
Should be:	x1fe	---	---	---
Header 1st	00 0000 0000	-----	-----	-----
Header 2nd	00 0000 0000	-----	-----	-----
Header 3rd	00 0000 0001	-----	-----	-----
Header 4th	00 0000 0000	-----	-----	-----
ECC Status	Absent	----	----	----
Format ID	HD CC	----	----	----
Language	1st	----	----	----
CC Data ID	Ex Fmt CC	----	----	----
Send Mode	Sequential	----	----	----
Packet Flags	Intermediate	----	----	----
TR-B.23 Picmt	OK	----	----	----

ARIB Status	
Transmitting Station Code:	
Transmitting Station Time:	
ARIB B.39:	Missing
ARIB B.37:	---, SD, Analog, Mobile
ARIB B.35:	Missing
ARIB B.23_1:	Missing
ARIB B.23_2:	Missing
ARIB TR-B.22:	Missing
ITU-R BT-1685:	Missing

Figure 67: ARIB STD-B.37 display (with the associated ARIB Status display)

The decoded ancillary data includes the following:

- DID - Data Identifier of the requested closed captioning packet; can be any of the following:
 - Analog signal - 0x5F
 - SD Signal - 0x5
 - HD Signal - 0x5F
- SDID - Secondary Data Identifier of the requested packet; can be any of the following:
 - Analog signal - 0xDD
 - SD Signal - 0xDE
 - HD Signal - 0xDF
 - Mobile signal - 0xDC
- Field/Line - The field or line of the video from which the packet was acquired. Displays 1 for progressive formats.

NOTE. *The Line field turns red if the ARIB B.37 packets are not on the line as defined by ARIB TR-B.23.*

- Format - Indicates the name of the ancillary data type or standard.
- Header 1st - Displays the first of four User Data Words of the corresponding packet, in binary.
- Header 2nd - Displays the second of four User Data Words of the corresponding packet, in binary.
- Header 3rd - Displays the third of four User Data Words of the corresponding packet, in binary.
- Header 4th - Displays the last of four User Data Words of the corresponding packet, in binary.
- ECC Status - Indicates the presence or absence of the Error Correcting Code information in the payload.
- Format ID - Indicates whether the packet is for HD, SD, Analog, or Mobile captions.
- Language - Indicates the language code (1st through 8th) of the packet.
- CC Data ID - Indicates the CC Data ID of the packet. Can be one of the following:
 - Exchange Format CC
 - Exchange Format PMI
 - Exchange Format Page 1
 - Exchange Format Page 2
 - Short Form Management Data

- Short Form Text
- Undefined or Dummy Data
- Set Mode - Mode can be either Sequential or Buffer.
- Packet Flags - Indicates whether the packet is Leading, End, Intermediate, or Single.
- Checksum - Indicates the checksum word that was recovered from the acquired packet.
- Placement - Can display either OK or ERROR, indicating whether the ARIB B.37 packets are present in the allowable configuration(s) specified in ARIB TR-B.23.

ARIB STD-B 35 display and status screens

The ARIB STD-B.35 display shows the decoded data for video signals using ancillary data compliant with ARIB STD-B.35. When this display is selected, the instrument searches the signal for ARIB STD-B.35 packets using the DID/SDID combinations defined by ARIB.

ARIB B.35 Display																
DID:	5f (25f) Type:					2 SDID:					fd (1fd) DC:		255 (2ff)			
Field:	1 Line:										20 Stream:		Y			
Status:	PRESENT Checksum:					x21b					Should be:		x21b			
Format:	ARIB B.35 Data Prog. Exchange															
000	016	032	048	064	080	096	112	128	144	160	176	192	208	224	240	
140	140	140	140	140	140	140	140	140	140	140	140	140	140	140	140	
140	140	140	140	140	140	140	140	140	140	140	140	140	140	140	140	
140	140	140	140	140	140	140	140	140	140	140	140	140	140	140	140	
140	140	140	140	140	140	140	140	140	140	140	140	140	140	140	140	
140	140	140	140	140	140	140	140	140	140	140	140	140	140	140	140	
140	140	140	140	140	140	140	140	140	140	140	140	140	140	140	140	
140	140	140	140	140	140	140	140	140	140	140	140	140	140	140	140	
140	140	140	140	140	140	140	140	140	140	140	140	140	140	140	140	
140	140	140	140	140	140	140	140	140	140	140	140	140	140	140	140	
140	140	140	140	140	140	140	140	140	140	140	140	140	140	140	140	
140	140	140	140	140	140	140	140	140	140	140	140	140	140	140	140	
140	140	140	140	140	140	140	140	140	140	140	140	140	140	140	140	
140	140	140	140	140	140	140	140	140	140	140	140	140	140	140	140	
140	140	140	140	140	140	140	140	140	140	140	140	140	140	140	140	
140	140	140	140	140	140	140	140	140	140	140	140	140	140	140	140	
140	140	140	140	140	140	140	140	140	140	140	140	140	140	140	140	
140	140	140	140	140	140	140	140	140	140	140	140	140	140	140	140	
140	140	140	140	140	140	140	140	140	140	140	140	140	140	140	140	
140	140	140	140	140	140	140	140	140	140	140	140	140	140	140	140	
140	140	140	140	140	140	140	140	140	140	140	140	140	140	140	140	

ARIB Status	
Transmitting Station Code:	
Transmitting Station Time:	
ARIB B.39:	Missing
ARIB B.37:	ID, SD, Analog, Mobile
ARIB B.35:	OK
ARIB B.23 1:	Missing
ARIB B.23 2:	Missing
ARIB TR-B.22:	Missing
ITU-R BT-1685:	Missing

Figure 68: ARIB STD-B.35 display (with the associated ARIB Status display)

The decoded ancillary data includes the following:

- DID - Data Identifier of the requested packet; permissible values range from 1 to 0xFF (255) inclusive.
- Type - Type of the ANC Data packet. For ARIB B.35, this is always a Type 2 packet (DID less than 0x80), as defined by SMPTE 291M. The actual value (with parity bits added) is displayed in parentheses.
- SDID - Secondary Data Identifier of the requested packet; permissible values range from 0 through 0xFF (255) inclusive. This field only appears when a Type 2 packet is selected (see above). The actual value (with parity bits added) is displayed in parentheses.
- DC - Data Count word of the acquired packet. The number of User Data words is displayed in decimal. The actual value (with parity bits added) is displayed in parenthesis, in hexadecimal.
- Field - The field of the video from which the packet was acquired. Displays 1 for progressive formats.
- Line - The line of the video (within the field) from which the packet was acquired.
- Stream - For HD (SMPTE 292M), indicates whether the ancillary packet was acquired from the Y or C data streams. Displays N/A for SD.
- Status - Indicates whether packet(s) of the desired type are present in the video; also indicates Checksum or CRC errors.
- Checksum - Indicates the checksum word that was recovered from the acquired packet.
- Should be - Indicates the checksum word computed by the instrument, based on the packet data.
- Format - Indicates the name of the ancillary data type or standard.
- User Data Words - Contains the payload of the ancillary packet, displayed in hexadecimal. Displays all 10 bits.

ARIB TR-B 23 (1) display and status screens

The ARIB TR-B.23 (1) display shows the decoded data for video signals using ancillary data compliant with ARIB TR-B.23 (1). When this display is selected, the instrument searches the signal for ARIB TR-B.23 (1) packets using the DID/SDID combinations defined by ARIB.

ARIB TR-B.23 (1) Display															
DID:	5f (25f)			Type:	2			SDID:	Fc (2fc)			DC:	255 (2ff)		
Field:				1			Line:	20			Stream:	Y			
Status:	PRESENT			Checksum:			x11a			Should be:			x11a		
Format:	ARIB TR-B.23 User Data (1)														
000	016	032	048	064	080	096	112	128	144	160	176	192	208	224	240
140	140	140	140	140	140	140	140	140	140	140	140	140	140	140	140
140	140	140	140	140	140	140	140	140	140	140	140	140	140	140	140
140	140	140	140	140	140	140	140	140	140	140	140	140	140	140	140
140	140	140	140	140	140	140	140	140	140	140	140	140	140	140	140
140	140	140	140	140	140	140	140	140	140	140	140	140	140	140	140
140	140	140	140	140	140	140	140	140	140	140	140	140	140	140	140
140	140	140	140	140	140	140	140	140	140	140	140	140	140	140	140
140	140	140	140	140	140	140	140	140	140	140	140	140	140	140	140
140	140	140	140	140	140	140	140	140	140	140	140	140	140	140	140
140	140	140	140	140	140	140	140	140	140	140	140	140	140	140	140
140	140	140	140	140	140	140	140	140	140	140	140	140	140	140	140
140	140	140	140	140	140	140	140	140	140	140	140	140	140	140	140
140	140	140	140	140	140	140	140	140	140	140	140	140	140	140	140
140	140	140	140	140	140	140	140	140	140	140	140	140	140	140	140
140	140	140	140	140	140	140	140	140	140	140	140	140	140	140	140
140	140	140	140	140	140	140	140	140	140	140	140	140	140	140	140
140	140	140	140	140	140	140	140	140	140	140	140	140	140	140	140

ARIB Status	
Transmitting Station Code:	
Transmitting Station Time:	
ARIB E.39:	Missing
ARIB E.37:	HD, SD, Analog, Mobile
ARIB E.35:	Missing
ARIB B.23 1:	OK
ARIB B.23 2:	OK
ARIB TR-B.22:	Missing
ITU-R BT-1685:	Missing

Figure 69: ARIB TR-B.23 (1) display (with the associated ARIB Status display)

The decoded ancillary data includes the following:

- DID - Data Identifier of the requested packet; permissible values range from 1 to 0xFF (255) inclusive.
- Type - Type of the ANC Data packet. For ARIB TR-B.23-1, this is always a Type 2 packet (DID less than 0x80), as defined by SMPTE 291M. The actual value (with parity bits added) is displayed in parentheses.
- SDID - Secondary Data Identifier of the requested packet; permissible values range from 0 through 0xFF (255) inclusive. This field only appears when a Type 2 packet is selected (see above). The actual value (with parity bits added) is displayed in parentheses.
- DC - Data Count word of the acquired packet. The number of User Data words is displayed in decimal. The actual value (with parity bits added) is displayed in parenthesis, in hexadecimal.

- Field - The field of the video from which the packet was acquired. Displays 1 for progressive formats.
- Line - The line of the video (within the field) from which the packet was acquired.
- Stream - For HD (SMPTE 292M), indicates whether the ancillary packet was acquired from the Y or C data streams. Displays N/A for SD.
- Status - Indicates whether packet(s) of the desired type are present in the video; also indicates Checksum or CRC errors.
- Checksum - Indicates the checksum word that was recovered from the acquired packet.
- Should be - Indicates the checksum work computed by the instrument, based on the packet data.
- Format - Indicates the name of the ancillary data type or standard.
- User Data Words - Contains the payload of the ancillary packet, displayed in hexadecimal. Displays all 10 bits.

ARIB TR-B 23 (2) display and status screens

The ARIB TR-B.23 (2) display shows the decoded data for video signals using ancillary data compliant with ARIB TR-B.23 (2). When this display is selected, the instrument searches the signal for ARIB TR-B.23 (2) packets using the DID/SDID combinations defined by ARIB.

ARIB TR-B.23 (2) Display																		
DID:	5f (25f)					Type:	2					SDID:	fb (1fb)		DC:	255 (2ff)		
Field:	1					Line:	20					Stream:	Y					
Status:	PRESENT					Checksum:	x219					Should be:	x219					
Format:	ARIB TR-B.23 User Data (2)																	
000	016	032	048	064	080	096	112	128	144	160	176	192	208	224	240			
140	140	140	140	140	140	140	140	140	140	140	140	140	140	140	140			
140	140	140	140	140	140	140	140	140	140	140	140	140	140	140	140			
140	140	140	140	140	140	140	140	140	140	140	140	140	140	140	140			
140	140	140	140	140	140	140	140	140	140	140	140	140	140	140	140			
140	140	140	140	140	140	140	140	140	140	140	140	140	140	140	140			
140	140	140	140	140	140	140	140	140	140	140	140	140	140	140	140			
140	140	140	140	140	140	140	140	140	140	140	140	140	140	140	140			
140	140	140	140	140	140	140	140	140	140	140	140	140	140	140	140			
140	140	140	140	140	140	140	140	140	140	140	140	140	140	140	140			
140	140	140	140	140	140	140	140	140	140	140	140	140	140	140	140			
140	140	140	140	140	140	140	140	140	140	140	140	140	140	140	140			
140	140	140	140	140	140	140	140	140	140	140	140	140	140	140	140			
140	140	140	140	140	140	140	140	140	140	140	140	140	140	140	140			
140	140	140	140	140	140	140	140	140	140	140	140	140	140	140	140			
140	140	140	140	140	140	140	140	140	140	140	140	140	140	140	140			
140	140	140	140	140	140	140	140	140	140	140	140	140	140	140	140			

ARIB Status	
Transmitting Station Code:	
Transmitting Station Time:	
ARIB B.39:	Missing
ARIB B.37:	HD, SD, Analog, Mobile
ARIB B.35:	Missing
ARIB B.23_1:	OK
ARIB B.23_2:	OK
ARIB TR-B.22:	Missing
ITU.R BT-1685:	Missing

Figure 70: ARIB TR-B.23 (2) display (with the associated ARIB Status display)

The decoded ancillary data includes the following:

- DID - Data Identifier of the requested packet; permissible values range from 1 to 0xFF (255) inclusive.
- Type - Type of the ANC Data packet. For ARIB TR-B.23-2, this is always a Type 2 packet (DID less than 0x80), as defined by SMPTE 291M. The actual value (with parity bits added) is displayed in parentheses.
- SDID - Secondary Data Identifier of the requested packet; permissible values range from 0 through 0xFF (255) inclusive. This field only appears when a Type 2 packet is selected (see above). The actual value (with parity bits added) is displayed in parentheses.
- DC - Data Count word of the acquired packet. The number of User Data words is displayed in decimal. The actual value (with parity bits added) is displayed in parenthesis, in hexadecimal.
- Field - The field of the video from which the packet was acquired. Displays 1 for progressive formats.
- Line - The line of the video (within the field) from which the packet was acquired.

- Stream - For HD (SMPTE 292M), indicates whether the ancillary packet was acquired from the Y or C data streams. Displays N/A for SD.
- Status - Indicates whether packet(s) of the desired type are present in the video; also indicates Checksum or CRC errors.
- Checksum - Indicates the checksum word that was recovered from the acquired packet.
- Should be - Indicates the checksum work computed by the instrument, based on the packet data.
- Format - Indicates the name of the ancillary data type or standard.
- User Data Words - Contains the payload of the ancillary packet, displayed in hexadecimal. Displays all 10 bits.

ARIB TR-B 22 display and status screens

The ARIB TR-B.22 display shows the decoded data for video signals using ancillary data compliant with ARIB TR-B.22. When this display is selected, the instrument searches the signal for ARIB TR-B.22 packets using the DID/SDID combinations defined by ARIB.

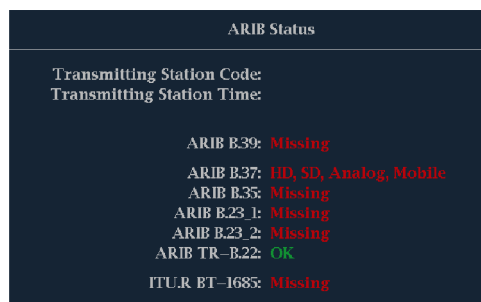
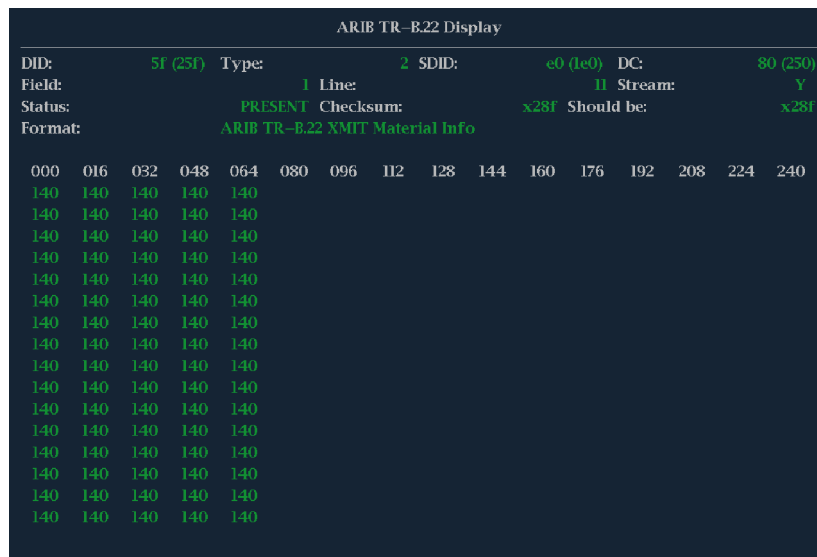

Figure 71: ARIB TR-B.22 display (with the associated ARIB Status display)

The decoded ancillary data includes the following:

- DID - Data Identifier of the requested packet; permissible values range from 1 to 0xFF (255) inclusive.
- Type - Type of the ANC Data packet. For ARIB TR-B.22, this is always a Type 2 packet (DID less than 0x80), as defined by SMPTE 291M. The actual value (with parity bits added) is displayed in parentheses.
- SDID - Secondary Data Identifier of the requested packet; permissible values range from 0 through 0xFF (255) inclusive. This field only appears when a Type 2 packet is selected (see above). The actual value (with parity bits added) is displayed in parentheses.
- DC - Data Count word of the acquired packet. The number of User Data words is displayed in decimal. The actual value (with parity bits added) is displayed in parenthesis, in hexadecimal.
- Field - The field of the video from which the packet was acquired. Displays 1 for progressive formats.
- Line - The line of the video (within the field) from which the packet was acquired.
- Stream - For HD (SMPTE 292M), indicates whether the ancillary packet was acquired from the Y or C data streams. Displays N/A for SD.
- Status - Indicates whether packet(s) of the desired type are present in the video; also indicates Checksum or CRC errors.
- Checksum - Indicates the checksum word that was recovered from the acquired packet.
- Should be - Indicates the checksum work computed by the instrument, based on the packet data.
- Format - Indicates the name of the ancillary data type or standard.
- User Data Words - Contains the payload of the ancillary packet, displayed in hexadecimal. Displays all 10 bits.

Audio monitoring

Your instrument can monitor embedded audio signals, measure levels, monitor phase, display phase correlation, and monitor surround-sound audio. You can specify meter ballistics and scales, set test and peak program indicator levels, and specify how phase is displayed.

To configure embedded audio inputs and alarms

Audio inputs come set to factory defaults. As a result, you may need to configure them before performing the audio monitoring procedures in this section. Your setup here determines, in part, which audio-signal characteristics are displayed.

Perform the following steps to configure the embedded audio inputs:

1. Press the **CONFIG** button to display the configuration menu.
2. Select **Audio Inputs/Outputs**, and then select the input to be configured: Embedded A, Embedded B, or Embedded Dual Link.
3. Select **Bar Format**, and then select one of the following formats:
 - **Raw Pairs** for a *stereo with SAP and discrete channels* type installation.
 - **Program (Surround)** for a surround sound type installation.
4. If you selected the Program (Surround) bar format, select **Program Cfg** and then select the type of surround sound installation.
5. If you selected the Program (Surround) bar format, select **Surround Mapping** and then set the mapping type to **SMPTE 320** or **UK**.
6. Set the bar to input mapping as follows:, and then
 - a. Select **Bar to Input Map**.
 - b. Select which input pair should be displayed in each bar pair.
 - c. Select which inputs are allowed to generate alarms.
 - d. Select the **Return** box to return to the Configuration menu.
7. Repeat these steps for any other Audio inputs that you want to configure.

To display an audio input

You select the audio input to be monitored from the front-panel **AUDIO** button pop-up menu. Note that the Audio display can appear in only one tile at a time.

1. If you are in Quad Tile mode, select the tile in which you want to monitor an audio signal.
2. Press and hold the **AUDIO** button to select the Audio display and open the Audio pop-up menu.
3. Select **Audio Input**, and then select the desired audio input. See [Audio input](#) on page 62.

To check audio level and phase

Level meters are vertical bar graphs on which the height of the bar indicates the amplitude of the audio program in the corresponding input channel. Use the Audio pop-up menu to change the input and turn on and off the Phase display. Other meter characteristics such as ballistics, scale units, and program and test levels are configured through the Configuration menu.

If your instrument is equipped with optional audio features, it can display phase of one input pair as a Lissajous pattern, and display relative phase on all four pairs of inputs with correlation meters.

To check audio level

1. Open the audio display in one tile and select an input. See [To display an audio input](#) on page 222.
2. Configure the input for your installation. See [To configure embedded audio inputs and alarms](#) on page 221.
3. Check the level meter bars for current audio levels, which are displayed according to the selected meter ballistics. Each bar displays three colors.
 - Green – Indicates audio levels below the test level.
 - Yellow – Indicates audio levels between the test and peak program level.
 - Red – Indicates audio levels above the peak program level.

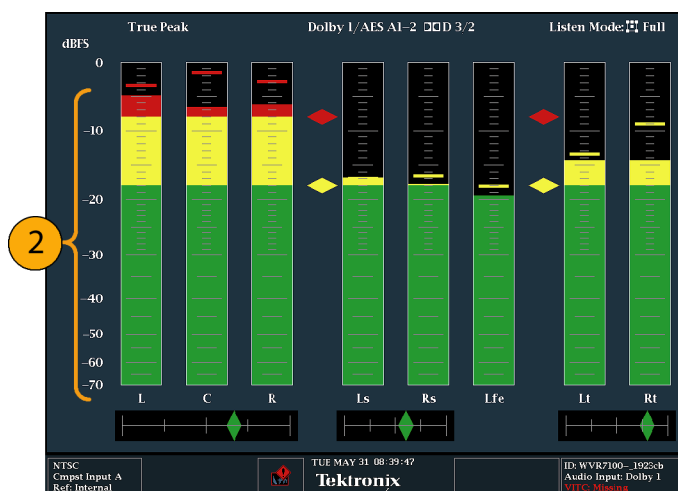

Figure 72: Audio levels

To check audio phase

1. Select **Aux Display**.
2. Select **Phase Display** to turn it on.
3. Select the **Phase Style**. Choose either a **Lissajous Soundstage** or **X-Y** orientation for the Lissajous signal.
4. Select the phase pair to be displayed, or select **Custom** and select independent channels using the Phase Channel A and Phase Channel B entries.
5. Set the Audio Input to match the signal that you are checking (or use the Audio Follows Video mode set in the CONFIG menu).
6. Check for Phase correlation of the signals, noting the following:
 - Phase correlation meters are located under the appropriate bars and one is duplicated under the phase display.
 - For identical and correlated signals, the indicator is white and moves to the right side.
 - For highly correlated signals, the indicator is green and moves to the right side.
 - For uncorrelated signals, the indicator is yellow and tends to stay in the middle.
 - For anticorrelated signals (one goes up when the other goes down), the indicator is red and moves to the left side.

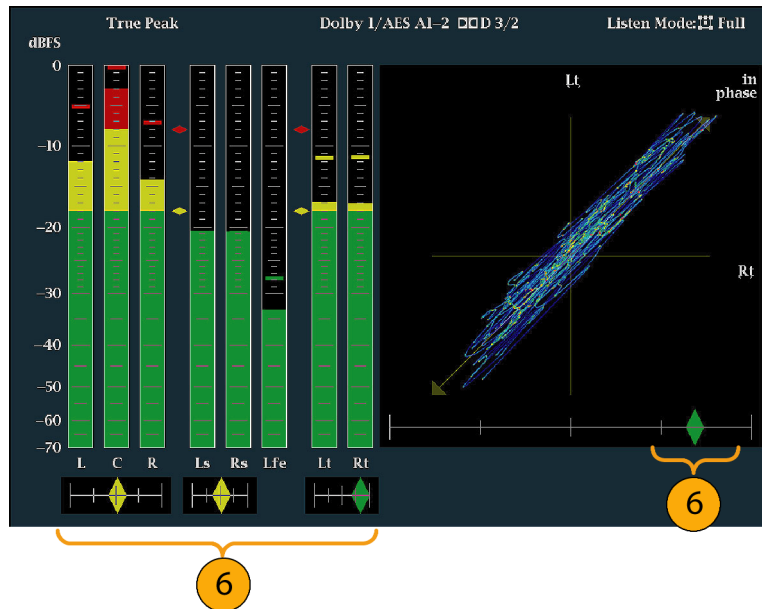

Figure 73: Checking for phase correlation

Usage notes

- The Lissajous or phase display is a plot of one channel against another on an orthogonal pair of axes.
- Soundstage plots the two channels at 45 degree angles, with the mono combination appearing on the vertical axis— like a left-right image in a studio.
- X-Y plots left-channel data on the vertical axis and right channel data on the horizontal axis, emulating the X-Y display of an oscilloscope.
- The following response times of the correlation meters can be set from the Configuration menu.

Speed setting	Response averaging time (s)	Speed setting	Response averaging time (s)
1	0.0167	11	3.0
2	0.0333	12	3.5
3	0.0667	13	4.0
4	0.1333	14	4.5
5	0.2667	15	5.0
6	0.5333	16	5.5
7	1.0	17	6.0
8 (default)	1.5	18	6.5
9	2.0	19	7.0
10	2.5	20	7.5

To monitor embedded 16-channel audio

To configure audio inputs for embedded 16-channel audio

To set up an Audio Input for embedded 16-channel audio:

1. Press the **CONFIG** button to open the Configuration menu.
2. Select **Audio Inputs/Outputs > Video to Audio Map**.
3. Select **SDI Input 1A** or **MUTLI IN 1B**.
4. Select **Emb. 16-Ch**.
5. To set the appropriate ballistics for the level meter display, use the **Digital Audio Displays > Ballistics** selections to set the ballistics to **True Peak**, **PPM Type 1**, or **PPM Type 2**.
6. Press and hold the **AUDIO** button to open the Audio pop-up menu.
7. Use the arrow keys to select **Audio Input** and then select **Follows Video**.
8. Press the **AUDIO** button to close the pop-up menu.

Functions not supported for 16-channel audio. The following functions are not supported for 16-channel audio:

- Audio input to bar mapping
- Audio output mapping
- Correlation meters
- Lissajous and phase displays
- Headphone

NOTE. *You cannot modify the input and output mapping because the mappings are fixed for 16-Channel audio.*

To set the audio input for embedded 16-channel audio

1. Press and hold the **AUDIO** button to open the Audio display and view the Audio pop-up menu.
2. Select **Audio Input** and then select the **Emb. 16-Ch** option.
3. Press the **AUDIO** button to close the pop-up menu. The following figure shows the 16-channel audio bars display.

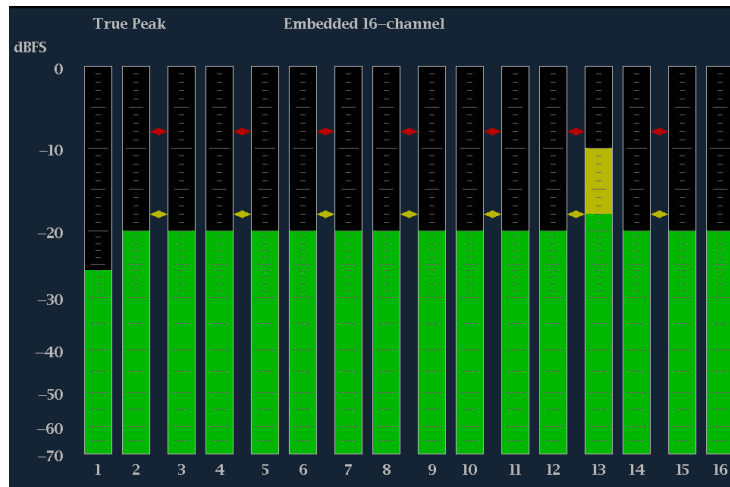

Figure 74: 16-Channel audio bars display

To quickly select channels 1-8 or 9-16 of the embedded audio

1. Press and hold the **AUDIO** button to open the Audio display and view the Audio pop-up menu.
2. Select **Audio Input** and then select **Emb. 1-8** or **Emb. 9-16**.
3. Press the **AUDIO** button to close the pop-up menu.

NOTE. When the audio input source is set to *Emb. 16-Ch*, *Emb. 1-8*, or *Emb. 9-16*, you can then use the left/right arrow keys to quickly toggle through these three audio input sources.

To check surround sound

Your instrument can also display the surround sound listening environment. The following procedures help you get started.

1. Open the audio display in one tile and select the input containing the surround audio. See *To display an audio input* on page 222.
2. Configure the input for your installation. See *To configure embedded audio inputs and alarms* on page 221.
3. Select **Aux Display** and then select **Surround Sound Display**. Press **SEL** or the right-arrow key to turn the phase display on.
4. Set the Audio Input to match the signal that you are checking.

NOTE. If you want the level bars labeled with their surround sound channel names instead of channel numbers, select (Surround) when you configure the audio inputs.

5. Set the surround **Dominance indicator** to **ON** or **OFF**.
6. Use the level bar display to monitor level control. See *To check audio level* on page 222.
7. Use the surround display to monitor relative loudness of the individual elements rendered in a surround-sound listening environment. Check the surround sound display for performance parameters and indicators.

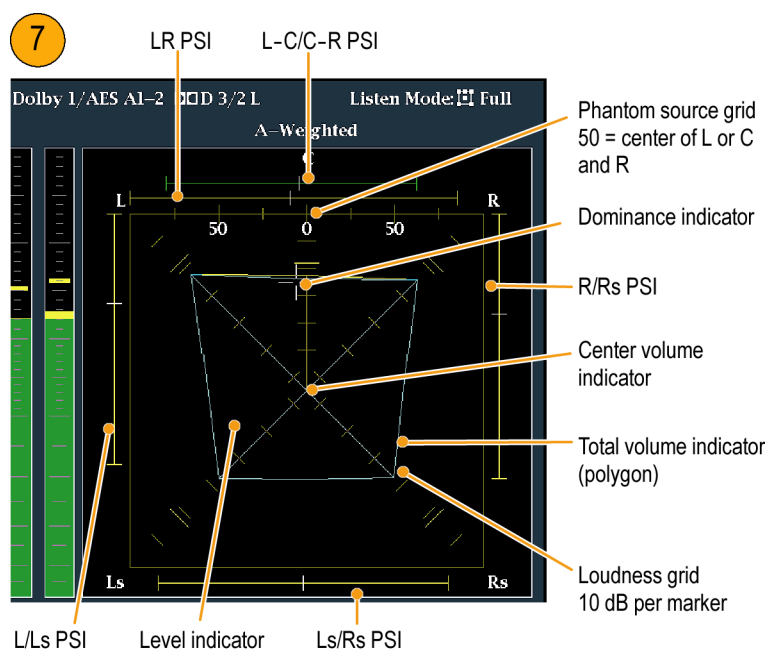

Figure 75: Surround sound indicators

NOTE. The Audio Surround Sound display is courtesy of Radio-Technische Werkstätten GmbH & Co. KG (RTW) of Cologne, Germany.

Elements of the surround sound display

- Level Indicators – indicate the audio level balance among the left (L), right (R), left-surround (Ls), and right-surround (Rs) channels as cyan lines on the Loudness Grid.
- Loudness Grid – the ruled scale, radiating from the center, on which the level indicators register their audio level and balance. The scale has tic marks at 10 dB intervals. An additional tic mark indicates the –18 dB level. The –18 dB and –20 dB levels are typically used for aligning audio levels.
- Total Volume Indicator – the cyan polygon formed by connecting the level indicator end points, showing the total sound volume of the L, R, Ls, and Rs channels. Each connecting line bends away from the center if the two signals have a positive correlation, bends toward the center if the signals have a negative correlation, and do not bend if the signals are uncorrelated.
- Center Volume indicator – displays the sound volume of the center channel as a vertical yellow bar between the L and R channels, and connects the ends of the L, C, and R audio level indicators with straight lines.
- Channel-Pair Phantom Sound Indicators (PSIs) – located on each side of the Surround Sound display, indicates the location of potential phantom sound sources formed by adjacent channels. The white tic marks on these moving bar indicators show the phantom source locations. The bar length indicates the correlation between the adjacent channels. A short-to-medium length green bar indicates positive correlation between the channels, forming a localized phantom sound source located at the white tic mark. The bar grows to full length and changes color to yellow as the correlation moves to zero, indicating a wide, non-localized sound image. The bar changes color to red for adjacent channels with significant negative correlation. For negative correlations, the ends of the PSI for the L and R channels continue to grow at a 45° angle while the other PSIs remain at full length.
- Center-Pairs Phantom Sound Indicator – a fifth PSI at the top of the display shows potential phantom sources formed by the LC channel pair and the CR channel pair. If the L, R, and C channels all have the same signal level, the white tic mark on the bar appears directly above the C level indicator. The white tic mark moves right or left depending on the relative balance between the three channels. A short bar to the left of the white tic mark indicates a positive correlation between L and C. The bar grows as the correlation decreases. Like the L-R PSI, the bar continues to grow at a 45° angle for negative signal correlations. The bar to the right of the white tic mark behaves similarly, depending on the C-R correlation. This PSI indicator uses the same color coding as the other PSI indicators.

Usage notes The displays shown here are examples of how the surround sound waveform appears for some typical signal types.

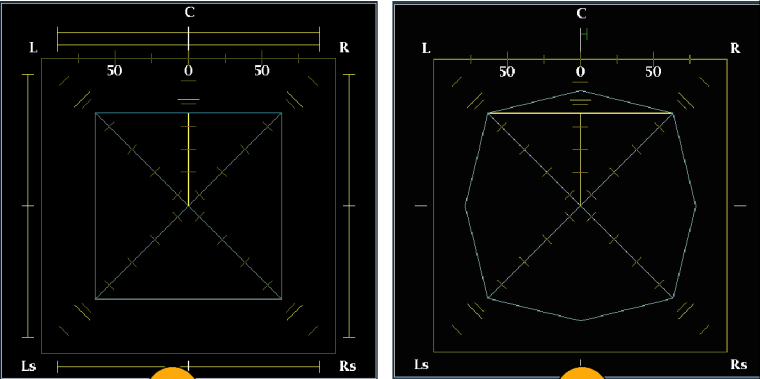
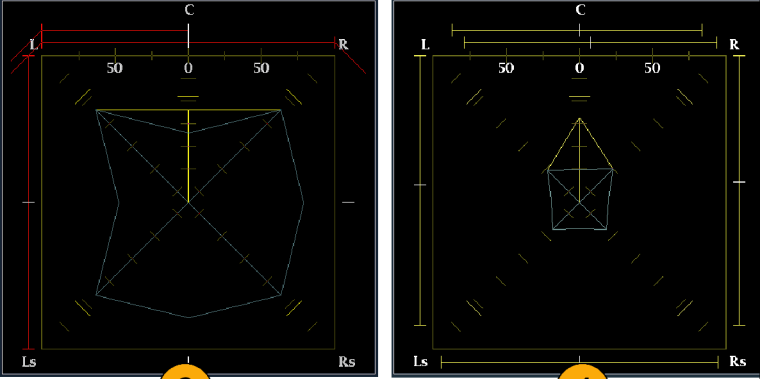
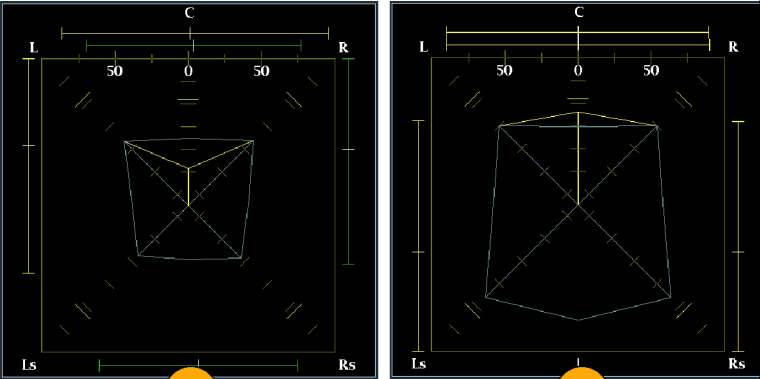
Typical signal types	Display examples
<p>1. Uncorrelated signals: same level in the L, C, R, Ls, and Rs channels.</p> <p>2. Sine wave test tone: same level in the L,C, R, Ls, and Rs channels. All signals are in phase, creating phantom sources between the adjacent channels.</p>	 <p>The first monitor (1) shows a square waveform with a diagonal cross, indicating uncorrelated signals. The second monitor (2) shows a regular pentagon waveform, indicating a sine wave test tone in phase across all channels. Both monitors have a scale from 0 to 50 on the horizontal axis and are labeled with L, C, R, Ls, and Rs channels.</p>
<p>3. Same as 2, with the exception that Channel L is out of phase.</p> <p>4. Surround sound program with strong center channel presence.</p>	 <p>The third monitor (3) shows a distorted pentagon waveform where the left channel (L) is out of phase. The fourth monitor (4) shows a small pentagon waveform centered on the C channel, indicating strong center channel presence. Both monitors have a scale from 0 to 50 on the horizontal axis and are labeled with L, C, R, Ls, and Rs channels.</p>
<p>5. Surround sound program with weak center channel presence.</p> <p>6. Monaural signal in channels Ls and Rs, creating a phantom source in the center, as in a 3.1 surround sound system.</p>	 <p>The fifth monitor (5) shows a small pentagon waveform centered on the C channel, indicating weak center channel presence. The sixth monitor (6) shows a pentagon waveform with a significant peak on the C channel, indicating a phantom source in the center created by a monaural signal in Ls and Rs. Both monitors have a scale from 0 to 50 on the horizontal axis and are labeled with L, C, R, Ls, and Rs channels.</p>

Closed captioning (CC) teletext AFD and safe area compliance

With Option DATA installed, this instrument can monitor for CC data (including V-Chip ratings) present in the selected signal and display that data overlaid on the Picture display. (CEA 608 (VBI), CEA 608 (ANC), CEA (608/708), CEA 708, TeletextB (VBI), TeletextB OP47 SDP (ANC), and TeletextB OP47 Multi (ANC) closed caption transports are supported.

Your instrument can also display Safe Action and Safe Title graticules, allowing you to monitor for incorrect placements of graphics, logos, and other branding elements. This will help you ensure that those items do not obscure text or essential action. SMPTE, ITU, and ARIB TR-B.4 standards are supported.

NOTE. *CC/Teletext format monitoring is tile specific. To simultaneously monitor more than one format, select the appropriate settings in the desired tile.*

Monitoring CC and teletext

Perform the following procedures before monitoring CC and Teletext.

To configure CC and teletext

1. From the CONFIG menu, select **Aux Data Settings**.
2. Select from the following CC types:
 - CEA 608 Settings
 - CEA 708 Settings
 - Teletext B Settings

Configuring CEA 608 settings.

1. Select **CEA608 Settings** from the Aux Data Settings submenu.
2. Select **CEA608 Required** and then select **Yes** or **No**, depending on whether you want to monitor for required settings.
3. Select **CEA608 Transport**, and then select from Auto, Line 21, S334 (RAW), or S334 (CDP). If you select **Auto**, the instrument will search for any available transport.
4. Select **VBI Mode**, and then select Auto or Manual. If you select **Manual**, set **VBI Line Num** using the General knob.
5. Select **VBI Timing** and select Normal, Early, or Late.
6. If required services is set to Yes, select **Req Services** and press the **SEL** button. This will show a dialog box that allows you to select CC and Text required channels.

Configuring CEA 708 settings.

1. Select **CEA708 Settings** from the Aux Data Settings submenu.
2. Select **CEA708 Required** and select **Yes** or **No**, depending on whether you want to monitor for required settings.
3. If required services is set to Yes, select **Req Services** and press the **SEL** button. This brings up a dialog box that allows you to select CC and Text required channels.

Teletext b settings.

1. Select **Teletext B Settings** from the Aux Data Settings submenu.
2. Select **Teletext Required** and select **Yes** or **No**, depending on whether you want to monitor for required settings.
3. Select **WST Transport**, and select from Auto, VBI, OP47 (SDP), or OP47 (Multi). If you select **Auto**, the instrument searches for any available transport.
4. If required services is set to Yes, select **Teletext Req Pages** and press the **SEL** button.
5. When Teletext Required Pages dialog box appears, use the General knob to navigate to the box in the **Allow Alarm** column that is next to the page for which you want monitor.
6. Press the **SEL** button to mark the box.
7. Press the right arrow key and then press the SEL button to highlight the **Page Number** box.
8. Use the General knob to set the box to the desired page number and press the **SEL** button.
9. When you are finished with your selections, use the down arrow to navigate to the **Return** box and press the **SEL** button.

To view CC status and subtitles

1. Select a tile.
2. Press and hold the **STATUS** button to display the Status pop-up menu.
3. Select **Display Type**.
4. Select **Aux Data Status**. The Auxiliary Data Status display shows the status of the closed caption data.

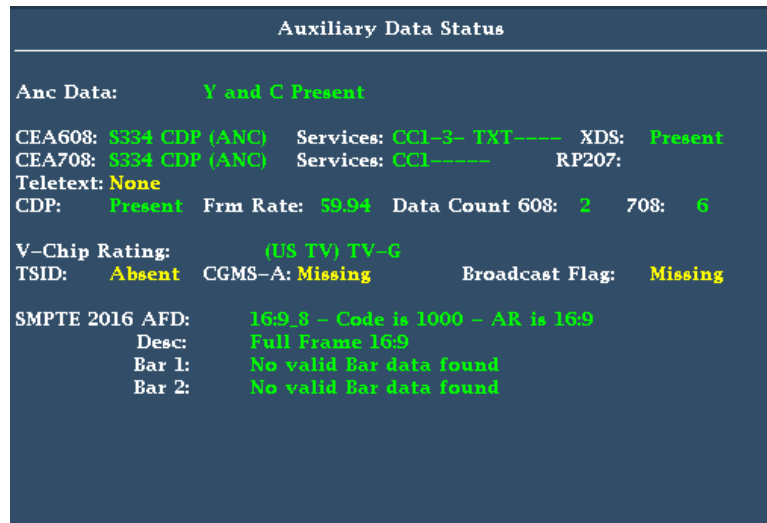

Figure 76: Auxiliary Data Status display

To display CC

1. Select a tile.
2. Press and hold the **PICT** button to display the Picture pop-up menu.
3. Select **CC/Teletext Format** and select the CC type, if any, you want to display.
4. Select the channel, service, or page to display.

The Picture display includes Closed Captioning in the area designated by the Closed Caption data.

5. Press the **PICT** button again to dismiss the Picture pop-up menu.

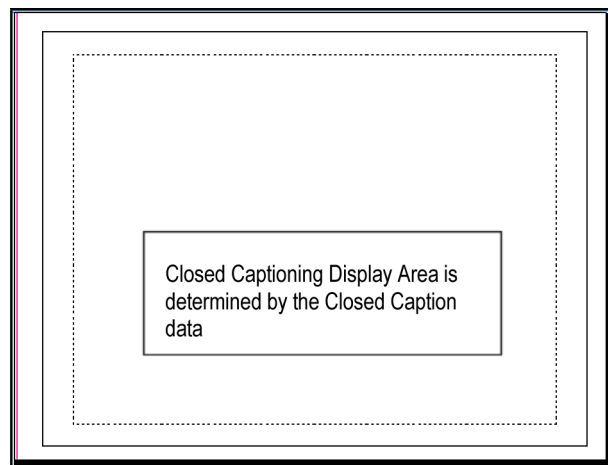

Figure 77: Closed caption display area

- Usage notes**
- PICT displays in individual tiles allow their Services and Pages to be selected independently.
 - CC text is not captured with the Picture image when using Freeze.
 - CC/Teletext setups are also stored when saved with Presets and restored at power on.
 - The CC alarms are available from the Configuration menu in the Alarms submenu under Closed Captions/Metadata.
 - Teletext can be viewed as captions or as a whole page.

Monitoring for safe area compliance

To display graticules for monitoring for incorrect placements of nonessential elements relative to essential ones, set global settings in the Configuration menu and turn on up to four Safe Area graticules, each with independent settings, in the Picture menu.

To configure safe area graticules

Before using Safe Area Graticules, configure them from the Configuration menu by performing the following steps:

1. Select **Graticules** and then select **Safe Area Graticule Standard** from the CONFIG menu.
2. Choose from the **SMPTE**, **ITU**, or **ARIB TR-B.4** standards. The selection you choose will be the graticule used when **AUTO** is chosen for any of the four Safe Area Graticules, accessed in the Picture menu.
3. To set the Height, Width, and Offsets of the title and action areas for Custom Safe Graticules 1 and 2, first select the title or action to change.
4. Set the percentage level for each of the parameters. Parameters are set as a percentage of screen height or width, and you can watch the graticules update on the screen as you change them.

NOTE. *The custom parameters you set are used when or is chosen for any of the four Safe Area Graticules accessed in the Picture menu.*

To display safe area graticules

1. Select a tile.
2. Press and hold the **PICT** button to display the Picture menu.
3. Select **Safe Area Action 1**.
4. Select one of the following:
 - **Auto** to let the instrument automatically select the size and offsets of the safe area.
 - **4x3, 14x9, or 16x9** to set the safe area size and offsets appropriate for these aspect ratios based on the selected standard.
 - **Custom_1** or **Custom_2** to set the safe area size and offsets to match the custom settings in the Graticules Configuration menu.
5. After setting each Safe Area selection, press the **PICT** button to dismiss the pop-up menu.

Usage notes

- The Safe Action Area shows the maximum image area within which all significant action should be contained; the Safe Title Area shows the maximum image area within which all significant titles should be contained.
- Safe Area Graticules can globally be configured to comply to accepted standards in the Configuration menu.
- Custom selections for vertical and horizontal size and offset of the Save Areas can be set in the Configuration menu.

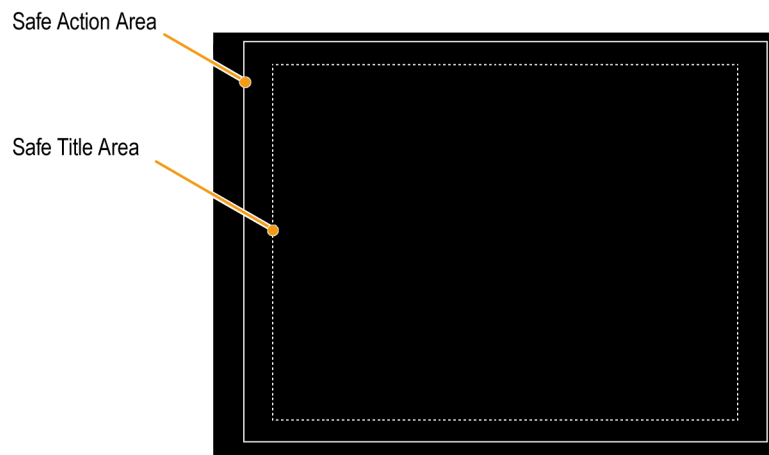

Figure 78: Safe Action and Safe Title areas

Monitoring for AFD compliance

To display graticules for monitoring for AFD compliance, you must turn the graticules on from the pop-up menu in the Picture Display. View information about AFD graticules on the Auxiliary Data Status display.

To configure AFD graticules

1. Press and hold the **PICT** button to display the Picture menu.
2. Select **AFD Graticules** and then select **On**.

View the graticules in the Picture display. AFD information can viewed in the Auxiliary Data Status display. See [Auxiliary Data Status display](#) on page 118.

Remote Web interface

The instrument can be accessed four ways over an Ethernet network:

- Use a Web browser to access the instrument Web page.
- Download a Java applet to allow control and display of a virtual front panel.
- Load a Java application onto the host PC to allow control and display of a virtual front panel.
- Use SNMP, where commands can control the instrument and the instrument can send traps in response to error conditions.

Web browser

Using only a Web browser, you can access the instrument Web page. To access this page, simply enter the IP address of the instrument into a Web browser on a computer. From this page, you can save screen captures, download presets, view the event and diagnostic logs, and even browse the online help. You can also download a Java applet or the SNMP MIB.

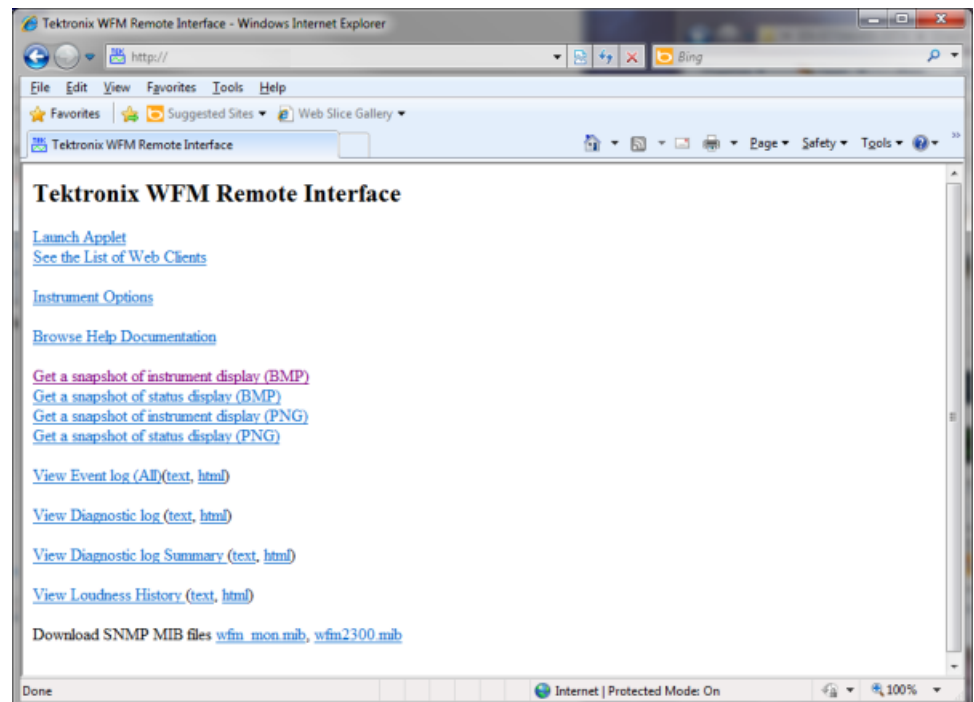

Figure 79: Remote Web interface

Java applet

If you have the correct system configuration, you can download and launch the Java applet (referred to as “remote applet”) from the instrument Web page. The remote applet provides a menu bar and a virtual front panel that gives complete control over instrument settings from a remote computer. The remote applet can also show the instrument displays at a rate of a frame every few seconds.

Java application

A Java application (referred to as “remote application”) can be downloaded from the Tektronix Web site and loaded onto a PC. The remote application is very similar to the remote applet, but it has greater capability for storing presets, since it has access to storage on the host machine. The remote application also starts more quickly than the applet since it does not have to download over the network each time it runs.

The remote application also permits you to access several unique utilities and settings that relate to WVR remote display refresh rate. See Settings... dialog for more information on how to use these features.

NOTE. *Java version 1.4.1 or higher is required for proper operation of both the Web applet and the application. For operating the applet, you should use Microsoft Internet Explorer version 6.0 or higher. Netscape 6.22 and Mac OS X have exhibited some problems with window re-sizing, so users who wish to use these browsers are encouraged to download the application instead of using the applet. Operation with other browsers or versions has not been verified.*

Network access

Network access can be controlled by parameters in the CONFIG menu under the Network Settings submenu. These settings allow you to enable or disable access through the network, set community strings, and set addresses. See [Configure the network interface](#) on page 20.

NOTE. Some Web browsers interpret IP addresses with leading zeros as octal numbers. For example, if the address of the instrument is of the form 124.161.038.151, then enter it in the browser as 124.161.38.151.

SNMP control

SNMP control is primarily intended for access by means of automation systems. The complete SNMP MIB can be downloaded from the instrument Web page. You can also download a printable version of the MIB from the Tektronix Web site: www.tektronix.com/manuals.

SNMP Traps can be sent to up to four addresses when error conditions are detected. See [Configure the network interface](#) on page 20.

Use the CONFIG menu to set various parameters that will generate SNMP trap error reports. Some of those parameters are listed below.

- Use the menu selections under **Gamut Thresholds** to set the minimum and maximum gamut limits for composite signals derived from the SDI signal, set the minimum and maximum luma levels, and specify the percentage of the total image pixels that can be outside the current gamut or luma limits and not generate error reports.
- Use the menu selections under **Alarms** to enable various alarms that will be reported in the log.
- Use the menu selections under **Aux Data Settings** to set various expected data parameters.

General information

Screen resolution Web interface operation is optimized for screen resolutions of 1024 x 768 or higher. Operation on computers with lower resolution has not been verified.

Multiple clients The instrument supports up to three remote clients simultaneously. The remote display update rate decreases with multiple clients.

Screen capture The screen capture for a remote display can be corrupted if the settings are changed on the remote instrument while the screen capture is in process. The result is a capture that is a mix of the settings before and after the change was made. This only effects a screen capture in progress when the change is made. Subsequent captures, taken when no setting changes are occurring, will be correct.

Web interface and SNMP command conflicts If you run the Web interface and at the same time send a very high rate of SNMP commands, then the Web interface may not always display the true state of the instrument. Usually the Web application will recover with a few seconds of break in the SNMP command stream. In extreme cases, you may fill up the allowed memory on the PC running the Web applet or application and have to stop and restart the Web program to recover.

Application examples

- **Timing a studio:** This section contains three different procedures for timing a studio.

Your instrument supports multiple methods and techniques for timing a studio, all of which require an external reference to your instrument. Timing a studio involves adjusting the references going to different sources so that their output feeds have the same timing when they arrive at a common point, such as a production switcher. For digital systems, timing typically must be close, but not exact, because most switchers have some tolerance for timing errors. For analog composite systems, the timing may need to be matched within a small part of a subcarrier cycle to prevent hue shifts when switching between sources.

- **Troubleshooting cable problems:** This section contains a procedure for troubleshooting cable problems.

You can use this instrument to generate a test signal that you can route through your studio and back to the instrument to troubleshoot problems with signal cables.

Timing a Studio: Using the traditional method

Your instrument makes the traditional method of comparing Horizontal and Vertical timing easier by providing flexible tiles and a Freeze function. To time a studio using the traditional method, you store an input as a baseline and compare signals that you time against the baseline.

1. Select a tile in which to time the active input. Select **WFM**.
2. Apply the first input signal to the appropriate input, terminate it properly, and select it.
3. Push and hold the **WFM** button. From the **Display Mode** submenu, select a display mode that is appropriate to the signal that you input.
4. Apply the house reference signal to the external reference input, terminating it properly.
5. Press the **EXT REF** button to select External Reference mode. (Connected to the house reference.)
6. Put the selected tile in line mode Using the **SWEEP** button menu.
7. Use the **HORIZONTAL** knob to center the sync edge or the SAV pulse. (If using the SAV pulse, turn off Stripping EAV/SAV/ANC in the SDI Input setting of the Configuration Menu.)
8. Press the **MAG** button to increase the timing resolution.
9. Activate another waveform display in a second tile.
10. Press and hold the **SWEEP** button and select **FIELD** to put the display in field mode.

11. Use the **HORIZONTAL** knob to center the vertical interval.
12. Press the **MAG** button to increase the timing resolution.
13. Press the **CAPTURE** button to save the waveform as a baseline.
14. Apply an input that must match timing of the first input.
15. Adjust the timing offset of the signal being timed to match the timing to the saved baseline.
16. Repeat steps 14 and 15 for any other required signals.

NOTE. Use the Cursors as markers or to measure timing differences between sources.

Other tiles can be used to set fine timing and check color frame alignment on composite signals. Alternatively, the other two tiles could be used for line and field rate displays without Mag active to show the location of significantly mistimed signals.

Timing a Studio: Using the timing display method

The Tektronix Timing Display provides a quick, easy way to measure the timing of an input relative to the external reference:

- The rectangular display automatically scales to match the input signal. For progressive signals, the display represents one field; for interlace signals, the display represents one frame; and for composite inputs, the display represents one color frame.
- The cross-hair in the center represents zero offset, and the circle represents the timing of the input signal. Lines of advance or delay are shown as vertical displacement, while timing errors of less than one line are shown as horizontal displacement. If the input is at the same time as the reference, then the circle will be centered on the cross-hair.
- The timing offset is also shown numerically as lines and micro-seconds of advance or delay in the boxes at the right side of the display.
- For input and reference signals with closely related frame rates, there is only one timing relationship, so a single circle is shown on the display to indicate the timing offset of the input signal.

- For input and reference combinations with more complex relationships, multiple circles are displayed to indicate all the possible interpretations of the timing offset, with the one that is closest to zero shown with emphasis. The numerical readouts will correspond to the timing indicator circle with the emphasis.
- The **Relative to:** box indicates the chosen zero point for the timing display. The default is Rear Panel. In this mode, the offset is zero when the input and reference are at the same timing at the rear panel of your instrument. The other choice is Saved Offset. In this mode, you can save the timing from one signal and then display the timing relative to that saved offset.

**To use the timing display
to time a signal to a
reference**

1. Select a tile in which to time the active input.
2. Apply the input signal to be timed to the appropriate input, terminate it properly and select it.
3. Apply the house reference signal to the external reference input, terminating it properly.
4. Press the **EXT REF** button to select External Reference mode.
5. Press the **MEAS** button to select the Timing display for the tile selected in step 1.
6. If only one circle is displayed, adjust the timing offset of the black generator to match the timing to the external reference. Adjust for a perfect coincidence of the circle around the reference target (circle turns green at coincidence) and null values of the vertical and horizontal timing readouts.
7. If multiple circles are displayed, the timing is complex, and you must choose the one you want. The measurement that is closest to zero offset is displayed with emphasis and appears in the readouts.

NOTE. See *Timing Displays for Simple Versus Complex Timing for more information about complex timing displays and their elements.*

8. Repeat step 6 or 7 for any other signals.

NOTE. As you adjust timing, the circle representing the input timing may jump occasionally. This is because the color frame detection circuit can be temporarily disrupted as the signal shifts. The jump is often a multiple of the field time. The circle will settle back to the correct location in a second or so.

Timing a Studio: Timing multiple inputs to a router

Use the **Relative to:** function to set the offset between a master signal and a reference signal as the zero-point reference for time-down applications. The **Relative to:** box indicates the chosen zero point for the timing display:

- **Rear Panel.** In this mode (default), the offset is zero when the measured signal input and reference are at the same timing at the reference at the instrument rear panel. This setting was used in the Timing Display Method procedure.
- **Saved Offset.** In this mode, you can save the timing from a master signal relative to the reference as the zero point offset. Then route other inputs and measure relative to this saved offset.

To time the inputs to a router

1. Perform steps 1 through 5 of the previous procedure.
2. Route the signal you want as the master to the appropriate input, SDI or Composite, and terminate properly.
3. Route the reference signal to the reference input and terminate appropriately.
4. Save the timing offset for the master input (**MEAS > Save Offset > SEL**) and select the **Relative to: Saved Offset** mode from the pop-up menu.

NOTE. You cannot save the timing offset if either the input or reference is missing or unlocked. You also cannot save a reference when in internal mode. Saving an offset in these conditions would lead to misleading results so it is not allowed by the instrument. A warning message will appear on the screen if you attempt to save the offset when it is not allowed.

5. Now select other inputs to the router to be connected to the instrument. For each input, the relative timing will be displayed.
6. Adjust the timing offset at the master sync source to time down the inputs to the router to match the master.

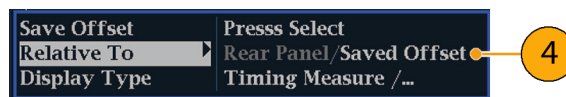

Usage notes

- The resolution of the timing display for SD signals is one 27 MHz clock cycle or 37 ns. For HD signals, it is one clock at 74.25 MHz, which equates to about 13.5 ns. To get the greater accuracy needed for a composite signal, first use the timing display to get close, then use a vector display for the final burst phase alignment. Since the instrument can display both the timing display and a vector display simultaneously (each in its own tile), this process can still be easy and quick.
- For an SDI input relative to an analog reference, the situation is more complex. For the timing display, three definitions of “zero offset” on an SDI input are supported, Analog (DAC) and Serial (0H) and Saved Offset.

The **Analog (DAC)** setting uses the methodology illustrated in appendix B of SMPTE RP168. This method shows the SDI signal being converted to analog. The converted analog signal is then compared to the analog reference. For this mode the nominal delay of the D to A converter is assumed to be 4.6 microseconds for SD, 1.3 μ s for HD and 0.0 μ s for 3 Gb. The 0.0 μ s delay for 3 Gb means the Analog (DAC) and Serial (0H) modes are equivalent for 3 Gb signals.

The **Serial (0H)** setting, uses the methodology implied in appendix A of SMPTE RP168. In this mode timing is considered to be zero when the 0H sample of the serial stream aligns with the reference edge of the analog sync. Note that this timing is actually at the scrambled interface which is slightly different than timing to the parallel data into the serializer or the parallel data out of the deserializer due to delays in those functions.

- In the **Relative to: Rear Panel** mode, this 3 μ s conversion delay is removed from the measured offset before the display is generated. In the **Relative to: Saved Offset** mode, it has no effect.

In the **Relative to: Saved Offset** mode, the timing of one signal is “saved” and then that becomes “zero” for subsequent measurements. This removes any need for a specific definition of zero timing, since the display shows the difference in timing between the initial and current signals.

- This timing relationship between input and reference is also compatible with the waveform mode. That is, if you have zero timing on the Timing display and change from internal to external reference, the displayed waveform will not shift position.
- You can use the External Reference Waveform display to troubleshoot problems with the reference signal. See [External Reference Waveform display](#) on page 92.

NOTE. *If you have an input and reference combination that requires multiple timing indicator circles, then it can be misleading to compare timing offsets between multiple inputs. Because the timing display chooses the smallest of the possible timing offsets, if a large timing difference exists between two inputs, then they may not be matched. This problem also occurs using traditional timing methods unless you use something similar to the SMPTE318 10 field flag to identify a specific sub-multiple of the reference.*

Troubleshooting cable problems

You can use this instrument to generate a test signal that you can route through your studio and back to the instrument to troubleshoot problems with signal cables. The following procedure tests both SD and HD signals.

1. Press and hold the **GEN** button, and then use the arrow keys to set the **Display Type** selection to **Generator Status**.
2. Use the arrow keys to set the following signal characteristics:
 - Set the **SDI Output** selection to **Test Signal**.
 - Set the **Signal Pattern** selection to the desired test signal type.
 - Set the **Signal Level** selection to **Level A**.
 - Set the **Signal Format** selection to **SD SDI 525i**.
3. Connect the SDI output from the instrument directly to one of the SDI inputs on the instrument (SDI A or SDI B).
4. Press and hold the **STATUS** button, and then use the arrow keys to set the **Display Type** selection to **Video Session**.
5. In the Video Session display:
 - a. Press the **SEL** button to reset the video session display.
 - b. Verify that the signal format matches the format that you selected for the SDI output signal.
 - c. Make a note of the displayed values for the **F1 AP CRC** and **F2 AP CRC** entries. The CRC values depend on which test signal you selected to output from the instrument.
6. Connect the SDI output of the instrument to an input link in your video system.
7. Connect the output of your router or patch panel to one of the SDI input connectors on the instrument (SDI A or SDI B).
8. In the Video Session display:
 - Verify that the signal format matches the format that you selected for the SD-SDI output signal.
 - Verify that the displayed values for the **F1 AP CRC** and **F2 AP CRC** entries are the same as you noted in step 5.
 - Verify that no CRC errors are reported, which indicates an error free transmission of the signal through the system.
9. Press and hold the **GEN** button, and then use the arrow keys to set the **Signal Format** selection to one of the 720p, 1080i, or 1080p formats.
10. Press the **STATUS** button to return to the Video Session display.
11. Press the **SEL** button to reset the Video Session display.

12. For one minute, check the following In the Video Session display:
 - Verify that the signal format matches the format that you selected for the HD-SDI output signal.
 - Verify that **OK** is displayed as the status for the **Y Chan CRC Error** and **C Chan CRC Error** statistics.
 - Verify that the **Err Secs** readouts for the **Y Chan CRC Error** and **C Chan CRC Error** statistics are not increasing each second. If the Err Secs value(s) are increasing each second, then you are approaching the digital cliff where errors will occur.
13. Repeat steps 1 through 12 to test SD and HD signals through each input link to your video system.

Index

A

- AC adapter, 7
- Accessories
 - optional, 5
- AES Channel Status display, 109
- AES signal
 - MULTI IN input, 41
- AFD
 - monitoring for compliance, 236
- Alarm
 - allowed responses, 166
- Alarm descriptions, 169
- Alarm Status display, 110
- Alarms
 - categories of, 166
 - configuring and using, 166
 - general, 166
 - remote monitoring of, 169
 - status display, 169
 - to monitor, 169
 - using, 166
- ANC (Ancillary) Data
 - display, 48
- ANC Data Inspector, 48
- Applications
 - checking Chroma/Luma delay, 199
 - timing a studio, 241
- ARIB Status display, 208
- ARIB STD-B.35 display, 213
- ARIB STD-B.37 display, 211
- ARIB STD-B.39 display, 209
- ARIB TR-B.22 display, 218
- ARIB TR-B.23 (1) display, 215, 216
- Arrowhead display
 - composite gamut, 205
 - gamut pop-up menu, 53
- ASI input, 41
- ASI stream types, 57
- Audio
 - Above-bar warnings, 60
 - AUDIO button, 48, 59
 - checking surround sound, 227
 - configuring and monitoring, 221
 - configuring inputs
 - for embedded 16-channel audio
 - for embedded 16-channel audio, 225
 - display, 59
 - displaying an input, 222
 - In-bar warnings, 60
 - pop-up menu, 61
- Audio Control Packet
 - display, 112
 - packet format and structure, 112
- Audio Generator Status
 - display, 65
- Audio input
 - allow alarms for, 221
 - configure for pairs or surround, 221
 - displaying, 222
 - map bars to input, 221
- Audio level
 - checking, 166, 221, 222, 227
- Audio phase
 - checking, 222
- Audio Session display, 115
- Auxiliary Data Status display, 118
- AV Delay Measurement
 - display, 78

B

- Bar Targets
 - Vector pop-up menu, 100, 142
- Basic operation, 47
- Battery, 8
- Battery low indicator, 40
- Battery pack
 - charge level indicators, 14
 - installation, 10
- Black events, 134
- Bowtie
 - center waveform, 82
- Bowtie display, 81

C

- Cable loss measurements, 197
- Cable problems
 - troubleshooting, 246
- Calibration
 - service options, 6
- Center on
 - Vector pop-up menu, 142
- Center waveform
 - Measure pop-up menu, 82
 - Waveform pop-up menu, 93, 102, 150
- Center Waveform
 - Vector pop-up menu, 100
- Checking surround sound
 - task description, 227
- Chroma/Luma delay, 199
- Closed captioning
 - configuring and monitoring, 231
- Composite gamut
 - diamond display, 205
- Cursors
 - measurement, 156

D

- Detected ASI stream types, 57
- Diamond
 - gamut pop-up menu, 91
- Diamond display
 - checking RGB gamut, 202
 - construction of the diamond graticule, 202
- Display
 - how to control, 33
 - status bar icons, 40
- Display modes, 47
- Displaying an audio input, 222
- Displays
 - how to select, 32
- Documentation
 - purposes of, xv
- Dominance indicator
 - Audio pop-up menu, 63
 - how to display, 227
- Dual Link signals, 42

E

- EAV and SAV
 - finding in the active video stream, 85

- Error Log
 - elements of the display, 124
- Error Log display, 123
- Errors
 - status indicators, 38
- External Reference Waveform
 - center waveform, 93
- External Reference Waveform display, 92
- Eye measurements, 190

F

- Factory preset recall, 163
- Filter
 - Waveform pop-up menu, 150
- Flat
 - Waveform pop-up menu, 150
- Follows video
 - Audio pop-up menu, 62
- Front-panel controls
 - layout and index to usage procedures, 28
 - scope of, 27
- Frozen events, 134

G

- gamut
 - diamond display, 202
- Gamut
 - arrowhead display, 205
 - Arrowhead display, 51
 - button, 51, 90, 106
 - checking, 201
 - Diamond display, 90
 - pop-up menu, 53, 91, 107
 - Split Diamond display, 106
- Gamut display
 - checking RGB gamut, 202
 - composite arrowhead display, 205
- Gamut thresholds
 - adjusting, 201
- Genlock
 - external reference signal, 42, 45
 - SDI video output, 44
 - Status Bar icon, 38

H

- Headphone volume
 - adjusting, 160
- How to
 - adjust audio volume, 64
 - check surround sound, 227
 - configure and enable SNMP control, 22
 - connect to a network, 20
 - control the display, 33
 - determine status, 38
 - enable the Web remote interface, 22
 - find more information, xv
 - monitor alarms, 169
 - monitor closed captioning, 231
 - monitor embedded 16-channel audio, 225
 - set the Web password, 22
 - time a studio, 241
 - use online help, 31

I

- Incoming inspection, 24
- Infinite persistence, 2, 29
- Information
 - where to find more, xv
- Inputs
 - selecting, 43
- Inspection
 - incoming, 24
- Installation
 - battery pack, 10
 - power cord, 8
 - power requirements, 7
 - power-on and power-off procedures, 12
- Instrument displays, 47
- Instrument options
 - checking installed, 4
- IP settings, 20

J

- Jitter measurements, 194

L

- Lightning
 - display, 98
 - Vector pop-up menu, 100, 142

- Lightning display, 199
- Limits
 - gamut, 201
- Lissajous Snd Stage
 - Audio pop-up menu, 63
- Lissajous sound stage
 - phase style, 224
- LTC signal
 - MULTI IN input, 41
- LTC Waveform
 - center waveform, 102
- LTC Waveform display, 101
- Luma
 - Waveform pop-up menu, 150
- Luma/Chroma delay, 199

M

- Measure
 - pop-up menu, 137
- Measurement
 - Relative to:, 138
 - save offset, 137
- Measurement cursors, 156
- Monitoring Audio
 - task description, 221
- Monitoring CC and safe area compliance
 - task description, 231
- Moving picture, 147
- MULTI IN input, 41

N

- Network
 - connect to, 20
 - IP settings, 20
 - SNMP settings, 22
- Network software upgrade, 182

O

- Online help
 - how to use, 31
- Operation
 - basic, 47
 - control levels (types), 27
 - verification, 24

Options

- accessories, 5
- checking installed, 4
- power cord, 5
- service, 6

Overlay

- Waveform pop-up menu, 149

Overlay mode (TandemVu®), 29

P

Parade

- Waveform pop-up menu, 149

Phase (audio)

- correlation meter response times, 224

Phase Display

- Audio pop-up menu, 63

Phase Pair

- Audio pop-up menu, 63

Phase Style

- Audio pop-up menu, 63

Physical Layer

- configuring and monitoring, 187

Picture display, 103

Pop-up menus

- Audio, 61
- External Reference Waveform, 93
- gamut, 53, 91, 107
- LTC Waveform, 102
- Measure, 137
- Vector, 100, 142
- Waveform, 149

Power

- AC adapter, 7
- battery, 8
- how to turn off, 13
- how to turn on, 12

Power cord

- options, 5

Presets

- exporting, 164
- factory, 163
- importing, 165
- recalling, 163
- saving, 162
- using the USB for, 165

Q

Quad Tile

- defined, 2

R

Recalling presets, 163

Reference signals

- genlock, 42

Relative to:

- Measure pop-up menu, 138

Remote Web interface, 237

Repackaging for shipment, 25

Repair

- service options, 6

RGB

- Waveform pop-up menu, 150

RGB gamut

- diamond display, 202

S

Safe area

- monitor for compliance, 234

SAV and EAV

- finding in the active video stream, 85

Save

- Measure pop-up menu, 137

Save display to USB, 29

Saving presets, 162

Screen shot of display

- save to USB, 29

SDI > Composite

- Waveform pop-up menu, 150

SDI signal

- MULTI IN input, 41

SDI Status display, 128

SDI/ASI Status display, 129

Selecting a display, 32

Service

- options, 6

SFP

- connecting a signal, 46

SFP Status

- elements of the display, 127

SFP Status display

- STATUS button, 126
- Signal generator, 44
- SNMP control settings, 22
- Software upgrades
 - Network procedure, 182
 - USB device procedure, 181
- Split Diamond
 - gamut pop-up menu, 107
- Split Diamond display, 106, 201
- Status
 - determining, 38
 - display, 108, 123
 - STATUS button, 108, 123
- Status bar, 38
- Surround sound
 - displaying and checking, 227
 - signal display examples, 229
- SW Upgrades
 - troubleshooting, 185

T

- TandemVu® (Overlay), 29
- Teletext, 231
- Tile
 - mode, how to enter, 33
 - to select a, 33
- Tile select mode, 29
- Timing
 - Chroma/Luma delay, 199
- Timing a studio
 - task description, 241
 - timing display method, 242
- Timing display, 136, 242
- Timing Measure
 - display, 136
 - MEAS button, 136
- Troubleshooting
 - cable problems, 246

U

- Upgrading software, 179
- USB
 - save display to, 29
- USB device software upgrade, 181

V

- Vector
 - display, 140, 199
 - pop-up menu, 100, 142
 - VECTOR button, 140
- Vector pop-up menu
 - Bar Targets, 100, 142
 - Center on, 142
 - Center Waveform, 100
- Verification
 - basic functional, 24
- Video Generator Status
 - display, 144
- Video Session display, 131
- Volume
 - adjusting, 160

W

- Warnings
 - Above level bars, 60
 - in level bars, 60
- Waveform
 - center waveform, 150
 - display, 148
 - Filter, 150
 - Filter:Flat, 150
 - Filter:Low Pass, 150
 - Filter:Luma, 150
 - overlay, 149
 - parade, 149
 - pop-up menu, 93, 102, 149
 - RGB, 150
 - SDI > Composite, 150
 - WFM button, 148
 - YPbPr, 150
 - YRGB, 150
- Web interface, 237

X

- X-Y
 - Audio pop-up menu, 63
 - phase style, 224

Y

YPbPr

Waveform pop-up menu, 150

YRGB

Waveform pop-up menu, 150